

**AMERICAS OLDEST AND LARGEST CB MAGAZINE**

Since 1962 nearly 20,000,000 copies sold!

**CB RADIO**

**\$9**

DECEMBER  
1976

**\$2.00**

**7**  
pages of  
**CB**  
Newswire

D 08818

**Professor Tomcat's Guide To Talkin' That CB Lingo**

**Distance Deluxe**

**The Big Skip**

**Sure-Fire TVI Cure**

**Anatomy Of  
A Scanner**

**14 big  
monthly features**

**THE  
OFFICIAL  
CB RADIO  
Magazine**

**Dozens Of New CB Products**

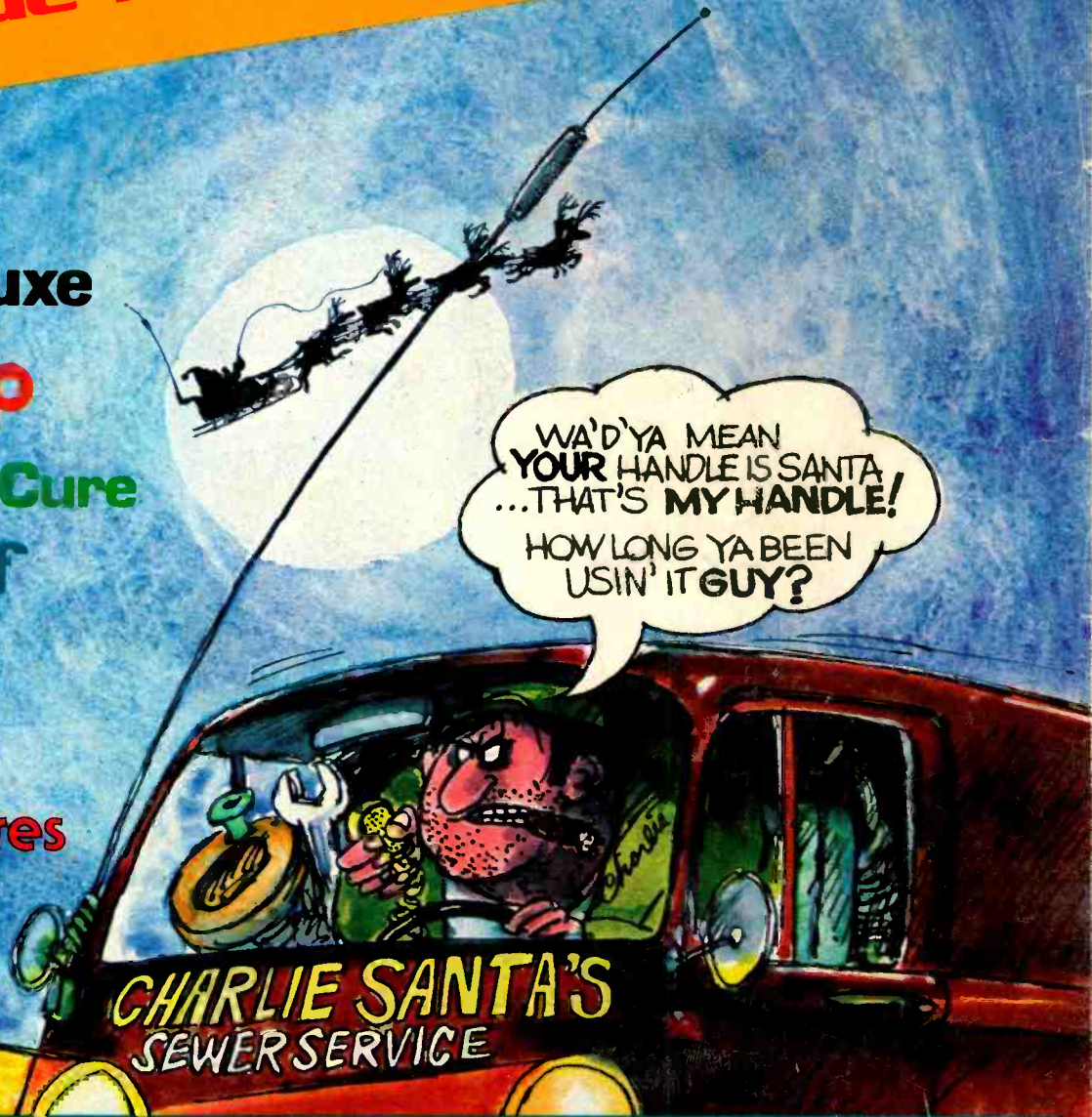



# Our tough new CB's are too tough for the competition.



550



650



750



950



ComPhone™ 23A

A CB mobile has to be tough to give the kind of performance you expect from it day after day and mile after grueling mile.

Anyone who knows CB will tell you Lafayette mobiles perform. And our new models are just as tough. Check our specs. They'll tell you you're getting a tough performer.

You'll be getting a choice of features too. From performance features like digital-phase-lock-loop crystals synthesis, Range-Boost and quiet operation packages to convenience features like local/distance switches, separate PA controls, handset mike and speaker on the Com-Phone™ 23A, and variable tone controls. You'll get just the CB mobile that fits your demands without demanding too much from your budget.

We also protect your budget with our strong product warranties, in-store repairs and our own CB experts.

You'll find all this waiting for you at the Lafayette stores and dealers coast to coast.

Buy a Lafayette mobile, it's the easy way to know you're getting a tough CB.

Specifications	550	650	750	950	ComPhone™ 23A
Sensitivity at 10 dB S/N	0.5mV	0.7mV	0.7mV	0.7mV	0.7mV
Selectivity at 10KHz	60dB	45dB	45dB	45dB	45dB
Aud. Power output to external speaker	2.5 watts	3.0 watts	3.0 watts	3.0 watts	3.0 watts
RF Power output	4 watts	4 watts	4 watts	4 watts	4 watts
Noise Limiter Circuitry	Yes	Yes	Yes	Yes	Yes
S/PRF Meter	Yes	Yes	Yes	Yes	Yes
PA CB Modes	Yes	Yes	Yes	Yes	Yes
Price	\$99.95	\$129.95	\$169.95	\$199.95	\$189.95

All models surpass D.O.C. & F.C.C. Transmitter RF spurious and harmonic attenuation requirements.

# Lafayette

There is no competition.



TELSAT SSB-100

# Advanced SSB performance second to none.

Lafayette's new SSB line has set new standards for SSB performance.

Compare our specs with anyone else. Our 100% solid state electronics, quiet operation packages and our advanced receivers plus full-power transmitters with Range-Boost put us out ahead.

Our features are advanced as well. The Lafayette SSB line has features like crystal lattice filters, easy controls for switching from AM to upper and lower sidebands and product detectors for clear reception in the SSB mode.

Another Lafayette advance is our product warranty, in-store repair program and our own CB experts. Find them and the new SSB line at any of the Lafayette dealers and Lafayette stores coast to coast.

SSB is the most advanced CB on the market today. And Lafayette's new SSB line gives the most advanced performance. Period.

	TELSAT SSB-100 base station transceiver	TELSAT SSB-75 mobile transceiver	TELSAT SSB-50A mobile transceiver
SENSITIVITY AM/SSB at 10 dB S/N	1.0mV/0.25mV	1.0mV/0.25mV	1.0mV/0.25mV
SELECTIVITY at $\pm 10$ kHz	90dB	90dB	90dB
AUDIO POWER OUTPUT to external speaker	3 watts	3 watts	3 watts
RF POWER OUTPUT AM/SSB P.E.P.	4 watts/ 12 watts P.E.P.	4 watts/ 12 watts P.E.P.	4 watts/ 12 watts P.E.P.
NOISE LIMITING CIRCUITRY	yes	yes	yes
S/PRF METER	yes	yes	yes
PA/CB MODES	yes	no	yes
SPECIAL FEATURES:	Fine Tuning Noise Blanker RF/SWR, S/MOD meters	Fine Tuning	Fine Tuning Noise Blanker
PRICE	\$349.95	\$249.95	\$329.95

All models surpass FCC and D.O.C. requirements for spurious response and harmonic attenuation.



TELSAT SSB-75



TELSAT SSB-50A

# Lafayette

There is no competition.

For more information and a free catalog please write: Lafayette Radio Electronics, Box 153, 111 Jericho Tpke., Syosset, N.Y. 11791  
Copyright 1976 Lafayette Radio Electronics



Mura, now we hear you above all the others; better than ever before. Your voice sounds amazingly crisp and clear. Without garble and without audio breakup. We copy your beautiful voice coming through the revolutionary new Model PRX-100 technologically advanced PRM™ microphones, designed to carry your voice further than the others.

Here is what the PRM offers. Unlike other power microphones which just amplify your voice, PRM (peak redistribution modulation) tailors your voice signal to give the highest

average modulation without clipping and over-modulation. PRM circuitry, patented\* and exclusive to Mura, reshapes unsymmetric voice peaks to assure high modulation density without peak overload.

For full information on the exciting PRM™ line of microphones and other outstanding Mura products, visit your nearest CB outlet today. Ask him for Mura — to be sure that you are getting the finest accessories available. Or write to us directly.

\*U.S. Patent No. 3,050,339 and Foreign Patents

# Mura, we read you. Loud and clear.



**M MURA**  
CORPORATION  
177 Cantiague Rock Road,  
Westbury, N.Y. 11590



# HIT THE ROAD WITH THE AUTOMATIC CB. JOHNSON.

You've got four hundred miles of dotted white line stretched out in front of you. And a couple of dozen tons riding in back.

That's why you keep the automatic CB sitting at your side. No hassle, no gadget controls, just the crisp, clean Johnson sound all day long. Automatically.

Johnson's exclusive voice tailored circuitry automatically drops off unwanted frequencies to give you clear



reception. Our automatic noise limiter keeps reception clean and built-in gain control prevents "blasting" and "fading."

Johnson's unique electronic speech compression automatically selects and compresses the clearest voice frequencies to produce

uniform, high-level modulation and maximum transmit range. All automatically.

When you hit the road, go with Johnson CB. We back every Johnson with a full year parts and labor warranty and walk-in service at more than 850 locations. See a Johnson CB dealer and take off on the great American adventure.



## JOHNSON

E. F. JOHNSON COMPANY, WASECA, MINN. 56092  
In Canada: A. C. Simmonds & Sons, Ltd.

**JOHNSON CB. THE GREAT AMERICAN ADVENTURE.**



Experience is the best teacher. You might settle for any CB first time around. Understandably. A lot of people think they're all pretty much alike. But you'll soon discover that, like everything else, there are exceptions.

Ask the pros. America's long distance truckers. These guys talk CB day in and day out. And they demand the best. That's why truckers refer to the Cobra 29 as "The Diesel Mobile."

Listen to Cobra. You'll hear a big difference. Because the Cobra 29 gives you features which assure crystal clear reception. Like switchable noise limiting and blanking, to cut out practically all pulse and ignition interference. Add squelch control and RF gain and you've got exceptional — adjustable — receiver clarity. Even in the heaviest CB traffic. You also get Delta Tuning which makes up for the other guy, because even off-frequency transmitters are pulled in. Perfectly.

Talk to Cobra. And you know you're punching through. One glance at the

29's over-sized illuminated meter tells you just how much power you're punching out and pulling in. For voice modulation the DynaMike delivers at 100%. Same way with power: The 29 transmits at maximum power levels.

Sooner or later you'll get a Cobra. And you'll get engineering and craftsmanship second to none. Performance that will make your first CB seem obsolete. Reliability and durability that have set standards for the industry. Above all, you'll get power. The power to punch through loud and clear like nothing else. Because when it comes to CB radio, nothing punches through loud and clear like a Cobra.



Punches through loud and clear.

Cobra Communications Products  
DYNASCAN CORPORATION  
6460 W. Cortland St., Chicago, Illinois 60635

# IF YOUR FIRST CB ISN'T A COBRA YOUR SECOND ONE WILL BE.







14 Vanderventer Avenue  
Port Washington, N.Y. 11050

America's Oldest & Largest CB Magazine

VOL. 16, NO. 12 December, 1976

OUR COVER: A hearty laugh and a "Hi-Yo Santa" from the lone stranger breaking through on all channels. Give Santa a break — good will to all! Cover illustration by John Kane.

### Table of Contents

- CB NEWSWIRE ..... 10
- PROFESSOR TOMCAT'S GUIDE TO TALKING THAT CB LINGO,  
    Sound Like An Old Timer ..... 26
- THE BIG SKIP ..... 32
- ON THE COUNTERS ..... 35
- DISTANCE DELUXE ..... 52
- TOMCATTIN' WITH TOMCAT ..... 58
- BILL ORR ON ANTENNAS, PART 10: The "102 Whip" ..... 63
- BREAK ... LOWER SIDE ..... 68
- TOMCAT'S PRODUCT REPORT ..... 72
- ANATOMY OF A SCANNER, PART 1: Scanner Receivers ..... 76
- FCC APPLICATION ..... 83
- SET, HIKE AND 10-4! ..... 86
- THE SAGITTARIUS CB PERSONALITY ..... 93
- COMING EVENTS ..... 95
- TOMCAT'S SURE FIRE TVI CURE ..... 96
- BASIC RADIO, PART 10: Electromagnetism and Magnetic Units . . 102
- WASHINGTON OUTLOOK ..... 112
- CB RADIO'S NUTS & BOLTS DICTIONARY ..... 121
- 6 CB IDEAS. .... 138
- CB USAGE TIPS FROM S9. .... 141
- FOREIGN QSL CARDS ..... 142
- TEMPORARY PERMIT ..... 147
- DX KORNER. .... 149
- THE MONITOR POST. .... 153
- CLASSIFIED ADS ..... 156

CB RADIO/S9 (Title registered U.S. Post Office) is published monthly by Cowan Publishing Corp. Executive editorial and advertising offices at 14 Vanderventer Ave., Port Washington, L.I., N.Y. 11050. Telephone: (516) 883-6200. Subscription Rates: One Year \$12.00, Two Years \$20.00, in the United States and Possessions, APO, FPO. Canadian and foreign rates: One Year \$13.00, Two Years \$22.00. Printed in U.S.A. Entire contents copyright 1976 by Cowan Publishing Corp. No portion of this magazine may be reproduced for any purpose whatsoever without the express written permission of the publisher. CB RADIO/S9 does not acknowledge or return unsolicited material. We regard all material sent to us by and about CB clubs or organizations (whether in club bulletins or otherwise), and from manufacturers or distributors of commercial products, as being submitted for publication as a public relations or publicity gesture. While we pay for stories and articles specifically written for our exclusive use and accepted for publication, we do not pay for any public relations or publicity material which we publish. Stories or articles sent by Registered or Certified Mail are not accepted. All circuits, designs and construction projects in CB RADIO/S9 are strictly experimental and we do not guarantee the results which can be expected from their use or application.

Controlled Circulation Postage Paid at Glasgow, KY and Port Washington, NY

SEND FORM 3579 TO: CB RADIO/S9  
14 Vanderventer Ave., Port Washington, L.I., N.Y. 11050

# Service with a Smile

**That's What You Can Expect  
When You Deal With  
Sandro's - The LARGEST  
Distributor on Long Island.**

---

**Factory Distribution Center  
for these major brands:**

- \* Mura \* Sharp \* Courier \*
- \* Turner \* Gold Line \* Astatic \*
- \* Regency \* Shakespeare \* Hy Gain \*
- \* Johnson \* SBE \* Vancor \*
- \* Pace \* Antenna Specialists \* Pride \*
- \* Robyn \* Royce \* Antenna Inc. \*
- \* Amphenol \* Valor \* RMS \*

You can also call us for your  
hi-fi, tv appliance  
and tape recorder needs.

---

## SANDRO'S ELECTRONICS INC.

1559 BRENTWOOD ROAD  
BAYSHORE, N.Y. 11706

(516) 666-4434

Send \$3.00 for Dealer Catalog—  
refundable with first purchase.







**CB RADIO**

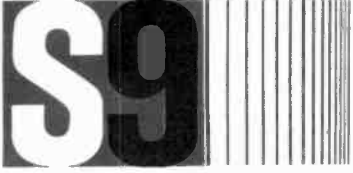

**EDITORIAL STAFF**

*editor*

TOM KNEITEL, KEZ5173

*contributing editors*

DON JENSEN

RICK MASLAU, KNY2GL

GARY DECKELNICK, KCS0994

**BUSINESS STAFF**

*chairman of the board*

S. R. COWAN, KCV7359

*president and publisher*

RICHARD A. COWAN, KGB4096

*associate publisher*

RICHARD A. ROSS

*adv. representatives*

RICHARD A. COWAN

JACK N. SCHNEIDER

*circulation manager*

GLORIA FORSYTH

*circulation assistant*

NANCY GOLD

*production manager*

KAREN FUSCO, KSI0167

*production assistant*

LORI RESSA, KBH2503

*production consultant*

CARY L. COWAN, KZR4375

*classified ad manager*

EILEEN LUCEY

*art director*

WILLIAM H. TRAVIS

*art staff*

LIZ BEENER

SHERYL STERN

HAROLD PERRY

*director of public relations*

MARC GILMAN, KSU7373

*controller*

CARY L. COWAN, KZR4375

*west coast adv. rep.*

BILL SLAPIN & CO.

16200 Ventura Blvd., Suite 209

Encino, CA 91436 (213) 995-0257



# GET HIGH ON A FULL SIGNAL GET A TRI-EX 37-TC

When you're at least a full wavelength above the ground—your signal's got to be full!

Tri-Ex's 37-TC tower will put you up there. Comes with base tilt and mounting plate, mounting stub for rotator. All steel. Cranks up from an easy-to-reach nesting of 21-feet to a high 40-feet counting your rotator and antenna.

So, whether you're an "ace" or an "apple," insider's jargon for an important CB'er or CB addict, at every "Moth Ball" (Annual CB Convention), there's going to be talk about Tri-Ex's super 37-TC tower.

If you're really serious, now's the time to act. Call or see your dealer today. And put 4 sq. ft. of antenna up there on your 37-TC. At this low price.

## \$219.



**Tri-Ex<sup>®</sup>**  
**TOWER CORPORATION**  
7182 Rasmussen Ave. Visalia, Calif. 93277

## ORIGINAL HUSTLER



Get base station reports from your mobile with this 74" original Hustler antenna.

**Model CB-111**—fender or deck location

**Model CB-211**—bumper mount location



# First and with CB

**WITH HUSTLER ANTENNAS YOU BUY FOR THE FUTURE! GET TOTAL 40 CHANNEL COVERAGE PLUS MORE!**

From the original Hustler of 1961 to the newest CB-AM/FM design, get superior 40 channel coverage plus reserve for future channel expansion.

**HUSTLER ANTENNA PRODUCTS**—for sixteen years—original designs—created and manufactured by American ingenuity, labor and materials—used by communicators throughout the world.

Hustler designs are patented under one or more of the following assigned to New-Tronics Corporation 3287732, 3513472, 3419869, 3873985, 3327311, 3599214, 3582951.

Graphs shown with each antenna are plotted from actual mobile installations and illustrate the ratio of forward to reflected voltage (VSWR) over a total of seventy (70) channels.

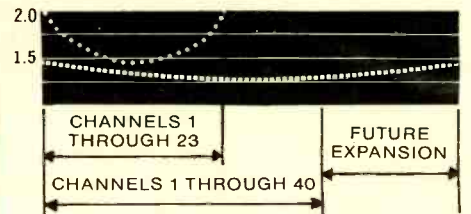

..... average antenna with limited channel use.  
 — antenna with total channel coverage.

## TRUCK & RV's

Hi-Q" Twin Huskies for rugged performance. Dual 51" antenna system attaches to all West Coast style mirrors.

**Model HTM-1**

Single Husky with mirror mount

**Model HSM-1**

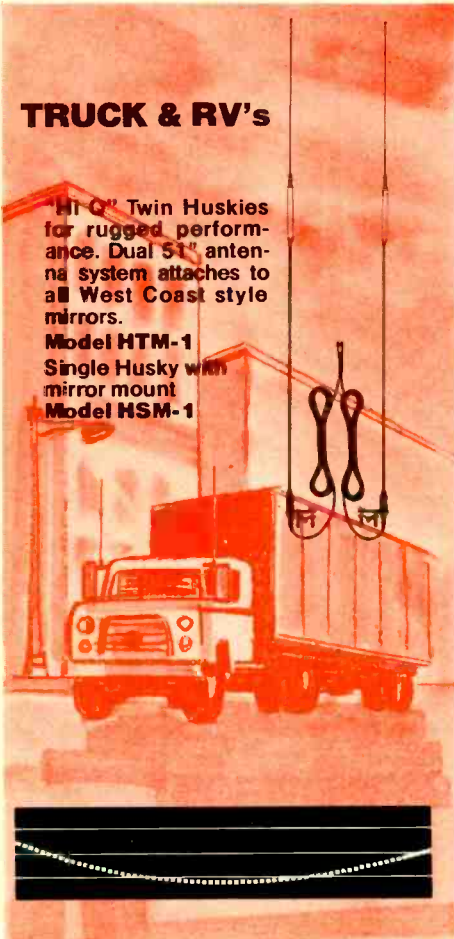

## DELUXE MOBILES

Choose from four versions of this popular 48" antenna for trunk lip or roof/deck mounting location.

Trunk lip mount

**Models XBLT-3, XBLT-4**

Roof/deck mount

**Models XBL-3, XBL-4**



## CB-AM/FM

Get combined Citizens-band two way and entertainment radio performance with this deluxe 48" trunk lip mount antenna, **Model HLM-27Z**





# Foremost TOTAL Coverage!

"the home of originals"



Available from  
all distributors  
who recognize the best.

**new-tronics  
corporation**

15800 Commerce Park Drive  
Brookpark, Ohio 44142  
(216) 267-3150

Exporter: Roburn Agencies, Inc., New York, N. Y.

## ULTRA PERFORMANCE

Custom assemble your Hustler for the ultimate in mechanical and electrical performance — lowest SWR, outstanding signals, transmitting and receiving.

**Model MO-1 or MO-2**  
mast and **RM-1'S** Super  
Resonator



## SUPER-FLEX STAINLESS

Cowl or trunk groove mount, super-flex stainless steel 48" antenna for excellent performance and economy.

**Model FGB-27L** with cowl  
mount

**Model TGF-27L** with trunk  
groove mount



## DELUXE DUALS

Get optimum all directional coverage. Easy to install! 48" antennas with trunk groove mounts.

**Model SDTs**

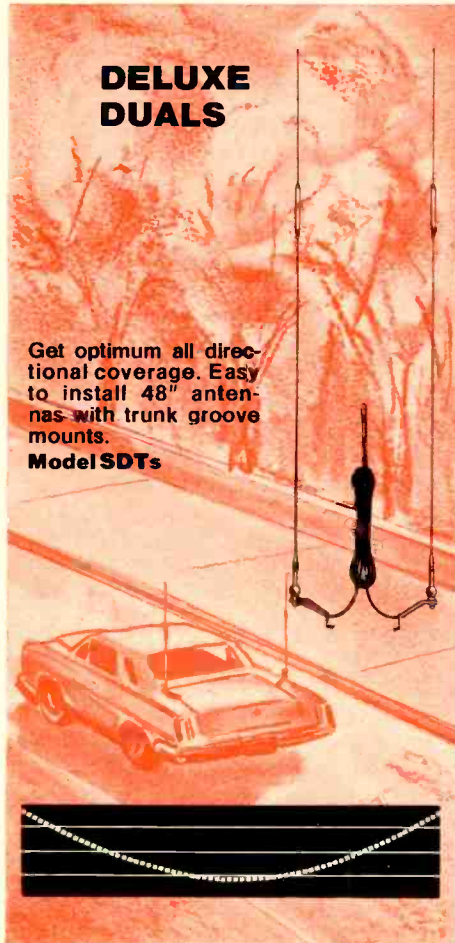

## SPECIAL DESIGN

Trunk lip mount 48" white vinyl covered stainless steel antenna. Easy to install, no holes to drill.

**Model TLA-27L**  
Antenna only-3/8"-24  
base **Model FG-27**



## "POWER-PACKER"

Super-flex stainless steel 55" antenna and deluxe trunk lip mount with 180° swivel adjustment.

**Model HQ-27M**  
Antenna only, 3/8"-24  
base  
**Model HQ-27**



# CB Newswire

YOUR CB NEWSPAPER

DECEMBER, 1976

INCLUDED IN \$9

## CB National Posse

Chief Robert Ferguson, President of the American Federation of Police who uses the handle *Smokey Bear 1* is contacting all CB operators to help form the *CB National Posse*® as auxiliary members of the American Federation of Police.

"The purpose is simple. There are millions of citizens who now have inexpensive means to report accidents, crimes, problems in their community. If we can get volunteers to act as an extension of our eyes and ears we can catch criminals in the act", stated Ferguson who heads the Bath Township Police in Ohio. He is head of the 50,000 member association of law enforcement officers located in Miami.

What we plan to do, he stated, is to open membership to licensed CB opera-

tors. We will issue them a special ID card with their call letters, name, and "handle". An emblem for the back of the car will show they are a member of the National CB Radio Posse and have agreed to follow certain rules of membership.

The membership rules are:

1. To pledge to obey all traffic rules and conduct yourself as an example to other CB operators.
2. To report to any local Smokey station in your area, any criminal activity in progress and to observe that action until the police arrive. Posse members are never to attempt to apprehend a criminal unless called upon by a police officer asking for aid who has the authority under the law to grant you temporary police powers.
3. To assist motorists in distress and to report any accident where aid is

needed. Each member must pledge to carry in the car a first aid kit, flags and warning flares and a hand fire extinguisher in case of an emergency.

"We feel that a CB Radio Posse member will help us reduce crime because the main problem is manpower. Each member will get a training manual and our magazine and that will keep the Posse member in touch with law enforcement problems and build a foundation that we knew in the days of the old west. That's why we selected the handle "Posse" member . . . the pioneer spirit of the wagon train protecting the men and women of this nation," stated Chief Ferguson.

Any CB operators can get more details by writing to Smokey Bear 1, CB Radio Posse, 1100 NE 125th St., North Miami, Fla. 33161, or by calling on his CB radio to Smokey One in the Miami area when out on the road.

## DANGER OF POWER LINES

Installation of antennas for CB base radio stations continues to result in tragic and unnecessary fatalities and injuries to Georgia citizens, Grady Baker, Georgia Power senior vice president announced.

Baker urged persons planning to install antennas for CB base radios to check carefully to see that the antennas are located well away from power lines.

"A good test," he said, "is to see whether the antenna would touch a power line if it fell in any direction from the base. If there is any possibility of this happening, the antenna should be set elsewhere."

Baker also said that persons with base antennas already installed should check them closely for proximity to electric lines and arrange to have them moved as soon as possible.

"The aluminum used in these installations," he explained, "is an excellent conductor of electricity; and even if they should come in contact with some of the lower power distribution lines, either a fatality or a serious injury would easily follow.

The utility official said that CB operators with base station antennas too

close to power lines should contact their local Georgia Power Company office. The company will provide assistance in moving the antenna. Because of the extreme danger involved, he urged CB operators not to attempt to move antennas without assistance from Georgia Power personnel.

"In actuality," he added, "it is against the law to have any kind of metal object of this type closer than eight feet to a power line. This is a law that has seldom had to be enforced, however, since nearly all persons who might be in violation immediately contact us for assistance in moving the antenna or other metal object as soon as they become aware of the extreme danger."

Baker said that in earlier years installation of TV antennas had caused many unnecessary fatalities throughout the state. He said that as more and more persons became aware of the dangers associated with such installations, these fatalities took a downward trend. He said safety officials are hopeful that as more CB operators become aware of the danger of placing and installing antennas near distribution lines, these fatalities, too, will go downward.

## CB Conference

On July 31 and August 1, 1976, Charles Thomas, President and Ann Clem, First Vice President of the Citizens Radio Federation of Virginia, Inc. attended the Southeastern Conference held in Lakeland, Florida. The Southeastern Conference is comprised of the ten Southern states and is a major contributing factor to the United States Citizens Radio Council.

During the meeting various reports were given by the state delegates on the progress of projects such as the Heading Conservation Program; how each state was dealing with the technical problems, educational programs being used and communication ideas.

Committees were established for the next term and appointments made. Charles Thomas of Virginia was appointed to head the organization committee and will function in the capacity of assisting the states of Tennessee, Kentucky and Mississippi to establish and have working a vital, functioning state organization.

The next Southeastern Conference will be hosted by the state of Virginia on February 19 and 20, 1977. For additional information, please feel free to contact either Charles Thomas at 703-361-3000 or Ann Clem at 703-573-3385.



**You can own  
the finest in CB  
if you buy Tram.**

**You can save  
a lot of money  
if you buy now.**



This is your Tram opportunity!  
Your once in a lifetime chance to own the  
finest CB you can buy... and save money, too.  
When you select the Tram XL, XL5 and Diamond  
40 or 60 base station-quality mobile sets, you get all the  
outstanding features, high performance and prestige that have  
made Tram the standard of quality in the industry. And you'll find  
the price on these 23-channel mobile units a very pleasant surprise.  
Take advantage of this Tram opportunity at your CB dealer. There will  
never be a better time than now to trade up to Tram at substantial savings.

# CB Newswire

YOUR CB NEWSPAPER

DECEMBER, 1976

INCLUDED IN S9

## CB Enthusiasts

### 'The Good They Do Outweighs The Bad'

It may surprise some Citizens Band radio enthusiasts, but state troopers like the rigs, even though they are used to report "Smokey the Bear's" location on the highways.

"They do hinder at times, but the good they do outweighs the bad by quite a bit," Maine State Police Sgt. Havan B. Hutchinson said. Hutchinson works at Troop G, which patrols the Maine Turnpike.

Hutchinson said that about 20 of the men in his unit have Citizens Band radios and monitor Channel 19, used by truckers and other motorists. Three do not.

"The smokey reports are not really a problem," he said in a telephone interview.

The reports of troopers' locations on the pike, he said, slow down cars, which is what the police are trying to do anyway.

CBers, especially truck drivers, help by reporting accidents and other highway problems quicker than the police

could be alerted by telephone, he said.

Hutchinson said that neither he nor his men have been led on any wild goose chases because of CB.

He said he recently got a call on the CB that appeared to be from or about a trooper, when no policeman was in the area.

"Before I could say anything, the truckers got on and climbed all over him (the caller). They won't call in with something that hasn't happened," he said. "We don't try to trap them, and they don't try to trap us."

Hutchinson said some motorists, especially those in "fourwheelers" or sedans, think there is a war going on between the troopers and the truckers.

"I haven't found it to be a war, it's just the opposite," he said.

Truckers, he said, almost always respond to a call for assistance from the police. The calls frequently are to relay the location of an accident to other drivers.

And, he said in one instance truckers put the word out to stop reports on troopers locations when the police were involved in a stakeout to catch a criminal rather than speeders.

Hutchinson's views were shared by Lt. Bennett R. Dunbar, whose men patrol the interstate highway from Augusta to Houlton.

Dunbar agreed that the reports of accidents and dangerous drivers have far outweighed any disadvantages of smokey reports.

State troopers using CB buy them on their own.

The most enthusiastic reaction to CB came from Bangor City Policeman Russ Elbrecht, who said the radios have improved rapport between the police and other citizens.

"We've had a pretty good rapport with CBers because quite a few of the guys in the department are CB nuts themselves," Elbrecht said. He placed himself in that category.

Capt. Jerald F. Boutilier, head of the state police detective squad, said the only problems the radios have caused him is that they are stolen frequently.

The policemen said there have been very few incidents of persons using the radios while committing a crime or of hampering the police by trying to play cop.

## CB LINGO BECOMES SPANISH

Citizens-band-radio jargon in the Miami area has taken on a Spanish accent.

CBers tuning in Channel 14 might hear something like this: "Este es Capitan Arana dandole un 7388 por 2000 al cien y al millon y rompe costilla, y me quedo en 10-7."

Literally translated, it means: "This is Captain Spider giving you a 7,388 by 2,000 to the hundredth and millionth power and a ribbreaker, and going on standby."

Even Latins don't know why they say that, they just say it.

On a typical day, Latin CB fans might jump into their "movibles" (automobiles), turn on their "hierros" (radio equipment), and sign onto the "galinero" (chicken coop), the term for Channel 14, to try to find their "coleguitas" (good buddies).

Because of the popularity of CB radio among some 400,000 Latins in Miami, Channel 14 often is "de pared a pared y de techol a piso" (wall to wall and ceiling to floor). That means it's full and everybody tries to talk at the same time.

## Police Arrest Of Conn. CBer Gets A Stormy Reception

The arrest of a motorist for using a CB radio while driving has brought a demand from a state legislator that the state police clarify the situation.

Republican Rep. Astrid Hanzelek wrote Cmsr. Edward Leonard asking that he determine whether the law makes such an action illegal. The Suffolk lawmaker told Leonard she had received "conflicting opinions" from state police headquarters in Hartford and Meriden.

Mrs. Hanzelek said she was acting because one of her constituents—a Windsor man—was arrested and paid a \$15 fine for using a CB radio while operating his car.

There is a rather ambiguously written

law on the books banning the use of radio telephones while a passenger car is in motion. This statute, however, contains a variety of exceptions on certain other equipment.

Mrs. Hanzelek pointed out she is not sure whether the CB equipment is regarded as a hand radio telephone. If it is, she said to Leonard, then the state police should "publicize the legal restrictions" on CB use.

The legislator also maintained that if the law prohibits CB owners from using their equipment while driving it should be changed.

Leonard, on vacation, was not available for comment. However, a state police spokesman said no comment would be made on Mrs. Hanzelek's letter until it was received and the picture studied.

Other police sources, however, said the law—although rarely enforced—does prohibit persons driving cars—not trucks—from using CB equipment while moving on the road.



# Antenna Specialists introduces the "Problem Solvers"

## Seven new solutions for CB Antenna mounting problems

When it comes to CB antenna installations, not all vehicles are created equal. There are times when the conventional roof or trunk mount just won't fill the bill. For those of you with such special mounting problems, we proudly dedicate our new line of "Problem Solvers".

### Here's a new angle

Keeping a hatchback mounted mobile antenna in the vertical position sounds impossible. But our new M-275 has a swivel-ball whip adaptor that permits vertical adjustment with the touch of a set screw. A new permanent installation without drilling holes.

### How not to be noticed

There are times when you'd rather not advertise that you've got a CB radio. Like when your car is left unattended. Our MR264 3-way disguise antenna not only keeps your secret, it also doubles as an AM/FM broadcast antenna. And for a non-disguise 3-way antenna that gives great CB performance, check out our M-267. Both models feature easily detachable stainless steel whips.

### Now you see it, Now you don't

What do you do for a CB antenna when you change cars constantly? Just take along our MS178 magnetic mount. It mounts and unmounts in seconds without leaving a trace.

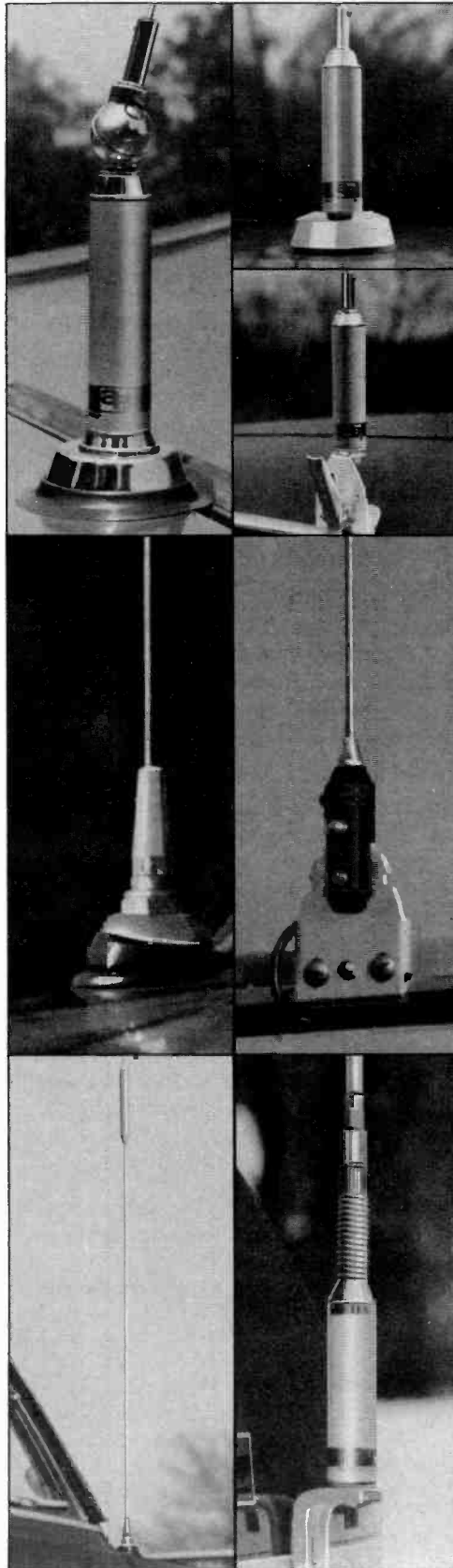

Powerful ceramic magnets grip firmly even at highway speeds. And it won't scratch the paint. Another solution is to clamp on our MR131 rain gutter mount. Its heavy duty spring loaded clamp grabs like a vise but releases with just a squeeze.

### When you've gotta keep it down

Low hanging branches and garage doorways just aren't forgiving of CB antennas. That's why our MR180 uses the famous "Flipper" gutter mount. The "Flipper" permits vertical, horizontal and in-between positioning of the antenna in either direction. Mounts easily on rain gutter without drilling holes.

### Good news for the fiberglass crowd

Getting a CB antenna to perform well on a non-metallic vehicle used to be impossible. Not any more. The M-306 utilizes a unique "no ground plane" design that makes it the perfect choice for owners of motorcycles, snowmobiles, sailboats and just about any other fiberglass vehicle. Fiberglass whip, stainless steel shock spring and weatherproof molded coil total only 53" overall.

When it comes to choosing the right antenna, don't settle for less than the best. Look for the Stripes of Quality.



The best-selling CB antennas going.  
We'll bet our AS on it.



© "Stripes of Quality"

the antenna specialists co.

12435 Euclid Ave., Cleveland, OH 44106. a member of The Allen Group, Inc.,

# CB Newswire

YOUR CB NEWSPAPER

DECEMBER, 1976

INCLUDED IN S9

## 'Tiny' Gets CBers Message: L-O-V-E

Mrs. Judith Kalen used to think CBers were "the noisiest, craziest people around."

Now, she thinks the citizen's band radio enthusiasts are "pretty fabulous people."

CBers from Cicero to Rockford, IL, have organized to raise more than \$6,000 for Mrs. Kalen's 7-year-old daughter, Jennifer, who has been fighting for her life against cancer since February. Her CB handle (code name) is "Tiny."

The Cicero Channel 12 CB Club gave the Kalens a check for \$3,700. "Helping this little girl live one or two more years is worth more than anything to us," said one of the club members, John Gray.

Earlier, the 10-4 Community Helpers CB Club in Rockford, near the Kalen's hometown of Loves Park, raised \$3,000 through a variety of events.

Jennifer has a rare form of cancer in her rib cage. She underwent an operation in February and now is being treated through chemotherapy. Her doctors have given her a one-in-four chance of survival, Mrs. Kalen said.

Jennifer became a CBer herself, Mrs. Kalen said, when she got on the air on the family's unit during trips to and from the hospital. Jennifer's conversations with other operators alerted them to her plight, Mrs. Kalen said, and fundraising efforts "snowballed" after the Rockford group decided to hold a raffle.

"These CB people are fantastic," said Jennifer's father, Frank Kalen, a superintendent at Viking Chemical Co., a member of the Rockford CB group. "These CB freaks are one big happy family."

Along with the gifts of money have come honorary memberships in various CB groups for "Tiny." And, her mother said there have been many good wishes for the 35-pound second grader.

"The help is really appreciated," Mrs. Kalen said. "Sometimes you get to thinking that all people are out for themselves. But those people out there are really fabulous."

## CB is women pro golfers' best friend

"This is Giraffe to Soup Spoon . . . Putt, Putt's got to drop out of the convoy . . . for a pit stop."

The world of CB has come to the Ladies Professional Golf Association tour. If your vehicle is equipped with a CB, you might have heard the above message.

Translated, it means Carol Mann was calling Bonnie Bryant that Betty Burfeindt would be leaving a six-car caravan to seek a rest room.

More than 25 women who gathered for the Babe Zaharias Invitational recently now use CB radios for security and a way to beat the boredom of their endless trips across the country.

The women's handles are as colorful as their golfing attire.

Miss Mann's is a natural since she stands 6-foot-3. Miss Bryant picked Soup Spoon because she has a reputation as a lousy cook. Miss Burfeindt's label of Putt-Putt refers to her skills on the course.

Some of the handles are less easily explained. Sandra Post, for instance, probably intrigues truckers when she signs on as Shady Lady. I couldn't bring myself to ask for an explanation.

At the opposite end of the CB band, there's Pam Higgins, an eye-catching blonde with a bubbly personality who checks in as Sunshine Girl.

Other handles include Banana Two because Lenore Beserra loves bananas, Snowflake for Kathy Hite, Bo Peep for Clifford Ann Creed, Lolly Pop for Pat Bradley, Baby Blues for Cathy Dugan, Thoroughbred for Gloria Ehret.

"I get a lot of questions concerning my handle," said Miss Ehret. "Everyone thinks I must raise horses. Actually, it's the name of a line of clubs for the equipment company I represent."

Continued Miss Ehret: "30-hour drives between tour stops are not uncommon for us. The CB help us pass the time and avoid traffic congestion. You know, the 55-mile-per-hour speed limit really kills us on long trips.

"Quite often, we'll form six or seven-car caravans and rap with each other all the way. I used to kill time by listening to tapes on the car radio. I've sent them home. CB is much more fun."

## CB Operators Have Direct Police Communication

The Barberton Police Dept. has become one of the first in the State of Ohio to be equipped with a citizens band radio to monitor emergency calls from local operators.

Gary Sutton, a firefighter and owner of Tri-City Communications donated a \$300 CB radio and antenna to the department to monitor the calls.

Police said the local department may be the first in Ohio equipped with CB communications equipment.

Sutton said calls to police may be made on Channel 9 which is an emergency channel established by the Federal Communications Commission.

CB operators who spot suspicious activity, criminal action or emergency situations may contact police by simply paging them over their units.

Emergency calls to the Barberton Police Dept. will be enough of a call signal for the dispatcher at the desk to

answer Sutton said. The dispatcher will then send police and emergency equipment to the scene of the incident.

"The unit was donated to the police to set up a better communications network with the public, especially those with mobile CB units," Sutton said. "We hope it will benefit both and result in better safety protection."

Sutton said the CB craze has equipped one in every ten cars on the road with a mobile unit. "Those mobile units could be a great help to deterring crime and possibly saving someone's life in an emergency," he said.

Chief Jack Gascoyne said Sutton and his department worked with the FCC for a year to get the plan approved.

"We think it will give us greater emergency contact with the public and may allow us, in certain instances, to respond more quickly to emergency situations," he said.



# GR-R-REAT GIFT. THE TIGER MARK 2™ CB FROM PEARCE-SIMPSON.



This Christmas give the gift of gab.  
A Pearce-Simpson Tiger Mark 2 CB.

You can't pick out a better citizens band radio for the money. It's got features a lot of the others don't offer at any price. Like HetroLock™ for zeroing in on the right frequency, and Receiv-O-Slide™ tuning for best reception and adjustment of signals (even from off-freq. sets). And it's backed

by a company that's been a leader in personal two-way communications for years.

So put the Tiger Mark 2 on your Christmas shopping list. It's one gift that'll be talked about for a long time to come. See your Pearce-Simpson dealer or write Box 520800, Biscayne Annex, Miami, FL 33152. In Canada, Scotcomm Radio, Inc., 4643 Levesque Blvd., Chomeday, Laval, Quebec.

#### IMPORTANT NOTICE

We'll remanufacture any 23 channel Tiger Mark 2 purchased now to 40 channels after Jan. 1, 1977 pending FCC approval. Ask your Pearce-Simpson dealer for details.

**PEARCE-SIMPSON**  
DIVISION OF GLADDOG CORPORATION  
THE CB RADIO • MARINE RADIO • ANTENNA PEOPLE.

# CB Newswire

YOUR CB NEWSPAPER

DECEMBER, 1976

INCLUDED IN \$9

## D.C. CB Helps Speed Tips On Traffic

WMAL Radio is pleased with the way its expanded coverage of area traffic troubles is working. In addition to the helicopter reports, the station since March has been bringing listeners reports radioed in from owners of CB Radio sets.

The reports come from members of National Capital Radio Emergency Association Citizen Teams (REACT), a non-profit organization offering emergency communications using two-way radio transmission.

The arrangement has resulted in swift reports of traffic difficulties. Recently a motorist reported seeing a traffic accident, and heard it aired on

the radio five minutes later. The broadcast resulted from a CB radio report to the REACT unit at WMAL. The accident report was relayed by the station monitor to the police, then typed for broadcast on WMAL's drive-time show "Two for the Road."

Over 400 REACT area members are participating in scouting the metropolitan area during weekday morning (6:30 to 9:30 a.m.) and evening (3:30 to 6:30 p.m.) drive times looking for accidents, disabled vehicles, traffic light malfunctions, detours, etc.

WMAL Program Manager Marc Kuhn says the CB reports appear to be "timely, reliable and comprehensive," and emphasized that the service has verification checks to insure accuracy.

A similar operation at Detroit's WJR was so successful the station dropped its police helicopter reports. WMAL officials have expressed satisfaction with the radio reports to date, but expect also maintain the helicopter traffic lookouts.

## Race Fans Establishing Own Network

The No. 1 sports network may not be on any television dial. It may soon be on the nation's highways, where tens of thousand of citizen band radio-equipped auto racing fans and participants are exchanging weather and road information, directions and race information.

Racing CBers, including fans, drivers, car owners and race officials, have begun communicating on CB channel one, a hitherto relatively quiet area of the 23-channel public radio band.

Channel one was suggested almost simultaneously by two racing writer-publicists, Russ Lewellen of Pittsburgh and John McKarns, Elmhurst, Ill. McKarns helped organize a dozen Chicago area tracks to adopt channel one as the "official" channel for racing communication. The tracks will urge their fans to pass along weather info and directions as they travel to races.

Earlier, Gary Sterner, publisher of the West Coast racing tabloid, Racing Wheels, suggested race fans use CB's to exchange info, and the publication began listing the "handles" (CB nicknames) of western racegoers.

The current issue of Racing Promotion Monthly, the newsletter for speedway promoters, reports on the CB craze and its possible effect on speedways. RPM suggests a number of ways track operators can benefit from the wide use of CBs among fans and entrants. Included are operation of CB base stations at tracks, to "talk in" fans, establishment of speedway CBers' clubs, and occasional reduced-rate admissions for CBers. One track, Islip Speedway, held a "CBers' Day," and admitted CB license holders free.

RPM's publishers, SpeedArt Enterprises, have also printed bumper strips with the legend, "Goin' Racing on CB-1," to help racing CBers identify each other visually. Information from SpeedArt, Box 277, Chanhassen, Minn. 55317.

## CB Operators Aid Des Moines Police

The Des Moines (Iowa) Police Department and a group of area citizens band radio operators have joined forces to add thousands of pairs of "eyes and ears" to the streets here in an effort to help police in quick crime detection and accident reporting.

The program, called "Des Moines Police Monitor," consists of 86 CBers who, on a rotating basis, monitor an emergency CB frequency (channel 9) and forward reports of emergency situations directly to police dispatchers on a special telephone line.

Sgt. James Breining of the police department's community relations unit said the program now is in effect only from 2 p.m. to 11 p.m. each day. However, it is expected the program will be expanded to a 24-hour operation, he said.

Breining said CBers are "one of the few groups left that are eager to help," and "it's definitely to our advantage to have their assistance.

"The biggest problem in the past has been we get a flood of calls after something comes over channel nine," he said. "This way, we now have one person we can rely on and who we can get back to if needed."

Breining said each of the monitors has been assigned an identification number and given instructions on what type of information is needed and what the reporting CBER should do, if anything, when he spots an emergency situation.

The CB end of the operation, which is not affiliated with any CB organization, is headed by Harold and Bernice Adams of 2523 E. Aurora Ave.

Adams said there are several thousand CBers in Des Moines who now can call "Des Moines Police Monitor" on channel nine to report accidents, crimes or other emergency situations.

Breining said the program does not cost the city any money because the 86 monitors are donating their time.



# TRADE BACK OFFER

## **KRIS**<sup>®</sup> WILL GIVE YOU UP TO \$140 CREDIT FOR YOUR **KRIS** CB

...when you trade in on  
a NEW **KRIS** 40 channel CB  
in 1977

Don't miss out on any of the fun.  
Buy any Kris CB\* now through  
December 31, 1976... Use it...  
Enjoy it! On January 1, 1977, new  
CB regulations become law and  
NEW Kris 40 channel CB's make  
their exciting debut. Your Kris CB  
will be worth up to \$140 in trade  
on a new 40 channel Kris CB  
radio. That's up to \$140 credit  
guaranteed by Kris, Inc.

**\$140 CREDIT**



\*Offer good on all Kris CB radios,  
except Models XL70 and 23+,  
through March 31, 1977.

REMEMBER, IF IT'S  
**KRIS** ...IT'S CLASS

SEE YOUR KRIS DISTRIBUTOR  
FOR DETAILS.

**KRIS**

Pioneer Road, Cedarburg, WI. 53012  
Telephone (414) 375-1000

# CB Newswire

YOUR CB NEWSPAPER

DECEMBER, 1976

INCLUDED IN S9

## CBer Aids In Sea Rescue

Flo Woodson of Spring, Texas, better known by her CB handle "White Rose" will always be remembered as "an angel from Heaven" by the captain and crew of the shrimp boat, "Leslie D". The only contact between the boat and "White Rose" was through a CB radio. From early in the evening to 5:30 a.m., "White Rose" stayed in touch with the shrimper that had lost power and drifted into commercial shipping lanes in the Gulf of Mexico. The entire bay area was without phones because of a storm that had hit the community earlier that day. "White Rose" managed to contact a four-wheeler, who in turn notified the Coast Guard. The "Leslie D" was rescued after many hours of anxious waiting.

This month, "White Rose" has been selected to receive the Midland Good Buddy Award for the major part that she played in the rescue of the distressed boat. She is a member of the Copperhead Gap Association, a public service oriented CB organization.

Twelve other Good Buddy merit certificates were awarded this month to individual CBers and CB groups who have used CBs in a worthwhile manner to help others.

Suffolk REACT in New York, an all-volunteer group that monitors the emergency channel in their area is dedicated to detecting and relieving emergency situations. The group has saved many lives by relaying emergency messages to police.

Thomas K. Squier, Sr. of 4331 Breck Avenue, Winston-Salem, North Carolina, makes it his business to help out lost motorists or travelers in distress. His job often requires him to be up at odd hours, so he listens to his CB for situations that require help.

The Green County REACT Team 22, in Springfield, Missouri, received a Good Buddy Award for conducting a four day hunt for a dog that had bitten a small boy. The team also helps out in a variety of situations from automobile accidents to directing lost motorists.

The Trailblazers CB Camping Club, in Westport, Indiana, was awarded for their devotion to helping others. Major projects organized by this group include a "coffee break" to raise money for the

widow of a fellow CBER who passed away and had no insurance, and a "safety break" over the Memorial Day weekend to provide coffee and donuts to weary travelers.

Gene "Redbone" Wingham and his wife, Linda "Buttercup" Wingham, of Rt. 2, Bedford, Kentucky, raised nearly \$2600 for a five-year-old girl who needed open heart surgery. The Winghamams contacted friends and fellow CBers to put on a "coffee break" and

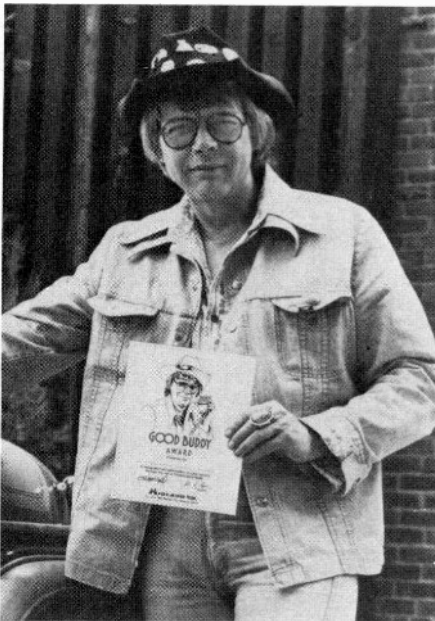

auction in their community to raise funds for the expensive operation.

Tex Lewis, better known as "Land Base Tex", a disabled veteran from Beeville, Texas, was selected to receive a Midland Good Buddy Award for offering assistance to travelers passing through the small town where he lives.

John "Lumberhauler" Bergeron, of 99 Pesting St., New Bedford, Massachusetts, was named as a Midland "Good Buddy" for his persistence in helping others. Twice in one year, Bergeron has stopped at the scene of an accident, and his own car has been hit while placing an emergency call on his CB radio. Even this does not deter Bergeron from assisting distressed motorists whenever he can.

Bob DeVan's quick responses have won him a Good Buddy Award from Midland. DeVan, who goes by the

handle "Bugs Bunny" provides assistance by relaying information that he receives over his CB radio to sources who are prepared to give proper aid. Situations where he has made emergency transmissions include relaying information to a hospital about the ear injury of a two-year-old girl, and reporting car accidents to rescue units so help could be dispatched to the scene.

The Eau Claire Citizens Band Communications Club, a 60 member volunteer organization, funded completely by the members themselves, protects and offers civil assistance to the Greater Eau Claire Area. The club's activities have covered a wide range from posting security when a den of bears wandered into a heavily populated section of the city, to directing traffic during a Bicentennial celebration. The club is of great help during the tornado season when manpower is limited.

Mr. and Mrs. Glenn McClure, Mr. and Mrs. Bloyd, and Mr. Charles Freudenstein of Hanover, Indiana raised nearly \$1600 through a coffee break and dance in their community to help defray medical costs for a friend who is suffering from cancer.

The Lucky to Be Alive SSBers citizen band radio club raised \$300 for senior citizens at the King-Kennedy Center in Modesto, California. The group, which has been in existence for less than one year, raised the money through a spaghetti dinner held in the community.

Jim Tiana, of Rt. 13, Fairmont, West Virginia, better known as "Big Apple" by fellow CBers, was selected to receive a Midland Good Buddy Award for such deeds as helping stranded travelers in the middle of the night, fighting fires, looking for missing persons, and directing motorists through town.

Each Midland "Good Buddy" receives a merit certificate signed by Midland's president, and Midland's CB spokesman, top recording star, C. W. "Convoy" McCall. A personal letter from McCall accompanies each award.

If anyone knows of an individual or group that is worthy of receiving the Good Buddy Award, nominations can be sent directly to: The Midland Good Buddy Award, c/o Midland International, 1900 Johnson Drive at State Line Road, Shawnee Mission, Kansas 66205.



# Three "power mike" gift ideas from Telex.

"Power mikes?" you say, "but two of them look like headsets." And you're right! And if you're a seasoned CBR

ready to move up, take a second look at the aviation-type Telex CB-88 power-mike headset. Your CB listening is private; lets others around you visit, relax or sleep without a blaring speaker. You hear better and transmit better. Weighs less than 3 oz. Uniquely, you can wear it without the headband by attaching it to your eyeglasses (adapter included). Check out the CB-1200, especially right for high-noise environments, and the aviation-inspired Double-Header power mike. Then move up to Telex, the quality standard of the aviation communications industry, now producing the most powerful CB gift ideas around. And if you want to drop a loud-and-clear hint, just tear out this ad and leave it where your gift-giver will find it... or take it to your Telex CB dealer for a gift-idea demonstration.



Can be worn without headband. Easy-to-use eyeglass adapter.

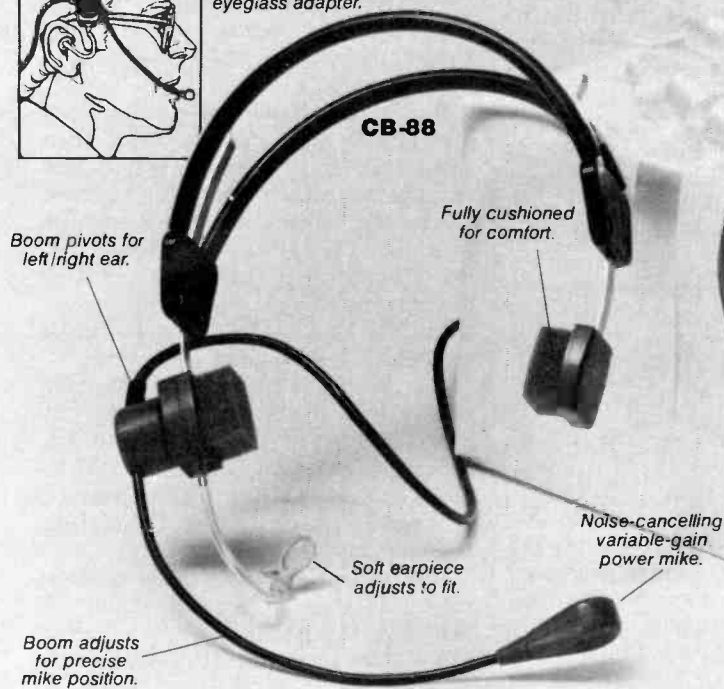

Use as conventional power mike or as superior noise-cancelling, power mike thanks to Double-Header feature.

Built-in variable gain power amplifier.



CB-73

Style used by pilots around the world, fits every hand.

Front mount ends mike fumbling. Mike comes off bracket in talk position. Rear mount also included.

Adjustable mike boom, 310° swivel, close to lips.

The Pilot People

## TELEX

COMMUNICATIONS, INC.

9600 Aldrich Ave. So., Minneapolis, MN 55420 U.S.A.  
 Europe: 22 rue de la Legion d'Honneur 93200 St. Denis, France  
 Canada: Telak Electronics, Ltd., Scarborough, Ontario.

# CB Newswire

YOUR CB NEWSPAPER

DECEMBER, 1976

INCLUDED IN S9

## Polly Wants A Kraco!

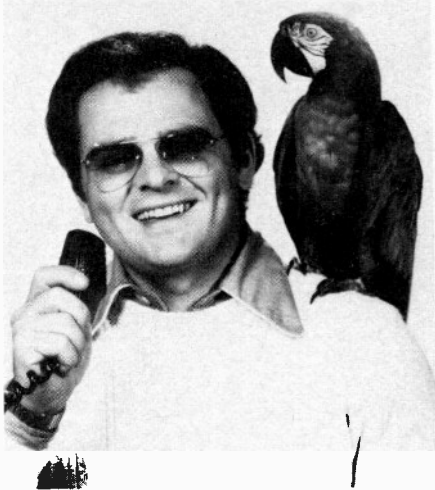

Gary Berghoff, co-star of the TV series "M\*A\*S\*H," and Kraco the parrot will team up in TV commercials for Kraco's line of CB radios. Berghoff will be the first of a number of top stars promoting the Kraco line.

"Polly wants a Kraco. Kraco CB for everyone who wants more than a squawk box," will be the theme line of TV and radio commercials, newspaper, magazine and billboard ads and point-of-purchase display material.

Kraco has allocated more than \$1 million for the remainder of 1976 to promote its CB line in the top 20 markets across the nation, according to president Larry Kraines.

## CBer On Trial For Murder, Battled Over Air Time

The explosion of CB radio sales has led to battles for air time all over the country. "Bear Tracks" died after one such squabble and "Blue Rover" is on trial for murder in his death in Lincoln, Nebraska.

And the case may rest on the testimony of "Sidekick" and the "Blonde Bomber."

Blue Rover is the citizens band radio "handle" of Clyde Rice, 31, who is charged with first-degree murder in the April 10 slaying of Donald Edelman. Edelman's tag was Bear Tracks.

A spokesman for the FCC says similar squabbles have been reported all over the country as 15 million CB-set owners vie for time. Incidents have included beatings, threats and vandalism of CB antennas.

Rice is accused of deliberately running Edelman down with a pickup truck in the parking lot of VFW club. Edelman, 40, died three days later.

Witnesses agree on one point—the incident was preceded by an argument over a CB radio channel.

Edelman's widow, Sandra, testified that her husband had a running argument with Rice over the air about monopolizing a channel. She testified she had heard each man threaten the other.

Rice testified that he and Edelman

decided to meet at the parking lot. Rice said the two had an argument, and that he was trying to drive his truck out of the parking lot when he "accidentally struck" Edelman.

Key testimony has come from Ken Dettmann, known as "Sidekick" on the CB airwaves, and from Rene Swanson, known as "Blonde Bomber."

Mrs. Swanson testified that the two men exchanged punches before Rice jumped back into his truck and made seven or eight passes at Edelman. Mrs. Swanson said she drove to the parking lot with Edelman.

Dettmann, who said he was in Rice's truck, testified that as Rice was preparing to drive away Edelman ran up to the truck, "twisted the mirror off and kicked the door twice."

Dettmann said Rice waved a pistol at Edelman to scare him, then put it down and tried to drive away several times but Edelman grabbed the hood of the vehicle.

Dettmann said he heard a "thud," and told Rice he thought Rice had run over Edelman. Rice answered, "No I don't think we hit him," and backed up.

Dettmann said he then heard another thud. "The front wheel must have drove over him again," Dettmann said.

## CB Show/USA Set For Boston Kickoff

CB SHOW/USA, a series of major CB shows for the general public in principal cities across the country, kicked off October 14-17 in Boston, Massachusetts.

Special exhibits demonstrate the many uses of CB rigs in trucks, vans, boats and recreation vehicles as well as passenger automobiles. The many potential CBers who attend the shows will get their first "hands on" experience with live CB setups in the Hall, and have the opportunity to purchase a variety of mobile rigs, base stations for home use, and a full range of accessories.

CB Show/USA is scheduled for 1976 showing in Atlanta and Oklahoma City during November; during 1977 it will appear in Houston, Denver, San Francisco, Los Angeles, Portland (Oregon), St. Louis, Chicago, Detroit, Buffalo and Washington, D.C.

Information regarding exact dates or exhibition space is available from CB SHOW/USA, 30 Newbury St., Boston, MA 02116; telephone (617) 266-4316.

## Mexico Says Leave CB's Home

U.S. tourists should leave their citizen band radios behind unless they are licensed in Mexico, Mexican Consul Rene Morlet of Phoenix says.

Morlet said he was told that Americans using the sets without Mexican licenses had them seized for return when they left the country.

"But there is considerable trouble involved in reclaiming property seized in connection with a law violation," he said. "You would all be happier if you left those CB transmitters at home."

Mexican officials reacted when U.S. tourists used CB radios to maintain contact and their traffic disrupted Mexican emergency broadcasts.



Our most expensive AM mobile . . .



the NEW  
**Sabre**

... featuring phase-lock loop circuitry (PLL) and LED digital readout.

Browning's performance and quality have been tested and proven by knowledgeable CBers throughout the world. Learn why they have relied upon the name Browning since Citizens Band began almost two decades ago.

See Browning's entire line of products at your nearby CB specialty store.

**browning**  
bringing people together

browning laboratories, incorporated, laconia, new hampshire 03246

... Use S9 READER SERVICE.

S9 • December 1976 • 21

# CB Newswire

YOUR CB NEWSPAPER

DECEMBER, 1976

INCLUDED IN S9

## Help Us Publish CB Newswire!

Be an S9 Reporter! Get your hometown CB news in the pages of S9. Send your news clippings to us and we'll try to bring your area news on to the national CB newswire—through the pages of the nation's oldest and largest CB publication. If you enclose a self-addressed, stamped envelope with your news clippings, we'll send you an S9 PRESS CARD! Address your news clippings to:

**Tomcat, CB Newswire  
CB Radio/S9 Magazine  
14 Vanderventer Ave.  
Port Washington, N.Y. 11050**

## Kraco Donates CB Radios To Chowchilla

School buses in Chowchilla, Calif., scene of the mass kidnapping of 26 school children and their bus driver, will no longer be isolated on their daily runs thanks to a gift of 24 CB radios and antennas from Kraco Enterprises.

Kraco president Larry Kraines flew to Chowchilla to present the communications equipment to members of the school board and to meet Frank Edward Ray, hero of the July 15 kidnapping.

One of the CBs, with his name inscribed, was presented to Ray in recognition of his heroic action in freeing the children and himself after 36 hours of captivity.

Kraco headquarters, here, was deluged with telephone calls and letters praising the company for its civic action after news of the donation was carried on TV, radio and in newspapers throughout the country.



Chowchilla's hero school bus driver Frank Edward Ray gets a CB radio for his bus from Larry Kraines (1), president of Kraco Enterprises. Kraco donated 24 CB radios and antennas to the city to make school buses safer.

Kraines, father of three young children, said, "We donated the CBs to Chowchilla because my wife and I prayed and agonized with those parents of the abducted children and we felt we could best put the 'golden rule' into practical application by helping to make the city's school buses safer"

## Operation Ears

The Scottsdale (Arizona) Police Department has started a new program

entitled "OPERATION EARS". We had five thousand booklets printed and placed in C. B. stores, restaurants, hotels and as hand outs at the local channel breaks.

At one of the local breaks, over 250 channel 14 people took up a collection and raised enough money to put a base station and antenna at the police headquarters.

We are monitoring Channel 9 with our base station, three supervisor's trucks and two of our 30 marked patrol vehicles have C.B. radios.

We are receiving several calls a day from the citizens on the C.B. radios and have found that our response time has been reduced considerably.

We are also receiving more information now that we can talk direct to the citizen that is at the accident or calling in the suspicious activity. It has also brought the police officer and the C.B. community closer together in this city of eighty-eight thousand people and ninety square miles.





# What height is right?

## with a **TURNER SKY KICKER**

Model SK22B

# It doesn't matter

If you've ever installed a base station antenna, you know how much the db gain is influenced by the height at which the antenna is mounted. As a matter of fact there are many antennas on the market that even have MINUS DB GAINS at certain heights. Well, you needn't worry any longer about critical mast lengths. The NEW TURNER SK22B will give you a consistently good db gain at ANY HEIGHT. Turner's revolutionary gamma matching system eliminates depleting mast effect. Just set your mast where you want it and install!

- 5/8 WAVE
- GROUND RADIAL
- OMNI-DIRECTIONAL
- PERFECT GAMMA MATCH
- BETTER THAN 4 db GAIN
- NO LOADING COIL TO BURN OUT
- STANDARD MAST MOUNTING
- 80 MPH SURVIVAL WIND LOAD
- LESS NOISE
- LESS PRECIPITATION STATIC
- WILL TAKE UP TO 1000 WATTS

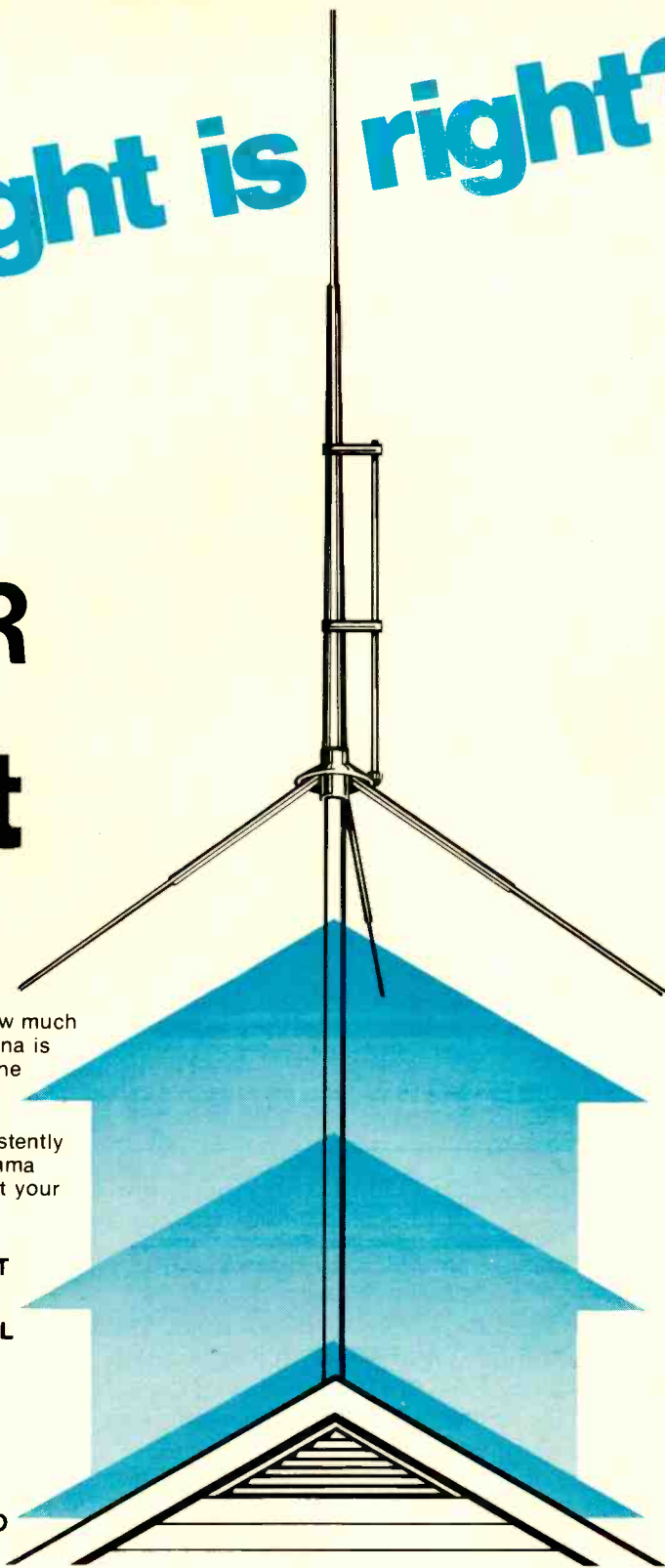

**\$44<sup>95</sup>**  
suggested  
retail price

**TURNER** | MICROPHONES  
ANTENNAS

716 Oakland Road N.E., Cedar Rapids, Iowa 52402

**CONRAC**  
CORPORATION

Give your base station or CB mobile two-way improvement. Ask for Turner microphones and Signal Kicker antennas, wherever better CB products are sold.

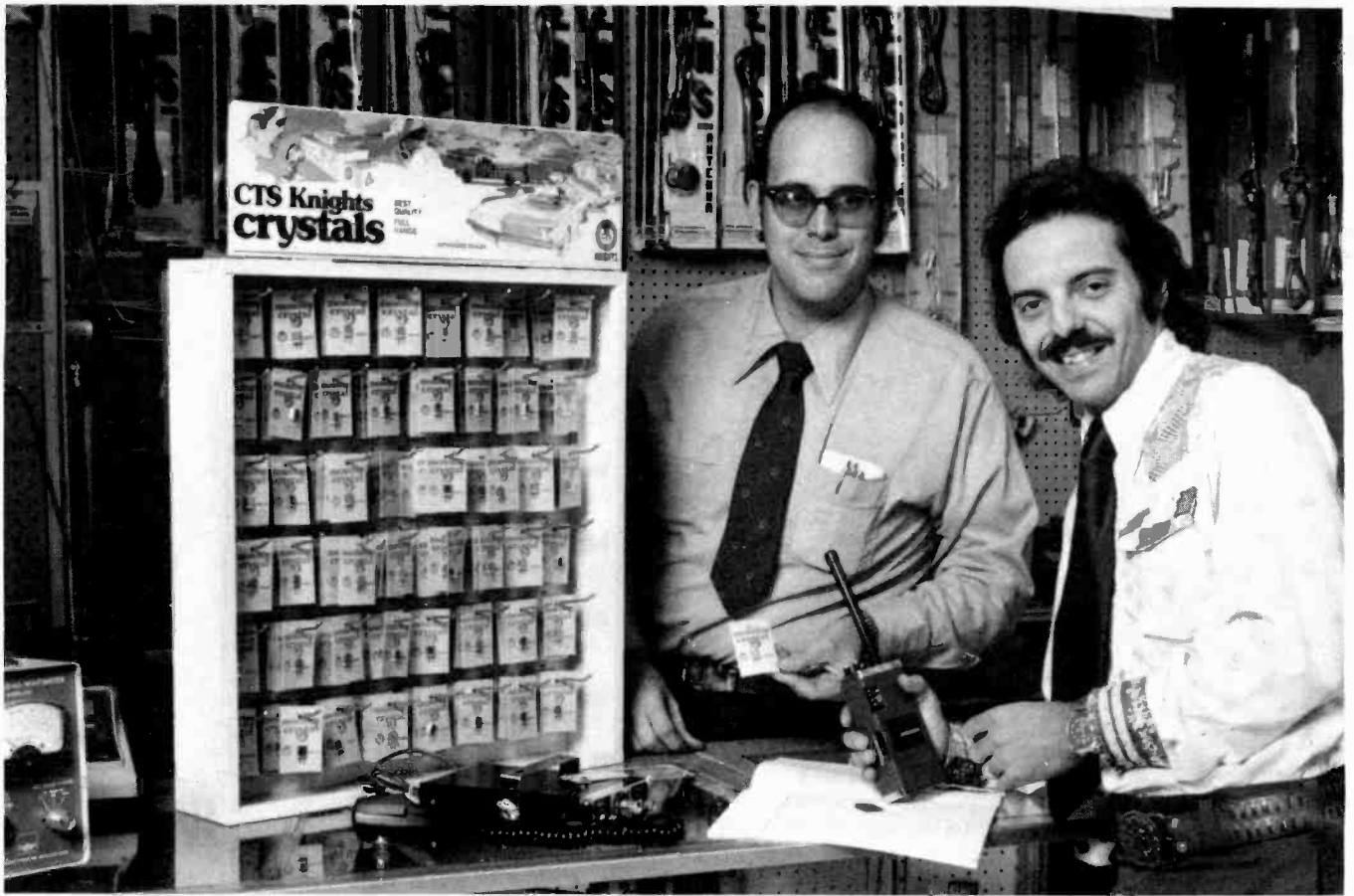

# How can you be sure which crystal is best?

Graham Electronics in Indianapolis knows crystals. They carry nothing but CTS Knights. "We previously stocked other brands," General Manager Larry Stein (above, right) said, "but we found we couldn't meet all of our customers' needs for changing and growing frequencies except from our CTS stock." While CTS crystals are known for highest quality all across the land, here's one place that leaves no doubt of it whatsoever.

Stein and Bruce Gibson (above, left), Graham's Communications Department Manager, agree that CTS is a "finer crystal than anything in the market. CTS has the broadest line," they said, "and we have no problems. Our percentage of return is nil!"

"Is this crystal accurate?" is the most asked question. The answer is "absolutely yes," thanks to CTS gold frequency calibration and mil-quality features. That really convinces radio enthusiasts that CTS is best, the Graham management believes. "We can give them any CTS crystal they need... for any set... right at our counter," Stein and Gibson agreed.

You can enjoy this same fine quality and constant satisfaction, wherever you are. Take a tip from this full line electronic parts and equipment wholesaler. See your nearby CTS dealer for any crystal you might need.

And for a handy reference book on CB, monitor and 2-meter crystals, send the coupon now with \$1 for **CTS Knights Crystal Guide**. And from now on, you too will rely on CTS Knights, 100%.

## CTS KNIGHTS, INC.

SUBSIDIARY OF CTS CORPORATION, ELKHART, INDIANA  
402 REIMANN AVE., SANDWICH, IL 60548, PHONE: (815) 786-8411



CTS Knights, Inc.

402 Reimann Ave., Sandwich, IL 60548

I enclose \$1. Please send my copy of CTS Knights Crystal Guide.

NAME \_\_\_\_\_

ADDRESS \_\_\_\_\_

CITY \_\_\_\_\_ STATE \_\_\_\_\_ ZIP \_\_\_\_\_



**SPECIAL  
OFFER!**

**Buy 23-channel  
CB now. Get new  
40-channel later  
at 1/2 price!**

UPON FCC TYPE ACCEPTANCE

**"Don't be without CB while waitin' for the FCC"**

NO MODIFICATION FEES—NO MODIFICATION DELAYS—OWN AND KEEP TWO UNITS



**handic®**

handic USA, Inc., 14560 NW 60th Ave., Miami Lakes, FL 33014

**THE ORANGE EQUIPMENT KNOWN FOR  
PROFESSIONAL QUALITY THE WORLD OVER**

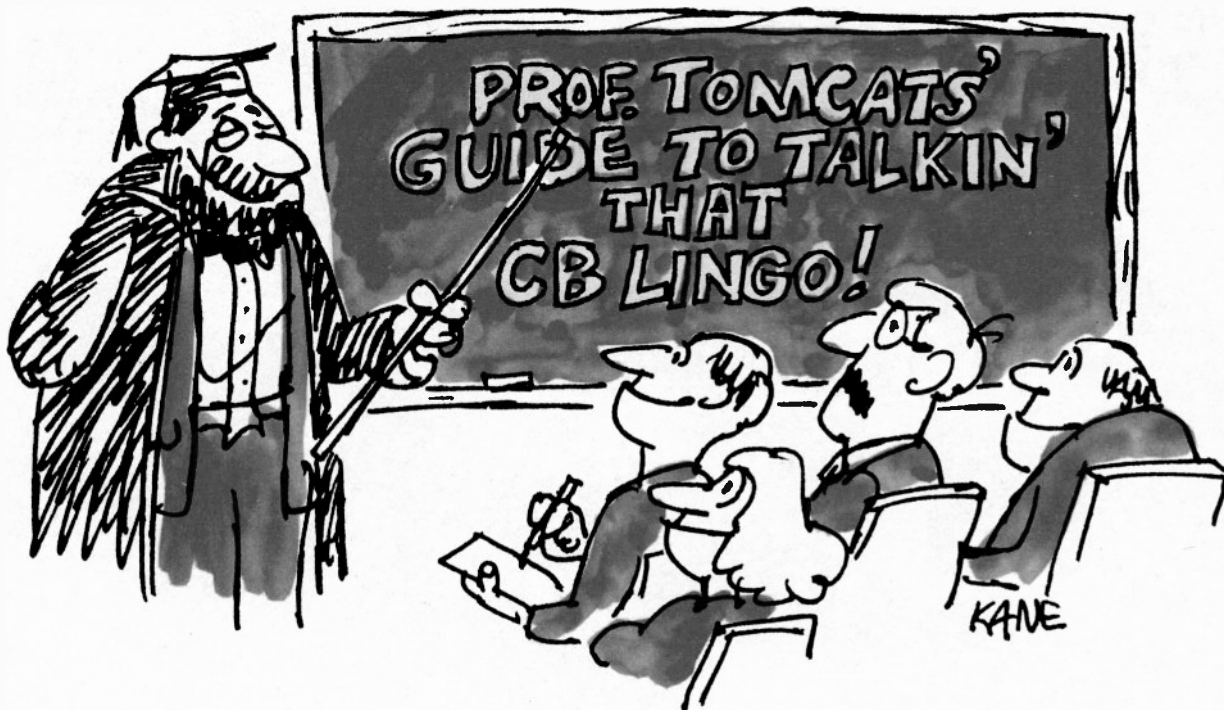

by Tom Kneitel, TOMCAT, S9's Editor

**N**EW operators always seem to have that gnawing fear that they will *sound* new, that within the first five words they speak they will reveal to the world that they are on the air for the first time. Even many people who have been on for a long period of time still retain this fear because they haven't found it easy to master the art of speaking the language of CB radio. I don't know why there is such a fear that someone might identify another operator as being *new*, but to many operators it's a bad scene!

To help meet these needs, a number of books and dictionaries have appeared on the market giving long lists of CB words, however, as helpful as they might be, there are still other factors to be considered. For one thing, at least 60 to 75% of the words and terms listed in these publications are so seldom heard in use that they are hardly worth noting, and secondly, speaking CB is a lot more than having a list of words. If you had a French dictionary could you speak French? Obviously not! There are rules of grammar and all sorts of other considerations in putting the words together into meaningful sentences—then there is pronunciation and lots more! Same with CB lingo. The books just don't ever tell you!

Have no fear, *Tomcat* is here! I have distilled into a single concise home study lesson all of the major

factors in how to instantly speak CB like an ace—or at least you can bluff your way through a shout to the point where you *sound* as if you had been on the air for years! Just follow these simple guidelines.

#### THE GENERAL ACCENT

The biggest asset is a dialect which places your roots in the Deep South—but not necessarily the modern south, but the Deep South that appears in multi-million dollar Hollywood flicks about the Deep South. Listen to the record *Convoy* (remember that golden oldie?) a few times to aid you because that's the proper accent. In fact, before *Convoy* came out, nobody even realized that you were *supposed* to speak with an accent or dialect. Now it is a fact that all CB'ers are permitted and authorized to speak that way, whether you're from Minnesota or Manitoba—so don't worry about the fact that you normally sound like you come from Baltimore, Boston, or Brooklyn! I can assure you that nobody will ever question that you hail from Seattle but sound like Savannah!

Further to the general accent which should pervade your accent, note that there are certain words and phrases which cannot be read coldly from a CB dictionary and which must be pronounced in a very special way to be authentic. Like, only a total greenhorn

would pronounce the word *roger* the way it looks on paper. The only way to pronounce this word is *r-a-a-a-juh!* with the accent on the final *juh!*

Another example is the term 10-4. This should be pronounced *Ten-Foe!*

Going further, we have the expression *come on*, used to invite another station to transmit to you. This word is pronounced *kay-moan?* Note that it is stated as a question, with the stress on *moan*. To be perfectly in style it should be said twice—*kay-moan? kay-moan?*

Then there are those expressions which probably were once separate words but have now become single words which apparently combine elements of the original words, however the roots of these words are lost in history. For instance, the word *gimmeesumnumberz* is a word meaning *I am willing to tell you how your signal strength reads on my meter*. There are too many of these words to list here, however be aware that they are amongst the most difficult part of learning to speak CB since they do not appear in any CB lingo dictionary.

### HANDLES

A good rule to follow, when referring to yourself on the air: the words *the one* should precede your handle. If your handle is *Flying Flunkie*, you'll sound much more authentic if you refer to yourself as *The One Flying Flunkie*.

If you are speaking about another operator, that rule is cancelled. It is poor taste to call another station *the one*. Other stations should have the word *that* attached to their handles, so instead of speaking about calling *Disco Dolly*, you would shout *That Disco Dolly*. Optionally, the word *that* may be added to the names of roadways (*That East West Greenstamp*) and cities (*That Cactus Patch*). It's a nice touch and shows breeding, but it isn't an absolute must—but it's the difference between a person who calls a tomato a tomato and someone who says *tah-mah-to!*

Instead of or in addition to handles, a great many stations identify by unit numbers, and an acceptable way to address one of these stations on the air is by adding the word *Mister* to the number—*C'mon back Mister 477!*

Besides being concerned with station handles and unit numbers, you're going to have to face up to the fact that cities, states and towns often have their own handles which *must* be used. New York City has to be called *The Big Apple*, Chicago should be called *The Windy City*, Florida is the *Bikini State*—there are a whole selection of place names to use. Of course, not every community in the world has an established CB lingo handle—but you can always make one up in a pinch. This is done by adding the words *that old* before the community's name, and the word *town* after it. So if you were to refer to Glitchville, you would say *That Old Glitchville Town*. The height of accomplishment in this art was achieved one day while I was mobiling in Maine—I asked a CB'er where I could



find a good place for trout fishing and he directed me to a place *near that old Old Town town!*

### PRONOUNS, TENSE & THAT STUFF

While the words *I* and *me* are acceptable, the plural forms (*we*, *us*, etc.) are much more acceptable—this being because the true CB'er thinks of himself as a single communications unit with his radio equipment—hence saying things such as *we* when referring to himself—like a king might do. Also, the words *are* and *am* are NOT to be used at all and some operators have determined that it may be a serious violation of CB lingo rules to use them—although substitutes are available if necessary. So, instead of saying *we are gone*, the proper way of stating this is *we gone!*

The word *be* has many CB applications, including as a substitute for *are* and *am* for those who feel that it helps to fatten out a CB expression. So instead of *we gone*, you might say *we be gone*. One of those little things which makes CB lingo so flexible and fascinating. The word *be* can also be used for *is*, as in *where be your 20?*

All inanimate objects such as roads, CB gear, vehicles, etc., are feminine in gender and must always be considered to be *she*.

So if you were asked what type of wrapper you were in you might say *she be green with a white top*.

### USE OF NUMBERS

With but little practice one can become a master at the use of numbers.

All road designator numbers are said digit by digit—and it is preferred if they start with the word *that*. So instead of saying *Route Three Twenty Six*, you would more properly say *That Route Three Two Six*, as in *That Route Three Two Six, she be clean and green!* See, you're getting the knack! Just add a *Good Buddy* to the end of that sentence and you could *pass* for an old pro *even now!*

Numbers are used interestingly at the end of many contacts, such as wishing *good numbers* on the other station, even though the specific meaning of that phrase seems to be obscure and is one of the great riddles of the Egyptian Sphinx. Some operators are rather specific in which of the good numbers are to be invoked, so therefore you might wish to bestow *threes* or *threes and*





*eights* upon another station. Since the term *eights* refers to the old radio expression "88's" which means "love and kisses," you might wish to use some discretion as to whom you say this—even though most CB'ers either don't know or care what it means. On CB everybody loves everybody—guess that's why so many guys always say *threes and eights* to each other. A little love I can handle, I don't know that I'm ready for kisses at this point!

The 10-Code is another famous set of CB numbers—use it as often as you can. It's a great time saver. Isn't it much easier to tell someone *I've got a 10-1 copy on you* than just saying something stupid like *Can't hear you!* Actually you might have shortened the entire message down to the term *10-1* alone, without all of the words—but what fun is that? CB is to communicate—*words* are communication, if we just wanted a bunch of numbers we could replace ourselves with computers!

So, the 10-Codes are then to be inserted into sentences as if they are words themselves, get it? Sometimes they are used and misused to reconfirm and emphasize the words spoken in a sentence, just in case there was some doubt as to the meaning of what you said—such as *nothing else to say so we be standing by and going 10-10!* Another example: *Can you relay a 10-5 to our mobile unit?* Or how about, *You sound great, real 10-2 copy!*

Don't worry about your inability to memorize these signals, it's not too important and you can probably fake many of them until you've got them mastered. As a last resort, if someone throws one at you that you don't understand, just go back with something like *Yeah, 10-4, 10-4—we got a wild 10-47 situation here now so we have to back outa here now!* Or try: *That's a 10-61 if we ever heard one, Good Buddy!* Neither of these will have any meaning at all to the other station, except to let the other operator know that you are not to be trifled with.

Signal reports are another use of numbers, all S-meter readings must be announced in *pounds*, and are to be considered to be the result of the effects of a signal being forcibly thrown or hit upon your equipment. So when you are asked, *What be we hitting*

*you with?* You are expected to present your reply in terms which will relate to that context—*You be hitting us with 9 pounds!*

Now, when somebody is going to give you a signal report, it apparently makes no difference at all that you may have been talking to them for several minutes and they could have looked at their S-meter at any time during that period. They seemingly are unable to get their meter to give an adequate reading even while you're asking them to give you the signal report. Due to some insufficiency in the design and manufacture of CB equipment, S-meters only work when they are recording a signal which is being modulated with the mystical numbers *1-2-1-2-1-2*, said exactly that way *and in no other way*. So if you want an *accurate* report on your signal, you'll have to remember to say *What be we hitting you with? 1-2-1-2-1-2*.

All channel numbers are referred to *only* by individual digits—anybody who would refer to *Channel Fourteen* would be talked about. The proper and acceptable way of saying it is *Channel One Four*.

### CATCH WORDS AND PHRASES

It's very effective to sprinkle your conversation with all manner of incidental words, phrases, and sound effects if you really don't have much to say but want to be polite anyway. For instance, you could reply to almost any message thrown at you with *Mercy Sakes!* (*whistle*) *You cottonpicker!* *Gimmie some more of that good modulation, you rascal!* It doesn't mean much but it will make the other operator happy and he'll rattle on for another few minutes before you have to say anything else.

Of course, the ways of saying *yes* are wide and varied, and include the following catchwords: *10-4, 4-10, A Big 4, 4, That's a 4, 40-10, 40-Roger, Roger-D, Roger, etc., etc.* You can intermix these, and don't forget that each can be repeated for effect—*4-10, 4-10!*

I do permit *advanced* students of mine to commence every transmission with the absolutely meaningless expression *Aiyee 10-4* (which is a real crowd pleaser! Beginners are not encouraged to try this for fear of mispronouncing it and blowing the whole thing. It could take months to rebuild the ol' image after drop-

**ATTENTION DEALERS! Is your present distributor "Missing the C.B. sales target?"**

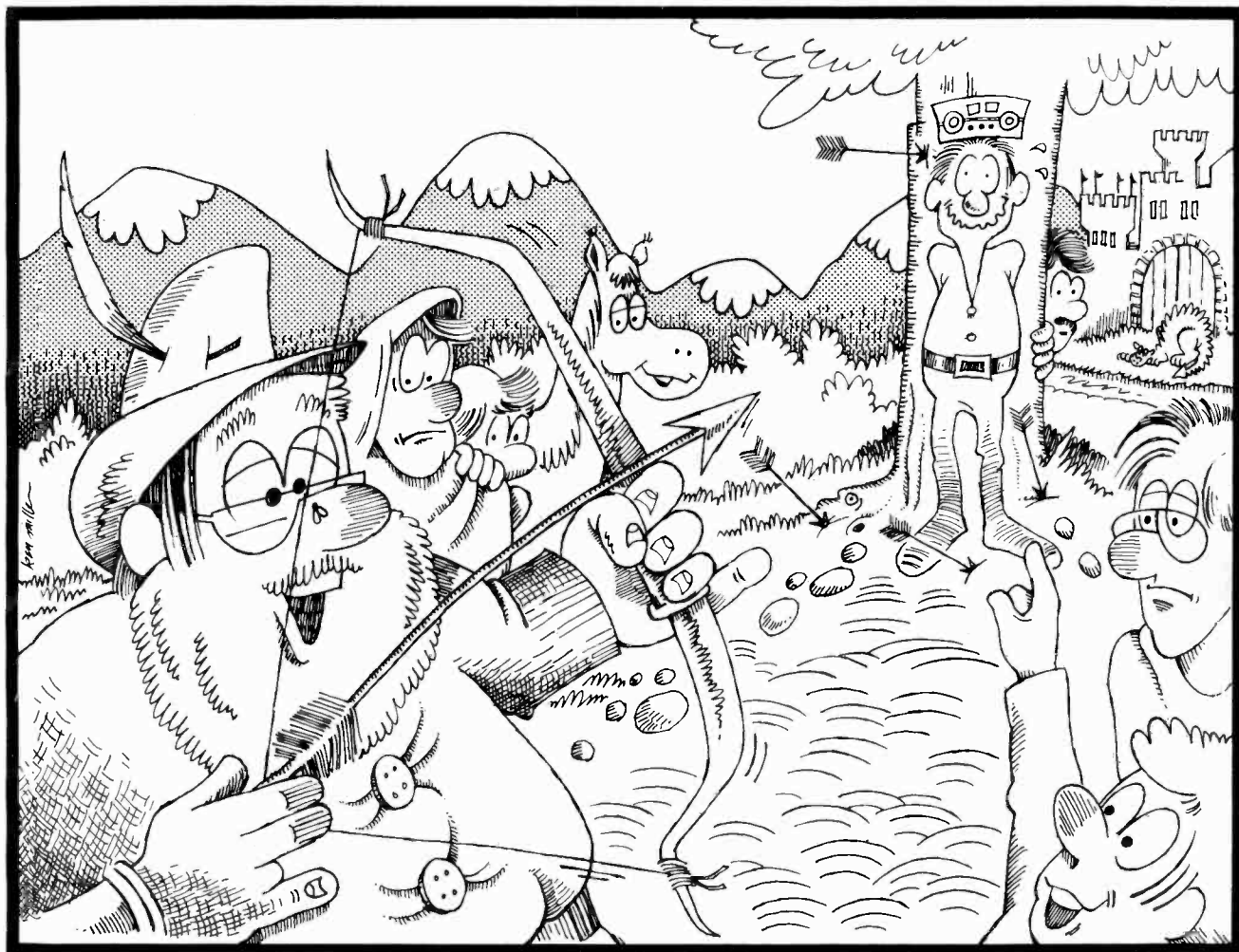

**AT BENNIES, WE AIM TO PLEASE!**

**Send \$5.00 (deductible from your first order) and your tax number for your copy of our new 248 page catalog. It's a sure shot.**



**BENNIES**

**WAREHOUSE DISTRIBUTION CENTER  
RD No. 1 Berwick, Pa. 18603 Phone 717-759-2201**

ping the ball with a poorly pronounced *Aiyee 10-4!*).

Note that all CB conversations must contain liberal sprinklings of the word *definitely* and the expression *for sure*. There is no limit to the amount of times these can be tossed into one conversation, or the manner in which they are used—you can really innovate with them too. Say things such as *we definitely using this one Frammis-23 base station for sure!* Follow it up with *For sure, you definitely have crystal clear audio!* (Audio is rated only as being *crystal clear* or *clear as a bell*.)

Bone up on all of the ways to back out of a contact with style and grace—*Have a good day today and a better day tomorrow!* or something along those lines is good to start off with. There are dozens and you are encouraged to collect an assortment which can be used freely. Those with a religious blessing connotation are popular in some quarters. In some areas, look for wildly funny ones relating to different aspects of male/female relationships.

### MAKING CONTACT

For those of you who want to really sound like the ultimate in professional CB operators, I would suggest devising some clever and unique way of breaking onto a channel, as simply asking for a break by saying *break* sounds too much like a newcomer. Be clever, listen to some of those people who have dreamed up their own distinctive announcements like *breaker broke broken*, or *Bray-kah Bray-kah Bray-kah*, or similar. Even if you can't think up one of these for yourself, if you reply to a station which has used one of these really funny and original announcements, you can always elbow in on the other guy's far-out sense of humor by repeating his own funny break—saying something like *go ahead breaker broke broken!* That should leave everybody on the channel in stitches even though they've only heard it 206 times in the past two hours!

When calling another station, it is preferred if you add the expression *we trying* (pronounced *we trine*) after your call—as in *Mister 877, The One Unit 485 calling. We trying!* This is needed so that the station being called will know that you aren't making idle test calls just to check out your operating technique, but that you are seriously and definitely attempting to get a response—that you are for sure trying in every way you know how to make contact. This way, the other station won't say to himself—*there goes that 485 fooling around again!* Instead he will say—*this is no fooling, he is actually attempting to reach my station!* You will find that *we trying* definitely gets you a lot more responses.

### ABUSE

Various abusive words are frequently employed on the CB channels, but it's all in the realm of good natured fun!

It is very fashionable to try to annoy a distant station to the point where they will have to reply to you whether they feel like talking to you or not—you take this approach: *C'mon back to me you no good loud-mouth cottonpicker, don't you have any ears? Maybe y'got peanut butter in your ears you bigmouth rascal! Don't you pig farmers want to talk to anybody but yourselves? This is almost certain to get you a response—however once you are called you must then show the other station that you didn't really mean it and that it was all in fun. This is done by degrading your own station—*We got the weakest station in the county, our rig be a 1 tube hunk of junk using a damp shoelace as an antenna—our microphone is a Dixie cup and a piece of thread! Next week we definitely switching over to a power mike, replacing the Dixie Cup with a old tuna fish can, etc., etc.**

It is fitting at these times to call the other operator *Fella, Buddy, You Rascal, You Rascal You, You Cottonpicker, You Loudmouth*. Of course, the tried and true *Good Buddy* is always useful—and I think you'll find







the term *Guy* is used mainly for those with whom you are annoyed, as in *Listen Guy, you already had your nickel's worth on this channel!*

Through it all, intersperse all of your communications with generous portions of *Mercy Sakes, Gollllleeeee! Who-eeee!* and whistles; before long you'll be indistinguishable from any old timer!

**THE BOTTOM LINE**

There are still many areas to explore. If Latin is a dead language, then CB-ese is still in its early stages of development, so you can feel free to be creative. All of those wonderful words and phrases we are already using had to start somewhere! Some one person must have been the first to say *Catch ya on the back stroke* and all those kind of things. Yes, even *you* could be the creator of much to tomorrow's CB lingo, the father or mother of a whole cascade of new and clever words and phrases.

You think that there is no room for improvement? In a language system which calls for female operators to be addressed as *good buddies*, and where guys are wishing each other love and kisses, there are some definite areas for expansion!

Well, mercy sakes, you cottonpicker! We definitely gone, we down, we out, we reading the mail, we be 10-8 on the channel for sure! C'mon, c'mon? Here be the ol' Tomcat definitely going 10-7, 10-8, 10-10, for sure. Catch you on the flip-flop you rascal. Gotta copy? Whooooooeeeeee!!! Pick it up breakers!



**SPECIAL BICENTENNIAL**  
*The Liberty 200*

"THE LIBERTY 200"

- \* Bicentennial Limited Edition
- \* Gold Antique Finish
- \* Two-stage silicon transistor pre-amp with volume control.
- \* Up to 35db more gain than conventional ceramic models.
- \* The Liberty 200 is a special Bicentennial issue made exclusively for Wright Electronics by Turner Corporation. Quantities are limited.
- \* Contact Stewart Daniel, Sales Mgr.

\* WHOLESALE ONLY!  
\* DEALER/DISTRIBUTOR inquiries invited

*Wright Electronics, Inc.*  
P.O. BOX 312•200 WISTERIA DRIVE  
HATTIESBURG, MISS. 39401 PH 601-544-5881

# The Big Skip

by Frank R. Motley

■ wuz comin' down and around the mountain. Seein' it wuz Christmas there hadn't been nobody on my cotton pickin' CB fer a hour: thought I'd try her again.

"Breaker!  
Breakety-broke!  
Anybody got a copy on this ole Unit 966?"  
Nearly jumped outa my britches.  
Jes like he was settin' in my ol pick 'em up truck with me come the comeback.







"Mercy sakes there, God. You're definitely puttin' a big twenty-plus on me here on this end. What kinda set you got there? Ten four?"

"Oh, I just got one of them little ol' twenty-three channel jobs. Bring it back."

"Yeah, ten-four on that rig, God. We must be gettin' a mighty big skip today. Never even heard of your ol' twenty there fer sure. How fer apart you reckon we are there good buddy?"

"Mercy sakes there good buddy, we're at least two hundred million light years apart, ten-four?"

"Mercy sakes. Yeah, ten-four on that twenty. Don't know jes how fer that be. But it's definitely a monster skip fer five watts of power, ten-four?"

"Ten-four on that monster skip, Knob Rabbit. The conditions are just right for a message I have for you to 10-5 to the world."

"For sure we gonna hafta back 'em down now, God. I see a bear in the grass on the median strip and he's got a picture taker fer sure."

"Ten-four, Knob Rabbit. Been definitely good modu- latin' with you fer sure. This is God, we be down and on the side. We gone."

"Ten-four, God. Have a good day today and a bet- ter day tomorrow, and may the good Lord take a likin' to you! Can't afford to spend none of the green stamps. Breaker! Breaker! Any of you cotton pickers passin' the seventeen-mile marker southbound had better smile. You'll be on television. There's a smokey settin' up in the grass there on the medium and he's takin' pictures fer sure."

"Yeah. Bring it on breaker!"

"Yeah," I said, "mercy sakes there good buddy, who've I got on that end. Ten four?"

"Yeah, ten four there, good buddy. Mercy sakes, you got that one and only original *God* on this end. Come back."

"Come back on that handle one time there good buddy," I called, "did you say *Odd*?"

"Negatory there good buddy. That handle's *God* on this end. Ten four?"

"Yeah, a big fat ten four on that *God, God.*"

Then he come back. "What's your handle there you cotton pickin' cotton picker? Whip it on."

"Yeah, ten-four there *God*. You got the one and only Unit 966, the Knob Rabbit on this end fer sure."

"Ten-four Knob Rabbit. What's your twenty?"

"I'm just passin' that ol' Wayne Feed store, *God*, with the hammer down and doin' it to it, southbound. How'm I puttin' out to you there?"

"Ten-four, Knob Rabbit, you're comin' in wall-to-wall and tree top tall on this end. Puttin' a big ten-plus on the meter. How am I doing it to you? Comeback."

"Comin' in real good on this end, *God*. Really blowin' smoke up the holler. What's your twenty there, *God*?"

"I'm just in the middle of that ol' *Andromeda Galaxy.*"

"Yeah, ten-four on that *Andromeda Galaxy*. You a base or a mobile?"

"I got a mobile on this end, Knob Rabbit. I'm on the move and just passin' through. I'm only on this chan- nel once a year or so. I want to give a message of joy to all the good buddies."

"Yeah. Ten-four on just passin' through. Is that *Andromeda Galaxy* anywhurs near *Hawleyville Cor- ners*? Come back."

"That's a big negatory, Knob Rabbit. I'm a good ways from that ol' *Hawleyville Corners* town fer sure."





# Wilson Electronics Corp.

## NEW LONG BOOM 12 ELEMENT LASER BEAM

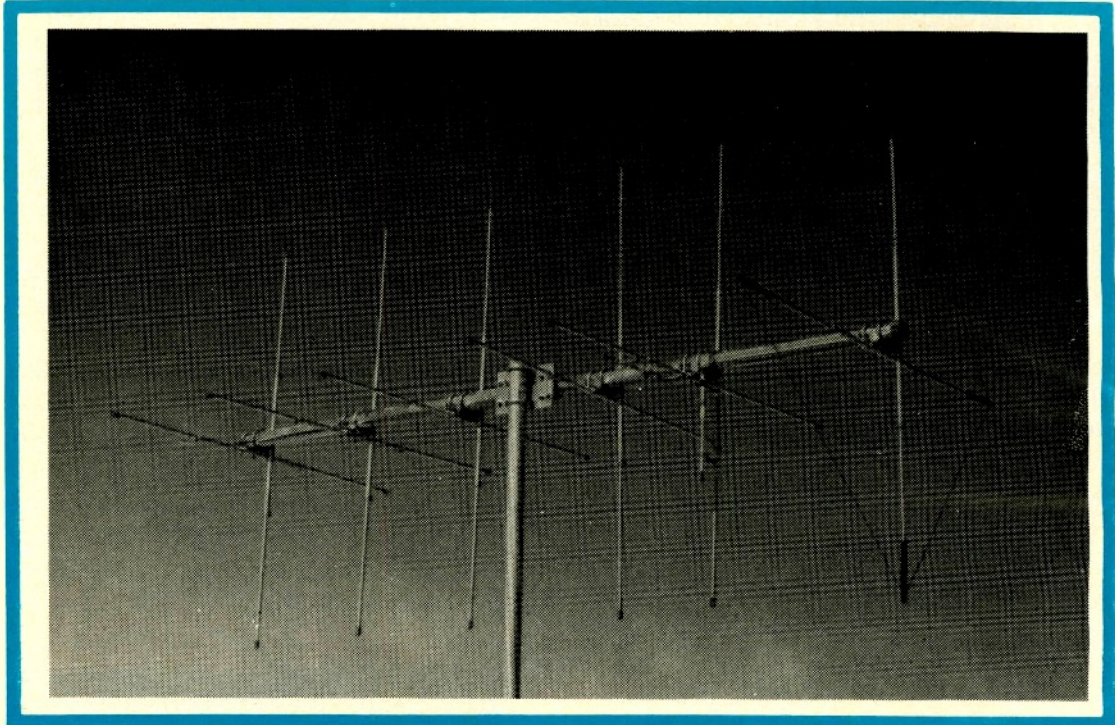

**31 FT. BOOM**

**400 WATTS EFFECTIVE POWER**

The new 12 Element Laser has been expanded to achieve the maximum forward gain and front to back ratio covering a wide range of installations. This is achieved by the unique use of a Quad Reflector and Yagi Parasitic elements. There are six elements horizontal and six elements vertical, scientifically spaced, on a new 31 ft. boom. The 12 Element Laser has been tested and proven. It is second only to the Super Laser 500. The same top quality aircraft aluminum that has made Wilson Electronics famous, is used in the new 12 Element Laser.

#### MECHANICAL SPECIFICATIONS

- Boom Length - 31 ft.
- Longest Element - 17.5 ft.
- Elements - Aircraft type aluminum
- Element Mounts - Aluminum extrusions - Quad Reflector Wire - 14 GA. Copper Stranded
- Boom - 2" OD
- Weight - 45 lbs.
- Fiberglass spreaders
- Recommended Rotor - Ham II

#### ELECTRICAL SPECIFICATIONS

- Gain - 17 dB
- Front to back ratio - up to 40 dB
- Side Rejection - up to 45 dB
- Horizontal or Vertical Polarization
- Power Capability - 2,000 watts
- Adjustable Gamma Matches for Horizontal & Vertical
- SWR - 1.3 to 1 or less
- 400 Watts effective multiplied power

**SEE YOUR FAVORITE DEALER**



**4288 S. POLARIS**

**LAS VEGAS, NEVADA 89103**

**(702) 739-1931**



# ON THE COUNTERS



## SBE "TOUCH/COM"

SBE's one-of-a-kind Touch/Com is a unique 23-channel transceiver in which controls for all key functions usually found on the front panel are brought out on the microphone.

Complete CB operation is now possible entirely from the microphone. Two up/down buttons on the top of the microphone control channel changing—one for advancing to higher channels, and the other for reversing to lower channels. By momentarily pressing the appropriate button, the set will "step" to each channel, up or down. By depressing the button and holding it in, the channels will continue to change rapidly. The channel readouts on the microphone are large base-station sized red LED's, polarized for easy daylight viewing. Full range volume and squelch thumbwheel controls, both fully adjustable, are located on the right side of the microphone. A push-to-talk switch is located on the left.

The Touch/Com, engineered with the famous SBE "Formula D" circuitry, includes phase-lock-loop with digital synthesis for 23-channel precise-frequency operation. The dual-conversion receiver contains an extremely selective 4-pole ceramic I.F. filter for sharp selectivity. Field Effect Transistors in the receiver RF section lead to optimum sensitivity with a low noise ratio. Receiver automatic gain control yields smooth

undistorted audio under varying signal conditions. Audio tone is adjustable.

The transmitter features the maximum legal output power with peak modulation, derived from a built-in speech processor.

The transceiver is equipped with front panel controls for audio tone, public address volume, local/distance switch control, delta tune, noise limiter, "on air" transmit light, and a large illuminated combination power output/S meter.

The receiver section utilizes dual conversion which enhances selectivity and decreases adjacent channel interference.

The unit operates on either 13.8 volts direct current positive or negative ground systems.

Priced at \$289.95, the SBE "Touch/Com", identified as Model No. SBE-32CB, comes with full control microphone, mounting bracket, connecting cables, and PA speaker plug.

For further information, write SBE, Inc., Dept. P, 220 Airport Blvd., Watsonville, CA 95076.



## 23-CHANNEL MOBILE CB TRANSCEIVER

The Royce Model 1-655 incorporates THE WIRELESS chassis—Royce's revolutionary new innovation in citizens band radio design. THE WIRELESS is a manufacturing procedure utilizing automated assembly of modules on modern production lines. Each module is automatically tuned and tested to strict computer programs. There are no wires connecting modules. Not one point on the modules or chassis is soldered by hand. And, each circuit module is mated to the master board by precision assembly techniques. (continued)

## ON THE COUNTERS (continued)

The Model 1-655 features: Full 23-channel operation from Royce's exclusive Gyro-Lock (PLL) system; large, illuminated 1½" x ¾" S/RF meter; exclusive IC audio stage with 6 watts RMS; amplified AGC circuit; three ceramic filters; dual conversion receiver plus tuned RF stage; metal case RF output transistor; positive or negative ground operation for any vehicle, with plug-in DC cord; relay switching; L.E.D. transmit light; AMC circuit; fully variable squelch control; large 3" speaker; continuous fine tuning control; full-size, plug-in mike; accessory jacks for external speaker, P.A. speaker, and DC power cord; and a rugged, scuff-resistant, vinyl-clad metal cabinet.

For more information, contact Royce Electronics Corporation, 1746 Levee Road, North Kansas City, Missouri 64116.

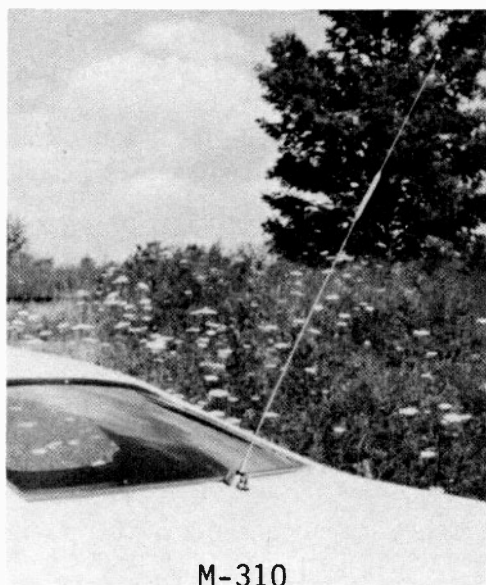

M-310

### NEW LOW PROFILE TRUNK MOUNT

A new low profile CB antenna that mounts easily on the trunk lid without scratching paint is now available from The Antenna Specialists Co.

The new model, M-310, utilizes the famous Antenna Specialists "Quick Grip" mount that fastens firmly without drilling holes or damaging painted metal surfaces.

This new addition is a compact center loaded antenna with a weatherproof coil on a stainless steel whip that measures only 48" overall. Includes 17 feet of coax and PL-259 connector.

Manufacturer's suggested list price: \$19.95. For further information, contact: The Antenna Specialists Co., 12435 Euclid Avenue, Cleveland, Ohio 44106.

### UNIVERSAL MOUNT CB ANTENNA

Antenna, Incorporated has introduced a universal, mount mobile antenna for CB.

The Peace Maker (Model 12610) mounts virtually anywhere, and features a 34-inch base loaded whip an-



tenna, professional grade coaxial cable and connector.

The universal mounting base consists of a clamp bracket fitted with a clamping plate and two lock screws. The mounting base will attach to any piece of metal up to ¼-inch thick. Two "L" shaped brackets attached to the base rotate independently to vertically align the antenna whether it is mounted horizontally, vertically or at any angle. The lower bracket rotates 360-degrees and the upper bracket 180-degrees, providing an unlimited number of mounting configurations.

The base loaded antenna features a 34-inch whip made of 17-7PH stainless steel to resist bending and a stainless steel spring to prevent damage to the antenna in low clearance areas. It is designed to achieve a voltage standing wave ratio of 1.5:1 or less and is fully weatherproof.

Suggested resale price of the Peace Maker is \$25.95. The mount alone (Model 18710) has a suggested resale price of \$13.88.

All Antenna, Incorporated products are manufactured in the United States and are completely tested and inspected before leaving the factory to ensure the highest quality.

For further information on the universal mount antenna and the complete line of Antenna, Incorporated products, contact Randall J. Friedberg, Antenna Incorporated, 23850 Commerce Park Road, Cleveland, Ohio 44122.



### CB TRANSCEIVER/ANTENNA PACKAGE

A special package containing both its CB-800 transceiver and CA-11 mobile antenna is being offered retailers by Sharp Electronics Corporation.

(continued on page 41)



# Ears to You from Radio Shack

## Realistic® TRC-74

100 mW. 2-channel capacity. Push-pull audio, sliding A-B channel selector. FCC Type Accepted.

**2195\***



## Realistic TRC-75

100 mW. 3-channel capacity. Battery meter, earphone jack, separate speaker and mike. FCC Type Accepted.

**2995\***



## Realistic TRC-180

2 watts. 3-channel capacity. Range-Boost antenna system. FCC Type Accepted.

**4995\***



**Realistic TRC-200**  
5 watts, 6-channel capacity. Range-Boost antenna system. Hi-Lo power switch, battery/RF power meter. FCC Type Accepted.

**9995\***



## Realistic TRC-3

100 mW, one channel. Superhet with push-pull audio, ruggedized case.

**1595\***



**Archer Micro**  
**1995\***  
pair

Top quality in a shirt pocket size. Chrome trim.



## Archer® Standard

Patented lock-on talk switch. Volume control.

**795\***  
each  
**1495\***  
pair



With a walkie-talkie you've *always* got ears. For traveling, camping, boating, work, rag-chewing. You'll wonder how you got along without one. All with Channel 14 crystals and batteries. What could be nicer to give?



**FREE!**

164-page 1977 catalog. Full color. See what's *really* new in electronics. Get your copy now at our store near you.

SOLD ONLY WHERE YOU SEE THIS SIGN:

**Radio Shack®**

A TANDY COMPANY • FORT WORTH, TEXAS 76107  
5000 LOCATIONS IN NINE COUNTRIES

\*Prices may vary at individual stores and dealers

# You get a better "break" with Gemtronics CB Radios

Gemtronics CB Radios give you a better break on quality and value.

Because every unit is marine-quality—designed and engineered to the same exacting specifications as our famous ship-to-shore communications systems. So every Gemtronics CB Radio gives you extra sharp clarity in transmission and reception. And each

comes with a one-year guarantee (parts and labor) plus the expert service to back it up. Gemtronics also offers a premium line of scanners and antennas. So whatever you're looking for in CB Radios and accessories, see your Gemtronics Dealer soon.



**GEMTRONICS**



A **Kayot** Company

Gemtronics/Division of Gem Marine Products, Inc., Box 1408, Lake City, South Carolina 29560  
Dealer Inquiries Welcome

# Two-way improvement



New fold-down RV antenna provides full 40-channel capability. Also available for luggage racks.



Has your CB ever let you down? Right when you needed it the most?

It could be that "good deal" antenna. Or the lightweight mike that came with the set. To get the most out of your CB, switch to Turner at both ends.

Try a Turner amplified mike. You'll find out how much talk power your set can really deliver. For full range when you need it.

Make sure your antenna is dependable. Step up to a Turner. Turner builds them tougher. There are 43 models for all kinds of base and mobile installations.

Ask anybody who has been around CB for awhile. They know us. Wherever CB is sold, Turner.

The talk of the road

**TURNER**  
MICROPHONES  
ANTENNAS

CONRAC  
CORPORATION

716 Oakland Road N.E., Cedar Rapids, Iowa 52402

Merry  
Christmas  
*from all of us at*

**S9**



Hy-Gain 9 (Model 2679) 23-channel citizens two-way transceiver bolts securely in protected location in trunk or under seat.

Hy-Gain AM/FM/CB 40-channel cowl mount antenna. Replaces your standard auto antenna but looks like original automotive equipment. So you know it's CB ready. But the rip-off artists won't.

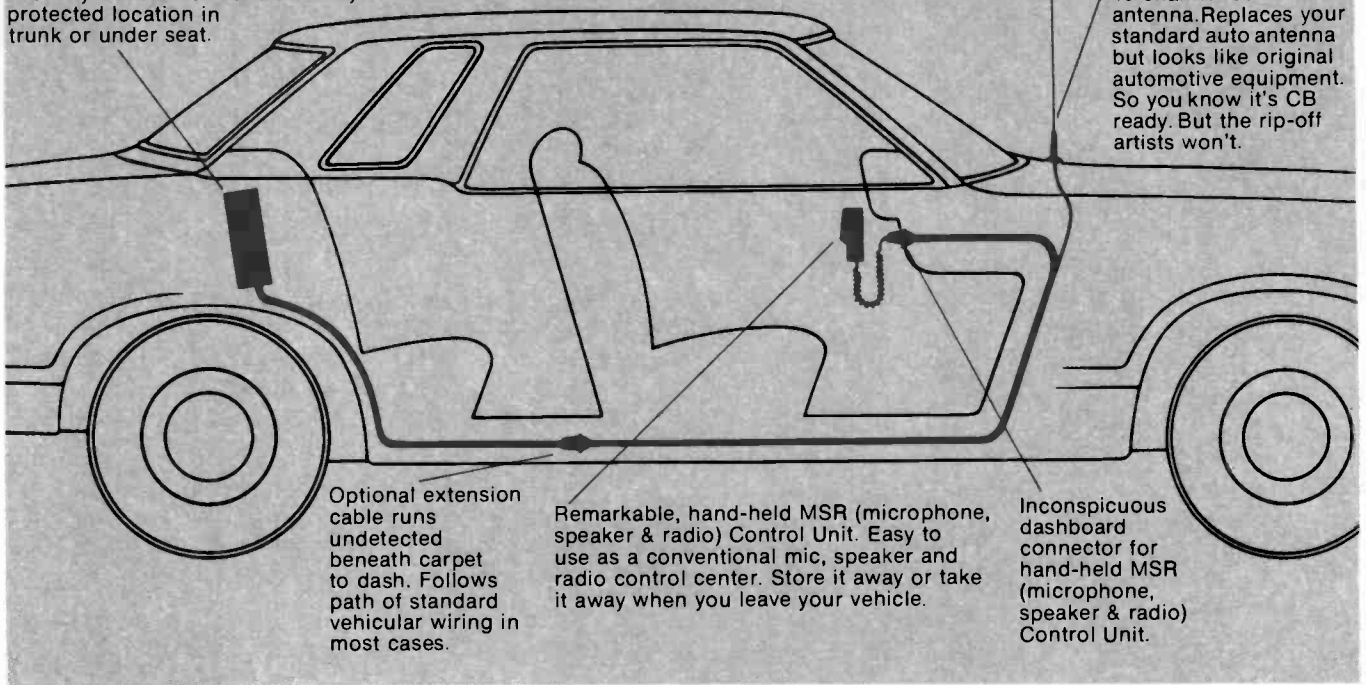

Optional extension cable runs undetected beneath carpet to dash. Follows path of standard vehicular wiring in most cases.

Remarkable, hand-held MSR (microphone, speaker & radio) Control Unit. Easy to use as a conventional mic, speaker and radio control center. Store it away or take it away when you leave your vehicle.

Inconspicuous dashboard connector for hand-held MSR (microphone, speaker & radio) Control Unit.

# Now, the radio that's out of sight is ready for 40 when you are.

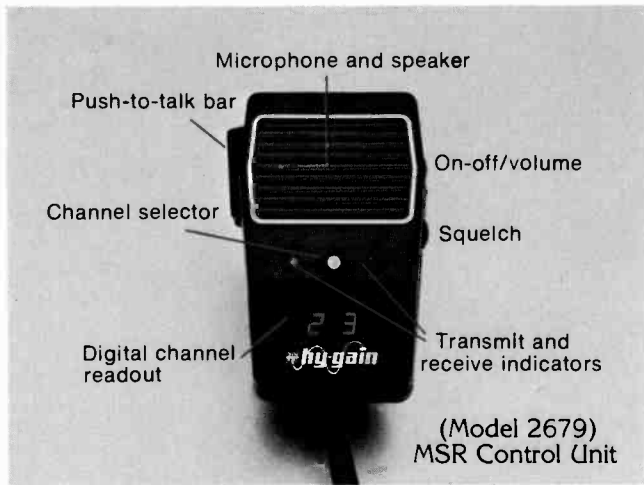

(Model 2679) MSR Control Unit

Our Hy-Gain AM/FM/CB cowl mount is the perfect 40-channel antenna to go with your Hy-Gain 9. It replaces your standard auto antenna. And looks just like original equipment. So you'll know you're CB ready. But the rip-off artists won't.

The only part of the Hy-Gain 9 that's around while you're around is our ingenious, hand-held MSR Control Unit for operation of microphone, speaker and radio. Take it with you or store it when you go. And all that's left is an inconspicuous connector under the dash. Everything else is out of sight.

Including performance. With the Hy-Gain 9 you get advanced noise limiting. Range boost. Automatic gain control. Mic preamp. TVI filter to help prevent TV interference. And the incredible frequency stability of Hy-Gain Phase-Lock-Loop circuitry.

See the citizens two-way system everyone's looking for at your Hy-Gain dealer. It's ready for 40 when you are. And ask about our more than 300 other fine two-way communications products. For the name of your nearest Hy-Gain dealer call 800/447-4700. In Illinois 800/322-4400.

The Hy-Gain 9 (Model 2679) 23-channel citizens two-way mobile transceiver goes out of sight. In the trunk or under the seat. Away from temptation. And it comes with a certificate for remanufacture to FCC 40-channel specifications. It's our guarantee your new radio will be 40-channel ready.

If, after January 1 and FCC acceptance, you want all 40 channels, send us your certificate. And \$25 for remanufacturing. We'll remanufacture your radio for all 40 channels (offer expires June 30, 1977).



Hy-Gain Electronics Corporation 8601 Northeast Highway Six; Lincoln, NE 68505  
Hy-Gain de Puerto Rico, Inc. Box 68; Naguabo, PR 00718

The following Hy-Gain 23-channel radios can be remanufactured to FCC 40-channel specifications after January 1, 1977 and FCC type acceptance.

681, 682, 2680, 2681, 2682, 2683, 2679, 3084

If you currently own one of these radios, a 40-channel certificate may be obtained from your Hy-Gain dealer.

## ON THE COUNTERS (continued)

The package—CB-PAK-2—offers the retailer a compact package that includes the two elements a CBER needs to transmit and receive. It enables the retailer to display and sell both elements together.

The CB-800 features a LED digital channel indicator and a pulsing red light for Emergency Channel 9. Like all Sharp CB transceivers, it has phaselocked loop circuitry.

The CA-11 is a trunk mount lip type antenna with a three-step telescopic rod which telescopes from a minimum of 26 inches to a maximum length of 60 inches.

The CB-PAK-2 carries a suggested retail price of \$169.95. Contact them at 10 Keystone Place, Paramus, N.J. 07652.

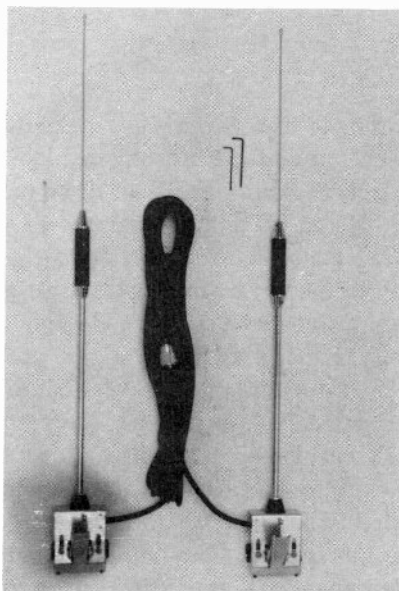

### TWIN GUTTER-MOUNT ANTENNA

Mura Corporation announces the addition of the CBA-4, a twin gutter-mount antenna, to its existing line of Rangefinder™ antennas. Combining the convenience of *gutter-clip mounting*, with the range and radiation pattern of a *dual cophase antenna*, the CBA-4 incorporates a high degree of performance and practicality.

Ideal for car, van or truck, the CBA-4 is sturdily constructed of the highest quality material: chrome-plated brass, *heavy gauge copper windings*, and a high tensile-strength, stainless steel whip. All of which provide for long life, rust resistance and top performance. Additionally, the CBA-4 includes tunable whips for achieving low SWR, and simple spring-mounting clamps for quick installation and release—*without screws and without drilling*.

A nine-foot dual coaxial cable leads from the antenna, terminating in a standard PL-259 type plug connector. All *hardware is included*.

The new CBA-4 antenna has a suggested list price \$39.95 and is available at leading electronic and CB communication centers. For further information, write to Mura Corporation, 177 Cantiague Rock Road, Westbury, N.Y. 11590.



### CB-SAVER

Falcon Enterprises, Inc. has released the CB-SAVER, a storage and travel case for CB radios.

The all new CB-SAVER has a tough, attractive, molded case with foam cushion interior. The foam interior panels are adhesive backed and removable for custom fitting of most CB radios up to 3" X 9" X 12". Ideal for use with slide or lock mount brackets, the CB-SAVER provides a safe, secure means of storing or transporting CB rigs.

The "Do-It-Yourself" custom fitting takes only minutes and the CB-SAVER protects radios from damage and dirt while providing a practical solution to the increasing problems of theft.

The CB-SAVER is the ideal compliment for any CB-radio and accessory program, with tremendous potential for all levels of CB merchandising.

For further information contact: Falcon Enterprises, Inc., 3960 S. Marginal Rd., Cleveland, OH 44114.

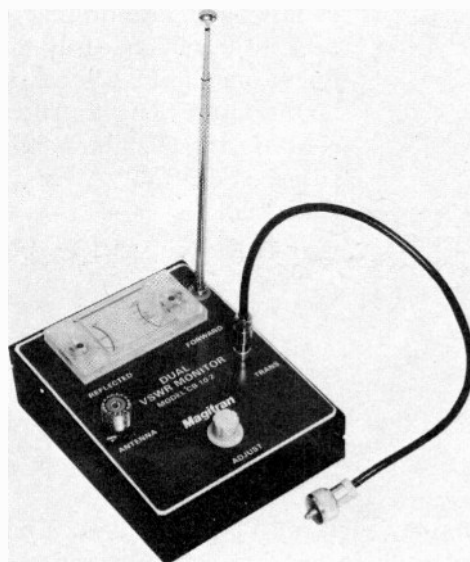

### METER, METER ON THE WALL . . . WHOSE SIGNAL IS STRONGEST OF THEM ALL?

A new VSWR meter, from The MagiTran Company, may not allow you to cast any spells, but it sure will

## ON THE COUNTERS (continued)

tell you a thing or two about your CB signal.

This unique new dual meter VSWR and field strength monitor, Model CB 10-2, enables continuous monitoring of output power and antenna condition on any base station or mobile CB equipment. The dual meter feature eliminates the need for switching, as is the problem with single meter units. And the CB 10-2 can remain in the circuit continuously, without any power loss.

The simple operation of the new dual meter monitor allows you to adjust the level on one meter and read VSWR on the other meter. A built-in telescopic antenna is used for field strength measurements.

The CB 10-2 offers an inexpensive method of obtaining sophisticated VSWR and field strength measurements and is easily installed, virtually in seconds. The monitor comes complete with all interconnecting transmitter cables.

Contact Magitran Company, Moonachie, NJ 07074.

### A CB ANTENNA READY FOR CHANNEL EXPANSION

Anixter-Mark introduces "The Long Gainer"—a new tunable base loaded stainless steel antenna that can be easily adjusted to cover all channels across the band. Just a simple turn of the frequency adjustment screw brings in the desired channel clearly. It also has the capability of tuning in all the new channels as they become available.

The smart-looking "Long-Gainer" has a long lasting stainless steel whip and deluxe mount with high quality coaxial cable designed for easy snap-on installation. No drilling is required, because it mounts easily to the trunk lip. A genuine PL-259 coaxial connector that insures long life is also included.

Maximum height: 60". Tuning range, 26.9-27.5 MHz (50 plus channels).

Contact your local Anixter-Mark dealer.



### CB HEADSET

Telex's new lightweight CB headset, Model CB-88, features a noise-cancelling power microphone that delivers clear, crisp voice transmission even in a moving vehicle where wind, traffic, and engine noise normally interfere with sound quality. The mike has a variable-gain amplifier and is mounted on a pivoting boom so that it can be positioned close to the lips and moved



aside when not in use. A push-to-talk switch has a clip for convenient attachment to shirt or blouse.

The headset, weighing less than three ounces, closely follows the design of pilots' headsets, of which Telex is the leading manufacturer. Incoming signals are carried directly to the ear by means of a soft eartip, allowing even weak signals to come in clearly. The unit can be used with either the left or right ear, and—if desired—can be worn without the headband. An adapter is furnished which allows the ear-piece to be clipped to the user's eyeglasses. This also allows the CBer to monitor the radio in private without disturbing passengers. Price is below \$70.

Detailed information may be obtained by writing Telex Communications, Inc., 9600 Aldrich Avenue So., Minneapolis, Minn. 55420.



### MOBILE ANTENNA ELIMINATES NEED FOR GROUND

Owners of boats, sports cars, fiberglass surfaced RV's, tractors, motorcycles . . . vehicles of all kinds con-



A few minutes alone with our new LED frequency counter and you'll know what we mean. The FC-1 speaks for itself. Quietly. With all the features and craftsmanship the serious CBe demands.

The FC-1 indicates transmitter frequencies in a range from 5 KHz to 40 MHz, on a big, bright five-digit LED display. Two crystal controlled time base ranges offer  $\pm 00$  Hz accuracy on the lower range or  $\pm 1$  KHz on the upper range. With the flip of a switch.

Other features include a two position sensitivity switch, AC operation, or DC operation with positive

or negative grounding.

Craftsmanship: The FC-1 is built to be rugged and sensitive. To help you get all the power and accuracy that high-priced set you're so proud of was built to give. Siltronix guarantees it with a comprehensive testing program and a full warranty against defective parts and labor. And with the reputation of being the CB sister of another top name in radio electronics, Swan.

If you're on the look-out for a hot new accessory, look for the Siltronix FC-1. You won't find it just anywhere. Only at the better pro radio shops. Even then you may

have some trouble, because these meters seem to be disappearing off the shelves quicker than you can say LED. If you need help, call us for the name of the Siltronix dealer nearest you.

It's worth some extra looking. The Siltronix FC-1, built to quietly dazzle your ears off.

Sells for \$169.95.



A Division of Cubic Corporation 330 Via El Centro  
Oceanside, CA 92054 (714) 757-8860

## The Siltronix FC-1. Built to quietly dazzle the ears off the serious CBe.

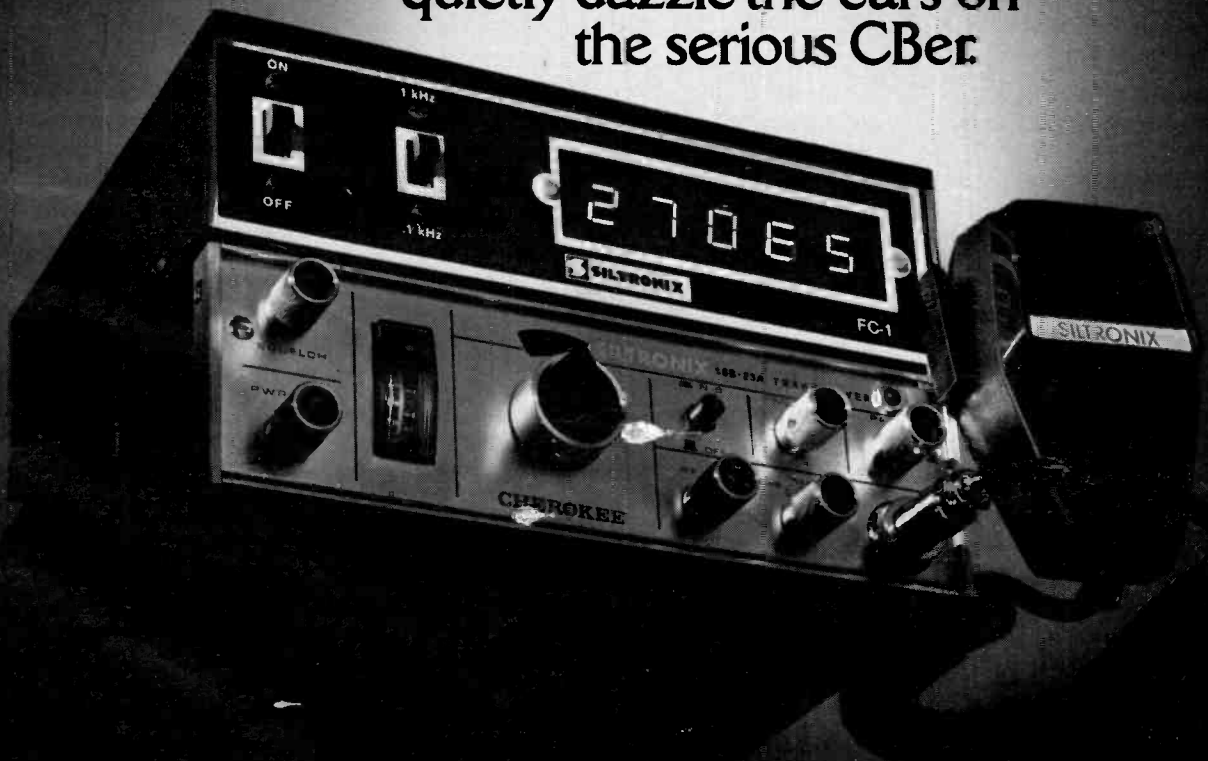

# Craig Scanners. On top of the action.

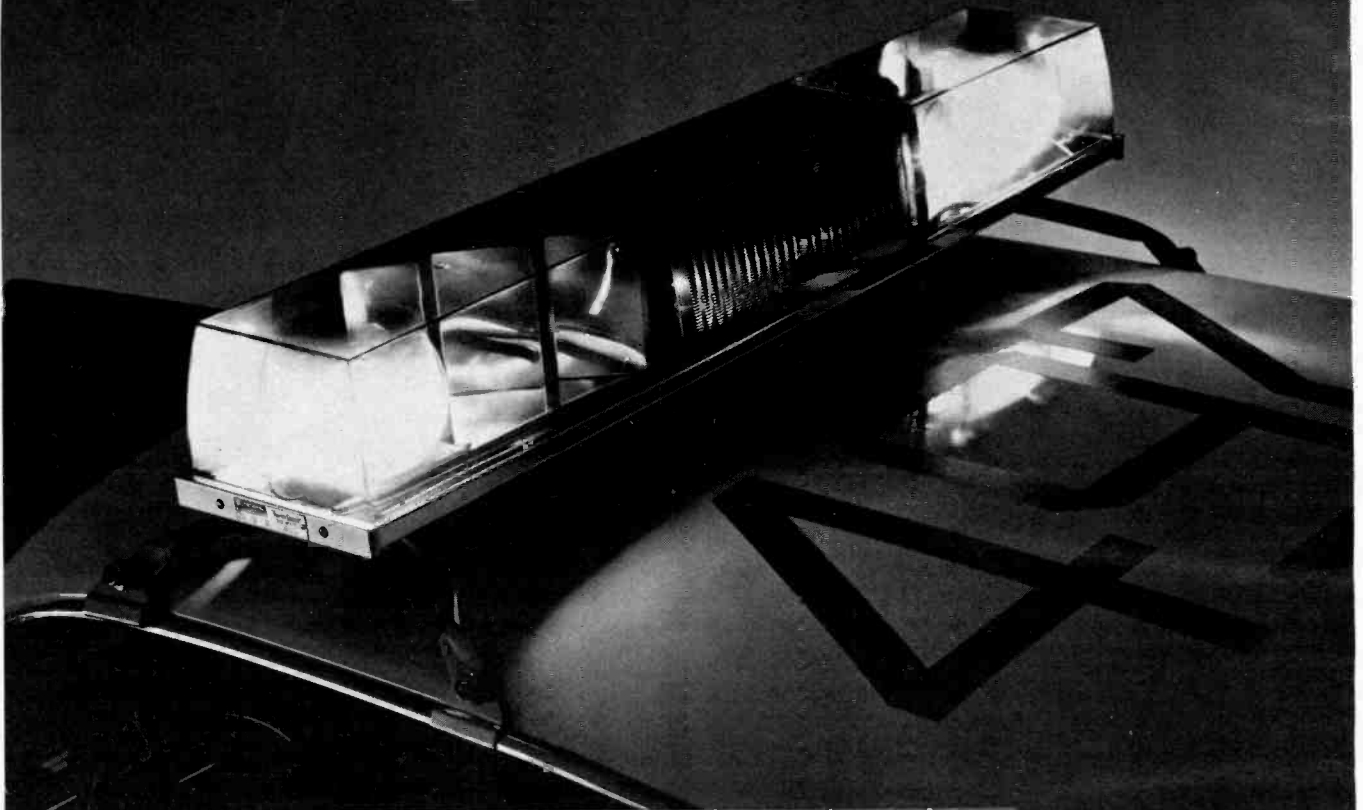

Craig Scanners keep you right on top of the action. At home or in your car, you hear emergency broadcast calls as they happen. It's like being right there at the scene of the action. □ You can rely on Craig's rugged line of multi-band scanners to give you the clearest reception even under the toughest conditions.

Craig Corporation, 921 West Artesia Blvd., Compton, Calif. 90220  
In Canada: Withers Evans, Ltd., 3133 Sumner Ave., Burnaby, B.C., Canada V5G 3E3

## ON THE COUNTERS (continued)

structed with fiberglass surfaces, can now enjoy extra-distance CB communications with the rugged new "John Paul Jones" (Model 10-500) CB mobile antenna with ball mount, just released by the Breaker Corporation, Arlington, Texas U.S.A.

A new antenna design from Breaker, the 51-inch Model 10-500 incorporates special top and base loading to achieve an effective ground plane thus eliminating the necessity for a metallic mounting surface. A heavy-duty chrome-plated ball mounting surface. A heavy-duty vertical orientation of the antenna from any surface and an Auto-Flex stainless steel spring protects the whip from obstructions or other excess stress loads.

Optimum 1.5:1 VSWR is achieved across the 27MHz band with an adjustable white fiberglass top-loaded stinger. The stinger includes a noise reducing black static arrestor. The lower section is stainless steel with white, heat shrink tubing. The slim line top load coil is ABS encapsulated for extra long life, according to Breaker.

The new "John Paul Jones" (Model 10-500) mobile CB antenna is available nationwide at electronic distributors conveniently skin-packed on striking red, white and blue display cards. It comes complete with mounting hardware, allen wrench for fine tuning, plus 18 feet of coaxial cable with pre-assembled PL-259 and SO-239 connectors. It has a suggested retail price of \$32.95.

For further information on the new CB antenna and Breaker's new "Freedom Line" of Class D Band mobile and base station antennas, plus a full complement of accessories contact Breaker Corporation, Marketing Department PR, 1101 Great Southwest Parkway, Arlington, Texas 76011.

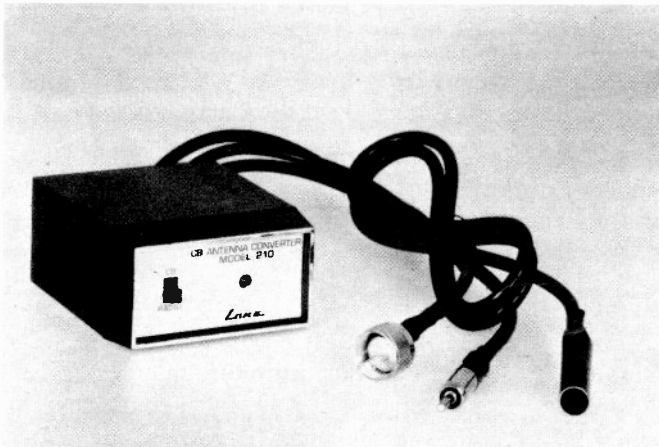

### ANTI-THEFT DEVICE

Lake Electronics, Inc., has introduced an internal antenna converter designed to prevent thefts of citizens band radios. Model 210 was especially designed to eliminate the number one problem facing most CB users today.

"Up to now, the external CB antenna was a dead give-away to thieves," said Leo Kassin, president of the Glenview, Illinois-based national manufacturer.

"We feel our antenna converter is the ultimate anti-theft device.

"Our Model 210 simply connects to the CB transceiver; then the unit is plugged into the car radio and both the car radio and the CB operate off a regular car antenna. After installation, there is no visible external equipment to attract attention to your CB unit."

The light, compact unit measuring 3½" long by 2¾" wide by 1½" deep, has a CB/car radio switch to clearly indicate which unit is operating. A tuning set-screw enables the user to adjust the SWR to its lowest point. An indicator light provides assurance of proper antenna tuning.

"We really feel this Lake product is the answer to the numerous thefts that have plagued the millions of CB users across the nation," added Kassin.

Model 210 has a suggested retail price of \$19.95. The antenna converter comes in attractive silver-chrome and black.

Contact Lake Electronics, 1948-E Lehigh Rd., Glenview, IL 60025.

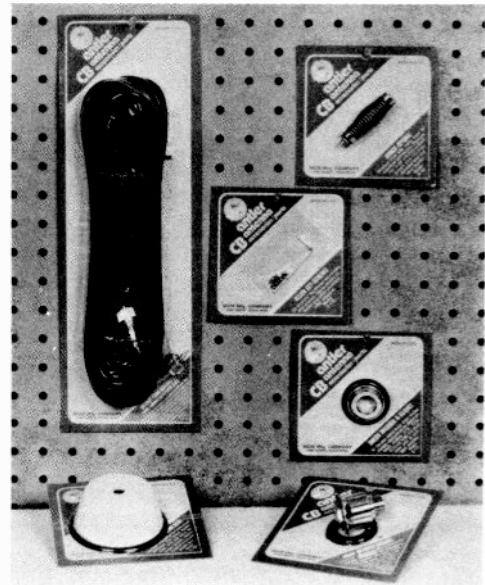

### ANTENNA ACCESSORIES

A line of Antler antenna replacement parts and accessories has been introduced by MCM Manufacturing Company, according to an announcement by the Fort Worth, Texas firm. The new line includes a wide assortment of original equipment replacement parts, RG58/U and RG8/U coax cable assemblies and specialty items such as mike clips and weather caps to protect antenna base connectors when the antenna is removed.

Wendell Layne, sales manager, points out that the new parts and accessories line will provide Antler owners immediate parts replacement in the event of accidental antenna damage without waiting for shipment from the factory. The Antler accessories line is available nationwide through authorized Antler dealers and distributors.

(continued)





### 5-INCH HORN SPEAKER

Ideal for indoor/outdoor vehicle, marine or home CB rig or P.A. amplifier use, the 5-inch Model 13-505 horn speaker just introduced by the Breaker Corporation, Arlington, Texas, offers a full 8 watts (15 watts peak) power output.

The attractive, white heavy-duty molded plastic horn suits any vehicle or home decor. A convenient locking nut base fastener permits vertical directional adjustments of the horn for optimum listening. It's complete with 14-inches long connecting leads.

Model 13-505 is attractively packaged, complete with all hardware and is available at local electronic distributors and many retail outlets selling Breaker CB Communications products. The new speaker, plus many other Breaker "Freedom Line" CB accessories also make highly appreciated gifts for CB'ers. List price is \$15.95.

For additional information, contact the Breaker Corporation, Marketing Department, 1101 Great Southwest Parkway, Arlington, Texas 76011.

### NEW LINE OF CB TEST/POWER METERS

Backing up EICO's re-entry into the CB communications field, is a complete assortment of test equipment that will service the aftermarket sales to CB operators. All the test units are housed in formed metal cabinets that are eye-appealing and will surely capture a goodly share of impulse sales.

The EICO 715 "Transmatch". This compact unit performs yeoman service by monitoring RF power to 50 watts, standing wave ratio, both forward and reflected power, modulation percentage, and it features a built-in dummy load to match 50Ω. No physical connection to the existing equipment is required, and the telescoping antenna can be adjusted for optimum reading. The EICO 715 is offered at a list price of \$69.95.

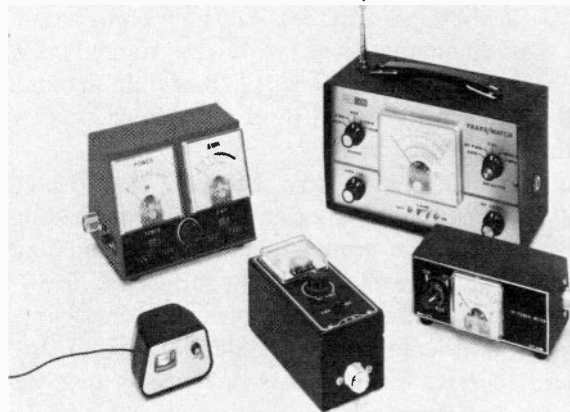

The EICO 725 SWR/Power meter connects between the transceiver and the feedline to the antenna, featuring minimal insertion loss to reduce power reduction. The dual-range wattmeter has a front panel switch to select either 0-10 or 0-100 watts. This dual range and the broadband frequency response of 3MHz to 144MHz makes it ideal for CB or amateur radio application. The EICO 725 is modestly priced at \$39.95.

The EICO 735 is a 1000 watt, inline power output meter for 52Ω lines. It absorbs negligible power when in use, and will continuously monitor powers up to 1000 watts. Three ranges expand the meter from 0-10 watts, 0-100 watts and 0-1000 watts. The useable frequency range is 3 MHz to 150 MHz. The EICO 735 is priced at \$29.95.

The EICO 745 SWR/Field Strength Meter connects into the circuit and continuously monitors standing wave ratio, relative forward and reflected power, as well as field strength. Ideal for setting up and observing the transceiver installation, this unit keeps tabs on your transmitter output. It is capable of measuring standing wave ratios of 3:1 or higher. The EICO 745 is tagged at only \$19.95.

The EICO 755 Mini Mobile Field Strength Meter monitors both antenna and transceiver operation and performance. It is passive, in that no operating power is required. It needs neither tuning nor attachment to any part of the transceiver. The frequency range of this unit is 2 to 200 MHz, and the EICO 755 is priced at only \$9.95.

This integrated line of test equipment and monitoring aids for the CB market introduce a new concept in service to the operator. The individual operator can KNOW how well his signal is getting out instead of having to depend on the usually poor judgement of others on the air.

For further information contact: Mark Ehren (212) 272-1100, EICO Electronic Instrument Co., Inc., 283 Malta Street, Brooklyn, N.Y. 11207.

### CORDLESS TELEPHONE SYSTEM

An unusual amount of cordless telephone portability and extended range up to 2000 feet is featured in the new Model 500 HANDIFONE System marketed by



B — In-Dash CB/AM-FM-MPX/8-Track



841 — In-Dash AM-FM-MPX/8-Track

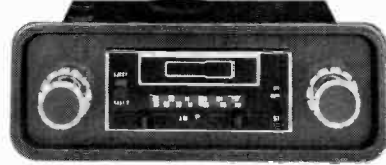

604 — In-Dash AM-FM-MPX/Cassette



606CB — In-Dash CB/AM-FM-MPX/Cassette



607 — Mini Stereo Cassette Player

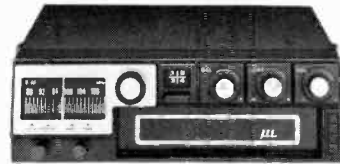

517 — FM-MPX/8-Track

## Only J.I.L. has the combination to the CB/Car Stereo Market.

- CB/8-TRACK/AM-FM-MPX
- CB/CASSETTE/AM-FM-MPX
- IN-DASH, UNDER-DASH
- CASSETTES, 8-TRACKS
- AM-FM-MPX RADIOS
- RADIO/TAPE COMBINATIONS

Whatever you want in car stereo, J.I.L. has the answer. All the combinations, all the features, all the fun! Moreover—from the 23-channel combination CB units to the tape players and radios — everything J.I.L. makes is engineered to the highest quality and performance standards and is carefully inspected before it reaches you. That's our promise to you and we deliver what we promise.

For complete information write:

**J.I.L.** 737 W. Artesia Blvd., Compton, CA 90220



THE

**\$4.95**

# FOILER™

**STOPS THE THIEF!**

## SIMPLE

FOILER mounts to the bracing of the lid. No leaks. Only FOILER mounts on front or side of trunk lid. Uses your present trunk lip antenna and mount. Self-grounding.

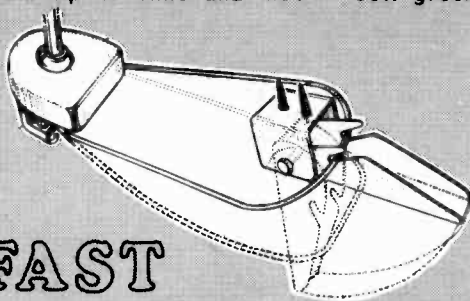

## FAST

SNAP LATCH OPEN, disengage stainless steel spring.

## CONVENIENT

TAKE OFF antenna and mount completely.

## PRACTICAL

STOW AWAY anywhere, even when your trunk is loaded.

RELAX, the thief won't know you have a radio.

SEE YOUR DEALER TODAY!  
If there is no dealer in your area, send  
\$4.95 + 50¢ postage to Dept. 112, SouthCom.



**SOUTHCOM, INC.**  
P. O. Box 11212  
Ft. Worth, Tex. 76109



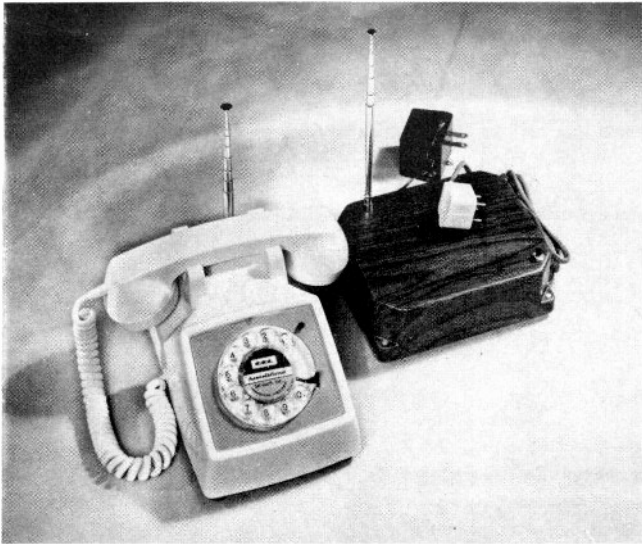

Gutzmer International, Inc., Milwaukee, Wisconsin. Highly sensitive electronic circuitry, plus strict attention to telephone-quality performance permits the Model 500 System to be applied to many additional commercial, industrial and consumer applications. Until the Model 500, cordless telephones were limited to ranges of approximately 300 feet.

The new Model 500 System also includes exclusive features, such as optional pushbutton to dial pulse conversion which permits operation through any telephone exchange . . . convenient last-dialed number memory for use when busy signals are encountered . . . and, a battery saver system that provides up to 10 hours constant talk time, or two weeks standby usage. It is also fully FCC approved, according to Gutzmer International, Inc.

HANDIFONE electronics are housed in a standard desk type telephone set that includes a telescoping antenna which operates in conjunction with a compact Transponder base station. The attractive walnut finished base station plugs into any standard telephone extension jack and operates from 110 V.A.C. The HANDIFONE uses two widely differing frequencies for its duplex operation and there are six different operating channels available.

Suggested retail price of the new Model 500 HANDIFONE System is approximately \$595.00 F.O.B. Factory. It comes complete with battery-operated, rotary dial HANDIFONE, battery charger plus transponder and direct phone line connection.

Further information on the new extended range Model 500 HANDIFONE cordless telephone system may be obtained from Jack Huismann, Vice-President Sales & Marketing, Gutzmer International, Inc., P.O. Box 27243, Milwaukee, Wisconsin 53227.

#### EQUIPPED FOR 40 CHANNEL OPERATION

Sencore Inc., received the FCC announcement of the increase from 23 CB channels to 40 CB channels in stride. "We were expecting the announcement," said



Herb Bowden, Sencore President, as he pointed with great satisfaction to the CB42 CB Analyzer that was designed with 45 channels since its introduction at the Newcom Parts Show in May. "We were simply waiting for the announcement of the exact frequencies from the FCC," Mr. Bowden said.

"All we have to do is program the frequencies on the production line as we start to manufacture the CB42," he continued. All necessary hardware and extra switch wafers for 45 channel operation were designed into the front panel during early development of the CB42. Provisions for 45 channels will remain for the possibility of an additional 5 channels, in case the FCC decides on further expansion at a later date.

"There will be no obsolete Sencore equipment in the field if we can help it," Mr. Bowden explained, as he added that there would be no price increase on the CB41 Automatic CB Performance Tester that is now being shipped to distributors with 50 channel capability.

#### GLOSSARY OF ELECTRONIC TERMS

If you're stumbling over some of the electronic jargon that's piling up in today's industry, this newly expanded Glossary of Electronic Terms is for you. For example, it explains what "GIGO" means—a programmer acronym for "garbage in, garbage out." "GIGO" is used to describe an incorrect output of a computer.

This pocket sized Glossary has been expanded to 40 pages and lists 425 commonly used electronic terms, computer terms, and acronyms (electronic "alphabet soup") ranging from "ACC" (Automatic Chroma Control) to "Zoning" and explained in layman terminology. 4" x 9" size. In addition a metric chart has been added.

The Glossary can be imprinted for give away use. Available for \$1.50 postage-paid in quantities of 1 to 9 copies, and \$1.20 in lots of 10 to 99 from Henry Lavin Asso., Inc., 12 Promontory Drive, Cheshire, Conn. 06410. Quantity pricing and imprinting is also available.

(continued on page 122)

# Just Because You Were There First Doesn't Make You A Professional

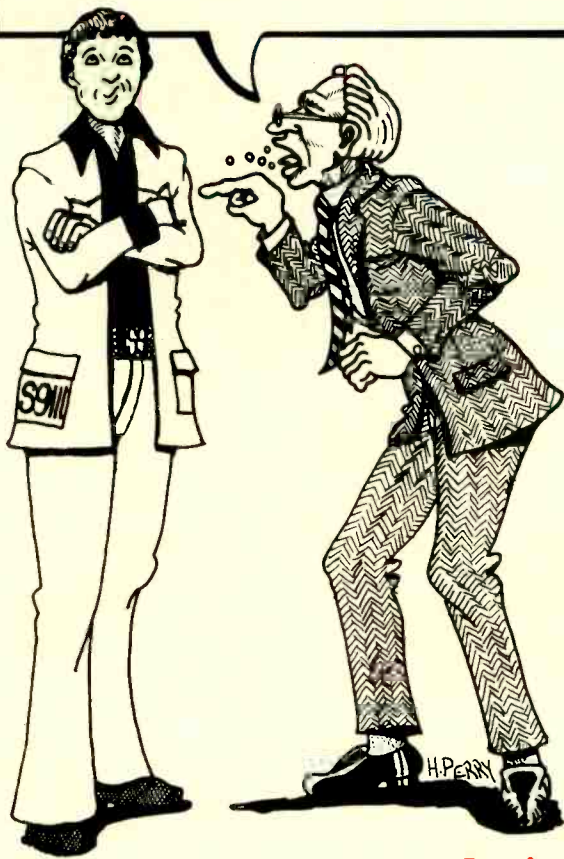

This challenge was thrown at us by the publisher of a brand new CB monthly.

**And you know what?**

## He's right!

But when we reminded him that: **S9 is printed by** R.R. Donnelley the world's largest commercial printer and that ...

**S9 is distributed by** ICD (a division of the Hearst Corporation), the country's largest newsstand distributor and that ...

**S9 is sold by** more than three thousand professional CB retailers, and that ...

S9's publisher has been turning out magazines for slightly more than thirty six years ...

**He didn't have much more to say.**



*Published since 1962 by professionals*

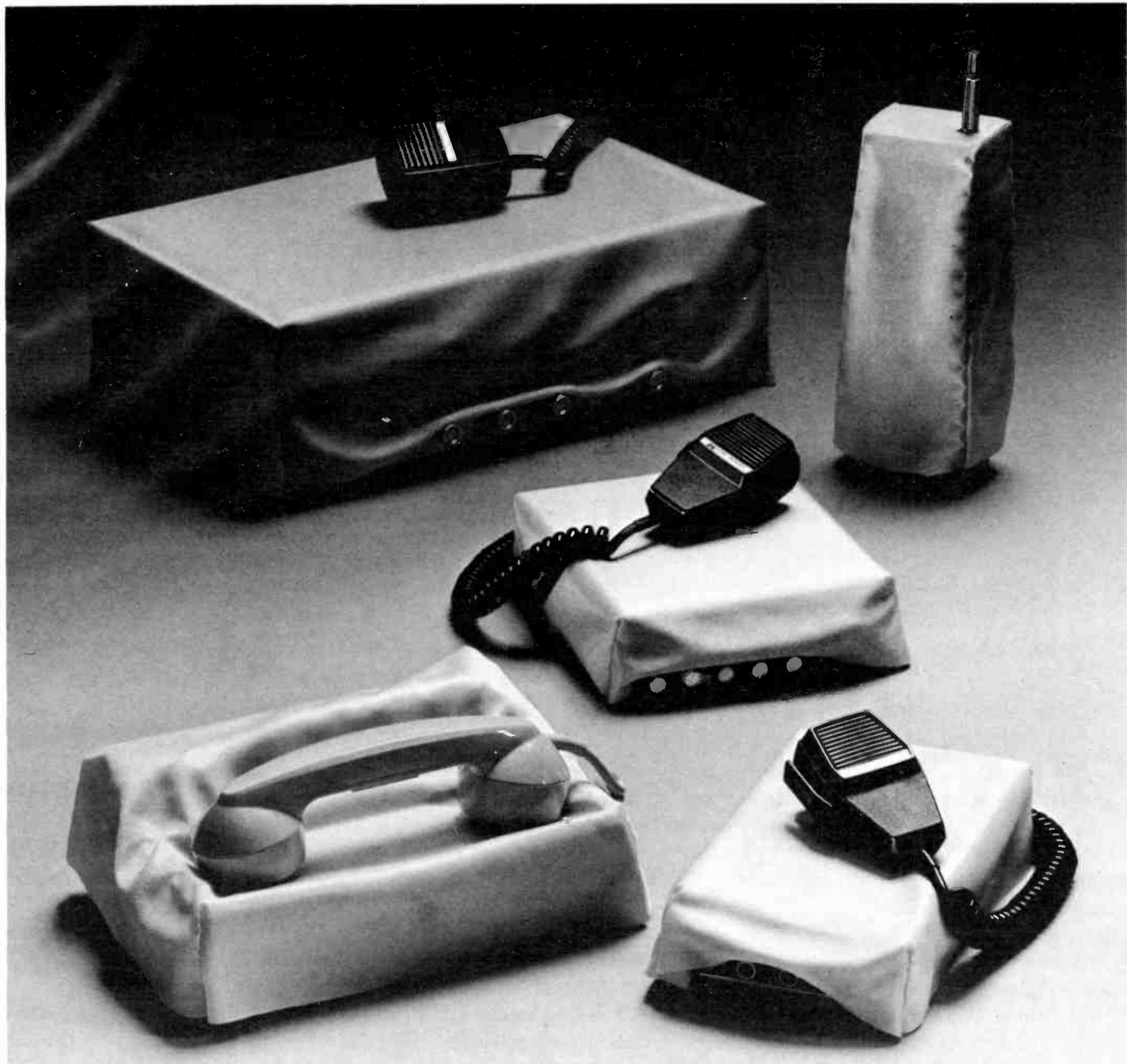

## You ain't seen nothin' yet.

Midland 40 channel CB's are coming in 1977.

The reasons more people bought Midland 23 channel CB's in 1976 are the same reasons more people will buy Midland's 40 channel CB's in 1977.

In CB radios, you get to be number one by giving people exactly what they want. And you'll find just what you want in Midland's 1977 line. Top performance. Wide selection. Most-wanted features. The best buys for the money.

We plan to stay number one. So just when you think you've seen all you could possibly see from Midland, get ready to see a lot more. Like the best new line of 40 channel transceivers available anywhere, coming in 1977.

**MIDLAND CB**<sup>TM</sup>  
Communications Division

P.O. Box 1903, Kansas City, MO 64141.

A Member of the Beneficial Corporation Family  
Copyright 1976 Midland International Corporation



# DISTANCE DELUXE!

Electronically

by Mr. Dana W. Atchley, Jr., Microwave Associates, Inc.,  
Burlington, Massachusetts 01803, and Mr. Gary Straw,  
Manager, Point Sebago, So. Casco, Maine 04015.

**CB** may be a hobby to some of us, but its use is absolutely fundamental to the efficient operation of Point Sebago, a luxury resort campground on Sebago Lake, Maine. Point Sebago consists of 220 acres of natural forest with 425 camping sites. During the summer season there are often over 2100 visiting guests in attendance at one time. As many as 100 visitors are equipped with CB. Gary Straw, Sebago's Manager, and his crew, operating under License KYO-9047, keep Channel 11 humming around the clock, with over 50 to 75 calls a day originating from the base station and an equal number being initiated by the various service managers as they travel around the site making sure that all the guests are happy. In addition to the normal camp activity, Point Sebago runs six sightseeing trips a day in a large boat around Sebago Lake, with trips over 7 miles away from the camp.

Co-author, Mr. Gary Straw, the University of Vermont trained General Manager of Point Sebago, had come to the conclusion that his existing CB network was ineffective due to frequent interference and lack of range. For assistance Straw turned to Dr. Lawrence Gould, an M.I.T. physics graduate, President of Microwave Associates, Inc. in Burlington, Massachusetts, and owner of Point Sebago. A colleague of Gould, Mr. Dana W. Atchley, Jr., Chairman of the Board of Microwave Associates with many years of communications engineering, suggested that considerable improvement could be achieved by the use of a single four-element phased array similar to that developed by Atchley and several other colleagues at

Microwave Associates after extensive computer modeling and experimentation at frequencies ranging from 144 MHz to 3.8 MHz. Straw and his Sebago crew enthusiastically endorsed the idea and set to work on getting the equipment together for the installation. However, before talking about specific details of this novel installation and its success, a few words on the general subject of phased arrays:

Directional antennas are as old as the hills with most directive CB installations using the traditional slow mechanical rotatable type of array constructed with parasitic elements. However a properly designed electronically switchable *phased* array can provide comparable directivity over 360° *instantaneously* without requiring mechanical rotation. The most popular use of phased arrays to date has been by the military for tracking a multiplicity of fast moving targets such as guided missiles, etc. A typical military phased array looks outwardly like a huge inclined billboard, several hundred feet square. This type of array usually is electronically steerable over an angle of only 60° and is useful only for highly specialized military applications. The phased array discussed in this article is much simpler and considerably more flexible and consists of four vertical antennas mounted at the corners of a square and coupled by four separate equal lengths of coaxial cable to the CB transceiver through a special circuit designed by Mr. Harlan Howe and Mr. Marion E. Hines of Microwave Associates which is called an "Electronic Beam Steerer". A front panel selector switch provides five positions N, E, S, W or OMNI.

# Steered Phased Array For CB Base Station Use

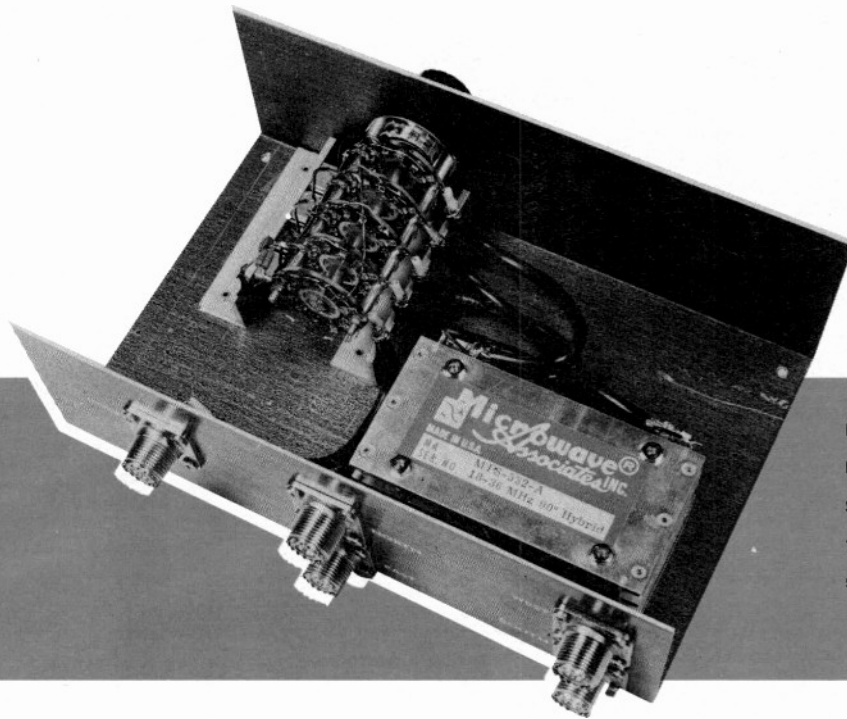

Photo 1—MA-55614  
Electronic Beam  
Steerer Box showing  
the 90° hybrids and  
switching arrangement.

This little box shown in Photo 1 takes the RF power from the transmitter, splits it to four equal parts by use of four special printed circuits called "90° Hybrids" and then passes it through four equal length cables to the antenna in such a manner that at a given switch position (for example: North) the antenna at the North corner of the square receives one-fourth of the total power delayed electrically 180° (18.18 nanoseconds), the two side antennas (E and W) receive two additional quarter power splits delayed each 90°

(9.09 nanoseconds), and the rear antenna (S), the remaining quarter with no delay. This process of power splitting and the delaying of different portions of the energy is called "phasing" and by this process the energy of all four antennae is formed into a beam pointing along the diagonal from S to N. The main lobe is 97° wide to the half power point, with a measured front-to-back ratio of over 14 dB and a measured front-to-side ratio of approximately 9 dB. The gain provided is equivalent to increasing the transmitter power by at least a factor of 4. By simply switching the selector switch on the Electronic Beam Steerer, the main lobe can be switched into any one of four quadrants effectively covering 360° of azimuth. A fifth position labeled OMNI is available which, as the name implies will work in all directions simultaneously, but with performance 6 dB down from the selected beam position. A diagram of the MA-55614 Electronic Beam Steerer is shown in Figure 1.

This rather simple device provides all the virtues of a mechanically rotated beam without involving any rotation time. Rotator motors wear out and can freeze up in winter. Electrical switching is instantaneous and reliable. A manufacturer, Antenna Specialists, has for some time marketed a 3-element CB antenna using some of these principles. However, the particular beam setup described in this article differs from their three-element array in that in their antenna, only two of the elements are driven at any given time, hence only three 120° beams are selectable. In our four-element array all four elements are always being driven thereby in-

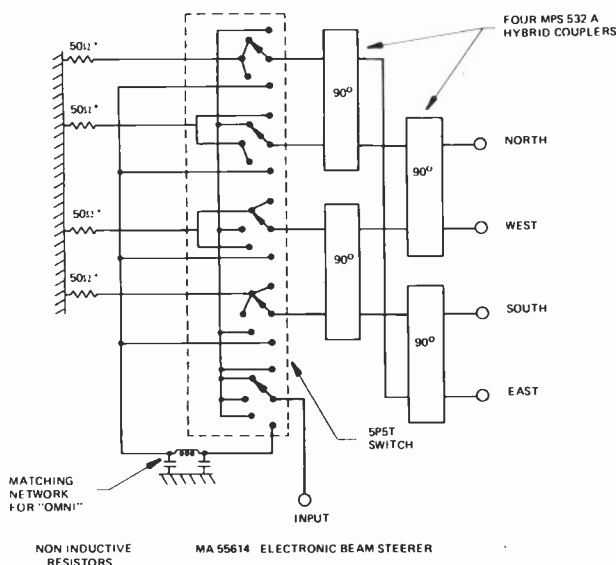

FIGURE 1—Schematic of Electronic Beam Steerer Box.



**Photo 2—Installation of the Array at the Point Sebago Base Station. Antenna elements at the left of the picture form the new phased array. The single antenna formerly used is shown in center photo.**

creasing the efficiency and providing appreciably better front-to-back, front-to-side and forward gain performance.

Photo 2 and Figure 2 show the first installation of this new array at Point Sebago. The four Ringo CR1 half wave vertical elements supplied by courtesy of Cushcraft are mounted on four 20' small stripped pine saplings. The pine saplings are not normally necessary but were used since they are in superabundance at Point Sebago. A standard guyed TV pipe masting would be perfectly adequate. The scaffolding around the four saplings allowed us to climb up and tune each individual element; however, this will not be necessary in any future installation since the elements can easily be pre-matched on the ground before being

raised to their normal operating position. Spacing between adjacent antennae is approximately 10'9" although this dimension is not critical. The base of each element is connected by four 138' lengths of RG58 50-ohm line to the labelled terminals on the rear of the Electronic Beam Steerer, the North element to the North connection, East to the East, etc. To reduce line losses, keep these feed lines as short as possible.

How does it perform? Gary Straw is now achieving much better performance than ever before. All of his large campsite can be covered by leaving the beam pointed in a single direction. He can now achieve supercommunications from the base station with the smallest hand-held CB set in the camp even at the most unfavorable location. This is something he never could

**FIGURE 2—Diagram of Installation with Pattern.**

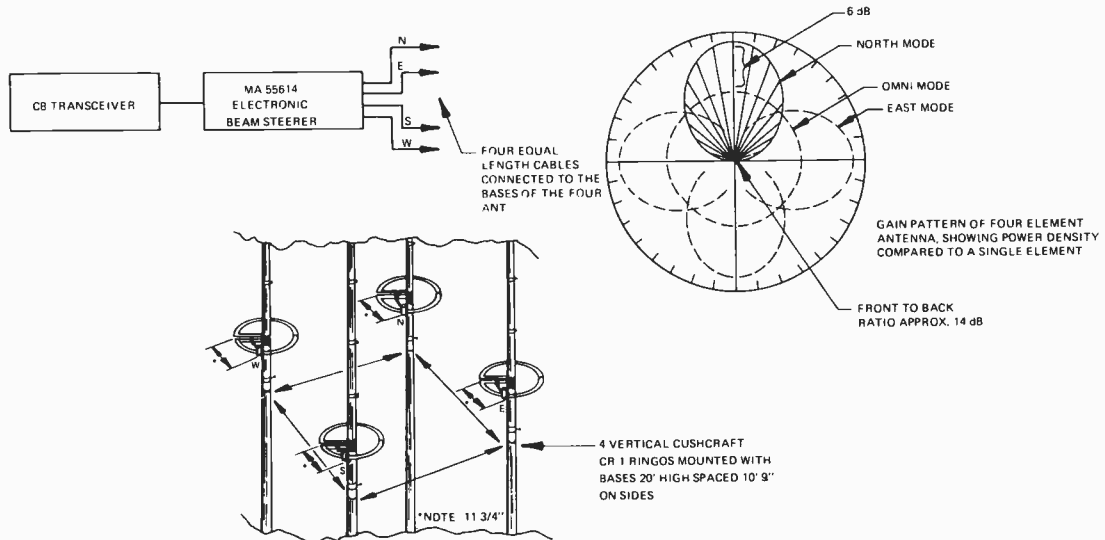



# Tune Into Another World.



Type-Accepted

The Palomar 21 2-way radio can put you in tune with the C.B. world.

No matter where you are, you're never out of touch. And the real Palomar 21 is precision built to provide strong, clear reception on all 23 channels

Our new gain-control mike adds so much broadcast power, you're sure to be heard.

When it comes to delivering state-of-the-art performance... at budget prices... the Palomar 21 is worlds apart from the rest.



**PALOMAR** Electronics Corporation  
**'We're Wired for Progress'**

665 Upper Street • Escondido, Calif. 92025 • Telephone: (714) 746-2656

do before. The greatest relief, perhaps, is the fact that when the cruise boat takes off six times a day he knows that if the weather kicks up—as it can frequently on Lake Sebago—he can be in contact with the boat. With no problem at all, using a “legal” powered Realistic Navaho Transceiver at the base station (Photo 3), he can have Q5 contact with the boat at its greatest distance which is 7 miles. The super front-to-back ratio has almost completely rejected locals coming in from the rear of the beam resulting in close to interference-free reception. One interesting effect has been that as you switch into the four quadrants some “skip” usually comes in from the North, West and South switch positions. However, when you point East (which is towards the relatively empty Atlantic Ocean) the band becomes deathly quiet. The first impression is that the E switch position is defective, but after having sent a CB equipped



Co-author Atchley makes an adjustment to one of the four Ringo Antennas.



Photo 3—Installation and Front View of the Beam Steerer Box and Navaho Transceiver.

car out many miles to the East, the beam worked beautifully, hence the “problem” lies completely in the lack of “skip” propagated stations from the East. The directivity of the array is such that it is possible actually to use it as a crude direction finder. The match into the “Electronic Beam Steerer” is better than 1.3 to 1. Although the question does not concern Point Sebago, it should be pointed out that the MA 55614 is a very broad band and will perform well over the whole citizen’s band without readjustment. All in all, Gray and his crew are very happy and have already asked for a similar installation for a second base station.

Summarizing, it looks as though this grandchild of the great military phased array will be most useful as a CB base station where reliable communications must be carried on with many different mobile signals arriv-

ing from widely varied directions. From the point of view of RF ecology, often overlooked today, the new array confines its radiation to a single quadrant greatly reducing the RF “pollution” in the remaining 270° of arc.

Interested? Contact Dana W. Atchley, Jr. at Microwave Associates, Inc., Burlington, Massachusetts 01803, or next summer drive up to Point Sebago, So. Casco, Maine off Route 302, and have a “listen”.

Co-author Gary Straw and his wife, Patty, with one of the many portable transceivers used throughout the Camp.







**FROM COURIER**  
THE PERSON, INDUSTRIAL & MARINE

990 South Fair Oaks Avenue,  
Pasadena, Ca. 91105

We're Courier. We've been making CB's since CB began. CB radios with engineering innovations like those found in Dual Gate FET receivers and Phase Lock Loop circuitry... And the most complete line of Single Side Band units available. We are a bit further down the road—and now is the perfect time to get on down the road with us, because now your Courier dealer is specially pricing all 23 channel units! You can take advantage of these "specials" and get a FREE GIFT, a Courier CB lock mount with every purchase through Christmas! It makes your set theft proof and portable. "Perfect Time" you may say, "but what about the 40 channel sets?" Let's clear the air about 23 vs. 40 channel rigs. CB radio is people-to-people communication. The original 23 channels are and will remain America's "party line"... where all the action is. Channel 9 will always be the emergency channel, and channel 19 the channel for trucker reports. But most important of all, the cost of 23 channel is far less today than 40 channel will be in the future. So instead of waiting you can buy and enjoy a 23 channel set now! For Courier quality at a special price—plus a free lock mount—call 1-800-421-8260 (in California, 213-666-8888) for the name of your nearest Courier dealer. You'll like being a bit further down the road with us!

# A little further down the road

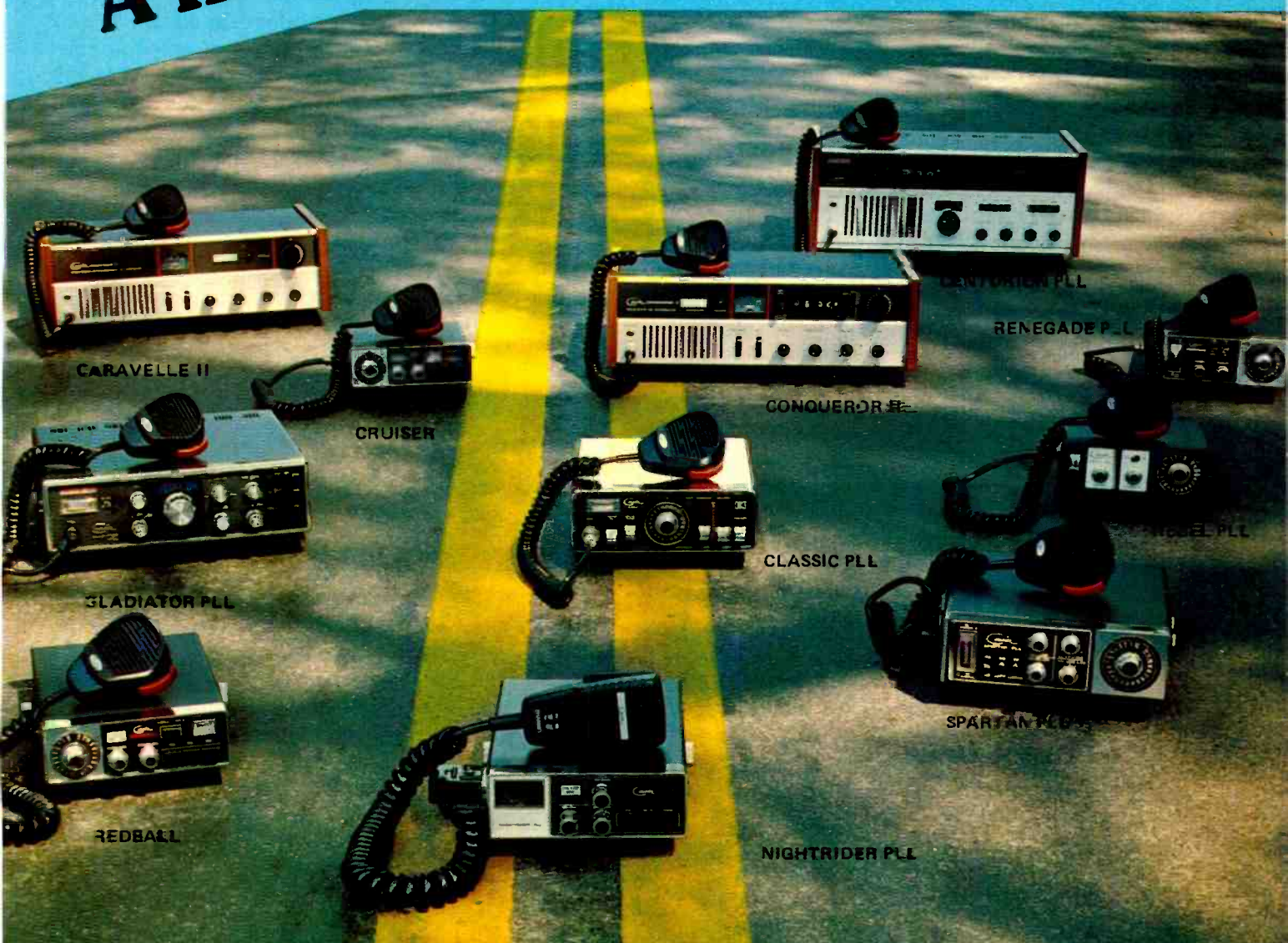

NO FOR THE ROAD SALE! BUY A 23 CHANNEL CB, GET A 40 CHANNEL SECOND CB FOR \$69. SEE YOUR DEALER FOR DETAILS!



# TOMCATTIN' with "Tomcat!"

Across The Channels With  
S9's Editor, Tom Kneitel (Tomcat/ KEZ5173)



**N**EWEST kinks in CB'ing are the hitchhikers who stand along the sidelines of the nation's traffic arteries holding walkie talkies tuned to Channel 19, the truckers' channel—they don't have to use their thumb to flag down a ride. All they do is shout the truckers and 4-wheelers as they zoom by! . . . A Nassau County smokey with ears (his handle: *Diesel Chaser*) was cruising Route 495 in N.Y. State recently when he received a shout from an 18-wheeler named *Hobo*. *Hobo* was looking down into the car driving along side his truck and surveyed the seat-covers. He saw something interesting—rather suspicious looking cigarettes being hand rolled. So he radioed the car's plate number to *Diesel Chaser* who promptly pulled the vehicle over for a check. He found 4 joints, a plastic bag of grass and some hash in possession of the 18 year old YL driver. She should have been *walking the dog* instead of *blowing smoke!* . . . Lots of the new 4-letter/4-digit "mouthful" callsigns are now on the air—wonder who will have the dubious honor of being the first such operator to run afoul of Uncle Charles? . . . From seeing the wares on display at coffee breaks, jamborees, and in the "underground" CB market, it certainly appears that linear amplifiers are still in plentiful supply. Whether called shoes, boosters, heat, afterburners, footwarmers, sneakers or whatever—Uncle Charlie has never been able to stem the tide of this thriving market despite all manner of legislative tricks. Like the man said, if there is a market for a product—you can't stop somebody from doing the old *free enterprise* trick that the U.S. was founded upon! . . . Y'know what would be a great idea—if they made some attempt at standardizing CB rig microphone connectors and the pin connections. Some plugs are 2-pins, 3-pins, and all manner of other designs. And even with those rigs which share the same design plugs (same number of pins) with other rigs, the connections are different from one rig to another. Even

taking into account that the circuits in various pieces of gear vary (electronic vs. relay switching, etc.) there still can be standardization within the several major categories of CB circuits. Would be convenient when replacing or adding mike connectors, or haven't you looked at the instruction sheets for hooking up mikes to connectors? Also—why is it that the neighborhood electronics store is always "just out" of the one connector you need—but they've got dozens of others in stock. A long time ago there were several types of antenna connectors in use on CB rigs—the standard SO-239 that is used today, then there were rigs that used phono pins, and still others use automobile radio type jacks. Eventually someone talked the manufacturers into getting it all together. Maybe now's the time to get it all together again. What about it Electronic Industries Association—think you can handle it? . . . Monty, *Wheeler Dealer* (also known as that Unit 944), called on the LL to say that he has put so many greenstamps into his base station that he now knows the true meaning of the letters "CB"—Mr. 944 sez they mean *Constantly Broke!!!* . . . Speaking of Unit Number ID's, those of you who want one of them assigned to you, along with a nifty *Certificate of Registration* showing the number, the issue date, and your name and/or handle; PLUS a detailed report on how to make the most of CB radio (as thousands of operators are already doing) by using Unit Number ID's—it's all available for only \$2.95 and a self-addressed stamped envelope sent to Z-Tech, P.O. Box 70-U, Hauppauge, N.Y. 11787. These people are the national registry for *all* Unit Number ID's—and if you are already using a Unit Number ID, they will register it for you and send you the foregoing material. Unit Numbers are a ball!!! . . . From north of the border we heard from Jean, the *Lumberjack* (also Unit 444-F), who says that Channel 9 in Canada is presently not reserved for emergencies on an exclusive basis—it's also a

# Sooner or later you're gonna be up to your ears in heavy traffic, endless static, and bein' walked on.

## Ham it up with the S225.

The "S" stands for *synthesized*, which means you get the whole band, without the need for expensive crystals. The first "2" means this band is in the 2-meter wavelength area of the spectrum. And the "25" tells you power output, variable from 1 to 25 watts, continuous wave. AMCOMM's S 2 25. The most advanced, synthesized VHF-FM transceiver available, providing communication capabilities CB can't approach.

## A taste of honey.

800 channels. Not 23, or 40 but EIGHT HUNDRED channels, of virtually static free FM communication. With this choice of frequencies available, why are you still waiting to break? If the 25 watt output power of the S 2 25 isn't enough, it can be amplified up to one KILOWATT, legally. But with the S 2 25 that isn't necessary, due to an impressive device called a *repeater*, which is capable of transmitting and receiving signals concurrently.

The S 2 25 has a range of 20 to 30 miles, and a repeater 25 or 30 miles away can rebroadcast your signal 30 to 40 miles, to the "other side". That's a total of 70 miles.

## The AMCOMM connection.

The S 2 25 has an optional accessory which in conjunction with a repeater, will enable you to call home *without* your having a base station. The device with push buttons is a *touch-tone encoder*. It allows you to communicate with anyone having access to a telephone in the repeater's local calling area. (Limited to non-business communication). These repeaters are maintained by amateur radio clubs, and you as a member of one club would enjoy this advantage all over the country, through automatic "courtesy membership" in all repeater clubs. With the addition of the touch-tone encoder, your S 2 25 combines the mobility of radio with the accessibility of the telephone system. No base station. No mobile operator. And no phone bill which reads like the Gross National Product.

## Seizin' of the switch.

It appears now that many people want something *beyond* CB, such as the ham communication features of the S 2 25. In view of the growing interest in ham radio, the American Radio Relay League (ARRL) expects thousands of CBers to cross over to amateur radio next year. And to make it easier for you to get started, they have put together a basic course package, including an orientation manual, a Morse code practice cassette, and a U.S. call area wall map. You can get this package from your dealer in exchange for seven of your hard earned dollars, or, you can

## Stash the cash.

When you purchase the AMCOMM S 2 25, we'll give you this ARRL package free and include the official ARRL License Manual. All the information you'll need to get your Technician Class ticket. Bodacious, indeed! For more information write to Steve Fried, V.P., AMCOMM, 730 W. McNab Road Fort Lauderdale, Florida 33309.

# 800 CHANNELS. 25 WATTS. LEGAL.







# all the best to you

Look at 'em. Aren't they pretty? But, their real beauty is the way they'll turn your CB on! Because with a "Kriket®" external CB speaker, you can hear more clearly than you ever thought possible.

Who else makes a full line . . . to accommodate your every need? Isn't it about time somebody did?

Give one to a friend **you** care about.  
Priced from \$14.95 to \$24.95.  
Available at CB dealers everywhere!

*Kriket Cares*

 **af<sup>s</sup>/Kriket**® speakers

World Wide Headquarters  
**Acoustic Fiber Sound Systems, Inc.**  
7999 Knue Road, Suite 116  
Indianapolis, Indiana 46250  
(317) 842-0620

Exclusive Canadian Distributor  
**Persona Communications Ltd.**  
1149 Pioneer Road  
Burlington, Ontario L7M 1N7  
(416) 639-9070

All AFS®/KRIKET® speakers are manufactured in the U.S.A. using American materials and craftsmen.

Copyright 1976 Acoustic Fiber Sound Systems, Inc.



## TOMCATTIN' WITH TOMCAT (continued)

calling channel. Jean figures that there is so much non-emergency use of Channel 9 in Canada that it is part of the problem with the clutter on the channel which is skipping around the U.S. and causing so many problems—and that it's also jamming emergency use in Canada! . . .

. . . *Jumping The Gun Dept.* Some distributors have been getting an early toe hold on the new channels. Last August, one dealer I know showed me a CB rig he had for sale which was all set to go on 44 channels, *including 7 channels below Channel 1!* He said that the rig was modified by the distributor and that he had been selling them like the proverbial hotcakes since July—set was going for \$225. Although the whole modification was unauthorized, he said that he could barely keep them in stock!!! . . . The FCC, which had denied CB'ers the right to obtain add-on devices to achieve the new channels with their existing equipment, is permitting manufacturers to remanufacture existing CB gear to meet the new specifications and operate on the new channels. Some manufacturers have already announced their intention to do this for certain pieces of their gear, which they will accept back at the factory for remanufacturing at costs ranging from \$25 to \$95 . . . Did you ever

pecting that Uncle Charlie was going to permit the sale of add-on devices to modify 23 channel rigs to 40 channels . . .

. . . A few issues back I casually asked if there were any CB old timers from around 1962 or before still on the channels. I received some interesting replies, which I'll share with you . . . For one thing, I heard from Joe Squarzini, formerly 2W3382, presently KAA3605. Joe is buddy of mine from the old 5 Watt Wizards club we had back around 1959—and I hadn't heard from him since those carefree days. Joe reminded me of the old CB-political wars that existed between the Queens and Brooklyn sections of N.Y. in those days—mainly centered around who "owned" Channel 7. Today, Joe is on SSB, and he lives near Washington, D.C.! Joe's saltmines are at Satellite Business Systems—a company attempting to establish a domestic satellite communications system for integrated data, voice, video, and facsimile. Just think Joe, that's a long way down the road from the *CB-1 Lunchbox* with the Essco converter bolted to it! . . . I also received a scolding from Pete Nosler, formerly 17W3325, now KNH0935, of Wichita, Kansas. *Uncle Pete* says he sent me a card for swapping back in 1961 when my 10-20 was Modesto, Calif., but that I never returned a card to him. Sorry, Pete, I just sent you one—doesn't take me long to answer my mail, only 15 years! . . . Mrs. Gilbert Elgin, of Amarillo, Texas, used to be KEG3179—but is now known as KLU6487 and *The Blue Angel* and is probably one of the original CB'ers in her area . . . Mike, formerly KAK0464, presently KBI2504, of Rye, N.Y. reminds me that his local Civil Defense agency was 2W4868, then later 2O0450. They are still on the air as KBI0712 on CB Channel 2, also as KRS358 (public safety service) on what is to become Channel 27 . . . Ray Bouchard, formerly 2Q4755, now KDI2741, has lived in the Bikini State for the past dozen or so years. Ray monitors on 19 to aid the truckers, and also is on 16L sideband. Ray comments that in his neck of the band so few people use FCC callsigns that you can hardly get someone to come back to you if you use 'em! . . .

. . . Old timer Frank J. Ralph, who was KFC1346 back in 1962, and is KLA5873 these days, holds down the channels in Guerneville, Calif., and remarks on the many misuses of Channel 9 which have diminished its potential as an emergency channel . . . Glenn Moore, who was IIW2120 from Downey, Calif., back in 1959—also had the callsigns IIW55748, IIW9704, KFC0969, KFD0952, KFD5789, KLA5759 as he moved from place to place over the years. Today, Glenn is KXF2476 in Albert Lea, Minn., where he is also active on the Ham bands . . .

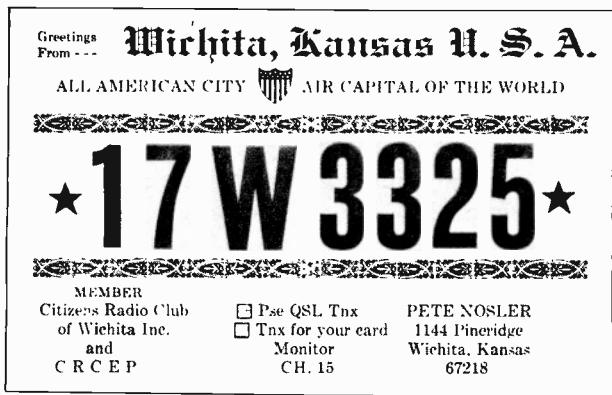

see those bumper stickers which say WARNING: I BRAKE FOR SMALL ANIMALS? I saw a CB equipped VW Bug with a bumper sticker stating WARNING: I GIVE BREAKS TO SMALL CARRIERS! . . . Burt Reynolds is starring in *Smokey and the Bandit*, a comedy-adventure about a chase between a *Tijuana Taxi* and an *18-wheeler* through 5 states—whole thing features the use of CB radio. They filmed it last September on location in Georgia . . . Heard on Channel 8: One CB'er was asking for a radio check and going through the whole counting 1-2-1-2-1-2 bit when someone came back and said, *Hey buddy, if you're having trouble, the next number is 3!* . . . Many CB equipment dealers are ticked off at the FCC—they were hoping and ex-

James D. Clark, now KCJ7476 and *Chief Bull Feathers*, in Richmond (Va.) tells me that he has been able to hang on to his original CB callsign since 1963—but he recalls the days when you got a new callsign every time you changed 10-20's, even if it was across the street! . . . Ron Hartgerink, formerly 19Q6679, is now KQA8130/*Wooden Shoes*, hailing from Lansing, Mich. Ron says he still enjoys reading his S9—has been with us for many years! . . . Bill Herz, formerly 2Q6413, now KBM6662/*Fat Man*, of Pompton Lakes, N.J., got his original license October 30th, 1961—still has it preserved under-glass! . . . John E. Layman who held the calls 4Q1350 and KCF2402, is still around as KZE4615/*Jigsaw John*, of Appleton, N.Y. John tells me that he remembers the very first issue of S9 back in 1962—wow! I can barely remember it myself! . . . Also on the bands after many long years is Bill J. Keesee, of Pylesville, Md. Back in the ancient days Bill was 4W0392, today he is KO11163/*Rink*. If any CB'ers in South Dakota have some wallpaper to send to Bill, he sure would appreciate it—that's the only state he's missing from his collection. Just send them to William J. Keesee, Pylesville, Md. 21132. Bill sez *thanks!* . . . For those of you who have asked me to list some of the CB callsigns which I have had as I hopped around the country, the only ones I can recall at the moment are: 2W1965, 2A0305, 18A6171, 12Q1747, 10Q3161, KBG4303, KQD4552—I think that there were a few others but I disremember at the moment! . . .

. . . Kenn Rothman from Cleveland, Ohio, started out on CB as 19A7734 in 1959—then graduated to 19Q9338 a year later. Today, as KBY0535, he's still on the channels! . . . Ted McCoy, Sales Representative at Springfield, Ill., broadcasting station WTAX, started out in CB back in 1959 too—as 15W2260, then, when the "new" callsigns came in he was issued KLH3537. Today his license reads KDK0562,



but most of those on the band know him as *Stubble-duck!* Ted recalls that his first rig was a Johnson Messenger I, the great old 5-channel rig with the steel mesh case . . . One of the lowest "old type" CB callsigns we've yet come across from a currently active operator is 2W0234, issued to Walter Ungerer, now of New Castle, Del. License was issued in 1957 for Class C radio control on Channel 23 using 30 watts! . . . Of the group of letters which have come in from old timers, one that particularly touched a note in my noggin was from Homer E. Neely, of Wenatchee, Wash., who was originally 14W1866 (now KND1929). The 14W callsign seemed vaguely familiar to me and I went back and dug through my old logbooks—shure 'nuff I worked Homer back in 1961 when I was on the West Coast! Also from the Pacific northwest and still active in CB is Clarence E. Carter, Allyn, Wash., then (1960) KFI1474, now KR D3384! . . . We saw some nifty CB jewelery crafted by Regal Lapidaries showing their clever CB friendship emblem surrounded by the words *Bonus Sodalis* (means *Good Buddy* in Latin)...

*Tomcat!*

**Sensational price!**  
**Superb quality!**

**69<sup>95</sup> 119<sup>95</sup>**  
(30mHz Kit) (250 mHz Kit)

**6-DIGIT FREQUENCY COUNTERS**

A counter-offer you can't refuse! It's rock-bottom price and sky-high quality make it your best buy! We've proved it to thousands. Let us prove it to you!

- 100mHz Readout
- Ham, CB, & Commercial Bands
- 1Hz Optional
- Master Chg./B. Americard OK
- Crystal Time-Base
- Add \$2 Shipping

All counters can be factory wired and tested.

**Hufco** Write or call today!  
P.O. Box 357, Dept. 53,  
Provo, UT 84601 (801) 375-8566



# Bill Orr on Antennas

## PART 10: THE "102 WHIP"

In the May/June issue of *S9 Magazine* I referred to the so-called *102 whip* mobile antenna. This is a mobile antenna that is *about* one-quarter wavelength long, or 102 inches. The mention of this antenna brought a blizzard of mail, most of which was concerned with the length of the antenna. Some of the questions asked were:

"My whip is only 101 inches long. What should I do?"

"I measured my whip and it is 103.45 inches long. How can I shorten it?"

"Do you measure the whip to the end of the coaxial plug or to the spring mount?"

"My whip measures 102¾" to the mount, but only 101¼" to the point where the coax is attached. Which measurement is the true length?"

Holy smoke! What a tempest in a teapot! How many CBers are out, crawling around their vehicle, measuring their whip antenna length with a micrometer? Relax, good buddies, it isn't that big a deal!

### THE "102 WHIP"

The basic mobile antenna is a quarter-wavelength whip. That is, the whip antenna is about one-quarter as long as the length of the radio wave. The important word is *about*—perhaps *approximately* would be a better word choice. In order to lower some high blood pressure readings, let's take a close look at this interesting antenna.

The fundamental radio antenna for any type of reception or transmission is the half-wavelength antenna, or dipole. In the very early days of radio—before the turn of the century—Marconi discovered that a quarter-wavelength antenna would work well, when the ground was used to replace the missing quarter-wavelength (Figure 1). A simple picture is that the ground provides a "mirror image" of the missing portion of the antenna.

The "perfect" quarter-wave antenna is a thin vertical whip mounted over a very large, copper ground plane. By "very large", it is meant that the ground plane extends to infinity in all directions. This is, of course, impractical, but a copper ground plane that is large with respect to the antenna size will give almost equal results.

Now, what happens when the copper ground plane is removed and the quarter-wave whip antenna is mounted on a vehicle? First of all, the vehicle is not a ground plane and, in fact, is *insulated* from the ground by the rubber tires. Second, most ground is an imperfect conductor, being full of rocks, dry soil, worms, tin cans and a certain amount of sand. And to make matters more complicated, most vehicles do not rest on the ground, they roll along a road, or highway, which is either asphalt, cement or possibly gravel. All of these substances are poor conductors of radio energy.

Because of all of these imperfections, the mobile whip antenna is a very poor example of the "perfect" antenna as it has an imperfect ground beneath it. And like a lot of other things in our daily life, it is a compromise that somehow works.

### THE VEHICLE IS NOT A GROUND

The automobile, or vehicle, really isn't a perfect ground and it is not a flat plane. It is lumpy, and sticks up in odd directions. And no two makes of vehicle have the same shape or profile! How can the poor antenna manufacturer guess whether his antenna is going on a

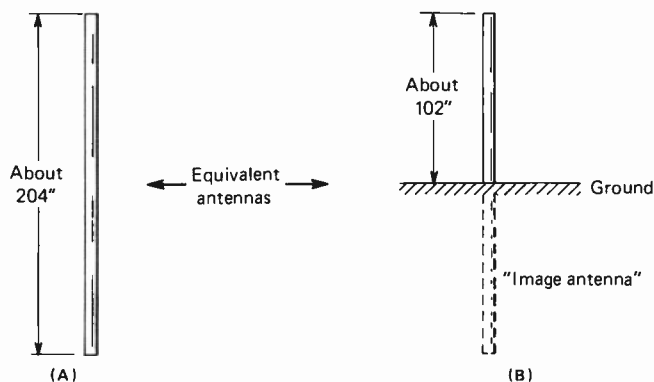

Fig. 1—The basic antenna element is the half-wavelength antenna (A). Marconi discovered if the lower end of an antenna is grounded, it need only be a quarter-wavelength high to operate at the same frequency as an ungrounded half-wavelength antenna. The ground acts as an "electrical mirror" and the missing half of the antenna is supplied by the mirror image (B). In real life, the quarter-wave vertical antenna is not actually grounded at the base, but is fed by a coaxial cable with equivalent results. The mobile whip antenna is a version of the Marconi, with the body of the automobile substituting for the ground. The comparison is not strictly true, as the body of the vehicle is insulated from ground by the rubber tires. Even so, the body of the car is large enough to approximate a true ground.



Pinto, a Cadillac Seville, a beat-up truck, a recreation vehicle, or whatever? He can't! However, experience has told him that these theoretical problems are not very important in real life. With the millions of whip antennas used in police, military, industrial and government service over the past 30 years, enough experience has been gained to prove that the length of a quarter-wave whip mounted on a vehicle is *not particularly critical*, and that for the CB channels the length of the "102 whip" is not critical within three or four inches.

Using delicate and expensive instruments a radio engineer could determine the exact length for resonance on *one* CB channel for *any* whip antenna mounted on *any* vehicle under one particular set of circumstances. But the knowledge wouldn't be of much use, as it would not apply to another make of whip mounted on a different vehicle in a slightly different position. And the truth of the matter is that all quarter-wavelength whips on all vehicles work just about the same, and with approximately equal results. As a result, fiddling around with the length of the quarter-wave whip, or worrying whether it is too short or too long is a waste of time and energy. *As long as the transmitter loads up properly and works OK, that's all that counts!*

#### HOW ABOUT MY SWR?

A lot of CBers get into needless problems worrying about the SWR reading, or measurement, they make on their quarter-wave whip antenna. Remember the "perfect" whip mounted on the infinite copper ground plane I mentioned earlier? Well, this "perfect" antenna would provide a SWR reading of about 1.4 on the meter and no amount of adjustment would make it better!

Paradoxically, the "imperfect" combination of the quarter-wave whip mounted on a vehicle often provides a lower SWR reading than does the "perfect" antenna! This is because the body of the vehicle gets into the act. It is not a good ground and is, in fact, insulated from the ground. As a result, the body of the vehicle acts as a poor antenna to some extent, radiating a little bit of radio energy in some directions. It also acts as a radio shield, blocking radiation in other directions, too. The result is that the antenna radiation pattern around the body of the vehicle is irregular, as discussed in last month's column.

But the fact remains that whip length is *not* critical, and that the SWR reading of a quarter-wave whip is also not indicative of performance. *You mount the whip on the vehicle and if you have hooked it up to your equipment properly, it works!* And no amount of horsing around with whip length or changing the length of the coaxial line from the whip to the CB equipment is going to make a bit of difference in antenna operation or change your signal report from your good buddy down the road a piece!

One problem area still exists that hasn't been discussed yet. There's a bewildering variety of CB sets on the market. Some of them are good and some of them are junk. It's hard for an expert to separate the good ones from the poor ones and some of the poor ones are pretty bad. The better rigs can operate well into antennas that exhibit a high value of SWR whereas the cheaper ones cannot. In most cases, the "cheapies" deliver less and less power output as the SWR increases until, with a very high value of SWR on the line, the power output is close to zero! In all cases, however, a SWR of 2 (sometimes referred to as 2-to-1) or less, is perfectly OK. When the SWR starts to creep upwards towards 3, the "cheapie" CB sets start to fold up, whereas the well-designed rigs still work OK. But when the SWR goes much above 3, the greater percentage of CB sets start to drop in power output. And when the SWR is as high as 5 or 6, the power output of most of the sets observed by the writer of this column, is down to a few tenths of one watt!

The sharp CB operator will quickly observe from this example that the SWR reading *is* important, but not from the point of view of the antenna. It is important in regard to the operation of the CB transmitter. High SWR almost always means low transmitter output, especially with the cheaper models of CB equipment! Low SWR, on the other hand, permits all makes and models of CB gear to function to the level of highest efficiency. And the line of demarcation between low SWR and high SWR usually falls between readings of 2 and 3 on the SWR meter scale.

#### THE 102 WHIP. THE BEST CB ANTENNA?

Well, then. If the 102 inch whip is a full quarter wave antenna and has no lossy loading coils, doesn't it stand to reason that is the best CB antenna as far as efficiency goes?

Alas, the picture just isn't that clear. It is difficult to mount an antenna almost 9 feet high on a vehicle. If it is mounted low on the vehicle, the body of the vehicle is in close proximity to the whip and can cause "radio shadows" around the vehicle. If it is mounted high on the vehicle, it can strike overhead obstacles. And when the vehicle is travelling fast, the wind resistance of the 102 whip causes it to bend backwards from the vertical position.

I'm sure many CBers have observed other CBers, tooling along with a 102 whip mounted on their vehicle, the whip bending back like a flexible fishing pole until the tip section is nearly horizontal with respect to the ground! Bad business! As the whip moves back, it changes position with respect to the vehicle and is detuned, causing the SWR reading to rise, and the transmitter power output to drop. And in addition, the efficiency of the antenna drops as it bends downward into a horizontal position.

The only solution to this problem is to tie the whip in position with light nylon fishing line so that it re-



# You can turn the CB boom into income...with NRI's complete communications course.

**NRI can train you at home for a part-time job or a full time career in communications.**

The field of communications is bursting out all over. Millions of CB sets are in operation with millions more being sold annually. That means countless careers in design, installation and maintenance. Start training at home now, the NRI way, to get you all-important First Class FCC Radiotelephone License and qualify for one of these openings.



covers AM and FM Transmission Systems; Radar Principles; Marine, Aircraft, and Digital Electronics; and Mobile Communications. You must earn your First Class Radiotelephone FCC License or you get your money back.

are 8 reference texts, and 14 coaching units to make it easy to get your Commercial Radiotelephone FCC License—enabling you to test, install and service communications equipment.



## CB Specialist's Course also available.

NRI now offers a special 37-lesson course in CB Servicing. You get your own CB Transceiver, AC power supply and multimeter, for hands-on training. Also included

## Over a million have enrolled with NRI.

Send for the free NRI catalog and discover why more than a million people like yourself have chosen the NRI way as the right way to get ahead. You learn at home with bite-size lessons, progressing at your own speed to your FCC License and then into the communications field of your choice. There's no obligation and no salesman will call.

If coupon is missing, write: NRI Schools, 3939 Wisconsin Avenue, Washington, D.C. 20016

## Learn on your own 400-channel, digitally-synthesized VHF Transceiver.

The 48-lesson NRI Complete Communications Course teaches you to service and adjust all types of two-way radio equipment (including CB), using the one unit that is best equipped to train you for CB, Commercial, and Amateur Communications: a "designed-for-learning" 400-channel, two meter VHF transceiver and AC power supply. Then we help you get your FCC Amateur license, with special instructions so you can go on the air. The unit can be mounted in your car, or you can use it as a base station.

The complete program includes 48 lessons, 9 special reference texts, and 10 training kits. Also included are: your own electronics Discovery Lab, a new Antenna Applications Lab, an Optical Transmission System, CMOS Digital Frequency Counter, and TVOM. The course

**RUSH for FREE Catalog**

**38-126**



**NRI SCHOOLS**  
McGraw-Hill Continuing  
Education Center  
3939 Wisconsin Avenue  
Washington, D.C. 20016



Please check for one free catalog only. No salesman will call.

- Complete Communications Electronics with CB • FCC Licenses • Aircraft, Mobile, Marine Electronics
- CB Specialists Course

- Amateur Radio • Basic and Advanced
- Digital Computer Electronics • Electronic Technology • Basic Electronics
- TV/Audio Servicing • Choose from 5 courses
- Electrical Appliance Servicing
- Automotive Mechanics • Master Automotive Technician and Basic Course
- Auto Air Conditioning
- Air Conditioning, Refrigeration, and Heating • Basic and Master Courses.

Approved under GI Bill if taken for career purposes.  Check box for details.

Name \_\_\_\_\_ Age \_\_\_\_\_  
(Please Print)

Street \_\_\_\_\_

City/State/Zip \_\_\_\_\_

A National Home Study Council Accredited School

# THE STORM ALARM.

IT WARNS YOU ABOUT STORMS THE WAY  
A SMOKE ALARM WARNS YOU ABOUT FIRES.

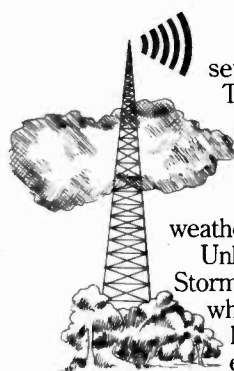

It sounds an alarm.  
A built-in alarm that's set off any time—night or day—when severe weather threatens.

The alarm is triggered by a signal from your local National Weather Service transmitter.

After it sounds, a complete report on the danger and survival instructions come on.

When conditions are normal, the Storm Alarm picks up the weather station's continuous, up-to-the-minute forecasts.

Unlike ordinary weather radios, which the user must monitor, the Storm Alarm continually monitors itself. The alarm sounds full blast whether or not you have the volume turned up and are listening. You're warned even when sleeping.

Crystal-controlled and switch-selectable.  
Superior reception from as far out as 40-50 miles. Works on AC. Built-in back-up battery feature. 25" telescoping antenna.

2 1/4" speaker. Unit only 3" x 5" x 1 1/4".

With all these features, it's no wonder a leading electronics magazine called the Storm Alarm a "sensitive weather receiver, and for a relatively low price (under \$40) an excellent disaster alarm."

The increase in U.S. weather emergencies has led to the development of this unit.

Today, tornadoes, hurricanes, severe thunderstorms and marine emergencies are a constant threat to life and property.

For a free "Tornado Tips" booklet and the name of your nearest dealer, write us at 637 S. Dearborn, Chicago, Ill. 60605.

Get the Storm Alarm.  
It's a foul and fair weather friend.

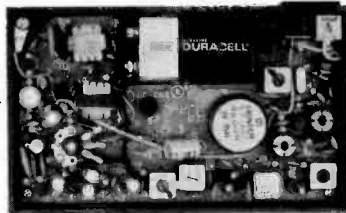

## STORM ALARM™

FROM WEATHERALERT

© 1976 by WeatherAlert™, Chicago, Ill. 60605

# BRONCO BULLWHIP®

## HEAVY DUTY CB ANTENNA FIBERGLASS WHIP

- EXTRA STRONG SIGNAL
- STANDARD THREAD
- TOP LOADED
- LOW VSWR

AVAILABLE  
IN

**5**  
SIZES

Ideal for:  
• AUTO  
• VAN  
• BOAT



ORDER  
TODAY!

### SCIENTIFIC ANTENNAS CO.

2732 Wisconsin Avenue  
Downers Grove, IL 60515  
(312) 960-0567

Enclosed is my check/M.O. for \$ \_\_\_\_\_

- 3 Foot Whip Antenna \$12.00
  - 4 Foot Whip Antenna \$12.50
  - 5 Foot Whip Antenna \$13.00
  - 6 Foot Whip Antenna \$13.50
  - 8 Foot Whip Antenna \$14.95
- Add \$1.00 for shipping & handling.

Name \_\_\_\_\_

Address \_\_\_\_\_

City & State \_\_\_\_\_

**DISTRIBUTOR INQUIRIES INVITED!**



## BILL ORR ON ANTENNAS (continued)

mains vertical, regardless of wind pressure. And this is usually easier than it sounds.

If you have a pickup truck, a neat solution to the problem is shown in Figure 2. Mount the whip below the rear window on a small bracket. A rubber ball is pushed on the whip to prevent it from banging into the rear wall of the cab. The cab doesn't cast much of a "radio shadow", yet it protects the whip from much of the air blast caused by movement of the vehicle.

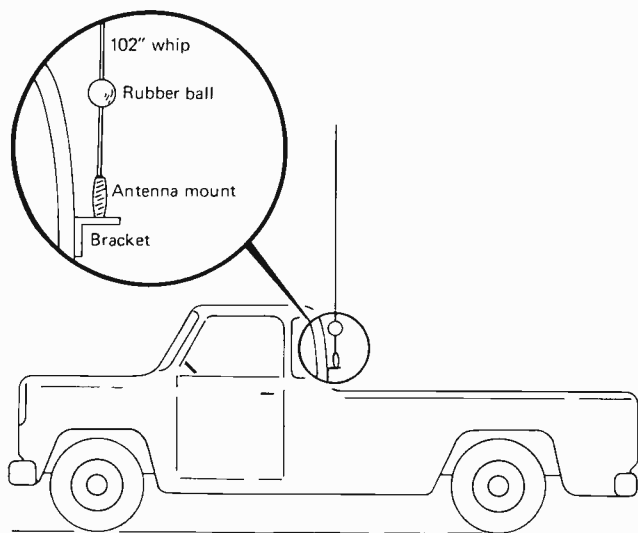

Fig. 2—A convenient place to mount a 102 whip on a pickup truck is below the rear window on a small metal bracket bolted to the outer wall of the cab. Make sure the bracket makes a good ground to the cab body. An antenna mount is affixed to the bracket and the whip protrudes above the cab. Center the whip so that it is in-line with the center line of the vehicle. A rubber ball is spiked on the antenna so that when it moves about it does not touch the metal wall of the cab body above the window. With the antenna centered on the rear wall, the radiation pattern is very nearly omnidirectional, yet the whip is mounted low enough on the body so as not to strike overhead obstacles.

For those CBers who have automobiles of more or less conventional styling, the 102 whip presents a problem. Even though it is the most efficient mobile antenna to use the great length and perplexing mounting problems present enormous obstacles. What can be done?

In my opinion, if the 102 whip is not practical, the next best solution is to use a coil-loaded, short whip and mount it on the rear trunk deck of the automobile (Figure 3). Trunk lid mounts are readily available and many "loaded" CB antennas are made by various manufacturers. I prefer a *center loaded* antenna (sometimes called a top loaded antenna) over a *base loaded* antenna as it is more efficient, and I like the loaded antenna to be as long as possible (1). Short, loaded antennas will work, but as the antenna gets shorter,

(1) Several manufacturers make medium length loaded antennas suitable for this type of mounting. Examples are: *The Antenna Specialists Co.* "Big Momma" M-413 whip (77" long). *Hy-Gain Electronics Corp.* "Mother-Trucker II" model 515 whip (75" long). *Mosley Electronics Co.* "Tarantula" CT-3 whip (54" long). *Avanti Research and Development Co.* HIPPO-6 model AV-326 whip (72" long). *Anixter-Mark Co.* KW-10 whip (72" long).

the efficiency drops rapidly. The wise CBER wants to put as much of his signal into the air as possible and very short, loaded antennas are to be avoided except as a last resort.



Fig. 3—The Masley CT-2 "Tarantula" whip is representative of the compact, center-loaded mobile antenna. The whip is only 54" high. The missing portion of the antenna is wound up into a coil placed at, or near, the mid-point of the antenna. Center-loaded antennas are to be preferred to base-loaded antennas, as they have greater efficiency. The tip section of the whip is adjustable, permitting the whip to be used over a wide range of frequencies.

## THE NEW CB CHANNELS

This summer, the FCC announced that additional CB channels will be made available in early 1977. How well will your existing mobile antenna work on the new channels? Will you have to buy a new antenna to use the new channels? Good questions, and ones that are not easily answered.

Generally speaking, users of 102 whip antennas will find out that their antenna will work on the new bands with little or no problems. Users of short, loaded whip antennas, however, may be in trouble. The shorter the whip, the more critical is the adjustment. In other words, the antenna is frequency-sensitive. Mini-whips (those less than 30 inches long) are very sensitive, and some of them have an adjustable tip section that is set for the lowest SWR reading on your pet channel. Operated off-channel, the SWR rises rapidly and transmitter power output drops. Most mini-whips, then, will have to be readjusted for the new channels and once readjusted, probably won't give good performance over the old channels! Thus, to jump back and forth between new and old channels, adjustment to the length of the mini-whip probably will have to be done.

Longer whips, such as the 48 inch to 74 inch loaded whip probably will work over some, or most, of the new channels before the antenna efficiency drops badly. However, it may be necessary to adjust antenna length for lowest SWR at the highest channels or the lowest channels.

You can determine if your whip will work over the new CB channels with the aid of your trusty SWR meter and a few simple experiments. These tests will be discussed in next month's column. So until then, hold the hammer down.

15 16 17

by Bill Sanders,  
CLI-1849, KW-5304  
SSB-295

S9's Monthly Column for Sidebanders

## BREAK... LOWER SIDE

**IF YOU'RE ON SIDEBAND OR PLANNING TO GO ON SIDEBAND IN THE FUTURE—BE AWARE THAT THEY DON'T USE CB "HANDLES" ON SIDEBAND CHANNELS! THEY USE "SIDEBAND ID NUMBERS." SEND A SELF-ADDRESSED STAMPED ENVELOPE TO THIS COLUMN AND WE'LL SEND YOU AN APPLICATION TO JOIN THE "SSB NETWORK," OLDEST & LARGEST NATIONAL SSB NETWORK!**

I don't know if you made it to Colorado this past July for the 5th Annual National Sideband Convention, but if you missed it you should be all the sorrier for it! All is not lost—because the 6th Annual National Sideband Convention is all set and scheduled. This time it's at Expo Square in the Tulsa Fairgrounds (21st St. and Yale Ave.) in Tulsa, Okla. The dates are July 15, 16, 17, 1977. Advance ticket donation is \$4, and at the gate it's \$5—under 12 are free! A Grand Prize is to be drawn for—a Yaesu FT-101-EE, with 6 accessories for the thing! There are plenty of motels in the area and lots of parking space at the Convention—so make plans to be there. For tickets and whatever, contact the National Sideband Convention, P.O. Box 15656, Tulsa, Oklahoma 74115.

Remember the flood of Big Thompson Canyon in Colorado last summer? Well, it was CB'ers who were an all important part of the organization and evacuation of the area—this info from Larry, SSB-1141, who was part of the emergency work. Larry would like to hear from any area SSB'ers whom he hasn't hooked up with yet on the band—drop him a note if you live in the Estes Park area. His QTH is Box 488, Association Camp, Colo 80511.

Dennis, of Larchmont, N.Y., asks if the new channels will cause any change in the old gentlemen's agreement about Channels 16 and 18 being SSB channels, or if SSB'ers will move to other channels. My own feelings are that Channel 32 will (or should) be a Sidebanders channel, especially since we have noted it in rather heavy Sidebander use of this frequency for many years prior to its being authorized. I think we might try to hang on to it now that it's "legal."

Well, it is unfortunate but interesting—I mean we ran a story last July called *Channel Jumpers, Beware!* It was about operators who operate on channels outside the edges of the band—and we had information that Uncle Charlie had his ear tuned to those channels. A number of readers, including many HF sideband operators, said that it just wasn't true and that S9 had fallen prey to Uncle Charlie's scare tactics. Hey, we know scare tactics when we see them, but we had what might be termed "inside" information on this. The bottom line is that on July 22 (the latter part of the month in which we ran our article) Uncle Charlie tuned up his ears on the HF channels in the northern New Jersey area. U.S. Marshals, accompanied FCC people and a handful of search warrants, pounded on the doors of 7 sidebanders at 6 A.M. during the regular early-morning HF net in the area. They confiscated \$10,000 worth of CB gear!

Some of the stations which have operated on the HF channels have been noted by a number of operators using so-called "Statewide Whiskey" ID's, and we have received mail asking about them. Reader Dan Gerschutz in Ohio, in fact, comments that he has often heard stations using a "17W" identifier which is similar to the old-style FCC CB call signs. Stations operating on the HF channels (those channels above the high frequency end of the CB channels) have traditionally used "special" identifiers for operation on those frequencies, avoiding the use of their regular Sideband ID's normally used on the regular CB channels. For a while, there were a popular series of high frequency ID's in vogue which began with the letters HF, HFA, HFB, HFC, HFD, and HFX—but these seem to be taking a back seat to a newer type of prefix which is apparently replacing these ID's. This new system is the so-called "Statewide Whiskey" system, which gives each state, province, and nation a distinctive prefix of 1 or 2 digits followed by 1, 2, 3, or 4 digits. The prefix for Pennsylvania is "2W," so an operator there might be 2W7, or 2W866, etc. It seems that each state and province has a local organization which assigns these ID's to members within their own region—either over the air, or by mail. For those of you who have asked for a listing of the prefixes, here they are:

## "STATEWIDE WHISKEY" PREFIXES

1 Delaware	21 Illinois	41 Montana	60 West Indies
2 Pennsylvania	22 Alabama	42 Washington	61 Puerto Rico
3 New Jersey	23 Maine	43 Idaho	62 Panama
4 Georgia	24 Missouri	44 Wyoming	& Centr. Amer.
5 Connecticut	25 Arkansas	45 Utah	63 Venezuela
6 Massachusetts	26 Michigan	46 Oklahoma	64 Brazil
7 Maryland	27 Florida	47 New Mexico	65 Argentina
8 So. Carolina	28 Texas	48 Arizona	66 Chile
9 New Hampshire	29 Iowa	49 Alaska	67 Australia
10 Virginia	30 Wisconsin	50 Hawaii	68 Guam
11 New York	31 California	51 New Brunswick & Nova Scotia	69 Japan
12 No. Carolina	32 Minnesota	52 Quebec	70 England
13 Rhode Island	33 Oregon	53 Greenland	71 Germany
14 Vermont	34 Kansas	54 Ontario	72 France
15 Kentucky	35 W. Virginia	55 Manitoba	73 Italy
16 Tennessee	36 Nevada	56 Sask.	74 Sweden
17 Ohio	37 Nebraska	57 Alberta	75 Ireland
18 Louisiana	38 Colorado	58 Brit Columbia	76 Spain
19 Indiana	39 N. Dakota	59 Mexico	78 Bermuda
20 Mississippi	40 S. Dakota		

The first 50 numerals represent the numerical order in which the states were admitted to the Union (U.S.). *Don't* write to us for details of specific addresses of local or regional organizations assigning these high frequency ID's—we *don't* have this information available, however local high frequency fans seem to know where to hook up with such ID's for their own area.

My own number is 11W1189, just for the record!

A few issues back we ran a blurb on station "98," in Freeport, Grand Bahamas—Walter being the operator. Guess I should have known better—but if I had asked the *ol' Tomcat* (SSB-13) at the time I could have shown you a QSL card from Walter. Serves me right—but better late than never. So, here is a copy of Walter's red, white, and blue QSL card, courtesy of SSB-13.

Those operators in the New York area who have heard the popular local "KW" ID's on the air have always been curious as to whether it is a club, an association, or *what!* The *KW Group* (that's how they dub themselves) began back about 1964 when some operators around New York got together to yak on



Here's a QSL card from Walter, Station "98" in Freeport, Grand Bahamas Islands. Courtesy Tomcat, SSB-13.

Channel 17 with some of the more quaint antique sideband gear. By 1965 these fellows had started utilizing ID numbers starting with the letters "KW," and the group had grown to about 150 members (KW-150), having switched over to Channel 16-Lower. Twelve years and about 6,000 KW-numbers later, the *KW Group* is still on the scene in the metropolitan New York area. One of the guiding lights of the *KW Group* is Tony, KW-12, President of the North Atlantic Sideband Association. So, if you hear any guys with New York type accents and KW-numbers, you know who

(continued on page 155)



This guy seated at the mike is none other than Tony, KW-12, who has been on the bands since the very earliest days of sideband. Tony hails from Long Island and is known from coast to coast by Sidebanders.



# **An Open Letter From Mike Dale of Palomar East Ltd. To: All Present and Prospective CB Dealers.**

As you are all aware, there is a great deal of uncertainty at the consumer level concerning the present and future status of the CB Radio market. We receive hundreds of calls daily from our present dealers, and from many would-be dealers, all pertaining to the advisability of stocking inventory on twenty-three channel radios. We believe that it's our duty to keep our dealers aware of current market trends on the premise that a well-informed dealer is a valuable asset to the public as well as to his suppliers.

To begin with, I'd like to emphasize that the demand for twenty-three channel radios is not only remaining strong, it's actually growing every day. When the forty channel sets become available next year, there will probably be a tremendous demand for those twenty-three channel sets still available. The reasons are obvious; the twenty-three channel sets cost less, they are available for retrofit to forty channels in most cases, and the need for more than a few channels actually doesn't exist in most areas of the country. In fact, I wouldn't be a bit surprised if a demand for twenty-three channel sets were to build for several years yet,

much the same as the demand for six and twelve channel sets lasted for many years after the twenty-threes hit the market.

In addition, reliable sources predict that there will be no great abundance of forty channel sets well into 1977, and we can't visualize millions of new Cbers waiting six months or more to get on the air. We at Palomar East have not curtailed our inventory of twenty-three channel sets; to the contrary, we have increased our inventory with the expectation of being a vital source to our dealers, present and future. We anticipate a drastic shortage of twenty-three channel sets beginning within the next month, and lasting well into next year. When that shortage occurs, Palomar East will be here to serve your needs—in all areas.

Unfortunately, the CB Radio Service has received some very unwarranted and erroneous bad press from several of the nation's largest newspapers. Reports that sun-spots will restrict CB usage are gross exaggerations designed to sell papers. So too, are reports that forty channel sets will make present sets obsolete. But the public has been exposed to these wild and incorrect statements, so it's up to us, as marketers to make the public aware of the true facts. If you need assistance in educating your consumer customers, call on us for help. We're here to service you in many ways, and that's just part of our job. This is what has made Palomar East one of the largest two-step distributors in the country, and why we'll continue to be just that. Your best supply for all your needs.



**PALOMAR East Ltd.**

Worldwide Electronic Distributors

Palomar Square, 80 Blaisdell Road, Orangeburg, N.Y. 10962  
2629 North 24 Drive, Phoenix, Arizona 85009

For Speed Service: phone (914) 359-8800

Plus the new Arizona number: (602) 257-8404



SBE



ROBYN



GEMTRONICS



COURIER



ROYCE



PEARCE SIMPSON

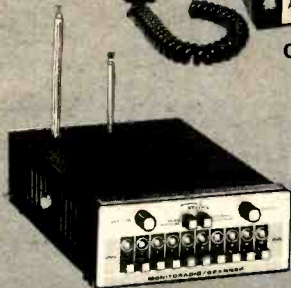

REGENCY



TEABERRY



PALOMAR

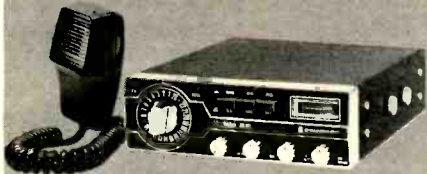

STANDARD

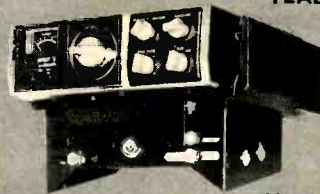

HY-GAIN



BROWNING



KRIS



TRAM



JOHNSON



XTAL



SILTRONIX



PACE

**Palomar East stocks all these lines...  
and many more!**

*Wilson Electronics  
Corporation*



**TURNER**



**avanti**



**PALOMAR East Ltd.**  
Worldwide Electronic Distributors

Palomar Square, 80 Blaisdell Road, Orangeburg, N.Y. 10962  
2629 North 24 Drive, Phoenix, Arizona 85009

For Speed Service: phone (914) 359-8800  
Plus the new Arizona number: (602) 257-8404

**new-tronics  
corporation**



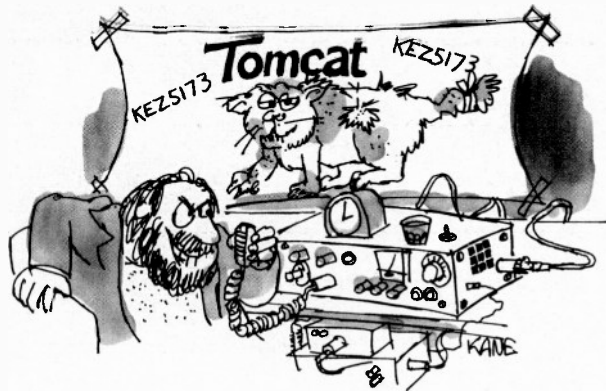

# TOMCAT'S Product Report

## THE SENCORE CB PERFORMANCE TESTER

One of my fantasies is to design a CB rig tester which really gives a spectacular reaction to the rig it is checking—perhaps playing a rousing Sousa march for good sets, and reacting to junky sets with an assortment of Bronx cheers and offensive tape recorded comments (“Get this lemon off the service bench quick! You gotta be kidding! Send this bomb back to the Smithsonian!” and like that). Well I never got around to it but in the meantime Sencore, Inc., (3200 Sencore Drive, Sioux Falls, SD 57107) is filling in the gap more than adequately with their new CB-41 Automatic CB Performance Tester.

Of course it isn't going to play Sousa or give off Bronx cheers, but it will give you a quick rendition of the more important features of your CB rig, either mobile or base! For instance, if somehow you feel that your shouts are going unanswered and you are relatively assured that it's not because of some objectionable aspect of your personality, well—maybe the old MegaHerz Maker just isn't up to snuff!

So, you fire up the Sencore CB-41 and perform the RF power and percent modulation tests to instantly check out if the thing is still putting out 4 watts, and if the mike, audio circuitry, and modulation stages are copasetic. These two tests will indicate how (and if) your transmitter is behaving.

You can also switch over to check out the SWR of your antenna system, which reports to you in vivid color how well your sky hook is accepting the power being sent there by the rig. Now, while many SWR meters see how you're doing on

only one single channel at a time, and bearing in mind that you may have a beautifully low SWR at one end of the band and an uncomfortably high SWR at the other end—especially on a 40 channel rig—you will be pleased to note that Sencore CB-41 lets you know what's going on right across the band from one end to the other!

The RF power test measures the Peak Envelope Power (PEP) and average power from AM rigs, and the same test can be used to put a SSB rig through the 3rd degree.

As a bonus feature, the CB-41 has a built-in dummy load.

The whole device is a 2-part system, the meter itself, and also the RF sensing section which is placed in the coaxial antenna cable of your station (you can leave it in the line, it doesn't diminish your signal).

Now here are two nice extras, first: it comes with a 15-minute tape recording which discusses the unit and how to use it—pretty handy if you're one of the many who look up on any type of instructional material with horror—this makes it *really* simple! The other feature I like a lot is their “100% Made

Right Lifetime Guarantee” which guarantees the unit against factory defects for as long as it is used.

The quality of the unit is such that it is equally usable by professional CB service technicians as well as individual CB'er.

I found it a handy and well made piece of gear, from one of the better known manufacturers in this field. Sells for \$148, and is available through about 500 Sencore distributors around the country. Tell 'em *Tomcat* sent ya!





TO CLEAR AND HOLD A HANDLE FOR 7 DAYS CALL **THE HANDLE HOT LINE** 24 hours a day (218) 283-9290

# NOW YOU CAN REGISTER YOUR HANDLE

## THE ONLY NATIONAL REGISTRATION YOU NEED

**First we search** our files to see if your requested handle is available.

**Then we register** your handle.

**YOUR HANDLE REGISTRATION CERTIFICATION CARD FOR YOUR WALLET**

TO KEEP YOUR REGISTRATIONS CURRENT, THIS REGISTER YOUR REGISTRATION CERTIFICATE

1407 ELIZABETH ST.  
BLANDER, WIS.

IS REGISTERED WITH THE

**National Bureau of Search and Call Registration**

Box 1976 INTERNATIONAL FALLS, MINN. 56649

00001

RECOGNIZED AS THE ONLY RIGHTFUL USER OF THE HANDLE

SIGNAL SUCK

BY THE

**National Bureau of Search and Call Registration**

*Non-governmental clearing and registration house serving the CB Fraternity since 1958*

**National Bureau of Search and Call Registration**

Box 1976  
International Falls,  
Minnesota 65549

*Terry Stone*  
SIGNATURE OF REGISTRANT

*R. M. Kruecker*  
NATIONAL DIRECTOR

**\$2<sup>00</sup>**

**OVER  
300,000  
HANDLES  
ALREADY**

### MAIL THIS INFORMATION TODAY

FIRST NAME

LAST NAME

NUMBER AND STREET

CITY

STATE ZIP

REQUESTED HANDLE

IS THIS HANDLE BEING HELD FOR YOU  YES  NO

WOULD YOU LIKE ADDITIONAL FORMS FOR FRIENDS  YES  NO

WOULD YOU LIKE A GROUP OR CLUB REGISTRATION KIT  YES  NO

**\$2<sup>00</sup>**

- Registration avoids confusion over multiple use of the same handle.
- Establishes your claim to prior usage under law.
- Each handle is registered to only one person in the country.
- All bureau records are absolutely confidential.
- The bureau is not a government agency.
- Your registration is a beautiful document suitable for framing.
- Registration fee is \$2.00.
- Your fee is returned if your requested handle is unregistrable due to prior registration.
- Your handle can be changed at any future date, free of charge, by simply returning your registration document along with your request for a new handle.

Enclose Check for \$2.00 and mail to:

**National Bureau of Search and Call Registration**

Box 1976  
International Falls, MN 56649

Now from M-Tron...

# A Security Blanket for Crystal Buyers

**RELAX** M-Tron has a plan that can make crystals the least of your worries. Our *Security Blanket* program is ready to give you:

- GUARANTEED PRICE**—a highly competitive unit cost that you can count on for the length of your "blanket" plan.
- GUARANTEED DELIVERY** of every scanner crystal you order in the shortest possible time.
- GUARANTEED QUALITY**—all M-Tron crystals carry our famous "life of the set" warranty.

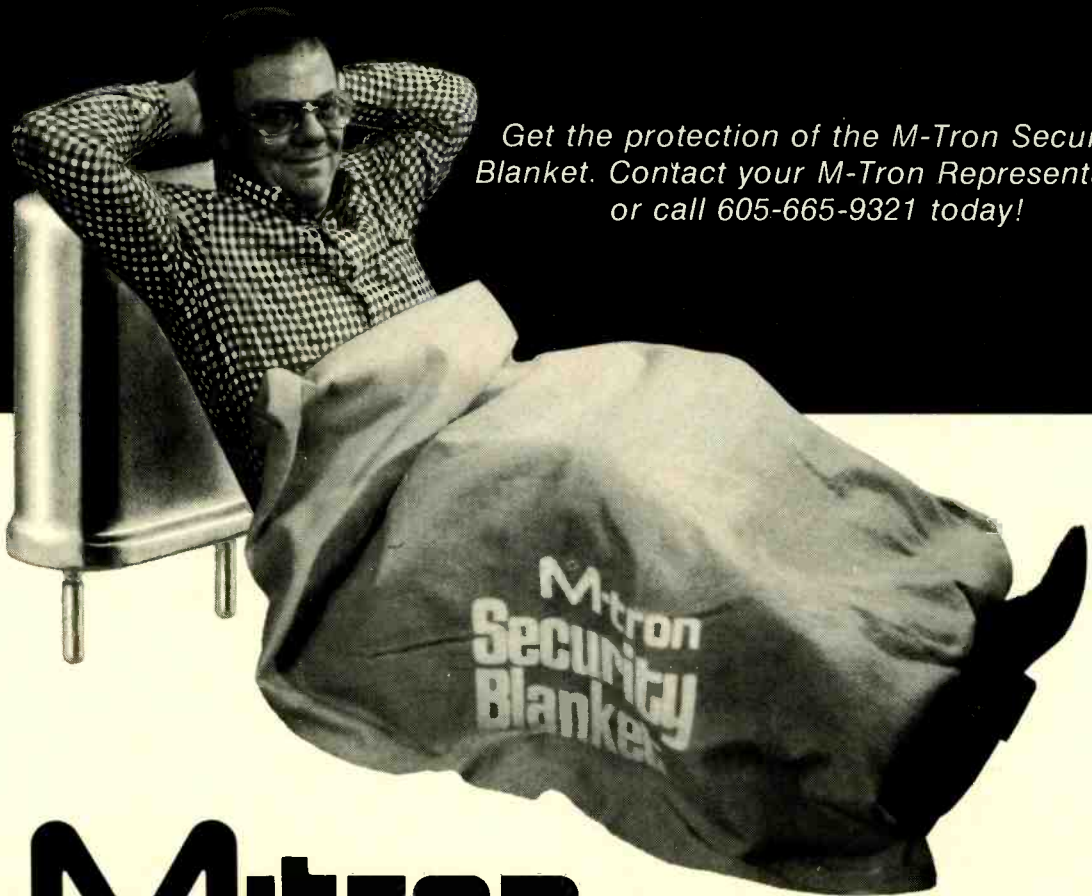

Get the protection of the M-Tron Security Blanket. Contact your M-Tron Representative or call 605-665-9321 today!

# M-tron INDUSTRIES, INC.

P. O. Box 630, Yankton, South Dakota 57078



# The Big Stick<sup>®</sup> Antenna.

## High, wide- ranging and handsome.

ENGINEERED  
FOR  
PRESENT  
23 CHANNELS  
AND ADDITIONAL  
17 CHANNELS  
AUTHORIZED  
FOR USE  
AFTER 1-1-77

This half-wave, omni-directional fiberglass beauty punches out the big signal from 60 feet up to outperform all other base station antennas.

The Big Stick Antenna illuminates 12 times more capture area at 60 feet, sending the energy towards the horizon in a unique low angle radiation pattern.

Distributed dielectric loading, achieved by Shakespeare's exclusive fiberglass construction, enables the Big Stick to outrange taller, heavier metal antennas under all conditions.

Move up to the Big Stick. Pretuned. No ground radials. Works anywhere with any length cable. Also available in a lower cost model, Big Stick II. Shakespeare Antenna Group, P. O. Box 246, Columbia, South Carolina 29202.

Style 176



*Shakespeare*

THE ROYAL LINE OF FIBERGLASS ANTENNA

In Canada/Len Finkler, Ltd.,  
25 Toro Road, Downsview, Ontario



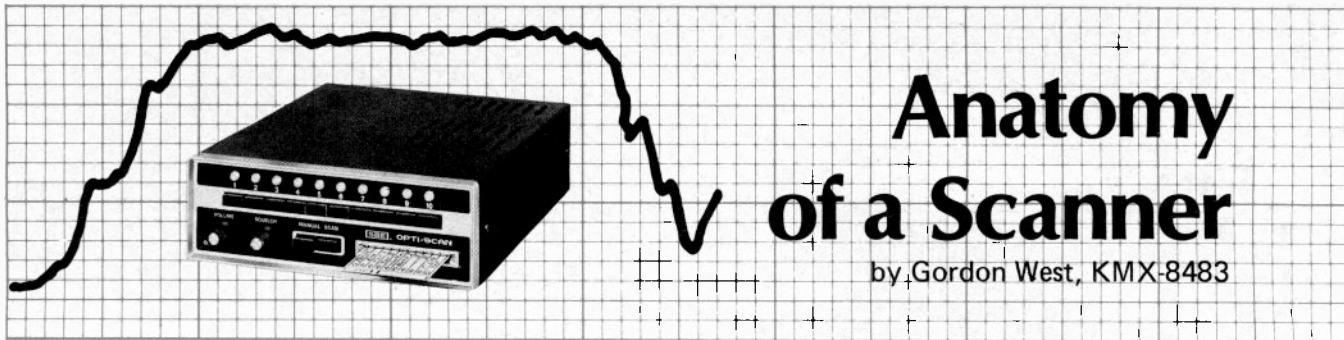

# Anatomy of a Scanner

by Gordon West, KMX-8483

## PART 1: SCANNER RECEIVERS

**L**ET'S take a look at an exciting area in personal communications—the scanner.

This series will take you on a complete tour of scanners, with Part I giving the philosophy behind the development of a scanner receiver. "Anatomy of a Scanner" series will go into great depths on scanners—all the way from crystal correlations, bands, plug-in modules, circuitry—we're going to cover the works in a logical sequence in this multi series on scanners.

What is a scanner, you say? A scanner is any radio receiver that may automatically be switched on to sample various frequencies and channels. Remember in the old days when those exclusive automobiles had a certain type of radio that automatically found stations simply by depressing a tuning bar? This was probably one of the first uses of a scanner in an automobile—this time scanning for stations on the broadcast band.

Only trouble here—it wasn't really automatic. If you wanted to go to a next station, you manually had to push the scan button. It would then "lock up" on the new station.

Twenty years ago if one wanted to hear the local police department, all he would have to do is to run right down and purchase a tunable receiver that would cover the frequencies that the police department broadcasted on. Take for example a police department that might broadcast at 45.38 MHz. The radio enthusiast would need to select a tunable receiver that would span between 30 and 50 MHz, and simply tune around until he would be able to hear the particular police department transmitting precisely on 45.38. His dial would probably only read 44 MHz—45 MHz—46 MHz—and he would simply have to tune somewhere in between 45 and 46 MHz to pick up the station.

Then this same radio enthusiast might want to listen in on the police department—whose broadcast frequency might be 154.275 MHz. Now he had a problem. His present police receiver only

spanned 30 to 50 MHz, and he would now need a new receiver. So he went out and bought another one—this time a tunable receiver that covered from 150 through 170 MHz, picking up that elusive fire department frequency at 154.275 MHz.

In order to receive both stations, both receivers would have to be left on. Sometimes he would hear no stations when they were not transmitting—sometimes he would hear one—the other—and sometimes both would come over a pair of loud speakers at the same time!

Now this same radio enthusiast decides he wants to listen in on the local ambulance company, operating on 155.160 MHz. He's in good shape in that his newly purchased fire receiver covers that frequency, and he need only shift his tuning dial to the right to pick up the ambulance company—waiting to tune them in when they begin to transmit to properly spot the frequency.

But now that he's got the ambulance company tuned in—he lost the fire department frequency. Well, maybe if he was lucky, and had one of the less expensive receivers, he might be able to pick them up both by putting the tuning selector at about midpoint between both services! If only he had a device that would sample each frequency automatically, as well as some sort of receiver that would encompass more than one band of frequencies.

As receiver technology advanced, there were multi band receivers that would pick up the 30 to 50 MHz band, and the 150 to 170 MHz band. These "dual-band" monitor receivers were quite popular back then, but still had one drawback—they could only hear one frequency at a time. This began the birth of the scanner.

It's well disputed in manufacturing circles as to who really invented the scanner. One leading firm says that they did, and they hold a patent on the scanner circuit technique. They also go so far as to claim that other manufac-

turers have to pay them royalties on their patent. Checking with other manufacturers, they claim the same thing, but in reverse! But whoever it was, they really did bring an exciting tool for the radio enthusiast to operate.

**THE SCANNER HOBBY—CONTAGIOUS.** Probably one of the easiest ways to be bitten by the scanner bug is to listen in on a friend's scanner receiver. Chances are, he has it programmed for the local police, fire, paramedics, weather service, and other exciting users of FM two-way radio.

Almost everyone not familiar with monitoring thinks that these type of two-way broadcasts take place on frequencies so high that they may only be received by communication monitors that cost literally thousands of dollars—absolutely untrue!

Almost every two-way radio user broadcasts in three discrete bands that will be described in next month's article. These bands are well within the reception capabilities of inexpensive scanner monitor receivers.

So what's so exciting to listening to these police, fire, and medical frequencies? Can't you imagine the excitement of hearing a policeman responding with sirens wailing in the background to a tremendous auto accident nearby—and then hearing his reports on what casualties he has at the scene?

"Fire Unit 21, we are 1097 the scene and have a residence completely engulfed in flames. Wait—there's someone trapped on the second story. Unit 47, bring the net and try a ladder up to that window where the lady is waving. Wait a minute—she may jump, so bring your net. . ."

Hearing actual fire two-way radio transmissions like this is not at all uncommon—as well as hearing the background noise of confusion, hoses being energized, and approaching sirens. A scanner will receive all of these transmissions that are normally directed from the fire department to their base headquarters — this time intercepted

# POWER WING...

*Everything a CB Antenna Should Be  
and MORE!*

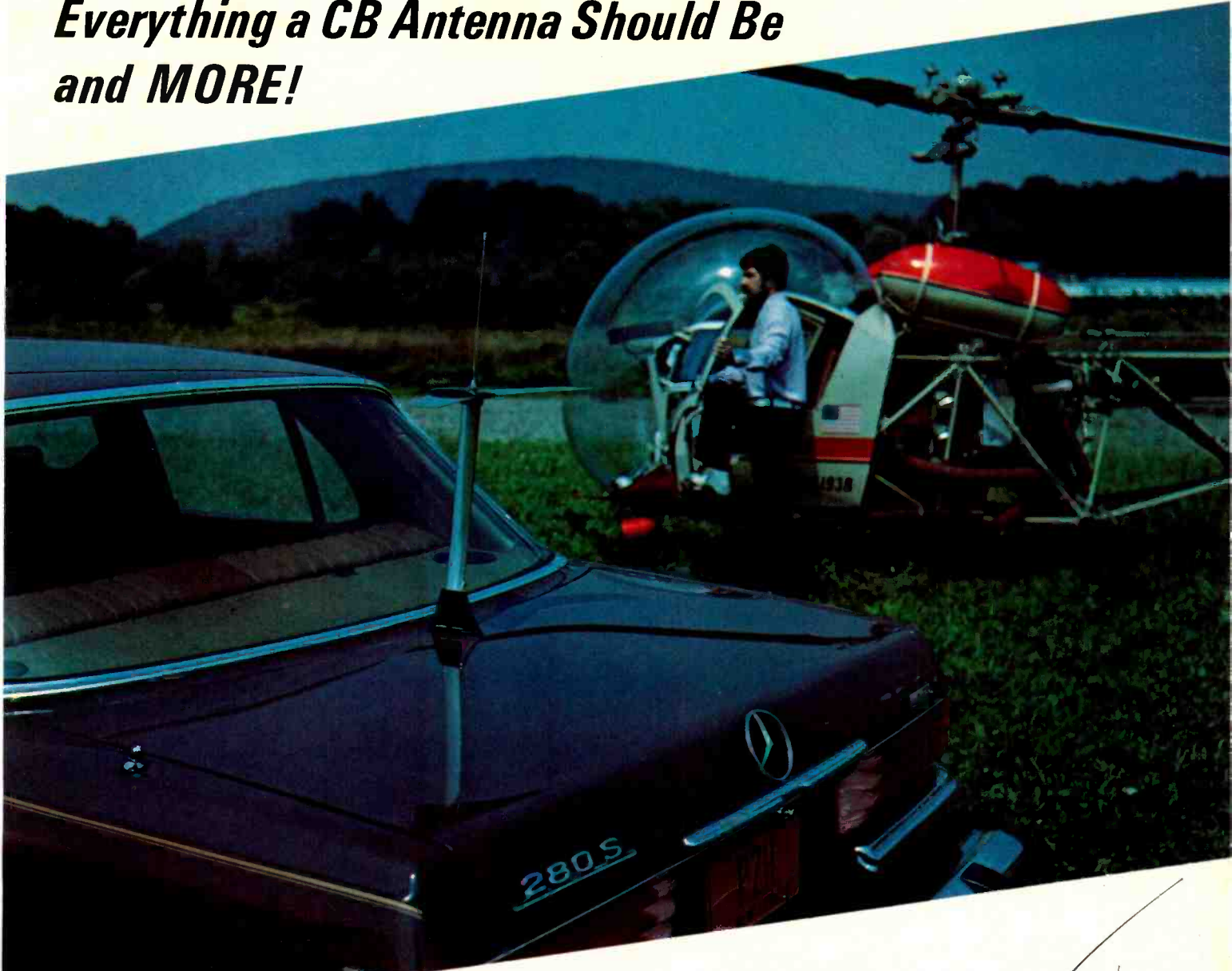

**Power Wing**—the new compact 16" CB antenna that outperforms antennas more than twice its size. Delivers **PERFORMANCE...FEATURES...STYLING!**

**Capacitive Top Loading**....Power Wing uses this principle to make a shorter CB antenna with higher average current and greater radiating efficiency than anything in its class!

**High Q Coil**....the most efficient coil design of any antenna. That means greater gain and higher wattage capabilities.

**Average SWR of 1.4:1**....capacitive top loading and wide monopole design enable Power Wing to retain the benefits of high Q coil while successfully broadening bandwidth. Good SWR, great gain with 23 or 40 channel transceivers.

**Theft Proof**....removes in seconds for safe storage or car washing.

**Low Profile**....only 16" from base to wing....won't hit garage doors, trees, etc.



**No Detuning**....rigid aerodynamic construction prevents Power Wing from detuning. Radiation pattern remains constant!

**Quality Components**....sturdy aircraft aluminum, chrome, stainless steel, factory installed connectors and a tough marine acrylic weather proof coating. That's what makes Power Wing an award winning CB antenna.

**Power Wing**....power-packed features in a high performance, great looking CB antenna. Available wherever Channel Master products are sold. For more information write:

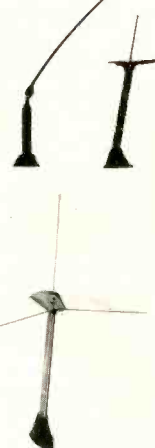

**Channel Master** **CB** antennas  
...the big name in

DIVISION OF AVNET, INC. CBW1076, ELLENVILLE, N.Y. 12428



## ANATOMY OF A SCANNER (cont'd)

harmlessly by you and your scanner receiver.

"Medic 31, we're on scene with a possible juvenile drowning—male, age 8, salt water rescue with no apparent respiration. We are beginning mouth-to-mouth resuscitation—and will check for vitals."

"Medic 31, this is Costa Mesa hospital—hook up your EKG and send us your patient's vitals."

Your medic channel on your medic receiver now goes definitely quiet—and you can probably visualize the paramedics hooking up their radio monitoring equipment preparing to send their young patient's vital life signs to a local hospital—and you are hearing everything direct.

There it is—the familiar beep-beep-beep—a rising and falling sound that you know corresponds to the patient's heart beat. Whew, this tells you immediately that the paramedics are receiving heart electrical pulses, and that young drowning patient might still have a chance to live.

"Medic 61, we have received EKG strip, and request you begin IV fluids beginning with . . ."

I'm happy to say that the young man was saved—probably owing his life to the two-way radio circuit that transmitted his life signs to the local hospital via the paramedics walkie talkie radio setup. And through the use of your monitor scanner receiver, you were actually able to hear everything, live, direct, as it was really occurring. You will probably even read about it the next day in the paper—and no doubt you'll know that what you heard was a hundred times more accurate than what was reported a day later.

"Beeeeeep—special weather advisory—a funnel cloud has been sighted just south of Dayton, and residents are urged to take cover. I repeat, a funnel cloud . . ."

For those that live in areas that are frequented by tornadoes, hurricanes, and other natural disasters, the United States N.O.A.A. Weather Service provides immediate weather information on one of two selected weather channels, capable of being received by your monitor scanner. Your monitor now has taken on a new role—that of a life saver for you!

There are literally thousands of frequencies—more than 16,000—that may be received on a scanner receiver. You would obviously want to choose only those frequencies that would be of prime interest to you in your local area of monitoring. For the many volunteer firemen throughout the country, and for those that operate aboard rescue squad

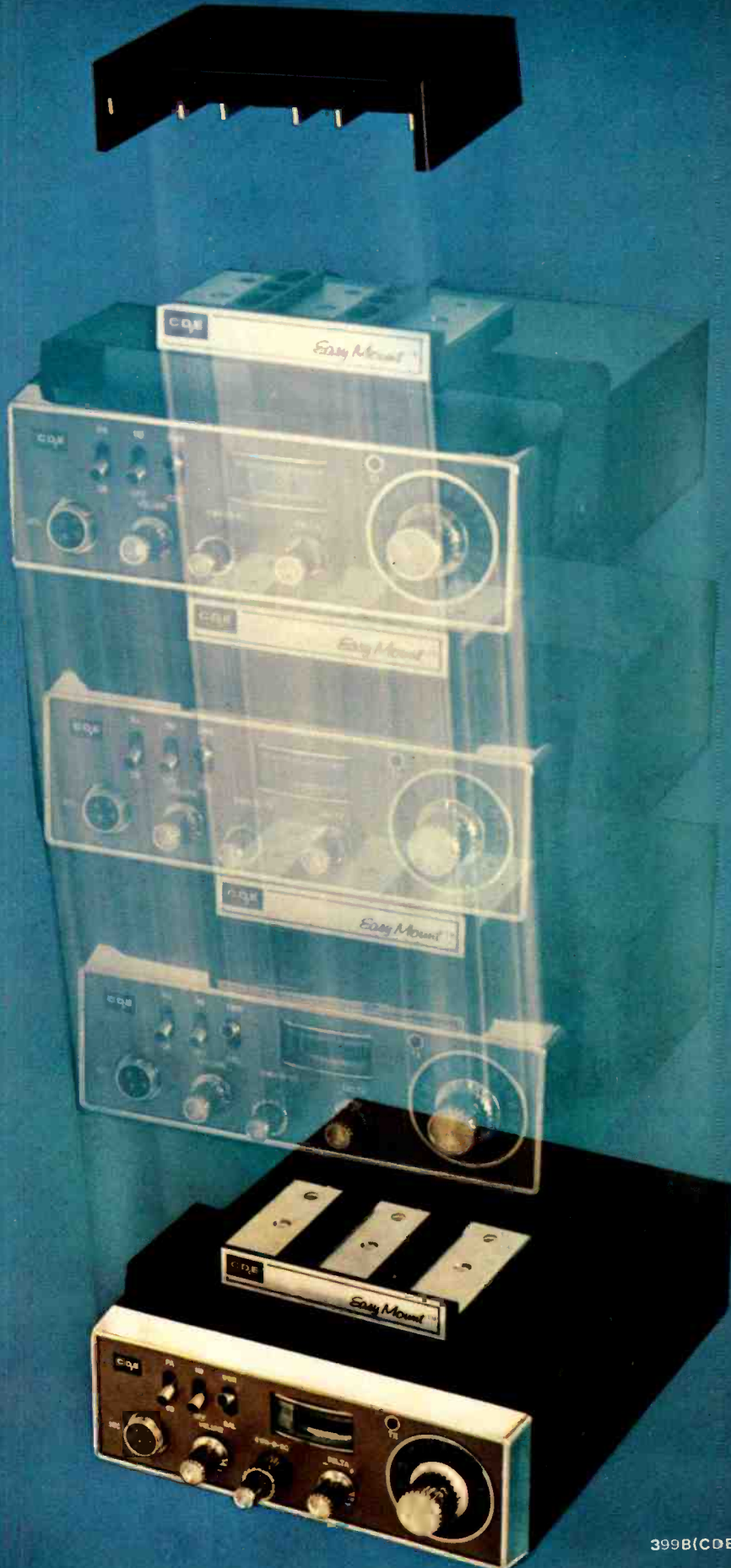

399B(CDE)

For Information About Our Advertisers . . .



vehicles, scanners to them are essential in the performance of their duty.

It's probably divided in just about half in the use of a scanner—one half listening to scanner receivers for the enjoyment of hearing the action, and the other half listening to scanner receivers in the performance of their duties.

A word of caution on the latter use—anything you may hear on a scanner is considered confidential, and except for two-meter amateur radio broadcasts, you must keep what you hear confidential. This is a basic law as set forth by the Communications Act. Even though you might be operating a tow truck company, and you hear your local police department on your scanner report a traffic accident two blocks away, you are not permitted by law to act on any message received on that scanner until you have been officially called by that police department to respond to the accident.

The same might hold true for the



casual eavesdropper—you might hear a terrific news story in the making, but you are prohibited by law from divulging anything you hear to a news media.

Or take the criminal that might want to use a scanner in pulling off his next burglary at night—if he is caught, not only will he be prosecuted for burglary, but he also faces some stiff federal penalties for operating a scanner monitor in an illegal fashion—for the use of committing a crime.

"Illegal scanners being seized by police—mobile scanning monitors still illegal in State of Kentucky in spite of numerous court test cases across country where monitors have been declared legal to use. Moonshine State police stop out-of-state cars, confiscate scanners, fine hapless motorists and socks him with court costs."

This was a report published in a local media daily report—and I imagine that in some backward States, what was reported is really occurring. Some States—some cities—some communities—have local laws regarding the use of a scanner monitor installed in a moving vehicle. Although most of the time

... Use S9 READER SERVICE.

# EASY MOUNT DELUXE MAGNETIC CDE CB RADIO MOUNT



The CDE Easy Mount is truly the luxury way to use and protect your CB radio. It is the first mount designed expressly for two-way communications equipment and is far superior to ordinary slide brackets. A unique design utilizes magnetic power to automatically hold your transceiver in place...and provides a quick connect/disconnect system for both antenna and power allowing instant, easy removal of the radio to prevent theft.

The Easy Mount uses three powerful permanent magnets to make positive contact assuring maximum signal transfer with perfect VSWR match. Ordinary slide brackets use flexible metal strips which can easily bend and wear to produce mismatch causing loss of signal or even "blow" the RF output stage of your transceiver.

Installation is as simple as 1-2-3 and gives you a neat, flush mount appearance. You also have the flexibility of using your Easy Mount under the dash or on the transmission hump. With an optional top section, you can instantly transfer your transceiver from vehicle to vehicle...to your boat or home.

Ease of use...maximum performance...flush mount design...plus a one year warranty all add up to make the Easy Mount your best investment in transceiver protection...don't settle for anything less.



**CORNELL-DUBILIER ELECTRIC CORPORATION**  
SUBSIDIARY OF FEDERAL PACIFIC ELECTRIC COMPANY  
1605 Rodney French Blvd., New Bedford, Mass. 02744

339A(CDE)

*This is the Legendary*

# FUZZBUSTER®

## POLICE RADAR MONITOR



### PEACE for the Professional Driver

**(Ask any long-haul trucker . . . he'll tell you about it.)**

A military type radar receiver that works two to ten times farther than radar. Parametric design provides unparalleled sensitivity, but rejects false signals. No installation or antenna. Adopts to positive or negative ground vehicles.

A unique AUDIO CUEING system announces radar lock-on with a short beep. The visual indicator is then used to estimate where and what type of speed trap is being encountered. The receiver is especially effective against the new moving radar.

*Proven by thousands of truckers over billions of miles, nationwide, and now available to the general public!*

**IF IT DOESN'T SAY:**



**IT'S BOGUS!**

**DEDUCT 10%** if you have paid a SPEED RADAR TICKET in the preceding 12 MONTHS. Send ticket or cancelled check with order. Copies O.K.; original returned.

Please rush me a Fuzzbuster. My check for \$89.95 is enclosed. Wenover Associates P.O. Box 231 Burlington, Mass. 01803

Name \_\_\_\_\_  
Street \_\_\_\_\_  
City \_\_\_\_\_  
State \_\_\_\_\_ Zip \_\_\_\_\_

### ANATOMY OF A SCANNER (cont'd)

when these cases have been brought to court, they have been thrown out, in some States, such as Kentucky, it appears that the law still sticks.

As to whether or not a trooper could really confiscate a unit without a court order is truly legal—I would have to honestly think no. But nonetheless, they do get a bit excited if a scanner monitor is found in your possession in an automobile. If you plan to use a scanner in your State in a moving vehicle—check it out, and make sure that you don't get "ripped off" by these backward authorities.

I say "backward thinking" in that scanners many times operated by good samaritans may help police in locating wanted vehicles—or lost children—or other matters where the public could help. In fact, there are some State police agencies throughout the country that advocate the use of scanners by private citizens, and hold monthly meetings with scanner enthusiast groups.

If police departments really want to keep their transmissions secretive, they can switch to the not-so-costly "scramblers" that make their voice totally unintelligible to the scanner listener. Although you may be tuned into their precise frequency, the "scrambler" makes all transmissions garbled to your ears—but clear to each other who have unscramblers in their police units and base stations. Only about 2% of the police departments across the country use scramblers, and their use is generally intermittent, with primary use on stakeouts and pending drug busts.

Mobile scramblers operated by motorists in States that do not prohibit their use are a great way to keep apprised of traffic conditions. Many news broadcast stations have helicopters that may be received on a scanner that broadcast up-to-the-second live reports on traffic conditions. Many highway patrols constantly update their dispatchers with road conditions—and these updates are seldom ever heard on commercial radio. By listening to these traffic reports, you can generally find a way to stay out of the congested areas.

Or maybe you're the scanner "Walter Mitty"—who pictures himself at the scene of those dramatic two-way radio earnings! I think we all have a little bit of that in us—and when I hear an exciting call—I can really visualize myself right there along with the radio operator.

**(continued on page 120)**



**MAKE**

# COMMTRON PROVE IT!

"Write or call and we'll show you how and why Commtron has the lowest prices on famous brands of 23-channel CB's... why Commtron always has the unbeatable deal! We're also unbeatable with the perfect solution to 40-channel CB sales. Commtron wants your business, and we'll prove it!"

*Jack Silverman*  
PRESIDENT



## OUR LOWEST PRICE LIST

We'll prove we have the lowest price on these CB's. Send in the coupon and we will send you this ad with the prices filled in and unbeatable prices on many more models.

<b>MIDLAND:</b>	13-857 .....	?	<b>REGENCY:</b>	CR-202 .....	?	<b>PACE:</b>	CB-166 .....	?
	13-862 .....	?	<b>COURIER:</b>	Redball .....	?		CB-161 .....	?
	13-893 .....	?		Classic III .....	?		CB-162 .....	?
<b>JOHNSON:</b>	123A .....	?	<b>ROBYN:</b>	Spartan .....	?	<b>J.I.L.:</b>	852-CB .....	?
	130 .....	?		SX007 .....	?		606-CB .....	?
	250 .....	?		TR 1230 .....	?	<b>SBE:</b>	Touch-Com .....	?
<b>TEABERRY:</b>	T-Scout .....	?	<b>ROYCE:</b>	LB-23A .....	?		Brute .....	?
	Tele-T .....	?		1-653 .....	?	<b>PEARCE-SIMPSON:</b>	Cortez .....	?
	5 X 5 .....	?		1-658 .....	?		Tiger 23-C .....	?
	T-Charlie-1 .....	?		1-614 .....	?		Cougar 23-D .....	?
						<b>X-TAL:</b>	Super Lynx .....	?
							XCB-7 .....	?
						<b>GEMTRONICS:</b>	GTX 3323 .....	?
						<b>GREAT:</b>	GT-418 .....	?

## 40-CHANNEL "HEAD START" PLAN

For every 23-channel CB purchased before December 1, 1976, Commtron issues you a certificate guaranteeing you first priority in obtaining new 40-channel units. We have made cash deposits with many leading manufacturers to insure our customers are among the first to receive 40-channel CB's. Each of the numbered certificates you redeem with Commtron gives you special savings and immediate delivery of 40-channel units when they become available. Offer limited to bona fide dealers and may be withdrawn at any time. Hurry, and be the first dealer in your area with 40-channel CB's.

## PROVE IT!

S-12

- Send me your dealer price list with your 'Unbeatable Deals'
- I want to know more about your 40-channel 'HEAD START' Plan

I'm an authorized CB dealer. Here's my card to prove it!

Name \_\_\_\_\_

Firm \_\_\_\_\_

Address \_\_\_\_\_

City \_\_\_\_\_ State \_\_\_\_\_ Zip \_\_\_\_\_

Please send to your nearest Commtron distributor.

## CALL TOLL FREE

Ohio Calls: 1-800-362-9110  
Calls from: 1-800-321-9142  
Mich., Ind., W. Va., Ky.,  
Western N.Y., & Pa.



The leader in communications distribution

5657 Canal Road  
Cleveland, Ohio 44125 . (216) 447-0393

2450 Bell Avenue  
Des Moines, Iowa 50321 . (519) 244-8233

5606 Parkersburg Drive  
Houston, Texas 77036 . (713) 780-2550





# Ask an old salt about the best CB for your car. He'll say "Shakespeare".

He's depended on Shakespeare's reliability for a long time. And he carries that confidence right onto the road.

He knows quality when he sees it. And from his years of experience at sea, he knows the Shakespeare heritage is one of rugged reliability. He won't stake his life on second-best.

Shakespeare means precision solid-state electronic equipment. Designed to give optimum power and clarity. Punching signals through loud and clear.

And Shakespeare teams power and performance in CB radio to give you total control everytime you break.

The entire Shakespeare CB radio line deserves your attention. They stand apart in a class by themselves. Engineered better to be the best. Ask the man who knows.



Less than \$390.

**Shakespeare GBS/5000.**

The long range capabilities of SSB let you monitor Channel 19 for road conditions and a check on local weather long before you get there. This high capacity transceiver utilizes the most advanced state-of-the-art technology to provide the finest performance. GBS/5000... the rig that incorporates the range, clarity and convenience of SSB communication.

*Shakespeare*

**Sea tough. Highway dependable.**

Shakespeare Electronics Group, P.O. Box 246, Columbia, S.C. 29202 USA



**OFFICIAL**  
**FCC**

**APPLICATION**  
**ON REVERSE SIDE**

**FCC FORM 505**

December 1974

**APPLICATION FOR CLASS C OR D STATION  
LICENSE IN THE CITIZENS RADIO SERVICE**

**Instructions**

**A.** Use a typewriter or print clearly in capital letters. Stay within the boxes. Skip a box where a space would normally appear.  
**B.** Sign and date application.  
**C.** Enclose appropriate fee with application. **DO NOT SUBMIT CASH.** Make check or money order payable to Federal Communications Commission. No fee is required for an application filed by a governmental entity. For additional

fee details, including amount and exemptions, see Subpart G of Part I, FCC Rules and Regulations.  
**D.** Do not enclose order form or subscription fee for FCC Rules.

**E. MAIL APPLICATION TO FEDERAL COMMUNICATIONS COMMISSION,  
GETTYSBURG, PA. 17325.**

1. Complete if license is for an individual

Applicant's First Name            
Init.      Last

2. Date of Birth

Month      Day      Year

3. Complete if license is for a business

Applicant's Name of Business, Organization, Or Partnership

4. Mailing Address (Number and Street) If P.O. Box or RFD# Is Used Also Fill Out Items 8-10.

5. City

6. State      7. Zip Code

8. If Item 4 is P.O. Box or RFD#, Give Address Or Location Of Principal Station

**NOTE:**  
Do not operate until you have your own license. Use of any call sign not your own is prohibited

9. City

10. State

11. Type of Applicant (Check one)

Individual       Association       Corporation  
 Business Partnership       Governmental Entity  
 Sole Proprietor or Individual/Doing Business As  
 Other (Specify) \_\_\_\_\_

12. This application is for

New License  
 Renewal  
 Increase in Number of Transmitters } **IMPORTANT**  
Give Current Call Sign

13. This application is for (Check only one)

Class C Station License  
(NON-VOICE—REMOTE CONTROL OF MODELS)  
 Class D Station License (VOICE)

14. Indicate number of transmitters applicant will operate during the five year license period (Check one)

1 to 5       6 to 15       16 or more (Specify No.   
and attach statement justifying need.)

15.-Certification      I certify that:

•The applicant is not a foreign government or a representative thereof.  
•The applicant has (or has ordered from the Government Printing Office) a current copy of Part 95 of the Commission's rules governing the Citizens Radio Service.  
•The applicant will operate his transmitter in full compliance with the applicable law and current rules of the FCC and that his station will not be used for any purpose contrary to Federal, State, or local law or with greater power than authorized.  
•The applicant waives any claim against the regulatory power of the United States relative to the use of a particular frequency or the use of the medium of transmission of radio waves because of any such previous use, whether licensed or unlicensed.

**WILLFUL FALSE STATEMENTS MADE ON THIS FORM OR ATTACHMENTS ARE PUNISHABLE BY FINE AND IMPRISONMENT. U.S. CODE, TITLE 18, SECTION 1001.**

16. \_\_\_\_\_  
Signature of: Individual applicant, or authorized person on behalf of a governmental entity or partnership, or an officer of a corporation or association

17. Date \_\_\_\_\_



# DISAPPEARING ACT

## MOTORIZED CB ANTENNA by FAMOUS ARCHER<sup>®</sup>

Flip its switch, and the Archer electric antenna extends to its full 33" length *and turns your CB radio on*. Flip again, and it retracts into the fender *and turns your radio off*. Nobody will know you've got ears — it's Archer's automatic answer to CB rip-offs. A top performer that ends the bother of removing your antenna. Adjustable SWR. Center loading coil, excellent for mobile use.

Quality materials and workmanship. Installation hardware and instructions included. Our "disappearing act" is another reason why a million CB'ers will choose Radio Shack's Archer brand this year. Get 21-970 and you'll have something to hide and nothing to lose. Only 59.95\*.

now you see it.  
now you don't.

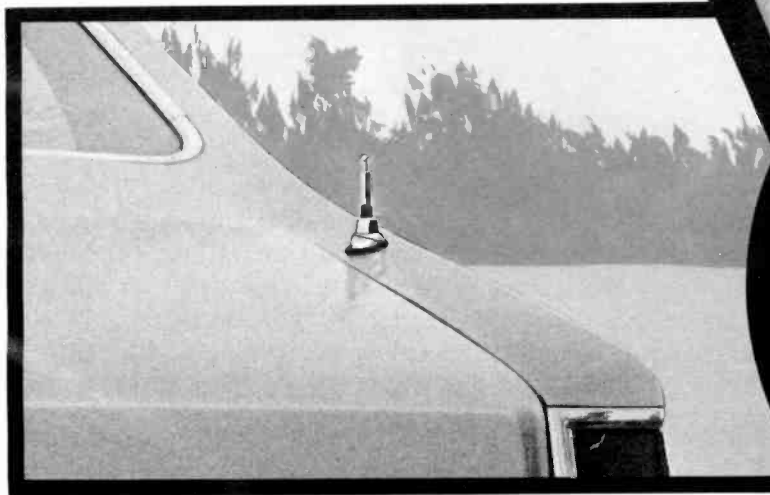

ASK FOR OUR '77 CATALOG



FREE! 164 pages, full color, 2000 exclusive items. Come in for your copy today!

LEADING THE WAY IN QUALITY CB SINCE 1960

# Radio Shack<sup>®</sup>

A TANDY COMPANY • FORT WORTH, TEXAS 76107  
5000 LOCATIONS IN NINE COUNTRIES

\*Price may vary at individual stores and dealers.

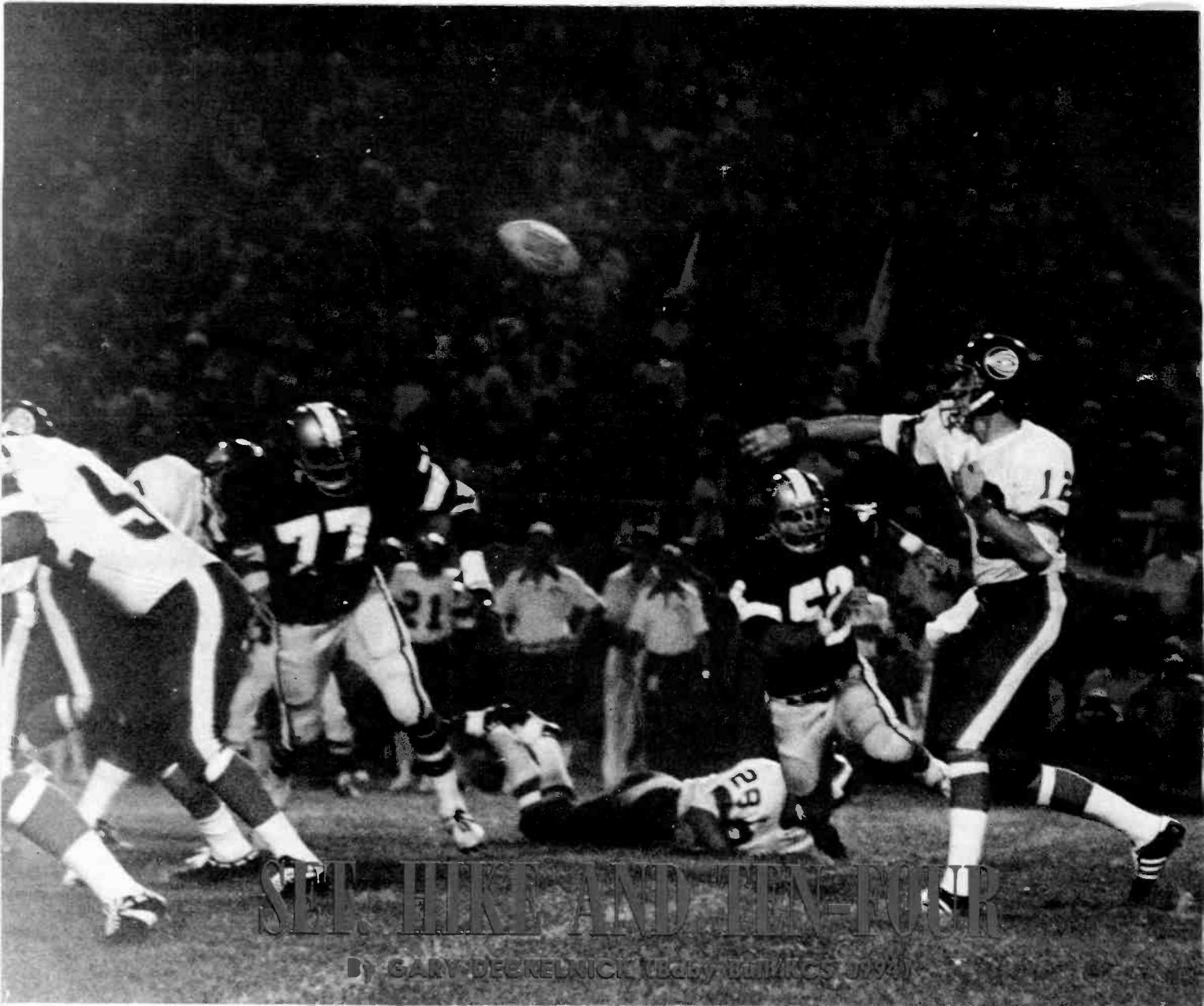

## SEE, HEAR AND TEN-FOUR

By GARY DEKRELUICK (with BOB DAVIS)

**F**OR years, Bob Davis has had practice calling signals. He began as a young quarterback in Neptune, N.J., high school and worked his way up to the New York Jets and the champion Florida Blazers.

And now that his professional football career is behind him, Bob, or as his many CB friends know him, the Jersey Scrambler, has no intention of abandoning his signal calling. He's just switching to a new set, the 10-code.

He is one of the newest to join the expanding ranks of CBers and he also may be the first to conceive of CB as an entertainment center for his business.

"I'm opening Bob Davis Restaurant," explained the former quarterback who decided to retire from professional ranks when the World Football League folded after two seasons.

"It will have the regular stuff any restaurant of its kind has to have. There will be a television and maybe a quarterback night once a week when an athlete is here to meet the customers. But I'm thinking of leaving the base station receiver in the bar on, say, channel 19. I find people like to listen to the truckers talk."

Davis was a much travelled quarterback in the National Football League but he didn't really have a chance to show his ability to the fullest there. During his prime years, he played with the Jets. But they also had a quarterback during those years named Joe Namath.

"I have no regrets about playing behind Namath," said Davis. "He was a good guy to play behind. You learned a lot. But I had more fun with the Blazers."

He joined the Florida team when the WFL began in 1974 and unlike many of the football players who jumped, he didn't suffer financially when the league folded.

"They owe me a lot of money that I will never get," he said. "But I got more up front than the other guys, so I did okay."

During his first season, he led the team to the league championship. But when the league fell under the weight of its money problems in the second year, Davis decided to hang up his Jersey.

"I miss it," he says. "There is no question about that. But every athlete also gets involved in outside business and there comes a time when you just cannot divide yourself between them."

Before he opened his restaurant, Davis joined the insurance business, an occupation he still maintains. Because he is who he is, however, he had customers who would deal only with him.

"Every time I had to leave for a season, it cost me business," said Davis. "Once I was all set to close a big deal but we couldn't finish it before training started and I lost it."

As a football player, Davis took the approach that practice makes perfect. And he tried the same approach with CB. But its use was thrust upon him before he was really ready and he recalls being more nervous than he ever was in a football game.



"I wasn't sure what to say on the radio when I first got it in my car," he recalls. "So I was practicing. I was holding the mike and talking to it but the mike wasn't keyed."

"Then, I heard some goodbuddy calling me. He described my car perfectly. So I answered him and I told him it was my first conversation and I was still new at it. He was very helpful."

Kit Davis, Bob's attractive wife, says it is the friendliness exemplified by almost all CBers that has made her a confirmed radio user.

She uses the handle, Corner Wire, after a difficult shot in paddle tennis. Like her husband, Kit is an athlete and she has had unusual success in making the shot. A paddle tennis court is on a platform surrounded by wire as a boxing ring is surrounded by rope. A corner wire shot is one that bounces off both wires near the corner where they meet.

"Society is very cold today," said Mrs. Davis, who met her husband during their years at nearby high schools and dated him through college. "You can walk down the street and pass someone and they will not even nod hello."

"But on the radio, everyone is very friendly and everyone wants to help each other. I like that."

It was that kind of help that Davis was led to believe he could get that convinced him to buy his first CB. He was about to take a trip to Florida last spring to vacation and visit old friends.

But he was going to places he hadn't been before and he wasn't sure of the route.

"My lawyer is a CB bug and he told me to get a set," Davis says. "He said I would find it useful on the trip and he was right. I avoided one big traffic jam by learning about it on the radio and taking an alternate route."

He also was able to get help for at least one broken down motorist by using channel 9 and he heard other CBers help out numerous other persons in trouble.

By the time he returned from the trip, he knew that both he and his wife wanted one for their cars and the base for their home is next.

He also envisions a base station in his insurance



# tenna-loc<sup>®</sup>

**THE ANTI-THEFT CB ANTENNA LOCK**

## PROTECT YOUR ANTENNA

# tenna-loc it!

**tenna-loc** is the first, really positive protection designed to keep your antenna intact and in place — year round! Yes, you may remove it for car wash or long term storage . . . but there's no need to every time you park! It works like a charm in all kinds of weather and keeps on working for years. **tenna-loc** features a turn-proof locking stud integrated into a specially notched U-bolt with a 5-tumbler, corrosion proof key lock. We also give you a heavy-duty mounting bracket

and an electro-polished, stainless steel replacement cup, where needed, for easy, quick installation. At \$11.95 (approx), it's a steal! Get one today.

- Choice of models, to fit most trunk mount antennas.
- Installs quickly, easily; keeps your antenna secure.
- Chrome plated, 5-tumbler, corrosion proof key lock.
- Exclusive, turn-proof, U-bolt with lock-in stud.
- Made in U.S.A.; patent pending.

**See Your Dealer!**



A product of:  
**VERNITRON CORPORATION**  
CONSUMER PRODUCTS DIVISION  
Lake Success Park, Community Drive, Great Neck, N.Y. 11021 (516) 487-0140

## SET, HIKE AND TEN-FOUR (continued)

office that office workers could use to relay important messages to him.

And there also will be that base station at his restaurant so customers at the bar can listen to the truckers try to avoid the Smokies.

Ironically, that is one use for the CB that Davis does not have, even though it's among the most popular uses for the radio among his fellow CBers.

"I don't speed so I don't worry about the Smokies," says Davis. "Sometimes I give out a Smokey report, though, just to be helpful.

He took the handle Jersey Scrambler in memory of the days when he was a quarterback who could run as well as pass. It was not unusual to see Davis burst from a pocket and tuck the ball under his arm to peel off a long gain.

He's also easy to talk with if any CBers are ever in shouting distance of his home a few miles from Asbury Park, N.J. When he's in the area, he's usually on channel 10.

When he's away from the area, perhaps calling on a customer, look for him on channel 19. That's the best place for a person looking for an address to pick up the proper signals.

And whether he's behind the mike or behind a big line waiting for a football, Bob Davis always has his signals straight.



... Use S9 READER SERVICE.

**Antenna** Incorporated

U.S. MANUFACTURERS OF  
**THE BEST IN  
CITIZENS BAND  
ANTENNAS**



MAGNET MOUNT

**ZAPPER**  
MODEL 13510  
BASE LOADED  
MAGNET MOUNT  
\$28.88

**MATCHLOCK**  
MODEL 13511  
CENTER LOADED  
MAGNET MOUNT  
\$28.88

**Antenna, Incorporated**

23850 Commerce Park Road, Cleveland, Ohio 44122  
(216) 464-7075

In Canada: E.S. Gould Marketing Co., Ltd.  
109 Montee De Liesse - Montreal, Quebec H4T 1S9 Canada  
Antenna, Incorporated, International Division  
P.O. Box 1002 - Rockville Centre, New York 11571

# ATTENTION CB'ers

NOW YOU CAN HAVE YOUR  
C.B. SETS REPAIRED by  
PROFESSIONALS!

- We will repair any AM C.B. set for \$25.00 plus parts.
- We will repair any SSB C.B. set for \$35.00 plus parts.
- All sets will be shipped back to you C.O.D. plus shipping within 72 hours after receipt.
- If we feel a set is beyond repair, it will be returned to you collect for shipping charges plus \$5.00 inspection fee.

Please include schematic, board layout, and instruction manual if you have them. They will be returned with repaired set.

**CB REPAIR CENTER INC.**  
**980 EAST 35 STR.**  
**BROOKLYN, NEW YORK 11210**  
**212- 253-8787**

Authorized warranty repair for  
UNIMETRICS HYGAIN FANON/COURIER MIDLAND CRAIG ROSS  
MOTOROLA GEMTRONICS ZODIAK WESTLAND COBRA KRIS

Manufacturers, distributors, sales outlets, we will  
do your repairs, warranty & non warranty.

Please contact Leonard Knigin



Of the umpteen magazines now serving the **CB Radio Market**



**One stands alone!**

While all the magazines are sold on the newsstands... and some are sold in CB retail stores...



**S9, of all these publications, is unique because:**

More than 50,000 hard core CB hobbyists subscribe only to S9! These are the experts who are guiding today's new CB'er on what to buy, where to buy it, what features to choose and what price to pay.

**The experts are what make S9 the unique CB monthly. If you don't believe us, find a CB expert and ask him. He'll probably end up selling YOU an S9 subscription.**



# CB'ers... GET LEGAL!



**\$10,000 FINE AND/OR ONE YEAR  
IN JAIL IF YOU OPERATE  
WITHOUT AN FCC LICENSE..... IT IS A FELONY!!**

*"This is the most up-to-date, authoritative CB-Kit on the market!"*

*Bob "Stash" Vissichio  
New York City, N.Y.*

**only  
\$4.95**

## C.B. RADIO-STATION KIT

**NEW!**  
Contains  
FCC Temporary License!  
Over 1,000 Words  
in Glossary!

**A MUST FOR EVERY CB'er!  
DON'T TAKE THE CHANCE!  
GET ORGANIZED!**



### EACH KIT CONTAINS:

1. FCC TEMPORARY LICENSE
2. FCC PERMANENT LICENSE APPLICATION
3. COMPLETE FCC RULES AND REGULATIONS
4. TRANSMITTER I.D. CARD
5. HOW TO BUY A CB-SET WITHOUT GETTING RIPPED-OFF!!
6. MAKING YOUR FIRST TRANSMISSION-- WITHOUT GETTING LAUGHED-OFF THE AIR!!
7. GLOSSARY OF SLANG AND TECHNICAL TERMS USED BY CB'ers.
8. U.S. ROAD MAP SHOWING MOST OFTEN USED CHANNELS
9. C.B., JOURNAL AND LOG BOOK
10. FIRST-AID INSTRUCTIONS!!
11. BUMPER STICKER: "Licensed CB Operator".
12. ALL 10-CODES
13. STURDY MOBILE-STATION ORGANIZER

Copyright © 1976 S.Stanley

Steve "CB" Stanley  
4820 Biltmore Drive  
Coral Gables, Florida 33134

Please send \_\_\_ CB-Kit at \$4.95 ea. plus .25 postage. Two or more Kits at \$4.50 ea. plus .25 postage. Enclosed you will find \$\_\_\_ in cash, check or money-order. My satisfaction guaranteed.

Name \_\_\_\_\_ Handle \_\_\_\_\_

Address \_\_\_\_\_

City \_\_\_\_\_ State \_\_\_\_\_ Zip \_\_\_\_\_

**DEALERS MAY INQUIRE  
ALL ORDERS SHIPPED IMMEDIATELY!**

MAIL TODAY

Give Your Xmas Gifts This Year  
with **PRIDE**



Here are two fabulous new CB accessories that will make ideal gifts for the holiday season. And while you're at it, you'll probably want them for your own stocking as well.

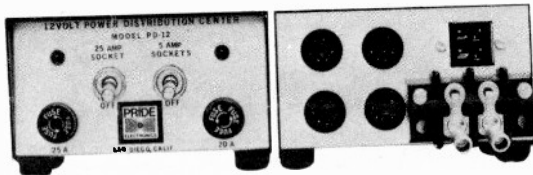

Just **\$27<sup>95</sup>**

Assembled with the highest quality components and workmanship, the Pride Power Distribution Center is backed by a full one-year warranty.

Look at these features:

- Remote switching of up to five 12 volt accessories
- Special 25 amp RF power amplifier socket
- Built-in line filtering for ignition noise attenuation
- Zener diode voltage spike protection
- LED status indicators
- Heavy duty master power switches
- Complete and fully accessible fuse protection
- Mounting bracket supplied
- Full one-year warranty

**THE GREAT NEW DB20 PREAMP FROM PRIDE ELECTRONICS**

This red hot receiver preamp not only brings in the weak signals, but it actually increases your signal-to-noise ratio on the receiver. What's more, you can use it to attenuate super strong signals for better readability. An ideal gift for the CBer who wants the best.

Just **\$59<sup>95</sup>**



FACTORY DISTRIBUTION CENTER FOR MOST MAJOR BRANDS OF COMMUNICATIONS EQUIPMENT



**Bennies Warehouse Distribution Center**

R.D. 1 — BERWICK, PA. 18603



PHONE: 717 - 759-2201

# The Sagittarius CB Personality

NOVEMBER 22-DECEMBER 21

BY PAPERDOLL—KMI 4549



**M**AGNANIMOUS Sagittarians flash by in their king of the road Cadillacs with twin hustlers putting out from their telephone-type rig. Big talkin' wheeler dealers, you'll find this sign of the traveler strong in your long haul 18-wheelers. These naural born comedians and musicians keep you entertained for miles while you copy some of the wittiest modulations and poetry on the frequency. Doo-dah. Long shot gamblers, be sure of the odds when you dare a bet with Sagittarius. They can't resist a gamble. Lover of animals, particularly horses, it's a good bet your race track addict or horse trailer hauler is a Sagittarian, fer sure. These active fire sign folk are fleet-footed in sports themselves and are usually winners by three lengths. A YL Sagittarian is more settled than her male counterpart and happy to be a domestic shanty keeper. Be prepared to truck em on down the road with your buffalo who likes to roam. Forthright and direct, this ninth sign of the zodiac may sometimes inadvertently offend their good buddies with their blunt opinionated comebacks. They don't really mean to be negatory—only honest. Be prepared to jot down their priceless pearls of wisdom, for they are also the philosophers of the horoscope. Typical handles might be: Royal Flush, Pony Express, Honest Abe, Lucky Lady, Fury, The Joker, Pixie!

## NOVEMBER STAR CHECK

**SAGITTARIUS**—Decebmer starts out on a sportive note as Sagittarians take to the snow on their waxed slats. Better wear horse blinds along with your goggles, though. Distractions like those body perfect snow bunnies and buffalos might make you miss a mogul. Take care not to miss your wallet also, as you complete your Christmas shopping. Pickpocketous conditions prevail around the end of the month.

**CAPRICORN**—This is your season, Capricorn, to get out in the monster lane and hightail it to where it's at. You're feeling healthier and more attractive than ever. An old friend comes creeping out of the shadows of the past to stir up your life again. Prepare. You may be asked to change your New Year's Eve plans quite suddenly.

**AQUARIUS**—Much behind the scenes activity this month. A well guarded secret regarding an ex-mate leaks out on New Year's Eve. You manage to hide your chagrin and look fantastic anyway. Christmas this year is the merriest ever as you receive a super unexpected present.

**PISCES**—Holiday socials introduce you to a few new good buddies who help you through those work 20 doldrums, where you have to gracefully get through an altercation around the 6th of December. Better half may feel neglected towards end of month as you gadabout with these new acquaintances.

**ARIES**—The urge for foreign travel hits you this month, so better start tapping out that code in morse. Travel may be in conjunction with career, which gets sidetracked December 29th. That suggestion you came up with at work 20 is finally approved and becomes financially rewarding.

**TAURUS**—Tune up your sideband and straighten the shanty as you hear from a distant relative over the holidays. Extra pounds continue to pile up as indulgent Taurus imbibes "to be social." Easy to guess what your New Year's resolution will be.

**GEMINI**—Generally jubilant Gemini has both heads going in different directions this month to complete last minute shopping and keep up with better half's stressful irritability. Much confusion over mate's money or business deal arises December 29th. Time to quietly circulate among friends and see the New Year in.

**CANCER**—Cancer's co-workers shift the load while they go 10-7 over the holidays. Don't grumble too much, though. Higher-ups are not in the best of spirits this season. Better half is extra loving and endows you with 73's, 88's and all the good numbers—can't wait to give you that unexpected special something for Christmas. Enjoy till December 29th when your gears may all get jammed as plans are all of a sudden reversed.

**LEO**—Successful Leo is just beginning to reap satisfying leaps up the ladder at work 20. Do not, however, take anyone there at their word on New Year's Eve, especially in regard to financial promises, as dual Mercury backtracks in your chart. December 6th brings a sexy dark stranger from skiiland into your life. It could be love at first sight.

**VIRGO**—Busy Virgo puts the hammer down and accelerates his pace to the tune of the holidays. It's open house at the home 20 as good buddies from near and far come through your door and ring your phone. You may find yourself babysitting instead of needing one on New Year's Eve, though.

**LIBRA**—Make sure your ears are on while you zip from place to place this month visiting and trying out your new downhill gear on that white fluff stuff. Back em down on the boulevard the beginning of the month or a well hid Smokey may come out of the bushes after you. Loving Libra does a lot of fun sharing with a certain someone who helps ring in 1977.

**SCORPIO**—Watch that December 6th full moon and your greenstamps. Holiday shopping could do a number on you as you tend to be more generous than ever this year. You happily hear from an old friend who brings good tidings December 29th. Home 20 is gayly decorated and a warm by the fireside recluse for your holiday vacation. . . . 73's and 88's till next month



Wilson

## ALPHA V58

### 5/8 Wave Ground Plane

The Alpha V58 is a full 5/8 wave ground plane with four full size radials, using a loop for loading which eliminates the need for a coil that could easily burn out. The use of DC ground reduces the static noise and gives a cleaner received signal.

- Gain 5.14 dB
- 4 full length radials
- Loop loading
- 1.1 to 1 SWR
- No coils to burn out
- Will handle 2,000 watts
- Height, 21 ft.
- Weight, 7 lbs.
- New radial hub design

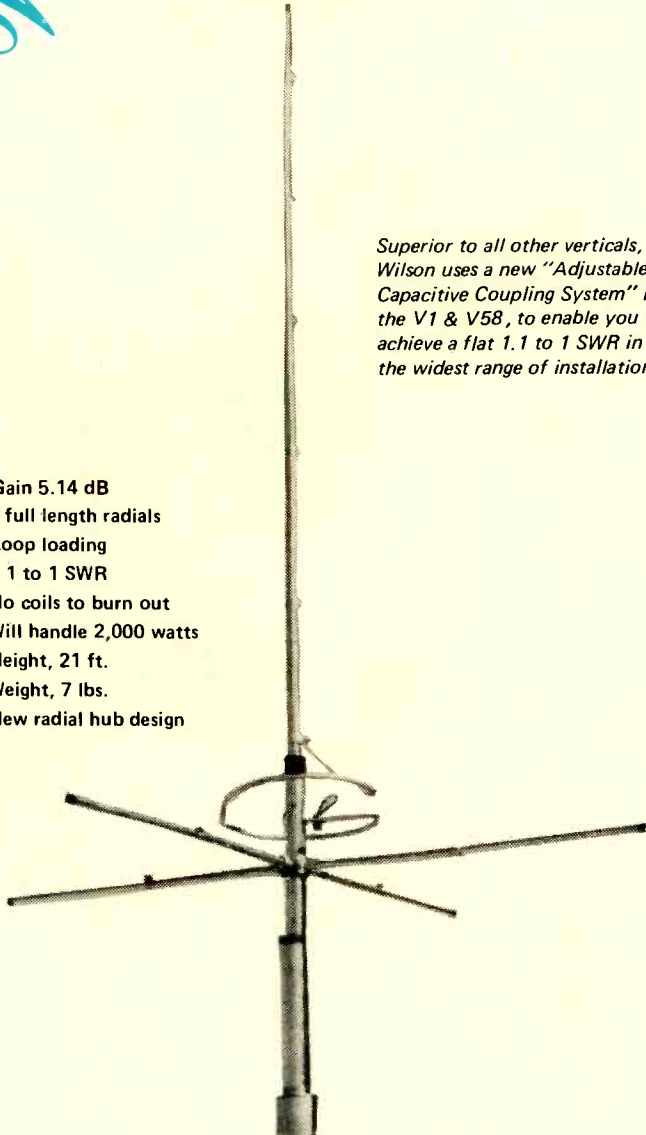

*Superior to all other verticals, Wilson uses a new "Adjustable Capacitive Coupling System" in the V1 & V58, to enable you to achieve a flat 1.1 to 1 SWR in the widest range of installations.*

SEE YOUR FAVORITE DEALER

Wilson Electronics Corporation



4288 S. POLARIS

LAS VEGAS, NEVADA 89103

(702) 739-1931

## V1

### 5/8 Wave Ground Plane Without Radials

Our V1 is a 5/8 wave vertical ground plane without radials.

It's the perfect antenna campers and mobilers like to have for portable operation. It is quick & easy to set up or take down. Be on the air in less than 5 minutes after arriving at your camping spot.

- Gain 3 dB
- No radials
- Loop loading
- 1.1 to 1 SWR
- No coils to burn out
- Will handle 2,000 watts
- Height, 21 ft.
- Weight, 5 lbs.

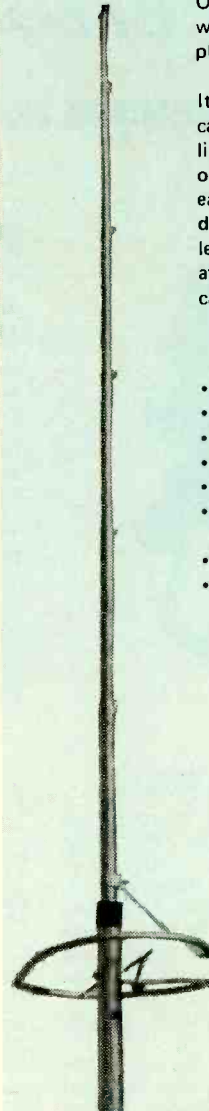

**Ideal  
for campers or  
portable operation**

# COMING EVENTS!

If you wish your Jamboree or Coffee Break listed in this column, the information must be sent to S9 at least 4 months in advance.

## DECEMBER

*Jamboree*, December 12, Desert Inn, 30-80 Whitestone Parkway, Flushing, NY. Sponsored by the American CB Radio Club, Inc., Box 321, Bronx, NY 10469.  
*9th Anniversary Christmas Party*, December 12, Community Building, North Main Street, Marion NC. Sponsored by Radio Patrol Emergency Service and Community Watch, Inc. For more information contact them at Rt. 3, Box 68, Marion, NC 28752.

## JANUARY

*Jamboree*, January 9, Desert Inn, 30-80 Whitestone Parkway, Flushing, NY. Sponsored by the American CB Radio Club, Inc., Box 321, Bronx, NY 10469.

## FEBRUARY

*6th Annual Communications Conference*, February 17th-20th, Mayflower Hotel, Washington, DC. For more information contact Lionel C. Barrows, Jr., Ph.D., Dean, or Ms. Peggy D. Pinn, Conference Director, Howard University.

## JUNE

*2nd Annual Armadillo Flats National Jamboree*, June 3rd-5th, Ottumwa Coliseum, Ottumwa, Iowa. Hosted by Armadillo Flats Iowa. For more information contact Armadillo Flats, Inc., P.O. Box 313, Oskaloosa, Iowa.

# MAGNA MOUNT™

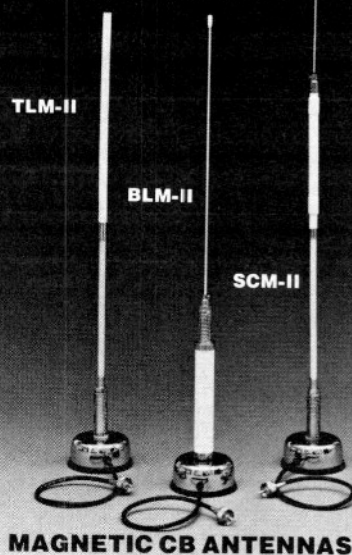

### CHANGE VEHICLES!

MagnaMount magnetic base antennas transfer in moments from one vehicle to another.

### NO HOLES TO DRILL!

MagnaMounts come ready to use; they require no holes, brackets or "rigging". Simply place the antenna where desired.

### ROOF-CENTER PERFORMANCE!

MagnaMount antennas eliminate large "blind" areas of poor transmission and reception found with off-center locations such as bumper and side mounts.

### CONCEALABLE FOR SECURITY!

MagnaMounts prevent theft and vandalism by permitting easy removal of the entire antenna and mount for concealed storage!

### END CLEARANCE PROBLEMS!

Compact sizes plus easy removability let you take your vehicle anywhere without fear of damage to your antenna!

### "MOBILIZE"

### YOUR WALKIE-TALKIE!

A MagnaMount can double, triple or quadruple the range of your walkie-talkie for use as a mobile unit.



**CPD INDUSTRIES**  
 2100A E. WILSHIRE AVE., SANTA ANA, CA. 92705

MFRS. OF BLUE STREAK and RAMM  
 ANTENNAS and HARDWARE  
 MADE IN U.S.A.

# BREAKER-GOOD BUDDY! IT'S HERE!!

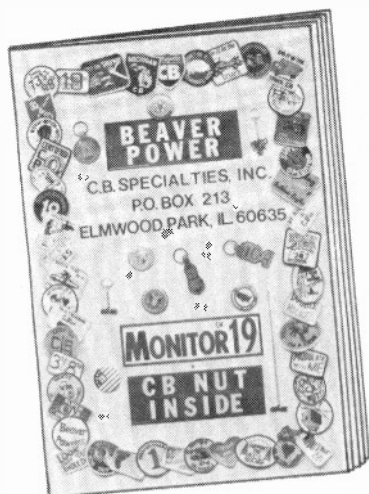

- ★ THE FIRST COMPLETE SPECIALTY CATALOG FOR CB'ERS'
- ★ OVER 350 ITEMS OF OUTSTANDING VALUES  
 BUMPER STICKERS • PATCHES •  
 JEWELRY • BUTTONS • T-SHIRTS, Etc.
- ★ MOST ITEMS CUSTOMIZED OR PERSONALIZED  
 YOUR HANDLE • GROUP/CLUB EMBLEM
- ★ WIDEST CB SELECTIONS TO DAZZLE & DELIGHT  
 YOU!
- ★ CHECK US OUT FOR QUALITY, SERVICE & FAST  
 DELIVERY
- ★ MAIL FOR YOUR FREE EXCLUSIVE SHOP-AT-HOME  
 CATALOG NOW!

WRITE TO:

73's 88's

**CB SPECIALTIES, INC.**

P.O. BOX 213

ELMWOOD PARK, ILL. 60635

WHOLESALEERS WRITE FOR SPECIAL PRICE LIST

... Use S9 READER SERVICE.

S9 • December 1976 • 95

# ***TOMCAT'S SURE FIRE TVI CURE!***

Got those pesky neighbors pounding on your front door again? Have you put so many filters on your rig that it's a miracle anything is getting through on any frequency?

Don't give up! When all else fails, here's the ultimate neighbor silencer! Cut this page out of CB RADIO/S9 and hang it up near your operating position, or (if the guy is already stalking up the driveway for the 8th time this week), stick it to your front door with some chewing gum. You might even wish to print up copies and distribute them to all of your neighbors as a preventive measure. Let us know how it works for you.

## **TO MY NEIGHBORS:**

### **NOTICE CONCERNING ALLEGED TV INTERFERENCE FROM THIS TRANSMITTER**

1. You have called to my attention the fact that transmissions from my station are causing interference to your TV reception.
2. Interference such as you describe is not caused by CB operations, as CB stations cannot and do not cause TV interference. Nor is this interference the result of any malfunction of my equipment or poor operating habits—for my station is NOT a CB station.
3. Be advised that your government is placing a \$500 per year tax on all TV receivers. Because it is difficult at this late date to obtain a listing of TV set owners for taxation purposes, your government has established a vast network of TV jamming installations with the hope that TV set owners will make themselves known to these jamming stations so that their names can be added to the tax rolls. This station is just such an installation.
4. Your government greatly appreciates your turning yourself in. You will be one of the first taxed. You have also verified that this TV jamming equipment is functioning properly.
5. We have also made note of the time and channel you reported this jamming. This information will be given to several TV program rating surveys.
6. You have therefore provided a valuable service to the entertainment industry and to your government.
7. So that you will not be the only one taxed, please be patient as we continue our TV jamming operations.

---

**OPERATOR  
OFFICE OF TV TAXATION**



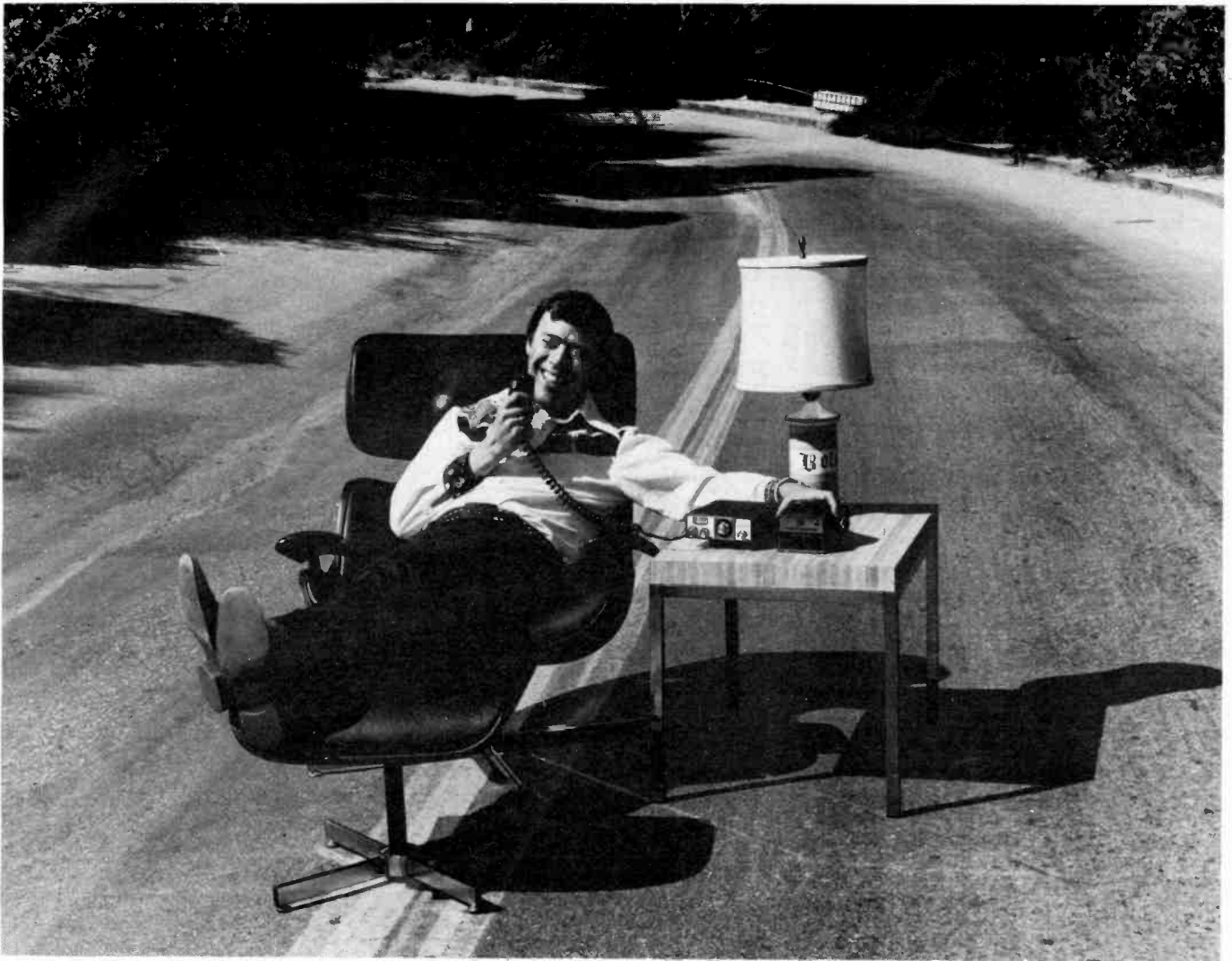

# OPERATE YOUR MOBILE RADIO AS A BASE STATION



## **NPC** Regulated Power Supplies

**ELECTRONICS**

Now, get full-time use out of your mobile radio. New low cost NPC Regulated Power Supplies let you use your mobile radio in your home as a base station. Model 12CB4 quickly and easily converts mobile CBs to home base stations. (Also available with built-in loudspeaker, Model 13CB4.) ★ Model 103R designed for converting single



side band CBs to a base station. ★ Model 109R ideally suited for 2 and 10 meter mobile Ham radios. ★ Other models for mobile radio and CB base station use. All short circuit protected, American made, UL approved and come with one year warranty.

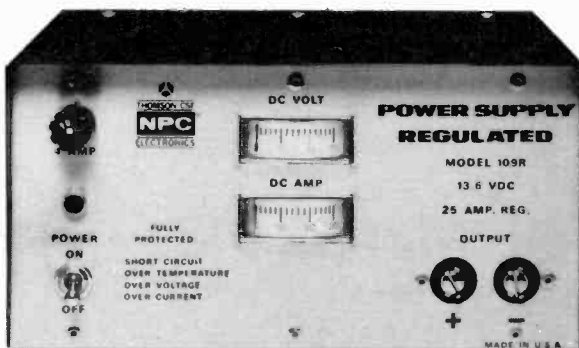

Available at your local NPC dealer.  
For the one nearest you, contact:  
**NPC ELECTRONICS**  
6660 Variel Ave.  
Canoga Park, CA 91303  
(213) 887-1010

# Dealers, Here are 7 good reasons why Centennial is your best single source for all your CB needs...

**1 Centennial** stocks virtually every major brand of radio, antenna and accessory in depth. This means that you can order whatever you need, when you need it, and be assured of immediate delivery.

**2 Centennial** stocks all major brands in such large quantities that the savings we enjoy are passed on to you with the best competitive prices in the industry.

**3 Centennial** has specialized in CB and personal communications for more than fifteen years. Our experience and guidance can save you valuable time and dollars.

**MIDLAND**



Model 13-955

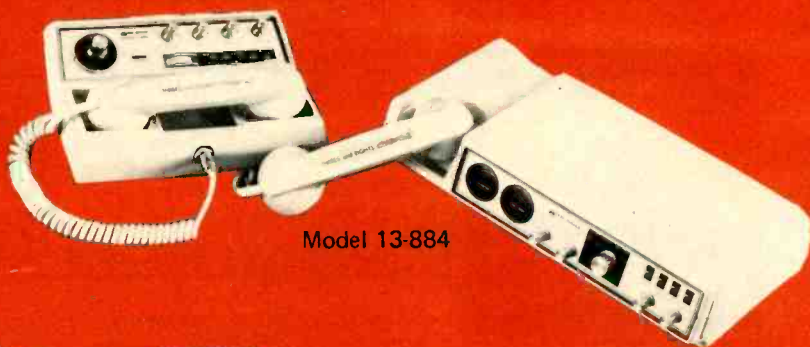

Model 13-884



Model 13-892



Model 13-893

**Centennial Communications Inc.**  
585 Yonkers Avenue, Yonkers, N.Y. 10704

Our 35th year in business

Dealers ask for Johnny or Len

914/476-2100

Model 18-279



# 4 Centennial

maintains a full-time working staff of trained CB sales experts. This means instant service when you call or drop in to place your CB equipment orders.

# 6 Centennial

plans to remain in the CB two-step business for many years. When the late comers have abandoned the market, we'll still be here to serve you.

# 5 Centennial

backs up every product sold with superior service. You need never worry about being stuck with inferior merchandise or factory rejects. —The most liberal dealer policy in the industry.

# 7 Centennial

sales and service personnel love their work. We enjoy dealing with our dealer customers. This is reflected by the cordial and courteous reception we extend to all our customers, no matter how large or small.



**Royce**  
electronics  
corporation



Model 1-624



Model 1-653



Model 1-650



Model 1-640

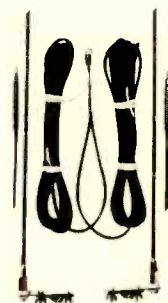

Model 2-224



Model 1-620



**Centennial**  
**Communications Inc.**

585 Yonkers Avenue, Yonkers, N.Y. 10704

Our 35th year in business

Dealers ask for Johnny or Len

914/476-2100



# Dealers, Here are 7 good reasons why Centennial is your best single source for all your CB needs...

**1 Centennial** stocks virtually every major brand of radio, antenna and accessory in depth. This means that you can order whatever you need, when you need it, and be assured of immediate delivery.

**2 Centennial** stocks all major brands in such large quantities that the savings we enjoy are passed on to you with the best competitive prices in the industry.

**3 Centennial** has specialized in CB and personal communications for more than fifteen years. Our experience and guidance can save you valuable time and dollars.

## Electra Bearcat



Bearcat III



Bearcat 8



Bearcat 101

Bearcat Portable Scanner



**Centennial Communications Inc.**  
585 Yonkers Avenue, Yonkers, N.Y. 10704

Our 35th year in business

Dealers ask for Johnny or Len

914/476-2100



Bearcat IV

# 4 Centennial

maintains a full-time working staff of trained CB sales experts. This means instant service when you call or drop in to place your CB equipment orders.

# 6 Centennial

plans to remain in the CB two-step business for many years. When the late comers have abandoned the market, we'll still be here to serve you.

# 5 Centennial

backs up every product sold with superior service. You need never worry about being stuck with inferior merchandise or factory rejects. —The most liberal dealer policy in the industry.

# 7 Centennial

sales and service personnel love their work. We enjoy dealing with our dealer customers. This is reflected by the cordial and courteous reception we extend to all our customers, no matter how large or small.



Plus

AFS ■ Anixter Mark ■ Antenna Specialists ■ Avanti ■ Cobra ■ Cush Craft ■ Electra ■ Francis  
Madland ■ Mosley ■ Mura ■ New Tronics ■ Pearce Simpson ■ Regency ■ Robyn ■ Royce  
Shakespeare ■ Standard ■ Tennelec ■ Turner ■ Wilson ■ Xtal and many more!

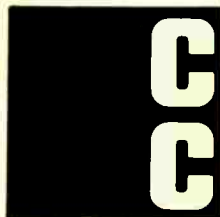

**Centennial  
Communications Inc.**

585 Yonkers Avenue, Yonkers, N.Y. 10704

Our 35th year in business

Dealers ask for Johnny or Len

914/476-2100



# INTERESTED IN HAM RADIO?

Then  
**S9**'s  
 Sister  
 Publication



is for **YOU**

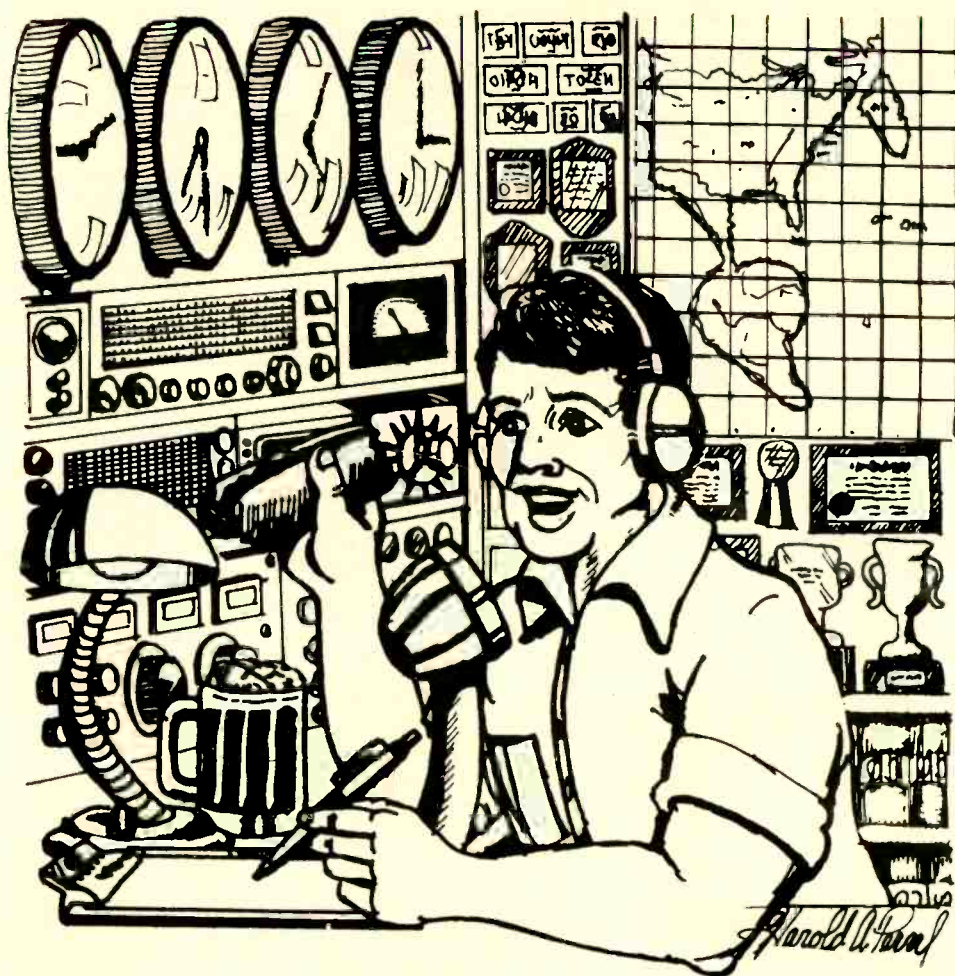

A recent survey of S9 readers indicated that two out of every three replying to our questionnaire would like to become an amateur radio operator. And we're all for that, because **CQ**, The Radio Amateur's Journal, is the oldest magazine in our company's stable.

**CQ** is not just another ham publication; it's the only ham publication aimed at the beginner as well as the old timer. It's the only ham magazine that recognizes that every new ham isn't an electronic engineer. The editorial features in **CQ** are aimed at people — people like yourself who turn to amateur radio as a means of having fun.

**CQ** caters primarily to the operating end of radio, with just a smattering of technical material to keep you up to date on what's happening. And even the technical portions of **CQ** are presented in a manner that every new amateur will understand.

In other words, **CQ** is the fun magazine in the amateur radio field. It's the amateur magazine that you'll enjoy from cover to cover. And remember, **CQ** is brought to you by the same folks who bring you S9. What more could you ask for?



The  
 Radio  
 Amateur's  
 Journal  
 Since 1945

14 Vanderventer Ave.  
 Port Washington, L.I.,  
 N.Y. 11050

Dear OM:

Enclosed please find \$ .....for ..... Year(s) Subscription to **CQ**,  
 The Radio Amateur's Journal.

NEW: Start with ..... issue  
 RENEWAL

Name ..... Call .....  
 Address .....  
 City ..... State ..... ZIP .....

	Domestic	Foreign
One year .....	<input type="checkbox"/> \$7.50	<input type="checkbox"/> \$8.50
Two years .....	<input type="checkbox"/> \$13.00	<input type="checkbox"/> \$15.00



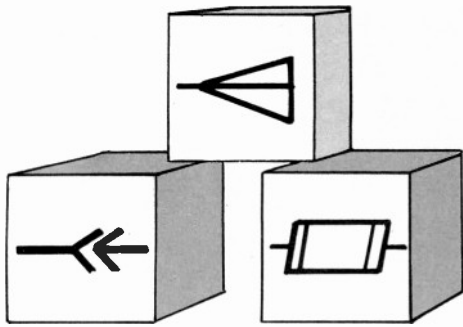

# Basic Radio

by Irving Tepper

## PART 10:

### Electromagnetism and Magnetic Units

In 1819 a Danish physicist, Hans Oersted, discovered a relationship between magnetism and electricity. He observed that the pointer of a magnetic compass deflected each time it was brought near a wire carrying an electric current. When the electric current was cut off the compass needle returned to its original position pointing North. The only possible conclusion was that a *wire carrying an electric current generated a magnetic field*. Further investigation showed that the field existed over the full length of the wire, was at right angles to the wire (see Fig. 3.9), that the direction of the lines of force in the magnetic field was determined by the direction of the electron flow and that the greater the current flow the stronger the magnetic field strength. The term used to define a magnetic force generated by an electron flow is *electromagnetism*.

**Domain Theory**—Why an electron flow produces a magnetic field can be explained by the Domain Theory which involves electron spin. From our earlier studies of atomic structure (Part 1, Feb. 1976), we learned that all matter is composed of atoms which, in turn, are composed of protons and electrons. It was also explained (Part 2, March, 1976), how electrons could generate an

electric field. An electron, *while in motion, also generates a magnetic field*. The total magnetic field generated in an atom is determined by the number of electrons spinning in each direction. If the atom has an equal number of electrons spinning in opposite directions, the magnetic fields cancel each other and the atom is magnetically neutral. If, however, more electrons spin in one direction than the other, the effect is a magnetic field around that atom. There is no assurance that the individual atoms are magnetically neutral in any piece of magnetic material. When the bar of material is formed there are local interactions between the magnetic fields of each atom causing groups of atoms to produce parallel magnetic fields. This group of atoms, each magnetically oriented in the same direction is called a *domain*. Approximately ten million domains exist in one cubic millimeter of the magnetic material. While each domain is magnetized they are not all magnetized in the same direction. The result is that the fields of each domain usually cancel, averaging out into a non-magnetic state.

If the magnetic material is placed in an external magnetic field the domains will align themselves with that field. As the external magnetic field strength is increased more and more domains line up with the field. If the material being magnetized is soft iron, the domains will return to their original states when the field is removed (temporary magnet). If the material is steel, the domains will still remain aligned when the field is removed (permanent magnet).

**Electron Flow and the Magnetic Field**—Earlier (in Parts 3 and 5, April and July, 1976), it was shown that a current flow consists of a movement of free electrons from the negative terminal of a voltage source, around the circuit and back to the positive terminal of the voltage source. Each of the electrons in movement has a magnetic field about it and since all the electrons are moving in the same direction each magnetic field is also moving in the

same direction. The fields around each electron being in the same direction are additive and the total field is that produced around the conductor as shown in Fig. 3.9. As the electron flow is increased the strength of the magnetic field increases.

The *direction* of the magnetic field can be determined by a method referred to as the *left hand rule*. The left hand, as shown in Fig. 3.10, is wrapped around the conductor with the thumb pointing in the direction of the electron flow. The curled fingers now point in the direction of the movement of the magnetic lines of force.

If the direction of the electron flow in Fig. 3.10 is reversed the direction of the thumb would also have to be reversed. The fingers would curl in the opposite direction, indicating a reversal of the magnetic field direction. Note that the magnetic field around a single straight wire has no North or South pole, only direction.

**Magnetic Fields and the Wire Loop**—The magnetic field around a straight wire, in addition to having no polarity,

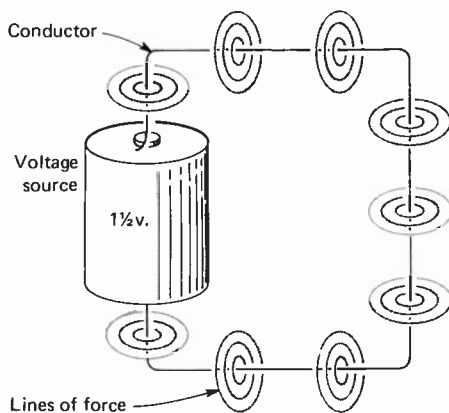

Fig. 3.9—When electrons flow through a conductor a magnetic field is developed at right angles to that conductor along the entire length of the wire.

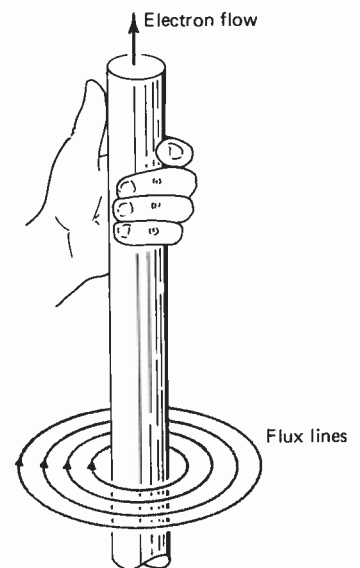

Fig. 3.10—Left hand rule used to determine the direction of the magnetic field around a conductor.

# REGISTER YOUR CB HANDLE

## WITH OUR INTERNATIONAL NETWORK

If you are proud of your Handle, register it with SEC and receive an attractive 8 x 10 Wall Certificate, and your Handle embossed on a plastic card (just like a credit card).

The SEC Computerized Registration System protects your Handle and guarantees no duplicate registration within your county area. Each Handle is checked on our computer for duplicate registration. In the event of duplicate registration, your second choice is automatically registered.

Each registrant's Handle is listed in the SEC CB National Handle Directory. Registration is valid for five years with re-registration available.

Each registrant receives their Citizen's Band Radio Station Plastic Card (just like a credit card) and an attractive 8 x 10 Wall Certificate. You may also order an FCC approved Radio Station License or Form 452-C to attach to your unit. Get the Directory for quick, easy reference of thousands of handles, FCC Part 95, FCC Call Signs Listing, and Lingo Dictionary.



CB Handle Card



FCC Approved License Card



FCC Approved Form 452-C

Southern Embossing Co.  
Dept. S-9  
P.O. Box 17515  
Nashville, TN 37217

- 1 \$5.00 ENCLOSED. Register my CB Handle, send me my CB Handle Card and Certificate.
- 2 \$6.00 ENCLOSED. Reserve my copy of the Directory and send it as soon as available.
- 3 \$10.00 ENCLOSED. Send me items 1 and 2 above.
- 4 \$3.00 ENCLOSED. Send me an FCC Approved embossed plastic License Card.
- 5 \$2.00 ENCLOSED. Send me an FCC Approved embossed plastic Form 452-C to put on my radio.
- 6 \$15.00 ENCLOSED. Send me items 1, 2, 4, and 5 above.

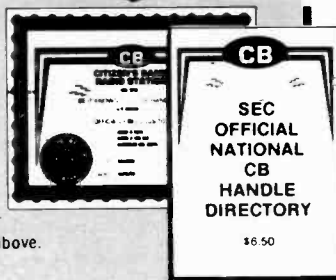

FULL NAME \_\_\_\_\_

STREET ADDRESS \_\_\_\_\_

CITY \_\_\_\_\_ STATE \_\_\_\_\_ ZIP \_\_\_\_\_

COUNTY \_\_\_\_\_

FAVORITE CHANNEL \_\_\_\_\_ FCC CALL SIGN \_\_\_\_\_

EFFECTIVE DATE OF LICENSE \_\_\_\_\_ EXPIRE DATE \_\_\_\_\_ CLASS \_\_\_\_\_ NO. RADIOS \_\_\_\_\_

1st CHOICE HANDLE \_\_\_\_\_

2nd CHOICE HANDLE \_\_\_\_\_

Check or Money Order enclosed

Charge to my Credit Card

BankAmericard

Master Charge

Exp. Date Month/Year \_\_\_\_\_

Credit Card No. \_\_\_\_\_

Master Charge Interbank No. \_\_\_\_\_

FEE \_\_\_\_\_

Applicable Taxes \_\_\_\_\_

TOTAL \_\_\_\_\_

Signature \_\_\_\_\_

### BASIC RADIO (continued)

has no practical use. The lines of force are spread out over the full length of the wire and are very weak. By forming the wire into a loop as shown in Fig. 3.11, two very important changes take place. First, all the magnetic lines of force pass through the center of the loop concentrating the lines of force; this means a stronger field in the center of the loop. Second, all the lines of force move through the center of the loop in the same direction (left hand rule). Since we know that magnetic lines of force leave the North pole of a magnet and enter at the South pole, we can see that the loop in Fig. 3.11 produces a field with a *polarity*. The single loop, therefore, produces a magnetic field similar to that produced by a bar magnet but much weaker.

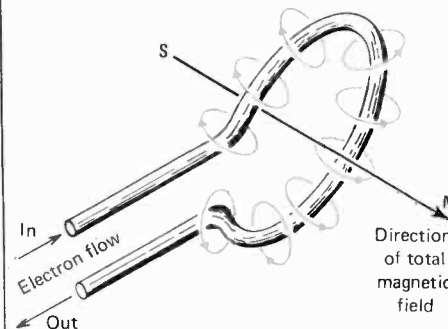

Fig. 3.11—Forming a conductor into a loop concentrates the magnetic field increasing its strength and produces a polarized field.

**The Coil**—If we wish to increase the strength of the magnetic field generated by the loop shown in Fig. 3.11, we can increase the current flow through the conductor or *increase the number of loops*. When additional loops are formed close together the structure is called a *coil*. The coil and its schematic symbol are shown in Fig. 3.12.

The magnetic field formed by each loop of the coil adds to the field of the neighboring loop to produce one large field. How this happens is shown in Fig. 3.13 where only the top portion of two turns are redrawn. The current flowing through each loop is in the same direction making the field of each turn additive. The more turns added to

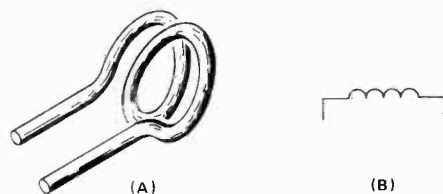

Fig. 3.12(A)—Formation of a coil and (B) its schematic symbol. The number of loops drawn in the symbol has only a general bearing on the number of turns in the actual coil.





**BASIC RADIO** (continued)

If the coil and voltage combination shown in Fig. 3.14 should produce 500 lines of force then its core (air in this instance) has a flux of 500 lines or  $\phi = 500$  lines. Compared to an elec-

trical circuit the flux is the equivalent of current flow,  $I$ .

*Flux Density*—The flux density is the number of magnetic lines for a given unit area, one square inch, and is defined by the letter  $B$ . The flux density,

$B$ , may be calculated from

$$B = \frac{\phi}{A}$$

where  $\phi$  = total magnetic flux  
 $A$  = total area in square inches

**Experiment #10—Electromagnetism**

**Materials**

- 1—Roll of #22 Magnet Wire (Radio Shack #278-003)
- 1—Perfboard (Radio Shack #276-1583)
- 3—Fahnestock Clips (Radio Shack #270-393)
- 2—Resistors 100 ohms ½ watt (Radio Shack #271-012)
- 1—9V Battery and connector clip
- 1—Directional magnetic compass
- 15—4", 20D common nails

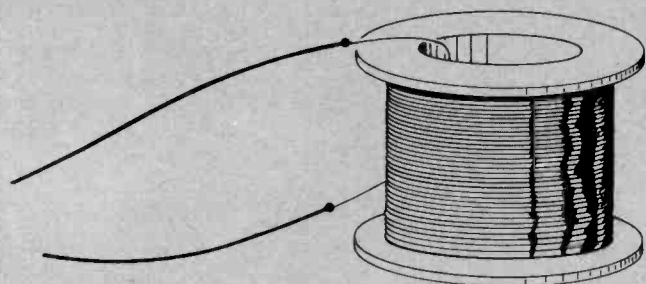

Fig. 1—Coil with two leads soldered enables easy connection into the circuit shown in Figs. 2A and B.

**Procedure:**

1—Solder two six inch lengths of hook-up wire to the ends of the coil of magnet wire as shown in Fig. 1. (Be sure to remove the insulation as described in Step 1 of the procedure of Experiment #2B, April 1976, p. 109).

2—Measure the resistance of the coil. It should measure approximately two ohms. If placed directly across the 9V battery, the current flow will be  $I = E/R = 9/2 = 4.5A$ . This is much more current than the battery can provide so in order to prevent

this overload we will limit the current to 0.1A using a series resistor. The value of resistor needed is calculated using Ohm's Law.  $R = E/I = 9/.1 = 90$  ohms. We will use a 100 ohm resistor as shown in Fig. 2A.

3—Wire the circuit shown in Fig. 2B on the perfboard but do not connect the battery to the circuit.

4—Place a magnetic directional compass about 3 to 4 inches from the end of the coil as shown in Fig. 3.

5—Connect the battery to the circuit and observe the behavior of the compass pointer. Disconnect the battery.

6—Add a second 100 ohm resistor in parallel with the existing one in order to increase the current. Reconnect the battery and note the increase in compass pointer movement. This is due to the increased field strength caused by the greater current flow. Disconnect the battery.

7—Reverse connections 1 and 2 in Fig. 2 in order to reverse the direction of electron flow through the coil. Reconnect the battery and note the direction of movement of the compass needle. It should have reversed. Disconnect the battery.

8—Using the left hand rule for coils as explained in Figs. 3.15A and B, determine the polarity of each end of the coil for steps 5 and 7 and see if it corresponds to the direction of the compass pointer movement.

9—Add an iron core to the coil by inserting fifteen 4D, 4" long common nails into the center of the coil form. Alternate the heads, 8 from one side and 7 from the other side.

10—Connect the battery and note the increased magnetic field strength as indicated by the movement of the compass needle.

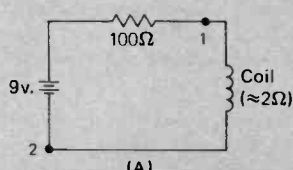

Fig. 2(A)—Circuit to be wired for the experiment. (B) Pictorial of the circuit to be wired.

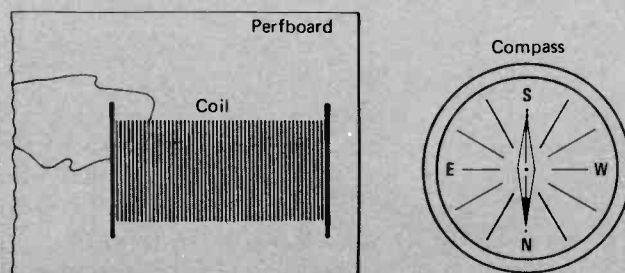
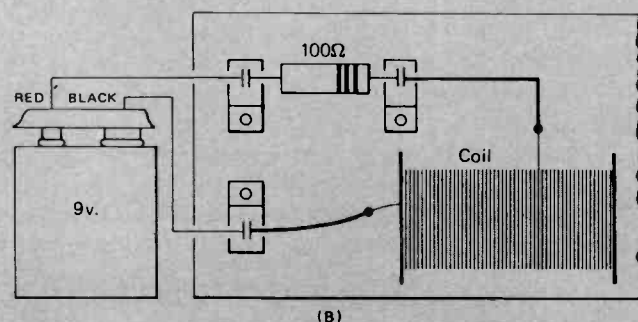

Fig. 3—Position of compass pointer and coil. Set the coil so that its core axis will be at right angles to the compass needle which will automatically point North. Be sure there are no magnetic devices around the compass such as magnetized tools or the multimeter which has a strong magnet built into the meter movement.

If the core area of the coil in Fig. 3.14 is 2 square inches and the total flux is 500 lines then

$$B = \frac{\phi}{A} = \frac{500}{2} = 250 \text{ lines/in}^2$$

**Magnetomotive Force**—The flux in the magnetic system is generated due to magnetomotive force, *mmf*, which is derived from the movement of electrons through a wire. The *mmf* can be calculated by multiplying the current by the number of turns in the coil. This is also defined as the *ampere-turns* or

$$F = NI$$

where *F* = *mmf* in ampere turns  
*N* = number of coil turns  
*I* = current in amperes

When comparing the magnetic circuit with an electrical circuit *mmf* can be considered as the equivalent of the voltage.

**Field Intensity**—Another term frequently encountered is the *field intensity*, *H*. The field intensity is determined by dividing the *mmf* by the length of the core. Thus

$$H = \frac{F}{l} = \frac{NI}{l}$$

where *l* = core length in inches  
*F* = ampere turns

*H* = ampere turns per inch of core length.

**Permeability**—The permeability of a material was defined earlier as the ability of that material to conduct magnetic lines of force (Part 8, Oct. 1976). Different core materials will produce stronger or weaker electromagnets so the higher *mu* ratings are preferable because they develop the strongest fields. With air rated as a *mu* of 1, the permeability of a material is rated by the increase in flux when it replaces air. Mathematically it is expressed as

$$\mu = \frac{\text{Flux with material in core}}{\text{Flux with air core}}$$

Permeability may also be expressed as

$$\mu = \frac{B}{H}$$

where *B* = flux density in in<sup>2</sup>

*H* = magnetizing force in NI/inch.

The greater the flux density, *B*, for a given magnetizing force, *H*, the greater the *mu* of the material.

**Reluctance**—The reluctance of a material was defined earlier as the opposition of that material to magnetic lines of force (Part 8, Oct. 1976). The symbol for reluctance is *R* and the unit has no name. In an electrical circuit its

# Dealers!

Our CB Catalog is Chock Full of CB Radios, Antennas, & Accessories.

We stock these major lines in depth, & sell to dealers only!

Antenna Specialists \* Astatic \* Avanti  
 \* Browning \* Command \* Courier \*  
 Cush Craft \* Gemtronics \* Hy-Gain  
 \* Johnson \* Kris \* Midland \* Mosley \*  
 New-Tronics \* Pace \* Pearce-Simpson  
 \* Robyn \* Royce \* Shakespeare \*  
 Siltronix \* SBE \* Teaberry \* Tram  
 \* Taylor \* Turner \*  
*and many more!*

Write or call today for all your CB needs

Southern Distributing Company

2601 Deans Bridge Road

Augusta, GA 30906

(404) 736-5526

Send letterhead for complete catalog.  
 \$3.00 deductible on first order.

## Increase Your Range With The New Ameco PREAMPLIFIER



Model CPM  
 \$39.95

- Boost receive power 630 times. (28 db. gain)
- Works on all 40 channels.
- Uses a tuned RF stage to amplify CB signals and reject interference.
- Advanced solid state control circuitry for automatic operation.
- AM or SSB. ● Easy to install.

Ameco, the "preamp pioneers" for over 20 years, now brings the CB'er the most advanced circuitry. Model CPM is designed for 12V. mobile use and can be used for a base station by taking power from the transceiver or a 12V. supply. Complete with mounting bracket and hardware. Write for additional details.

AMECO EQUIPMENT CO.  
 275 Hillside Avenue  
 Williston Park, N.Y. 11596

## COMMANDER BASE ANTENNAS

Excellence in Performance

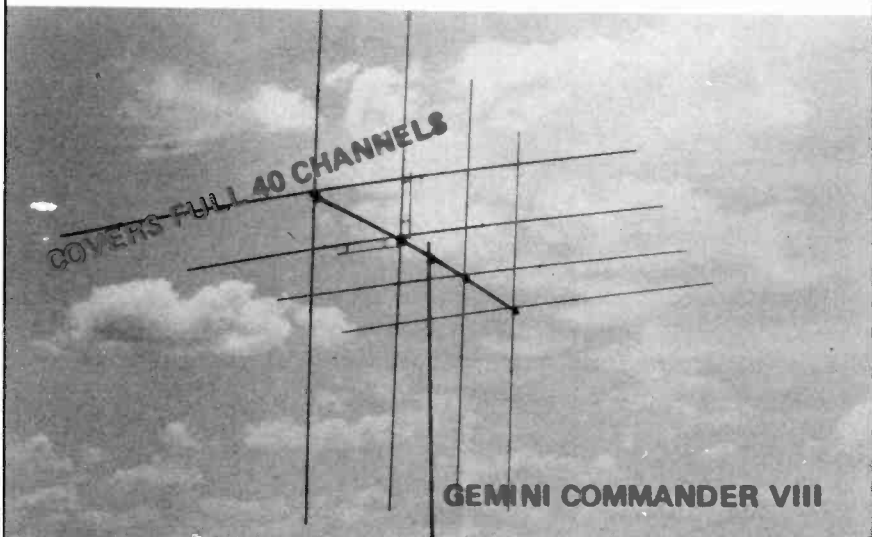

All beams and verticals are ruggedly constructed of tempered aluminum and plated steel hardware. All feature fast accurate tune-up for the lowest SWR.

- Gain 14.5 dB
- Front to back ratio 38dB
- Boom length, 15.5 ft.
- Weight, 35 lbs.
- Horizontal or vertical polarity
- Twin 50 Ω Gamma Match
- Power capability, 2,000 watts

See Your Favorite Supplier

NCC-2706 National Circle—Garland, TX 75041

(214) 271-3651

# ATLANTIC SPEED CENTER

2 East 39th Street, Wilmington, DEL. 19802 — 302/762-9040 & 762-6827

**Dealer  
Inquiries  
Invited**

To Sell These Famous Lines:

- Antenna Specialists
- Astatic
- Avanti
- CDE Rotors
- D & A
- Hy-Gain
- Johnson
- Kris
- Midland
- Panasonic
- Para Dynamics
- Pearce Simpson
- Robyn
- Royce
- Shakespeare
- Stam-Comm
- Turner
- Vanco

DEALERS - Call  
TOLL FREE  
800-441-7630

## Anatomy of a Scanner (from page 80)

"... he's turning left on Center Street in excess of 80 miles per hour—I just think he threw a bag of some white material out the window at Center and Elm Street. He's now turning left on Pomona Street—going out of control—struck a parked vehicle and is now stopped. Wait a minute—he's getting out of the vehicle, and I'm going after him on foot."

Silence for thirty seconds. (Obviously out of breath) "Suspect—in—custody—. . . Send two tow trucks, and I'm returning to the station with suspect in a new pair of uniform trousers!"

You and I were right there, weren't we, subduing that suspect!?

Scanners are exciting, and to assist you in the best selection of a scanner to hear all the calls in your immediate area, next month we'll take a look and see how to identify those many public agencies that operate two-way radios, and find out exactly what frequency and in which band they're operating on so that you may tune them in.

# HEY! Getcha Giant Skipland Map Poster!

The **CB Skipland Map** in our November issue has been souped-up and reprinted by popular demand! We made a more detailed (lots more things—including most major cities with their CB handles) huge size version (17 by 23 inches) on high quality, colored stock—just right for the wall of your CB shack! It's sort of a limited edition, so now's the time to move if you want one! Here's how to get your own highly detailed version: fill in the coupon below, enclose only **\$1.75** (includes postage and mailing) and send it back to us! This map will really blow smoke with everybody who sees it!

Please send me \_\_\_\_\_ copies of the Giant Skipland Map Poster.

Name \_\_\_\_\_

Address \_\_\_\_\_

City \_\_\_\_\_

State \_\_\_\_\_ Zip \_\_\_\_\_

Return order to:

CB Skipland Map  
c/o S9 Magazine  
14 Vanderverter Avenue  
Port Washington, N.Y. 11050

# FREE YOUR GUIDE TO THE BEST VALUES IN CB and HAM RADIO



The new Heathkit catalog describes nearly 400 superb electronic kits including the world's most popular line of Amateur Radio equipment and special buys on assembled, name-brand CB gear. Send for your copy today!

Heath Co., Dept. 170-24, Benton Harbor, MI 49022

LOW, DIRECT-TO-YOU, MAIL ORDER PRICES ON FAMOUS ROYCE, JOHNSON AND MIDLAND CB RADIOS — ANTENNAS TOO!

**FREE**  
**Send for it!**

HEATH  
**Schlumberger** Heath Company, Dept. 170-24  
Benton Harbor, Michigan 49022

Please send me my FREE Heathkit Catalog.  
I am not on your mailing list.

Name \_\_\_\_\_

Address \_\_\_\_\_

City \_\_\_\_\_ State \_\_\_\_\_

CL-618 Zip \_\_\_\_\_



## BASIC RADIO (continued)

equivalent is the resistance,  $R$ . Mathematically reluctance can be expressed as

$$R = \frac{l}{\mu A}$$

where  $l$  = length of the magnetic circuit in inches

$A$  = cross-sectional area of the magnetic core in square in.

$\mu$  = permeability of the magnetic circuit material.

From the above formula we can see that any increase in  $\mu$  or the cross-sectional area of the core results in a lowered reluctance.

It is also possible to develop a magnetic "Ohm's Law" based on the fact that we equated  $I$  with  $\phi$ ,  $E$  with mmf ( $F$ ) and  $R$  with reluctance,  $R$ . Thus we have

$$I = E/R$$

$$E = IR$$

$$R = E/I$$

$$\phi = F/R$$

$$F = \phi R$$

$$R = F/\phi$$

The English system of magnetic measurements is fully summarized in Chart I above.

Quantity	Symbol	Unit	Formula
Flux	$\phi$	Number of lines	$\phi = F/R$
Flux density	$B$	lines per square inch	$B = \phi/Ain^2$
mmf	$F$	Ampere turns (NI)	$F = NI = \phi R$
Field Intensity	$H$	Ampere turns per inch	$H = F/l$
Permeability	$\mu$	(no unit or name)	$\mu = B/H$
Reluctance	$R$	(no unit or name)	$R = F/\phi = l/\mu A$

Chart I

### Suggested Reading

Schrader, R. L., *Electronic Communication*, Third Ed., New York: McGraw Hill, pp. 47 to 51.

Tepper, Marvin, *Basic Radio*, Second Ed., Vol. I. Rochelle Park, New Jersey: Hayden Book Co., pp. 109 to 115.

### CORRECTIONS

Part 6, August 1976—p. 65, Fig. 2—The meter pointer is reading 11 ohms, not 12 ohms. It should have been drawn one division to the left of its present position.

p. 71, Fig. 4—The wire that connects from the top clip (plus battery terminal) to the top of the resistor has to be removed if any current is to be indicated on the milliammeter.

p. 83—Answer #7 should read 0.12 ohms

$\pm 5\%$ , 1% reliability factor. #21 should read  $50 \times 100 = 5K$ .

We hope these errors did not cause too much confusion. If you read the text carefully, the correct answers should have been fairly obvious.

### SELF CHECK QUESTIONS

- 1—A magnetic field is developed in the center area only of a wire carrying an electric current flow. T or F.
- 2—The direction of the magnetic lines of force around a conductor carrying an electron flow is dependent upon the direction of the electron flow. T or F.
- 3—The strength of the magnetic field around a wire is not affected by the strength of the electron flow. T or F.
- 4—The magnetic field around a wire formed into a loop becomes stronger and now possesses polarity. T or F.
- 5—If the core of a coil of wire is iron rather than air, the total field strength would tend to decrease unless more current was caused to flow through the turns. T or F.

- 6—The reversal of the direction of the circular magnetic lines of force around a wire would indicate that the electron flow through the wire had been reversed. T or F.
- 7—What is the advantage of forming a coil of many turns of wire rather than a single loop?
- 8—How will the pointer of a magnetic compass behave when placed next to a wire carrying an electron flow?
- 9—What do the fingers in the left hand rule for conductors indicate?
- 10—What do the fingers in the left hand rule for coils indicate?
- 11—Define the term magnetic flux and draw its symbol.

- 12—The flux, in a magnetic circuit, is comparable to current in an electrical circuit. T or F.
- 13—What is meant by flux density and what symbol is used to define it?
- 14—What is the flux density of a core 4 square inches if the magnetic flux is 1500 lines?
- 15—What electrical unit compares to the magnetic unit, mmf?
- 16—How is the magnetomotive force in a circuit calculated?
- 17—How is the field intensity,  $H$ , of a magnetic circuit determined?
- 18—How is the reluctance of a core material related to its (a) length, (b) cross sectional area, (c)  $\mu$ ?

15—voltage  
16—mmf = NI, the number of coil turns multiplied by the current flow in amperes.  
17—By dividing the magnetomotive force by the length of the core of the coil to get the mmf per inch of core length.  
18—(a) As the core length increases the reluctance increases.  
(b) As the cross sectional area of the core is increased the reluctance decreases.  
(c) As the  $\mu$  of the core material is lowered the reluctance decreases.

8—The magnetic field about the wire will cause the pointer to deflect.  
9—The direction of the lines of force around the wire.  
10—The direction of the electron flow through the coil turns.  
11—Magnetic flux is the total number of lines of force leaving or entering a magnet and is defined by the Greek letter, phi.  
12—T  
13—Flux density is the number of magnetic lines of force in one square inch. It is defined as  $B$ .  
14— $B = \phi/A = 1500/4 = 375$

1—F, it is developed over the entire length of the wire.  
2—T  
3—F, the greater the electron flow, the stronger the magnetic field.  
4—T  
5—F  
6—T  
7—A coil is capable of producing a stronger magnetic field for a given electron flow.

### ANSWERS TO SELF CHECK QUESTIONS

**merchandising** magazines have  
their place... **retailing**  
magazines do too... in their limited  
capacity... **but** what you need  
to sell your message is a magazine  
that covers...



That's it in a nutshell. You need **CB Radio Marketing**, the only monthly magazine that gives your distributor and your dealer the editorial guidance he needs to grow and prosper.

Compare **CBRM's** editorial content with that of either the "merchandising" or "retailing" magazine in the CB field. Frankly, it puts the others to shame. Only **CBRM** guides your customer on how to advertise, how to regulate inventory, how to run a service shop, how to run a better business. Compare **CBRM** with the others, and ask yourself which magazine you'd read if you were a CB dealer or distributor. We know you'll choose **CBRM** because it's got better content and more of it.

And then compare ad page rates. You get 22,000 CB trade coverage for only \$710 per page on a 12 time basis. That's many hundreds less than the cost for merchandising or retailing magazines.

And wouldn't you expect the best value in a CB trade publication to come from Cowan Publishing? After all, our **CB RADIO/S9** is the largest and best CB consumer book in the field!

**End of message . . . . .**

# CB testing just became a snap.

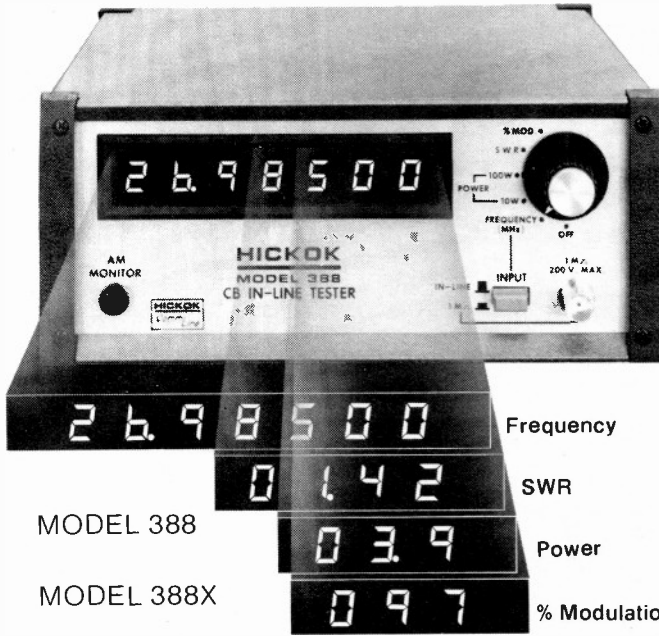

MODEL 388

MODEL 388X

Hickok Model 388X features a precision temperature compensated crystal oscillator with 1 ppm accuracy.

## Now one unit does it all.

Hook our versatile Model 388 in line with your transmitter and instant digital readouts of a transmitter's four most important operating parameters are a turn of a switch away.

A front-panel AM Monitor Output makes scope display of modulation easy. A pushbutton selects front panel or in-line frequency input. And changing to 12V operation is easy, too.

Get your hands on the new Hickok Model 388 CB In-Line Tester. We're betting you can't let go.

The Hickok Model 388 CB In-Line Tester is one element of the modular Hickok CommLine.

**HICKOK**  
*CommLine*

In stock and available from . . .

**FORDHAM**

RADIO SUPPLY CO., INC.  
855R Conklin St., Farmingdale, N.Y. 11735  
(516) 752-0050

YOUR ONE STOP DISCOUNT CENTER  
CB Radios • Test Equipment • Tubes • Tools • Electronic Supplies

Send for FREE 108 page catalog

# The COMMUNICATOR

14 Vanderventer Ave., Port Washington, New York 11050

## DEALERS

If you haven't yet subscribed to THE COMMUNICATOR, you're missing out on vital news important to *your* business. THE COMMUNICATOR is the only newsletter in the industry directly devoted to CB marketing.

The latest issue of THE COMMUNICATOR includes these features:

- Latest FCC license figures for Class D CB
- Latest news on the Status of Class E CB
- Equipment availability lists for all major CB Distributors. You can't sell 'em if you don't stock 'em.
- New product roundup of CB transceivers, antennas and accessories.
- New marketing ideas for increasing CB sales.
- A market survey questionnaire directly aimed at getting more information to aid your sales.

So don't put off entering your subscription to THE COMMUNICATOR.

Every issue you miss can mean \$\$\$\$ lost.

**TODAY! NOW! BEFORE YOU FORGET!**  
**PRONTO!**

## THE COMMUNICATOR

Suite 1, 14 Vanderventer Ave.,  
Port Washington, New York 11050

Please enter my subscription for 1 year to  
THE COMMUNICATOR.

Enclosed find  check  money order  
 cash, in the amount of \$15.

Name (individual)

Title

Company Name

Street Address City State Zip

Dealer  Distributor  Amateur Radio  CB



**HUSTLER**  
**No-Rob Knob**  
**SAVES YOUR CB RADIO**  
 for only **\$1.95**  
 get fast out-of-sight  
 CB Antenna  
 storage...

**No-Rob Knob theft proofs your CB radio**

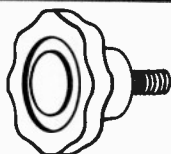

In seconds, install or remove your Hustler rain gutter antenna for quick, out of sight storage. Retain the superior electrical performance and mechanical security of a permanently mounted antenna. Easy conversion; just replace the regular locking bolt with the No-Rob Knob. Fits all Hustler rain gutter mounts and rain gutter mount antennas manufactured since 1962.

AVAILABLE FROM ALL DISTRIBUTORS WHO RECOGNIZE THE BEST!

**new-tronics corporation**

Brookpark, Ohio 44142

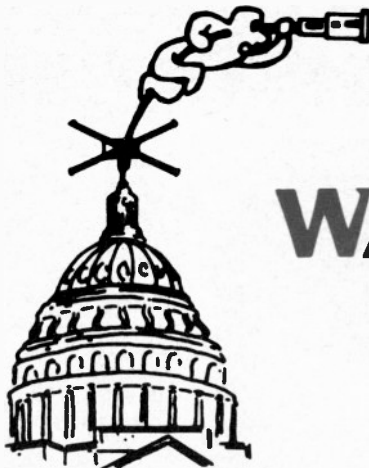

# WASHINGTON OUTLOOK

## BOOTLEG CB EQUIPMENT SEIZED IN DES MOINES

Allen (Barney) Donaldson, United States Attorney for the District of Southern Iowa has announced that over \$5,000 in illegally used CB radio equipment was seized August 25 in a crack-down on illegal Citizens Band operators in the Des Moines area.

The seizures were the result of an extensive investigation by the FCC into the operation of illegal radio stations which were transmitting on unauthorized frequencies, operating overpower equipment, transmitting obscene language and violating other FCC regulations.

Donaldson stated that United States Marshals, who were accompanied by agents of the FCC from Grand Island, Nebraska, simultaneously executed five search warrants in the metropolitan Des Moines area, seized the equipment and closed down the stations.

The search warrants were issued by Federal Magistrate, R. E. Longstaff.

Vital communications such as police, fire, rescue and aviation are jeopardized by the lawless operation of Citizens Band Radio. The illegal use of CB equipment also interferes with the legitimate CB users, local, state, and federal government radio use, and AM/FM and television reception.

Federal law provides penalties of up to \$500.00 per day, per offense for violation of FCC Rules and Regulations and one year's imprisonment and a \$10,000 fine for the unlicensed use of CB equipment.

## BIRMINGHAM CB OPERATORS FINED FOR OPERATING ON UNAUTHORIZED FREQUENCIES

In another similar case, John O. Overstreet, William R. Sexton, Raymond C. Tyler, and James C. Leathers, all Class D Citizens Band radio operators, were fined in U.S. Magistrate's Court, Birmingham, on August 23, 1976, after pleading guilty to charges of operating illegal transmitting equipment on unauthorized radio frequencies.

U.S. Magistrate Edwin L. Nelson fined Tyler and Leathers \$200.00 each. Overstreet and Sexton were fined \$10.00 and both waived possession of their seized amateur radio transceivers to the U.S. Government. The equipment in each case was valued at approximately \$400.00 to \$500.00.

The cases were presented by Assistant U.S. Attorney Bill L. Barnett following investigation by engineers from the Commission's Atlanta and Powder Springs, Georgia, offices.

The cases arose from an April 1976 crackdown on illegal operators ordered by United States Attorney Wayman G. Sherrer. The illegal operators were monitored while transmitting on unauthorized frequencies interfering with bands used by U.S. Government business and Special Industrial services. At that time a number of transmitter/receivers were seized by U.S. Marshals accompanied by FCC engineers.

## NOTICES OF APPARENT MONETARY LIABILITY

The Commission, by its Field Supervisors, on behalf of the Safety and Special Radio Services Bureau, issued Notices of Apparent Liability to Monetary Forfeiture on various dates to the following radio station licensees in the Citizens Radio Service for willful violation of various sections contained in Part 95 or a repeated violation of Section 1.89 of the Commission's Rules: Endicott, N.Y., William E. Strubeck, \$50, KGK-2096.

Endwell, N.Y., John Harris, \$50, KJH-13760.

Johnson City, N.Y., Lawrence E. Houghton, \$50, KEQ-6851.

Kirkwood, N.Y., James W. Jackson, Jr., \$50, KZY-2260.

Vestal, N.Y., Ramone L. Martin, \$50, KHA-1125.

Dickson City, PA., Stanley A. Borden, \$100, KIP-2073.

Scranton, Pa.

James P. Albrecht, \$150, KTW-7666.

Anthony T. Cerre, \$50, KNI-6908.

Mario Emiliani, \$150, KIQ-7920.

Carol A. Godlewski, \$50, KBA-3505.  
 Joseph R. Yuhre, \$50, KJY-18505.  
 Milltown, Wisc., Gary S. Sandifer, \$50,  
 KLX-1373.  
 Bonner Springs, Kans., Raymond D.  
 Bombardier, \$50, KHM-2085.  
 Lincoln, Nebr., Lyle P. Trumnley, \$50,  
 KBF-3392.  
 Omaha, Nebr., Donald O. Luttrell, \$50,  
 KBR-7344.  
 Stromsburg, Nebr., Vayden R. Ander-  
 son, \$50, KIW-0840.  
 Ducanville, Tex., Benny F. Pannell,  
 \$50, KHZ-4483.  
 Pearland, Tex., Sammy L. Bell, \$50,  
 KKP-8810.  
 North Huntington Beach, Calif., Larry  
 E. Echols, \$50, KOK-9814.  
 Redondo Beach, Calif., Joseph M. Leb-  
 man, \$100, KFN-4657.  
 Santa Ana, California  
 Romeo Fournel, \$100, KRF-92704.  
 Alfred Garside, \$200, KFQ-4256.  
 Donald L. Silvis, \$50, KCQ-1408.  
 Josh Tabb, Jr., \$100, KTV-9113.  
 Claddie Tripp, \$50, KNQ-6429.  
 Stanton, California  
 Richard J. Shinkle, \$100, KNX-5876.  
 Roger D. Dunlap, \$100, KNR-6553.  
 Westminster, Calif., Richard F. Castro,  
 \$100, KSQ-2820.  
 Minden, La., Danny Wayne Hammon-  
 tree, \$50, KIJ-4366.  
 Birmingham, Ala., Euell H. Kicker, Jr.,  
 \$50, KZO-3291.  
 Atlanta, Ga., Al R. Cook, \$50, KGA-  
 0385.  
 Austell, Ga., Timothy J. Mitchell, KMK-  
 7951.  
 Conyers, Ga., Thomas C. Sexton, \$50,  
 KBW-4649.  
 Mableton, Ga.  
 Mark M. Blair, \$50, KFD-0286.  
 Wayne A. Darnett, \$50, KBS-0542.  
 Fred D. Powers, \$50, KJP-6389.  
 Endicott, N.Y., John R. Guarnieri, \$50,  
 KZC-8445.  
 Middleton, Pa., Phillip M. Mostoller,  
 \$50, KHP-9810.  
 Fairbanks, Alaska  
 Margret E. Johnson, \$50, KHD-  
 2489.  
 Patrick M. Sisco, \$100, KWL-9751.  
 Fort Wainwright, Arizona, James D.  
 Braswell III, \$50, KMH-5062.  
 Yacoit, Washington, Robert E. Audet,  
 \$50, KEL-9278.  
 Tampa, Florida, Stephen R. Conrad,  
 \$150, KGV-1663.  
 Baltimore, Maryland, Robert J. Man-  
 ning, \$50, KXC-5522.  
 Cumberland, Maryland, William J.  
 Struntz, \$50, KWS-21502.  
 Joppa, Maryland, John L. Kidwell, Jr.,  
 \$50, KTP-0960.  
 Billerica, Mass., Norman Metivier, \$50,  
 KWI-4612.  
 Fitchburg, Mass., Charles A. Jarvis,  
 \$50, KTE-3973.

(continued)



# CB WAREHOUSE

## Cash in on the CB Radio Market.

**YOU'LL MAKE A BARREL  
FULL OF BUCKS!**

**ONE STOP FOR:**

- RADIOS** - Over 15 different manu-  
facturers - million dollar inventory
- ANTENNAS** - 4,000 in stock
- ACCESSORIES** - 10,000 parts in  
stock
- SERVICE** - Authorized warranty sta-  
tion for most major brands
- REPLACEMENT PARTS** - Midwest's  
largest distributor of CB compo-  
nent parts and CB semi-conductors

**BEST PRICES  
SAME DAY SHIPPING**

Dealers Phone (312) 481-3446 for free catalog  
and price list/Or write: **CB Warehouse**  
1607 Western Ave.  
Chicago Heights, IL 60411

## The World's Classiest Mount for CB Radios.

The "Ten-Two" CB radio mount is handsomely designed and rugged. Made of tough, finely textured black thermoplastic that will complement any auto interior, it has everything a quality mount should have.

**BETTER SOUND:** Communications speaker improves clarity, filters out noise—mount directs sound at the driver, not the floor. **SAFETY:** Controls and mike are easily reached and visible from normal driving position.

**PORTABILITY:** Radio is detached quickly and easily. Nothing to unplug—antenna, power and speaker cables are wired through contacts in the mount. **INSTALLATION:** Mounts securely to the transmission hump or roof.

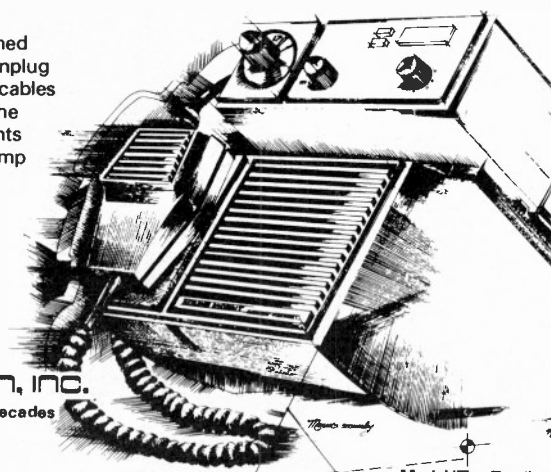

**GAMBER-JOHNSON, INC.**

Quality Manufacturers for over 2 decades  
 801 Francis Street  
 Stevens Point, Wisconsin 54481  
 (715) 344-3482

# SOUND MOUNT

1502 happy  
**DRAGON** dealers  
 feature

# JOHNSON radios...

**Powerful all Solid State  
 base station  
 Messenger  
 250**

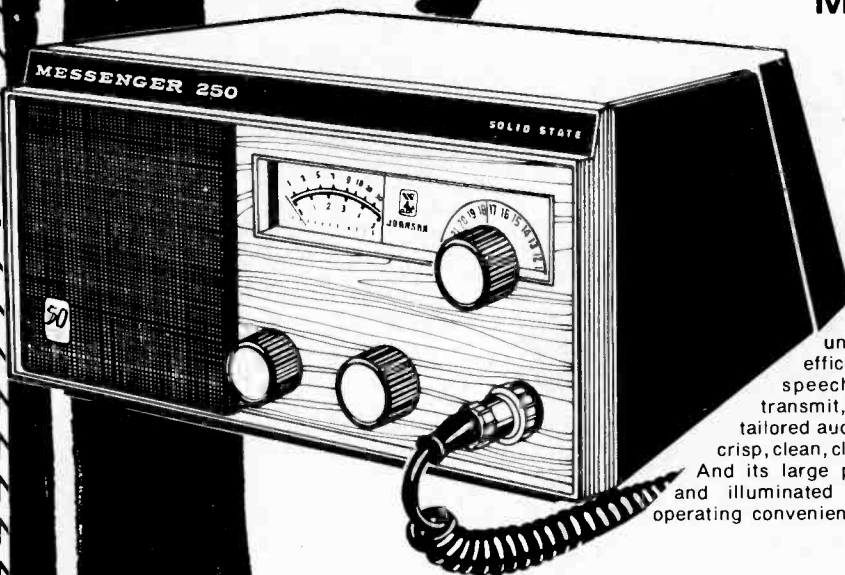

Messenger 250/  
 with hand mike  
**\$244.90**

Messenger 250  
 (less mike)  
**\$229.95**

Messenger 250 is a 100% solid-state base station of unparalleled power and efficiency. Electronic speech compression on transmit, plus special voice-tailored audio on receive deliver crisp, clean, clear communications. And its large professional controls and illuminated metering put real operating convenience on your desktop.



*"When you're a  
 Happy Dragon Dealer you  
 can select from over  
 16 nationally known  
 brands of CB radios!"*

CALL OR WRITE FOR  
 DETAILS

# Dragon Communications

P.O. Box 186  
 Excelsior Springs, Mo. 64024  
 1-(816) 637-6011  
 1-800-892-7241 or  
 1-800-821-2782

244 N.W. 39th  
 Oklahoma City, Ok. 73112  
 (405) 525-8844  
 1-800-654-8462



## WASHINGTON OUTLOOK (cont'd)

Shelby, N.C., Jack E. Mode, \$50, KSB-4886.  
Troutman, N.C., Lenwood E. Berry, \$50, KWT-6027.  
Roanoke, Virginia, Charles E. Hall, \$50, KWY-5324.  
Billings, Montana, Gerald D. Borsvold, \$50, KWQ-8036.  
Anaheim, Calif., Ferol C. Lawson, \$100, KZK-6732.  
Costa Mesa, California  
Hydro Engineering Company, \$100, KGO-0962.  
Brian L. Krotje, \$150, KWF-0570.  
Jerry R. Nona, \$100, KSE-1157.  
Garden Grove, Calif., Jon R. Goalen, \$50, KNH-0083.  
Huntington Beach, California  
Terrence K. Calderwood, \$100, KHM-2855.  
Daniel E. Mahan, \$100, KNB-9653.  
David E. Rhodes, Jr., \$100, KLK-8717.  
Lee Anna V. Westsell, \$50, KKM-5507.  
Santa Ana, Calif., Earl F. Baker, \$100, KFT-1602.  
Stanton, Calif., Olivia E. Canada, \$100, KXV-6041.  
Westminster, Calif., Eugene L. Franklin, \$100, KCR-8844.  
Anaheim, California  
John A. Aughton, \$50, KME-3093.  
Luther W. Bryant, \$150, KIN-0321.  
James A. Sandgren, \$150, KXA-2741.  
Buena Park, Calif., Fred L. Puttillo, \$100, KHO-2678.  
Costa Mesa, California  
Norman L. Bates, \$150, KZE-7616.  
Chester L. Botkins, \$50, KLU-8232.  
Gary F. Lormen, \$100, KZE-0235.  
Walter J. McMahan, \$50, KIP-2418.  
Louis Sawyer, \$50, KIL-1336.  
Cypress, Calif., Donald R. Raley, \$50, KWO-5559.  
Fountain Valley, Calif., Douglas J. Weber, \$100, KGZ-3982.  
Fullerton, California  
Robert J. Hebert, \$50, KFH-2487.  
William A. Smith, \$100, KCU-1887.  
Garden Grove, Calif., Albert H. Gould, \$100, KLU-6274.  
Huntington Beach, California  
Robert G. Blackwell, \$100, KHN-2153.  
Jason C. Dieterman, \$50, KGV-7628.  
Richard E. Esslinger, \$50, KRE-92647.  
Michael R. Morjoseph, \$100, KXO-6562.  
Glen W. Roberts, \$100, KZO-1748.  
James K. Rogers, \$50, KHK-2355.  
Harold G. Unger, \$100, KXM-4927.  
Mark A. Villasenor, \$50, KOS-9953.  
James Ward, \$100, KOB-6585.  
Barbara A. Weinstein, \$50, KEZ-5641.

La Miranda, Calif., Roy L. Koch, \$50, KRK-90638.  
Los Alamitos, California  
Mike L. Shields, \$100, KWP-5211.  
Robert L. Brodtkin, \$100, KSA-0398.  
Clovis, Calif., Loyd Leslie, \$50, KWA-6919.  
Fresno, Calif., Coulter M. Shuck, \$150, KRA-2021.  
Clearwater, Fla., Dennis G. McCarthy, \$100, KER-7552.  
Largo, Fla., Patty Anne Rennels, \$150, KYB-8582.  
Orange Park, Fla., Clayton A. Vagnini, \$100, KSQ-4399.

Pinellas Park, Florida  
John P. Janssen, \$150, KIK-9806.  
John L. Middleton, Jr., \$150, KFD-5095.  
Saint Petersburg, Florida  
Thomas R. Cobb, \$100, KHT-2952.  
Joseph N. Kempmiller, \$100, KBH-0892.  
Sarasota, Florida  
Ted Garcia, \$100, KTR-2779.  
Arthur N. Johnston, \$100, KJR-2159.  
Lesley J. Neville, \$50, KNM-7450.  
Frank J. Sarnal, \$100, KHQ-7770.  
Paul D. Shrader, \$50, KSB-4309.

# We put the switch and the sound exactly where they belong.



The Safety Mic lets you concentrate on the driving, with both hands always on the wheel. The microphone switch mounts on the turn-signal lever or the gear shift; push-to-talk button activates the 500-ohm microphone. The headphone is voice-engineered and impedance-matched; features automatic gain control to prevent blasting.



The new Twin-Visor speaker clips right to your visor, out of the way, yet close enough to override external noise without overloading your amplifier. The Twin-Visor contains two speakers and the sound is carefully voice-tailored to let the message come through clearly.

Write for literature on these and other Superex CB products: base station mics, voice-operated relays, single-sided headphones, two-sided base station headphones.

 **SUPEREX**  
PRODUCTS WITH A DIFFERENCE

151 Ludlow St., Yonkers, N.Y. 10705 • In Canada: Paco Electronics Ltd., Montreal

## WASHINGTON OUTLOOK (cont'd)

Warren L. Vale, \$100, KSL-7912.  
Atlanta, Ga., Franklin Farmer, \$50, KMW-6736.  
Conyers, Ga., Lloyd F. Allen, \$50, KBA-6741.  
Peru, Indiana, Stan Scalabrin, \$50, KJN-9460.  
Houston, Texas, Harold N. Blair, \$150, KJR-6787.  
Hancock, Md., Dale W. Robinson, \$50, KFD-8233.  
Binghamton, N.Y.  
Phyllis A. Devine, \$50, KNJ-5236.  
Riker L. Dleffenbach, \$50, KYA-8141.

Harvey J. Greenblott, \$50, KYS-4727.

William C. Hall, \$50, KXS-5446.  
Margaret H. Johnson, \$50, KMT-2634.

Rozane M. Miller, \$50, KSH-7515.  
John D. Sponable, \$100, KZH-4190.  
George H. Wahl, \$50, KHT-7356.

### Endicott, N.Y.

Dianne D. Burgher, \$50, KWK-0776.  
Cresco Florist and Greenhouses, \$50, KTI-9075.

San Francisco, Calif., Raymond S. Teshara, \$50, KJJ-7546.

Cumberland, Md., John Elwood Layton, \$50, KJL-21502.

Bridgeport, Conn., Tim Adams, \$50, KZQ-6311.

Bandhor, Kansas, Richard C. Newman, \$200, KXY-0146.

### Muskogee, Oklahoma

Fred D. Carnell II, \$150, KDJ-3582.  
Jimmie P. Platt, \$50, KZO-9671.  
Sentinel Alarm Co., \$200, KBD-9790.

Keith G. Simmons, \$50, KCF-8949.  
Eddie L. Walker, \$50, KMU-5648.

Connellsville, Pa., Steve J. Bable, \$50, KCY-5493.

### Brandenton, Florida

Robert A. Slaughter, \$100, KZL-7065.

Ralph E. Wilkins, \$150, KOP-2245.

Enid, Oklahoma, Earl B. Shelton, \$50, KCY-4445.

### Staunton, Va.

Jimmy Ferguson, \$50, KJZ-0355.

William Floyd, \$50, KID-3171.

Glenwood E. Johnson, \$50, KGW-1695.

Roy V. Miller, \$50, KHS-5101.

David E. Wolfe, \$50, KJV-4832.

Lee R. Wilkerson, \$50, KTH-1477.

Trinity, N.C., James Ledbetter, \$50, KHC-7657.

### Amarillo, Tex.

Jack E. Glover, \$50, KGM-8127.

Ray Graham, \$150, KFK-9466.

Wayne W. Hall, \$150, KEB-6040.

Canyon, Texas, Donald L. Robertson, \$200, KWV-5840.

Silverton, Texas, Michael L. Haney, \$50, KWG-7173.

Tahoka, Texas, William P. Cox, \$50, KIE-5308.

Tulia, Texas, A. J. Henderson, \$50, KSF-9837.

Dover, Del., Charles D. Coverdale, \$50, KGY-3035.

Easton, Md., David R. Sinclair, \$150, KIC-7808.

Westminster, Md., Doris M. Eyler, \$50, KBF-6645.

Bath, Pa., Daniel A. Shuey, \$50, KBS-5154.

Martinez, Ga., Kenneth A. Daniel, Sr., \$100, KZB-1521. For violation of Section 95.95(c) of the rules by failing to identify radio station by the assigned call sign and Section 95.83(b) of the rules by communicating, or attempting to communicate, with a unit of the same station or another Citizens radio station over a distance of more than 150 miles.

Portland, Texas, Norman L. Deavers, \$50, KED-2704. For violation of Section 95.95(c) of the rules by failing to identify radio station by the assigned call sign.

### Paducah, Ky.

Ray D. Galloway, \$50, KFG-0204.

For violation of Section 95.95(c) of the rules by failing to identify radio station by the assigned call sign.

Richard T. Rgland, \$50, KFJ-6597.

# End of the Radio Noise Era

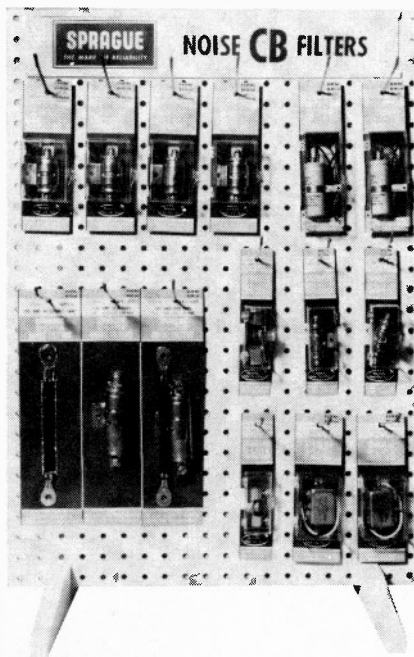

## Q-Line™ Noise Filters Knock Out Mobile Radio Interference Once and For All!

Solve vehicle-originated noise problems in your car, truck, or tractor with these super filters. Made by the world's largest and best-known capacitor manufacturer, they're highly efficient, reasonably priced, easy to install, and built to last. Look for the Sprague Q-Line Filter display at leading dealers.

**WE WELCOME  
YOUR  
INQUIRIES.**

For the Sprague distributor or dealer nearest you, write to: Joe Cronin, Sprague Products Co., 663 Marshall St., North Adams, Mass. 01247.



WORLD'S LARGEST MANUFACTURER OF CAPACITORS



For violation of Section 95.95(c) of the rules by failing to identify radio station by the assigned call sign.  
**Savannah, Ga., Edward H. Todd, III,** \$50, KFQ-7848. For violation of Section 95.95(c) of the rules by failing to identify radio station by the assigned call sign.

**Lubbock, Texas, John V. Hye,** \$100, KIO-4758. For violation of Section 95.95(c) of the rules for failure to identify subject radio station by the assigned call sign.

**Lumberton, Miss., Daniel S. Davis,** \$150, KJK-5700. For violation of various sections of Part 95 of the Commission's rules including Section 95.95(c) of the rules by failing to identify radio station by the assigned call sign.

**Baton Rouge, La., Frank F. Roberts, Jr.,** \$100, KTM-9033. For violation of Section 95.95(c) of the rules by failing to identify radio station by the assigned call sign and Section 95.41(d) of the rules by operating radio station on a frequency not authorized by the Commission for use by such station.

**Ewa Beach, Hawaii, Charles R. Hibbs,** \$50, KBS-5599. For violation of Section 95.83(b) of the rules by communicating, or attempting to communicate, with a unit of the same station of another Citizens radio station over a distance of more than 150 miles.

**Baltimore, Md., Robert K. Barr,** \$50, KCC-9378. For violation of Section 95.83(a)(7) of the rules for transmitting music, whistling, sound effects or any other material for amusement or entertainment purposes.

**New Orleans, Louisiana, Lawrence F. Dulchich,** \$50, KLK-6051. For violation of Section 95.95(c) of the rules for failure to identify subject radio station by the assigned call sign.

**Mobile, Alabama, Lawyer B. Thomas,** \$50, KFF-1964. For violation of Section 95.95(c) of the rules for failure to identify subject radio station by the assigned call sign.

**Hixson, Tennessee, Richard D. Welch,** \$100, KTG-7609. For violation of Section 95.95(c) of the rules for failure to identify subject radio station by the assigned call sign.

**Robstown, Texas, John Webb Welding Company,** \$50, KBE-1424. For violation of Section 95.83(b) of the rules for communicating, or attempting to communicate, with a unit of the same station or another Citizens radio station over a distance of more than 150 miles.

(continued)

\$1,000  
**REWARD**  
 \$1,000

I will pay a \$1,000 reward as compensation for a like new or mint Lionel train engine Number 5344 if accompanied by the original full scale freight cars or red "rail chief" passenger cars that were originally catalogued with this engine. The engine mentioned above is also referred to as the "scale Hudson", and sometimes is referred to by the Lionel catalog number 700E, although that number doesn't appear on the engine itself.

I will also pay top cash for any of the following pre-WWII Lionel engines in really fine condition:

- # 250E Hiawatha # 255
- # 256 # 260E # 263

Many prewar Lionel engines are worth hundreds of dollars to a true collector, and thousands of these engines gather dust in attics and basements across the country. I'm willing to pay hard cash to get them for my collection.

If you have **any** old Lionel trains or accessories, please get in touch with me. But please, make certain that you list the numbers on the side of the engine or cars, since this is the key to determining the collector's value.

**Dick Cowan**  
**CB Radio/S9**  
**14 Vanderventer Avenue**  
**Port Washington, N.Y. 11050**  
**Phone: (516) 883-6200**

ORDER NOW!

**IT'S BODACIOUS!**

**POLISHED PEWTER-LOOK**  
**CB JEWELRY**

- Your Favorite CB Lingo on Pendants & Pierced Earrings W/Hypo-Allergenic Wires
- For Yourself and Every Member of Your CB Club
- Terrific Gift Idea!

**\$3.00** Mass. residents add 5% sales tax



Earrings Shown Actual Size  
 Pendants Larger W/18" Chain

Send Check or Money Order Only To:

MY IDEA  
 BOX 544  
 HOLLISTON, MA 01746

PLEASE PRINT CLEARLY TO AVOID ERRORS

NAME \_\_\_\_\_  
 STREET \_\_\_\_\_  
 CITY \_\_\_\_\_  
 STATE \_\_\_\_\_ ZIP \_\_\_\_\_

SHOW QTY. DESIRED IN BOX PROVIDED  
 TOTAL ENCLOSED \$ \_\_\_\_\_

EARRINGS			PENDANTS		
<input type="checkbox"/> 1	<input type="checkbox"/> 6	<input type="checkbox"/> 11	<input type="checkbox"/> 1	<input type="checkbox"/> 6	<input type="checkbox"/> 11
<input type="checkbox"/> 2	<input type="checkbox"/> 7	<input type="checkbox"/> 12	<input type="checkbox"/> 2	<input type="checkbox"/> 7	<input type="checkbox"/> 12
<input type="checkbox"/> 3	<input type="checkbox"/> 8	<input type="checkbox"/> 13	<input type="checkbox"/> 3	<input type="checkbox"/> 8	<input type="checkbox"/> 13
<input type="checkbox"/> 4	<input type="checkbox"/> 9	<input type="checkbox"/> 14	<input type="checkbox"/> 4	<input type="checkbox"/> 9	<input type="checkbox"/> 14
<input type="checkbox"/> 5	<input type="checkbox"/> 10	<input type="checkbox"/> 15	<input type="checkbox"/> 5	<input type="checkbox"/> 10	<input type="checkbox"/> 15



# CONVERT MOBILE CB TO "HOME BASE" INSTANTLY!

NEW STACO HEAVY DUTY  
POWER SUPPLIES CONVERT  
AC TO CONTINUOUS 13.8VDC  
FOR FULL TRANSMIT POWER!

Powers CB, SSB, Stereos,  
Tape Decks and other auto  
accessories. Hook-up 2  
wires, antenna and plug  
into standard AC outlet. No  
background hum, reliable,  
economical and quiet.  
Choice of 3 models.

Features: Automatic Dual  
Overload and Short Circuit  
Protection, Solid State Re-  
liability, Integrated Circuit  
Regulation Control, 90 Day  
Warranty, Made in U.S.A.

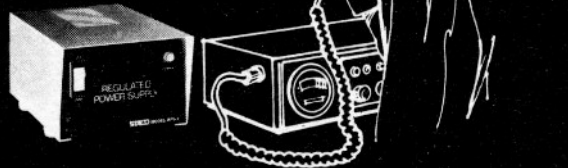

AVAILABLE NATIONWIDE FROM:  
LEADING CB RADIO DEALERS & STORES!

"40 years of Electronic Experience"

**STACO**  
INCORPORATED  
2240 E. Third St., Dayton, Ohio 45403  
(513) 253-1191 • TWX: 810/459-1798 • TELEX: 288-032

DISTRIBUTOR INQUIRIES INVITED!

## WASHINGTON OUTLOOK (cont'd)

### SHOW CAUSE NOTICES

The Commission, by its Safety and Special Radio Services Bureau ordered the following licensees to show cause why their licenses should not be revoked for violation of various sections of Part 95 of the rules including Section 95.95(c) of the rules by operating without being identified by its assigned call sign at the beginning and conclusion of each transmission or series of transmissions:

#### Memphis, Tennessee

Frank L. Sweeney, KEU-0814.

Melvin M. Billings, KJS-7116.

Fort Collins, Colo., Michael E. Dodge, KHL-6924.

Houston, Texas, William D. Gafford, KWT-1844.

The Commission, by its Safety and Special Radio Services Bureau ordered the following licensees to show cause why their licenses should not be revoked for violation of Section 1.89 of the Commission's rules by failing to respond to official communications:

Branford, Conn., Richard L. Crouch, KBV-3107.

Sulphur, Louisiana, Joe H. Duhon, KIL-4611.

Hillcrest Heights, Md., Larkin P. Davis, KGM-3773.

Edison, N.J., Fortunato Landscaping, Inc., KAB-0934.

Highstown, N.J., New Jersey Automatic Door Co., KAB-1207.

Plainfield, N.J., Judkins Colonial Home, KAB-0712.

Blaine, Wash., Joseph A. Colon, KHP-9712.

Pipestone, Minn., Darrell L. Hein, KIN-7793.

Crescent City, Calif., Albert R. Brennan, KEW-0272.

Annapolis, Md., Coy M. Truelove, KDI-6032.

Pearland, Texas, D. S. Enterprises, KYN-6909.

Cupertino, Calif., Michael J. Gitschel, KEU-4528. For violation of 308(b) of the Communications Act of 1934 by failing to respond to official communications.

### DISMISSED & SET ASIDE

The Commission, by its Safety and Special Radio Services Bureau dismissed proceedings on orders to show cause for the following:

Nowata, Okla., Jimmy D. Foster, KDS-8352.

Garden Grove, Calif., Nancy C. Gates, KDV-4667.

Pana, Ill., Violet C. Blankenship, KGQ-2911.

Lawrence, Mass., Wm. H. Robichaud, Sr., KGR-6065.

## Tired of Crowded CB Channels?

Then you want a  
GRC-11 RANGE CONTROLLER

Eliminates

- INTERFERENCE ON CROWDED CHANNELS
- EAVESDROPPING ON PRIVATE CONVERSATIONS
- BLEEDTHROUGH FROM OTHER CHANNELS

**\$39.95**



PLUS . . .

Fantastic "Private Mode" bonus feature allows you private conversations car to car. Installs in 5 minutes. Requires no power. Connects between any CB set and CB antennas.

## You Can't Steal What You Can't See

Operate your CB with your regular car antenna.

No CB antenna necessary.



**\$49.95** The PROFILE ANTI RIPOFF costs more but works better.

No complex extra meters to buy. Has built-in traffic light indicator. Green light, everything's right. Red light, simple knob adjustment. Listen to your AM/FM radio even while transmitting!



Send Check, Money Order, BankAmericard or Master Charge Number  
With Expiration Date. Now in Stock for Immediate Shipment.

**Glatzer Industries Corp.**

268 Huguenot Street • New Rochelle, N. Y. 10801

(914) 576-2700 Dealer Inquiries Invited!

Hayward, Calif., David Joseph Lenz, KXP-4287.  
 Carscent City, Calif., Albert R. Brennan, KEW-0272.  
 Albonito, Puerto Rico, Wiltre R. Santiago, KIW-3822.  
 Little Rock, Arkansas  
 Robert A. Elmore, KOR-4317.  
 Raney Investment Company, Inc., KOR-4259.  
 San Bernardino, Calif., Donald P. Winchel, KSU-6904.  
 Buffalo, N.Y., Edward R. Traky, KJT-9329. Set aside order of revocation and dismissed the proceeding.  
 Santa Ana, Calif., Deborah D. Smith, KFN-9279.  
 Commerce City, Colo., Edgar Lee Huff, KDM-8236.  
 Denver, Colo.  
 Patrick L. Duffy, KJS-0259.  
 Arthur L. Moore, KFU-5191.  
 Hartford, Conn., Ronald G. Chase, KDU-1998.  
 Holy Hill, Fla., Joseph R. Pratt, KFR-8735.  
 Milton, Fla., Robert D. Patterson, KHM-9051.  
 Tampa, Fla., Joseph R. Conway, KEX-4852.  
 Bridgeview, Ill., Robert J. Vrastil, KSN-6678.  
 Plymouth, Mass., Robert D. Lacombe, KIN-5214.  
 Lincoln, Park, Mich., Daniel Delao, KBP-4503.  
 Chemult, Ore., Alvin L. Babcock, KHP-3041.  
 Sandy Springs, S.C., Mathre R. Scearce, KFX-7483.  
 Fairbanks, Alaska, Anthony G. Bremer, KGW-5265. Dismissed petition for reconsideration of order of revocation.  
 Oklahoma City, Oklahoma, Michael W. Greenway. Ordered to cease and desist from further violations of Section 301 of the Communications Act of 1934, by operating radio transmitting apparatus without a valid radio station license.

**BARGAIN HUNTING?**  
 Send 35¢ to Dep't. **9**  
 FOR BARGAIN CB CATALOG!  
**HENSHAW'S**  
 7622 Wornall, Kansas City, Mo.

**★ DEALERS WANTED ★**  
 —All Major C.B. Lines—  
 SELL CB FULL OR PART TIME  
**GORDON ELECTRONICS**  
 Box 513 Johnstown, N.Y. 12095  
 FREE (518) 762-1811 CATALOG



## FIND HIM BEFORE HE FINES YOU.

Put a BEARFINDER® Electronic Radar Detector on your dashboard! It plugs into your car cigarette lighter, is easily removed for storage, and can be set for either audio or visual warning.

Built with the extra-reliability of solid state components, BEARFINDER features an adjustable sensitivity control so you can set it to highway or city driving. And whether that radar is moving or sitting still, the BEARFINDER can spot it long before it spots you. It all adds up to the most reliable, effective way yet to avoid speed traps. See the BEARFINDER today, wherever CB equipment is sold... because you never know where Smokey's going to be lying in the weeds taking pictures.



**BEARFINDER INC.**  
 105 N. Walnut Street • Sidney, OH  
 45365 • Phone: (513) 224-3591

## THE BEARFINDER

Available wherever CB equipment is sold.

## SENTURION from RADATRON

THE ULTIMATE  
RADAR DETECTOR

**\$89.95**



The manufacturer's of the world famous, patented Radar Sentry introduce the professional drivers Model "SENTURION". Look at these advanced features:

- Deluxe die cast metal case
- 12 Volt Operation — connects to vehicle ignition — positive or negative ground
- Visual and audible warning
- Computer designed horn antenna
- Utilizes integrated circuitry
- Maximum Sensitivity and Long Range
- Dual mounting brackets
- Detects moving radar and speed gun, plus "standard" traffic control radar.
- Complete with instruction/operation manual
- Automatic Noise Limiter

Complete distributor/dealer promotion program available.  
 Write for details today!

PLEASE SEND \_\_\_\_\_ SENTURIONS AT \$89.95 EA. PLUS POSTAGE AND TAXES WHERE APPLICABLE PAYMENT BY:  CASH  C.O.D.  MASTER CHARGE  AMERICAN EXPRESS  DINERS CLUB  CARTE BLANCHE

Credit Card Number \_\_\_\_\_ S-9

Name \_\_\_\_\_

Address \_\_\_\_\_ City \_\_\_\_\_ State \_\_\_\_\_ Zip \_\_\_\_\_

RADATRON CORP., 2424 NIAGARA FALLS BLVD., N. TONAWANDA, N.Y. 14120

# Cobra is in Iowa

## Royal Radio

1922 E. 14th Street, Des Moines, Iowa 50316, (515) 266-5315



Call your Cobra key distributor for the name of your nearest Cobra dealer.



**DOES IT AGAIN**  
... SUPERIOR QUALITY  
*Our 13th Year Serving the CB Market*

"Moving' up" with

**Firestiks**

**NEW LOW 50 CH. SWR**

- FOR CARS, CAMPERS, TRUCKS, MOTORCYCLES, RV'S, BOATS, ETC.
- TRUE HIGH GAIN WHIP MADE IN PHOENIX, ARIZONA
- TUNED FROM 26.965 TO 27.405 PLUS
- 3/8 WAVE TOP LOAD
- AVERAGE SWR 1.5 TO 1
- MORE EFFICIENT THAN CENTER OR BASE LOAD TYPE ANTENNAS
- RUGGED FIBERGLASS CONSTRUCTION
- 3/8-24 HEAVY DUTY THREADED BASE
- FITS ANY SINGLE OR CO-PHASE ANTENNA SYSTEM
- FIRE RED WITH WHITE TIP OR WHITE WITH RED TIP

**NEW SUPER TIP!**

- ALWAYS USE COAX CABLE 18'-20' LONG
- NO TUNING NECESSARY
- NOISE LIMITING STATIC SHEATH COVERING REDUCES NOISE UP TO 50%

IT TAKES A TOP ANTENNA TO MAKE A TRANSCEIVER DO ITS BEST WORK

**KW3 \$13<sup>95</sup>**

SUGG. LIST .....  
A 3' HEAVY DUTY EQUAL TO MOST 6' ANTENNAS

**KW5 \$15<sup>95</sup>**

SUGG. LIST .....  
A 5' HEAVY DUTY WHIP THAT WILL MAKE YOU SOUND 10' TALL

BASES NOW RIVETED SO THEY CANNOT BREAK!



"Rabbit Ears" are real "Hot Rods!"

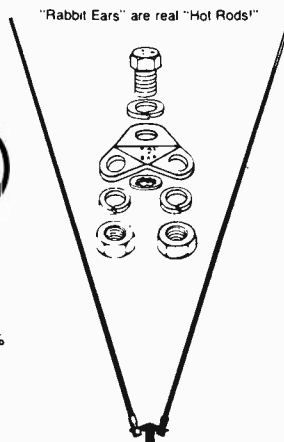

LEAN V-BAR TO AREA OF MOST METAL ON VEHICLE!

**V-Bar Mount** <sup>PAL</sup> K-10 LIST \$295

(TO MAKE RABBIT EARS)

INSTALL V-BAR ON ANY SINGLE OR CO-PHASED TRUNK, ROOF, MIRROR OR BUMPER MOUNT, WITH 3/8-24 THREADED BASE!

V-BAR IS SCIENTIFICALLY FORMED SO THAT WHEN USED WITH 2 PAL "FIRESTIKS", YOUR AUDIO TO THE STATION YOU ARE TALKING TO IS INCREASED UP TO 40%. YOUR RECEPTION WILL INCREASE UP TO 25%.

PHOTO SHOWS "RABBIT EARS" SET-UP USING 2 PAL "FIRESTIKS". PAL V-BAR ASSEMBLY, ON STUD MOUNT. FITS ALL 3/8-24 THREADED MOUNTS

**WATCH FOR NEW "FIRESTIK" UFO BASE STATION ANTENNA**

**SEND FOR FREE [PAL] FULL LINE CATALOG INQUIRIES INVITED**

PLEASE CHECK:  DEALER  DISTRIBUTOR  USER  
(Please Print)

NAME: \_\_\_\_\_

ADDRESS: \_\_\_\_\_

CITY: \_\_\_\_\_

STATE & ZIP: \_\_\_\_\_



**ELECTRONICS CO.**  
2962 W. WELDON, PHOENIX, ARIZONA 85017  
(602) 264-0214  
*A Division of Fire Communications Corporation*



# CB RADIO'S Nuts and Bolts Dictionary

By Harold Perry

Down through the ages man has developed ingenious methods of communication, such as the drum, flag codes, flashing mirrors, blinking lights, carrier pidgeon, telegraph, telephone and graffiti in public toilets. At the very core of these various techniques is the *spoken word*. Man *speaks* in order to express his ideas. This has been going on since the early caveman grunted out his simple message "Grunt uung gorff broogg gontunk!" which meant ("No sit on fire, sit on rock!") and "Grunt offt grawt uungh ong ohohuh oop grak!" (No eat woolly mammoth yet, you kll it first!) and has been refined to its present day sophistication: "Give me liberty or give me death!" — "That's one small step for man, one giant leap for mankind." — "Hey, gimme anudder beer!" and "Hi sailor. New in town?"

In recent years, with the greatly increased use of CB Radios, a new form of American Slanguage has arisen. Words take on a completely different meaning from the original intent. An example is the word *Bear*. To CBers and t-uckers, a bear is not a large furry creature that romps through the forest eating fish, berries and an occasional lumberjack, but is a slang term for policeman.

Now for your information, entertainment and revulsion, S9 hesitantly presents its NUTS AND BOLTS DICTIONARY. The words and their definitions are correct but the accompanying cartoons are totally demented, and not to be exposed to young impressionable minds that are so easily deranged.

## EARS



That's Your CB Radio. If you ain't got no rig, then mercy sakes that's the ugliest set of windbreakers I done ever eyeballed.

## BIG MAMA



It sure ain't Calucci's mother, but a term for a Large CB Antenna.

## HONEY BEAR



A law enforcement officer of the female persuasion. Yer know, a broad wit a badge.

## MOTH BALL



Besides being the all American Bug past time it's also an Annual CB Convention

HAVE YOU GOT A CB SLANG WORD THAT I DON'T HAVE? (You probably do!) Then send it to me and I'll put it in the next issue of S9 with your name and handle. In case of duplicate definitions the one postmarked first will be used. SEND postcards to: HAROLD PERRY c/o S9 Magazine 14 Vanderverter Ave. Port Washington, New York 11050

# Precision

## THAT'S WHAT YOU GET FROM SENTRY CRYSTALS.

Sentry's manufacturing methods are the most precise anywhere. We start with the Brazilian quartz. We use the latest state-of-the-art specifications. Then we add a lot of care from our trained, experienced personnel. Gold-plated quartz for longer life. And rigid standards of quality control.

The result? The most stable, reliable communications crystals money can buy.

Since Sentry has the largest semi-processed crystal bank in the world, we can custom-make crystals for any rig. Any frequency. Faster than anyone else in the business.

We process our orders quickly, too. And we stand behind our work. With solid guarantees.

Maybe that's why people who count on communications count on Sentry.

*Send for our complete 1976 catalog. It's just \$1.50, deductible from your first order. It may be one of the best communications investments you'll ever make.*

Crystal Park, Chickasha Oklahoma 73018

**Sentry**  
Manufacturing  
Company

Tuned-In to  
Quality

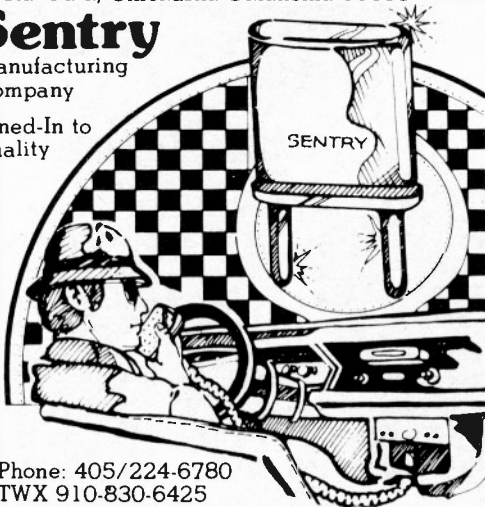

Phone: 405/224-6780  
TWX 910-830-6425



Sentry Mfg. Co.  
Crystal Park  
Chickasha, Okla. 73018

CB/S92

Please send me the complete 1976 Sentry Catalog immediately. Enclosed is a check or money order for \$1.50

Name \_\_\_\_\_

Address \_\_\_\_\_

City \_\_\_\_\_

State \_\_\_\_\_

Zip \_\_\_\_\_

## ON THE COUNTERS

(from page 49)



### IN-DASH CB WITH STEREO

Automatic Radio, leader in automotive electronics for over 50 years, announces the introduction of its new in-dash CB transceiver with AM/FM stereo radio. Model CXB-2472 has a full-featured CB transceiver with delta tuning, squelch control, S/RF meter, illuminated channel selector, and detachable microphone. The AM/FM multiplex radio provides beautiful music, including FM stereo broadcasts, through its powerful amplifiers. The radio features stereo indicator light, on/off volume control, tone, tuning, fader and balance controls. An exclusive "monitor" feature allows the user to enjoy the AM/FM stereo radio without missing any activity on CB. Adjustable shafts provide secure, convenient in-dash installation in most cars—a solution to the growing problem of CB theft. Model CXB-2472 has a suggested list price of \$295.95. See your local Automatic Radio dealer.



### HIDE-A-WAY™ CB RECEIVER

The HIDE-A-WAY CB receiver is installed behind the dash and connects to any standard AM or AM/FM auto radio for tuning. It receives at a range of up to 10 miles using a standard radio antenna.

The HIDE-A-WAY is exceptionally dependable. The power relay, which is the weakest link is rated at 5 million operations.

If the unit should fail, it automatically reverts to normal radio reception. Disagreeable background noise and "RF trash" is effectively eliminated by unique cir-

cuts in the HIDE-A-WAY which discriminate between unwanted noise and voice transmissions.

**Power requirements**

1. Input band width = 1 MHz. (-3DB)
2. Input frequency = 26.965 to 27.225 MHz (all 23 channels)
3. Tuning stability =  $\pm 200$  P.P.M. throughout ambient temperature range.
4. Input impedance = approximately 300 ohms
5. Maximum input signal = 10 DBM. (acceptable distortion)

For further information contact: Eagle Electronics, 2714 Louisiana, Houston, Texas 77006.



**NOISE SUPPRESSION FILTER**

EMI-15A—knocks out ignition hash.

The EMI-15A is a three-element low-pass LC filter designed to control ignition system generated noise. It prevents coupling of ignition impulses into the vehicle primary wiring system and supplements suppression-type plug wiring. Insulation is at the battery connection to the coil or electronic system.

The introduction of high-voltage, solid state ignition systems in all American automobiles in 1975 more sharply brought into focus the suppression of ignition interference. Fully 50% of engine noise problems come from the ignition system.

Suggested retail price: \$6.95.

Availability: From stock.

Contact: Morgan Cox, Marine Technology, 2780 Temple Ave., Long Beach, CA 90806.

**THE CITIZENS BANDWAGON**

Oden, Inc., 201 N. Broad St., Phillipsburg, N.J. has introduced the Citizens Bandwagon, a promotional merchandising concept offering CB related gift items.

The Citizens Bandwagon features a wide assortment

... Use S9 READER SERVICE.

# Traveling?

stay on the air with the  
**Barker & Williamson**  
CB-27 Portable Whip Antenna

- Simple clamp-on mounting fits almost anywhere
- Quick disassembly to 2-foot, 2-piece package
- Power Safety Factor 360 watts
- Weighs only 2 pounds
- Coax feed line supplied

**Only \$29.95**

Professional quality since 1932

**Barker & Williamson**  
Canal Street  Bristol, PA 19007  
Write for distributor list.

## AMAZING APARTMENT ANTENNA!



APT-3, the *shoestring* antenna that ends the CB base-station antenna hassle! Simply attach the APT-3 to the inside of your window with the suction cups provided, connect to your transceiver and tune for maximum power! *GAIN: Range on ground level equal to mobile antenna. Increases dramatically with height.*

**SEND \$29.95**



Money back guarantee within 30 days upon written request. Please allow 60 days for delivery.

<input type="checkbox"/> Check or Money Order	APT-3's at \$29.95 ea. = \$ _____
<input type="checkbox"/> BankAmericard	
<input type="checkbox"/> Mastercharge	Signature _____
Interbank No. _____	Address _____
Card No. _____	City, State, Zip _____
Expiration Date _____	
<b>VALCOM, INC. P.O. BOX 937 LAS CRUCES, NM 88001</b>	



# TELL THE WORLD YOUR CHANNEL!



## WITH A CHANNELTAG™

Identify your channel at a glance to other "Good Buddies" with this 2 x 7½ inch highly reflective metallic sticker. The CHANNELTAG is easily visible day or night on your window or bumper. It is made of the finest weather resistant material with an adhesive backing. Our designs feature bold letters on your choice of a red, white, or blue background. Choose your favorite channel or channels from 1 to 23 and order today!

**CHANNELTAG™** P. O. BOX 4196  
MALIBU, CALIFORNIA 90265

**\$150 each or three for \$400**  
available in channel numbers 1 thru 23

PLEASE SEND ME:

<input type="checkbox"/>	<input type="checkbox"/>	NAME _____
QTY.	CHANNEL NUMBER(S)	ADDRESS _____
<input type="checkbox"/>	<input type="checkbox"/>	CITY _____ STATE _____ ZIP _____
RED	WHT	BLU
<input type="checkbox"/>	<input type="checkbox"/>	<input type="checkbox"/>
CHECK	M. O.	



## Radio & Accessories

**B & J TWO-WAY LTD.**  
1516 SE 44th  
Oklahoma City, Oklahoma 73129  
(405) 673-1381



*Dealer Inquiries Invited!*  
Send \$2.00 with company letterhead.  
Refunded with first order.

### ON THE COUNTERS (continued)



of attractive and clever brass plated CB belt buckles; complementary belts in a brand new package; embossed leather key fobs; quality cast metal key fobs on leather; and 100% cotton, American made T shirts with large 4-color CB designs.

The display is a unique snap-together mock up of a van, with pockets to attractively show all the merchandise. A colorful carton header card uses CB "lingo" and includes an aerial made of plastic. Dimensions are 68" high, 30" deep and 24" wide when assembled.

Suggested retail value of the package is \$600.00, with wholesale cost at \$289.00.

Oden manufactures and internationally markets a broad line of personal and decorative accessories in leather, wood and cast metal. Catalogue available by writing on your letterhead.

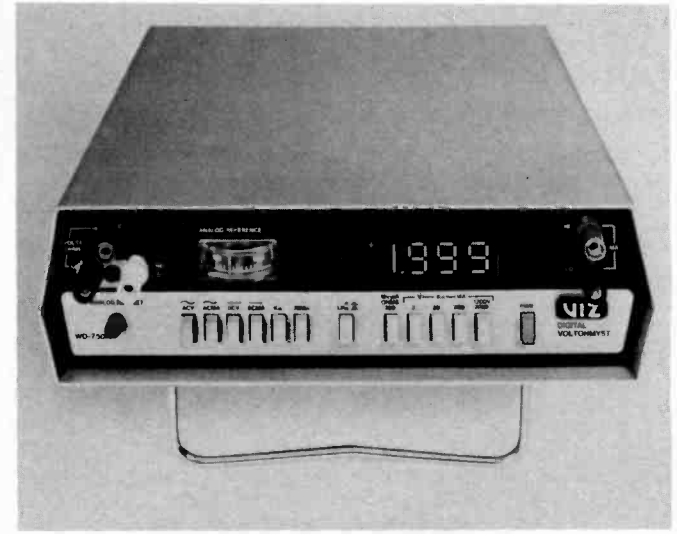

### DIGITAL MULTIMETER

VIZ Test Instruments Group, Philadelphia, Pa., has added the first digital multimeter to the line of test

instruments it acquired from RCA. The new multimeter is one of several new products that VIZ has announced as part of an ambitious new product introduction program.

The WD-750A VoltOhmyst®, priced at \$267 (dealer optional price), offers features found in multimeters priced much higher. An exceptionally bright 3½-digit ¾" LED display makes the VoltOhmyst DMM easy to read even in the most brightly lit areas. A built-in analog meter makes peaking and nulling much easier than with other digital meters. The unit is powered by either 120V ac or by its own built-in rechargeable long life nickel-cadmium battery.

The multimeter has six dc and six ac voltage ranges covering from as little as 1mV to 1,200V (rms for ac). There are five current ranges from 1µA to 1A and six resistance ranges from 1 ohm to 10 Megohm. Resolution is about 0.1% full scale, input impedance is 10 Megohm, and accuracy is comparable to the best laboratory-type instruments.

The WD-750A has a low-power resistance range for measuring resistance in circuits with semiconductors, and its autopolarity feature saves the time and difficulty of deciding which test lead should be connected to a measurement point.

Well marked pushbutton function selectors make operation fast and easy. Built-in overrange protection ensures that the meter will not be damaged by an inadvertent high voltage or current.

The unit is shielded from stray RF signals by its rugged, bump-resistant vinyl-clad steel case (10½"x 3¼"x11"). A combination carrying handle and tilt stand makes the instrument easy to use and easy to carry. And because it has its own self-contained recharger, there is no cumbersome line-cord recharger to get in the user's way. The instrument is self-zeroing and provides internal adjustments for periodic recalibration to ensure long-term accuracy.

Further information, on the WD-750A digital Volt-Ohmyst, including the names of nearby VIZ distributors, can be obtained from Robert Liska, VIZ Test Instruments Group, 335 E. Price St., Philadelphia, Pa. 19144.

#### BOOKLET ON CB RADIO ANTENNAS

An informative booklet for everyone interested in CB radio has recently been published by The Antenna Specialists Co.

The new piece, entitled "CB Facts and Fables", highlights the subject of CB antennas and dispels many of the myths about them. Written in easy-to-understand language, the author, Forest H. Belt, analyzes the nature of CB antennas—how they work, which types work better than others and why.

Copies of the booklet are available from your Antenna Specialists Representative, The Antenna Specialists Co., 12435 Euclid Avenue, Cleveland, Ohio 44106.

(continued)

## YOU CAN'T BEAT THE BEST!

**Fiberglass Antennas Work Best — And Francis Makes The Best Fiberglass Antennas.**

*That's because Francis Industries holds the original patents on Fiberglass CB Antennas as well as fiberglass marine antennas. We make a complete line of whips, mounts, co-phase harness and complete antenna systems to fit every CBer's needs.*

*Ask your local dealer about our reputation for quality and performance. We think you'll be impressed enough to join thousands of CBer's who are already enjoying the best.*

### FRANCIS INDUSTRIES

431 W. Broad St., Pataskala, OH 43062  
614/927-4091

## A BOMAR FIRST . . .

"Color-Pak"  
Crystals for

- ★ CITIZEN BAND
- ★ MONITOR RECEIVERS
- ★ MARINE RADIO
- ★ TWO-METER



Look for the attractive,  
multi-colored display rack

at your local dealer, or —

WRITE FOR NAME OF NEAREST DEALER



# BOMAR

## CRYSTALS

the "long playing" crystals

**BOMAR CRYSTAL COMPANY**

201 Blackford Ave., Middlesex, N. J. 08846

Phone (201) 356-7787

**"BROADCASTER" SPRING CHAMP  
GUTTER MOUNT CB ANTENNA**

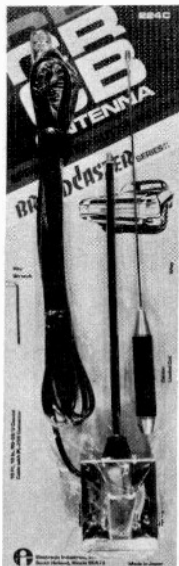

Electronic Industries "Broadcaster" gutter mount CB antenna features quick mount spring clamp—center loaded coil—stainless steel whip—10 ft. 10 in. RG—58U Coaxial cable with PL—259 connector. SWR adjustment. Hex key wrench.

The heavy chrome finished antenna with black coil jacket is packaged on full view display card.

For complete literature and the name of Electronics Industries representative in your area, write Electronics Industries, Inc., 33 Taft Drive, South Holland, Illinois 60473.

**CB LOCK**

Memphis Metal Works has introduced the "CB CRIMESTOPPER," a new CB Lock which can be installed in minutes. No special tools or skills are required.

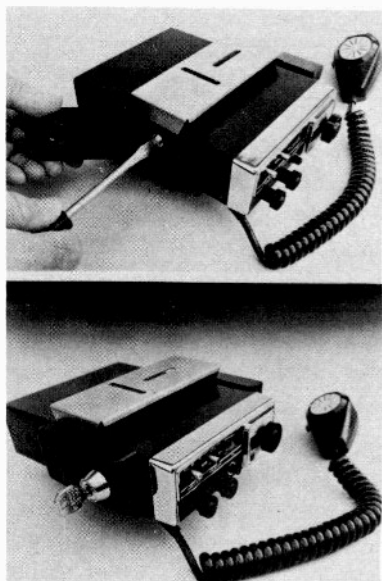

This new "CB CRIMESTOPPER" lock completely covers the screws or knobs which secure the CB to its mounting bracket. The CRIMESTOPPER features heavy gauge metal with a high quality automotive lock. Visible from outside the car window, the would-be thief can see the "CB CRIMESTOPPER" in place. It is obvious that removal of the CB will be extremely difficult.

A unique feature of the "CB CRIMESTOPPER" is

**WE HAVE  
THE KEY  
TO PROFIT**

There's tremendous profit in the exploding C.B. market - land, marine, everywhere! We have huge inventories of top brands - and 24 hour service. We also have the KEY to turning merchandise - effective marketing programs! Our proven know-how will assure what you want - a good bottom line!  
Write or call today!

**UNIVERSAL  
COMMUNICATIONS, INC.**  
1722 Terrace Drive  
St. Paul, Minnesota 55113  
In Minnesota, call collect:  
612/636-1771  
Outside Minnesota, call free:  
800/328-9600

**ATTENTION CB'ers**

NOW YOU CAN HAVE YOUR OWN CUSTOM MADE "HANDLE STICKER!" FOR VEHICLES OR HOME EACH ONE AN ORIGINAL WORK OF ART!

**FEATURING:**

- ★ RIGID VINYL STICKER - 4 in. x 11 in.
- ★ CHOICE OF COLORS, WHITE OR YELLOW BACKGROUND WITH BLACK, RED, OR BLUE HANDLE LETTERS
- ★ ALL LETTERING INDIVIDUALLY STYLED BY OUR EXPERT ARTISTS
- ★ CUSTOM DESIGNED 3 IN. COLOR CARTOON OF YOUR DESCRIPTION
- ★ ADHESIVE BACKING FOR EXTERIOR MOUNTING, FRONT MOUNTING STRIPS FOR INTERIOR USE
- ★ FRONT SEALED WEATHER-PROOF CLEAR LAMINATION
- ★ GUARANTEED! Return within 7 days for full refund if not completely satisfied

*My Handle Is...*  
**The MONSTER**

**★ GREAT FOR GIFTS!**

**INCREDIBLE VALUE** ★ COMPLETE PRICE ONLY \$4.95

SEND CHECK OR MONEY ORDER TO  
**NOAH COMMUNICATIONS INC.**  
1325 North Forest Rd. Suite 320, Williamsville, New York 14221  
716 888-1415 Member Buffalo Area Chamber of Commerce

**ORDER FORM**

NAME \_\_\_\_\_  
ADDRESS \_\_\_\_\_  
CITY, STATE, ZIP \_\_\_\_\_  
HANDLE \_\_\_\_\_  
CARTOON DESCRIPTION \_\_\_\_\_

COLORS: Check one of each  
BACKGROUND - White \_\_\_\_\_ Yellow \_\_\_\_\_  
LETTERS - Red \_\_\_\_\_ Blue \_\_\_\_\_ Black \_\_\_\_\_

**DEALER INQUIRIES INVITED**

**NEOSONIC  
FS10  
Filtered Sound  
CB Speaker**

**CLEANEST SOUND AROUND**

The Sonosphere driver of Model FS-10 is able to provide high fidelity reproduction over the 300-4000Hz voice range because of a built-in, sharp cut-off LC filter. The response curve has been tailored to match the response curve required for speech so that maximum intelligibility is obtained from CB signals. Cutting off the upper end of the frequency band very sharply eliminates virtually all of the unwanted noise, squeals and whistles that normally occur in CB reception.

**NEOSONIC  
Corporation of America**  
180 Miller Place, Hicksville, N.Y. 11801

Exclusive U.S. distributor of  
Sonosphere home & auto speakers.



**ON THE COUNTERS** (continued)

resistant stainless steel. It mounts to the floor of the vehicle. This is a completely anti-rattle, multi-angle, theft-resistant mount. Use applications have been found in taxi-cabs, vans, commercial vehicles, cars, boats used in high theft areas. Price is \$79.95.

Manufacturer: Equipment Security Specialists, Inc., 5555 N. Tocama Avenue, Suite 005, Indianapolis, Indiana 46220.

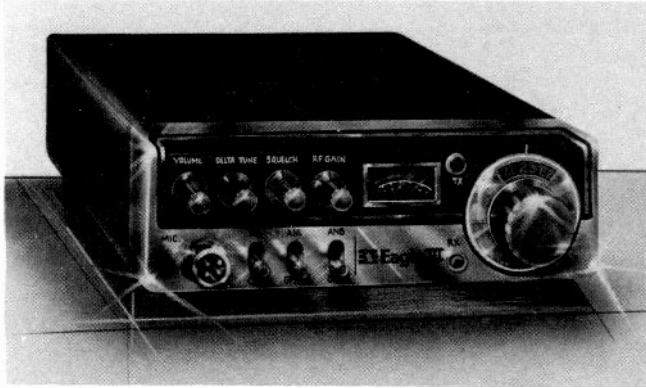

**THE EAGLE FLIES!**

Eagle Electronics will be marketing several excellent CB radios this year.

They feature sophisticated styling backed by the finest components. Quality and dependability will be stressed by Eagle Electronics in their radios as well as

their receivers and superior CB antennas.

Pictured is the Eagle III 23 channel CB radio. This radio has many features including delta tune, squelch control and R F gain. It has P.A. capability in addition to controls for ANL, and ANB.

There are also three other Eagle radios soon to be included in this fine line of CB products.

For additional information contact: Eagle Electronics, 2714 Louisiana, Houston, Texas 77006.



**AUTOMATIC RADIO ANNOUNCES "MINI" CB TRANSCEIVER MODEL CBU-2068**

Automatic Radio announces its new miniature-sized under-dash CB transceiver, Model CBU-2068. Measuring only 7¼"D x 5"W x 1¾"H, this attractive wood-

**READER SERVICE**

WANT MORE INFORMATION ON PRODUCTS IN ADS OR ON THE COUNTERS SECTION? The handy new Reader Service Coupons below, if used properly, will get this information to you in the shortest time possible. A coupon must be filled in for each new product or advertised product of interest. The name of manufacturer must be included as well as your name, address, etc. We will forward these requests on the same day received. Send to S9 Reader Service, 14 Vandewater Avenue, Port Washington, NY 11050.

PLEASE LIST NAME AND ADDRESS OF LOCAL CB DEALER:

Name:.....  
 Address:.....  
 City:..... State:..... Zip:.....

Please send me information on \_\_\_\_\_ Page No. \_\_\_\_\_

Manufacturer \_\_\_\_\_

Name \_\_\_\_\_  
 Address \_\_\_\_\_  
 City \_\_\_\_\_ State \_\_\_\_\_ Zip \_\_\_\_\_

An S9 Magazine Reader Service DEC. '76

Please send me information on \_\_\_\_\_ Page No. \_\_\_\_\_

Manufacturer \_\_\_\_\_

Name \_\_\_\_\_  
 Address \_\_\_\_\_  
 City \_\_\_\_\_ State \_\_\_\_\_ Zip \_\_\_\_\_

An S9 Magazine Reader Service DEC. '76

Please send me information on \_\_\_\_\_ Page No. \_\_\_\_\_

Manufacturer \_\_\_\_\_

Name \_\_\_\_\_  
 Address \_\_\_\_\_  
 City \_\_\_\_\_ State \_\_\_\_\_ Zip \_\_\_\_\_

An S9 Magazine Reader Service DEC. '76

Please send me information on \_\_\_\_\_ Page No. \_\_\_\_\_

Manufacturer \_\_\_\_\_

Name \_\_\_\_\_  
 Address \_\_\_\_\_  
 City \_\_\_\_\_ State \_\_\_\_\_ Zip \_\_\_\_\_

An S9 Magazine Reader Service DEC. '76

Please send me information on \_\_\_\_\_ Page No. \_\_\_\_\_

Manufacturer \_\_\_\_\_

Name \_\_\_\_\_  
 Address \_\_\_\_\_  
 City \_\_\_\_\_ State \_\_\_\_\_ Zip \_\_\_\_\_

An S9 Magazine Reader Service DEC. '76

Please send me information on \_\_\_\_\_ Page No. \_\_\_\_\_

Manufacturer \_\_\_\_\_

Name \_\_\_\_\_  
 Address \_\_\_\_\_  
 City \_\_\_\_\_ State \_\_\_\_\_ Zip \_\_\_\_\_

An S9 Magazine Reader Service DEC. '76

Please send me information on \_\_\_\_\_ Page No. \_\_\_\_\_

Manufacturer \_\_\_\_\_

Name \_\_\_\_\_  
 Address \_\_\_\_\_  
 City \_\_\_\_\_ State \_\_\_\_\_ Zip \_\_\_\_\_

An S9 Magazine Reader Service DEC. '76

Please send me information on \_\_\_\_\_ Page No. \_\_\_\_\_

Manufacturer \_\_\_\_\_

Name \_\_\_\_\_  
 Address \_\_\_\_\_  
 City \_\_\_\_\_ State \_\_\_\_\_ Zip \_\_\_\_\_

An S9 Magazine Reader Service AUG. '76

Please send me information on \_\_\_\_\_ Page No. \_\_\_\_\_

Manufacturer \_\_\_\_\_

Name \_\_\_\_\_  
 Address \_\_\_\_\_  
 City \_\_\_\_\_ State \_\_\_\_\_ Zip \_\_\_\_\_

An S9 Magazine Reader Service DEC. '76

Please send me information on \_\_\_\_\_ Page No. \_\_\_\_\_

Manufacturer \_\_\_\_\_

Name \_\_\_\_\_  
 Address \_\_\_\_\_  
 City \_\_\_\_\_ State \_\_\_\_\_ Zip \_\_\_\_\_

An S9 Magazine Reader Service DEC. '76

that one lock may be used alone, or two may be used for even greater protection. When a pair of "CB CRIMESTOPPER" locks are ordered, they are furnished with common keys.

The "CB CRIMESTOPPER" locks are available direct from Memphis Metal Works at \$7.95 each for the Mark I (single lock), or \$14.95 for the Mark II (a pair of "CB CRIMESTOPPER" locks with common keys). One size fits all standard CB's.

For further information contact Joe Travis, Memphis Metal Works, P.O. Box 38184, Germantown, Tennessee 38138.



**TECH SPRAY**

Amarillo, Texas, Tech Spray, Inc. has just released its newest product, CB Contact Cleaner. It is being marketed by the Klear Tone division. Klear Tone is the brand name used for all consumer oriented products marketed by Tech Spray.

CB Contact Cleaner safely removes grease, dust, grime, dirt, nicotine etc. It is designed to be used on internal chassis parts, contacts on quick-disconnect assemblies, cable ends and connectors for good solder connec-

tions, and microphone contacts. Leaves no residue, is non-flammable and safe on plastics.

CB Contact Cleaner is available in a 6 oz. can and is listed in the Klear Tone Product Sheet under product number 2216-6S.

Contact Tech-Spray, P.O. Box 949, Amarillo, TX 79105.

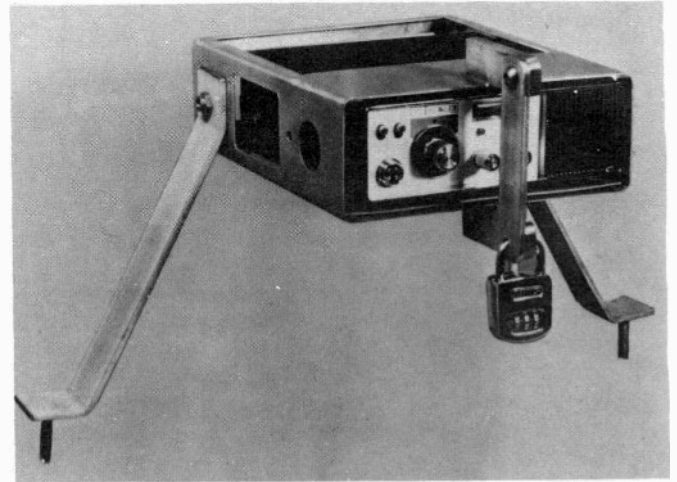

**LOCK 'EM OUT!**

Equipment Security Specialists, Inc. is marketing a new theft-resistant CB and 2-way radio enclosure for mobile use. The enclosure is made entirely of saw-

FIRST CLASS  
Permit No. 392  
Port Washington  
New York

**BUSINESS REPLY MAIL**

No postage stamp necessary if mailed in the United States

Postage will be paid by

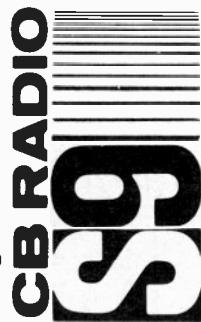

14 Vanderventer Avenue  
Port Washington, NY 11050

FOLD HERE

FOLD HERE

grained unit has PA circuitry, switchable ANL (Automatic Noise Limiter), and the exclusive "Fiber-Optics" transmit/receive beacon, which allows a single lens to glow either red or green to show the transceiver's mode of operation. Other features include illuminated channel selector and dual function S/RF meter, plus detachable microphone, variable squelch and on/off volume control. Model CBU-2068 is available for immediate delivery and has a suggested list price of \$146.50.

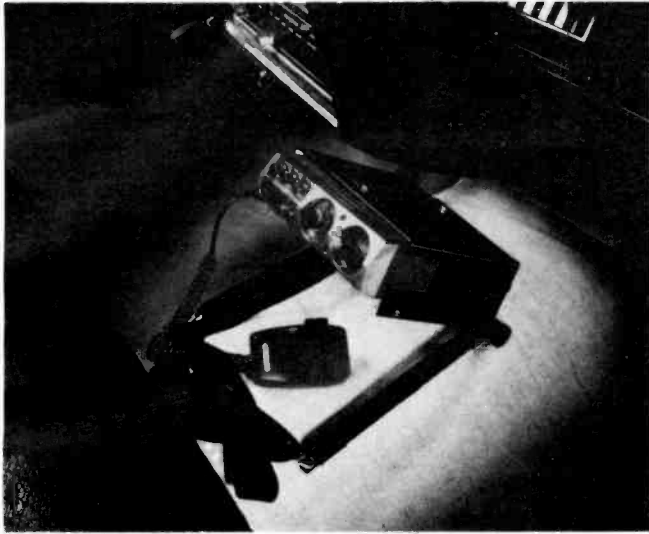

### TAG-A-LONG

The CB "Tag-A-Long" is a revolutionary new concept in CB radio mounts. Its unique patented design is adjustable to accept most CB units and can be conveniently used as a hump mount, as a stand for base use or as a light weight carrying case. The hump mount installation is self standing and does not require hole drilling; as a base, it can be set on any convenient flat surface; the attached strap permits the user to carry his CB safely over his shoulder. Permanent assembly and installation of the CB "Tag-A-Long" takes less than 10 minutes.

For additional information and availability contact: P. N. R. Dynamics, 11099 Sprague Road, North Royalton, Ohio, 44133.

### RECREATIONAL VEHICLE MOUNT

Heavy-duty CB antennas to meet the needs of highway travel and the outdoors enthusiast has been added to the Antler antenna line. The new antennas feature heavier rods, shock springs and sturdy 17-7 PH stainless steel whips to help absorb the punishment of high speed and off-road travel.

The new Antler models include a center load single, a set of cophased twins and a rugged base load model. Each features a bracket designed to fit luggage racks, extension "west-coast" type mirrors or any tubular metal frame up to 1" in diameter. The bracket is formed of heavy-gauge, chrome plated steel and allows an upright antenna position regardless of the mounting

# COM-ON WE'VE GOT IT



NORTH TAMPA C. B. CENTER, INC'S.

## UNITED COMMUNICATION SUPPLY CO.

Wholesale Only

HOT LINE! CALL 8A.M. to 8P.M. 813/971-1648

13748 Nebraska Avenue

Tampa, Florida 33612

2473 Delow Drive

East Point, Georgia 30344

404/766-4191

## We're Fighting Inflation... No Price Rise for '76



### FOR FREQUENCY STABILITY

Depend on JAN Crystals. Our large stock of quartz crystal materials and components assures Fast Delivery from us!

Two CRYSTALS FOR  
Meter Citizens Band Monitor  
Band Radio Receivers

### CRYSTAL SPECIALS

Frequency Standards	
100 KHz (HC 13/U) .....	\$4.50
1000 KHz (HC 6/U) .....	4.50
Almost all CB sets. TR or Rec .....	\$2.50
(CB Synthesizer Crystal on request)	
Amateur Band in FT-243 .....	ea. \$1.50
80-Meter .....	\$3.00 (160-meter not avail.)

For 1st class mail, add 20¢ per crystal. For Airmail, add 25¢. Send check or money order. No dealers, please.



Div. of Bob Whan & Son Electronics, Inc.  
2400 Crystal Dr., Ft. Myers, Fla. 33901  
All Phones: (813) 936-2397

Send 10¢ for new catalog



# cb mobile cb base

COVER 40 CHANNELS NOW!

## CX-1000 3.75 dB GAIN CITIZEN'S BAND BASE ANTENNA

Designed to withstand nature's abuse... CX-1000 is an 18' high "package of dynamite performance" for AM or sideband. This omnidirectional base antenna has a precision tuned coaxial stub system for perfect match and low ohmic losses. Made of heavy wall, bright finish seamless aluminum tubing and stainless steel fasteners.

## TRUNK BUSTER FIBERGLASS MOBILE

Our 48" Top loaded or tunable tip antenna with solid one piece no hole trunk lip mount. The mount has foam protective pad and spring loaded cable contact. Complete high performance systems preassembled with 18' cable and connector.

CM-403 Trunk mt. with 48" whip  
CM-404 Trunk mt. with 48" tunable whip

*Cushcraft products are stocked by  
dealers throughout the world.*



# Cushcraft

CORPORATION

P.O. BOX 4680, MANCHESTER, N.H. 03108

## ON THE COUNTERS (continued)

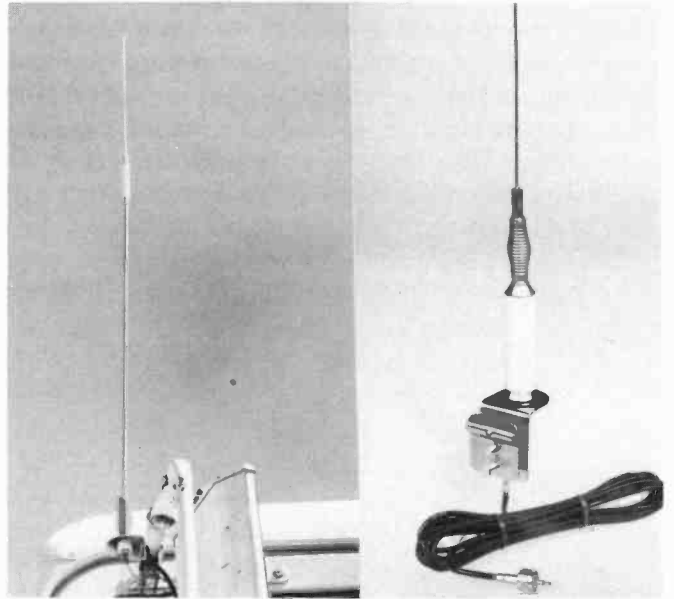

angle. When desired, the right angle antenna plate can be bolted directly to the vehicle for added rigidity.

All Antler antennas are manufactured in the U.S.A. of corrosion resistant materials to prevent rust and resultant loss of signal strength. The coils are moisture sealed and individually precision tuned to provide the lowest possible SWR readings when properly installed.

Antler antennas are available at leading CB dealers nationwide through authorized distributors who maintain local inventories of Antler antennas, accessories and factory replacement parts.

Model 1C40, Heavy Duty, Center Load, Sug. Retail \$25.95. Model 1C42, Heavy Duty, Center Load Twin, Sug. Retail \$39.95. Model 1C75, Heavy Duty, Base Load, Sug. Retail \$24.95.

For more information: Wendell Layne, Sales Manager M C M Mfg. Company, 6200 S. Freeway, Fort Worth, Texas 76134.

## CB ANTENNA

Electronic Industries "Broadcaster" convertible trunklip or roof mount deluxe antenna features base loaded coil with black coil jacket and black fiberglass whip. 17 ft. RG-58/U coaxial cable with PL-259 connector. SWR adjustment 2 HEX key wrenches.

The black coil jacket and black fiberglass whip are trimmed with heavy chrome plating and bubble packed on card for full view display.

For complete literature and the name of electronics industries representative in your area, write Electronics Industries, Inc., 333 Taft Drive, South Holland, Illinois 60473.



## CBer's!

You've never  
heard it so good.

### Model O-83

CB Extension Speaker —  
Indoor/Outdoor. All weather.  
20 ft. cord. Audio level control.  
8 ohms. 10 watts M.P./30  
watts P.P. 10 1/2" X 11" X 5 1/4"

Model MS-1 — 4" all weather  
mini speaker.

Model MS-2 — 4" all weather  
mini speaker on stand with  
audio level control.



### Model CBS-4

CB Extension Speaker —  
Mounts easily. Swivel bracket  
for all angle direction. 10 ft.  
cord. 8 ohms. 5 watts M.P./  
10 watts P.P.



### Model SPC-8

CB Trumpet Speaker —  
Completely weatherized.  
Perfect for mobile & marine  
operations. 5" bell. 8 ohms.  
12 watts of power.

Model SPC-10 — 6" bell.  
8 ohms. 15 watts of power.



Write for details. **Speco speakers**

## Components Specialties Inc

393 South Franklin Street,  
Hempstead, New York 11550, (516) 292-9500.

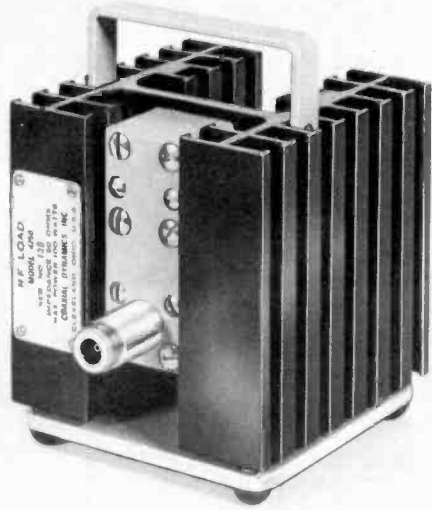

### DUMMY LOAD

Model 4250 is an efficient dummy antenna or load for maintenance of Radio Frequency transmitters with average power outputs up to 100 watts. It can be used in any position without loss of performance or exasperating oil leaks. Non-radiating, the 4250 will not interfere with other operating systems. It is useful as a tool in maintaining services such as mobile radio, aircraft radio, ground to air, ship board radio and citizens band radio. The Model 4250 is ideal for laboratory use, on the production line, the service

bench or any application where radio frequency from D.C. through 512 MHz must be terminated. Built to stand severe operating conditions and extremes of environmental changes.

For complete description and specifications write: Coaxial Dynamics, Inc., 13110 Enterprise Avenue, Cleveland, Ohio 44135.



### NEW IRON-ON CB PATCH

A timely line of iron-on patches embroidered with colorful CB emblems is now being introduced by Joy Insignia, Inc. for use as inexpensive in-package giveaways and special incentive premiums. (continued)

# CRAZY Harvey's CB SHOPPE

We've got the "Big" NAME BRANDS for the smallest dollars. Whether it be CB, Marine, Car Stereo etc... Crazy Harvey's has it, and with **BIG DISCOUNTS**, not just a few dollars off!

Send for our Free Catalog of prices and brands. Our new address:

**CRAZY HARVEY'S  
CB SHOPPE**  
8848 Orchard Tree Lane  
Towson, Maryland 21204  
(301) 821-0792

Name \_\_\_\_\_  
Address \_\_\_\_\_  
City \_\_\_\_\_ State \_\_\_\_\_ Zip \_\_\_\_\_

**Time  
+  
Frequency  
=  
TF-1000**

...OUR LATEST  
BRAINCHILD!

Transmitter frequency is of major concern to the sophisticated operator. The Pride TF-1000 provides the readout necessary to ensure that your transceiver is precisely on channel—every time you talk.

The TF-1000 also functions as an accurate time-of-day clock! Handsomely styled, ruggedly built, the TF-1000 is a quality addition to the advanced operator's station.

**SPECIFICATIONS:**  
Power requirements: 110-120 volts, 60 Hz, 10 watts  
Size: 8½" wide x 3" high x 9¾" deep  
(21.5 cm x 7.5 cm x 25 cm)  
Weight: 2.2 lbs. (1 kg)

**FEATURES:**  
Automatic time-frequency switching  
Large bright display  
In-line installation  
12/24 selectable time display

TF-1000 TIME / FREQUENCY COUNTER

7322 Convoy Court, San Diego, CA 92111  
Telephone (714) 292-0766  
TWX 910-335-1511

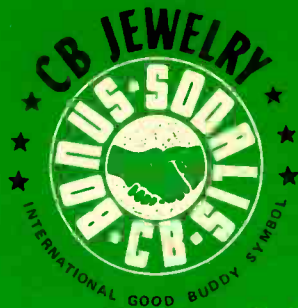

**Good Buddy  
BONUS SODALIS™**

*Regal Lapidaries, Inc.*

BONUS SODALIS™ TRADE MARK OF REGAL LAPIDARIES INC.

All Rings are Solid Bronze 14kt. Gold Plated, Antiqued

**BS MEN'S / LADIES RING**



# 503

\$14.<sup>95</sup>

Solid bronze universal Good Buddy symbol.



# 502

\$12.<sup>95</sup>

**CB RING**



# 303

\$9.<sup>95</sup>

Solid bronze antiqued. Instant recognition of friendship anywhere.

**BS BELT BUCKLE**

Handsomely minted in solid bronze.

\$9.<sup>95</sup>

# 500



**BS KEY CHAIN & PENDANT**

# 504

\$4.<sup>95</sup>

# 501

either or



Handsomely minted in solid bronze.

*SPECIAL for CB CLUBS - Club name inscribed, inquire .....*

Telephone (212) 758-8068

\* Copyright 1976 Regal Lapidaries Inc.

Check item number box. Enclose check or money order payable to:

**REGAL LAPIDARIES INC.**

420 Madison Avenue  
New York, N.Y. 10017

Check Item	Number Desired	Amount Enclosed
500 <input type="checkbox"/> Belt Buckle	.....	.....
503 <input type="checkbox"/> Men's Ring	.....	.....
502 <input type="checkbox"/> Ladies Ring	.....	.....
501 <input type="checkbox"/> Pendant	.....	.....
504 <input type="checkbox"/> Key Chain	.....	.....

All items except buckle available in Sterling - \$10.00 extra!

Total

**DEALERS AGENTS - INQUIRE**

# Why it pays to buy CB equipment where you see the CEDA Seal

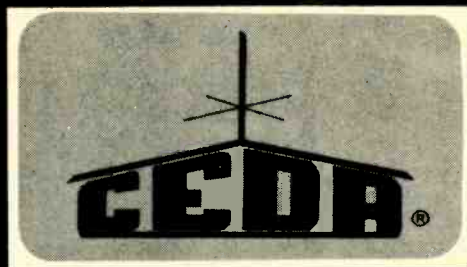

CEDA, the Communications Equipment Distributors Association, is composed of the major wholesalers in the personal communications industry, working together to maintain standards of quality, service and consumer protection.

When you see the CEDA Seal in a CB dealer's window, it means you've found a CB specialist, one you can trust, because he's pledged to uphold CEDA's standards. Associate Dealer Members of CEDA are equipped to handle your problems and answer your questions, and serve your CB needs not only before you buy, but *after*.

Look for the CEDA Seal before you buy. It pays.



COMMUNICATIONS EQUIPMENT DISTRIBUTORS ASSOCIATION.

*Dealers: Write for information on how to qualify as an Associate Dealer Member of CEDA*



P. O. BOX 1118, CARBONDALE, IL, 62901;  
OR PHONE (618) 549-1242.



## ON THE COUNTERS (continued)

Newest member of the Joypatch® family, the CB patch line consists of twelve dye-fast emblems depicting commonly-used CB terminology. The round and square-shaped patches are designed to appeal to the youth markets and CB enthusiasts. Safe to transfer onto virtually any natural or synthetic fabric, the patches are guaranteed machine washable and dry cleanable.

An optional CB Talk Guide defining CB terms in a wallet-sized four-page booklet is also available as part of the premium package.

To meet individual customer requirements Joy will supply the patches unwrapped or in polybags, with or without the Talk Guide. Custom designs are available on request. For additional information, contact: Joy Insignia Inc., 320 69th St., Guttenberg, N.J. 07093.



### AUTO ANTI-THEFT HORN ALARM

Along with the growth in vehicle installations of CB radios, tape decks and other expensive electronic equipment has come an alarming increase in break-ins and thefts. General Automotive Electronics of Carlstadt, N.J. provides effective economical protection for this problem with the new 72600 keyless horn alarm. Packaged on a self-promoting blister card, this new alarm is attractively priced and has been designed for quick, easy installation by do-it-yourselfers.

Armed and disarmed by a hidden switch inside the car, the 72600's patented sensor activates the car horn with attention-getting blasts whenever it detects unauthorized opening of hood, trunk, all doors . . . or tampering, cutting of wires or removal of CB radio, stereo tape deck, etc.

The 72600 incorporates features usually found only in more expensive, dealer-installed alarms such as built-in recycler that automatically cuts-off the alarm after 4 minutes, then rearms the system thereby pro-

(continued)

# The Bandmasters

Pearce-Simpson, the full-line CB radio company, is now the full-line CB antenna company with its complete selection of stainless steel and gleaming white fiberglass antennas from 18 inches to 18 feet. Built for base station or mobile use, these high efficiency instruments — some with tunable tips — are available for rooftop, trunktop, trunklid, bumper, or "West Coast" mounting. And each and every one of them is completely weathertight. For top on-air performance and greater signal power, transmitting or receiving, choose a rugged Pearce-Simpson. The Antennas that beat the Band.

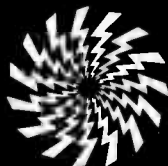

**PEARCE-SIMPSON**  
DIVISION OF GLADDING CORP.  
P.O. BOX 520800, BISCAYNE ANNEX, MIAMI, FLORIDA 33152  
TELEPHONE: 305-592-5550

**ON THE COUNTERS** (continued)

viding continuous protection while preventing battery drain or horn damage. Other strong selling points are entrance and exit delays, and complete solid state construction. Point-of-purchase window streamers and ad mat slicks are available for promotion purposes.

Additional information and catalog available by writing to: General Automotive Electronics, Inc., 462 Barel Ave., Carlstadt, New Jersey 07072.

**CALL LETTERS**

Show off your call letters and handle in style. "GLITTER FOIL" 3" high letters and numbers will stick to any clean, hard surface. This is a polyester material, not metal. Also perfect for home, mailbox, etc. And, they are legal for boat identification!

Gold or Silver, rainbow reflective, "GLITTER FOIL" w/adhesive backing is available at 50¢ per letter or number.

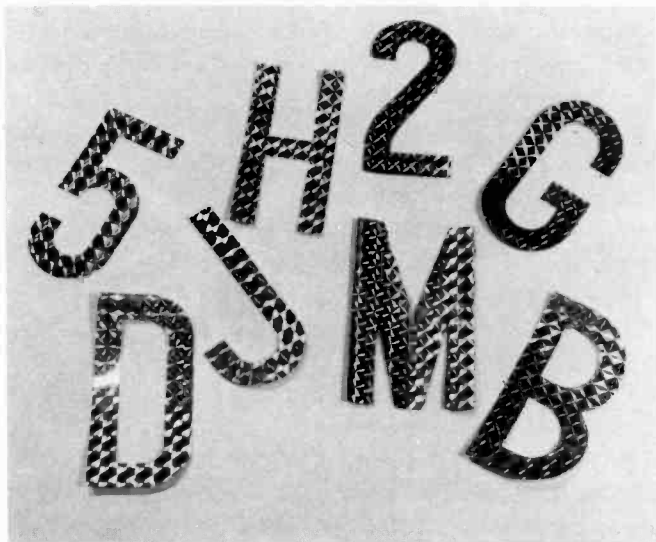

Write: Seelig's Custom Finishes, P.O. Box 179, Dept., Inglewood, CA 90306.

# HAPPY HOLIDAYS

**ANTENNAS**

## ATTENTION DEALERS... "you need a Dealers Distributor!"

Clercom does not claim to be No. 1 or even No. 2, however, we are big enough to serve you and small enough to know you and appreciate your business. We are a "DEALERS DISTRIBUTOR" as we do NOT retail out the front door, publish retail catalogues, mail out "Discount Price List" or encourage sale of lines sold in "Discount Stores." Your business is our business. Your success is our success.

STEREOS



CR-123B



ACT-E 8 H/U



CR-185

ACCESSORIES

CLERCOM INC. 131 C Route No. 1--- Williamsburg, Ohio 45176 54 Major Lines  
513-724-2285

A CHARTER MEMBER OF  THE COMMUNICATIONS EQUIPMENT DISTRIBUTORS ASSOCIATION.

**CB RADIOS**

# THE VERDICT IS IN!

**S9** Leads its Closest Competitor by 2½ to 1

**That's right;** during the past year and a half S9 ran 2½ times as much editorial content as CB Magazine. And... S9 total pages ran 45% ahead.

The comparison chart tells the story:

	S9 TOTAL PAGES	CB TOTAL PAGES		S9 EDITORIAL PAGES	CB EDITORIAL PAGES
May '75	100	68	May '75	38½	14
June	104	68	June	30½	16
July	100	84	July	36½	23%
August	116	76	August	41%	12%
September	116	88	September	44%	22%
October	134	104	October	50	29%
November	140	100	November	44½	24%
December	196	100	December	60	21½
January '76	180	116	January	49	35
February	144	68	February	54	23
March	176	84	March	61½	24½
April	240†	116	April	110+	44+
May	164	132	May	58	43%
July	180	140	July	64½	49%
August	180	132	August	71	44%



† Including CB Radio Marketing

**Now,** we hope you judge **S9** on its own merits. But, if you like to have something else to compare us with, the number two magazine is a fine place to start. And any way you compare, S9 stands out as Number One in every respect. Show these facts to your CB friends. They'll thank you for it, and we'll be most grateful.

## CB SPECIALS-R.F. DRIVERS-R.F. POWER OUTPUTS-FETS

2SC481 1.85	2SC767 15.75	2SC866 5.85	2SC1449-1 1.60	40081 1.50
2SC482 1.75	2SC773 85	2SC1013 1.50	2SC1475 1.50	40082 3.00
2SC495 1.10	2SC774 1.75	2SC1014 1.50	2SC1678 5.50	2SC608 4.85
2SC502 3.75	2SC775 2.75	2SC1017 1.50	2SC1679 4.75	SK3046 2.15
2SC517 4.75	2SC776 3.00	2SC1018 1.50	2SC1728 2.15	SK3047 3.75
2SC614 3.80	2SC777 4.75	2SC1173 1.25	2SC1760 2.15	SJ2095 3.50
2SC615 3.90	2SC778 3.25	2SC1226A 1.25	2SC1816 5.50	SK3048 3.25
2SC616 4.15	2SC797 2.50	2SC1237 4.50	2SC1908 .70	SK3054 1.25
2SC617 4.25	2SC798 3.10	2SC1239 3.50	2SC1957 1.50	
2SC699 4.75	2SC781 3.00	2SC1243 1.50	2SF8 3.00	2SK19 1.75
2SC710 .70	2SC789 1.00	2SC1306 4.75	HEP-S 3001 3.25	2SK30 1.00
2SC711 .70	2SC796 3.15	2SC1306-1 4.90	2SD235 1.00	2SK33 1.20
2SC735 .70	2SC799 4.25	2SC1307 5.75	MRF8004 3.00	
2SC756 3.00	2SC802 3.75	2SC1307-1 6.00	4004 3.00	3SK40 2.75
2SC765 9.50	2SC803 4.00	2SC1377 5.50	4005 3.00	3SK45 2.75
2SC766 10.15	2SC839 .85	2SC1449 1.30	40080 1.25	3SK49 2.75

## JAPANESE TRANSISTORS

2SA52 .60	2SB187 .60	2SC458 .70	2SC815 .75	2SC1569 1.25
2SA316 .75	2SB235 1.75	2SC460 .70	2SC828 .75	2SC1756 1.25
2SA473 .75	2SB303 .65	2SC478 .80	2SC829 .75	
2SA483 1.95	2SB324 1.00	2SC491 2.50	2SC830 1.60	2SD30 .95
2SA489 .80	2SB337 2.10	2SC497 1.60	2SC839 .85	2SD45 2.00
2SA490 .70	2SB367 1.60	2SC515 1.80	2SC945 .65	2SD65 .75
2SA505 .70	2SB370 .65	2SC535 .75	2SC1010 .80	2SD68 .90
2SA564 .50	2SB405 .85	2SC536 .65	2SC1012 .80	2SD72 1.00
2SA628 .65	2SB407 1.65	2SC537 .70	2SC1051 2.50	2SD88 1.50
2SA643 .85	2SB415 .85	2SC563 2.50	2SC1061 1.65	2SD151 2.25
2SA647 2.75	2SB461 1.25	2SC605 1.00	2SC1079 3.75	2SD170 2.00
2SA673 .85	2SB463 1.65	2SC620 .80	2SC1096 1.20	2SD180 2.75
2SA679 3.75	2SB471 1.75	2SC627 1.75	2SC1098 1.15	2SD201 1.95
2SA682 .85	2SB474 1.55	2SC642 3.50	2SC1115 2.75	2SD218 4.75
2SA699 1.30	2SB476 1.25	2SC643 3.75	2SC1166 .70	2SD300 2.50
2SA699A 1.75	2SB481 2.10	2SC644 .70	2SC1170 4.00	2SD313 1.10
2SA705 .55	2SB492 1.25	2SC681 2.50	2SC1172B 4.25	2SD315 .75
2SA815 .85	2SB495 .95	2SC684 2.10	2SC1209 .55	2SD318 .95
2SA816 .85	2SB507 .90	2SC687 2.50	2SC1213 .75	2SD341 .95
	2SB511 .70	2SC696 2.35	2SC1226 1.25	2SD350 3.25
		2SC712 .70	2SC1243 1.50	2SD352 .80
2SB22 .65		2SC713 .70	2SC1293 .85	2SD380 5.70
2SB54 .70	2SC206 1.00	2SC732 .70	2SC1308 4.75	2SD389 .90
2SB56 .70	2SC240 1.10	2SC733 .70	2SC1347 .80	2SD-390 .75
2SB77 .70	2SC261 .65	2SC739 .70	2SC1383 .75	2SD437 5.50
2SB128 2.25	2SC291 .65	2SC735 .70	2SC1409 1.25	MPS-U31
2SB135 .95	2SC320 2.00	2SC711 1.75	2SC1410 1.25	at 4.00 ea.
2SB152 4.50	2SC352 .75	2SC762 1.90	2SC1447 1.25	MPS 8000
2SB173 5.50	2SC353 .75	2SC783 1.00	2SC1448 1.25	at 1.25 ea.
2SB175 .55	2SC371 .70	2SC784 .70	2SC1507 1.25	
2SB178 1.00	2SC372 .70	2SC785 1.00	2SC1509 1.25	
2SB186 .60	2SC394 .70	2SC793 2.50		

## POWER-TRANSISTORS HIGH-VOLT. TV. TYPE

BU204 1300V 3.90	BU207 1300V 5.40	2SC1172B 1100V 4.25
BU205 1500V 4.70	BU208 1500V 6.25	2SC1308 1100V 4.95
BU206 1700V 5.90	2SC1170 1100V 4.00	2SC1325 1100V 4.95

## OEM SPECIALS

1N270 .10	2N960 .55	2N2219A .30	2N2913 .75	2N3740 1.00	2N4401 .20
1N914 .10	2N962 .40	2N2221 .25	2N2914 1.20	2N3771 1.75	2N4402 .20
	2N967 .50	2N2221A .30	2N2916A 3.65	2N3772 1.90	2N4403 .20
2N173 1.75	2N1142 1.35	2N2222 .25	2N3019 .50	2N3773 3.00	2N4409 .20
2N179 .90	2N1302 2.25	2N2222A .30	2N3053 .30	2N3819 .32	2N4410 .25
2N327A 1.15	2N1305 .30	2N2270 .40	2N3055 .70	2N3823 .70	2N4416 .75
2N334 1.20	2N1377 .75	2N2322 1.00	2N3055 .75	2N3856 .20	2N4441 .85
2N336 .90	2N1420 .20	2N2322 1.00	2N3227 1.00	2N3856 .85	2N4442 .90
2N338A 1.05	2N1483 .95	2N2324 1.35	2N3247 3.40	2N3903 .20	2N4443 1.20
2N398B .90	2N1540 .90	2N2325 2.00	2N3250 .50	2N3904 .20	2N4852 .55
2N404 .30	2N1543 2.70	2N2326 2.85	2N3375 6.50	2N3905 .20	2N5061 .30
2N443 1.75	2N1547 2.40	2N2327 3.80	2N3393 .20	2N3906 .25	2N5064 .50
2N456 1.10	2N1548 .80	2N2328 4.20	2N3394 .17	2N3925 3.75	2N5130 .20
2N501A 3.00	2N1549 1.25	2N2329 4.75	2N3414 .17	2N3954 3.50	2N5133 .15
2N508A .45	2N1551 2.50	2N2368 .25	2N3415 .18	2N3954A 3.75	2N5138 .15
2N555 .45	2N1552 3.25	2N2369 .25	2N3416 .19	2N3955 2.45	2N5198 3.75
2N652A .85	2N1554 1.25	2N2484 .32	2N3417 .20	2N3957 1.25	2N5294 .50
2N677C 6.00	2N1557 1.15	2N2712 .18	2N3442 1.85	2N3958 1.20	2N5296 .50
2N706 .25	2N1560 2.80	2N2894 .40	2N3553 1.50	2N4037 .60	2N5306 .20
2N706B .40	2N1605 .35	2N2903 3.30	2N3563 .20	2N4093 .85	2N5354 .20
2N711 .50	2N1613 .30	2N2904 .25	2N3565 .20	2N4124 .20	2N5369 .20
2N711B .60	2N1711 .30	2N2904A .30	2N3568 .20	2N4126 .20	2N5400 .40
2N718 .25	2N1907 4.10	2N2905 .25	2N3642 .20	2N4141 .20	2N5401 .50
2N718A .30	2N2060 1.85	2N2905A .30	2N3643 .15	2N4142 .20	2N5457 .35
2N720A .50	2N2102 .40	2N2906 .25	2N3645 .15	2N4143 .20	2N5458 .30
2N918 .35	2N2218 .25	2N2906A .30	2N3646 .14	2N4220A .45	C103Y .25
2N930 .25	2N2218A .30	2N2907 .25	2N3730 1.50	2N4234 .95	C103d .40
2N956 .30	2N2219 .25	2N2907A .30	2N3731 2.75	2N4400 .20	C106b1 .50
					C106di .75

### SILICON UNIJUNCTIONS

2N2646 .60	2N4871 .50
2N2647 .50	2N4891 .50
2N6027 .55	2N4892 .50
2N6028 .70	2N4893 .50
D5C37 .25	2N4894 .50
2N2160 .65	MU10 .40
2N4870 .50	

### INTEGRATED CIRC.

UA703C .40
709C OP. AMP. .25
741C OP. AMP. .25
7400 .15
TA7061P at 3.50 ea.
TA7205P at 10.00 ea.
UPC100ih2 at 6.00 ea.
NE555 at 1.25 ea.

### RECTIFIERS

	10	100
IN4001	.60	5.00
IN4002	.70	6.00
IN4003	.80	7.00
IN4004	.90	8.00
IN4005	1.00	9.00
IN4006	1.10	10.00
IN4007	1.20	11.00



**New-Tone Electronics**  
**P.O. Box 1738 A**  
**Bloomfield, N.J. 07003**  
**Phone: (201) 748-6171**  
**748-6172**  
**748-6173**

### ALL PARTS GUARANTEED

N.J. residents add 5% sales tax. Minimum order \$5.00. All orders add \$1.00 postage. Dealers write or phone for discount prices.



# CB SAM SEZ



I WANT TO TELL ALL MY GOOD BUDDIES OUT THERE HOW TO CONVERT THEIR MOBILE CB TO A DELUXE HOME BASE STATION. IT'S MAGITRAN'S DELUXE SUPER REGULATED POWER SUPPLY WITH BUILT-IN SPEAKER.

MODEL CB123 WILL HANDLE A FULL 3AMPS CONTINUOUSLY AND 6AMPS SURGE - THAT'S ENOUGH TO RUN ANY MOBILE CB AND YOUR 8-TRACK STEREO TOO!



THIS DELUXE BABY'S ALSO GOT A SPECIALLY DESIGNED BUILT-IN VOICE COMMUNICATION SPEAKER THAT IMPROVES VOICE CLARITY-WALL-TO-WALL

AND THERE'S A POWER BOOST FEATURE THAT IMPROVES RECEPTION AND MAXIMIZES YOUR TRANSMISSION TO THE LIMIT OF THE LAW.

SO TAKE IT FROM CB SAM-IF YOU WANT YOUR MOBILE RIG TO PACK A HE-MAN PUNCH, COMIN' AND GOIN' AS A BASE STATION, GET YOURSELF A MAGITRAN CB123.

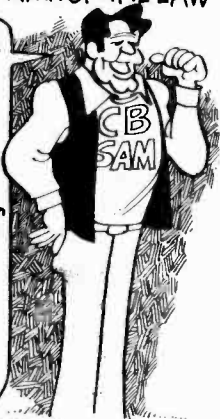

Model CB 123

**MAGITRAN COMPANY**  
311 EAST PARK STREET  
MOONACHIE, N.J. 07074

## TAB POPULAR CB BOOKS

**CB Radio Operators Guide - 2nd Edition**  
Tells what CB is, how it is used, how to buy and install equipment - PLUS Part 95, the FCC rules regulating CB. 256 pps  
Order No. 799  
Paper \$5.95      Hardbound \$8.95

**Practical CB Radio Troubleshooting & Repair**  
Complete details on CB operation, installation and repair, including 21 programmed troubleshooting charts and complete schematics for 18 popular transceivers. Also an in-depth section on antennas and feedlines. 238 pps.  
Order No. 754  
Paper \$5.95      Hardbound \$8.95

**Pictorial Guide to CB Radio Installation & Repair**  
Step-by-step guide to car and base systems installation and basic maintenance. 256 pps.  
Order No. 683  
Paper \$5.95      Hardbound \$8.95

**Citizens Band Radio Service Manual**  
All-in-one troubleshooting and maintenance guide for all types of CB sets, including a 36-page schematic foldout section. Step-by-step repair procedures and trouble-analysis charts. 192 pps.  
Order No. 581  
Paper \$5.95      Hardbound \$8.95

### ORDER FORM

	No.		Price

Name \_\_\_\_\_  
Address \_\_\_\_\_  
City \_\_\_\_\_ State \_\_\_\_\_ Zip \_\_\_\_\_

S9 Magazine  
14 Vanderverter Ave.  
Port Washington, N.Y. 11050

Ship the books listed below. To cover shipping, I've added 50¢ for the first book and 25¢ for each additional book. Enclosed \$ \_\_\_\_\_

## HEY "GOOD BUDDY"



LOOK

**LISTEN - Are You Having Trouble Locating Those CB'ers You Spoke With Last Month or Last Year?**

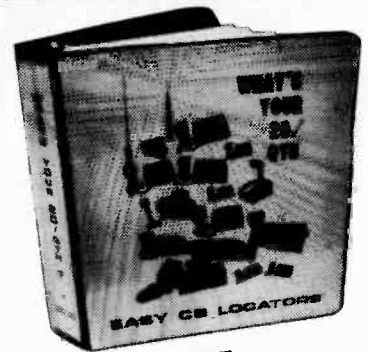

**\$14.95**

Complete + Postage

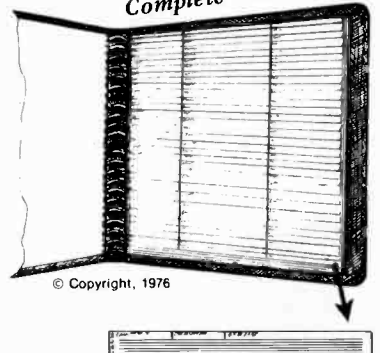

© Copyright, 1976

**INSTANTLY LOCATE THEIR CALL NUMBERS OR HANDLE WITH EASY CB LOCATORS™**

a beautiful book, custom designed to easily locate call number, personal/handle, 20/QTH and other info on all your CB Buddies. With this system you only write the information ONCE and you have it for a LIFETIME. You can move it ANYPLACE in the Book at ANYTIME.

-NOT AN ORDINARY LOG BOOK-

**LOCATE THEM INSTANTLY**

We include 10 code, CB Lingo Sheet, instruction brochure and other items.

**START YOUR PERMANENT FILE ORDER NOW**

**EASY CB LOCATORS, INC.**  
Huron Trail, Oak Ridge, N.J. 07438

Your Name \_\_\_\_\_

Address \_\_\_\_\_ Street \_\_\_\_\_

Town/City \_\_\_\_\_ State \_\_\_\_\_ Zip \_\_\_\_\_

Please send me \_\_\_\_\_ **EASY CB LOCATORS™**  
@ \$14.95 ea. + \$2.45 postage

Enclosed is my check/money order in amount of \$ \_\_\_\_\_

# ATTENTION

CITIZENS BAND RADIO OPERATORS

LIGHTED SWITCH



# FIRST TIME OFFER



NEW!

- Lights up to indicate output power.
- Flashes to indicate modulation strength.
- Simply connect to antenna jack.

NO MORE RADIO CHECKS NEEDED

TRI-MET INDUSTRIES NOW PRESENTS IT'S ALL NEW "PERSONALIZED" TRANSMIT & MODULATION LIGHTED INDICATOR UNIT.

Look at these fantastic features:

- \*Can be used as a transmit & Modulation check each time your mic button is pressed.
- \*You can personalize your unit with your handle, call numbers, on the air, etc., with our enclosed rub on letters kit.
- \*Can be used as a trouble light, map light or mood light, etc., in home or auto.
- \*We include complete instructions on use and installation.

## POWER & MODULATION



### MAIL THIS COUPON TODAY!

Total amount enclosed \$ \_\_\_\_\_ sales tax). Check or money order. C.O.D.

Charge:  American Express  Bank Americard  
 Master Charge MC Bank # \_\_\_\_\_

Card # \_\_\_\_\_ Exp. Date \_\_\_\_\_

Signature \_\_\_\_\_

Name \_\_\_\_\_

Address \_\_\_\_\_ Apt. # \_\_\_\_\_

City \_\_\_\_\_ State \_\_\_\_\_ Zip \_\_\_\_\_

TRI-MET INDUSTRIES, INC.

P. O. Box 1572

Binghamton, New York 13902

Phone: Area Code 607-723-8924

# \$ 4.95

(Plus sales tax, if any)

plus \$.50 for shipping and handling

DEALER INQUIRES INVITED

## CB's - SWL's - EVERYONE!!!

### BECOME A HAM RADIO OPERATOR & EARN A CASH AWARD FROM YAESU ELECTRONICS CORPORATION

Here's how:

- ◆ Obtain an amateur radio license for the first time between November 1, 1976 and June 30, 1977.
- ◆ Purchase a new FT-221 transceiver from any authorized Yaesu dealer between those dates.
- ◆ Send us a photocopy of your new license and bill of sale from your dealer (made out to you) showing the serial number and date of purchase.
- ◆ Upon verification, Yaesu will send you an incentive award of \$25.00 under the purchase price and refund to you the \$4.00 license fee in addition. **Total Savings: \$29.00**



- World-wide communication through satellites (Oscar 6 and 7)
- Join MARS and Civil Defense radio nets
- Perform valuable community service
- As an amateur radio operator you can communicate everywhere
- Small antenna - 19 in. whip for most local communication

Your new **YAESU FT-221** is power supply equipped for mobile or fixed base operation and gives you the entire two-meter band . . . the thrill of FM repeater channel operation, SSB DXing, AM and CW!

**America needs more trained radio operators of all types and this is how Yaesu will reward you for continuing your interests, and let you enjoy the best of two worlds!**



Yaesu Electronics Corp., 15954 Downey Ave., Paramount, CA 90723 - (213) 633-4007



# Electronic Fleamarket

*a new monthly publication  
from the publisher of S9*

THE ELECTRONIC FLEAMARKET is a complete new shopping source for anyone interested in buying, selling or swapping used electronic equipment of any kind.

It will appeal to CBers, hams, experimenters and professionals.

THE ELECTRONIC FLEAMARKET will contain thousands of classified ads on transmitters, receivers, transceivers, test equipment, amplifiers, antennas, towers, stereo equipment, etc.

It will also contain ads from retailers, wholesalers, and manufacturers offering used equipment for sale.

Classified ads will be published free of charge to all regular subscribers of S9. Free ads will be limited exclusively to individuals. Commercial ads may be ordered at a rate of 25 cents per word, with a \$3 minimum. Non-commercial ads for non-subscribers are 10 cents per word, \$1 minimum. THE ELECTRONIC FLEAMARKET will be available on a paid subscription basis only at a cost of \$10 per year. All issues will be mailed by first class mail on the tenth of each month.

SPECIAL CHARTER SUBSCRIPTION rates available to S9 subscribers at a saving of 20%. Use the special sub blank below and get your first year's subscription for just \$8. But don't delay!



**ELECTRONIC FLEAMARKET**  
14 Vanderventer Avenue  
Port Washington, NY 11050

Please enroll me as a charter subscriber to

"ELECTRONIC FLEAMARKET" at the rate of \$8.00

Name \_\_\_\_\_

Address \_\_\_\_\_

City \_\_\_\_\_

State \_\_\_\_\_ Zip \_\_\_\_\_

# G

# CB

# IDEAS

by **MODULATING MAMA (Ellen)**

1. Room Divider—changeable QSLs—Constructed of 1" wood strips supplied with small size spring clips (possibly wood clothes pins) fastened to both sides of the strips. Spacing of strips would be determined by the local size of QSLs such as the usual post card size and the new Mini-cards, etc. The strip arrangement may be either horizontal or vertical again depending upon the taste of the builder.

This style lends itself best to the upper portion of the divider with the base being a more conventional planter or even a partition matching the rest of the room. The strips can be finished with paint including the clothes pins if the wood type are used. The use of peg board on the lower half of the base toward the CB area could supply plenty of tool hanging room.

2. Room Divider—Permanent QSLs—Semitransparent panels can be made to fit from floor to ceiling with QSLs and S9 symbols arranged in permanent lamination with Castoglas or similar products. Castoglas comes with full instructions for the lamination process



—QSLs and S9 symbols would be very attractively preserved in a lovely addition to the room that is durable and washable. It may even be the perfect spot for some fanatics since Castoglas comes with directions to make the bathtub type shower enclosure.

3. Coffee Table Top or Bar Top—One last Castoglas project—It can be formed into any free flowing shape desired and to almost any thickness. A background of semi-transparent Castoglas filled in with discarded transistors and round diodes, etc. When dry this could be the base for QSLs, club decals, more serious CB symbols, etc. attractively arranged to be permanently laminated by crystal clear material. Castoglas makes delightful Bar tops or Coffee tables because it can receive any individual's hobby and it is nearly indestructible and shows no glass rings.

4. CB'ers Lamp—An old discarded table-type microphone can be transformed into an attractive lamp, appropriate not only to the CB or Ham room but to the family room or children's room. It would be nearly unbreakable.

Remove any wiring in the base and stand and components in the head. This leaves an almost hollow shell. Simply drill a hole through the top to receive hollow brass lamp rod one inch longer than the mike height—Brass lamp rod is available at nearly all hardware stores where they will be glad to thread it on both ends for you. Purchase a brass lamp socket and shade bracket. Complete threading the electrical wiring from the socket through the hollow rod and attach a plug on the end. Most mikes don't even require felt on the base because they have grommets. Finish by adding weight needed for balance—Plaster of paris is good for this.

5. CB'ers Lamp Shade—Purchase a plain plastic lamp shade of the size most suited to the base. Remove the cellophane protective wrapping. Paint various CB symbols and S9's and transmission streaks, etc. after tracing them in faint pencil for placement. One of the best paints for this is a new "acrylic" poster paint that will adhere to the plastic surface and is washable as well as reasonably transparent when applied to transparent or lighted surfaces.

#### CB DECORATING IDEAS

6. Curtains—Any pastel or white curtains made of material conducive to textile painting can be CB personalized with careful attention to the decor of the individual's home. Familiar symbols like the Club Roster Call Signs, the FCC shield, the S9, transmission streaks, or even electronics trademarks could be painted in the color of the walls or main item in the room.

I am using this for my boy's room. It will be colorful, modern, and very unique. Many CB mothers who have walkie-talkie owners will take to this also. At least it is different from cowboys and Indians, saddles and brands, or baseball bats, and footballs. My own preference will be the "border design" along the sides and bottom of the curtains rather than frilly fringers, ruffles, or flowers.

... Use S9 READER SERVICE.

# Free Classified Ads

Your classified ad may be run Free of Charge in *THE ELECTRONIC FLEAMARKET* — this offer is good for all S9 and/or Fleamarket subscribers every month. Please limit ads to thirty words or six lines and not more than two ads per month. You can buy, sell, swap or advertise for QSLs. Your ad may cover ham gear, CB gear, test equipment, stereo, or anything else an electronic hobbyist may find of interest.

Remember, this service is absolutely *free* to subscribers who use the coupon below (or a reasonable facsimile thereof). *THE ELECTRONIC FLEAMARKET* will be read by thousands of electronic hobbyists, so don't miss out.

After all, could the price be better?

#### ELECTRONIC FLEAMARKET

14 Vanderventer Avenue  
Port Washington, NY 11050

Please run the classified ad listed below in the first available issue:

---

---

---

---

---

---

---

---

\*\*\*

Name \_\_\_\_\_

Address \_\_\_\_\_

City \_\_\_\_\_

State \_\_\_\_\_ Zip \_\_\_\_\_

# BIG MOUTH

## CB mobile/base station speaker

**ENGINEERED FOR VOICE INTELLIGIBILITY  
BIG MOUTH IS ALL GUTS**

- Crisp • clean voice reception.
- BIG 5 inch heavy-duty speaker.
- Rugged 3/8" wood enclosure with handsome walnut vinyl finish, just like the professional systems.
- Swivel bracket mounting hardware.
- For all base stations, cars, RV's, Vans, Trucks.

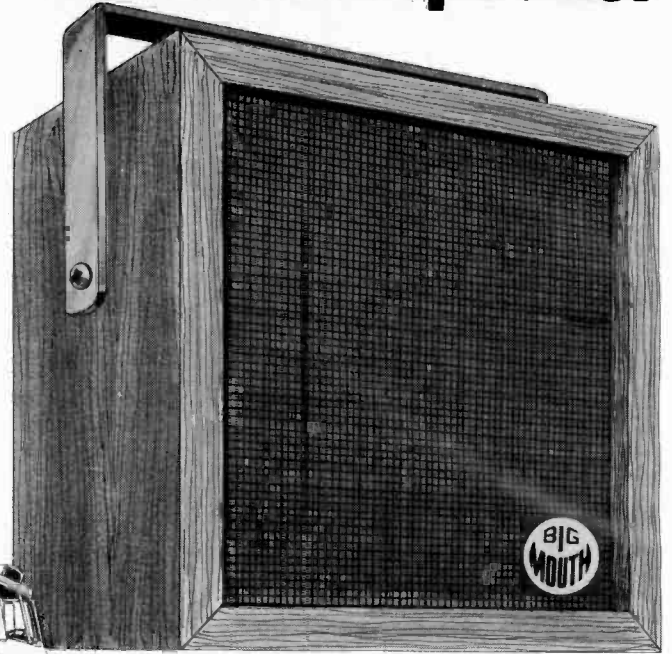
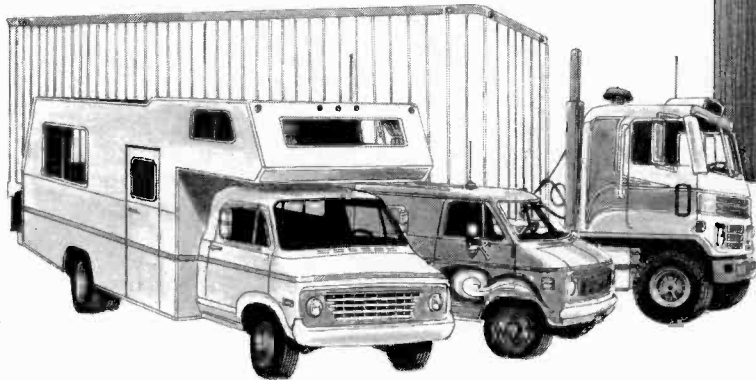

The ideal CB speaker  
for RV's • Vans •  
Trucks • Cars

**Argos**  
SOUND

A Division of Argos Products Company  
600 So. Sycamore St., Genoa, Illinois 60135

## AC Power Line Filters

C-509-L Power Line Filter designed to minimize most severe interference to CB receivers and radios, and also prevents CB radio signals from entering power line; 5A maximum rating.



C-508-L Power Line Filter suitable for moderate interference to CB receivers and radios, and also prevents CB radio signals from entering power line; 3A maximum rating.

Look for these and other Miller CB filters and accessories at your electronic outlet.

Full line brochure on request.



**BELL INDUSTRIES**  
J. W. Miller Division  
19070 REYES AVE. ■ P.O. BOX 5825  
COMPTON, CA 90224

## Chirping CARS?



The "EARSPLITTER BIRDY" can be activated at your leisure by a switch under your dash, or controlled automatically when the car is put into reverse. Now, watch the people smile—guaranteed to attract lots of attention. Sounds like a nest of happy, chirping birds. A great safety device too!



**HOUSE OF POWER**  
P. O. Box 306, Merrick, N.Y. 11566

# CB Usage Tips From S9

(CUT OUT & PLACE AT OPERATING POSITION)

## Preferred & Designated Channels

- Channel 9 Emergencies only
- Channel 13 Maritime
- Channel 16 Single Sideband only
- Channel 18 Single Sideband only
- Channel 19 Trucks/Vehicles in transit\*

\*Note that in many areas there are also 1 or more additional channels designated and/or normally used for in-transit vehicles, most often Channels 10 and/or 12. This is especially true in metro areas and their suburbs where Interstate Highways are on 19 and secondary roads such as parkways are on alternate channels. It is not the practice for mobile units on such channels to request breaks. Base stations are requested to avoid using all area in-transit vehicle channels in order to permit their full, free, unobstructed and exclusive use by in-transit vehicles. "Channel Monitors" are neither required nor desired on in-transit channels and are requested to honor any in-transit channels which may have been so designated in local areas by the operators by means of their customary and general usage habits.

Those operators who feel the need to function in CB by establishing themselves as "Channel Monitors" should not expect to monitor or control distant stations which are being received at S-3 strength or lower. They should also be aware of the fact that even those local stations in their area may not wish to avail themselves of their services; all stations having free access to the channels may elect to bypass the monitor

should they wish to do so. Those who attempt to pass themselves off as "Channel Monitors" as a ploy to hog the channel for their own purposes should expect to be ignored by most stations. Those monitors who are successful are those with a good signal and good ears, who earn the respect of other operators by keeping their own transmissions as brief as possible, by giving up their own rights to hold conversations while acting as monitor. ALL transmissions from the monitoring station should consist solely of acknowledging breakers who wish to use the channel, and NOTHING more. During busy periods monitors should deny requests for 10-36's and radio checks on their channel.

Those seeking 10-36's should be encouraged and instructed in the art of telling time by means of wristwatch, clock, or broadcast radio station. Those whose primary interest in CB is chucking carriers and/or playing music are requested to consider the pleasures and benefits to be derived from finger painting and shock therapy, respectively.

Stations using power mikes should be cautious that their audio levels are set to a level which will not cause voice distortion, over modulation, or splashover on adjacent channels.

Single Sideband stations generally operate on Channels 16 and 18, although this may vary in specific areas. Stations using standard AM transmission are requested to avoid use of local Sideband channels, likewise Sidebanders are requested to confine their transmissions to those channels established locally for their use.

COMMUNICATION WORLD ELECTRONICS  
P.O. BOX 1020  
WATERBURY, CONNECTICUT 06720



SOLVE YOUR TVI PROBLEMS  
**LPF-1000**  
ADJUSTABLE TRANSMITTER  
LOW PASS FILTER

◆ ELIMINATES TV INTERFERENCE ◆



### designed for:

HAM RADIO & CB COMMUNICATION

The **BEST ADJUSTABLE** low pass filter/antenna tuner

- ACHIEVES MAX. ATTENUATION of both HI&LO BAND TVI, yet maintains a LOW SWR
- Functions as an effective Antenna tuner
- Handles up to 1 KW
- 100 db rejection of spurious RF above 40 MHz
- Has VARIABLE INPUT Impedance— 50—70 Ω
- Negligible insertion loss
- Supplied with complete instructions
- Compact • made in u.s.a.

\$39.95 DIRECT FROM MFG. SHIPPED C.O.D.

OR SEND MONEY ORDER OR CHECK TO:

C.W.E. P.O. BOX 1020

WATERBURY, CONNECTICUT 06720

DEALER INQUIRIES INVITED

## Interference MANUAL

A while back S9 put out a dandy (and handy) manual about detecting and eliminating TV Interference, Power Line Interference, Mobile Noise. It was a smash success and we sold out the print run in short order—we thought! A recent inventory of our stock room disclosed that we still had one half of a precious carton of these books remaining. So, hop to it all you who have been bugging us about this book—here's your chance to snap up the few remaining copies of this publication, which has now become a rare classic! Pre-inflation prices, too. *Only \$1, plus 25 cents postage—first come, first served, while they last!*

**NOISE ELIMINATION MANUAL**  
c/o S9 Magazine  
14 Vanderventer Avenue  
Port Washington, NY 11050

**ATTENTION DEALERS:**  
WIDEST SELECTION —  
BEST PRICE — FASTEST SERVICE!

Beltek	Siltronix
Browning	Tram
Courier	Unimetrics
Gemtronics	Yaesu
Hy-Gain	A/S
Johnson	Avanti
Midland	CPD
Pace	Everhardt
Palomar	Hustler
Pearce-Simpson	Mark
Royce	Shakespeare
SBE	Goldline
Standard	Xtal

COMPLETE LINE OF ACCESSORIES  
SEND \$1.00 FOR DETAILS

## HENSHAW'S

7622 Wornall, Kan City, MO 64114  
1644 E. McDowell, Phoenix, AZ 85006  
5050 E. Belknap, Ft. Worth, TX 76117



# FOREIGN QSL CARDS

## IL VOLO DEL CIUCO

O modular con impegno ed essere uomini  
o in Empoli voler per Corpus Domini.

RADIO TATO 1°

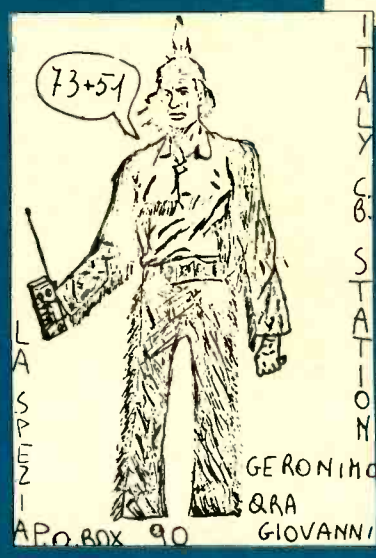
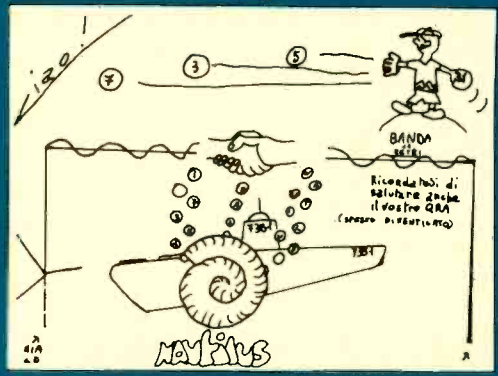

TO BE OR NOT TO BE  
A "C. B."  
(applies to Italianmen, too!)

Break!  
CQ - CQ DX  
CQ - CQ DX  
Break!

LAT. NORD 43° 41'  
LONG. EST 10° 52'  
I - S - W 59459

Authorization No. 8888 for Tommy Bony!

73's 51's 88's  
and best wishes.

QSL from:  
PAPA TANGO (in DX)  
OPERATOR PIERO  
P.O. BOX No. 38  
56027 SAN MINIATO (Pi)  
(ITALY)

MONITOR Ch. 8-11  
All 23 and More

STAZIONE JUMBO - JET

OPERATORE  
- GINO -  
P. O. BOX 4012  
16145 GENOVA - ITALY

73 + 51  
C.Q. CQ.  
ROGER

STAZIONE FORTUNATO  
P.O. BOX 14  
89100 Reggio Calabria  
ITALY

73's 51's 88's

C.B. STATION  
Operatore: PIERO

QSL from:  
TATO (PT - 44 in DX)  
P.O. BOX 38

56027 S. MINIATO (Pisa)  
ITALY

MONITOR Ch. 9 - 11



Ride the CB boom  
to growth  
and  
profits...



1972



1973



1974



1975

## Become an ECHO Distributor

Citizen band radio is booming. And there is no end in sight. Trucker, banker, doctor, hobbyist — and just plain old John Q. motoring public. Everyone is making the move to CB. And this spells opportunity for you.

As an Echo distributor you can get to the top of the boom fast. We are a worldwide organization with modern distribution and service facilities and enormous purchasing powers in CB equipment and accessories. This enables you to sell the highest quality CB equipment at the lowest possible price, making the highest possible profit. And our servicing capability is second to none.

Too good to believe? Well, there's more to our total distributor program:

- Attractive, colorful catalog which you provide free to your trade.
- Authorized service centers for KRIS, JOHNSON, ROYCE, PACE, HY-GAIN, COURIER, ELECTRA-BEARCAT and, of course, ECHO.
- Single source supply for most popular brand mobile and base station units.
- Professional sales counseling from people who have been in CB since 1962.
- 90-day repair or replacement policy.
- Echo Extra — monthly specials designed to build traffic and sales.
- Computerized control of inventory and order processing saves you time and headaches.
- National advertising, supporting literature, and a monthly newsletter backs your selling effort.

Like to learn more how you can grow in CB as an Echo distributor? Call or write today.

*We'll be happy to send our new catalog.*



**ECHO COMMUNICATIONS, INC.**

World-Wide Distributor of Quality CB Equipment  
Cedarburg, Wi. 53012 USA (414) 377-5050

For States of: Hawaii, Alaska, Washington, Oregon, Nevada and California, Contact our California Distribution Center — 13030 East Firestone Blvd., Santa Fe Springs, Calif. 90670  
Phone: (213) 921-0607

Please send dealer information today 1866-4

Name \_\_\_\_\_

Phone \_\_\_\_\_ Date \_\_\_\_\_

Address \_\_\_\_\_

City \_\_\_\_\_ State \_\_\_\_\_ Zip \_\_\_\_\_

# Dealers Needed

*The New Source of Supply you've Been looking for*

We're a New Factory Direct Distributor, carrying the Complete Regency Line and 48 Other Major Lines. We offer quick courteous service and are well stocked. Please your wallet with our prices and your customers with fast delivery. We are looking forward to serving you. Our goal is to help you build your business.

ACCESSORIES



CR-123B



ACT-E 8 H/U



CR-185

STEREOS

## POPLAR ELECTRONICS

5030 Poplar Level Road - Louisville, Kentucky 40219  
Phone: 502-966-2106



ANTENNAS

**Attention Dealers!**  
AUDIO/VIDEO DISTRIBUTORS COMMUNICATIONS DIVISION  
**WELCOMES DEALER INQUIRIES!**  
COMMUNICATIONS DIVISION  
Audio/Video Distributors Inc.  
8848 Orchard Tree Lane  
Towson, Maryland 21204  
301-821-0790

EMBLEMS

EMBLEMS



Beautiful, washable swiss embroidered emblems custom made to your design. Send your design today for a firm quote. Any number from ten to thousands. Ideal identifiers for clubs, organizations or events. Write now for free booklet with design hints and ordering information. Your satisfaction guaranteed. A. T. Patch Co., 334 Bethlem Rd., Littleton, NH 03561.

## CB Secret Antenna

- CONVERTS YOUR CAR RADIO ANTENNA TO A CB MOBILE ANTENNA\*
- EASY-TO DO IT YOURSELF INSTALLATION

Limited **5 yrs** Warranty  
Unit will be replaced for 5 yrs.

**\$13.95**

**MONEY BACK GUARANTEE**  
If you are not completely Satisfied

**"SECRET" BECAUSE NO CB ANTENNA IS VISIBLE**

- HELPS STOP THEFT •
- For all antennas, including windshields



**ORDER TODAY**

**Sandia Sales**  
235 K Robbins Lane  
Syosset, N.Y. 11791

Please rush me 1 CB Secret Antenna at the purchase price of \$13.95 plus 90¢ for Shipping & Handling  
Enclosed is  Check or  Money Order for \$ \_\_\_\_\_  
Sorry No C.O.D.'S (N.Y. Residents Add Sales Tax)

Please Print  
Name \_\_\_\_\_  
Address \_\_\_\_\_  
City \_\_\_\_\_ State \_\_\_\_\_ Zip \_\_\_\_\_





# 5

## great reasons

why *YOU*  
should subscribe to  
(if you aren't already doing so)



1. You'll save a bundle. Newsstand copies are \$2.00 each, or \$24 for a year's supply. Your subscription costs only \$12 – or half as much.
2. You'll get S9 earlier. Subscriber copies will reach you as much as two or three weeks ahead of newsstand or store copies.
3. You'll be sure of getting your copy. Many times S9 is sold out before you can find it. Your subscription is like an insurance policy of fun reading.
4. You'll get a bonus. Right on! A 24 page copy of the FCC Part 95 CB regulations. The Commission says it's a must for every CBer.
5. You'll make our editor very happy. And there's nothing more important than having a happy Tomcat (that is, if you're going to keep a Tomcat on the premises, as we do.)

So, indulge yourself. S9 is the CB magazine that doesn't quit when it comes to giving CBers all the scoop on what's happening out in the CB world. Do it now! Today! Before you forget!! After all, spreading joy is what CB's all about, now, isn't it?

S9 MAGAZINE  
14 Vanderventer Avenue  
Port Washington, N.Y. 11050

Here's my .....\$12 for a 1 year sub,  
.....\$20 for 2 years. This is a.....new  
sub, or a.....renewal. Please include my FREE  
copy of FCC Part 95 CB Regulations.

*Allow six weeks for delivery of first subscription copy.*

Name \_\_\_\_\_ Call \_\_\_\_\_

Address \_\_\_\_\_

City \_\_\_\_\_ State \_\_\_\_\_ Zip \_\_\_\_\_

## HOW ABOUT THAT

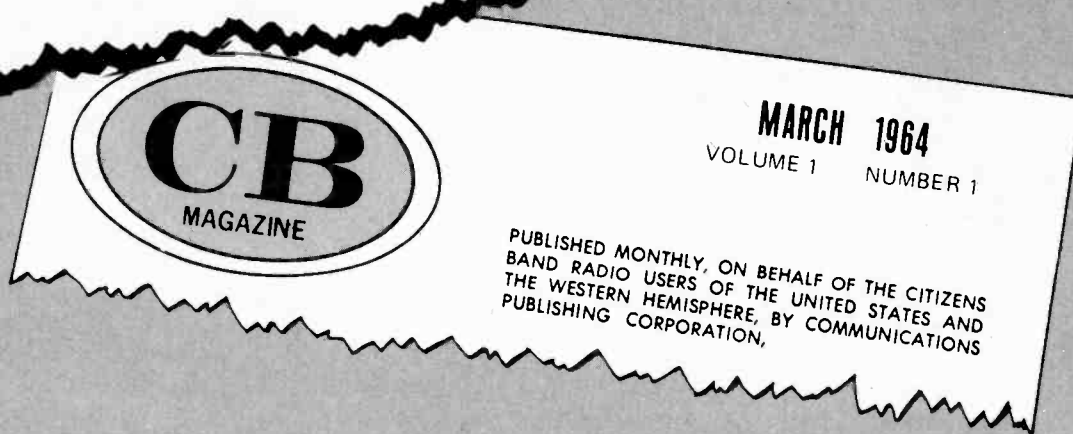
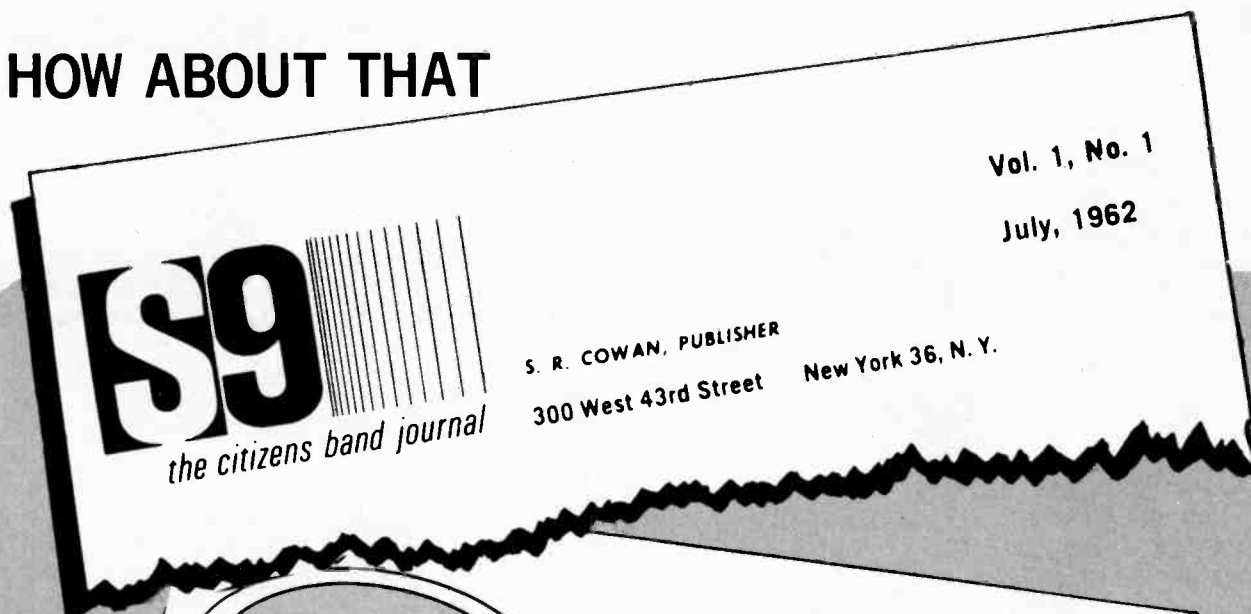

In their latest advertising, CB Magazine claims to be the oldest, most widely read magazine in the CB radio market.

The evidence is quite clear that S9 was on the scene almost two full years earlier.

## HOW ABOUT THAT!

CB Magazine's advertising also claims the largest circulation and best cost per thousand.

## HOW ABOUT THAT?

FCC FORM 555-B  
April 1976

# Temporary Permit

## Class D Citizens Radio Station

# 1

### Instructions

- Use this form only if you want a temporary permit while your regular application, FCC Form 505, is being processed by the FCC.
- Do not use this form if you already have a Class D license.
- Do not use this form when renewing your Class D license.

# 2

### Certification

Read, Fill In  
Blanks, and Sign

#### I Hereby Certify:

- I am at least 18 years of age.
- I am not a representative of a foreign government.
- I have applied for a Class D Citizens Radio Station License by mailing a completed Form 505 and \$4.00 filing fee to the Federal Communications Commission, Box 1010, Gettysburg, PA. 17325.
- I have not been denied a license or had my license revoked by the FCC.
- I am not the subject of any other legal action concerning the operation of a radio station.

\_\_\_\_\_  
Name

\_\_\_\_\_  
Signature

\_\_\_\_\_  
Address

\_\_\_\_\_  
Date Form 505 mailed to FCC

**If you cannot certify to the above, you are not eligible for a temporary permit.  
Willful false statements void this permit and are punishable by fine and/or imprisonment.**

# 3

### Temporary Call Sign

- Complete the blocks as indicated.

Use this temporary call sign until given a call sign by the Federal Communications Commission.

<b>K</b>	<input type="checkbox"/>	<input type="checkbox"/>	<input type="text"/>	<input type="text"/>	<input type="text"/>	<input type="text"/>	<input type="text"/>
	↑	↑	↑				
	Initial of Applicant's First Name	Initial of Applicant's Last Name	Applicant's Zip Code				

# 4

### Limitations

Your authority under this permit is subject to all applicable laws, treaties and regulations and is subject to the right of use or control by the Government of the United States. This permit is valid for 60 days from the date the Form 505 is mailed to the FCC.

**You must have a temporary permit or a license from the FCC to operate your Citizens Band radio transmitter.**

**Do Not Mail** this form, it is your Temporary Permit.

*See the reverse side of this form for a summary of operating instructions.*





# Using Your Citizens Radio Station

(See Part 95 of FCC Rules & Regulations for complete instructions on authorized station use.)

## Welcome to the Citizens Radio Service

Citizens Band Radio is a shared communications service with many people using the same frequencies and channels.

The guidelines provided in this form are not intended as a substitute for FCC Rules, but as a general reference to those operating practices and procedures which will benefit you and other users of Citizens Radio.

Your compliance with these guidelines and your consideration for the rights of others in your radio service is necessary if the full potential and enjoyment of Citizens Radio is to be realized.

**1**

## Who May Operate Your Citizens Radio Station?

You, members of your immediate family living with you, and your employees while on the job.

**2**

## How Many Transmitters Does this Permit Authorize?

A maximum of five (5).

**3**

## Can the FCC Inspect My Station?

Your station and station records must be available for inspection by an authorized agent of the FCC.

**4**

## Where Should I Keep This Permit?

Keep it in a safe place. Post photocopies at all fixed station locations. Indicate on photocopies the location of this permit. Attach a card with your name, address and temporary call sign to each transmitter.

**5**

## How Shall I Identify My Station?

Identify transmissions in English with your temporary call sign.

**6**

## How Can I Use My Station?

Use it for private short-distance radio-communications for your personal or business activities. Channel 9 is reserved solely for emergency communications and to assist motorists.

### Prohibited Communications Include:

- Activities contrary to law
- Transmitting obscene, indecent or profane messages
- Communicating with non-Class D stations
- Intentional interference to other radio stations
- Transmitting for amusement, entertainment, or over a public address system
- Transmitting false distress messages
- Advertising, selling, or for hire

**7**

## How High Can My Fixed Station Antenna Be?

See Section 95.37 if your antenna will be over 20 feet above ground. Additional information is available in SS Bulletin 1001-h.

**8**

## May Amplifiers Be Used With My Transmitter?

'Linear' amplifiers are absolutely prohibited. 'Power' microphones may require adjustments to your transmitter.

**9**

## Who Can Make Adjustments to My Transmitters?

Adjustments affecting proper operation may be made only by, or under the supervision of a licensed first or second-class radio operator.



Send SWL reports to:  
 Don Jensen  
 c/o CB Radio/S9 Magazine  
 14 Vanderventer Ave.  
 Port Washington, NY 11050

**W**HAT can I hear on shortwave? That's a question that many beginning shortwave listeners ask. And when you come right down to it, it isn't really that easy a question to answer.

There are thousands of stations on SW. Those stations are located in more than 200 different countries. They range in power from under 100 watts to hundreds of thousands of watts. These stations are packed into the dozen shortwave broadcasting bands between 11 and 120 meters, with plenty of broadcasters tucked into out-of-the-way, out-of-band frequencies between the bands.

Some of these stations are very easy to hear regardless of the listener's experience in tuning SW signals or the sophistication of his receiving equipment. Other stations are sometimes heard but, because of propagational factors, may be missing from the bands for months on end. Still other stations are so difficult to hear because of schedule or low power or some other factor that they have never been reported logged in North America.

But when the novice SWL asks what he can hear, he usually means what can I hear easily and regularly. And, often, he also means, if he hasn't begun to try to listen to stations broadcasting in foreign languages, what stations can I hear with English programs.

If the original question is narrowed to stations broadcasting in English which are more or less easy to hear on shortwave, the answer is a bit easier to give. But it isn't necessarily a short answer.

There are well over 100 countries with shortwave stations which broadcast, at sometime during their schedule, in the English language. At least half of those stations could be considered reasonably good bets for most shortwave listeners.

In last month's DX Korner I focused on a number of the European stations broadcasting in English, when and where to tune for them. In this and coming DX

Korner columns I'll focus on other continents. This month the target continent is Africa.

Alphabetically-speaking, the first African is Algeria. The governmental shortwave voice is Radiodiffusion Television Algerienne with transmitters at Algiers. English programs are scheduled for 1900 GMT on 11,910 kHz.

Botswana in southern Africa is not an especially easy catch on 4,845 kHz, but it is possible to hear Radio Botswana at 0500 GMT.

Burundi is represented on our African shortwave list by a religious broadcaster, Radio Cordac, located in Burundi's capital of Bujumbura. It is a rather tough logging to make on 4,900 kHz but if you hear it at all it will be after 0400 GMT.

Radio Yaounde, in the west African country of Cameroon, is a station of little difficulty to hear. English is scheduled for 0530 GMT on 4,972.5 kHz.

Radiodiffusion Television Congolaise is the official shortwave outlet of the People's Republic of the Congo, which is a former French possession not to be confused with the old Belgian Congo, which is now Zaire. That may be confusing but you won't be confused if you just tune 15,190 kHz about 2130 GMT.

Now we come to a really good bet for beginning SWLs. Egypt is the country and Radio Cairo is the station, and a powerful, easy to hear station at that. Listen for Radio Cairo's English programs at 0200 to 0330 GMT on 9,475 kHz.

Next come a pair of "G" countries, one rather easy, the other a somewhat difficult logging. The tougher of the two is Radio Gambia which transmits on 4,820 kHz in English about 0600 GMT. It is worth going after, however, since there are reports that the station will leave the air forever, perhaps within a year.

The easier logging is Radio Ghana, another west African station, which broadcasts in English from 2000 to 2100 GMT on 11,850 kHz.

Ivory Coast is another former French Colony in Africa. This explains the station's French name, Radiodiffusion Television Ivoirienne. RTVI is located at the Ivory Coast capital of Abidjan and transmits on 11,920 kHz. Listen for this one between 1845 and 2000 GMT.

Kenya is a tough country to hear, but if you hear it

## **DX KORNER** (continued)

the frequency will be 4,804 kHz and the time to log the Voice of Kenya is about 0300 GMT.

Just a few kilohertz down the dial and also a rather hard one to hear is another station in southern Africa, Radio Lesotho. This station operates on 4,800 kHz and you won't hear it until after the Latin American outlet on the same frequency signs off. The time to try is about 0500 GMT.

A bellweather station for African reception on the 60 meter band often is ELWA, a missionary broadcaster at Monrovia, Liberia. When ELWA is putting in a good signal, then it is time to try for some of the harder-to-hear Africans. ELWA's frequency is 4,770 kHz and try tuning either after 0600 GMT, or before the station's sign off, say around 2230 GMT.

One of the more solid signals from Africa comes from the transmitter of the Voice of Nigeria at Lagos, Nigeria. Look for English programming from this one on 7,275 kHz about 0600 GMT.

Yet another religiously oriented station on shortwave is FEBA, the Far East Broadcasting Associates (Why is this station called "Far East" when it is closer to Africa? The answer is that it is affiliated with a shortwave operation in the Philippines.). FEBA is located on the island of Mahe, one of the Seychelles group in the Indian Ocean. Two frequencies to try about 1530 GMT are 11,810 and 15,325 kHz.

Sierra Leone often puts in a solid signal on 3,316 kHz late at night, say after 0600 GMT. The station is the Sierra Leone Broadcasting Service and it is located at the city of Freetown.

A lead pipe cince as one of the easiest stations in Africa to hear is South Africa's Radio RSA. Tune this one in English at 2230 GMT on 9,585 kHz.

If you come to the conclusion that there are a number of missionary stations in Africa, you're right on target. There are quite a number of these religious outlets on shortwave. Another one is Trans World Radio, an outfit that also owns stations in Monaco and on the Caribbean island of Bonaire in the Netherlands Antilles. This TWR outlet is located in Swaziland. You can try about 0600 GMT on 3,275 kHz for this one.

With new transmitters, Uganda has become an easier country to log in the past year or so. Radio Uganda can be heard with fairly good signals on 9,730 kHz, broadcasting in English at 2030 GMT.

And, having run the alphabet from A to Z, we come to Radio Zambia. Give this African a try at 0600 GMT on 7,235 kHz.

Now these times and frequencies were correct, to the best of my knowledge, at the time this column was written. However station schedules and, especially frequencies do change without much warning.

For more such data on stations which broadcast in English on shortwave, I suggest you write to the North American Shortwave Association, a DXer/SWL club. NASWA offers a list of stations with English broadcasts. All you need to do is include with your request

a stamped, self-addressed envelope. Send your request to North American SW Association, Box 13, Liberty, Indiana 47353. And while you're at it, why not also ask for information on becoming a member of NASWA. You don't have to . . . but it's a good move.

## **WHAT'S NEW**

**QUIET BEN**—According to TV correspondent Garrick Uteley, Big Ben, the well-known great clock in London's Westminster Tower, had a radio stand-in. On August 16, when Big Ben was shut down for repairs, the British Broadcasting Corporation had to find a substitute. DXers know that the chimes of Big Ben are usually heard on the BBC's shortwave transmissions at 1200 GMT, that's noon in London. The BBC's substitute chimes were from Great Tom, a not-so-well-known clock in the tower of St. Paul's Cathedral in London.

**WHITMER 1977?**—1976 was officially dubbed, by several major broadcasting stations and by SWL club organizations as "World DX Club Year." The purpose of such a dedication was to focus attention on the many shortwave listeners and DXing clubs around the world. Now well-known Swedish broadcaster, Arne Skoog has put forth a suggestion for 1977. Arne suggests it be designated "International Broadcasters' Year" and urges listeners to support their favorite SW stations and programs. And one of our readers had yet another suggestion for 1977. "How about designating it World Youth Year?" He believes that it is time younger SWLs were recognized.

**POWER OF POSITIVE COMPLAINING**—Not too long ago the Voice of America announced that the U.S. broadcasting agency would no longer announce the overseas relay stations transmitting its programs. The identification announcements will be simply "from Washington D.C." despite the fact that the signal may be relayed by a VOA transmitter in the Philippines, Greece, Liberia or whatever. This was termed a "simplification" by the VOA.

But this policy also meant that the VOA would no longer QSL by transmitter site, shutting off a traditional avenue for verifying some interesting overseas countries in which VOA relay transmitters are located.

ANARC, the Association of North American Radio Clubs recently got a letter from U.S. Senator Gary Hart (D. Colo.) responding pleas for assistance in getting this policy changed.

Sen. Hart's letter read: "I was as unhappy as you with this so-called simplification and made further inquiries to VOA. Persistence . . . finally paid off and the station changed its mind.

"Briefly, the brand new and revised VOA QSL policy is this: (1) Sites will continue to be listed on VOA's frequency schedule, which will be sent to anyone requesting a copy from VOA; (2) After ascertaining the correct site from the frequency schedule, include the site in your (reception) report along with a request for verification of the site. With luck, this new



procedure will enable beginning and advanced DXers alike to verify sites from Greenville to Monrovia and Rhodes, while still saving the VOA's tight budget.

"With best wishes for all gud DX, 73, GARY HART, U.S. SENATE."

Right on, Senator Hart! And, Senator, you sound mighty savvy about this shortwave listening hobby. Et tu?

**TAPED AID**—The popular handbook especially for inexperienced DXers, *DXing According to NASWA* is now available in a tape recorded, spoken version for those persons with sight disabilities. Recorded on cassette by Jim Conrad, a professional broadcaster, this two-hour introduction to DXing is available through the North American SW Association, P.O. Box 13, Liberty, Indiana 47353, for \$4. For each cassette sold, NASWA will donate \$1 to the DXers Handicapped Aid Program.

### QUESTIONS AND COMMENTS

"You mention shortwave listening and DXing clubs from time to time," writes Bart McKee of Pittsburgh, PA. "I'd like to know more about these clubs. I want to join one but don't know which one is best for me."

You're a wise shopper, Bart. Bet you watch your pennies in the supermarket too.

You, and all the rest of DX Korner's readers, can get a summary sheet explaining all about the various clubs affiliated with the Association of North American Radio Clubs (ANARC) by sending a stamped, self-addressed envelope to Dave Browne, Executive Secretary, ANARC, 557 North Madison Avenue, Pasadena CA 91101.

Arthur Beekman of New Orleans, LA, reports he's heard an interesting station recently.

"It is a special transmission from Greenland," Art writes, "and I hear it on about 14,442 kHz at about 1300 GMT."

"The station mentions it being a radiotelephone circuit between Greenland and Denmark. But it goes on to give a lot of information about Greenland, including its size, population, etc."

Yep, Art, this is both interesting and a bit puzzling. It is not a broadcast in the sense that what you are hearing is not a program. It is a repeated "marker," often called a "voice mirror," used by point-to-point communications transmitters, overseas telephone companies and the like. These repeated markers "hold" the channel for the station when it is not relaying message traffic. The markers also make it easier for receiving stations to tune in these utility operations.

What is unusual about this Greenlandic transmission is the great detail and the considerable amount of information packed in what is, essentially, only a tuning signal.

Now that just about does it for another month. How about it? Will I be hearing from you during the next month?

... Use S9 READER SERVICE.

## HAVE YOU MADE CONTACT WITH THE



NAME	HANDLE	PRIMARY CHANNELS
Tom Kneitel	Tomcat SSB13, KW146 CL173	10, 12, 19 16L, 18U
Karen Fusco	One Duster LIS813	13 16L, 18U
Lori Ressa	Loreli	12, 19
S.R. Cowan	Gramps	19
Richard Cowan	Trainman	13, 16L, 19
Cary Cowan	Green Dragon Sleeping Beauty	12, 17, 19
Marc Gilman	Deacon CLI34, KW339 SSB30	12 16L
Gordon West	California Dreamer	9, 16L
Gary Deckelnick	Baby Bull	7, 19
Bill Sanders	SSB295, CLI1849 KW5304	16L, 18U
Hal Keith	Flasher	12
Pat Hartman	Six Pack	4
S9 Office Station	Deadline Base KW4405 SSB250	8 16L, 18U

## HOW 'BOUT IT? GIVE US A SHOUT!

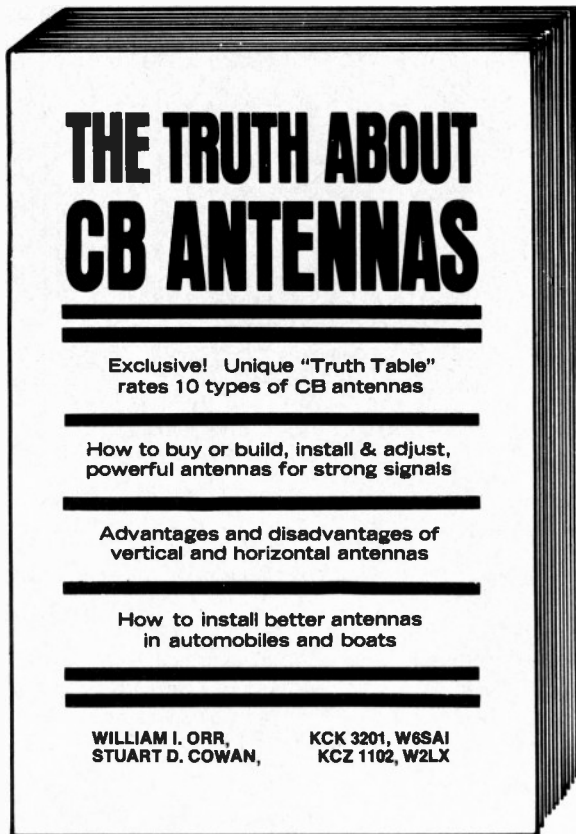

*New  
Handbook  
Reveals*

**THE  
TRUTH  
ABOUT  
CB ANTENNAS**

**\$4.95**

\*(postpaid)

- \* Exclusive "Truth Table" gives actual Db gain from 10 types of CB antennas.
- \* 240 pages — 146 illustrations — 18 chapters.
- \* "A great CB Antenna Handbook!" George R. Wood, KBI-3274 - W1SR, RCA.

Your CB antenna is the key to clear, reliable communications. Most CB antennas are improperly installed and adjusted. They do not work anywhere near peak efficiency. Moreover, to impress buyers a barrage of non-facts about inferior antennas is

used by some antenna manufacturers to gain quick sales. Now, for the first time, this new Antenna Handbook exposes false claims and gives you a unique "Truth Table" so you can determine for yourself the true power gain of any CB antennas!

Book Division, Cowan Publishing Corp.  
14 Vanderventer Avenue  
Port Washington, N.Y. 11050

- Check
- Money Order

Sirs:

Please send me.....copies of **THE TRUTH ABOUT CB ANTENNAS**

Name \_\_\_\_\_ (Please Print Clearly)

Street Address \_\_\_\_\_

City \_\_\_\_\_ State \_\_\_\_\_ Zip \_\_\_\_\_

\* Residents of N. Y. State include appropriate Sales Tax



# The Monitor Post

by Rick Maslau, KNY2GL

## "RUBBER DUCKIE"

A new flock of "Rubber Duckie" antennas and hardware have "just hatched" at Russell Industries, Inc.

The expanded "Rubber Duckie" line now includes antennas for CB, VHF, UHF, lo band, tri band, business band and for ham use.

Added also to the new antenna line are new, miniature pin plug (PL-259) bases, right angle (PL-259) connectors, thumb screw adapters and standard screw bases (5/16"x32 and 1/4"x32). All of Russell's new CB antennas and hardware are available from stock.

Contact Russell Industries, Inc., 3069 Lawson Blvd., Oceanside, NY 11572.

## NAVIGATION RECEIVER

Collins Avionics Division of Rockwell International has announced a new ARINC 547 navigation receiver, the 51RV-4. The new receiver uses digital techniques to provide improved performance and reliability at lower cost than equivalent analog equipment.

The Collins 51RV-4 weighs 45 percent less than current equivalent receivers, consumes one-third the power and provides at least a 6 db advantage in VOR sensitivity. In the new Collins 51RV-4, the detected VOR signal is converted to a digital word for decoding and processing. The digital techniques used in the signal processing circuitry substantially reduce azimuth error below values typical of previous analog equipments. Both the digital and analog RNAV outputs of the 51RV-4 provide an accuracy of  $\pm 0.5^\circ$ . Synchro output accuracy is  $\pm 1.5^\circ$ . The ILS deviation is accurate to  $\pm 1.5$  micro-volts.

In addition to standard ARINC 547 outputs, the 51RV-4 provides sine-cosine and digital RNAV outputs and a video output. Up to seven 1000 ohm deviation loads can be driven by the 51RV-4 without strapping. This extremely flexible range of outputs, combined with the high instrumentation capacity, suits the Collins 51RV-4 to a wide range of applications.

The 51RV-4 provides 46 db cross modulation protection on adjacent channels and 60 db protection beyond the adjacent channel. Also, in the VOR mode, the

51RV-4 will reject a minimum of 10,000 micro-volts of undesired signals in the absence of a desired signal.

Featuring an all-solid-state synchro drive, the 51RV-4 contains no moving parts, eliminating the requirement for periodic maintenance. Modular construction and easy component access simplify troubleshooting and maintenance. Weight of the Collins 51RV-4 ranges from 9.9 to 11.0 pounds depending on selected options.

Contact Collins Radio, Cedar Rapids, IA.

## DIPOLE ARRAY ANTENNA DATA OFFERED

American Electronic Laboratories, Inc. (AEL), offers technical information on two models in its line of coplanar log periodic dipole array antennas.

Models APN 1509 and 1202A cover the 20 to 1000 MHz frequency range. They both feature a detachable dipole element assembly for tactical utilization of the antenna. Model APN 1509 consists of snap-on dipole elements. The APN 1202A elements are bolted in place.

Both antennas meet the requirements for testing in accordance with SAE specification J551 on electromagnetic interference.

Data sheet #20-8 can be obtained by writing to American Electronic Laboratories, Inc., MS/1122, P.O. Box 552, Lansdale, PA 19446.

## CERTAIN STATIONS REQUIRED TO MODIFY LICENSES

In accordance with Section 81.360(a)(2) of the Commission's rules, radiotelephony frequencies in the band 2000-2850 kHz will be available to limited coast stations after January 1, 1977, only if the licensee applies for and, if authorized, provides radiotelephony service on frequencies in the band 156-162 MHz.

Licensees of limited coast stations concerned should submit an FCC Form 503 prior to November 1, 1976, requesting modification of their station license to include radiotelephone frequencies in the 156-162 MHz band. Since this modification is required by the FCC, applications involving only this modification may be processed without a filing fee. Such applications received without a filing fee will be processed for a license hav-

ing the same expiration date as the license currently held. Such applications received with a filing fee of \$4.00 will be processed for modification and renewal for a term of five years.

### FCC PROPOSES TO AMEND RULES

The FCC has proposed amending its rules to permit the operation of a communications system on the Great Lakes to provide very high frequency (VHF) regional and other public correspondence radio-communications service to vessels.

The action was in response to a rulemaking petition filed by Lorain Electronics, a Lorain, Ohio, radio communications firm and licensee of FCC public coast radio stations.

Lorain Electronics is authorized to operate a prototype VHF system until January 1, 1977, and on March 10, it furnished the FCC with a detailed report on its system which it said, was operating successfully.

Lorain's proposal for regular operation of the system calls for the use of some existing public coast stations and some new stations, all of which would operate on Channel 86 (161.925 MHz) and on either Channel 84 (16.825 MHz or Channel 87 (161.975 MHz) at 16 locations.

Its proposed system would provide automated and manual communications as well as other new radio services, and would cover the entire navigational area of the Great Lakes in the United States, as well as much of the Canadian navigational waters.

Lorain's proposed system differs from existing VHF public coast station service in that it would consist of about 16 coast stations spread throughout the Great Lakes area, linked together by a land wireline, and all using a "common channel" for teleprinter and facsimile operations. Most would be unmanned and controlled from a central location in Lorain, Ohio.

(Existing VHF public coast stations ordinarily operate as separate and independent units, and are not linked together into any kind of integrated or centrally controlled system, either by land wireless or radio frequencies.)

The Commission said the establishment of new VHF radiotelephone services through a system of interconnected public coast stations as proposed by Lorain Electronics might be in the public interest and advantageous to the maritime community.

However, Lorain Electronic's proposed system is inconsistent with existing rules, and the FCC asked for comments on the following changes that would be required to implement the proposed system:

—Disregarding the 30 mile limitation between public coast stations and permitting an overlap greater than the 20 percent now allowed for stations operating in or near a system of interconnected public coast stations;

—Amending the permissible emission provisions of the rules to provide for and allow the transmission by

system stations, and ship stations communicating with other ship stations of F2 (teleprinter) and F4 (facsimile), as well as F3 telephony emissions on one channel to be used as a "common" channel and F4 on the prime working channel;

—Changing certain conditions of use criteria for the frequencies involved and allowing the assignment of a second channel for radiotelegraph communications without the traffic showing now required by FCC rules;

—Making minor changes in the rules concerning station equipment required for automatic operations and station log entries when made automatically.

### THE PRIVATE EYES HAVE IT

I have always been fascinated by communications systems utilized by private security and investigative agencies—guess you might say that it's my specialty.

There are several categories of agencies included, some are armed guards—those who are basically hired to patrol factories, stores, offices, construction sites, etc. Then there are agencies which employ private detectives who work on domestic, industrial, insurance, and other cases—very often on an undercover basis. Also included are so called "Central Alarm Agencies," these are outfits which install burglar and fire alarms that are connected to the agency headquarters—when an alarm goes off, the police or fire authorities are notified and the agency dispatches its own agents to the scene. I also include various armored car and truck outfits within the scope of my interest. Then, last but not least, there is the individual "private eye," who works alone rather than for an agency.

Some of these agencies are structured and as complex as many a police department, with ranks, inspections, marked patrol cars, etc. Larger agencies are often interconnected by private line and TWX to offices across the nation.

As you might have imagined, 2-way communications are often a part of such operations, and a wide variety of systems are pressed into service. Some agencies have hit upon Class D CB, while some are licensed on non-CB channels within the 27 MHz band. Others use a few walkie talkies operating on the low, high, and UHF bands. Some agencies do not operate their own communications systems, but rely upon the telephone company mobile operators, or upon "radio common carrier" services—this saves them the expense and trouble of setting up their own base stations(s).

But there are still a large number of these organizations, who *do* have their own 2-way communications systems on the low, high, and UHF bands. Some of these systems are sophisticated multi-channel installations with efficient and sharp dispatching—better than many a police department I have monitored, I suppose this is because quite a few of the employees of these agencies are or have been police officers at one point or another in their careers.



Needless to say, these private agencies are not wildly ecstatic about giving out the intimate details of their communications operations, probably for the same reasons that so many public safety agencies like to keep the data to themselves. It is available though—and I am happy to say that, even though I felt that I had put together a fairly comprehensive listing for my own use over the years, I have now realized that there were several times more stations to hear than I had even *imagined!* I happened upon this data in a publication entitled *SECURITYCOMM-1*, which lists the locations, frequencies, call signs, and operating agency names of *more than one thousand* private security forces and agencies which operate their own 2-way communications systems between 30 and 470 MHz, this covers all 50 states. Covered are private detectives and agencies, guard services, watchmen, central alarm systems, security police and patrols, armored truck and car services—and more!

This publication is from CRB Research Inc., P.O. Box 56, Commack, NY 11725. The *SECURITYCOMM* directory is \$3, postpaid.

I'm all ears over the private eyes!

## BREAK . . . LOWER SIDE

(from page 69)

they are. If it's a Brooklyn accent and the ID number is KW-146, you've got S9's Tomcat!

A few readers have written to ask for some comments on the sideband equivalent of *10-10 On The Side*, as might be used on AM. Apparently some operators are using QSX while others are using an assortment of other signals. Our own preference, and the one suggested by the Sidebanders' Service Bureau (SSB Network) is QTX, which seems more appropriate than QSX. The signal QSX indicates that you are listening for a specific station on a particular channel. The signal QTX simply says that you are keeping your station open until further notice. Seems much more appropriate, and is used this way by members of the *SSB Network*.

In many areas of the nation, members of the *SSB Network* get together on Channel 16-Lower for informal rap sessions, roll calls, etc. Most popular time seems to be about 8 P.M. local time on Sunday nites. If one isn't already going in your area—and you're an *SSB Network* member—then why not start one? You're NOT an *SSB network* member? Then be one! Send a stamped self-addressed envelope to this column, or direct to the Sidebanders' Service Bureau, P.O. Box 381-R, Smithtown, N.Y. 11787. In a short time you'll have a set of national *SSB* numbers.

# Dealer Business Card Advertisement

*This advertising section is reserved exclusively for CB dealers who wish to keep their name in front of their local customers, but who would otherwise not advertise in a national publication. The ads included are limited to one column inch; advertising copy is limited to non-mail-order type. The costs for business card ads are \$45.00 prepaid. In addition to the ad in the business card section, each dealer participating receives twenty five copies of the issue containin his ad, to sell or pass out in his store. For further information, dealers should contact the publisher, S9 Magazine, 14 Vanderverter Ave., Port Washington, NY 11050. Phone: 516/883-6200.*

TOP OF THE LINE RADIOS  
AT BOTTOM OF THE LINE PRICES  
**QUALITY LINE ELECTRONICS INC.**  
Transit Town Plaza  
Williamsville, N.Y. 14226  
716-631-3332  
RETAIL WHOLESALE

★ **AED** ★  
**COMMUNICATIONS SERVICENTER**  
CB & FM 2-Way Radios - Antennas - Scanners - Crystals  
SALES - INSTALLATION - SERVICE  
2517 Wyandotte Road Willow Grove, Pa. 19090  
(215) 659-3754

**SPEED EQUIPMENT INC.** (516) 883-7819  
One of L.I.'s fastest growing C.B. Dealers carrying a full line of C.B. equipment in stock.   
*We install what we sell!*  
Sales: 139 Main St. Installations: 137 Haven Ave. Port Washington, New York 11050

**CB SYSTEMS LTD.**  
*Specializing in CB Repair, Parts and Replacements!*  
P.O. Box 1, Burtonsville, MD. 20730  
—Send for Price Lists— (301) 384-4873

C.B. RADIOS POLICE & FIRE MONITORS  
**ESSEX ELECTRONICS CO.**  
705 SOUTH MARLYN AVENUE  
BALTIMORE, MARYLAND 21221  
WHOLESALE DISTRIBUTORS  
DEALERS WELCOME  
301-686-8080 RADIO & TV PARTS

**PEARCE-SIMPSON**  
Represented, Proudly, in the Northeast by:  
 70 W. Main St.  
Northboro, MA 01532  
(617) 393-2411  
Contact us for name of your nearest Northeast Dealer.

ENJOY THE THRILL OF UNDERPAYING  
**COBRA-TRAM-BROWNING**  
QUALITY LINE ELECTRONICS INC.  
STONY HILL PLAZA, RT. 6  
BETHEL, CT 06801  
203-792-7750  
WHOLESALE RETAIL

# CB SHOP



Rates for CB SHOP are 10 cents per word for advertising which in our opinion, is obviously of a noncommercial nature. A charge of 50 cents per word is made to all commercial advertisers or business organizations (minimum ad, \$20.00). Regular S9 display advertisers are exempt from the classified ad minimum rate. A 5% discount is in effect for an advance insertion order for six consecutive months.

We do not bill for advertising in CB SHOP. Full remittance must accompany full orders

sent in; otherwise, will not be run or acknowledged.

Closing date is the 5th of the third month preceding publication.

Because the advertisers and equipment contained in the CB SHOP have not been investigated, the publisher of S9 cannot vouch for the merchandise or services listed therein.

All paid classified ads must be sent to the attention of Eileen Lucey, Classified Ad. Manager.

**OFFICIAL 10 CODE & Q SIGNALS**, 6x9 glossy white card stock, black ink. Both \$1.00. Lile Guill-Code, Rustburg, VA 24588.

**THE HANDY HELPER** is what every CBER needs! Made of unbreakable plastic, it lists the 10 code, important ham q signs for SSB, truckers "slanguage", technical terms and compares the new 40 channel with the old 23. The HANDY HELPER attaches to your vehicles sun visor, dash, or "shack" table. Send \$2.98 to Spectrum Communications, 1522 Indigo Drive, Oshkosh, WI 54901.

**YOUR HANDLE OR DEALER TRADE-MARK** prepared in artwork for printing QSL cards, letterheads, decals, invoices, bumper stickers, memo pads etc. Send sketch of your individual design using black and any other color plus \$49.50. Fifteen years experience preparing designs for printing. Fast Service CB Art Studio, 5172 Rollins Ave., Suite 1, Jacksonville, FL 32207.

**CALLSIGN AND HANDLE** engraved on 1x3 plastic badge with pin/clutch. Choice of colors, all with white lettering—maplewood, green, red, black, blue, orange—\$1.75. H & H Plastic Engravers, P.O. Box 6606, Pine Bluff, AR 71601.

**CB DECALS:** 12 new designs, all in color, individually polybagged, self-adhesive, weather-proof vinyl. Retail at \$1.00 each. Wholesale prices available to dealers, clubs and associations that offer 100% and more profits. Prices include free display racks, free advertising placards, and free shipping in USA. Fantastic for coffee breaks and jamborees. Send for FREE full-color catalog sheet to: WALKING TALL, P.O. Box 659, Bronx, NY 10469 or call 212/863-4848.

**FREE CB HANDLE RECORD BOOK** with purchase of CB Handles with humor, over 300 handles, short stories and poems. Send \$3.00 to Billy R. Smith, 616 Sixth St., Hilltop Ct., Bloomington, IL 61701.

**INTRODUCTION TO CB SIDEBAND**—Undecided? This comprehensive 65 page primer covering radios, equipment, antennas and proper on the air procedures will help you. Also contains Q-code, 10-code and pertinent Part 95 rules. Send \$2.00 to P.O. Box 396, Reseda, CA 91335.

**HANDLES—CALLSIGN DECALS** 3" x 18" hand painted black or silver \$3.95 ea. 2 for \$6.95. Jersey Jogger, P.O. Box 662, New Monmouth, NJ 07748.

**SPECIAL** — 100 QSL IRC'S—Only \$1.00. Tower-SN, Drawer 10083, Charleston, SC 29411.

**ATTENTION CB DEALERS:** Having hard time getting CB sets? We carry a full line, including Pearce-Simpson, Robyn, Browning, Johnson, Royce, Police Monitors, Crystals, New-Tronics, Antenna Specialists (E & S CB Sale & Service) R4, Winchester, IN 47394. Ph. 317/584-0343.

**FCC REGULATIONS-Part 95**-Condensed in easy to read language. Plus a Glossary of popular CB terms. \$3.00 to Peters, 11 Hampton St., Sayville, NY 11782.

**WE NEED DEALERS!** Get on our mailing list for weekly dealer specials on Citizens' Band radios & accessories. Over 100 major lines. Our dealers enjoy same-day service, dealer-support aids, plus access to dealer discounts on several hifi and other consumer electronic merchandise. You will PROFIT as a 10-4 dealer. Write today: 10-4 Communications, 704 W. Buffalo St., Ithaca, NY 14850.

**WANTED:** Car telephones and mobile telephone parts, heads, cables etc. Greg Hyman, 87 Yonkers Ave., Yonkers, NY 10701. 914-476-4330.

**CB CLUBS**—Engraved 3-line pin badges (\$1.50 each in quantity orders). Free Sample to clubs. We have engraved over 25,000 for CB'ers. Wharton Plaques, (Est. 1953) Worcester, NY 12197.

**TIRED OF LISTENING TO LOCAL CB'ers?** You can hear CB'ers thousands of miles away if you know when to listen. For specific dates and times for next 3 months, send \$5 to COPUS, PO Box 13821S, Atlanta, GA 30324. Caution: Talking to CB'ers over 150 miles away is illegal.

**I'LL WRITE YOUR CB HANDLE INTO A POEM.** Send \$2.50 to Billy R. Smith, 616 Sixth Street, Hilltop Ct., Bloomington, IL 61701.

**ALABAMA DEALERS;** we carry most major brand CB radios and accessories. Same day shipping from on the shelf stock. Dealers only. Ask for "SANDEE" or send letter head to TUCKER BROTHERS- Box 177, Cripwell, AL 35054. Tel. 205-525-5341 or 525-5808.

**NEW CHROME MYLAR** colorful bumper decals, from designers and manufacturers. Interwagen Corporation, 8819 SW 129th Terrace, Miami, FL 33156 (305)233-3470. Distributors wanted, send \$13.00 for sample kit (\$35 retail value).

**CB DEALERS**—Send letterhead for complete wholesale catalogue on all communications equipment. Four Wheeler Communications, 10 New Scotland Ave., Albany, NY 12208. 518/462-0202.

**JOIN INTERNATIONAL EMERGENCY RADIO PATROL.** Details free. Write Box 434 Saint John, New Brunswick, Can. E2L 4L9.

**CB DEALERS**—Send today for our price list, same day service. Reputable company in CB business for over 8 years. Over half-million dollar inventory. CB DISTRIBUTORS, Box 15883, Baton Rouge, LA 70815.

**SMOKEY'S RADAR BUGGING YOU?** Loaded with speeding tickets? Insurance gone up? We have the answer. H & B Enterprises, Box 477, Candler, NC 28715.

**MAKE PHONE CALLS FROM YOUR CAR,** transmit television pictures! Amateur radio is fun. Six months ago I was a CBER, now I am an extra class amateur. Let my technique get you started toward the excitement of amateur radio. Novice Type FCC. Questions and beginner code tape all for only \$5.00. Send check or money order to: Amateur Radio, 2666 Fair Oaks Lane, Cincinnati, OH 45237.

**FRAME YOUR HANDLE GOOD BUDDY.** Display both your call sign and handle with a personalized license frame. Distinctive, heavy duty, reinforced die cast frame, triple chrome plate. Fits standard 6" x 12" license plates. Names engraved in phenolic. Please print handle and call sign and send \$6.95 plus \$.75 postage with home-20 to: Con Dist., 175-C Long Pont Road, Hewitt, NJ 07421. NJ residents add 5% sales tax.

**PROTECT YOUR HANDLE,** Register with the AMERICAN CALL SIGN REGISTRATION BUREAU. Receive beautiful three color wall certificate and wallet card. Nationwide coverage. No duplicates. Also register SSB numbers, monitor numbers and Ham certificates. Send \$4.00 to Box 9922, Hanahan, SC 29410.

**YOU SAVE BIG MONEY!** Surplus, clearouts, bankruptcy inventory, deals. Catalog \$1 (re-deemable). ETCO, Box 741, Dept. 59, Montreal, Canada H3C 2V2.

**CB RADIOS AT WHOLESALE PRICES!** Listing 50 cents. Going Ham? YAESU FT-101E in stock. Sideband Specialty, Box 573-DC, Oak Harbor, WA 98277.

**JOIN THE BROTHERHOOD OF CB'ERS** a Nationwide organization. Equipment and handle registry; overnight accommodations; bi-monthly magazine published by us; ID Card; 5 x 7 wall card; bumpersticker and more. Complete membership \$5.00 or free details. Box 461, New Haven, CT 06502.

**HANDLE BARS (tm)**—two 3-1/2" x 15" ID stickers with your handle and call letters (must be included) plus 2 favorite channels, \$5.00 ppd. Please print all copy: limit handle to 15 letters. Allow 3 wks. for delivery. Idea House, Rye, NY 10580.

**QSL CARDS—SOMETHING COMPLETELY different!** Nothing even close to it on the market! Not made of paper or card stock! The "Cadillac" of QSLs! Samples: \$1.00-Fully refundable with order. MAC'S SHACK, Box 1171B, Garland, TX 75040.

**DEALERS — CHECK OUR EXTREMELY** Low prices and same day shipping for Midland, Shakespeare, Turner, Breaker, Ampenol, Consolidated Towers and more. Send for free catalog. Sugar Shak Distributors, 1025 N. King St., Hampton, VA 23669. 804/723-7090

**LOOK! \$1.00 ENGRAVED HANDLE PINS.** 1" x 3" plastic. White letters on blue, black, red, green, walnut. Black on white, yellow, Max line (1 or 2): 16 letters, spaces. Fast. Order Holly Engraving, Box 3926-B, Hollywood, FL 33023. Brochure: with order or stamp.

**DEALERS WANTED.** Most major CB brands, scanners, Ham gear. Large inventory, low prices, fast courteous service. JRD Distributors, 131 Harbor Circle, New Orleans, LA 70126. 504-241-8500.

**AMATEUR & COMMERCIAL LICENSES** easily obtained with economical books and tapes. Speak to the world from your car or base. Free information. Ameco Publishing, 275S Hillside, Williston Park, NY 11596.

# NO CODE!

## A New Ham License Is On The Way!

Yes, the FCC has proposed a new class of Ham License that will require *no* knowledge of the Morse Code! The frequencies and operating privileges are still up in the air, but there's no doubt that a new, easy-to-get Ham License is going to be here soon.

If you're interested in adding Ham Radio to your communicating skills, you should start *now* to learn what this Amateur (Ham) Radio stuff is all about.

And the easiest way to learn what it's all about is to read *CQ*, The Radio Amateur's Journal. *CQ* is published by the same people who bring you *S9*, and they've been publishing *CQ* for over 30 years. That makes *CQ* the oldest independently published Ham magazine in the USA....and the most widely read, too.

*CQ* will keep you up to date on all that's new in Ham Radio - the new equipment, the newest antennas, Slow Scan Television, DXing, Contests (*CQ* runs the biggest and best Contests in the Ham world), and much, much more. You won't want to miss a single issue.

Subscribe today!

*CQ* The Radio Amateur's Journal  
14 Vanderventer Ave.  
Port Washington, NY 11050

Yes, I want to start learning all I can about Ham Radio! Please enter my subscription to *CQ* today.

- One year, 12 issue.....\$7.50  
 Two years, 24 issues....\$13.00

Enclosed is \$ \_\_\_\_\_ for \_\_\_\_\_ years subscription to *CQ*, The Radio Amateur's Journal. Rush my first issue to me immediately!

NAME.....  
ADDRESS.....  
CITY.....  
STATE.....ZIP.....

... Use S9 READER SERVICE.

PACE, MIDLAND, ROYCE, and HY-GAIN CB Radios, All models at wholesale, 30% to 40% below list prices. Midland No. 13-888 \$142.00; Royce No. 1-614 \$195.00; Hy-Gain 674-B \$265.00; Midland No. 13-892 \$199.00; Catalogs \$1.00 from: DAY ELECTRONICS, Suite B-5, 3039 Shrine Place, Los Angeles, CA 90007.

ROCK BOTTOM PRICES on Name Brand CB Radios, Antennas and Accessories. Free price sheets. GRC Enterprises, Dept. S1, Taunton, MN 56291.

KEEP IN TOUCH! Custom Printed QSL cards with your photo. Post card size. For free sample, write Bargains Unlimited, 208 Orange Avenue, Fort Pierce, FL 33450.

CALL SIGN—HANDLE molded in durable pressure sensitive plastic, 3" x 12" 1 line \$2.95 5" x 12" 2 lines \$4.50 Red or black on white. No COD's. We pay shipping. Club emblem molds available for clubs. Gene's Signs, P.O. Box 7852, Midfield, AL 35228.

QSL CARDS, LOG BOOKS, BUMPER STICKERS, scratch pads, stationery, envelopes, etc. Complete line of CB Operating supplies. Send for free catalog. Patronics, Inc., Dept. QS, P.O. Box 3314, Shiremanstown, PA 17011.

YOUR HANDLE AND CALL sealed in 12 oz. Thermo-Temp drinking mug. Keeps drinks hot or cold. Dishwasher safe. Satisfaction guaranteed. Makes personal and inexpensive gift. \$2.50 each postpaid. Americana, Box 423, Bridgewater, MA 02324.

EARN CASH FOR YOUR CLUB. Take orders for Thermo-Temp drinking mug or tumbler personalized with your club insignia. Keeps drinks hot or cold. Everyone in club will want one. Self addresses stamped envelope brings information. Americana, Box 423, Bridgewater, MA 02324.

DISTINCTIVE ENGRAVED ID PLATES, 4-color anodized aluminum, 3 1/4" x 1 3/4". Handle, call number, social security number, name. Carry or attach near transceiver. Send \$2.00—COBBIE'S GIFTS, P.O. Box 2, Deal, NJ 07723.

CB/SCANNER PRICES DRASTICALLY REDUCED. AM Mobiles from stock 30% plus off. Cobra 21 \$119, Pace CB143 \$89, Pace CB-2300 \$149, SBE, Electra, Pearce-Simpson, Royce, Tram, more, AM/SSB Discounted. Sale Catalog \$1: Communications, Box 128, Pittsford, NY 14534.

QSL CARDS—Build your collection 25 different QSL cards \$2.50 or 25 of your QSL cards send to other CB'ers \$2.50: Send orders to: Arrid House, P.O. Box 389, Dept. Nine, Bronx, NY 10458

YELPING SIREN ALARM for your car. Activated by existing door buttons for courtesy lights, stays on once door opens until deactivated. Use existing P.A. speaker or install separate speaker. 12 Volt with 5 watts output. Highest quality PC board and components. Unit assembled, tested, less speaker-on/off switch \$14. Simple installation instructions included. Siren Alarm also available whereby interruption of grounded trigger line activates unit \$12. STOP BURGLAR ALARMS, Box 500, Hiawatha, IA 52233.

MAIL-IN CB REPAIR: Write or call for procedures and flat-rate price schedule. Most radios in return mail within 48 hours. COMMUNICATIONS UNLIMITED, P.O. Box 55, 1-70 & US 42, London, OH 43140 (614) 852-9446.

CB'ERS—SHOOT LEGAL "SKIP" worldwide on thousands of channels! Join ARC to learn how. \$4.00 Life Membership or 25 cents brings information. American Radio Council, Box 1171, Garland, TX 75040.

FACTORY DIRECT CB ACCESSORIES: DE-102 filters for superior CB reception through interference, DE-102A for base station \$51.95. DE-112A power supply converts mobile into a powerful base \$36.95. Other accessories available. Add \$2 for shipping. Dynamic Electronics Inc., Box 896, Hartselle, AL 35640

ASSOCIATE MEMBERS WANTED to join American CB Radio Club. Receive attractive club buckle, membership card, permanent club I.D. number, 10-code, CB language, bumper sticker, etc. Associate Membership only \$6.00 a year. Mail check to American CB Radio Club Inc., P.O. Box 321, Bronx, NY 10469.

WANTED ANTIQUE GLASS—Looking for old milkglass purple, slag, carmel and green-town too. Tell me what you have—I pay the highest prices. Write, Jack Schneider, c/o Cowan Publishing, 14 Vanderventer Ave., Port Washington, NY 11050.

SIDEBAND DECALS! Tell the world that Sideband is the greatest! Spectacular new 3-1/2 inch 3-color water transfer Sideband decals! One decal only \$1.25 ppd.! Two or more only \$1.00 each ppd. Dealers wanted! Sidebanders' Service Bureau, Box 381-Y, Smithtown, NY 11787.

POLICE/SHERIFF SHOULDER PATCHES! Authentic! Exclusive! Rare! Limited Supply! Multi-colored embroidered uniform patches from actual agencies. No lists, our choices sent, while supply lasts! 5 different only \$5, ppd. CRB Research, Inc., P.O. Box 56-X, Commack, NY 11725.

WANTED FOR \$\$\$CASH! Back in 1957 the Lionel Train Company made a small set of toy trains specifically designed for girls. It had a pink locomotive and several other cars, all in pastel shades. The set wasn't very popular, hence not too many sold. However, I need this set for my collection, and am willing to pay up to \$400 cash for a complete set in mint condition. If you have this item please write: Dick Cowan, S9 Magazine, 14 Vanderventer Ave., Port Washington, NY 11050.

SIDEBANDERS! Old Timers! Newcomers! Future Sidebanders! Affiliate with the largest, oldest and most well known SSB Network! No charge for SSB ID numbers from current numbering blocks. Lots of extras and goodies available! Send self-addressed stamped envelope for FREE info and application. No obligation! Sidebanders' Service Bureau, P.O. Box 381-X, Smithtown, NY 11787.

SECRET SCANNER FREQUENCIES? Many public safety and federal gov't. agency frequencies are "unlisted"—that is, "missing" from frequency listings available to the general over-the-counter buyer! What good is a scanner without ALL of the frequency data? Get those unlisted frequencies and lots more ONLY in CRB Research directories, the original Official "insiders" directories used by public safety agencies and scanner users since 1967! Exclusive directories for many other services (mobile telephone/private detectors/aero/railroad/remote broadcast pickup/etc.) also available! Still only \$3 each, or send a postage stamp for fantastic BIG new catalog! CRB Research Inc., P.O. Box 56-X, Commack, NY 11725.

SINCERE CH-9 MONITORS—We need one Chartered team in each county in the U.S. Canadians welcome. Write Highway Assistance Modulators, 5221 Creekwood Dr., Harrisburg, PA 17109. Team protection assured.

LOOKING FOR OLD LIONEL TRAINS. Interested only in "O" Gauge, excellent to like-new condition. Primary interest is locomotives prior to 1952, but will consider complete sets or more recent models. Am willing to buy outright for cash or swap radio gear to meet your needs. Write Dick Cowan, WA2-LRO, c/o S9 Magazine, or call 516/883-6200.

SCANNER OPERATORS! Are you registered? Be assigned your own personal monitoring ID letters inscribed on beautiful 2-color bordered certificate, plus discounts and goodies! Thousands already registered! Only \$5, ppd. from CRB Research, Box 56-X, Commack, NY 11725.

NOW FROM THE LARGEST WAREHOUSE IN THE EAST. Same day delivery for on the shelf stock. All major brands. 24-hour service. Send for dealer catalog and free gift offer. Send letterhead to: PALOMAR EAST LTD., Palomar Plaza, P.O. Box 148, Congers, NY 10920.

**CB DEALERS:** Wren House Electronics is your one-stop distributor for all your CB needs. All major brands of CB radios, antennas, accessories and related equipment. Fast service, competitive prices and one of the best dealer programs in the business. Wholesale only. Send letterhead and \$2 for latest catalog and dealer price list to Wren House Electronics, Inc., Dept. S9C, 1438 Brook Dr., Downers Grove, IL 60515.

**I WILL GUARANTEE YOUR INVESTMENT** in a business of your own. When qualified, you can earn at least \$1,000 income every month — part time. To find out how to qualify, call Alan I. Charof - 212-343-1335, Metro, NY.

**NEED HELP?** Send your letterhead for our free wholesale CB catalog. Weekly specials available. Write to Alamo Wholesalers, Dept. S Drawer 4316, Victoria, TX 77901.

**INTERESTED IN SWAPPING QSL Cards?** Want to wallpaper your walls with QSL cards? Join the Carnival QSL Club of the world, 1124 High Bluff, Dubuque, IA 52001.

**S9, P.R. EMBLEM** send \$3.00 plus 25 cents postage for one. William Davidson, 26 Knight St., Glens Falls, NY 12801.

**FOR SALE:** New Tennetrac V 12 Channel scanner receiver with FM radio. \$175.00. Orlian Cain, Griswold, IA 51535.

**1—PAIR LAFAYETTE** Dyna-Com. 3-watt, 3 channel Walkie-Talkies—1 antenna broken needs replacing. Both for \$69.00. You Ship. Bondurant, Box 7171, Tampa, FL 33603.

**GET THIS! CIGAR CITY "TAMPA"** Jamboree Souvenir patch—dime each plus SASE w/order. Bondurant, P.O. Box 7171, Tampa FL 33603.

**CB HAM DEALERS:** Send your letterhead for free catalog. Siltronix, Swan, Midland, Pearce-Simpson, D & A, Black Cat, Hustler, Avanti, etc. Appliance & Equipment Company, Inc., 2331 Vance Jackson, San Antonio, TX 78213. 1-512-733-0334.

**CB DEALERS WANTED.** We sell to dealers only: No retail sales. Call or write for information on our dealer program. DRAGON COMMUNICATIONS, 411 Kansas City Ave., Excelsior Springs, MO 64024. 816/637-6011, OR—2244 NW 39th Street, Oklahoma City, OK 73112. 405/525-8844.

**CB RADIOS, VHF/UHF monitors, crystals, antennas.** All brands. Lowest pricing possible. Southland, P.O. Box 3591-F, Baytown, TX 77520.

**BEAUTIFUL QSL CARDS**—Want your custom designed QSL card to truly stand TALL among the rest of the "Ordinary Wallpaper"? Breathtaking samples and information only \$1.00, refundable with first order. BACK-ACRE CB Printers, Box 18608-S, Milwaukee, WI 53218.

**FCC TEST ANSWERS \$10.00** specify class Dixie Tec Box 8352, Savannah, GA 31402.

**MOBILE IGNITION SHIELDING** provides more range with no noise. Available most engines in assembled or kit forms, plus many other suppression accessories. Free Literature. Estes Engineering, 930 Marine Drive, Port Angeles, WA 98362.

**DETER CB THEFTS,** Large red, white and blue window decal warns that vehicle is protected by burglar alarm system. 2/\$1. Adhesive door label for home warns of modern burglar alarm system 2/\$1. Bitner, 14421 Bensley, Chicago, IL 60633.

**WYOMING RANCH LAND.** 10 acres \$30 down, \$30 month. Owner-Mike Gauthier, 9550 G Gallatin, Downery, CA 90240.

**QSL CARDS**—2 color 12 pt. glossy white, 500 for \$8.00, 1,000 for \$14.00. Over 300 designs. Catalog & Samples, \$1.00. Lile Guill, Rustburg, VA 24588.

**THE JUNK BOX**—Interesting to CBers. Sample copy 75 cents. Placement on latest junk mail list \$1.00. The Junk Box, P.O. Box 872, Peabody, MA 02149. U.S.A.

**QSL—QSL—QSL—WORLDWIDE QSL.** Send QSL Cards to: Philip Steven Kurland, 357 East 201 St., Apt. 1-F, Bronx, NY 10458.

**SOUTHEAST DEALERS AND DISTRIBUTORS:** Best Prices. Same Day Service. Most Major Brands Available. Hustler, Turner, Royce, Robyn, Regency, Johnson, Xtal, Midland, SBE, Kris, and many more. Call or write for price list. L.E.S. Wholesale Dist., 16773 S.W. 304 St., Homestead, FL 33030. 305-248-6304.

**CB INSURANCE PLAN:** Protect your valuable CB mobile or base investment with a 'protection' plan. Total cost \$2. Be safe from ripoffs. Geyer, 230 E. Grand Ave., Rahway, NJ 07065.

**CB DEALERS WANTED**—Low Dealer Prices on Robyn Radios and On-Guard Products. We have discount prices on other major brands. Pearce-Simpson Simba \$475, Pace 1000B \$375. Send 20 cents for price list. Simmons CB Radio Sales, Rt. 2, Bloomington IL 61701.

**WHAT'S YOUR HANDLE?** Attention all CBers, make sure your handle is included in the book "CB Handles", the Whos Who of CB. For information send self addressed stamped envelope to, CB Handles, Box 3515B, Quartz Hill, CA 93534.

**WANT TO BUY:** Will pay top dollars—hard cash—for old Lionel Trolleys in any condition. Also want Old Lionel or Ives Standard Gauge trains. Your old clunker may be a collector's dream. Don't be bashful. Write Dick Cowan, c/o S9 Magazine, 14 Vanderventer Ave., Port Washington, NY 11050. Phone: 516/883-6200.

# Why & How to use CB Accessories.



## We Wrote the Book...

to show you how easy it is to suppress noisy CB pop and crackle... filter out pesky reception problems... obtain the correct antenna placement and match! You'll find these and other vital CB performance facts in this important booklet—all as a service from Gold Line, producers of precision designed CB accessories that can help make your CB radio a *Powerhouse Performer*.

## FREE!

This valuable booklet is yours for the asking. Just fill in coupon below and mail today. Or, ask the authorized Gold Line CB Accessories dealer in your area for a free copy.



**GOLD LINE** Your Accessory Power House  
25 Van Zant Street, E. Norwalk, Conn. 06855

Clip and mail today for your Free Gold Line Booklet!

**Gold Line CB Accessories** 25 Van Zant Street, East Norwalk, Conn. 06855 Dept. S12  
Gentlemen: Please send free copy of your booklet "Why and How To Use CB Accessories"

Name \_\_\_\_\_

Address \_\_\_\_\_

City/State/Zip \_\_\_\_\_

**Distributor inquiries invited.**



WILKES-BARRE & HAZELTON CB'ers. Mountaintop REACT needs dedicated volunteers to monitor Ch. 9. Contact Clinton Chamberlin, 10 Old North Rd., Walden Pk., Mountaintop, PA 18707. Call 868-5015.

PROTECT GEAR with bold burglar alarm warning stickers. Strong self-stick vinyl striking green/yellow design. Only \$2 for 5. Enclose self-addressed stamped envelope. CRB Research, Inc., P.O. Box 56-XC, Commack, NY 11725.

FOR THE BEST IN CB & AMATEUR GEAR. Tempo One. Silttronix 1011B & Skipper 73. For immediate delivery, call or write: PAL-OMAR EAST LTD., Palomar Plaza, P.O. Box 148, Congers, NY 10920. (914)268-9258.

UNIT NUMBER ID'S! Everybody's using them these days! Don't you have yours yet? Your existing Unit Number registered or a new one assigned to you by the national registry for ALL Unit Number ID's; PLUS a 2-color official Certificate of Registration showing Unit Number, your name and/or handle, the date of registration; PLUS exclusive special report on how thousands of CB'ers are now getting more use and enjoyment from their hobby by using Unit Number ID's in addition to or instead of "handles." Everything for only \$2.95, plus self-addressed stamped envelope. Z-Tech Enterprises, Box 70-W, Hauppauge, NY 11787.

OFFICIAL IO CARDS/CREDENTIALS for Police Dept./Deputy Sheriff/Highway Safety Patrol/Volunteer Ambulance Corps/Rescue Squad/Fire Dept.! Beautiful professional 2-color wallet size ID cards. Sent blank (we do not inscribe name). Available in large or small quantities. Sample set of all 6 cards only \$3, ppd., PLUS FREE BONUS Official CB Operators ID Card. Civil Defense credentials also available to authorized CD units. Order now! CRB Research Inc., P.O. Box 56-X, Commack, NY 11725.

NASSAU COUNTY CB'ERS: Don't sit back... Join REACT!! Central Nassau County REACT, one of the first and largest teams in the nation would like you as a member. We are an independent, non-profit volunteer public service team dedicated to aiding you, our fellow CB'er in time of need. Send today for more information and a membership application to: Central Nassau County REACT, P.O. Box 406-S, Westbury, NY 11590.

WANTED: Courier Gladiator. Mine was stolen 1-25-76, Send Price, SASE, MSB 1525, AI, P.O. Box 45, Weirg Beach, NH 03246.

WANT TO BUY: Certain issues of Pogo, Uncle Scrooge, and Classics Illustrated comic books. Some worth \$25 or more to me. (I swap QSL's too). Randy Gregg, 3601 Lancaster Lane N., Plymouth, MN 55441.

WORLDWIDE QSL Cards needed-send QSL cards to: Philip Steven Kurland, 3000 Valentine Ave., Apt. 1A, Bronx, NY 10458.

FOR SALE: New Comrade IV by Automatic Radio. 11-channel CB mobile \$80.00. Orlian Cain, Griswold IA 51535.

TOWSON REACT needs new members. For information write: Towson REACT Inc., P.O. Box 9790, Towson, MD 21204, or Call 301-666-2238.

SWAP OLD HAM MAGS (CQ, QST, 73, HR) & S9 for Callbooks, ARRL Handbooks. Donald, 6059 Essex, Riverside, CA 92504. 714-687-5910.

WANTED—Mint postage for use in place of IRCs; all countries. Buy or swap. Don Erickson, 6059 Essex, Riverside, CA 92504.

CB SHOW, November 27 & 28 at the Long Island Arena, Commack, NY. Sponsored by Trade Show Productions, Inc. For more information contact them at 74 A Bell St., W. Babylon, NY 11704, or phone (516) 752-0310.

JOIN PORTLAND METROPOLITAN—REACT. Call Jack, 284-0779, Portland, OR 97211.

STOP STATIC—Give yourself a present—AUTOTRON by AVTEC — Stops alternator and other static. Gets the signals through. 20 day money back guarantee. \$13.95, AVTEC Mfg., P.O. Box 722, Union, NJ 07083.

SCANNER CRYSTALS from America's leading supplier—sent to you postpaid and factory fresh from an inventory stock of 100,000 crystals! \$3.95 for multiple orders! Send postage stamp for free catalog and special order form! Z-Tech Enterprises, P.O. Box 70-A, Hauppauge, NY 11787.

JOIN PORTLAND METRO REACT, Call Uncle Wayne, 233-9155, 1833 S.E. Alder, Portland, OR 97214, KDL-1468.

GUARANTEED 100% QSL CARDS with numbers only. Buddy packs to 100. Extras appreciated. KCO-2682, PO Box 8726, Boston, MA 02114.



# CRYSTALS

Same Day Shipping  
From  
America's  
Largest Inventory of

Standard C.B. Crystals/Ham Crystals

High Frequency C.B. Crystals

Crystal Controlled Sliders/Ham Gear

NATIONWIDE DISTRIBUTORS—DEALERS WANTED

CALL TODAY

TENNESSEE  
CRYSTAL COMPANY

P.O. BOX 73

LEBANON, TENNESSEE 37087

(615) 449-1856

# ADVERTISER'S INDEX

## MANUFACTURERS

Acoustic Fiber Systems . . . . .	60
AmComm . . . . .	59
Ameco Equipment Co. . . . .	107
Antenna, Inc. . . . .	89
Antenna Specialists Co. . . . .	13
Argos Sound. . . . .	140
Avanti Research & Dev., Inc. . . . .	Cover 4
Barker & Williamson . . . . .	123
Bomar Crystals . . . . .	125
Browning Labs, Inc. . . . .	21
CDE . . . . .	78, 79
CPD Industries . . . . .	95
CTS Knight . . . . .	24
Channel Master CB . . . . .	77
Cobra Comm., Div. Dynascan . . . . .	4
Component Specialists . . . . .	130
Craig Corp. . . . .	44
Cush-Craft, Inc. . . . .	130
Echo Comm. . . . .	143
Fanon/Courier Corp. . . . .	57
Francis Industries . . . . .	125
Gamber Johnson . . . . .	113
Gemtronics . . . . .	38
Glatzer Industries Corp. . . . .	118
Gold Line . . . . .	158
Handic of USA, Inc. . . . .	25
Heath Co. . . . .	108
Hufco . . . . .	62
Hy-Gain Electronics . . . . .	40
JIL Corp. . . . .	47
Jan Crystals . . . . .	129
Johnson, E.F., Co. . . . .	3
Kris . . . . .	17
Lafayette Radio Elect. . . . .	Cover 2, page 1
M-Tron . . . . .	74
Magitran . . . . .	136
Midland . . . . .	51
Mura Corp. . . . .	2
Neosonic . . . . .	126
New-Tronics Corp. . . . .	8, 9, 112
Pal Electronics . . . . .	120
Palomar Electronics . . . . .	55
Pearce-Simpson Co. . . . .	15, 133
Pride Electronics . . . . .	131
Radatron . . . . .	119
Radio Shack . . . . .	37, 85
Robyn International . . . . .	6
SBE . . . . .	Cover 3
Scientific Antenna . . . . .	66
Sentry Manu. Co. . . . .	122
Shakespeare Company . . . . .	75, 82
Siltronix . . . . .	43
Southcomm . . . . .	48
Sprague . . . . .	116
Staco Inc. . . . .	118

Superex Electronics Corp. . . . .	115
Telex . . . . .	19
Tennessee Crystal Corp. . . . .	159
Tram/Diamond Corp. . . . .	11
Tri-Ex Towers. . . . .	7
Turner Div., Conrac Corp. . . . .	23, 39
Valcom, Inc. . . . .	123
Vernitron Corp. . . . .	88
Weatheralert. . . . .	66
Wenover . . . . .	80
Wilson Electronics . . . . .	34, 94
Yaesu . . . . .	137

## DISTRIBUTORS

Atlantic Speed Center . . . . .	108
Audio Video. . . . .	144
B & J Two-Way Ltd. . . . .	124
Bennies Comm. . . . .	29, 92
CB Warehouse. . . . .	113
Centennial Comm., Inc. . . . .	98-101
Clercom. . . . .	134
Commtron . . . . .	81
Communications World Elect. . . . .	141
Crazy Harvey . . . . .	131
Dragon . . . . .	114
Fordham . . . . .	111
Gordon Electronics . . . . .	119
Henshaw's . . . . .	119, 141
NPC Electronics . . . . .	97
New-Tone Electronics . . . . .	135
Noah Communications . . . . .	126
Palomar East, Ltd. . . . .	70, 71
Poplar . . . . .	144
Royal . . . . .	120
Sandro's Electronics. . . . .	5
Southern Dist. . . . .	107
United Communications . . . . .	129
Universal Communications . . . . .	126
Wright Elect. . . . .	31

## MISCELLANEOUS

Bearfinder . . . . .	119
CB Hall of Fame . . . . .	105
CB Repair Center . . . . .	89
CB Specialties. . . . .	95
CEDA. . . . .	132
Channel Tag . . . . .	124
Easy CB Locators . . . . .	136
J. W. Miller. . . . .	140
My Idea. . . . .	117
NCC. . . . .	107
NRI . . . . .	65
Nat'l. Bur. of Search & Call Reg. . . . .	73
Patch, A. T. . . . .	144
Regal Lapidaries . . . . .	132
Sandia. . . . .	144

Southern Embossing . . . . .	104
Steve "CB" Stanley . . . . .	91
Tri-met Industries . . . . .	137

## COWAN PUBLISHING ADS

A Professional. . . . .	50
CB Radio Marketing. . . . .	110
Electronic Fleamarket . . . . .	138, 139
House of Power. . . . .	140
How About That? . . . . .	146
Interested in Ham Radio? . . . . .	103
Interference Manual. . . . .	141
No Code!. . . . .	157
Old Lionel Trains . . . . .	117
One Stands Out! . . . . .	90
Reader Service . . . . .	127, 128
S9 Staffers . . . . .	151
Subscription Form. . . . .	145
Tab Popular CB Books . . . . .	136
The Communicator . . . . .	111
The Truth About CB Antennas . . . . .	152
The Verdict Is In. . . . .	135
Tomcat's Skipland Map . . . . .	108

## BUYER BEWARE!

The publisher of S9 accepts advertising from manufacturers, dealers and distributors who, in our opinion, offer readers a high level of quality in products and/or service. Wherever possible we attempt to publish additional information on these products in the form of technical equipment evaluation reports.

Readers should be aware that, at the present time, the CB radio market is drastically backordered in almost every product category, but especially so in transceivers and antennas. We wish to remind our readers that we carefully screen all potential advertisers. In the event that a company's products do not appear within our advertising pages, there's a strong likelihood that it has not passed our minimum standards.

We strongly urge readers to purchase from those companies whose advertising appears in S9; by doing so, you will be assured that the company with whom you're doing business is a reputable one. You'll also be supporting those companies that help make S9 possible. Now, we recognize that many advertisers cannot advertise in every issue. If you don't see the company's ad in the current issue, check back two or three issues to be certain, since almost every major advertiser appears six or more times in one year. If you have doubts about the reliability of any particular product or company, feel free to contact our publisher for information. This service is offered as a safeguard to our readers.

# All SBE 23-channel CB units have a 40-channel future.

With all the talk about 40-channel CB units tomorrow, why should you buy SBE 23-channel units today?

Simple. We just give you the chance to buy today with tomorrow in mind.

Which is what the SBE FUTURE-40 CB UPDATE PROGRAM is all about. Here's how it works: We're including a special Future-40 Certificate with all SBE 23-channel units. It entitles the SBE buyer to update his 23-channel unit to 40 channels



A Future-40 CB Update Program Certificate comes packed in each of the following SBE units: Coronado II (SBE-10CB), Cortez (SBE-21CB), Formula "D" (SBE-26CB), Catalina III (SBE-29CB), Touch Corn (SBE-32CB), Brute (SBE-34CB), Trinidad (SBE-11CB), Trinidad II (SBE-30CB), Sidebender II (SBE-12CB), Sidebender IV (SBE-27CB), Console II (SBE-16CB), Console IV (SBE-28CB)

within 1977.

You send in the certificate, we'll set up the update of your unit to a full 40 channels. All, for a reasonable charge, depending on the model involved.

Simple as that.

All in all, the SBE Future-40 CB Update Program is aimed to hit those people who'd like to buy now, but are a bit confused about what's around the corner.

And thinking ahead, about what's around the corner, that's what SBE is all about.



**Better Communications through Creative Technology**

For information write: SBE, Inc., 220 Airport Blvd., Watsonville, CA 95076

INTERNATIONAL OFFICES: E. S. Gould Marketing Co. Ltd., Montreal, Canada/Linear Systems S.A. Geneva 1, Switzerland



The CB antenna has as much to do with the performance of a CB installation as your radio. The majority of CB disappointment can be cured by a good antenna properly installed and tuned. This is why we cut a Racer 27 base in half to show why

# AVANTI CB Antennas are Better!

## HERE IS PROVEN QUALITY ...

**A.B.S. (Acrylonitrile-Butadiene-Styrene)** — A tough material used to form the base of the antenna and cover the coil.

**EXCLUSIVE HERMI-COIL (Hermetically Sealed Coil)** — A special molding process provides a weather-proof coil environment. Helps maintain the characteristic antenna impedance, even in damp or salt water atmospheres. Hermi-Coil also helps eliminate internal surface leakage.

**RIBBED BASE** — Provides a long leakage path such as used in high voltage insulators, spark plugs, etc. This keeps external R.F. currents from leaking across the surface between the radiating element to ground, especially when moisture or grit accumulates on the base.

**CONDUCTOR BRAID** — Look inside the spring on our mobile, you'll find a tin plated copper braid directly connecting to the top and bottom. This assures a positive, constant value connection during spring flexure.

**100% TESTING** — Beside the regular mechanical inspection, each mobile antenna is tested for V.S.W.R. and "Q" before shipping.

### SPECIFICATIONS — AV-327

#### Electrical

¼ Wave Length Unity Gain 27 MHz  
Impedance — 50-52 ohms  
Coil — Shunt Fed Hermi-Coil  
Includes 17' RG58-U

#### Mechanical

Radiator — 17-7PH Stainless Steel  
Spring — Stainless Steel  
Whip Length — Max. 46"  
Base Material — A.B.S. — Chrome Plated Brass

WRITE FOR FREE CATALOG



RESEARCH AND DEVELOPMENT, INC.

340 Stewart Avenue,  
Addison, IL 60101

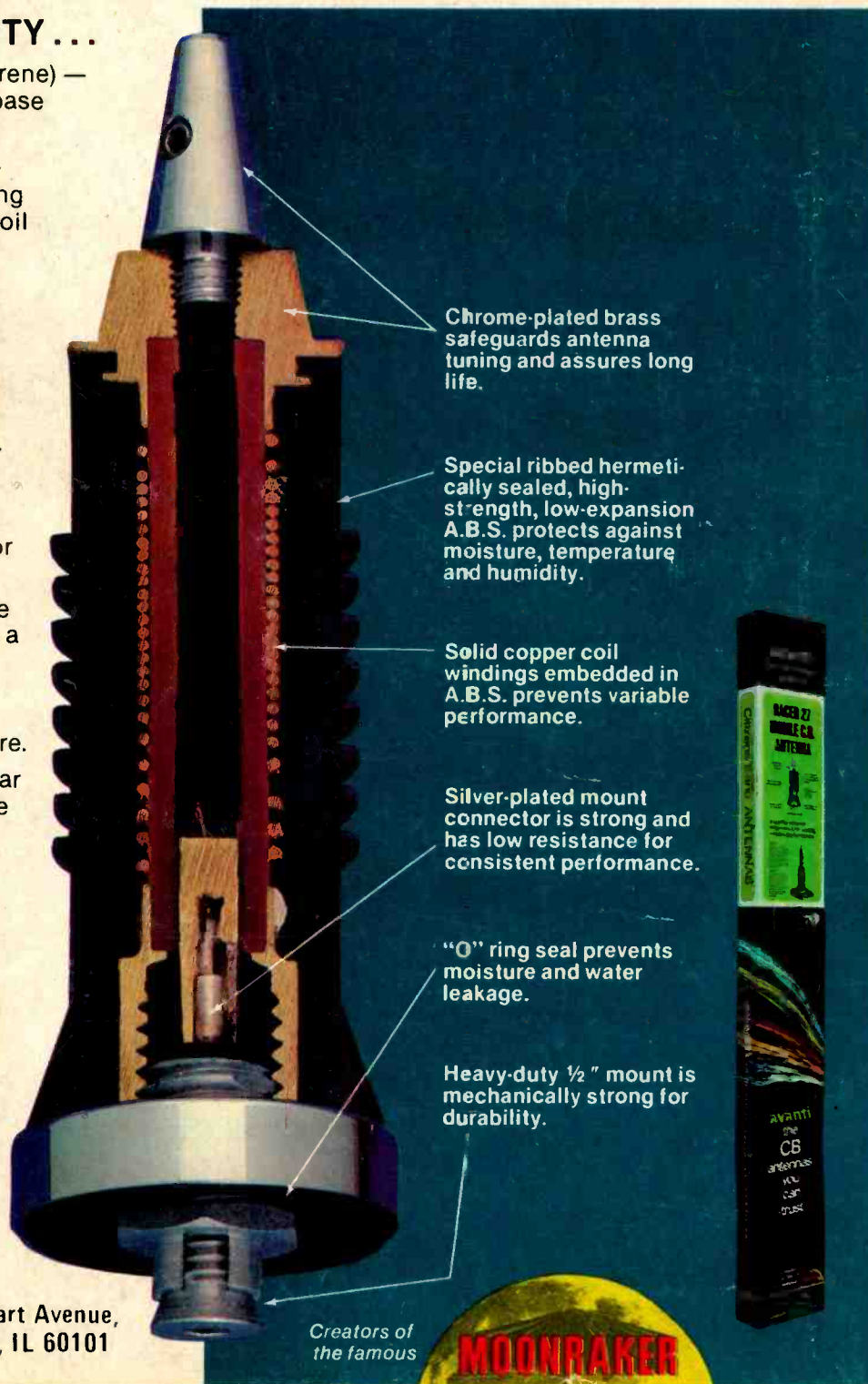

Chrome-plated brass safeguards antenna tuning and assures long life.

Special ribbed hermetically sealed, high-strength, low-expansion A.B.S. protects against moisture, temperature and humidity.

Solid copper coil windings embedded in A.B.S. prevents variable performance.

Silver-plated mount connector is strong and has low resistance for consistent performance.

"O" ring seal prevents moisture and water leakage.

Heavy-duty ½" mount is mechanically strong for durability.



Creators of  
the famous

**MOONRAKER**