

CB

AN ARGUS SPECIALIST PUBLICATION

CITIZENS' BAND

FOR BRITAIN'S 250,000 CB USERS

RIG ROBBERS
DIY alarm
system

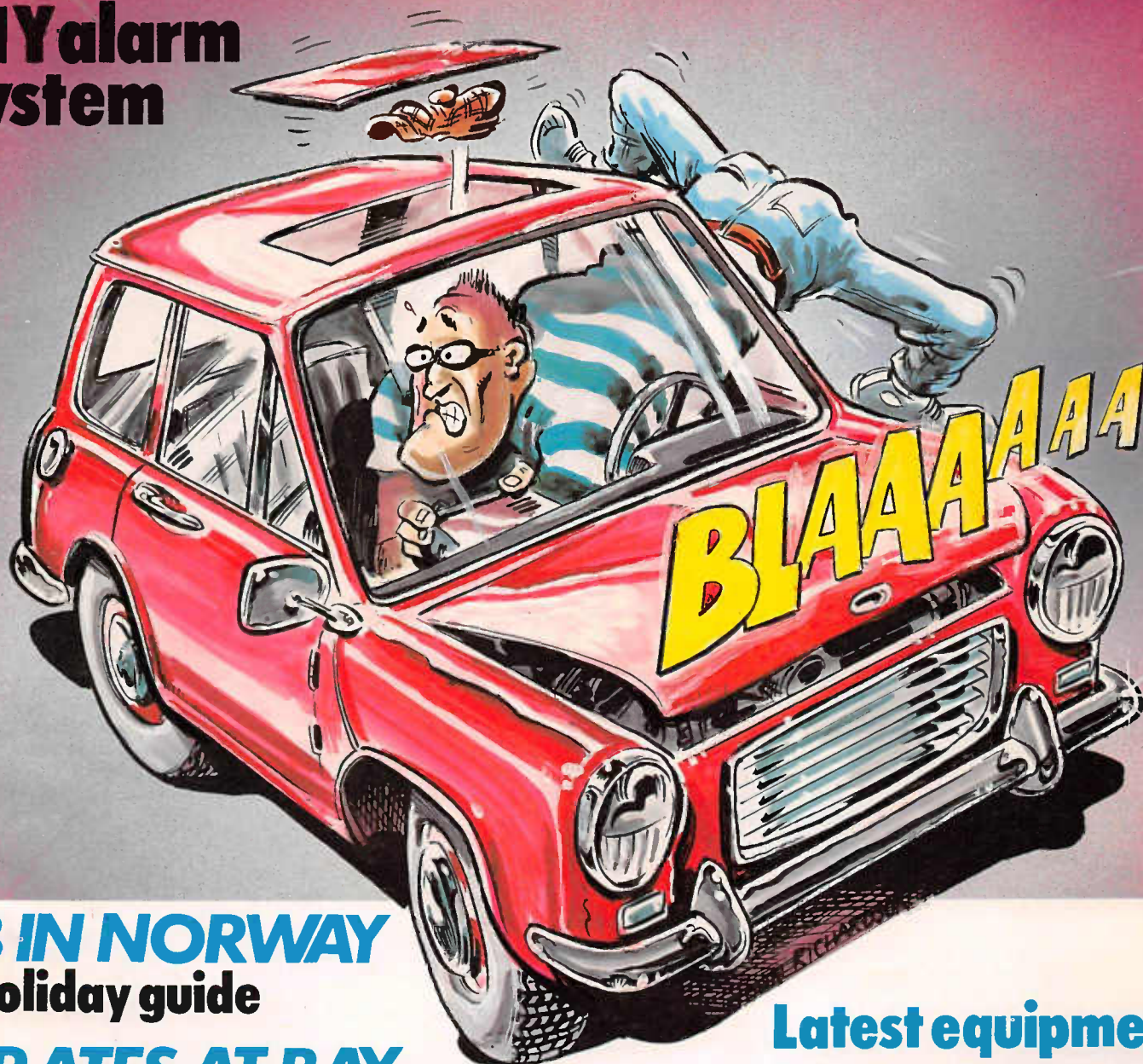

CB IN NORWAY
A holiday guide
PIRATES AT BAY
Radio anarchy

Latest equipment,
clubs and QSL news

THUNDERPOLE II & III

Thunderpole Mk II & Mk III from the UK Market leader of the fastest selling high performance legal base station antennae.

The ever popular Mk II

- Base loaded ribbed coil design on a single radiating element 1.5m long. Doubly encapsulated windings for maximum performance and all weather protection.
- Pre-tuned and requiring no S.W.R. adjustment
- Precision machined alloy base with 3 angled ground planes each 2.67m long with cross bracing, designed for maximum performance.
- Power handling 500w, frequency 27mhz, S.W.R. 1:1.5 or less.
- Base for 1 1/4" diameter. Pole mounting.

The Mk III-one step ahead of the rest

- Centre loaded helically wound coil with low radiation angle. Shrink wrapped for all-weather protection.
- Bigger diameter, radiating element 1.65m long, making the most of the latest H.O. specifications.
- Power handling 500w wide frequency band covering 120 channels, low S.W.R.
- Suitable for all models—AM, FM, SSB.
- Base for 1 1/4" diameter. Pole mounting.

Thunderpole Hatchback / Boot Mount

No drilling or soldering necessary, standard 3/8" UNF. Thread mounting adjustable angle with positive non-slip action.

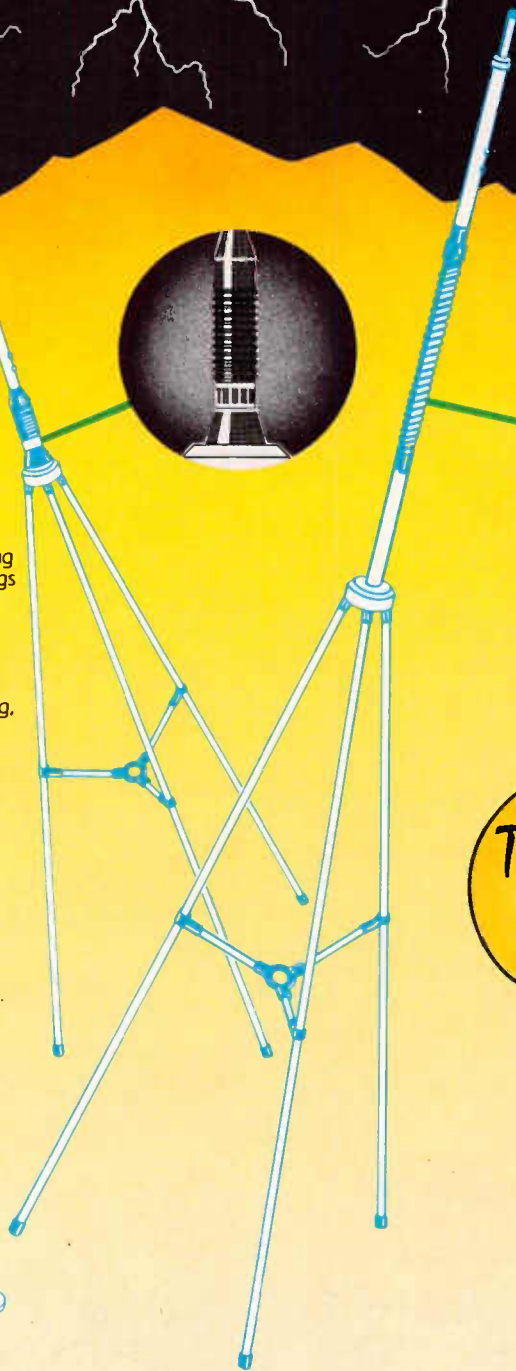
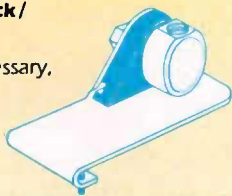

THUNDERPOLE
Simply the
Best!



THUNDERPOLE ANTENNA U.K. LTD.,
a subsidiary of Freeman & Pardoe Ltd.,
Tything Road,
Arden Forest Industrial Estate,
ALCESTER, Warks. B49 6ES.
Phone: Alcester (0789) 762673.

Ask for Thunderpole at your local stockist

THE THUNDERPOLE design and name are registered trade marks of Freeman & Pardoe Ltd.
©Freeman & Pardoe 1984/1985/1986.

CB

CITIZENS' BAND

April 1988

Volume 6

Number 5

C O N T E N T S

ISSN 0261-0361

Editor Eamonn Percival
Group Editor Chris Adam Smith
Ad Manager Chris Harris
Copy Control Jayne Penfold
Design ASP Art Studio



Update 6

Latest news and products from the CB world.

Back Chat 8

Readers' postbag to let us know your views and opinions.

Pirates at Bay 22

A look at the naughty boys in the communications world.

End of an Era 12

We bid a fond farewell to the DTI's Barry Maxwell.

CB Crossword 21

Pit your wits with this CB teaser.

CB in Norway 36

A special holiday guide for a Norwegian CB vacation.

Over the Air 10

Shepherd Man returns with some charity news.

CB in Depth 30

The conclusion of Paul Coxwell's exhaustive articles on CB.

QSL 17

Card sharp time again with David Shepherdson.

DIY Rig Protector 26

An inexpensive burglar alarm for your rig.

Truckstop 38

More opinions about big-wheelers, plus a few namechecks.

Lady Breakers 15

Willy-nilly silliness from Filly.

Citizens' Band Magazine A.S.P. Ltd., 1 Golden Square, London W1R 3AB. Telephone 01-437 0626. Typesetting by Multiform Photosetting Ltd., PO Box 88, University Place, Spott, Cardiff Tel: (0222) 462320.

Printed by Loxley Brothers Ltd., Aizlewood Road, Sheffield S8 0YS. U.K. newtrade distribution by SM Distribution Ltd., 16-18 Trinity Gardens London SW9 8DX. Tel: 01-274 8611.

Overseas sales and non newtrade sales by Magazine Sales Department, No. 1 Golden Square, London W1R 3AB. Tel: 01-437 0626.

Subscription Department: Infonet Ltd., 5 River Park Estate, Berkhamsted, Herts HP4 1HL. Tel: 04427 76661-4. U.S.A. Subscription Agent: Wise Owl Worldwide Publications, 4314 West 238th Street, TORRANCE, CA90505, U.S.A.

NEVADA

Formerly Telecomms

934 Mhz PERSONAL RADIO EQUIPMENT

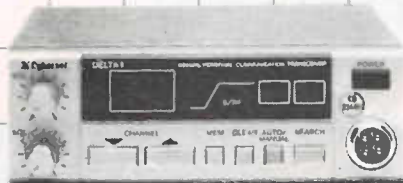

NEVADA HL 910R MASTHEAD PWR/PRE AMP

Gives the full legal 8 watts at the masthead from an in-built power amp plus an ultra-low noise pre-amp for ultimate receive performance.

£199



CYBERNET DELTA 1 934 Mhz TRANSCEIVER

A super sensitive set with many added features.

£365

+ £5 DELIVERY
H.P. AVAILABLE

(SUBJECT TO STATUS & DEPOSIT (A.P.R. 36.9%))



UHF MASTHEAD SWITCH MODEL CAS-A2

Using 'N' type sockets to reduce losses this unit allows remote switching of antennas on the mast - fed from one coax cable

£49.95

OUR NEW 1987 BUMPER CATALOGUE CONTAINS MANY PAGES OF 934 Mhz INFO AND PRODUCTS. SEND IN £2 AND RECEIVE THE CATALOGUE PLUS £2 VOUCHER.

ACCESSORIES

P7M-E Mag Mount 7 dBi Antenna	£55
P714R-E GTR Mount 7dBi Antenna	£49.72
PA7-E Base Colinear 7dBi Antenna	£67.75
TC12L 12 Element Beam 18dBi Antenna	£45
HRA 934L in line Pre-amp	£139.95
HRA 900 Masthead Pre-amp	£147.80
WR 900 SWR/PWR Meter	£54.72
HP 5900 Deluxe SWR/PWR Meter	£89.95
WELZ 2 Way N Switch	£42.32
UHF1200 25W Amp (For Lossy Feeder Pairs)	£99.00

SADELTA MICROPHONES

BASE MICS

BRAVO PLUS

Base power mic with crisp and punchy audio including modulation meter and roger beep.

£49.16

MB30 PLUS

An economy version of the Bravo Plus without meter and slide control.

£36.14



ECHO MASTER PLUS

Probably the UK's most popular base echo mic. A mellow but powerful sound with dual tone roger beep and internal 9 volt battery

£69.95

NEW HAND MICS

ME3 ECHO MIC

The same superb quality as the Echo Master Base mic.

£35.36

MP2 POWER MIC

Housed in a lightweight super Hitec case. This mic gives a clean powerful audio.

£22.41

MB4 ROGER BEEP MIC

Same spec as the MP2 but with switchable roger beep facility.

£22.95

MRI REPLACEMENT MIC

Replaces those old fashioned bulky mics. This one is light and easy to hold.

£15.85

EFFECTS UNITS

SUPER PUNCH BOX

A parametric tone circuit enables super punch to be obtained from any normal mic.

£43.47



EC 980 ECHO UNIT

Puts the famous Sadelta echo onto any mic of your choice.

£49.95

AMATEUR AMPLIFIERS

TC35DX 30W Mobile (26-30Mhz)	£24.95
TC50DX 15W Mobile (50Mhz)	£29.95
B150 150W (26-30Mhz)	£55.74
B300P 400W (3-30Mhz)	£148.00
B299 300W (3-30Mhz)	£116.00
B507 600W (3-30Mhz)	£299.00
767 150W Mobile (26-30Mhz)	£49.90
737 80W Mobile (26-30Mhz)	£44.76
A300 300W Mobile (26-30Mhz)	£129.00

WE STOCK A FULL RANGE OF AMATEUR RADIO EQPT. SEND IN FOR OUR CATALOGUE, FOR FURTHER DETAILS

BREMI BACK IN THE UK!

POWER SUPPLIES (To Full B.S.I. Spec.)

BRS 27 3/5 Amp	£19.95
BRS 31 5/7 Amp	£29.95

MISCELLANEOUS

BRL 210 Mains Amp	£119.03
100 Mhz Freq Counter	£74.00
150 Mhz Freq Counter	£79.00
BRC 22 1 KW Wattmeter	£39.95

MULTIMETERS

BRI 5080 20k Multimeter	£25.95
BRI 5085 50k Multimeter	£29.95
BRI 5090 33k Multimeter	£29.50

K40 PRODUCTS

K40 DYNAMIC MICROPHONE

Housed in a rugged case with extra heavy duty cable and magnetic back clip.

£16.95



K40 MOBILE ANTENNA

Probably the best selling CB antenna in the world.

£42

K40 SUPER MAG MOUNT

£14.66

(£2 p+p)

PLUS ALL THE SPARES TO KEEP YOUR K40 GOING

HOTLINE (0705) 662145

THE U.K.'S LEADING DISTRIBUTOR

ALL ITEMS ARE AVAILABLE FROM OUR MANY U.K. DEALERS OR DIRECT

**USE YOUR CREDIT CARD
FOR IMMEDIATE DESPATCH**

VISA

AMERICAN EXPRESS

Access

NEW LOW PRICES FROM UNIDEN



UNIDEN 400
(C.E.P.T.) RADIO
NOW ONLY
£99.95

UNIDEN 300
Base Station
Standard 40 channel
radio
NOW ONLY **£149.95**



NEW (C.E.P.T.) RADIOS

ZODIAC M244
One of the most comprehensive sets
available. Features include:- Scan,
Priority Scan, Local/DX, Rx
Sensitivity, Mic Gain, PA/CB
Facility, Selcall
Optional Extra. **£227**

ZODIAC P2040
A fully professional handheld
housed in a rugged metal cabinet. A
truly versatile unit with provision for
external antenna, speaker, mic and
power supply. These sets have
been used by the
army in Sweden. **£199**



DNT CONTACT 40
A super slimline radio with channel
control on
the microphone. **£89.95**

27Mhz
MASTHEAD SWITCH
MODEL AS-HF2
Now you can run two antennas from
one feeder by using this switch to
select them at
the masthead.
Power: 400W P.E.P. **£39.95**



☆☆☆ SEND IN NOW ☆☆☆

FOR OUR NEW BUMPER CATALOGUE

Packed full of the latest products
and full info on all out CB,
Amateur and 934 Mhz
equipment.

☆☆☆ ONLY £2 ☆☆☆
(Includes a £2 Voucher)

THE UK'S SCANNER SPECIALISTS

NEW MODELS AND
LOWEST PRICES FROM
UNIDEN BEARCAT



MODEL BC 50 XL
Handheld scanning receiver
with 10 memories.
Covers 66-88MHz,
136-174MHz, 406-512MHz
£99.99

MODEL 100 XL
HAND HELD
Scanner with 16 channels
memory scan covering
66-88MHz, 118-174 Mhz,
405-512 Mhz
Super sensitive receiver.



£199.99



MODEL 70 XLT
New pocket size scanner
with 10 memories
66-88 Mhz, 118-174 Mhz,
405-512 Mhz.

£229

BLACK JAGUAR
POCKET SCANNER

Switchable AM/FM. Covers CB
plus the following frequencies
26-30MHz, 60-80MHz, 210-260MHz,
115-118MHz, 410-520MHz.

ONLY
£225



MODEL 175 XL BASE
Scanning receiver with 16 channel
memory scan covering: 66-88MHz,
118-174 Mhz, 405-512 Mhz.

NEW LOW PRICE
£189.99

SCANNING
ANTENNAS
CTE DISCONE
WIDEBAND ANTENNA

Receive: 70 - 700 Mhz
Transmit: 70 - 500 Mhz
Power: 500W
8 Element High Quality

£26

SSE DISCONE
RX ANTENNA

70 - 500 Mhz With 3 Elements **£24.95**

BASE ANTENNAS

TC52 1/2 wave 1KW	£19.95	SPITFIRE 3 Ele Beam	£46.45
TC58 3/8 wave 1KW	£29.92	SPECTRUM 200	£79.95
SALIUT 27 3/4 wave	£68.00	SKYLAB U.K.	£24.00
		SKYLAB	£24.00

NEVADA

189 LONDON ROAD PORTSMOUTH HANTS PO2 9AE



UPDATE



Editorial

Upon flicking through the pages of this issue, I am sure you will notice the we have finally reached the end of Paul Coxwell's superlative series on CB in Depth. I would like to personally thank Paul for his sterling work in producing this lengthy piece, which I rate as the definitive work on the innards of a rig. I am not alone in believing this, as countless readers have written to praise

Caman Beval

Sponsored Shave

Cross Breakers are organising a charity event, in aid of the Meningitis Trust. It will take the form of a total head and beard shave. Victim of this massacre is the well-known and much-loved Chris (Grizzly) from Gloucester.

At the Cheltenham eyeball, at The Swan Inn, Coombe Hill on May 8th, Grizzly will be set upon with a razor and is willing

the work. If you are one of the few readers who do not keep their magazines for longer than a year, why not cut out these pages and keep them in a folder for future reference?

Thanks are also in order to the Norwegian Tourist Board for their help in providing photos of our special holiday guide. A nicer bunch of people you couldn't wish to meet.

Sadly, we bid a fond farewell to Barry Maxwell of the DTI this issue. Barry is going onto bigger and better things and he will be sorely missed in the CB world.

Last but not least, I would personally like to raise a couple of digits to a certain CB distributor who, in a very abusive telephone call, described your favourite magazine as "a comic, a rag", and who would "give it about two months before it folds". These are exactly the same words he uttered to me over three years ago — and we're still going strong, mate!

to have the whole lot removed in aid of this very worthwhile cause. Of course, Grizzly wants to make a lot of money for this charity, and so asks you all for your sponsorship. Well known on the DX and eyeball circuits, Chris should have been heard of, if not met. It will certainly be a shock to the system to see him doing a 'Kojak' impersonation on this year's circuit. The only

problem is that he will probably have to change his handle, (he certainly looks like a Grizzly at present). Those of you who would like to sponsor this event, please contact Cross Breakers at P.O. Box 15, Radstock, Avon. All sponsorship and donations will be very gratefully received on behalf of the Meningitis Trust. Please give your support for this very worthwhile cause. The more money that Chris can raise means a quicker cure or vaccination found for this killer disease. Get your cheque books out, and send in some cash.

Ham Club Closes

Due to the pressure of running his own business, Martyn Bolt has, unfortunately, had to close the books on the Ham International Radio Club.

Martyn attempted to find someone to take over the club without success as he has a few items of club stock left (rubber stamps, embroidered patches etc). He is now selling these at 60 per cent of retail value so, if anyone would like a souvenir of the group, a stamped addressed envelope will bring the latest list and a copy of Barter News, his listing of used radio equipment. Write to: 112 Leeds Road, Mirfield, West Yorkshire WF14 OJE.

Sixth for Sierra Tango

News has just started to filter in about the Sierra Tango DX club's sixth annual eyeball which is to be held at the Robin Hood Camp, Coast Road, Rhyl, North Wales on

the 9th, 10th and 11th September.

Chalets are available in either two, four, six or eight-berth formats and the club would like to point out that, after a few problems last year, children will be made welcome *this* year. Anyone wishing to book chalets or stalls should either write to PO Box 8, Rhyl, North Wales, or telephone Rhyl 54207 or 50161.

Inkford Brook Breakers

The Inkford Brook Breakers Club, based in Birmingham, have asked us to let readers know of their existence — so here goes. The club has been going for 13 months and is both a DX and a social club. They welcome new members with ideas for club activities. Contact the Secretary, PO Box 1022, Hall Green, Birmingham B28 OYB.

New Dates for HEDS

In the March issue of *Citizens' Band*, we carried an announcement about the 1988 Home Entertainment Dealer Show (HEDS), to be held at the Birmingham National Exhibition Centre. The dates for the show have now been changed.

HEDS will now be held from August 16-18, a Tuesday to Thursday period, as opposed to the originally announced May 8-10, a Sunday to Tuesday slot. Explaining the date changes HEDS' Director Tony May, of the NEC's Exhibitions Division, said: "We have taken full cognisance of a special dealer survey, soon

to be published by 'Video Week' magazine, which shows categorically that the most popular venue and date is Birmingham in the Autumn.

"May was never our ideal choice for HEDS '88 but projected availability of space at the NEC limited us to specific dates and a specific hall. After studying the 'Video Week' survey we approached the NEC again and were delighted to be offered appropriate Autumn dates, previously not available".

Mr. May emphasises that the original concept of HEDS would remain the same but that because of the increased space available a number of extra special features will now be incorporated "making the

show even more varied and interesting".

As the new dates mean HEDS will now be held in a peak school holiday period, one of many special features is likely to be a purpose-built children's viewing theatre; possibly sponsored by a major video distributor.

Reiterating the original reason for launching HEDS, Mr May added; "As well as providing visitors and exhibitors with a many-faceted catalyst for improving communications and dialogue between dealers and manufacturers, the show also gives the home entertainment industry the opportunity to increase its European and worldwide market and status".



New Mikes from Midland

Two new microphones have recently been introduced, manufactured by CTE International in Italy with the Midland brand names.

Both microphones are unique to the CB market since they are the first to use a luminescent material. On both, the PTT switch, volume control and microphone

holder glows in the dark. No more fumbling around at night for your mike!

Both mikes are part of CTE's new high-quality line of accessories being introduced in the coming months.

The F10 pre-amplifier microphone will sell at £14.95 and the F14 power/roger bleep mike at £24.95. Our thanks to Nevada in Portsmouth for the information.

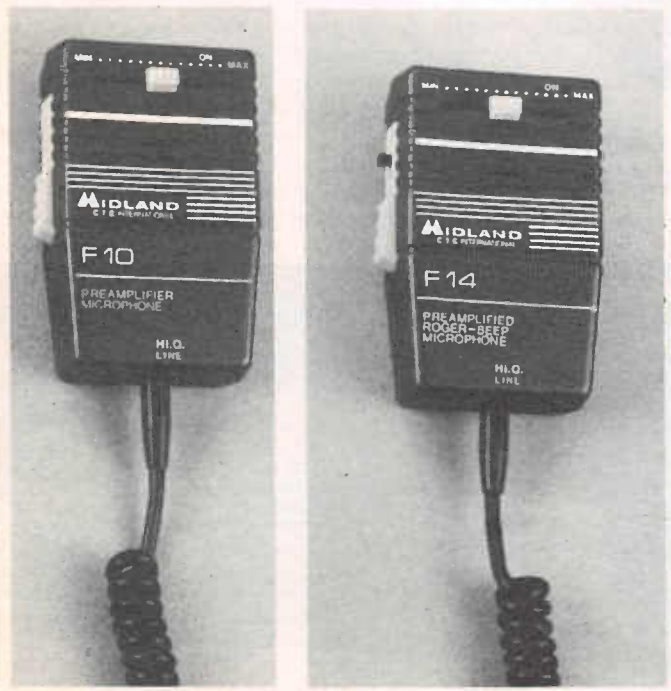

MERCIA QSL CLUB (COVENTRY)

Mercia Charity Night

Mercia QSL Club (Coventry) are holding a charity fund-raising night in memory of their much-loved, late Chairman, Folksinger (Brian Sunderland) who passed away suddenly in November '87. It was one of Brian's dearest wishes that the club raise money for Birmingham Children's Hospital, much publicised at present.

It will be held in the upstairs room of Coventry Transport Club, corner of Stoney Station Road and Cambridge Street, Coventry at 7.30pm on Saturday 19th May. Events planned include a disco, Miss Mike Quebec 1988, a 'throw 10p and the nearest to the whiskey bottle wins it'

competition, a Dutch auction, a raffle and the highlight of the evening — Big Daddy Tom and Speedy Bee Terry — who have agreed to lose their much-loved beards for £100. No-one can remember seeing Tom without a beard, so it may be a great shock, especially to his wife, Chris (Paper Lady)!

The whole evening should be a fun night out, created especially to make you part with your hard-earned cash. Entrance is 50p on the door, so there is no need to book tickets. If you can't go, then please feel free to send your donations to Mercia QSL Club, P.O. Box 158, Coventry, CV6 6BD. All proceeds to go to the Birmingham Children's Hospital for much needed equipment.

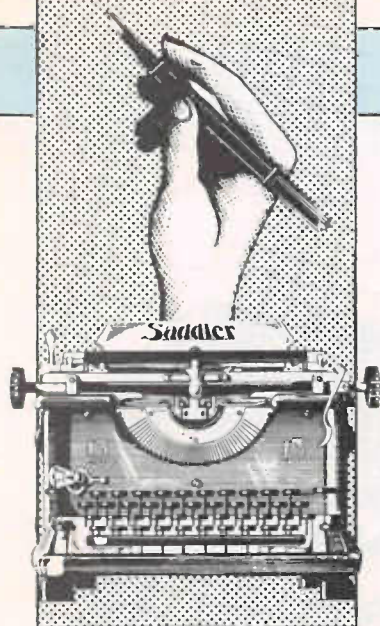

BAD BUDDY?



Bad Buddy?

The wonderfully named Giramondo lives in Cheltenham and has a nice line in subtle humour...

Further to the picture printed in Citizens' Band magazine (page 23, February 1988 issue) showing a gentleman monitoring traffic conditions on a by-pass and reporting to the CB users thereupon: Whilst I appreciate that the location is not necessarily within the UK jurisdiction, I wish to draw attention to the contravention of item 10 which I read on the back of my Citizens' Band Radio Licence (expiring 07/88).

I grant that his heart is no doubt in the right place and that he is making every effort to be helpful, in the tradition of "A

Real Good Buddy". However, such acts, especially when witnessed by the general non-discerning public, are liable to misinterpretation. As such our pastime can so easily be brought into ill-repute and be frowned upon.

In the interests of good public relations will you be so good, next time he makes a circuit, as to *Dell* him that he has in fact become a law-breaker?

Thanking you in anticipation of your most kind inattention to this not-so-significant salient point.



"... A CAMEL HAS SHED ITS LOAD ON THE BY-PASS - BUT THEN IT'S ALL CLEAR THROUGH TO BAGHDAD."

filters, and personally I would not buy a new rig unless it incorporated the various mods that have been devised over the past few years to improve performance, I am certain that the 404 does not contain any such refinements, as the supplier would make a sales pitch on these to justify a £30 to £40 higher price.

The article actually states that this rig is a well thought-out middle range model and this has prompted me to again look for a top-quality model but I can't find anything on the market which claims to be better and is in fact better.

The average CB rig is, in my opinion, a very poor example of modern radio technology and is made to a price and one only gets what one pays for but for those of us who want the best and are willing to pay for it cannot seem to find anything; or at least I cannot. The DTI has much to answer for this, as who is going to produce a range of special sets just for the British market?

The Zodiac M244 would appear, on the face of it, to be a step in the right direction but I know of no-one who does a sale or return on such items, therefore I and others are going to have to wait a long time for the word to get around to tell us if it is any good or not, unless some enterprising supplier can produce an independent performance report. These

Wary and Unsure

Newboy writes from Essex and appears to have some doubts about the latest on the market...

No doubt the D-Day Rig article was read with interest by many breakers, but unfortunately it told me little or nothing and certainly not enough to encourage me to spend an over-the-top price for a rig which can be no different to the now-called older rigs of a slightly higher frequency as there was nothing in the article to even suggest that the PC-404 (400) is any improvement on the 200.

The 200 is a very good rig but only after the local doctor has fitted active crystal



Bad Buddy:: Dodgy Dealers:: Whoops:: Wary and Unsure

things must even now be available as the models are only new to this country, and must have been written up abroad, and suppliers should note that there are many who would pay good money for good tests, and, as far as the M224 is concerned, the first supplier who can prove to me that this is the best would get my order.

Please do not think that I am knocking the review, as any information to the CB user is most welcome, and we have been out in the cold long enough as far as the radio fraternity is concerned — especially the RSGB who refuses to acknowledge that we exist (I resigned when I found out that they do not even permit CB advertising) but we have noticed that the biggest TVI offenders are RSGB members with souped-up CB sets and twigs. One only has to listen to their broadcasts to realise that something more than the normal rig is being used.

Dodgy Dealers?

Furniture Man, from Holyhead, wants to get a few things off his chest...

I am writing to complain about the Editorial which appeared in the February issue, volume 6, number 3, in which you said "What's gone wrong? Is the equipment too expensive?". My answer to that is, yes far too expensive for what it is. You are forgetting that these frequencies have been around for a long time, it is only now that we have been allowed to transmit on them legally. Do you remember the old sidebands and AM? Well, they are still transmitting and they are still knocking the FM frequencies to bits. The difference between the new frequency and the old frequency is that the new one will get hit harder than the old one.

To answer your next question "Are we all too afraid to invest in what many must think of as a white elephant?", the answer is no, it is not a white elephant. It can get out very well. I have a friend George the Ground Plane on Anglesey, who can get



out very well on the new frequency when the conditions are right. He has had Holland, Germany, Switzerland and Poland. Even I have had Switzerland, so you see you really can get out. I have just a few things that I would like to mention about CB Magazine, and this is the advertising on new CB radios, especially the Alpha 4000 and the Alpha 4002 from Germany. They look exactly the same as the Rotel RVC 240 and the Rotel RVC 220. How can they justify the price of the rigs when I bought my RVC 240 for just £20 new? And so did a lot of my fellow CB'ers, and that was only 2 years ago when a SuperStore in Holyhead bought a job lot and sold them to us. Since then we have had to rely on Mail Order or very long journeys to CB Cabins.

Which brings me to aerials like the Sirio 2012 of Italy, GPA 1/2 wave, Black Shadow 1/2 wave C.T.E. Spectrum 2001 and the C.T.E. Spitfire 3-element beam which are all illegal for 27 use. Why are these for sale in your magazine? Why can't we have more legal aerials for 27 instead?

Point taken, Furniture Man, but (a) we, as a magazine, have no control over prices of rigs and other equipment set by distributors/dealers and (b) as yet, it is not illegal to carry advertisements for the antennas you mention. Although - note well - it looks as though legislation may be passed soon to prohibit same.

Whoops!

Two letters now, from eagle-eyed readers who spotted a not-so-deliberate mistake in our January issue. The first is from Atlantic Swimmers from Chorley, the second from Arthur from Romford...

In the January 1988 issue, there was an article called *Talking Tartan*. It was three pages long and showed (in red) six graphics — all the same — of a castle. What's so bad about that, I hear you say. Well, I shall tell you. It is, in fact, Caernarvon Castle which, surprise, surprise, is in North Wales.

Is there a reason for this? Maybe the Scots love it so much and have built a replica, or that the Welsh don't like it and have let the Scots have it — or maybe you made a mistake.

I probably won't be the only person to notice this so I thought I'd let you know. Apart from the odd mistake which anyone can make, I would like to congratulate you on a superb magazine.



It is a well known fact that the best people Wales has produced are often to be found in England, but aren't you going a bit far by giving away Caernarvon Castle to the Scots — not once but six times as you appear to be doing on pages 28, 29 and 30 in your January issue?



OVER THE AIR

Shepherd Man reports on some recent charity successes

Whilst having a natter to Eamonn (ED Cit'Band) the other day, he informed me that Mack The Hack had decided to call it a day and stop writing for this magazine. It seems that Malcolm has, in his words, "dried up" on information. Now, for many readers including myself, he will be missed and although some readers might not agree with this, he has in the past years been of great interest to many Cbers and played a big part in this magazine. I would like to thank him for all that work and wish both him and his family the very best for the future and I am sure that he will write the odd piece in the future.

I am always interested in reading local club and group magazines and newsletters, so if anyone wants to send me a copy of them I would be very pleased to receive them. I know that these publications rely on others to send them information, so please give them every support. Sad news from Snapshot (Chris); he is thinking about giving up the publication of CB Newsletter as he is finding it very hard to get any information from breakers and clubs. I only hope that he will continue, and that he will be given

the support that he deserves.

As was to be expected, some breakers are now changing over to the new frequencies and this has meant that many users are finding it harder to get the 'long distance copies' that we have become accustomed to. Although these breakers are not changing in droves it has brought with it the problems that we have all come to expect from UK FM (Muppet Mode). Many breakers had been hoping to get a 'clean' frequency and the chance to use CB in a better way. To those who are changing I would ask on behalf of those who are already there, please respect the new frequency and your fellow users, so that we can all enjoy its use. We do not need the music-players, those who use foul language and those who talk on the 09. In fact it may be the right time for the RIS to take an interest in the users, and put paid to those who abuse the laws, before it gets too overcrowded. At the risk of upsetting many users, I think that it is a shame that the prices of these CEPT sets are now going down.

Anyway, what do you think of the new frequencies? Many people are now expressing great interest in the thought of having a "legal" SSB system in the future and I am sure that other readers would like to know your thoughts. What about some sort of test?

Like most things to do with the radio world CB is not without its problems. Many of you will of course know that 'only type-approved sets' can be used on CEPT. To which, I would ask all those who are intending to buy new sets, check with the DTI for the 'Approved' ones. Some shops and outlets are telling breakers all sorts of stories in an effort to get hold of your money. As another check, get the shop to do a 'power output test' on new rigs, as many new frequency sets have been found to only push out between 2 and 3 watts total. If you have been sold a set as 'Type-Approved' and

it's not, or you have another problem, contact your local trading Standards Office and explain the problem. You are covered under the 1968 Act. However, you should first of all take the set back to the place of purchase and explain any problems. They should then offer to exchange the set for another 'Approved' model or refund your money *IN FULL*. Remember that we have the ultimate power — and these shops and outlets rely on giving good service, otherwise they will go out of business.

It is always surprising to find the ways in which breakers around the various parts of the country use CB. That is, apart from the obvious ways. On my travels around various parts I have found some breakers playing games such as 'noughts and crosses', 'chess' and even 'battleships'. But one of the funniest has to be a form of 'University Debate'. This consists of a chairman and four main speakers. Two 'for' the debate, and two 'against'. Then a selection of 20 local breakers who vote on the final outcome after the four speakers have said their piece. The range of subjects are endless, and you can have a lot of fun — with the most obscure of subjects. But, remember to limit the total amount of time per subject.

Or perhaps you can try a 'general debate', where you appoint a chairperson and a number of local breakers (say 20) and, via the chair, talk about a given subject. In this you can raise a point and object to matters raised. Although, please remember to keep it light-hearted otherwise you could end up losing a few friends. It is best to pick a good chairperson - one who will keep the flow going and pick up on certain points. Maybe if you all belong to the same CB Club you could put the ideas into a hat and draw them out in order, and work you way down the list. For the best results try and think of silly things that you know many others will enjoy — remembering that you will attract a very large number of listeners. Well what sort of games do you play? Let us know and we will print yours.

As we start into another year, let's hope for a better one. Many groups, clubs and organisations are making plans for events. So how would you feel about inviting the DTI (RIS) to attend these functions? Not to bust people but to meet the breakers and have a chat. Maybe to even offer advice and give out the CB Information Sheets etc. I am sure that they would gain a lot of respect from some breakers, and even obtain the odd piece of information about some of the local "muppets". In fact, Miss Dilys Gane (Director of the RIS) has said that she has no objections to her people attending functions — provided that you contact the local office and that it does not interfere with any of their other duties. So what do you think? Does this sound like a

good idea? We are forever moaning that we can never get to meet these people — so now is your chance. They must be able to attend *some* functions!

I know that one or two clubs have decided not to hold their annual eyeballs and other events this year, because of the costs involved. So why can't a few of these clubs get together and put on one big event. This way, and with some thought, they could even plan bigger events — maybe turning them into weekend events, with a place for people to camp out overnight. Or how about an all-night eyeball. This could be good fun — in the dark! Has this ever been tried?

News just in of the "Sixth Annual Cycle Ride" from Richmond (Surrey) to Brighton on Sunday 14th August 88.

Many breakers will know this one as the "Poppy Run". The aim is to raise money for the Royal Star and Garter Home for disabled soldiers and airmen (reg charity). It is run by the 2LO Radio Club, and you can get sponsor forms or enter the ride by contacting them through: 2LO Poppy Run 88, PO Box 50, East Molesey, Surrey KT8 9QH. The annual "Auchenlarie Eyeball Weekend" will take place from 29th April to 1st May 88. This is a very big weekend in Scotland and worth the trip. To book a caravan, stall and get other details, contact Cree Valley Breakers Club, PO Box 1, Wigtown, Scotland DG8 9HA.

The first 'International CB Meeting' organised by The Smugglers & Bexhill Renegades will be on the 5th & 6th March 88, at the Graville Hotel, Sea Road, Bexhill-on-Sea, East Sussex. Accommodation details, stalls and tickets etc can be obtained by applying to: Meeting Organiser, PO Box 139, Bexhill on Sea, East Sussex, TN40 2AF.

MAD DXers are holding a Barbecue and Eyeball 5th June 88 at the Forest of Dean. They are also holding a Mass CB Rally at Landsdown Racecourse, Bath, on 11th September 88. Overnight camping is available at both events plus much more besides. Contact PO Box 12, Kingwood, Bristol BS15 5DT for further details.

The Warminster Eagles DX Club proudly offer CBers the chance to attend their 3rd Annual Eyeball at Longleat Safari Park (not in with the lions I hope!) on 31st July 88, where there will be lots of games to play and stalls to visit, as well as a visit into the gardens (included in the ticket prices). More details from: PO Box 13, Warminster.

The 2nd Tripe City Breakers Eyeball is on the 27th August 88 at the Barton Equestrian Centre (3 miles North of Preston). It is an undercover venue with facilities for stands etc. Please get in touch with: Flying Haggis, 217 Queens Road, West Church, Accrington, Lancs.

Solway Pirates have moved the dates for their annual eyeball, because it

clashes with another large event. CB 4 The Blind in Brighton are having their eyeball again this year. These dates and others will be printed as soon as they are confirmed. Esk Valley Breakers are doing a sponsored Modulation on the 7th & 8th May, a sponsored 8½ mile walk on 22nd May and a 36-mile cycle ride on 5th June, in aid of Highbank Old People's Home in Dalkeith. They are offering some prizes on the modulation and they would welcome sponsorship support from others. More details from: Esk Valley CB Club, PO Box 5, Bonnyrigg, Edinburgh EH19 3HQ.

Another group looking for sponsorship is "The First Monitoring Service of Great Britain (voluntary organisation) — CB 4 The Blind (Brighton) & Guide Dogs for The Blind Cycle Ride". It takes place from the 1st to 4th of April 88 and the select team of six (unfit) CBers will attempt to cycle 250 miles. For further details contact: MSGB c/o School House, Meadway School, Littleton Street, London SW18 3SZ. Both CB 4 The Blind & Guide Dogs are registered charities. Many CBers play an important role in helping others throughout the year and, without your support, many needy people would be found short of finances.

Lastly, have you heard the new name for "Yuppies". It is "Lombards", it stands for: Lots Of Money But Are Right Dickheads (sounds like some breakers I know!).

by

GUILDFORD COMMUNICATIONS



934 Mhz preamps

Masthead £99.95 in line £84.95

SUPERIOR Performance

GREATER Sensitivity

LONGER Range up to 14 Db gain

34, Aldershot Rd, Guildford, Surrey, GU2 6AF
Tel: 0483/574434

Serving CBers since 1979 S.A.E. for 1000 item price list
TRADE ENQUIRES WELCOME

Barry Maxwell has worked within the Department of Trade and Industry for over 20 years, during which time he has held a number of senior positions, the most recent of which was as Head of the Radiocommunications Division's Licensing Branch. In more than four years in this post he has seen many changes in the regulations surrounding the varied types of radio licence, including CB, for which his department was responsible and many of the relaxations which have reduced the burden of red tape which once accompanied the CB licence have come about at his suggestion. Now Mr. Maxwell is moving on to pastures new but before he goes, he has agreed to give *Citizens' Band* the lowdown on just what it takes to regulate Britain's complex communications networks.

Barry came to the Radiocommunications Division, then the Radio Regulatory Division, in October 1983. He was among the first batch of DTI officials to take over what had, until then, been a department of the Home Office and, like many of his colleagues, he found the Home Office procedures which he had inherited something of a culture shock. To use his own words: "I found myself in charge of about 30 people and responsible for more than 100 different forms of radio licence. Some of them, such as research establishment licences, were so obscure that they took up hardly any time at all. Others, particularly CB, affected literally hundreds of thousands of people so that someone had to deal with them on a full-time basis. At that time, the recognised CB service was less than two years old, and, before I had even got the feel of the place, I found myself embroiled in picking

up the threads of its first ever licence review, which had begun shortly after we arrived".

Within days of taking up his post, he was faced with a barrage of submissions to Ministers, Parliamentary Questions and correspondence about licence changes. He told us: "I had to learn the regulations as quickly as possible in order to appreciate the likely effects of the many changes that were being urged upon us. It wasn't easy but I have always felt that it gave me an unequalled insight into both the needs of operators and the sometimes difficult task of reconciling them with the requirements of the law. It is often one thing to know what you expect from a new rule and another to see its implications once the legal beavers have finished interpreting it, so that we had to be most precise in the way that changes were proposed".

The result of these first few weeks of

END OF AN ERA

Keith Townsend bids a fond farewell to the DTI's Barry Maxwell



hectic activity appeared in November 1983 and included the introduction of a minimum licensing age, direct supervision of younger operators and the recommendations for the emergency use of channel 9, incorporated in the CB Code of Practice.

Consultation

Returning for a moment to thoughts of those first days, Barry explained: "I was the first member from within the DTI to transfer to the RRD after its move from the Home Office. I came from an environment where consultation with outside bodies was a natural way of life. I sensed that the consultation environment had only just started as far as CB was concerned but it is very necessary for Government to have an active dialogue with industry and users. The best policy is that derived from widespread consultations, so that the views of everybody with a genuine interest are taken well into account.



"Meetings with the CB user groups were still in their infancy back in 1963. Although they grew, both in terms of attendance and the length of their agendas, they never lost their special appeal to me. Many meetings held inside Government tend to be very formal but this could never be said of meetings with the CB lobby! The old Civil Service term 'a frank and useful exchange' has long been recognised as a euphemism for us being called great wallies. I never minded. I took being called 'great' as a real compliment. We did, of course, have our own triumphs, like the time that BCBC's Keith Townsend tried to light the cork tip of his fag by mistake! As Chairman of the meeting I felt obliged to point out to him that I was not prepared to accept any CB burners within the hallowed corridors of Waterloo Bridge House!

"But seriously, the consultative meetings were refreshing in their frank two-way dialogue and a lot of useful ideas resulted from them. They helped us to explain our views to the enthusiasts and to take account of the positive proposals which they put to us, often in the most forceful of terms. I believe that CB representatives were also a little surprised at the lack of 'them and us' atmosphere of these meetings, apparently a strong contrast to what they had experienced in the past".

Clearing at 29MHz

Those who remember the pre-legalisation CB campaign will recall the shock and horror with which all and sundry greeted the Home Office suggestion that the only part of the spectrum available for a CB service was on the UHF band at 'around 900MHz'. It was far from what enthusiasts had been seeking and would isolate them from CB users around the world for ever. Even after the Home Office agreed, under the weight of thousands of responses to its Green Paper to allocate a part of the 27MHz band there was widespread dismay at their choice of frequencies and user groups never gave up the campaign for compatibility with the rest of the world. Despite this, the Home Office remained adamant and it was not until the DTI took over that the question began to receive serious consideration. Even then, the administration felt obliged to tell user groups that there were massive difficulties in the way of such unity. Other services were still using the frequencies in question and it was going to be a long and extremely expensive business to relocate them.

Mr Maxwell recalls: "The biggest task that I had in my entire time with the Radiocommunications Division was to clear the 27MHz frequencies in line with the CEPT recommendations. CB users often put to me the view that these frequencies should have been allocated to CB from the outset in 1981. If only that could have been the case, then my job would have been much simpler, but no-one knows better than I do why that was not possible. The CEPT frequencies were already occupied by three other services, on-site paging, as used in many hospitals, radio control and data buoys.

"Relocating the data buoys was not too difficult. Alternative spectrum was found higher up the band and since these devices were located out to sea, we could use frequencies close to the television IF (intermediate frequency) band without the risk of ruining anyone's television reception. Model control was much more difficult. Model owners wanted new frequencies in order to achieve a degree of harmonisation with their European counterparts. We were eventually able to satisfy this aim but what was to become of all the modelling kits already in use at 27MHz?



Fortunately, in common with its American forerunner, the CEPT specification has some 'windows' in it and we were able to direct modellers to these frequencies. In fact, we found that most modellers were keen to move off 27MHz so the release of new frequencies for model control was seen as good news, even with those who wanted to stay with 27MHz despite the fact that too would soon be dominated by CB.



The most difficult issue was on-site paging. Here, we were dealing with many users, often in sensitive areas such as hospitals. TV Band 1 proved to be the long-term solution. The old 405-line black and white television transmissions were due to come to an end, releasing a considerable amount of spectrum for re-allocation to other services. Unlike CB channels, which are only 100KHz wide, a single black and white TV channel occupied about 5MHz of spectrum and there are a number of such channels within the band. We were able to release a block of frequencies from Band 1 to satisfy the long-term needs of the paging industry but how would the users react? How would you feel if you had spent thousands of pounds on a new paging system, only to be told that a group of hobby users were moving onto the frequencies? We eventually found a remedy by securing the agreement of the users of a frequency close to 27MHz that some of their frequencies might be made available for re-tuning existing paging equipment likely to be affected by the coming of the new CB facility. So we formulated a new strategy for on-site paging, which meant new frequencies in Band 1 and other frequencies within tuning range so that those subject to interference from CB could have an escape route".

A Big Job

Explaining the amount of work involved in reconciling the needs of all the various types of users, Mr Maxwell told us: "Creating this policy took quite a while. If I had one pound for every meeting that I had with user groups, firms or associations, I would be a rich man by now. We also had to satisfy those services whose frequencies were harmonically related to the CEPT CB allocation, but that's another story. We were only grateful that the CB lobby remained patient throughout these long and complicated negotiations. Believe

that and you will believe anything! The CB postbag was always bulging and the most popular question was always 'When can we have the CEPT frequencies?' At last, on September 1st 1987, all this work reached a successful conclusion. It was a very satisfying moment. At last we could really reply to all those letters and tell people 'It has happened!' I knew from the outset just how much CBers wanted those frequencies but we were faced with the task of satisfying everyone all the time, a difficult task indeed".

Correspondence

"As I say, we had a very full mailbag on CB. It was not possible to do everything that people had wanted (well, some of the suggestions were physically impossible!) but we did take note of their views and much that had been done on CB came from our listening, reading and noting. Hobby radio of all forms excited its enthusiasts and they all tend to believe that Government should do what they think is right. In considering CEPT CB, as in so many other things, we do have others to consider as well, but we do our best".

We have always tried to give people a full answer to their questions. To those who have written, theirs is an important letter, even though it may be only one of hundreds which we have received on that day and I and my staff were always ready to treat them with equal importance, even though I often felt that it was the short-term jobs, such as working through the mail mountains, that conspired to delay longer-term issues. Nevertheless, it is you, the CB users, who are our customers and we have a duty to satisfy your legitimate needs. As in meetings with user groups, some really useful points came out of the correspondence, so that answering letters was a task worth taking trouble with".



Enforcement

Although Barry's position as Head of the Licensing Branch was not directly concerned with enforcing licence regulations, his job involved regular consultation with members of the Radio Investigation Service, and on this subject he was prepared to stick up for his colleagues, right to the hilt.

"I have noticed a very significant change in CB regulation enforcement during my four years as Head of

Licensing. At the outset the RIS was being run by British Telecom and it seemed that they had little time for CB enforcement. Soon after the DTI took over responsibility for the investigation service the policies were reviewed and this has led to CB being given a far greater degree of importance. A degree of importance which I have always felt it deserved".



Informing the Masses

Perhaps it is his long association with industry that has made Mr Maxwell aware of the true value of public relations. He explained that one of his department's major successes, as far as he was concerned, had been their regular CB Information Sheets.

"Never have I come across so many rumours as abound in the world of CB and that is why I welcomed the many factual articles which have appeared in *Citizens' Band* over the years and why the excellent CB section who worked with me put so much into preparing our Information Sheets. It was always a source of considerable satisfaction to me that they became, and remain, so popular. I was also pleased when *Citizens' Band* was able to help us by distributing copies of the CB Code of Practice in one of its issues. I thought this was a superb example of the Press and Government working together for the benefit of the users, on whom we both rely, of course".

Still on the subject of your favourite bedtime reading, Mr. Maxwell was unable to resist the opportunity to make sure that we owed him a small favour for the future. In a comment designed to send the Editor running to ask for a rise, he said: "Within RD, we have always read *Citizens' Band* with a great deal of interest and have particularly welcomed some of the thoughtful articles where it was clear that a lot of research had been put in. For instance, the article on a United Europe was an excellent guide to another countries' regulations".

Licence Review

Reflecting on what he sees as four years of hard but interesting work, Barry told us: "My last major job on CB was to clear the licence review group, whose work culminated into the issue of the new licence to coincide with the release of the CEPT frequencies. A lot of work went into the licence review. We started with a 'blank piece of paper' approach. First we

built in all the good points from the existing licence and then examined all the points which had been raised over the years of correspondence, consulted widely within the Department and within Whitehall in general and, of course, had several meetings with CB user groups. The new licence is the product of all this and I hope that because it derives from such a broad base, it will prove enduring. I was particularly pleased that we were able to incorporate the Code of Practice, formerly a separate document within it. It is presented in a much more tidy way and gives more prominence to the important aspects of the Code. I am also delighted that it has brought about some relaxation in the rules governing the use of CB aerials. Getting agreement for this from other users of the spectrum was a far-from-easy task, but one which I feel has worked out to everyone's advantage".

The Future

"After four years in the RRD I knew that it was time to move on but I would have liked to see the full CEPT service get going. As we head towards a single European system in the 1990s the UK adoption of the CEPT specification is a significant contribution to the 'one-market' principle, as far as radio is concerned. There is also an exciting challenge ahead at 934MHz, a service which, despite its early critics, has proved well worthwhile. There is a lot yet to be settled on the subject of Short Range Radio, first reported in *Citizens' Band*, but it is good to see UK firms taking a positive interest in this market. It is certainly an area to watch, for both business and individual use.

Barry Maxwell left the Radio Communications Division to take up a challenging new post in Lord Young's new Enterprise Initiative and claims that we have given him good training for the post, as "CBers were full of enterprise and initiative". He tells us that he misses the radio world, in which he still takes a keen interest. He assured us that although he is not (yet) an active radio user, his wife and kids can't understand why he should take a keen interest in particular antenna arrays whenever they are out in the car. He simply regards it as a legacy for four years working in radiocommunications.

Those of us who met and worked with Barry Maxwell over the years grew to know him as a powerful ally of CB, though getting him to move once he had dug his heels in could be more than a mite frustrating! Despite his predilection for Spurs, he is a gentleman who listened with respect and interest to the views put to him during debates even when, as occasionally happened, they got a little heated. His calming influence and ready wit will be sorely missed by those with an eye to the future of CB. Here at *Citizens' Band*, we are indebted to him for countless favours over the past four years and wish him well for the future.



LADY BREAKERS

CB GHOST TOWN

Is Filly correct in assuming that CB is dead?

The thick red words on the bright white postcard jumped out and hit me as I idly scanned the motley collection of yellowed and fading advertisements in the dingy post office window.

Old Miss Pringle, the ancient sub-postmistress who was probably presiding over the dark and cramped little post office/stores when Julius Caesar came to survey the fields of Kent, never removes an advertisement once placed in her window. The window, fly-blown and murky with the dust and grime of centuries, is a fascinating social history of the village. There is even a flimsy, curling piece of paper bearing faded sepia lettering offering a nearly-new baby's perambulator for the generous sum of two shillings and sixpence. I kid you not. A new ad only gets to go in when an existing one finally crumbles into dust. I think she still charges a halfpenny for the privilege.

The postcard which had attracted my attention was evidently new; it had certainly not been there yesterday. FOR SALE, it announced. CB MOBILE RIG, EXCELLENT CONDITION, RF GAIN, TONE CONTROL, LOTS OF EXTRAS. SENSIBLE OFFERS ONLY PLEASE. Good heavens, I thought, startled. Oily Rag from the garage was selling his rig. What on earth for?

Another postcard caught my eye, inscribed in small but beautiful lettering. FOR SALE. CITIZEN'S BAND BASE STATION WITH ACCESSORIES. GENEROUS DONATION TO CHURCH FUNDS PLEASE. What, the Vicar too? What was going on?

And there was another. FOR SALE, CB MOBILE RIG, BUILT-IN SWR METER NEEDS ATTENTION, NEARLY NEW ANTENNA, ONLY £75 ONO. It was an epidemic! Big Jane, stalwart of the local breaker club, was selling out! My world reeled. Was I to be the only breaker left in the village? Who would I talk to?

I scanned the window but there were no more of the disturbing advertisements. So Shocker the Electrician hadn't sold out, or Jimmy Cricket, or Chalky from the

local JMI school. The world remained spinning on its axis. I walked next door to the newsagent and picked up the latest issue of the local freesheet — those things with 20 pages of ads and an article about knitting or the local football team — and turned in trepidation to the free ads at the back.

And there it was! FOR SALE — CB RIG — GOOD CONDITION — £20 FOR QUICK SALE. He'll be lucky, I snorted, thinking of Shocker's ancient and battered set. Three ads down, there was Jimmy Cricket's mark of treachery — MOBILE RIG, ONE YEAR OLD, RF GAIN, TONE, DELTA TUNE, SWR METER, ALL ACCESSORIES, £95 ONO. I gazed at the paper, scanning the columns for any more rats deserting the sinking ship. But what sinking ship? What did they all know that I didn't. There were no more CB ads that I could see, and I breathed a sigh of relief. Chalky remained true...then.

I walked down the high street, thinking furiously. What was going on? A horrible thought struck me. Was the DTI about to ban Citizens' Band? It had never liked us breakers much, had it? Yes, but what about those CEPT frequencies? A cunning blind! Why had *Citizens' Band* magazine not said anything about this? Why had it not warned me? Call itself a magazine? Ha! I'd sue the editor. Call himself a journalist? Ha!

I met Chalky, walking fast towards the post office. He saw me, and seemed to hesitate. I eyed him narrowly. Was it my imagination, or did he look shifty? Was he refusing to meet my eye?

"Er, hi, Filly", he said nonchalantly.

"Just, er, on my way to Miss Pringle's".

"To buy a stamp, no doubt", I said.

"Er, that's right, to buy a stamp, yes. Well, must be off".

"Will I see you at the meeting tomorrow?" I asked cunningly. Would he have the barefaced cheek to tell me that yes, he would be at the breaker meeting tomorrow night when it was obvious he was on his way to sell out like all the

others? I could see the tell-tale postcard sticking out of his pocket.

Chalky looked surprised. "Of course", he said, and walked on past me. He could act, I'd give him that. That look of surprise would have fooled Laurence Olivier. I glowered at his departing back and stalked off down the street. So! They had all heard the news and were trying to sell out before anyone else caught on, were they? Perhaps they were even hoping mugs like me would buy their obsolete old equipment! Well, two could play at that game! I hurried home and drafted my own advertisement, pricing my equipment well below everyone else's. There! If there were any buyers out there who didn't know what was about to happen, they'd buy *my* stuff! Ha! Thought they could put one over on Filly, did they? Ha! I rushed off to the post office.

That evening, I met Big Jane and Oily in the pub, both looking pleased with themselves. I joined them, smirking.

"You look cheerful, Filly. Won the Pools?" Jane commented.

"No, I found a buyer for all my CB stuff. Got a good price, considering", I chortled. "I got a clear conscience, too. He wanted it for his son to practice basic electronics on, so he won't mind when — well, you know".

Jane looked puzzled. "When what? I assumed you had picked up a bargain like the rest of us down at the Breaker Bistro. I got a brand new base station for half price!"

I gaped.

"Yeah, and I found a brilliant mobile for 75 per cent off! Knockout!" enthused Oily.

I started at them.

"You know, the Breaker Bistro sale", said Jane impatiently. "Word went round that he was selling up fast and selling his new stock cheap. Must admit, I thought we'd stolen a march on you, but we might have known better! He didn't have much stuff and it went fast. All gone now, of course".

"Er..." I said. "Jane - how much did you want for that mobile of yours?"

C.T.E. INTERNATIONAL s.r.l.

MANUFACTURERS OF HIGH QUALITY ACCESSORIES IN EUROPE FOR OVER 15 YEARS

FOR THE AMATEUR RADIO AND C.B. ENTHUSIAST.



New Products for the U.K

ACCESSORIES

CT 1600

2 MTR FM Handheld Transceiver
A super sensitive h/held with full spec. PWR:- 1.5.W/0.5W repeater shift thumbwheel CH. selection

£178.00

New

FD 1350

Frequency counter
10hz - 1.3 Ghz
8 Digit accurate counter requires 13.8 V supply max input sig. 1.V.P.P. impedance:- 50 OHM/50 PF



£139.42

HQ 25

Pre-Amplifier
Designed to boost reception on all but the very best radios.
Supply:- 12 V DC
Freq:- 26 - 30 Mhz
Gain:- 25 dB



(For amateur use only).

£25.70

HQ 375 C

Pre-Amplifier
Featuring a variable gain control and 'on air' indicator this low noise pre-amp uses an FET to boost reception.



(For amateur use only).

£28.80

HQ 315

SWR/Power/ Mod. Meter
Measures power in 3 ranges up to 1 KW with an AM modulation meter (if required).

Supply:- 10 - 15 volts DC
Freq:- 3.5 - 150 Mhz
Power:- 10/100/ 1000 Watts



£59.96

ANTENNAS

SPECTRUM 200

5/8 Base Ant.
A top of the range antenna suitable for 26 - 30 Mhz and powers of up to 2.5 KW.
Gain:- 6.8 dB



£79.95

FUTURA

5/8 Base Antenna
Using High Quality Aluminium and a superb base coil. This is a top of the range antenna.



£29.92

SKYLAB

Europes most popular base antenna with 6dB gain and high efficiency. 26-30 Mhz



£24.00

SPITFIRE

Belemt Beam
One of Europe's most popular beams, this antenna is lightweight and high gain.

Freq:- 26 - 30 Mhz
Power:- 2 KW

£46.45

SALIUT 27

3/4 wave ultra-high gain base antenna. Adjustable 26-30mhz power max. 2 KW gain 6.5 dB. The ultimate base antenna for long distance work. Height. 9.1. mtrs



£68.00

AMPLIFIERS

CONDOR

Base Amplifier
A new broadband amplifier. Foil the radio amateur. Covers 26 - 30 Mhz.
Power:- 160 W



ETBA

767

Mobile HF linear power: 80W switchable class "C" or "AB" suitable for AM-FM- CW-SSB remote control facility

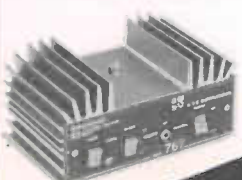

£41.90

737

Mobile HF linear power: 50W max input: 10W suitable for AM-FM- SSB



£44.76

757

Mobile HF linear power: 150W switchable class "C" or "AB" suitable for AM-FM- CW-SSB remote control facility

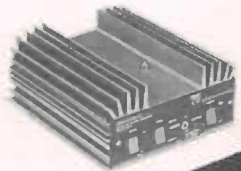

£116.87

A300

HF Power Amplifier
A new mobile HF power amplifier and pre-amplifier with pre-amp. Switchable Class AB and Class C.

Power:- 300 W PEP

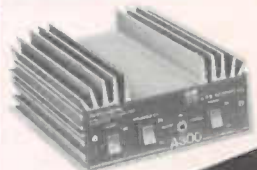

£129.00

FOR USE BY LICENSED RADIO AMATEURS ONLY

Send £2 for the complete CTE and Nevada catalogues and receive a voucher for £2 on your first purchase



CTE products are available from authorised stockists throughout the UK or direct from

UK Office and Distribution:-

Nevada Communications,
189 London Road, North End, Portsmouth, PO2 9AE.
Tel: (0705) 662145. Telex: 869107 TELCOM G



COMMUNICATION THE

QSL WAY



More names and addresses from QSLers all over the world, courtesy of David Shepherdson

This month I think I'm going to have to apologise to a few people! First of all, to anyone who wrote to me via the magazine in the last four months of 1987 who are still waiting for a reply (if return postage was included) or a mention, sorry. At the time of writing, I have just received a pile of letters from those four months, so read on! In the past I have mentioned that any letters sent to me via the magazine take on average an extra six weeks before I see them so anything urgent or regarding forthcoming events should be sent direct to my home address (3 Tarn Villas, Cowpasture Road, Ilkley, West Riding of Yorkshire, LS29 8RH). Until recently the "record" stood at eight weeks delay between a letter being sent and my seeing it. However, this has now been completely and utterly smashed with the eventually arrival of a letter which took ten months to be forwarded from London to me! Congratulations to who ever was concerned!

In the December issue I started off with the promise of a "Forecast Table" of forthcoming events as I didn't have any firm news to hand. The promise was there, but the table wasn't! Not my fault, well, perhaps I did go on a little but I did send the table, honest! Continuing on the same subject, that of forthcoming events, I currently have a list of about a dozen during the year ranging from the "Giant Meeting" in April at Co. Durham to the "North Wales Eyeball and Evening of Entertainment" in September at Bodolwyddan. Regretfully, because of the size of this list I cannot mention each event in each issue, and therefore can only use the most immediate three or four. If however you would like a copy of this list for your own reference or if you

PECHVOGEL · Honstraat 34, 5334 JM Velddriel · Nederland



poma-cards 87/4965

OFFICIAL GROUPCARD

Controlled by poma 3800



poma-cards 87/5355

have been organising an event which you haven't yet let me know about. then drop me a line as soon as possible! For a copy of the list, just ask for a copy and please do remember to enclose a 13p (Second Class - UK) stamp and providing I can read your address, I'll be very happy to send you one. If you are having a "do" and haven't let me know, then drop me a line as quickly as possible with plenty of clear information about where it is, who to contact, how much admission is charged (if any), how much for a club's stall, and who, in the case of a charity, would benefit from any proceeds.

Now, this is the April issue, which could come out in March so you should therefore have this in time to read about the brothers who are walking between Arbroath and Stoke-on-Trent in aid of Multiple Sclerosis and the Blackfriars Special School. This sponsored walk starts on Monday April 4th and anyone who wishes to sponsor or eyeball them will be most welcome. For details of the route and how to sponsor, please drop a line to Phillip (*The Wanderer*), PO Box 4, Arbroath, DD11 1HS, Scotland, but please don't forget a SASE for a reply, thanks. Hope the weather's better than as it is as I write this! Brrr!

Also in April in the aforementioned Giant Eyeball held at the Youth Centre, Stanley, Co. Durham. If previous years are anything to go by it'll be pretty well attended and I would hope to see many of you up there myself! I don't yet have full details of all that is planned for up there, but by this time, the leaflets should be circulating around the country. If you haven't yet seen one of these leaflets, then drop a line to the contact address with a SASE and ask for one. Please do note that the date for this meeting is not what I (mistakenly) called the Bank Holiday Weekend; don't know what I was thinking of then, but it's the 17th of April and *NOT* the usual last week of the month. For Currie Card collectors, this meeting is one of *THE* meetings of the year as many people have a new card done especially for the meeting and I've heard a rumour that at least one new club will be launched on the day! I've been sworn to secrecy so all I can say is that I've seen the draft of the new club and I think it's going to be a fast moving club!

Another meeting in April could be that of the Cutty Sark Club but since my old friend Tony (*Nighthawk*) retired from OSling I'm sorry to say that my contacts with the club haven't been the same. Could I ask if the ORC is holding a repeat of last year's Social Evening, details of which arrived too late for last year's events. If so, please let me know as soon as possible, thanks.

A request in now from a couple of Welsh Breakers who are in the process of compiling a Black List of QSLers who say they QSL 100 per cent but don't. Copies of this list are available for 5p per sheet

QSL from
Grüner Weltliner
ALPACA

Qualitätswein aus Österreich

Weinbaugebiet Kammptal-Donauland

QSLer Addresses:

David (<i>Smokey Chaser</i>)	60 Brynglas, Pontlottyn, Nr Bargoed, Mid. Glam., CF8 9QS.
Allan (<i>Greenfingers</i>)	214 St Fillans Rd, St Marys' Dundee, Scotland.
Henk (<i>Pechvogel</i>)	Honstraat 34, 5334 JM Veldriel, Holland.
Les (<i>Paramedic</i>)	190 Chelmsley Road, Chelmsley Wood, Birmingham, B37 7SR.
Dave (<i>Podgy</i>)	35 Gairloch Drive, Perkinsville, Chester le Street, Co. Durham, DH2 1JA.
Lynda (<i>Spectrum</i>)	TSB 22, PO Box 26, Prestwich, Manchester, M25 7JQ.
Barry (<i>VTOL</i>)	39 Holborn Road, London, E13 8PB.

QSL Club Addresses:

Cutty Sark Club	116 Bradenham Ave, Welling, Kent, DA2J
Lima Delta DX Group	PO Box 242, Cambridge, CB1 2EJ
Organised Radio Club	PO Box 3, Heanor, Derbyshire, DE7 7UH
Papa Mike DX Group	PO Bo 14, Swindon, Wilts, SN2 1HR
RNI DX Group Int	PO Box 01, A-3491 STRASS Australia

When writing to any QSL Club or Firm, always include return postage to assist with their reply, it does help.

plus a SASE. All funds received will be donated to the local hospital. Personally I'm not too keen on black lists of any types as they always upset somebody. If you wish to see this list and support a worthwhile cause at the same time, David's (*Smokey Chaser*) address is in one of the panels.

A request for a mention from one of our regular readers starts off this month's names and that's from Allan (*Greenfingers*) of Dundee. Allan sends out a bumper bundle of all sorts of cards and is well worth a good QSL for. Allan

depends on the CB and the Post for most of his contacts as he is virtually housebound but makes up for this by QSLing to the hilt! A request via Ray (UK POMA Rep) for a mention for a friend of his from Holland who swaps and controls about 20 POMA Collector Series cards. Although Henk (*Pechvogel*) cannot speak or write in English, you can write to him in English as his daughter translates for him. (Well, I can't read or write in Dutch so that makes us even).

Ray also says in his letter that he thinks that Sundown of America is trying to start

printing again and asks if anyone is still owed money or designs from the last time that they were active, could you be kind enough to get in touch with him (Ray) with details. From Birmingham hails Les (*Paramedic*) who wanted a mention, say no more Les, 'tis done! Whilst from Co. Durham, yet another card from Dave (*Podgy*) and from Manchester a bundle of cards by Sharp Graphics from Lynda (*Spectrum*) and last personal for just now is a new QSLer, or at least a QSLer with his first QSL cards, that being Barry (VTOL) of London. Both he and Lynda have said how pleased they are with the results that their respective printers have done with their original rough drawings

A couple of local clubs now who would like to be better known and as they and their members QSL; where better than through these pages! The first (in date order, it was posted four months before I got it!) is the Papa Mike DX Group of Swindon. The club has a POMA FCC card available to members and the club now hopes to extend their membership throughout the rest of England and into Europe. No details of cost was included in the letter I received, either of the price of cards or of membership, but anyone who is interested, Keith (*Special K*) asks for you to drop him a line and he will reply in a few days.

The other local club which sent some details is the Lima Delta DX Group of Cambridge. The group has been going

QSL Services Addresses:

Currie Cards	89 Derwent St, Blackhill, Consett, Co Durham, DH8 8LT.
POMA (Ray - UK Rep) Raymac Display	PO Box 106, Canterbury, Kent, CT1 3YN No 2 Showfield Ind Units, Pasture Lane Ind Est, Morton, North Yorks. (Send £2 for sample pack & £4 credit towards order).
Sharp Graphics	PO Box 3, Grangemouth, FK3 9BD. (0324-473432).
Glass Engraving	Bob McWilliam, 150 Yoden Road, Peterlee, Co Durham, SR8 5DU. Tel: 091 5868889

VTOL

BARRY KEATES
39 Holborn Rd., London E13 8PB, U.K.

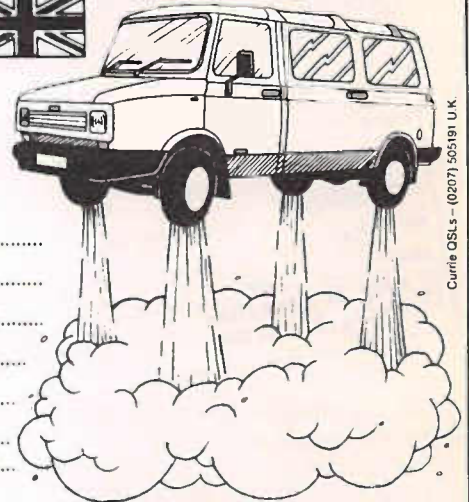

Currie QSLs - (0207) 505191 U.K.

QSO WITH

DATE TIME

MODE R S T

FREQ/CHANNEL WATTS

MY TX/RX

ANT MIC

BASE MOBILE QTH

PSE QSL TNX QSL

**73's FROM
PARAMEDIC**

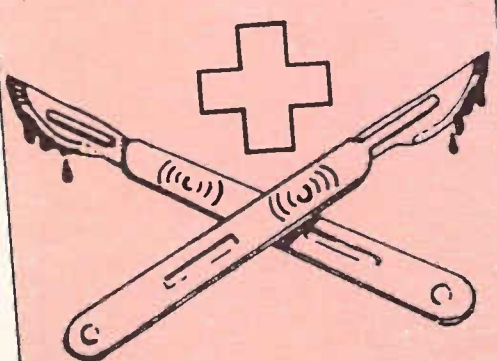

CHELMSLEY WOOD

**Q.S.L
ACTION LADY**

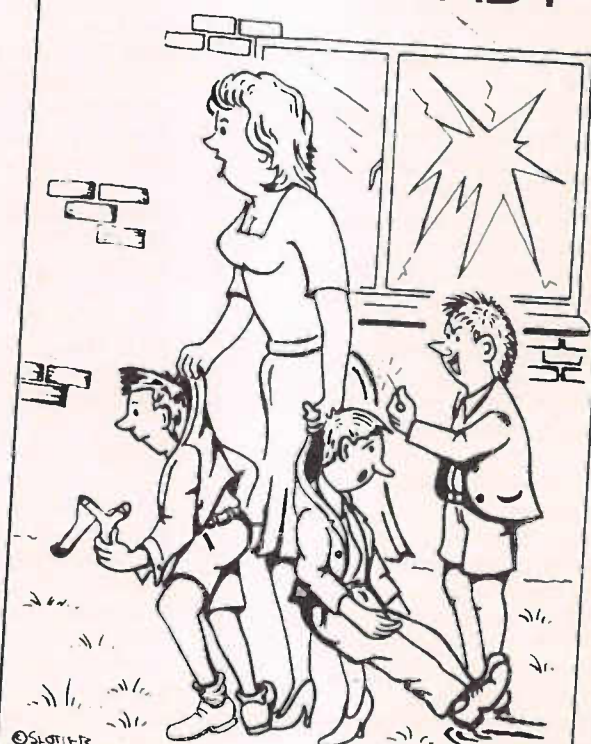

© SLOTTIER

474

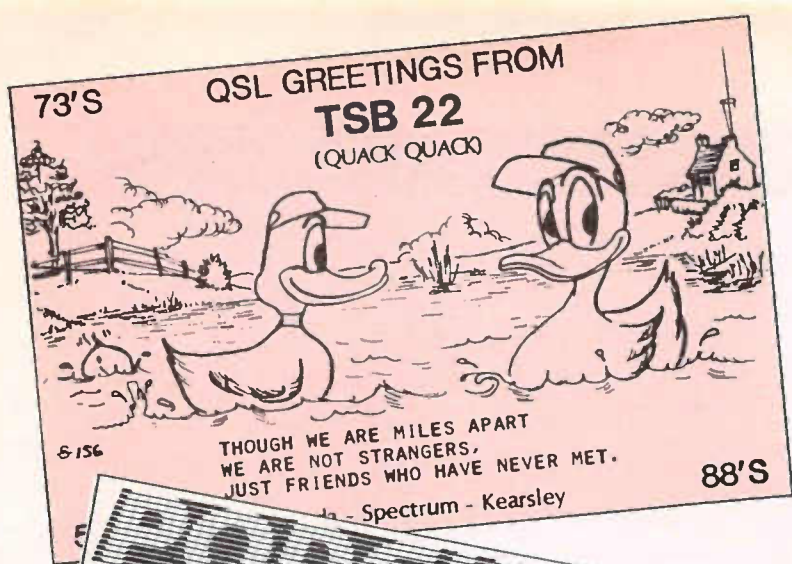

DAVE SMITH - GB332
 35 Gairloch Drive, Perkinsville
 Chester le Street, DH2 1JA, England, U.K.

QSO WITH
 DATE TIME
 MODE R S T
 FREQ/CHANNEL WATTS
 MY TX/RX
 ANT
 BASE MIC
 PSE QSL MOBILE QTH
 TNX QSL

Current Collector No. 547
 poma-cards 86 4280



for just over two years now and wishes to attract members from outside the Cambridge area. Cost of membership is £3 a year for which you get use of the PO Box and 10 Club Cards. Members outside of Cambridge should send a supply of SASE's for the return of any QSLs sent via the PO Box. The PO Box is emptied once a week and interested QSLers should contact Colin (Cardsharp).

A letter has come my way from a DX Group in Austria. It has about 100 members though I don't have any idea of membership cost. Edward (Hon. President) complains that in Austria there isn't a CB magazine like this, (well, actually he said as good as this, but I shouldn't say that). The group was formed in January 1983 and is run from Vienna though the group's President actually lives in Durham here in the UK. The group designs and prints their own cards and wishes to encourage friendship between QSLers worldwide. Any UK QSLers who wish to join will be made most welcome. What's the name of this group I hear you shout! That's the difficult part, the card say it's the RNI DX Group which I think stands for Radio North-Sea International.

That's it, out of room once more. If you want a mention then please drop me a line either via the mag or direct to 3 Tarn Villas, Cowpasture Road, Ilkley, West Yorkshire, LS29 8RH. If it's urgent then I'd suggest you send it direct rather than via the mag and any news of forthcoming events is always welcome, the sooner the better please and if you want a reply, then please don't forget a SASE or similar.

Forthcoming Events:

April 17th — Co Durham Giant Eyeball '88 held by GBQDC at the Stanley Youth Centre, Stanely. Contact Ad: GBQDC Eyeball '88, PO Box 5, Consett, Co Durham, DH8 8LT.

April ? — Cutty Sark POMA Meet ??? — Cutty Sark Club, 116 Bradenham Ave., Welling, Kent, DA16 2JG. *NO INFO RECEIVED YET*

May 7th — Tango Papa Charity Eyeball in aid of Multiple Sclerosis Research, held at the Floral Hall, Southport from 10am until 4.30pm with an evening of entertainment from 5.30 to 11.30 pm. Tickets cost £1 for either day or evening event, or £1.50 for both. Contact: Public Relations Officer, Tango Papa (83) Charity Eyeball, PO Box 13, Southport, Lancs.

June 11th & 12th — Worthing DX & QSL Group 1988 Eyeball being held at the Worthing Rugby Football Ground. Sat: Car Boot Sale & Evening Disco/Supper, Sun: WDX Eyeball, Club/Trade Stands etc etc. Contact: Stuart (WDX 01), PO Box 404, Worthing, West Sussex, BN14 7EB

June 19th — Sheffield Charity Gala & CB Eyeball held once again at the British Steel Sport's Ground, Tinsley, Sheffield. The venue is approximately one mile from Junction 34 (M1). Contact Derek (Roadrunner), PO Box 275, Sheffield, S2 5HY for further details or to book a stall (Clubs: £5 for 12 foot plot). Admission *FREE* and there will be displays during the day from The Royal Air Force, Police and local Fire Brigade.

June 26th North Wales Breakers 1st Annual Eyeball held at the Nova Complex, Cental Beach, Prestatyn, North Wales from 11 am until 1630hrs, with an evening of entertainment from 1930hrs to 2300hrs. Contact Ad: Derek (Red Devil), PO Box 35, Prestatyn, Clwyd, LL19 9YH, (or 0745 686564).

When writing for details on any of the above, don't forget a suitable SASE for the Club's reply. Also, should you send monies to book, don't forget a SASE if you require a receipt.

CB CROSSWORD

Relax for a few minutes with a crossword designed specially for CBers! Some answers are technical, others aren't, some are even abbreviations, so get thinking!

ACROSS

- 1 We usually do our best to minimise these on the feeder (8,5)
- 6 A component often found inside 27 down
- 7 A noisy extra found on many rigs
- 8 What 4 down will be in a bad storm
- 9 Three letters to strike fear into the hearts of many!
- 10 And two letters that no longer do!
- 14 This guy may have found an extremely powerful CB very handy
- 14 Current in short
- 18 Metering those waves again
- 18 Capacitance at the top of an antenna
- 20 A technical term for rig
- 21 What you would pay for many rigs in their country of origin
- 22 A cut short transmitter
- 24 Nice to SEE what's working
- 25 Very useful, but things we often don't want
- 28 Hopefully used in conjunction with 22 across
- 29 The original British term for 4 down
- 30 You may get stuck with one of these if you're not careful who you buy from.
- 31 Anyone for soldering?
- 32 Related to 455 and 10.695
- 33 O.K. in the States, but not in Britain
- 35 Antenna principles on waves again!
- 37 Japanese direction - definitely on the beam
- 38 Mobile antennas are usually this
- 39 What many CB conversions are most certainly not
- 40 Without this to connect them all those fancy parts would be useless

DOWN

- 1 Virtually all modern receivers don't half mix things up!
- 2 These appear every half-wavelength on 1 across
- 3 A little used channel - hopefully
- 4 An electrical R.F. radiator
- 5 Negated negative
- 6 For CB your feeder is usually this
- 12 37 across must do this, unless you talk one way
- 13 You don't have one? Naughty! (Unless you're American these days).
- 15 Incoming signal too weak? Use one of these.
- 17 A greatly misused royal pronoun
- 19 Don't interfere with this if you know what's good for you
- 20 You may connect a wire to this, even at an airport
- 23 Greek antenna adjustments!
- 26 Many people talking, but some way slip through
- 27 Two of these with string may be more private than CB
- 30 Very few CB set-ups are 100% this
- 34 33 Across is one of these
- 36 Two letters for signals you can hear

5	T	A	N	D	I	N	G	W	A	V	E	S	5		
			O		I		N			E					
7			8	D	O	W	N	9	T		10	O			
			E		L	E	12	E	13	A	M	15	S		
			16	W	R		U	N	I	X	R				
18		19			20	R	A	N	S	C	E	I	V	E	R
					24	E	N	A	E	A	A				
22	X				23	R			N	24	A	M	P		
			25	A		M		26		27	S		P		
28				M					29	A	E	R	I	A	L
			30	L		M		N	31		N			32	F
			E	A		33	A	34	M		35	36		F	
37	A	G	I			38	L	O	A	D	E	D			I
			A			D									E
39			L					E						40	R



CAPTAIN SPARX

PIRATE PURSUIT

Captain Sparx uncovers the truth on radio wickedness in the sticks



Like all those stories of the Loch Ness Monster, the barmy summer season brought out those yarns of radio pirates (according to some writers, such characters ought to be fed to the Loch Ness Monster, as soon as they, and the Monster, are apprehended).

Cover of an 'anarchist publication', 'Radio is Our Bomb', was shown on prime time television, excerpts from its contents not yet being banned by the House of Lords. No doubt about the incitement to violence in this publication, but such daft efforts have been around for years (anyone here remember that elegant publication, 'Oz' circa 1970?) and one can hardly encourage kids to get into computers and communication, etc without having this sort of occasional bump. Incidentally, anarchists have long been scapegoats, and were much abhorred in the UK press long before radio. 'Anarchy' covers a whole hill of beans of philosophic outlook; those behind 'Radio is Our Bomb' are not so much real anarchists, as nut-cases.

Even so, whilst the public must do all it can to counteract the violence in our society, some of it shaped by what is shown as 'respectable TV', one wonders what we are supposed to do in terms of helping catch the radio pirates. One can imagine the response of many overworked policemen at being told that

Radio Rissole had just come back on the air. I once rang the police to point out that a herd of cows had left a field and were ambling along a country road much used by traffic, and I must say that response was — dare one say — thoughtful. Of course, the bovines might have been carrying concealed pirate radio antennae between their horns.

Though public-spirited folks might call the cops in order to explain that Roger Rudechops appears to be erecting something like the Eiffel Tower on the high-rise apartment block nearby, there is really little specific guidance from the authorities. When the US Federal Communications Commission (FCC) began to deregulate CB radio some years ago, complaints about overwhelming amplifiers and other boondoggery were on the whole greeted with the same enthusiasm given to creeping alopecia. CB operators of the clean and green variety were forever writing into the magazines claiming that their informed complaints were being ignored.



Reason: lack of staffing adequate to chase the wicked gents, a state of affairs allegedly close to home. Even in Australia, that land of free speech and warmth to officials specially economic with the truth, the Department of Communication (DOC) has been charged with similar complaints by honest operators. The kind of response reportedly given to the Australian good guys was: 'we know they are a trial, but we are praying they might get struck by

lightning'. Now, similar problems seems to be part of the reason behind this summer's nadginess regarding the illicit operators.



Following the statements to the media, the Institution of Professional Civil Servants, the professional association representing RIS engineers, said that one reason for the present creeping radio anarchy is a cutback of personnel, to some 50 per cent over the last three years. When the Radio Investigation Service (RIS) was transferred from the Department of Trade and Industry (DTI) to British Telecom (BT) in 1984, as part of that consumer clobbering process known as privatisation, the workload of the RIS required some 300 engineers. These were of course charged with a range of regulatory tasks, only some ten per cent of the total being involved with CB radio etc. Rather less than the ideal 300 were employed at the time of transfer, around 280. But at July 1987, the RIS reportedly employed around 125, which is somewhat less than 300 (check it on your electronic calculator). Also there are rumours that the number may be cut further.

Cynics, a growing fraternity in the old country, may even suggest that the statements re pirate radio are part of a growing antipathy between the Government and the privatised British Telecom which has somehow not won many hearts and souls to the cause. We pass no comment, being appreciative of the problems facing BT management. All the same, the RIS staffing situation could

help explain why the public are being drawn into the pirate radio chasing debate. Every man, or woman, his own RIS inspector! That is, as in the USA, a growing wave of public concern about interference with legal radio, etc is encountered not by honest references to cutbacks in staff and resources in bandit-chasing, but rather in breast-beating re human wickedness, and ... the anarchists. Of course, Britain today is a sort of vast wonderland of organisations running down employees to the point that they can't do their job properly. Captain Sparx has some personal experiences of this, which could embarrass some pretty well-known companies if mentioned. There is a point where productivity becomes depravity.

Defending the clean up campaign, one of our wisers and betterers said in July that no government had done more for the cause of community radio, etc. He did not refer to the fiasco of May 1986, when diligent licence applicants suddenly learned, and that through a written parliamentary question rather than clear statement to appropriate media, that the deal was off. At that time, it was clearly predicted that pirate radio would probably increase, at least in part through ethnic and non-English speaking population groups, feeling that there was no point in waiting further. No-one would suggest, least of all this magazine, that such people are inclined to criminality, but a large number of illegal operators certainly include them. On the other hand, it seems likely that some stations are out to make money, by various means including some advertising. There are some sharp and nasty characters in pirate radio, but they are not necessarily anarchist. If anything they would deem themselves entrepreneurs of the kind much admired today, and only doing on radio what others have done in the City — a point of view which could be debated.



Even in the USA — where some illegal operators believe that they are running radio beams with green men from Venus, etc — such reversals of policy have not occurred as that experienced here with community radio licensing. Of course, the way things are, it may yet turn out that someone sold the CB frequencies to the Iranians a couple of years ago without telling the President. But if the authorities in Britain want a whole-hearted and informed public co-operation in pirate pursuit, they have to be specific about proposed action, seeing that members of

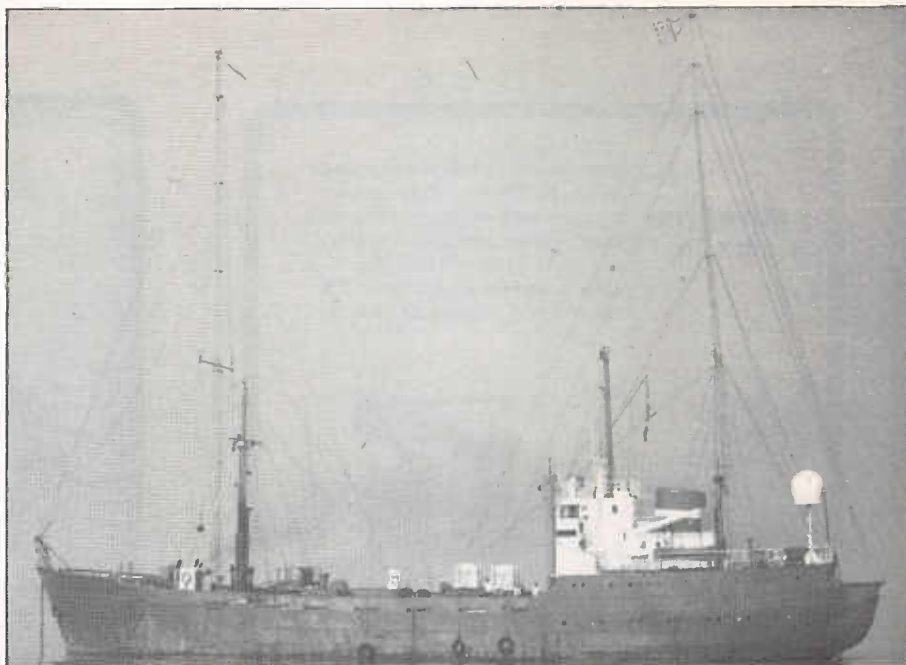

the public do not want to be seen as sneaks, or chumps troubling the police about minor misdemeanours. Theoretically, it ought to be possible to award community radio licences, on an advance basis, before allocating frequencies, i.e. to identify those worthy applicants who will receive licences, and who can therefore get some kind of organisation going — including dummy programme production and income-finding. Captain Sparx, an old hand in the advertising business, can confirm that setting up such an enterprise takes a lot of time. As someone just said the other day, 'There's still a lot of big talk about community radio, man, *but there ain't no prospect*'.

How bad is the situation in pirate radio? According to a 'Daily Mirror' report (29 July) some 200 illicit stations operate in London alone, twenty to thirty being heard at any one time. If this is true, and who would want to contradict Captain Bob's Merry Team, there should be a certain ease in tracing operators, if the will and resources are present. Of course, the use of remote control transmitters and other techniques can make tracing difficult, but this year has seen an increase in RIS bandit-chasing of some more than 200 raids on more than seventy stations. Human beings, following the alleged anarchist guidelines, plus their own nasty tendencies, may clobber RIS personnel — but such people duff up store detectives in the same way, as I saw quite clearly in my years in radio retail business. Illegal radio operators inclined to bruise kindly RIS personnel are probably of the ilk waiting to knock about others, too. Part of the general violent society problem, alas, and no use blaming on pirate radio.

There are overtones of US experience in the present situation here. It was often said that FCC inspectors would often

poke rebuking letters, threatening withdrawal of licences, and inflicting modest fines, into mailboxes of offenders rather than wait for the opportunity of personal conversation. The same approach is necessarily taken by noise abatement officers in Britain who could, if present trends continue, find themselves in nose-bleeding situations akin to those suffered by RIS men. When truly big busts became unavoidable in the USA, FCC teams went in, the police around for reinforcement, and a certain amount of hell-raising went on. Also, the media, including the CB press, were encouraged to cover the story, it being thought that big-boots geniuses would be much discouraged by such identification.



I would not say that it worked, and a better idea may be that of an Australian operator who proposed putting punishment of illegal operators on prime-time TV. He suggested that removal of both hands with an axe might be a good enough warning to the others. Captain Sparx, having heard about pirate operators over what seems a long life from his Flying Circus days, thinks that it all comes down to one simple idea. Give the RIS the tools and let them finish the job. Also get on with the job of introducing community radio with more urgency. Apart from that, we could do with a revival of church-going and all-round honesty, but that is beyond anything we could recommend.

SHARMAN'S

MAXCOM MX7E

Instant, Fully Portable and mobile 4 Watt, 40 Channel Transceiver. Complete with antenna, magnetic mount, power connector, battery pack, carry case and belt clip. Squelch and Volume control, TX indicator and attenuator switch.

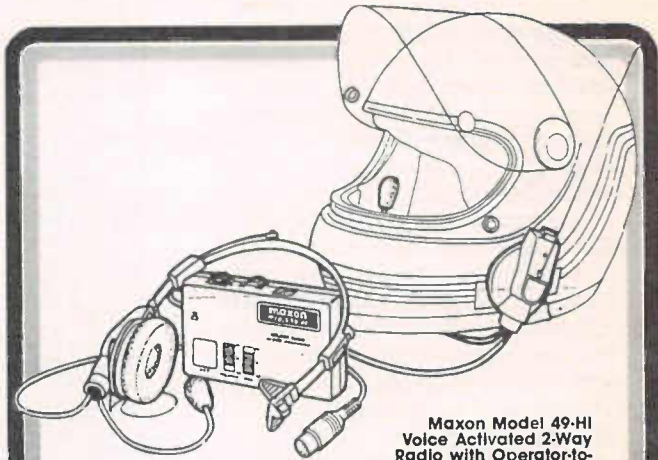

Maxon Model 49-HI Voice Activated 2-Way Radio with Operator-to-Passenger Intercom

Here's a 49 MHz FM transceiver AND intercom combined in one compact, versatile communications package. It's ideal for cycling, boating, snowmobiling—any recreational or industrial activity that involves the use of helmets. The primary headset permits AUTOMATIC VOICE ACTIVATED 2-way radio communication with other transceivers on the same frequencies—UP TO 1/2 MILE AWAY! The second headset lets the passenger monitor the vehicle operator's 2-way conversation, and talk with the operator via intercom. BOTH HELMET CONVERTIBLE HEADSETS install easily, without cutting or drilling. In most open and closed face helmets. Rugged control unit weighs less than nine ounces and has a handy belt/pocket clip.

Also Available:
Model 49 H5 ... Helmet available 49MHz FM 2 way radio operating on 5 channels

maxon



ES 880 ECHO CHAMBER



KA 50 PROFESSIONAL QUALITY GUTTER MOUNT



HP 55W SHARMAN'S 5 INCH 8 OHM 8 WATT HORN



SW7-12 COMMUNICATIONS SPEAKER WITH FILTER



SHARMAN METER SWR-2T

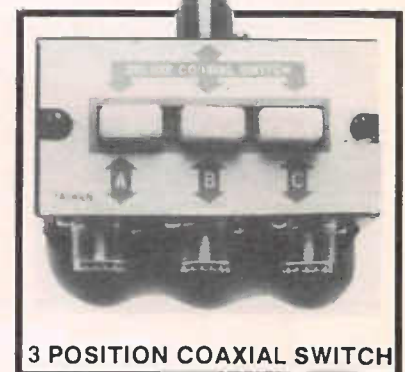

3 POSITION COAXIAL SWITCH

If you would like further details of the full range of CB equipment, telephones, In Car entertainment, portable TV and radio and all the benefits of dealing with one of the country's major wholesalers, then please phone 061-834-9571 for immediate attention.

**3 BURY NEW ROAD, MANCHESTER M8 8FW
TEL: 061-834 9571 TELEX 665446 Sharma G**

SHARMAN'S

WHOLESALE

DISTRIBUTORS FOR:

HARVARD[®]

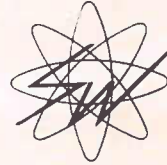

CTE INTERNATIONAL[®]

maxcom

DNT

Extensive ranges of
CB equipment in stock
at the best prices for you!

STRICTLY TRADE ONLY

SHARMAN'S WHOLESALE

SUPPLIES THE TRADE NATION WIDE

--- ONLY A PHONE CALL AWAY ---

061-834 9571

061-834 9571

061-834 9571

061-834 9571

061-834 9571

RING NOW FOR OUR SECURICOR DELIVERY DETAILS!

WHOLESALE

DIY RIG



PROTECTOR

David Cox offers this simple and inexpensive DIY burglar alarm system

The project to be described here is a very simple burglar alarm system, for the protection of CB and radio equipment in the car. It costs less than a fiver to build and can be constructed and installed with the minimum of fuss in a few hours. As the unit uses only one relay, a fuse and a switch, even the complete novice should be able to construct and install the unit without encountering any problems. The following notes on the relay have therefore been included for the novice and may be found to be helpful.

The Relay

Fig 1 shows the internal layout of a basic relay. Essentially, it consists of an electromagnet, a soft iron armature and a set of contacts. When an electric current flows through the electromagnet, a magnetic field is produced which attracts the armature towards the electromagnet. The movement of the armature effectively pushes the pair of contacts together and allows a separate electric current to pass through them. The general purpose of the relay is to allow a relatively low power circuit to control a higher power one. An example of this could be a low voltage signal to operate a mains powered motor; the input signal would be connected to the coil

(electromagnet) of the relay and the mains and motor connections would be made to the relay contacts.

As mentioned previously, Fig 1 only serves to demonstrate the most basic kind of relay. This useful component is available in many shapes and sizes, but the main distinguishing factors are:-
1) Coil operating voltage and resistance.
2) Number of switching contacts.
3) Contact ratings.

The latter refers to the maximum voltage and current that may safely pass between the contacts.

The relay used in this project is slightly more complicated and a layout similar to the one used is shown in fig 2. Note that there are now three contacts in the relay. The third contact is used to allow current to pass from the centre contact to either of the other two. This is so because contacts 1 and 2 are joined together when the relay is not in operation, or de-energised, but contacts 2 and 3 are joined only when the relay is energised. From the diagram in fig 2, it can be seen that when the relay is energised, contact 2 is pushed away from contact 1 and towards 1. As contact 2 is common to both 1 and 3, it is normally referred to as the "pole". Hence, as the pole is connected to contact 1 when the relay is de-energised, this contact is known as the normally closed contact. Its opposite is contact 3, which is labelled the normally open contact. These two terms are abbreviated to n.c. and n.o. respectively. This particular kind of relay is called the "one pole changeover" or the "single pole, double throw" (SPDT). Other types of relay include the double

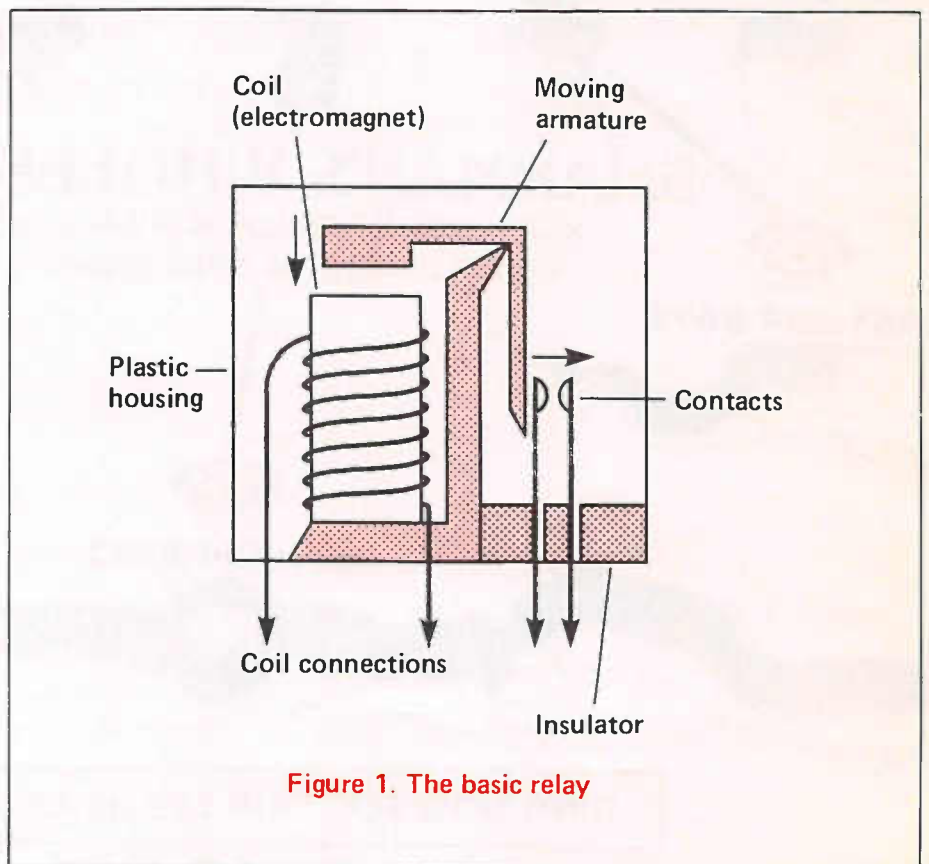
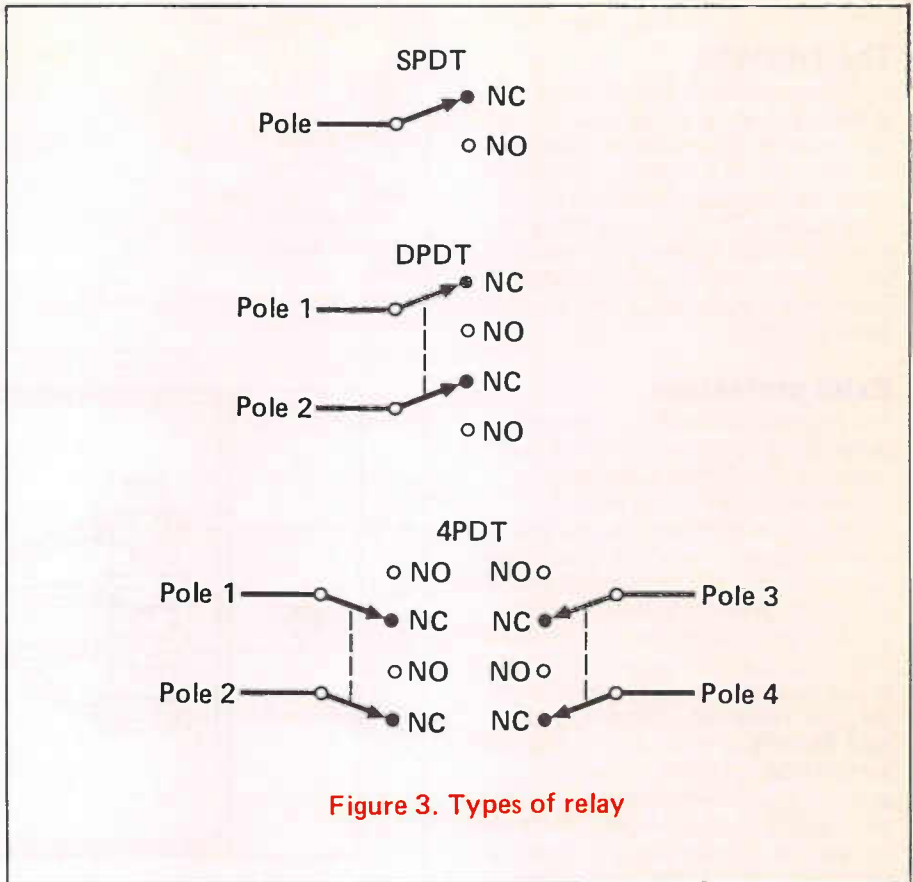
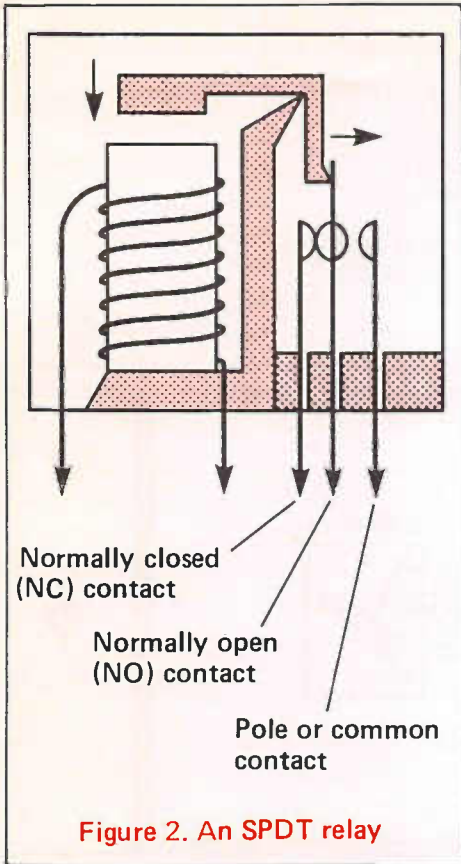

Figure 1. The basic relay



pole double throw, (DPDT) type, which contain two SPDT switches sharing one coil. A relay containing 4 switches is also widely available. A diagram outlining the connections made in each of the above relays is shown in fig 3. Fig 4 is a diagram of the actual relay used in this project.

The Circuit (see fig 5)

When the alarm is in operation, but has not yet been triggered, the relay has a positive supply via the terminal block part a, and has a negative connection from the trip wire, which runs from terminal block part c. (see installation). The relay is thus energised and the pole is connected to the normally open contact.

When the alarm is activated, the trip wire is essentially severed and so the relay is de-energised. The pole of the relay therefore has the effect of connecting positive to the horn, via S1b. The horn should then command the attention of passers by.

The alarm is de-activated by the hidden switch, S1, which both disconnects the horn from the unit and connects the relay to an alternative earth. The trip wire will need to be replaced before the unit can be returned to the standby mode.

Construction

Electrical construction is straight forward, requiring just 5 interconnecting wires. Care should be taken when soldering to the relay to avoid connection to the wrong terminals. Also, it is possible that two terminals may be "bridged" by a stray wire or solder and this should be

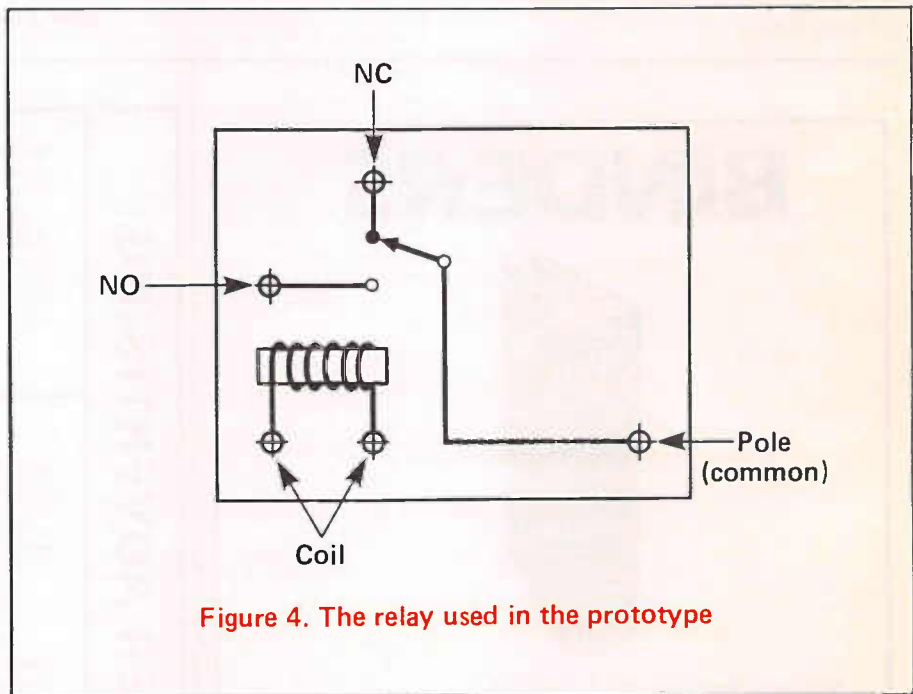

checked against before installation. One of the five terminals on the relay is not used.

The box used for the prototype was one supplied by Maplin and was found to be ideal for this project. However, any box of a suitable size may be employed. It is recommended that the unit should be installed within the cabin of the car. If it is placed in the engine compartment, the housing will need to be weatherproof. Fig 6 shows the component positions in the prototype. The terminal block and the

relay were glued into position using a very strong adhesive.

Installation (see figs 6 and 7)

A suitable location was first chosen to mount the switch and the main box. The wiring was then completed using suitably rated and coloured cable. An inline fuseholder and 5A fuse were included between the unit and the battery for safety. Note that this unit is for negative earth only.

The Trip Wire

If only one piece of equipment is to be protected, then the trip wire can simply be connected to any metal area on the equipment. Note that there must be no more than one strip wire having only one earth contact. Therefore, a single wire running through, but *not* connected to various items of value before finally being connected to earth, will protect all of the items in the line.

Extra protection

The principle of operation of this unit is quite simple to define. The unit has a "sensing" input which is normally connected to earth. If this input is disconnected from the earth, then the alarm will sound. Therefore, the unit can be found controlling other aspects of security. One example makes use of a cheap product which can be purchased from Maplins and security shops. That product is simply a length of aluminium foil, 1/2 inch wide, with adhesive on one side. The idea is to stick the foil around a window (about 1 inch from the frame) with one end connected to the unit and the other connected to earth. Now, when the window is broken, the foil is broken as well and the input to the unit is severed, sounding the alarm. Once again, all for under a fiver!

Components

Item	Maplin Code
DPDT Switch	FH39N
SPDT Relay	YX97f
1 1/4 in. 5A Fuse	WR15R
Inline Fuseholder	RX51F
Terminal Block 5A	HFO1B
Cable Red/Black	XR44X/XR40T
Box	(EG) YN37S
Mounting Hardware, connectors, solder	

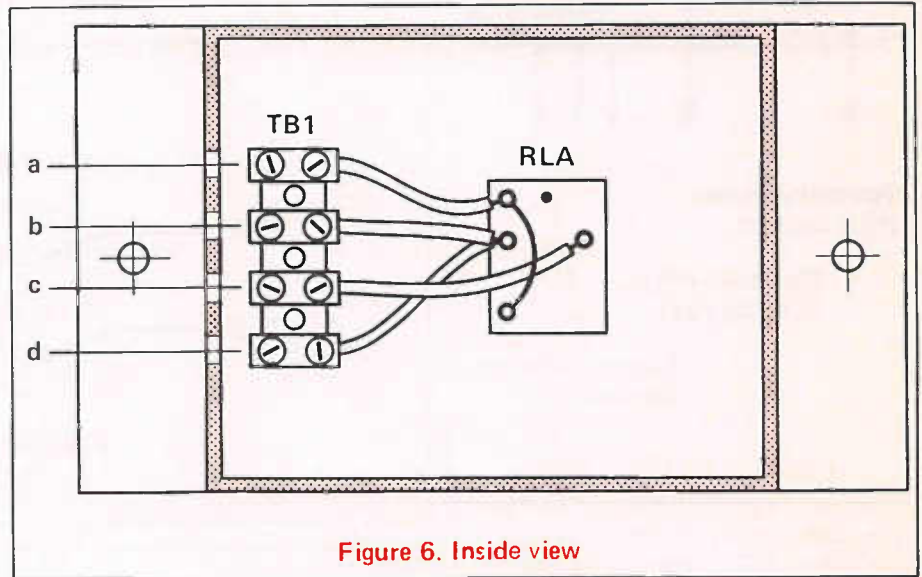

Figure 6. Inside view

BINDERS



For your Valuable Collection of
**CITIZENS BAND
MAGAZINES**

*Smart *Easy to use *Top Quality

To ASP Readers Services, PO Box 35, Wolsey House, Wolsey Road, Hemel Hempstead, Herts HP2 4SS (0442-41221).



Please supply Citizens Band Binders @ £5.95 inc. P&P
Total £ (Please make cheque payable to ASP Ltd.)
Years Required — 198.... 198.... 198.... 198....

Name

Address
Please allow 21 days for delivery

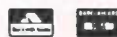

MAIL ORDER ADVERTISING

British Code of Advertising Practice

ADVERTISEMENTS IN THIS PUBLICATION ARE REQUIRED TO CONFORM TO THE BRITISH CODE OF ADVERTISING PRACTICE. IN RESPECT OF MAIL ORDER ADVERTISEMENTS WHERE MONEY IS PAID IN ADVANCE, THE CODE REQUIRES ADVERTISERS TO FULFIL ORDERS WITHIN 28 DAYS, UNLESS A LONGER DELIVERY PERIOD IS STATED. WHERE GOODS ARE RETURNED UNDAMAGED WITHIN SEVEN DAYS, THE PURCHASER'S MONEY MUST BE REFUNDED. PLEASE RETAIN PROOF OF POSTAGE/DESPATCH, AS THIS MAY BE NEEDED.

Mail Order Protection Scheme

If you order goods from Mail Order advertisements in this magazine and pay by post in advance of delivery we will consider you for compensation if the Advertiser should become insolvent or bankrupt, provided:

1. You have not received the goods or had your money returned; and
2. You write to the Publisher of this publication, summarising the situation not earlier than 28 days from the day you sent your order and not later than two months from that day.

Please do not wait until the last moment to inform us. When you write, we will tell you how to make your claim and what evidence of payment is required.

We guarantee to meet claims from readers made in accordance with the above procedure as soon as possible after the Advertiser has been declared bankrupt or insolvent (up to a limit of £2,000 per annum for any one Advertiser so affected and up to £6,000 per annum in respect of all insolvent Advertisers. Claims may be paid for higher amounts, or when the above procedure has not been complied with, at the discretion of this publication, but we do not guarantee to do so in view of the need to set some limit to this commitment and to learn quickly of readers' difficulties.)

This guarantee covers only advance payment sent in direct response to an advertisement in this magazine (not, for example, payment made in response to catalogues etc. received as a result of answering such advertisements). Classified advertisements are excluded.

PLEASE ALLOW 28 DAYS FOR DELIVERY

Back numbers of *Citizens' Band* are available for the last 12 months only. Each magazine will cost £1.85 including postage. Past features have included:

- November 1986: Safety First; PRS — an Alternative; DX Hints and Tips
- December 1986: New Frequencies; DIY RF Wattmeter; Antenna Evaluation
- January 1987: Computers and CB; Beginners' Guide
- February 1987: CB Myths and Legends; Signal Improvement; CB Lingo
- March 1987: Bearcat Handheld Scanner; Choosing Your Equipment
- April 1987: CB in Depth part 1; Setting Your Sites; Back to School
- May 1987: French CB; Six Years Later; Walkie-Talkie Mods
- June 1987: CB in America; DIY Overmod Indicator; Community Radio
- July 1987: Government Green Paper; Successful Soldering; Surface-mounted Components
- August 1987: Moonraker Handheld; CB in Norway; New CB Licence
- September 1987: Uniden 400; QSL Courtesy; Truck King Profile
- October 1987: Zodiac CEPT sets; Taxis and CB; Starline Voice Controller

Readers SERVICES

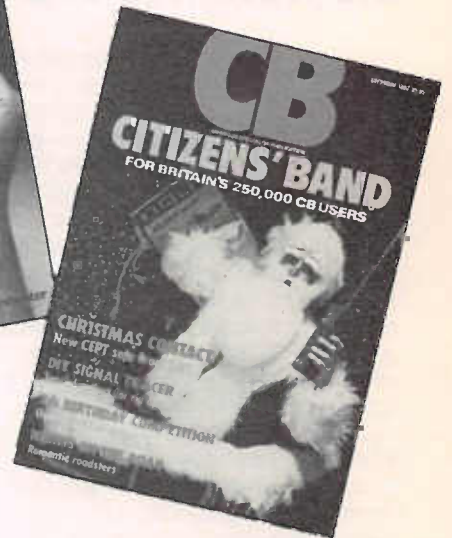

Cut out and send to:
Citizens' Band,
Infonet Ltd,
5 River Park Estate,
Berkhamsted,
Herts HP4 1HL
Tel: (04427) 76661/4



Please commence my annual subscription to *Citizens' Band* with the issue. I enclose a cheque/postal order for £..... made payable to 'ASP Ltd' or debit from my Barclaycard/Access No

valid to

Name

Address

Signature

£16.20 (UK)	£21.80 (Far East)
£20.10 (Europe)	£20.50/\$30.00 (Elsewhere)
£20.30 (Middle East)	

Please send the following back issues of *Citizens' Band* at £1.85 per copy

Total cost of order £.....

Write with cheque or PO to:
ASP Readers Services Dept.
PO Box 35,
Wolsey House,
Wolsey Road,
Hemel Hempstead,
Herts HP2 4SS.



Please send... *Citizens' Band* binders at £5.95 each.

Delete as appropriate:
I enclose cheque/postal order/money order for the above amount payable to '*Citizens' Band*'. Please debit my Access/Visa account number:

Signature

Name

Address

CB IN DEPTH

(PART 13)

At last, the bit you've been waiting for — the final part of Paul Coxwell's look at the workings of a rig. This time — SSB!

Having covered just about everything else, we turn our attention to single sideband transceivers this month. SSB is one of the most efficient ways of transmitting because there are no superfluous carriers wasting power and no duplication of information as with AM. Way back at the start of this series we looked at the operational and technical merits of SSB, so go dig out your April 1987 issue of *Citizens' Band* and have a quick recap. Just for convenience the outline of SSB is shown in fig. 1 once again. At (a) we have a conventional AM signal comprising the carrier and two mirror-image sidebands. In this instance, the transmitter is being modulated by a two-tone signal, one at 1 kHz the other at 2 kHz. At (b) the carrier has been suppressed leaving a DSB (double sideband) radiation and at (c) we have removed one sideband to leave true SSB (in this case upper sideband).

Generating SSB

The circuitry of an SSB radio is necessarily more complex than either AM or FM sets and the alignment is also more critical. The standard way to generate SSB in CB equipment for a long time has been to use a balanced modulator followed by a crystal filter unit. The basic balanced modulator circuit is shown in fig. 2 but there are many slight variations. The RF input must be at a much greater level than the audio for correct operation and the action of the diodes is to suppress the carrier but leave the two sidebands intact. If the output was connected to a spectrum analyzer you may well see a display intact. If the output was connected to a spectrum analyzer you may well see a display resembling that of fig 1(b), assuming a two-tone input of course. In much newer equipment, the balanced modulator is often yet another "black box" integrated circuit, such as the AN612. A small preset potentiometer must usually be adjusted to null out the carrier as best as

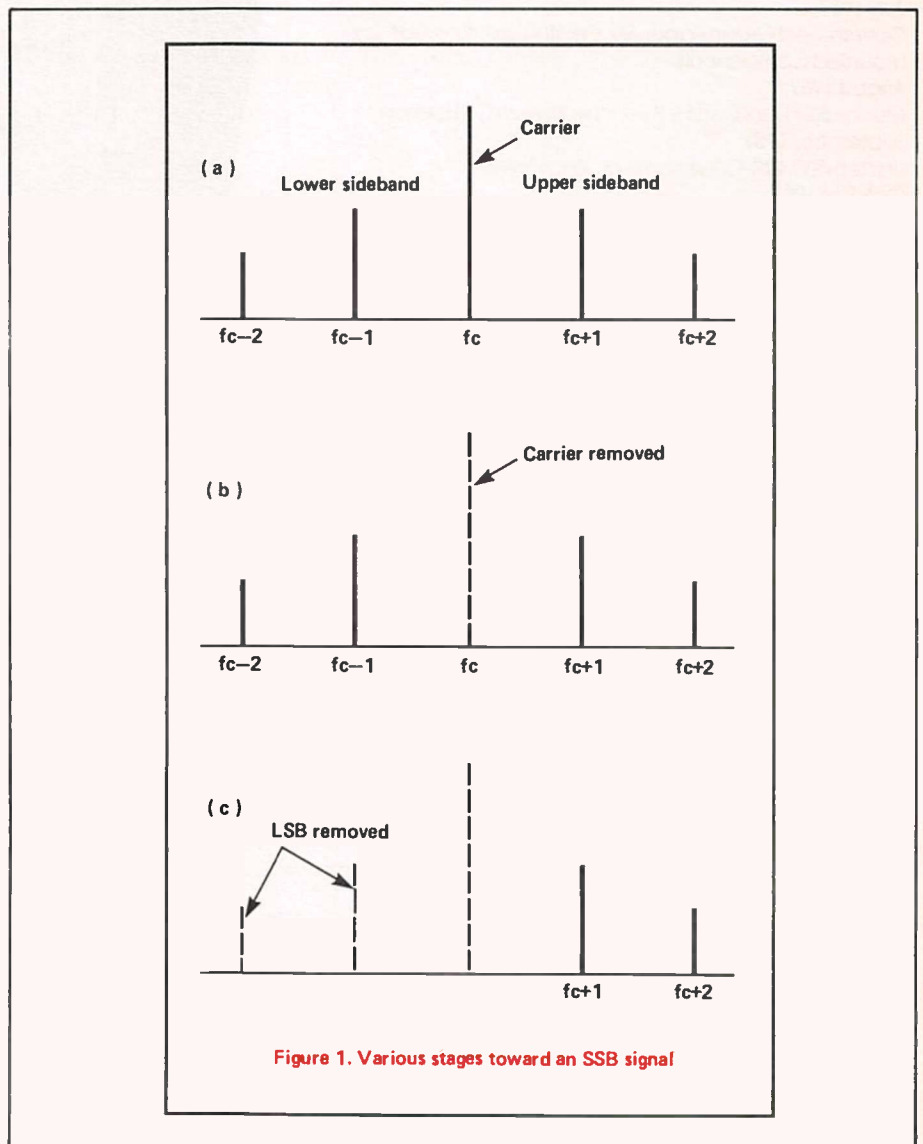

Figure 1. Various stages toward an SSB signal

possible. The output from the balanced modulator is devoid of a carrier but still contains both upper and lower sidebands and this is where the crystal filter comes in. This filter must really be a good one with sharp attenuation outside the required passband to remove the unwanted sideband. The attenuation at the output of the rig is typically 50dB or

so, or to put it another way with the usual 12W PEP the unwanted sideband power will be down to nearly a tenth of a milliwatt!

Obviously the frequency of a crystal filter will be fixed, so with the VCO changing frequencies for different channels how do we arrange things? You'll find that the mixing process used in

SSB radios is a little more complicated than many AM-only sets. Figure 3 shows a typical arrangement in block form, this particular circuit being used by Uniden in a multi-mode transceiver. Taking straight forward AM and FM first we have the VCO running 10.695MHz below the required channel frequency, thus enabling the oscillator to feed the first mixer in the receiver directly to obtain the first I.F. (this was covered a few months back). The PLL device used in this chassis runs at low frequencies and there is therefore an oscillator running at 15MHz to downmix the VCO output to somewhere around 1 to 2 MHz for the PLL. On transmit, the output from the VCO remains the same and is mixed with the signal from a 10.695MHz oscillator to provide the desired output at 27MHz — all easy stuff so far if you've kept with us through this series.

When the radio is switched to SSB however the 10.695MHz signal is passed through the balanced modulator before reaching the transmit mixer. This results in a double-sideband suppressed-carrier

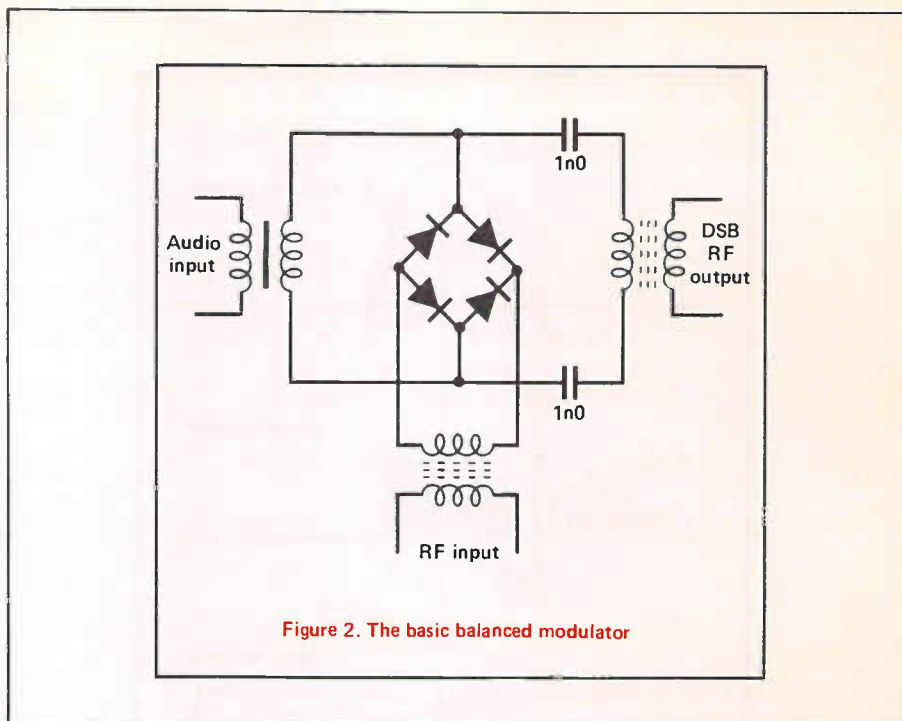

Figure 2. The basic balanced modulator

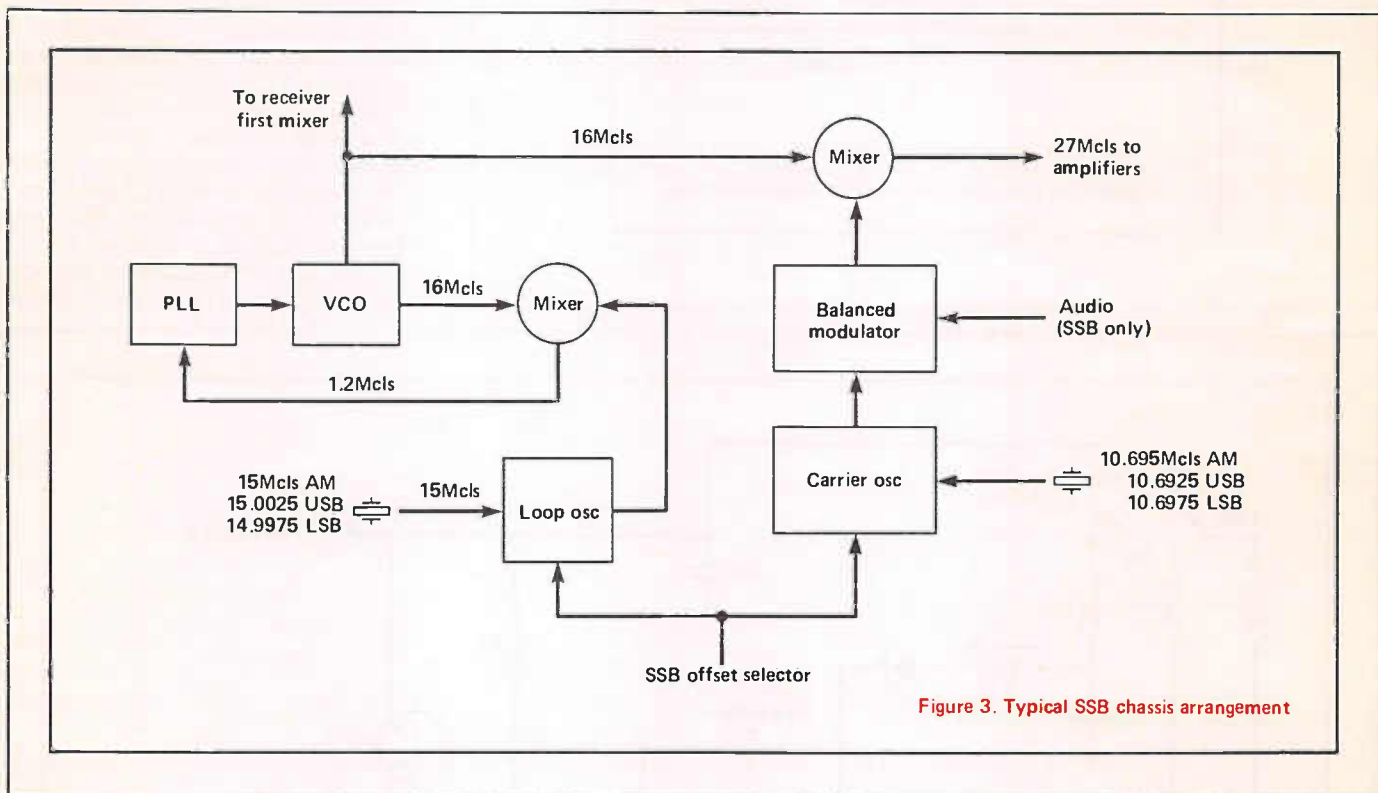

Figure 3. Typical SSB chassis arrangement

signal as already described which is then fed through a crystal filter to leave just one sideband. When mixed with the constant 16MHz from the VCO the result is a 27MHz SSB emission. The VCO frequency changes to switch channels just as on AM and the balanced modulator and crystal filter always work at the same frequency.

Unfortunately however, we must introduce a complication — how do we select between lower and upper sideband? The output from the balanced modulator is double-sideband and it is the crystal filter that determines which sideband is suppressed so it would seem

logical to switch between two filters with slightly different frequency responses, one to remove the USB, one to remove the LSB. This solution is perfectly acceptable from a technical point of view but the good-quality crystal filters needed here are pretty expensive. As with most mass-produced equipment a \$5 saving on each set soon adds to the profit when production runs into thousands of units! What actually happens then is that the oscillators are slightly shifted in frequency so that the other sideband is suppressed by the same filter. In fig. 3 when we switch from AM to USB the carrier oscillator shifts frequency to

10.6925MHz (i.e. 2.5kHz down), and when switched to LSB it shifts to 10.6975MHz (2.5kHz up). This results in one or other sideband being located in the passband of the crystal filter, see fig. 4.

So far, so good, but if the output of the filter were mixed with the same VCO signal as on AM the final output would be 2.5kHz too high on LSB and 2.5kHz too low on USB. To get around this problem we just arrange for the VCO to shift by the same amount but in the *opposite direction*. The easiest way to do this here is to shift the 15MHz oscillator so on USB it goes up to 15.0025 and on LSB it goes

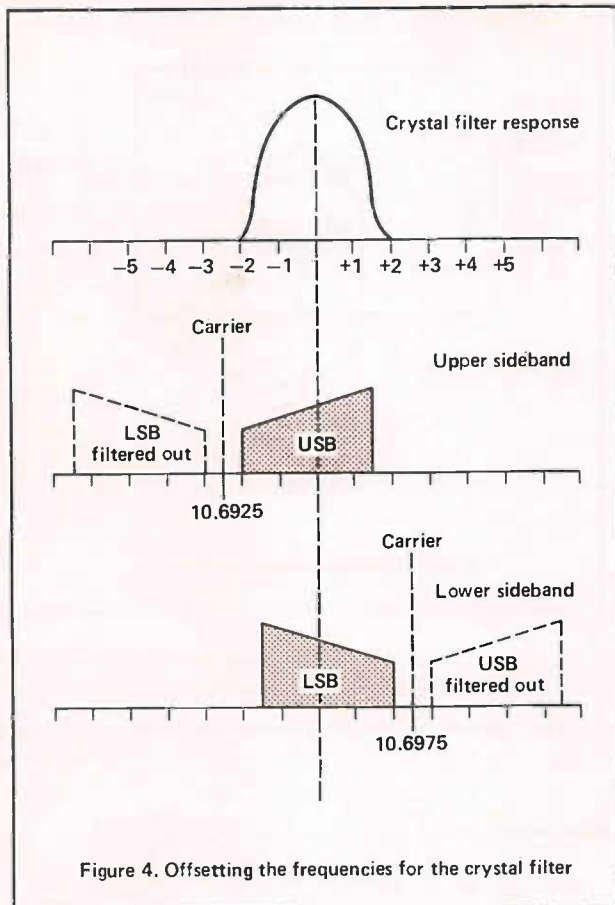

Figure 4. Offsetting the frequencies for the crystal filter

down to 14.9975 MHz. This counteracts the offset of the 10.695MHz carrier oscillator resulting in a signal still correctly centred on the appropriate channel.

There are many variations of this idea of course and the exact offsets and mixing depend on the chassis. Sometimes for example, you will find that the oscillators are only shifted in frequency for LSB and the crystal filter response is centred a little higher than the nominal 10.695MHz here. This will be found in many Cybernet export sets.

Figure 5 shows how the offsets may be applied to an oscillator. The transistor is configured as a standard Colpitts Oscillator which by now you are no doubt fed up of seeing! Instead of the crystal being returned directly to ground or through a trimmer capacitor we have a neat little circuit that allows three different inductor/capacitor combinations to be selected. When AM or FM is selected a positive voltage is applied through the mode switch to L4. The circuit is completed via L1, D1 and R5, the diode being forward-biased, the diode effectively connects L1 and C1 in series with the crystal allowing it to run at one particular frequency, this being fine tuned by adjusting L1. Diodes D2 and D3 are reverse-biased to keep the other sections of the circuit effectively inoperative. On USB diode D2 is forward-biased allowing L2 and C2 to control the frequency and on LSB L3 and C3 set the offset. R5 is necessary to provide a DC path to ground for biasing the diodes and coils L4, L5 and L6 offer a

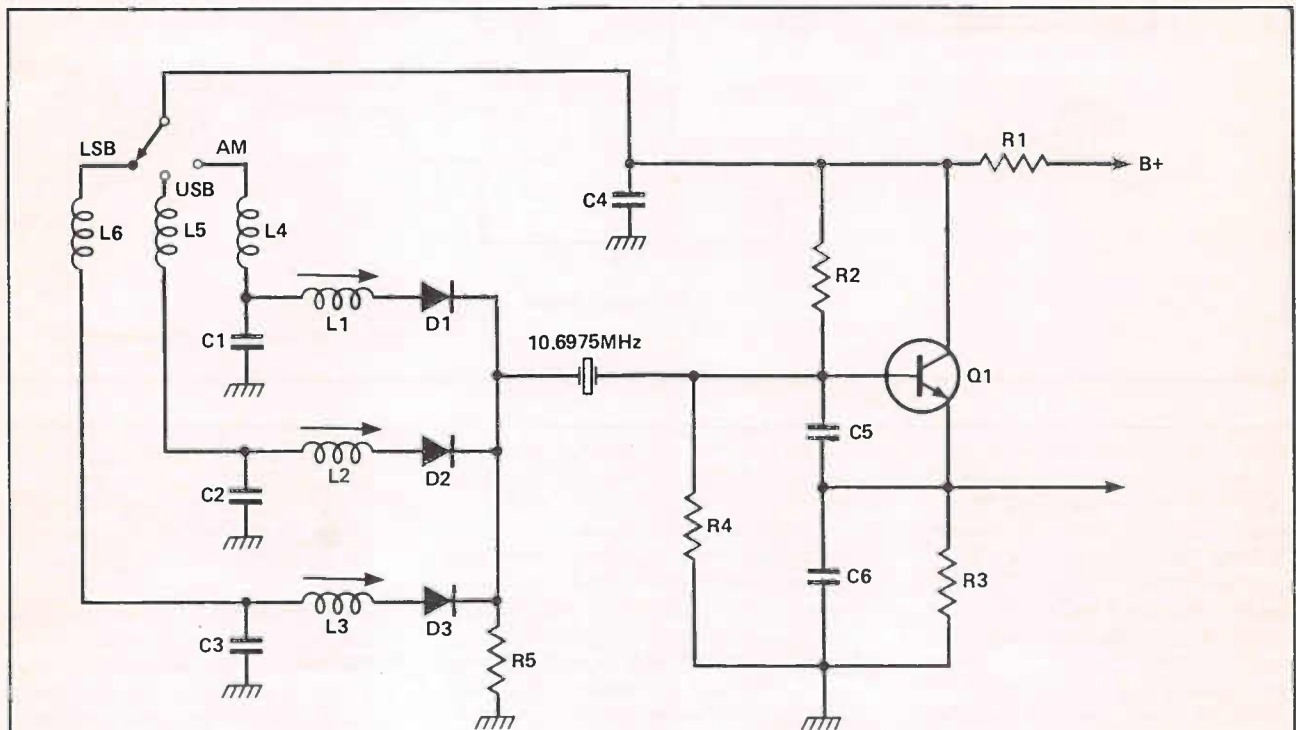

Figure 5. Applying offsets to a crystal oscillator

path to the DC control signals but block RF. The capacitance of the wiring to the mode switch would otherwise affect the oscillator. With our example of above L1 would be set to give 10.695MHz, L2 for 10.6925 and L3 for 10.6975MHz. A similar arrangement is employed to shift the downmix oscillator circuit.

Automatic Level Control

Just as we must have limiting to prevent over-modulation on AM and FM so we must have some control on SSB as well. Trying to drive the transmitter too hard will result in the tops of the output waveform being "chopped-off" causing splatter, distortion, and interference. This is often known as "flat-topping" from the shape of the output waveform when shown on an oscilloscope. Some ALC circuits operate just over the A.F. portions of the transmitter but the better systems monitor the RF output and control the gain of the microphone amplifier from the overall RF level. The limiters work in a very similar way to those shown for AM modulators but input is from a rectified sample of RF.

SSB Power Amplifier Stages

When we looked at the final RF power output stage we saw that in AM and FM transmitters it may well operate in class C, i.e. biased below cut-off. This is fine where there is no amplitude variation with modulation (FM) or where the modulation

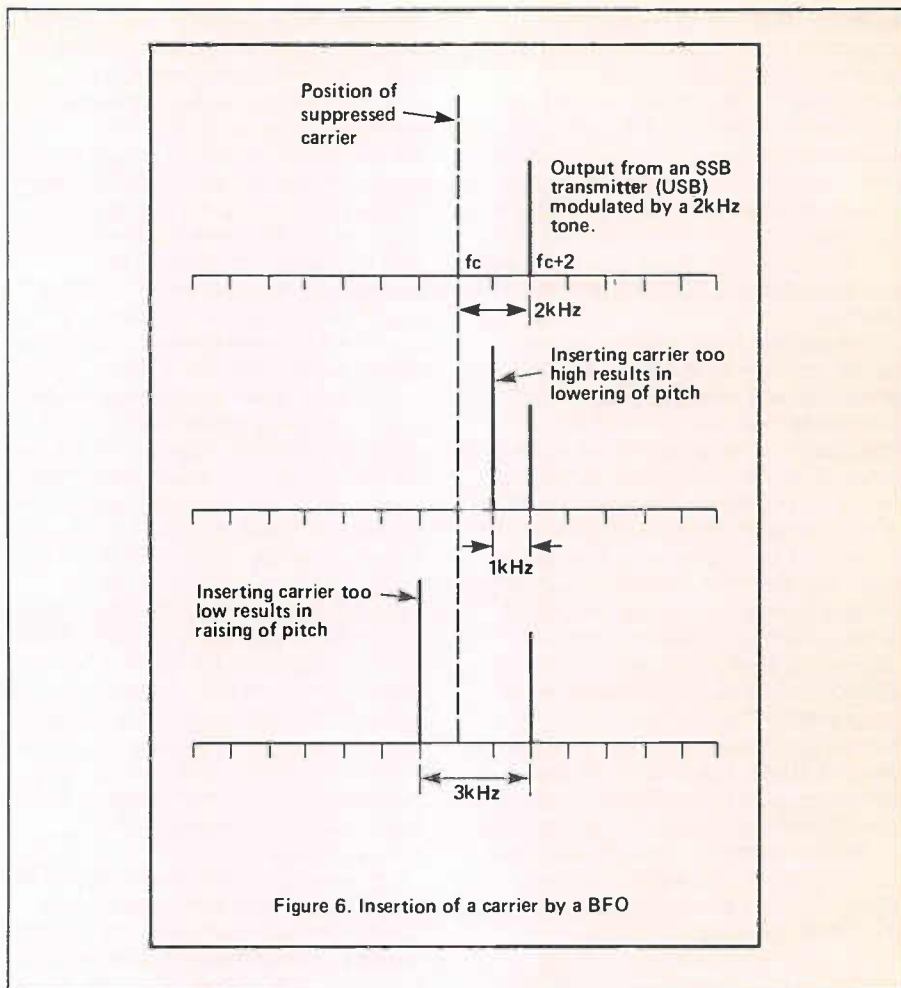

Figure 6. Insertion of a carrier by a BFO

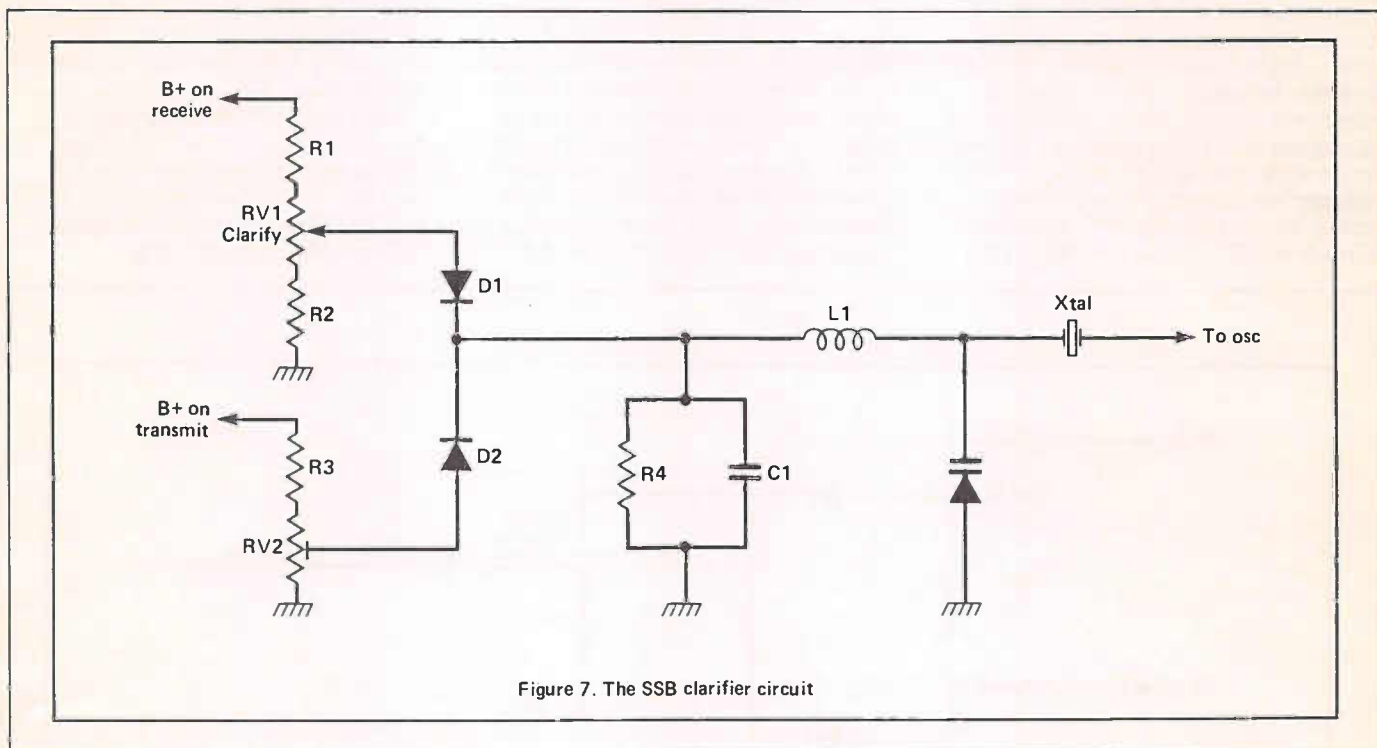

Figure 7. The SSB clarifier circuit

is applied at the final amplifier and not before it. Because the SSB signal is generated in its entirety before the output stage however the power amplifier must be completely linear in operation, otherwise distortion is introduced. This means that Class C amplifiers are definitely out and the biasing must be

carefully adjusted so that the transistor is operating completely linearly. Refer back to part 3 of this series for more details about transistor biasing.

Receiving SSB signals

To receive an SSB signal, we must re-insert the missing carrier. The oscillator

that performs this function may be called a Beat Frequency Oscillator (BFO) or Carrier-Insertion Oscillator. Just as we generated SSB at a fixed frequency so we re-insert the carrier at a frequency that is independent of the channel selected. The easiest way of doing this is to apply the BFO signal to the I.F.

amplifiers, and in most modern CB equipment this will be at 10.695MHz. It is quite common for multi-mode transceivers to use double-conversion 10.695MHz/455kHz on AM and FM but only single-conversion to 10.695MHz on SSB. A crystal filter on SSB reduces the receiver bandwidth from the 6 or 7kHz on AM to around 3kHz. This ensures that only the correct sideband is received and that any neighbouring signal is suitably rejected.

The circuitry is just like that we saw earlier when we dealt with receivers in general. Now a neat little dodge that is sometimes found; remember the crystal filter used in generating SSB? Well, it's sitting there doing nothing useful during reception and the receive filter would be doing nothing during transmissions so why not use the same filter for both and save some money? That's exactly what many chassis do in fact, including the Uniden one we examined earlier on. The loop oscillator is shifted up and down by 2.5kHz depending on whether upper or lower sideband is selected so that the correct part of the signal "fits" through the crystal filter. Continuing with that same design, the 10.695MHz carrier oscillator is also used during reception to re-instate the carrier at the SSB detector, following the I.F. amplifiers. The same ± 2.5 kHz offsets are applied to counteract the 15MHz loop signal changes.

Now we have just one more little item to consider — the fine tune or clarifier control. This is absolutely essential for SSB reception because the exact carrier insertion frequency must be adjusted to match the incoming signal. If the carrier is inserted at too low a frequency then the voice will sound high-pitched on USB or low-pitched on LSB. Similarly if the carrier signal is too high then voices will be high on LSB and low on USB. It is the

difference between the inserted carrier and incoming sideband that governs the pitch of reproduced signals and the clarifier must be adjusted to precisely match the carrier removed at the transmitter. Because the I.F. centre-frequency and bandwidth are fixed by the I.F. transformers and crystal filter it is usual to tune the signal by varying the VCO frequency, thus shifting the incoming signal within the I.F. "window" or passband. The VCO frequency is adjusted by varying the loop oscillator, a typical arrangement being shown in fig. 7.

A varactor diode is inserted in series with the crystal which is wired into the usual Colpitts-style oscillator. R1, R2 and VR1 form a potential divider which has power applied only during reception. The DC voltage is coupled via D1 and L1 to the varicap diode which shifts the frequency by a small amount as the clarifier is altered. L1 is the usual choke to allow a DC path but to block RF. When the radio is switched to transmit power is removed from the VR1 network and applied to the second potential divider chain R3 and VR2. The potentiometer is a preset on the circuit board which is set during regular alignment of the rig. Diode D2 is now forward-biased and D1 reverse-biased.

The overall result is that on receive the exact frequency is determined by the position of the fine tuning control but on transmit it is fixed by VR2. If the transmit frequency were allowed to be altered with the receiver it would make two-way communication difficult at times — as station A tunes in Station B he also shifts his transmitter frequency slightly so that when he next transmits station B has to re-tune him. Station B has now altered his transmit frequency so that when he next talks station A has to re-tune and so on. Controls allowing the transmit frequency to be altered (apart from the channel

selector) are also illegal in many countries, so radios designed to be within the regulations must be made this way. In England of course SSB is not allowed at all on CB but you may still find an odd fine tuner, often labelled Delta Tune — these two affect only reception.

Frequency Shift Controls

Whilst masquerading under different names these all do the same thing — allow the complete radio, transmitter and receiver, to be shifted up or down by about 5 or 6kHz allowing inter-channel working. They won't be found on legal radios in any country but are ever popular on multi-band multi-mode sets. Figure 8 shows the typical wiring of a shift control; it is wired after the fine tuning with its receive/transmit diode switching so that it is operative during both reception and transmission. Enough said.

Conclusion

Well folks, that just about wraps it up for this series. We've looked at receivers, transmitters, modulation, demodulation, AM, FM, SSB, switching, regulators, PLLs, indeed just about everything. Obviously there was much more detail for each section but we've been going quite long enough at it is. If you stuck with us throughout and managed to understand everything along the way you're a good few points up on your buddies. Maybe now you've gained sufficient interest to warrant going out and buying a few books and service manuals to learn some more — and there's plenty to learn.

Many thanks to you all for making it through my pages of waffle and may your oscillators remain free from drift. Next month to round off we'll have a CB In-Depth Quiz, just to see how much you've remembered. So long!

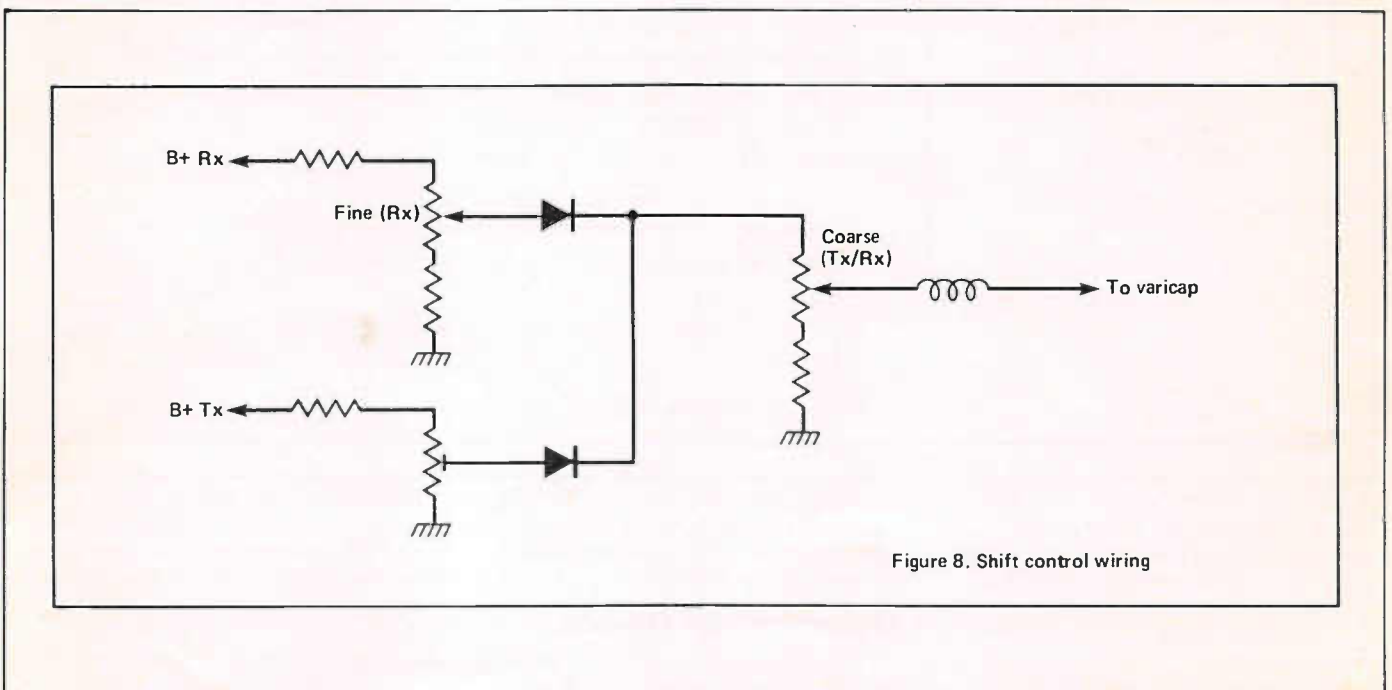

Figure 8. Shift control wiring

TWONG

JOHN RICHARDSON

NO ONE HAS HEARD FROM OUR HERO THE GODLING TWONG! IT SO QUIET! IT SO PEACEFUL! IT SO BORING!

GANSA! WHAT'LL THE C.B.ERS DO WITHOUT THEIR GODLING HERO?

NO LOONY? NO LOONY? NO LOONY?

NO MORE LOONY!

NOW! BACK TO THE RIG!

VIPPEE HE GONE F'REVER!

NO MORE LOONY!

SO WHERE HE AT? HAS HE GONE DOWNA BOOZER? HAS HE RUN OFF WITH LADY DI? HAS HE GONE PEE-PEE? WELL, HAS HE?.. EH? EH?

NO HE HASN'T!

HE ANSWERED A SUMMONS FROM THE GODFATHER, ZEUS!

S'THERE!



SO, OUR HERO HURTLES UP TO HEAVEN, 'COS HE'S OBEIENT 'COS HE'S BRAVE. 'COS HE'S GODLY. ALSO, 'COS HE'S DOWN A NUMBER IN HIS Y-FRONTS! IF HE HAD ANY Y-FRONTS...

ME IT COMIN' BOO G!

BLOWN!

SWAN!

SWAN!

LISSEN, FIMM'YUGS! I GOT THIS PAIN IN THE OL' FOOTAROTIE, AN' NONE OF OUR HEAVELY QUACKS CAN CURE IT!



SO IN OUR INFINITE WISDOM WE FIGURE MAYBE ONE OF THEM PUNY, MORTAL-TYPE HUMMANS CAN COME UP WITH SOME MEDICINE SO YOU GET TO ASK 'EM! OK?



O.K. MAKE WITH THE FUNNY EARS!

AN' DON'T COCK IT UP...



WE GOTTA FIX OJ HIS POSITION!

AN' WE MIXED THE MEDICINE!



US C.B.ERS SUPPOSED TO STICK TOGETHER! Y'GOTTA HELP 'OL TWONG, AN' SEND HIM SOME FOOT TONIC!



SO ZEUS GETS HIS TONIC...

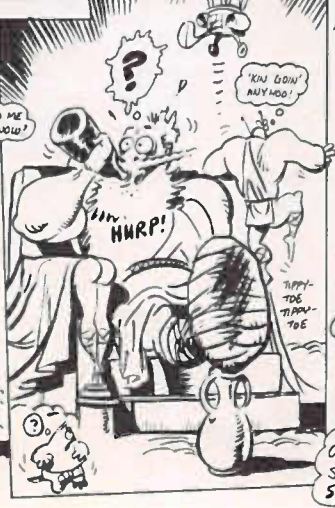

MEANWHILE, BACK ON EARTH...



A CB HOLIDAY IN NORWAY

Motoring in Norway with your CB radio? Snoopy, our Norwegian correspondent, comes up with some extremely useful information

If you are holidaying in Norway, I would strongly recommend that you take your rig along. Particularly so with your new PR27GB rig. As a native, I have, on occasion, had the pleasure of receiving calls from UK breakers camping in Norway. I have even been able to give some advice and make new friends by eyeballing, as a result of the call.

CB regulations in Norway are as follows: 40 legal channels from 26.965 to 27.405MHz (CEPT channels), 4 watts is the maximum power level on both AM and FM modes and there is no restrictions on antenna length!

We use channel 3 as our calling channel (AM/FM 26.985MHz). Our early regulations were for 23 channels AM, so today you will find most FM modulation in the upper half of the band and AM mostly in the lower half.

Right, you are on holiday in Norway - how do you make contact with the natives? Call on channel 3. The majority of the operators have a fair command of the Queen's English. A few might be a little shy to take you on to start with so, if there's no response, you could think about breaking in on a running contact.

The Norwegian word for 'break' would be 'kort' ('short'), so, by repeating 'kort' briefly, the response in Norwegian would be 'kom in kort'. (Yes, you've guessed it.

he meant to say 'Come in, shortly!) Easy? It's not *all* Greek!

Well, now you have established your first contact with the aborigines! From now on, it is up to you and your Queen's (or Maggie's) English. You will find us all terribly Anglophile.

Apart from channel 3 (AM/FM), you may also find channel 9 used for FM calls. At one time it was considered an emergency channel but this may differ from place to place. To my knowledge, there are no regular monitoring services for Mayday calls in operation. Your safest bet would be channel 3.

Now some points of general information. Your point of entry would probably be by car ferry to Oslo, the capital, or to Stavanger, or Bergen on the West Coast. Bear in mind 'though that the districts east of Oslo have no scenic interests whatsoever. The hills, the highlands and the fiords are all to the north-west of Oslo.

Up in the highlands you will find excellent QTHs for your DXing. The 'Eyetic' QRM can be dreadful at times!

Some general advice on motoring in Norway now. All major roads are good, even for caravans. When planning your daily mileage, be warned - you will hardly ever make it! Too much to see, stops for taking photographs and, in the fiord districts of western Norway, you

may have to queue up for ferry crossing in the summer peak season. The best time to travel is from May to mid-September. Peak traffic is usually to be found in July.

As far as climate is concerned, dress exactly as you would for summer at home. You are *not* going to Siberia! The main unit of currency is the NOK (Norwegian krone (same as 10p). Please note that Danish or Swedish coins would hardly be accepted. A final word of warning about money and cost: in this country, even the victuals are loaded with VAT and prices for groceries are very high. In order to avoid paying through the nose, I would advise you to stock up well, a little before leaving home. Fill up your boot with whatever you can to keep body and soul together.

Camping sites are very well organised, also with cabins for hire but, in addition, this country is sparsely populated. There are only 4 million of us on 125,000 square miles! So, if you find a place you fancy away from farmland, park off the road and enjoy your elbowroom. Have a nice time away from the madding crowd.

NB: It is always a good safeguard, when visiting any foreign country, to check with the relevant authorities as to the ever-changing rules and regulations on using or bringing in CB equipment.



RAP FOR REPS

Are sales reps the worst driving offenders on the roads today?

Gosh, March already and I thought it was only the end of January! Never mind the weather, it will soon be summer again — and then Christmas!

Well, for the past two months, I've been boring you all silly with the review of the new range of Scania trucks. Sorry, but it is supposed to be 'Truckstop' and is meant for truckers to read. It seems that I was sadly mistaken, when I recently said that I had only got five or six readers. It's really amazes me, that most people I speak to, not only like — but LOVE to read my page. Wonders will never cease. Righto, back to business.

Last month, if the editor printed it, I mentioned a long-lost copy of mine, being Nigel, Bell-Boy, alias The Printer. He was having a moan at me, that although he loves reading my columns, he is a bit disappointed that I only ever mentioned truckers and forget about those people, engineers, sales reps, consultants, etc. who traverse our motorways daily. Well, I suppose I could always say that this is *supposed* to be the truckers' page. I won't though; what I will say is that I haven't forgotten you all. I would LIKE to, 'cus I've found reps especially, to be one of the worst kind of car drivers. But I'd better not go too far into that one. Actually, a lot of the people I mention from time to time, really drive cars and small vans. One of my favourite 'gay' truckers, actually uses a very small car to deliver computer bits all over the country. So there, Nigel. That's my excuse and I'm sticking to it. Yet another car driver gave me a call the other day. He is one of my biggest fans I reckon. Many many moons ago, on attending an eyeball at Cheltenham, he found me, and asked ever so nicely if I would mind having my photo taken with him. (I take awful photos, but he said they turned out great. It's a wonder I didn't break the camera!) Anyway, as I've never mentioned him before, best wishes to Peter, Senator from Bristol, and don't forget to send me a copy of the photo! Whilst on the subject of eyeballs, anyone

who wants to meet me (and probably live to regret it), I shall be attending the Mercia QSL Club of Coventry's Eyeball on Sunday June 5th at Caludon Park, Coventry — just off junction 2 of the M6. I'd be pleased to see all or any of you there!

Senator's moan — well, he reckons there is a severe shortage of inexpensive overnight accommodation for reps etc, near our motorways, and that he doesn't really feel welcome if he goes into a truckstop with beds, in his suit. I suppose that is understandable, most truckers feel that you are all on huge expense accounts and can afford hotels. But Peter says there ought to be more cheaper priced bed and breakfast places nearer to motorway exits. So, if anyone out there is thinking of buying a guest house, there's a tip for you.

Another quick mention to *Toy Boy*, from Barston who comes up to Coventry most days. He made me an offer that I very nearly didn't refuse. Also to a member of the Mafia Squadron from Rainy City (Manchester), who asked me why I hadn't done a review of the new ERF 'C' Series. Well, as I told you, Mucky Duck, if ERF deemed to send me their press releases, I would certainly give their truck a mention. Mucky Duck reckons (the fool) that they compare most favourably with the new Scania and Volvo ranges. Whilst I'm at it, I'd like to thank Scania and Seddon Atkinson, who were the only manufacturers to take heed of my request for Press releases. If any of the other 'drivers' are reading this, then please pass it on.

The Lady Truckers Club, run by Ilona Richards is planning another Sponsored Hitch to raise money for Great Ormond Street Children's Hospital. This year, Ilona plans to send a Teddy Bear on a sponsored hitch. He will set off on Monday 16th of May and will travel

around the U.K. in trucks and will record the details of every lift, so that when, and if, he returns, we will know the exact mileage he has covered. All members of the Lady Truckers Club will have a sponsorship form in their possession. They will be asking people to have have a go (50p a go) at guessing the total mileage that Teddy will travel. There will be some good prizes to be won. Just in case Teddy gets lost, Ilona will be going with him to hold his hand. So you lot out there, if you see a lady trucker about, stop her and ask if you can have a couple (or more) guesses. All the proceeds are going to Great Ormond Street Childrens Hospital. So get your money out and have a go. If you don't have any contact with Lady Truckers (aren't you the unlucky ones) then write to Ilona and pledge your monies, at The Lady Truckers, 1 Horton Avenue, Stretton, Burton Upon Trent, Staffs De13 ODP.

Well I hate to have to say this all over again, but I'd love to hear from you all. Unfortunately, I've gone (at long last) and found myself a part-time job, so I won't be on the rig that much now. (Or is it — fortunately?) But I still love receiving and reading your letters. I've had three recently, which unfortunately I haven't got space to mention them here, but I promise to do that next month. If you can tell me a funny story about one of your mates, I'd love to embarrass them for you, and I promise not to mention your name, if you don't want me to. Come on folks, drop me a line and let me know *what you* want to read about. Saves me a lot of embarrassment. Write to me, Brandybird, c/o PO Box 158, Coventry, CV6 6BD and please enclose a stamped addressed envelope if you would like a reply.

That's about it for another month, stay lucky lads and lasses, truck 'em easy and most of all stay safe.

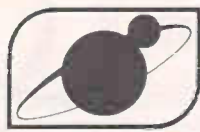

BREMI®

We are pleased to introduce this famous brand name back into the UK. BREMI equipment is of the highest quality - in fact, they are currently the ONLY manufacturer to have full British Standard Institute approval for their CB Power Supplies.

STABILIZED POWER SUPPLY MOD. BRS 27

- Input voltage : 240V AC 50 Hz
- Output voltage : 13.8V DC
- Current : 3A max.
- Stability : Better than 0.1% with variation of 10% or load variations from 0 to 3A
- Protection : Electronic with current limiter.
- Ripple : 1 mV with 3 A load

£19.95

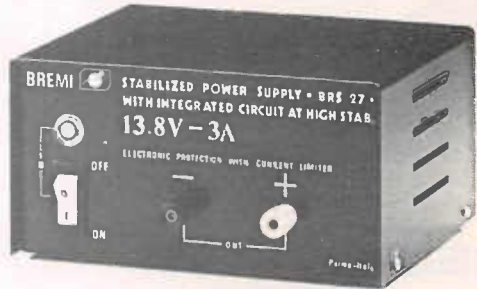

STABILIZED POWER SUPPLY MOD. BRS 31

- Input voltage : 240V AC 50 Hz
- Output voltage : 13.8V DC
- Current : 5A cont. 7A surge.
- Stability : Better than 0.4% with mains variation of 10% and load of 0 to 5A
- Protection : Electronic with current limiter.
- Ripple : 10 mV with 5 A load

£29.95

DIGITAL FREQUENCY COUNTERS

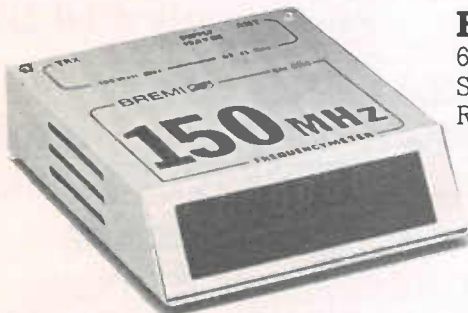

BRI 8150 150MHz

- 6 digit counter
- Supply : 11-15V DC
- Resolution : 1 KHz

£79

BRI 8100 100MHz

- 6 digit counter
- Supply : 11-15V DC
- Resolution : 100 Hz

£69



BREMI BRL 210. MAINS AMPLIFIER

- Output Power : 200W PEP
- Input Power : 1-20W PEP
- Frequency : 26-30Mhz
- Suitable For : AM/FM/SSB

£119.03



BREMI BRG 22. SWR/POWER METER

- This is a general purpose unit, covering 3-150Mhz for SWR.
- The Watt Meter covers 26-30Mhz
- Power : 1KW in 3 ranges (10, 100 & 1000 W)

£39.95



A NEW RANGE OF BREMI ANALOGUE MULTIMETERS

- MODEL BRI 5080 20K Ohm/V DC £25.95
- MODEL BRI 5085 50K Ohm/V DC £29.95
- MODEL BRI 5090 3.3K Ohm/V DC £29.50

BREMI EQUIPMENT IS AVAILABLE FROM YOUR LOCAL DEALER

CALL US NOW FOR DETAILS OF A STOCKIST IN YOUR AREA

UK IMPORTERS

NEVADA COMMUNICATIONS

189 LONDON ROAD, NORTH END, PORTSMOUTH, PO2 9AE
Tel: (0705) 662145 FAX: (0705) 665126 TELEX: 869107 TELCOM G

Pama & Co

FOR

WHOLESALE ONLY

Pama & Co

RIGS

uniden 100



One of the most popular Mobile Rigs around. It has excellent sensitivity and anti 'bleed over' facility of the 200.

uniden 200



One of the best mobiles around with R.F. gain, tone control and other features, it has a good sensitive RX section with low 'bleed over'.

uniden 300



Undoubtedly the 300 is the best selling base station in the U.K. Its features includes mic gain, R.F. gain, power and tone controls and S meter. Value for money? It's unbeatable.

uniden 400



The first available rig for CEPT frequencies manufactured to the highest standards. Features include mic gain, R.F. gain, squelch, 40 channels and a low 'bleed over'.

AERIALS

NEW Pama SUPA TRI

EXCEPTIONAL PERFORMANCE FROM THIS TRIPLE LOADED HIGH QUALITY ANTENNAE SIMPLY... THE BEST.

INTRODUCTORY OFFER PRICE

Retail Price

£19.95

GET £5 OFF THE SUPA TRI AERIAL WHEN YOU PURCHASE THE UNIDEN 400

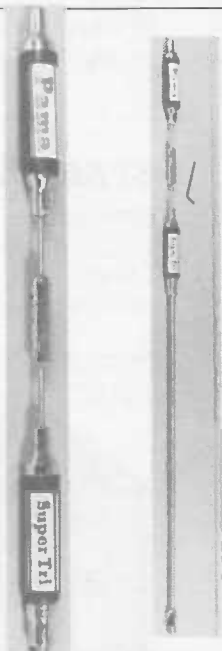

Pama TRI

OUR No. 1 AERIAL IS STILL AVAILABLE MADE FROM THE HIGHEST QUALITY MATERIALS THE PAMA TRI HAS A PERFORMANCE UNEQUALLED BY ANY ANTENNAE IN ITS PRICE RANGE.

Retail Price

Pama Tri only £14.95

WHOLESALE OF

CTE - ZETAGI - **maxcom** - SADELTA - **uniden**
MIDLAND - ~~NEVADA~~ - **THUNDERPOLE** - SIRIO
HEMBRO - **Pama** - **lemm** - **antler**

FOR WHOLESALE ORDERS PLEASE TELEPHONE
AND WE WILL GIVE YOU OUR IMMEDIATE ATTENTION
ALL ORDERS DESPATCHED IN 24 HRS.
LOOK FOR THE PAMA DEALER STICKER



AVAILABLE AT MOST GOOD C.B. SHOPS

**PAMA HOUSE, 433 WILMSLOW ROAD,
WITHINGTON, MANCHESTER M20 9AF.**

Pama & Co

TEL: 061-445 8918
061-434 5701
Telex 666762 PAMA COG
Fax 061 445 0978

Pama & Co

SNUGGLE UP TO A LITTLE EXTRA THIS SPRING

FROM OUR UNIQUE RANGE WE HAVE SELECTED THE FOLLOWING CONVERSIONS

FM MODE CONVERTER: For radios with only a single 10.695 IF (e.g. AR144/Cobra 146)

Model FMC 1 Module only £39.00 Fitted £49.95 plus P&P

For AM radios with 455KHz second IF

Model FMC 2 Module only £12.95 Fitted £25.00 plus P&P

SPEECH PROCESSOR: Switchable, variable and universal for LOUD audio on transmit. As reviewed in December Citizens Band

Module only £17.95 Fitted £25.00 plus P&P

NOISE SQUELCH: Automatically squelches noise whilst allowing voice signals through regardless of signal strength.

Module only £11.95 Fitted £18.00 plus P&P

ROGER BLEEP: Programmable - for K tone, R, V or custom

£11.95 Fitted £16.00 plus P&P

Hygain V - Original authentic sound £11.95 Fitted £16.00 plus P&P

MULTIMODE BAND CONVERTER Gives LoLo to HiHi and Legals plus A channels on PLL 02A, MC 145106 and MB 8719 radios by programming with diodes. Also covers 10 metres with repeater shift. Other mods required are covered in detail in the optional Technical manual.

Module only £19.95 Fitted Ask for a quote

Technical Manual £4.50

80 CHANNEL MODULE UK Legals and CEPT (mid band) frequencies (see below)

Module only £27.00 Fitted £39.00 plus P&P

160 CHANNEL MODULE UK Legals plus Lo, Mid (CEPT) and Hi Bands

Module only £37.00 Fitted £60.00

Our 80 and 160 channel conversions are complete replacement synthesisers covered by comprehensive step by step Instructions written specifically for your radio... unlike others.

One module covers both 7137 and 9119 PLL radios. (DNT/Grandstand also available). It has been tried and tested over three years of production - not rushed out for CEPT introduction... unlike others.

The module is easy to set up without expensive test gear and DC switched not VCO switched which avoids harmonic interference... unlike others.

IN SHORT... DESIGNED FOR SUCCESSFUL FITTING BY THE NOT SO TECHNICALLY MINDED

For full details of our sales repair and conversion services please send a large SASE or phone for instant quotation.

We supply to the trade at attractive discount prices. ACCESS accepted.

CB EQUIPMENT - CONVERSIONS - REPAIRS - DIY MODS

J. D. Custom Electronics

18 DEANS WAY, EDGWARE, HA8 9NL

Tel: 01-906 1225

Hours of business: Mon.-Fri. 9.00-5.30, Saturday 9.00-1.00.

SMJ ELECTRONICS

Specialists in Semiconductors

Transistors

2N3055	£0.42	2SC945	£0.08	2SC2028	£1.25	2SK30	£0.37	8D235	£0.28
2N3773	£1.40	2SC1060	£0.59	2SC2029	£1.25	2SK33	£0.40	8D241	£0.34
2N3866	£1.10	2SC1061	£0.57	2SC2078	£0.55	3N201	£1.11	8D243	£0.34
2SA473	£0.46	2SC1096	£0.71	2SC2085	£0.49	3SK40	£1.27	8D244C	£0.35
2SA564	£0.10	2SC1213	£0.12	2SC2082	£1.32	3SK48	£2.71	8D245	£0.84
2SA608	£0.11	2SC1306	£1.21	2SC2097	£21.09	3SK88	£0.45	8D246	£0.75
2SA673	£0.13	2SC1312	£0.09	2SC2099	£19.25	3SK97	£1.66	8D902	£0.49
2SA678	£0.38	2SC1318	£0.10	2SC2166	£0.83	40673	£1.30	8F244	£0.39
2SA683	£0.20	2SC1359	£0.13	2SC2236	£0.22	BC107	£0.11	8F245	£0.29
2SA684	£0.28	2SC1384	£0.23	2SC2290	£23.61	BC108	£0.07	8F250	£0.25
2SA699	£0.66	2SC1398	£0.60	2SC2312	£2.85	BC109	£0.13	8F251	£0.24
2SA733	£0.13	2SC1674	£0.15	2SC2314	£0.30	BC141	£0.26	MRF237	£3.36
2SA966	£0.28	2SC1675	£0.13	2SC2329	£0.10	BC142	£0.19	MRF238	£13.64
2SA999	£0.10	2SC1678	£1.08	2SC2395	£16.20	BC182	£0.06	MRF450	£13.50
2SA1012	£0.67	2SC1815	£0.10	2SC2539	£10.79	BC184	£0.10	MRF450A	£13.80
2SA1015	£0.08	2SC1909	£0.91	2SC3020	£12.30	BC212	£0.07	MRF454	£22.94
2SB525	£0.25	2SC1945	£3.63	2SD234	£0.46	BC214L	£0.06	MRF455	£9.80
2SC380	£0.09	2SC1946	£12.62	2SD235	£0.68	BC238	£0.06	TIP29C	£0.26
2SC495	£0.40	2SC1947	£3.78	2SD313	£0.41	BC639	£0.11	TIP30C	£0.29
2SC536	£0.10	2SC1957	£0.56	2SD325	£0.36	BC540	£0.14	TIP31C	£0.28
2SC710	£0.10	2SC1959	£1.58	2SD330	£0.46	BD131	£0.38	TIP32C	£0.33
2SC711	£0.09	2SC1970	£1.48	2SD380	£4.26	BD132	£0.38	TIP41C	£0.27
2SC730	£3.67	2SC1971	£2.82	2SD471	£0.26	BD135	£0.22	TIP42C	£0.27
2SC828	£0.10	2SC1972	£8.25	2SD837	£0.79	BD139	£0.21	TIP120	£0.38
2SC900	£0.27	2SC1973	£0.58	2SD880	£0.41	BD140	£0.25		
2SC930	£0.17	2SC2002	£0.25	2SK192	£0.25	BD201	£0.33		

FCC Conversion Boards

We stock a range of modification boards to convert the most popular UK FM rigs to work on the new FCC band in addition to the existing UK band. Please quote make and model of CB when ordering. Price £9.99

Active Filter Boards

A 10.695MHz active filter specifically designed for the HAM International and NATO 2000 type CBs. This board significantly reduces image reception and cross modulation without affecting sensitivity. Price £6.90

Crystal Filter

This is a 10.695MHz 1kohm 10kHz bandwidth xtal filter suitable for most FM CBs. The filter greatly reduces cross modulation (bleedover) and is extremely easy to fit. Price £2.39

Integrated Circuits

7805	£0.27	HA1377	£1.73	LC7120	£2.75	RC4658	£0.51	TDA1010	£1.10
7808	£0.34	HA1388	£2.77	LC7130	£3.26	S042	£2.50	TDA1011	£1.37
7812	£0.27	HA1392	£1.90	LC7131	£2.88	TA7081	£0.78	TDA1020	£1.99
7815	£0.35	HA1394	£2.72	LC7132	£2.89	TA7120	£0.58	TDA1510	£3.18
7818	£0.59	HA1397	£2.56	LC7137	£3.15	TA7130	£0.46	TDA1512	£3.12
AN240	£1.13	HA1398	£2.57	LM324	£0.41	TA7204	£1.38	TDA2002	£0.63
AN6551	£0.73	LA1230	£1.27	LM386	£1.15	TA7205	£0.96	TDA2004	£1.68
AN7131	£1.37	LA4102	£0.84	M51102	£1.85	TA7217	£1.19	TDA2005	£1.40
AN7140	£1.18	LA4112	£0.94	M51513	£1.86	TA7222	£1.24	TDA2020	£1.81
AN7178	£2.47	LA4140	£0.58	M51515	£1.94	TA7227	£2.07	TDA2030	£1.06
BA402	£0.59	LA4201	£1.15	M51517	£2.06	TA7240	£1.98	TDA2811	£0.86
BA521	£1.35	LA4220	£1.41	MB3712	£1.22	TA7241	£1.98	UPC1028	£0.98
BA656	£0.92	LA4250	£2.23	MB3730	£2.06	TA7270	£1.86	UPC1032	£0.73
CD4001	£0.28	LA4400	£2.59	MB3756	£1.83	TA7271	£1.86	UPC1158	£2.05
CD4008	£0.89	LA4420	£1.32	MB8719	£4.12	TA7274	£1.90	UPC1181	£0.89
CD4011	£0.11	LA4422	£0.92	MC3402	£0.30	TA7310	£2.01	UPC1192	£0.89
CD4049	£0.25	LA4440	£1.89	MC3359	£2.54	TA75902	£0.97	UPC1185	£1.75
CD4066	£0.34	LA4445	£1.35	MC3359	£2.54	TBA800	£1.38	UPC1186	£0.71
CD4069	£0.18	LA4460	£1.47	MM5510	£3.00	TBA810T	£0.49	UPC1230	£1.49
HA13001	£1.60	LA4461	£1.47	NE567	£0.52	TC9106	£4.31	UPD858	£1.65
HA1366V	£1.72	L81405	£2.24	PLL02	£5.70	TC9109	£5.46	UPD2816	£5.34

We have listed only a small proportion of our stock. Please feel free to contact us with your requirements. All prices are quoted as the one off prices. Discounts being available for quantities of ten or more of any one device. Same day despatch on all items in stock. Cheque/Postal order with order. Please add 75p postage and packaging on all orders under £10.00. All prices are exclusive of VAT. All mail order to: 55 Slateford Road, EDINBURGH, EH11 1PB. Callers welcome. Tel: 031 337 6950/031 337 2446.

WIRES ©1988

by Mouse

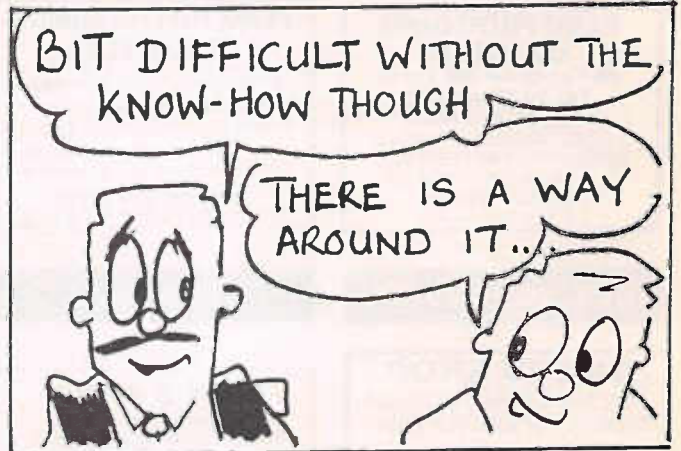

ACCESSORIES



WHOLESALE DEALERS CB Giant range of CBs and accessories, contact us today for fast, friendly service, competitive prices, widest range and latest CB products.

TEL: 061-445-8918 061-434-5701 WE DELIVER NATIONWIDE - OPEN EVERY DAY, SUNDAY BY APPOINTMENT
Telex: 666762 PAMACO G Pama House, 433 Wilmslow Road, Manchester M20 9AF



BREAKER BASES

AVON

Gloucester Rd, Patchway, Bristol. Tel: 0272 694331
All your CB requirements including 934 cordless telephones and portables. Personal service. Why not ring us?



CHESHIRE



LARGEST STOCKIST OF NEW AND S/HAND CB EQUIPMENT IN THE CREWE AREA

CB37
15 Middlewich Street
Crewe CW1 4BS
Tel: 0270 588440 day 841418 eves

DEVON

AGRIMOTORS

Merton CB & Radio Centre
Merton Garage & Post Office, Merton, Nr Oakhampton EX20 3DZ

Open 6 days 9-6
(Sundays by appointment)
Specialists in 934MHz
Suppliers of all 27MHz and 934MHz equipment
Tel: 08053-200

ESSEX

CB RADIO & MODEL HOBBIES

Parndon Mill, Parndon Mill Lane (next to rugby club), Harlow.
TELEPHONE: 0279 418817
C.B., REPAIRS, TELEPHONE EQUIPMENT, IN-CAR RADIO, RADIO-CONTROL
Open: Mon-Sat 9.30am-6pm
Sundays 10am-12am

BEDFORDSHIRE

ELECTROCOMM CB SHOP

2A Tennyson Rd, Luton
Tel: 0582 458310
CB RADIOS ALL ACCESSORIES. RELIABLE .SPEEDY REPAIR SERVICE.
USED CB's BOUGHT AND SOLD
(Open 9-6 Mon-Sat)
1/2 mile town centre

CHESHIRE

PENKETH ELECTRONICS & CB SUPPLIES

5 Chapel Road, Penketh, Warrington
We are the CB stockists for the Cheshire/Merseyside area. Sales & Service, Audio & Hi-Fi Accessories. Secondhand Hi-Fi bought and sold.
Telephone 092 572 3282
Open 9.30-5 (except Wed & Sun)

DORSET

WEYMOUTH OPEN CHANNEL

27 & 934MHz
Extensive stock always available + computer repairs
Also phone equipment & computer software
Open 10-5.30 Mon.-Sat.
Telephone enquiries & mail order welcome.
91A Chickereall Road, Weymouth, Dorset
Telephone: 0305-78777

GLOUCESTERSHIRE



(Established 1978)
Block 38, Upper Mills Estate, Bristol Road, Stonehouse Glos.
Tel: 045 382 6710
Junc. 13, M5, Stroud exit
First right past the Ship Inn.
Open: 9-5 Mon.-Fri.

C.E.P.T./UK, FM/934 MHz
Send £1 & first class stamp for our latest catalogue.
Cheques/postal orders payable to D.E.S.

BUCKINGHAMSHIRE

THE TV SHOP

MILTON KEYNES LARGEST STOCKIST OF CB EQUIPMENT
For repairs, spares, accessories, and all your CB needs
3 Croftcourt, Stony Stratford
Milton Keynes,
Buckinghamshire MK11 1HS
Tel 0908 565981

CORNWALL

RON'S SHOP

46 Lower Bore Street, Bodmin, Cornwall PL31 2JY.
Tel: Bodmin 0208 4569
CB RADIOS and all ACCESSORIES
CORDLESS TELEPHONES and ANSWERING MACHINES, RADIOS, ELECTRICAL GOODS, ETC.

DURHAM

IAN FISHER COMMUNICATIONS OF STANHOPE

Main distributors of 27 MHz CB Radios, and the new CEPT radios including SATCOM AND DNT. Distributors for 934MHz equipment. Large stocks of coaxial cable, Plugs, sockets, and adaptors. Also Greenpar, BNC and N type plugs.
Market Shop, Market Place, Stanhope, Bishop, Auckland. Tel: 0388 - 528464
Open Mon-Sat 10.30-6.0pm Sun. 2.30pm-4.30pm

HAMPSHIRE

CB EQUIPMENT

Telephone and Communication Systems
Complete Repair Service
Accessories
WINCHESTER ELECTRIC
46-48 St Georges Street
Winchester
(0962) 54743
OPEN 6 DAYS A WEEK

CAMBS

Tower Communication

Everything for the 27MHz & 934MHz CBer. Radio Amateur or SWL
★ First Class Sales & Service ★
11 High Street,
Haddenham, Cambs.
Tel: Ely (0353) 740306



CORNWALL

CHAT BACK CB CENTRE

FULL STOCKS OF 934MHZ & 27MHZ AMATEUR RADIO - PMR & NEW CEPT CORDLESS PHONES - REPAIRS
Opening Hours: Mon-Fri 9am-5pm
Sat 9am-1pm
Easthill, Tuckingmill, Camborne, Cornwall TR14 8QL.
Tel: 0209-715773

ESSEX

WOODFORD CB CENTRE

528 Chigwell Road, Woodford Bridge, Woodford Green.
Tel: 01-504 9652
We offer a full repair service and rig conversions. We will match any genuine advertised price.
LARGE RANGE OF CB EQUIPMENT
Open Tues-Sat 10am-5pm

01-437
0626

ACCESSORIES

WHOLESALE

CB radios, aerials & accessories delivered to your shop. Contact for price list.

Pama House, 433 Wilmslow Road, Manchester M20 9AF.



OPEN EVERY DAY, SUNDAY BY APPOINTMENT

NATIONWIDE DELIVERY

DEALERS contact us today for Fast, Friendly Service, Competitive Prices, Widest Range & Latest

CB Products

Tel: 061-445-8918 061-434-5701
Telex: 666762 PAMACO G



BREAKER BASES

HAMPSHIRE

P. SQUIRE (ANDOVER) LTD.

19 Bridge Street, ANDOVER, Hants
Tel: 0264-52623

SPECIALISTS IN
CB SALES AND SERVICE
Very large selection of Rigs and Accessories.

Repairs, and Services Reasonable prices. Expert Advice — Free.

Open 8.30 to 5.30 (excl. Wed. & Sun.)

KENT

R G ELECTRONICS

For all your C.B. equipment

Established six years

Open six days Mon — Sat
HP Terms available

For Mail Order Catalogue send two 18p stamps to 64 Oxford Street, Whitstable, Kent CT5 1DG.

Tel: 0227 262319

LONDON

HENRY'S

934MHz and 27MHz

CB and accessories catalogue S.A.E.

404 Edgware Road,
London W2 1ED
01-724-0323

Open 6 days a week

SURREY

ELITE COMMUNICATIONS

THE TOTAL COMMUNICATION COMPANY

132A ELM ROAD,
KINGSTON UPON THAMES,
SURREY.

TEL: 01 - 546 5662
ALL CB CLUB MEMBERS
RECEIVE 10% REDUCTION
ON PRODUCTION OF ANY CB
MEMBERSHIP CARD.

HAMPSHIRE

BREAKER'S WORLD

2 High Street, Bordon, Hants.

We are the experts in communication.

Full range of CB and accessories in stock.

Fully equipped workshop for repairs.

Open 7 days a week

Mon-Sat 10am-6pm

Sun 10am-1pm. 04203-4684

KENT

CQ SHOP

1 St. James's Road, Gravesend, Kent DA11 0JH.
Gravesend 67171

FOR ALL YOUR COMMUNICATION REQUIREMENTS
CB, RADIOS, AMATEUR RADIO ACCESSORIES

Installation & repairs

* METAL DETECTORS *

MAIL ORDER SERVICE

"communicate with confidence"

NORFOLK

PARKSIDE CB CENTRE

CB Radio specialist.

Extensive range stocked. Mail order service available. Phone for details. Agents for Nevada 934. CB repairs & modifications undertaken.

A148 Fakenham Rd. Thurford,
Fakenham, Norfolk
(0328) 77402

HERTFORDSHIRE

934MHz 27MHz

Largest selection of
CB Equipment

Mail
Order
Service

Rickmansworth
C Communications Centre
37-39 Station Road, Rickmansworth,
Herts WD3 1QP

Tel: (0923) 775577/770634

Mon.-Sat. 9am-6pm

Wed 9am-1pm and 3pm-6pm

LANCS



TIGERS CAGE
CB SUPPLIES

FOR ALL YOUR CB NEEDS

MAILORDER WELCOME

Open: Mon-Sat 9am-4pm

Sun 9am-4pm

343, Chorley New Road,

Horwich, Lancs. Tel: 0204 68218

NORFOLK

B A YEOMANS & SON

TV and Electrical
65 North Walsham Rd.,
Norwich, Norfolk

Tel: 0603 46294

Discount CB/Anything electrical.
Savings just a phone call away.

Used CB bought and sold.
CB REPAIR SPECIALISTS
TRADE WELCOME

NORTH YORKSHIRE

CRAVEN COMMUNICATIONS
CENTRE

top quality rigs, twigs and other gear,
at low low prices. SAE for complete
price list or phone 0756 69871
(Tues to Sat. 1pm - 8pm).

24 Hour Ansaphone.

25 Raikes Road, Skipton,
Nth. Yorks. BD23 1NP.

NORTHAMPTON

EARLS BARTON CB SHOP

J.R. Engineers

FULL RANGE CB EQUIPMENT
SERVICE AND REPAIRS

Open Monday — Friday 9-6

Saturday 9-5

Sunday 10.30-12.30

38a DODDINGTON ROAD
(STD 0604) 810000

MANCHESTER

ace

Alarm and Communications Equipment
FOR ALL YOUR CB REQUIREMENTS

WIDEST RANGE
IN UK

OPEN EVERY DAY

061-445 8918

061-445 4757

Telephone Orders Welcome
433 Wilmslow Road, Withington
(opp. Library) Manchester

PHONE
EVELYN
COOMBES
IF YOU
WANT TO
ADVERTISE

01-437
0626

ACCESSORIES



WHOLESALE DEALERS CB

Giant range of CBs and accessories, contact us today for fast, friendly service, competitive prices, widest range and latest CB products.

TEL: 061-445-8918 061-434-5701 WE DELIVER NATIONWIDE - OPEN EVERY DAY, SUNDAY BY APPOINTMENT
Telex: 666762 PAMACO G Pama House, 433 Wilmslow Road, Manchester M20 9AF



BREAKER BASES

OXFORDSHIRE

MODULATIONS COMMUNICATIONS
62 Wootton Road, Abingdon, Oxon. OX14 1JD
Tel: 0235 - 21400
Open: 6 days Mon-Sat 9-5.30
Instant credit facilities. Agents for 934 MHZ Wholesale, Retail and NEW CEPT CB NOW AVAILABLE

SOMERSET

COOPER + HOLMAN COMMUNICATIONS
15 North Street, Crewkerne, Somerset TA18 7AL.
Mail Order available.
Send £1 for catalogue, refundable with first order.

WEST YORKSHIRE

SUPERSLAB CB CENTRE
John A. Dobbins Ltd
Bradford Road, A650, East Ardsley, Nr. Wakefield
Tel: 0532 524586
LARGEST STOCKIST OF CB EQUIPMENT IN THE NORTH (Trade and Retail)
Full Repairs Service
Mail Order

SOUTH YORKSHIRE

CB
IXL ELECTRICAL
REPAIRS. NEW AND S/HAND RIGS AND TWIGS.
394 LANGSETT RD SHEFFIELD
0742 337857
9-6 Mon - Sat

SURREY

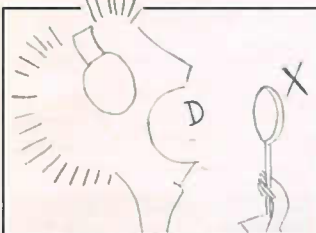

D.X. CENTRE CB & ACCESSORIES
137 Windmill Road, Croydon.
Tel: 01-684 7457
Mon.-Fri. open till 8.00pm
Sat. open till 6.00pm

SURREY

GUILDFORD CB
Surrey's biggest stockists of CB equipment and accessories
Low prices, technical know-how. Repairs. 934 and Amateur. Cobras and Yaesu wanted.
34 Aldershot Rd., Guildford 574434

WEST MIDLANDS

HEWARD'S HOME STORES LTD (Established 1963)
822/4 Kingstanding Road, Birmingham B44 9RT.
Tel: 021-354 2083
G4RJM with 38 years in the Radio Trade Ham Equipment urgently wanted Open: Mon-Sat 9-6
WE WELCOME ALL CB'ers

SOUTH YORKSHIRE

North Saturn Communications
The Communication Specialists
CB - PMR - CORDLESS PHONES IN-CAR TELEPHONES
Mobile Phones, Cellnet/Vodafone
5 Odeon Arcade, Hallgate, Doncaster South Yorkshire DN1 3LZ
Tel: (0302) 66352 & 65991
Mobile Phone 0836 608111

SURREY

The Mad Baron
Rigs - Twigs and other Bits Supplied and Repaired
Phone BOB on Byfleet (09323) 49377 (24 hour Answerphone)
27-934 - AMATEUR - PMR & TELEPHONES
ACCESS AND VISA CARDS WELCOME
MAIL ORDER AT COST
PO Box 88, WEYBRIDGE, KT13 0RT

YORKSHIRE

LEN BERRY ELECTRONICS LTD.
We monitor channel 0723-373914 or eyeball at:
147 VICTORIA ROAD, SCARBOROUGH, YORKSHIRE

CB CATERS FOR THE WORLD OF CITIZEN BAND PHONE NOW TO ADVERTISE

NORTHUMBERSIDE

BREAKER ONE NINE CB CENTRE
414 BEVERLEY ROAD, HULL
Tel (0482) 447560
LARGE SELECTION OF NEW AND SECONDHAND CB EQUIPMENT. FULL RANGE OF C.E.P.T. RIGS AVAILABLE
EXCELLENT REPAIR SERVICE

SUSSEX

The C.B. Centre
Inrange Ltd, 8 Marine Court, St. Leonards on Sea.
Tel: Hastings (0424) 443185/442025
Open: Monday to Saturday 9.30 - 5.30
Retail & Wholesale

YORKSHIRE

EMPRESS TRADING CO. THE No. 1 C.B. SHOP
WIDE RANGE OF RIGS & TWIGS ALL ACCESSORIES AVAILABLE, "PART EXCHANGE WELCOME"
ALSO. 2 WAY TAXI AND T.V. AERIALS, TELEPHONES, IN CAR. RADIOS AND ELECTRICAL GOODS.
ANY ENQUIRIES WELCOME.
TEL: (0274) 499340
564 Thornton Road, Bradford BD8 9NF

CB
CITIZENS' BAND
01
437
0699



CLASSIFIED

Lineage: 54p per word including VAT
Minimum 15 words

Semi Display: £8.50 per single column centimetre
Minimum 2.5 centimetres

Sue Curtis, CB Classified Dept, Argus Specialist
Publications Ltd, 1 Golden Square, London W1R
3AB

ACCESSORIES

WHOLESALE

CB radios, aerials & accessories
delivered to your shop. Contact
for price list.

Pama House, 433 Wilmslow Road,
Manchester M20 9AF.



OPEN EVERY DAY, SUNDAY BY APPOINTMENT

NATIONWIDE DELIVERY DEALERS

contact us today for
Fast, Friendly Service, Competitive
Prices, Widest Range & Latest
CB Products

Tel: 061-445-8918 061-434-5701
Telex: 666762 PAMACO G

FOR SALE

934MHz Reftec Base Station.
Base Microphone T.W. 2325.
Rotor Controller Box. Twin
Yagi Beams. Power Splitter.
Reftec Colinear. L.M.W. Pre-
Amp. Coax H.100 £480 o.n.o.
Cybernet Delta 1 + P7E Antenna
£300 o.n.o. Tel: 0754 880508.

NEW LEGAL FREQUENCY

★ New & Old Frequency CB's in Stock ★ Best Prices Paid for Used CB's ★
Conversion Kits Uniace Audioline to New frequency £6.99 ★ Conversion Kits
Uniace Audioline to new & old frequency £9.99 ★ Conversion Kits Cybernet
Board CB's to new and old frequency £9.99 ★ DNT, Wagner, Lake etc. £15

THE AERIALS BELOW SUIT EITHER FREQUENCY

Thunderbolt	5.99	Taxi/Ham Hgain %	4.99	5ft Centre Loaded	6.50
Super Thunderbolt	6.99	5ft Base Loaded	3.50	5ft 2 Coll	8.50
Long Coll	7.99	2ft Base Loaded	3.50	1ft Rubber	3.99
Twin Thunderbolt	9.99	3ft Centre Loaded	4.99	Saturn Base	15.99
Super Modulator	10.99				

BA YEOMANS & SON 65 North Walsham Road, Norwich 0603 46294

EQUIPMENT

LES EVANS ELECTRICAL TEL: WEM (0939) 32090

NEW AND USED CB'S, FCC
CONVERSION BOARDS,
AERIALS, TRANSISTORS, IC's &
MANY MORE ACCESSORIES.
SHOP OPEN SATURDAYS ONLY
OR BY APPOINTMENT

CARDS, STICKERS & BADGES

S.J. Tonks (CB Components)

Suppliers of Transistors,
ICs, 10m Conversion Boards

Books and boards from CB
CITY INTERNATIONAL

NEW!

"THE CB EPROM DATA
BOOK" written by "The
Specialist" for Amateurs
who wish to convert CB to
10m by themselves: fifty
four pages packed with
information including
Eprom codes and PCB
layouts! Complements Lou
Franklin's "THE CB PLL
DATA BOOK".

How to modify the PLL for
the 10-Meter Ham band.

● Service Manuals for UK and Export CB Radios ●
Crystals and Crystal Filters ● Spare parts for Uniden and
Cybernet rigs ● Microphone plug screws - countersunk
and clamp ● Nickel plated rig screws and plastic screws ●
Replacement VCO screwcores for PLL02A blocks ● Large
selection of CB radios and accessories.

Write or phone for a FREE catalogue or call in -
we are only a mile from junction 9 on the M6.
53-55 Darlaston Road • Walsall West
Midlands • WS2 9QT • (0922) 646710



GLOSSY QSL and Eyeball
Cards. Many colours with gold/
silver/coloured lettering. S.a.e.
order form and samples. Sharp
Graphics, P.O. Box 3, Grange-
mouth FK3 9BD. (0324)
473432.

QSL CARDS gloss or tinted
cards. SAE for samples, to
Twrrog Press, Dept CB
Penybont, Gel-Lilydan,
Blaenau, Ffestiniog, Gwynedd
LL41 4EP.

Full Colour QSLs 1000 £58
● Personalised QSLs 1000 £17.50 ●
Eyeball Cards 1000 £10 ● Em-
broided Patches 100 £120 (sample
£2) ● Club Stamps Mounted 50 £50.

DIY QSLs 1000 £2.50
Eyeball Cards 100 £1.10
DIY Bargain Pack 100 of each £3

SASE for details: CURRIE QSLs
Room 2, 89 Derwent St., Consett,
Co. Durham, DH8 8LT, England.

LOWEST PRICES for rubber
stamps, printing, key fobs,
patches, etc. Free comprehen-
sive catalogue. Tel: 0795
665789.

WANTED

C.B. EXCHANGE

Buy (Working or not) cash by return. Sell
fully serviced and aligned S.A.E. for
availability or Tel: (0253) 886632
North West House, Poulton-le-Fylde,
Blackpool, Lancs. FY6 8BN.

WANTED

IDEAS, INVENTIONS WANTED.
CALL I.S.C. 01-434 1272 or
WRITE: DEPT (ASP) 99 REGENT
ST. LONDON W1.

PLANS

SURVEILLANCE DEVICES,
Bug Detectors, Voice, Scram-
bler, Directional Microphone,
Many others. SAE for list, Plans
Centre, Unit 7, Old Wharf,
Dymack Road, Ledbury HR8
2DS.

"THE SHACK"

UK FM CB RADIO REPAIRS & SUPPLIER OF
ACCESSORIES & ASSOCIATED
COMPONENTS...

Requires technical service information test
equipment, accessories & components.
Manufacturers & wholesalers are invited to
send Catalogues & Price Lists.

We also buy C.B. Radios (working or not)

"THE SHACK"

231, CAXTON ST. SUNNYHILL DERBY DE3 7RB

Tel: 0332 760353

CALLERS BY APPOINTMENT ONLY

CRYSTALS

QUARTZ CRYSTALS and
filters. Phone for details/S.A.E.
list. Gollodge Electronics,
Merriott, Somerset TA16 5NS.
Tel: 0460-73718.

C.B. DEADLINES

June issue: 10/4/88

July issue: 9/5/88

August issue: 7/6/88

BE SAFE AND LEGAL WHEN MOBILE

with the "SPEAKEASY" Handsfree
Microphone £15.00 Inclusive.

Radio Baby Listener, transmits every sound
to ordinary FM Radio £7.50 inclusive.
Call Box - tapes your telephone
conversations automatically onto standard
cassette recorder. £16.50 inclusive.

S.A.E. more details

Live Wireless c/o Video World
7 Wesley Street, Southport,
Merseyside

Mail Order only please.

TRUCK KING THE TRUCKERS SHOP **U.K.'S No.1 TRUCK** **TRUCK KING & CB STORE** **NOTE We Have Moved**

AS ONE OF THE UK'S OLDEST ESTABLISHED CB SPECIALISTS (TRADING SINCE 1979) WE HAVE THE WIDEST RANGE OF CB'S AND ACCESSORIES IN THE COUNTRY ALL MAIL ORDER ITEMS ARE CHECKED & TESTED BEFORE DESPATCH AND FULLY GUARANTEED.

011 Junction 5 M1. 320 St. Albans Road, Watford, Herts. WD2 5PQ

TEL (0923) 35943

IF YOU ARE BUYING A NEW CB RADIO THIS MONTH
Check our very low prices then save even more on our special offer items!

NEW PRICE

UNIDEN 400 (CEPT Spec) £98.00
UNIDEN 100 (UK Spec) £69.95
UNIDEN 200 (UK Spec) £99.95
UNIDEN 300 BASE (UK Spec) £148.00
AUDIOLINE 342 ONE HANDER (UK Spec) 85.00
ZODIAC M 244 (CEPT Spec) ... £179.00

MIDLAND 77-104 Mini Rig (UK Spec) ... £65.00
MIDLAND 77-805 Portable/Mobile (UK Spec) £95.00
DNT COMPACT 40 with Scan Mike (CEPT Spec) £85.00
905 COMPACT - NEW RADIO (UK Spec) £59.95
BREAKER 40FM (CEPT Spec) £69.95

MOONRAKER MASTER HAND HELD (UK Spec) £75.00
DNF 4000 HAND HELD (CEPT Spec) £89.00
MAXCOM 7E HAND HELD (UK Spec) £85.00
SATCOM 4F HAND HELD (CEPT Spec) £159.00

YES, IF YOU BUY ANY ONE OF THE CB RADIOS LISTED IN THIS ADVERTISEMENT NOW, YOU CAN AT THE SAME TIME PURCHASE ONE OF THE SPECIAL OFFER ITEMS BELOW AT A SUPER LOW PRICE!

This offer is subject to one special offer item per each CB radio ordered and is only available to mail order purchasers. Goods must be ordered and paid for together and can be sent to one address only. No catalogue discount vouchers will be accepted. Offer closes May 14th 1988. All offers subject to availability.

SPECIAL OFFER ITEMS
*SUBJECT TO RADIO PURCHASE

K40 ANTENNA
OFFER PRICE **£36**
SAVE £6 ON LIST PRICE

*SUBJECT TO RADIO PURCHASE

ASTATIC TEARDROP
OFFER PRICE **£40.00**
SAVE £6 ON LIST PRICE

*Includes Wiring & Battery State radio model type when ordering

*SUBJECT TO RADIO PURCHASE

ES990
OFFER PRICE **£49.00**
SAVE £6 ON LIST PRICE

*SUBJECT TO RADIO PURCHASE

LEMM MINI GP DX
OFFER PRICE **£16**
SAVE £5 ON LIST PRICE

Standing just over 2m high the new GP DX comes with a stand off bracket for outside mounting or can freestand in a room or loft. Top loaded for high performance but compact enough for use where a discreet antenna is required. Performance equal to many bigger base station antennas and highly recommended.

LEGAL

*SUBJECT TO RADIO PURCHASE

THUNDERPOLE 3
OFFER PRICE **£18**
SAVE £7 ON LIST PRICE

Incorporating 3 angled 1/4 wave radials and a helically wound centre load whip. This well known home base twig is a popular choice for both CEPT and U.K. frequencies.

LEGAL

*SUBJECT TO RADIO PURCHASE

UBC-100XL SCANNER
OFFER PRICE **£169**
SAVE £20 ON LIST PRICE

The Uniden 100XL is a crystalless, hand-held scanner with more scanning power than many base or mobile units. Sixteen channels cover nine bands, including the aircraft band. Your priority frequency is checked automatically every two seconds. The keyboard can be locked to prevent accidental programming. The LCD display is lighted for better night viewing.

*SUBJECT TO RADIO PURCHASE

RP105 PRE AMP
OFFER PRICE **£26.00**
SAVE £3.95 ON LIST PRICE

*SUBJECT TO RADIO PURCHASE

HAM INTERNATIONAL ROS 110 SWR-POWER-MATCHER UNIT
OFFER PRICE **£19**
SAVE £7 ON LIST PRICE

Gives SWR measurement, power read out to 100 watts plus built-in matcher unit. Supplied also with field strength antenna and AM monitor facility with earpiece. Good quality unit with most of the required facilities for CB use incorporated.

*SUBJECT TO RADIO PURCHASE

MAIL ORDER To: TRUCK KING, Dept CB4
320 ST. ALBANS ROAD, WATFORD WD2 5PQ
Enquiries/VISA/ACCESS orders phone (0923) 35943
All prices quoted include post & packing Overseas orders add 20% (E Sterling only please)

QTY	ITEM	£

3rd EDITION CATALOGUE

If you have not yet seen our vast range of radio products then you really should send for our new catalogue. Sixty four fully illustrated pages show a massive selection of items covering all aspects of CB radio plus of course a full range of trucking accessories. Please send £1.50 cheque/PO (price includes £1.50 worth of discount vouchers).

Name _____ I enclose Cheque/PO. for £ _____ payable to Truck King
 Address _____

I wish to pay by ACCESS VISA AMEX (Tick) Card No. _____
 ACCESS/VISA orders phone 0923 35943

PLEASE USE A SEPARATE SHEET OF PAPER IF YOU NEED MORE ROOM OR DO NOT WISH TO CUT YOUR MAGAZINE.

SIRIO antennae

**"COPIED BY MANY"
EQUALLED BY NONE**

NEW

GPE 27% Base Antennae

Type: $\frac{5}{8}$ λ ground plane
 Impedance: 50 Ohm
 Frequency: 27 MHz
 Polarization: vertical
 V.S.W.R. 1.2:1
 Max. Power: 500 Watt
 Gain: 3.5 dB ISO
 Connection: UHF FEMALE
 Length: approx. mt. 6.50
 Weight: approx. kg. 2.5
 Mounting mast: \varnothing mm 30/40



SIRIO CT27

Short centre loaded DV type but with robust steel shaft and shock spring, good performance for its size. (70cm S/S COMP.)

SIRIO T27

Pint sized version of the DV-27 includes shock absorbing spring, used usually where a short whip is essential - van or truck roofs especially. (60cm F/G COMP.)



NEW

GPS 27 $\frac{1}{2}$ Base Antennae

Type: $\frac{1}{2}$ λ ground plane
 Impedance: 50 Ohm
 Frequency: 27 MHz
 Polarization: vertical
 V.S.W.R. 1.2:1
 Max. Power: 500 Watt
 Gain: 3 dB ISO
 Connection: UHF FEMALE
 Length: approx. mt. 5.50
 Weight: approx. kg. 2.1
 Mounting mast: \varnothing mm 30/40

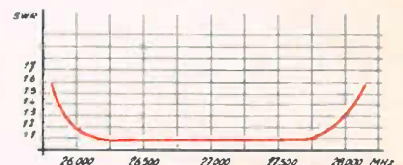
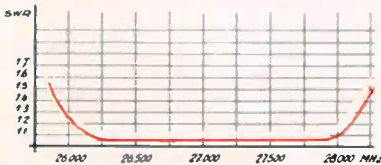

KF Gutter Mount

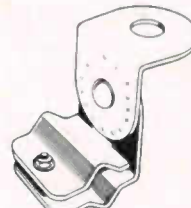

Mirror Mount

SIRIO Panther 27
 A slightly longer all black version of the CT27



Mag H12 PL



Base Mount

SIRIO T2-27

580mm long all black. Helically wound. 400W.



Galletto Screw + Bolt



Galletto Wingbolt



'N' Connector

WE ALSO HAVE:

SIRIO: Mirror Mount
 SIRIO: Gutter Mount
 SIRIO: Bases
 SIRIO: DV Nut & Bolts
 SIRIO: Adaptor
 SIRIO: P.L. Conn
 All in stock in WORCESTER

WE ALSO OFFER

a large range of our own brand, highest quality Coax & Twin Core Power Cable, available in WORCESTER for your collection or our delivery to you.

See your Local Distributor otherwise we will tell you who is your nearest.

COMASID INT UK LTD

SOLE AGENT/
IMPORTER

Tel: 0905 29118
 Telex: 336655
 Fax: 0905 28279