

# CB

## HORIZONS

JUNE 1962  
40 CENTS

FCC EXAMINER SUGGESTS CB RULES NOT VALID!

# WORKING SKIP LEGAL?

SEE PAGE 8

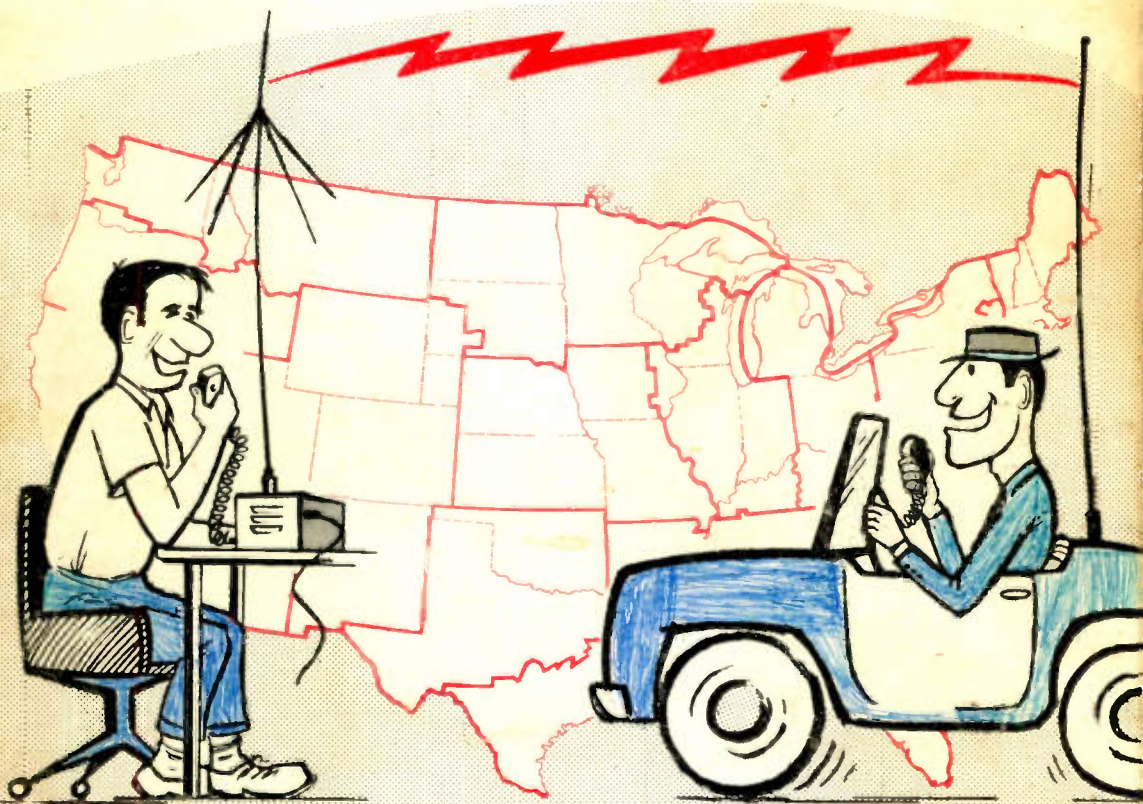

THE CITIZENS BAND RADIO MAGAZINE

INTERNATIONAL'S

# Executive

**FOR SUPERIOR CITIZENS**

The ultimate in Executive Citizens transceivers. New crystal filter which minimizes adjacent channel interference in the receiver. New built-in receiver calibration circuit. New International NR squelch. New 12 position crystal control transmit channel selector. New front panel microphone jack. New provision for connecting external speaker and S/meter. Tunable dual conversion superheterodyne receiver covering all 23 channels. Two crystal control receive positions. Push-to-talk operation. Three way power supply for 6/12 vdc and 115 vac. Full five watts plate input. Certified tolerance  $\pm .005\%$ . **Complete with 1 transmit crystal, 1 receive crystal, new style ceramic microphone and coil cord.**

\$199.50\*

International's exciting New compact transceiver. Field tested full five watt transmitter contained in the higher price Executive transceivers. Certified tolerance  $\pm .005\%$ . Tunable superheterodyne receiver covering all 23 channels. Three position crystal control transmit channel selector. Manual transmit-receive control. Noise limiter. Available accessories include four separate power supplies — 6 vdc, 12 vdc, 24 vdc, or 115 vac, push-to-talk relay kit, and 12 position transmit channel selector. **Complete with 1 transmit crystal, matching microphone and external speaker, but less power supply.**

\$69.50\*

## MODEL 100



## MODEL 10



*See The Executive Series at Your Authorized International Dealer*

**INTERNATIONAL CRYSTAL MFG. CO., INC.**

# transceivers

## BAND COMMUNICATION

### MODEL 50



A precision engineered transceiver featuring push-to-talk operation. Three position crystal control transmit channel selector. Dual conversion superheterodyne receiver tuning all 23 channels. Full five watts plate input. Crisp and clear modulation. Certified tolerance  $\pm 0.005\%$ . Two crystal control receive positions. Series Gated automatic noise limiter. New International NR squelch. Three way power supply for 6/12 vdc and 115 vac. Additional features of the Executive Model 100 may be added at any time. The Model 50 is a rugged yet handsome piece of communication gear equally at home in the office, service truck or field. Complete with 1 transmit crystal and matching microphone.

\$149.50\*

\*Suggested Price

## FREE 1962 CATALOG

Your buying guide for precision radio crystals, electronic equipment, and Citizens Band accessories . . . contains suggested oscillator circuits, plus technical information on selecting the proper crystal. Write today for International's 1962 catalog. It's FREE.



18 NORTH LEE  
OKLAHOMA CITY, OKLAHOMA

International Crystal Mfg. Co., Inc.  
18 North Lee, Oklahoma City, Okla.  
Please rush FREE 1962 International Catalog.

NAME.....  
Please print

ADDRESS.....

CITY.....ZONE.....STATE.....

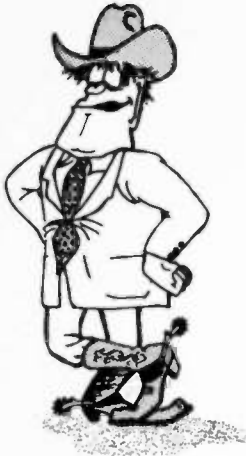

## OZZIE'S MAIL- BOX

Dear Ozzie:

I have just finished building the two element beam that was described in the October 1961 issue of CBH. The total time and construction-matching was 3 hours. The total cost was \$1.33. It really works great! I can pick up mobile units up to 25 miles away. Naturally, I would like to see more articles on different antennas. I'm sold!

Lawrence J. Koprivo  
11Q1919

Lawrence:

It's a funny thing about construction articles. Before any construction article goes into print we either build it here or obtain a reasonable assurance from the writer that the unit has been built and actually will do the job as stated. But even when we build the units here, we have to keep in mind that our lab people have 8 hours per day, 5 days per week experience working with schematics, beams and the like. So it does our heart good to hear that CB'ers in the field are finding our construction articles useful and workable, when many of our readers are actually building for the first time. Let's face it . . . there's nothing quite like rolling your own!

Ozzie Old Buddy:

We have been hearing a lot of static about 'NATCH-9' and read about it in every issue of CBH. In April Uncle Tom said "who will tell them about NATCH-9?" in his report on Ford's new soles gimmick.

My thought, when reading this was "who will tell me about it?" Can you help?

Gil Long, 1Q6002  
Andover, N. H.

Gil:

We would like to think that every active CB'er knows about NATCH-9, Gil, but this just isn't so, as you well know. So, we do our bit by plugging it in the magazine, and asking that local clubs adopt it at their very next meeting. Of course, most of us aware of NATCH-9 now know that a 6 inch red strip painted on top of your whip lets other CB'ers who pass you on the highway know that you are listening on channel 9 when you aren't gabbing.

Dear Ozzie:

As a member of the official family of our local CB club, The Central Aroostook CB Radio Club, I am requesting information on public addresses to be given to local groups such as the Rotary, on the topic of what CB radio is, and why. Can you help?

Dr. W. S. Unger, D.O., 1Q5626  
Presque Isle, Moine

Doc:

We can't personally be of much help but we think we know how to stir up the right kind of action. We feel that talks such as you are looking for would be very popular if presented by a representative from local clubs at such service groups as the Rotary. Certainly groups such as this contain a lot of businessmen, and they are prime users of CB radio! We feel, however, that this is a function that a group such as the NCRL or MCEU should undertake.

Dear Ozzie:

As a fifth prize winner in your January Give-Away, of two James Knights Crystals, I wish to extend my thanks to you and to the James Knights Company. The word around here was that I probably would receive just any two crystals and since I had a CB set that doesn't use third overtone crystals, like the majority do, I wouldn't be able to use them. But I was overwhelmed at the time and expense Mr. J. R. Knights, Chairman of the Board at JK went to, in writing to me asking what type of rig I used and what crystals I would like. He wanted me to be satisfied, and I sure am! Thanks again.

Gene Hinesley, 18W2774  
New Castle, Indiana

Gene:

Some CB'ers apparently feel that CB manufacturers are out to "get all they can get, and then get some more." Nothing could be further from the truth. CB manufacturers recognize the big stake they have in our field, and we have found almost without exception that they try their best to do a good job in keeping us in good equipment. Of course we are all human, and make the occasional mistake. But overall, we've got one heck of a great group of manufacturers.

Ozzie:

I would like to commend and give a vote of thanks to one who has given so much and asked for so little. This is a man whom I believe could be called an "un-sung hero." He has worked conscientiously and energetically, he has never refused a demand, he has devoted every moment to the betterment of the MCEU and CB radio. To you John Krejc, 2W4586, I thank you with my whole heart for your unselfish devotion and for all of your respect and understanding that you have shown CB radio.

Governor Bert Endress, 2W9623  
New Jersey State HQ, MCEU

Bert:

You are not the first to write about the untiring work being carried forth by CBH Assistant Citizens Communications Manager John Krejc, 2W4586. John's devotion to the CB cause is unusual and very commendable. Readers will find an important announcement about Krejc and his new position in the CB world in the CCM reports section for this month.



*May we  
bend an "ear"  
for a moment?*

There's much to be said for the slim, inconspicuous, yet professional appearance of the "MAGGIE-MOBILES". Still more for their clean, crisp signal and unbelievably low noise level.

But the real point of this message is a hidden virtue you can't see or hear. It's called, "17-7 stainless steel", one of the most resilient alloys ever made. We use nothing else in our MAGGIE-MOBILES, even though it costs considerably more than the stainless steels used in run-of-the-mill whips. Here's why:

You can bend it full circle, from tip to butt; let go and it snaps back to a perfect vertical. (Don't try this with other brands.) It slips around obstructions like an eel. No breakage . . . no "water shorts".

One more reason why Antenna Specialists' brand antennas are preferred by more citizens banders than any other kind.

Switch to a "**MAGGIE-MOBILE**"  
Base-loaded CB 27Mc  
**ANTENNA**



**Mounting's a "snap" too!**

Available in three simple and attractive mounts . . . 20 ft. cable with connectors attached . . . take your choice!



**MODEL M-67**

Roof mounted entirely from outside. Ideal omni signal pattern. Only **\$15.68** (net)



**MODEL M-74**

Cowl or deck. Ingenious swivel base adjustable up to 35° angle. Only **\$19.32** (net)



**MODEL M-73**

Trunk groove mount. No holes in-body! Fits all makes and models. Only **\$17.06** (net)

P.S. Your CB base station should have the famous big-gain, easy-to-install Magnum 27. It won't bend.

For complete information, see your local citizens band supplier or write for specifications to:

**the antenna specialists co.**

12435 Euclid Avenue, Cleveland 6, Ohio  
Export Div., 15 Moore St., New York 4, N.Y.

# CB HORIZONS

PUBLISHED MONTHLY BY HORIZONS PUBLICATIONS, INC.  
POST OFFICE BOX 1557 OKLAHOMA CITY 1, OKLA.

## STAFF

**BOB COOPER, 12Q2339**  
Publisher-Editor  
**JIM KYLE, 10W0901/K5JKX**  
Technical Editor  
**JOHN KREJC, 2W4586**  
CCM Coordinator  
**CARLYNE SILVA, 12Q2207**  
Editorial Assistant  
**GAR GREENE, JR., 1W4844**  
Contributing Editor  
**BOB BUCKLAND**  
Canadian Editor

**STAN SEARLE**  
Art Director

## OFFICES

**Advertising—**  
4 NW 7th Street  
Oklahoma City 1, Okla.  
Central 2-1108

**Circulation—**  
P.O. Box 1557  
Oklahoma City 1, Okla.  
Central 2-1109

**Editorial—**  
4 NW 7th Street  
Oklahoma City 1, Okla.  
Central 2-6290

**Call Collect**  
for Advertising  
Space Reservations

**Canadian Office**  
P.O. Box 563  
Chatham, Ont.  
Tel. 519 ELgin 4-3106

## ADVERTISING

CB HORIZONS magazine accepts commercial display advertising from bona fide manufacturers, distributors of electronic equipment and associated apparatus. Advertising rate card and coverage data available upon request.

## CIRCULATION

CB Horizons is now read by more than 70,000 CB radio enthusiasts every month, covering all 50 States, Puerto Rico, U.S. Possessions, Canada, and 18 Central and South American countries where 27 mc transceivers are in use. Detailed circulation breakdown upon request.

## SUBSCRIPTION

Subscription rates in the United States — \$4.00 per year. Single copies 40c each (50c in Canada). Subscriptions outside the U.S.A. — \$5.00 per year. Subscription remittances should be made by bank draft or postal money order. Airmail subscription available at \$7.00 per year, U.S.

## TABLE OF CONTENTS

### FEATURES

<b>CB RULES NOT VALID?</b>	
FCC Examiner Blasts Part 19 Enforcement.....	8
Message from the Publisher.....	10
<b>HOME BREW DISCONE</b>	
How to build the near-ultimate base antenna.....	14
<b>ILLEGAL USE OF CB</b>	
CBH Questions Senator Karl D. Mundt.....	20
<b>A CB CHANNEL CHOPPER</b>	
Another use for nuvitors.....	26
<b>MIDWEST JAMBOREE</b>	
Time and place of the gathering.....	33
<b>MORE ABOUT 30-WATT RIGS</b>	
Details for business users.....	35
<b>IMPROVING MODULATION</b>	
Modifications for most any rig.....	36
<b>MAKING THE QUAD WORK</b>	
Even we make mistakes, sometimes.....	37
<b>NATIONAL CCM COORDINATOR NAMED</b>	
Devotion to CB brings a new job.....	42
<b>HELP ON THE HIGHWAY</b>	
Nationwide dealer directory.....	46
<b>YOU CAN HELP EDIT CBH</b>	
Picking next month's features.....	49
<b>THE CB KYLE-O-WATT, PART 2</b>	
For those of you who need the parts list.....	56

### DEPARTMENTS

<b>OZZIE'S MAILBOX</b> .....	4
<b>CBL CARD OF THE MONTH</b> .....	33
<b>CHANNEL 24</b> .....	35
<b>CB TECH TALK</b> .....	36
<b>CB SHOWCASE</b> .....	38
<b>CBH LAB REPORTS</b> .....	40
<b>CCM REPORTS</b> .....	42
<b>CLASSIFIED</b> .....	48
<b>NCRL NEWS AND VIEWS</b> .....	52
<b>GAR'S GABBINGS</b> .....	57

CB HORIZONS (title registered U. S. Post Office) entered as Third Class postage in Oklahoma City, Oklahoma. All copyright and editorial rights reserved by Horizons Publications, 1962.

The entire contents of this magazine are copyrighted by Horizons Publications. No article in this magazine may be reproduced in whole or in part without the written permission of the publishers.

COVER: FCC Hearing Examiner Donahue has blasted Part 19. Read all about it on page 8, this issue.

FOR POWER OR PORTABILITY . . . UNCOMPROMISING ENGINEERING WITH

# EICO® CITIZENS BAND TRANSCEIVERS

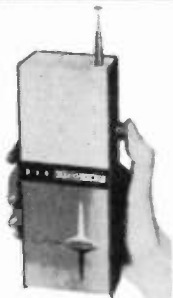

Operates 2500 hours on 1 rechargeable leakproof battery

**EICO WALKIE-TALKIE MODEL 740: Kit \$54.95. Wired \$79.95.**

Carrying Case \$3.95.

Complete with rechargeable battery & charger. No license or permit needed . . . no age limit

**U. S.-made  
an original  
product of EICO  
research**

Size: 7 1/4" x 2 3/4" x 1 5/8", weighs only 19 oz. . . . fits comfortably in hand, slips easily in jacket pocket.

- Finest U. S.-made nickel-cadmium rechargeable battery provides about 8 hours "on" time with 50% duty-cycle operation on a single charge • Battery can be recharged 300 times, replacing over 1,000 penlight cells (over \$200.00 worth) • Leakproof nickel-cadmium battery is hermetically sealed in plastic — can never cause corrosion damage • Full 100mW input to Final, as permitted by FCC for Unlicensed Citizens Band Operation • Crystal-controlled transmit & receive • Full modern superhet receiver • 9 transistors and 1 diode • Range 1 1/2 miles under average conditions • High quality circuit board, beginner-tested instructions for complete kitbuilding ease and assurance • Make a "network" with 2 or more EICO #740's or with EICO 770 series or with EICO 760 series

## NEW VERSATILITY WITH NEW DELUXE 770 SERIES

	Kit	Wired
Model 770†: 117 VAC only	\$79.95	\$109.95
Model 771†: 117 VAC and 6 VDC*	89.95	119.95
Model 772†: 117 VAC and 12 VDC*	89.95	119.95

†U. S. Patent #D-190,970 \*Including Posi-Lock Mounting Bracket

"A steal . . . Better than manufacturing specs . . . Publisher Cooper reports base-to-mobile contact out to 22 miles consistently, often to 40 miles . . . Thorough manual is almost a handbook for CB radio."—CB HORIZONS

Front panel selection of one of 3 transmit crystals with continuous receiver tuning over all 23 CB channels, or a fourth transmit crystal with appropriate receiving crystal. Press-to-talk button on microphone; transmit-receive switching accomplished by high-quality relay with minimum capacity between contacts to prevent current leakage at RF frequencies. Superhet receiver with RF stage for high sensitivity & proper signal-to-noise ratio. 1750 KC IF strip for unequalled image rejection & freedom from oscillator "pulling" on strong signals. IF strip prealigned so that only "touchup" alignment without instruments is needed. Current metering jack in series in cathode circuit allows checking of input power to transmitter final and adjusting it to FCC limit. 13-tube performance (4 dual function tubes, 4 single function tubes, plus germanium diode). Adjustable squelch control (in addition to automatic noise limiter). Optimum adjustment to any popular CB antenna assured through use of variable pi network in output. AVC. 3" x 5" oval PM speaker. Supplied complete with 8 tubes & 1 transmit crystal (extra crystals \$3.95 each).



The entire transmitter oscillator circuit and RF final in every EICO transceiver, kit and wired, is pre-mounted prewired, pretuned, and sealed at the factory (about 3 hours of skilled labor, precision adjustments and testing), complying with FCC regulations (section 19.71, part d). This permits you to build the kit and put it on the air without the supervision of a commercial radio-telephone license.

## STANDARD 760 SERIES

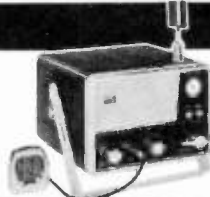

	Kit	Wired	*Including
Model 760: 117 VAC only	\$59.95	\$89.95	Posi-Lock
Model 761: 117 VAC and 6 VDC*	69.95	99.95	Mounting
Model 762: 117 VAC and 12 VDC*	69.95	99.95	Bracket

Same uncompromising engineering, same care and precision, and largely the same circuitry as in 770 series (above), lacking only multiple-channel transmitting, crystal receiving, and push-to-talk microphone.

## BEST BUYS IN SERVICE INSTRUMENTS: everything from Scopes to Probes



DC-5 MC 5"  
Scope #460.  
Kit \$79.95  
Wired \$129.50.  
Also available—  
5" Push-Pull  
Scope #425.  
Kit \$44.95  
Wired \$79.95

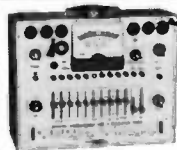

Dynamic  
Conductance  
Tube and Transistor  
Tester #666  
Kit \$69.95  
Wired \$109.95  
Complete with steel  
cover & handle

Peak-To-Peak  
VTVM #232  
& Uni-Probe®.  
Kit \$29.95  
Wired \$49.95  
VTVM #221  
Kit \$25.95  
Wired \$39.95



†Pat. #2,790,051

TV-FM Sweep  
Generator & Marker  
#368  
Kit \$69.95  
Wired \$119.95



EICO, 3300 N. Blvd., L.I.C. 1, N.Y. CB-6

- Send Free 32-page catalog & Distributor's name.
- Send Free Schematic of Model No.
- Send new 36-page GUIDEBOOK TO HI-FI for which I enclose 25¢ for postage & handling.

Name \_\_\_\_\_  
Address \_\_\_\_\_  
City \_\_\_\_\_ Zone \_\_\_\_\_ State \_\_\_\_\_

Export Dept., Roburn Agencies Inc.,  
431 Greenwich St., New York 13, N.Y.

Add 5% in West

# CB Rules Not Valid?

When a horse-drawn vehicle and a railroad train simultaneously approach an intersection, each shall stop until the other has passed.

Interlocutor: How long did the speaker speak? End man: Too long!

No, it wasn't a joke session. These were two examples used by FCC Hearing Examiner Thomas H. Donahue to illustrate why he feels that many of the rules contained in Part 19 (CB's commandments) "place licensees in a state of perpetual violation" and "lose all semblance of guides to conduct."

Donahue's 34-page initial decision royally roasted the existing rules; he specifically found sections 19.61 (a) and 19.61(c) in direct contradiction of each other (as the horse and the train cited above), Section 19.61 (a) was lambasted further as *void for vagueness* and a possible censorship attempt.

It must be emphasized that the decision is an *initial* one. Experienced Washington observers believe rule changes to eliminate many of examiner Donahue's objections will appear shortly.

The decision was issued following a hearing concerning the license of Warren G. Holleman, 4W0656, of Falls Church, Va. Holleman had applied for a modified license to increase his number of authorized transmitters to five; the Commission had refused his application because of alleged past offenses. These alleged offenses, included *nature of communications, length of transmission, transmission of profane language, and other rule violations.*

Donahue held that out of the large complex of charges directed at Holleman, the FCC staff scored only twice. The examiner said evidence clearly established that on three occasions time limits were exceeded, and that on one occasion Holleman made false representation to the Commission.



Otherwise, though, Donahue declared, the FCC *has failed* due to *failure of proof, faulty reasoning, and inadequate support in law.*

The examiner concluded that *grant of the application at issue, all things considered, might best serve the public interest.*

Along the way, Donahue found possibly-fatal flaws in the legal standing of enforcement action against these widespread practices:

1. "Non-substantive" communications between different licensees.
2. Too-long transmissions (so long as five-minute limit is not exceeded).
3. "Loaning" of call letters to friends for their use.
4. Content of communications being offensive to other listeners (so long as no clearly illegal language is used).

One of Donahue's major attacks was directed at the section of the rules (19.61a and 19.61c) which prohibit *non-substantive* communications between different licensees.

He pointed out that 19.61a requires that communications between stations of different licensees be *substantive messages relating to the . . . activities*



of the individuals concerned and that current enforcement actions interpret this to mean that the activities of both licensees be involved.

On the other hand, 19.61c requires that any communications from a CB station must concern *only* the activities or affairs of the licensee.

Donahue declared that the two rules together place any licensee in the position of violating one if he follows the other. He likened it to an old law school saw illustrative of ineptness in legislative draftmanship—the horse vs. train example cited at the beginning of this article.

The plain fact is, said Donahue's decision, the examiner has no clear idea

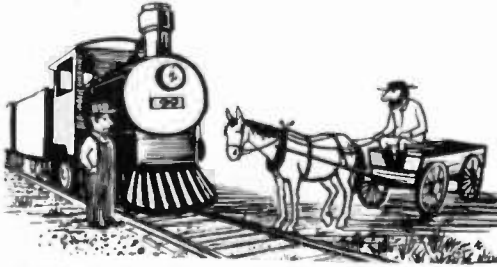

of what the thrust is of the two rules when read together, he doubts that the Bureau has, and he does not see how licensee could be expected to have had such knowledge.

The examiner continued his attack on 19.61a, and the limitation of CB communications to substantive use. He cited section 19.1's provision that the citizens radio service is intended for private use, and noted that both 19.61a and 19.61c provide for personal use of CB. He then went on (bypassing the question of who would determine whether words spoken privately concerning personal affairs were substantive) to attack the meaning of the word substantive in itself.

After quoting a dictionary definition, which showed no meaning obviously applicable to nature of communications, Donahue posed the question of whether the word 'substantive' as used in the rule and defined in the dictionary is capable of conveying to a licensee any reasonable idea of what he may or may not transmit.

He answered his own question with the comment, *Isn't the Commission operation as advocated here by the Bu-*

WHATAYA MEAN—  
"IS MY TRANSMISSION  
SUBSTANTIVE?"!!



reau, taken as a whole, essentially this: 'Here, Mr. Holleman, is a citizens radio station license. You may operate your station for, among other things, your private personal affairs. There are no understandable standards governing the contents of the transmissions you may make but if we don't like what you say, we will take your license away?'

The examiner then turned to the question of length of transmissions. He asked, first, *how long is 'minimum practicable transmission time'?* In a service set up for personal and private use he continued, *who is to say how long is too long?* At this point, he cited the "minstrel" logic of the existing interpretation that the content of the message itself indicated it was too long with the example cited at the beginning of this article.

Donahue concluded that this portion, too, of Part 19 must be considered void for vagueness.

In the matter of loaning call signs—Holleman was accused of letting some 25 persons use his call in violation of section 19.92—the examiner declared that nowhere in the rule does it explic-

itly state that under no circumstances may one person use the call letters assigned to another or that under no circumstances may an unlicensed person operate a station using the call letters assigned a licensee.

Donahue termed the whole question of loaning call letters (in this case at least) samples of the questions that



arise in connection with the proof relied upon by the Commission which stands unanswered in the record.

The examiner discounted the FCC position that Holleman violated section 19.3 of the rules by transmitting messages offensive, contumelious and derogatory to members of various races and religious beliefs.

Donahue declared that save for the requirement of American citizenship, the rules impose no requirement as to licensee qualification. He went on to

conclude that unless the Commission does establish . . . standards in this band, a licensee, barring language clearly illegal, has a right to say over the air what he pleases.

In general comments concerning the rules in Part 19, Donahue said, *Quite frankly, in the examiner's view, Part 19 of the Commission's rules leaves a good deal to be desired as an instrument of regulation.* He said he believes the Commission has been placed in the position of reading in to it (Part 19) licensee restraints that are not there in words and cannot rationally be inferred from substance.

Lest anyone think the FCC is an all rules and no heart agency, note this item from the Washington file:

The Commission has waived section 19.61c of its rules to grant a Class D CB license to the Radio Cab Service Association, Bartow, Fla.

The rule provision waived was that requiring that all CB communications be limited to the licensee's own business or personal activities.

The Radio Cab Service Association is a non-profit group, organized to provide a radio communication service to its seven independent-taxi-driver members. The dispatcher will be a blind man specially trained for the job by the Florida Council for the Blind. Necessary radio equipment was purchased by the State of Florida and loaned to the association at no cost to provide employment for the handicapped dispatcher.

## MESSAGE FROM THE PUBLISHER

### BOB COOPER, 12Q2339

The article you have just read, and the report from the CBH Washington Bureau appearing on page 20 of this issue clearly indicate that *something is in the wind for Class D CB Radio.*

Under FCC Examiner Donahue's ruling, the FCC apparently has no rules which they can enforce in the following areas:

(19.61a) This portion relates to substantive communications. This is the portion that has kept our DX minded members from turning loose with "CQ DX 11 Meters" whenever skip stations are in. According to Donahue, the very meaning of **substantive** itself is questionable, especially in the way

that the Commission seeks to use it! In other words, under the present rules and regulations, at least as they now exist, DXing may be legal! Notice we say **may be**. It will depend on how fast the FCC acts to close this apparent loop-hole, and how the field force of FCC inspectors choose to interpret Donahue's decision.

(19.92) This portion of the rules relates to the "loaning of call-letters from one licensee to a party not licensed, or to another licensee." Donahue states "Nowhere in the rule does it explicitly state that under no circumstances may one person use the call letters assigned to another or that under no circumstances may an unlicensed person operate a station using the call letters assigned to a licensee."

(Continued on Page 34)

# WERE YOU A CB'er IN AUGUST 1961?

Chances are you were, and you remember how great the 52 page 'Special Issue' 1962 CB Equipment Directory from CB Horizons was.

After this issue went into print, Horizons received more than 7,000 requests for additional copies of this great issue. All we could say was

**Sorry . . . all sold out!**

°This year—don't miss out on the fabulous CB EQUIPMENT DIRECTORY ISSUE. We know that no matter how many thousand extra copies we print, CBH-August will be all sold out just days after it hits the newsstands!

## YOUR ONLY GUARANTEE OF A COPY THIS YEAR?

A subscription—entered this month, in plenty of time to receive the August Directory issue—which goes on-sale July 10!

. . . YES—Sign me up for 12 issues of CB HORIZONS, including the fabulous August 1962 Equipment Directory. Start my subscription pronto—right away! \$4.00 enclosed.

Name \_\_\_\_\_ CB Call \_\_\_\_\_

Address \_\_\_\_\_

City/Town \_\_\_\_\_ Zone \_\_\_\_\_ State \_\_\_\_\_

**Airmail today to:**

**CB HORIZONS**

**P.O. Box 1557**

**Oklahoma City 1, Okla.**

## **1962 "Q Series" Call-Book Order Form**

WHAT! You don't have a copy of the 276 page Call-Book Handbook Annual for 1962? How can you operate without one? How, for example, can you locate the 80,000 Q call CB'ers listed? How can you put your new station on the air without the installation Handbook? No-one deserves to operate under these hondi-caps! Order your copy today. Use this form. QUICK! Before the supply is exhausted forever!

. . . YES—I want a 1962 Call-Book/Handbook annual. Send me this 276 page marvel. I am enclosing \$3.95, and understand you guys at CBH will ship parcel post pre-paid to my door.

Name \_\_\_\_\_ CB Call \_\_\_\_\_

Address \_\_\_\_\_

Town/City \_\_\_\_\_ Zone \_\_\_\_\_ State \_\_\_\_\_

**Airmail today to:**

**CB CALL-BOOK**

**P.O. Box 1557**

**Oklahoma City 1, Okla.**

# SPECIAL INTRODUCTORY OFFER TO SUBSCRIBE TO THE CB CALL-BOOK/DIRECTORY

*a monthly publication of reference material for CB'ers*

Look of these exclusive features in the brand new monthly reference book for CB'ers.

- ★ Complete listing of all CB'ers licensed by the FCC for the past 30 days
- ★ A Directory of CB Monitoring Channels—nearly 2,000 USA towns listed with the local 'CB Channel In Use'. Perfect for travel spotting of crystals needed to communicate with CB'ers in strange areas.
- ★ CB Clubs—Over 500 listed, with complete addresses. Puts you in contact with the CB leaders in communities all over the country!
- ★ CB Equipment Directory—Monthly, continually revised with new equipment added every month. New price changes, new features, new models. Every new CB unit manufactured appears in the Monthly Equipment Directory. Actually one of the handiest directory features you could imagine.
- ★ Every fourth month—a complete directory of the nation's CB-dealers, including a specially prepared listing of what equipment lines each carries, their hours of operation, and much more!
- ★ FCC REPORT—the very latest in CB news from Washington! License revocations, new rule proposals, changes, the works.

**YOU CAN HAVE THIS EXCLUSIVE SERVICE FOR A NEW  
LOW COST—JUST \$4. PER YEAR**

**THIS MONTH ONLY—**

this attractive coll-sign and name lope identification pin in red and white (actual size shown)

**KHA1742  
RONALD HOLLINGER**

**FREE WITH YOUR SUBSCRIPTION!**

(a \$2.95 value)

(tear off and airmail)

... **YOU BET**—sign me up for 12 information packed issues of the CB Call-Book Directory, starting with the June 1962 issue (comes out May 25). \$4.00 enclosed. Don't forget my red and white lope identification badge . . . a \$2.95 value!

(please print)

Name \_\_\_\_\_ CB Call \_\_\_\_\_

Address \_\_\_\_\_

Town/City \_\_\_\_\_ Zone \_\_\_\_\_ State \_\_\_\_\_

**Airmail today to:  
CB CALL-BOOK DIRECTORY  
P.O. Box 1557  
Oklahoma City 1, Oklahoma**

**NOPE**—This offer won't be repeated again soon—and it does expire midnight  
June 10, 1962!

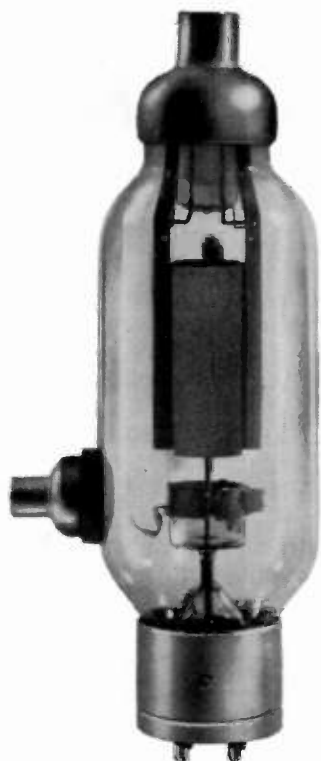

## CB GALLON?



write for free brochure

**\$189.50**

Slightly higher west of Rockies

One gallon (thousand watt) output is something you would never expect the Courier 1 to deliver. But . . . you do get 68% transmitter efficiency, 3.4 watts out with 5 watts in! This is only one of the reasons why CBER's applaud the Courier 1 as the finest. Add to this the distinct advantages of a dual power supply (mobile and base — 110V and 12V) operation, a low noise front end (thanks to our use of the Nuvistor tube) and, of course, superior performance and reliability. Want more before you buy? Check these features . . .

- 12 CHANNEL TRANSMITTING
- 23 CHANNEL TUNABLE RECEIVER
- BUILT-IN "S" & "RF" METER
- FRONT PANEL RF GAIN CONTROL
- BUILT-IN SQUELCH
- ELECTRONIC SWITCHING (NO RELAYS)
- UNITIZED HAND WIRED CHASSIS
- FULLY MODULATED (100%)
- CADMIUM PLATED FOR MARINE USE
- ENTIRE UNIT SLIDES OUT ON TRACKS

• ALSO AVAILABLE IN 110V and 6V

**e.c.i.**

electronics communications, inc. 325 no. macquesten pkwy. mt. vernon, n.y.

# Homebrew Discone

—STAFF—

Are you looking for the ultimate in base-station antennas?

Of course you are—just like everybody else. And no matter how many chunks of metal and wire you hang in the air, you're never going to stop looking for that *ultimate* antenna, because it will never be built. Base station antennas have too many different requirements for any single design ever to be "the ultimate."

But the discone—originated during World War II and re-discovered about

a year ago for CB use—comes awfully close to being that impossible "ultimate sky-wire." It offers a near-perfect match to 52-ohm coax cable; an operating range of 10-to-1 in frequency (relatively unimportant for CB use but essential should you ever decide to go into ham radio or the commercial FM systems operating between 30 and 175 mc.); and freedom from any critical tuning adjustments.

In addition, because of our 20-foot limit on antenna height, the discone offers greater ground-wave range pos-

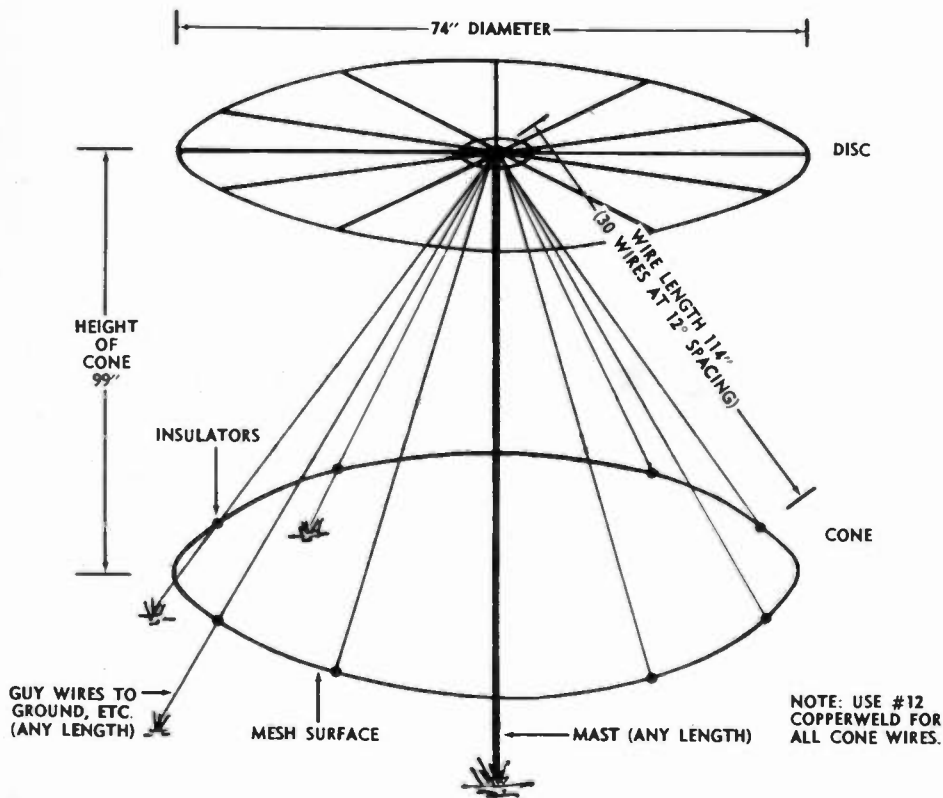

Figure 1. Discone For CB, Overall View.

# Browning Says...

**You can  
improve  
your CB  
coverage!**

23/S-NINE TRANSMITTER



R-2700-A RECEIVER

**Unless you are already using Browning CB equipment, your coverage can be improved. All you need is the R-2700-A Receiver and 23/S-NINE Transmitter as your base station . . . Let us prove it to you!**

Send today for new Browning 24-page color catalog. Write Dept. H



**browning**  
Browning Laboratories, Inc.,  
100 Union Avenue  
Laconia, New Hampshire

**AS LOW AS \$15 PER MONTH AFTER SMALL DOWN PAYMENT**

**SUBSCRIBE TO MONTHLY CALL-BOOK THIS MONTH 15**

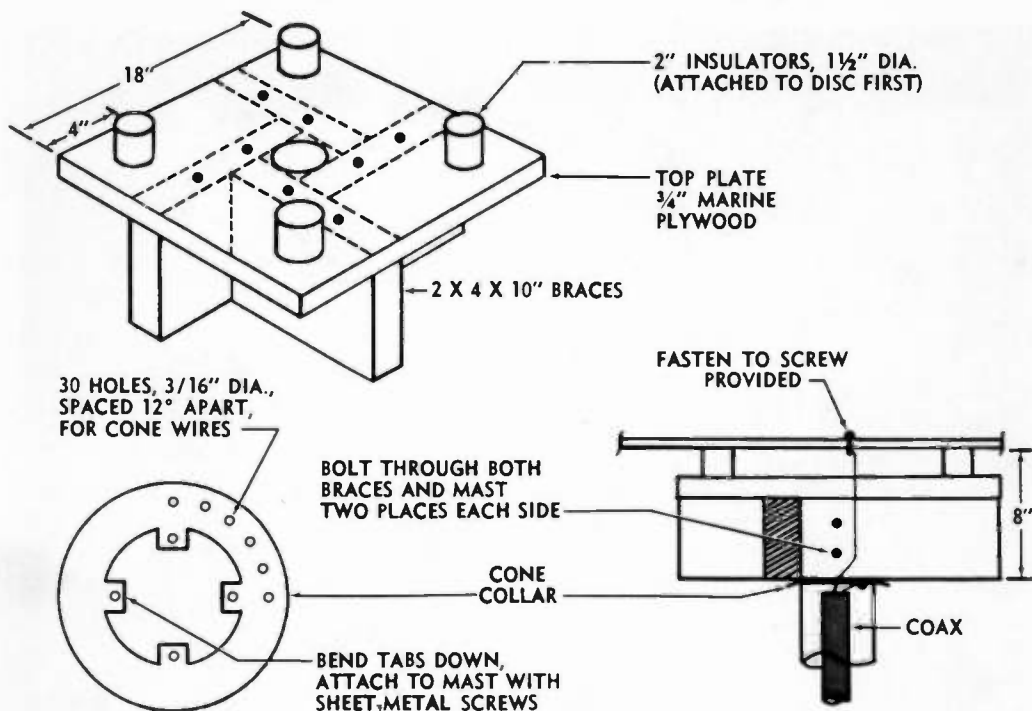

**Figure 2. Insulator details.**

sibilities than do many other vertically-polarized antennas. This comes about because its most effective portion is located right at the top of the pole; other designs have their most effective portions part-way down the mast which usually results in a closer "radio horizon."

By now, you're probably asking "Where can I get one of these gadgets?" As this is written, you can't but you can build one at a reasonable outlay of time and cash.

Before starting construction, though, it's best to know just what a disccone antenna is and what it is supposed to do. Basically, the disccone consists of an inverted (point to the sky) metallic cone with a large disc (also metallic) balanced on the point. The disc is really fastened firmly, and insulated, instead of balanced—but at any distance it looks like a balancing act (see Figure 1).

The coax feed line comes up inside the cone. The shield of the coax con-

nects to the cone, and the center conductor connects to the disc.

Thus, the cone becomes a continuation of the shield, while the disc becomes a reflector connected to the center wire.

In practice, outgoing RF energy hits the disc and is reflected out the open side of the affair. If the "slant angle" of the cone sides is correct, though, the outgoing signal can't tell what's happening to it and the SWR will be down to 1.0.

The important things electrically, then, are to keep the slant angle of the cone sides proper and to keep the top disc level. Good insulation between disc and cone at the center is also essential.

Mechanically, an 11-meter disccone is quite an impressive array—and offers much, much wind resistance. If you built one out of solid sheet metal, the first breeze would tend to whip it away like a sail.

However, a fine-mesh screen looks to RF like a solid sheet of metal if



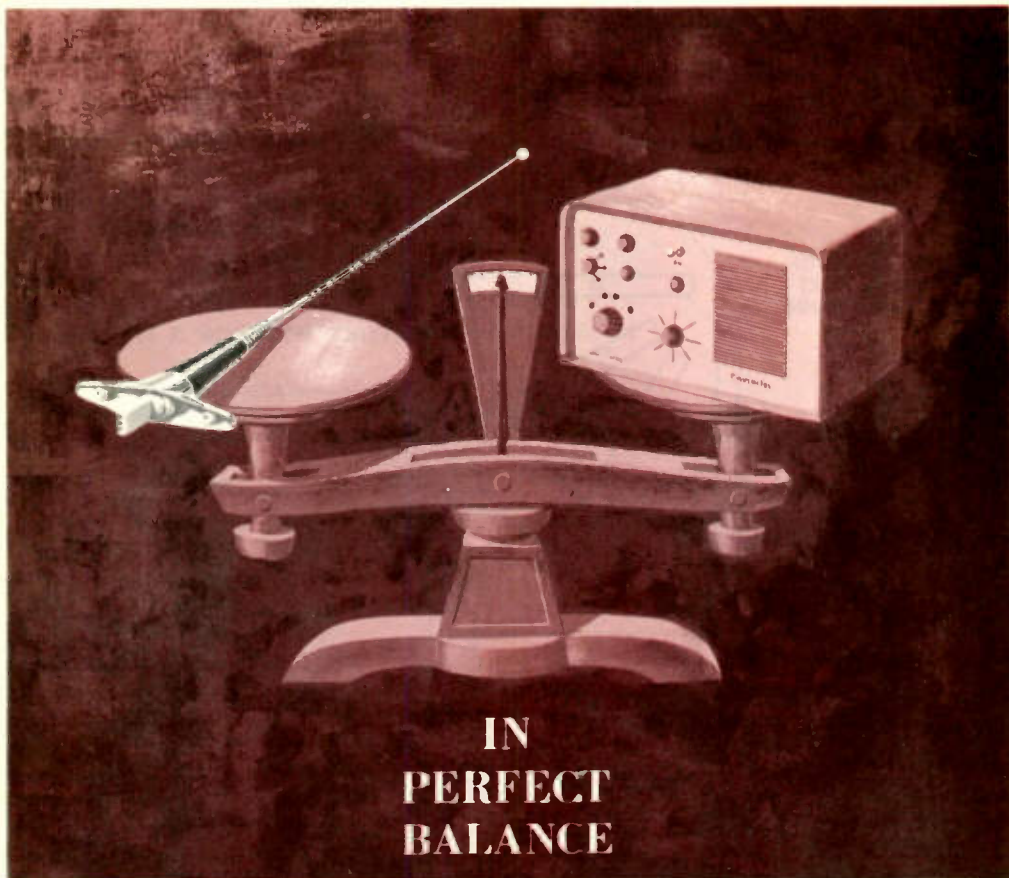

**IN  
PERFECT  
BALANCE**

**THE ANTENNA IS 50% OF YOUR MOBILE SYSTEM:** make sure of optimum performance with the all-new Stinger Model ST-27. Provides a sleek-look-of-quality package for automotive, aircraft, and marine applications!

Proven best of its type available today, Stinger's latest mobile whip answers: **WHAT'S NEW?** Installation: now much easier than ever, done entirely from the outside surface! No need to drop headliners! Mount: highly polished, hand-polished chrome finish. Engineering: new electromechanical features that provide easy mounting, better performance (up to 3-db system gain for greater range; improved signal-to-noise ratio). **WHAT'S OLD?** Length: still less than 30 inches, for vehicle rooftop mounting without damage to or from overhang structures. Theory: still a design based on the rf, inductive, transformer-coupled, high-gain theory . . . for higher transmission efficiency, extra-high-gain reception, and relatively equal transceiving characteristics in all directions. Guarantee: still with a money-back performance guarantee. **YOU CAN'T GO WRONG . . .** If you're in mobile, Class D, 27-mc operation, the Stinger ST-27 is designed for you. Request Bulletin SM-101, or see your franchised Stinger distributor for a demonstration today! **Calibration** Standards' Stinger Products, Box 2315, City of Industries, La Puente, Calif.



**Stinger\***

\*Registration Pending.

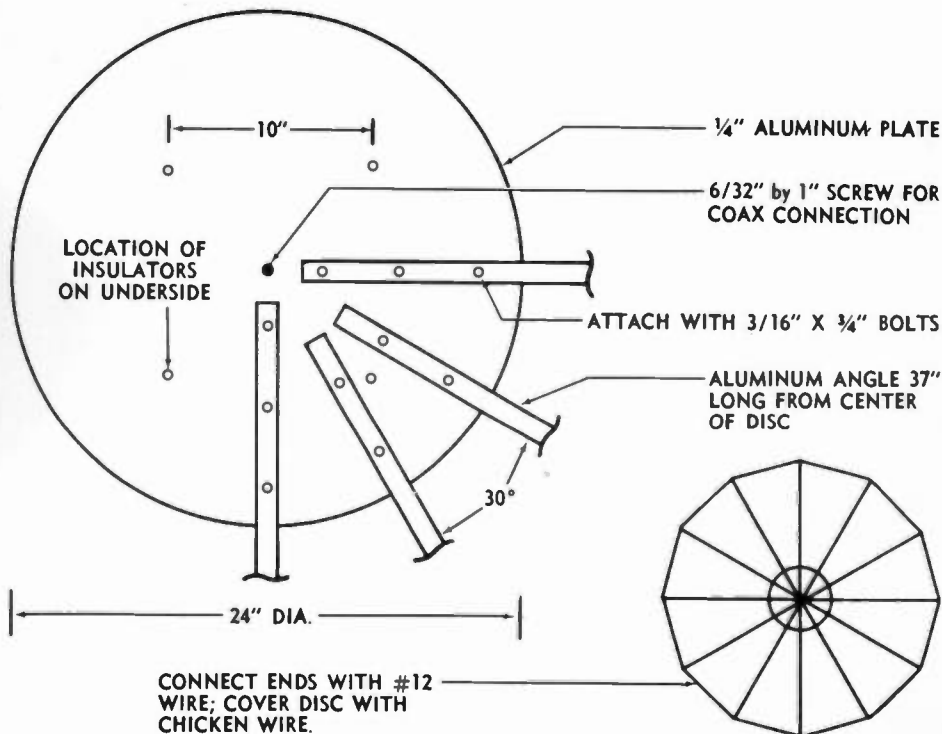

Figure 3. Details Of Disc assembly

—and *only* if—the spacing between conductors in the screen is small compared to the wavelength of the RF. This is the key to our construction.

For instance, a screen spacing of 0.01 wavelength is plenty close enough to look solid to RF. Yet at 11 meters this becomes a spacing of 0.11 meter or 4½ inches (approximately) so that you could use very coarse fencing mesh for lowest wind resistance.

Best results were obtained with a type of fencing usually called “chicken wire” screening. This has a hexagon screen pattern about an inch wide between conductors. You can use it for the surface of both the cone and the disc, cutting wind resistance to an absolute minimum.

However, the chicken wire is too flexible to stand up by itself. You must put a framework behind it for support. Wooden framing is okay, but aluminum angle stock is just as easy to work with and lasts longer.

The only really tricky part about the whole antenna is construction of the insulator that goes between the

disc and the cone. It's shown in detail in Figure 2; follow the drawing closely and you won't go wrong.

Actual construction procedure is as follows: First, put up your mast. It can be any length between 9 feet and 19 feet. Next, fasten the insulator-and-guy-ring structure to the top of the mast. Now, connect the coax to the insulator-and-guy-ring assembly. Put together the disc assembly on the ground and get it into position on the insulator aloft (this may require some help.) Attach the guy wires to the assembly and secure them at anchor points selected so as to give the proper slant angle. Finally, cover the guy-wire structure with chicken wire, soldering the joints, and you're ready.

The disc assembly referred to above is shown in detail in Figure 3. It should be completely assembled on the ground and lifted to the top of the pole before securing to the insulators—otherwise, the affair will be too top-heavy.

When you're finished, hook the other end of the 52-ohm coax to your transmitter and fire up.

# MARK *Static Sheath*\*

*Eliminates Noisy Precipitation Static\*... Improves Signal-to-Noise Ratio  
Affords up to 20 db Operating Gain . . . Increases Receiver Sensitivity  
Extends Intelligible Coverage. Easiest to install.*



**INCREASE COVERAGE**

## **MARK II SUPER BEACON FIXED STATION ANTENNA** *with exclusive Static Sheath\**

Design advantages of the new **MARK II** now make it possible to step up the efficiency of your CB operation, and maintain clearer communication over greater distances. 19 feet overall, the omnidirectional **MARK II** makes fullest use of the 20-foot legal length limit. Requires no radials or skirts. Provides 1 db gain over ground plane antennas. Employs a full half-wave radiator voltage fed through a special launcher-matcher cable section for excellent impedance match over the entire citizens band. Low angle radiation insures utmost efficiency and maximum contact with mobile units.

Improved mechanical features and extra-rugged base support pipe add to its reliability. Simplified clamp mounting makes installation easy.

\***Precipitation Static** is caused by charged particles in the air impinging in a continuous stream on metal antenna radiator surfaces. It is revealed by a continuous hissing background noise. The patented **Mark Static Sheath\*** is a tough, durable, dielectric plastic covering that acts as an electrical insulator and eliminates static interference caused by the precipitation effect.

## **MARK HW HELIWHIP®\* MOBILE and MARINE ANTENNAS** *Top-Loaded, 50-Ohm Load . . . with Static Sheath \**

Shortened mechanical structure and other Mark features bring new efficiency, new compactness, new convenience to CB communication. Molded Fiberglass, with **Static Sheath.\*** Designed to replace lengthy stainless steel whips. Far superior to whip and loading-coil combinations. Can be located on upper portion of vehicle such as trunk lid, cowl, fender or hood to obtain proper ground plane. Single-hole mounting. 18', 3', 4' and 6' mobile models. **Heliwhip Marine Antenna** (6' long) eliminates need for metal ground plane.

See Your **B & K** Distributor or  
Write for Catalog **HW19-CB**

\*U.S. Pat. 2,966,679  
U.S. Process Pat. 2,938,210



**MARK HELIWHIP®\***

Another Fine Product Line by

**B&K MANUFACTURING CO.**

Dept. CB-5, 1801 W. Belle Plaine  
Chicago 13, Illinois



# Illegal CB

When in Rome you do as the Romans do. When in Washington, you do as Washingtonians do. When you arrange an exclusive and confidential interview with a United States Senator as important as Karl D. Mundt, you play the game strictly according to the rules.

The rules this time included prepared questions, presented to the Senator prior to the interview.

You will notice a number of points about the facts contained in this report. While the interview is current, the dates mentioned are up to seven years old. The reason for this is obvious. This information came to light, for the most part, during Senate hearings on gambling practices in the United States. In nearly every instance the offenders have been prosecuted under the law. And in almost every instance, the example involved Class A or B Citizens Band Radio. However, this is not to say that Class D radio is clean, necessarily. When these Senate hearings were held Class D CB radio was

either non-existent or in infancy. Today over ¼ million individuals and 1 million transceivers are licensed in our service. And investigation continues into the possibility that Class D radio, too, is being used for illegal gambling or racketeering practices.

This report is presented in the hopes that it will enlighten and inform you, and possibly alert you to a very real menace to the growth of our service. For if a case could be built against the proper uses of CB radio, the FCC might be forced into a position of tougher licensing, thereby making it more difficult for the small businessman and average citizen to have two-way communications.

On the other hand, if we are alert and informed users of two-way radio, we will watch for mis-uses in the service, reporting them to FCC authorities and thereby helping to keep our service from the stigma of possible enforcement crack-downs on the part of the FCC.

An enlightened two-way user is a booster of CB radio.

**Question: Senator Mundt, how did the actual illegal use of two-way (CB) radio first come to your attention?**

Answer: "This was first brought to my attention during the time that our Senate Select Committee on Improper Activities in the Labor or Management field, more commonly known as the Senate Rackets Committee, held its extensive hearings. Specifically, on June 4, 1959, it was the subject of interest when the then Chairman of the FCC, Mr. John C. Doerfer, appeared before the Committee. It was renewed last year during the course of the hearings on Gambling and Organized Crime held by the Senate Permanent Subcommittee on Investigations, of

(Continued on Page 22)

With more than 250,000 U.S. Citizens licensed to use CB radio currently, odds are that we have a few 'bad-apples' in the barrel. Recently CBH's Washington staff learned of a pending investigation into CB radio by the Senate Permanent Subcommittee on Investigations. Some Senators, it is learned, feel CB licensing regulations are too lax and that members of the criminal element can easily obtain licenses. Find out who, where and why here as CBH Staffer Robert C. Diefenbach interviews Senator Karl D. Mundt (S. D.) on "Illegal Uses of CB Radio."

# TOTALLY NEW DESIGN

MORE THAN A NEW MODEL...AN ENTIRE NEW CONCEPT..

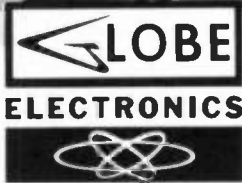

## STAR 5 DUAL CONVERSION CHANNEL C-B TRANSCEIVER

... UNDER EQUAL CONDITIONS ...

### the globe star OUTPERFORMS ANY TRANSCEIVER MADE

The first unqualified new design in the transceiver field. Dynamic new dual conversion, superhetrodyne circuitry eliminates adjacent channel interference. . . . increases operating range. This is the very finest . . . in performance . . . in construction . . . in durability . . .

- Plus . . .
- Full A.M. modulation and adjustable squelch.
  - High level, "push-to-talk" professional microphone with coil cord.
  - Adaptability to 5 channels.
  - Dual purpose circuitry offers 16 tube power.
  - Heavy duty chassis . . . irridite plating.
  - Built to meet F.C.C. and Canadian Specifications.

Delivered COMPLETE with one set of crystals, AC line cord, DC power cord, microphone bracket, operating instructions and F.C.C. free license application.

FULL 90 DAY WARRANTY

Model No. 65-120 ..... 159.95 net

### GC ELECTRONICS CO.

DIVISION OF TETRON ELECTRONICS INC.

400 So. WYMAN ST. • ROCKFORD, ILL., U.S.A.

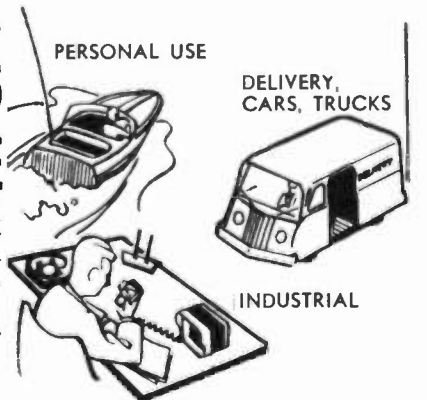

**FREE SPECIFICATION SHEET AND CATALOG—SEND TODAY!**

NAME \_\_\_\_\_

ADDRESS \_\_\_\_\_

CITY \_\_\_\_\_ STATE \_\_\_\_\_

SUBSCRIBE TO MONTHLY CALL-BOOK THIS MONTH 21



Sen. Mundt during interview

which I am the ranking Minority Member."

**Question: During the investigations, what examples of two-way radio being used for illegal purposes were revealed?**

**Answer:** "It was first disclosed that the pinball monopoly of Steven D. Sohacki and George Welbourn, operating in Hammond, Indiana and all of Lake County except East Chicago, were actually using two-way radio to dispatch and send repair servicemen and equipment to pinball locations. The license was issued by the FCC on November 16, 1955 and was to expire November 16, 1960, until our Rackets Committee held hearings on the matter June 4, 1959. The Citizens Radio Station license was issued to the Indiana Supply Company, at the request of an application signed by Steven S. Schacki.

"(A second example) was Carlos Marcello, a well known gangster, hoodlum, alien and ex-convict who controls organized crime in practically all of its forms in the Greater New Orleans area. He was a 50% partner in terms of profit with the Jefferson Music Company, 335 Huey P. Long Avenue, Gretna, Louisiana. This company operates slot machines, pinball machines and jukeboxes with the other 50% of the profits going to Vincent Marcello, Carlos' brother. Vincent is, however, recorded as sole owner, at the Metropolitan Crime Commission in New

Orleans. On December 11, 1957, the FCC issued a Citizens Band Radio License authorizing construction of a transmitter (base station) and 13 transceivers in cars and trucks belonging to the servicing department of the Jefferson Music Company. The gambling machines were known by the Crime Commission to be operating in violation of Louisiana law."

(There are other examples.)

**Question: Do you see any further dangers, possibly not yet revealed (or obvious), in the indiscriminate licensing or sale of two-way radio equipment to the public?**

**Answer:** "The ease with which an applicant can obtain a Citizens Band License, and the fact that the FCC does not screen the applicants, coupled with the fact that Mr. Doerfer (Ex-FCC Chairman) indicated the FCC monitors less than 2% of the operating frequencies leads to all types of possibilities that may arise in the field."

**Question: What steps would you suggest towards lessening the potential use of two-way CB radio for illegal purposes?**

**Answer:** "As you know, in 1946 the Federal Communications Commission set aside 10 megacycles of space to the average citizen who could not otherwise qualify or would not be eligible for a license in the many other services. (In 1958 the Commission set aside yet another 230 kilocycles of space for Class D Citizens Radio service, further reducing the licensing restrictions and making two-way radio available to virtually every 18 year old or older citizen of the United States.) This space is being used primarily by small businesses and the average citizen in the street for personal communications, garage door openers, and so on.

"I was surprised to learn that licenses are rarely turned down and, if so, usually the applicant indicates he is not a citizen, or may mistakenly apply on his original application for a power or frequency which is not available.

"As I suggested to (FCC Chairman) Mr. Doerfer at the time of the Select Committee hearings in 1959, it seems

(Continued on Page 24)

After Years of Research . . .

# ANTENNA CO. OF AMERICA

*Proudly Announces the*

FIRST AND ONLY

## TUNEABLE ANTENNA DESIGNED FOR 23 CHANNELS

Now YOU can PEAK YOUR ANTENNA for maximum wattage output!

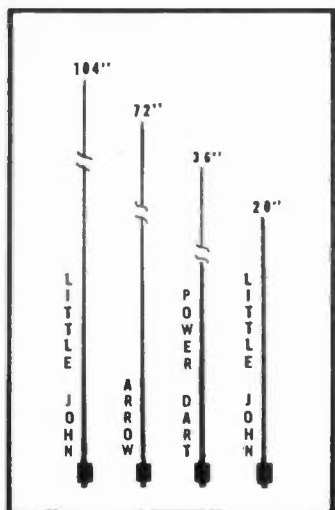

"The Antenna Engineered for Supremacy" . . . defies comparison!

- TUNEABLE
- LOW ANGLE OF RADIATION
- WEATHERPROOF CONSTRUCTION
- BASE
- 360 DEGREE RADIATION PATTERN
- DESIGNED FOR 23 CHANNELS
- LOW S.W.R.
- FIBERGLASS CONSTRUCTION
- CHROME PLATED

**More Power for the Money!  
An Unbeatable Antenna Value**

IT PEAKS TO YOUR SET!

**MARINE ANTENNA – Model MXR-9  
BASE STATION – Model BXR-10**

SEE YOUR LOCAL DEALER NOW . . . AND GET A  
TUNEABLE ANTENNA FOR YOUR SET.

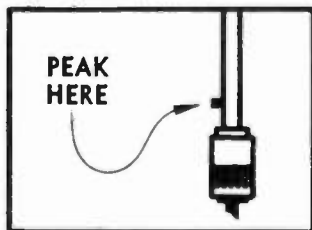

For Information Write: \_\_\_\_\_

# ANTENNA CO. OF AMERICA

85 PROSPECT STREET

STAMFORD, CONNECTICUT

PH. FI 8-9628

to me that some type of applicant-screening could be invoked by the FCC and the purpose for which the license is requested should be (so) stated. I believe the latter is now being done, but it might be wise to have this rendered in the form of a sworn statement. In addition, a closer monitoring of the licensee's activities, including "spot Monitoring" might be of some benefit. I certainly do not suggest that the freedom of communication should be impaired but I do believe that a greater supervisory control should be exercised by the FCC in this area, so as to prevent and/or detect the illegal use of these radio systems. It was indicated to me that one of the reasons a fee is not charged the applicant (at present) for his license is that the radio spectrum in which he operates belongs to the public and that the absence of the fee would negate the proposition that the licensee had any property right in it; rather it is treated as a privilege to be allowed to operate within the citizens band. This, then, would seem to be all the more reason why the FCC could and should revoke his license if he operated in an illegal manner, or if he continually refused to cooperate with recognized enforcement agencies engaged in the pursuit of their duties. At present, after an allegation of illegality is received by the FCC, an investigation is conducted. If the investigation sustains *reasonable doubt* as to the legality of the operation, the FCC so indicates to the licensee. The licensee is then entitled to a hearing. If the evidence adduced at the hearing establishes the illegal operation, a license revocation would follow. Any other action would be taken by the Department of Justice or the appropriate state agencies."

**Question: Has the FCC responded to the Committee's recommendations?**

Answer: "Actually, I do not believe the Investigations Subcommittee and the earlier Select Labor Committee have made *formalized* recommendations to the FCC. This statement should be qualified to the extent that the Chairman, Senator John L. McClellan, did write Chairman Newton Minow of the FCC last September, at my sug-

gestion. The letter to Chairman Minow grew out of a revival of the Jefferson Music Company-Carlos Marcello incident last year, and we were informed shortly thereafter that the company's transmitter is not in operation but, rather, that the radio equipment has been stored. Additionally, in 1959 when (then Chairman) Mr. Doerfer testified before our Select Labor Committee I asked him if a licensee, when asked before a tribunal of law or a congressional committee if he has a station or if he has a license for it, and that party resorts to the Fifth Amendment, whether that would tend to establish some doubt as to the proper use of his license. Mr. Doerfer replied that this would be a violation of FCC rules by failing to cooperate in regard to supplying information (material). Such a licensee (if he chose not to answer questions from proper authorities) would be placing himself in the position where it would be the duty of the FCC to revoke his license."

**Question: Do you feel, then, that the FCC, as a regulatory agency, has sufficient power to prevent or at least hinder the use of two-way (Citizens Band) radio for unlawful purposes?**

Answer: "It would seem to me that the FCC, by utilizing an applicant-screening system and by exercising greater supervisory control could have sufficient authority to curtail the use of two-way radios for unlawful purposes. In all fairness, it should be pointed out that the FCC, since 1954, has requested an additional appropriation from the Congress to increase their field of monitoring services, without much success. Perhaps (it will) be incumbent upon Congress to lend assistance to the FCC in this regard.

## CLARIFICATION

*It's come to our attention that the transformers specified by the author of the Phone Patch article in the May issue cost \$77 between them. This expense is unnecessary; other transformers can be substituted. For the G-15, you can use a Triad T-2X or a Stancor A-4749. For the G-65, either a Triad TY-45X or a Stancor A-8101 will work nicely. Total list price of these substitute transformers is less than \$20.*



# RADIO HAMs! FLEET OWNERS! CB OPERATORS!

(INBOARD BOAT OWNERS, TOO!)



## SUPPRESS RADIO FREQUENCY INTERFERENCE in your MOBILE RADIO GEAR!

Deluxe Type SK-1 SUPPRESSIKIT has full 60 ampere voltage regulator and generator THRU-PASS® capacitors designed for heavy-duty, continuous operation in hot engine compartments. Shilded armature and field leads keep noise level to a minimum!

The Sprague SUPPRESSIKIT—especially developed for Amateur, Citizens' Band, Industrial, or Public Service mobile equipment. Easily installed on any truck, car, or boat engine using a 2-pole 6-volt or 12-volt d-c generator.

★ Every THRU-PASS capacitor, as well as the field R-C suppressor, in the Deluxe Suppressikit has been designed for quick, simple, effective installation. The generator capacitor is built for continuous heavy duty 257°F (125°C) operation. The combination of a full 60 ampere current rating and the high rated operating temperature gives you an extra factor of safety against expensive generator burnouts, unlike many suppression assemblies containing general-purpose capacitors. The lower noise level, plus the time saved in installation, are well worth the slight extra cost! And you won't suffer the aggravation of trying to figure how to mount ordinary general-purpose feed-thru capacitors when you install the SK-1 Deluxe Suppressikit according to the comprehensive step-by-step instructions in each neatly-packaged kit.

ONLY \$17.<sup>85</sup> net

COSTS A LITTLE MORE, BUT  
GETS THE JOB DONE PROPERLY!

ORDER FROM YOUR SPRAGUE DISTRIBUTOR  
He'll be glad to explain the SUPPRESSIKIT—and answer questions you may have. See him today!

Send check or money order... get your SUPPRESSIKIT without delay... We ship immediately... No shipping charges to you!

### Just Look at the Advantages of the Type SK-1 SUPPRESSIKIT

- ★ Provides effective R-F interference suppression at moderate cost.
- ★ Permits faster, more readable, less tiring communication at greater ranges.
- ★ Makes possible H-F interference control by means of new, extended range, THRU-PASS capacitors which are effective through 400 mc.
- ★ Heavy-duty capacitors avoid "short-outs", preventing generator failure.
- ★ Contains only 5 easy-to-install basic parts—practically a "do-it-yourself" kit.

### SPRAGUE PRODUCTS COMPANY

519 Marshall St., North Adams, Mass.

All right! Send me an SK-1 SUPPRESSIKIT at once.

I am enclosing  money order  check for \$17.85.

NAME \_\_\_\_\_

ADDRESS \_\_\_\_\_

CITY \_\_\_\_\_ STATE \_\_\_\_\_

# A CB Channel Chopper

By **ELWOOD C. THOMPSON,**  
19W5762

Columbus, Ohio

"Sorry Unit 3, I cannot copy you through the local interference. Give me a call later when you are closer. 19W5762 base, 10-10 on channel 3."

How often have you run into the same type of problem in your daily use of CB? Plenty, I'll bet.

One of the least used schemes presented in the past few years for the reduction of receiver interference is the low-pass audio filter. Connected into the audio circuitry of your regular CB receiver, it will reject all frequencies above some "cut-off" frequency while passing all lower frequencies with little or no attenuation.

We all know that most of the intelligibility of speech is between 500 and 2500 cycles. The major portion of speech power is normally concentrated below 500 cycles and these low frequencies are the ones that modulate the transmitter most heavily. Compressing the audio frequencies not only puts more modulation power in the optimum frequency band but also reduces hum, because the low frequency response is reduced, and helps reduce the width of the channel occupied by the transmitter, because of the reduction in the amplitude of the higher audio frequencies. By the same token, narrowing the receiver bandwidth in

the audio section, one can secure a better signal-to-noise ratio.

The signal shown in Figure 1 occupies about 20 kc. and will cause QRM within 10 kc. of its carrier. Figure 2 is a 3 kc. audio filter that has narrowed the audio passband so that the signal disappears less than 3500 cycles each side of the carrier frequency. *The whole signal now occupies less than 7 kc!* Three such signals can now fill in the space occupied by the typical signal shown in figure 1, *without interfering with each other.* The only loss that occurs by using a low-pass filter is in the modulator. This can be compensated by turning up the gain slightly.

The principle of the circuit shown in Figure 3 is simply that of an RC filter with its effective "Q" stepped up by means of a 6CW4 Nuvistor amplifier stage and a feedback loop connection. The feedback loop gain determines the "Q" of the resonant peak, and this "Q" is adjustable to correct the droop of the RC connections up to the point of cut-off. The gain of the unit is determined by the ratio of R2 to R3. If they are equal, it will be slightly less than 1. The source impedance should not be too high. 200 K source impedance is the top limit and around 50 k is better. Too high a source impedance will drop the gain and round off the response curve. Unless a considerable mismatch

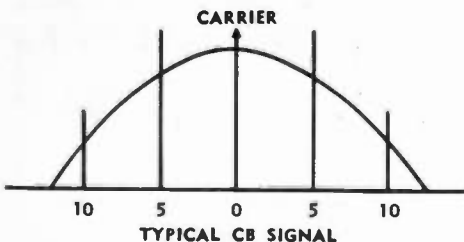

Figure 1

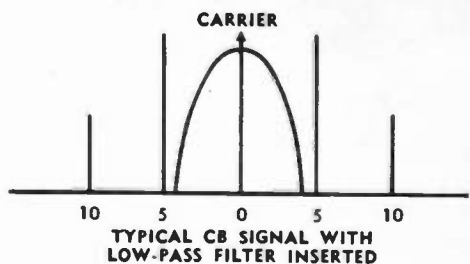

Figure 2

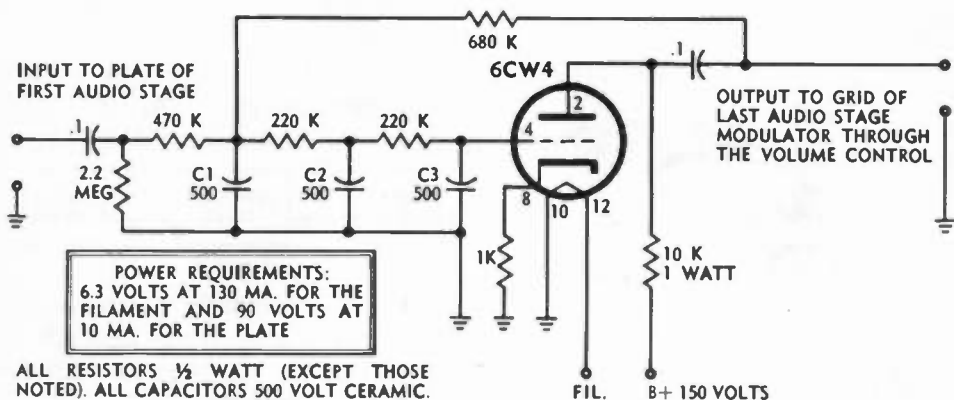

Figure 3

occurs between the filter and receiver output, little, if any attenuation of signals in the range below 3 Kc. will be noted.

The RC filter is simply made of 3 resistors and capacitors. Capacitors C1, C2, and C3 filter the audio frequencies. The output of the RC filter goes to the grid of the 6CW4; output is taken from the plate. The feedback connection runs from the output back to the input of the filter via the 680 K resistor. A 2.2 megohm grid leak completes the

d.c. circuit to ground for the 6CW4. Three RC networks in cascade will shift the phase amplitude between almost 0 and 270 degrees, depending on R and C and the frequency used. Accordingly, the bandwidth may be controlled by changing the values of the capacitors C1, C2, and C3. Wiring of the filter is simple and straightforward and not critical as to lead length or component placement. Our original

(Please turn the page)



MODEL 254C

## GET IMPROVED CB AUDIO, GREATER RANGE WITH **TURNER** CB MICROPHONES



MODEL 350C

Manufacturers know this — that's why more Turner microphones are used as original equipment on CB than any other. The Turner Model 350C (List \$16.80) for top mobile rig performance; the Model 254C (List \$23.50) ideal for base station operation.

### The Turner Combo

Get both matched ceramic microphones in the Turner Combo, available at your Parts Distributor or Citizens' Band headquarters at \$40.30 List.



THE TURNER MICROPHONE COMPANY  
902 17th St. NE Cedar Rapids, Iowa

Gentlemen:  
Please send me complete information and specifications on the  Turner Mobile Model 350C  the Turner Base Station Model 254C  the Turner Combo.

NAME \_\_\_\_\_

ADDRESS \_\_\_\_\_

CITY \_\_\_\_\_

ZONE \_\_\_\_\_ STATE \_\_\_\_\_

THE **TURNER** MICROPHONE COMPANY

902 17th St. NE, Cedar Rapids, Iowa  
In Canada: Tri-Tel Associates, Ltd., 81 Sheppard Ave. West,  
Willowdale, Ontario

**NOW** YOU CAN LEAVE THE

*Cesco*

*Thruline*

**TRANSICHECK**

Model CB-52-T

**IN LINE CONTINUOUSLY  
WITHOUT POWER LOSS!**

The new Thruline Transicheck is a patented development by CESCO employing a miniature coaxial cylindrical unit utilizing mutual inductance and capacity coupling and linear conducting tests on Citizen Band transceivers operating in the 26 and 27 mc. Bands.



Design Patent 11029052

- Accurately checks VSWR
- Measures Power Output calibration
- Can be ordered special calibrated to 25 & 50 watts.
- Sensitive Field Strength Meter
- No power limitations
- Continuous guard on transmitting conditions
- Helps you tune your antenna for maximum results
- Shows any defect in antenna
- Usable as an overmodulation indicator

**A CB BEST BUY!** **\$24<sup>95</sup>** NET

See your CB Distributor or Write for catalog on Thruline and other CB products.

**CONTINENTAL  
ELECTRONICS & SOUND CO.**

6151 Dayton Liberty Road  
DAYTON 18, OHIO

model was built into a 1½ inch cube of flashing copper.

A test set-up for measuring the frequency response (figure 4) will quickly show the optimum values to use.



Figure 4

This unit is actually a double barrelled thread. As shown in figure 5, the filter can be added in the transmitter to confine your transmitter audio frequencies to that portion of the voice range where maximum intelligence is concentrated. One change will be made for transmitter applications, however. A 6C4 triode (instead of the 6CW4) will be substituted here. Figure 5 spots the most likely location for filter, in

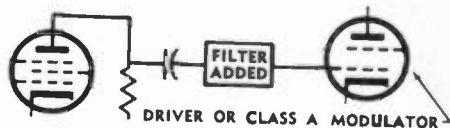

Figure 5

the modulator. Here it is located in the grid circuit of your modulator tube, after your speech amplifier or modulator drive tube.

On transmit, figure 6 shows the response curve which you should obtain with the filter. This is by no means ideal, but the attenuation above the cut-off rises rapidly enough to provide a marked improvement in the overall intelligibility of your signal.

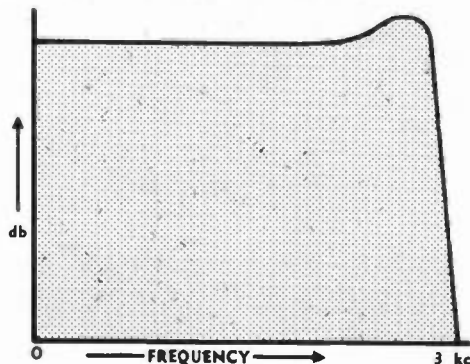

Figure 6

# **HERE IT IS!**

## **National MCEU CB Jamboree**

### **3 BIG DAYS! July 6, 7 & 8**

To be held at the beautiful NEW YORK STATE FAIR GROUNDS in Syracuse, New York, the birthplace of the **MOBILE CIVIL EMERGENCY UNIT, INC.** EVERYONE IS INVITED TO ATTEND. YOU NEED NOT BE A MEMBER OF MCEU to visit with us at the National Jamboree and second annual convention.

What is a Jamboree? It is a Time to get together with your CB families and meet the face behind the voice; that old-man sounding voice that is only 24, or the deep sounding female voice that is really a sweet thing. It is a time to see the latest in CB equipment all on display in the mammoth Colosseum at the Fair. It is also a time to take a rest from the road and daily grind, relax and enjoy the fun, music, entertainment, prizes, good food and best of all, good companionship. See how it has helped others. Bring your friends, bring your family. The fair grounds will have a camp site located on the infield, and also a trailer site where the Midway normally is located, with running water and lights.

ADVANCED REGISTRATIONS are \$2.00 per family—HIGHER after May 31st, so ~~get your registration in the mail today.~~ Your check or money order will be your receipt until you receive the stub. RETURN THE ENTIRE FORM. Do not tear off. Please print name and address plainly. We will insert this section of the ticket in a window envelope and if the mailman can't read it, you won't get it back. Some folks are making up a caravan and attending as a group. The Maumee Valley Club from Ohio has already made plans to do this, and we hope that you can get a group from your area to do the same. If you need more registration cards, let us know and we will send you as many as you need.

If you are not a member of MCEU, Inc. you might like to know a little more about it. To quote CB Horizons magazine, MCEU is about the only real national CB club, that is, one which is well established throughout the country that has been providing beneficial member-service for a long period of time. WE QUOTE PAGE 4 OF THE MARCH ISSUE, "**We recommend it to our readers.**" To get back to what is MCEU, Inc., they are a national organization of CB operators banded together for the betterment of Citizens Band Radio. They are out to help you, you can help them with your attendance. Come on out and join in the fun. The Jamboree is open to all, MEN-WOMEN-CHILDREN. Folks in Canada that want to get a little advanced feeling of what CB is all about, come on down, we know that you will add to the fun and good fellowship.

**TURN PAGE FOR MORE EXCITING INFO!**

ADVANCE REGISTRATION

M.C.E.U. — CITIZENS BAND

# JAMBOREE and NATIONAL CONVENTION

NEW YORK STATE FAIR GROUNDS

JULY 6-8

SYRACUSE, NEW YORK

NAME \_\_\_\_\_

ADVANCE REGISTRATION

ADDRESS \_\_\_\_\_

\$2.00 PER FAMILY

CITY \_\_\_\_\_ STATE \_\_\_\_\_

AFTER MAY 31, 1962

CALL LETTERS \_\_\_\_\_

\$2.50 PER FAMILY

## MCEU NATIONAL JAMBOREE

## MCEU NATIONAL JAMBOREE

NAME \_\_\_\_\_

NAME \_\_\_\_\_

ADDRESS \_\_\_\_\_

ADDRESS \_\_\_\_\_

CITY & STATE \_\_\_\_\_

CITY & STATE \_\_\_\_\_

CALL NUMBER \_\_\_\_\_

CALL NUMBER \_\_\_\_\_

~~DO NOT DETACH~~

Please Check Items Pertaining To You:

DAYS YOU WILL BE AT THE JAMBOREE:

\_\_\_\_\_ WILL BRING FAMILY  
NUMBER OF CHILDREN \_\_\_\_\_  
AGE BRACKET \_\_\_\_\_

JULY 6 \_\_\_\_\_ 7 \_\_\_\_\_ 8 \_\_\_\_\_

LIST NAMES HERE FOR NAME CARDS

\_\_\_\_\_ NEED MOTEL INFORMATION

\_\_\_\_\_

\_\_\_\_\_ NEED HOTEL INFORMATION

\_\_\_\_\_

\_\_\_\_\_ WANT TRAILER SPACE

\_\_\_\_\_

\_\_\_\_\_ SLEEPING BAG AREA

JOIN THE FUN . . . FILL OUT THIS CARD TODAY.  
DOOR PRIZES . . . FUN FOR EVERYONE!

\_\_\_\_\_ TENT SITE

Come To The Jamboree In Syracuse For A WONDERFUL VACATION! July 6, 7, 8th

Mail This Registration To Address Below. No Cash—Make Check Or M. O. Payable To:

# MCEU, INC.

1203 BUTTERNUT STREET SYRACUSE 8, NEW YORK

PLEASE RETURN THIS ENTIRE FORM—DO NOT DETACH ANY PART.

A Letter to YOU from . . .

# MCEU INC.

## NATIONAL HEADQUARTERS



1203 BUTTERNUT STREET

SYRACUSE 8, NEW YORK

Dear Citizens Band Friend:

The purpose of this letter is to explain what is "MCEU", its purpose, its functions and objectives.

"MCEU" means Mobile Civil Emergency Unit, a nationally organized group of citizens band operators, with chapters throughout the continental United States.

MCEU originated in Syracuse, New York and has spread very rapidly to the other states.

A chapter can be formed with a minimum of nine members, and is each affiliated with the national headquarters. Each chapter governs itself with its own local officers.

One of MCEU's main purposes is to aid, via citizens band radio, in any emergency.

A National convention is held each year for all chapters, to elect members to the board of Directors, amend the constitution and for general business. Each chapter sends two delegates to represent them. As many as wish may attend from each chapter; however, only delegates may vote.

The MCEU News, which is paid for as a part of your dues, consists of articles from each chapter correspondent, the fishermen's corner—in season, a report from your national board, new rules and regulations, want ads, new circuits and designs, and all good ideas sent in. To comply with postal regulations we must set a price on the subscription to the paper. This is \$1.75. All are reminded however, that only members may subscribe to the paper. Through our own publication we keep ourselves banded together, make better use of our CB facilities and help our fellow-men.

IN UNITY THERE IS STRENGTH, and in MCEU you have a voice which speaks with the combined weight and strength of all its members banded together. This voice may be directed toward Washington or anywhere else it is needed.

MCEU, Inc. recommends the use of channel 11 as the call channel. Thus anyone in the country can reach assistance or help no matter where they may be. We also urge everyone to respect the rights of others. Call and get your party on 11, then move to a side channel for your message. The only exception to this would be calls of an emergency nature.

Many chapters have adopted as side channels 4, 7, 13, and 19. The other channels are left for those business concerns which do not want to use 11 as a call channel; however, each chapter uses side channels as they fit into their local picture.

All members receive on receipt on their annual dues, a complete club roster of all chapters in the country as well as those members not from the area of a chapter, a membership card, a decal for your vehicle, The MCEU News and for a nominal fee a Scotchlite reflector sticker for each end of the car which shows the individual call letter and number of the member.

Our objectives: To ASSIST in any emergency via CB radio, TO PLEDGE ourselves to the betterment of CB, TO UNITE CB'rs into a national CB radio league to be known as M.C.E.U., Inc. Its objectives are to keep each other informed and up to date on citizens band through its own newspaper the MCEU News. All members receive the paper on receipt of their dues.

Remember, if ever in trouble call MCEU for help, we're radio equipped! If you are, won't you join us? We would like you to.

SEE YOU AT THE JAMBOREE !!! Sincerely yours.

*The Board of Directors*

TURN PAGE . . .

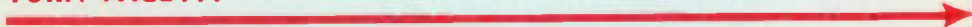

I would like to JOIN MCEU . . .

## HERE IS YOUR MEMBERSHIP APPLICATION

(Please Print or Type)

### MOBILE CIVIL EMERGENCY UNIT INC. - MEMBERSHIP APPLICATION

Check Here If This Is A Renewal

NAME \_\_\_\_\_ CALL NO. \_\_\_\_\_ PHONE NO. \_\_\_\_\_

ADDRESS \_\_\_\_\_

CITY \_\_\_\_\_ COUNTY \_\_\_\_\_ STATE \_\_\_\_\_

OCCUPATION \_\_\_\_\_

NO. UNITS MOBILE \_\_\_\_\_ BASE \_\_\_\_\_ PORTABLE \_\_\_\_\_

WHAT CHANNELS DO YOU NORMALLY MONITOR \_\_\_\_\_

All memberships cease December 31. Fiscal year is January 1 to December 31. Return application with total remittance to local chapter secretary. All others make payable to MCEU Inc., c/o Chuck Satterlee, national secretary, 1203 Butternut Street, Syracuse 8, New York.

Annual membership dues for the year 1962 in the Mobile Civil Emergency Unit Inc., \$2.25. \$1.75 of this amount is for a subscription to the MCEU News for one year. Return this bill form with remittance.

I hereby apply for membership in MCEU Inc. and will abide by its rules and regulations.

CHAPTER \_\_\_\_\_ DATE \_\_\_\_\_

SIGNATURE \_\_\_\_\_

For further information, write to: M. C. E. U., Inc., 1203 Butternut Street, Syracuse 8, N. Y.

## Manufacturers & Distributors'

### Application for Display Space

In the State Fair Colosseum Bldg. during the MCEU Convention

IF YOU ARE INTERESTED IN DISPLAYING YOUR PRODUCTS AT THE MCEU JAMBOREE/CONVENTION MAIL THIS APPLICATION TODAY!

Date \_\_\_\_\_

Please reserve \_\_\_\_\_ booth(s) for our use at the 2nd National Convention and 1st National Jamboree, MCEU Inc., Friday, July 6 through Sunday, July 8, 1962. In making application we agree to exhibit under and comply with the rules and regulations as stipulated by MCEU Inc. and the State Fair Authority.

Booth Size: 8' x 10'. \$75.00 For Single; \$125 For Double

Name of Company \_\_\_\_\_

Address \_\_\_\_\_

By \_\_\_\_\_ Title \_\_\_\_\_

MAKE CHECKS PAYABLE TO: MCEU, INC. 1203 BUTTERNUT ST., SYRACUSE 8, N. Y.





This month's winning CBL card is the type that slips by you the first time but leaves you thinking. So you go back a second time and look at it more carefully. "Humm" you think to yourself, "cute layout, identifies both the home location at Cherry Hill, N. J. (3Q2693) and the vacation home at Beach Haven, N. J. (KCC0187). But so what?"

Then it hits you! A husband and wife card that reads (across the top) "United



we stand, Divided we call." Cute! Very cute indeed.

You still don't get it? Go back and read it again . . . if you don't get it after three times around, give up. You never will, and you probably won't (especially if you are single!).

Two colors, red and black. The brainstorm of Theodore and Junetta Mehl, 3Q2693 and KCC0187 respectively. It won them a six month's extension to the CBH subscription. So how about sending along your card? CBL Card of the Month, P.O. Box 1557, Oklahoma City 1, Oklahoma.

### Midwest Jamboree

August 8-11 has been set for the Midwest National Jamboree to be staged in the Carroll County Fairgrounds, Milledgeville, Illinois. The Carroll County Radio Patrol will patrol the radio display building (an area 40 by 100 feet). For full information contact Exhibit Chairman David Reavley, c/o National Bank of Sterling, Sterling, Illinois.

Step Up  
C-B  
Performance  
With The  
New

## MILEAGE MAKER ANTENNA

By

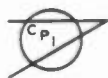

Creative  
Products Inc.



### HERE'S WHY THE MILEAGE MAKER IS MILES AHEAD

The Mileage Maker is furnished as a 102 inch, center loaded, fiberglass antenna. With inherent low capacitance, radiation resistance and efficiency are maximized and greater performance is enjoyed. The fiberglass antenna rod, produced by a patented process, features a continuous fiber construction for maximum strength and high stiffness to weight ratio.

Protection from precipitation static is inherent in the fiberglass-embedded conductor design.

Creative Products' use of advanced materials and proven techniques has produced a mechanically superior antenna with increased efficiency to a new high of 95% . . . resulting in 100% increase in transmission distance!

Step up performance by ordering the Mileage Maker today . . . . \$18.95 list.

If you have a stainless whip, get improved performance by ordering a base loading coil .. \$6.65 post paid.



Visit your Dealer, or Write:

**CREATIVE PRODUCTS INC.**  
6944 Plainfield Rd. · Cinn. 36, O. · Ph. SY 1-0030

# THE MAC-67 "GUT-R MOUNT"

NOW! A Retractable CB Antenna Mount Designed for Optimum Gain & Coverage

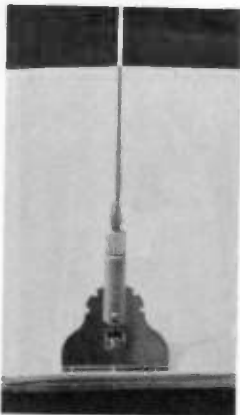

This new precision-built mobile antenna mount from McCullough-Aero Corp. enables you to achieve maximum gain and coverage with a car roof level antenna—**WITHOUT DRILLING HOLES IN YOUR CAR TOP!** The "GUT-R MOUNT" positively locks antenna in position; won't dip even at high speed! Collapses and locks down . . . for complete versatility. The "GUT-R MOUNT" attaches easily and quickly to your car's rain gutter. Any standard  $\frac{3}{8}$ " 24-thread whip mounts on the "GUT-R MOUNT" in just seconds. All steel and aluminum construction, ruggedly built to take a tremendous beating! For better mobile coverage with a roof-top antenna—get the new "GUT-R MOUNT"

from McCullough-Aero Corp. Just \$9.95 postpaid, or send \$2.00 and your "GUT-R MOUNT" will be shipped C.O.D. (Clip coupon on opposite page.)

- **RETRACTABLE**—at a touch of your hand. Enables you to have your car washed or put in garage without removing antenna.
- **RUGGED**—sturdily built of steel and aluminum to give you years of service. Supports torque and whip of a 102" steel antenna.
- **POSITIVE LOCK**—won't allow antenna to slip back while driving. Only releases when you disengage it.
- **NATURAL PLANE**—car top is a natural plane which will increase antenna efficiency.
- **ADAPTABLE**—fits any standard whip with  $\frac{3}{8}$ "-24 thread.

**NO OTHER MOUNT CAN MEET THESE SPECIFICATIONS!**

DEALER INQUIRIES INVITED

McCULLOUGH AERO CORP.

ELECTRONICS DIVISION

TO ORDER USE COUPON  
ON OPPOSITE PAGE

(Message From 12Q2339—Cont. from 10)

This does not necessarily mean you can feel free to loan out your call-letters to any and all, at your own whim. It does mean that according to Examiner Donahue the present rules do not prohibit such action on your part.

So where does all of this lead us? Is CB 'up for grabs'? Should we follow Part 19, or do we just assume that it is a lot of hog-wash and go ahead and do exactly as we please?

Speaking as the Publisher of the nation's CB radio magazine, I certainly do not feel qualified to suggest that you go ahead and call CQ, loan out your call-letters and talk as long as you wish.

I do feel qualified to state that we can look to the FCC for a new set of rules and regulations very shortly, and I forecast that these new rules will be strict, precise and well defined.

How strict, how well defined and how precise could depend to a large measure on how we conduct ourselves in the interim, while (in effect) Part 19 is of questionable value. If we show the Commission that we are capable of using restraint during this period, it is just possible that we will ultimately end up with more reasonable regulations we can all live with.

However, if we allow ourselves to take advantage of the present questionable value of Part 19, Washington observers predict that CB Radio will suffer the wrath of the Commissioner as no other service has ever suffered before.

One final word of caution. Examiner Donahue's action is not a mandate to run amuck on the airwaves. Take it as a warning that more regulatory controls are blowing in the wind. Now it's up to us to convince the FCC that that wind need not blow too hard . . . for we have received the "message", and are willing to do all we can to live by it.

12Q2339

## 50-50 Fund

Smoldering ruins were all that remained of the 1Q5050 home at 132 Old Holyoke Road, Westfield, Mass. when the Westfield 5 X 5 CB'ers met to help the Markewicz family get back on their feet. An early afternoon fire wiped out the family home. One of 1Q5050's losses was his 1200 card CBL collection which can never be replaced. Clubs throughout the country are collecting change and "trading stamps" for the "50-50 Fund". If your club wants to help, or if you have a CBL card for burned out 1Q5050, drop your contribution to Westfield 5 X 5 CB'ers, Box 10-4, Parcel Post Station, Westfield, Mass.

# Channel 24

By  
**BOB COOPER, JR., 12Q2339**  
Publisher-CB Horizons

In this ever changing world of CB radio it should not shock too many to learn that after his initial one-year contract with Horizons Publications, CBH managing editor Tom Kneitel (and family) have returned to the land of skyscrapers and cramped quarters, New York City.

Tom first brought his family to Modesto, California just one year ago when CBH was in its infancy. Then as his efforts bore fruit and our circulation grew we were forced to seek-out additional printing facilities to meet the skyrocketing demand for CBH each month.

Now 2W1965/12Q1747/10Q3161 returns to New York as 2W1965. In the year that he rubbed elbows and mixed printers ink with your publisher, Tom acquired his amateur radio license and has now accepted a writing-editing position with Cowan Publishing Company, New York City. Cowan publishes, among others, CQ-The Radio Amateur's Journal. It would appear that 'our Tom' will be shortly penning articles for the hams. We wish him luck.

Nothing is so confusing as mis-information. Case to point: The cover story in the April issue of CB Horizons. Headlined "Do You Know About This 30 Watt 11-Meter Rig" the story went on to state that many business, farming and industrial minded CB'ers could be using the 30 watt 27 megacycle Business Band Radio Service and be free of the regulations of 5 watt Part 19. The real truth of the matter is this. CB sets now on the market do not meet the strict provisions of this Business Radio Service. You must file considerably more detailed applications with the Commission for the Business Radio Service than for Part 19 radio. And, the cost can run three times as much per installation. If you still want to know the details about operating in this higher power service, drop me a line and we will work up a series of articles on the subject.

# INCREASE FIELD STRENGTH 50%

With the Remarkable New  
*"Mobil-Plane" MP-1*

This remarkable new attachment for CB mobile antennas is **guaranteed by the manufacturer to increase relative field strength by 50-100 percent** (model MP-1 or "in excess of 100 percent with the MP-6.") (CBH lab tests on the MP-1 showed an 85% increase in relative field strength.)

Make your mobile unit the loudest on the band! Hear more stations, work greater mobile to mobile distance! This easily installed capacity hat requires no cutting or trimming. Use field strength meter to position, and then lock down the holding screws. Slips over existing whip, complete instructions provided. Available to fit all 102-inch whips, top and center loaded whips, or with adapter sleeves for fiberglass and small diameter non-standard whips. Available with blue or black anodized aluminum hub (model MP-1) or nickel plated hub (model MP-6).

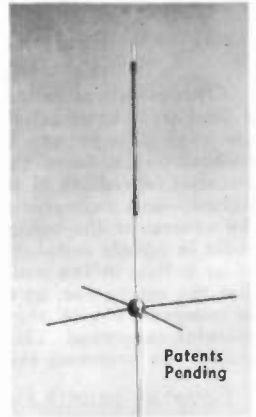

THE ORIGINAL AND ONLY MOBIL-PLANE

See the new "GUT-R MOUNT" shown on opposite page.

**MCCULLOUGH-AERO CORP.**  
5615 CENTINELLA BLVD.  
CULVER CITY, CALIFORNIA

- Rush me "Gut-R Mount", \$9.95 Enclosed.
- Rush me "Mobil-Plane" MP-1, \$5.95 Enclosed.
- Rush "Mobil-Plane" MP-6, \$7.95 Enclosed. My antenna is (specify if not 102" std. diam. stainless steel whip)
- Ship C.O.D. items checked above, \$2.00 ea. encl. (Calif. residents include 4% sales tax)

NAME \_\_\_\_\_

ADDRESS \_\_\_\_\_

CITY \_\_\_\_\_ STATE \_\_\_\_\_

DEALER INQUIRIES INVITED

**MCCULLOUGH AERO CORP.**

ELECTRONICS DIVISION

5615 CENTINELLA BLVD. — PH. EX 8-6243  
**CULVER CITY, CALIFORNIA**

# CB TECH TALK

## IMPROVING MODULATION

By **JIM GOULD**  
Kokomo, Indiana

(This modification was developed for use with a Courier I; however, the ideas and procedures are applicable to any CB rig which needs additional audio. Since the operator's voice is an essential ingredient of the audio channel in any station—and an ingredient which is never under the control of the equipment designer—lack of audio in certain installations cannot be interpreted as a flaw in the equipment. It merely means that the equipment, as designed, happens not to be compatible with the voice of the individual operator concerned. The modification Gould describes can overcome this handicap.—editor)

Several months ago, I wrote about a transistor pre-amp built into the microphone to bring up the audio. This unit worked fine with several rigs, but when added to a Courier I the pre-amp caused distortion, apparently by overloading. Since I needed the additional audio, I had to get rid of the distortion. This required addition of a handful of resistors and capacitors in the set, but now the signal brings such comments as "You have an S-2 on the meter, but you sound like an S-5 signal," or "It seems you don't have any carrier, it's all modulation."

The modifications themselves—which can be made in any similar set—divide into four steps. The first is to add a negative feedback network around the modulator. Figure 1 shows how. The two capacitors in series act as a voltage divider across the 6BQ5 output, and the 150K resistor serves to isolate the network from the mike input.

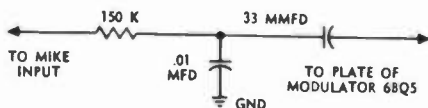

Figure 1

The second step was to remove the high-frequency filter capacitors from

the 6BQ5 plate and grid. The plate capacitor, C1 from plate to screen, came out easily. However, the grid capacitor is part of a complete inter-stage network contained in one small printed-circuit package and is a bit more difficult to disconnect.

The easy way to remove this one is to disconnect the ground lead from the printed-circuit package and connect a 470K resistor from the 6BQ5 grid to ground. This resistor replaces the one inside the package which was also disconnected when the ground lead was lifted.

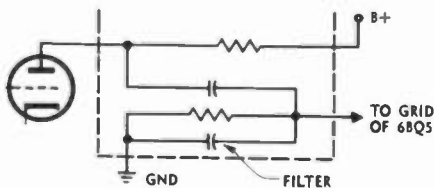

Figure 2

Step three of the customizing procedure was to change the value of the 6BQ5 cathode resistor. The proper value was determined by on-the-air tests with 18B2321 in Marion, Indiana, 27 miles away. Resistors ranging from 1000 ohms down to 22 ohms were tried; the higher value gave me less trouble with feed-back but the modulation was low. The lower values gave more modulation, but the carrier level dropped considerably from the extra current drain. The best result was with a 100-ohm resistor. Lower values gave no significant increase in audio, but cut the carrier level down.

The final step was to change the voltage-dropping resistor between the modulator and the final amplifier. I am not sure what the original resistance was, but it is now 500 ohms, and pro-

vides the maximum legal input power when the power supply resistor (XMTR) is reduced to half its original resistance (as it is in my set). The capacitor in parallel with the dropping resistor was removed and replaced with one of the same value but a higher voltage rating (5 microfarad, 100 volts).

The difference between the modulation of the set before any work was done on it and after completion was the difference between partial copy (80 to 90 percent on an S-5 carrier from Kokomo to Marion, 27 miles) and solid contact. Before the change was made, the modulation did not move any S-meters either in or out of town. Now, with the S-5 reading in Marion, the forward modulation pushes the reading a quarter of an S-unit on peaks. Many CBers in the 25-60 mile range comment on the modulation. Frequently, they ask "what type of compression amplifier do you have?"

### Canadian CB Is On The Air!

On April 1 the first Canadian General Radio Service (GRS) licenses were granted. Since that date our neighbors to the north have taken to 'CB Radio' with ever increasing numbers. The first Canadian CB'er- reader to report his call to CB Horizons was Roy Bowers, XN46010, of Sudbury, Ontario. Roy uses an Eico 772.

Ozzie

### OOPS!

It's apparently antenna-building time again—and several of our readers have inquired about an apparent contradiction in an antenna article which appeared last August. The article in question tells how to build a "cubical quad" antenna; the text gives one set of instructions for attaching the feedline but the illustrations show a different method.

It's our sad duty to report that we made a boo-boo. The illustrations show the *wrong* way to do it; the text is correct. Apparently an artist put some words in the wrong place (thus reversing the proper instructions for attaching the feedline) and nobody saw it in time to make it right.

Our thanks to Ken Moyer and Wayne Jenkins, Jr., among others, for calling this to our attention.



**RUN — DON'T WALK**  
to your nearest dealer for

**JAMES KNIGHTS**  
**"GOLDEN LINE"**  
**CITIZENS BAND**  
**CRYSTALS**



Dealer, distributor and  
manufacturer inquiries invited

**The James Knights Company**  
**Sandwich 2, Illinois**

NEW!





Only 1½" x 2½" x 4"

"NOISTOP" ELIMINATES IGNITION INTERFERENCE CAUSED BY NEARBY CARS AND TRUCKS... boosts range and performance by letting you hear signals normally lost due to ignition interference!

Thousands in use by CB'ers throughout the country! Prevents receiver jamming from trucks, cars, outboard motors, or other nearby source of pulse-type electrical noise! No need to suppress your car—ideal for base station use.

\$16.95  
NET

Completely wired, tested and guaranteed. Installs in 20 minutes.

DETAILED INSTRUCTIONS FOR:

EICO 761 762	KAAR TR-32
ELMAC CD-5	KNIGHT C-27
GENERAL MC-4	LAFAYETTE HE-15A, 20-A
GLOBE CB-100, 200	POLYCOMM PC-2
GONSET G-12, 14	RAYTHEON TWR-1
HALLICRAFTERS CB-2, 3	R. C. A. MARK VII
HEATHKIT GW-10	UTICA MC-27
INTL. CRYSTAL 50, 100	VOCALINE ED-27M
JOHNSON "Messenger"	WEBSTER 4-11

See your distributor, or write to:

BUSINESS RADIO CO. INC.

P. O. Box 5652 • Mpls. 17, Minn.



## NEW CB PRODUCTS OF THE MONTH

Globe Electronics Co., Rockford, Illinois has given CB Horizons the **positive scoop** on their brand new dual conversion CB transceiver.

The Globe Star (see photo) features push-to-talk operation, retractile cord microphone, adjustable squelch, 10 tubes plus diode rectifier (16 tube performance), heavy duty iridite plated cabinet with heavy guage metal chassis for maximum mechanical and electrical stability. Globe reports the new unit will open with a 1/10 microvolt signal.

The dual-conversion superhet circuit is designed for maximum rejection of adjacent (off-channel) signals. Price is \$159.95. The unit will be shown for the first time at the May Parts Show in Chicago.

But you can gather a flock of pre-release literature by writing to Frank Christy, Globe Electronics, Rockford, Illinois. Tell him CB Horizons sent you.



**Globe Star Transceiver**

Lafayette Radio Corporation, 111 Jericho Turnpike, Syosset, L. I., New York has up-dated their famous HE-20 transceiver, and is calling the new unit the HE-20B. Featured in the new unit is an 8 channel transmit selector, superhet receiver with 8 crystal controlled receive positions (plus tunable, of course), and an overall sensitivity of less than 1 microvolt. A push-to-talk ceramic hand held microphone has been attractively styled for the unit. An 'S' meter with switching circuit allows you to monitor the incoming signals, and final amplifier output power

as well. A special bracket makes mobile mounting a cinch.

Price is still \$109.50 direct from Lafayette, or through the many Lafayette Distributors.

**Robert's Communication Equipment** has come up with a real winner. As the photo shows Robert's has designed a professional appearing (and performing) "Universal Mounting Rock" for CB mobile equipment. Here's what it does. The unit mounts under your dash, and requires only four holes in the cover of your CB transceiver. It is available in three sizes to mount any type rig to any (within reason!) car. The unit is chrome plated, and is available with accessory pieces to mount on the transmission housing (in case you have an MG and can't get it under the dash). An additional accessory, as shown in the photo, are panel light and switch (left to right on unit at top). The lang and short of this invention is a nice looking rugged method of mounting any CB rig to your car, with instant removal when you go to base operation. BUT—the unit cannot be removed until the person attempting the removal has inserted the proper key into the lock on the unit and unlocked the catch. In other words, the unit can't be stolen. Very nice. You can flood the manufacturer with inquiries in care of Robert's Communication Equipment, Post Office Box 4515, Panorama City, Colifarnia. The price? \$12.95 to \$13.95.



**Rig-Lok Universal Mounting**

Here's another new CB transceiver. **Hollmark Instruments**, a division of Texas Research and Electronic Corporation, announces their new 12 channel crystal controlled unit. Designed for commercial applications, the unit operates from both 115 vac and 12 vdc. One of the many features of the handsome unit is the illuminated S-Meter, shown in the photo, in the center of the rig.

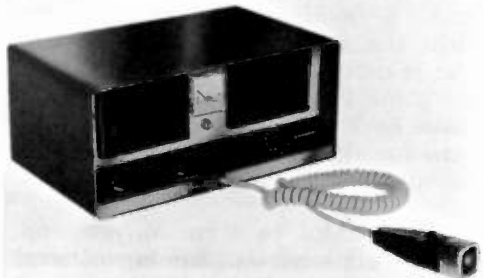

**Hollmark Model 2-12**

According to Hallmark, the model 2-12 transceiver has 'over 3.2 watts output' with such other features as push-to-talk operation, ultra sensitive squelch (better than 0.3  $\mu$ V for 10 db of signal plus noise to noise ratio), and 3 watts of audio output.

Price is \$149.50 from your dealer or direct from the manufacturer. Write him in care of Robert Olander, Hallmark, 6612 Denton Drive, Dallas, Texas.

Finally this month, a real surprise for those CB'ers who have caught-up the speech amplifier-compressor craze.

**Communications, Inc.**, 33 Danbury Road, Wilton, Connecticut has come up with a real snazzy looking and performing audio compressor amplifier.

As the photo shows, this is a real professional looking piece of gear! The 'Speakeasy' (some-

one was bound to come up with that one!) includes a modulation control, accurate modulation meter, and in and out control. The end result is a gadget that assures you of absolute control of your audio power on your carrier at all times. The meter lets you crank it right up to but (if you are careful) not over 100 percent. The in and out control should be handy when you have a lot of background room noise and you don't want the kid's squeals to modulate your rig.

The Speakeasy is readily adaptable (with instructions supplied) to some 22 different rigs, which include most all of the popular units.

Write Communications, Inc. for full details . . . and don't forget to tell them where you saw this scoop!

**Literature Available**

**Calibration Standards Stinger Products** has just released Bulletin SM-101, describing a newly designed mobile CB antenna. The new antenna line (an up-dated version of the popular Stinger line of one year ago) is available in two models, the ST-27 for automotive or marine use and the ST-27A for aircraft use.

The new bulletin illustrates the unit and its various applications. Complete engineering specifications are listed as well as a money-back performance and product guarantee.

Write for free Bulletin SM-101 from D.W. Marks, General Manager, Calibration Standards Stinger Products, Box 2315, City of Industries, La Puente, California.

RCA has announced that the Distributor Products Department of the RCA Electron Tube Division has assumed complete responsibility for

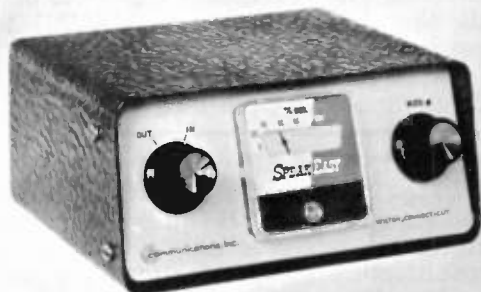

'Speakeasy' Compressor

The new Seco SIGNAL FILTER eliminates ignition equipment interference, steep wave front "hash" and background noise. It's the smallest, most rugged noise limiter and controllable squelch on the market. A dual high mu triode

- Increases reception range—in many cases up to several times.
- Produces effective quieting operation without audio distortion—even on very weak signals.
- Filters out noises from your own and passing vehicles without costly suppression installations.
- Make listening easier—increased intelligibility reduces fatigue.
- Defies vibration, shock, dust and dirt—encapsulated electronic circuit assembly.
- Adapts to most CB transceivers using tubes—all AM superheterodyne receivers with 6 or 12 volts AC or DC and 150 volts "B" power supply—mobile as well as base stations.

and dual diode circuit electronically clips noise pulses out of your signal.

Simple installation instructions with easy-to-follow two-color schematics included with each SIGNAL FILTER.

See your electronic supply dealer—or if he doesn't have the Signal Filter, send in the coupon below.

**SECO ELECTRONICS, INC.**

1207 S. Clover Drive, Minneapolis 20, Minn.

Please send (Qty) \_\_\_\_\_ SIGNAL FILTERS postpaid

check  money order for \$ \_\_\_\_\_ (\$15.88 ea.) is enclosed.

PRINT NAME \_\_\_\_\_

ADDRESS \_\_\_\_\_

CITY \_\_\_\_\_ STATE \_\_\_\_\_

sales of distribution of the RCA line of CB transceivers.

Incidentally, just so we can say you saw it here first, RCA is about to break their new 'MARK VIII' CB transceiver which is like nothing you have ever seen from RCA. Watch for details here soon.

## The CBH Lab Reports . . .

### WE TEST

★ OZCO 1-10'er

★ VOCALINE PT-27

---

Several manufacturers have recently come out with devices to enable both CB units and standard car broadcast receivers to operate from the same antenna (usually a CB whip mounted in the broadcast-antenna location).

Of these, *one* of the most notable is the Ozco 1-10. It's a small aluminum box with a coax connector on one end and two coax cables coming out the other. One of the cables goes to the CB unit, the other to the car radio. On the side of the box, protected by a rubber grommet, is an adjusting screw.

We put the 1-10 into the mobile installation (unit 1) of 10W0901 for an operational test. Installation was a five-second affair: the antenna lead came off the back of the CB rig and was attached to the 1-10; the 1-10 CB cable was attached to the CB unit; and the 1-10 BC cable was run to the car radio and plugged in.

With no further adjustment, broadcast reception was excellent. However, the job wasn't *quite* finished. We tuned to channel 9, waited for someone else to come on the frequency, and then tuned the 1-10 through the screw at the side for maximum receiving signal strength. The instructions said to use a "non-metallic" screwdriver but we used a small, dial-knob, metal screwdriver with a plastic handle and it apparently made no difference.

Now with everything tuned up we were ready to test—and here's where we got a surprise. Some of these units allow the antenna to be used for both

units—but not for both at once. In other words, when you talk on the CB rig you have to turn down the volume on the car radio because your own voice comes back out at you! From the simplicity of the 1-10's appearance, we frankly expected this to happen with it.

But not so! CB rig on transmit or receive, it made no difference to the broadcast radio. Both local and distant BC stations came in loud and clear, regardless.

This is not to say that similar units made by other firms may not also be excellent; however, they'll have to battle the chief operator at 10W0901 to get *him* to switch!

Or, in other words, we unhesitatingly recommend the Ozco 1-10.

---

### VOCALINE PT-27

In the course of testing various transceivers and other CB equipment in the Horizons' lab, we usually find that manufacturers' specifications are exceptionally accurate. Most of the time, a rig will do just about what the maker claims it will—no less, and no more.

Of course, now and then we come across one which—for various reasons, usually a bad part—doesn't come up to its specifications. These tests, you don't read about.

But it's even more seldom that we test a unit and find that the builder *underrated* it. When that happens, we think it's news!





And that's just exactly what *did* happen when we tested the Vocaline PT-27 portable transceiver!

Vocaline Co. of America, manufacturer of the excellently styled unit, said the user could expect a range of "about 2 to 3 miles."

Our field test showed excellent operation (against a conventional base station) at a range of *five* miles.

The PT-27 is a complete departure from conventional transceivers. It operates from self-contained storage batteries, making use of both tubes and transistors. It features four-channel operation, with the instant choice of either fixed or tunable reception.

A unique feature, which found special favor with our tester, is the "fine tuning" control for the crystal-controlled receiver channels. This control allows you to move almost a full channel either side of the center frequency, thus making it easy to peak up an incoming signal which may be just a few cycles off the frequency.

Another unusual feature of the PT-27 is the built-in broadcast-band re-

ceiver, which tunes the full broadcast range. Among other things, this allows you to monitor for Conelrad alerts no matter where you may be.

The PT-27 has many uses; aside from the obvious applicability to hunting and camping trips, the rig makes a fine portable "base station" for emergency work. It can be rushed to a roadblock, carried in a boat on flood-rescue missions, installed in a hospital emergency room, or packed into inaccessible mountain terrain. The location makes no difference to the PT-27—it is completely self-contained.

Operation of the PT-27 is conventional despite the unconventional circuits. A knob on the side selects operating mode (BC rcv, FIXED CB, or TUNE CB), and front-panel controls, each clearly labeled, do the rest. Our tester reports the squelch action among the best he has ever handled, and the noise limiter must be counted among the more effective on the market.

The PT-27 is available from many CB distributors; advertised net price is \$199.95.

# NEW! RIG-LOCK

## UNIVERSAL MOUNTING RACK FOR MOBILE EQUIPMENT

This handsome, chrome-plated mounting rack lets you transfer CB equipment quickly and easily from one vehicle to another. Ideal for business, emergency and pleasure use. Unit locks securely in place; discourages theft. (Made of 18-gauge steel.) Instantly removable for service. Mounts compactly under dash or on transmission hump\*. Panel light for tuning\*.



### Model A (1 1/4 x 7 3/4 x 9")

Mounts Sonar, Executive, Webster, Eico, Ray-Tel, Poly-Comm, Apelco, Karr, Browning, Mobilair, General.

12.95

### Model B (1 1/4 x 11 x 8 1/4")

Mounts Hallicrafters, Lafayette, Courier, GW-10, Town & Country, RCA, Globe, Heathkit, Lafayette 6-2-10 Meter Rigs.

13.95

### Model C (1 1/4 x 6 1/2 x 9")

Mounts Gonset, Johnson Viking, Eico, Gonset Super 12 Converter, FM Converters, Johnson Ham Units.

12.95

\*Brackets for transmission mounting 1.98

\*Panel light and switch 1.31

Available Southern California Local Dealers. Order by Model Number or send make of unit with order. Check or Money Order; No C.O.D. (California residents add 4% sales tax)

## Robert's Communication Equipment

POST OFFICE BOX 4515 — PANORAMA CITY, CALIFORNIA

SUBSCRIBE TO MONTHLY CALL-BOOK THIS MONTH 41

# CITIZENS COMMUNICATIONS



**ATTENTION ALL CCM's and ACCM's**  
CB Horizons is very pleased to announce that effective with the very next issue (July) of CBH, John Krejc, 2W4586, 40 Lonzo Avenue, Garfield, N. J., will assume the new post of Executive Coordinator for the CCM Program.

So fast and furious has the Citizens Communications Reports section in CBH grown that a brand new Editorial Post on the CBH staff has been created to head up this program.

CB'er Krejc is one of the most devoted and hard-working CB'ers in America today. It is no mere coincidence that a letter appears in "OZZIE" this month commending the fine job he has done, and is doing.

From this point on, all CCM and ACCM reporters should have their typewritten reports in Krejc's hands not later than the 18th of each month. Those clubs who have been sending copies of their club papers to CBH should also put Krejc down for a second copy. And finally, new applicants for CCM's (a few posts still available, such as the 7th Coll Area, 12th Coll Area, 13th Coll Area, 14th Coll Area, 16th Coll Area, 21st Coll Area and 23-24 call areas) and ACCM's should direct their attention to Krejc, 2W4586, 40 Lanza Avenue, Garfield, N. J.

10-7

**FIRST CALL AREA:** CCM-Donald O. MacLeod, 1W8438, 26 Elmview Circle, Dover, N. H.; ACCM's-Muriel Brumage, 1Q2576; Seth B. Paull, 1W1717; William M. Welch, 1Q5640; George Michaels, 1Q1657.

The Lake Sunapee Citizens Bond Radio Alert Unit, a new club recently formed in Western New Hampshire, submits their first report. This club, "formed as an educational aid and service unit", meets the first Sunday of each month at Gordon Hall, Sawyer Center, Colby Jr. College in New London. They monitor channels 11 and 20 and visitors are welcome at their meetings. Frank Morse, 1W1624, is President. Over in Vermont the Twin State Five Watters of Windsor announces they are still working on their July Jamboree in conjunction with the Civil Air Patrol. The date has been changed to July 21 and Springfield, Vermont is the center for the festivities. Provisions are being made to accommodate "fly-in visitors" at the Springfield airport. The March meeting of the Tri-County Emergency Communication Net, Inc., was held at the fire station in South Berwick, Maine, featuring Browning Labs representative Gar Greene, CBH's roving reporter. Gar gave a very interesting report on the Chicago CB convention. For the benefit of summer visitors soon to be invading New England, we have

reports of Monitoring Channels from several of the CB Clubs along the Mass.-New Hampshire border. Ould Towne Radio Club of Newburyport, Mass. monitors channel 19; CB 5'ers of Dover, N. H. monitors channel 15; CB Socialites of Plaistow, N. H. sit on channel 9 and the Tri-County Emergency of Dover keeps an eye on channel 20. The southern New England Citizens Radio Association is planning an outing for June 24. President Donald Peterson reports prizes will be given away, including an ECI traceriver, antennas, Call-Books and many accessories. The club now has 95 members. **Remember the "Giant Eyeball QSO" of 1961?** It's back again, with the Citizens Bond Radio Association of Norwalk, Conn. sponsoring again. June 17 is the date, and Cove Morino, Golf Pasture Beach Road, East Norwalk, Connecticut the location.

**SECOND CALL AREA: CCM-Don Lehr, 2W3911, 39 West Blvd., Rockaway, N. Y.; ACCM-John F. Krejc,**

North Jersey Chapter of MCEU announces the forming of a new chapter locally. Newest to join the growing MCEU is Bergen County Chapter. The Union County Citizens Radio Emergency Corps was recently pressed into service at a general alarm fire in a Linden, N. J. Lumber Yard. Corps Director Jack Roppoport of Union mobilized 16 walkie-talkie units and mobile units to handle crowds and traffic. Nossou CB Club Prexy Len Pottruck advises his club's electronic course is going great guns. The club meets the first Sunday of each month at club headquarters, 4115 Hempstead Turnpike in Bethpage. Meeting time is 8:30, why not drop in. Acton is fast becoming the motto of the newly organized Ocean County Emergency Aid Network, better known as "OCEAN". The group has been active cleaning up the mess created by recent winter storms along the New Jersey coast line. The Harlem Valley CB Club of Powling, N. Y. is forming an Emergency CB Natural Disaster Net. There is continual increased interest in electronics, and the club is purchasing and assembling of club meets popular kits as a cooperative-educational project. The Queens Chapter of the Citizens Bond Radio Relay League, Inc. is planning an indoor exhibition of CB equipment and accessories to be staged on June 17th from 2 PM to 10 PM at Sunnyside Gardens, which is Queens County's largest sports arena. Facilities for 48 exhibit booths will be available. Interested manufacturers, others should contact Frank Spinko, Sr., 2W9804, 83-07 St. James Avenue, Elmhurst 73, New York.

**THIRD CALL AREA: CCM-Chester Zubrzycki, 2724 W. Third Avenue, Chester, Pa. ACCM's-pending**

On May 24 at 8 PM sharp the South Eastern Pennsylvania Citizens Radio Club will present a film, sponsored by Bell Telephone Company, an exciting film entitled "32 Seconds to Survival". The unusual part of this program will be a phone company demonstration of a Direct Priority Line to NORAD HQ in Denver, Colorado. This is the first event of its kind in Delaware County, and all are welcome. Channel 9 will be monitored. This same club will cooperate with The Delaware CB Association to set up communications at the 75th Anniversary Parade honoring the town of Woodbury, N. J. Down South Jersey way, along the coast from Tom's River to Wildwood and inland to Mays Landing, the CB Boys have organized the oil encompassing "Seacoast Radio Club". Club members have participated in several large fires, a 24 hour search for a six year old boy believed drowned, and work with the Coast-Guard Auxiliary Flotilla. The club is promoting channel 13

for marine usage. The club has also established channel 9 for calling and monitoring.

**FOURTH CALL AREA: CCM-George W. Adkins, 4Q1018, Little Manor Court, Ocean City, Maryland.**

All clubs are requested to send news to this reporter as I am your new CCM for the 4th Call Area.

This unit took a trip to Baltimore recently and summertime travelers planning a trip into the area will be interested in learning that channels 2, 5 and 11 are most commonly used in the metro Baltimore region. We would like to commend the excellent and even heroic work of the Eastern Shore Marine Radio Club (CB) during the infamous storm which ravaged the area in March. The boys kept rescue operations intact and sped evacuation of Ocean City, Maryland and Fenwick Isle, Delaware by hours, cooperating with local authorities. CB radio aided in the rescue of a six year old girl near Havre de Grace, Maryland. The Havre de Grace Tri County 11 Meter Club, and the CB 11 Club of Baltimore turned out 15 mobile units and 3 walkie talkies. 4Q0809 set up a rig in the police department to coordinate the successful search.

**FIFTH CALL AREA: CCM-J. M. Robinson, KC10528, 9547 Granby St., Apt. 1, Norfolk 3, Va.; ACCM-J. P. Setliff, 5Q2388, RFD #1, Dudley, N. C.**

On February 12 ACCM J. P. Setliff visited the Durham, N. C. CB Club. Setliff notes this is one of the largest CB meetings he has attended and that Durham CB'ers are very well organized. A representative of WTVB-TV gave a short talk on amateur radio and invited interested CB'ers to attend the local ham club meeting. Club members have bonded together to purchase insurance on their CB gear. On March 1 the long awaited March of Dimes Banquet was under way at the Barbeque Lodge in Kinston, N. C. The banquet was given in the honor of the Eastern North Carolina CB'ers, in appreciation of the many hours given to the Dimes Drive in January. The Banquet was a huge success . . . more than 200 guests were on hand. The Helping Hand CB Club of Kinston has really put CB radio on the map in this area. This is one region where the average 'Citizen' can tell you exactly what CB radio is! From the Tidewater area of Virginia comes many reports of CB activities during the recent storm which swept the eastern coast. It would be almost impossible to list the CB'ers who really deserve the credit, thanks and appreciation for their assistance during the storm. In this area of Norfolk, Newport News, Hampton, Portsmouth and Virginia Beach, Virginia people in general know who these CB'ers are. The amateur radio boys even expressed their gratitude for a job well done by the CB'ers. In Norfolk, the Norfolk Citizens Radia Club worked from CB headquarters and handled every assignment quickly and efficiently. The club provided a variety of services—transportation, errands, uniting of families, recovery of misplaced items and persons, etc. Perhaps the CB'ers of Hampton and Bucroe Beach deserve an extra pat on the back. Their region was nearly totally destroyed, but they were right in there pitching and helping from the start. It is in times of disaster that it becomes more obvious than ever that if you really want to do something for CB there is no better way to do it than through well organized, well planned CB Club activities. If you wait until a disaster strikes to organize, chances are it will be too late to be effective. Edward Norwood, Jr. reports a new CB Club, the Old Dominion Radio Club, has been formed in Richmond, Va. Temporary officers include Willard Ingram, 5Q1824. The group meets on the second and fourth Wednesday of each month at Westover Theatre, 4712 Forest Hill Avenue, Richmond. The 5 Watt Ridgerunners Citizen Band Radio Club hangs out around Staunton, Virginia with Ray Pascal, 5W4188 serving as President. They meet on the second Tuesday of the month . . . give them a look next time you are in the area. They boast over 100 members now.

**SIXTH CALL AREA: CCM-Don W. Sanford, 6Q3944, Box 304, Northport, Alabama; ACCM-Ken Chambliss, 6Q4462.**

The Hillbilly CB Jamboree is definite for July 11-14 now, which will run concurrent with the Hillbilly Homecoming Annual event. This year's meet is to be held in Maryville, Tennessee, and the Hillbilly CB Club of Blount County is managing the CB part of the affair. Blount County Fair Ground is the center of activities.

**SEVENTH CALL AREA: CCM-none presently.**

The count-down is on for the National CB Jamboree, being staged by the Central Florida Alliance of Citizens Band Clubs. Participating clubs include Cape Canaveral, Greater Orlando, Volusia, Indian River, Brevard 10-4 Club and a lot of individual non-club affiliated CB'ers. Hugh Pinney, 7Q0523 and Howard

# THANK-YOU . . . from Horizons

## DEAR READER:

IT'S NOT TOO OFTEN THAT WE FEEL HUMBLY GRATEFUL. TODAY WE DO. JUST ONE YEAR AGO CB HORIZONS, AND HORIZONS PUBLICATIONS, INC., WERE BORN. OUR THEN MINIATURE STAFF OF SIX HAS GROWN INTO A VERY COMFORTABLE HARD-WORKING CREW OF 18 THAT STRETCHES FROM CALIFORNIA TO WASHINGTON, D.C. OUR ENTIRE OPERATING BUDGET FOR JUNE 1961 WILL BE SUPERCEDED BY OUR PRINTING COSTS ALONE IN JUNE 1962. THIS MAKES OUR PRINTER HAPPY . . . AND IT ALSO INDICATES THAT THROUGH THE TREMENDOUS SUPPORT GIVEN US BY READERS AND ADVERTISERS, WE HAVE BEEN ABLE TO GROW TO SERVE YOU BETTER. THIS MONTH'S CBH CARRIES 60 PAGES. A YEAR AGO THERE WERE BUT 40; A 50% GROWTH IN 12 MONTHS.

WE THANK YOU FOR MAKING ALL OF THIS POSSIBLE, AND WE PLEDGE OUR CONTINUING EFFORTS THROUGHOUT OUR SECOND YEAR TO MAKE CB HORIZONS EVER MORE VALUABLE TO YOU—THE CB'ERS OF AMERICA.

SEE YOU ON THE BAND!

BOB COOPER

12Q2339

## VERTICAL OR HORIZONTAL

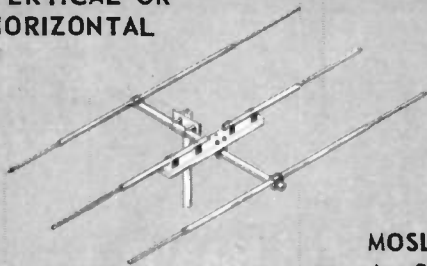

MOSLEY  
A-311  
BEAM

## BEST POINT-TO-POINT COMMUNICATION

FCC regulations limit actual power input of Citizens Band transmitters to 5 watts. With the popular Mosley A-311 three element beam you can achieve a legal effective power input of 40 watts. (Note: 9 d.b. signal gain of the A-311 gives you a power gain of approximately 8.) Write Dept. CBH22 for complete specifications.



List \$46.88

Electronics Inc.

BRIDGETON, MISSOURI

Gibson, 7Q1840, have been two of the most enthusiastic workers behind the project which promises to be one of the outstanding CB events of 1962. The site of the convention is to be just outside Cape Canaveral, Florida, assuring all visiting CB'ers with an excellent opportunity to see the most famous land area in the country, including the missile launching pads. Things start rolling at 10 AM July 6 with plenty of sunshine, beach and fish-fry activities planned, in addition to the exhibits from participating manufacturers. The center of the meet will be the new luxury motel owned by the seven Mercury Astronauts. Tours galore, including Patrick AFB will be included. Send for more information on this great vacation and CB meet activity by addressing your CBL card to Hugh Pinney, 7Q0523, P.O. Box 764, Cocoa, Florida.

**EIGHTH CALL AREA: CCM-Ralph M. Lord, 8W1494, 4834 Crown Avenue, Baton Rouge, La.**

Your CCM has had several fine letters from CB'ers in this area. CB'er Clint Cavin, SP4 US Army sends along the following. Following the re-activation of Fort Polk, CB has gotten into full swing with about 30 CB units on the base. At present 25 are mobile, 5 are base. They operate channel 11, but plan to swing to Notch-9 soon. I have received two very nice publications from Evelyn Barnes (8Q0794) of Pascagoula, Miss. The club is very active there, both socially and also in rendering service to law enforcement and emergency agencies. The ladies have formed a Breakfast Club at which time they meet at one of the member's homes for "eye-ball-quo's" and breakfast. Evelyn's publication is quite interesting and anyone may have a copy by writing to her at 1503 Fern St., Pascagoula, Mississippi (\$1.20 per year).

Harold and Pauline Olive, along with this reporter, are interested in holding a state CB convention in the near future. If you are interested and would attend such a meeting, drop me a line at the address heading up this column.

Pat McDonald has been installed as Communications Officer for the Emergency Communications Organization in Baton Rouge, La. L. C. Sanders was elected to the Board of Directors to fill the vacancy left by Pat. There is still much activity throughout the 8th district I am not aware of. Come on all of you clubs . . . put me on your club paper mailing lists, and have your club secretary keep me informed of your activities.

**TENTH CALL AREA: CCM-Bob Johnson, 10W4389, 4300 Rector Avenue, Fort Worth, Texas; ACCM-James Abney, Jr., 10Q2516.**

April 1 saw Shilbey County Fairgrounds booming with CB signals (and their harmonics!) and a CB Bar-B-Que. 175 were in attendance, with the 8th, 9th and 10th Call-Areas represented. The Caddo CB Club of Marshall, Texas will hold a big Bar-B-Que with all of the trimmings July 29th. Cost will be \$1. per person, or \$.50 per head for the kiddies. All you can eat and lots of free prizes. RCA, Gonset and other firms will have displays. 10Q0974, President of the McKinney, Texas CB Club recently staged a covered dish dinner. 72 showed up! The Greater Dallas Citizens Band Radio Club, Dick Johnson-Prexy, has a majority of its members enrolled in a First Aid Class. The club is shooting for a total of 500 members by the end of the year, and it looks like they will make it! CB-7 is to hold another all day get together on Sunday June 10. Tom Davis, 10W2545 will be host at his home on Scuba Point, Passum Kingdam Lake. This is to be a family affair. Highlight of the meet will be a series of demonstrations by Tom on Scuba Diving, rescue work. Lots of free camping area for the CB'ers as well. Channels 7 and 11 will be monitored.

**ELEVENTH CALL AREA: CCM-R. V. Watson, 2206 W. Palo Verde Drive, Phoenix, Arizona; ACCM's-Jack W. Kinsey, 11Q5345; Mrs. Donna Marshall, 11Q5171.**

The Five Watt Wizards held their regular monthly meeting the 16th. Plans were made for a field trip to Calico Ghost Town in the desert near Barstow, California. This is a new club in the San Bernardino area, and members are eagerly solicited. If you are interested, contact Jack Kinsey on channel 16 in the evening, or during the day on channels 16 and 20. Others who have data on the club available include KEJ0922, 11Q1761, 11Q4691, 11Q2675, 11Q2948 or 11Q1146.

**TWELFTH CALL AREA. CCM-none currently.**

On April 8th the 11 Meter Radio Club of San Francisco, Inc. threw a Jamboree for everyone interested in CB radio in the Bay Area. Some 500 were on hand, including 315 cars in the parking lot with 'whips'. One of the biggest boosters of the Jamboree was the Napa Valley CB Club, from 'up north'. Renie Malsack, 12W4248, was the Chairman of activities and singly

And now - America's **FINEST!**

CITIZEN'S BAND  
MOBILE

- 17 Tube Performance
- 6 Crystal Controlled Channels
- Manual Tuning of All 23 Channels
- Dual Superhetrodyne Receiver
- Pi Network & Harmonic Trap
- Adjustable Squelch
- Series Gated Noise Limiter
- Transistorized Power Supply
- 6 or 12 Volt D.C. Input

MODEL TR-70 \$225



with Turner Mic 350C

ENGINEERED BY **TRAM** ELECTRONICS

PRESENTING — The TR-70 CITIZEN'S BAND MOBILE RADIOPHONE. At last — a mobile that will really get out. Copy your stations from locations you never thought possible. Extended range and fewer "dead spots" are now yours with the hottest mobile on the market.

With 100% modulation you will be transmitting with the crispest signal ever. Be free from adjacent channel interference and have four watts of undistorted audio at your fingertips as well as 3.5 watts MINIMUM output. This mobile combines TRAM base station performance with mobile compactness. It is designed to operate on either 6 or 12 volts DC.

The companion TR-27 Base Station — \$249

FOR MORE DETAILED INFORMATION AND SPECIFICATIONS, WRITE TO



**TRAM ELECTRONICS**  
 P. O. BOX 187, WINNISQUAM, N. H.

responsible for the jamboree. SF area CB'ers can get acquainted with the 11 Meter Radio Club by writing to P.O. Box 4182, San Francisco.

**FIFTEENTH CALL AREA: CCM-Spencer Van Noy, 15W1894, 632 E. 3900 South, Salt Lake City 7, Utah.**

15Q0754 announces the formation of a new Citizens Band Radio club in Denver. The first meeting of the 'Central Colorado Citizens Radio League, Inc.' was held April 4 with 30 charter members on hand to take the pledge. Future plans include the formation of a Technical Committee, formation of a technical library, joint meetings with the popular Denver Metro Club, dances and group outings. Everyone is welcome at the meetings. Look for 15Q0754, John Demeter, on the air for complete information, or drop him a note at 1633 S. Monroe, Denver 10.

**SIXTEENTH CALL AREA: CCM wanted. How about you?**

**EIGHTEENTH CALL AREA: CCM-Ralph E. Combs, 18B1711, 202 Bolivar, Owensboro, Ky. ACCM's- D. C. Walcott, 18A4803; Thomas Gilliams, 18Q41868.**

The Cedar Rapids Citizens Radio Club and the Civil Air Patrol held a joint alert on March 25 to test their response to a flood emergency. These organizations assisted police during last spring's flood, and stood ready to assist again this year if needed. At 1:30 PM the alert was called into action over the special CB base station set up at police headquarters. CAP Executive Officer Nick Shrope and Bert Collins, 18Q0570, co-ordinator of the Cedar Rapids CRC. Within 30 minutes 15 CB mobile units and CAP personnel had responded and met near the dam on the Cedar River.

An Emergency Squad has been formed, and it will be known as Rescue 7. Emergency equipment is carried by the squad and can be put into service within minutes of any danger or alert call.

Our thanks to Bob Vogel, 18A5401, Dr. Wm. Ward, 18W8555, Bob Colony, 18Q1831 and members of the Hawkeye Citizens Band Club for their excellent monitoring of the CB channels for all transmit mobiles from all over the county coming and going to the Iowa games and special events held in Iowa City.

The Bartholomew County CB Club of Columbus, Indiana is sponsoring a Jamboree June 24 at the 4-H Fairgrounds outside of Columbus on Highway 58. A parade will start at 10:00 PM sharp, forming at the fairgrounds, heading on through town and back to the fairgrounds at 11 AM. Police escort will be provided. Bring a well filled picnic basket and a \$.50 fee for registration. Prizes and drawings will be in abundance. Channels 11, 9 will be monitored. For further information contact Joe West, 18Q7667, RR #5, Columbus, Indiana.

The Wabash Valley Citizens Radio League is planning their CB Jamboree for mid-July. Sunday July 15 is the date, and famous Turkey Run State Park the site, near Marshall in west-central Indiana. There will be games, prizes, displays of CB equipment and entertainment for all the family. Picnic baskets will be the order of the day. Contact KHA1353, R. L. Winklepleck, 107 Berkeley Drive, Terre Haute, Indiana for full details.

**NINETEENTH CALL AREA: CCM-Carl Wesser, Jr., 19W6285, P.O. Box 'V', Presque Isle, Michigan.**

Heard from the Twin City CB'ers of Southwestern Michigan, including the Benton Harbor and St. Joseph areas. They have been organized since last August and have a roster of 60 members. They monitor channel 9 and use it as a calling channel only. President is Don Hallman, 19A6703. The club holds two meetings per month, the first Saturday and the 3rd Thursday. Saturday meetings are 1:30 PM and the Thursday meetings are 7:30 PM. Meeting center is the Producers Creamery Building, 1330 Empire Avenue, Benton Harbor, Michigan. Channel 17 has been selected by the group for club activities.

On a recent trip to Flint, Mrs. Chet James, 19Q2145, welcomed the use of CB. While traveling on interstate 75 near Flint she developed car trouble. Using CB she summoned 19W7712 and 19Q7668 who got her going again in quick fashion.

The Top of Michigan CB Association now has a roster of 49 members. Ed Bauchey 19Q4083 has been appointed as a committee of one to check with the Tri County Civil Defense and see what help the CB group can be.

**TWENTIETH CALL AREA: CCM-Jack Marshall, Box 260, RD #1, Conastota, N. Y.**

The Krystal Crackers of Oneida, N. Y. are doing a bang-up job. Plans are underway to hold a picnic with

(Continued on Page 56)

**NEW AMECO NUVISTOR PREAMPLIFIER**

for **CITIZENS BAND**

Lowest Noise—25 db Gain

Add an Ameco Nuvistor Preamplifier to your transceiver, converter or receiver to improve your reception of weak signals, extend your receiving range, reduce image and spurious signals. Uses RCA 6DS4 Nuvistor. Compact, low power requirements.

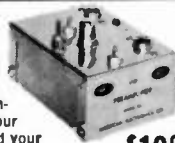

**\$1395**

Model PV  
Wired

At leading electronic distributors, or write Dept. C-4  
(Dealer Inquiries Invited.)

**AMECO EQUIPMENT SALES CORP.** 178 HERRICKS RD. MINEOLA, L.I., N.Y.  
Affiliated with American Electronics Co.

**FREE! 20-PAGE BROCHURE**

Covers the latest in Citizens Band equipment and accessories. Nuvistor Pre-Amps, Ameco, Cadre, DeWald, Globe, Mark-Mobile, Hy-Gain, Hi-Par, Polytronics, Turner and many others! Send for Free Copy today. (Request Brochure No. CB-6-62)

FREE WITH ANY ORDER . . . RADIO DISTRICT CHART. Shows both "K" calls and numeral calls, plus "10 Signals" chart. Printed on either card stock for Base Station or "Kleen Stick" for Mobile Units. (Specify when requesting.)

DISTRIBUTORS OF QUALITY CB EQUIPMENT

**GEODE INDUSTRIES** KHA 2436

106 West Main — New London, Iowa

**PERFORMANCE! DEPENDABILITY! QUALITY!**

**SPACE RAIDER'S** outstanding line of CB Antennas incorporate the same high reliability factors that our Commercial and Amateur customers have enjoyed since 1953.

The GP-27-1: Ground Plane Antenna. All aluminum elements and mounting bracket. 3/4" x .050 wall telescoping to 5/8" tips of 6063 T-6, mounting bracket of tough 7075 aluminum. GP-27-1 **\$25.95**

The CL-27: Colinear Array Antenna. Improved gain over ground plane, with low angle radiation. Radials same rugged stock, 9' long. Vertical element 1" at base, 5/8" at tip, approx. 18' long. All elements premium 6063-T-6, mtg. bracket 7075 aluminum. CL-27 **\$35.95**

The CB-11-3: 3-element Beam. Center Sections 1 1/2" O.D. Adjustable End Sections 1" O.D. Boom 2" O.D. 12' long. .17-.17 wavelength spacing. Forward Gain 8db. Front/Back Ratio 20 db. CB-11-3 **\$44.50**

The CB-11-6PD: For the Ultimate in Performance. True Cross Polarization gives maximum signal level, transmitting or receiving. 6 elements, same rugged stock as CB-11-3, Boom 12' long. Forward Gain 12 db. Front/Back Ratio 44 db. \*pat. pending CB-11-6PD



1076 E. Walnut St., Pasadena, Calif.

Orders over \$35, shipped prepaid in (48) USA. Write for complete specifications.

# Help on the Highway

With summertime upon us, many of the nation's CB enthusiasts take to the roadways for a bit of sightseeing and general vacation traveling with the family. During the past two months CB Horizons has been gathering information from many of the nation's leading CB dealers-service shops concerning their willingness to help out a CB'er who gets stranded in a strange town with a busted mike cord or bum set of crystals. The following listing is by no means representative of the entire nationwide group of stores (some 1100 in all) which specialize in CB sales and service. This listing does represent, however, those stores and service centers who indicated a willingness to be listed here as *available to help* whenever the need arises. Stores not listed may bring pertinent data to the attention of the Publisher, and they will be included in a future issue of CB Horizons when this listing is brought up to date.

## Using The Guide

As you can quickly see, each state is broken down, alphabetically, into towns and cities. The towns listed are followed by a company name, and address. On the next line you have a listing of the brands the firm carries, whether they sell or sell and service, their operating hours and finally, their CB call and the channel they monitor. This means you can 'call-ahead' for service, crystals, or whatever is needed as you enter a town which has a dealer listed here.

Perhaps this would be a good time to suggest that all CB equipment dealers get together, through *CB Horizons*, and pick a single channel which all will monitor for service calls. In this way all CB'ers could have one crystal position in their rig set aside for a specific crystal (ie. Channel 6 or

some other) which they would be assured of being able to use to raise some emergency repair for their equipment. On a nation-wide basis, an agreed upon *Emergency Service Channel* makes more sense than many of the other various channels now set aside for marine, calling motels, etc. What do you think?

Whenever possible, patronize these helpful stores. They have indicated their willingness to be of service to you.

## CALIFORNIA

**Canoga Park**—Sandy's Elect., 21305 Saticoy Johnson, Gonset, Stinger, AS/P, De Wald, Noistop. Sell only. Open 10 AM- 8 PM wkdays, 10-4 Sundays. **11Q2614, monitors channel 1 10-8 daily.**

**Downey**—Master Elect., 8356 E. Firestone General, Sonar, Globe, Webster, Lafayette, Polycom, Hy Goin, AS/P, Master Mobile, Noistop, Gizmotchy. Sell and service. Open 10 AM-9 PM wkdays, 10-6 Sat. **Call pending, monitors channel 11 when store is open.**

**Eureka**—Burgh's, 28 West Wabash Citi-Fone, Sonar, General, International. Sell and service. Open 8 AM-8 PM. Modifications and Freq. Cks. **12W2981, monitors channel 4 while store open.**

**Fresno**—Mobile Radio Sales, 1215 W. Dayton General Radiotelephone and used equip. Sell and Service. Open 10 AM-9PM. Modifications and Freq. Cks. **12W2295 monitors channel 9 while store is open.**

**Hemet**—Gil Severns, 40400 E. Florida Eico, General, Gonset, International, Johnson, Multiproducts, Polycom, ECI. Sell and Service. Open 8 AM-5:30 PM. Modifications. **11W-0802, monitors channel 11, 16 while store is open.**

**Hollywood**—Pacific Radio, 1351 Cahuenga Eico, General. Sell only. Open 8:30 AM-6 PM. **11W7343.**

**Inglewood**—11158 So. Inglewood Kaar, General, International. Sell and service. Modifications, Freq. Cks., installations, tune-up. Open 9 to 9. **11W6001, monitors channels 11 and 20.**

**Long Beach**—Scott Radio, 266 Alamitos Johnson, Hallicrafters, Eico, Sonar. Sell only. Open 8:30 to 5:30. **11W2601.**

**Menlo Park**—C-D Comm., 1081 El Camino Raytheon, Webster, ECI. Sell and Service. Modifications, Freq. Cks., Marine Service. Open 9 to 9 Wkdays. **12W3219, channel 11.**

**Oakland—Victor Elect., 3519 McArthur**  
International, Gonset, RCA, Osborne, Sonar,  
PR Crystals. Sell and Service. Open 9-6  
M.W.F. 9 to 9. **12W3104, monitors channel**  
**3.**

**Pasadena—Dow Radio, 1759 E. Colorado**  
Johnson, Globe, Heath, Eico, Gonset, Halli-  
crafters, Citifone. Sell only. Open 8 AM-6 PM,  
M.F. open 8-9. **11W8505.**

**Sacramento—Selectronics, 4113 Franklin**  
Hallicrafters, Johnson, International, Jones,  
Hy-Gain, Master Mobile, Telrex. Sell only.  
Store hours, W., Th., F., Sat. 10 AM-6 PM.  
**12W1323, monitor channel 11.**

**Son Francisco—B H & J, 3845 24th St.**  
International, Webster, General. Sell, service,  
modifications, Freq. Cks., Open 8 AM-12 N.,  
4 PM-8 PM. **12W4724, monitors channel 20**  
**during store hours.**

**Son Bernardino—Arrowhead, 1216 "D" St.**  
Koor, Utica, USL, Hallicrafters, Keltner, Globe,  
Spacefone, Transcendor, Personalphone, PR  
Xtals, Master Mobile, AS/P. Sell and Service.  
Modifications, Freq. Cks. Open 9:30-6:30.  
**11W1552, monitors channel 19 when store**  
**is open.**

**Son Luis Obispo—Sepost Radio, 344 Higuera**  
Paco, Monarch, Hi-Yi. Sell-Service, modifica-  
tions. Open 10:30-5:30, Tu.-Sat.

**South Gate—Clairborne, 4085 Tweedy Blvd.**  
Johnson, International, Gonset, Marina, ECI,  
Hy-Gain, Noistop, Hammarlund, Seco. Sell  
only, with Freq. Cks. Open 9-9. **11Q3303,**  
**monitors channel 9 during store hours.**

**Toft—Porter TV Service, 420 Wood**  
RCA. Service only. Open M-Th. 4:30-9:30  
PM, Fr. Sat. 8-3 PM and 7-9 PM. **11W7597**  
**monitors channel 9 during store hours.**

**Von Nuys—Thrifty, 13647 Burbank Blvd.**  
Eico, Shell, Philmore, Globe, Raytheon, Halli-  
crafters, Gonset. Sell-service, modifications,  
Freq. Cks. Open M-Th. 9-6, Fri. 9-9, Sat. 9-6,  
Sun. 10-4. **11Q3465, monitors channels 1-22**  
**during shop hours.**

## COLORADO

**Denver—Rodio Prod., 1237 16th Street**  
Gonset, Hallicrafters, Globe, Johnson, Eico,  
Keltner. Sell only. Open M- Sat. 9-6. **15Q-**  
**0483, monitors channel 11.**

## CONNECTICUT

**Hartford—Corky's, 100 High Street**  
RCA, Gonset, Hallicrafters, Johnson, Vocaline,

International. Sell only. Open 9-5. **1W6512,**  
**monitors channel 11.**

**New Haven—Radio Elect., 57 Whalley Ave.**  
Layfayette, Gonset, Texas Crystals, Mark,  
Shakespeare, Turner, Mosley, Webster. Sell-  
service. Open daily 9:30-6 PM, Thurs. to 8  
PM, Sat. 9-5. **1W5407.**

## DISTRICT OF COLUMBIA

**Washington—Electronic Whlse., 2345 Sherman**  
Polycom, Utica, RCA, Osborne, Johnson, Halli-  
crafters, Eico, Gonset. Sell only. Open 9-5:30  
wkdays, 9-1:30 Sat. **Monitors channel 22.**

**Washington—Silberne Radio, 3400 Georgia**  
Globe, Sonar. Sales only. Open 8:30-5:30  
wkdays, Sat. 8:30-1 PM. **4W2106, monitors**  
**channel 11.**

## FLORIDA

**Niceville—Fincks, 336 Bayshore Drive**  
Open 7 AM-12 PM. **7W2442, monitors chan-**  
**nel 7.**

**Sarasoto—Shorty's Radio, 4008 Chesnut**  
International. Sell-service, modifications, Freq.  
Cks. Open 8 AM-8 PM. **7W0980, monitors**  
**channel 9.**

## GEORGIA

**Cortersville—Ga. Electronic Supply**  
Open 6 PM-9 PM weeknights, 9 AM- 6 PM  
Saturday. Sell-service. **6W7231, monitors**  
**channel 21 during store hours.**

**Grove Town—James W. Arnold, Box 29**  
Globe, Layfayette. Open 5 PM-10 PM.  
**6Q6630, monitors channel 11.**

## ILLINOIS

**Champaign—Electronic Parts, 905 S. Neil**  
Johnson. Sell only. Open 8 AM-5 PM. **18W-**  
**5722.**

**Chicago—Green Mill, 145 W. 111th St.**  
Eico, Johnson, Sonar, Gonset. Sell only. Open  
9-6 daily. **18W4098, monitors channel 7 dur-**  
**ing store hours.**

**Lisle—Honkinson Supply, 1909 Ogden**  
International, Layfayette. Sell and service.  
Open 8 AM-6 PM Mon-Thurs. and 9-1 on  
Sunday. **18W8348, monitors channel 9, 8**  
**AM- 6 PM.**

**Peorio—B and A, 2039 W. Humboldt**  
International, Hallicrafters, and manufacturing  
of SWR meters, B and A Gen-O-Trap, dum-  
my loads. Sell and service, modifications,  
Freq. Cks. Open 8:30 to 7 PM. **18W2026,**  
**18W7805, monitoring channel 9 from 9 AM**  
**to 7 PM.**

(Continued on Page 51)

## TRANSMITTER BOOST! RECEIVER BOOST!

The ELENCO POWER GAINER Audio Compression Amplifier provides more Talk Power for your CB Transmitter. It also gives you 20 db Audio Gain in the Receiver! Performs as a Volume Compression Amplifier for the CB Receiver . . . ALL IN ONE UNIT! Only 3 connections to rig; pre-wired quick disconnect plug and socket supplied.

PG-1 for 110 Volt Operation

PG-12 for 12 Volt Operation

PG-6 for 6 Volt Operation

Order Direct from Factory or See Your Local CB Dealer.

All Models ONLY \$45<sup>00</sup>



- ★ Simple to Connect
- ★ Instruction Book Included
- ★ For Mobile or Base

Direct Dial  
219-563-4536

## ELECTRONIC ENGINEERING CO. - WABASH, IND.

# CB DEALERS AND DISTRIBUTORS

Are you stocking the 1962 CB Call-Book/Handbook? Nearly 300 pages of information no CB'er can afford to be without. Over 20,000 sold to date... already in second printing!

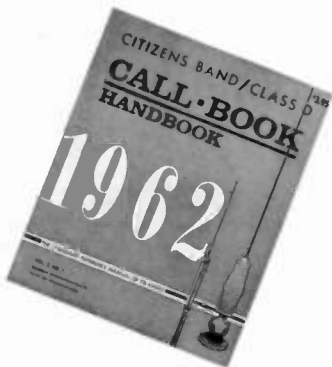

Order your copies now for re-sale to area CB'ers. This reference book annual is pre-sold to CB'ers every month by CB Horizons and the CB Call-Book Directory (monthly). Many dealers are in their third, fourth and fifth re-orders!

**Resale Price . . . \$3.95**

On company letterhead, order your copies today. Enclose payment with order and we will ship with shipping charges prepaid.

**Pricing schedule:**

1-10	\$2.65 each
11-50	2.60 each
51 or more	2.55 each

Order today from:

CB Call-Book Annual  
**Horizons Publications**  
P.O. Box 1557  
Oklahoma City 1, Oklahoma

## CLASSIFIED

Rates for classifieds are 10c per word for advertising which, in our opinion, is obviously of a non-commercial nature. A charge of 25c per word is made to all commercial advertisers or business organizations. We do not bill for advertising in CLASSIFIEDS, nor can we acknowledge receipt of copy sent in. Full remittance MUST accompany all orders. NOTE: The products and services advertised in this section are not guaranteed by the publisher of CB HORIZONS. Closing date for the July issue is May 23rd, in Oklahoma City.

**LAFAYETTE HE-15, HE15A** plug in crystal receiver converter. No wiring. No more station hunting. Always tuned to your channel. Switches from tune to crystal receive in three positions. \$10.95 with one crystal, specify channel. F. Abate, P.O. Box 206, Pompton Lakes, N. J.

**RADIO COURSE** only \$14.95. Includes all tubes, parts, tools, instructions. Write for full information. Progressive 'Edu-Kits' Inc., Dept. 501-BW, Hewlett, New York.

**CB's Colorful Rainbow Calls**, space age and comic. Samples 25c (deductible). C. Fritz, Box 1684, Scottsdale, Arizona.

**CB CLUB MEMBERS**—We sell our CB testing equipment at special discount rates to clubs! Write for details today! H & L Electronics, P.O. Box 125, Medford, Oregon.

**CB WALKIE-TALKIES** — 9 transistor Superhet units \$66 per pair; With B/C band receiver built in, \$70 per pair postpaid. A/C adapters for above, \$4 per pair. Send bank or cashiers checks —shipment direct from stock in Tokyo. Brochure and order form on request. The Rotoken Corp., 18 Mikawadoi, Minato-ku, Tokyo, Japan.

**MODULATION BOOSTER**—Its new! Its terrific! As much as doubles your transmit and receive range with no violation of FCC power regulations. Compact—easy to install, with instructions. Net \$14.95. Dealers write too. ROKO Products Inc., Box 3766, Baltimore 17, Maryland.

**BRAND NEW Government surplus**, 30-40 mc dual conversion FM superhet receivers include 13 tubes and 10 audio filters. Fine for conversion to CB, ham or radio control. Built in 28 volt DC dynamotor can be converted to 115VAC or 6/12 VDC. \$29.95 plus freight. Weighs approximately 50 lbs. Spera Electronics, 37-1-33 St., Long Island City, N.Y.

**HALLICRAFTERS CB-3's** only \$13.00 down and \$5.85 per month. Gonset G-14's only \$13.00 down and \$5.85 per month. Gonset G-15's with tunable receiver and dual conversion only \$19.00 down and \$8.50 per month. Act now—Echo Communications, P.O. Box 223, Cedarburg, Wisc.

**SUPER SQUELCH &** noise eliminator will knock out most ignition noise from your mobile unit and other cars in traffic. Johnson, Heath, GW-10, Sonar, Lafayette and others. State set and operating voltage (ie. 6 or 12). Units are tailored for each set and will NOT work efficiently on other sets. Price \$12.50. Preamplifiers for Heath GW-10, \$9.50. Electronic Enterprises, Box 86, Brookline Station, Missouri.



**CB QSL CARDS**—Call Letter D-Cals. Send 25c for large selection of glossy, multi color samples. Handy '10-Code' included free. Dick Stauffer, 19QA0625, 1996 N. M-18, Gladwin, Michigan.

**TONE SIGNALS** (new type—unlike Q-Bird or T-Call). Complete with instructions \$3.95 each. Ideal Enterprises, Box E, Wessington, South Dakota.

**SK-3 RF PRESELECTOR KIT** for GW-10, GW-11. Increases sensitivity at least 3 "S" units. Easily wired, installed in one evening without cutting transceiver wiring. High-GM tube, all parts, complete instructions included for \$8.99 (postpaid.) Holstrom Associates, P.O. Box 8640, Sacramento 22, California.

**CB QSL CARDS**—W50WC's Hobby Print Shop now offers beautiful two and three color CB QSL cards for less than 2c each! Send for free samples. W50WC's Hobby Print Shop, P.O. Box 9445, Austin 17, Texas.

**NEED CB QSL CARDS?** Fast service. 200 for \$5.00 postpaid. Send 25c for samples and 50c coupon. McCartney's, Freedom, Indiana.

**FIX YOUR OWN TV**, Save 80%! Send for FREE ILLUSTRATED CHART showing how! We'll include GIANT electronic catalog. Zalytron, 220-C West 42nd Street, N.Y., N.Y.

**ANTENNA SWITCH**—Operate one CB on two antennas or two CB sets on one antenna. Attractive stainless steel. Takes PL-259 plugs. Net \$7.95. ROKO Products Inc., Box 3766, Baltimore 17, Maryland.

**FREE SAMPLES**—CB QSL Cards. \$2.50 per 100 in 3 colors, postpaid. Garth Printing Company, Box 51, Jutland, New Jersey.

**CB CALL CARDS**—printed. 2 colors, your design or ours, \$6.50 for first 100, \$3.50 thereafter per 100. Geode Industries, KHA-2436, 106 W. Main Street, New London, Iowa.

**CB WPE QSL CARDS** Finest quality, multicolor. 10c for samples. Radio Press, Box 24A, Pitts-town, New Jersey.

**DENVER AREA**—International Crystal, Osborne, Sanar and others. Extra powerful Walkie Talkies and shock mounted units for Jeeps, industry, etc. Mountain Radio, 509 Colorado Building. AC 2-0362.

**2 x 3 WARNING DECAL** against illegal use, 4/\$1. Code Caller (Q Bird), printed circuit kit \$2.50. Wired \$3.50. Call Letters or name on plastic strip 6/\$1. Channel nos. 1-23, 2 sets \$1.00. 9 Transistor walkie-talkie regular \$59.95, special \$29.95 or 2 for \$55.00. CB Products, Box 457, Encino, California.

**SIGNAL BOOSTER** increases transmitter signal to maximum. Free literature. Sunlong, Box 382, Lockport, New York.

**WORLD'S BEST ENGINEERED** deep fringe television antennas. Designed for 175 miles plus reception. Built by TACO, these are the world's finest 10 element ruggedized all aluminum (welded) construction high gain TV antennas. Not for normal home use, recommended for deep fringe only. Original cost \$245.00 each. Now F.O.B. Oklahoma City \$125.00 each or two for \$250.00 (new) with special coaxial phasing balun for stacking two ten element models. Send cashier's check or money order only. Limited supply available. Carbob Enterprises, 4343 Hayden Lane, Oklahoma City 12, Oklahoma.

## TRAVEL . . . from page 49

### Roanoke—Tri Von, Box 132

International, AS/P, Stinger, Sonotone Sell, service, modifications, Freq. Cks., alignment, suppression of noise. Open 9-5, 7:30 to ????.  
**18W9729, 18W9730, monitors channels 9-14 during store hours.**

### INDIANA

#### Anderson—Ballinger Television, 408 E. 8th

International, L-Coil, Knight Crystals, Vocaline. Sell-service, modifications, Freq. Cks. Open 9-5. **18W2183, monitors 9-19 during store hours.**

#### Bloomington—Lefferson Radio, 405 S. Walnut

Vocaline, General, Hallicrafters, Hy-Gain, Tenna, Newtronics, Turner, Ross, Pierce-Simpson, Philmore, De Wald, Cush-Craft. Sell-service. Open 7:30-6 PM. **18W3627, monitor channel 12 during store hours.**

#### Hammond—Community Radio, 5807 Calumet

Sales and service, modifications, Freq. Cks. Open 9-6 daily, til 9 PM Mon. and Thurs. **18W7461, monitors channel 22 during store hours.**

(Continued on Page 53)



with 1 pair of crystals, microphone and power cables

**\$179.50**

**NOW... Tomorrow and for years to come!**

## Sonar CITIZENS BAND RADIO

- 8 Channels, crystal controlled transmitter and receiver • Tunable receiver for 22 channels • Transmitter 100% Class B modulated
- Adjustable squelch • Automatic noise limiter • R. F. Power indicator
- 1 Year guarantee • Easy to install. Ideal for home, boat, car or business. Weighs only 9 lbs. . . 4 3/4" x 9 1/2" x 11 1/4" • FCC Type accepted\* (\*in preference to only certification).

SONAR RADIO CORPORATION, 3050 W. 21 St. • B'klyn 24, N.Y.  
Please send me complete information on Model "E" CB Radio.  
Dept. 139

NAME \_\_\_\_\_

ADDRESS \_\_\_\_\_

CITY \_\_\_\_\_

STATE \_\_\_\_\_

**SUBSCRIBE TO MONTHLY CALL-BOOK THIS MONTH 51**

# NCRL News and Views

Very shortly all N.C.R.L. members will receive an offer to participate in an electronic course which will be conducted by mail. The course will be absolutely free with no strings attached. Upon satisfactory completion of the course a beautiful diploma will be awarded. The course was never promised or even discussed, but it's N.C.R.L.'s way of saying thanks.

On April 28, we held our first CB rally in Huntington, West Virginia. This was also the beginning of our presentation of the National CB Achievement Award which is pictured on this page. The award is designed to symbolize, acknowledge and encourage outstanding citizen banders. By outstanding we mean a citizen bander who through CB communication has saved a life, or one who through his constant vigilance has contributed a great deal to the common good of two-way communications. Nominees are selected in one of two ways. First they may be selected by a unanimous vote by their fellow club members. Then one of the club officers (preferably the chairman) must notify the N.C.R.L. headquarters in writing stating why their nominee was elected. The second way a citizen bander may be nominated is through a national CB publication and in turn the publisher must write in person to N.C.R.L. recommending the individual of their choice. All elected nominees will be considered by N.C.R.L.'s board of directors. If, in the board's opinion, the nominee is above average in his contribution to Citizens Band Radio, then he will be elected to receive the National CB Achievement Award. The trophies are awarded at CB Rallies such as the one conducted at Huntington, West Virginia. These rallies will be presented throughout the United States and all Call areas will have the opportunity to participate.

A great deal of excitement has been stirred up in N.C.R.L. headquarters lately. **Operation Club Programs** is getting its final touches. One question constantly put to N.C.R.L. by club officers is, **What does your organization offer our club?**

For months now the N.C.R.L. staff has been working on a quarter million dollar library which includes carefully selected material designed to make club members anxious to attend their next meeting. Everything imaginable in club program material will be available. Printed literature, slides, recordings, and 16mm sound film will be at the disposal of participating clubs.

Here are a few examples of what this quarter of a million dollar library contains: electronic courses on 16mm sound film starting with elementary electronics through transmitters and receivers. Upon completion of this particular series of films, NCRL diplomas will be awarded to participating clubs; other 16mm sound films on electronics which are not only educational but very entertaining; printed material by the carload, covering such topics as how to get the most out of that antenna, to a complete course in electronics; recordings designed to be informative and entertaining to CB clubs, and 35mm slides showing how your transceiver is put together by carefully trained personnel at the plant. What's more, **it's all available right now!** Our brochure "Operation Club Program" is available to CB clubs only. All requests must be made in your club's name and address only.

Put your club on the NCRL mailing list today by requesting same at NCRL, 6272 West North Avenue, Chicago, Illinois.

## JOIN UP NOW!

The NCRL nation-wide membership drive is underway. Thousands of new NCRL members are proud of the fact that they are in on the ground floor of the nation's CB Radio organization. NCRL lapel membership pins, and membership wall certificates are ready for mailing.

### NCRL MEMBERSHIP APPLICATION

(you may use this form or submit a facsimile)

\_\_\_\_\_ Enclosed non-club membership fee (annual) of \$3.50

\_\_\_\_\_ Enclosed club membership fee (annual) of \$3.00.

I certify that I am a member of the \_\_\_\_\_ Radio Club,

Town \_\_\_\_\_ State \_\_\_\_\_

(Note: If you belong to a local CB club, you are entitled to join as a club member applicant—\$3.00—thereby crediting your local club with your membership in the NCRL. Please indicate which you are.)

Name \_\_\_\_\_ CB Call \_\_\_\_\_

Address \_\_\_\_\_

Town \_\_\_\_\_ State \_\_\_\_\_

Mail to:

NCRL  
6272 W. North Avenue  
Chicago, Illinois

CB Horizons makes this page available monthly for the reporting of news connected with the efforts of the National Citizens Radio League to form a truly nation-wide organization of CB radio operators and licensees. CB Horizons believes that CB Radio operators do need a nationwide organization, and with the proper promotion and acceptance by CB clubs and individuals, the NCRL 'could' be that organization. For your own protection, shouldn't you investigate the NCRL today?

## TRAVEL . . . from page 51

**Indianapolis**—Van Sickle, 4131 N. Keystone Eico, AS/P, Hallicrofter, Citifane. Sell, service, Freq. Cks. Open 9-6 daily.

**South Bend**—Colfax Co., 747 S. Michigan Polycam, Gonset, Citifone, Eico, Regency. Sell only. 8:30-5 PM daily.

## IOWA

**Iowa City**—Bob Vogel, R. Rt. 2 Johnson, ECI, AS/P, J. K. Crystals. Sell only, service available however. Open anytime, day or night. 18A5401, monitors channel 18.

## KANSAS

**Baxter Springs**—Commercial Elect., 411 East 13th Street.

International, sales and service. Modifications and Freq. Cks. Also custom work. Open 8 AM-9 PM. 17Q1060 monitors channel 22.

## MAINE

**Lewiston**—Lewiston Elect., 11 Bellgarde International sales and service, modifications, Freq. Cks. Open 9 AM-10 PM six days a week. 1Q1212, 1W3351 monitors channel 11.

**Portland**—Radio Service, 42 O'Brien St. Citifone, Crater Lake Antennas, Hunt crystals, Electra-Voice. Sell, service, modifications, Freq. Cks. 1W4211, monitors channel 1 24 hours per day.

## MASSACHUSETTS

**Fall River**—Universal, 345 Frost Street International, Cadre, Philmore, Mark, Stinger Futura, Naistap, Cesco, Rohm Towers, Globe. Sell, service, Freq. Cks. Open 9 AM to 9 PM. 1W2058, monitors channel 9, 8 AM-11 PM.

**Granby**—Jiffy, 5 Corners Modifications, customizing of gear 1W4849, monitors channel 7.

**Greenfield**—Fairbrother Radio, 29 Alden International, sales and service. Modifications, Freq. Cks. 1W1470, monitors channel 11.

**North Quincy**—Metric, 14 Walker Street International, Mark, various cable and accessory lines. Sales and service, modifications, Freq. Cks., installations. Open 9-5. 1W5121 monitors channel 15, 9-5.

**Reading**—Graham Radio, 505 Main Street Gonset, Hallicrofters, Johnson, Sanar, De Wald. Sales and service, modifications, Freq. Cks. Open 9 AM-6 PM. 1W1166.

**Springfield**—Bennett Elect., 527 Belmont Lafayette, Gonset, Sanar. Sales and service. Open wknights to 6 PM, Mon. and Fri. til 9 PM. 1Q2944, monitors channel 9 during store hours.

**West Wareham**—John Andicade, 277 Main Vacoline, Citizens Radio, several antenna, meter, accessory lines. Sales and service, modifications, Freq. Cks. 1Q1480, monitors channel 18 9-5 daily.

## MICHIGAN

**South Haven**—Overheul's, 505 Phoenix Koor, Citifone, De Wald, Spacephone. Sell only. Open 9-5:30 daily. 19W3855, monitors channel 9 during business hours.

## MINNESOTA

**Wyoming**—Johnson Radio, Box 117 Johnson, Miratel. Sales only. Open 8 AM to 5 PM. 16W2989, monitors channels 5 and 11, 8 AM to 10 PM.

## MISSISSIPPI

**Pascagoula**—May's, 1024 South Market Sonar, Johnson, Texas Crystals, Mark Shakespeare, Wen, AS/P. Sales only. 8Q0074.

## NEBRASKA

**Omaha**—Ladd Elect., 111 N. 41st St. Johnson, Citifone, RME, Gonset, AS/P, Mark, Hy-Gain, Mosley, Hammarlund. Sales only. Open 9 AM-6 PM. 17W1025, monitors channel 19 at random times.

## NEW HAMPSHIRE

**Gilford**—Coffeebean Net, 37 Bedford Knight Crystals. Sales only. 1Q2622, monitors channel 11.

## NEW JERSEY

**Bloomfield**—Parts Unlimited, 1 State St. Eico, Johnson, Gonset, Hallicrofters, Hammarlund, Heath. Sales and service. Open 9-6 Tu., Wed., Thur., Sat. 9-9 Mon., Fri.

**Jamesburg**—Jasko's TV, Rt. 522 Polycam, T-Craft. Sales and service. Open 9 AM to 9 PM. 2Q6860, monitors channel 4 during store hours.

## NEW MEXICO

**Albuquerque**—Clemons, 1216 4th St. N.W. Koor, International, Pierce-Simpson. Sales-service, modifications, Freq. Cks., emergency service anytime. Open 8 AM-5 PM or by appointment. 15W0701, monitors channels 2 or 11.

## NEW YORK

**Bronx**—Bainbridge, 2649 Bainbridge Ave. Manufacturers dual conversion adaptor kits. Store hours by appointment. 2W3815, monitors channel 5.

**Bronx**—House of Sound, 2119 Starling RCA, Roytheon, De Wald, ECI, Globe, Polycam, Hallicrofters. Sales and service. Open 9:30 AM-6 PM. 2Q5351, monitors channels 7, 9, 16, 4 PM to 10 PM.

**Flushing**—Stuart, 79-12 Parsons Blvd. International, Pierce-Simpson, Eico, De Wald, Ameco, Philmore, HH Smith, Utico, Turner, Astatic, Shell. Sales and service. Open Mon., Wed., Fri. 9-9. Tu., Thur., Sat. 9-6. 2W8304, monitors channel 9, 9 to 9.

**Rome**—Clemons Sales, Upper Floyd Ave. International and a complete line of accessory supplies. Sales and service. Open 9-9. 20W2840, monitors channel 11, 9-9.

**Syracuse**—Leo-Mac 2-Way, 3602 Court St. Bendix Marine. Sales and service. Service on all makes, modifications, Freq. Cks. Open 9-5:30 wkdays, 9-1 Saturday. 20Q1998 monitors channel 11 during store hours.

## NORTH CAROLINA

**Enfield**—Bellamy Bros., 110 Whitfield St. International, General. Sales and service. Modifications, Freq. Cks. Open 8 AM to 6 PM. 5Q0722, monitors channel 11 during store hours.

**Winston Salem**—Seivers, RFD #3 International, sales and service, Freq. Cks. Open 9 to 6. 5W0427 monitors channel 9 during store hours.

## OKLAHOMA

**Tulsa**—Radio, Inc., 1000 S. Main Street Hallicrofters, Johnson, Osborne, Heath, Eico, (Please turn the page)

# GIANT CB SALE!!

- 50 FT.—RG58U COAX CABLE SALE **\$1.95**
- 100 FT.—RG58U COAX CABLE SALE **\$2.99**
- 50 FT.—RG8U COAX CABLE SALE **\$4.49**
- 100 FT.—RG8U COAX CABLE SALE **\$7.99**

## GET THAT SIGNAL OUT WITH ULTRA-LO-LOSS FOAM COAX CABLE!!

- 50 FT.—RG58U COAX CABLE SALE **\$2.49**
- 100 FT.—RG58U COAX CABLE SALE **\$3.99**
- 50 FT.—RG8U COAX CABLE SALE **\$4.95**
- 100 FT.—RG8U COAX CABLE SALE **\$8.99**

- 3-ELEMENT CB BEAM ANTENNA\* SALE **\$10.99**
- COMMAND COMET ANTENNA (Reg. \$10) Top-loaded mobile whip+trunk lid mount SALE **\$6.99**
- COMMAND STANDARD II MOBILE ANTENNA\* heavy-duty body mount+spring+102" whip SALE **\$6.69**
- COMMAND CGP-1 GROUND PLANE (Reg. \$16) solid alum. rods, heavy duty SALE **\$9.99**
- COMMAND CORTEZ MOBILE ANTENNA top-loaded, st. steel, chrome body mount SALE **\$4.99**
- COMMAND CORSAIR MOBILE ANT.\* bumper mt.+spring+102" whip SALE **\$8.99**
- COMMAND CORSAIR II MOBILE ANT\* double bumper mount +spring+102" whip SALE **\$9.99**

- CDR ANTENNA ROTATORS (Reg. \$26) SALE **\$19.98**
- JK CB CRYSTALS—TRANSMIT OR RECEIVE specify make, model, channel SALE **\$1.99**
- GENERATOR NOISE SUPPRESSORS (tunable) (GNS) (Reg. \$4) 3 or more — \$1.49 ea. SALE **\$1.99**
- 15-PC CB SILENCER KIT (Model SN-2) consists of GNS+ spark plug & dist. suppressors, gen. oond.+hy-pass feedthrus, etc. SALE **\$3.99**

- CRYSTAL SOCKETS FOR CB **10 for 89c**
- S-METERS FOR CB SALE **\$2.99**
- BASE-LOADED INDOOR CB ANTENNA SALE **\$2.49**
- TOKYO ROSE STUDIO MIKES FOR CB SALE **\$4.89**

CB DEALERS!!! Write for Quantity Prices!

### \* THESE ANTENNA SHIPPED RAILWAY EXPRESS

COLLECT ONLY  
Check items wanted. Return ad or order w/check or money order. Include postage, excess refunded. Sorry, no C.O.D.'s.

### Grove Electronic Supply Company

4111 W. Belmont Avenue  
Chicago 41, Illinois

- Rush items checked.
- Send latest CB sale catalog.

Name .....

(please print)

Address .....

City ..... Zone ..... State .....

## TRAVEL . . . from page 53

Ganset, AS/P, Mark, Hy-Gain, Master Mobile, Cesca. Sales only. Open 8-5 Mon. to Friday. 8-12 Sat. 10W1886 monitors channel 4 during store hours.

### OHIO

**Blue Creek—Tom's Radio, Box 63, Rt. 1**

International, Mark, Ross Labs. Sales and service, general repairs, modifications, 19W3828, monitoring channel 9.

**Columbus—Independent Supply, 245 E. Long**  
Polycom, Eico, Cadre, Telephone & Elect. Sales and service, Freq. Cks., modifications, any service work. Open 8:30- 5 PM. 19W5517, monitoring channel 9 during store hours.

**Chesapeake—Atkins Radio, 180 3rd Ave.**  
Utica, Sales and service. Open 8 AM to 5 PM. 19W4040, monitors channel 11 during store hours.

**Cuyahoga Falls—D and D Elect., 114 Portage Trail**

International, sales and service. Open 10 AM-9 PM. 19W3076 monitors channel 11, 8 AM-11 PM.

**Ironton—City Electronics, 6th and Vine**  
Citifone, Regency. Sales and service. Open 9 to 5. 19Q9619, monitors channels 9, 3.

**Marion—Bell Radio, 527 N. Main**  
Gonset, General, Cadre, International, De Wald, AS/P. Sales, service, modifications, Freq. Cks. Open 9 AM to 8 PM. 19W5264, monitors channel 11 during store hours.

**Newton Falls—Johnnie's, 228 Milton Blvd.**  
James Knights Crystals, RCA, Citifone. Sales and service. Freq. Cks., antennas and accessories. Open 9 to 9. 19W4673, monitors channel 11 during store hours.

**Norwalk—Izzard TV, 88 Corwin Street**  
International, Citifone, Regency. Sales and service, modifications. Open 9-6. 19W8207, monitors channel 5 during store hours.

**South Euclid—Johnston, 4438 Mayfield Rd.**  
RCA, Hallicrafter, AS/P, Sanar. Sales and service. Open Mon, Wed, Thurs, Sat. 8:30-6. Tuesday, and Friday to 9 PM. 19Q6807, monitors channel 7, 14 hours daily.

### PENNSYLVANIA

**Philadelphia—Audiotronics, 3818 Chesnut**  
International, Sanar, Citifone, Polycom, ITT, De Wald, USL. Sales and service. Modifications, Freq. Cks., licensed technician on duty. Open 8:30-5, 7 to 11 daily except Sunday. 3Q2172 monitors channel 9 during store hours.

**Scranton—Petillo TV, 413 N. Main Ave.**  
International. Sales and service, modifications, Freq. Cks., repairs. Open 10 AM to 6 PM. 20W3295 monitors channel 20, 10 AM to 10 PM.

**York—Leose's, 201 S. George Street**  
International, Eico, Hunt Crystals, AS/P, Columbia. Miniphone. Sales and service, modifications, Freq. Cks., general service. Open 9 to 6 daily, to 9 PM Wed. and Friday. 3W3248 monitors channel 1 during store hours.

### RHODE ISLAND

**Providence—Elmwood Elect., 37 Elmwood**  
Hallicrafters, Gonset, Glabe, Vocaline. Sales and service, modifications, Freq. Cks., general repairs. Open 8:15 AM to 8 PM. 1W6998 monitors channel 2 and 3 during store hours.

## SOUTH CAROLINA

**Myrtle Beach—Tommy's Two-Way, 402 W. Broadway**

Utica, AS/P, Mark, Turner, Cesco, Texas and General Crystals, Seco, Philmore, Hammarlund. Cushcraft. Sales and service. Modifications, Freq. Cks. Open 9-6. **6W7020 monitors channel 11 9 AM to 11 PM.**

## TEXAS

**Dallas—Horton Elect., 2354 Fobens**

Hallmark, Tel-Rad, L-Coil. Sales and service. Freq Checks. Open 6 AM to 10 PM. **10W1688 monitors channel 11 during store hours.**

**Decatur—Laird Elect., Box 492**

Johnson, Utica, General Electric. Sales and service. Modifications, Freq. Cks., installation and service. Open 7 AM to 6:30 PM 7 days per week. **10Q0206 monitors channels 11 and 9 during store hours.**

**Fort Worth—Charles Horn, 423 S. Summit**

International, Petersen Crystals, Mark, Crater Lake, Turner, Osborne. Sales and service, Freq. Cks., repairs. Open 8-5:15 daily, Saturday 8-1. **10W1820 monitors channels 11, 20, 8 AM to 6 PM.**

**Houston—Tele-Comm, 3820 Almeda**

Globe, Cadre, Paco. Sales and Service. Modifications, Freq. Cks. Complete FCC licensed Technician service. Open 8:30 AM to 5:30 PM. **9Q0362 monitors channel 11 during store hours.**

**Lubbock—College TV, 1623 College Ave.**

Hallicrafters, RCA, Raytheon. Sales and service. Modifications, Freq. Cks., complete alignment service. Open 9 AM to 7:30 PM. **10W0497 monitors channel 11 24 hours a day.**

## VIRGINIA

**Hampton—Tom's TV, 1001 Big Bethel Rd.**

RCA, Gonset, International, Utica, Webster, Raytheon, Polycom. Modifications, Freq. Cks., all CB service. Open 6 PM to 9 PM Mon-Friday 10 AM to 6 PM Saturday. **5W2965 monitors channel 11 during store hours.**

**Newport News—Central Supply, 806-39th**

Utica, Mosley, Hy-Gain, PR Xtals. Sales only, service available separately. Open 8 AM to 5 PM, Mon-Friday. 8-1 Saturdays. **5Q1424, 5W3407 monitor channel 11 during store hours.**

**Roanoke—McNight Inc., 405 Shenandooh Ave.**

Regency, Utica, De Wald, USL, International. Sales only. Open 8:30-5:30 daily. **5W1389 monitors channel 11 during store hours.**

## WASHINGTON

**Seattle—C & C Labs, 4800 Delridge Way SW**

Kaar, Gonset, Polycom, Raytheon, Sonar. Sales and service, modifications, Freq. Cks., complete antennas, crystals, service. Open 8:30 AM to 7:00 PM. **14W1962 monitors channel 11 during store hours.**

**Seattle—Radio Supply Co., 6213 13th Ave. S.**

Johnson, Hy-Gain, AS/P, Cesco. Sales only. Open 9 AM-6 PM, Tuesday to Saturday. **14W1212.**

(Please turn the page)

# NEW CB FILTER!



## GAVIN INTRODUCES A NEW FILTER TO END TELEVISION INTERFERENCE PROBLEMS ON THE CITIZENS BAND!

The CITIZENS BAND FILTER is a multiple stage, low - pass filter designed expressly for the 11 meter band. Factory tuned to cause essentially no loss on the Citizens Band and to reduce all signals in the television band by a factor of 100,000. Installs directly in Coaxial antenna line of either 52 or 72 ohms. Measures 4" by 2" by 2". Supplied with UHF connectors.

SEE YOUR LOCAL DEALER  
OR ORDER DIRECT  
FROM FACTORY.

## CB'ers Net only \$7.45

Write for brochures on the 6 meter Maverick, the 2 meter BP 144, the low band F810 and other communications filters.

## GAVIN INSTRUMENTS INCORPORATED

Depot Sq. and Division St.  
SOMERVILLE, NEW JERSEY

# FREE!

## 3" CALL & NAME PIN

**KHA1742  
RONALD HOLLINGER**

Isn't this an attractive pin? You bet it is! And it can be yours—FREE . . . this month only . . . if you take advantage of the special Call-Book/Directory offer on cardboard insert Page 12 of this issue. The pin is red with white lettering. It has a heavy-duty dovetailed fastener, is pliable and nonbreakable. This is not an inexpensive pin! Only the highest quality components are used in its manufacture. CB Horizons has contracted with Metalcraft Co., Mason City, Iowa to supply these pins to all CB'ers subscribing to the Call-Book/Directory this month.

**SEE PAGE 12  
SUBSCRIBE TODAY!**

*Now Available!*  
**Smea POW-R-MIKE**



Model "M" *Now Only* **\$39<sup>95</sup>**

- FOR USE WITH CB TRANSCEIVERS
- SELF-CONTAINED 110 V. POWER SUPPLY
- SELF-CONTAINED CERAMIC MICROPHONE
- INCREASES TALK POWER WITH NO INCREASE IN CARRIER STRENGTH
- INDIVIDUALLY TESTED—GUARANTEED
- MOBILE MODEL AVAILABLE SOON!

See your local CB Dealer or Write Direct to:

## Smea Engineering

TIPTON, INDIANA

### TRAVEL . . . from page 55

#### WEST VIRGINIA

**Sophio**—Mountaineer, 369 Main Street  
RCA, Cadre, Vocaline, International, Regency.  
Sales and service. Modifications. Open 9 to 6.  
**19W5822** monitors channel 11 from 9 AM to 12 PM.

#### WISCONSIN

**Kenosha**—Chester, 2012 52nd Street  
Johnson, Gonset, Utica, Eico, Polycom. Sales only. Open 9 AM to 5:30 PM Mon-Sat. Mon. and Friday evenings open to 9 PM. **18W2375** monitors channel 7 during store hours.

**Sheboygan**—Nitzze's, 1129 N. 8th St.  
Johnson, AS/P. Sales only. Open 9 AM to 5:30 PM. Saturday 9-12:30 PM.

### CCM REPORTS . . . from page 45

the Chenango County CB Club. 60 CB'ers attended the last meeting, on April 14.

The Sullivan Trail CB Club held its latest meeting April 17. Your reporter apologizes for not being present, but I do have to make a living to keep my electricity turned on and my rig warm. It's an endless cycle, I know, but I'm not always able to get away to attend as many meetings as I would like to.

The Madison County Radio League is doing their part to be a BIG PART of the National Convention and Jamboree to be held July 6, 7, 8 in Syracuse. We ask your cooperation in getting advance registration as soon as possible.

How about a note from your individual CB'ers? What are you doing besides monitoring channel 9, in your area?

**TWENTY-SECOND CALL AREA: CCM-William C. ('Uncle Willie') Ihlefeld, 22Q0035-u3, P.O. Box 728, Hato Rey, Puerto Rico.**

The Puerto Rico CB Club is up and coming. It started with 8 members and now has 50 in good standing! The present officers are Manuel Perez Ramero-President; Agustin Galarza-Vice President; Primo Villanueva-Treasurer; Juan A. Ojeda-Secretary. Meetings are held the third Tuesday of each month at Civil Defense headquarters. Eight members of the group are now attached to Local Civil Defense. This reporter hopes to have some news in the not too distant future concerning St. Thomas and St. Croix, U. S. Virgin Islands, where our most southern and eastern CB'ers reside.

### OOPS AGAIN!

Like another well-known radio magazine, we're starting a tradition of leaving something essential out of at least one construction article per issue. It really wasn't intentional, but here's the parts list you must have to build the "Kyle-O-Watt" power booster featured in the May issue:

- R1 27,000 ohms, 1/2 watt composition resistor
- R2 33,000 ohms, 1-watt composition resistor
- C1 50 pf disc ceramic capacitor
- C2, C3 0.001 mf disc ceramic capacitors
- C4 0.01 mf 1600-volt disc ceramic capacitor
- C5 3-30 pf mica compression trimmer
- C6 150 pf silver mica capacitor
- L1 Miller type 4404 variable inductor
- RFC 660 microhenry RF choke
- tube 6AK6

ceramic 7-pin socket, chassis, wire, solder, 2 one-terminal tie points, 1 two-terminal tie point, phono, jack, nuts and bolts.

# GAR'S CABBINGS

Gar Greene, 1W4844  
CBH Roving Reporter

In Chattanooga, Tennessee, I met Charlie Agan, 6W5984, and his wife Mandy. Charlie told me all about the new *Volunteer State Citizens Band Radio Club, Inc.* The purpose of the club is "to promote and protect the economical and general welfare according to the ability and means of the organization; to assist in law enforcement, Civil Defense, and rescue work." This progressive club meets on the first and third Tuesday of each month at the Osborne Community Center and all are welcome.

I recently received the first issue of their club paper called *The Breaker-Chattanooga Chew Chew* of which Charlie Agan is the editor. Charlie told me that he is very much interested in swapping with other club publications. His address is 1216 McCallie, Chattanooga, Tenn.

Arriving in Knoxville I was greeted by a delegation from the *Hillbilly CB Club of Blount Co.* (Maryville, Tenn.). They informed of their coming Jamboree on July 11-14. The "Hillbillies" are headed by President Ralph Lowe, 6Q1915, and anyone desiring information on the Jamboree are to write to Ralph Lowe, Box 206, Maryville, Tenn. and he will be glad to reply. The club's calling channel is 3.

The *CB Volunteers* of Knoxville is one of the few clubs which has their own clubhouse. The club is presently being led by Ray Gassaway, 6W5629, and in the past the club has thrown three successful CB picnics.

The *CB Volunteers* have a bowling league in which they compete against the *Hillbilly CB Club* each week. Incidentally, this year in Tennessee CBers will be able to have their call letters on their license plates. I also hear that this service is available in Wisconsin.

BE THE FIRST TO HAVE

## hallicrafters

### NEW CB-3A *littlefone*



\$159<sup>95</sup> (S-meter optional extra)

**\$14<sup>95</sup> DOWN!** **\$7<sup>25</sup> Per Month**

12 V & 110 V MOBILE OR BASE

"Sandy" Says,

"Get the set that was field tested by experts . . . and I will pay the shipping!"



- 8 Channel Crystal Controlled
- Maximum adjacent-channel rejection without loss of sensitivity through new type dual conversion
- Exclusive drop-down chassis
- Mounting kit for Mobile installation
- Built-in accessory Jack (for external speaker, etc.)
- S-Meter kit is optional, complete and ready for easy installation (In place of removable panel.) Just 8.95 extra.



**ORDER TODAY!**

## ECHO

**COMMUNICATIONS, INC.**  
Box 223 • Cedarburg, Wis.

- O. K. "Sandy", ship me a new CB-3A immediately! Enclosed is \$14.95—monthly payments will be \$7.25.
- Include S-Meter kit. \$8.95 enclosed.
- Please send more information.

Name \_\_\_\_\_

Call (optional) \_\_\_\_\_

Address \_\_\_\_\_

City & State \_\_\_\_\_

# LAFAYETTE is America's Citizens Band Headquarters



HE-29A

Ship to Shore



On the Farm



Construction Work



**NO LICENSES,  
TESTS OR  
AGE LIMITS**

## 9 -TRANSISTOR PORTABLE CITIZENS BAND "WALKIE TALKIE" T.M.

**32.95**  
2 for 64.00  
No Money Down

PORTABLE—  
POCKET SIZE  
Only  
6 3/4 x 3 1/4 x 1 3/8"



- Completely Wired—Ready to Operate • Fully Transistorized—9 Transistors plus 1 Diode • Uses Inexpensive Penlight Batteries
- No License, Tests or Age Limits • Comes with Leather Carrying Case, Earphone, Antenna, Batteries and Crystals

As simple and easy to use as the telephone—and twice as handy. Receives and transmits up to 1.5 miles under average conditions. Weighs only 18-oz. and slips into your pocket. Push-to-talk button operates built-in speaker as sensitive microphone.

### New! LAFAYETTE HE-15B CITIZENS BAND TRANSCEIVER



MADE IN U.S.A.

Only  
**59.50**  
No Money Down

Superheterodyne receiver now with 8 crystal controlled transmitting positions.

- Effective Full-wave variable noise limiter
- Front panel RF jack
- Ceramic temperature free microphone
- Improved selectivity and power output
- Complete with Transmitting crystal for channel 9

### New! LAFAYETTE HE-20B CITIZENS BAND TRANSCEIVER



MADE IN U.S.A.

Only  
**109.50**  
No Money Down

Now With 8 Crystal Controlled Transmit Positions and 8 Crystal Controlled Receive Positions

- 14 Tube performance
- Tuneable over all 23 channels
- Adjustable Squelch
- Effective series gate noise limiter
- Built-in power supply for 110V AC or 12V DC.
- Complete with matched Crystals for channel 9

### LAFAYETTE ALL-IN-ONE CITIZENS BAND MOBILE ANTENNA

The Scoop Buy for  
Citizens Band Mobiles

**6.95**

HE-800WX

- Chrome Swivel Base • Stainless Steel Spring • 102 1/2" Stainless Steel Whip for Optimum 11-Meter Performance

Chrome swivel ball mount base designed for mounting on any surface. Stainless steel spring holds rod in property adjusted position.



### LAFAYETTE TRANSISTORIZED FIELD STRENGTH METER TM-16A

- Permits Easy Tune-Up For Maximum Transmitter Output
- Earphone Jack To Monitor Audio • Tuned Input 2.53 to 57 MC



**15.95**

Ideal for use with Ham, Citizens Band or other transmitters within its frequency range. Tunes Transmitter and antenna to maximum RF output. Big 200 µA meter. Powered by 1.5 V battery.

### LAFAYETTE RADIO

SEND FOR LAFAYETTE'S  
NEW 1962 CATALOG

Catalog 620  
340 Giant  
Size Pages

LAFAYETTE RADIO  
DEPT CBE-3  
P.D. BOX 10  
SYOSSET, L. I., N. Y.

**Free!**

- Send FREE 1962 Catalog 620 featuring the full line of Lafayette C.B. Equipment

\$..... Enclosed for Stock No. ....

Name .....

Address .....

City .....

Zone .....

State .....





HERE'S THE NEW, 2-WAY  
HAND-HELD TRANSCEIVER THAT  
OUTPERFORMS 'EM ALL!

**PERSONAL** *Messenger*

• No license required—may be used at once! • Meets FCC requirements for use with licensed Citizens' Band stations, too!

This is the new "Personal Messenger"—a superbly engineered 2-way crystal-controlled transceiver so compact it fits in your hand—so flexible it can be used in thousands of applications! 11 transistors and 4 diodes—superheterodyne receiver with exclusive tuned R.F. amplifier gives you twice the sensitivity and more than 40% more range than units with conventional circuitry! Powerful two-stage transmitter delivers more power output than similar units with the same rated input! Unmatched audio intelligibility and razor-sharp voice reproduction—automatic noise limiter—automatic volume control—positive squelch control—elastic hand strap—operates on nightlight or rechargeable nickel-cadmium batteries.

**\$109.50**

ILLUSTRATED AT LEFT—The Viking "Messenger"—maximum legal power Citizens' Band crystal-controlled transceiver. Excellent receiver sensitivity and selectivity—highly efficient transmitter punches your signal home! Built-in squelch—AVC—ANL. With tubes, push-to-talk microphone and crystals for 1 channel.

FROM **\$134.95**

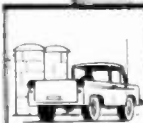

Delivery or  
fleet operation



Your own  
personal use



Construction or  
Business

**FREE**  
Color Brochure



**WRITE TODAY**



**E. F. JOHNSON COMPANY**

2410 Tenth Avenue S. W. • Waseca, Minnesota

• Please rush me your full color brochure.

NAME \_\_\_\_\_

ADDRESS \_\_\_\_\_

CITY \_\_\_\_\_ STATE \_\_\_\_\_

Manufacturers of the world's most widely used personal communications transmitters



# ABC's

# OF BASE STATION ANTENNA SYSTEMS FOR CITIZENS BAND

## A CCEPTED THEORY

Maximum low angle of radiation occurs with a  $\frac{5}{8}$ -wave length vertical radiator over a perfect conducting ground.

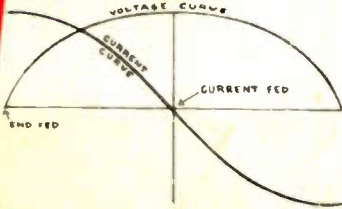
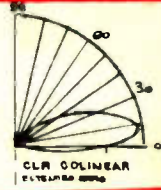
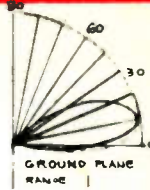

## B ASIC FACTS

1. Current feeding is most easy to control, insuring optimum transfer of energy through a perfect match.
2. Current feeding as opposed to voltage feeding eliminates the need for using lossy matching transformers.

## THE Hy-gain

### 3.4 DB OMNIDIRECTIONAL GAIN IN FIELD STRENGTH INTENSITY\*

\*Only gain measured in Field Strength Intensity is reciprocal for both transmitting and receiving. Plus up to 20 db gain in improved Signal/Noise ratio. (Signal/Noise references improved reception only!)

*5/8 wave, current fed Colinear citizens band antenna is guaranteed to outperform any vertically polarized omnidirectional antenna on the market today!*

Commercial construction of heavy wall aluminum alloy and stamped steel fittings to withstand winds up to 100 mph. Fiberglas Impregnated styron base assembly on welded steel for maximum vertical rigidity. 52 ohm coax fed. Max. SWR 1.2:1 or less. 9' radials. 20' overall height.



## C OLINEAR

ONLY  
**\$49.95**  
LIST



*Write for complete technical bulletin*

## COMPLETE LINE OF ANTENNAS AND ACCESSORIES FOR CITIZENS BAND

BULK RATE  
U. S. POSTAGE  
**PAID**  
Permit No. 7  
Okla. City, Okla.

CB HORIZONS  
P. O. BOX 1557  
OKLAHOMA CITY, OKLAHOMA