

C-ED

Addressing the Addressable Tap
Translators Unleashed

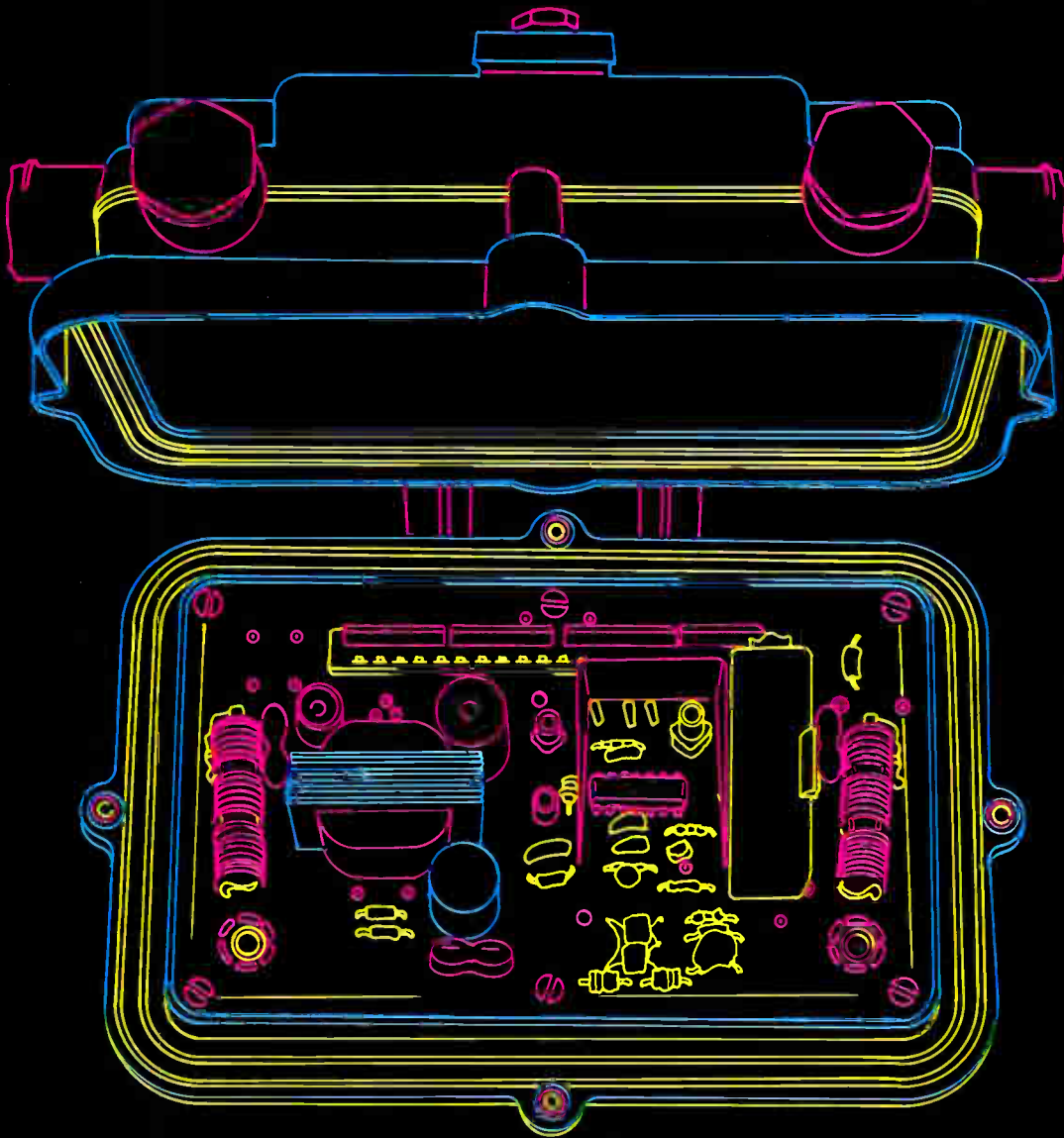

681020 029 811 0
S107 B1 3
FRED E MC CORMACK ENG&E
BOX 5221 STATE UNIV STA 68
FARGO ND 58102

Communications-Engineering Digest
Reporting the Technologies of Broadband Communications

February 1978
Volume 4, No. 2

OAK converters and decoders save you more than money.

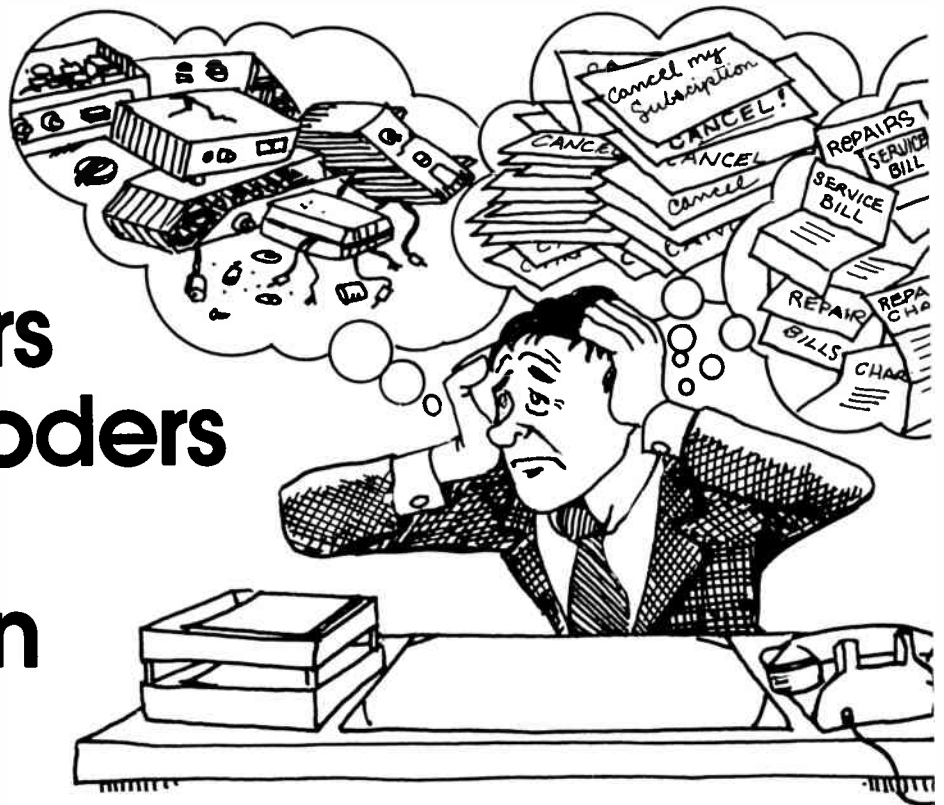

When you're looking for converters or decoders, you have to look beyond price, and look for the best in performance and reliability as well. The lowest priced terminal in the world would be a bad buy if poor performance and reliability caused frequent service problems, lost revenue and lost subscribers. You can fill your system needs without compromise, because Oak offers a wide product selection.

Oak products are *designed* to save you money and subscribers, by reducing future maintenance costs. Before an Oak converter or decoder reaches your system, it has received exhaustive testing. Our total investment in test instruments for quality control is in the millions.

With Oak, costly delivery and service delays don't happen. We back our commitment to cable system operators with rapid service turn-around, reducing your need to keep spares on hand. *Every* customer receives a solid one-year product warranty. But perhaps of greater importance is that when you buy from Oak, you know you'll be having fewer service calls and less chance of lost revenue.



Oak offers a full line of converters and decoders and converter-decoders, including: ①SCC single-channel converter, ②Econobloc 7-channel converter, ③Trimline II 35-channel converter, ④Multi-Code 35-channel converter-decoder and ⑤companion Jewel Case remote unit, ⑥Econo-Code single- and two-channel converter-decoder and ⑦Mini-Code single-channel low-band decoder. Contact Oak for all the details.

OAK Industries Inc.

CATV DIVISION/CRYSTAL LAKE, ILLINOIS 60014

TELEPHONE: 815 • 459 • 5000 ■ TWX: 910 • 634 • 3353

C-ED News at a Glance

WASHINGTON, D.C.—The **Federal Communications Commission** has adopted a Report and Order, Docket 20539, **allowing translators the flexibility of adding FM microwave feeds**. The result is that translators can now be fed by CARS, satellites and standard terrestrial common carrier microwave. The NCTA was highly opposed to this "open door" policy. See C-ED page 16.

WASHINGTON, D.C.—Warner Cable's **QUBE operation** in Columbus, Ohio, has been **granted use of the 2 GHz spectrum**. QUBE cited its need was based on programming similarly used by broadcasters. See C-ED page 16.

WASHINGTON, D.C.—The **FCC** has **granted spectrum relief, to cable systems running out of CARS-band channel capacity** in certain areas of the country. The commission responded favorably and permitted those systems to use the adjacent band used by broadcasters for inter-city relay. See C-ED page 16.

WASHINGTON, D.C.—The **FCC has voted that** cable operators no longer must receive approval from the commission's Common Carrier Bureau to make changes in the signals they carry from the domestic satellite. As a result of this decision, **cable operators are only required to make an initial application for the standard earth station license**.

WASHINGTON, D.C.—NAB President **Vincent Wasilewski** has **urged FCC attention on** such cable issues as the **carriage of radio signals and syndicated exclusivity in cable**. He reminded FCC Chairman Charles D. Ferris that an interim policy on cable carriage of radio signals has been in effect since 1972, pending the issuance of rules on the subject in Docket 19718. See C-ED page 16.

WASHINGTON, D.C.—**NCTA's engineering committee will meet** on February 1 **to discuss** several issues, including the advisability of promoting a **voluntary common pilot carrier frequency** for signal leakage applications. See C-ED page 17.



Kenneth Gunter, chairman of the NCTA engineering advisory committee.

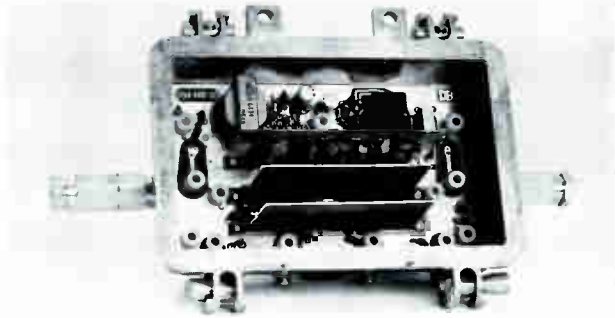

Page 9



Page 24



Page 30

FEATURES

Delta-Benco-Cascade's Intelligent Tap <i>The theory, design and application of the addressable tap (Part One)</i>	Page 9
Merrill Cable Equipment's Access I Addressable Tap	Page 21
Magnavox' MX 4000 Addressable Tap with Remote Subscriber Control	Page 25

DEPARTMENTS

C-ED News at a Glance	Page 3
Inside C-ED	Page 4
SCTE Comments and Chapter News	Page 6
News	Page 16
Technology	Page 30
System Profile <i>UA-Columbia Cablevision's Oakland, New Jersey System</i>	Page 32
Ad Index	Page 34

OPINION

Editor's Letter	Page 5
Bud Desmond Memorial	Page 24
Canadian Comments	Page 33

Cover: February's cover illustration—the addressable tap—depicts the emphasis of this month's issue of *C-ED*.

Business

Robert Titsch/*President and Publisher*
James S. Povec/*Vice President, Sales*
Michael Borer/*Business Manager*
Joyce Hemmen/*Assistant Business Manager*

Editorial

Paul FitzPatrick/*Editor-in-Chief*
Toni Barnett/*Managing Editor*
Ron Cotten/*Technical Editor*
Brian Lamb/*Washington Bureau Chief*
Barbara Ruger/*N.Y. Bureau Chief*
William Shaffer/*Editorial Assistant*
Paula Martin/*Contributing Editor*

Production

Diane Adams/*Art Director*
L. Saiber Ehrlich, Sharon Hutton,
Pat Isenberg/*Artists*
Lorraine Gomez, Merry Frizzell/*Composition*

Circulation

Michael Gumb/*Circulation Director*
Yvonne Bauer/*Asst. Circulation Director*

Advertising

Sandra Carpenter/*Advertising Director*
Marty Laven/*Account Executive*
Lyn Lamb/*Traffic Manager*

Editorial Advisory Board

Stuart L. Bailey/*Jansky & Bailey*
Warren L. Braun/*ComSonics, Inc*
Richard G. Covell/*GTE Sylvania*
Kenneth L. Foster/*New York State Commission
on Cable Television*
G.C. Kleykamp/*UA—Columbia Cable*
James Luksch/*Texscan Corporation*
Harold R. Nuß/*Storer Cable TV*
James Richardson/*Cable Research*
Kenneth Simons/*PECA, Inc*
Thomas D. Smith/*Scientific-Atlanta*
James Wright/*Rockford Cablevision*



President

Robert D. Bilodeau/*Suburban Cablevision*

Eastern Vice President

Glenn Chambers/*American Television
& Communications*

Western Vice President

Frank J. Bias/*Tele-Vue Systems, Inc*

Secretary-Treasurer

Charles Tepler/*Tepler Publishing Co., Inc*

Executive Director

Judith Baer/*Washington Office,
1100 17th Street N.W. Suite 506
Washington, D.C. 20036
(202) 659-2131*

Titsch Publishing, Inc.
1139 Delaware Street
-or- P.O. Box 4305
Denver, Colorado 80204
(303) 573-1433

Washington Bureau
P.O. Box 19268
Washington, D.C. 20036
(202) 892-4200

New York Bureau
4 Duncan Road
Hohokus, New Jersey 07423
(201) 444-8929

Editor's Letter

Still another personal tragedy has taken its toll in the cable industry—Bud Desmond of Times Wire and Cable died of a heart attack in his home on January 14, 1978. Bud's companionship and contributions to his company, and the cable industry itself, will be sorely missed. A special memorial to Bud can be found on page 24. We, at Titsch Publishing, would like to extend our deepest sympathies to Muriel Desmond and her daughters.

This month's issue of *C-ED* brings you another series of articles we think you'll find informative. Our main stories feature the guts, theory and application of the addressable tap by Delta-Benco-Cascade, Ltd., Merrill Cable Equipment and Magnavox. You'll find those timely articles on pages 9, 21 and 25, respectively.

We also have some politically interesting legislative news provided by our Washington Bureau. See the news article on "Translators—An Open Door Policy" on page 16. We've also explored how UA-Columbia's system in Oakland, New Jersey is succeeding due to "controlled engineering." You'll find that story on page 32.

When you've finished with these special features, we urge you to read the latest in technology, technical news and what's going on with the SCTE. We think you'll find these articles informative and up-to-date.

Paul A. FitzPatrick

AML Microwave—it works. And not just on paper.

AML is the only microwave system proven in the field. There are more than 150 systems currently in use.

HUGHES MICROWAVE™
COMMUNICATIONS
PRODUCTS

Formerly Theta-Com™ AML
P.O. Box 2999, Torrance, CA 90509. (213) 534-2146
AML Canadian Distributor:
Micro-Sat Communications, Ltd.,
Ontario, Canada L1W3A4.

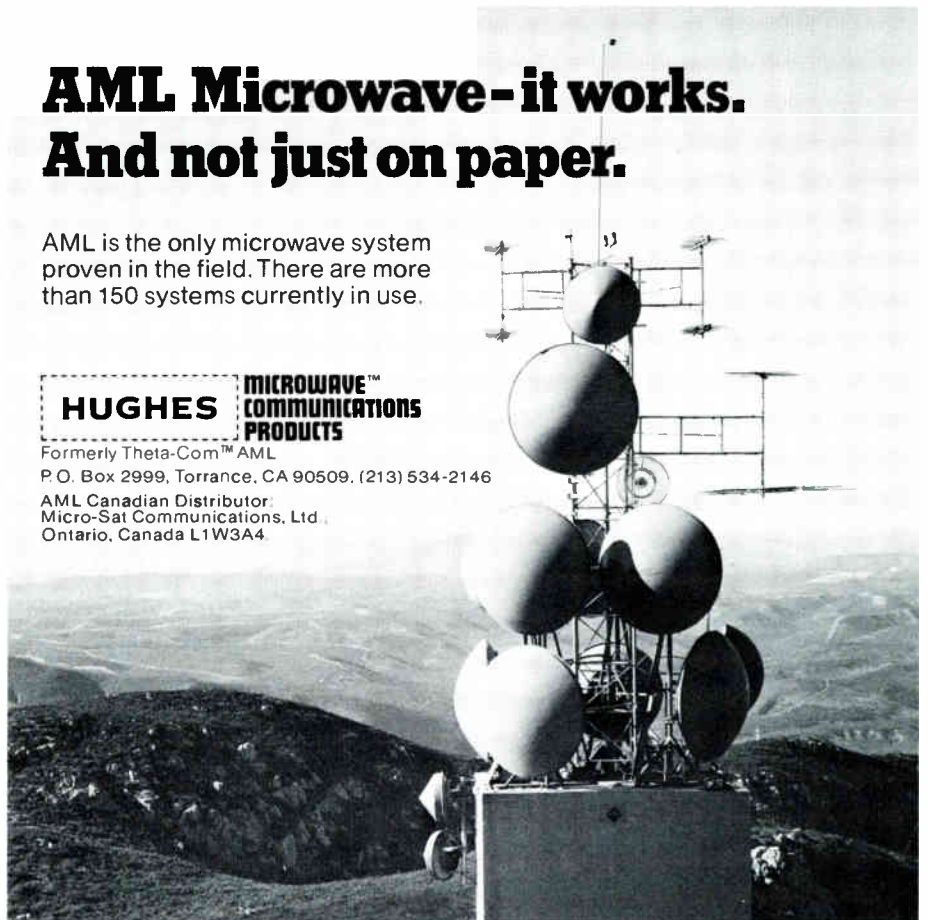

How Difficult It Is!

Some believe that presiding over the Society's affairs represents some extraordinary output on my part, but this is not so. The composition of SCTE membership is that of technical and engineering types, which provides an inherent barrier from active participation. This has also been the history of analogous organizations. Bob McMillan, writing in the North Jersey IEEE member newsletter about the results of his nomination efforts, thanked the Rank and File for their efforts in the following manner: "Bless you, North Jersey IEEE members, for your indifference. Had each of you 5,000 members voted in the recent IEEE election, it would have taken many more weeks of effort to check the names and tabulate the votes. Hurrah! You didn't do this to me—only 100 engineers voted. This is a reasonable number of votes to count . . ."

SCTE experiences have been similar, and perhaps it should be so: except for life and death emergency situations. The magnitude of the job is considerably

reduced when, after asking for technical articles, participation in *C-ED*, names of members for nominations to various elective posts, names of members for nominations to award programs, etc., we get but a handful. Ergo, we are not burdened with the chore of sorting out volumes of mail, and are able to avoid sensitive situations that arise when trying to decide long lists of otherwise qualified individuals who might serve or receive an award. The size of the job is further diminished in an organization such as ours when only a handful of members need to be satisfied. This number is less than three percent. Responding to the remaining 97 percent is purely mechanical. They never express an opinion one way or the other, so we assume they are happy with the affairs of their society. For the three percent that require overt attention by management, we need satisfy only the majority, minimizing the work load even further. Doing the monthly column is likewise easy. The response is trivial, no matter what I say—even when I deliberately intend to provoke.

Now that the secret is out as to how

easy this job really is, I suppose we will be inundated with demands to spread the glory up and around. Based on this rationale, why not be president of the SCTE, if it doesn't take any effort?

Since the principle of Action and Reaction equally applies to the absence of action, it follows that very little effort is required to meet the challenges offered by the job. Q.E.D., the validity of my thesis is proved through the natural law of physics by virtue of the corollary: for every Inaction there is an equal and opposite Reination. Oh well, I wish this job were more difficult.



Bob Bilodeau, President

IDEAL FOR FSM CALIBRATION

EASIEST CALIBRATOR TO USE

Totally eliminates cumbersome tuning required by competitive calibrators

Sadelco, Inc.
Sadelco, Inc.
Sadelco, Inc.

Call or write for free color brochure

299 Park Ave., Weehawken, N.J. 07087
Tel. 201-866-0912

General representative for Europe:
Catec AG Luzern/Switzerland, Habsburgerstr 22
Tel. 041-41-75-50 Telex TELFI 78168
IN CANADA: Comm-Plex Electronics Ltd. IN MEXICO: Polytronic, S.A.,
Cuernavaca 152-A, Mexico 11 D.F. Mex. Tel. 5-53-77-17 & 5-53-87-00.

1/4 dB ACCURACY 4.5-300 MHz



SPECTRUM CALIBRATOR MODEL 260-B

SPECIAL FEATURES:

- Extremely Flat White Noise generator
- 73.5 MHz CW Reference Generator
- Pulsed RF Reference Generator
- Precision Step Attenuator
- Ni-Cad Battery Powered
- Calibrate field strength meters
- Determine peak reading errors
- Measure gain, loss, and response
- An accurate standard signal source

Available at major CATV Distributors

SCTE/CATA Joint Seminar An Overwhelming Success

ST. CLOUD, FLORIDA—On January 5 and 6, SCTE and CATA co-sponsored a hands-on technical session hosted by RF Systems at RF's new facility in St. Cloud, Florida. Approximately 100 participants attended the two-day session.

Bob Welsh of Wavetek, Dan Yost of Compucon, Jerry Thorn of RF Systems, Inc., Tom Humphries of Scientific Communications, Inc., and George Bell of Microdyne spoke on subjects ranging from FCC filing procedures to frequency interference, system tests and measurements, and alignment and troubleshooting of capital TVRO's.

RF Systems, Inc. provided lunches on both days as well as transportation between their facility in St. Cloud and the Red Carpet Inn West in Kissimmee, where the participants stayed. On Thursday evening, Al Jones and Bob Tenten of HBO provided a hospitality suite for all attending the seminar.



Earle Davis (left), marketing manager/CATV, RF Systems, Inc.; Judith Baer, executive director, SCTE; and Stephen Effros, executive director, CATA, were on hand for the St. Cloud, Florida, SCTE/CATA technical session.

SCTE/IEEE Third Annual Conference on CATV Reliability Announced

WASHINGTON, D.C.—Frank Bias, vice president of engineering, Viacom Communications and Archer Taylor, Malarkey Taylor and Associates, have announced plans for the Third Annual SCTE/IEEE Conference on CATV Reliability to be held at the Holiday Inn-West in St. Louis, Missouri on March 7 and 8, 1978. Bias and Taylor serve as co-chairmen for the joint meeting, representing SCTE and IEEE respectively.

The 1978 CATV Reliability Conference will feature discussions and papers on four

major topics of concern to the cable TV industry. Included in the format are panels on System Design-Components Reliability; System Reliability through Redundancy and Design; Bonding and Grounding; and Powering and Cost Reduction Techniques. Host moderators will be Alex Best, Scientific-Atlanta; Gayheart C. Kleykamp, UA-Columbia; Frank Bias; and Robert Bilodeau, Suburban Cablevision.

Each panel will feature four speakers on various aspects of each major topic. TVROs and headend components are included, as is discussion of the National Electric Code, demonstration of powering techniques, basic headend engineering and reliability and down-to-earth information of interest to industry technicians and engineers. Registration is open to members of SCTE and IEEE. Non-members are also invited to participate.

SCTE will call its Tenth Annual Membership Meeting at the Conference; and during this meeting, more than 60 Charter SCTE members will receive commemorative plaques noting their participation in forming the group. The SCTE Member of the Year will also be honored during the luncheon meeting and new members of the SCTE board of directors will be introduced.

Information on registration is available from SCTE, 1100 17th St., NW, Suite 506, Washington, D.C. 20036. Telephone (202) 659-2131.

Regional Contacts For SCTE Meetings

Pacific Northwest

Cliff Schrock at (503) 644-0161
Northern California

Frank Bias at (415) 829-1811
Southern California, Arizona, Nevada & Utah

Abe Sonnenschein at (213) 534-2121
Colorado & The Rockies

Judith Scharf at (303) 771-8200
Oklahoma, Arkansas, Nebraska & Mid-America

Bruce Uerling at (308) 635-3163
Texas & New Mexico

Dick Covell at (915) 544-7550
Kentucky & Tennessee

Dave Franklin at (502) 442-6382
Great Lakes Region

Don Meinders at (715) 341-0136
Illinois & Indiana

Bill Ellis at (812) 424-5541
Alabama, Mississippi & Louisiana

Travis Nabors at (601) 328-1786
Maine, Vermont & New Hampshire

Sam Shearer at (802) 864-5749
Massachusetts, Rhode Island & Connecticut

Jim Petro at (203) 481-3434
Upstate New York

Jim Emerson at (315) 682-2670
Ohio & Western Pennsylvania

Jim Palmer at (814) 238-2461
Eastern Pennsylvania

Joe Gans at (717) 455-6851
New York City & New Jersey

Ed Horowitz at (212) 556-2826
Mid-Atlantic/Appalachia

Jim Grabenstein at (301) 722-6540
Georgia & The Carolinas

Guy Lee at (404) 266-2288
Florida & The Caribbean

Ralph Haimowitz at (305) 589-3846
Quebec

Camille Gelinis at (819) 537-1849
Ontario (Society for Cable Television Engineering)

Brian James at (416) 676-9600
Vancouver (Western Society of Cable Television Engineers)

M.A. Shiel at (604) 298-6664

COULD YOU REALLY
MAKE TWICE AS MANY
AMPLIFIER COMPONENTS
IF YOU DIDN'T TEST 'EM
SO MUCH?



MAYBE NOT TWICE AS MANY,
BUT IT TAKES A LOT OF TIME
TO 100% TEST ALL RF
PARAMETERS. TEMPERATURE
CYCLING, 8-HOUR BURN-IN
AND BATCH SAMPLING LIFE
TESTS TAKE TIME, TOO.

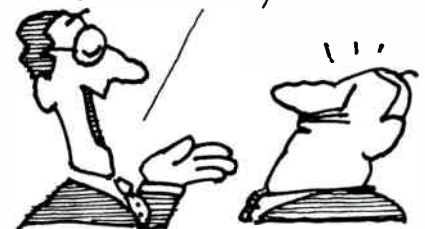

the best components for CATV amplifiers
come from **TRW** RF SEMICONDUCTORS

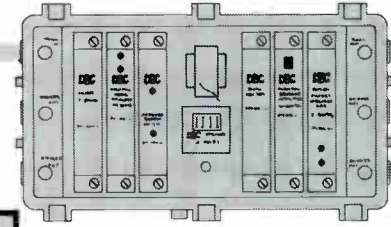
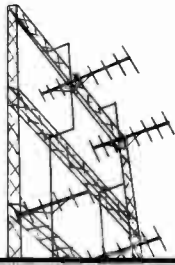

CASCADE 300

CELECOM

DISTRIBUTION LINE AMPLIFIER

TRUNK QUALITY IN A LINE
EXTENDER BY USING TRUNK
AMPLIFIER MODULES IN A
SMALL HOUSING

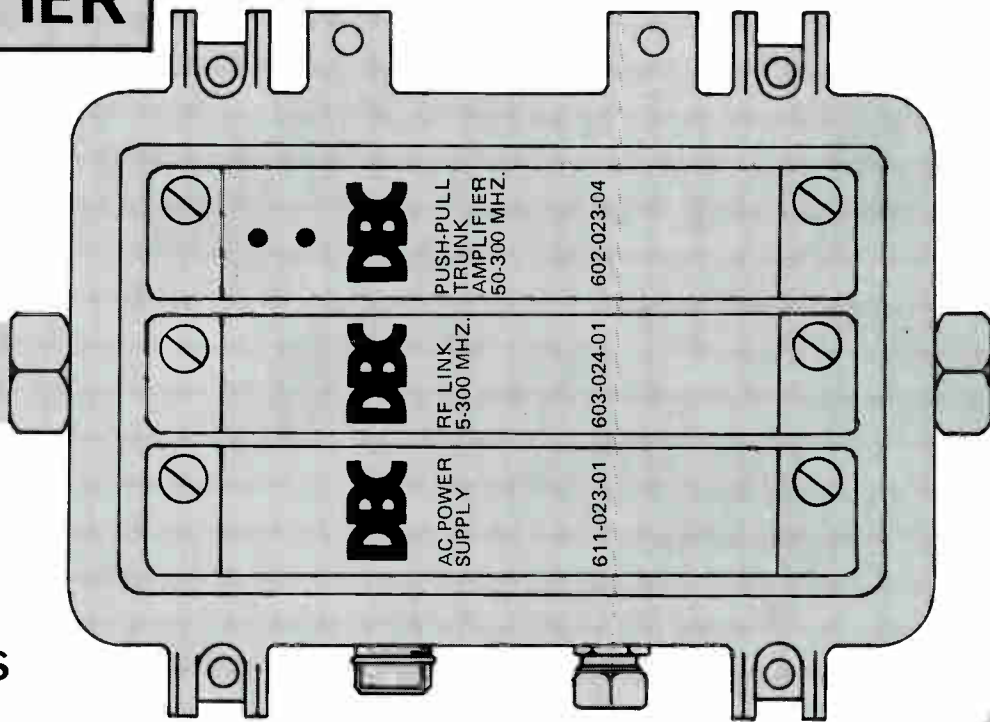

CAPABILITIES INCLUDE:

- ALC OR MANUAL CONTROL
- LO AND HI-GAIN OPTIONS
- REMOVEABLE MOTHERBOARD
- 30/60 VOLT POWER SUPPLY
- POWER INSERTION
- TWO-WAY OPTION
- TRUNK INTERCHANGEABILITY



DELTA·BENCO·CASCADE

124 Belfield Road, Rexdale, Ontario, Canada M9W 1G1
Telephone (416) 241-2651 Telex 06-965552

CALL OR WRITE TO YOUR NEAREST OFFICE: Philip Allman, 4913-205th Street, Langley, B.C. V3A 5T7. Tel. (604) 534-3710; Tom Holgate, 4330 Halifax Street, Burnaby, B.C. V5C 3X5. Tel. (604) 294-6816; Ken Jones, R.D. 1, Box 69, Beaver Springs, Pa. 17812. Tel. (717) 658-2282; U.S. REPRESENTATIVES: Bruce Martin, Cablevision Equipment Co. Inc., 3838 Cavalier Drive, Garland, Tex. 75042. Tel. (214) 272-8551; Neil Phillips, Signal Vision Inc., 23932 Jarrow Lane, El Toro, Cal. 92630. Tel. (714) 586-3196; U.S. WATTS LINE (800) 828-1016

The DBC Intelligent Tap System⁽¹⁾

(Part one in a series of two.)

The Intelligent Tap System was invented by Stern Telecommunications Corporation and was developed and exclusively licensed to Delta-Benco-Cascade, Ltd.

By Joseph L. Stern and Joseph Garodnick of Stern Telecommunications Corporation; and David Fear and Paul W. Lancaster, Delta-Benco-Cascade, Ltd., Ontario, Canada.

1 978 is the year of addressable subscriber control. This need has been discussed for years. This is one method for the improvement and growth of CATV. Now that production has started and deliveries are being made, the time has come for a very close look at the entire addressable tap system and how it works.

This article will describe not just another addressable tap but the Delta-Benco-Cascade Intelligent Tap System: its design criteria, its embodiment as well as its present and future features.

System Summary

Classically, the approach to remotely controlling multiple devices is to communicate by using space multiplexing, frequency multiplexing, time and code multiplexing or a hybrid of these three schemes.

Space multiplexing requires a separate wire circuit for each device. This approach is not directly feasible in CATV systems since one cable is shared by a large number of taps. (However, this situation does exist in MATV with the B-T

"Centap" systems.)

Frequency Multiplexing requires a receiver that can distinguish one frequency from a number of others. This method is used in the telephone industry with MF tones, sub-groups, groups, master groups for control and for transmission of information. In the present state-of-the-art, the complexity of circuits that detect a single frequency among many others is extensive.

Time and Code Division Multiplexing requires a logic that will synchronize and extract information at precise time or code intervals. This method is presently being used in the telephone and space communications industries for high-speed data transmission.

The Intelligent Tap System makes use of all three of these classical systems.

A typical CATV system is comprised of multiple trunks from one or more hubs with each trunk branching into multiple feeder lines. These trunks contain power supplies that energize the repeater amplifiers. In the Intelligent Tap System, the standard power supply is replaced with an IT system power supply.

Using RF (any existing pilot frequency, or other frequencies) the headend communicates with this power supply by using both frequency and time-division

multiplexing. Large systems use frequency-division multiplexing where the receiver inside the power supply is tuned to one of many frequencies. Time-division data is transmitted on these telemetry frequencies to the IT power supplies. The power supplies in turn interpret the data and transmit information to the Intelligent Taps contained within that power-supply section.

The data transmitted to the tap is contained within the frequency of the cable power itself. That is, the binary data directly modulates the AC power. Trunk amplifiers, bridgers, and line extenders are transparent to this modulation of the power-supply frequency. The data is transmitted to up to 1024 taps per powering section in a time-division multiplex format whereby each tap recognizes and confirms an address before it accepts operational data. The data receiver within the tap is merely an RC low-pass filter.

The contents of the data within the tap effects any of three control functions for any or all of four subscribers (a total of 12 functions). The data rate along a trunk from headend to the power supply is 20 kbps (kilobits per second). The data is sent using a pulse-width modulation on any available or existing pilot frequency. The bandwidth required is 120 kHz. The central controller at the headend sends

(1) Patent Pending No. 33295/75

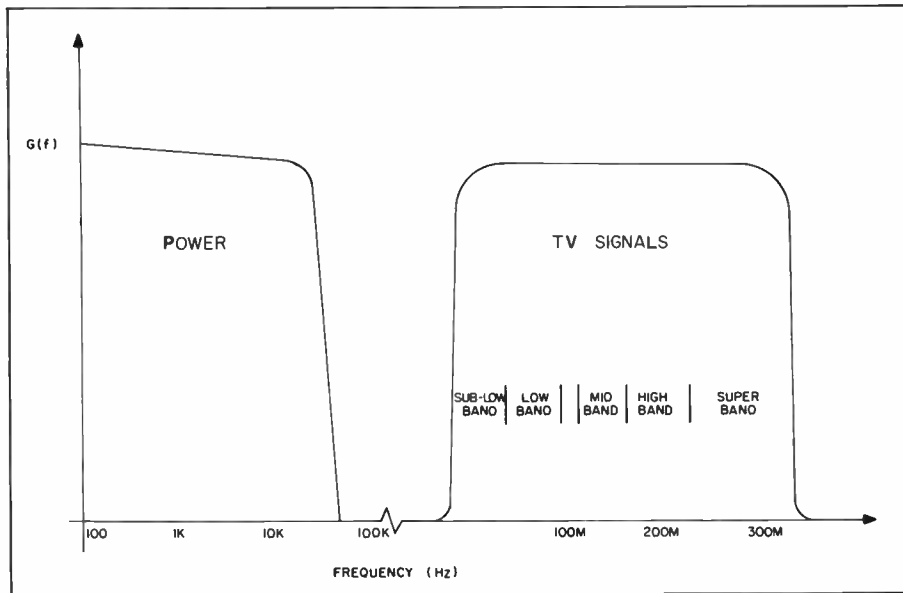

Figure 1

data to each trunk emanating from a hub using space-division multiplexing since access to each trunk is available at the hub. The data rate from central control is 20 kbps times the number of trunks at the hub.

Why is all this done in this fashion? The bottom-line answer is reliability and economic viability. Within the tap, there is a proprietary LSI (Large Scale Integration) chip. By limiting the number of tap addresses to 1024, the number of pins needed to program the LSI chip becomes 10. The tap was designed to provide basic service control (control of the entire RF signal) and independent control of two pay-TV channels provided to four subscribers. Therefore, the number of control functions that are handled by one tap is 12. This requires 12 more pins on the LSI chip. Using three pins for power and one for input data, an LSI chip can be constructed with only 24 pins. The smaller the number of pin-outs on a chip, the lower the cost. Since baseband data is available in the power frequency, the data receiver is an RC filter. This is certainly less expensive and more reliable than an RF telemetry receiver.

To allow a cable system with perhaps many thousands of subscribers to utilize a cost-effective and reliable system, it has to be sectorized and the power supply was the obvious choice. What was effectively done was that some intelligence was removed from the individual taps and put in the power supply location. Since one power supply may serve many hundreds of taps, we were able to afford the provision of a high-quality, highly reliable

RF telemetry receiver in the IT power supply.

Theory of Operation

The coaxial cable used in CATV systems generally has two separate bands of carriage; one permitting power to be carried in the system, and the other permitting the carriage of RF signals. This is shown in Figure 1.

Conventional cable systems carry 60 Hz power on the coaxial cable along with RF. The power provides the energy for the trunk and distribution amplifiers in the system. The 60 Hz power is usually derived from special constant-voltage type power supplies.

The classical approach to remote

control on an RF system is shown in Figure 2, and is in essence a duplicate of an RF paging receiver, but with some switches in place of the "beeper." This is a very complex system and extremely expensive to provide reliable operation in an outdoor environment. A simplification of this system is shown in Figure 3 where audio tones (with frequencies between 10 kHz and 100 kHz) are applied directly on the coaxial cable. This simplification is still complex and expensive and particularly difficult to keep operating properly in an outdoor environment. The ultimate reduction in complexity and cost is provided by direct demodulation of the 60 Hz nominal power with data and the required receiving device is shown in Figure 4. The Intelligent Tap control system makes use of the 60 Hz power to convey data to the remote receiving unit.

The system is comprised of three basic blocks:

- Headend control and transmit
- Power supply unit
- The addressable tap unit.

Signal commands in the system originate at the headend control unit and are sent to the power-supply unit on the coaxial cable as modulated RF signals. The power-supply unit acting as a buffer then transmits commands to the addressable tap units within its sector.

The IT power supply is designed so that either 60 Hz or 120 Hz can be impressed upon the cable. Within the Intelligent Tap, the frequency of the power being sent is sensed in such a manner that 120 Hz represents a logical "zero" while 60 Hz represents a logical "one." Using this method, complex RF and tone

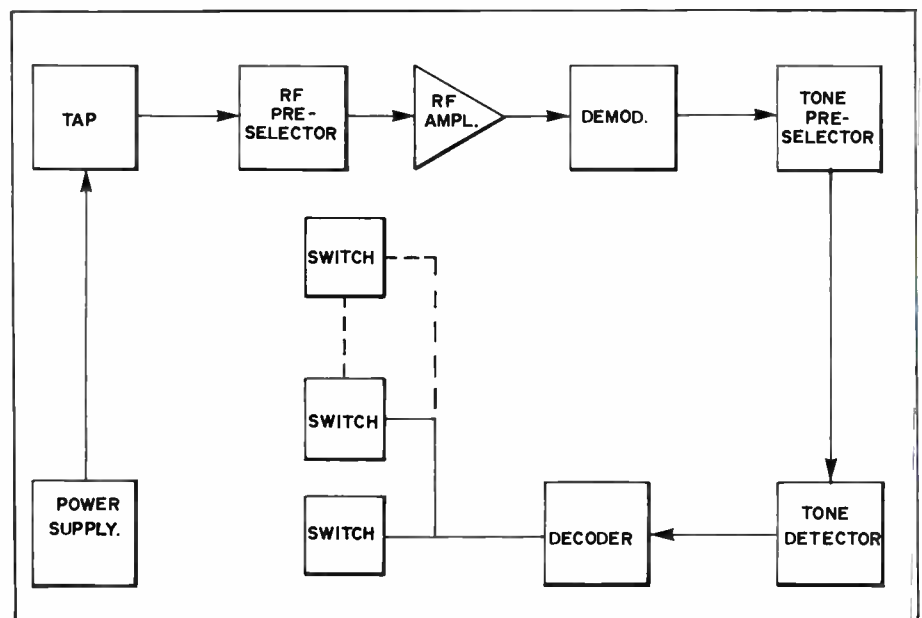

Figure 2

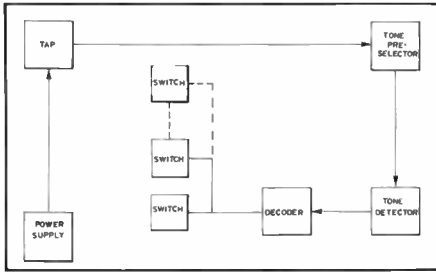

Figure 3

receivers and detectors are not needed.

It is this fact which makes the Intelligent Tap unique from all others. It should be noted that the frequency of the signal representing a logical "zero" is not restricted to 120 Hz but that this is a convenient frequency to use on existing CATV systems in the USA. Detailed tests have shown that power supplies within the amplifiers in cable TV systems are not affected by the shift from 60 Hz to 120 Hz and operate perfectly well utilizing these two signals as a power source.

The headend contains a control unit which sends the following data down the cable to the power supply via an RF telemetry channel:

- Power supply address (seven bits).
- Tap address (ten bits).
- Control functions (five bits).
- Overhead start, stop, parity (three bits).

This information is sent as one asynchronous burst of data.

In the quiescent state, the power supply is constantly impressing 60 Hz on the cable. When data is received from the RF channel, all power supplies decode the data and follow instructions indicating whether or not the power frequency should be modulated with the received data. It is not called upon to service its collection of taps. It continues to impress 60 Hz on the cable.

Within each tap, the data is decoded and if the tap address, start, stop, and parity are congruent with that which has been sent on the modulated power, a control function is enabled.

The modulation type chosen for the communication link between the headend and the remote points is pulse-width modulation (PWM) on an amplitude shift keyed (ASK) carrier. In general, any modulation scheme can be used. PWM is used so that the data is self-clocking and no bit synchronization is needed. ASK is used because standard pilot carrier transmitters and receivers may be easily modified for this application. There is no restriction on the carrier frequency. An

existing pilot carrier generator may be used. When one power supply is communicating with a tap, other power supplies may be addressed.

Given the number of bits that need to be received by a tap, the data rate from headend to power supply was chosen to be 20 kbps.

As previously stated, the power supply transmits data as 60 Hz or 120 Hz on the cable power system. Within the tap, each positive zero-crossing of the power system triggers a one-shot multi-vibrator contained in the proprietary LSI chip, set for a pulse duration of approximately six

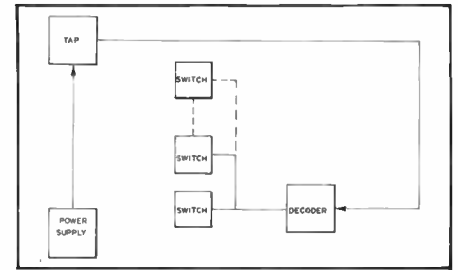
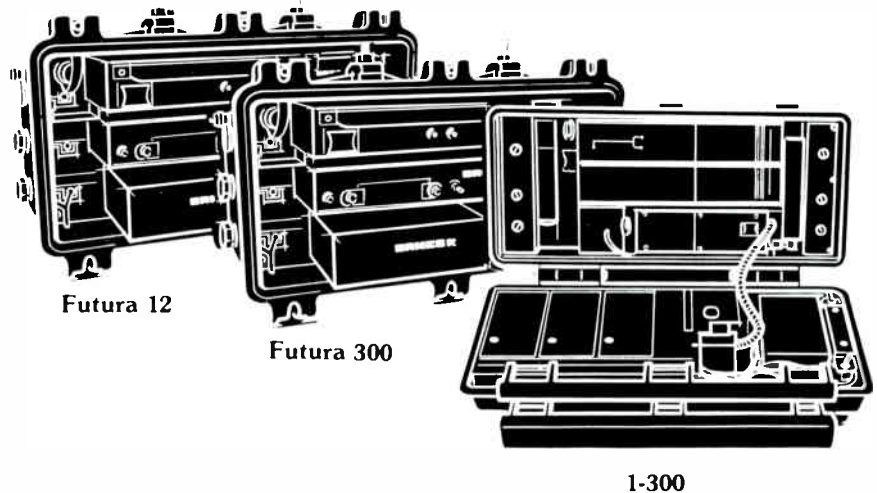

Figure 4

milliseconds. The output of this one-shot becomes a data strobe. Hence, if 60 Hz is received, it is decoded as a logical "one" and 120 Hz as a logical "zero."

Gamcor is proud to produce these proven Coral champions.

All these Coral amplifiers are in current production at Gamcor.



*Complete repair service available

Call or write for more information:

GAMCOR CORP.

291 Cox Street, Roselle, NJ 07203
(201) 241-7500 Telex 138-005

Distributed in Canada by Media House, 195 First Ave., Ottawa K1S 2G5 (613) 236-2404.

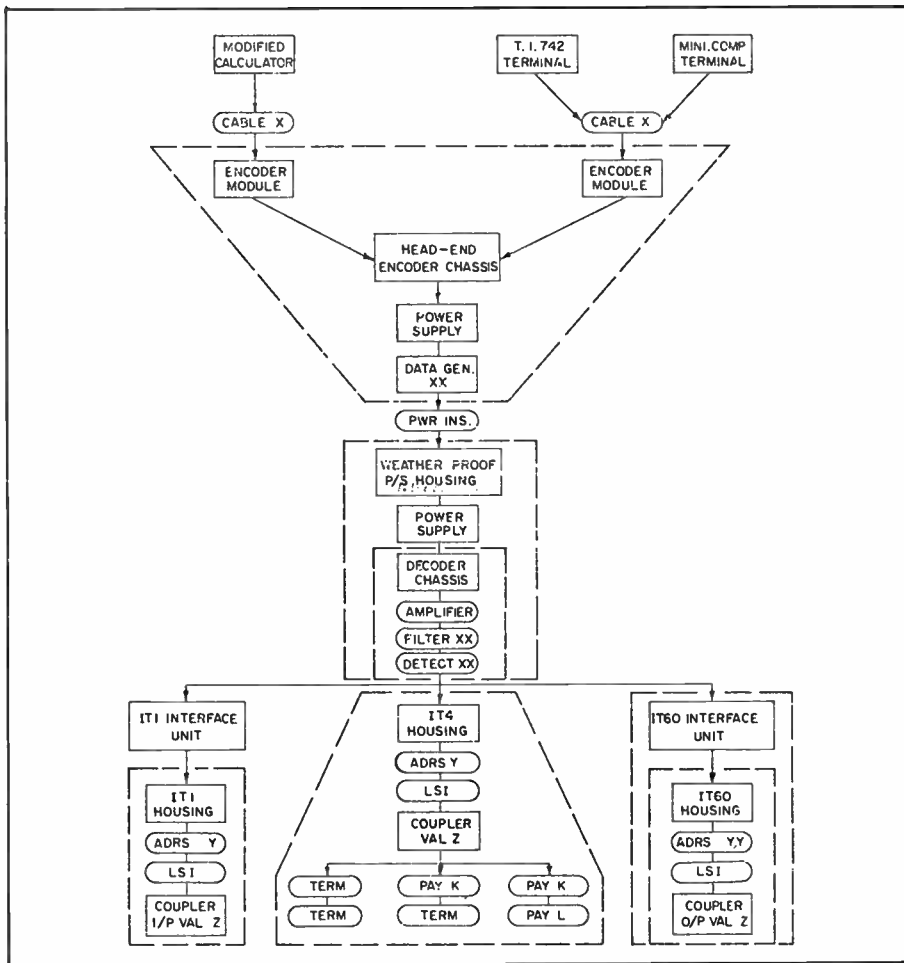

Figure 5

System Operation

Headend: The headend control system (Figure 5) is ultimately responsible for management of the system. The level of sophistication of equipment at the headend is determined by the size of the network and a cost-performance analysis.

Manual Operation: All headend systems must contain the I/O (Input/Output) module, RF modulator (switch), and RF pilot frequency generator. In the case of a local control within an apartment complex, or an individual apartment for test purposes, a sector commander is utilized. The customer "address book" is referenced by the installer or operator. He simply establishes the proper address and functions on the sector commander and depresses the operate switch. A second type of manual operation is available through the use of a keyboard control (Figure 6). This unit can be located at the CATV system office, at any distant point or in an apartment complex. The customer address and function desired is punched up, displayed for cross-checking, and the transmit key is then

depressed sending the signal through the system to the tap or taps. In operation, the hardware provided automatically transfers the sector commander switch data or the keyboard strobed data to a parallel-to-serial converter. It then adds, starts, stops, parity bits and shifts out the code at 20 kbps to a modulator. The modulator converts the digital data to



Figure 6

pulse width format which controls an electronic switch on the output of a pilot carrier generator.

Computer Operation: A more sophisticated system, less prone to operational errors, adds a mini-computer, keyboard and a small display. The customer "addresses" (power unit and tap) can now be easily entered in decimal notation. With a teletype machine, or other printer, a printed record of all entries is maintained, as well as a permanent paper or magnetic tape for future automatic updating or control of the network. Another system option incorporates a dual cassette or cartridge storage and thermal printing machine (Figure 7). One cassette or cartridge might contain the customer addresses (in any order desired), and the other a record of entries for the day (week or month). For a reasonably sized system, several cassettes or cartridges will be required to hold all of the customer addresses.



Figure 7

Updated address tapes can be made, by the same mini-computer, (from the entry record tape and the keyboard) during off hours.

A further optional refinement to the system would add a large disc memory, real time clock and possibly a high speed line or form printer. All of the customer's data would now be on the disc memory. This system automatically maintains billing status; generates invoices and internal program usage print-outs; automatically turns on and off the desired programs for customers; automatically updates the entire system (at night) to catch up with low priority updates and corrects any errors. If a two-way trunk is in use, the return data may include status information from the power units on signal levels, quality, etc., as well as customer data. **C-ED**

The March issue of C-ED will feature the conclusion of DBC's Intelligent Tap article. Highlights of the second part will include system operation, description of the tap and various methods of controlling and jamming premium television channels.

First Class
Permit No. 4957
Denver, CO

Business Reply Mail

No Postage Stamp Needed if Mailed in the United States

Postage Will Be Paid By

Communications-Engineering Digest

P.O. Box 4305
Denver, CO 80204

2-78

New! From **Arvin. Systems Inc.**
NON-DUPLICATION AND MULTIPLE CHANNEL SWITCHER
Model DCP-6000 ✓Check these features . . .



✓30 Minute Switching Intervals
✓7 Day Programming on Plexiglass Disc
✓No Pins—No Diodes No Switches
✓Optical Reader
Only **\$795.00**
✓Switches DC-300Mhz 90 dB-Isolation
✓Solid State electronic logic
✓Electronic Digital Clock, L.E.D. readout with accuracy of AC Line Frequency

MODULAR
Program 2 to 50 channels

Call Us Collect Today . . .
Arvin. Systems Inc.
CATV Div. (614) 756-9222

Name _____
Company _____
Address _____
City _____ State _____ Zip _____
Phone _____

First Class
Permit No., 4957
Denver, CO

Business Reply Mail

No Postage Stamp Needed if Mailed in the United States

Postage Will Be Paid By

CableFile

c/o Titsch Publishing Inc.,
P.O. Box 4305
Denver, CO 80204

Please fill out and return this card for qualification purposes. *Communications-Engineering Digest* is the official journal for the Society of Cable Television Engineers.

Official Audit Request Form

1. Please send me my complimentary one year subscription to *Communications-Engineering Digest* Yes No
2. Please check type of business in which you work (Only one please).
 - CATV System Operators
 - CATV Contractors and Consultants
 - Pay TV
 - CATV Component Manufacturers, Dealers, and Distributors
 - Microwave and Telephone Companies
 - TV, AM, Broadcasters
 - Educational, TV Stations, Schools, and Libraries
 - Closed Circuit TV Users
 - Financial Institutions, Brokers, Attorneys, and Government
 - Agencies
 - Program Producers, Program Distributors, and Advertising Agencies

Please make any address changes.

Name (please print) _____

Your Title _____

Signature _____

Date _____

First Class
Permit No. 12
Lancaster, OH

Business Reply Mail

No Postage Stamp Needed if Mailed in the United States

Postage Will Be Paid By

Arvin® Systems, Inc.

CATV Division

P.O. Box 200

Lancaster, OH 43130

ATTENTION: Sales Dept. ICP-6000

New 1978 CableFile

More information on cable than ever before!

Yes, send me the new 1978 edition

Enclosed is my check for \$29.95

Bill me Send information on group discounts

Name _____

Company _____

Address _____

City _____ State _____ Zip _____

Colorado residents add 3½% sales tax

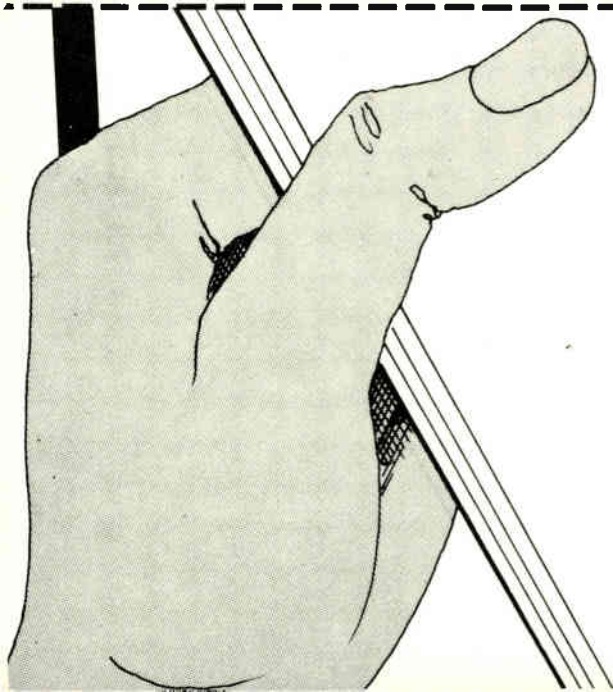



CERROFOAM GXX™

**offers everything
an extra low loss
cable can.**

When it comes to gas expanded polyethylene cable, our Cerrofoam GXX™ offers it all. Extra low loss. 10% lower than first generation gas injected cable — with an excellent array of physical properties. Controlled adhesion. For both effective moisture resistance and an easy to strip dielectric to facilitate connector installation. And the dielectric has memory to hold its shape even under the roughest kind of handling or environmental conditions. Plus there's full utilization of the 5-300 MHz range.

Cerrofoam GXX™. An effective way to lower overall system costs — and still maintain high reliability and performance standards.

When you have a problem. We get involved.

Write for free sample and data



**CERRO
COMMUNICATION
PRODUCTS**

COAXIAL CABLE/RF DEVICES

Member of the Marmon Group

Halls Mill Road, Freehold, New Jersey 07728 ■ (201) 462-8700

Door Open to Translators

WASHINGTON, D.C.—The Federal Communications Commission has adopted a Report and Order, Docket 20539, that permits translators the flexibility of adding FM microwave feeds. The FCC was petitioned to permit FM microwave feeds because the present use of translators with AM amplitude modified microwave is expensive and inefficient. Previously, translators had been limited to direct pickup or AM microwave feeds. The results of this Report and Order is that translators can now be fed by CARS, satellites and standard terrestrial common carrier microwave.

The NCTA was opposed to this "open door" policy because, with this new capability to import signals from long distances with good reproduction quality, translators may become much like cable systems in importing signals from great distances.

According to Robert Luff, vice president of engineering for NCTA, "There are certain aspects of the commission's final Report and Order that

does not meet our favor and we intend to seek reconsideration. The FCC," Luff added, "decided to go ahead and make a final decision in this proceeding without first addressing the NCTA petition of formulating an overall national policy for translators."

A spokesman at the FCC indicated that should translators change character and become distant signal importers, the FCC will then address that issue.

FCC Grants Spectrum Relief

WASHINGTON, D.C.—Cable operators have been running out of CARS-band channel capacity in some areas of the country. In those high-usage microwave areas some systems have petitioned the FCC, on an individual basis, for spectrum relief. The commission responded favorably and allowed those systems to use the adjacent band used by broadcasters for inter-city relay.

A petition was filed for general industry-wide relief so that individual systems would no longer have to endure a cost and time delay for filing of individual waivers. So far, that petition has resulted in a reasonable amount of frequency relief for some systems.

office in Washington, D.C. Manning the new office is CATA's new executive director, Stephen R. Effros. The new office is located at: 1100 17th Street NW, Washington, D.C. 20036 (Suite 506). The telephone number is (202) 659-2612.

CATA's president-elect Ben Campbell felt the association needed the ability to monitor events in Washington more closely.

The Effros choice "is a natural one," stated CATA president and board chairman Kyle Moore. "Steve came to CATA as associate general counsel from a five-year stint at the FCC's cable television bureau, where he was heavily involved in cable policy making matters."



Featured above is CATA's executive director Stephen R. Effros.

If you missed seeing

**THE
MERCHANDISER™**

At the Western Show,

you owe it to yourself
to contact us
for more information

395 Ironwood Drive
Salt Lake City, Utah 84115
(801) 486-3833

**SYSTEM
CONCEPTS**

QUBE Gains Access To 2 GHz Spectrum

WASHINGTON, D.C.—In response to a separate petition filed by Warner Cable's QUBE operation in Columbus, Ohio, the FCC has granted use of the 2 GHz spectrum to that system. QUBE specified that its need was based on programming similarly used by broadcasters.

The advantages of the 2 GHz spectrum are less expensive equipment, the equipment is more readily portable and the 2 GHz band provides fast rebroadcasting.

The FCC, however, did not grant overall authority to all cable systems into the 2 GHz band. It did specify that if a cable system can demonstrate a need for access into the 2 GHz spectrum the FCC might grant individual requests.

CATA Opens Washington Office

WASHINGTON, D.C.—On January 3, 1978, CATA opened its new full-time

NAB President Urges FCC's Attention on Cable Issues

WASHINGTON, D.C.—Vincent T. Wasilewski, president of the National Association of Broadcasters, cited several long-pending matters, such as the carriage of radio signals and syndicated exclusivity in cable, "that would seem ripe for action" at the FCC.

In his recent letter to Chairman Charles D. Ferris, Wasilewski reminded the FCC chairman that an interim policy on cable carriage of radio signals has been in effect since 1972, pending the issuance of rules on the subject in Docket 19718. Wasilewski further noted that both radio and television stations "have a vital stake in the establishment of rules designed to assure carriage of local signals."

In addition, Wasilewski made reference to a petition filed before the commission by the NAB on June 24, 1976, "urging adoption of rules providing full syndicated exclusivity protection in all

television markets and extending the zone of protection from 35 to 55 miles in the hundred plus markets." Wasilewski requested the FCC chairman's prompt attention on both matters and said in his introductory statements, "The agenda of unfinished business includes items designed to foster such important public interest objectives as promoting technological innovation in the broadcasting industry, encouraging diversity of programming and eliminating overly restrictive regulations and unnecessary paperwork."

CATV and Broadcasting Inquiry Continues

WASHINGTON, D.C.—The cable television and broadcast industries have taken decidedly different approaches to studying the economic relationship between CATV and broadcasting. In comparison to the theoretical model approach taken by the National Association of Broadcasters in preparing studies for the FCC's economic inquiry, NCTA has approached the fact finding mission simplistically. According to Kathy Hilton, NCTA vice president of research, "Our studies are not of the 'what if' nature.

They are simple studies that show little that is new or different . . . only that cable is being hurt."

To demonstrate that cable is being harmed by existing FCC rules and that the rules are not necessary to protect broadcasters' interests, NCTA is undertaking five studies. One of the new research techniques being employed by NCTA is the use of an audience survey in which viewing habits of cable, non-cable and pay-cable homes are being monitored by the use of viewer diaries. Placed in viewer homes, the diaries are used to measure local station audience loss due to cable and to further isolate particular factors that influence the level of impact. Also measured as part of NCTA's research will be audience diversion as a direct result of cable programming—cable—a project that will update the study of audience diversion undertaken in 1976 as part of NCTA's syndicated exclusivity comments.

Nearing completion is an indepth analysis of recently released FCC studies that strongly suggest cable has *not* harmed broadcasting and a study of the success of post-1972 systems as compared to "grandfather" systems in the same market. The study will help demonstrate the effect of the 1972 rules

on cable system performance. A study of major markets not served by cable is also being conducted to determine what factors have inhibited new market development.

NCTA to Discuss Common Pilot Frequency

WASHINGTON, D.C.—As *C-ED* goes to press, we have learned that NCTA's engineering committee will meet on February 1 to address several issues. In particular, the committee will discuss the advisability of promoting a voluntary common pilot carrier frequency for signal leakage applications. If the FCC's field operations bureau or the FAA wanted to engage in a more effective monitoring plan, whereby they could also monitor cable systems for leakage, all the systems would have to use the same pilot frequencies.

The drawbacks to this proposal are that some systems not on the specific pilot frequency would have to adjust to that situation. Pending the results of the engineering committee's meeting, a letter will be sent to the FCC cable bureau advising them of NCTA's recommendations.

Radiation Monitoring

Mid State offers two systems that meet new FCC monitoring requirements. The ST-1 "Cuckoo" with its proven reliability is now an industry standard. A low cost FM radio is used as a receiver to patrol for leaks. The ST-1C is a crystal controlled version for use with the new CR-1 crystal controlled receiver. Write or call for complete details.

ST-1 \$295

CR-1 \$100

ST-1C \$395



M_{ID}
S_{TATE}
C_{OMMUNICATIONS, INC.}

SIGNAL LEVEL METERS ● CALIBRATORS
RADIATION & FREQUENCY INSTRUMENTATION

174 S. FIRST AVE., BEECH GROVE, IND. 317-787-9426

We've cut power consumption 18 watts without cutting corners!

Second order is 83 dB
@ 36 dB out... 2 to 7
dB better than
competition!

At a 51 dBmV output,
a -76 dB third order...
3 to 5 dB better than
competition!

No deviation between
modulated and un-
modulated carriers,
because of unique
design of peak
detection circuitry!

Improved noise figure.
Without equalization
this is now 7.5 dB...
1 dB better than
competition!

Power supply pro-
tected for reliable
operation... now can
withstand 3000 V
peak surges!

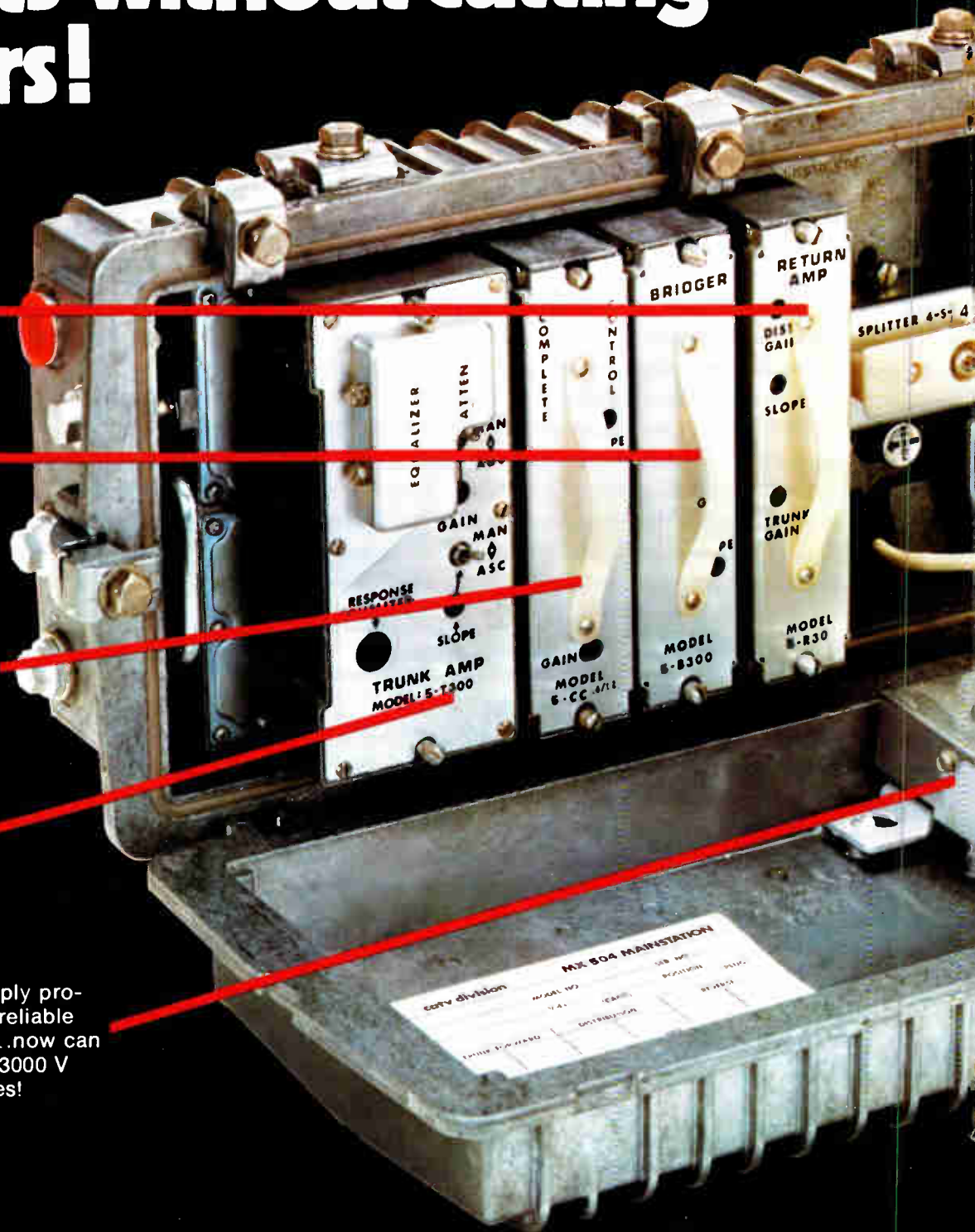

to

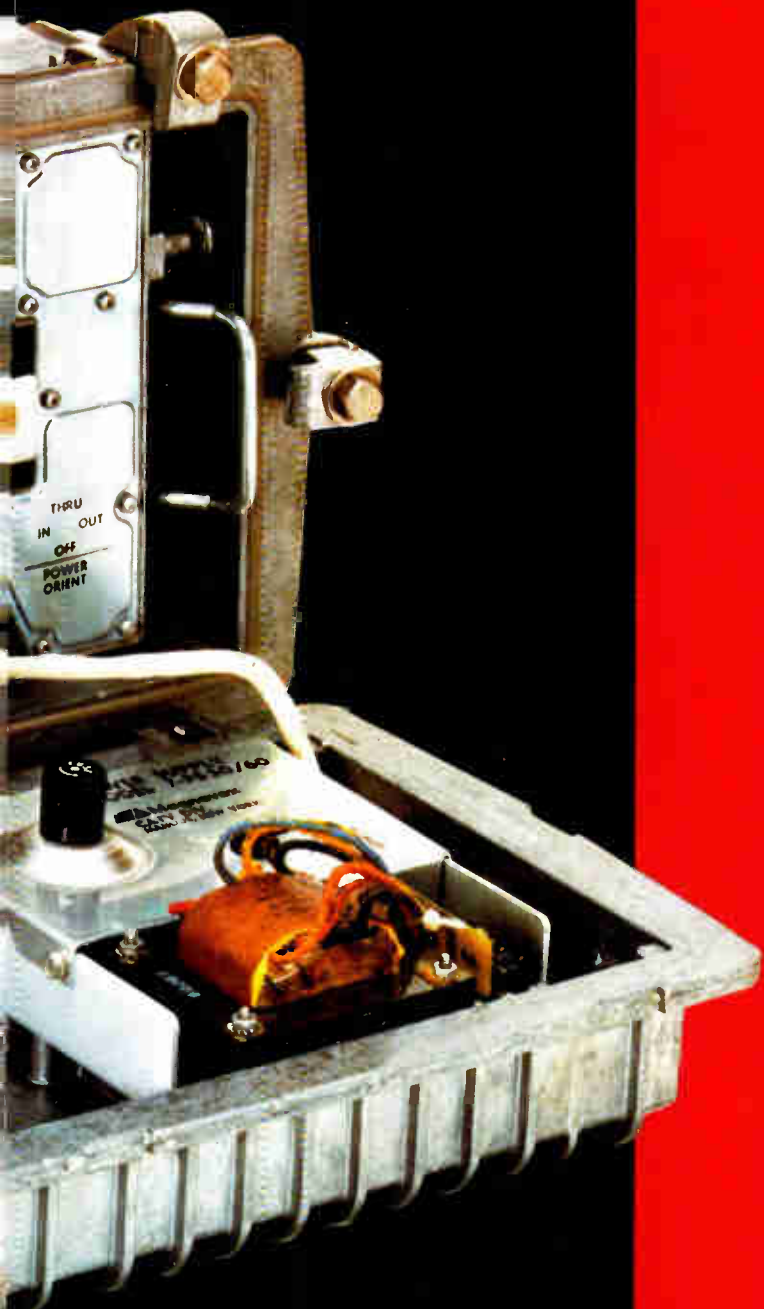

The New **MAGNAVOX MX-504** Mainstation Amplifier

You can cut mainstation power needs up to 35%—and get even better performance—with the new Magnavox MX-504 Series Mainstation Amplifier. It needs only 18 watts in trunk service—and with proven Magnavox dependability!

Magnavox pioneered in all-IC mainstation amplifiers. We were first to offer them in large-scale production. That's because IC suppliers designed to Magnavox specifications, and delivered!

Now, the suppliers have met today's new Magnavox specifications for advanced IC's with dramatically lower power needs—and even better performance.

Put Magnavox lower power and higher performance to work for your bottom line. Call us today. Magnavox CATV Systems, Inc., 133 West Seneca St., Manlius, N.Y. 13104. Toll-free, East of the Mississippi: 800-448-9121. West: 800-448-5171. Also: 315-682-9105.

Magnavox

Until now you wouldn't consider buying a demod for \$1775.

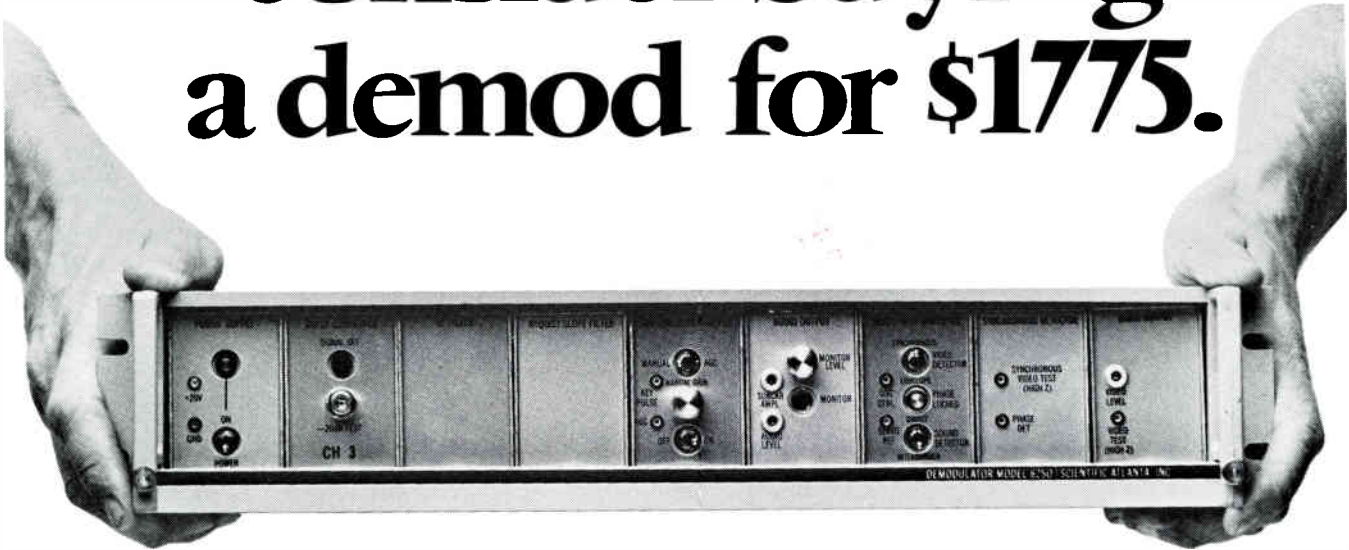

The remarkable Scientific-Atlanta 6250 falls about \$7,000 short of the price you might normally pay for a comparable high quality demodulator. But it doesn't fall short in engineering and performance. We've sold over 300 6250 Demodulators since its introduction a year ago. In fact one group of station engineers wrote, "we are amazed at your demod's performance," after comparative bench tests against a unit close to the \$10,000 range.

Consider the specs. 100 uv input sensitivity. Video response ± 0.5 dB to 4.18 Mhz, $\pm 2.5\%$ differential gain and $\pm 1^\circ$ differential phase. With audio response ± 0.5 dB 30 Hz to 15 KHz.

Consider the features: Zero chopper capable of operation from external as well as internal command. Envelope detector with optional syn-

chronous detector. Intercarrier sound detection, also direct mode with synchronous detection option. Local or remote control of chopper on/off, envelope/synchronous detection, intercarrier/direct sound detection. Automatic switch-back to envelope mode if phaselock is lost in synchronous mode. AC operation with optional +DC standby powering. Optional powering from -DC.

Consider the organization. At the forefront of the companies who are revolutionizing world communications via satellite, Scientific-Atlanta has had to meet some of the toughest requirements for performance, reliability and economy. The results of this experience are evident in our advanced 6250 Demodulator.

For a demonstration, call Harry Banks at (404) 449-2000. Or write us.

**Scientific
Atlanta**

United States: 3845 Pleasantdale Road, Atlanta, Ga. 30340, Telephone 404-449-2000, TWX 810-766-4912, Telex 054-2898
Canada: 678 Belmont Avenue West, Suite 103, Kitchener, Ontario, Canada N2M-1N6, Telephone 519-745-9445, Telex 069-5239
Europe: 1-7 Sunbury Cross Centre, Staines Road West, Sunbury on Thames, Middlesex TW16 7BB, England,
Telephone Sunbury on Thames 89751, Telex 896015

ACCESS 1 A New Concept in Control

By Robert Wilson, engineering manager
Merrill Cable Equipment Corporation
Phoenix, Arizona

Control is vital to a CATV system - or for that matter to any business. As a businessman the CATV operator is well aware of problems such as: "AGC control", "budgetary control" or "construction cost control."

But what about control of his most valuable asset . . . his service? To most operators "service control" has meant such things as physically connecting or disconnecting a subscriber, installing converters, traps or perhaps patrolling his system with a detector to locate unauthorized subscribers.

With an MCE Access 1 system, however, the operator not only has control of his system but the ability to exercise that control almost instantaneously from his office, headend or virtually any other location desired. Access 1 lets you provide service **where** you want to **when** you want to.

How It Works

As figure 1 indicates, the Access 1 system consists of a central Processor unit which transmits frequency coded command signals throughout the system, and a number of CAP-TAPS (Controlled Access Point and Tap) which convert these signals into actual operational functions.

Each 4 output: CAP-TAP is able to serve up to four subscribers and has the ability to select and respond to its' particular address from a group of 65,000 discrete addresses. Additionally, one CAP-TAP processor can be used to address a number of individual trunk lines in a system. Each trunk line can have 65,000 addresses.

Listed below are the basic service functions performable on command where CAP-TAPS are connected to Service Drops.

- Connect basic cable service
- Disconnect basic cable service
- Connect basic cable service and premium channel number "1" only
- Connect basic cable service and premium channel number "2" only
- Connect basic cable service and both premium channels.

In addition, with a simple plug in change, the above functions can be modified to offer various other levels of service such as:

- Connect basic service, premium channel number "1" and FM service
- Connect mid band service only
- Connect low band and mid band service only
- Connect high band only
- Etc.

The subscriber command signals may be transmitted continuously, if desired, up to a maximum rate of 1,200 individual commands per minute with no interference to any of the other channels. These command signals may be entered into the processor manually by using the self contained keyboard on the Processor. If desired, tape cassette or computer may be used for larger systems. An RS-232-C interface connection is a part of the processor. This permits a wide variety of standard peripheral equipment to be interconnected to the Processor. Consequently, many accounting, billing and control functions can be processed in tandem with commands to the Processor.

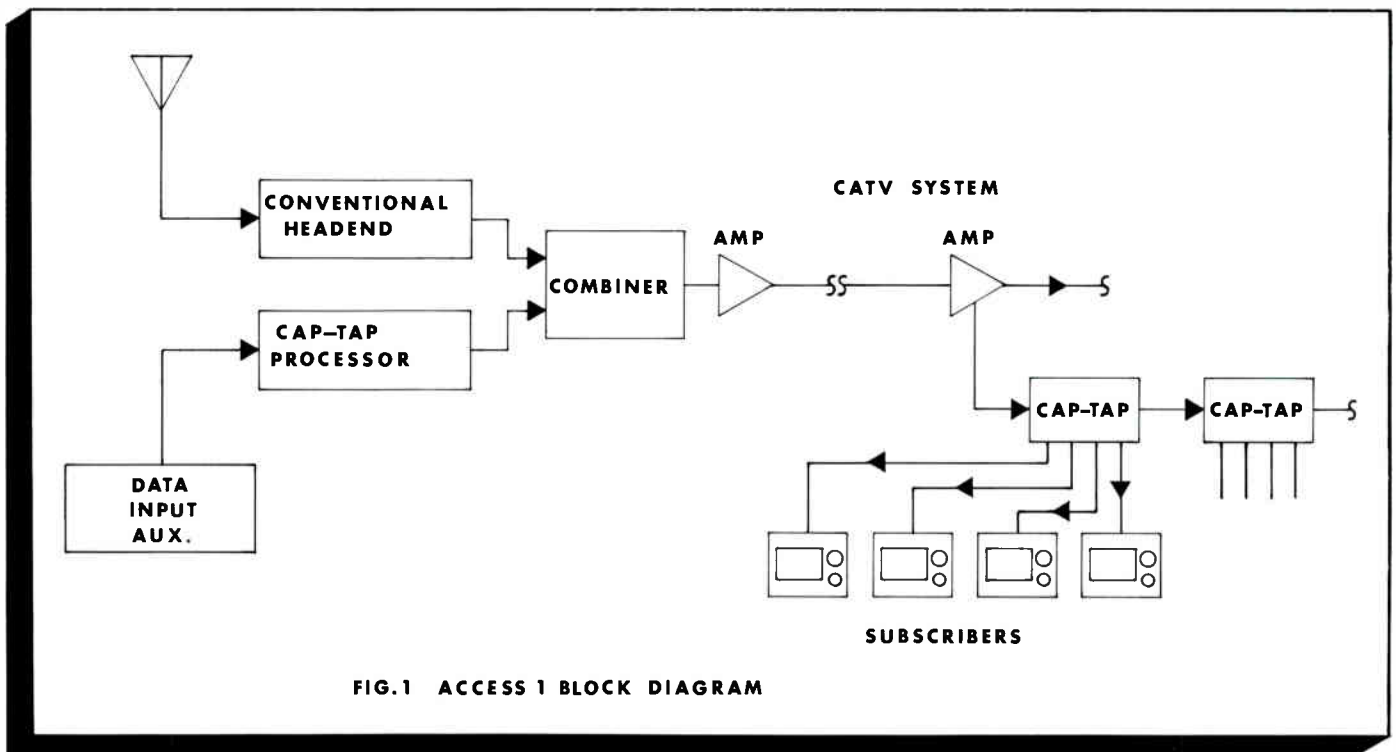

FIG. 1 ACCESS 1 BLOCK DIAGRAM

Operational Features

From a system standpoint, installation of an Access I system differs little from other standard CATV equipment. For example, special care has been taken in the design of the CAP-TAPS to make them appear electrically similar to standard passive taps. As the chart below illustrates, both the thru insertion loss and tap values compare favorably to a commercial quality customer tap. In most applications few if any design changes are required.

Tap Value (db)	9	13	15	18	21	24	27	30	33	36
Insertion Loss (db)	∞	3.5	2.0	1.2	0.9	0.5	0.5	0.5	0.5	0.5

The total power consumed by a CAP-TAP is less than 1/4 watt per subscriber which in most cases can be absorbed into the system design with little or no powering changes required.

The only special attention required when installing a CAP-TAP is a selection of the proper power supply tap position for that particular location and a check of the command signal level to insure that it is within the required range.

If maintenance is later required, the CAP-TAP has been designed so that the entire module may be unplugged, the address card and tap value boards interchanged with spare modules and the entire assembly reactivated in a matter of seconds. The defective module may then be repaired at the operators own repair facility using standard test procedures. If desired it may be returned to MCE's factory for reconditioning.

All production line testing of the CAP-TAP is done using special automated test equipment at MCE's factory. This insures

both high production capability and rigid quality control.

Special field versions of these line testers are available to the system operator who desires to do his own maintenance work.

Design Features

The basic internal functions of the CAP-TAP are illustrated in the simplified block diagram shown in figure 2.

Signal flow from input to output is accomplished in the same manner as a conventional passive tap with the exception that surge voltage protection has been provided on both input and output ports to protect the active portions of the tap.

Signal flow from input to subscriber output is routed through an additional directional coupler which is connected to a frequency selective FM discriminator. This tuned discriminator detects the command carrier and recovers its' coded information. The inherent reverse isolation of this additional directional coupler not only provides response protection to the tap's thru signal flow but protects the discriminator from deliberate attempts by subscribers to inject "piracy signals."

This coded data is presented to the address matrix and a parity check made. Only if the command address being detected is the same as the pre-assigned code on the plug-in address card will the command information be entered into the control logic and set up the desired operational status.

Depending upon the command given the status of the control logic may or may not permit the cable signals to flow through the premium filters, the connect/disconnect switch and on to the subscriber.

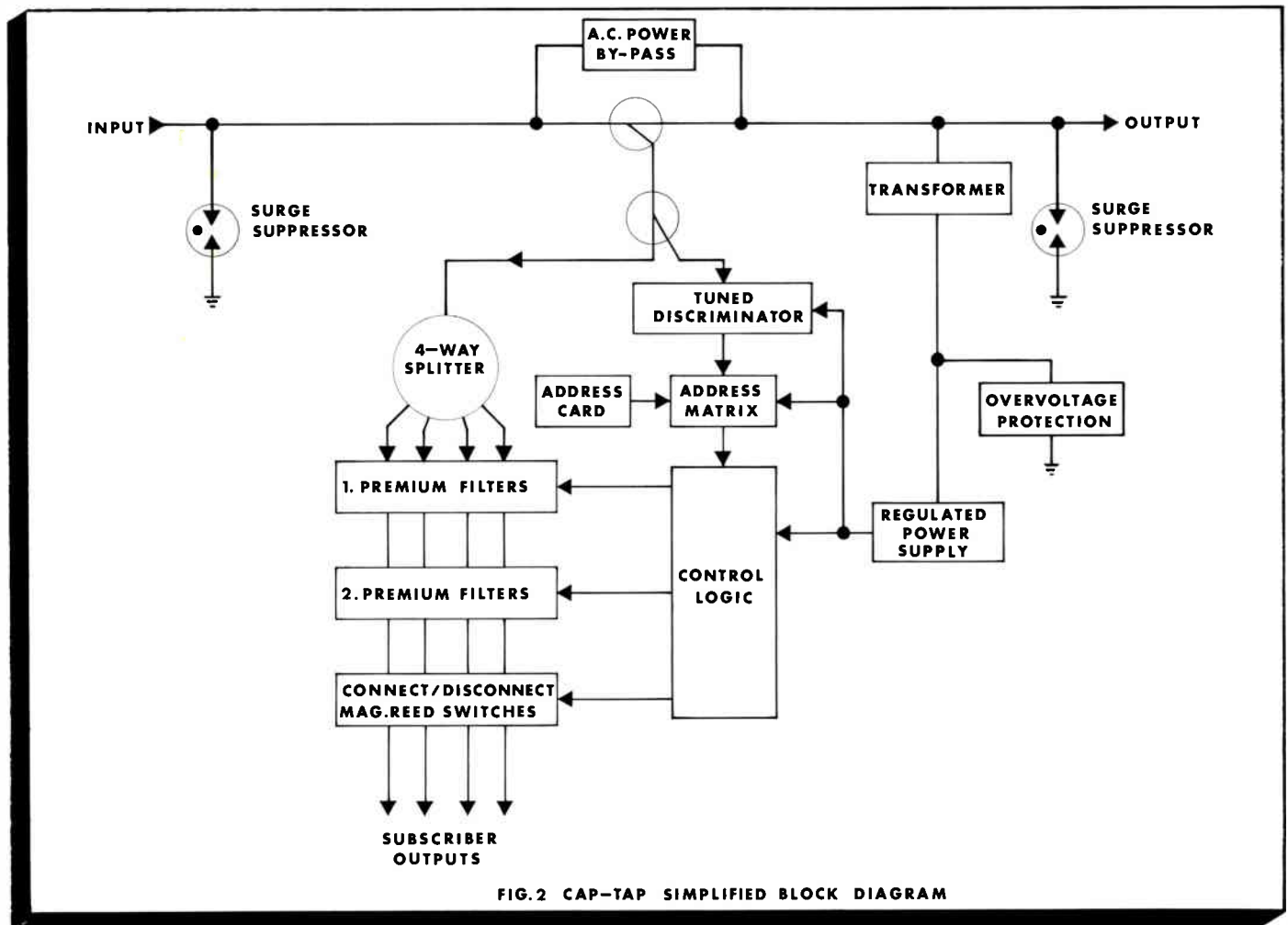

FIG.2 CAP-TAP SIMPLIFIED BLOCK DIAGRAM

The basic control element of both the premium filters and the connect/disconnect switch is a magnetic reed relay. These devices function much like a balanced "teeter totter" in that they require only a small electrical "push" to cause them to change state and, when once latched into their new position, will remain indefinitely without further power. This unique ability not only provides the CAP-TAP with a memory of subscriber status in the event of external power interruption, but allows the CAP-TAP to continue functioning as a preset passive tap even in the event of a complete internal power or logic failure until repair can be made.

Control of the desired premium channels is accomplished with passive type filters which are available in either band stop or band pass configurations. The filters are modular in design and controlled by a reed relay. This modular approach not only allows the operator to purchase a CAP-TAP with basic on/off capability only and then add other services as they are needed, but permits a large variety of control options as the preceding tabulation indicated.

Power to the active portions of the CAP-TAP is provided by directing a portion of the tap's thru power to a tapped transformer which can be adjusted for optimum power transfer at the particular voltage available. The transformer output is then coupled to a conventional regulated series pass power supply with the input voltage limited by the use of a high absorption type Metal Oxide Varistor. This combination, working in conjunction with the input/output surge voltage suppressors, provides dependable and trouble free operation even when the CAP-TAPs are installed in areas of high lightning and surge activity.

Uses of An Access I System

The operator with an Access I system at his disposal will quickly discover that in addition to the basic ability to connect and disconnect subscribers by remote control, he has a number of other "tools" which may not be readily obvious.

For example, various "levels" of service may be offered using certain channels or groups of channels which may be marketed to meet specific needs in specific areas.

Premium channel "previews" may be periodically allowed to enable the operator to use his own cable system as his best advertising medium.

Security of service becomes nearly foolproof since all control functions are accomplished at the tap location inside of a water tight cast aluminum housing. If desired, this housing can be secured with special theft proof bolts for optimum security.

Collections become much easier to manage with the ability to temporarily interrupt service. Without the need for a costly service call to the subscriber's home, collection work can be handled at your convenience by telephone, and in a timely manner.

A system "audit" may be performed at any time in a matter of minutes. Simply send out command signals which will put your system into the desired status and record what was done. With the addition of a computerized billing system to the Access I system, the entire audit and a hard copy record can be made before you begin the day's work.

In our discussion of the Access I system we have tried to highlight some of the financial advantages of using this method of service control, and to outline the technical features in such a manner that the concepts can be appreciated in a CATV system environment.

The cost of installing an Access I system can be amortized in many CATV plants in less than three years - could your system be ready for Access I? **GED**

Just Another Pay TV Trap? **NO WAY!** **EAGLE** has THE Notch-Filter for YOUR System!



DROP-COLLAR INSERTS

EAGLE ALSO HAS:

- Scramblers (all channels & midband).
- Outdoor (pole mounted) descramblers.
- Security Shields.
- Band Pass Filters.
- High Pass & Low Pass Filters.
- Wide Band Traps.
- F.M. Filters.
- Citizen Band Filters.
- Special Application Filters.

FEATURES:

DESCRAMBLERS & TRAPS MOUNTED OUTDOORS

(out of the hands of the subscriber, accessible for servicing and inspection).

SECURITY

Tamper proof shields over all units.
Special special tools for installing & removing.

TEMPERATURE STABLE

Temperature compensated for maximum notch stability over wide range of temperatures.

ANTI-CORROSION

Thick wall brass housing, nickel plated.

SHOCK RESISTANT

Rugged construction & potted to stabilize circuitry mechanically & electrically.

NO EGRESS WORRIES!

CALL OR WRITE FOR DATA OR SAMPLE:



(315) 638-2586
P.O. Box 93
Phoenix, N.Y.
13135

IN MEMORIAM

Bud Desmond has been an employee of Times Wire and Cable for 17 years. In the course of his work with us, he functioned in many capacities, primarily as sales and marketing manager, concentrating on the CATV market. In that capacity, he had the opportunity to function with the National Cable Television Association in many activities.

More importantly, however, in all of the business deals that I have ever seen Bud Desmond involved in, his sense of fairness and consideration of the person or company sitting on the other side of the table from him was most impressive.

We will all miss his counsel, his fellowship and his knowledge in the years to come.

—Larry DeGeorge

Freeman F. (Bud) Desmond, director of marketing for Times Wire and Cable, passed away suddenly from a heart attack on Saturday, January 14th, at his home in North-Haven, Connecticut. His wife Muriel and their two daughters, Michele and Sharon, were with him. Bud was 49 years old.

Bud joined Times Wire in 1961 as eastern regional sales manager, and during his 17 years with the company had made a steady rise through the sales and marketing divisions. In 1967, he became product manager for connectors. The following year, Bud was appointed northeast-CATV products. In the position of national

On March 30, 1974, director of marketing responsible for the marketing areas as keting functions for

From 1955 to 1961, Burndy Corporation. the National Cable and the Pioneers Club

Bud was born and raised in Newbury Port, Massachusetts, and attended Catholic University in Washington, D.C. He received his A.B. degree in English from St. Johns College in Brooklyn, New York.

All of the people in the cable industry who have worked with Bud, and all of his friends at Times Wire and Cable, have experienced a great personal loss in the death of Bud Desmond. He is survived by his wife and two daughters.



ern sales manager for 1969, he moved up to sales manager.

Bud was named di- for CATV products, development of new well as existing mar- the company.

Bud was with the He was a member of Television Association of the CATV industry.

Bud's been with Times for well over 15 years and he was very highly respected. It's going to be a very hard post to fill because he crossed into several lines. Frankly, everyone loved him. He had a tremendous rapport in the company and was exceedingly well liked by his associates, by his bosses, by the people under him and by the vendors he dealt with.

—Irving Kahn

Bud was one of the first acquaintances I met in the industry 20 years ago. It is always a sad occasion when a young industry like ours begins to lose good men like Bud. He will be sorely missed by all of us.

—Ken Gunter

Bud has been with Times Wire and Cable for over fifteen years and functioned first in OEM sales and then in CATV. He proved himself to be a very unique and effective salesman. He was a unique guy who could sell effectively and, at the same time, be loved and respected by his customers. He will be sorely missed at Times.

—Bill Lynch



Magnavox MX

4000 Addressable Tap with Remote Subscriber Control

By Joseph Ostuni, national product manager, Magnavox CATV Systems, Inc., Manlius, New York.

The MX 4000 is a cable-powered remotely-controlled subscriber service tap which combines several technologies to provide instantaneous access from a remote location to the level of service available to any individual customer.

Capability to Control

- Disconnection and reconnection of service to the cable subscriber
- Elimination of illegal connections that would have reconnected themselves
- Assures that disconnect list is completed
- A paid delinquent account can be reconnected immediately
- Pay-TV one channel or by adding a module it is possible for cable

operator to offer a second pay service.

The physical embodiment consists of:

- A conventional type directional coupler splitter tap
- A transformer input power supply
- A CMOS data processing section
- An array of broadband and band selection switching networks for subscriber control each of 4 ports.

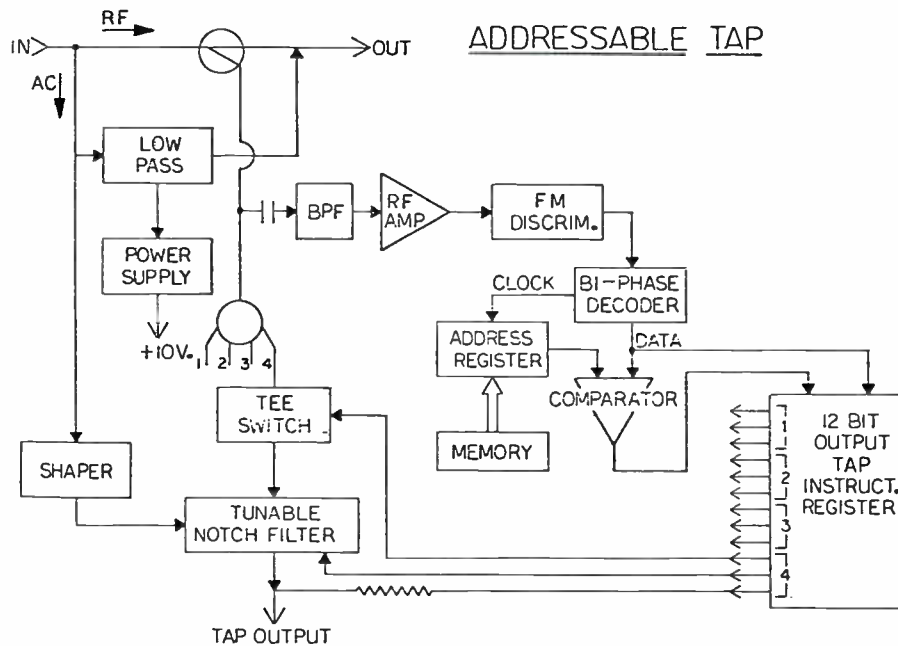

Figure 1

Equipment required:

- Keyboard which is entirely manual limited by the speed of the operator.
- OR a HP9815A terminal that previously has been loaded into a magnetic cassette with subscriber's address and level of service. With this unit a hard copy print out is also available.

The cable system that has a mini-computer used for accounting would have no difficulty adapting to a program to provide a method of addressing the RSC tap and print out the level of service of each subscriber.

Mechanical Embodiment

The MX 4000 is a two-piece unit consisting of a mounting/cable entry housing (top half of MX 3800 8-way tap) and a power/logic/control module. Standard features include seal-port entry connector receptacle, double "O" ring weather seal and plated brass "F" connectors with integral "pharmaceutical" closure seals. Second premium

channel control is achieved by securing an additional module over the subscriber output ports. As with all Magnavox equipment, the active module is completely strippable for quick field changeout.

The electronic networks are stratified onto three separate PC boards which can be arranged to form any desired combination of tap value, control channel, number of ports, pilot frequency, number of channels, etc.

Functional Routines

Passive tap section

A ferrite coupled directional tap and splitter combination is used in a conventional way to obtain four subscriber outputs over the frequency range of 5 to 300 MHz. Power diplexing filters are also used to provide an isolated power source for the DC supply.

Power supply section (In-tap housing)

AC line voltage is converted to necessary DC by a loosely-couple transformer which provides basic surge protection. Additional surge control is

accomplished by a 130 volt MOV voltage variable resistance. Voltage regulation is established by simple-series pass regulation which is capable of sustaining an output short circuit.

The Magnavox patented undervoltage regulation feature is also used to provide ripple-free DC.

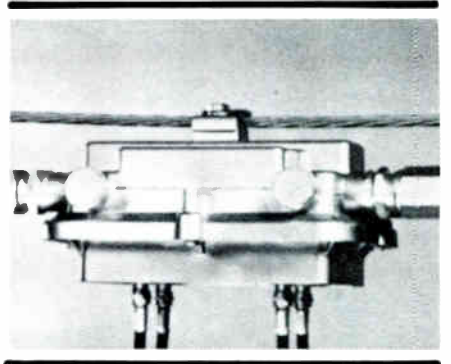

The Magnavox system utilizes only as many addressable taps as needed

Power Supply/Receiver

These two functions are done on the top level board. Also, RF signals are routed through a conventional directional coupler and power passing network. An isolation step-down transformer, with decoupled secondary, provides a high degree of surge protection. A zener stabilized series regulator also assures additional voltage and surge control.

The receiver portion is a single IC chip which includes a high gain limiting amplifier, quadrature detector and buffer amplifier.

A 9V transistor battery is used during power outages and servicing for fail-safe retention of memory. A standard battery may be used for one-two years of life at low cost. A rechargeable Ni-cad unit will provide more than five years of service, but is expensive. A rechargeable alkaline cell is the most attractive from a cost/durability consideration. Note—a trickle charge of 1 mA is continuously applied to the standby battery.

Data processing section (See Fig. 1)

The subscriber's address is converted into a binary encoded form. The address and level of service data is modulated on an RF carrier, the frequency of which can lie anywhere with the pass band of the amplifier used in the system.

In the tap, the data processing begins with a narrow band RF filter and FM integrated circuit receiver which are coupled after the directional tap for negligible thru-line loading. The insertion loss of the addressable tap is equal to a standard passive directional

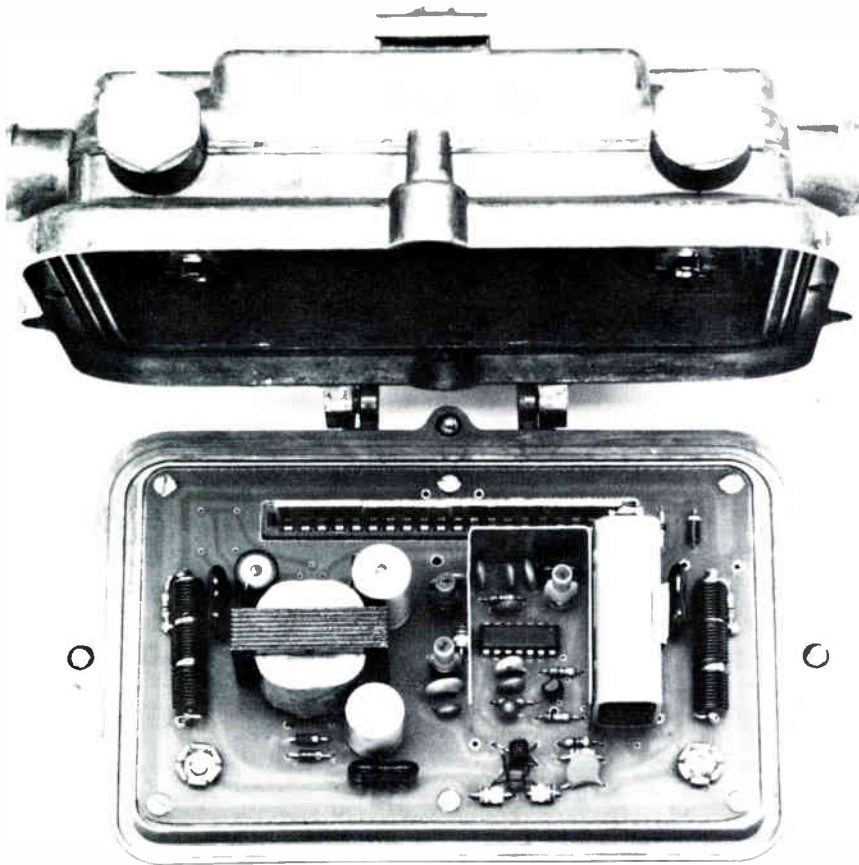

Magnavox' new addressable tap is designed for computerized subscriber control systems' basic and/or premium service.

EXTRA! EXTRA! TEXSCAN FAMILY LOCATED

Search Ends

An extensive search for a full service CATV company has come to a successful conclusion.

Texscan Corp. provides a full range of CATV products; line amplifiers, passives and test equipment. Texscan also provides industry technical training seminars.

The goods are produced in

Indiana and Arizona, with full national marketing services via direct regional sales personnel.

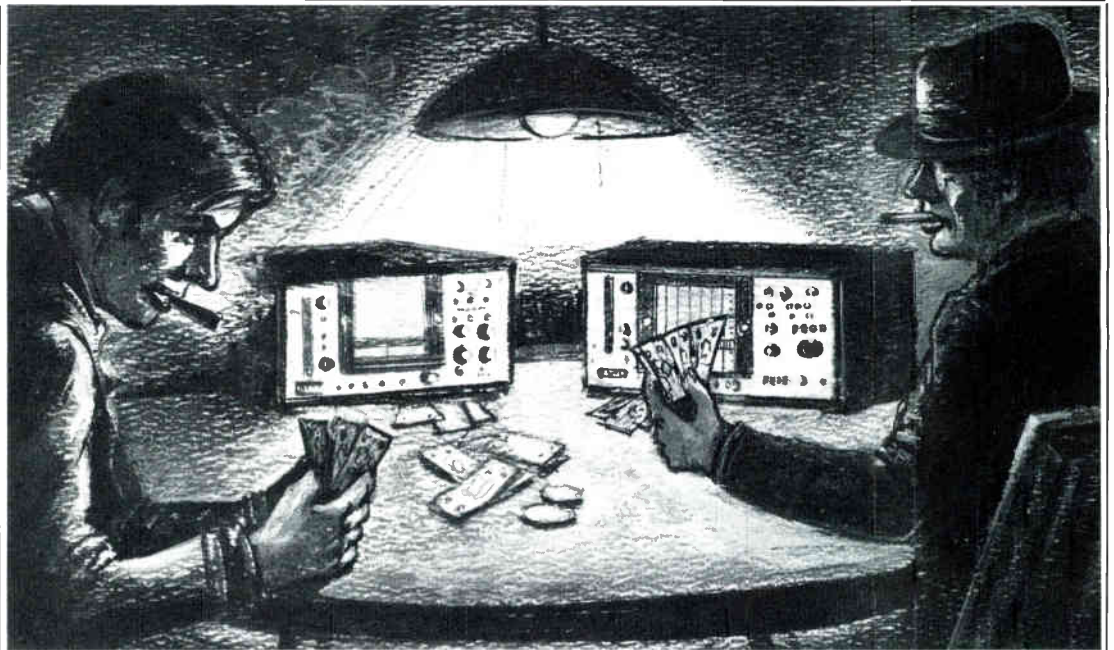

TEXSCAN says—"Take our Family to meet your Family—or Else!"

MUG SHOTS OF "THE FAMILY!"



TFC-7

Frequency Counter

The tuned frequency counter is wanted for system proof of performance, video demodulation & precise, counted variable marker functions.

This versatile instrument provides both preselector/stripper functions with a broadband 5-300 MHz counter.

Description:

- All channel performance
- 0 dBmV sensitivity
- Accurate
- Variable gate time

Wanted for \$1900



VSM-5A

Spectrum Analyzer

The VSM-5A is wanted for complete spectrum analysis requiring phase lock and narrow resolution bandwidths. This instrument is capable of all FCC proof of performance measurements except system flatness.

Description:

- 4-350 MHz
- Crystal markers
- Amplitude calibrator
- -50 dBmV sensitivity
- Battery operated portable

Wanted for \$3995

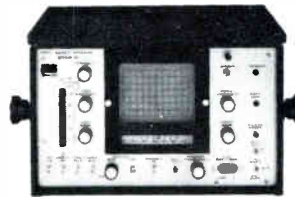

9550T&R

"Simo" Sweep

The simosweep twins are wanted for precise system alignment and balance.

Description:

- +60 dBmV output
- ±0.25 dB flatness
- Remote triggering
- Battery operated
- Long persistence
- Variable frequency marker
- Storage interface

**Wanted for: "T" \$995
"R" \$1950**

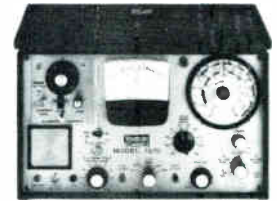

7270

Field Strength Meter

The 7270 is wanted for accurate level measurements. The new (pat. pend.) peak detector and rotary attenuator are identifying marks for this accurate (typically ±0.5 dB) instrument. The Ni-Cad battery provides more than 8 hours use on a charge.

Description:

- 8½" × 13¼" × 8¼" — 15 lbs.
- 5-216 MHz
- 10 μV sensitivity
- Rugged construction

Wanted for \$895

These instruments have "records" of proven reliability under adverse field environments. They have been on the loose for at least 5 years.

There are other members of the gang, such as frequency counters, sweep generators, oscilloscopes, bridges, attenuators, filters and passive components, as well as distribution amplifiers and passives.

To apprehend members of the Texscan family: Write or Call

Texscan

Texscan Corp.
2446 N. Shadeland Ave.
Indianapolis, IN 46219
(317) 357-8781

For Your CATV Distribution Needs:
Theta-Com Div. Texscan Corp.
2960 Grand Ave.
Phoenix, AZ 85017
(602) 252-5021 or 800-528-4066

Overseas
Texscan
Northbridge Rd.
Berkhamstead
Hertfordshire
England, UK

tap. Following the receiver is a biphase decoder to separate clock information and data which were combined at the sending terminal. A permanent field-programmable memory periodically loads a clocked address register, the contents of which are sequentially compared to the received data word. Invalid addresses prohibit the instruction section of the data from entering the instruction register. Valid address instruction enters to refresh or change current register contents. The entire sequence requires 1.3 milliseconds per four-port tap. If basic service is being switched off, attenuation inserts 55 dB to

40 dB of attenuation to the port being addressed. This is not always sufficient. Therefore, we also jam the band that is being secured, which also eliminates the sound and video.

In the tap, a standby battery is diode-coupled to the logic and memory circuits to preserve instruction information during powerout intervals.

Digital Decoder/Address Comparator

The second board contains the necessary CMOS IC's to decode the receiver output. This system employs a 25 kHz phase locked loop which

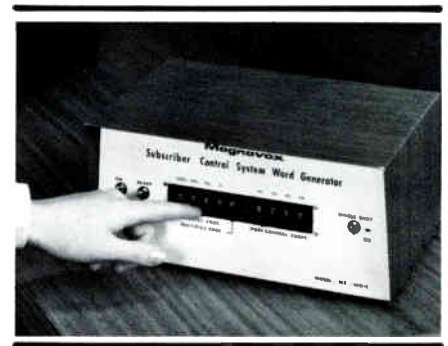

The addressable tap system uses a word processor generator that performs the same instant connect/disconnect function offered by expensive mini-computers, at a much lower cost.

separates the incoming FSK signal into data and timing information.

An address comparison register checks transmitted address characters against predetermined plug-in values (15 bits total), corrects correlation between memory and data addresses and permits passage of a sixteen bit instruction word. The first four bits contain the multiplex code for the apartment control unit (MX 4400). These bits are disregarded in the MX 4000. The remaining 12 bits are directed, three bits each to the four subscriber ports. Functions controlled are (1) basic broad band service (a prerequisite for premium channel service), (2) premium independent control of two channels (if unit is equipped for such control).

Subscriber Control

The bottom board accepts RF and control signals as inputs and directs appropriate service to each of the four ports.

Basic service is controlled by a pin diode network which has less than 1 dB loss in the service mode and modulates between 10 and 35 dB typically in the disconnect mode (60 Hz modulation frequency). The resulting "scrambling" is independent of tap output levels and often produces results better than attenuation alone.

Premium service is controlled by a trap technique. As in basic service control, a narrow band notch to all-pass transformation is made at a 60 Hz rate to produce a form of video scrambling. In normal trapping techniques, 40 to 50 dB depth is required to produce sufficient picture impairment. Temperature stability is also essential. With the "modulated trap," 30 dB produces highly impaired reception. The narrow band width of ± 2 MHz also permits use of adjacent channels. CED

ComSonics® COAXIAL RELAY THE BEST IN THE BUSINESS



FEATURES

- High isolation
- Virtually no insertion loss
- No third order distortion
- Excellent return loss (VSWR)
- Single polarity control voltage
- Two switching methods available

TYPICAL SPECIFICATIONS

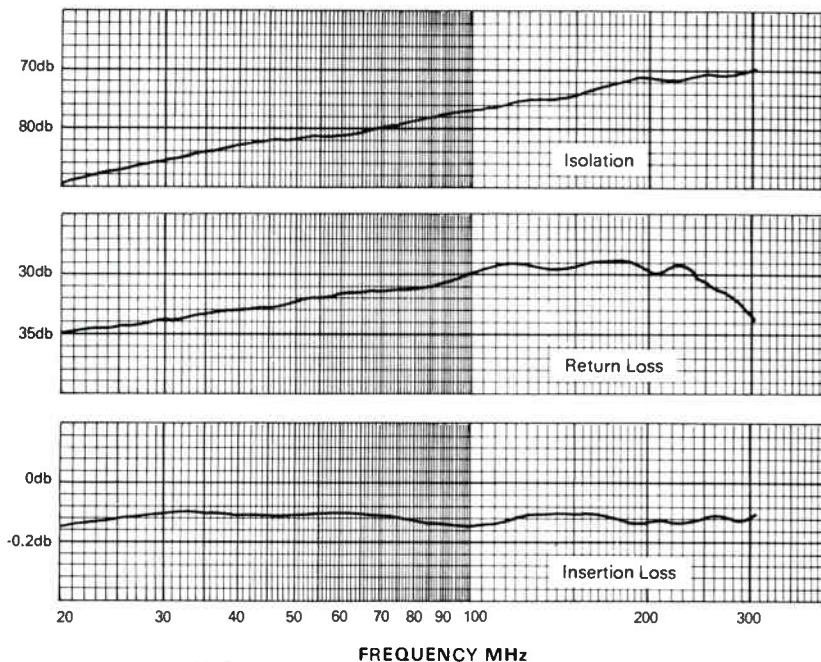

ComSonics, Inc.®

P. O. BOX 1106 • HARRISONBURG, VIRGINIA 22801 • 703-434-5965

THE ONLY TAP OF ITS KIND

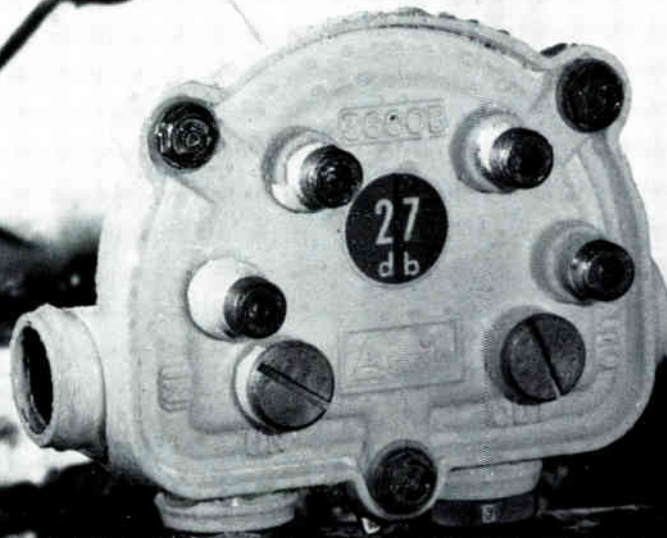

MOISTURE SEALED & CORROSION RESISTANT

AND ONLY \$7.25 (5.50*)

No other tap provides this protection:

- Baked-on, Polyurethane Finish plus a Totally Water Sealed Assembly
- Patented Non-Shearing Center Seizure Mechanism ● Modular ● 5-300 MHz
- Eye-level Center Seizure Connections ● *With a standard irridite finish

ARVIN/CATV

ARVIN SYSTEMS, INC. An Arvin industries Subsidiary
P.O. Box 200, Lancaster, Ohio 43130 • 614/756-9222

For Delivery—Call

Cablevision Equipment Company
Garland, TX 75042
214-272-8551

Signal Vision, Inc.
El Toro, CA 92630
714-586-3196

Comm-Plex Electronics
Montreal, Quebec CANADA H4P1V4
514-341-7440

Emjay Electronics
Drexel Hill, PA 19026
215-284-6338

John Weeks & Assoc.
Lawrenceville, GA 30245
404-963-7870

Pay-TV

EEG's R-X LOCK Parental Control Trap for Pay-TV Channels

EEG Enterprises Inc. now has available the model TRX - 101 R-X LOCK, a lock switchable CATV trap, which permits parental control of pay-TV channels. R-X LOCK traps the picture carrier of the pay-TV channel by more than 55 dB, effectively eliminating both picture and sound for that channel when the subscriber so desires. The lock has a quality 5 tumbler, die-cast cylinder. The input F connector is protected by the security shield supplied on the assembly. The unit mounts with 2 screws or double sided tape which are also supplied.

R-X LOCK is presently available for channels 2, 3, 4, 5, 6, and A and is priced at \$13.00 in quantities under 100.

Power Supplies

Dynascan Introduces Low-Distortion Function Generator for Only \$175

Dynascan Corporation has just announced the introduction of a low-distortion B&K-PRECISION function generator. B&K-PRECISION's new model 3010 function generator offers convenience and excellent waveform accuracy at an affordable price. Frequency coverage is unusually wide, spanning 0.1 Hz to 1 MHz in six ranges, with each range providing linear 100:1 frequency control. The 3010 generates sine, square, TTL square and triangle waveforms.

Range and function selection is push-button controlled for fast, error-free operation. Frequency generation originates from a stable voltage-controlled oscillator (VCO) which can be varied on each range by the front-panel FREQUENCY control or the VCO external input. If a 0 to 5.5v ramp is applied to the VCO external input, the 3010 will provide a 100:1 output frequency change. When used in this manner, the 3010 can serve as a sweep generator for response measurements in audio and I-F circuits. When an audio signal is applied in place

of a ramp, the 3010 will produce a direct FM output.



AM Compressor/Limiter Optimizes Modulation Levels

Broadcast Electronics has introduced the model AM-400 AM Compressor/Limiter. Designed for smooth, noise-free control of transmitter input levels, the AM-400 protects against overmodulation while automatically maintaining average modulation at optimum levels.

This unit features an adjustable compression release time (5 to 40 seconds for 20 dB release), symmetrical or asymmetrical processing, one microsecond attack time and a +20 dBm output capability. Switch selectable operating modes include: compression and limiting; compression only; or fixed gain conventional amplifier.



New VIZ Wattmeters Are Easy to Use, Highly Accurate

VIZ Test Instruments Group of VIZ Mfg. Co. has introduced two new easy-to-use wattmeters that are ideal for testing ham, vhf, fm, and even uhf transmitters as well as popular cb units.

The WV-551A dummy-load rf wattmeter has a broad frequency range—from 1.9 to 512 MHz. Its power range is 0.5 to 15W with full-scale accuracy better than 5 percent. Input impedance is 5 ohms \pm 2 percent, and VSWR is less than 1.15 at 500 MHz. It is simple to use: the transmitter output line is connected directly to the unit and readings are taken

from a taut-band meter. The user price is \$60.00.

The WV-552A in-line rf wattmeter is a dual taut-band meter unit used to measure forward and reflected power—especially useful in matching and adjusting ("tuning") transmitters to antennas for optimum power output. One side of the meter is connected to the transmitter and the other side to the antenna lead. Readings are then simply taken from the two easy-to-read meters.

Miscellaneous

Valtec Announces First Fiberoptics General Purpose Cable

Valtec Corporation has announced the PC 10, the first general purpose fiberoptic communication cable. The PC 10 is a single large-core plastic-clad silica fiber enclosed in a rugged dielectric jacket.

PC 10 can be used for high bandwidth optical transmissions over distances ranging from a few inches to two kilometers. Some of the applications are computers, avionics, cable television, field cable, telephone communications, industrial control, process control in explosive atmospheres and shipboard data transmissions.

Valtec states that PC 10 is the most economical cable currently available, with a cable price of \$1 per meter, and low-cost connectors and diodes readily available.

New Microcomputer from Labtest

Labtest Equipment Company, has announced the availability of their model 300 microcomputer as a new product for the industrial small computer market. Designed around the Intel 8080 microprocessor CPU, it is offered specifically for use in dedicated systems, control, and other industrial applications requiring a very reliable computer. Having no front panel switches, it is self-contained in a rugged all-metal RFI enclosure, includes extensive RFI and noise filtering, comes completely assembled and tested with 10K memory, one I/O board, power panel, cables and connectors, 2 fans, power supply, I/O ports, and a 22 slot motherboard.

WHY THE MCE NOVA ADDRESSABLE TWO-WAY TAP? BECAUSE IT IS HERE. NOW.

The NOVA Cap-Tap (Controlled Access Point and Tap) is a fact today. Practical. Proven in actual service. Saving money on both standard and premium TV systems with up to 65,000 subscribers. Here is what Hank Lockhart, General Manager of Sammons Communication Company of Harrisburg, PA., has to say about this advanced product:

"The NOVA taps required no new hardware or special tools to install. In appearance, they're slightly larger than old-fashioned taps.

"Neither extreme temperatures nor lightning surges have affected their performance. In fact, in the six months since installation, no NOVA tap has required any service at all.

"The remote functions have worked perfectly, such as connect and disconnect; and Accounts Receivable has used conveniences such as clerical and installer time.

"We also have a better handle on piracy and illegal use of signal with the NOVA taps."

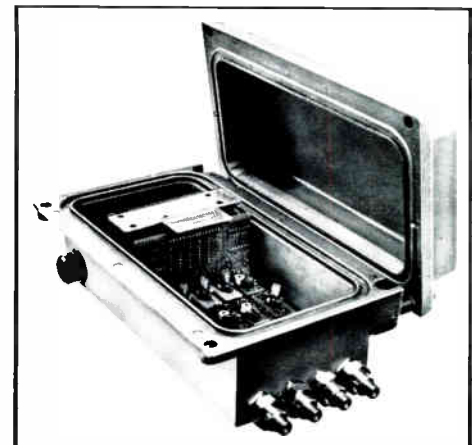

The all-new 5—300 MHz NOVA Cap Tap is useable with new and existing cable systems.

Address inquiries to:



**Merrill Cable
Equipment Corp.**

2949 West Osborn Road
P.O. Box 13741
Phoenix, Arizona 85002

A Question of Control

By Thomas L. Gimbel, P.E., director of engineering.
UA-Columbia Cablevision of New Jersey.

UA-Columbia Cablevision of New Jersey is franchised to operate in thirty-five communities in northern New Jersey.

Today, the system consists of 725 miles of plant serving 26,000 subscribers. When construction is completed, the system will consist of approximately 1,500 miles of cable plant which will pass nearly 250,000 homes.

UA-Columbia Cablevision has flourished in the number one broadcast market achieving nearly a 50 percent penetration of its cable service even though eleven channels are available off-air to subscribers who can see the New York City skyline.

The reason for such success in this extremely competitive entertainment market is the original programming, only available on the cable: local news, sports, computer data channels including wire service news and stock reports as well as Madison Square Garden Sports and special first-run movies, nightclub acts and special entertainment features. However, the realization of this success has been an engineering feat. A large system involving many components, processes and people had to be joined together and coordinated through a system of control.

The delivered pictures have to be of the highest quality, backed by reliable service as well as skilled and courteous company personnel. The company quality assurance program maintains this standard.

The quality assurance program applies to each step of the system construction, drop installations and maintenance.

Selection of hardware and equipment is done on the basis of an approved vendor list. All components considered for use by the system are evaluated by the UA-Columbia corporate engineering lab in San Angelo, Texas, and only listed after passing rigorous environmental and reliability testing. Matching transformers are selected as carefully as are the headend processors. The overall system integrates the use of microwave, conventional cable as well as special telephone lines for combined usage of broadcast channels, data transmission, locally originated programs and special Madison Square Garden and Home Box Office feeds.



UA-Columbia's channel 3 control room.

Construction contractors are controlled by use of a Standard Practice Manual, which describes in detail how to properly install an "F" fitting, warehouse trunk cable and which tool to use in forming an expansion loop.

Once the standards are set, evaluation of performance is done continually by inspectors or auditors and corrections made when necessary. The construction turnkey contractor is monitored by two full time construction supervisors who continually inspect for adherence to the standard practices.

A drop inspector monitors the performance of the contract installers. Records are kept of individual craftsman's performance and discrepancies are corrected immediately.

A telephone auditor contacts a sample of the customers visited by the in-house service force to insure proper resolution of the problem and subscriber satisfaction.

An independent quality control technician routinely monitors and records system electrical performance at predetermined test points throughout the system to assure the effectiveness of the system maintenance program. He also visually inspects the plant for mechanical deficiencies such as broken lashing wire.

Failure analysis is performed on all defective components removed from service to determine the cause of failure and to develop modification which will prevent future failures. Component manufacturers are informed of the failure data and are generally anxious to make the required product improvements.

To be successful in the number one broadcast market requires a daily recommitment to operate the most reliable and well maintained cable system possible.

Keep it Simple! (And save money)

There is an alternative to the pin type connector. It's the LRC pinless feed thru connector.

It has fewer parts and is simpler to manufacture. Therefore, it is less expensive.

Of course, LRC manufactures both center pin and feed thru connectors. But, which one should you consider installing? To get the answer, simply discuss the engineering aspects of your system with the connector specialists at LRC.

It's just that simple.

LRC
The CATV Connector Specialists.

LRC ELECTRONICS, INC.

901 SOUTH AVE., HORSEHEADS, N.Y. 14845 PHONE 607-739-3844
AVAILABLE IN EUROPE THRU: Electro Service N.V., Kleine Nieuwendijk 40, B 2800 Michelen, Belgium
CANADA THRU: Electroline TV Equipment, Montreal, Quebec

Broadcast Satellites - Friend or Foe of the Cable Industry

By Kenneth Hancock, Director of Engineering, CCTA

Over the past few months a number of articles have appeared in the media both in Canada and in the United States on the effect of future broadcast satellites on the cable television industry. Most of these articles and programs have made such dire predictions as "when viewers can pick up the satellites direct from their roof top antenna they will no longer subscribe to cable" and "broadcast satellites mean the death of cable." This was perhaps good copy but not necessarily good sense. The purpose of this article is to take an objective view of what broadcast satellites will be able to do, where they fit into the evolutionary time scale of both the traditional broadcast industry and of the cable TV industry, and finally, what is likely to be the true impact of this new technology on the development of the Canadian cable television industry.

Space technology has improved significantly over the last decade, resulting in the current situation where domestic communications satellites have larger antennas and sufficiently high power to permit the use of ground stations with three to five meter dishes (16 to 26 feet) and comparatively inexpensive room temperature electronics. It is understood that in the United States the cost of a ground station for a single channel, including construction, is about \$17,000. In Canada at this time privately owned ground stations are not permitted. Obviously even a \$17,000 earth station is out of the question for home ownership. So, what is likely to happen in the future to permit inexpensive domestically owned satellite receivers? Two technological advances are expected to make this possible within the next ten years or so. The first of these is a change of frequency. Currently all *operational* communications satellites use the 6 GHz band for transmission and the 4 GHz band for reception. This creates two problems. The first of these is that the band is shared with terrestrial microwave systems with potential for interference between the two types of long haul transmission system, and the rapid saturation of the number of frequencies available for use.

The second problem is the comparatively long wave length of these signals. The gain of the parabolic antennas used is directly related to the size of the parabolic dish in wave lengths. If we decrease the wave length of the signals we can obtain equal gain with a smaller dish. To overcome both of these problems a new and smaller wave length has been allocated for the sole use of communications satellites. This is a 12 GHz band, the former being used for earth station reception and the latter for earth station transmissions.

The second technological development towards viability of broadcast satellites is one of higher powered satellites with higher gain antennas. The change to the shorter wave length gives the same antenna advantage to the satellite as it does to the ground stations. Unfortunately it also creates the problem of obtaining higher or equal power. Generally speaking the higher the frequency the more difficult it is to amplify. Despite this there has been considerable progress towards higher power 12/14 GHz satellites. The most obvious example of this is the joint American-Canadian experimental Hermes satellite which operates in the 12/14 GHz band with a 200 watt amplifier. This compares with the operational satellites of approximately 20 watts in the 4 to 6 GHz band.

Hermes has been used for broadcast satellite experiments including the reception of television programs on a 60 centimeter

(21 inch) antenna located on a desk adjacent to a window in an 18 floor office building. There is little doubt that within the next ten years we will see communications satellites orbited that will permit reception on dishes between one foot and two feet in diameter. These will feed directly into a domestic television receiver with the total satellite receive station, including dish, costing \$100 to \$200.

However, before readers go out and sell their shares in cable companies or look for new jobs, let us look at the likely evolution to this stage and the total impact on cable subscribers.

First of all, what are the advantages occurring from satellite distribution? The first advantage is the wide distribution obtainable on a reliable basis without tremendously high power terrestrial broadcast transmitters. The broadcaster could lease high power transponder channels, one directed to the east and one directed to the west, and provide an acceptable signal to every Canadian. At the cost of \$1.5 to \$2 million dollars per transponder channel per year, this would probably be the most cost effective for networks. The quality would be high and interference from other stations zero. This sound like a utopian situation. But what is so different from what is happening at the moment? The high population areas can already receive the same networks from their local stations using rabbit ears or small antennas. As all cable licencees know most people want more than this. They want a wide range of choice. They want community channels. They are prepared to pay their \$6 or so a month to receive this wide choice of services. The broadcast satellite will do nothing to change this situation.

What it will do is to bring TV, albeit only a few channels, to those areas of Canada for which it is uneconomical to provide cable distribution. The far North is an obvious user of a direct-to-home broadcast satellite. For the rest of Canada, that part of Canada that the Canadian cable TV industry sees as its market, broadcast satellites will have the same impact as one more off-air broadcaster becoming available. Current subscribers are unlikely to go out and pay \$100 to \$200 for a direct-to-home satellite converter to receive CBC, CTV, Global or even a single channel of completely new programming. The subscriber knows that he will get it on cable anyway. For those areas uneconomical for cable at the moment, certainly the direct broadcast satellite will be a boom, and will perhaps reduce the social pressure on cable companies to distribute to isolated areas.

Keep in mind that the scenario given in the previous paragraph is based on a direct-to-home broadcast satellite being in operation. This is likely to be an evolutionary rather than a revolutionary process. The next step will be higher powered satellites requiring a one or two meter dish, ideal for use by cable companies but too expensive for the home owner. This will permit even small cable companies to use the satellite. One can envision a whole range of "cable only" services being carried on the satellite, probably in pay-TV or premium service form, that will permit cable TV subscribers an even wider selection of programming. Such a ground station would probably cost 3 to 5 thousand dollars and enable the cable company to access major new revenues. This phase will take place before the full broadcast satellite phase and will allow even further consolidation of the cable subscriber base.



Help Wanted

Chief Engineers

American Television and Communications Corporation offers a growth opportunity for experienced cable TV engineers who want to become part of the company's aggressive management team.

ATC is seeking people to fill chief engineering positions in several of its major metropolitan area systems located in the East and Southeast.

Assume overall technical responsibility for modern cable facilities featuring . . .

- 500+ miles of active plant
- operational pay-TV
- active two-way services

Solid technical experience and demonstrated administrative ability will make you qualified for top salary/benefit-package and future growth.

Send your resume and salary requirements to:

Larry Janes
Director, Field Engineering
American Television & Communications
20 Inverness Place East
Englewood, Colorado 80110

An Equal Opportunity Employer

RESEARCH ENGINEER

PhD in Communications Engineering; duties involve research into signal processing techniques for image transmission of medical data. Applicant must have one to two years proven experience organizing and working on communication research projects; have published articles on subject. Salary \$19,000/yr., 40 hrs/wk. Research to be in Bethesda, Maryland at NIH facilities. Send resume to:

Director
Bioengineering Program
213 EE Building
University of Missouri
Columbia, MO 65201

CHIEF ENGINEER

Connecticut System seeks Chief Tech to assume full responsibility for maintenance and technical operations of a new system presently under construction. Must have Head End, supervisory and system maintenance experience. Microwave and F.C.C. license a plus.

Send confidential resume and salary requirements to:

Larry Noon
P.O. Box 685
Worcester, MA

or call 617-799-6430

TECHNICIAN WANTED

Mid-West system looking for working technician to maintain aerial and underground system with 4,000 subscribers. Salary commensurate with experience. Good potential. Resume held in confidence. Reply to Box C-ED-0116-4.

TECHNICIAN

250-mile Seattle area system with Sylvania and Kaiser equipment needs experienced CATV line technician to run service calls and perform system maintenance. 2 to 3 years cable experience with formal training in electronics. Salary commensurate with experience. Send resume to:

Bob Watson
Chief Tech
Liberty TV Cable
533 Main Street
Edmonds, WA 98020

CATV TECHNICIANS

Major MSO is seeking experienced technicians. Duties include trouble shooting and field maintenance. Construction and microwave experience with Second Class FCC License preferred. Excellent company benefits. Send confidential resume and salary requirements to:

H.R. Null
Director of Engineering
Storer Cable TV
P.O. Box 1178
Sarasota, FL 33578
(813) 371-6700 Ext. 226

An Equal Opportunity Employer

Business Directory

RONALD C. COTTEN & ASSOCIATES

Professional Engineers
ENGINEERING MANAGEMENT AND CONSULTATION

Phone: 303-770-4175

5726 S. Jamaica Way Englewood, Colorado 80110

Ad Index

Arvin/CATV.....	13, 29
Cerro Communication Products .	15
ComSonics	28
Delta-Benco-Cascade	8
Eagle Comtronics.....	23
Gamcor	11
Hughes Microwave	5
LRC Electronics	32
Magnavox	18, 19
Merrill Cable Equipment	31
Mid State Communications	17
Oak Industries	2
RMS Electronics.....	36
Sadelco	26
Scientific-Atlanta	20
System Concepts.....	16
Texscan	27
TRW RF Semiconductors	7
Vitek Electronics.....	35



Jerry Conn Associates, Inc.

MANUFACTURERS' REPRESENTATIVES TO THE CABLE INDUSTRY

P.O. Box 444
Chambersburg, Pa. 17201

Call (717) 263-8258 or
(717) 264-5884

Have you ever wanted reprints of an article or an ad? We will be glad to supply you with them. For more information about quantities and rates, contact: Sandra Carpenter, Titsch Publishing, Inc., P.O. Box 4305, Denver, CO 80204



Or...

**How to sell
much more
by offering
much more
without
paying
much more!**

It stands to reason that if you could offer Multi-Pay (a choice of two or more) services to each home passed, you'd have a much better chance of selling one or more of the services for a substantial increase in penetration of homes passed.

If you could do it without appreciably increasing your costs . . . would you? Of course you would . . . but can you? Of course you can!

VITEK's New Multi-Channel Traps are the answer for both new and existing systems. You already know VITEK's Cable Traps (the industry standard) are the best for Pay TV Security. They prevent theft of Pay TV Service *at the pole*. . .

Now, with VITEK's Multi-Channel Traps, you have the recognized advantage of having cable-traps on the pole plus the added advantage of being able to offer Multi-Pay service.

Plan your installation with VITEK's Multi-Channel Traps and offer 2 or more levels of pay-service. If you're offering three levels of pay-service

and you sell one of the three . . . replace the "Multi" with a "Dual-Channel Trap" and pass the selected service *only*. If you sell two out of three, replace with a Single-Channel Trap and pass the other two. If you can sell 'em all three, remove the Trap and that's all there is to it. *You'll smile all the way to the bank.*

Typically, the cost of installing VITEK Dual or Single Channel Traps are written off in a few months against income. And, remember . . .

All VITEK Cable Traps look like regular drop cable, have superior environmental stability, durability and are maintenance-free.

For additional information on Multi-Level Service, or an analysis of costs for a system being planned, or to upgrade a present system, call or write: Paul Ellman

VITEK Electronics, Inc.
200 Wood Avenue, Middlesex, N.J. 08846
Tel: (201) 469-9400

VITEK

RMS UNIPOWER™ SERIES

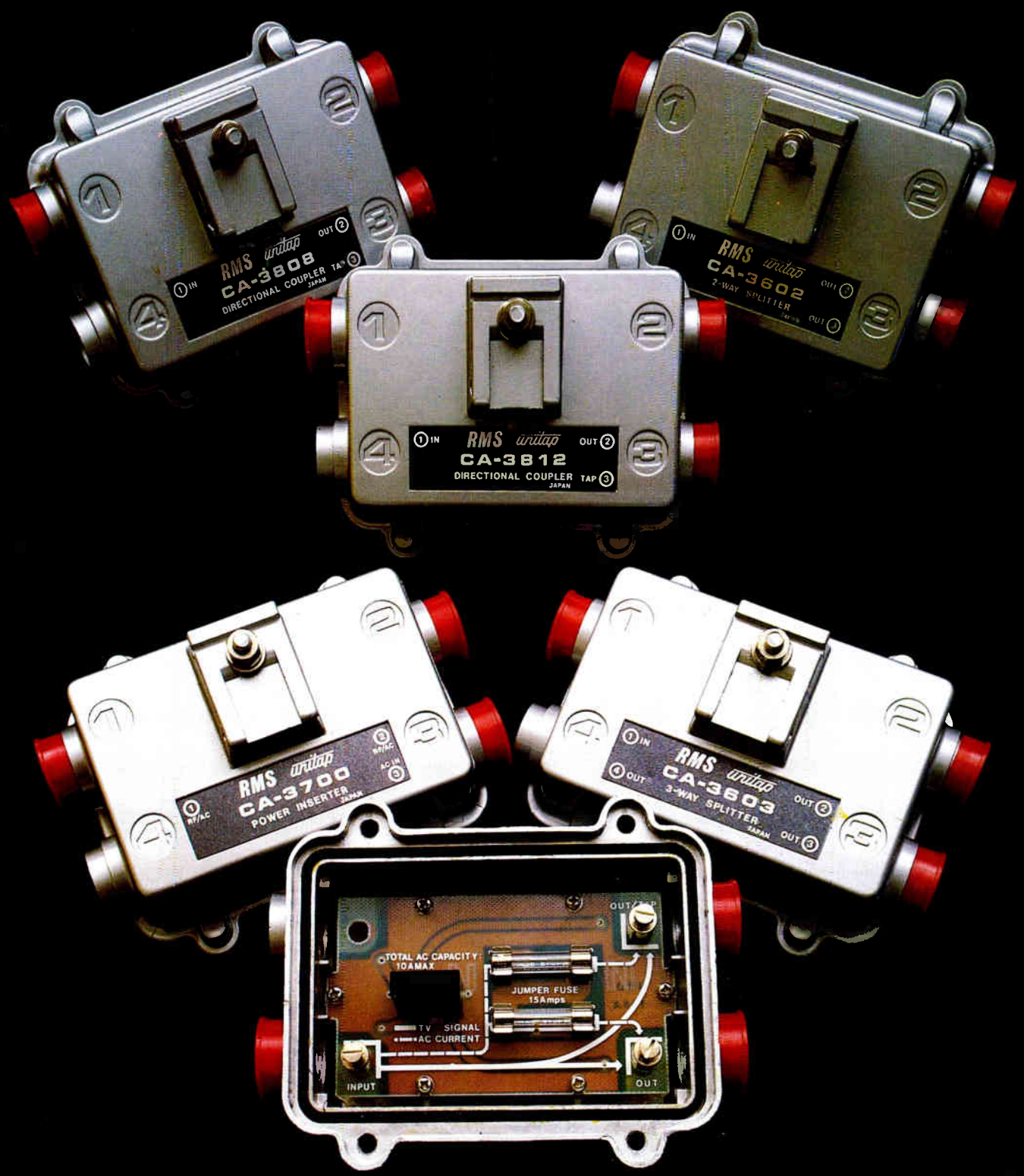

**RMS Unipower™ Series—It's Years Ahead.
Available immediately!**

RMS CATV DIVISION
ELECTRONICS, INC.

RMS ELECTRONICS, INC.
50 ANTIN PLACE
BRONX, NY 10462
CALL COLLECT (212) 892-1000