

BYTE

DECEMBER 1989

A McGRAW-HILL PUBLICATION



PRODUCT FOCUS:
HANDS-ON TESTS
OF SEVEN
CASE TOOLS

**BOLD
NEW
BREED**

LAPTOPS

Smaller, faster, lighter... better!



The Intel 80860

MIT's Media Lab

Understanding Protected Mode

Mac System 6.0.1 vs. OS/2 1.1

The Tenth Anniversary of the Spreadsheet:

Bricklin and Frankston on the Beginnings

Reed on the Future

REVIEWS

Five 32-bit Mac

Graphics Boards

QMS ColorScript 100

Project Scheduler 4

Watcom C 386

Toshiba T3100SX

Zenith SupersPort SX

GRIDPad

Toshiba T1000SE

Compaq LTE/286

\$3.50 U.S.A.
\$4.50 IN CANADA
0360-5280





THE DELL SYSTEM® 310
20 MHz 386.

The best combination of performance and value available in its class.

STANDARD FEATURES:

- Intel 80386 microprocessor running at 20 MHz.
- Choice of 1 MB, 2 MB, or 4 MB of RAM* expandable to 16 MB (using a dedicated high-speed 32-bit memory slot).
- Advanced Intel 82385 Cache Memory Controller with 32 KB of high speed static RAM cache.
- Page mode interleaved memory architecture.
- VGA systems include a high performance 16-bit video adapter.
- Socket for 20 MHz Intel 80387 or 20 MHz WEITEK 3167 math coprocessor.
- 5.25" 1.2 MB or 3.5" 1.44 MB diskette drive.
- Dual diskette and hard drive controller.
- Enhanced 101-key keyboard.
- 1 parallel and 2 serial ports.
- 200-watt power supply.
- 8 industry standard expansion slots (6 available).

**Lease for as low as \$131/month.
 △ Extended Service Plan pricing starts at \$251.

40 MB TTL Monochrome System	\$3,599
40 MB VGA Color Plus System	\$4,099
100 MB VGA Color Plus System	\$4,699
100 MB Super VGA Color System (800x600)	\$4,799

Prices listed reflect 1 MB of RAM. 150 and 322 MB hard drive configurations also available.

*Performance Enhancements (Systems 325, 310, and 316): within the first megabyte of memory, 384 KB of memory is reserved for use by the system to enhance performance. 4 MB configurations available on all systems. Call for pricing.



THE DELL SYSTEM® 316
16 MHz 386SX™

Expandable, affordable access to 386 architecture.

STANDARD FEATURES:

- Intel 80386SX microprocessor running at 16 MHz.
- Choice of 1 MB, 2 MB, or 4 MB of RAM* expandable to 16 MB (8 MB on the system board).
- Page mode interleaved memory architecture.
- VGA systems include a high performance 16-bit video adapter.
- LIM 4.0 support for memory over 1 MB.
- Socket for 16 MHz Intel 80387SX math coprocessor.
- 5.25" 1.2 MB or 3.5" 1.44 MB diskette drive.
- Integrated high performance hard disk drive interface and diskette controller on system board. (ESD) based systems include a hard disk controller.)
- Enhanced 101-key keyboard.
- 1 parallel and 2 serial ports.
- 200-watt power supply.
- 8 industry standard expansion slots (7 available).

**Lease for as low as \$98/month.
 △ Extended Service Plan pricing starts at \$234.

40 MB TTL Monochrome System	\$2,699
40 MB VGA Color Plus System	\$3,199
100 MB VGA Color Plus System	\$3,799
100 MB Super VGA Color System (800x600)	\$3,899

Prices listed reflect 1 MB of RAM. 150 and 322 MB hard drive configurations also available.



THE NEW DELL SYSTEM® 210
NETSTATION 12.5 MHz 286.

Its price, performance and expandability make it an ideal choice as a network workstation.

STANDARD FEATURES:

- 80286 microprocessor running at 12.5 MHz.
- Choice of 640 KB, 1 MB or 2 MB of RAM expandable to 16 MB (6 MB on system board).
- Network interface card.
- LIM 4.0 support for memory over 640 KB.
- Integrated diskette and high performance 16-bit VGA video controller on system board.
- Socket for Intel 80287 math coprocessor.
- 5.25" 1.2 MB or 3.5" 1.44 MB diskette drive.
- Integrated high performance hard disk interface on system board.
- Enhanced 101-key keyboard.
- 1 parallel and 2 serial ports.
- 3 full-sized 16-bit AT expansion slots available.

**Lease for as low as \$61/month.
 △ Extended Service Plan pricing starts at \$180.

Diskless with Ethercard Plus and PCOM	\$1,609
Single Diskette Drive and Ethercard Plus	\$1,678
20 MB hard disk with Diskette Drive and Ethercard Plus	\$1,978

Prices above reflect 640K of RAM. 40 MB and 100 MB hard disk configurations also available. 3COM's Etherlink II and Tokelink cards also available for netstation configurations. Please call for pricing.



THE NEW DELL SYSTEM® 210
12.5 MHz 286.

The price says this is an entry-level system. The performance says it's a lot more.

STANDARD FEATURES:

- 80286 microprocessor running at 12.5 MHz.
- Choice of 512 KB, 640 KB, 1 MB, or 2 MB of RAM expandable to 16 MB (6 MB on system board).
- Page mode interleaved memory architecture.
- LIM 4.0 support for memory over 640 KB.
- Integrated diskette and high performance 16-bit VGA video controller on system board.
- Socket for Intel 80287 math coprocessor.
- 5.25" 1.2 MB or 3.5" 1.44 MB diskette drive.
- Integrated high performance hard disk interface on system board.
- Enhanced 101-key keyboard.
- 1 parallel and 2 serial ports.
- 3 full-sized 16-bit AT expansion slots available.

**Lease for as low as \$64/month.
 △ Extended Service Plan pricing starts at \$190.

20 MB VGA Monochrome System	\$1,699
20 MB VGA Color Plus System	\$1,999
40 MB VGA Monochrome System	\$1,899
40 MB VGA Color Plus System	\$2,199

Prices listed reflect 512 KB of RAM. ††640 KB versions of the above systems are available for an additional \$80. 100 MB hard drive configurations also available.

All prices and specifications are subject to change without notice. Dell cannot be responsible for errors in typography or photography. **Payments based on a 36-month open-end lease. †Leasing arranged by Leasing Group, Inc. In Canada, configurations and prices will vary. DELL SYSTEM is a registered trademark of Dell Computer Corporation. Microsoft, MS, MS-DOS and NENIX are registered trademarks owned by Microsoft Corp. Intel is a registered trademark; 386 and 386SX are trademarks of Intel Corporation. UNIX is a registered trademark of AT&T. Dell UNIX System V is based on INTERACTIVE Systems Corporation's 386ix. †† Signifies trademarks of entities other than Dell Computer Corporation. ‡Service provided by Xenix Corporation. On-site service not available in certain remote locations. ©1989 Dell Computer Corporation. All rights reserved.

SAVE NOW ON THE DELL SYSTEM® 325 25 MHz 386.
 AN EVEN BETTER VALUE AT THESE NEW LOW PRICES.

STANDARD FEATURES:

- Intel 80386 microprocessor running at 25 MHz.
- Choice of 1 MB, 2 MB, or 4 MB of RAM* expandable to 16 MB (using a dedicated high-speed 32-bit memory slot).
- Advanced Intel 82385 Cache Memory Controller with 32 KB of high speed static RAM cache.
- Page mode interleaved memory architecture.
- VGA systems include a high performance 16-bit video adapter.
- Socket for 25 MHz Intel 80387 or 25 MHz WEITEK 3167 math coprocessor.
- 5.25" 1.2 MB or 3.5" 1.44 MB diskette drive.
- Dual diskette and hard drive controller.

- Enhanced 101-key keyboard.
- 1 parallel and 2 serial ports.
- 200-watt power supply.
- 8 industry standard expansion slots (6 available).

**Lease for as low as \$153/month.
 △ Extended Service Plan pricing starts at \$370.

40 MB VGA Monochrome System	\$4,199
100 MB VGA Color Plus System	\$5,099
100 MB Super VGA Color System (800x600)	\$5,199
150 MB Super VGA Color System (800x600)	\$5,699

Prices listed reflect 1 MB of RAM. 322 MB hard drive configurations also available.

All systems are photographed with optional extras.

Technically speaking, the Dell System® 325 is one of the most advanced 386™ computers available. And, according to PC Magazine, it's one of the most advanced 386 computers they've ever tested.

In benchmark after benchmark, the 25 MHz Dell System 325 ran circles around

THE FIRST PERSONAL COMPUTER THAT'S REALLY PERSONAL.

Of the more than 150,000 personal computers we've sold to date, each one has been individually configured to fit the needs of its owner.

The System 325 takes that idea

to its logical extreme.

For example, it runs either MS-DOS®, MS®OS/2, or our own Dell UNIX® System V. Which is compatible with AT&T's System V Interface Definition. And the world of XENIX® applications.

If speed is of the essence, we can include an optional Intel®

THE DELL 386 SYSTEM 325 HAS A 25 MHz CLOCK RATE, CACHE MEMORY CONTROLLER, IDE OR ESDI HARD DISK DRIVE, PAGE MODE INTERLEAVED MEMORY, AND 100% COMPATIBILITY WITH MS-DOS, OS/2 AND UNIX SYSTEM V.

a field of 386-based systems. A field that included the Compaq® 386/25.

A show of prowess that earned the System 325 PC Magazine's Editor's Choice award.

It was a goal we set for ourselves from the very beginning. And an objective anyone with a penchant for power and performance can appreciate.



80387 or WEITEK 3167 math coprocessor. And since nothing about this system is lightweight, the standard mass storage is a 100 MB hard disk drive. Or we can configure it with a 40, 150 or 322 MB hard drive.

As you might expect, the output is just as intense. You can choose between VGA Mono-chrome with

SO HOW COME YOU NEVER CALL?



*"The new
top-of-the-line
Dell System 325 is
a flagship worth
putting out in front
of the fleet."*

February 14, 1989

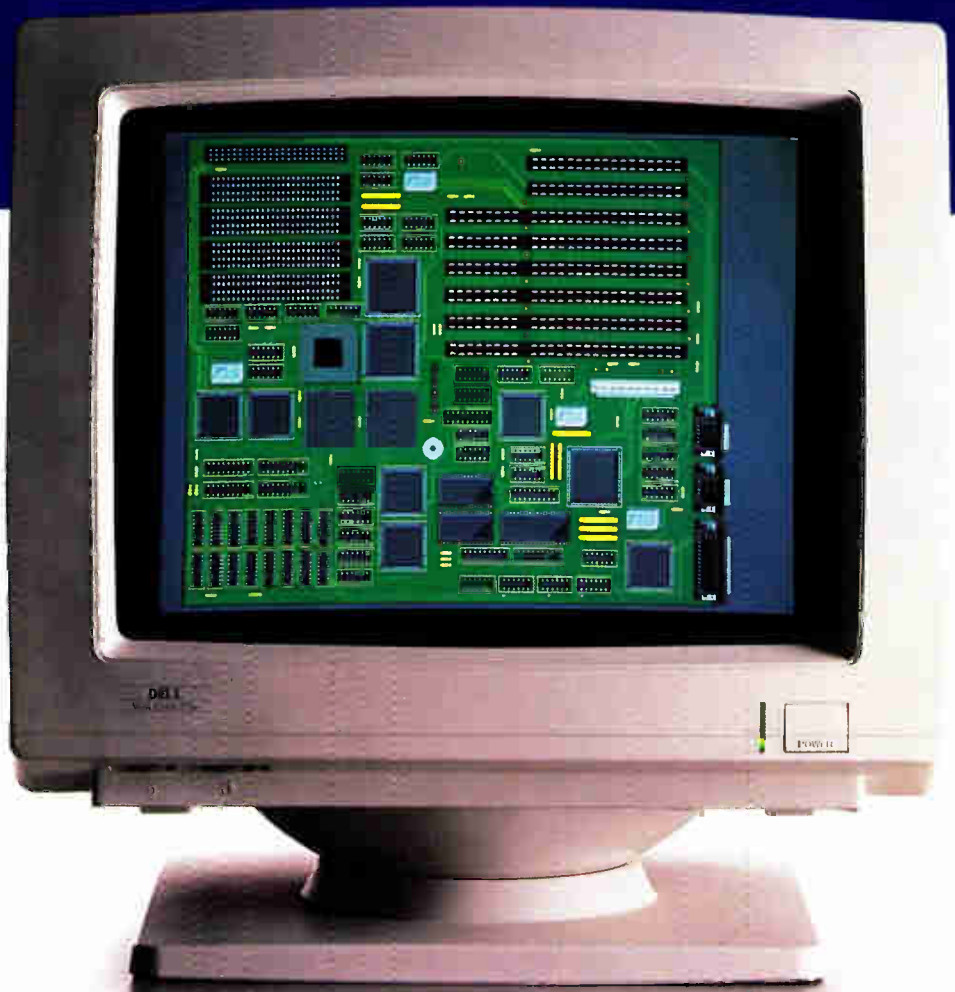

paper-white screen, VGA Color Plus, or Super VGA for high resolution colors displayed on a larger screen.

Even though the 325 gives you all this performance, it still leaves you six open slots for whatever else you might want to add.

And once you've told us what you want, we'll make sure what you want works — by burning-in the entire system unit.

COMPUTER RETAILERS ARE NO KNOWS.

There are some good reasons computer retailers won't know much about the System 325.

First, with all the new and increasingly sophisticated systems they have to keep up with on a daily basis, you can hardly expect them to know everything.

Second, because Dell sells direct.

Which means you now have the unique opportunity to talk directly with the people who make them. And ask things like, "What is page mode interleaved memory?" or, "How much SIMM RAM should I add?"

In other words, the kinds of details that are important to people who make computers and people who use them.

So dealing direct not only can save you up to the 35% mark-up, but 100% of the frustration.

WE COME WHEN WE'RE CALLED.

One of the things that very clearly sets Dell systems apart from other computers is not

just how they're sold but how they're supported.

Overkill was one description used in a recent PC Week article.

Perhaps.

But then, we think you'll agree, when something goes wrong, you want as much help as possible, right?

MAYBE YOU SHOULDN'T BUY ONE AFTER ALL.

No matter how many reasons we give you to buy a Dell system sometimes it makes more sense to lease one instead.

Whether you need a single computer, or an entire office

BEST OF ALL, YOU WON'T HAVE TO EXPLAIN TO A COMPUTER RETAILER WHAT ALL THAT MEANS.

Which is why every Dell system comes with a toll-free technical support line and self-diagnostic software. We're able to solve 90% of all problems right over the phone. The other 10% receive next-day, deskside service. Thanks to our new alliance with Xerox Corporation.

And you get all this help for a full year — whenever you need it — at no extra charge.^Δ

As you've probably guessed, one of the things that drives us most is customer satisfaction.

So we'd like to give you the ultimate guarantee:

Try a System 325 in your office for a month. Run your toughest applications. Put it through its paces, at your pace. If you're not completely satisfied, send it back anytime within 30 days. And we'll refund your money.

No questions asked.

full, there is a leasing plan for your business that is just like 100% financing.

And just as we can custom configure your computers, we can see to it you get a custom designed lease plan to fit your exact business needs.[†] A fact that has not gone unnoticed. Especially by the Fortune 500. Over half of whom now own or lease Dell systems.

And just as we welcome their business, we welcome your business, too.

Just call us, toll-free. And don't be afraid to ask us the tough questions.

That's the part we like best.

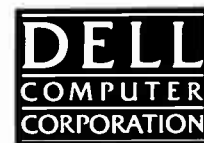

TO ORDER, CALL
800-426-5150

IN CANADA, CALL 800-387-5752
IN GERMANY, CALL 0610 3701100
IN THE U.K., CALL 0800 414535



powerCache 4... The most advanced What else would you expect



PC MAGAZINE, January 1989,
*"In a field of powerhouse machines
there can only be one winner, and
ALR's FlexCache is it."*

INFO WORLD, July 1989,
*"ALR Systems Unleash 486 Power. The
PowerCache 4 shines in the CPU-
specific portion of the InfoWorld Auto-
mated Benchmark Test, gaining a score
of 16.3."*

PC WEEK, July 1989,
*"Based on a series of benchmarks run
last week on Advanced Logic Research,
Inc.'s prototype 486 desktop system,
ALR will enter the 486 market with a
bang."*

At ALR, we will never rest on our laurels. We strive to be the best, as proven by our past achievements. Now with the introduction of the new ALR PowerCache 4™, we've designed a system that is far beyond comparison. Again, we have taken PC-microprocessing power a step further by designing a unique proprietary PowerCache 4 cache controller using ALR's custom ASIC chips which deliver the fastest processing speed ever.

More important, PowerCache 4 is the first PC to fully utilize 128-bit burst mode and a "read and write-back" 128KB cache design, providing a better than zero wait state performance as compared to the i386. Furthermore, the ALR PowerCache 4 is 100% IBM® PS/2™ Micro Channel™-compatible supporting bus mastering devices and giving

	ALR M130 Desktop	ALR M150, M350 M650 Floor-Standing	IBM M70-A21 Power Platform™
CPU	25 MHz i486	25 MHz i486	25 MHz i486
Bus	MCA	MCA	MCA
External Cache	128 KB cache Read and Write-Back	128 KB cache Read and Write-Back	None
Video Opt. on board	640x480 1024x768	640x480 1024x768	640x480 None
I/O Slots	6 expansion slots	6 expansion slots	3 expansion slots
Storage Expansion	4-3 1/2"	1-full height 2-1/2"-height 2-3 1/2" drives	3-3 1/2" drives
Disk Capacity	130 MB-260 MB	150 MB-650MB	110 MB
Price	\$9,990	Starting at \$11,490	\$12,990

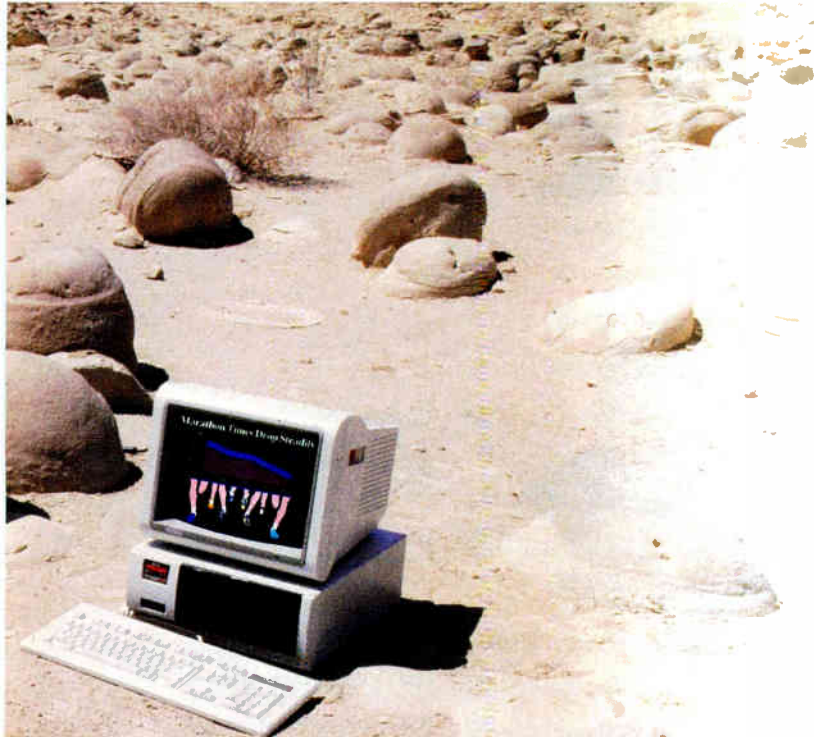

**California Anza-Borrego
Desert State Park**

(Cannonball-shaped sandstone. These concretions are formed of onion-skin layers of minerals resistant to erosion.)

i486™ system in the world. from the leader in 386™ technology.

you a more efficient system for a variety of multi-user and fileserver applications. Like most ALR computers, the PowerCache 4 is a truly balanced system. The fastest power is achieved by enhancing our PowerCache 4 design with the industry's fastest disk drives and interface. The PowerCache 4 systems come standard with a high-speed 15MHz ESDI and 32 KB hard disk cache on the disk controller. What more could you possibly need.

It's no wonder ALR remains ahead of the pack with our innovative design expertise. As far back as 1986, we've been recognized in the industry as a leader in performance. Recently, the highly acclaimed 386/220 won us "Best of 1987" from *PC Magazine*. 1988 brought us the honor of receiving the *PC Magazine* Award for Technical Excellence for designing the industry's most advanced cache architecture. As for 1989 we've already begun to excite the industry with the PowerCache 4.

Now, what else would you expect from a company who is so committed to innovation and high-performance technology that we take you a step beyond. At ALR, we are concerned with your processing needs. Our technical support staff is available to assist you by one simple phone call. All our systems are backed by a one year warranty. Call today for more information on the new PowerCache 4 and the name of an authorized reseller nearest you.

1-800-444-4ALR



PowerCache 4 is the first PC to fully utilize 128-bit burst mode and a "read and write-back" 128KB cache design, providing better than zero wait state performance as compared to the i386.



Home of the World's First 386 PC
Advanced Logic Research Inc.

Advanced Logic Research, Inc.
9401 Jeronimo Irvine, CA 92718
(714) 581-6770 FAX: (714) 581-9240
For our Canadian office:
1-800-443-4CAN
For our UK office:
0 635-521 844 FAX: 0 635-521 844
For our Singapore:
(65) 258-1286 FAX: (65) 258-1285

ALR and Advanced Logic Research, Inc. are registered trademarks. PowerCache 4 is a registered trademark of Advanced Logic Research, Inc. IBM and PC, PS/2, Micro Channel are registered trademarks of International Business Machines Corporation. Intel, 386 and i486 are registered trademarks of Intel Corporation.

PRODUCTS IN PERSPECTIVE

49 What's New

81 Short Takes

Wallaby, a Macintosh-compatible laptop
WordPerfect 5.1, supports a mouse and pull-down menus
Vellum, Ashlar's two-dimensional CAD for the Mac
TrackMan Stationary Mouse, a new input device from Logitech
Generic 3D Drafting, simple but elegant CAD
KDS-1984 TriSync, a large-screen color monitor from Sampo

REVIEWS

154 Product Focus: Making a Case for CASE
by the BYTE Staff
Choosing a CASE tool is a matter of methodology and computing environment.

179 Downsizing the Desktop
by Stephen Saichell
The 80386SX-based ADC Powerlite 386's small, integrated design makes for easy repairs.



COVER STORY

Laptops Forever

*by Frank Hayes,
Michael E. Nadeau, and
Stan Miastkowski*
page 93

New laptops
from Compaq, GRiD,
Toshiba, and Zenith
point to the future
of small computing.

185 Upscale Acer
by Jeff Holtzman
Is Acer's 1100/33 just another 33-MHz PC clone?

189 How to Put 16 Million Colors to Work
by Tom Thompson
The first wave of boards has arrived to help Mac IIs process 16 million colors. Here's how they stack up.

199 Power to the Programmer
by Fred Hommel
Watcom joins the 32-bit crowd with a new C compiler.

205 High-Fashion Unix on a PC
by Ben Smith
HP's Accelerated X Window Display Server lets you use your AT as an X Window workstation.

211 Clipper Applications Get SQL
by Marc Schnapp
The Library from Planet Software lets Clipper developers link applications to SQLBase.

217 Move Over, PageMaker
by Diana Gabaldon
TimeWorks' Publish It brings new features to Mac desktop publishing that PageMaker lacks.

EXPERT ADVICE

107 Computing at Chaos Manor: A Look Backward and Forward
by Jerry Pournelle
Jerry reminisces about the beginnings of microcomputers and looks at today's new products.

123 The Unix /bin: Unix Workstations Connect
by David Fiedler
A discussion on networking Unix workstations.

129 Down to Business: A Helping Hand
by Wayne Rash Jr.
A new workstation lets disabled users perform any function through the use of voice commands alone.

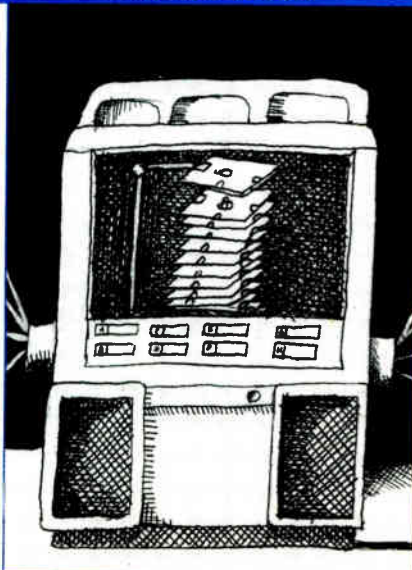

133 OS/2 Notebook: OS/2 Multitasking Revisited
by Mark J. Minasi
A simple program that lets you experiment with the priority mechanism.

137 Macinations: A Tale of Two Operating Systems
by Don Crabb
The Mac OS versus OS/2: Are you after performance or productivity?

141 Networks: When One Drive Is Enough
by Mark L. Van Name and Bill Catchings
Do personal computers attached to LANs need hard disk drives?

**REGIONAL SECTION
begins after page 80**

- 223 Manage It with Pictures**
by Lamont Wood
Project Scheduler 4 from Scitor Corp. offers graphically based project management for under \$700.
- 229 What Price Color PostScript?**
by Howard Eglowstein
QMS's new ColorScript 100 Model 10 printer promises color PostScript at a groundbreaking price.
- 234 Reviewer's Notebook**
A compilation of brief reviews and updates to previously published evaluations.

IN DEPTH

- 240 Introduction:
Sound and Image Processing**
- 243 Sounds and Images**
An overview of what's going on in the world of computer sight and sound.
- 245 Sounds**
by Gene Smarte
- 248 Images**
by Walt Penney
- 259 Putting DSPs to Work**
by Bobby Saffari
DSPs have become the unifying factor between sound and image processing for microcomputers.
- 277 Beyond Pattern Recognition**
by Raymond Kurzweil
Practical speech-recognition applications require a bit of intelligence.
- 293 Changing Perceptions of Reality**
by Benjamin M. Dawson
A variety of techniques that let you edit images in a variety of ways.
- 309 Pepperoni and Paperwork**
by Ira Scherr
How one company combined image, speech, voice, and fax to create a verbal document-retrieval system.
- 320 Words and Pictures**
PC boards for voice recognition and image processing.

FEATURES

- 324 Ten Years of Rows and Columns**
by Tracy Robnett Licklider
A decade ago, Frankston and Bricklin revolutionized the software world with the electronic spreadsheet.
- 333 The Intel 80860**
by Neal Margulis
A close look at Intel's newest RISC design.
- 349 Configuring Parallel Programs**
by Dick Pountain
A new tool that will make it easier to write software for parallel processing.
- 353 The Wizards of the Media Lab**
by Janet J. Barron
Researchers are exploring new ways for humans to interact with technology.
- 363 Making Waves**
by Mark Waller
The implications of packet radio are far-reaching.
- 371 Electronic Oxford**
by Eric Giguere
Years in the making, the electronic edition of the classic English dictionary nears completion.



Ten Years of Rows and Columns/324

HANDS ON

- 377 Under the Hood: Protected Mode**
by L. Brett Glass
Enhanced modes of Intel microprocessors provide greater address reach and safe multitasking.
- 387 Some Assembly Required: Input: Keep It Clean**
by Rick Grehan
Our IMAN program lets you build input screens that users can't mess up.

DEPARTMENTS

- 8 Editorial:**
The Last Word on the SX?
- 17 Microbytes**
- 32 Letters, Ask BYTE, and Fixes**
- 48C Chaos Manor Mail**
- 435 Coming Up in BYTE**
- 444 Print Queue**
- 448 Stop Bit**

READER SERVICE

- 434 Editorial Index by Company**
- 436 Alphabetical Index to Advertisers**
- 438 Index to Advertisers by Product Category**
- Inquiry Reply Cards: after 440**

PROGRAM LISTINGS

- From BIX: See 368**
- From BYTEnet:**
call (617) 861-9764
- On disk:**
See card after 352

BYTE (ISSN 0360-5280) is published monthly with an additional issue in October by McGraw-Hill, Inc. Postmaster: Send address changes, USPS Form 3579, and fulfillment questions to BYTE Subscriptions, P.O. Box 551, Hightstown, NJ 08520. Second-class postage paid at Peterborough, NH 03458, and additional mailing offices. Postage paid at Winnipeg, Manitoba. Registration number 9321. Printed in the United States of America. Not responsible for lost manuscripts or photos. Opinions expressed by the authors are not necessarily those of BYTE.

Copyright © 1989 by McGraw-Hill, Inc. All rights reserved. Trademark registered in the United States Patent and Trademark Office.



Subscription questions or problems should be addressed to: BYTE Subscriber Service, P.O. Box 551, Hightstown, NJ 08520.

Microsoft Excel - FFBLNS01.XLS

File Edit Formula Format Data Options Macro Window Help

B34

Future Fortune Company Consolidated Balance Sheet

Assets	1988	1987	1986	
Current Assets	\$132,546	\$104,668	\$91,787	\$6
Accounts Receivable	\$56,874	\$55,051	\$41,817	\$0
Inventories				
Other				
Total Current Assets				
Other Assets				
TOTAL ASSETS				
Liabilities and Stock				
Current Liability				
Accounts Payable				
Customer Deposits/D				
Royalties and Comm				
Accrued Compensat				
Notes Payable				
Income Taxes Payab				
Ready				

Designer - MKTSHR02.DRW

File Edit Draw View Change Arrange Line Pattern Text

Sales Volume to Trend

Year	Sales Volume (approx.)
1985	5
1986	15
1987	20
1988	25

By no small coincidence, Microsoft Windows works the way you do: On more than one thing at a time.



WYSIWYG. What you see on screen...

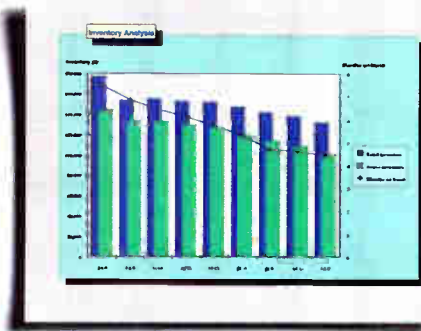

...is exactly what you get on paper.

An entire environment that let...

Future Fortune Company

8 cm.
7 cm.
6 cm.
5 cm.
4 cm.
3 cm.
2 cm.
1 cm.

1

Dough placement and size distinguishes Future Fortune's cookies from all others. Note: Diameter should be the standard 6 cm, while the thickness of the cookie should be reduced to .05 cm. FFC accounts report a reduction in thickness could mean millions of dollars in dough savings.

Old sayings may cost Future Fortune

It has been roughly 68 years since FFC last created new fortunes. But in light of the new logo and the whole new look brought to the company in the past year, the board of directors has unanimously voted to replace the old fortunes. President Jim Dearing explained, "As we exit the 1980's, people no longer believe in the same old lines, it's time to change".



More good news: Hundreds of great Windows applications are available right now, as you read.

Fortune Teller
1989

Cookie Standards, rolling in the dough

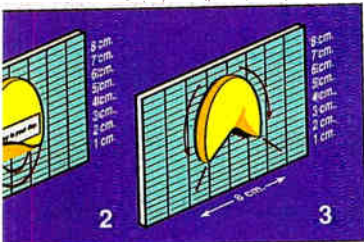

The last, and the most intricate, step in Future Fortune Cookie making is when our trade dimple is placed on the cookie. As the arrows indicate, it is important to pull down on both sides of the cookie as the dimple is pushed in from the bottom.

Fortunes for the month of August

- Find a reliable au pair.
- Important call on your car phone.
- Surgery lifts spirits as well as wrinkles.
- Will never return from maternity leave.
- It is a thing of the past. Invest in a car soon.
- Invest in real estate will only lead to frustration.
- Prosper as will your accountant.
- Wishes second nobody remembers.

You do amazing things—like this—simply.



We'd like everyone who's using Windows applications on a part-time basis to please stop.

The trouble with using Windows™ applications every once in a while, is that you're only amazingly productive every once in a while.

This has got to stop. Which is why there's the Microsoft® Windows environment—the first and only *graphical* environment to let you work with multiple Windows or DOS applications without ever closing a single file, or quitting a single program.



You may never see your C prompt again. Just give Microsoft Windows a 40-hour work week and you'll be pointing, clicking, cutting, pasting and flying through your work with the greatest of ease. Cut from a spreadsheet and paste onto a word processing document—without scissors and a copy machine. Exchange information, link files and programs, then watch your data get updated automatically, or if you prefer, at your command.

Call us at (800) 541-1261, Dept. J89 for more facts about how Windows can open up doors, and for our free Windows Shopping Catalog.

And see how the only way to get the most out of your Windows, is to look into ours.

Microsoft
Making it all make sense™

Customers inside the 50 United States, call (800) 541-1261, Dept. J89. In Canada, call (416) 673-9811. Outside the U.S. and Canada, call (206) 882-8661. © 1989 Microsoft Corporation. All rights reserved. Microsoft and the Microsoft logo are registered trademarks and *Making it all make sense* and Windows are trademarks of Microsoft Corporation.

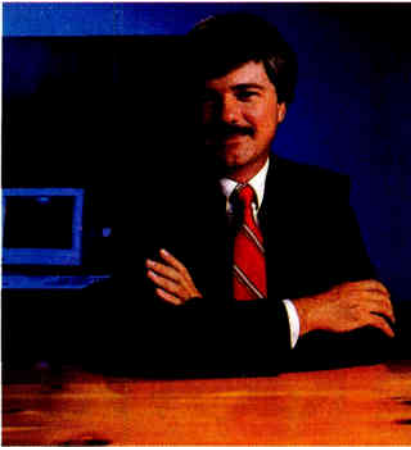

THE LAST WORD ON THE SX?

An 80386SX-based computer isn't necessarily cheaper than an 80386 machine, or faster than an 80286

At a recent trade show, I was part of a seminar designed to help attendees determine the relative strengths and weaknesses of the 80286, 80386SX, and 80386 chips.

It's a topic that won't go away. New SX machines appear almost every day, and confusion over just what 80286 machines can and can't do still runs strong.

Fortunately, a new tool will help sort out the confusion: the complete benchmark results of all the machines BYTE has tested. This compilation of results appears in BYTE's annual *IBM Special Edition*, which is now on sale. (The compilations also contain all our Mac benchmarks. But as the 80286/SX/80386 issue is Intel-family-specific, I'll stay on that side of the fence for now.)

It's instructive to pull out data comparing 80286, SX, and "true" 80386 machines from that mammoth list. For example, I'll focus on just one element: CPU performance.

The SX as an 80386

First, I'll look at how the SX stacks up against true 80386 chips (i.e., those not hobbled by the SX's 16-bit bottleneck).

True 80386 chips come in a variety of speeds. As of now, the SX is available in only one speed: 16 MHz. Clearly, the 20-, 25-, and 33-MHz 80386 chips will blow the doors off the SX, so I'll focus only on the slowest of the true 80386 machines: the 16-MHz units.

The SX machines we've benchmarked so far yield an average CPU index of 1.88

(where an 80286-based 8-MHz IBM PC AT equals 1). A sample of two dozen 16-MHz 80386 machines (mostly low-end clones) from our benchmark tables averages some 23 percent faster, with a CPU index of 2.33 (see the figure).

That's significant: Here are two types of 80386 chips, both running at 16 MHz, yet the full 32-bit version is 23 percent faster than its 16-bit SX cousin. Clearly, as an 80386, the SX comes up short. (Ironically, many low-end 80386 boxes cost less than their slower SX cousins.)

The SX as an 80286 Replacement

It's common knowledge that Intel first introduced the SX as a way to phase out the 80286. Thus, how does the SX stack up against 80286-based machines?

Well, 80286-based machines come in a wide range of speeds. Comparing SX machines to similarly clocked 80286 units shows no overwhelming advantage either way. They run roughly the same.

But wait, the 80286 is available in

speeds of up to 20 MHz, with 25-MHz chips due soon. We took a look back at the benchmark results for the fastest available (20 MHz) 80286 and compared them to the fastest available (16 MHz) SX. (We used the older non-80386-specific BYTE benchmarks to make sure that the playing field was level.) The results were surprisingly lopsided: The fast 80286 units ran a whopping 36 percent faster than the SX machines. Wow!

It's hard to see the SX as a particularly attractive replacement for the 80286, at least where raw speed is concerned.

So what's the SX good for?

Well, it's good for laptops, portables, and small-footprint desktop units. The prices of SX machines are dropping, and in settings where weight, size, and power consumption are the major considerations, the SX may prove to be an attractive alternative.

But for normal desktop applications, the SX is simply not a great choice. Yes, it will run true 32-bit software (e.g., DESQview/386 and Paradox 386), but the software will run more slowly than on most true 80386 machines, including many low-cost clones. For true 32-bit 80386 power, a full-blown 80386 machine is your only choice.

If you don't require a full 32-bit data path (say you want to run only today's DOS and OS/2 applications), a fast 80286—especially the 20- and 25-MHz units—will give you more speed plus full DOS and OS/2 compatibility. It should also cost less than today's SX machines.

Of course, in buying any machine, you need to look at the complete system: The world's fastest CPU can be turned into a snail if it's saddled with a sluggish hard disk drive or a slow video system.

The SX has its place. But so do the 80286 and the true 80386. Let an objective measure, such as benchmarks, sort out which is right for you.

—Fred Langa
Editor in Chief
(BIX name "flanga")

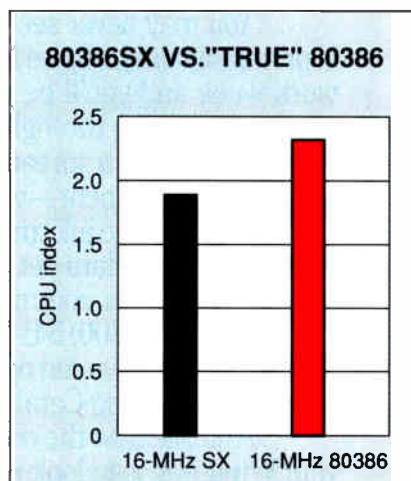

Even at the same clock speed, "true" 80386 machines run an average of 23 percent faster than 80386SX machines. (In BYTE's CPU index, higher numbers are better.)

At last, an assistant that follows your directions

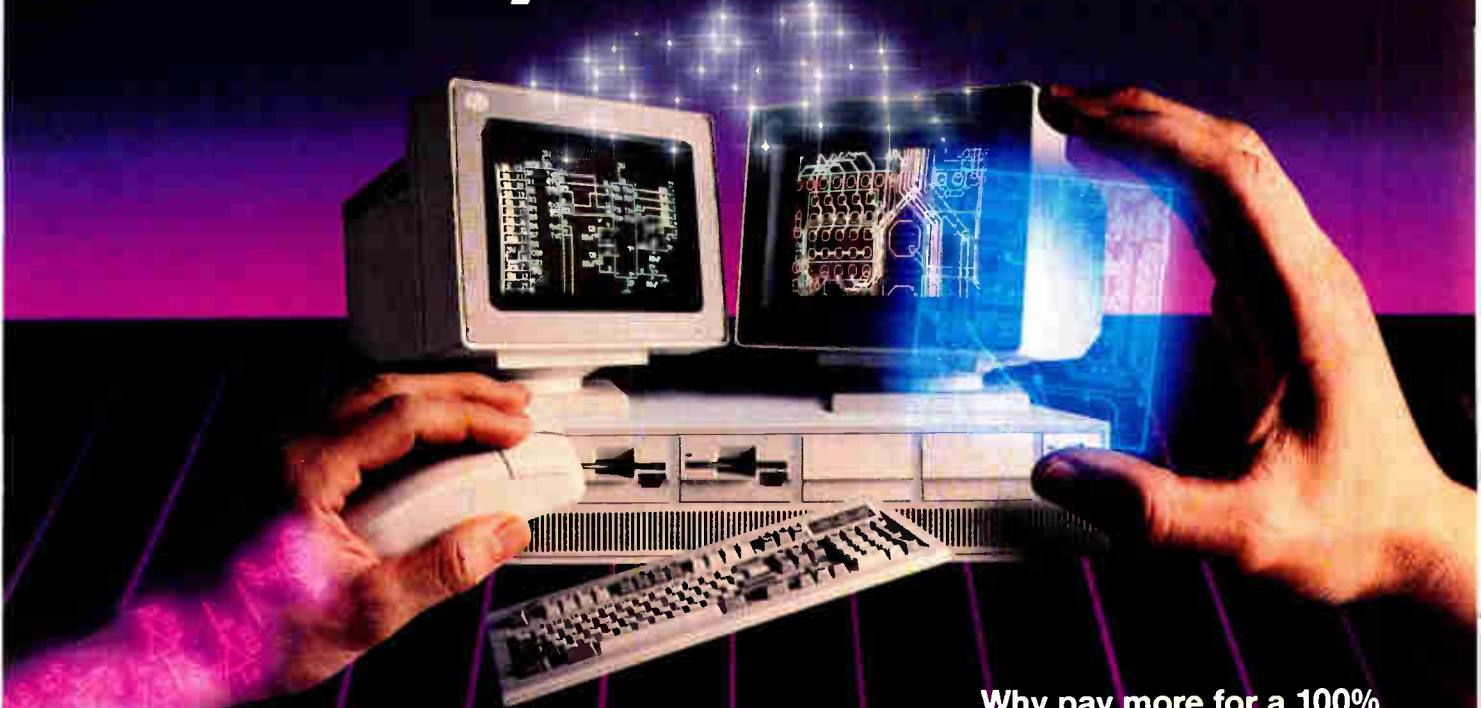

Wouldn't it be great to delegate your routing?

You can! We know your time is valuable. That's why Wintek pioneered comprehensive and affordable CAD packages for IBM personal computers. HiWIRE-Plus continued that tradition, integrating schematic-capture features and printed-circuit-artwork capabilities into one versatile package.

New autorouter.

The Autorouter for HiWIRE-Plus is powerful enough to handle the most demanding design problems, yet simple enough for a casual user. Just turn it loose on your design. It's hassle free because it works long hours, without supervision or errors.

100% autorouting.

The autorouter for HiWIRE-Plus rips-up, reroutes, and with appropriate design rules, racks up 100% completion.

- Forget gridded routers. This autorouter places vias and traces anywhere your design rules allow. With 1-mil resolution.
- Vary trace width and spacing for individual networks. Route 1, 2, 3, or more tracks between IC and connector pins.
- Set up boards from 1 to 250 layers, up to 60" x 60".
- Specify shape, size, and type of vias, layer-by-layer: through-hole, blind, buried, micro. Specify via types for individual networks.
- Use fewer vias and layers than comparably priced autorouters.
- For use on your IBM PC, XT, AT, PS/2, or compatible with 640K RAM.

Why pay more for a 100% autorouter?

Compare the features and performance to packages costing five times more. HiWIRE-Plus and the Autorouter for HiWIRE-Plus sell for \$895 each. Both have a no-nonsense, 30-day money-back guarantee. With unlimited, toll-free, no-charge technical support.

Let HiWIRE convince you that it makes a great assistant. Call us toll-free at (800) 742-6809 today and put HiWIRE-Plus and the Autorouter for HiWIRE-Plus to work for you tomorrow.



Wintek Corporation
1801 South Street
Lafayette, IN 47904-2993
Fax: (317) 448-4823
Phone: (317) 742-8428 or

(800) 742-6809



Smalltalk/V[®] PM.
 Think of it as a bold,
 “seat-of-the-pants” solution
 that cuts to the heart of the
 OS/2 Presentation Manager
 complexity challenge. Thus
 unlocking the potential of this
 powerful operating system.

With the introduction
 of Smalltalk/V PM, object-
 oriented programming



Introducing Smalltalk/V PM. The to fulfill the promise of OS/2.

moves out of the realm of mystery
 and into a new era of breakthrough
 applications that promises to be of
 legendary proportions.

OS/2 PM is designed to push

“user friendly” to a whole new level
 of sophistication. If you compare it
 to an orchestra, OS/2 has capabili-
 ties no ordinary assemblage of in-

struments has ever dreamed of

you go from designing to prototyp-
 ing to delivering a completed appli-
 cation in one seamless step, you
 cleanly avoid the old costly “crash
 and burn” delays so common with
 languages born in the age of main-
 frames.

UNLEASHING THE AWESOME POWER OF OS/2 PM

Smalltalk/V PM. It helps stop
 the natural drift toward vaporware
 so common in software develop-
 ment today. It lets you dive right in
 and get to the creative parts with-
 out the usual grunt work. For ex-
 ample, if you want to ignore the
 complexities of understanding
 OS/2 PM details you can immedi-

Is The Most Important Part Of Your Developer's Kit Missing?

OS/2 PM offers you a powerful, rich environment
 loaded with advantages like a Graphics Program-
 ming Interface (GPI), a LAN manager, multitask-
 ing, SQL, just for starters. And all of these
 components are accessible in a standard way using
 Smalltalk/V PM through Dynamic Link Libraries
 (DLLs). Combined with DDE (Dynamic Data
 Exchange), you can call and exchange data with
 other PM services or applications. Seamlessly.
 Now developers can write truly reusable compo-
 nents, which greatly increases their value. And
 you'll find Smalltalk/V PM the perfect “glue”
 between applications written in other languages.

possessing. Yet to tap
 its potential, OS/2
 PM demands a con-
 ductor capable of true
 genius. That conduc-
 tor is Smalltalk/V
 PM.

You'll find Small-
 talk/V PM a perfect
 language for repre-
 senting and manipu-
 lating high-level
 information. Because





The Great cut through the convoluted challenge with one bold, swift stroke of his sword. This "seat-of-the-pants" solution set in motion the prophecy that whoever unraveled the knot would one day rule Asia.

"THIS IS THE RIGHT WAY TO DEVELOP APPLICATIONS FOR OS/2 PM.

OS/2 PM is a tremendously rich environment, which makes it inherently complex. Smalltalk/V PM removes that complexity, and lets you concentrate on writing great programs. Smalltalk/V PM is the kind of powerful tool that will make OS/2 the successor to MS/DOS."

*Bill Gates, Chairman
Microsoft Corp.*

grammer struggling with the complexities of Presentation Manager should take a close look at this product."

*Charles Petzold, Contributing Editor,
PC Magazine*

"Digitalk's Smalltalk/V PM is dazzling! This product makes Presentation Manager pay off."

*Jeff Duntemann, Contributing Editor,
Dr. Dobbs Journal*

"Smalltalk/V PM is an excellent tool for rapid delivery of prototypes which have all the functionality and user interface of a complete PM application."

*Richard A. Landsman,
System Architect, Lotus Development*

"Smalltalk/V PM from Digitalk is the greatest! This is an incredible product."

*J.D. Hildebrand
Editor-in-Chief, Computer Language*

THE BEST PM INVESTMENT YOU'LL EVER MAKE

Smalltalk/V PM \$499.95

Prices and information on these and other Digitalk products are available on request:

Smalltalk/V, Smalltalk/V 286,
Smalltalk/V Mac

Smalltalk/V. A product of Digitalk Inc., 9841 Airport Blvd., Los Angeles, CA 90045. For information or to find a dealer near you call:

**1-800-922-8255
1-213-645-1082**

CompuServe 71361,1636
FAX 1-213-645-1306

Smalltalk/V is a registered trademark of Digitalk Inc. Prices subject to change without notice. Other product names are trademarks or registered trademarks of their respective holders.



fast, seat-of-the-pants way



THE FIRST FULLY-COMPILED SMALLTALK.

Because Smalltalk/V PM is fully compiled it provides you with a more responsive environment than ever before. Now you'll be able to generate stand-alone applications (.EXE).

debugger simplifies application development and gives you instant response when you implement an idea. Our extensive user manuals and tutorials have earned us high praise.

SMALLTALK/V PM. THE TALKING HAS

ALREADY STARTED.

"Digitalk's Smalltalk/V PM is a masterful implementation of a classical object-oriented programming language and a state of the art graphical user interface. Any pro-

Smalltalk/V

ately start creating without any limitations on your efficiency.

However, if you're the curious type, we have tools called browsers to help you fathom the masterpiece called OS/2 PM. You'll also find our incremental program development capability and push-button

BYTE

EDITOR IN CHIEF
Frédéric S. Langa

PUBLISHER/GROUP VICE PRESIDENT
J. Burt Totaro

OPERATIONS

Glenn Hartwig *Associate Managing Editor*

REVIEWS (Hardware, Software, Product Focus)

Michael Nadeau *Associate Managing Editor*, Dennis Allen *Senior Technical Editor, Software*, Richard Grehan *Director, BYTE Lab*, Stephen Apiki *Testing Editor, BYTE Lab*, Stanford Diehl *Testing Editor, BYTE Lab*, Howard Eglowstein *Testing Editor, BYTE Lab*, Stanley Wszola *Testing Editor, BYTE Lab*

NEWS AND TECHNOLOGY (Microbytes, What's New, Short Takes)

New York: Rich Malloy *Associate Managing Editor*, Andrew Reinhardt *Associate News Editor*
Peterborough: D. Barker *Senior Editor, News and Technology*, Anne Fischer *Senior Editor, News Products*, Roger Adams *Associate News Editor*, David Andrews *Associate News Editor*, Martha Hicks *Associate News Editor*
San Francisco: Nicholas Baran *Bureau Chief*, Frank Hayes *News Editor*, Jeffrey Bertolucci *Associate News Editor*

SPECIAL PROJECTS EDITOR

Gene Smarte

SENIOR TECHNICAL EDITORS

Ken Sheldon *Features*, Jane Morrill *Tazelaar In Depth*, Tom Thompson *At Large*, Jon Udell *At Large*

TECHNICAL EDITORS

Janet J. Barron, Alan Joch, Robert Mitchell, Robert M. Ryan, Ben Smith, Tom Yager

SENIOR CONTRIBUTING EDITOR

Jerry Pournelle

CONTRIBUTING EDITORS

Bill Catchings, Don Crabb, David Fiedler, L. Brett Glass, Hugh Kenner, Mark Minasi, Wayne Rash Jr., Mark L. Van Name

CONSULTING EDITORS

Jonathan Amsterdam, Laurence H. Loeb, Trevor Marshall, Stan Miastkowski, Dick Pountain, Phillip Robinson, George A. Stewart, Peter Wayner

COPY EDITORS

Lauren Stickler *Chief*, Cathy Kingary *Copy Administrator*, Susan Colwell, Jeff Edmonds, Judy Grehan, Nancy Hayes, Margaret A. Richard, Warren Williamson

EDITORIAL ASSISTANTS

Peggy Dunham *Office Manager*, Linda C. Ryan, June N. Sheldon, Lynn Susan Valley

ART

Nancy Rice *Director*, Joseph A. Gallagher *Assistant Director*, Lisa Nardecchia *Assistant*, Jan Muller *Assistant*, Alan Easton *Technical Artist*

PRODUCTION

David R. Anderson *Director*, Virginia Reardon *Senior Editorial Production Coordinator*, Barbara Busenbark *Editorial Production Coordinator*, Denise Chartrand *Editorial Production Coordinator*, Michael J. Lonsky *Editorial Production Coordinator*

TYPOGRAPHY

Sherry Fiske *Systems Manager*, Donna Sweeney *Applications Manager*, Christa Patterson

ADVERTISING/PRODUCTION (603) 924-6448

Lisa Wozmak *Director of Advertising Services*, Linda Fluhr *Customer Service Supervisor*, Lyda Clark *Senior Account Coordinator*, Dale Christensen, Karen Cilley, Roxanne Hollenbeck, Rod Holden, Susan Kingsbury *Creative Services Manager*, Lillian J. Doucet, Wai Chiu Li *Quality Control Manager*

EDITORIAL AND BUSINESS OFFICE:

One Phoenix Mill Lane, Peterborough, NH 03458, (603) 924-9281.
West Coast Branch Offices: 425 Battery St., San Francisco, CA 94111, (415) 954-9718; 3001 Red Hill Ave., Building #1, Suite 222, Costa Mesa, CA 92626, (714) 557-6292.
New York Branch Editorial Office: 1221 Avenue of the Americas, New York, NY 10020, (212) 512-3175.
BYTENet: (617) 861-9784 (set modem at 8-1-N or 7-1-E; 300 or 1200 baud).
Editorial Fax: (603) 924-2550. Advertising Fax: (603) 924-7507.
SUBSCRIPTION CUSTOMER SERVICE: Outside U.S. (609) 428-7070; inside U.S. (800) 232-BYTE.
For a new subscription—(900) 257-9402 U.S. only, or write to BYTE Subscription Dept., P.O. Box 555, Hightstown, NJ 08520.

Officers of McGraw-Hill Information Services Company: President: Walter D. Serwatka. Executive Vice Presidents: Kenneth E. Gazzola, Aerospace and Defense; Ira Herenstein, Computers and Communications; Russell C. White, Construction; Robert P. McGraw, Healthcare; Brian H. Hall, Legal. Senior Vice Presidents—Publishers: Laurence Altman, Data Communications; David J. McGrath, Engineering News-Record. Senior Vice Presidents: John W. Fink, Finance; Michael J. Koeller, Human Resources. Group Vice Presidents: J. Burt Totaro, BYTE; Norbert Schumacher, Energy/Process Industries. Vice Presidents: George Elinger, Circulation; Julia Lenard, Systems Planning and Technology; Elisabeth K. Allison, Planning and Development.

Officers of McGraw-Hill, Inc.: Joseph L. Dionne, Chairman, President, and Chief Executive Officer; Robert N. Landes, Executive Vice President, General Counsel, and Secretary; Robert J. Bahash, Executive Vice President and Chief Financial Officer; Frank D. Penglase, Senior Vice President, Treasury Operations.

ADMINISTRATION

Donna Nordlund *Publisher's Assistant*

MARKETING AND PLANNING

L. Bradley Browne *Director*
Pamela Petrakos-Wilson *Marketing Communications Manager*, Dawn Matthews *Public Relations Manager*, Lisa Jo Steiner *Assistant Promotion Manager*, Stephanie Warnesky *Marketing Art Director*, Sharon Price *Associate Art Director*, Julie Perron *Senior Market Research Analyst*, Faith Kluntz *Copyrights Coordinator*, Cynthia Damato *Sands Reader Service Coordinator*, Carol Pitman *Marketing Assistant*

FINANCIAL SERVICES

Philip L. Penny *Director of Finance and Services*, Kenneth A. King *Business Manager*, Marilyn Parker, Diane Henry, JoAnn Walter, Jaime Huber, Agnes Perry

CIRCULATION

Dan McLaughlin *Director*
Vicki Weston *Assistant Manager*, Karen Desroches *Distribution Coordinator*, Louise Menegus *Back Issues*, Ellen Dunbar *Direct Accounts Coordinator*, Karen Carpenter *Direct Accounts Telephone Sales Representative*

PERSONNEL

Patricia Burka *Human Resources Administrator*, Beverly Goss *Receptionist*

BUILDING SERVICES

Tony Bennett *Manager*, Cliff Monkton, Mark Monkton, Gary Graham

BIX BYTE INFORMATION EXCHANGE

DIRECTOR

Stephen M. Laliberte

EXECUTIVE EDITOR

George Bond

MANAGING EDITOR

Tony Lockwood

MICROBYTES DAILY

D. Barker *Coordinator*, Peterborough, Rich Malloy *New York*, Gene Smarte *Costa Mesa*, Nicholas Baran *San Francisco*, Rick Cook *Phoenix*, Frank Hayes *San Francisco*, Martin Heller *Boston*, Jason Levitt *Austin, TX*, Laurence H. Loeb *Wallingford, CT*, Brock N. Meeks *San Francisco*, Stan Miastkowski *Peterborough*, Wayne Rash Jr. *Washington, DC*, David Reed *Lexington, KY*, Andrew Reinhardt *New York*, Sue Rosenberg *Washington, DC*

GROUP MODERATORS

David Allen *Applications*, Leroy Casterline *Other*, Marc Greenfield *Programming Languages*, Jim Howard *Graphics*, Gary Kendall *Operating Systems*, Steve Krenek *Computers*, Brock N. Meeks *Telecommunications*, Barry Nance *New Technology*, Donald Osgood *Computers*, Sue Rosenberg *Other*, Jon Swanson *Chips*

EXCHANGE EDITORS

Laurence H. Loeb *Macintosh Exchange*, Barry Nance *IBM Exchange*, David Reed *User Group Exchange*

BUSINESS AND MARKETING

Patricia Bausum *Secretary*, Denise A. Greene *Customer Service*, Brian Warnock *Customer Service*, Tammy Burgess *Customer Credit and Billing*

TECHNOLOGY

Clayton Lisle *Director*, Business Systems Technology, ISCo., John Spadafora *Programmer/Analyst*

ADVERTISING SALES

Steven M. Vito *Associate Publisher*, Vice President of Marketing

Sara Lyon *Administrative Assistant*

Arthur H. Kossack *Eastern Regional Sales Manager*, (312) 751-3700

Jennifer L. Bartel *Western Regional Sales Manager*, (214) 644-1111

Susan Vernon *Sales Assistant*

NEW ENGLAND

ME, NH, VT, MA, RI, ONTARIO, CANADA, & EASTERN CANADA

Arthur H. Kossack (617) 262-1160

ATLANTIC

NY, NYC, CT, NJ (NORTH)

Kim Norris (212) 512-2645

EAST

PA, KY, NJ (SOUTH), MD, W. VA, DE, DC

Thomas J. Brun (215) 496-3833

SOUTHEAST

NC, SC, GA, FL, AL, TN, VA, MS

Arthur H. Kossack (404) 252-0626

MIDWEST

IL, MO, KS, IA, ND, SD, MN, WI, NE, IN, MI, OH

Kurt Kelley (312) 751-3740

SOUTHWEST, ROCKY MOUNTAIN

CO, WY, OK, TX, AR, LA

Karl Heinrich (713) 462-0757

SOUTH PACIFIC

SOUTHERN CA, AZ, NM, LAS VEGAS, UT

Ron Cordek (714) 557-6292

Tom Harvey (213) 480-5243

NORTH PACIFIC

HI, WA, OR, ID, MT, NORTHERN CA, NV (except

LAS VEGAS), WESTERN CANADA

Bill McAfee (408) 879-0371

(415) 362-4600

INSIDE SALES

Liz Coyman *Director*

Susan Boyd *Administrative Assistant*

NATIONAL SALES

Scott Gagnon (603) 924-4380

Mary Ann Goulding (603) 924-9281

Patricia Payne (603) 924-2654

BYTE BITS (2x3)

Mark Stone (603) 924-6830

THE BUYER'S MART (1x2)

Brian Higgins (603) 924-3754

REGIONAL ADVERTISING SECTIONS

Larry Levine (603) 924-4379

Barry Echavarría (603) 924-2574

BYTE POSTCARD DECK MAILINGS

BYTE DECK

Ed Ware (603) 924-6166

COMPUTING FOR DESIGN & CONSTRUCTION

COMPUTING FOR ENGINEERS

Liz Coyman (603) 924-2598

INTERNATIONAL ADVERTISING SALES STAFF

See listing on page 437.

Founder: James H. McGraw (1860-1948). Executive, editorial, circulation, and advertising offices: One Phoenix Mill Lane, Peterborough, NH 03458, phone (603) 924-9281. Office hours: Monday through Thursday 8:30 AM-4:30 PM, Friday 8:30 AM-1:00 PM, Eastern Time. Address subscriptions to BYTE Subscriptions, P.O. Box 551, Hightstown, NJ 08520. Subscriptions are \$29.95 for one year, \$54.95 for two years, and \$74.95 for three years in the U.S. and its possessions. In Canada and Mexico, \$31.95 for one year, \$59.95 for two years, \$79.95 for three years. \$50 for one-year air delivery to Europe, \$28.80 for one-year air delivery to Japan, \$14.40 for one-year surface delivery to Japan, \$30 surface delivery elsewhere. Air delivery to selected areas at additional rates upon request. Single copy price is \$3.50 in the U.S. and its possessions, \$3.95 in Canada, \$4.50 in Europe, and \$5 elsewhere. Foreign subscriptions and sales should be remitted in U.S. funds drawn on a U.S. bank. Please allow six to eight weeks for delivery of first issue. Address editorial correspondence to: Editor, BYTE, One Phoenix Mill Lane, Peterborough, NH 03458. Unacceptable manuscripts will be returned if accompanied by sufficient postage. Where necessary, permission is granted by the copyright owner for libraries and others registered with the Copyright Clearance Center (CCC) to photocopy any article herein for the flat fee of \$1.50 per copy of the article or any part thereof. Correspondence and payment should be sent directly to the CCC, 29 Congress St., Salem, MA 01970. Specify ISSN 0360-5280/83, \$1.50. Copying done for other than personal or internal reference use without the permission of McGraw-Hill, Inc., is prohibited. Requests for special permission or bulk orders should be addressed to the publisher, BYTE is available in microform from University Microfilms International, 300 North Zeeb Rd., Dept. PR, Ann Arbor, MI 48106 or 18 Bedford Row, Dept. PR, London WC1R 4EJ, England.

BYTE and **BYTE** are registered trademarks of McGraw-Hill, Inc.

Be Objective.

Turbo Pascal,[®] the world-standard Pascal compiler, adds Object-Oriented Programming with our new version 5.5. We combined the simplicity of Apple's Object Pascal language with the power and efficiency of C++ to create Turbo Pascal 5.5, the object-oriented programming language for the rest of us.

It's easy to extend yourself

If you're already programming with Turbo Pascal, it's easy to extend yourself from structured programming to object-oriented programming. And, Turbo Pascal 5.5 is the *only* compiler that is 100% source-code compatible with your existing Turbo Pascal 4.0 and 5.0 programs.

A fast object lesson

Object-oriented application programs more closely model the way you think. Objects contain both data and code. As in a spreadsheet cell, the value and the formula are together. Objects can *inherit* properties from other objects. For example, a Porsche Carrera inherits most

attributes from the base model 911, but it also sports a whale tail.

Turbo Pascal 5.5's object-oriented extensions give you code that's easier to change, extend, and support.

Turbo Pascal 5.5 Professional with Turbo Debugger[®] and Turbo Assembler[®]

The award-winning Turbo Debugger now includes an object inspector and hierarchy browser. And Turbo Debugger can debug any size program.

Upgrade objectively

Pascal owners: Upgrading from Turbo Pascal 5.0 to 5.5 is only \$34.95 plus \$5 shipping and handling (\$75 plus shipping and handling for owners of Turbo Pascal 4.0 or earlier). And upgrading from Turbo Pascal 5.0 and

earlier to Turbo Pascal 5.5 Professional is only \$99.95 plus \$10 shipping and handling. To order, CALL (800) 331-0877.

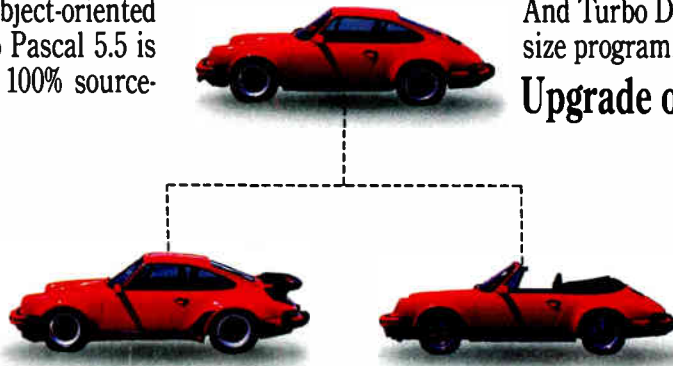

Inheritance provides powerful modeling capabilities by allowing objects to inherit attributes from other objects.

Turbo Pascal 5.5 Features

- Inheritance
- Static & dynamic objects
- Constructors & Destructors
- Object constants
- Compiles @ > 34,000 lines/minute
- New integrated environment tutorial
- Hypertext Help with copy and paste
- Enhanced smart linker & overlay manager
- Support for 8087/80287/80387
- Integrated source-level debugging



B O R L A N D

Code: MA42

Mail upgrade orders to: Borland, P.O. Box 660001, Scotts Valley, CA 95066-0001. For orders outside the U.S., call (408) 438-5300. Turbo Pascal, Turbo Debugger, and Turbo Assembler are registered trademarks of Borland International. Copyright ©1989, Borland International, Inc. All right reserved. BI 1324

Circle 49 on Reader Service Card (DEALERS: 50)

World Radio History

Document created using Aldus PageMaker® and Microsoft® Windows. Microsoft is a U.S. registered trademark of Microsoft Corp. PageMaker is a U.S. registered trademark of Aldus Corp. © 1989 Hewlett-Packard Company PE12822

At last! A new HP LaserJet just for you.

At only \$1495*, it's got your name on it.

The HP LaserJet printer family has expanded—in a small way.

The new HP LaserJet IIP (as in Personal) fits right on your desk. And, with a price almost half of the multi-user LaserJet Series II*, into most budgets.

Its simple front panel gives you easy, push-button control over the menu, the 14 internal fonts, form feed and other functions. It handles four different paper sizes: letter, legal, executive and A4, as well as envelopes. In portrait

*Suggested U.S. list prices:
LaserJet IIP \$1495;
LaserJet Series II \$2695.
Dealer prices vary.

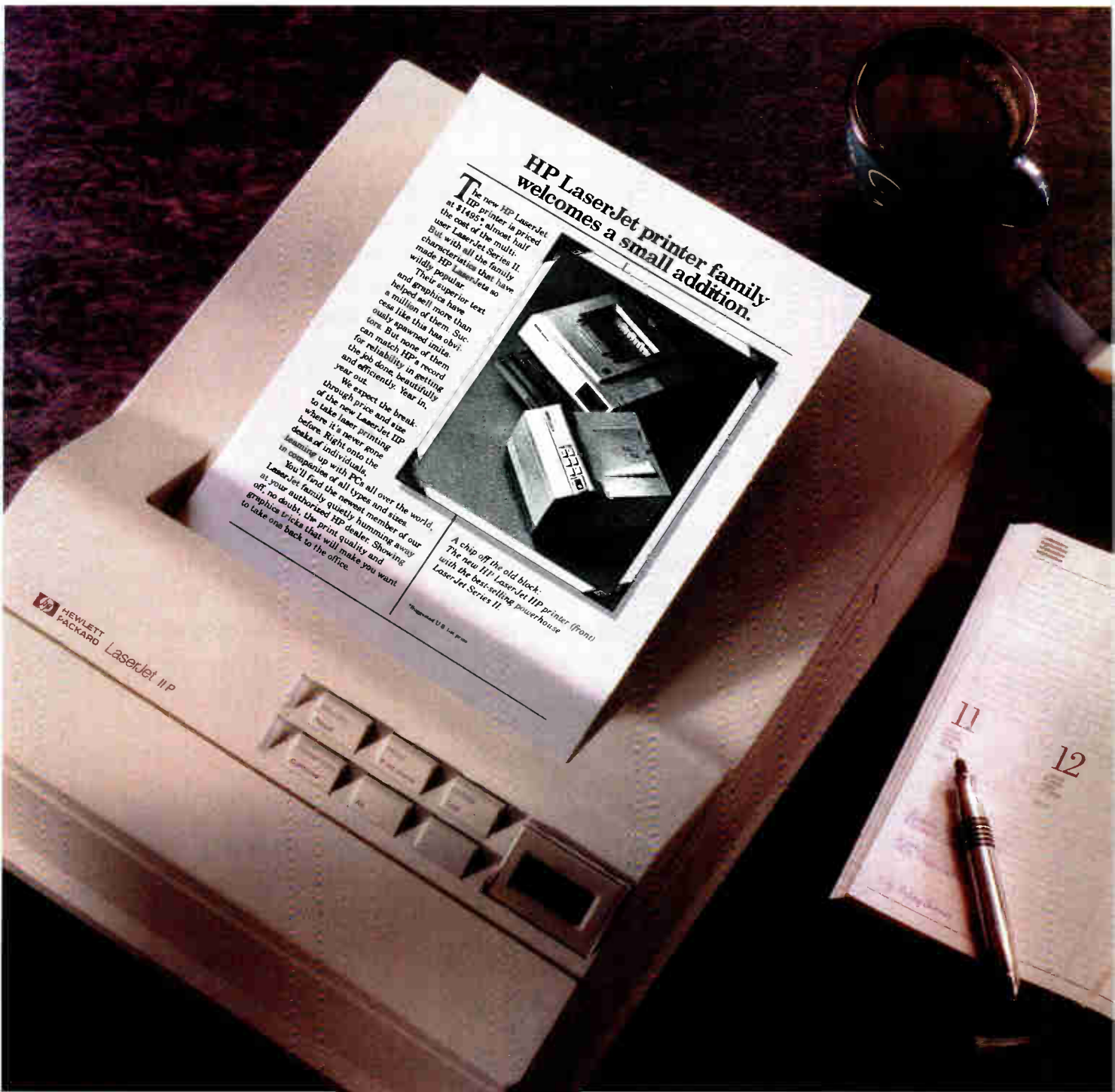

**HP LaserJet printer family
welcomes a small addition.**

The new HP LaserJet IIP printer is priced at \$1495*—almost half the cost of the multi-user LaserJet Series II. But with all the multi-characteristics that have made HP LaserJets so wildly popular...

Their superior text and graphics have helped all more than a million of them. Success like this has obviously spawned imitators. But none of them can match HP's record for reliability in getting the job done, beautifully and efficiently. Year in, year out.

We expect the breakthrough price and size to take LaserJet IIP where it's never gone before. Right onto the desks of individuals, in companies up with PCs all over the world.

You'll find the newest member of our LaserJet family quietly humming away at your authorized HP dealer. Showing no doubt, the print quality and graphics tricks that will make you want to take one back to the office.

*A chip off the old block:
The new HP LaserJet IIP printer (front)
with the best-selling power-house
LaserJet Series II.*

*Registered U.S. Pat. office

The new HP LaserJet IIP printer.

or landscape configurations. At four pages a minute. From one or two paper bins (the second is optional).

The 512K standard memory is upgradable to 4.5 Mbytes for more complex graphics and publishing programs.

And, of course, our new printer is compatible with the HP LaserJet Series II and virtually all popular PC software.

So call **1-800-752-0900, Ext. 277J** for your nearest authorized HP dealer. Then

introduce people at your company to their very own HP LaserJets.

There is a better way.

 **HEWLETT
PACKARD**

Circle 151 on Reader Service Card

12

Ways to Protect Your Networking Investment.

For networking file servers packed with performance, select a MaxSys™ system from CSS Laboratories and protect your investment 12 ways . . .

1. The 12-slot motherboard and 10 drive bays allow maximum system expandability for a longer return on investment.
2. Certified to run in all six operating systems: Novell Netware, SCO Xenix, ISC UNIX, IBM OS/2 EE, Microsoft OS/2 and Quarterdeck's DESQview.
3. Multiple choices to meet every performance need—386-20, 386-25, 386-33 and 486-25 MHz.
4. Large 64K two-way cache allows use of lower-cost DRAM in main memory.
5. Pipelined memory means faster operation under multi-tasking O.S.
6. Exclusive CSS Silent Memory Bus,™ triple-grounded to ensure maximum data integrity.
7. 100% AT compatible, 8 MHz I/O bus.
8. Reliable performance even with a "loaded" system—driven by a 400-watt power supply.
9. Mini-Tower option with five drive bays—for the flexibility to meet economy-conscious needs.
10. Ultimate software compatibility in all 286/386 operating environments.
11. Every board is individually tested and proven to perform, then tested again after system assembly.
12. Renowned CSS made-in-the-U.S.A. quality.

For more information on these or any of the other investment-wise CSS products—from desktop systems to the CSS Diskless Workstation, from motherboards and peripheral cards to high-speed text and graphics laser printers—just call or write CSS today.



CSS
LABORATORIES, INC.

A Solid Investment.

In the U.S.A. (714) 852-8161

In Canada (416) 882-0260

In the U.S.A.: 1641 McGaw Ave., Irvine, CA 92714. TEL: (714) 852-8161, FAX: (714) 852-9464. In Canada: 60 Mural St., Suite 1, Richmond Hill, Ontario L4B 3H6. TEL: (416) 882-0260, FAX: (416) 881-0461. AT is a registered trademark of International Business Machines. Silent Memory Bus, MaxSys, and the CSS logo are registered trademarks or trademarks of CSS Laboratories, Inc. All other marks are registered to their respective companies.

World Radio History

Circle 91 on Reader Service Card (DEALERS: 92)

MICROBYTES

Staff-written highlights of developments in technology and the microcomputer industry, compiled from Microbytes Daily and BYTEWEEK reports

Will Clock Speeds Top Out at 50 MHz?

An issue that computer designers can't seem to agree on is the ultimate potential speed limit of microprocessor clock rates. The more conservative argument, put forth at the Microprocessor Forum by *Microprocessor Report* editor Michael Slater and several other conference speakers, maintained that clock speeds will top out at about 50 MHz, primarily because of the limitations of conventional packaging and circuit board design, as well as the limits of memory speed.

"The electrical environment becomes a real problem at clock speeds higher than 33 MHz," said John Theus, chief designer of the Tektronix XD88 workstation.

Former IBM Fellow Andrew

Heller was decidedly more optimistic, predicting clock speeds of 100 and 150 MHz in the "next few years." Heller said new packaging techniques, such as "processor modules" and increased packaging density, would allow these higher clock speeds. Jim Peterson of Bipolar Integrated Technology said that his company is using bipolar technology to develop SPARC processors with a clock speed of 100 MHz.

Nevertheless, microprocessor experts agree that higher memory bandwidths (i.e., wider memory buses) would be needed to reach these higher levels of performance. MIPS Computer cofounder John Hennessy said that "64-bit address space is the next major architectural hurdle."

DEC's New Packaging Yields Denser Boards

Digital Equipment Corp. (Maynard, MA) has developed a new method for the electronic packaging of semiconductor chips that DEC says will yield processor boards with 30 times the density of the boards used in its VAX 8800 minicomputer. The packaging density determines the interconnect distances and thus the speed of signal propagation between ICs, DEC says. Signal propagation speed affects the cycle times of microprocessors and the data transfer rate between processors and memory. The typical signal propagation delays inherent in conventional printed circuit boards are a major obstacle to advances in processor performance.

DEC's new packaging technology, developed at the company's facility in Cupertino, California, consists of three main components: the High-Density Signal Carrier (HDSC), the Multi-Chip Unit (MCU), and the Planar Module, which connects multiple MCUs into a single system board. The HDSC performs the same function as a conventional board but allows circuit densities three to five times greater, DEC says. Using emitter-coupled logic (ECL) devices, the logic of the

four 15- by 12-inch boards of the VAX 8800 is represented on a single 4-inch-square HDSC—meaning a 30-fold increase in packaging density—according to DEC.

The HDSC is a nine-layer package on a substrate of polyimide-copper with a finished size of 4 inches on a side. Typical propagation delay on the HDSC is 160 picoseconds per inch, versus a delay of about 200 ps per inch on traditional boards, DEC says. The HDSC supports a range of chips, including ECL gate arrays and self-timed RAM chips developed by DEC. Power distribution and termination circuitry are built directly into the HDSC, eliminating the need for separate diodes, resistors, and decoupling capacitors.

The HDSC package mounts on the MCU, which can support up to 72 VLSI chips and has 800 I/O connectors (200 connectors on each side, 100 of which are ground connectors). Multiple MCU packages can be mounted onto the planar module, which is an advanced version of a printed circuit board. DEC officials displayed a 24- by 24-inch planar

continued

NANOBYTES

Intel will bring out a 50-MHz version of its 80486 this year, according to the man they call the "chief architect" of that processor, John Crawford. Ten years from now, Crawford predicts, we can expect the "Intel Micro 2000," a processor that will consist of 50 million transistors and, he promises, will be compatible with the 80386. (The BYTE News and Technology Department hereby announces its Micro 2000-based pocket-size workstation, making us the very first to introduce a system based on the forthcoming chip.)

Before the flood: Speaking of what's ahead, 80 80486-based systems are currently on the drawing boards in Taiwan, according to an Intel official. There are 400 80386-based machines in the works there, he said.

So how are the makers of more expensive personal computers going to separate their systems from the herd? Can you say **multimedia**, boys and girls? "Multimedia is a way for the truly value-added PC makers to distinguish themselves," said Bob Brannon, of Intel's Princeton (NJ) Operations, at a recent conference. Brannon works on Intel's Digital Video Interactive project, whose aim is to "get TV into the PC in an interactive fashion." TV-in-a-PC is something that the low-cost cloners can't afford to offer, he said.

PC fax boards could soon be exchanging binary files at 9600 bps. A binary-transfer standard for fax boards "is getting nailed down," according to George Masters, president of fax-board maker **Fremont Communications** (Fremont, CA). Some boards have a "peer to peer" binary transfer capability by which they can ship files to other boards of the same make, but there's no industry file transfer standard.

NANOBYTES

The Library of Congress's collection of 88 million printed and recorded items could someday be available on a **national information system**, if the government approves an advanced communications network proposed by Senator Albert Gore (D-TN). "Thousands of books could be on-line, available at the touch of a button," Gore said at a senate hearing recently. James Billington, the chief librarian for the Library of Congress, envisions citizens being able to go to their local library and browsing through the Library of Congress's resources via computer. Gore's proposal would create a **National Digital Library** of unclassified federal data banks and software libraries.

Some citizens at 1600 Pennsylvania Avenue are also backing establishment of a national computer network. The **White House Office of Science and Technology** has proposed setting up a National Research and Education Network, linking 1000 research sites around the country and capable of transmitting material at speeds comparable to sending 50,000 single-spaced typed pages in 1 second. "A future national high-speed network could have the kind of catalytic effect on our society, industries, and universities that the telephone system has had during the twentieth century," said OST head Allan Bromley in a letter to Congress.

Sun Microsystems (Mountain View, CA) has opened up its **SBus** to other companies for building add-in boards or computers. The SBus, which made its debut last spring in the SPARCStation, is capable of transferring data at 80 megabytes per second, Sun says; that makes it about twice as fast as the NuBus and the Extended Industry Standard Architecture bus. **Paul Borrill**, former National Semiconductor executive who helped develop the FutureBus specification and now works for Sun, emphasized that the SBus is "not specifically a system bus" but rather a "modular I/O interconnect," or a "mezzanine bus" that can coexist with other buses.

module containing 16 MCUs.

DEC has no plans to license its new packaging technology to other systems manufacturers. The new packaging will appear in a wide range of upcoming products from DEC, according to John Manzo, manager of systems software engineering. Other companies have been working on similar wafer-scale integration of circuits. IBM has developed a liquid-

cooled thermal conduction module that uses tiny thermally controlled bumps to connect circuits. Siemens and NEC are reported to have projects under way involving ceramics and high-density packaging. But DEC claims to be the first to have this technology ready for commercial use. At this point, though, it's not clear to what extent the packaging method will increase performance.

New Battery Could Last a Laptop's Lifetime

By the mid 1990s, your laptop computer could be powered by batteries that weigh one-fifth the weight of current cells, run for days before they need to be recharged, and last longer than the computer itself. And your desktop computer could have a built-in backup power supply the size of a couple of packs of cigarettes. The promise of these lightweight, long-life power cells comes from technology being developed by a young company called Moltech Corp. (Shoreham, NY).

Moltech is developing thin-film batteries based on solid conducting polymer electrolytes instead of the more conventional (and corrosive) liquid electrolytes used in most of today's batteries. Batteries based on liquid polymer electrolytes already exist, but they work only above 80°C, obviously limiting their utility in most applications. But Moltech scientists expect their solid solvent-free batteries to work at room temperature and below. Solid polymer batteries will be based on anionic groups (usually vanadium oxide or titanium sulfide) attached to a polymer "backbone."

Polymer batteries will have several advantages over current lead-acid and nickel-cadmium cells, Moltech president Terje Skotheim says. In addition to five times greater power storage capacity per weight or volume, they'll have a charge/discharge cycle

of more than 1500 cycles (as opposed to about 200 for current batteries), he says.

But the most intriguing thing about polymer batteries is their potential for ultralong life. They're expected to lose only 1 percent of their power capacity each month, Moltech says. Conventional batteries lose up to 30 percent per month while in use. "These batteries will outlast most devices that they power," Skotheim claims.

Because the batteries will be manufactured in polymer sheets, it should be easy to make cells of different sizes and capacities. For example, a tiny battery for a calculator could be made by "cutting off a small corner of the polymer sheet," according to Skotheim. A large-capacity battery for a backup power supply would result from "rolling up the polymer sheet."

Skotheim says polymer batteries will be less expensive to manufacture than conventional cells, but because of their size and expected longevity, they're likely to fetch a hefty premium in their initial incarnations.

But it will be a while before you'll be able to buy a lightweight, long-life battery for a laptop computer. Moltech doesn't plan to have a functioning prototype ready until "late 1991" at the earliest. And consumer applications probably won't be available until several years later.

New Titles Show Diversity of CD-ROM

We'll know that the CD-ROM market has matured when we need a CD-ROM just to list all the CD-ROM titles. Until then, we can gauge the market by the types of titles that make it to disk. Judging by recent releases, the CD-ROM catalog is

diversifying. Here's a sampling of some new platters.

Meridien Data (Scotts Valley, CA) has compiled hundreds of images sent back to Earth by the Voyager and Viking planetary probes. The GRIPS

continued

Until now there was only one way to integrate C and Assembler.



While C and Assembler give you power to burn, switching back and forth between them can leave your brain feeling a little fried.

All that stopping. And starting. And constantly retracing your steps.

Well, relax. Now there's Microsoft® QuickAssembler. Available with our clever QuickC® Compiler in one location: the first integrated environment for C and Assembler.

For the first time, you can save time with an integrated editor, compiler, assembler and debugger that let you create C programs, mixed C and Assembler programs, or Assembler programs that stand alone.

To make sure you feel at home in your new environment, we've designed Microsoft Quick Advisor, a hypertext electronic manual that coaches, coaxes and guides you on screen.

Quick Advisor gives you access to information on all ROM BIOS and MS-DOS® calls. And it even lets you cut and paste sample programs, so you can make both C and Assembler subroutines part of your routine in no time.

For more details on the incredible integrated power of QuickAssembler and QuickC Compiler, call (800) 426-9400. If you own QuickC Compiler version 2.0 already, we'll tell you how to add on QuickAssembler quick.

And take a load off your mind.



Microsoft
Making it all make sense.

S E R I E S

Work Areas

TRANSFILE

LETTERS

TRANSFILE

LETTERS

CUST

Name	Ext	Size	Last Modified	Attr
CUSTOMER	139	321	05-Sep-89	2 256
CUSTOMER	170	170	05-Sep-89	2 256
NEWS	3511	14	05-Sep-89	2 192
FINHELP	701	15	05-Sep-89	4 256
FWKPRO	EXE	100194	05-Sep-89	6 312
FWKPRO	DOC	446508	05-Sep-89	6 312

Invno	Cnum	Item	Price	Company	Contact	Address	City	St	Dig	Not
10002	2656	WC986	5.00	Head Hardware	Leroy Davidson	Attn: Hy P Daldee	Ma	02121	None	
10003	5604	WPN06	417.00	Campground	Roe Amiable	Main Office	Woodham	Ma	02091	None
10003	5696	1B+2G	18.00	Mariner's	Wilby Delibera	Main Office	Twin Pines	Ma	02041	None
10004	5104	MTY	837.00	French Har	Skippy Erickson	Dept 300 B	Speedway	Ma	02005	None
10005	8976	WIND4	10.00	Tall Men's	Brian Dubrouser	Unit #13 7	Pella	Ma	02000	None
10006	5608	PCF0PC	417.00	Pools R Us	David Lobos	Main Office	Pushington	Ma	02701	None
10006	5700	DISC	10.00	Office Fur	Chris Danglag	Main Office	Boomer	Ma	02031	None
10007	5600	SLBY	695.00	Helping Ha	Sally Emery	Ma				
10007	5692	CSC	695.00	Reporting	Kenny Waits	Ma				
				Production	Janet Stroller	Ma				
					Ciderville	Marty Mack	Ma			

September 1989 7:00 Staff Meeting,
 Be prepared to discuss the 12
 1 2 plan.

3 4 5 7 8 9 1:00 Lunch with
 Erickson at La
 10 11 12 13 14 15 16 Mabar.
 17 18 19 20 21 22 23 4:00 Meet with
 field personnel.
 24 25 26 27 28 29 30 9:25 Flight to
 Toledo

Company	Phone	Address	City	State	Zip
Head Hardware	326-4100	Attn: Hy P Daldee	Ma	02121	
Head Hardware	262-26-41	Attn:			
Maryanne Systems	419-29-75	Attn:			
Richard Hill Assoc	603-88-73	Attn:			
Norman Eggs	408-721-69	Attn:			
Smith and Assoc.	502-71-26	Attn:			
Software Inc.	316-24-34	Attn:			
Computers Plus	312-262-01	Attn:			

New FoxPro

Shifting the Balance Of Power in Database Management

There's a new leader in the relational database management world. Its name is FoxPro.

FoxPro is the first and *only* microcomputer database management system that combines astonishing performance with a sleek interface of amazing power and beauty.

- FoxPro offers all the elegance and accessibility of a graphic-style interface, yet operates at the stunning speeds possible only with character interfaces.
- FoxPro is so easy to learn and use, even beginners can become productive immediately; yet it's powerful and sophisticated enough to satisfy the needs of the most demanding developers and power-users.
- FoxPro gives you choices instead of limits: use a mouse or a keyboard; type commands or use the object-oriented interface; run in one window, or hundreds.
- FoxPro is so efficient, it runs in a 512K PC-XT, yet it's able to take advantage of the speed, expanded memory and extended video modes of the most advanced machines available. You don't even need a graphics card or special windowing software.

Nothing is Faster

Fox Software products are famous for their unmatched execution speed. FoxPro extends that tradition.

FoxPro is up to eight times faster than dBASE IV — more than 15 times faster than dBASE III PLUS!

And that blazing speed translates into unprecedented power. Now you can efficiently process gigantic databases with hundreds of thousands — even *millions* — of records.

Protecting Your Investment

With FoxPro, your existing FoxBASE+ or dBASE III PLUS programs will run perfectly — first time, every time, no excuses. And



FoxPro is language-compatible with dBASE IV. But FoxPro doesn't stop there. It has over 140 language enhancements not found in any version of dBASE. We've outdone ourselves by adding more than 200 language enhancements you won't find in FoxBASE+.

Best of all, FoxPro opens up whole new worlds for your applications by letting you move them onto a variety of different platforms.

The Tradition Continues

Fox Software is committed to excellence — our products prove it.

We've been producing superb database management software since 1983. And our products for both the PC and the Macintosh continue to win awards worldwide.

We've taken everything we know about software engineering, databases and interface design, and focused it into one remarkable product — FoxPro.

FREE Demo Disk

Shift the balance of power in *your* favor by trying FoxPro for yourself.

Call (419) 874-0162 now to get your free demo disk. Or ask for the FoxPro dealer nearest you. See for yourself: *Nothing Runs Like The Fox.*

FoxBASE+ Users:

Call About Our Liberal Upgrade Offer!

System Requirements: FoxPro operates in 512K RAM (640K recommended) with MS/PC-DOS 2.0 or greater and an 8086/8088, 80286 or 80386 microprocessor. For optimum performance, FoxPro takes complete advantage of any available EMS (expanded memory) or a math coprocessor.

Trademark/Owner: FoxPro, FoxBASE+/Fox Software; dBASE III PLUS, dBASE IV/Ashton-Tate.

Fox Software

Nothing Runs Like The Fox.

Fox Software, Inc. (419) 874-0162, Ext. 320
134 W. South Boundary FAX: (419) 874-8678
Perrysburg, Ohio 43551 Telex: 6503040827 FOX

Circle 131 on Reader Service Card (DEALERS: 132)

NANOBYTES

Solbourne (Longmont, CO) and **Matsushita Electric** of Japan are collaborating on a **64-bit SPARC** processor with a 40-MHz clock speed, said Solbourne's vice president of engineering, Mike Schumacher. Like other new chips, the Solbourne SPARC processor will include integrated integer and floating-point processors, separate instruction and data caches, and on-chip memory management. The chip will contain 1 million transistors and will measure only 15 millimeters on a side, Schumacher said. Solbourne plans to introduce a workstation based on the new processor in mid-1990.

Sybase (Emeryville, CA) has developed a specification for networked **communications between diverse database applications**. As an "open" standard, the Open Server application programmer interface will enable developers to create a server-based front end for non-Sybase databases and applications, the company says. This would allow minicomputer and mainframe databases (e.g., DB2, RMS, Oracle, and Ingres), other large-system applications, and real-time data feeds to be transparently accessed by any client or server application that supports the format. Open Server object code is slated to be released for Unix and OS/2 machines next year, Sybase said.

NIPS, not MIPS: Computers designed specifically to move data on and off networks will replace plain old computers as servers, says a new study from **Forrester Research** (Cambridge, MA). The report says this new breed of network computer will employ multiple buses, intelligent I/O subsystems, and multiprocessing capability to provide faster throughput than is possible with a standard computer; they'll also have redundant power supplies, backup components, and error-correction facilities. Instead of millions of instructions per second (MIPS), Forrester researchers say, these systems will be gauged by a new measurement: network I/Os per second, or NIPS.

(Government Raster-Image Processing Software and Data) disk contains photos of Mars, Jupiter, and Saturn, but not the recent photos of Neptune. Meridien concedes that it's not easy to find a specific image from among the hundreds on the disk but says it is trying to make the compact disk more user-friendly. The \$9 CD can be viewed with a Macintosh- or IBM-compatible drive.

Encyclopaedia Britannica (Chicago) has put all 26 volumes of Compton's Encyclopedia (31,200 entries) onto a CD and has added "multimedia" enhancements, such as color and black-and-white illustrations, sound (e.g., famous speeches and snatches of music), and animated sequences. Hypertext mechanics let you jump topics or delve further by clicking on words and icons. Compton's Multimedia Encyclopedia should be released next month at \$895 (\$795 for schools and libraries); it will work with IBM-compatible drives from Sony, Hitachi, and Amdek.

Wondering about that diet of Teenage Mutant Ninja Turtles cereal and Jolt Cola? The Food/Analyst from Hopkins Technology (Hopkins, MN) is a database of 5000 foods and 80 nutrients, including fast foods and breakfast cereals, that the company says can adapt to a user's eating habits and provide nutritional evaluations.

For companies doing business with the U.S. government, Optical Publishing (Fort Collins, CO) has put together Farsearch, a database containing the complete Federal Acquisitions

Regulations and list of Department of Defense FAR bases.

Need a fax number? If it's listed anywhere in the world, or if there's a telex number, Jaeger + Waldman Publications (Bethpage, NY) says you can find it on the J + W Commdisc.

Quanta Press (St. Paul, MN) is like one of those mail-order music houses that stock everything from Big Bill Broonzy to Yma Sumac. The company distributes an eclectic range of disks, some compiled by other publishers. The latest additions to Quanta's catalog include The World Factbook, an annual almanac compiled (and unclassified) by the Central Intelligence Agency; Dick's Some of the Earth's Planes, a visual digest of aircraft; Seals of the Government Printing Office (official emblems of federal agencies like the Railroad Retirement Board); Shareware Gold, a collection of shareware programs; and About Cows, a compendium of information on our bovine friends.

And one of the most browsed books in the world, the *Guinness Book of World Records*, has been adapted to CD-ROM by Pergamon Compact Solution (London) and Knowledge Set Corp. (Mountain View, CA). The company has added color photos, sound effects, animation, and music to this annual assemblage of data. To page through the \$99 Guinness Disk of Records and find out who holds the world record for pizza consumption, you'll need a Macintosh with a CD-ROM drive and HyperCard 1.2 or higher.

Compiler Optimization, Parallelism Hold Keys to Improving Processor Performance

To make the next leap forward in microprocessor performance, designers will have to improve compiler optimization and make better use of parallelism, according to experts gathered at the Microprocessor Forum in San Jose, California.

There is "real opportunity" in better compiler technology, with possible three- to fourfold performance improvements as a result, said Stanford University professor and MIPS Computer cofounder John Hennessy. The challenge is to enable compilers to recognize microprocessor operations that can be executed in parallel, rather than sequentially. Parallelism is inherent in simultaneous

integer and floating-point operations. With modern microprocessors now integrating floating-point and integer units on a single chip (e.g., Intel's 80486 and Motorola's 68040), developers must now update compilers to take advantage of this new level of integration, Hennessy said. Most compilers currently on the market cannot perform parallel floating-point and integer operations.

Andrew Heller, industry consultant and former IBM Fellow, agreed with Hennessy's view, saying that compilers must be designed "to recognize parallelism." He also said that compilers could benefit from better

continued

**Welcome
to the
Real-World.**

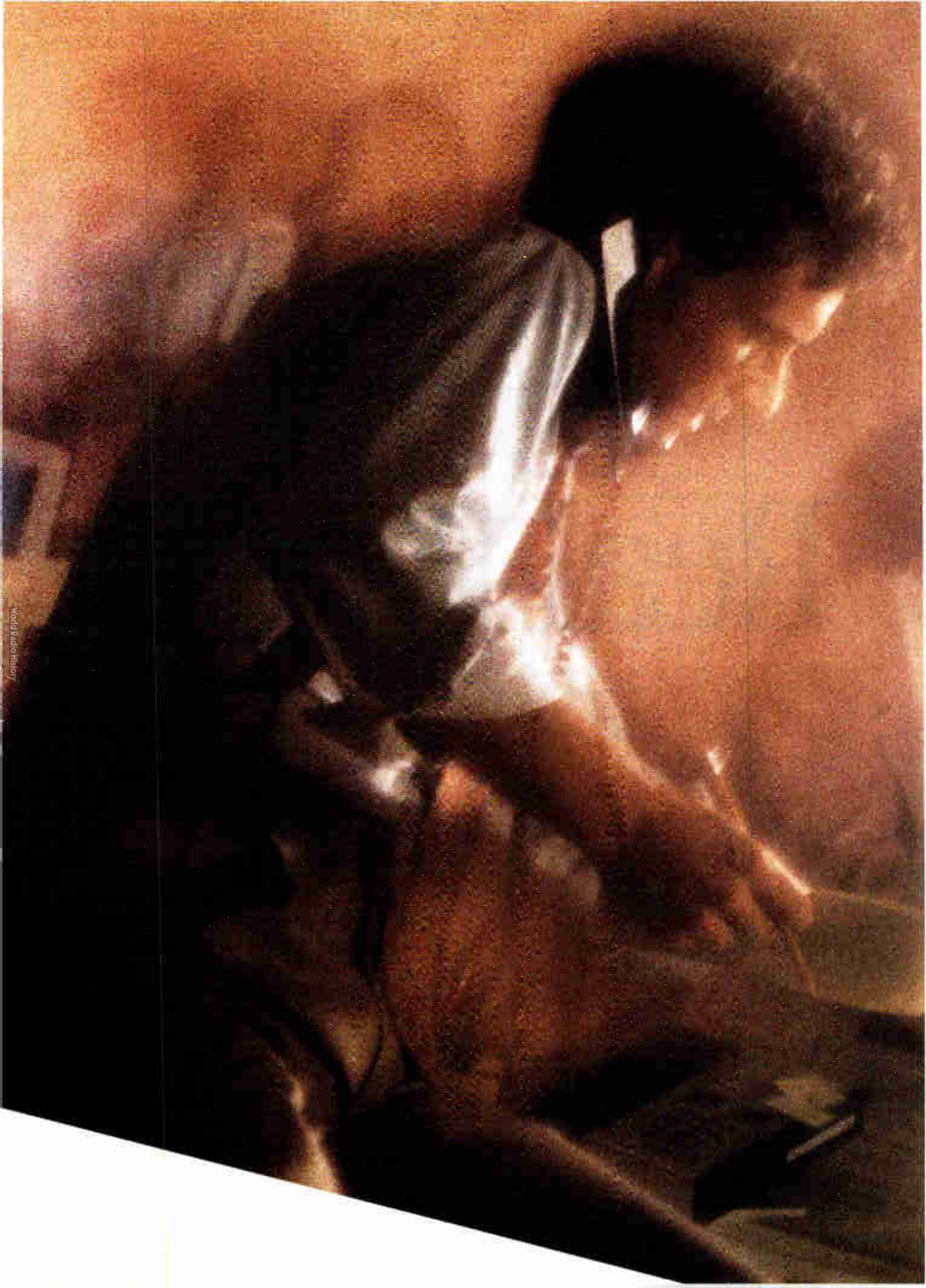

World Radio History

Real-World Centrex.

In the tidy world of diagrams, nobody ever moves to a new office. Or changes jobs. But in the real world, moves and changes create telephone chaos. Where can you find a phone system that puts you back in control? At your local phone company. With advanced Digital Centrex Service provided from the Central Office, you get to control, assign and service your own phone lines. Make your own moves and

**You and Your
Local Phone Companies**

changes. Right from your own premises. Employees get to keep the same phone number no matter where or how often they move. And you get to keep your sanity. All thanks to the state-of-the-art 5ESS[®] Switch from AT&T Network Systems. Need a change? Make a move. Call your local phone company.



AT&T
Network Systems

Circle 31 on Reader Service Card

NANOBYTES

Maxem Corp. (Tempe, AZ) is now offering **Cause**, its object-oriented programming software, in a package that contains a version for IBM compatibles and a version for Macintoshes. The new mixed-environment edition is priced at \$495, which is what the PC- and Mac-specific versions used to sell for; those editions now cost \$295. **Cause** is designed to let users develop custom applications **without learning a programming language**; instead, you pick and choose icons that represent functions.

Shareware collections were the **best-selling CD-ROMs** in 1989, according to a top-10 list compiled by the **Bureau of Electronic Publishing** (Upper Montclair, NJ), a disk distributor. Shareware Grab Bag (Alde Publishing) and PC-Sig Library (PC-SIG) sold more copies than Grolier's Encyclopedia (which was number one in 1988), Microsoft Bookshelf, Microsoft Programmer's Library, McGraw-Hill's Science & Technology Reference, and the Oxford English Dictionary, the company says.

One of the first things people notice about the little Zenith MinisPort computer is its use of **2-inch floppy disks**. "Cute," they say. "But where will I be able to buy them?" When Zenith introduced the MinisPort, no one was selling 2-inch floppy disks for computers (Sony and others were using them in electronic cameras). But now **Memorex** (Santa Clara, CA) is making the teeny floppy disks for use in computers. They're compatible with current floppy disks and can store 1 megabyte of data.

More than 30 companies involved in establishing a standard for **FDDI** (Fiber Distributed Data Interface) LANs have formed the **Advanced Networking Group** to investigate interoperability between products from different vendors. The ANG roster includes **Advanced Micro Devices** (the initial sponsor), Hewlett-Packard, AT&T, Sun, Ungermann-Bass, and Sony. The group's first task is setting up the Interoperability Test Center.

instruction scheduling techniques. "The biggest inhibitor [to improved performance] is the lack of software tools," said Heller.

"Parallelism is a key concept," said IBM's director of engineering for workstations, Phil Hester. "Compilers have to be able to dispatch multiple instructions in a given cycle."

Although the Microprocessor Forum is essentially a hardware conference, several speakers emphasized the importance of software in taking processor performance to the next level. Indeed, there was a grain of pessimism among the speakers in predicting future performance gains. Hennessy was not optimistic about the progress of multiprocessing, saying that it will be the late 1990s before multiprocessing systems actually come to market. "We have underestimated the complexity and system architecture problems" associated with

multiprocessing, he said, a sentiment echoed by other conference attendees.

The old problem of binary compatibility is another obstacle to performance improvements. According to Intergraph's technical marketing manager, Harley McGhan, designers of the first RISC processors were able to make major performance gains because they started with a clean slate; they didn't have to worry about binary compatibility with earlier generations. However, upcoming RISC chips will have to maintain binary compatibility, and this will limit the degree of performance improvements.

The annual Microprocessor Forum is organized by the *Microprocessor Report* newsletter and its editor, Michael Slater. You can order audiotapes of the proceedings by writing to Slater at *Microprocessor Report*, 550 California Ave., Suite 320, Palo Alto, CA 94306.

New ROM DOS Frees Space for Applications

Microsoft (Redmond, WA) has developed a version of MS-DOS that executes in the computer's ROM rather than in RAM. The company is aiming the ROM-executable DOS at makers of laptop computers and embedded systems—Poqet Computer, for example, is using ROM MS-DOS in its hand-held PC. Several computers come with DOS in their ROM chips, but they first load the operating system into RAM.

The main advantage of ROM-executable DOS is that it saves approximately 40K bytes of RAM, which is then available for other applications. Designers of embedded systems will be able to build DOS directly into the hardware and then will be able to run MS-DOS applications. The ability to build MS-DOS into embedded applications will make it easier to develop software for those systems, according to Microsoft product manager Mark Chestnut.

ROM-executable DOS is "preconfigured" in the host computer system, thus eliminating boot procedures from disk or time delays while the operating system loads into RAM.

Microsoft had to significantly rewrite MS-DOS to make it ROM-executable, program manager Tom Lennon told BYTE. "We had to completely reorganize the segmentation areas in memory," said Lennon. The ROM version is actually a "split system," using small portions of RAM for accessing "modifiable" data, such as the file structure, he said.

Microsoft will supply a "binary adaptation kit" to OEM licensees, which includes the code and instructions necessary for "burning" MS-DOS into the OEM's ROM chips. Emerson Radio Corp. and Headstart Technologies have licensed the product. Vadem Corp. will distribute ROM DOS for its Intel 80186-based embedded processor systems.

INMOS Cuts Cost of MIPS to \$2 Each

INMOS has designed a low-cost version of its 32-bit T425 processor that the company says is capable of 10 million instructions per second at 20 MHz; at a volume price of \$20 each, this translates into a price/performance

level of \$2 per MIPS, INMOS says. The new T400 has a full 32-bit integer-only CPU but no floating-point unit. It is fully software-compatible with other transputers.

continued

Intelligent Database Tools are Here!

Is your Database an Asset or just a File?

As your database grows, its potential value increases. Your challenge is to keep it error-free, understand it, and use it to make effective decisions. These are the tools you need:

SUPERVISOR

Maintain data quality and data integrity. Keep your database error-free. Database/Supervisor analyzes your databases and identifies *suspicious data items*, and patterns which are out of the ordinary. It automatically detects errors which violate statistical or logical integrity constraints. *If your database is being corrupted, Database/Supervisor will show you where.*

IXL The Machine Learning SYSTEM

Discover *hidden patterns and unexpected relationships* in your large database. IXL analyzes your database and generates easy-to-read rules using artificial intelligence and statistical techniques. While Database/Supervisor detects errors, IXL produces rules and decision-making insight. *The solutions you are looking for may already be in your database, waiting to be discovered.*

NEURAL/QUERY

Don't deny yourself inexact, but potentially valuable, answers to your database queries. Close matches are more valuable than *no response*. IXL and Neural/Query are perfect partners. IXL generates rules which can be exported. However, Neural/Query analyzes your large database, builds a network of partial matches, and provides the closest matching answer to your database queries. *Use the full informational content of your database.*

Intelligence COMPILER

The highest-level, easiest-to-use intelligent database environment today. Build dialogs automatically, link them with rules, frames and hypertext *in minutes*. Develop your intelligent application quickly and efficiently, then run it on multiple operating systems. The built-in relational database combines expert system logic with SQL-based object oriented queries. *Accomplish in hours what would otherwise take weeks.*

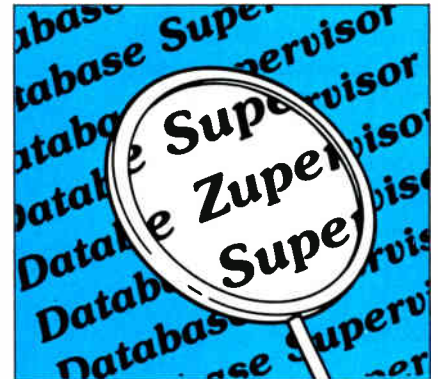

Will your database errors live forever?



Alone in a universe of data? Let IXL be your guide.



Are you sure you have no listing for the Vite House.

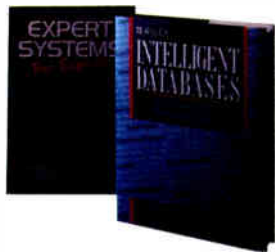

Our leadership in this field of technology is unsurpassed. Ask for our books *Intelligent Databases and Expert Systems for Experts* by K. Parsaye, et al., published by John Wiley.

Experts love our software:

The Intelligence/Compiler is a powerful state of the art system for real-world applications. Its intelligent editing and debugging facilities are a bonus. *AI/Expert Magazine*, February 1988.

Considering the variety of features that the Intelligence/Compiler provides, it is hard to believe that you can get better value for your money. *PC/AI Magazine*, June 1989.

Having used IXL on a large database of geological test data, we were surprised by the many relationships it found. This has greatly helped us to interpret our Oil Company database. *Mr. James Brown*, Oil Industry Consultant, July 1989.

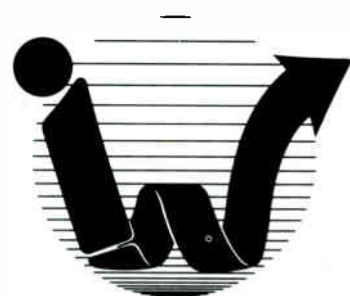

IntelligenceWare
The Next Level in Computing
Circle 162 on Reader Service Card

Yes, I want to win with your easy-to-use intelligent database tools.

Send me your complete collection of intelligent database tools for \$1,490.

Send me the three components: _____, for \$990.

Send me the single component: _____ for \$490.

Computer system: IBM/PC PS/2 Macintosh Also available on VMS, Unix and OS/2

Name _____ Check enclosed, Charge to: Visa MC AMX

Company: _____ Card No: _____ Expiration _____

Address: _____

Telephone: _____

For telephone orders call (800) 888-2996
Shipping and handling: US \$9, Canada and Hawaii \$20,
Overseas Air \$50. California residents please add 6.5% sales tax.

IntelligenceWare
9800 S. Sepulveda Blvd.
Los Angeles, CA 90045-5228
Telephone: (213) 417-8896
Telefax: (213) 417-8897

1 The NeXT™ Computer System is the first computer in the world (and so far the only) to use read/write/erasable optical storage. While PCs today are typically equipped with Winchester drives that store 20 to 40 MB, a single optical disk can store 256 MB. Plus, it is removable, for portability and added security. This dramatically new technology provides storage that is simultaneously vast, reliable and cost-effective—a combination unmatched by computers of any size.



2 NeXT has made the power of UNIX® usable by mere mortals. UNIX is the high-performance operating system used by workstations to achieve true multitasking and superior networking. Unfortunately, it has always been the antithesis of user-friendly. NeXT has given UNIX a revolutionary new interface—one that is both visual and intuitive. Now computer users of every level can instantly wield this tremendous power, with no technical knowledge whatsoever.



3 To achieve the power needed for the 90s, NeXT bypassed traditional workstation architecture and went directly to that of a mainframe. This eliminates bottlenecks and attains an extraordinary level of system “throughput”—the true measure of computer performance. Only through the use of VLSI (Very Large Scale Integration) technology could this architecture be reduced in size so that it could fit inside a desktop computer. It’s a mainframe on two chips.



4 While PostScript® has long been the industry standard for printing, NeXT has made it fast enough to also be used on the display. This “unified imaging model” ensures that what you see on



the display is precisely what you will get on paper. All your work, in any size type and any degree of rotation or magnification, appears with perfect 92-dots-per-inch clarity on the NeXT MegaPixel Display. And with laser precision at 400 dpi on the NeXT Laser Printer.

IN THE 90s, WE’L ONLY TEN REAL BREAKTH HERE ARE SEV

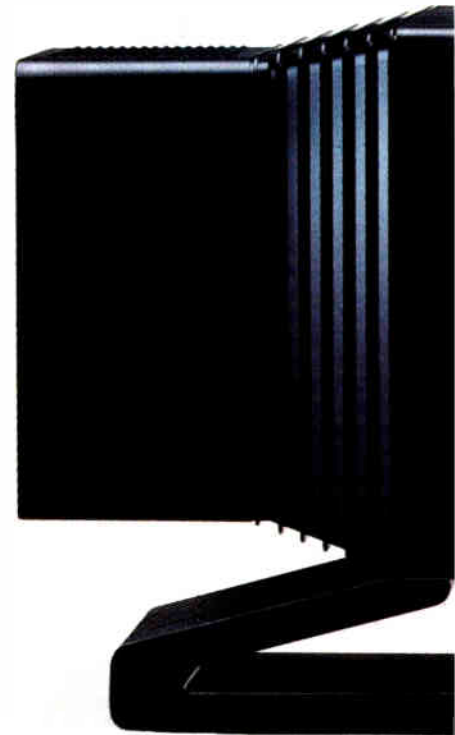

5 The NeXT Computer System is the first to be capable of producing CD-quality sound. Without requiring any additional equipment. This feat is made possible by a chip that has been specifically designed for the task of manipulating sound—the Digital Signal Processor (DSP). Because this processor is standard in every NeXT machine, software developers will be able to call upon its power to enrich programs we use every day. Now computers will not just be seen, but heard.



6 NeXT Mail takes electronic communications beyond anything you've seen on a personal computer before. Now you can send and receive multimedia mail—including text (with varied type fonts, styles and sizes), graphics and voice messages. And despite its high level of sophistication, NeXT Mail is so intuitive, you may not ever need to open the manual. NeXT Mail is built into the system, along with Ethernet and TCP/IP, so the NeXT machine can quickly become a part of existing networks.



7 Programmers can create software on the NeXT Computer up to ten times faster than on any other computer—the result of a breakthrough called NextStep.® It gives software developers the power to create the graphical user interface portion of their applications (often the most time-consuming and difficult part) without any programming at all. This revolutionary environment means we will see more programs, and better ones, in less time than ever possible before.

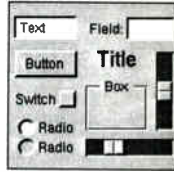

These seven breakthroughs will change the way we use computers in the 90s. Which is why Businessland, the leading supplier of computers to corporate America, chose the NeXT Computer System as the workstation they will offer. Call us at 800-848-NeXT, and we'll send you a 28-page brochure describing the NeXT Computer. We'll also give you the address of your nearest Businessland Center. There, you can experience for yourself the first seven breakthroughs of the 90s. And get a good idea where the next three will come from.



YOU'LL PROBABLY SEE BROUHOOTS IN COMPUTERS. NOT EVEN ONE OF THEM.



© 1989 NeXT, Inc. NeXT and the NeXT logo are trademarks of NeXT, Inc. NextStep is a registered trademark of NeXT, Inc. PostScript is a registered trademark of Adobe Systems, Inc. UNIX is a registered trademark of AT&T.

Circle 230 on Reader Service Card
World Radio History

NANOBYTES

IBM shaved 5.8 percent off the price of three PS/2 models and pruned the price of one by 20 percent. The 8086-based Model 30-021 now costs \$2255 (it was \$2395); the 80286-based Model 30-E21 now costs \$2445 (it was \$2595); and the big 80386-based Model 80 with a 314-megabyte hard disk drive now costs \$11,295 (it was \$11,995). The biggest cut came to the Model 70-121, an 80386-based box with a 120-megabyte hard disk drive; it now lists for \$6395 instead of \$7995.

Citing drops in the cost of memory chips, **AST Research** (Irvine, CA) took a chainsaw to the price of its 1-megabyte RAMpage PC board. The memory-expansion card now has a price tag of \$695; it used to be \$1245. AST also trimmed the price of its VGA cards; the 8-bit AST-VGA now costs \$399 (it was \$445), and the 16-bit AST-VGA Plus is now \$449 (it was \$599).

After a successful trial test, the **National Institute of Standards and Technology** (Gaithersburg, MD) is proposing that **ISDN** be part of the Government Open Systems Interconnection Profile. As of August 1990, federal agencies cannot buy certain telecommunications or network products unless they conform to GOSIP. NIST wanted to make sure ISDN and GOSIP can get along together before suggesting the former be a part of the latter.

Meanwhile, at Interop '89 in San Jose, CA, a group of vendors staged a demonstration of IBM PC applications running over an **OSI network** through a NetBIOS interface. In theory, this all means computer users will be able to communicate with a wide variety of systems based on different architectures.

Aldus (Seattle) says that PageMaker for OS/2 1.2 will support mainframe graphics files (CGM and GDDM/PIF) and will be able to drive Hewlett-Packard's Laser-Jets. The company expects to release sometime in early 1990 a **Russian version** of PageMaker.

INMOS says that it reduced the cost by having only two instead of four on-chip serial links and by including only 2K bytes instead of 4K bytes of on-chip memory.

The company hopes that the low price will encourage the use of several transputers in parallel, even in volume products like fax machines or PostScript printers.

INMOS says that its next generation of transputer chips will be drastically faster, will incorporate a large cache, and will be able to run standard operating systems more efficiently. The processors will be capable of performing 100 MIPS and 20 million floating-point operations per second, said **INMOS** technical director Peter Cavill in London. The new chip, currently called the H1, will not be available until 1991, he said.

The serial links on H1 will be speeded up to 100 megabits per second full duplex, Cavill said, but the most radical feature of the H1 will be its support for "virtual links"; an on-

chip packet network controller will multiplex messages onto links transparently so that a user program sees as many links as it needs, rather than the four fixed links of the current transputers. This could simplify the writing and configuring of parallel programs and could make programs easily portable among parallel computers of different topologies.

The network controller will also be able to "through-route" messages destined for other processors without any computational overhead. In turn, this should improve the performance of communication-intensive algorithms.

INMOS will add a hardware memory protection/management unit to allow standard operating systems like Unix to be run efficiently. The new design will also incorporate a DRAM controller that supports static column modes for fast RAM access. Some observers see these changes as **INMOS's** response to the Intel 80860 RISC processor.

Claris Aims to Ease Cross-Platform Transfers

Macintosh software maker **Claris Corp.** (Santa Clara, CA) is planning a common architecture for all its applications that the company says will make it easier to transfer files to and from computers of different makes. The company says that its new **XTND** (pronounced "extend") will enable software developers to create file translators that work with **Claris** products. **XTND** will let users directly import and export word processing, graphics, database, and spreadsheet files across multiple platforms, **Claris** claims. And because **XTND** will be common to all **Claris** applications, file translators will work with all **Claris** software; all that the Mac user will have to do is copy the appropriate translator file into the System folder, according to **Claris**.

MacWrite II 1.1 is the first program to incorporate **XTND**. The program supports 30 file-translation

formats and allows you to transfer data files directly with many Mac, IBM, mainframe, and minicomputer applications, the company says.

Instead of using a file-translation utility to convert your, say, **WordPerfect PC 5.0** file to the **MacWrite II** format, you select the **Open** command from the **MacWrite** menu, and **XTND** automatically translates the **WordPerfect PC** document to **MacWrite** format. Conversely, you can save a **MacWrite II 1.1** file in up to 30 different formats and then put **IBM PC** (and other) files directly into **MacWrite II** documents, according to **Claris** officials.

Claris plans to license the **XTND** developer's kit at no charge. The idea is that developers can create a translator file specific to their application's file format; this assures that **Claris XTND** applications can read and write data files of that format.

NEWS STAFF SEEKS NEWS. DIAL (603) 924-9281.

The BYTE news staff is always interested in hearing about new developments that might affect microcomputers, the way they work, or the way people work with them. If you know of a project that could shape the state of the art, please give us a call at (603) 924-9281 or write to us at One Phoenix Mill Lane, Peterborough, NH 03458. An electronic version of Microbytes, offering a wider variety of computer-related news on a daily basis, is available on BIX.

Without Teamwork[®] on your PS/2,

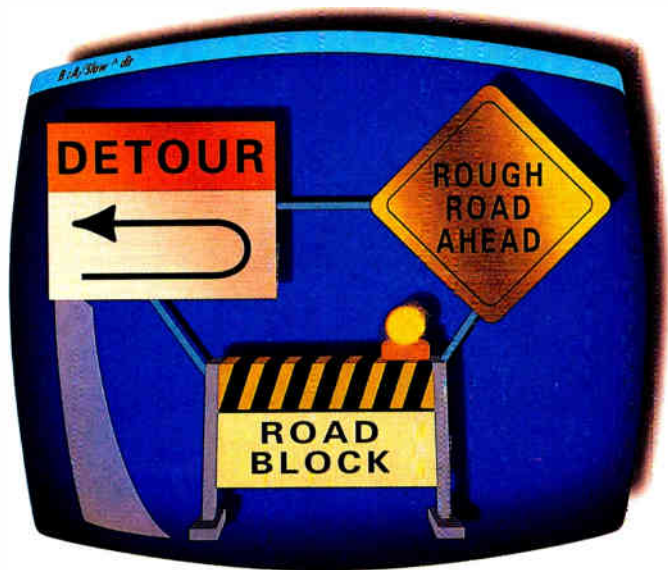

your development teams will never shift into high gear.

Now you can speed up the performance of your entire work group with a true multi-processing development environment for OS/2. Teamwork is the first CASE toolset to support OS/2 software developers. So if you've been driving DOS-based CASE tools and you're ready for workstation power, get ready to fasten your seatbelt.

The intuitive graphic user interface and the advanced multi-window, multi-tasking capabilities of Teamwork immediately improve individual and team productivity. Each developer creates, edits, and inspects multiple design views simultaneously with simple point and click operations. Teamwork fully integrates graphics and data for structured analysis, data modeling, real-time analysis, and structured design models. Rigorous support of standard methods, complete syntactical checking and balancing assure system quality.

Teamwork's own configuration management and project status help manage and control even your largest projects. Projects can be partitioned to allow parallel development by multiple analysts and designers. The project manager controls the process by the baseline, merge, and reconcile features of Teamwork.

If you're just getting started with CASE tools, Teamwork/PCSA is a DOS-based structured analysis tool that can also run on your PS/2. As your projects grow, Teamwork/PCSA gives you an easy migration path since it is fully compatible with Teamwork for OS/2.

Thousands of developers with applications ranging from financial to avionics already rely on the power of Teamwork. In fact, Teamwork is the world's leading workstation-based CASE toolset.

Cadre's hotline support, maintenance services, excellent documentation, and effective educational offerings make sure you get started right on the right track. That's all a part of Teamwork.

Call (401) 351-CASE

If you're ready to shift into high gear, then you're ready for Teamwork. Anything less, just won't meet your standards.

CADRE

Cadre Technologies Inc.
222 Richmond St.
Providence, RI 02903

Teamwork is a registered trademark of Cadre Technologies Inc. PS/2 and OS/2 are trademarks of International Business Machines.

Circle 29 on Reader Service Card

**WHO IN THEIR
RIGHT MIND
WOULD ORDER
A COMPUTER
OVER
THE PHONE?**

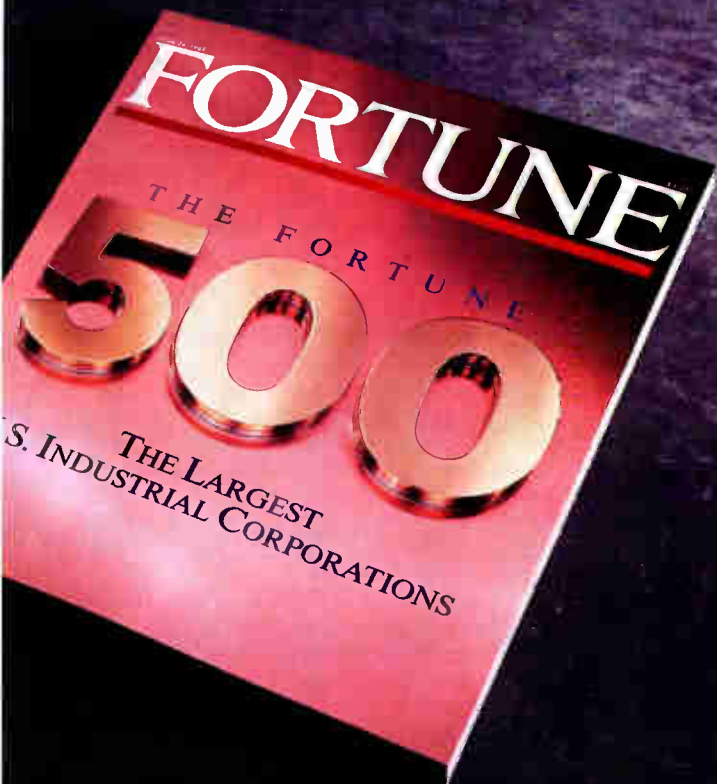

Over half of the Fortune 500 companies, that's who.

A group that, by and large, is not known for taking uncalculated risks.

So when it comes to buying personal computers, they scrutinize such things as reliability, compatibility, performance, price and, oh yes, support.

The same things any smart company would look at.

And the same things the editors at *PC Week* asked corporate volume buyers to rate in two recent polls.

The results were unprecedented.

SO HOW COME YOU NEVER CALL?

Dell 386[™]-based computers ranked first in 12 of 12 categories.

And our 286-based computers were first in 9 out of 12 categories. Making Dell the clear call in overall customer satisfaction, for the second time in a row. Over Compaq[®]. Over IBM[®]. Over everyone.

But it's not just our PCs that have caught the attention of corporate America. Our entire way of doing business is turning heads as well.

Because we sell direct. No retail stores. No retail salespeople.

Instead, you deal directly with someone who knows what they're talking about. And you get computers individually configured to your exact needs.

A process that not only saves you the 35% retail markup but 100% of the aggravation.

Which might prompt one to ask an even more relevant question: Who *wouldn't* order a computer over the phone?

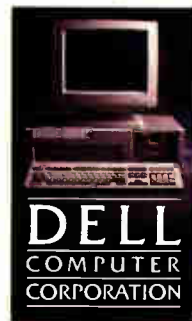

800-426-5150

For a free product catalog, call us. For Dell in Canada, call 800-387-5752.

Circle 103 on Reader Service Card

World Radio History

See Your Data



MapInfo software can find, display and analyze your data geographically. See your prospects, customers, facilities—anything in your database. Find addresses by street, ZIP code, city, etc. (We can even supply the maps.)



Any point or region on the map can have a complete record of data behind it. See your actual dBASE data in a window to view, edit, and print. Draw your own boundaries. Add titles and legends for high quality presentations.

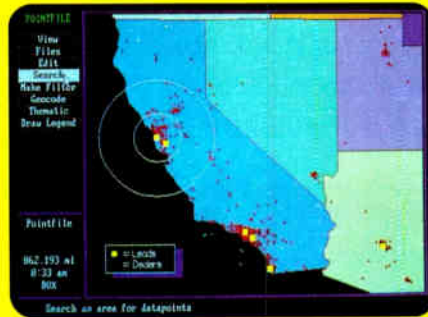

Perform analyses on your data to sum, average, or count your database records by location. Color sales territories by volume of orders, ZIP codes by numbers of leads, countries by your demographic data.

From street-level to worldwide, MapInfo can merge your databases with maps. Play visual "what if" with your data. See patterns, trends, and opportunities you never knew existed. If you need to map your data, MapInfo can do it for as little as \$750.

MapInfo now includes a map of the world and the U.S. with all ZIP code locations. Runs on IBM PCs or compatibles with 640K memory, a hard disk drive, and graphics, and comes network-ready.

MapInfo Corp.

Changing The Way The World Looks At Information™

200 Broadway, Troy NY 12180
To order, call 1-518-274-8673
or 1-800-FASTMAP Toll free.

MapInfo is a trademark of MapInfo Corp. dBASE is a trademark of Ashton-Tate.

LETTERS

and Ask BYTE

Data Compression Drawbacks

The 2400-bps modem evaluation ("4800 Bits, No Errors," June) was excellent; I was gratified to see some discussion given to the role of data compression. A very important question, however, was overlooked: What happens when you try to send already compressed data (e.g., .ARC files) to another computer via a data-compressing modem? The answer, I'm afraid, is that the file grows (and thus takes longer to send, defeating the purpose of on-line compression). This is true no matter what compression algorithm is used. Compression, ironically, involves some overhead.

Since the entire BBS world now uses off-line compression (via special utility programs) to achieve data reduction—and de facto high baud rates over telephone lines—the value of active data compression in a modem would seem to be undermined. Perhaps some modem manufacturers have incorporated automatic growth-detection and compression disablement schemes to deal with this problem.

Kas Thomas
Greenwich, CT

Bernard Jousse
Barzun, France

Whale Woes

In response to "Moby Dick 2.1" (Stop Bit, July), I would be happy to add my experience as an international reader of *Moby Dick*.

You may not be aware that *Moby Dick* was announced in translated versions at the same time as the U.S. version. Obviously, we had to wait another few months before we got translations of version 1.0.

Actually, we got version 1.0 in French at about the same time as you got 2.0. Unfortunately, most of the U.S. publishers with subsidiaries in Europe do not follow the same update policy in Europe and in the U.S.

What happened was that we received a letter stating that *Moby Dick 2.0* was out (in English; the publishers just decided to drop the translation) and that we could get it if we sent a copy of the original invoice, the book, and a check (usually 15 percent of the newer version's price).

Many of us were pained; we had already made notes on the pages, and we would lose them. Many of us were not fluent enough in English. And many of us were disturbed to learn through BYTE that 2.1 was already shipping.

And some of us tried to get 2.1 direct from the U.S. Unfortunately, some publishers refuse to sell direct to Europe; you must go through the local dealer.

Finally, some of us had reported errors in 1.0 that we discovered were not corrected in 2.0 because of the local subsidiary.

We passed your letter on to Melville Press, which responded as follows:

Nous sommes tres heureux a annoncer que Moby Dick es maintenant available in una versiona internationale. Esperamos que esta version gonna meeta all su expectationas. Si no, punta.

—Eds.

Bigger vs. Better

"Is Bigger Better?" (July) was timely and well-taken. I have another consideration to add to those that Ezra Shapiro discussed: the problem of insufficient memory.

First I tried the 1988 edition of TurboTax, which I installed and brought up, only to find that 640K bytes was insufficient memory. To run the program, I first had to disable Norton Commander, which forced me to revert to the DOS

continued

WE WANT TO HEAR FROM YOU. Please double-space your letter on one side of the page and include your name and address. We can print listings and tables along with a letter if they are short and legible. Address correspondence to Letters Editor, BYTE, One Phoenix Mill Lane, Peterborough, NH 03458.

Because of space limitations, we reserve the right to edit letters. Generally, it takes four months from the time we receive a letter until we publish it.

Our Customers Are Celebrating



Join the Party - For FREE!

For a limited time, customers worldwide who buy Vermont Views C-libraries will receive the Vermont Views Designer FREE.

A Planetary Task

The most critical software development task of the 90's will be to increase programmer productivity. How can busy C-programmers create powerful applications with a friendly user interface quickly and easily? Vermont Creative Software has the answer: the Vermont Views Designer.

The Global Solution

Vermont Views, the world renowned C-library for user interfaces, will soon include a screen designer that will cut your screen development time by more than 50%...and it's FUN to use. Tickertape and memo fields; scrollable form regions; nested menus; and form control functions are just some of the features of Vermont Views you can use with this sophisticated screen generator.

You'll no longer need to write code for screens with the Vermont Views Designer. Create forms, menus, dialogue boxes, and choice lists and store them in binary library format, *exactly as you design them on the screen*. Change them later if you like. Easy portability of applications to many operating systems including PC-DOS, UNIX, XENIX, VMS, and OS/2 gives Vermont Views universal appeal.

How You Can Join Our Party—For FREE.

We invite you to purchase Vermont Views v1.1, NOW by calling the number below. Upon its release, we'll send you VERMONT VIEWS v2.0 with the DESIGNER FREE, as our way of saying WELCOME TO THE PARTY. You must make your reservation now. This is a limited time offer.

R.S.V.P. 1-800-848-1248

Offer valid from November 18, 1989 until January 31, 1990.

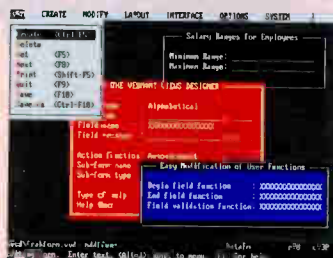

No Risk Revelry

Join the party. We're so sure you'll be celebrating with Vermont Views that we'll let you **return it anytime for a full refund**. Prices: \$395 for DOS; \$790 with full source code. Call for prices on UNIX, XENIX, VMS, and OS/2.



Vermont
Creative
Software

Pinnacle Meadows
Richford, VT 05476
Phone: 802-848-7731

FAX: 802-848-3502 Telex: 510-601-4160 VCSOFT

command-line method of selecting programs. I also had to disable SideKick and SuperKey, which meant that I lost the screen blanking and the ability to make notes quickly.

Next I tried SuperCalc 5, which offered a few suggestions about freeing up memory; but those didn't make enough room, and I could load only the smallest spreadsheets unless I was willing to dispense with a 100K-byte buffer.

The two programs have all sorts of

bells and whistles that are of no use to me. It would be great if they offered an optional stripped-down version that would leave enough memory for the workhorse utilities that I'm used to working with.

J. J. Hyde
Los Altos, CA

Feasible vs. Practical

We are writing in response to John William Mauchly Jr.'s letter (July) criticiz-

ing both our book, *The First Electronic Computer: The Atanasoff Story*, and G. Michael Vose's review of it (September 1988).

The most striking aspect of this letter from the son of the late John William Mauchly—who, with J. Presper Eckert, patented the ENIAC—is his failure to mention the federal court case on which our book is based, namely, the *Honeywell v. Sperry Rand* case that ended in invalidation of the ENIAC patent because of derivation from “one Dr. John Vincent Atanasoff.” In supporting Judge Earl R. Larson's decision, we rely heavily on evidence and testimony from this trial.

The Honeywell side produced conclusive evidence that Atanasoff invented an “automatic electronic digital computer” between 1937 and 1942, that Mauchly learned all about it in 1941, and that Mauchly and Eckert used major features of it in the ENIAC and also in the ED-VAC (the predecessor of the UNIVAC). The Sperry Rand side, for its part, could produce no evidence that Mauchly, prior to meeting Atanasoff, had progressed beyond a tiny neon flashing device in his claimed drive toward the ENIAC.

Mauchly himself gave some of the strongest testimony against his own early creative endeavors in electronic computing. He said, for example, that when he went to Iowa to see Atanasoff's computer, “I wasn't even thinking about inventing computing machines.”

Thus, reviewer Vose should not be charged with too readily accepting “a book that attempts to rewrite history.” The incorrect history was “rewritten” in an unappealed lawsuit, to which two corporations had devoted more than five years of legal effort and many millions of dollars. Vose not only cites that suit as the basis for our book, but also summarizes it.

Mauchly Jr.'s letter has two common arguments to which we want to reply—arguments disputing the status of Atanasoff's ABC as “the first electronic computer.” It was not first, he claims, because it “never ran,” and he cites the first airplane as surely “the one that flew.” But the ABC did run: It solved small sets of linear equations correctly. Its computing devices, its memory, its controls, and its base-conversion system all worked fine; only an I/O flaw in its binary-card system caused a very infrequent error that made the solution of large sets unreliable.

The analogy to the first airplane is, indeed, appropriate. The Wright brothers

continued

Engineers and Scientists Found Plotting Behind Businessmen's Backs!

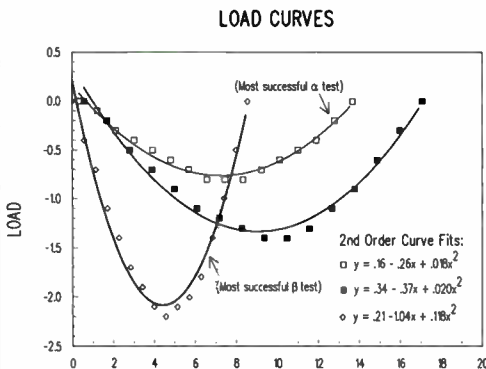

100% LOTUS Compatible

with
**TECH*
GRAPH*
PAD...**

Plotting and
graphing software
for engineers and
scientists.

Still trying to get engineering & scientific graphs from spreadsheets or business programs? If so, you need TECH*GRAPH*PAD, the industry standard technical graphing & plotting software for engineers & scientists. Directly reads data from Lotus 1-2-3 worksheets, other spreadsheets, & most data acquisition hardware & software. GUARANTEED easy-to-use or your money back!

According to PC MAGAZINE, "TECH*GRAPH*PAD is fast, easy-to-use, and produces good-looking output."



CALL for FREE Demo Disk

(617) 290-5900

Dealer Inquiries Invited;
International dealers fax (617) 890-1340

- X-Y, Semi-log, Log/Log, Polar Plots
- Curve Fitting • Data Smoothing
- Full control of Labels & Scale
- Independent X-Y Axes; Dual Y Axes
- Error Bars • Greek Letters • Symbols
- Laser Printer, Plotter, Printer Output
- IBM PC/XT/AT, PS/2, Apollo, DEC compatible

binary engineering

400 Fifth Ave. • Waltham, MA 02154 • Tel: (617) 290-5900 • Fax: (617) 890-1340

QUALITY BY DESIGN

PC WEEK reports that PC Designs dominated the CORP COMPUTER POLL, receiving top marks in four categories:
 1.-Compatibility with hardware and software 2.-Relative Performance 3.-Ease of Installation 4.-Ease of Configuration



GV286/120

- 80286 running at 12 MHz zero wait state.
- Proprietary, 32KB on-board RAM cache circuit using high speed (35ns) static RAM.
- 512KB RAM, expandable to 1MB on motherboard.
- Socketed for 8MHz 80287 math coprocessor.
- 5.25" 1.2MB or 3.5" 1.44MB floppy drive.
- Enhanced 101-key keyboard.
- Graphics adaptor features a full 256K of video RAM and 16-bit interface for full VGA capabilities on VGA Color System.
- 200-watt power supply.
- 2 serial/1 parallel port standard (on add-in card).
- ROM based set-up and diagnostics.
- Motherboard designed and manufactured in the U.S.A.
- Toll-free technical support.
- On-site Service for one year.



Oct. 13, 1987



GV286/20

- Choice of slimline or Baby "AT" desktop, space-saving footprints available.
- Top performance at lower cost.
- VLSI technology for increased reliability.
- 80286 running at 20 MHz zero wait state.
- Paged-interleave Memory Architecture.
- 1MB RAM standard, expandable to 2MB or 4MB configurations on motherboard.
- Socketed for 10MHz 80287 math coprocessor.
- 5.25" 1.2MB or 3.5" 1.44MB floppy drive.
- Enhanced 101-key keyboard.
- Graphics adaptor features a full 256K of video RAM and 16-bit interface for full VGA capabilities on VGA Color System.
- 200-watt power supply.
- 2 serial/1 parallel port standard (on add-in card).
- ROM based set-up and diagnostics.
- Motherboard designed and manufactured in U.S.A.
- Toll-free technical support.
- On-site Service for one year.



GV386/20 PLUS

- 80386 running at 20 MHz zero wait state.
- 1MB RAM on motherboard.
- System is capable of expanding to 16 MB of 32-bit RAM.
- Proprietary, 64KB on-board RAM cache circuit using high speed (35ns) static RAM.
- Socketed for 20MHz Intel 80387, or 20MHz Weitek 3167 math coprocessors.
- 5.25" 1.2MB or 3.5" 1.44MB floppy drive.
- 2, 8-bit, 4, 16-bit and 2, 32-bit memory expansion slots.
- Graphics adaptor features a full 256K of video RAM and 16-bit interface for full VGA capabilities on VGA Color System.
- 2 serial/1 parallel port standard (on add-in card).
- ROM based set-up and diagnostics.
- Motherboard designed and manufactured in U.S.A.
- Toll-free technical support.
- On-site Service for one year.



GV386SX

- Run 32-bit operating systems, applications software, or Windows 386 at a lower cost.
- Slim-line, space-saving desktop configuration.
- 80386SX running at 16 MHz zero wait state.
- 2MB RAM standard, 4MB capacity on motherboard.
- Socketed for 16MHz Intel 80387SX, math coprocessor.
- 3.5" 1.44MB floppy drive.
- VLSI technology for increased reliability.
- Graphics adaptor features a full 256K of video RAM and 16-bit interface for full VGA capabilities on VGA Color System.
- 2 serial/1 parallel port standard (on add-in card).
- ROM based set-up and diagnostics.
- Motherboard designed and manufactured in U.S.A.
- Toll-free technical support.
- On-site Service for one year.



"Overall, PC Designs' latest effort effectively integrates brand-name components and a proprietary motherboard to yield generally swift and solid performance. If you're in the market for a 386, this system is worth a look."

— PC MAGAZINE — May 30, 1989

* Now Available: In-Home and Office On-site Service with every complete system.

OPTIONS GV286/120

- RAM upgrades.
- Intel 80287 math coprocessor.
- MS-DOS 3.3 or 4.01.
- 256 VGA Video upgrade \$79.

NEW PRICES	TTL	800 X 560
	Mono	VGA Color
20MB, 65ms, WD 1:1	\$1,399	\$1,949
44MB, 23ms, WD 1:1	\$1,599	\$2,149
71MB, 27ms, WD 1:1	\$1,799	\$2,349
155MB, 18ms, ESDI	\$2,499	\$3,049
320MB, 18ms, ESDI	CALL	CALL

OPTIONS GV286/20

- RAM upgrades.
- Intel 80287 math coprocessor.
- MS-DOS 3.3 or 4.01.
- 256 VGA Video upgrade \$79.

NEW PRICES	TTL	800 X 560
	Mono	VGA Color
20MB, 65ms, WD 1:1	\$2,099	\$2,649
44MB, 23ms, WD 1:1	\$2,299	\$2,849
90MB, 18ms, ESDI	\$2,799	\$3,349
155MB, 18ms, ESDI	\$3,199	\$3,749

Circle 246 on Reader Service Card

OPTIONS GV386/20 PLUS

- RAM upgrades.
- 20MHz Intel 80387 and 20MHz Weitek 3167 math coprocessors.
- MS-DOS 3.3 or 4.01.
- 256 VGA Video upgrade \$79.

NEW PRICES	TTL	800 X 560
	Mono	VGA Color
20MB, 65ms, WD 1:1	\$2,349	\$2,899
44MB, 23ms, WD 1:1	\$2,549	\$3,099
71MB, 27ms, WD 1:1	\$2,749	\$3,299
155MB, 18ms, ESDI	\$3,449	\$3,999
320MB, 18ms, ESDI	CALL	CALL

OPTIONS GV386SX

- RAM upgrades.
- 16 MHz Intel 80387SX math coprocessors.
- MS-DOS 3.3 or 4.01.
- 256 VGA Video upgrade \$79.

NEW PRICES	TTL	800 X 560
	Mono	VGA Color
20MB, 65ms, WD 1:1	\$1,999	\$2,549
44MB, 23ms, WD 1:1	\$2,199	\$2,749
90MB, 18ms, ESDI	\$2,699	\$3,249

Ask about our "Lease/Purchase Agreement"

PC Designs

Since 1983

Call us for NETWORK SYSTEMS CONSULTING

WE CARRY SIMMS AND MATH COPROCESSORS

2300 North Homack Circle, Broken Arrow, Oklahoma 74012

For Export call: (918) 251-5550 • Local: (918) 251-7503 • Sales (918) 251-5550 • (800) 627-4248 • FAX (918) 251-7057 • EBBS (918) 252-9137



CALL DIRECT TODAY!

1-800-627-4248



formulated the principles of flight, through experimentation, and then built an airplane that flew a short distance, proving flight feasible, although not yet practical. Atanasoff formulated the principles of electronic computation, through experimentation, and then built a computer that solved small sets of equations, proving electronic computation feasible, although not yet practical.

Moreover, Atanasoff's work led directly to the ENIAC and on to the first generation of stored-program computers.

Mauchly also claims that the ABC was only partly electronic, because of its rotating memory. But this memory embodied three computing principles employed universally today: electronic regeneration of memory elements, rotation as a means of memory access, and the use of capacitors as memory elements. Furthermore, Eckert and Mauchly thought enough of the ABC memory to include its form in their 1953 Regenerative Memory patent, an electronic computer memory patent that Judge Larson also found derived from Atanasoff.

Mauchly Jr.'s letter has another argument that we want to answer. He claims

that we say his father got the very idea of electronic computation from Atanasoff, and then he cites a Mauchly letter written shortly before he met Atanasoff in which Mauchly declares his intention to build a key-operated "electronic computing machine to obtain sums of squares and cross-products." Actually, we take no such position; we even quote this letter.

What is worse is that Mauchly Jr. implies that this is all we say his father got from Atanasoff. In fact, we show that Mauchly got the concept of electronic switching, used throughout the ENIAC, from Atanasoff's computer, and the concepts of electronic memory regeneration and binary serial addition, used in the EDVAC (and the UNIVAC); moreover, that he and Eckert patented these concepts as their own.

John Mauchly Jr. concedes that our book replies to the arguments of his letter, but he asserts that our replies "only cloud the facts." We submit that he has conveniently sidestepped the real facts of this dispute—facts based on courtroom evidence and testimony.

His letter ultimately reaches a personal level, with completely groundless

charges. Such tactics, however, cannot undo this sad, but true, tale of misappropriated ideas.

Alice Burks
Arthur Burks
Ann Arbor, MI

Power Protection

I have read Mark Waller's article on power protection ("PC Power," Parts 1 and 2, October and November 1988) and his text box ("What Is a UPS?") in the Product Focus entitled "Curing the Brownout Blues" (April). But I'm now having a problem. I can't find a power conditioner that is built like the one he discussed, and I'm planning to get the American Power Conversion 800rt and plug a conditioner into it. Can you give me the names and possibly the phone numbers of some of the manufacturers whose power conditioners meet with your approval?

I have one other question regarding something Waller said in the text box. On page 170 he seems to be saying that the ferroresonant design is a good one. But in the October 1988 article, he seems to

continued

This Should Go On Your Desk For The Same Reasons It Goes On The Road.

Remember when sending a fax meant leaving your desk? Or when faxing on the road was almost impossible?

Those days are over. Introducing the WorldPort 2496™ portable fax and data modem.

Since it's external to your computer, it's easily shared around the office. And since it's battery powered and uses RJ11s or optional acoustic couplers, it connects to public phones and PBXs anywhere. Via Bell and CCITT standards worldwide. It even sends and receives fax and

data messages unattended or while you run applications.

But best of all, from your desktop or laptop, you can instantly connect with practically anyone anywhere who owns a fax or modem.

Unless, of course, they've ventured out on the road without one.

Call us today at 800-541-0345 (in New York, 516-261-0423) for more on the WorldPort line and the dealer nearest you.



Touchbase Systems, Inc.
160 Laurel Avenue
Northport, NY 11768
(516) 261-0423
Fax (516) 754-3491

WorldPort 2496 is a trademark of Touchbase Systems, Inc., © 1989 Touchbase Systems, Inc.

Every
500 years
or so,
an exceptional
printer
comes along.



Photo credit: Bettmann Archive

Johannes Gutenberg, 1454.

Introducing the new



printer that can raise your productivity as much as the new IBM LaserPrinter doesn't come along every day.

Not only does its advanced design make it outperform the HP LaserJet Series II, which up till now has been the benchmark in laser printing. But also, its advanced design

gives the IBM LaserPrinter a dramatically new, more space-efficient shape.

Yet with all this, there's one area in which the competition rises above us: their price.

We just advanced the art of laser printing 25%. The new IBM LaserPrinter gives you state-of-the-art print quality a full 25% faster than its main competitor.

25% faster printing, advanced features and a revolutionary streamlined design.



IBM LaserPrinter.

Why other printers can't follow in our footsteps. The advanced design and engineering of the IBM LaserPrinter give it a footprint that's 33% smaller than its main competitor's. And that 33% gives you more usable workspace.

And more drawer space, too. Because the IBM LaserPrinter's font cards are about the size of credit cards. Yet as compact as they are, they offer twice as many fonts as almost all its main competitors' large, old-fashioned cartridges.

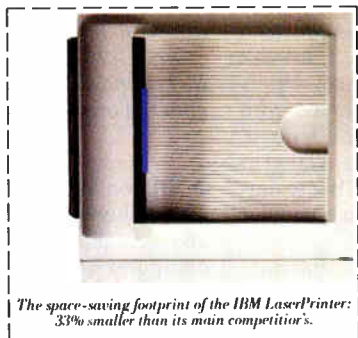

The space-saving footprint of the IBM LaserPrinter: 33% smaller than its main competitor's.

It's only up from there. Since the paper-handling options on the IBM LaserPrinter are stackable, you can add features, like high-capacity paper drawers (500 sheets and 75 envelopes), without sacrificing workspace.

And not only can you connect the IBM LaserPrinter to any IBM and many IBM-compatible PC's, but also, with its printer-sharing option, one IBM LaserPrinter can serve up to 6 PC's, for maximum cost-efficiency.

Another reason it's a new order of laser printer.

Unlike its main competitor, the IBM LaserPrinter collates letterheads, second sheets and envelopes. Most people would rather

give that job to someone else anyway. So it's nice to have a printer that will do it for you automatically.

Proof that less is more. The design and engineering of the IBM LaserPrinter are so advanced, it's got 60% fewer parts than the previous standard in laser printing. That means it's got 60% fewer things to loosen, snap or shear.

The solution is IBM. Yet, though it's a smaller, sleeker unit, the IBM LaserPrinter comes from a company with a big tradition of service and support. Which is very reassuring when you decide to break away from an old standard to go with the new one for years to come.

To do that as soon as possible, contact your IBM Authorized Dealer or IBM marketing representative. Find your nearest dealer by calling 1 800 IBM-2468, ext. 194.

	IBM LaserPrinter	HP LaserJet Series II
Speed	✓ up to 10 ppm	up to 8 ppm
Footprint	✓ 291 sq. in.	432 sq. in.
Paper-handling options	✓ 500 sheets, 75 envelopes	15 envelopes*
Collates letters/envelopes	✓ yes**	no
Plotter emulation	✓ standard	optional
Resident fonts	✓ 10	6
Font card size***	✓ credit card	"8-track" cassette
Standard weight	✓ 33 lbs.	50 lbs.
Parts***	✓ 400	1000
Dots per inch	300 x 300	300 x 300
Printer emulation	✓ IBM, HP compatible	HP compatible
Printer engine	IBM	Canon
List price	✓ \$2,595	\$2,695

*HP envelope tray replaces standard paper tray **With paper-handling options ***Approximate

**The new IBM LaserPrinter.
Suddenly, nothing else measures up.**





ASK BYTE

be saying that the ferroresonant design is a bad one because it regulates voltage, and the power supply in the computer doesn't need or want that. Can you explain and tell me if I should be looking for a ferroresonant design or avoiding it?

Bill Hogan
("bhogan" on BIX)
Wilmington, DE

That's a very good question. The seeming contradiction is one of expectation rather than application. When you think of an uninterruptible power supply, you expect it to do certain things over and above simply providing continuity of power. However, most UPSes or standby power systems cannot be counted on to be anything other than backup power sources.

Now, if the manufacturer has added a transformer, whether ferroresonant or low-impedance, this gives the device the features of a power conditioner. And this is the real point. Without a transformer of one kind or another, the neutral and ground are not bonded together—therefore, no common-mode protection is present. So a transformer is a must, whether it is included in the same cabinet as the UPS or purchased as a separate device.

So the choice is between a ferroresonant transformer and a low-impedance transformer like those found in most power-line conditioners. Ferroresonant transformers offer the benefit of regulating voltage, but PCs do not need voltage regulation for the reasons mentioned the article. Also, ferroresonant transformers are high-impedance devices, which means that they restrict the flow of current to the PC and cannot tolerate overload conditions. This is an undesirable characteristic, since the power supply in the PC wants to gobble lots of current every half cycle. Ferroresonant transformers are also inefficient, since the device is driven into saturation every half cycle. Therefore, they generate heat as well as audible noise. And they are three to five times heavier than the alternative. Ferroresonant transformers, however, are excellent normal-mode protectors, for the same reasons that created the weaknesses I have outlined above.

Low-impedance transformers do not restrict the flow of current and have high overload ratings. They offer no voltage regulation.

What it comes down to is this: A transformer is the best form of protection. Then the choice is between ferroresonant transformers, a good choice, and low-impedance power-line conditioners, the best choice.—Mark Waller

Start Talking

I have been considering computer applications that would involve files of digitally recorded sound effects and speech. A computer store salesman demonstrated such an application on a Macintosh II. I think that the product also included software and some kind of add-in card or sound-processing chip.

I have looked through a number of computer and electronics magazines for something similar that can be used with an AT-compatible computer. I haven't been very successful in my search. Is someone on your staff acquainted with such a product? At a minimum, I would like to have in/out jacks for connection to a stereo tape recorder. Any ability to digitally modify the sound in the computer would be a desirable option.

Regarding speech synthesis, the only consumer product I have seen is a dictionary/thesaurus from Franklin/Merriam-Webster that allows you to type in a word. It then displays definitions and speaks the word in a digitized voice. I would be interested in any other product that might be available that can be integrated into a computer.

Finally, I would appreciate any references or product names that would facilitate programming of animation on an AT-compatible computer. Most of the products I've read about deal only with Apple or Amiga computers.

David R. Brammer
Downers Grove, IL

You've stumbled into the two areas in which AT products are poorly represented. The application that you saw on the Macintosh was probably MacRecorder from Farallon Computing. Your average run-of-the-mill Mac includes hardware for playing back digitized sound. MacRecorder includes an external digitizing unit that plugs into the serial port and some spiffy editing software.

Alas, the MS-DOS world hasn't been graced with such cool toys. Digitized speech is done by simply sampling the analog signal with an A/D converter at twice the maximum frequency. You can record sounds with any reasonable ADC, providing it can sample at 6 kHz or better. You'd play back the sound through a DAC with similar capability. Software is another issue. I'm not aware of any software that promises general sound-editing capabilities. How well can you program?

Perhaps an easier way to get speech is

with a commercial synthesizer. The Votalker-1B from Votrax (38455 Hills Tech Dr., Farmington Hills, MI 48331, (313) 553-0580) is a board that fits in the bus and has reasonable text-to-speech translation software. Street Electronics (1470 East Valley Rd., A-2, P.O. Box 50220, Montecito, CA 93150, (805) 565-1612), which is famous for Apple II speech products, sells a PC board called the Echo PC2. Either of these boards will produce acceptable speech output for under \$100.

As for animation software, that's another area where commercial developers appear to have left the PC stranded.

Keep looking through the small ads in BYTE and other magazines. If you find either of these products, let us know.

—H. E.

A Silicon Weatherman

Do you know of a program on hurricanes and weather tracking? I have a Franklin computer that's compatible with the Apple IIe.

Rober J. Lever
Nokomis, FL

You can get computer-digestible weather data from a variety of sources. CompuServe (P.O. Box 20212, Columbus, OH 43220, (800) 848-8199) provides regularly updated maps that, with the proper software, you can display on-screen.

Other sources include Accu-Weather (619 West College Ave., State College, PA 16801, (814) 234-9601) and Weatherbank (2185 South 3600 West, Salt Lake City, UT 84119, (801) 973-3131).

Finally, if you want to put together your own weather station, the first eight issues of Circuit Cellar Ink magazine (4 Park St., Vernon, CT 06066, (203) 875-2199) carried an involved computer weather-station project.—R. G.

What Have I Caught?

I am using IBM AT and Dell 200 machines for work and development, and I'm encountering a computer virus. The symptoms are simple but very annoying—executable files that get contaminated grow by approximately 2K bytes after each load into RAM. Once a contaminated file is loaded into RAM, the RAM is contaminated, and any successive load of a clean file will contaminate that file.

The treatment I've chosen is to erase the contaminated file, cold-boot the PC, and load a clean file. For example, the executable file for dBASE III Plus 1.1 is about 133,632 bytes. After being loaded into contaminated memory, the file

continued

To learn Microsoft QuickBASIC, you only need a manual this thick.

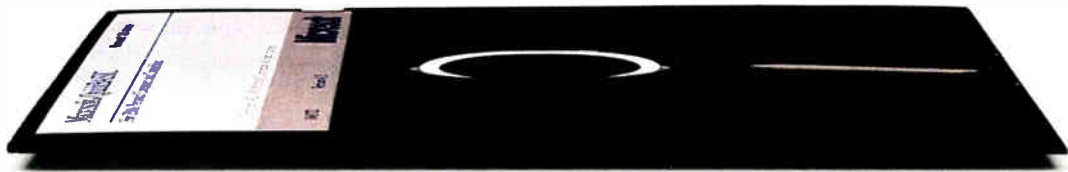

You're looking at something you won't see anywhere else.

It's called QB Advisor. A remarkable new hypertext electronic manual that can make you instantly more productive, even if you don't know the first thing about programming. QB Advisor actually lets you experiment by cutting and pasting useful sample programs right into your programming window. Only Microsoft has it. Only Microsoft could. And it's just one of the things you'll learn about new Microsoft® QuickBASIC version 4.5 for IBM® PCs and compatibles.

Another is the step-by-step tutorial that actually takes you through every stage of programming by working you through a complete program.

And QB Express—the interactive way to learn all about your programming environment in a matter of minutes—not hours.

Microsoft QuickBASIC also comes with Easy Menus that let you develop programs with

a minimum number of menu choices. Context-sensitive Help for immediate help with error messages and variables by simply punching a key, or clicking a mouse. And a built-in debugger that lets you see exactly what your program is doing, as it's doing it.

Best of all, Microsoft QuickBASIC is packed with enough power to handle whatever problems drove you to programming in the first place. Fact is, it translates your program into executable code at an incredible 150,000 lines per minute.

Microsoft QuickBASIC version 4.5. If programming is the only way out, this is the easiest way in.

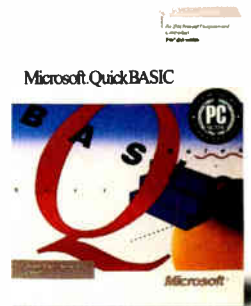

Microsoft
Making it all make sense.

Read Mac Disks in a PC MatchMaker

— the best way to share data between a PC and a Mac. The **MatchMaker** card lets you plug a Macintosh floppy drive into a PC.

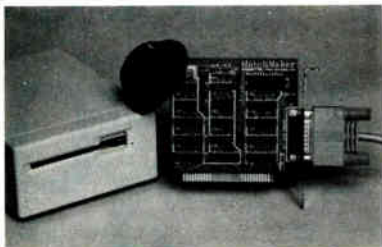

- Easy-to-install half-size card.
- Use any external Macintosh drive.
- DOS-like command software included.
- 1 year warranty, Made in USA.
- Also available; **MatchPoint-PC** to read/write Apple II disks.

"...by far the most cost effective solution..." PC WEEK

MicroSolutions

Computer Products

132 W. Lincoln Hwy.
DeKalb, IL 60115
(815) 756-3411

You already own a computer that can talk. Now let it.

The speech and sound specialist.

The Votrax Personal Speech System provides text-to-speech vocabulary that is virtually unlimited. Users can define an exception word table and customize translations to say just about anything!

The PSS can also mix speech and sound effects, or speech and music. It contains its own speaker, a programmable master clock, 256 programmable frequencies, a programmable speech rate for a more natural rhythm, and 16 programmable amplitude levels for incredible control of word emphasis. All this, without using valuable computer memory.

Why do you need a talking computer?

Applications for the PSS include spoken information transmission, display narration, and product demonstrations within businesses. It also makes data input verification possible for the blind, and is used by the disabled to assist with speech.

Children can use the PSS as a study aid, or to help games come alive with voice. Whatever a computer can do, the PSS can help do it better, at a cost of only \$449*.

There's also the Type-'N-Talk

For less complicated needs, at a lower cost, consider the Votrax Type-'N-Talk. Compatible with most computers, the TNT is now available for \$299*.

For more information about the PSS or TNT, call toll-free, or write:



38455 Hills Tech Drive
Farmington Hills, MI 48331-3421
1-800-521-1350
(In Michigan, call collect 313-553-0580)

*Suggested Retail Price

ASK BYTE

grows to about 135,200 bytes. (And this happens even with a read-only bit set.) I have no problem executing the file, however. Other programs completely hang the system, and I have to perform a cold boot.

Have you heard of this problem before? What is the best remedy?

Jonathan Cohen
Edison, NJ

We do have a remedy, but you may not like it. The only sure way to purge such a beast is to perform a low-level format on your hard disk drive and start from scratch. The virus has not only infected your executable files, it has tarnished your copy of DOS. If you now try to reinstall your applications using fresh floppy disks, your DOS will corrupt the new executables. It's a catch-22.

To kill off the virus, you should follow these steps:

1. Copy all text and data files to backup floppy disks—you've got to abandon those executable and communications files.
2. Perform a low-level format on your hard disk drive.
3. Boot your system from a factory-original DOS disk and reinstall DOS.
4. Reinstall your executable files from the original-release disks.
5. Copy back your data files.

This may seem like a drastic measure (especially if you don't have all your original-release disks), but you've got to destroy that copy of DOS. To prevent a recurrence, you should invest in a virus detector such as FLU-SHOT or SCAN34. Our January 1990 Product Focus will cover disk utilities; some of those packages include virus detectors.

We've heard of your problem before. Some similar strains include the Cascade virus (which expands files by approximately 1700 bytes) and the SumDOS virus (which expands files by approximately 1800 bytes). Don't you just love the folks who come up with these things? What a waste.—S. D.

My Computer Don't Rock

I am a third-year computer science student at AMA Computer College. I am also a part-time musician.

Ever since the introduction of MIDI software, I have been going through most of the shops in Manila trying to find a sequencing program. I have an IBM-compatible machine that I would like to use as a recorder/sequencer. Unfortunately,

continued

Now \$4995!
Suggested Retail Price.

These unretouched print samples show the superior print quality of QMS-PS 810 over printers using first-generation print engines.

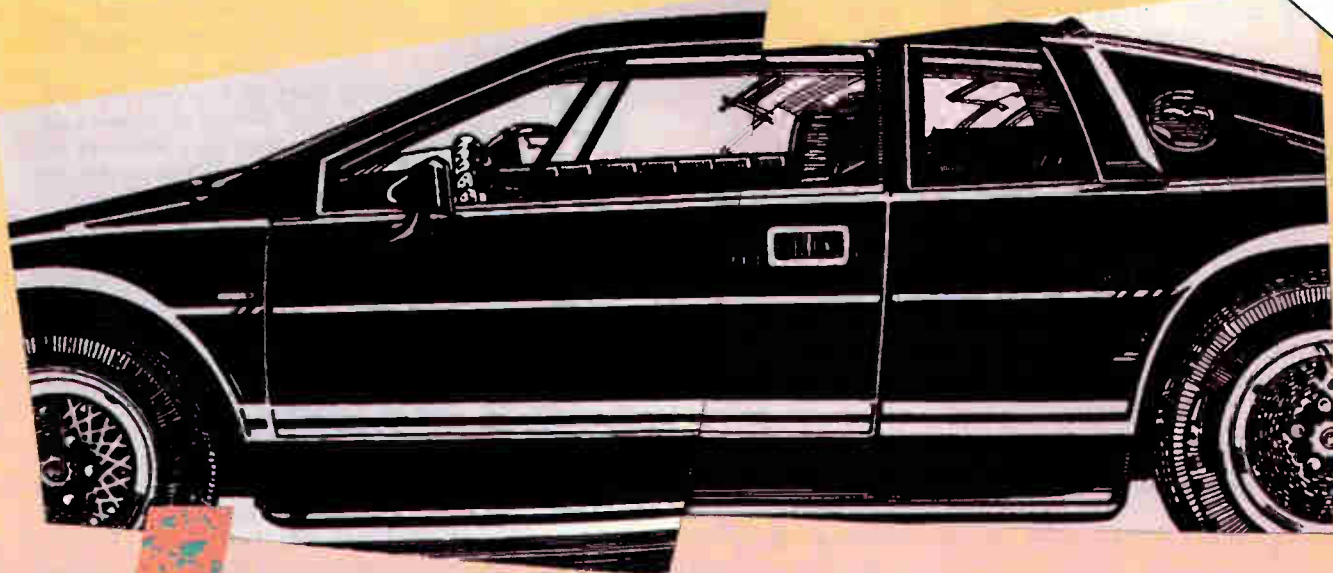

Introducing the PostScript laser printer that blacks out at high speeds.

The new QMS-PS[®] 810 can compose and print the most complex pages in record times, with richer, more saturated blacks than ever before. All with the desktop publishing power of Adobe PostScript[®], and the superior print know-how of QMS, an industry leader.

Under the hood QMS ASAP[™] (Advanced System Architecture for PostScript) is proprietary technology that helps eliminate the hardware bottlenecks that hinder other PostScript printers. As a result, QMS-PS 810 boasts processing speeds remarkably faster than other PostScript printers in its class. And faster output means greater productivity. In addition, the QMS-PS 810 laser

printer's new Canon SX[®] print engine covers solid areas and prints fine detail better than previous-generation engines.

Fast start, strong finish You can adorn your documents with one or all of the 35 Adobe typefaces. Thanks to PostScript, there's an infinite number of font variations available. You can also make type as large or as small as you want. And put it anywhere on the page. In fact, with PostScript you enjoy total control over the design of your page. It gives you the complete desktop publishing power to do things that would otherwise be virtually impossible. So you get high-quality output exactly how you want it.

Along with PostScript, the HP LaserJet[™], Diablo[®] 630 and HP-GL[™] printer emulations are added for your non-PostScript software.

The QMS-PS 810 laser printer is easy to use, maintain, and comes with a one-year warranty. It's available from Laser Connection dealers. Laser Connection is a sales and marketing subsidiary of QMS. For the dealer nearest you call **1-800-523-2696**.

In Europe (31)-30/420129

LASER CONNECTION[™]

A QMS[®] company

The following are trademarks of their respective companies: QMS, QMS-PS, ASAP, Laser Connection of QMS, Inc. PostScript of Adobe Systems, Inc. Canon, Canon SX of Canon, U.S.A. LaserJet+, HP-GL of Hewlett-Packard, Diablo of Xerox Corp.

**The new
8-page/minute
QMS-PS 810
laser
printer**



©1987 Laser Connection

Circle 270 on Reader Service Card (DEALERS: 271)

World Radio History

the shops here only have sequencing software for Apple's Macintosh.

Can you point me in the direction of a list of such MIDI software?

Alberto Vicente O. Santos
Manila, Philippines

There are a number of possibilities, so many that—although it might be impossible where you live—you should shop around and find the package that best meets your needs. Here's a partial list of products and manufacturers:

*Texture and Prism
Magnetic Music
6 Twin Rocks Rd.
Brookfield, CT 06804
(203) 775-7832*

*Cakewalk
Twelve Tone Systems
P. O. Box 226
Watertown, MA 02272
(800) 234-1171*

*Master Tracks, Jr.
Passport Designs
625 Miramontest St.*

*Half Moon Bay, CA 94019
(415) 726-0286*

*Sequencer Plus
Voyetra
Dept. 470
333 Fifth Ave.
Pelham, NY 10803
(914) 738-4500*

If you're interested in following trends in MIDI and the music industry, I suggest that you subscribe to Electronic Musician magazine (P.O. Box 3747, Escondido, CA 92025, (800) 334-8152).—R. G.

Fax Hunt

I have one telephone line into my apartment. I'd like to have three—one for voice, one for faxing, and one for my modem. Is there a way to combine them? I can imagine a modem that answers the phone and either receives the fax or data, or passes the call to my answering machine. Does anything like this exist?

Along the same lines, how can I receive a fax with a normal modem? I've seen dual fax/modem devices, but that seems like a waste. Can my 9600-bps

modem receive fax data and then let some software translate the "fax-speak" into something I can use?

C. Conrad Cady
Oakland, CA

Short of investing in a new combination fax/modem, there is no simple solution to your problem. Fax machines are designed to answer the phone on the first ring. Modems can be programmed to answer the phone after a specified number of rings. The problem arises because fax machines and modems use incompatible methods to transmit data, and neither device is smart enough to recognize the other's signals (at least not yet). So, to answer your second question first, no, you can't program your 9600-bps modem to receive "fax-speak."

You can add an onboard automatic switching device that will respond to a specific command to divert an incoming call to either a fax machine or a modem. One model, the Bit Phaxswitch, answers a phone call with a digitized voice giving instructions to the caller. When the caller responds with the spoken word "fax," the
continued

Buying an expensive book...

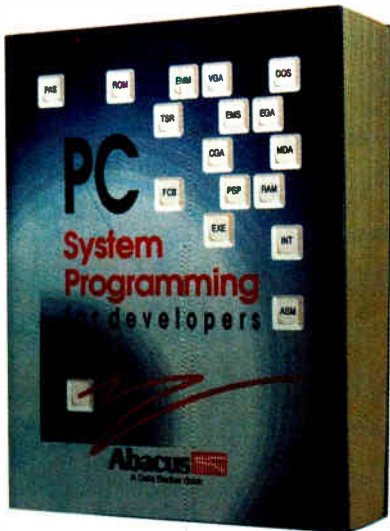

...doesn't guarantee that it will answer all of your DOS programming questions unless that book is readable, comprehensive and contains dozens of clear programming examples and explanations.

This new book **PC System Programming for Developers** is a literal encyclopedia of knowledge for the DOS programmer. It clearly explains all of the technical aspects of programming the PC, whether you write in BASIC, C, Turbo Pascal or assembly language. Some of the topics covered include:

- PC memory organization
- COM and EXE programs
- TSR programs
- Programming graphics cards
- Handling program interrupts in C, BASIC, Turbo Pascal and assembly language
- DOS structures and functions
- Hardware and software interrupts
- Writing device drivers
- Fundamentals of the BIOS
- Using extended and expanded memory

ISBN 1-55755-035-2: 940 page book **\$39.95**
ISBN 1-55755-036-0: 940 page book and 2 disks
with 1MB compressed programs **\$59.95**

In US and Canada add \$4.00 postage. Foreign orders add \$12.00 postage per book.

To order direct call TOLL FREE: 1-800-451-4319

Available at B Dalton Booksellers, Waldens and Software Etc. nationwide.
In the UK contact Computer Bookshops 021-706-1188. Write for our free catalog.

Abacus

Dept. B12, 5370 52nd Street SE
Grand Rapids, MI 49512
Phone: (616) 698-0330
Fax: (616) 698-0325

Top Performers.



H.I.M.S. 386SX/16 MHz

- INTEL 80386SX MICROPROCESSOR RUNNING AT 16 MHz
- SOCKET FOR 16 MHz 80387SX MATH COPROCESSOR
- 5.25" 1.2 MB OR 3.5" 1.44 MB DISKETTE DRIVE
- DUAL DISKETTE AND HARD DISK DRIVE CONTROLLER (1:1 INTERLEAVE)
- 1 MB 80 NS MEMORY (OR 2 MB, 4 MB EXPANDABLE TO 16 MB)
- 40 MB HARD DISK 38 MS, 800 KB DATA TRANSFER RATE
- HI-SPEED 2 SERIAL PORT(S), 1 PARALLEL PORT
- 101 ENHANCED TACTILE "CLICK" TOUCH KEYBOARD
- 200 WATT SWITCHING POWER SUPPLY
- 8 EXPANSION SLOTS (2-FAST SLOTS/8 BIT, 1-8BIT, 5-16 BIT)
- HI-PERFORMANCE 16-BIT VGA CARD (800 x 600) OR OPTIONAL (1024 x 768)
- 6 LAYER H.I.M.S. (U.S.A.) MOTHER BOARD
- LATEST AMI 386 BIOS (BUILT-IN DIAGNOSTICS, SETUP, AND HARD DISK FORMATTING UTILITY SOFT WARE)
- 10 YEAR BATTERY WITH CLOCK CALENDAR
- DISK CACHE AND EMS UTILITY SOFTWARE
- H.I.M.S. SMALL FOOT PRINT, 4 BAYS CASE

\$1750

HIMS 386SX 16 MHz WITH NO MONITOR

HARD DISK DRIVE	1 MB	2 MB	4 MB
66 MB 22 MS (800KB DTR)	1895	2050	2295
100 MB 22 MS (800KB DTR)	2095	2250	2550
120 MB 28 MS ESDI 1MB DTR	2550	2675	2950



H.I.M.S. PAGE MODE SERIES 16 AND 20 MHz 386

- INTEL 80386 MICROPROCESSOR RUNNING AT 16 MHz (OR 20 MHz)
- SOCKET FOR 20 MHz INTEL 80387 OR 20 MHz WEITEK 3167 MATH COPROCESSOR
- 5.25" 1.2 MB OR 3.5" 1.44 MB DISKETTE DRIVE
- DUAL DISKETTE AND HARD DISK DRIVE CONTROLLER (1:1 INTERLEAVE)
- 1 MB OR (4 MB OPTIONAL) 80 NS PAGE MODE MEMORY
- 66 MB 23 MS HARD DISK, 800 KB DATA TRANSFER RATE
- HI-SPEED 2 SERIAL PORT(S), 1 PARALLEL PORT
- 101 ENHANCED TACTILE "CLICK" TOUCH KEYBOARD
- 230 WATT POWER SUPPLY (110/220) FCC, UL, CSA, TUV APPROVED
- 8 EXPANSION SLOTS (2-32/8-BIT, 1-8-BIT, 6-16-BIT)
- HI-PERFORMANCE 16-BIT VGA CARD (800 x 600) OR OPTIONAL (1024 x 768)
- 6 LAYER H.I.M.S. (U.S.A.) MOTHER BOARD
- LATEST AMI 386 BIOS (BUILT-IN DIAGNOSTICS, SETUP, AND HARD DISK FORMATTING UTILITY SOFTWARE)
- 10 YEAR BATTERY WITH CLOCK CALENDAR
- DISK CACHE AND EMS UTILITY SOFTWARE
- 5-BAY STURDY DESKTOP CASE (6 BAY VERTICAL CASE OPTIONAL)
- FCC CLASS B ON TOWER & DESKTOP

\$2150

HIMS PAGE MODE 386/20 MHz WITH NO MONITOR

HARD DISK DRIVE	1 MB	4 MB
100 MB 22 MS 800 KB DTR.	2350	2695
120 MB 28 MS 1 MB DTR. ESDI	2795	3150
150 MB 16 MS 1 MB DTR. ESDI	2950	3295
330 MB ESDI 14 MS 1 MB DTR.	3795	4450



H.I.M.S. PROFESSIONAL SERIES CACHE PRO 386 20, 25 AND 33 MHz

- INTEL 80386 MICROPROCESSOR RUNNING AT 20 MHz (OR 25 AND 33 MHz OPTIONAL)
- SOCKET FOR 80387 OR WEITEK 3167 MATH CO-PROCESSOR
- 64 K 25 NS CACHE UPGRADEABLE TO 256 K. READ AND WRITE CACHE WITH WRITE BACK CACHE
- PAGE MODE MEMORY ARCHITECTURE
- 1 MB 80 NS MEMORY UPGRADEABLE TO 2, 4, 8 MB ON MOTHER BOARD, 16 MB WITH 32-BIT MEMORY CARD
- 5.25" 1.2 MB OR 3.5" 1.44 MB DISKETTE DRIVE
- DUAL DISKETTE AND HARD DISK DRIVE CONTROLLER, 1:1 INTERLEAVE
- HI-SPEED, 2 SERIAL, 1 PARALLEL PORT
- 250 WATT HEAVY DUTY POWER SUPPLY
- 101 ENHANCED TACTILE "CLICK" TOUCH KEYBOARD
- 8 EXPANSION SLOTS (1-32 BIT, 1-8 BIT, 6-16 BIT)
- LATEST AMI 386 BIOS (BUILT-IN DIAGNOSTICS, SETUP, AND HARD DISK FORMATTING UTILITY SOFTWARE)
- HIGH PERFORMANCE 16-BIT VGA CARD (800 X 600) OR OPTIONAL (1024 X 768)
- 6 LAYER H.I.M.S. 64/256 CACHE MOTHER BOARD
- 66 MB 23 MS HARD DISK 800KB DATA TRANSFER RATE.
- 6 BAY VERTICAL OR 5 BAY DESKTOP CHASSIS (SUPER VERTICAL 10 BAY WITH 375 WATT POWER SUPPLY OPTIONAL)
- FCC CLASS B ON DESKTOP OR TOWER
- DISK CACHE, EMS UTILITY SOFTWARE

\$2495

25 MHz Add \$300
33 MHz Add \$1200

CACHE PRO 386/20 MHz WITH NO MONITOR

HARD DISK DRIVE	1 MB	4 MB
100 MB 22 MS 800 KB DTR.	2750	3195
120 MB (ESDI) 28 MS 1 MB DTR.	3195	3595
150 MB (ESDI) 16 MS 1 MB DTR.	3350	3795
330 MB (ESDI) 14 MS 1 MB DTR.	4195	4695

IBM, COMPAQ, ALR, EVEREX, UNIX, XENIX, NOVELL ARE TRADEMARKS OF THEIR RESPECTIVE COMPANIES.

COMPANY

H.I.M.S. TECHNOLOGIES has been manufacturing hi-performance computers in California under OEM label for a number of years; and now H.I.M.S. is manufacturing under its own label the same hi-performance computers 286,386SX, 386 Page Mode and Cache 386 to satisfy your needs in price, performance and after the sale service, which seems to be a missing feature with most of our competitors. Just compare our competition and you will find the obvious, then add our One Year On-Site Service at no extra cost. . . . SURPRISE!!

PRODUCT

H.I.M.S. manufactures a complete breadth of 286, 386SX, Page Mode 386 and Cache 386 systems. H.I.M.S. is the only company currently supplying the industry with 386 Cache Pro in verticle, super verticle or desktop with FCC Class "B" approval. How about our 256K Write Back Cache Design at down to earth pricing? You can actually afford the high speed luxury! All the H.I.M.S. Systems can be custom configured to fit your needs, so call our expert sales executives to discuss your specifications. All H.I.M.S. Systems come assembled, tested and burned-in from the Factory for 72 hours at 60° Centigrade. The Hard Disk is pre-compurfted and formatted. H.I.M.S. carries a wide variety of options like: Video Cards for CAD/CAM and desktop publishing, printers, monitor's 14" to 25", Opto magneto drives, math coprocessors, plotters, pointing devices and software.

SERVICE

All H.I.M.S. computers come with a One-Year On-Site Service included. This gives you an immediate back-up just in case a problem may arise a technician can be in your location within 4 to 8 hours from our 414 service locations, including Puerto Rico and Canada. All products are made in the U.S.A.!!!

H.I.M.S. TECHNOLOGIES is the Price, Performance and after sales service leader in the Fast Group.

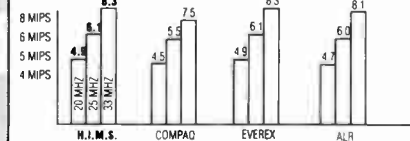

800-367-2924

H.I.M.S. TECHNOLOGIES

368 Montague Expressway • Milpitas, CA 95035
Phone: (408) 946-9711 • FAX: (408) 946-9744

Circle 367 on Reader Service Card

Rock Solid. HIMS TECHNOLOGIES

Everex's 386SX-based system offers two extras



August 1989 Everex STEP 386is

You can search high and low. But no matter where you look, no matter what price you're prepared to pay, you can't find another SX-based computer with extras like the Everex STEP™ 386is.

Namely, *PC Magazine's* Editors' Choice award and *Personal Computing's* Top Rated award.

How did the STEP 386is earn these accolades? It blazes its way to the top in practically every benchmark test. It runs all your current applications, and also all the 32-bit programs written for the 386, including UNIX® System V Version 3.2, Microsoft® Windows™ 386, and Paradox® 386.

And it gives you all this 32-bit power for little more than a 16-bit price.

(If you already own a STEP 286/12 or 286/16, by the way, you can easily upgrade your system to a STEP 386is just by plugging in our InSTEP™ daughterboard.)

Better yet, the STEP 386is comes with a host of other advantages.



he competition can't.



August 1989 Everex STEP 386is

Like full industry-standard hardware and software compatibility. Eight full-length expansion slots. Your choice of small footprint or standard chassis sizes. And all the support you'd expect behind Everex's family of award-winning STEP computers and peripherals.

All of which means, quite simply, that when it comes to value, you won't find a better personal computer than the STEP 386is. But don't take our word for it.

PC Magazine says it's "consistently tops in performance... offers the full benefits of the 386SX chip." *Personal Computing* says its "overall performance and practicality make it the Top Rated machine among the seven SX-based PCs we tested."

We say it's the best way to step up to 32-bit computing. Call 1-800-334-4552 for more information and the name of your nearest Authorized Everex Reseller.



Everex, STEP, InSTEP and the Everex STEP logo are trademarks of Everex Systems, Inc. 386 is a trademark of Intel Corp. All other names indicated by [™] or [®] are trademarks or registered trademarks of their respective holders. © 1989 Everex Systems, Inc.

Circle 122 on Reader Service Card (DEALERS: 123)

Bit Phaxswitch diverts the call to the fax machine. The Bit Phaxswitch is available for \$225 from Chaldar (P.O. Box 12566, El Paso, TX 79913, (800) 443-0791, fax (915) 772-4733).

Radio-Electronics magazine ran an article showing how to build an automatic switcher (October 1989, page 33). The Fax-Mate requires the incoming caller to enter the pound sign (#) from a Touch-Tone telephone before it will divert the call to the fax machine.—S. W.

I Need a Boost

I'd like to upgrade my Tandy 1200. Currently, my machine has an 8088 CPU, a 10-megabyte hard disk drive, and 256K bytes of RAM. My hobby is writing BASIC programs for genealogical and stamp-cataloging applications. All my programs are I/O-bound, even when compiled, and I'm looking for a way to improve execution speeds.

I'd also like to be able to run Peach-Tree Complete II, which requires 512K

bytes of RAM and at least a 20-megabyte hard disk drive.

I read with interest the Short Take on the SOTA 286i accelerator (December 1988). Now I have literature from Sota describing its 386si accelerator and optional Memory/16i. From the literature, it appears that the 386si and the Memory/16i could provide faster execution and increase my system's main memory to 2 megabytes, all for about \$1100. At this cost, I wouldn't hesitate to install a 40-megabyte hard disk drive for another \$600. If all went well, I would be set for at least five years.

However, when I visited the local retailer that carries Sota products, I was advised that it would be a mistake to try to upgrade in this way. According to the salesperson, the Tandy 1200 has an 8-bit bus that would prevent an accelerator from producing any improvement in I/O speed. At the same time, the salesperson was trying to sell me a brand-new 80386 machine. At this point, I need a second opinion.

George A. Pohl
Sherrill, NY

If you installed the Sota 386si card, you would have an 80386SX running at 16 MHz. This would increase the computational speed of your Tandy 1200, but you would still be I/O-bound because of the limitations of the 4.77-MHz 8-bit bus.

I'd advise you to take that \$1700 you wanted to invest in your old computer and purchase a newer AT compatible. You can get quite a reasonable machine with at least a 12-MHz 80286 CPU, 1 megabyte of RAM, and an EGA or VGA display for that amount. Check the ads in BYTE for a price comparison.

If you don't want to spend that much, at least increase the RAM in your Tandy 1200 to 640K bytes and obtain disk-caching and printer-buffering software. That will give you a noticeable improvement in I/O throughput.—S. W.

INTRODUCING THE



**\$35 CURE FOR
FEAR OF MATH**

STATISTICS

At last, PC users can master statistical analysis without a masters in math.

It's Victory Over Statistics, a 200-page manual, published by GTE Data Services, Inc. Written in everyday English, Victory Over Statistics with its menu-driven diskware will take you from the basics, such as averages and variance, all the way to double exponential smoothing and regression analysis. Step by step, at the pace you choose.

All you need is an IBM PC or compatible with a 5.25 disk drive and 128K memory plus \$35.00.

That's one set of numbers even a math hater can love.

GTE Data Services

THE POWER IS ON

FIXES

- In "The Unix Shell" (September) on page 318, near the top of the second column, the example should read: `rm -r wp*.*`. Omitting the backslash would cause all files in the current directory to be removed as well.

- In past months, the author's biography for David Fiedler (The Unix /bin) has been incorrect. Fiedler is the publisher of the journal *Root*, not the editor. Bruce Hunter is the editor. ■

To order, send the coupon and a check, payable to GTE Data Services, Inc. Please allow four weeks for delivery.

Here's my check for \$35.00, plus \$4.00 for postage and handling. Florida residents please add 6% sales tax. Please rush my Victory Over Statistics manual and disk.

Victory Over Statistics, F1M
GTE Data Services, Inc.
P. O. Box 290152
Temple Terrace, FL 33687-0152

Name _____

Address _____

City _____ State _____ Zip _____

Telephone Number (____) _____-_____

CHAOS MANOR MAIL

*Jerry Pournelle answers questions about his column
and related computer topics*

Stringing Up C

Dear Jerry,

Once again, you've shown your strong dislike for Unix and the C language. As I communicated to you before, I share your dislike of C's string-handling capabilities. Someone should improve that language by including in `<string.h>` the appropriate string functions to make C as easy as BASIC. An emulation of the MID\$, INSTR, and string concatenating syntax is particularly needed. In the C language, there is no equivalent for all the things you can do with BASIC's MID\$, while with other functions, such as LEFT\$ and RIGHT\$, you can write C subroutines easily enough. Maybe I am too stupid to write these, but I find string handling in C laborious; it can be done, but not elegantly.

A note about the Cray machine availability to the hoi polloi. With Intel's new chip, the 80860 (or N-10 or i860), we will soon see Cray-like desktop machines. There's little more need for the Cray and its availability.

Paul A. Elias
Fountain Hills, AZ

Well, the desktop Cray isn't quite here yet.—Jerry

Path-Name Lament

Dear Jerry,

I am writing to you in exasperation. I recently received Clipper, the dBASE compiler from Nantucket. I also have the SBT accounting system, which I keep organized in a number of different directories. I planned to use Clipper to recompile the SBT program whenever I make changes.

Much to my surprise, I discovered that Clipper does not support path names in its response files! There goes my file organization.

Now, we have had path names as part of the file specification since 1983, yet people are still writing programs that do not accept path names. Other examples are Make from Microsoft and Keymap from The Software Link. Frankly, I see very little excuse for this. If someone

needs to access more than the maximum 20 files, then he or she can define a new file-handle alias table and set the address at offset 0034H to point to it and then set the word at 0032H to the size of the new table. The only thing to make sure of is that all files are closed and that 0032 and 0034 are reset to their initial values when the program terminates.

As for parsing a file specification, I created a complete file-specification parser. It required two days to complete. I wrote it in Microsoft Pascal, using an IBM editor. I now use it in all my programs that require parsing or simply checking the correctness of a file specification. Are these people telling me that I can do something with my feeble resources that these "professional" software companies cannot?

Ed Swaneck Jr.
Poland, OH

Yeah. I get to feeling that way, too.

—Jerry

APL Coding

Dear Jerry,

I read with some interest your "Language Sojourn" column (April). My company—a consulting firm—recently worked on a similar application. Unfortunately, instead of having the luxury of choosing an appropriate language, we were forced to do the job in STSC's APL*Plus.

We had originally planned on doing the job in C, which would have taken a trifle more code than in BASIC and brought us in a healthy fee commensurate with the effort involved. As you might imagine, this turned out to be a consultant's nightmare: Instead of billing for the effort of development of

continued

Jerry Pournelle holds a doctorate in psychology and is a science fiction writer who also earns a comfortable living writing about computers present and future. He can be reached c/o BYTE, One Phoenix Mill Lane, Peterborough, NH 03458, or on BIX as "jerry."

NEW BLAISE TOOLS



*The fastest way to create
powerful programs
with Turbo Pascal
5.0 and Turbo C 2.0!*

Blaise Computing, manufacturer of function libraries that offer easy-to-use solutions to your programming needs, introduces:

POWER TOOLS PLUS/5.0—\$149

—completely integrated and lightning-fast routines to help you:

- ◆ Add moving bar pull-down menus and windows to your user interfaces; *NEW!* ◆ Generate context sensitive help screens; *NEW!* ◆ Add easy-to-use date and time conversion routines; *NEW!* ◆ Let users choose from window oriented pick lists; *NEW!* ◆ Create and access "huge" data structures; *NEW!* ◆ Use multiple-line edit fields with fully configurable edit keys; *NEW!* ◆ Speed up your sorting with flexible in-memory sort routines; *NEW!*
- ◆ Add EMS support; *NEW!* ◆ Write TSRs and ISRs easily; ◆ Control DOS memory allocation;
- ◆ Create powerful programs in Turbo Pascal 4.0 & 5.0!

Turbo C TOOLS/2.0—\$149

—tight, fast, high quality functions to help you:

- ◆ Add easy-to-use mouse support for windows and menus; *NEW!* ◆ Quickly include virtual windows and menus; *NEW!*
- ◆ Integrate your windows and menus with Turbo C's text windows; *NEW!* ◆ Create context-sensitive help screens; *NEW!*
- ◆ Provide multiple-line edit fields with fully configurable edit keys; *NEW!* ◆ Use keyboard and video services (including enhanced keyboard and VGA); *NEW!*
- ◆ Write TSRs and ISRs easily; ◆ Create powerful programs in Turbo C 1.0, 1.5 and 2.0!

FREE with these products!

Source code, complete sample programs, a comprehensive reference manual with extensive examples, the Norton Guides Instant Access Program, and an online database. We also offer free technical support and a bulletin board system dedicated to technical issues.

Unleash your programming potential!

Blaise Computing offers programming tools that are fast, flexible and affordable. Call now to order or to ask for a free brochure on our full line of products for C and Pascal.

Put Blaise tools to the test!

If at any time during the first 30 days you are not completely satisfied with their speed and flexibility, we'll refund your money.

Call 800-333-8087 today!

BLAISE COMPUTING INC.

2560 Ninth St., Suite 316, Berkeley, CA 94710, (415) 540-5441

FAX: 415-540-1938

Turbo C and Turbo Pascal are trademarks of Borland International.



20,000 lines of code, we were able to stretch it out to only 2000 lines of code and bill on the basis of results—a fraction of what we had anticipated.

Jedediah West
New York, NY

For getting a problem solved fast, there's often no way to beat APL, and the STSC implementation is, APL enthusiasts tell me, very good.

I sure wouldn't want to maintain an APL program, though.—Jerry

Software Modeling

Dear Jerry,

Your comments on *The Limits to Growth* by Dennis and Donella Meadows (June) brought back memories of the early 1970s, when the work and the subject were "hot" topics. I had worked for almost two decades in the nuclear energy program at Argonne National Laboratory, and I was familiar with computer modeling and the "science fiction" that often came out of it.

I attended a meeting of the Chicago section of the American Institute of Chemical Engineers at which Jay Forrester was scheduled to talk, but Dennis Meadows filled in at the last minute. In the question-and-answer session afterward, I asked Meadows about how the data was used to validate the model, since he had described the historical demographic, economic, and industrial data used to fit the coefficients in the various equations assumed to be valid. In particular, I wanted to know whether they had ever run the model backward to see if it would predict the past—a sensitive test, and a logical one.

Meadows replied that they had tried it, but the results were unsatisfactory, and they had no clear explanation at that time, so it was not included. My response was that there was no model that I could imagine that would include the effects of innovation or of unexpected catastrophe, and that the work was an unreliable extrapolation of data beyond reliability based on the instincts and insights of the well-meaning investigators. I dimly recall uncharitably referring to it as "mathematical masturbation."

With the 20/20 hindsight that comes with additional years of learning, I now recognize that although the data covered periods involving the industrial revolution, urbanization of society and the problems of cities, the period of modern sanitation and medicine, and the migration of intellectuals due to the persecutions in Europe and Asia, these points were often included only peripherally

and not in microscopic detail.

The recent spate of record high and low temperatures, of droughts and floods, and of increased ozone concentrations on the earth's surface and their decrease in the upper atmosphere indicate that, even with supercomputers, our models are better suited to predicting the past.

As an engineer, I am familiar with the successes of computer modeling of fluid flows. Yet they are still trying, retrospectively, to predict El Nino, the massive perturbation in the global weather cycle due to the coupling of the heat balance of the earth, winds, and oceanic upwelling. (A pedant would refer to this as thermal and hydrodynamic coupling between baroclinic and geostrophic flows.) We don't predict earthquakes; rather, we seek to minimize the consequences of earthquakes, volcanic eruptions, tornadoes and hurricanes, as well as other "short-term" natural disasters with major impact on the food chains, soil conservation, and the balances of weather and competing species.

I could go on, but you probably know as much as I do, or more. Where do we balance the responsibility to be complete and correct against calling attention to potential problems? The dilemma is an ancient one—free speech versus crying fire in a crowded theater, or crying wolf too often. In the nuclear safety business, we had some job security in thinking up unlikely mechanisms for accidents so we could study their potential consequences and how to prevent them. How is such "hazard mongering" different than the pronouncements of the Club of Rome?

In short, I enjoy your columns for their wide range and because they provoke thought, even if the problems don't always have a simple, or any, answer.

David Miller
Downers Grove, IL

When we were younger, "That's what the computer says" was a darned near unanswerable argument. Of course, computers can't do more than model what we already understand.—Jerry

Z-88 Problems

Dear Jerry,

I have been reading in BYTE about your adventures with a Sinclair Z-88. I have used one since October 1987, and I think my experiences might help you.

First, I think your machine is faulty. It shouldn't have lost your files, even if you didn't quite understand the file program-storage system. It also shouldn't have had the mysterious battery problem that you

mentioned in the June issue.

My Z-88 showed similar problems. It would very occasionally lose all suspended activities when it was lying low and "switched off." Sometimes it would operate again only after a soft reset. On other occasions, it showed battery problems similar to the ones that you mentioned. Because these faults were infrequent and had no apparent common cause, I always tended to think that I had done something wrong and that the machine was really O.K.

After I had used the machine regularly for about 11 months, the problems became more frequent, culminating in one glorious day when the Z-88 decided that the RAM packs I was using weren't really there at all. It wouldn't access them in any way.

That's when I sent the machine back and got a new one. My new Z-88 is perfect—there have been no lost files, no power supply problems.

The moral of this story is: Don't keep blaming yourself; blame the machine, and change it for a new one.

I must be one of the few people around who use a Z-88 as their main computer. I have access to other microcomputers—IBM PCs and clones, Macintoshes, and so on—but I decided long ago that I would never buy myself a machine until I could find one that didn't take over because of its physical size. Even in an office or study, a desktop microcomputer is pretty intrusive. I suppose I was unduly affected by Alan Kay's Dynabook paper all those years ago.

Anyway, when the Z-88 turned up, I grabbed it, and it's marvelous. Admittedly, you have to plan its operation differently from that of conventional microcomputers, but that doesn't mean that its systems are wrong and that the rest are right. Cambridge Computers was obviously unlucky in the timing of the launch of the Z-88, which coincided with the rapid rise in memory-chip prices. But I can't help thinking that Clive Sinclair's abhorrence of disk drives will prove right in the long run. Here in England, there is a cheap cassette tape streamer on the market that avoids the need for expensive EPROMs.

J. G. Chadwick
Warrington, U.K.

Well, Sinclair sent me another Z-88, but getting it seems to have cured all the problems of the original one!

I don't think I'd care to use the Z-88 as my only computer, but I do like its light weight, and I carry it most places I go.

—Jerry ■

Price
Quality
Service

**This is where it all
comes together.**



Quality

Gateway 2000's quality standards set us apart from our competition. From the top quality name brand components used in our systems to the painstaking quality assurance tests we run on our machines, you are guaranteed a top quality computer. Our complete line of computer systems are hand built in our factory located just outside Sioux City, Iowa. State of the art technology is used to provide you with a combination of performance, compatibility, and reliability that few vendors can match.

One customer recently wrote: *"The quality of your work is exemplary and frankly has made a lot of others jealous because they bought systems which were comparable in quality but with a stiff price difference"*—George Syty.

Service

Gateway 2000's service policies are the best in the industry. We stand behind all of our systems with a **30 Day Money Back Guarantee** and a **1 Year Warranty**. We also offer **Lifetime Toll-Free Technical Support**, and **Free Federal Express Shipping** of replacement parts. If our technicians can't solve your problems over the phone or Fed-X you a solution we can dispatch a technician to most locations to provide **Free On Site Service**. Our policies are great, but it's our people that really set us apart from the competition. Look at what our customers write:

"Thank you very much for kind attention and help. I am highly recommending your corporation to colleagues for your quality and service"—Herbert Markley.

"I've always heard your forte is customer service, and now you have definitely proven it to me"—Jose De Jesus.

"I am really glad I chose Gateway 2000"—Jerry Langland.

"I feel compelled to express my gratitude to your company for the impeccable service and support I received"—Andrei Weiszmann.

"It is a pleasure indeed, to work with a computer sales company that exhibits a genuine desire to satisfy the customer"—Ron L. Kinney.



GATEWAY 2000 • P.O. BOX 2000
SERGEANT BLUFF, IOWA 51054
800-523-2000 • 712-943-2000
FAX 712-943-2023

Due to the volatility in the DRAM market, all prices are subject to change.

This is where it all comes together.

We founded Gateway 2000 on this farm located near Sioux City, Iowa to provide top quality computers at unbeatable prices with uncompromising service after the sale. No other company offers you the combination of *Price, Quality, and Service* that we do. We want you to be completely satisfied with your decision to purchase a Gateway 2000 computer system, and you have our personal pledge that you will be. We look forward to you joining our thousands of satisfied customers, and establishing a long lasting business relationship.

Sincerely,

Ted Waitt
President

Norm Waitt Jr.
Vice President

Price

Gateway 2000 offers the most aggressive prices in the industry. We offer fully loaded machines for the same price as most vendor's stripped down models. One customer wrote "*I'm surprised that the computer media haven't mentioned anything about your prices relative to the rest. You don't merely edge them out you blow them away*"—Clarence Larson. Look at our prices on the back page of this ad, shop around, compare apples to apples, then call Gateway 2000's knowledgeable sales staff to discover the GATEWAY DIFFERENCE. "*I chose Gateway after much research because I felt that the product was the best value for the money and the sales staff was very patient with my never ending list of questions and and inquiries*"—Keith Lazan.

1 9 8 8



B Y T E

A W A R D O F

D I S T I N C T I O N



20 MHZ 386 VGA

- 4 Megs RAM
- 1.2 Meg 5¼" Drive
- 1.44 Meg 3.5" Drive
- 65 Meg 28ms RLL Drive
- 16 Bit VGA Board
- 14" 1024 x 768 Color Monitor
- 1 Parallel & 2 Serial Ports
- 101 Key Keyboard
- MS DOS 3.3 or 4.01

\$2795.00

64K Cache Add \$500

25 MHZ 386 VGA

- 4 Megs RAM
- 1.2 Meg 5¼" Drive
- 1.44 Meg 3.5" Drive
- 160 Meg ESDI Drive
- 16 Bit VGA Board
- 14" 1024 x 768 Color Monitor
- 1 Parallel & 2 Serial Ports
- 101 Key Keyboard
- MS DOS 3.3 or 4.01

\$3495.00

64K Cache Add \$500

33 MHZ 386 VGA

- 64K Cache RAM
- 4 Megs RAM
- 1.2 Meg 5¼" Drive
- 1.44 Meg 3.5" Drive
- 160 Meg ESDI Drive
- 16 Bit VGA Board
- 14" 1024 x 768 Color Monitor
- 1 Parallel & 2 Serial Ports
- 101 Key Keyboard
- MS DOS 3.3 or 4.01

\$4995.00

GATEWAY 386SX

- 2 Megs RAM
- 1.2 Meg 5¼" Drive
- 1.44 Meg 3.5" Drive
- 65 Meg 28ms RLL Drive
- 16 Bit VGA Board
- 14" 1024 x 768 Color Monitor
- 1 Parallel & 2 Serial Ports
- 101 Key Keyboard
- MS DOS 3.3 or 4.01

\$2395.00

with Desview 386



GATEWAY 2000 • P.O. BOX 2000
SERGEANT BLUFF, IOWA 51054
800-523-2000 • 712-943-2000
FAX 712-943-2023

Due to the volatility in the DRAM market, all prices are subject to change.

386SX LAPTOP

- Gas Plasma Display Screen
- 2 Megs RAM
- 1.44 Meg 3.5" Floppy Drive
- External Port for 5¼" Drive
- 40 Meg 28ms Hard Drive
- 1 Parallel & 1 Serial Port
- Full Length 16 Bit Slot
- Expansion Slot (16 Bit)
- External EGA Monitor Port
- 84 Key Keyboard
- MS DOS 3.3 Installed

\$2995.00

12 MHZ 286 VGA

- 80286-12 Processor
- 2 Megs RAM
- 1.2 Meg 5¼" Drive
- 1.44 Meg 3.5" Drive
- 65 Meg 28ms RLL Drive
- 16 Bit VGA Board
- 14" 1024 x 768 Color Monitor
- 1 Parallel & 2 Serial Ports
- 101 Key Keyboard
- MS DOS 3.3 or 4.01

\$2195.00

16 MHZ 286 VGA

- 80286-16 Processor
- 2 Megs RAM
- 1.2 Meg 5¼" Drive
- 1.44 Meg 3.5" Drive
- 65 Meg 28ms RLL Drive
- 16 Bit VGA Board
- 14" 1024 x 768 Color Monitor
- 1 Parallel & 2 Serial Ports
- 101 Key Keyboard
- MS DOS 3.3 or 4.01

\$2295.00

20 MHZ 286 VGA

- 80286-20 Processor
- 2 Megs RAM
- 1.2 Meg 5¼" Drive
- 1.44 Meg 3.5" Drive
- 65 Meg 28ms RLL Drive
- 16 Bit VGA Board
- 14" 1024 x 768 Color Monitor
- 1 Parallel & 2 Serial Ports
- 101 Key Keyboard
- MS DOS 3.3 or 4.01

\$2395.00

Call for Custom Configurations ■ Ask about our Installation Program

Circle 135 on Reader Service Card

WHAT'S NEW

HARDWARE • SYSTEMS

Apollo Underprices 68030-Based Unix System

The Apollo Series 2500 is a workstation—with all the bells and whistles of a LAN node—at a personal computer price. It includes a 20-MHz Motorola 68030, a 68882 floating-point coprocessor, 4 megabytes of RAM, and a 15-inch paper-white display with a maximum resolution of 1024 by 780 pixels.

There's no need for a hard disk drive; the system has networking support that includes built-in Ethernet, IBM Token Ring, and Apollo Token Ring support, Apollo says. But if you'd like a local drive, you can buy an optional 100- or 200-megabyte SCSI hard disk drive.

All the features of the 2500 are built onto a single motherboard that's approximately the size of a full-size IBM AT board. The only expansion slots are for the hard disk drive controller and for memory. The 2500 has room for 16 1-megabyte single in-line memory modules. When 4-megabyte SIMMS become available, users will be able to pack the machine with 64 megabytes, Apollo says.

The 2500 comes with Unix System V release 3. Apollo says that the system will run any of the 2500-plus Unix applications that run on other Apollo systems.

Price: \$3990; with 100-megabyte SCSI hard disk drive, \$5490; with 200-megabyte SCSI drive, \$8495; 19-inch monitor, \$1500.

Contact: Hewlett-Packard Co., Apollo Division, 330 Bilerica Rd, Chelmsford, MA 01824, (508) 256-6600.

Inquiry 1127.



Apollo built its Series 2500 with LAN support and Unix workstation performance.

Put an 80386SX in Your Lap

The LapPRO-386SX from Daphin Technology is an 8-/16-MHz 80386SX-based laptop system with no wait states. It comes with 2 megabytes of RAM, which you can expand to 4 megabytes.

Also included is a 40-megabyte 28-ms hard disk drive and a 1.44-megabyte 3½-inch floppy disk drive. You can also have the factory install a 5¼-inch floppy disk drive. A 10-inch 640- by 400-pixel LCD EGA/CGA monitor is standard, as is a

75-key keyboard with a numeric keypad.

The system's internal power supply automatically adjusts to changes in voltage, according to the manufacturer. It operates from a 110- or 220-volt power source, and also from a 12-V cigarette lighter. There's a removable and rechargeable battery pack.

The LapPRO-386SX measures 3 inches high by 12¾ inches wide by 16 inches deep, and it weighs 16½ pounds with the battery pack. **Price:** \$4995; expansion chassis, \$295; 80387SX-16 math coprocessor, \$550; 4-megabyte upgrade, \$735;

SEND US YOUR NEW PRODUCT RELEASE

We'd like to consider your product for publication. Send us full information, including price, ship date, and an address and telephone number where readers can get further information. Send to New Products Editor, BYTE, One Phoenix Mill Lane, Peterborough, NH 03458. Information contained in these items is based on manufacturers' written statements and/or telephone interviews with BYTE reporters. BYTE has not formally reviewed each product mentioned. These items, along with additional new product announcements, are posted regularly on BIX in the microbytes.sw and microbytes.hw conferences.

2400-bps internal modem, \$189; 360K-byte floppy disk drive, \$259.

Contact: Daphin Technology, Inc., 1125 East St. Charles Rd., Lombard, IL 60148, (312) 627-4004. **Inquiry 1128.**

Wang Reinforces Its PC Presence

Wang Laboratories has reinforced its formerly sparse line of IBM PC compatibles with four new systems. The quartet of Wang-designed-and-built clones includes 16- and 20-MHz 80286-based systems and two 80386SX-based systems: a 16-MHz AT clone and the company's first Micro Channel PS/2 clone.

The two 80286-based systems (dubbed the PC 250/16 and PC 280/20) and the 80386SX-based AT compatible (the PC 350/16S) include 1 megabyte of RAM and a single 3½-inch floppy disk drive. Wang touts its 16-MHz 80386SX-based MC 350/16S as compatible with IBM's PS/2 Model 55 SX but claims it has more on-board memory capacity and expansion options. The system includes five Micro Channel slots, 2 megabytes of RAM, a single 3½-inch floppy disk drive, and an on-board 16-bit VGA.

All four systems let you put up to 8 megabytes on the motherboard. Monitors are optional.

Price: PC 250/16, \$2095; PC 280/20, \$2995; PC 350/16S, \$2695; MC 350/16S, \$2995.

Contact: Wang Laboratories, Inc., One Industrial Ave., Lowell, MA 01851, (508) 459-5000.

Inquiry 1129.

continued

Really Seeing What You Get

While many applications trumpet their WYSIWYG abilities, the fact remains that what you see on the screen is only an approximation of the final printed output.

But MegaScan Technology's Document Display System (DDS) changes all that. With a display resolution of 4096 by 3300 pixels on a 19-inch paper-white noninterlaced diagonal screen, it actually shows 300 dpi on the screen, for nine times the display density of a VGA monitor.

The DDS has an active screen area of 13½ by 11 inches, letting you see full-page documents at the same size, density, and image quality—dot for dot—as laser-printed output. MegaScan claims that while fonts that are smaller than 8 points are usually illegible even on high-resolution monitors, DDS users can comfortably read fonts that are as small as 4 points.

The DDS card uses a 2-megabyte frame buffer, holding document images that are up to 12 million pixels, along with menus, display primitives, and data structures. And the system's dual-ported video RAM has a 1.5-gigabit-per-second data transfer rate to the monitor controller via a short optical-fiber cable. The monitor itself uses a 72-Hz refresh rate.

The DDS is available for the IBM AT and compatibles, as well as VMEbus systems such as Sun workstations. Drivers for popular graphical user interfaces, including Windows, are available now, with a Presentation

Smart, Cordless Mouse Distinguishes Between Apples, Amigas, and Ataris

Practical Solutions' new Cordless Mouse for Apple, Amiga, and Atari systems includes an 8-bit 12-MHz CMOS microprocessor for plug-and-play compatibility, the company says.

In conjunction with an infrared receiver and a set of adapters for the receiver, the Cordless Mouse works with Macintosh Plus, SE, and II models; all Amiga models; and both the Atari ST and Mega models, Practical Solutions says.

Resolution is 200 dpi, and tracking speed is rated at up to 600 mm per second. Like most other rodents, the

Cordless Mouse also has ballistic control, so the faster you move the mouse, the faster the cursor jumps across your screen.

For power, each Cordless Mouse requires two AAA batteries. A sleep mode works after the mouse is idle for more than 2 minutes, and an automatic shutoff function powers down the mouse after it sits idle for more than 10 minutes.

Price: \$149.95.

Contact: Practical Solutions, 1135 North Jones Blvd., Tucson, AZ 85716, (602) 322-6100.
Inquiry 1137.

Manager driver expected to be available by the end of the year.

Price: \$11,000.

Contact: MegaScan Technology, Inc., 42 South St., Hopkinton, MA 01748, (508) 435-2600.

Inquiry 1136.

Light Pens Meet PCs and CAD Terminals

The DT200 series of 1024-by-1024-pixel light pens is available for CGA, EGA, Super EGA, and VGA monitors, as well as for customized plug compatibility with several terminals.

Mac compatibility is next, the company promises, with a Mac product planned for mid-1990. Supported terminals—for CAD, process control, and menu selection—include Beehive, Harris, Telex, C. Itoh, Memorex, and Wyse.

Price: \$135 to \$210.

Contact: Design Technology, 1050-R Pioneer Way, El Cajon, CA 92020, (619) 440-7666.

Inquiry 1139.

Give Your PS/2 a Nine-Track Tape Memory System

Interface Data's XT/AT-compatible nine-track tape system is now available on PS/2 platforms. The new system consists of a Micro Channel architecture-based add-in card with cabling to your choice of breadbox-size or two-breadbox-size peripherals. Included on your MCA card is a 5-MHz Z80-based processor, which facilitates data transfer to a maximum rate of 250K bytes per second. Data transfer mode is direct memory access, interrupt controlled. RAM is 64K bytes.

Series 3/98 will read tapes on 7-inch reels at data densities of 1600 and 3200 bits per inch (for data backup). The larger Series 3/99 systems read tapes on 10½-inch reels. Each Series 3/99 reads tape densities of 1600 and 3200 bpi, as well as the more traditional 800-bpi densities. A high-performance Series 3/99 GCR (group code recording) system can handle tapes with 6250-bpi densities.

Price: Series 3/98, \$4995; Series 3/99, \$5499; Series 3/99 GCR, \$10,995.

Contact: Interface Data, Inc., 800 West Cummings Park, Suite 6900, Woburn, MA 01801, (617) 938-6333.
Inquiry 1138.

Two Printers in One

If your printing needs include both PostScript and Hewlett-Packard page-control-language (PCL) capabilities, Personal Computer Products' dual-standard Laser-Image 1100-PS will eliminate the big bucks and space problems of buying two printers. The 1100-PS includes both an Adobe PostScript interpreter and HP LaserJet Series II emulation. You can switch between the two with a front-panel switch.

The printer's PostScript interpreter has 35 typefaces from 11 font families, and, according to the company, it supports the entire Adobe library of downloadable fonts. On the Hewlett-Packard side, the 1100-PS includes 24 standard fonts, as well as support for all PCL-compatible downloadable fonts.

The 1100-PS comes with RS-232C, RS-422, and parallel ports. It's rated at 6 pages per minute at 300-dpi resolution. Two megabytes of RAM is standard, and you can expand it to a maximum of 4 megabytes. The standard paper tray holds 150 sheets, and the auxiliary tray holds 250 sheets. The printer is available alone or bundled with the ImagePress desktop publishing software.

Price: \$4995; with ImagePress, \$5295.

Contact: Personal Computer Products, Inc., 11590 West Bernardo Court, Suite 100, San Diego, CA 92127, (619) 485-8411.

Inquiry 1135.

continued

After centuries of practice, mankind perfects engineering calculations: MathCAD.

Announcing MathCAD 2.5: The Dawn of a New Age.

What the historians will call it, only time will tell.

Perhaps the Century of Speed, or the Era of Ease. But whatever the name, this is the age of MathCAD 2.5, the only math package that looks and works the way you think.

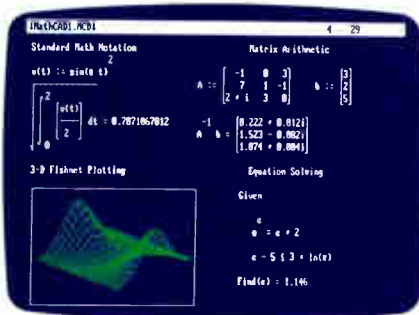

MathCAD 2.5 includes 3-D plotting, HPGL sketch import, and PostScript output.

MathCAD is far and away the best-selling math package in the world. Because it lets you perform engineering and scientific calculations in a way that's faster, more natural and less error-prone than the way you're doing them now—whether you're using a scratchpad, calculator, spreadsheet or program that you wrote yourself.

And now we've made the best even better. MathCAD 2.5 is a dramatically improved version that includes three-dimensional plotting, enhanced numerical analysis, and the ability to import HPGL files from most popular CAD programs, including AutoCAD.* And now you can print on PostScript* compatible printers.

And like before, MathCAD's live document interface™ lets you enter

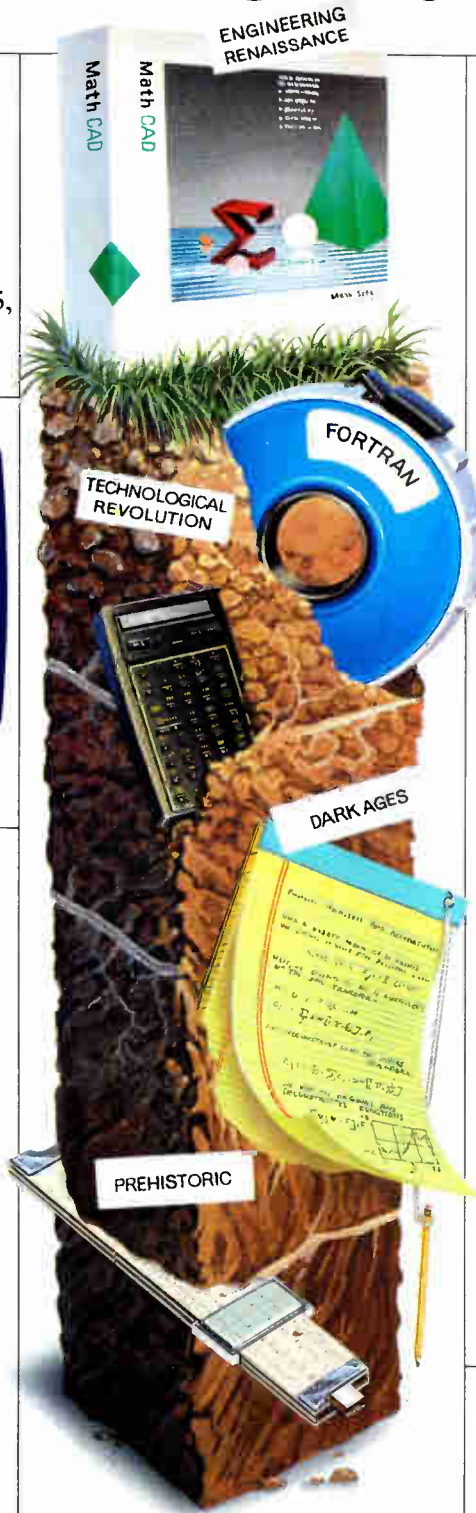

equations anywhere on the screen, add text to support your work, and graph the results. Then print your analysis in presentation-quality documents.

It has over 120 commonly used functions built right in, for handling equations and formulas, as well as exponentials, differentials, cubic splines, FFTs and matrices.

No matter what kind of math you do, MathCAD 2.5 has a solution for you. In fact, it's used by over 60,000 engineers and scientists, including electrical, industrial, and mechanical engineers, physicists, biologists, and economists.

But don't take our word for it; just ask the experts. PC Magazine recently described MathCAD as "everything you have ever dreamed of in a mathematical toolbox."



March 14, 1989 issue.
Best of '88
Best of '87

And for Macintosh* users, we present MathCAD 2.0, rewritten to take full advantage of the Macintosh interface. Entering operators and Greek letters into equations is pure simplicity!

Look for MathCAD 2.5 at your local software dealer, or give us a call. For more information, a free demo disk, or upgrade information, dial 1-800-MATHCAD (in MA, 617-577-1017).

Available for IBM® compatibles and Macintosh computers.

TM and ® signify manufacturer's trademark or manufacturer's registered trademark respectively.

MathCAD®

MathSoft, Inc. One Kendall Square, Cambridge, MA 02139

Some pointing devices
feel quite alien.





Not every kind of pointing device fits your kind of hand.

**TrackMan is built
the way you are.**

When we put our minds to designing the next generation of pointing devices, we started with our hands. It turns out that thumbs have over twice the muscle and agility of other fingers—which only go up and down.



We tested dozens of prototypes. None beat the body you see before you. A trim 4.25" x 5.25", fully equipped with a low-inertia, lightweight ball (placed under the thumb), three buttons (under the fingers), and room to rest the hand.

TrackMan is smart, too: adjustable from 50 to over 15,000 d.p.i. resolution (default at 300); on-the-fly ballistic driver; lots of built-in menus to speed up popular keyboard based applications. Even a shell for Lotus 1-2-3™



Simple to install, this stationary mouse is compatible with all other top-selling mice. TrackMan is guaranteed to work with any application on a 256K IBM (or compatible) personal computer. Price? \$139, complete with Satisfaction Guarantee, and 7-Days-A-Week Product Support.*

*For further information call:
800-231-7717
In California: (800) 552-8885
In Canada: (415) 795-8500
In Europe: ++41-21-869-9656*

LOGITECH



*Serial version. Bus version is \$149. ™1-2-3 is a trademark of Lotus Corp.

Circle 188 on Reader Service Card (DEALERS: 189)

Cutting-Edge Graphics for ATs

If VGA resolution, speed, and color choice aren't sufficient for your needs, Hewlett-Packard has a pair of IBM PC graphics boards that go beyond VGA by using Texas Instruments' dedicated graphics processor chips.

The HP Intelligent Graphics Controller 10 (IGC-10) uses a TI TMS34010 graphics processor. It gives you a 16- or 256-color display out of a palette of 256,000 and can display applications in 640 by 480, 800 by 600, and 1024 by 768 pixels. Hewlett-Packard says that in performance, the IGC-10 betters a standard VGA card by five times.

On the high end, the company claims that the Intelligent Graphics Controller 20 (IGC-20) is the first shipping PC graphics card based on the Texas Instruments TMS34020 graphics processor. It has 15 times the performance of a conventional VGA card, Hewlett-Packard says. With a capable monitor, the IGC-20 can give you 1024- by 768-

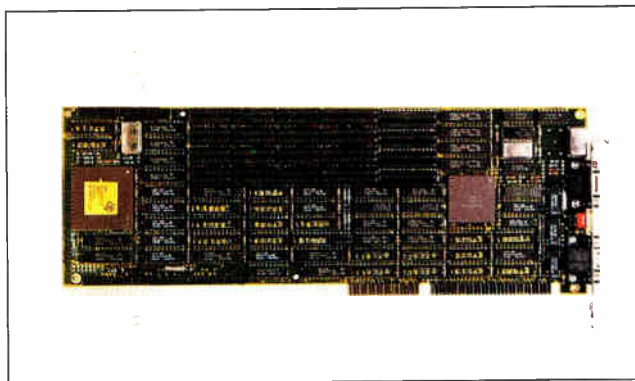

Hewlett-Packard says that its IGC-20 is a TMS34020-based board that offers 15 times the performance of a conventional VGA card.

pixel or 1280- by 1024-pixel resolution, and it displays 256 colors out of 16.7 million.

Both the IGC-10 and IGC-20 work with all IBM ATs and compatibles, as well as the new generation of EISA-bus systems. They're compatible with all software that works with the TIGA (Texas Instruments Graphics Architecture) 340 and the new Direct Graphics Interface Standard. DGIS-compatible software includes such common graphical user interfaces and applications as Microsoft Windows and GEM. Both boards also have a "VGA pass-through" feature that lets you use them in your system in conjunction with

a standard VGA board.

The boards each come with 512K bytes of RAM. But if you need even better performance, you can upgrade them. The IGC-10 takes up to 1 megabyte of video RAM and up to 3.5 megabytes of RAM; the IGC-20 will handle 2 megabytes of VRAM and 3.5 megabytes of RAM.

Price: Intelligent Graphics Controller 10, \$995; Intelligent Graphics Controller 20, \$2495; 512K-byte VRAM upgrade, \$400; 512K-byte RAM upgrade, \$330.
Contact: Hewlett-Packard Co., 3404 East Harmony Rd., Fort Collins, CO 80525, (303) 229-3800.

Inquiry 1141.

Add 80386SX Power to Your Wimpy 80286

While upgrading your 80286-based AT to the greater power of a 32-bit 80386SX processor has been possible for quite a while, you've been limited to add-in cards that are constrained by the speed of the bus. Cumulus says that its 386SX Card gets by this limitation through the simple process of plugging directly into your motherboard's processor socket.

The 16-MHz 386SX card replaces 80286 processors with clock speeds of up to 16 MHz. Cumulus says that if you have an AT or compat-

ible that runs at 8 MHz, you can expect a performance gain of 10 percent to 15 percent. The card, which measures 2½ by 2½ inches, also has a socket for an optional 80387SX math coprocessor. The company claims that this gives you four times the performance of an 80286/80287 combination.

The company says that once you've installed the 386SX Card, you'll be able to run all 80386-specific software, such as Windows/386 and DESQview/386. Also included is software that lets you run expanded

memory (EMS 4.0) applications in your system's extended memory.

The 386SX Card is compatible with PGA (pin grid array) and PLCC (plastic leaded chip carrier) socket types. You can install it in most IBM ATs, PS/2s, and compatibles, including the PS/2 Models 30 286, 50, 50 Z, and 60, and the Compaq Deskpro 286.

Price: \$595.
Contact: Cumulus Corp., 23500 Mercantile Rd., Cleveland, OH 44122, (216) 464-2211.

Inquiry 1140.

Link Your Micro Channel to a Laser Printer

The JLaser6-MC uses a high-speed direct video interface from your computer to your laser printer's print engine. According to Tall Tree Systems, this gives you print speeds that are two to six times faster than what you get using a standard parallel printer interface. It works with the Hewlett-Packard LaserJet Series II and all Canon SX print-engine-based printers.

The interface also gives you the ability to print true halftone images with up to 256 levels of gray at 70 lines per inch, and up to 128 levels of gray at 106 lines per inch. The company says that this is done by modulating the laser beam to a much higher resolution than normal.

For printing bit-mapped images, the JLaser6-MC needs 2 megabytes of expanded memory. If your system doesn't have EMS-compatible memory, you can add an optional 2-megabyte daughterboard to the JLaser6-MC that also gives you a SCSI port.

The JLaser6-MC package comes with a Micro Channel board, a video interface board for your laser printer, a connecting cable, and a Bit-stream Fontware disk. It also comes with drivers for Microsoft Windows, GEM, and Ventura Publisher, plus JBanner (an image and text utility) and JPlot (a Hewlett-Packard Graphics Language emulator).

Price: \$599; with 2 megabytes, \$899.
Contact: Tall Tree Systems, P.O. Box 50690, 2585 East Bayshore Rd., Palo Alto, CA 94303, (415) 493-1980.

Inquiry 1143.

continued

If You Want To Talk Fast DBMS Call 1-800-db-RAIMA™ And Start Screaming

You'll be screaming, all right. db_VISTA III from Raima Corporation combines the flexibility of a relational DBMS and the lightning speed of the network database model.

C db_VISTA III is written for C Programmers.

Source code available. The interactive database utilities and outstanding documentation make db_VISTA III easy to learn. All applications are portable to VMS, UNIX, OS/2, MS-DOS, even Macintosh. No royalties.

db_VISTA III is *Fast*. Using benchmarks originated at PC Tech Journal Laboratories, db_VISTA III measured 3 to 12 times faster than the average relational database! Call us and we'll send you the results.

Relational and Network Model Technology for Programming Flexibility.

Retrieve a record fast using the relational keyed access method

db_VISTA III Database Management System		
Features	Yes	No
db_VISTA 3.1 High Performance DBMS:		
Single and Multi-User available	✓	
Relational B-tree Indexing	✓	
Network Database Model	✓	
Multiple database access	✓	
Referential integrity	✓	
Automatic recovery	✓	
Record & File locking	✓	
RAM resident		✓
db_QUERY 2.1 SQL-based Query:		
Relational Query & Report Writer	✓	
db_REVISE 1.0 Database Restructure Program:		
Total database redesign/restructuring	✓	
Operating Systems*: VMS, ULTRIX, UNIX		
BSD 4.2, SunOS, XENIX, MS-DOS,	✓	
Macintosh and MS Windows, OS/2 compatible	✓	
C Compilers*: Most compilers supported		
C++ compatible	✓	
LANs*: 3COM, Novell, Banyan, AppleShare*		
WKS Library:		
Read & Write WKS, WK1 & DBF files	✓	
SOURCE CODE AVAILABLE:		
ROYALTIES: (Absolutely not!)		✓✓

*Other environments are supported; call for complete list.

and all related records can be immediately available using the network model. You decide how to combine these for best application performance.

 **SQL Support** with SQL-based db_QUERY, db_VISTA III's relational query and report writer.

db_VISTA Puts You in Some Fast Company.

Thousands of C programmers in over 50 countries worldwide use db_VISTA III, including APPLE, ARCO, AT&T, EDS, Federal Express, Hewlett-Packard, IBM, NASA...

Don't wait. Call Raima for more information about how you can build applications that are *screaming-fast!*

Call 1-800-db-RAIMA
(That's 1-800-327-2462)

db_VISTA III™
Database Management System

Rated Number 1
for Overall Performance
according to a *PC WEEK* Poll
of Corporate Satisfaction,
August 28, 1989.

 **RAIMA™**
CORPORATION BY129

Inexpensive Word Processor in a 3-pound Package

The WP-2 is an inexpensive laptop computer built for word processing. It features a 5.5-MHz Z80 chip, a 62-key QWERTY keyboard, and an 80-column by 8-row LCD screen. Standard memory is 32K bytes, 22K bytes of which is available for documents.

Besides the word processing program, Tandy added a 100,000-word spelling checker, a 200,000-word thesaurus, and communications software that supports ASCII and XMODEM.

Using the two function keys in combination with number keys, you can cut, copy and paste, search and replace, center and justify text, output to a printer, or initiate telecommunications. The telecommunications software runs through the WP-2's serial port, and there's a parallel port for printing.

The 8½- by 11¾- by 1-inch WP-2 is powered by four AA batteries, which Tandy rates at 12 hours. A lithium battery backs up the RAM and has an estimated life of more than five years.

Options include an AC adapter, 32K bytes of internal RAM (which must be dealer-installed), and an IC card that plugs into a side slot on the computer with an additional 32K bytes of RAM.

Price: \$349.95; internal 32K bytes of RAM, \$49.95; IC card, \$119.95; AC adapter, \$6.95.

Contact: Tandy Corp., 1800 One Tandy Center, Fort Worth, TX 76102, (817) 390-2129.

Inquiry 1147.



Tandy's WP-2 is a dedicated word processor with a built-in 200,000-word thesaurus and communications software.

Virtual Software for a Real Oscilloscope

Developed by National Instruments, CAT200 Virtual Instrument Software is the first shipping example of the company's DOS-based virtual-instrument technology. It's used to control Tektronix's 222 Digital Handheld Oscilloscope through a standard RS-232C serial link.

CAT200 re-creates on your computer screen the entire

front panel of the oscilloscope, allowing you to acquire, analyze, reduce, and store data using any IBM PC, PS/2, or compatible (including laptops). Tektronix says that the package is designed for both experienced and novice users.

Using a mouse, you can point and click to activate any of the 222's controls. You can also store commonly used setups for nearly hands-free use in the field. The package can display up to six different waveforms, which you can store for later analysis or compare with incoming

signals.

Tektronix says that a unique feature of the CAT200 package is its built-in support for Hayes-compatible modems. Using the telephone lines, you can link a PC running the package to a remote 222 scope, turning the telephone network into ultralong probes. You can then control the scope from your PC, just as if it were next to you. You can also upload and download captured waveforms between locations.

The software requires 640K bytes of RAM, an EGA or VGA graphics card, a hard disk drive, and a serial port. **Price:** CAT200, \$395; 222 Digital Handheld Oscilloscope, \$2450. **Contact:** Tektronix, Inc., P.O. Box 500, Beaverton, OR 97077, (503) 627-7111. **Inquiry 1149.**

Battery Power for Days on End

You can drive any electrical device that requires 12 volts of power, such as a portable computer, with the Bat/Pak 30-ampere-hour battery pack, according to Horizon Entertainment.

The pack comes with a meter, switch, fuse, and two output receptacles (XLR and cigarette lighter). The battery is a sealed lead-acid deep cycle type mounted in a case covered with black fiberglass and insulated with one-half inch of foam. The unit weighs about 25 pounds and measures 6¾ inches wide by 9½ inches deep by 9½ inches high.

Price: \$295; XLR charger, \$39.95.

Contact: Horizon Entertainment, Inc., P.O. Box 300146, Houston, TX 77230, (713) 747-6433.

Inquiry 1146.

Spectrum Analyzer Includes an XT

Rapid Systems' R375 is a 10-MHz IBM PC XT-based fast Fourier transform spectrum analyzer designed for engineering testing, including vibration, impact, ultrasound, modal, and mechanical analyses.

It analyzes two channels at once, with frequencies of up to 10 MHz and in the time domain to 2 MHz at 10 samples per cycle. Using a built-in digital signal processor, it can simultaneously display frequency spectra and associated time waveforms. Then you can automatically save the data to the 20-mega-byte hard disk drive or to a

floppy disk. The display is EGA-compatible, there's a mouse interface, memory is 640K bytes, and there is one serial and one parallel port.

Other features include linear or log scales, windowing, 65-dB dynamic range, programmable gain from 0.256 millivolt to 512 volts, switchable impedance from 50 ohms or 1 megohm, and 128K bytes of waveform memory.

Price: \$6995.

Contact: Rapid Systems, Inc., 433 North 34th St., Seattle, WA 98103, (206) 547-8311.

Inquiry 1148.

Programmer's Paradise (800) 445-7899



Microsoft, the industry trend setter at providing language tools for the software developer has done it again, with three new products to lead the way into the 90's. And Programmer's Paradise, the world's leading source of development software is ready to ship them to you. Call us today to order these and other outstanding Microsoft software products.



Microsoft OS/2 Presentation Manager Toolkit

The Microsoft OS/2 Presentation Manager Toolkit provides a complete set of visually-oriented software tools and documentation to help you develop the next generation of graphical applications for the OS/2 Presentation Manager. Presentation Manager provides a consistent, graphical user interface that makes applications easy to learn and use. The Toolkit includes the software to create and customize drop-down menus, dialog boxes, icons, and fonts that make this intuitive environment possible. Also included is a complete set of reference documentation; QuickHelp, the on-line, context sensitive reference; HelpMake to add to the QuickHelp database; over 3 MB of sample code; and 2 free hours of on-line support.

Microsoft QuickPASCAL

A powerful new implementation of Pascal that provides superior productivity and performance to current Pascal programmers, and also opens the door to object-oriented programming.

The QuickPASCAL compiler and linker are the fastest available for Pascal on a PC, assuring superior performance.

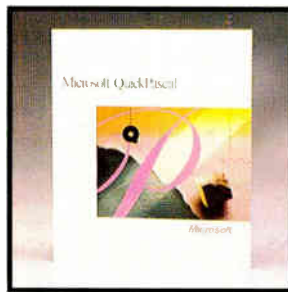

And QuickPASCAL integrates a compiler, editor and debugger into one highly productive, intuitive environment.

Object-oriented programming is expected to be the major programming development of the 1990s. Microsoft's implementation of object-oriented constructs in QuickPASCAL will provide you with an easy, smooth transition into object-oriented techniques.

Microsoft QuickC Compiler with QuickAssembler

Microsoft QuickC Compiler with QuickAssembler is the first product to fully integrate C and assembly language into one seamless environment, giving you maximum power and ease of use. Write and edit source code in C; accelerate speed-critical routines or gain low-level access to your hardware with assembly language; compile, assemble, run, and debug—all within the same integrated software development system. Comprehensive reference guides and innovative on-line learning tools make the two languages and the unique integrated environment easy to master. Two popular languages, one smooth environment—the power of C and the speed of assembler, together at last! Amazing!



THE MICROSOFT PRODUCT LINE

	LIST	OURS
MS BASIC/6.0	295	199
MS C	450	299
MS COBOL	900	599
MS Excel	495	279
MS Excel (MAC)	395	279
MS FORTRAN	450	299
MS Learning DOS	50	40
MS Mach 20	495	329
MS Macro Assembler	150	99
MS Mouse Bus or Serial		
w/ Paintbrush & Mouse Menus	150	99
w/ EasyCAD	175	119
w/ Paintbrush & Windows	200	139
MS OS/2 Presentation Manager Softset	150	105
MS OS/2 Presentation Manager Toolkit	500	329

	LIST	OURS
MS Pageview	50	40
MS Pascal	300	199
MS PowerPoint (MAC)	395	279
MS QuickBASIC	99	69
MS QuickBASIC (MAC)	99	69
MS QuickC	99	69
MS QuickC with QuickAssembler	199	135
MS QuickPASCAL	99	69
MS Sort	195	130
MS Windows/286	99	69
MS Windows/386	195	130
MS Windows Software Development Kit	500	319
MS Word	450	279
MS Word (MAC)	395	279
MS Works	149	99

An Invitation TOO Good To Refuse

You're invited to purchase Vermont Views libraries v.1.1 **NOW**, and receive Vermont Views v2.0 with the Designer **FREE** upon its release. This offer is good only until January 31st, 1990. *Don't be left out of the celebration!*

For more details, see our ad in this magazine.

LIST OURS

BORLAND

Paradox 3.0	725	509
SideKick Plus	200	139
Turbo Assembler/Debugger	150	105
Turbo Basic	100	69
Turbo C 2.0	150	99
Turbo C 2.0 Professional	250	169
Turbo Pascal 5.5	150	105
Turbo Pascal 5.5 Professional	250	175
Turbo Prolog	150	105
Turbo Prolog Toolbox	100	69

CREATIVE PROGRAMMING

VCScreen	149	115
Vitamin C	225	165
for OS/2	345	279
Reference Database	50	CALL

DIGITALK

Smalltalk/V	100	85
Communications	50	45
EGA/VGA Color Extension	50	45
Goodies #1, #2 or #3	50	45
Smalltalk/V 286	200	169
Smalltalk/V PM	500	425

FAIRCORN

c-tree	395	315
w/ r-tree	650	519
CALL	CALL	CALL
w/ r-tree, d-tree	495	395
d-tree	295	239
r-tree		

GSS

GSS*CGM Metafile Interpreter	295	249
GSS*GKS Kernel System	595	519
GSS*GPS Plotting System	395	329
GSS Graphics Devel. Toolkit	595	519
XVT	595	509

IGC

VM/386	245	199
VM/386 Multi-User	895	759
VM/386 NetPak	150	119

MEDIA CYBERNETICS

Dr. HALO III	140	101
HALO	395	279
HALO DPE	195	139
HALO for MS Developers	595	399
HALO for OS/2	695	489
HALO Programmer's Workbook	80	59
HALO Window Toolkit	595	419

MICROSOFT

MS BASIC/6.0	295	199
MS C	450	299
MS COBOL	900	629
MS FORTRAN	450	299
MS Macro Assembler	150	99
MS OS/2 Present. Mgr. Toolkit	500	349
MS OS/2 Softset	150	105
MS Pascal	300	209
MS Programmer's Library	395	275
MS QuickBASIC 4.5	99	69
MS QuickC 2.0	99	69
MS QuickC w/ QuickAssembler	199	135
MS QuickC w/ Mouse	199	99
MS QuickPASCAL	99	69
MS Windows	99	69
MS Windows/386	195	135
MS Windows Development Kit	500	349

MORTICE KERN SYSTEMS

MKS Awk	99	85
MKS Lex and Yacc	249	209
MKS Make	149	129
MKS Make for OS/2	249	209
MKS Programming Platform	665	565
MKS RCS	189	159
MKS RCS for OS/2	395	335
MKS SoftQuad Publishing Sys.	495	469
MKS Software Mgmt. Team	299	255
MKS Toolkit V3.1	249	209
MKS Toolkit V3.1 for OS/2	495	419
MKS Vi	149	129
MKS Vi for OS/2	199	169

NOVELL

Btrieve Single-User	245	185
Btrieve for DOS 3.1 Networks	595	449
Btrieve for OS/2	595	449
Btrieve for XENIX	595	449
C Network Compiler	695	525
C Network Compiler/ 386	995	799
NetWare C Interface for DOS	295	239
NetWare MHS	100	79
NetWare MHS Interface Guide	145	129
NetWare RPC	CALL	CALL
NetWare RPC for OS/2	CALL	CALL
NetWare SQL	595	449
NetWare System Calls for DOS	195	159
XQL	795	599
Xtrieve PLUS	595	459
Xtrieve PLUS for OS/2	595	459

PERISCOPE

80286 Flex Cable Kit	200	179
80386 Flex Cable Kit	400	359
Periscope I/OK	545	459
Periscope I/S12K	795	675
Periscope II	175	129
Periscope II-x	145	109
Periscope III/10 MHz	1395	1179
Periscope III PLUS/OK	1745	1479
Periscope III PLUS/S12K	1895	1595
Periscope IV/16 MHz	1995	1689
Periscope IV/20 MHz	2295	1945
Periscope IV/25 MHz	2595	2195

POLYTRON

C Beautifier	99	89
Personal PVCSS	149	125
Pfinish	395	335
Pfix Plus	395	335
Plink86plus	495	419
PolyAWK	99	85
PolyDoc	199	169
PolyLibrarian	99	85
PolyMake	149	125
PolyXRef	99	85
Professional PVCSS	395	335

SOLUTION SYSTEMS

Brief 3.0	199	CALL
w/ dBRIEF	275	CALL
C-Worthy	195	CALL
w/ forms	295	CALL
w/ forms and source	495	CALL
dBRIEF	95	CALL

WHITEWATER GROUP

Actor	495	429
Language Extensions I	99	85
Whitewater Resource Toolkit	195	169
WinTrieve	395	339

ZORTECH

Zortech B-Tree Tools	80	72
Zortech C	90	79
Zortech C Debugger	90	79
Zortech Pro Screen Tools	70	63
Zortech C Video Course	300	269
Zortech C Windows	70	63
Zortech C++	200	165
Developer's Edition	450	385
Zortech C++ Debugger	150	129
Zortech C++ Tools	150	129
Zortech C++ Video Course	CALL	CALL

PROGRAMMER'S POLICIES

Phone Orders

Hours 9 AM-7 PM EST. We accept MasterCard, Visa, American Express. Include \$4.00 per item for shipping and handling. All shipments by UPS ground. Rush service available.

Mail Orders

POs by mail or tax are welcome. Please include phone number.

International Service

Phone number required with order. Call or fax for additional information.

Dealers and Corporate Accounts

Call for information.

Unbeatable Prices

We'll match nationally advertised prices. (Subject to same terms and conditions.)

Return Policy

30-day no-hassle return policy. Some manufacturer's products cannot be returned once disk seals are broken.

LIST OURS

VERMONT VIEWS

C-PROGRAMMERS! Would you like to double your productivity and have FUN too? Vermont Creative Software has the answer with the imminent release of the Vermont Views Designer.

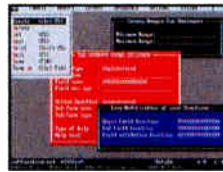

This intuitive, menu-driven, screen generator taps the resources of the 650 pre-coded functions of the Vermont Views libraries. Customize data entry forms, choice lists, menus and more. Our customers around the world will be celebrating this powerful enhancement of Vermont Views. See our ad in this magazine for more details on how you can join the party...and try out Vermont Views with the Designer.

List: \$395 Ours: CALL

TURBO C 2.0

The Turbo C 2.0 optimizing C compiler with the integrated source-level debugger includes the compiler, editor, and debugger.

Turbo C 2.0 is fast, compiling your code better than 16,000 lines per minute! The integrated source-level debugger allows you to set multiple breakpoints, watch variables, and evaluate expressions—all from inside your integrated Turbo C environment.

Other features include: support for six memory models; in-line assembler; automatic dependency checking; and more than 430 optimized functions. The editor even has EMS support.

List: \$150 Ours: \$99

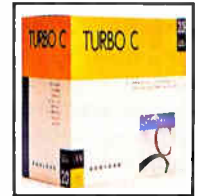

BORLAND

BRIEF 3.0 - The Programmer's Edition

Edit Your Programs More Productively Than Ever Before

The program that set the standard for program editing continues to lead the industry. Introducing BRIEF 3.0. New features include: multiple keystroke macros, a new C-like macro language, a source level macro language debugger for both macro languages, "smart" indenting and template editing for



Solution Systems

Ada, C, Cobol, BASIC, FORTRAN, Modula-2, and Pascal, and the ability to "zoom" your current window to full screen size. You'll also get the features over 50,000 current users have come to rely on: unlimited windows, Undo, compile within BRIEF, a LISP-like macro language, and much more.

List: \$199 Ours: CALL

VM/386 & NetPak Bundle

VM/386, the PC Magazine Technical Excellence Award-Winning multi-tasking product, does wonders on networks working with the new companion product, 386 NetPak. Each one of the multiple DOS sessions running under VM/386 can access network files and printers through the NetPak software. And you can run larger memory-hungry applications such as CAD or Desktop software without ever leaving the network. If you're running on a network, this bundle is a must!

VM/386 List: \$249 Ours: \$199 NetPak List: \$150 Ours: \$119 Together: \$269

IGC

International: 201-389-9228
Customer Service: 201-389-8950

Fax: 201-389-9227

Call or Write for Latest Free Catalog!

1-800-445-7899

Programmer's Paradise

Circle 263 on Reader Service Card

A Division of Voyager Software Corp
1163 Shrewsbury Ave., Shrewsbury, NJ 07702

World Radio History



An MNP Modem for Your Pocket

The latest in a line of pocket-size communications packages, Touchbase Systems' WorldPort 2400/MNP incorporates Microcom MNP Class 5 error correction and data compression in a package that measures 1 by 5 by 3 inches and weighs just 7½ ounces. The company claims it's the smallest (and lightest) MNP-5 modem available.

As with all Touchbase modems, you can power the WorldPort 2400/MNP off a single standard 9-volt battery or from an (included) AC adapter. It's backward-compatible with both Bell and CCITT transmission protocols, and it has an internal speaker as well as LED indicators for high speed, MNP, carrier detect, and low battery.

The WorldPort 2400/MNP is fully compatible with the industry-standard AT command set. And MNP 5 gives you an effective throughput of 4800 bps when you use it to transfer text files. It's also compatible with systems that use MNP Class 4 (without data compression).

The modem includes its own internal nonvolatile RAM, in which you can store two different configuration profiles and four telephone numbers. For on-the-road use where you can't plug the modem into a phone jack, the company offers an acoustic coupler that works with telephone handsets and lets you use the WorldPort 2400/MNP at 300 and 1200 bps.

Price: \$499; acoustic coupler, \$79.95.

Contact: Touchbase Systems, Inc., 160 Laurel Ave., Northport, NY 11768, (516) 261-0423.

Inquiry 1154.

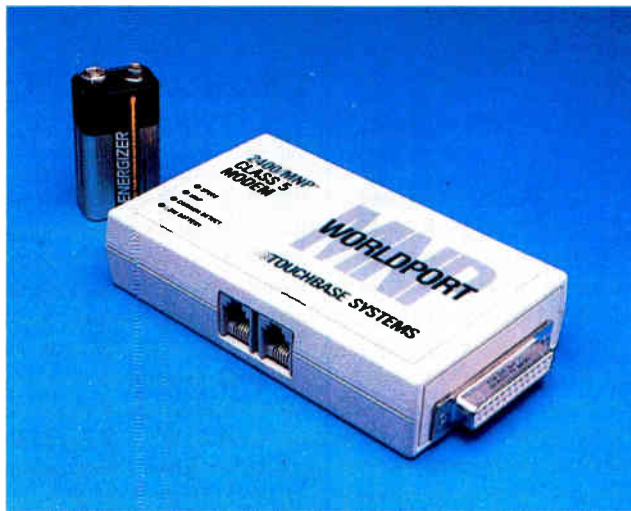

Touchbase Systems' WorldPort 2400/MNP pocket modem features MNP-5 data compression and error correction.

Put a Token Ring in Your Pocket

Xircom, the folks who brought you the first pocket-size stand-alone Ethernet adapter, now has a version for those who need to connect a laptop or desktop computer to an IBM Token Ring network.

Dubbed the Pocket Token Ring Adapter, the compact unit (about the size of a garage door opener) offers you the same plug-in-and-play capabilities of Xircom's Ethernet adapter. Like its brother, the PTR A plugs into any standard parallel printer port. Then you plug in the 4-Mbps Token Ring cabling to the other end. It's particularly useful for

networking if you have a computer without any open expansion slots.

According to Xircom, the PTR A is possible because of Texas Instruments' new two-chip Token Ring chip set, which just became available. The entire PTR A consists of just five chips, including 128K bytes of on-board RAM. The company says it is working on a 16-Mbps Token Ring model and will have a pocket-size ARCnet adapter available in early 1990. Other versions for all major LANs will follow shortly thereafter.

Price: \$795.

Contact: Xircom, Inc., 22231 Mulholland Hwy., Suite 114, Woodland Hills, CA 91364, (818) 884-8755.

Inquiry 1153.

SAA Interface, Security, and WAN Upgrade This Network Scheduler

Network Scheduler provides group calendars and appointment books for network users. The upgraded version, Network Scheduler II, provides a Systems Application Architecture-compatible common user interface and improved security.

Other enhancements include support for cc:Mail,

3Com's 3+Mail, Da Vinci Systems' MHS Link, and Consumer Software's Network Courier.

Price: Eight-user, \$495; 25-user, \$695; 50-user, \$995.

Contact: Powercore, Inc., One Diversatech Dr., P.O. Box 756, Manteno, IL 60950, (815) 468-3737.

Inquiry 1158.

Toshiba Makes the Mac Connection

Toshiba's new software program, MacMatrix, lets you hook your Mac to one of Toshiba's 24-pin letter-quality printers.

The software comes with a cable that connects a Toshiba SL or SX printer to a Mac Plus, SE, SE/30, II, IIcx, or IIx with System 6 or higher.

The driver supports four scalable outline fonts (Courier, Helvetica, Symbol, and Times Roman) in point sizes from 6 to 127, according to Toshiba. The driver also supports bit-map fonts and object-oriented graphics.

Price: \$49.

Contact: Toshiba America Information Systems, Inc., Computer Systems Division, 9740 Irvine Blvd., Irvine, CA 92718, (714) 583-3000.

Inquiry 1155.

Create a Menu

LAN system administrators can use Perfect Menu 2.0 to create a different menu for each person on the network.

International Computer Group says that the LAN version works with all NetBIOS-compatible LAN operating systems. The basic single-user program lets you customize your menu.

Perfect Menu runs in non-resident mode, even when you use E-mail, usage tracking, and screen blinking.

Price: Basic single-user, \$49.95; business single-user, \$84.95; five-user, \$195.95; unlimited users on one file server, \$349.95.

Contact: International Computer Group, Inc., 18520 Office Park Dr., Gaithersburg, MD 20879, (301) 670-7007.

Inquiry 1157.

continued

GO AHEAD, MAKE YOUR DAY

Point-and-Pick Your Applications

Choose the application you need quickly and easily directly from the menu—or even another application!

Run Several Tasks at Once

Switch instantly between active tasks in different applications at the touch of a keystroke!

Move Data Between Applications

Share data easily between applications like SCO™ Lyrix,® SCO Professional,® and SCO Integra™ with the electronic Clipboard!

Print While You Work

Move on to your next job while your last one is printing out—on a local or shared workgroup printer!

Link Up Your Business with Electronic Mail

Exchange messages and files—even spreadsheets and graphics—across the office or around the world!

Talk Across The Office

Instantly converse with other system users, screen-to-screen, with the handy Intercom!

Locate Business Contacts Instantly

Store, update, find, and sort addresses and phone numbers quickly and easily with the time-saving Directory!

Schedule Meetings and Resources

Check others' Calendars online for available times—then schedule and notify them automatically!

Calculate Within Any Application

Put the four-function, "running-tape" capabilities of an online Calculator right at your fingertips!

Add Only the Applications You Need

Build your own customized solution by adding individual applications as you need them!

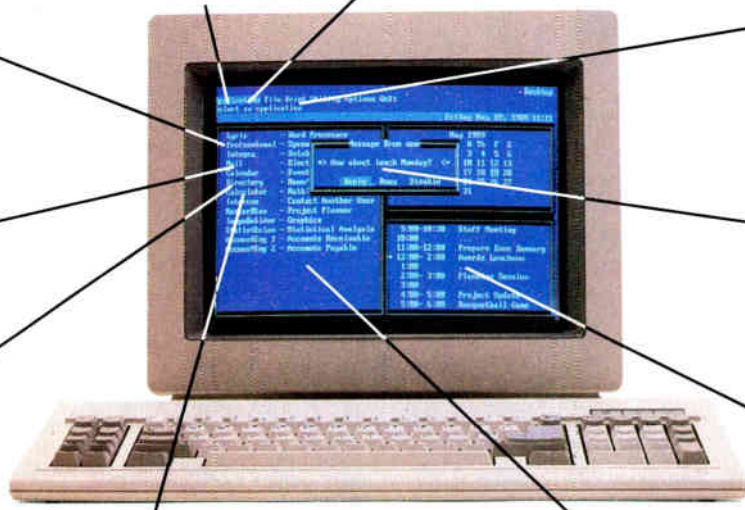

WITH THE SCO PORTFOLIO WORKGROUP SOLUTION

Get the competitive edge with the SCO Portfolio™ integrated workgroup solution!

Teamed with the world's most popular UNIX® System—SCO System V—the SCO Portfolio solution turns the 386™ personal computer into a workgroup powerhouse.

What's more, users only need to know how to use their familiar applications in order to put the amazing power of the UNIX System to work immediately.

With SCO Portfolio and the SCO Portfolio family of business applications, everyone in a workgroup can perform virtually any business task—from writing reports and creating financial analyses, to scheduling meetings and exchanging messages—far more productively than ever. And all using a single, standard—and cost-effective—386-based PC!

Get started today with SCO Portfolio Suite, and get all the advantages of a fully-integrated office system without compromising the functionality of full-featured business applications—all in one economical package.

SCO Portfolio Suite integrates the powerful SCO Lyrix word processing system, the SCO Professional 1-2-3® workalike, and the SCO Integra industry-standard-SQL database, with SCO Portfolio's convenient desk-top tools, customizable menu system, and electronic clipboard—and lets you add any other software of your choice under its easy-to-use menu, as well.

Contact your SCO authorized supplier or call (800) 626-UNIX (626-8649) for more information about SCO Portfolio and SCO Portfolio Suite and find out how easy it is to make your day—today!



(800) 626-UNIX (626-8649)

(408) 425-7222

FAX: (408) 458-4227

E-MAIL: ...!uunet!sco!info info@sco.COM

Persoft Emulates VT320 and VT240

Persoft introduced a network version of its VT320 text terminal emulation software package and version 3.0 of its multiuser DEC VT240 graphics terminal emulator. Both are also available in single-user versions.

Both SmarTerm 240 and SmarTerm 320 provide customized setups for each user and support any number of nodes. Supported networks include Novell's NetWare, Banyan's VINES, DECnet DOS, IBM LANACS, and 3Com/Bridge's Etherterm.

SmarTerm 320's emulation capabilities include downloadable characters used by WordPerfect and Oracle, 132-column text screens, and double-high, double-wide characters. A background mode allows file transfer and other emulator tasks while you're in your DOS application. To help you use DEC keyboard functions on a standard IBM

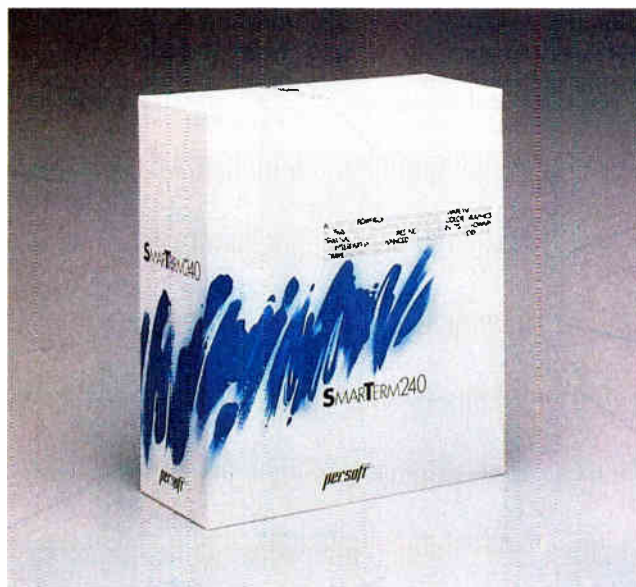

SmarTerm 240 version 3.0 is a multiuser DEC VT240 graphics terminal emulation package with LK250 keyboard support.

PC keyboard, Persoft included a WordPerfect driver and extended keyboard remapping.

SmarTerm 240 also includes LK250 keyboard support with this latest update. It now supports all of DEC's VT240 ReGIS graphics command language, permitting a full-screen display of a

ReGIS image on VGA, EGA, CGA, and Hercules systems.

Both SmarTerm 240 and 320 are priced in single-user versions, five-user versions, and add-on kits for five additional users.

Price: 320 individual package, \$195; 320 file server, \$895; file server add-on kit, \$550; 240 individual package,

\$345; 240 file server, \$1495; 240 file server add-on kit, \$995; trade-up from SmarTerm 220 to 320, \$97.50.

Contact: Persoft, Inc., UW Research Park, 465 Science Dr., Madison, WI 53711, (608) 273-6000.
Inquiry 1161.

Modem Mail, Phone Home

Modem Mail is a NetBIOS-compatible program that lets you use a modem to send and receive E-mail messages to and from your office LAN.

Modem Mail 2.0 supports 9600-bps (V.32) telecommunications—twice the speed of version 1.0.

On your remote IBM PC, you'll need at least 256K bytes of RAM, a modem, and a copy of Modem Mail 2.0. On your dedicated LAN workstation that receives calls from Modem Mail 2.0, you need a modem, the base E-mail package called Network Courier 2.0, and Modem Mail Postoffice software (which provides administrative functions like a regular post office).

One other enhancement to Modem Mail 2.0 is the function of Mailbag Maintenance, the company says. This lets you pick from all your messages the ones you want to download. Early next year, the company promises to have a package for Macintosh connectivity.

Price: Network Courier 2.0 and Modem Mail Postoffice, \$1490; Modem Mail 2.0 remote-user software for each node, \$95.

Contact: Consumers Software, Inc., 603-73 Water St., Vancouver, BC, Canada V6B 1A1, (604) 688-4548.
Inquiry 1164.

continued

Manipulate Database Files Locally, Remotely, or Both Simultaneously

Record-Trans 2.0 allows you to use a modem or a LAN for querying remote dBASE III or IV, Clipper, or FoxBASE database files and transferring specific database records rather than entire files.

Once you receive the files, at rates between 300 and 9600 bps, the modem version of Record-Trans lets you send back multiple records to multiple database files, thus upgrading several database files at once. Upgrading multiple databases in multiple remote locations is the next step. And with an Advanced Editor function, you can create batch files that both connect and update

many remote database locations without database operator intervention. Record-Trans also has log files to time-stamp activities in the systems.

The LAN version is compatible with any NetBIOS-compatible network like Novell's NetWare, Banyan's VINES, 3Com's 3+ and 3+Open, and so on. It has a Record Locking function that allows multiple users on your LAN simultaneous access to the database.

Both the modem- and LAN-compatible versions of Record-Trans allow simultaneous access to remote and local databases, with simultaneous display in two win-

dows on your screen. With this function, you can add, delete, and update records to the two databases at the same time. You can also cut and paste between the two databases.

Specific system requirements include MS-DOS 3.0 or higher, 512K bytes of RAM, a serial adapter, and a Hayes-compatible modem or NetBIOS-compatible network operating system.

Price: Modem version, \$250 per node; LAN, \$499.

Contact: Database & Datacom Solutions, 3611 South Harbor, Suite 215, Santa Ana, CA 92704, (714) 434-1000.

Inquiry 1156.

Now you can use old friends to access corporate data.

There you are cranking along at your desktop. Then it happens. You realize you need some critical data that resides on your mini or mainframe.

And you can't get it.

Unless of course you've got ORACLE®. For the first time PC and Macintosh users can access ORACLE and IBM® data from any of their favorite desktop applications.

You can query and update data on ORACLE, DB2™ and SQL/DS databases, using the applications you know and love, including Lotus 1-2-3®, 4th Dimension®, Hypercard™, Supercard™ and dBASE III Plus™. Your entire company's wealth of information is available immediately. Without leaving the desktop.

With ORACLE for Macintosh®, you'll be using one of the most popular user interfaces to access corporate data. Give it a test run with the Developer's Version for just \$199.

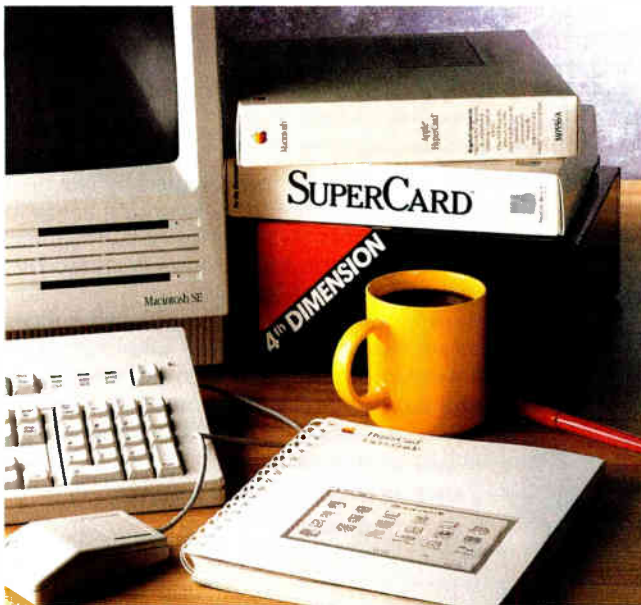

Or, you can have the Full Networking Version for only \$999. If you're a 4th Dimension user, consider ORACLE for 4th Dimension, the easiest way to access corporate data through familiar 4D applications. Also \$199.

On the PC use ORACLE for 1-2-3 for complete access to SQL databases from your familiar 1-2-3 interface. Or ORACLE dBaseXL, for giving dBASE III Plus applications access to your ORACLE and DB2 databases. Each for only \$299.

Give one of these ORACLE products a try for 30 days. Then, if you're not happy, send them back and we'll send you a full refund.

If you're not ready to give up on your old friends, there's only one thing to do. Call 1-800-ORACLE 1, ext. 4963 now. And enter the computing environment of the 90s.

ORACLE®
Compatibility • Portability • Connectivity

Copyright © 1989 Oracle Corporation. ORACLE is a registered trademark of Oracle Corporation. Macintosh is a registered trademark of Apple Corporation. Hypercard is a registered trademark of Apple Corporation. Supercard is a trademark of Silicon Beach Software Corporation. 4th Dimension is a registered trademark of Aclis Corporation. DB2 is a registered trademark of International Business Machines. OS/2 is a registered trademark of Microsoft Corporation. Lotus and 1-2-3 are registered trademarks of Lotus Development Corporation. dBASE is a registered trademark of Ashton-Tate Corporation. dBaseXL is a registered trademark of Oracle Corporation. Prices valid in U.S. only. ORACLE for Macintosh, \$199: Stand-alone version licensed for developers only. Requires Macintosh SE or II with 2MB of RAM, 5MB hard disk space, floppy disk drive, and Hypercard 1.2. Includes 30-day installation support, ORACLE database, Hyper*SQL (HyperCard Interface), SQL*Plus, OCI and Pro*C (Macintosh Programmer's Workshop required for programming usage), System Stacks and Example Stacks. ORACLE for Macintosh, \$999: Full networking version is \$999 and includes SQL*Net (for database communications) Async, DECnet, TCP/IP support, Aclis System's TSSnet DECnet protocol and drivers and Kinetic's TCPPort TCP/IP protocol handler and gateway software for the other machine. ORACLE for 1-2-3, \$299: Requires an 80286/80386 running DOS 3.0+ and Lotus release 2.01 or 2.2, 640KB of RAM plus either 1MB of extended memory or the reassignment of 1MB of expanded memory. Connectivity option with networking software starts at \$395. dBaseXL requires a XT PC with 640KB of RAM. Accessing remote systems requires database and networking software on host computer.

SAMSUNG/NOVELL

PCterminal/286

SAMSUNG/NOVELL

PCterminal/286

SAMSUNG/NOVELL

PCterminal/286

SAMS

PCterminal

SAMSUNG/NOVELL

PCterminal/286

SAMSUNG
386AE FILE S

How to plan your LAN.

You'll need a pencil.

That's to write down the telephone number on the next page. Which will connect you with Samsung's nationwide network of resellers. And the Samsung/Novell co-labeled line of LAN hardware.

It's pretty much that simple.

With one call you can plan on substantial savings over the big name computers which, despite high clock rates and even higher price tags, are not really optimized for networking.

And you can plan on 100 percent compatibility with all versions of Novell's NetWare,[®] because Samsung's LAN hardware was co-designed by Novell. Just like the label says.

THE TESTING WENT IN BEFORE THE LABEL WENT ON.

Both the Samsung 386AE and PCterminal/286 have

been tested exhaustively and certified by Novell for compatibility with all popular networking hardware and software products. As a matter of fact, Samsung's 386AE is one of 3 file servers certified by Novell to run NetWare 386.

For example, engineers at Novell successfully tested the PCterminal/286 LAN Workstation in no less than 1200 different network configurations... with 50 units running at once! That's a claim no other computer manufacturer can make.

NETWORKING VS. NOTWORKING.

What's the difference? Take our 386AE Fileserver, for instance. It includes Novell's Advanced BIOS, and eight expansion slots to accommodate multiple network interface cards and disk controllers. Plus an oversize power supply capable of driving dual high capacity hard disks and tape



SAMSUNG/NOVELL

PCterminal/286

SAMSUNG/NOVELL

PCterminal/286

SAMSUNG/NOVELL



SAMSUNG/NOVELL

PCterminal/286



SAMSUNG/NOVELL®

PCterminal/286

SAMSUNG/NOVELL®
SERVER

back-up system. Plus 4 megabytes of main memory for disk caching.

Then there's Samsung's PCterminal/286 Diskless Workstation which includes a built-in Ethernet interface and Novell's Remote Boot EPROM.

And not to be overlooked is our 16-bit SE2100 Ethernet Interface Card which provides up to twice the throughput for the price of an 8-bit card.

THE SAMSUNG COMMITMENT.

With 4 million monitors and half a million PC and LAN computers sold in 1988 alone, it's clear that Samsung has made a serious commitment to the marketplace. In all, Samsung offers no less than nine different PC and LAN computer models with seventeen color and monochrome monitors! And, as a 31-billion dollar international corporation, Samsung has the resources to provide continuous support for its customers.

So why not begin your network planning today? For the name of the Samsung reseller nearest you, write:

SAMSUNG, 3655 North First Street, San Jose, CA 95134, or call 1-800-446-0262.



SAMSUNG

Circle 287 on Reader Service Card (DEALERS: 288)

Smalltalks for PM and the Mac

Digitalk's latest Smalltalks offer object-oriented programming for Presentation Manager and the Macintosh environments. Smalltalk/V PM, a development environment for OS/2's Presentation Manager, gives you access to PM features such as Dynamic Data Exchange and Dynamic Link Libraries, letting you integrate and pass data to and from PM tools and other applications. Most important, it compiles incrementally to machine code, giving immediate notice of an error.

Smalltalk/V Mac 1.1, an upgrade of the Mac version, now includes a facility for returning an error code immediately upon failure, the company reports.

Digitalk claims that the Smalltalk/V PM source code is compatible with Smalltalk/V 286 and Smalltalk/V Mac, allowing you to port applications among the different environments. No runtime fees are associated with the PM version.

Smalltalk/V PM requires an IBM PC AT with OS/2 1.1 or higher and PM. Smalltalk/V Mac 1.1 runs on the Mac Plus.

Price: \$499.95; Smalltalk/V Mac, \$199.95.

Contact: Digitalk, Inc., 9841 Airport Blvd., Los Angeles, CA 90045, (213) 645-1082.

Inquiry 1116.

Expert System Under X Window

Knowledge Craft, the advanced toolkit for building expert systems, will soon be available running under the X Window System on the MicroVAX II and Sun worksta-

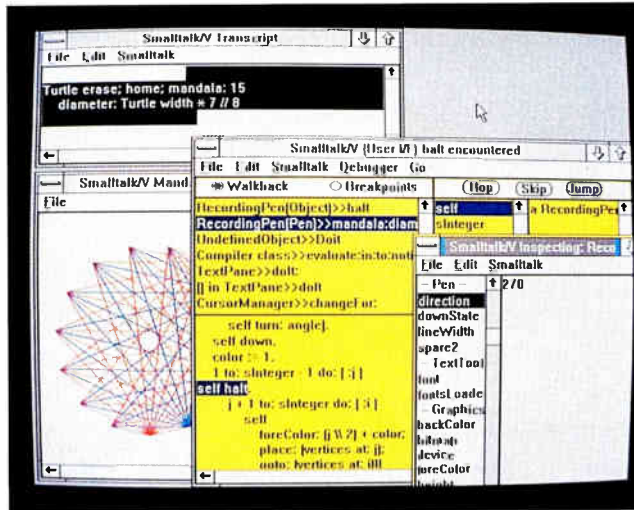

Smalltalk/V PM in action, debugging a drawing and stopping after each iteration.

tions, Carnegie Group reports. In addition to running under X Window and providing greater portability to other systems running under X Window, Knowledge Craft 4.0 will feature an object-oriented programming system and an Interface Development System (IDS) with graphics and a rapid prototyping capability. Carnegie Group reports that the new prototyping methodology is a shell that will let you develop knowledge-based applications more rapidly.

Carnegie Group also released KC Prime, which uses the basic components of Knowledge Craft (including the Carnegie Representation Language, its Workcenter, and the IDS) for developing knowledge systems that require representation support but may not need rules.

To develop a system with Knowledge Craft, you'll need about 16 megabytes.

Price: Knowledge Craft, between \$16,000 and \$36,000; KC Prime, between \$8000 and \$16,000.

Contact: Carnegie Group, Inc., Five PPG Place, Pittsburgh, PA 15222, (412) 642-6900.

Inquiry 1119.

Lattice Adds Numerous Features to Its C Compiler

Besides full compatibility with both DOS and OS/2, Lattice says version 6.0 of Lattice C includes major compiler enhancements, a global optimizer, new programming utilities, and many new library functions.

The company claims that the package has better performance than Microsoft's or Borland's versions of C. The better performance, according to Lattice, results from the new global optimizer, automatic register variable support, in-line function support, and optimized libraries.

The Lattice C development system now includes LASM, a new macro assembler that has special support for 80386-based systems. Lattice says it's compatible with MASM (Microsoft's assembler). LASM's output is compatible with CodeProbe (included with 6.0), so that you can debug assembly language programs at the source level.

New utilities with version 6.0 include an overlay linker, a Make utility, an LBIND utility, and several "Unix-like" tools, including EXTRACT, BUILD, DIFF, GREP,

SPLAT, TOUCH, and WC (word count). The company says that Lattice C works with DOS 2.0 and higher and all versions of OS/2.

Price: \$250; upgrade from version 3.4, \$90; upgrade from version 3.3 or lower, \$115.

Contact: Lattice, Inc., 2500 South Highland Ave., Lombard, IL 60148, (800) 444-4309 or (708) 916-1600. **Inquiry 1117.**

Create Expert Systems Under Windows

Kappa is a programming environment that you can use to simulate real-world situations and solve problems in business, science, and engineering. The program provides a library of more than 200 functions and supports three techniques for knowledge representation and reasoning: functional programming, object-oriented programming (OOP), and rule-based reasoning.

All three techniques are integrated in Kappa. You can invoke rules through functions and methods, send messages from functions and rules, and so on. The program also includes a set of tools for representing problems in graphical terms.

Kappa runs under Microsoft Windows on the IBM PC AT or higher with 640K bytes of RAM and a hard disk drive. By the time you read this, a Macintosh version should be available. A Unix version running under X Window should be available in the first quarter of 1990.

Price: \$3500.

Contact: MegaKnowledge, Inc., One Kendall Sq., Building 600, Second Floor, Cambridge, MA 02139, (617) 494-9234.

Inquiry 1118.

continued



QNX[®]

The OS for over-achievers[™]

QNX programmers have a decided advantage.

You see, people who use QNX enjoy the freedom that comes only with a flexible, modular OS. They appreciate the elegance of a **message-passing architecture**. And they marvel at the fact that QNX runs so lean — under 150K — yet out-performs any other PC operating system.

QNX users never worry about whether their applications will make it at runtime, because they know QNX has proven itself again and again in the real world.

It's no wonder that QNX users have achieved so much since the product was first released for the PC in 1982: over 80,000 systems installed in 47 countries world-wide, in all kinds of applications — from making cars to selling books to handling online credit card transactions.

One reviewer dubbed QNX "The multi-everything OS." Now, you might expect

multiuser and multitasking, but realtime? *And* integrated networking? *And* true distributed processing? Best of all, these terms take on a new meaning with QNX.

Multiuser, for instance, means up to 32 terminals per micro. **Multitasking** cashes out as 150 tasks per machine.

Realtime means not only priority-driven, preemptive task scheduling, but also speed: at 6,896 task switches/sec on a 16MHz 286, QNX is at least a full order of magnitude faster than a typical UNIX system. **Integrated networking** means you won't need yet another layer of software to set up a LAN, and you can use *any mix* of Intel-based micros — from vintage '81 PCs to PS/2s.

Distributed processing with QNX sounds too good to be true. But it is: *Any task can access any resource* — programs, files, devices, even CPUs — without going through the bottleneck of a central file server.

Besides the satisfaction that QNX developers get from using a fast, powerful, and flexible OS, did we mention that they also enjoy *free technical support*?

If you're wondering why you don't already know all about this great OS, you could try asking the over-achievers who are smugly guarding the secret of their success.

Better yet, give us a call. We'll tell you everything you need to know to become an over-achiever yourself.



For more information or a free demo disk, please phone (613) 591-0931.

Quantum Software Systems Ltd., 175 Terrence Matthews Crescent, Kanata, Ontario, Canada K2M 1W8
QNX is a registered trademark of Quantum Software Systems Ltd. UNIX is a registered trademark of AT&T. PS/2 is a registered trademark of International Business Machines Corporation. © 1989 Quantum Software Systems Ltd.

World Radio History

Circle 275 on Reader Service Card

Utility Eases Database Access for WordPerfect Users

Unless you have an integrated word processor and database product like Symphony or Microsoft Works, the everyday business task of linking data from databases to word processor-generated documents can get complicated. You have to insert the appropriate merge codes in your document and then extract the correct data from the database and dump it into a correctly delimited ASCII file.

Perfect Complement 2.0, a WordPerfect accessory, automates the database merge process between dBASE, Paradox, Lotus, R:base, and Symphony databases and WordPerfect documents. When used on an IBM PC with the Intel Connection Co-Processor Board installed, the program supports fax-merge operations. The company has also introduced a version that works with Oracle databases.

Perfect Complement provides a simple menu-driven system for defining merge fields and selection criteria, and for prompting you to enter appropriate data values in the form letter. The interface allows you to create libraries of documents that automatically access the specified database. You can attach conditions (such as an overdue date or insufficient funds value) so that only those records satisfying the conditions are merged into the document.

Price: \$149.95; Oracle version, \$295.

Contact: Perfect Complement Corp., 4979 Mercantile Rd., Baltimore, MD 21236, (800) 444-9544 or (301) 256-2000.

Inquiry 1101.

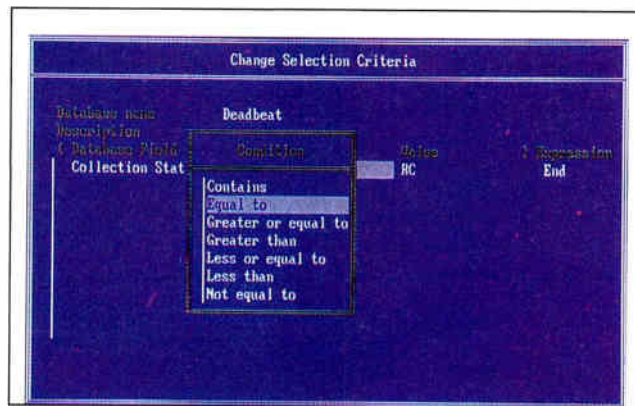

Perfect Complement, showing its external database reference.

Data in and out of Lotus 1-2-3 Without the Hassle

A program called RoundTrip can help you get data in and out of Lotus 1-2-3 by creating worksheets from ASCII- and dBASE-formatted reports and Symphony worksheets. The program can convert and update multiple worksheets into one worksheet and vice versa, Circle Systems reports.

With RoundTrip and a communications program, you can move data from any mainframe report file into a worksheet, complete with working formulas to perform what-if forecasting. You set up the process just once with a few lines of simple code.

RoundTrip can read a payroll file, insert names and pay rates into the model, produce sum formulas, and construct

separate worksheets or a single worksheet with subtotals for each division. Since you don't have to reenter data by hand, the program speeds up your work, and your data is transferred without errors.

RoundTrip works with columnar or delimited ASCII and supports Novell, DCA, Attachmate, Walker Richler Quinn, IBM, and Sun file transfer programs. It runs on the IBM PC with 256K bytes of RAM, Symphony, dBASE III or higher, and any version of 1-2-3 up to release 2.2. Circle expects to provide an upgrade to release 3.0 free of charge by the end of the year.

Price: Standard version (up to 12 worksheets at once), \$195; unlimited spreadsheets, \$695.

Contact: Circle Systems, 10001 Fourth Ave., Suite 3200, Seattle, WA 98154, (800) 456-4451 or (206) 682-3783.

Inquiry 1102.

Contact Database with Branched Scripts

LetterMaster Advanced is a customizable contact management database with a scripting system that lets you follow on-screen scripts during a sales phone call or presentation. The scripts are branched, allowing you to call up a response to any question raised during the presentation. According to Dilg Publishing, the number of branches you can create is limited only by available system memory.

LetterMaster Advanced's File Browser is dBASE-compatible and displays records in a table layout. Other features include contact record keeping, free-form notes with date and time stamping, an auto-dialer, a text editor and word processor, expense tracking, and a library of letters.

LetterMaster Advanced is available in a five-user LAN pack. The program runs on the IBM PC with DOS 3.0 or higher, a hard disk drive, and 640K bytes of RAM.

Price: \$495; LAN version, \$395.

Contact: Dilg Publishing, P.O. Box 110216, Arlington, TX 76007, (800) 338-9181 or (817) 860-0155.

Inquiry 1103.

continued

Time Management Hits Presentation Manager

Instead of conventional calendars and to-do lists, Active Life, a time management system for OS/2, flows all task and appointments into daily schedules. TimeStar Systems claims that this "dynamic system" is a far better method of planned sequencing and time allocation than conventional methods.

Additional features in-

clude alarms, week-at-a-glance pop-up calendars, historic archiving, and a companion database manager. This graphics and text database has auto-sorting, title/text searching, automatic telephone dialing, and a built-in word processor. You can also place graphics or scanned images alongside notebook text.

Active Life is a port of the Windows version, known previously as TimeStar 2.0, and requires an IBM PC AT with OS/2 1.1 or higher.

Price: \$199.

Contact: TimeStar Systems, 1803 Mission St., Suite 8, Santa Cruz, CA 95060, (800) 326-4391 or (408) 983-4930.

Inquiry 1106.

NEW Slot Card Systemizer SC!

Systemizing The truly universal LAN alternative...

The Systemizer SC - features memory resident printer controller, spooling, E-Mail and file transfer. For all MS-DOS® PC's and compatibles.

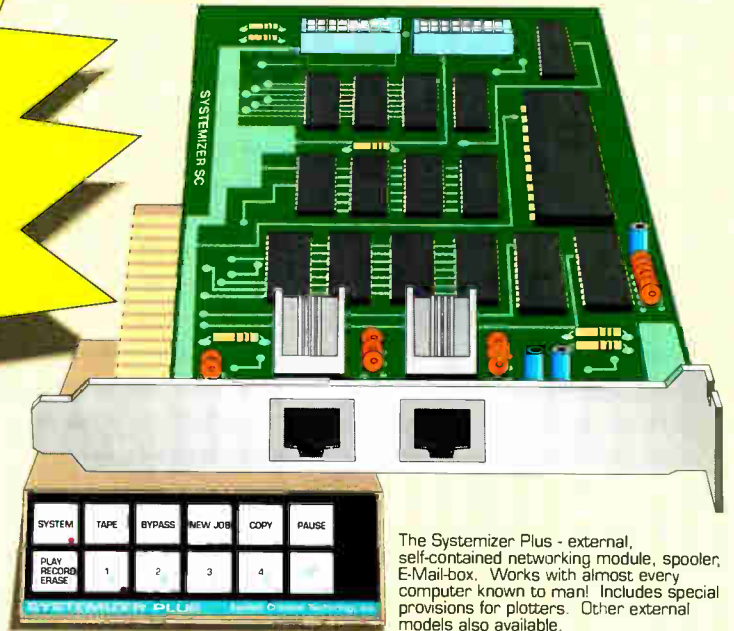

The Systemizer Plus - external, self-contained networking module, spooler, E-Mail-box. Works with almost every computer known to man! Includes special provisions for plotters. Other external models also available.

Up to 31 users can...

- Share Printers
- Share Plotters
- Share a Modem
- Exchange E-MAIL
- Transfer Datafiles

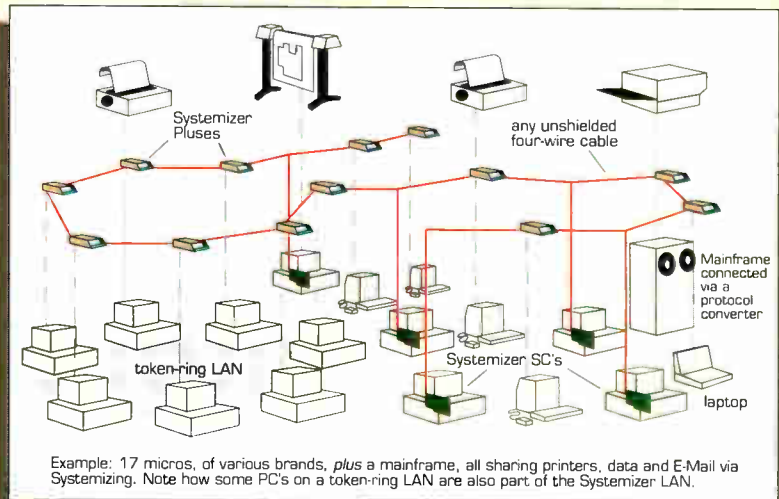

Systemizing has become the connectivity standard at many of the world's largest corporations and throughout the federal government. Ten's of thousands are already in use. The new Systemizer SC is the latest model in Applied Creative Technology's line of Systemizing products, and it delivers what 95% of corporate computer users want from a Local Area Network— at far less cost and complexity, and yet with much more versatility.

Corporate computing managers prefer Systemizing over other connectivity methods because it offers:

- Guaranteed software/hardware compatibility.
- Ability to mix PC's, LAN's, mainframes, laptops.
- Easy owner installation. Low cost cabling.
- 5 min. user training with no support needed after.
- Flexibility; readily accomodates growth and changes.
- Distributed processing for high speed and reliability.

And with the new SC, everyone can afford to Systemize!

**Call 1-800-433-5373
to get a FREE demo!**

The **CONNEXPERTS**SM
A Division of Applied Creative Technology Inc.
8333 Douglas Ave., Suite 700
Dallas, Texas 75225 U.S.A.
(214) 739-4200



Computer

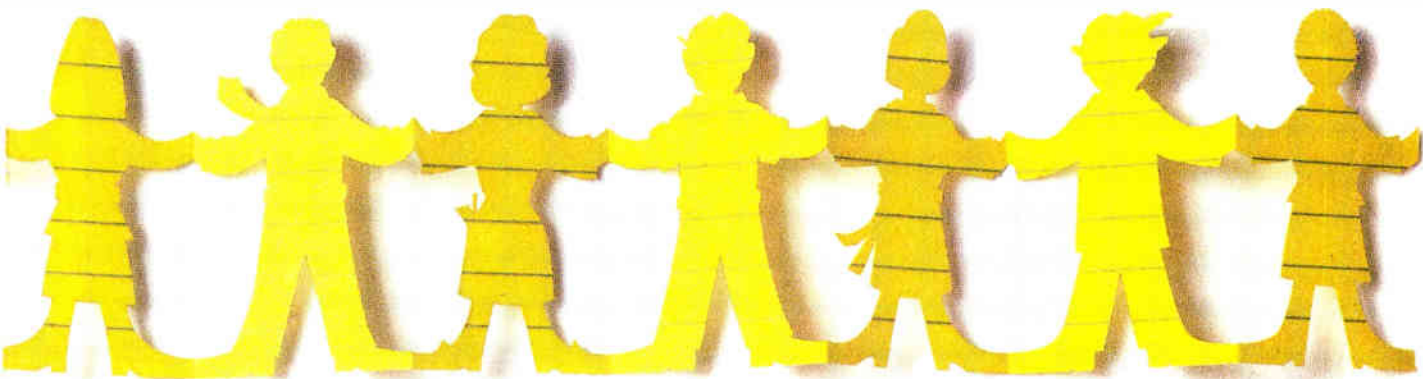

networking that's simpler than ever. OS/2 can do!

Seamless connectivity. Every business wants to have it. And every business will sooner or later experience the limitations of trying to achieve it with DOS. But OS/2[®] Extended Edition (EE) was designed for connectivity and simplifies it by providing the flexibility you need today and well into the future.

Right now, you may only want to share a laser printer on a LAN configured with Token-Ring or PC Network. With OS/2 EE and OS/2 LAN Server, it's simple. Later, when you need to do more, like access a mainframe computer, a different host or an Ethernet network, you can. OS/2 EE has these functions and more built in so you don't need all the extra communications software you needed under DOS.

Best of all, when you combine OS/2 EE with IBM's Micro Channel[™] and its interrupt-handling capability, you can run several communications sessions at once—without sacrificing reliability, even during peak load conditions.

Want to make the most of your computer networking? With OS/2 EE, the solution is IBM. And it's simpler than ever.

To find out more about OS/2, contact your IBM Authorized Dealer or marketing representative. For a dealer near you, call 1 800 IBM-2468, ext. 197.

Choose OS/2 now and get rebates on memory and software. Also get a free upgrade to Version 1.2 until December 31, 1989.



WE COULDN'T HAVE SAID IT BETTER...

"Microstat-II: Speed and More

I have used statistical packages since the bad old mainframe days, and I now own and regularly use six microcomputer stat packages, one of which is Ecosoft's Microstat-II. If Microstat-II had been my first stat package, the other five would have belonged to somebody else.

Do you want speed? Microstat-II is a racehorse that makes the highly touted [name deleted] look like a Clydesdale. Do you want coverage? Microstat-II provides you more tools at less than half the competition's price. Do you want to see a very nice and easy-to-use menu system? If you've used Lotus 1-2-3, you will find Microstat-II's menu bars to be very simple. Do you want to see some nice file structures? Take a look at Microstat-II."

Peter Robb
Review Responses
InfoWorld, Aug. 28, 1989

"Installation of Microstat-II is simple... The user interface is clean... a pleasant package to use..."

PC Magazine

"... one of the fastest IBM-PC statistical packages we have tested... using Microstat-II is a breeze."

InfoWorld

When it comes to ease-of-use, accuracy, and speed, Microstat-II is the statistics package of choice for IBM-PC's and compatibles. For more information, call or write:



Ecosoft Inc.
6413 N. College Ave.
Indianapolis, IN 46220
Orders: 1-800-952-0472
Tech. Info: 1-317-255-6476
FAX: 1-317-251-4604



ECOSOFT

WHAT'S NEW

CAD AND GRAPHICS



To create this image, StrataVision 3d imported a DXF wire-frame file. The camouflage is from a two-dimensional PixelPaint map that was wrapped around the body.

3-D Graphics Program Uses 32-Bit Color QuickDraw

The StrataVision 3d graphics program works with 32-Bit Color QuickDraw and lets you import objects from CAD and paint programs, add objects from an image database, and use rendering techniques to create images with the quality of a photograph, Strata reports.

One of the program's graphics techniques, extrusion, lets you push a two-dimensional graphic through space to create a three-dimensional object. The program's rendering modes include wire-frame, flat shading, Gouraud shading, Phong shading, and ray tracing. You can rotate, stretch, and scale three-dimensional objects.

StrataVision 3d imports DXF, IGES, Super 3D, Swivel 3D, PICT, Encapsulated PostScript, and MiniCAD+ files. The program exports PICT and TIFF files. Attribute and object libraries will also be available, says Strata.

To run StrataVision 3d, you need a Mac II, IIx, IIcx, or SE/30 with 2 megabytes of RAM, a hard disk drive, System 6.0.3, and 32-Bit Color QuickDraw.

Price: \$495; attribute library, \$89; object library, \$150.

Contact: Strata, Inc., 249 East Tabernacle, Suite 201, St. George, UT 84770, (801) 628-5218.
Inquiry 1121.

Built-in Scanner Control with PC Paintbrush IV Plus

PC Paintbrush IV Plus, ZSoft's newest version of its program for creating and retouching images, provides built-in scanner control, support for large images, and expanded and extended memory support. The program supports black-and-white, gray-scale, and color scanners, and if you use more than one scanner, you can save separate configuration files for each one for future use.

A prescan option lets you scan a full page at low resolution and select the portion of it that you want to scan at high resolution.

The program runs on the IBM PC with 640K bytes of RAM, DOS 3.0 or higher, a drawing device, and a hard disk drive.

Price: \$199.
Contact: ZSoft Corp., 450 Franklin Rd., Suite 100, Marietta, GA 30067, (404) 428-0008.
Inquiry 1124.

continued

X-BANDIT

Break the 640K DOS barrier and utilize the Advanced Features of the LIM 4.0 standard while using only one motherboard slot



DESIGN PHILOSOPHY

- The Teletek X-Bandit was specifically designed to utilize the advanced features of the Lotus/Intel/Microsoft EMS 4.0 Specification. Further, the X-Bandit's Segmented Memory Mapping capability allows the user to extend DOS size beyond the 640K barrier. It is available in both 8 and 16 bit versions for use in the IBM XT, AT, and compatible.

MEMORY

- Segmented Memory Mapping allows the user to fill out unused memory segments between 640K and 1024K. By "claiming" unused portions of memory in 16K increments, the user effectively increases TPA size. LAN or custom software modules, for example, can be loaded into these high memory areas thus relieving the lower 640K of TPA for other application programs.
- Split Memory Addressing allows the user to fill out conventional memory to 640K.
- Extended Memory Addressing is available for the PC/AT version.
- 2 Mb capacity in a single slot. Up to 8 Mb/system.
- Parity checking.

SOFTWARE

- Easy menu-driven auto configuration software.
- Device driver includes print spooler and RAM drive.
- Supports multitasking with the appropriate shell-resident software package.

SPEED

- 6/8/10 MHz speed with 0 wait states. 12 MHz speed with 1 wait state.

WARRANTY

- One year parts and labor.
- Now includes SYSTEM SLEUTH™ from DTG, Inc. A \$149 value.

TELETEK
4600 Pell Drive
Sacramento, CA 95838
(916) 920-4600
Fax (916) 927-7684

**MICROVITEC COLOR
DISPLAYS WORK EXTREMELY
LONG HOURS UNDER
DEMANDING CONDITIONS.**

Day in, day out, around the world, you'll find our range of color monitors and terminals hard at work. From the factory floor to the financial office, we've got what it takes to meet your demanding applications.

Microvitec's commitment to quality and reliability is found in every detail.



The highly proven Microvitec 20" Auto-Scan monitor is available in desktop, rack mounted and open frame packaging.

Every component, every assembly, every one of the quality assurance tests we perform during manufacture is dedicated to displaying the bright, crisp, colorful pictures you expect from your computer systems. Day in, day out.

Whether you want one display or one thousand, call Microvitec today. You can rely on us to work hard for you.

Microvitec Plc, Bolling Road, Bradford, West Yorkshire, BD4 7TU, UK.
Tel: (+44) 274 390011. Microvitec Inc., Atlanta, USA. Tel: (+1) 404 991 2246. Microvitec GmbH, West Germany. Tel: (+49) 211 24 30 51.

MICROVITEC

RELIABLE

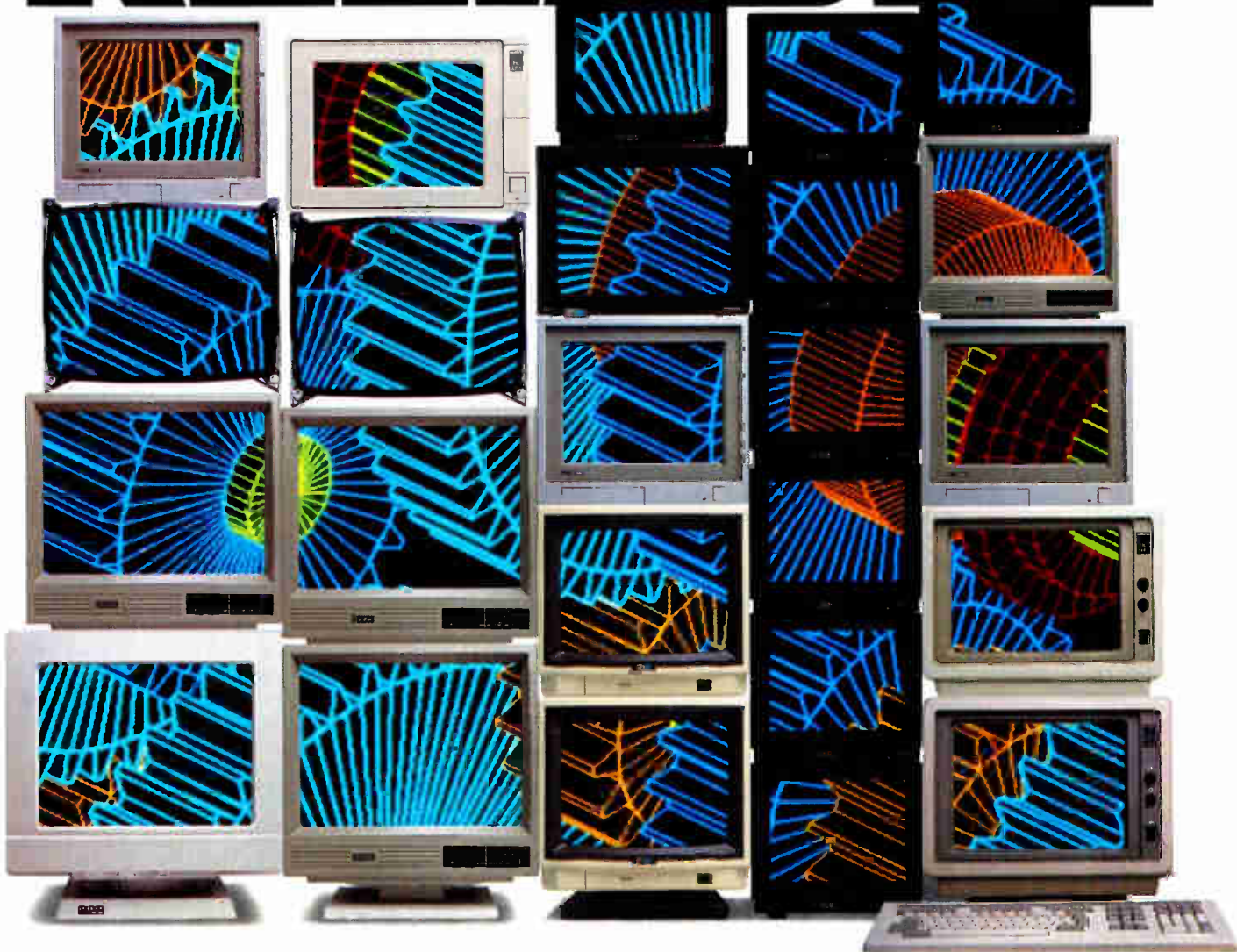

New!

Monitor & Control The World FROM YOUR PC

SOLUS, an integrated system, includes monitor, datalog and control software which features "Programming By Selection." You can create applications easily, with no prior programming experience.



ONLY \$895 Hardware Only VISA/MC/AmEx



The all new SOLUS™ Personal Control Computer™ lets you *monitor* and *datalog* just about any condition in the real world. Then, based on these monitored conditions, SOLUS lets you *control* a wide variety of electrical devices.

SOLUS makes it possible for any PC user to create powerful monitor and control applications. Quickly. Easily. Inexpensively. And with no prior programming experience.

SOLUS comes with a 30-day satisfaction guarantee.

Call toll free now: **800-247-5712**

Discover SOLUS today. And control the world around you!

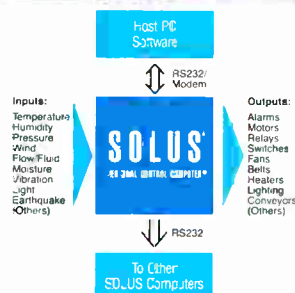

36 digital/analog input/output channels are compatible with standard sensors and output devices. SOLUS can be located on site, or remotely via modem.

Solus Systems, Inc.
4000 Kruse Way Place, 2•285
Lake Oswego, OR 97035 U.S.A.
Phone: 503•635•3966
Fax: 503•635•3004

© 1989 Solus Systems, Inc. SOLUS™ and Personal Control Computer™ are trademarks of Solus Systems, Inc.

WHAT'S NEW

CAD AND GRAPHICS

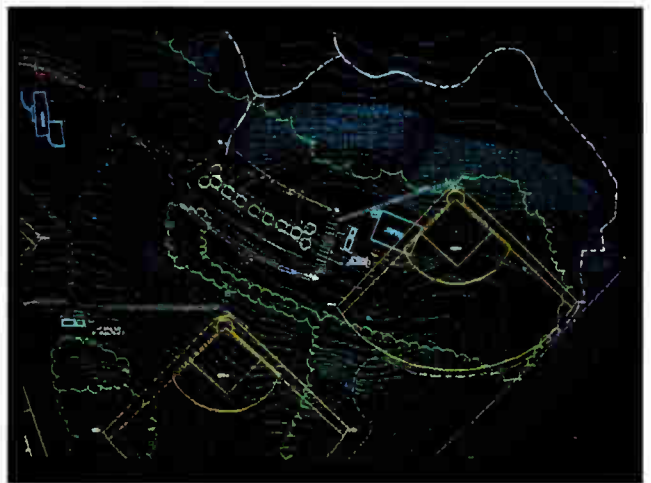

Peek/Smith used LandCADD's Site Planning module and Videoscapes to enter topographic information and plant materials to this baseball field.

100 Plant Images for LandCADD

LandCADD's Videoscapes, a visual database of plants for architects and civil engineers who use AutoCAD for site planning, contains about 100 pictures that you can access from within the AutoCAD drawing editor. Videoscapes works with LandCADD's Site Planning and Landscape Design add-ins for AutoCAD.

Videoscapes requires AutoCAD release 10 and LandCADD Site Planning and Landscape Design release 10.5 running on the IBM PC AT with 640K bytes of RAM, a hard disk drive, and a math coprocessor.

Price: \$295.
Contact: LandCADD, Inc., 7519 East Highway 86, Franktown, CO 80116, (303) 688-8160.
Inquiry 1123.

Make Your Presentations Move with Animator

Autodesk is touting its Animator program as the best way to make a business presentation or training session

come to life on an IBM PC with a VGA display. Animator lets you create, edit, and play full-length presentations in real time from your hard disk at up to 70 frames per second with up to 256 colors.

The program creates animations in five formats: cel animation, optical, polymorphic tweening, color cycling, and titling. Cel animations produce Disney-like animations, while polymorphic tweening is a form of object-oriented animation, where a square will gradually change into a star, for example. Color cycling animations are what you see on a TV weather report, with moving arrows and weather fronts.

The program requires an 80286-based PC or higher to create animations, but you can use an included public-domain player utility that will play animations on a standard IBM PC. If you have a VGA-to-NTSC card or conversion box, you can record to videotape. Animator requires 640K bytes of RAM and a hard disk drive.

Price: \$299.
Contact: Autodesk, Inc., 2320 Marinship Way, Sausalito, CA 94965, (800) 525-2763 or (415) 332-2344.
Inquiry 1122.

continued

Here's How We Protect Your Software And Profits Better.



We'll Never Tell.

Because our key-interrogation routines are *encrypted*, and our hardware is custom-wired to distinguish each of our clients' keys, our clients have the highest degree of security available.

Unlike other manufacturers, our routines assume responsibility for all hardware, software and timing issues. And what this means is that your engineering time and money won't be wasted reinventing protection schemes.

We offer two high security products for copy control: the KEY and the MEMORY KEY.™

Our protection devices can also be used for serialization techniques, software leasing,

modular software management, creative revenue collection, demo control and a path for future upgrades.

The information stored in the MEMORY KEY can be conveniently reprogrammed by your application software or at the end user's site via software disk or modem.

All our products attach conveniently to the printer port, are transparent and allow for unlimited back up copies.

For serious software protection, call now. And start protecting your profits. Hands down, we're better.

Encrypted routines provide the highest degree of security

Custom hardware and software for each developer

No batteries to fail or replace



No programming adapters necessary

Can be dynamically reprogrammed at the user site via diskette or modem.

Over 55 languages supported in DOS, XENIX and OS/2



MICROPHAR

**PROTECH
MARKETING, INC.**

1-800-843-0413

Se Habla Español

In Europe: Microphar, 42, Ave. Sainte Foy 92200, Neuilly Sur-Seine France
Tel: 33-1-47-38-21-21 Fax: 33-1-46-24-76-91, Call to obtain distributor addresses in:
Belgium, Ireland, Italy, Netherlands, Portugal, Spain, Switzerland, U.K. & W. Germany.

For Europe circle 264 on Reader Service Card

In the Americas and the Pacific: ProTech, 9600-J Southern Pines Blvd. Charlotte, NC 28217
Tel: 704-523-9500 Fax: 704-523-7651 Hours: Mon-Thurs: 8:30-7:00 ET, Fri: 8:30-5:30 ET
FOR A DEMONSTRATION PACKAGE OR ADDITIONAL INFORMATION, PLEASE WRITE OR CALL.

For Americas & Pacific circle 265 on Reader Service Card

We develop products on the premise that



Page Laser12: 12 ppm, up to 3 paper bins, 750 sheet capability, Toshiba/Qume, Diablo, IBM & HP emulations.



T1000: 6.4 lbs, 4.77MHz 80C88, 512KB RAM expandable to 1.2MB, MS-DOS in ROM, 720KB 3½" diskette drive. Built-in RGB, parallel, serial and external drive ports.



P341SL: Wide carriage (up to 270CPL), 216/72 cps, advanced paper handling, 4 part forms.



T1200FB: 9.8 pounds, 9.54MHz 80C86, 1MB RAM, 2 720KB 3½" floppy drives, removable/rechargeable battery pack.

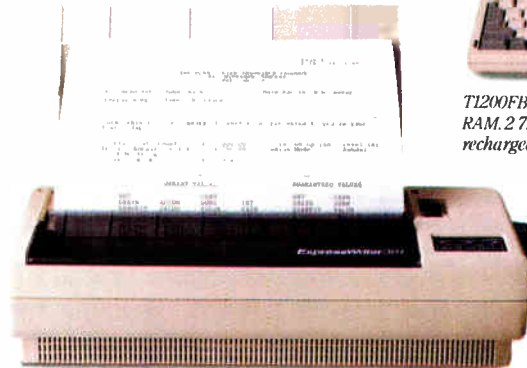

ExpressWriter 301: 4 lbs, letter-quality 24-dot print head, 60 cps, Toshiba/Qume and Epson LQ emulations, 5 resident fonts.



T3100: 12MHz 80286, internal IBM slot, 20MB hard disk, gas plasma display, 1MB RAM expands to 5MB, 1.44MB 3½" diskette drive.



T5100: 16MHz 80386 microprocessor, 40 or 100MB hard disk, 2MB RAM expandable to 4MB, 14.6 lbs. Built-in EGA display with high resolution gas plasma screen.



P351SX: 360/120 cps, 24-pin letter quality, color option, Toshiba/Qume and IBM emulations standard, Epson & Diablo emulations optional.

great minds don't think alike.

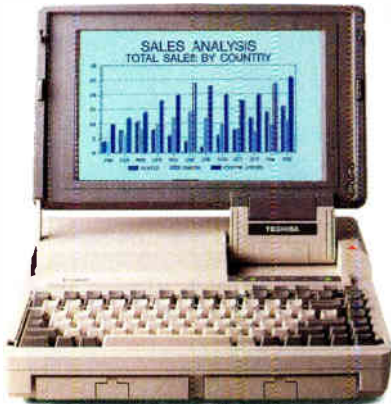

T1600: 11.6 lbs, Battery-powered 12MHz 286, 20MB hard disk, 1.44MB floppy, 1MB RAM expands to 5MB, backlit EGA LCD, removable/rechargeable battery packs.



T5200: 20MHz 80386 processor, 2 internal IBM compatible expansion slots, 40 or 100MB hard disk, VGA display with external VGA monitor port, 2MB RAM expandable to 8MB.



© 1989 Toshiba America Computer Systems Division

T3200: 12MHz 286, 2 IBM compatible slots, 40MB hard disk, 1.44MB floppy, 1MB RAM expands to 4MB, EGA screen.



PageLaser6: 6 ppm, 512KB standard memory. Emulations: HP Laserjet Series II, IBM Proprinter XL24. 2 HP Laserjet compatible font slots, multiple purpose tray, 4,000 prints per month, 35 pounds.



ExpressWriter 311: 24-pin dot matrix, 180 cps draft/60 cps letter quality, 3 resident emulations (Toshiba/Qume, Epson LQ, IBM Proprinter), 16K buffer, 5 resident fonts plus card slots, 11 lbs.

Numeric Keypad: full function, 15 or 17 keys, for many of our portable PCs.



T1200HB: 10.8 lbs, 9.54MHz 80C86, 20MB hard disk, 1MB RAM, includes 384KB LIM-EMS. Removable/rechargeable battery pack.



P32ISL/SLC (color): 216/72 cps, 24-pin letter quality, up to 360x360 DPI graphics, Toshiba/Qume and IBM emulations standard, Epson and Diablo emulations optional, 32KB print buffer, front panel controls, advanced paper handling.

People have their own ways of doing things. Some think fast. Some slow. Some work from 9 to 5. Others never stop.

That's precisely why we offer so many different products.

Including the widest range of truly portable PCs anywhere.

And a line of printers that includes everything from a high volume laser to a four-pound, letter-quality, battery-operated portable.

All of which can be easily networked. But all of which are designed to meet the individual needs of our users.

Because, at Toshiba, we have an incredibly diverse and sophisticated customer base.

And from what we can tell, they have only one thing in common.

They're all different.

For more information, just call us at 1-800-457-7777.

In Touch with Tomorrow
TOSHIBA

Toshiba America Information Systems, Inc., Computer Systems Division

Circle 322 on Reader Service Card (DEALERS: 323)

Mastermind... outsmarts all others.

a benchmark for application
and report production and
performance.....

LIMITED
TIME OFFER
\$395 \$299

Even though MASTERMIND looks like a work of Art, its real beauty lies in the fast and simple way it produces Applications and Reports for home, work or profit. Even an inexperienced novice can produce high quality Applications and Reports in minutes with absolutely no programming or knowledge of programming needed!



BENEFITS

- Expands your capabilities
- Open new opportunities for profit
- Lower your operating costs
- Satisfy your needs or client requirements
- Provide instant solutions to problems arising in your operating environment
- Reduces the number of pieces of software you will ever need to just one... MASTERMIND!

FEATURES

- powerful
- simple and easy to use
- reliable
- high performance
- integrated environment
- task and solution oriented
- friendly view as you go format
- customizable stand alone applications to your exact needs or customer requirements profitable for you
- learns and remembers each keystroke
- fast text processor for documentation
- many examples included
- built-in security system
- no royalty fees for stand-alone applications that you produce
- user-defined reports and forms
- low cost pre-fabricated applications available
- file manager included
- on-line interactive help included
- compatibility (see spec below)
- easy to follow documentation and operating instructions rich in examples
- 90 DAY WARRANTY
- solid customer support

USES

- Business
- Government
- Health
- Industry
- Science
- Legal
- Education

SPECIFICATIONS

REQUIREMENTS	MASTERMIND	MASTERMIND I	*MASTERMIND II	*MASTERMIND PLUS
DISPLAY	MONO/COLOR	MONO/COLOR	MONO/COLOR	MONO/COLOR
PRINTER	ANY	ANY	ANY	ANY
RAM	384K	512K	640K	640K
OPERATING SYSTEM	PC/MS DOS 2.1/HIGHER	PC/MS DOS 2.1/HIGHER	PC/MS DOS 2.1 or HIGHER MDS, VAX/VMS	PC/MS DOS 2.1 or HIGHER MDS, VAX/VMS
CPU	8086, 8088 30286, 80386	8086, 8088 80286, 80386	8086, 8088 80286, 80386	8086, 8088 80286, 80386
DISK STORAGE	360/720KB	360/720KB	360/720KB	360/720KB
NETWORKING	NO	NO	YES	YES
FIELDS PER RECORD	99	199	299	499
NUMBER OF RECORDS	UNLIMITED	UNLIMITED	UNLIMITED	UNLIMITED
NUMBER OF FILES	UNLIMITED	UNLIMITED	UNLIMITED	UNLIMITED
NUMBER OF DIR SORTS	99	199	299	499
RECORD SIZE	4096 BYTES	8192 BYTES	16384 BYTES	32768 BYTES
LINKAGE	YES	YES	YES	YES

SPJ DISTRIBUTING COMPANY

15455 N. Greenway-Hayden Loop Rd.
P.O. Box 13150
Scottsdale, AZ 85267

Name _____
Address _____
City _____ State _____ Zip _____
Telephone _____
 Check Money Order Visa MasterCard Amex
Card No. _____ Exp. Date _____

INVESTMENT OPPORTUNITIES — MASTERMIND is your blueprint to personal satisfaction and financial reward. Become an integral part of the MASTERMIND success story and achieve financial independence. To find out more about your profit opportunities as a Dealer or Distributor write or call:

Mastermind Software Company

15455 N. Greenway-Hayden Loop Rd. • P.O. Box 5823 • Scottsdale, AZ 85261 • (602) 443-3190

CALL NOW 1-800-328-4566

WHAT'S NEW

SCIENCE AND ENGINEERING



DADiSP 2.0, displaying raw data and several functions. Note that in the top middle window, a change in the raw data would change the maximum value in the annotation.

Data Analysis and DSP Spreadsheet

Spreadsheets are usually associated with the business world, but DADiSP 2.0 is a spreadsheet that lets you convert scientific data, run hundreds of analysis functions, and display the results next to the original data in up to 64 windows. As with a business spreadsheet, you can manipulate and link individual windows. A change in the original data is reflected in each linked graph. But instead of numbers or formulas in a cell, DADiSP windows (which you can zoom and scroll) contain entire waveforms.

DADiSP lets you take data in table, signal, waveform, and text formats and look at it from different points of view. One window can contain the imported waveform; a second window, its fast Fourier transform output; a third, several overlays of data; a fourth, a tabular view; a fifth, a three-dimensional plot; and so on. You can annotate each window, and a change in data is reflected in the annotation.

DADiSP 2.0 comes with hundreds of analysis functions, including signal arithmetic and calculus, peak find-

ing, and frequency domain analysis. A macro definition facility lets you create new functions.

All numerical calculations are performed in 8-byte IEEE-standard double-precision math, DSP reports. A pipeline lets you run other programs from the DADiSP worksheet, including those written in FORTRAN, C, BASIC, Pascal, and assembly language. DADiSP 2.0 supports digital filtering, and a separate module, the DADiSP-488 driver, lets you control and transfer data from IEEE-488-based instruments.

DADiSP 2.0 runs on the IBM PC AT with DOS 3.0 or higher, 2 megabytes of extended memory, and a hard disk drive. It operates under Unix on the HP 9000 Series 300 and Concurrent and Sun workstations, but not under Xenix on the PC.
Price: \$1695; workstation versions, \$2995 and up; DADiSP-488, \$195.
Contact: DSP Development Corp., One Kendall Sq., Cambridge, MA 02139, (617) 577-1133.
Inquiry 1109.

continued

MODEL	DESCRIPTION	RESOLUTION			MEMORY	MEMORY	Zoom, Pan.	NxM Conv.	Real-Time Frame Aver. Math & Logic	Hardware Window
		Spatial	Gray Levels	Number						
DT2862-60Hz ^a DT2862-50Hz ^a	Arithmetic Frame Grabber	512 x 512	256	8 ¹				8-bit or 16-bit ²	✓	
DT2862-60Hz ^a w/ DT2858 ^a	Frame Grabber & Frame Processor	512 x 512	256	8 ¹				8-bit or 16-bit ²	✓	
DT2862-50Hz ^a w/ DT2858 ^a	Frame Grabber & Frame Processor	512 x 512	256	8 ¹				8-bit or 16-bit ²	✓	
DT2861-60Hz ^a DT2861-50Hz ^a	Arithmetic Frame Grabber	512x512	256	8 ¹				8-bit or 16-bit ²	✓	
DT2861-60Hz ^a w/ DT2858 ^a	Frame Grabber & Frame Processor	512x512	256	8 ¹				8-bit or 16-bit ²	✓	
DT2861-50Hz ^a w/ DT2858 ^a	Frame Grabber & Frame Processor	512x512	256	8 ¹				8-bit or 16-bit ²	✓	
DT2851-60Hz ^a DT2851-50Hz ^a	High Resolution Frame Grabber	512 x 512	256	8 ¹				4-bit or 16-bit ²	✓	
DT2851-60Hz ^a w/DT2858 ^a	Frame Grabber & Frame Processor	512 x 512	256	8 ¹				4-bit or 16-bit ²	✓	
DT2851-50Hz ^a w/DT2858 ^a	Frame Grabber & Frame Processor	512 x 512	256	8 ¹				4-bit	✓	
DT2853-60Hz ^a DT2853-50Hz ^a	Low Cost Frame Grabber	512 x 512	256	8 ¹				4-bit	✓	
DT2853-SQ-60Hz ^a DT2853-SQ-50Hz ^a	Low Cost, Square Pixel Frame Grabber	512 x 512	256	Square Pixel Option				4-bit	✓	
DT2803-60Hz DT2803-50Hz	Low Cost Frame Grabber	256 x 256	64	8 ¹				4-bit	✓	



—Fred Molinari, President

Think of it as a Frame Grabber that's big on versatility and small on cost.

The DT2853 all-purpose frame grabber.

This \$1,795 frame grabber board contains all the basic essentials for image processing. Real-time capture and display with 512 x 512 resolution and 256 gray levels. Two onboard buffers. Onboard look-up tables. There's even an optional square pixel version available.

There's also a broad range of software available to support the DT2853 for specific applications, ranging from microscopy to modeling, to motion analysis and more. IRISutor™ Image Processing

Software is shipped FREE with the board.

Think of the DT2853 as a multi-purpose tool for real-time digital image processing on the IBM® PC AT®. Because it is.

You should also know that the DT2853 frame grabber wins the price/performance comparison every time. Because it gives you more features and options for less cost.

Call (508) 481-3700
In Canada, call (800) 268-0427

FREE 1989 Image Processing Handbook.



DATA TRANSLATION®

World Headquarters: Data Translation Inc., 100 Locke Drive, Marlboro MA 01752-1192 USA, (508) 481-3700 Tlx 951646

United Kingdom Headquarters: Data Translation Ltd., The Mulberry Business Park, Wokingham, Berkshire RG11 2QJ, U.K. 10734) 793838 Tlx 94011914

West Germany Headquarters: Data Translation GmbH, Stuttgarter Strasse 66, 7120 Bietigheim-Bissingen, West Germany 01742-54025

International Sales Offices: Australia (2) 662-4255; Belgium (2) 466-8199; Canada (416) 625-1907; China (1) 868-721 x4017, (408) 727-8222; Denmark (2) 274511; Finland (0) 372144; France (1) 69077802; Greece (1) 951-4944, (31) 527.039 (1) 361-4300; Hong Kong (5) 448963; India (22) 23-1040; Israel (3) 5401524; Italy (2) 82470.1; Japan (3) 502-5550, (3) 348-8391, (3) 355-1111; Korea (2) 756-9954; Netherlands (70) 99 6360; New Zealand (64) 9-545313; Norway (2) 53 12 50; Portugal (1) 545313; Singapore (65) 7797621; South Africa (12) 8037680/93; Spain (1) 455-8112; Sweden (8) 761-7820; Switzerland (1) 723-1410; Taiwan (2) 7020405

IRISutor is a trademark and Data Translation is a registered trademark of Data Translation, Inc. All other trademarks are the property of their respective holders.

Circle 97 on Reader Service Card

World Radio History

SCSI Storage Subsystems

286/386, Sun Microsystem, Macintosh,
Apple II, Tandy, Atari, Amiga
A-Hive—enclosure for SCSI drives
30watts \$119 65watts \$169

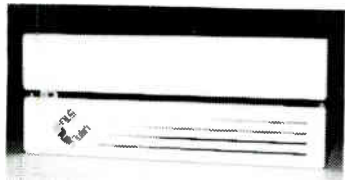

Hermit Crab—small portable hard drive

32MB \$429 200MB \$1999

SCSI Hard drive 32MB to 760MB

SCSI Tape drive 155MB

2HD/4 Floppy Controllers for 286/386

MFM/RLL 1:1 16Mhz

Tulin Corporation

2393 Qume Dr., San Jose, CA95131

Tel: 408-432-9025

Fax: 408-943-0782

WHAT'S NEW

SCIENCE AND ENGINEERING

Circuit Analysis with Seven Outside Connections

The ACNAP (AC Network Analysis Program) circuit analysis program for the Macintosh is a circuit simulator that analyzes up to 200 active and passive components and handles subcircuits with up to seven connections to the outside world.

The program supports unlimited-length keystroke macros; you can embed comments or instructions into the macro command and insert delays that wait for your input. With these macros, you can automate repetitive tasks or set up instructional sequences for later use by lesser-trained individuals, BV Engineering reports.

ACNAP performs Bode, Monte Carlo, sensitivity, noise equivalent bandwidth, spectra, component iteration, and worst-case analyses. You can create, combine, and edit component models and circuits that you save as single devices to a component library.

ACNAP works on the Mac 512K or higher.

Price: \$349.95.

Contact: BV Engineering Professional Software, 2023 Chicago Ave., Suite B-13, Riverside, CA 92507, (714) 781-0252.

Inquiry 1110.

Data-Analysis Program Develops Math Models

MINSQ (for "minimum squares") is a least-squares parameter-estimation and data-analysis tool that you can use to develop math models by performing simulations with known parameter values, MicroMath reports. You can use it to fit parameter values in model equations

to actual experimental data.

You can plot observed versus calculated values with data sets of up to 200 points. If your data has more than 200 points, a data sieve lets you use subsets of the data set by reading every *n*th point, for example.

MINSQ runs on the IBM PC with 640K bytes of RAM, a hard disk drive, and a graphics adapter. The program supports the 80x87 math coprocessor family. If you don't have a coprocessor, the program can emulate one.

MINSQ can't read arbitrary text files.

Price: \$179.

Contact: MicroMath Scientific Software, 2034 East Fort Union Blvd., Salt Lake City, UT 84121, (801) 943-0290.

Inquiry 1111.

Review, Cut, and Paste Waveform Files on the Mac

With WavEdit, you can review and edit large files of experimental data. You can open many data recordings and review them simultaneously, including any 8- or 12-bit files that can be saved in simple text or binary format.

Each recording appears as a chart-recorder-style display in a separate window; you can identify a region of interest and cut, copy, and paste your selection to a new file for display or to a desktop publishing program for incorporation into a publication or presentation. The program cannot delete or modify raw data.

WavEdit works on the Mac Plus, but a Mac II is better for large data files.

Price: \$395.

Contact: World Precision Instruments, 375 Quinpiac Ave., New Haven, CT 06513, (203) 469-8281.

Inquiry 1112.

WE ABSOLUTELY LEAD THE COMPETITIVE QUALITY, DELIVERY & PRICE

EXCELLENCE IS NOT THE LARGEST, NOT THE ELDEST, BUT WE ARE EQUIPPED WITH THE LATEST EFFICIENT TOOLS TO CREATE OUR PRODUCTS APPROACHING OPTIMUM.

COMPETITIVE QUALITY, DELIVERY & PRICE ARE OUR THREE OBJECTIVES.



E-117895

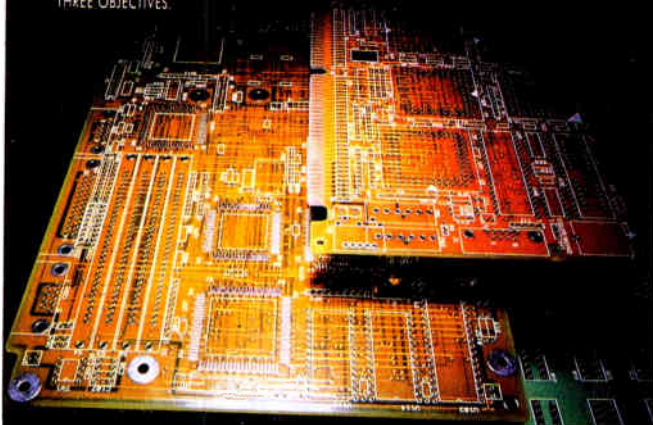

EXCELLENCE MULTI-LAYER
P.C.B. MFG CO., LTD.

3RD FL., 35, LANE 246, SIN MIN RD, NEI HU,
TAIPEI, TAIWAN, R.O.C.
TEL: 886-2-7941223~5 FAX: 886-2-7910397

Electrified

WE WILL TRY TO BEAT ANY PRICE ON ANYTHING FROM ANYWHERE !!!
A TRULY PROFESSIONAL STAFF WITH A COMMITMENT TO SERVICE !!!

MULTIMATE
Professional Word
Processing Software
Version 3.31
BRAND NEW For IBM & Compatibles
LIST \$495 - COST
\$99

★ COMPUTER COUNTRY ★

COMPARE!!! ★ **THE AWESOME 80286** ★ BRAND NEW!!!

QUADRANT 80286 — FULLY IBM COMPATIBLE

SYSTEM OPTIONS:

Controller — Dual HD FD	\$ 79
1.2MB — 5 1/4 Drive	79
360K — 5 1/4 Drive	79
720K — 3 1/2 Drive	99
1.44MB — 3 1/2 Drive-Requires DOS 3.3	119
20MB — Hard Drive	199
30MB — Hard Drive	249
40MB — Hard Drive	299
IRWIN 20MB Tape Back-Up System for AT Model 125-BELOW COST!!	199
Larger Hard Drives Available	Call
Color Monitor—	229
Hi-Res with Color Card	69
12" Monochrome Hi-Res TTL Monitor	69
Monochrome Card with Printer Port	49
DOS 3.1/3.2/3.3/4.01	39/49/69/79
Parallel Card	29
Serial Card	19
AT-Parallel Serial Card	29

512K INSTALLED — Full Size Case — 6Mhz — 200 Watt Power Supply
• 80287 Socket — Phoenix BIOS - 84 Key-IBM Style Click Keyboard
• Clock/Calendar with Battery Backup — 6-16 Bit and 2-8 Bit Slots
• Diagnostic Disk — 6 Month Warranty

\$449
COST

SPECIAL
512K MEMORY BOARD
UPGRADE - 1 MB OF
SYSTEM MEMORY
ONLY \$99

★ PRINTER POWER ★

IBM 5182 ★ COLOR PRINTER ★

★ BRAND NEW • HEAVY DUTY ★ LIST \$1995

- WIDE CARRIAGE (132 Column)
- 200 CPS Draft 110 CPS Correspondence 35CPS NLO
- Prints Black - 4 Colors and 8 Colors • Bidirectional Dot Matrix
- 9 Wire Parallel Interface • Tractor Included

\$499

FRONT — BOTTOM — REAR PAPER FEED
PAPER RACK AVAILABLE - Stacks Printed Paper — ONLY 12.95
Easy change Cartridge Ribbons - AVAILABLE
★ QUANTITY PRICING — CALL!!! ★ 30 DAY WARRANTY

★ THE SUPER SYSTEM ★

8088-2-TURBO COMPUTER SYSTEM SUPER INEXPENSIVE!!!

1-DRIVE IBM COMPATIBLE SYSTEM WITH 256K MEMORY!!! SUPER VALUE!!!

SYSTEM INCLUDES: 256K INSTALLED 8088-2 Processor
1-Half Height, 360K, 5 1/4 Drive INSTALLED • Dual Speed — 4.77Mhz and 8Mhz
— **TURBO** • 8 slots • 8087 Socket • 150 Watt Power Supply • Deluxe Keyboard
• Full Size Case for 4-1/2Ht. Drives • 1 Year Parts and Labor Warranty on Base Unit
(Hard Drives 90 Days)

SYSTEM OPTIONS:

ADD a 2nd 360K 5 1/4 Drive	\$ 79	Monochrome Card with Printer Port	49
ALL HARD DRIVES INCLUDE CONTROLLERS		Serial Card	19
ADD a 10MB Drive	149	Parallel Card	19
ADD a 20MB Drive	199	Clock/Calendar Card	29
ADD a 30MB Drive	299	Par/Ser/Clk/Game Card	49
ADD a 40MB Drive	369	DOS 3.1	39
12" Monochrome Hi-Res		DOS 3.2 with Basic	49
TTL Monitor	69	DOS 3.3 with Basic	69
Color Monitor—Hi Res		Memory Upgrade to 512K	69
with Color Card	229	Memory Upgrade to 640K	99

IMPOSSIBLE PRICE:
\$299
Quantity Pricing Available!

★ TERMINAL TREAT ★

Brand New!!! MODEL 4 TERMINALS

★ ALTOS ★ 14" - Flat Screen
Green Anti Glare Screen

Runs programs for WY-50, WY-100, Lear Siegler ADM-31,
Televideo 910 +925, and ADDS Viewpoint A-2-ASCII Display

80 Column - 26 Line - Modem Port - Auxiliary Port
50 - 38.4K Baud Rates - 16/32 Function Keys - Separate Cursor Keypad
Full Editing Keys - BRAND NEW - 90 DAY WARRANTY
List \$449
Normal Dealer Cost \$330 6 @ \$169 • 24 @ \$159 • 50 @ \$149
ONLY \$179

★ OKIDATA 294 ★

Color Printer LIST \$1200
400 CPS — 100 NLQ — Dual — 9 PIN
WIDE CARRIAGE

(132 Column) — Pull Tractor
IBM Parallel Interface — 8K Buffer
BRAND NEW — 1 Year Warranty
Uses Black or Optional 4-Color Ribbons
Ribbons are Available — CALL FOR PRICING
Serial Interface Units Available - CALL!!!

\$499
Quantity Pricing
3 = \$449 6 = \$439
12 = \$429 24 = \$419
Over 24 CALL!!!

CITIZEN MSP-50

BRAND NEW! - COLOR OPTIONAL!!
300 CPS, 50 NLO - Narrow Carriage, 9 - Wire
Epson IBM Compatibility - Push or Pull Tractor
Zero Tear Off - Top or Bottom Feed,
Automatic Paper Loading - 8K Buffer
18 Month Manufacturers Warranty - Parallel Interface

MSP-50 Options
Color Kit (7 colors) \$59
Serial Interface \$49
Font Card Sans, Serif, Operator \$59
Black or Color Ribbons Available - Call!!!

Amazing **\$269**
Only

Quantity Prices
3 for \$249
6 for \$243
12 for \$239
24 for \$229

CENTRONICS GLP

BRAND NEW!!! 100 CPS — 25NLQ
with Tractor
Parallel/Serial Interface
NARROW CARRIAGE
FULL WARRANTY!!!

Quantity Pricing LIST \$343
6 \$129
12 \$125
Over 12 - CALL!!!

ONLY \$139

★ MONITOR MANIA ★

PRINCETON GRAPHICS ULTRASYNCH

COLOR MONITOR
12" Multisync - Ultra Hi-Res
.28 Dot Pitch - 800 x 600
Demo Product - MINT CONDITION
FULL WARRANTY 1-YEAR!!!
BRAND-NEW CONDITION!!!
ONLY **\$399**
Monitor Cards on Special Also!!!

PRINCETON GRAPHICS 12" CGA COLOR MONITOR

BRAND NEW!!!
SUPER HI-RES — 600 x 400 MODEL MD-12
INCLUDES REQUIRED COLOR CARD
UNBELIEVABLE!!!
BETTER THAN EGA RESOLUTION!!!
.31 Dot Pitch-Dual Voltage
FULL 1-YEAR MANUFACTURER WARRANTY
THE BEST CGA RESOLUTION YOU CAN BUY!!!

ONLY **\$269**
LIST \$1049
Quantity Pricing
3 = \$249 6 = \$245
12 = \$239 24 = \$235
OVER 24 - CALL!!!

★★ **Electrified Discounters** ★★
DEALER INQUIRIES INVITED
CATALOG SENT WITH ALL ORDERS
1000 SHERMAN AVENUE
HARTFORD, CT 06114
FAX 203-248-8882
(203) 287-1976
AMERICAN EXPRESS

WHAT'S NEW

METRO NEW YORK • NEW ENGLAND

Mac Portable
Shown at BCS
General Meeting

In the same room that was used to demonstrate the original Macintosh to the Boston Computer Society almost six years ago, representatives from Apple Computer recently unveiled the long-awaited Mac Portable. Speaking at the John Hancock Hall in Boston, D. D. A. Didier Diaz, product manager for the Mac Portable line, answered questions about the design of the portable and took some ribbing about Apple's 90-day warranty along the way.

Diaz took a few minutes to assemble the Portable in front of the audience while discuss-

ing the finer points of the Portable's construction, even pointing out that the design team had signed its name on the bottom of the computer's housing (see the October BYTE, page 100). After discussing rest and sleep modes, the 15.67-MHz 68000 CPU, active-matrix LCD technology, and lead-acid gel versus nickel-cadmium batteries, Diaz opened the floor to questions.

Although it wasn't the first question asked, it was almost certainly on everyone's mind: What are Apple's plans for a smaller, lighter Portable? To that, Diaz read between the lines of the question and addressed the issue of price, too. "You have to compare it to machines that hardware-wise are comparable," he said. "So I think while cost

has been presented as one of the issues, it's not [compared to other machines]." As to the size and weight, he said Apple didn't want to compromise on the Portable's functionality.

When asked how tightly the Portable was sealed, Diaz said it was well sealed, but he advised against using it at the beach (this despite the fact that the opening video showed a woman sunbather using the Portable). "We did, and we paid the price for it."

Another question concerned a paged memory management unit, which is not built into the 68000 chip (the only feature of System 7.0 that doesn't work on the 68000 is the virtual memory capability). When asked if Apple had any plans to provide a PMMU for the Portable, Diaz

said, "Not at this point." When asked why Apple didn't use a 68020 or 68030 chip, he explained that a CMOS version of the 68030 isn't available. "The main reason is one of power."

Diaz said we could expect the optional adapter that converts the Portable's LCD signals into analog signals for National Television System Committee and European television signals by the end of 1989. On a NuBus expansion chassis, he said you can expect one, "but not from Apple." When asked when we can expect color for the Portable display, he said, "Color is not quite around the corner yet. It's somewhere a few years out."

And, naturally, someone asked about the length of the

continued

Lost in the Sea of Data Communications Equipment?

CALL
FOR OUR
V.32
SPECIAL

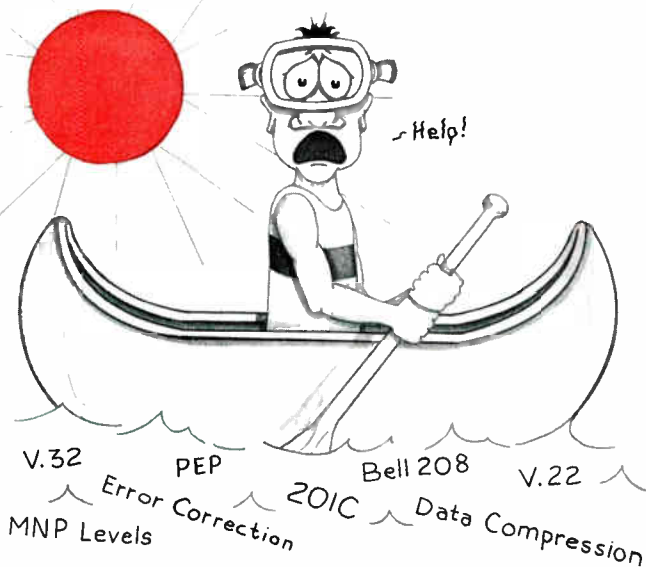

Call Direct of New England

for prompt answers and great prices on 2400, 9600, V.32, Multiplexers, and anything else you need.

Many Modems at Many Prices
We're here to help you right now!
Call (617) 272-6565.



Direct of New England, Inc.

ONE MOUNTAIN ROAD • BURLINGTON, MA 01803 (617) 272-6565

Distributors of: **MultiTech**
Systems

We make Dac-Easy™ look darn hard AND Peachtree® full of pits.

*A small business workhorse –
thousands of users
worldwide agree.*

Some accounting packages sound easy to use until you start to use them. Then you find out about the extras that come with them – like consultant time you'll probably end up paying for, expensive forms, and long learning curves. All you **really** want is an easy way to get your **bills out on time** plus **easy-to-read reports**.

The **Invoicer with Accounts Receivable** was designed by a small business owner who knew exactly what was needed. Now, **thousands of satisfied users** agree that this affordable, menu-driven program is the answer to their billing problems, too.

Before you commit to an "Easy" solution that turns out to be another hard lesson, give **The Invoicer** a **30-day money-back trial**.*

- **Free 60-day support line.**
- **Custom modifications available.**
- **Runs on IBM and compatibles, Apple II, and Macintosh.**
- **Accounts Payable and Sales Tracking/Inventory modules also available.**

The Invoicer with Accounts Receivable™

Only \$149

(Plus \$7.50 shipping and handling.)

Texas residents add 6.5% sales tax.

Visa, Master Card, American Express accepted.

* \$15 restocking fee if disk seal is broken.

Call

1-800-950-7943 To Order

OR 512-629-4341

**Or send check to MiccaSoft, Inc.
406 Windsor Lane, New Braunfels, Texas 78132**

Dac-Easy is a trademark of Dac Software, Inc. Peachtree is a registered trademark of Peachtree Software. IBM is a registered trademark of IBM Corp. Apple and Macintosh are registered trademarks of Apple Computer, Inc. The Invoicer with Accounts Receivable is a trademark of MiccaSoft, Inc.

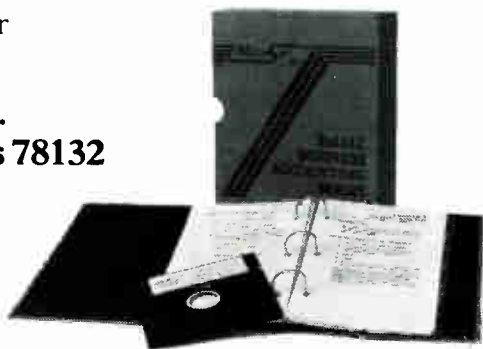

machine's warranty. When Diaz answered "90 days," many hisses could be heard from the audience. "So how long?" asked Diaz, to which several people replied, "One year."

Contact: The Boston Computer Society, One Center Plaza, Boston, MA 02108, (617) 367-8080.

Technology Conference Nanobytes

The 1989 AEC Expo, for architects and engineers, will be held at the Javits Convention Center in New York City on December 12-14. A section of the floor will be devoted exclusively to AutoCAD-compatible products.

Also, three days of conferences will be offered.

Price: Exhibits: free if you mail before December 8; \$20 at the door. Conferences: \$95 to \$200.

Contact: Expoconsul International, Inc., 3 Independence Way, Princeton, NJ 08540, (800) 873-3976 or (609) 987-9400.

The Baltimore Convention Center will be the site of the Baltimore Computer Conference and Exposition, which is organized by the Maryland Association of CPAs and National Trade Productions. MACPA and NTP plan to make the conference an annual event. It will be held on December 13-14.

Price: Conference: one day, \$35; both days, \$50. Exposition: free.

Contact: National Trade Productions, Inc., 313 South Patrick St., Alexandria, VA 22314, (800) 638-8510 or (703) 683-8500; Maryland Association of CPAs, 1300 York Rd., Suite 10, P.O. Box 484, Lutherville, MD 21093, (301) 296-6250.

The fourth annual technical conference on the X Window System will be held on January 15-17 at the Boston Marriott, Copley Place. The conference will consist of tutorials the first day, presentations the second and third days, and special "birds of a feather" sessions throughout the conference. There won't be any vendor exhibits.

Price: \$50.

Contact: X Technical Conference, MIT Conference Services, Room 7-111, 77 Mas-

sachusetts Ave., Cambridge, MA 02139, (617) 253-1700.

Computer Viruses the Topic of NetWare Meeting

The topic of the Metro New York NetWare Users Group's December 13 meeting will be computer viruses, the group reports. The meeting will be held at *Reader's Digest* offices in Pleasantville, New York, from 6:30 to 9:30 p.m. At press time, the speakers had not been finalized.

Contact: The Metro New York NetWare Users Group, c/o Veronica Goss or Steve Bachman, 200 Broadhollow Rd., Suite 207, Melville, NY 11747, (516) 385-9008.

OCTAGON'S TRUE 386-25 SYSTEM \$1744 COMPLETE

One Meg 80 ns RAM
AMI BIOS, Shadowing
Runs Zero-Wait State



1:1 Hd/Fd Controller
1.2 or 1.44 Floppy,
Graphics Card and Monitor,
Parallel and Serial Ports, HD Desktop Case, 101 Keyboard w/ tactile

feel, BTC 220 Watt Power Supply, One Year free On-site service included.

Make it easier on yourself.



FREE ON-SITE SERVICE LOWEST PRICES

OCTAGON 386-SX \$1199 COMPLETE

Intel 80386sx 16 Mhz CPU
One Megabyte 80ns RAM
AMI BIOS, w/Shadowing,
1:1 Hd/Fd Controller,
Graphics Card and Monitor,
1.2 or 1.44 Floppy, 101 Key Tactile Keyboard
Serial and Parallel Ports, 220 Watt Power Supply, One Year free On-site included.



CALL TOLL FREE
800-726-1775

Octagon
TECHNOLOGIES, INC.

Prices and specifications subject to change. All brand names are the registered trademarks of their owners.



HARMONY COMPUTERS

1801 FLATBUSH AVE.. (BET. AVES. J & K) BKLYN. NY 11210

ORDER DEPT. ONLY 800-441-1144 OR 718-692-3232 — INFORMATION 718-692-2828

10th Anniversary Specials

TOSHIBA T-1000 LAPTOP
\$629.00

H.P. LASERJET II
\$1579.00

PANASONIC 1180
\$159.00

IBM PS/2 #30 (286) 20 Meg
\$1679.00

WORD PERFECT 5.0
\$214.00

NEC MULTISYNC 3D
\$589.00

"PRINTER SPECIALS"

Apple Image Writer II	429
Diconix Ink Jet 150 plus	299
Epson X810	189
Epson FX 850	334
Epson FX 1050	439
Epson LQ 510	329
Epson LQ 850	499
Epson LQ 950	539
Epson LQ 1050	729
Epson LQ2550	929
Hewlett Packard Desk Jet Plus	669
Hewlett Packard Laser Jet II P	979
Hewlett Packard Laser Jet II	1579
IBM Proprinter 3	429
IBM Proprinter X24E	599

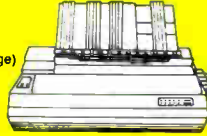
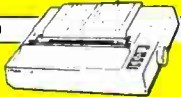

IBM AND COMPATIBLES

IBM PS 2 #30 (286) 1.44 Meg Dr.	1399
As above w/ IBM 20 Meg	1679
As above w/ IBM 30 Meg	1799
IBM PS2 Model 50Z (30 Meg)	2249
IBM PS2 Model 50Z (60 Meg)	2549
512K Upgrade for IBM PS 2 (30-286)	179
IBM PS/2 #55 SX 30 Meg (386)	2799
IBM PS/2 #55 SX 60 Meg (386)	3099
IBM P S 2 Mono Monitor (8503)	199
IBM P S 2 Color (8512) Monitor	449
IBM P S 2 Color (8513) Monitor	539



TURBO 386 (20 MHZ) 1.2 Drive 1 Meg Serial Parallel 1849

TURBO AT 286 12 MHZ, 1.2 Meg Drive Serial Parallel, 512K w/Monitor 849

EVEREX XT 12 MHZ w/ Monitor 549

Headstart 2 640K, 10MHZ, 5 1/4 & 3 1/2 Floppy Drives, Color Mono, Serial, Parallel, Game, DOS 3.3 799
Headstart 3 One Meg, 12 MHZ 5 1/4 & 3 1/2 Floppy Drives, 32 Meg H.D., Serial, Parallel, Game, Mouse, DOS 3.3, VGA Monitor 2299

MONITORS

Amdek 410A	149
Amdek 732 (VGA)	399
Princeton VGA Paperwhite	129
Princeton Max 15	249
Princeton Ultra Sync (16 inch)	849
Princeton Ultra Sync (14 inch)	499
NEC Multisync G.S. (Paperwhite)	229
NEC Multisync 2A (VGA)	479
NEC Multisync 3D	589
Sony 1304 Multiscan (1024x768)	649
Sony 1302 Multiscan	579
Sony 1320 VGA	469
Seiko #1440 (Res. 1024 x 768)	579
Zenith 1490 Flat Screen	579
Panasonic C1391	489
Mitsubishi Diamondscan #1381A	479
Goldstar Superscan #1440 (800 x 600)	449
Packard Bell (EGA) #1431	369
Packard Bell TTL Amber 12 Inch #1272A	89
Packard Bell TTL Amber 14 Inch #1472A	129
Packard Bell (RGB) #1452	249
Magnavox (RGB, Composite) 8CM515	269
Magnavox VGA	349



VIDEO CARDS

Hercules Monographic Plus w/Ramfont	154
Hercules VGA Card	159
Genoa Super Hi Res Plus	99
Genoa 8400 VGA w/512K	249
Video 7 VGA	189
Video 7 VGA 1024i 256K	219
Video 7 VGA 1024i 512K	289
Video 7 VGA Fastwrite 256K	199
Video 7 VGA Fastwrite 512K	269
Video 7 VGA VRAM (512K)	399
Orchard Pro Designer (VGA) 256K	229
Orchard Pro Designer (VGA) Plus 512K	299
STB VGA Extra EM 16 256K	229
STB VGA Extra EM 16 512K	299
ATI VGA Wonder 512K	289
ATI VGA Wonder 256K	219
ATI VGA Wonder 256K w/Mouse	249
ATI VGA Wonder 512K w/Mouse	319
Paradise Auto Switch (480)	139
Paradise VGA Plus	189
Paradise VGA Plus (16 Bit)	229
Paradise VGA Professional 512K	289
Everex Auto Sync (480) Deluxe	99
Everex Viewpoint VGA 256K	99
Everex Viewpoint VGA 512K	269
Harmony VGA (800 x 600)	149



IBM Proprinter 3XL	559
IBM Proprinter XL24E	799
NEC P2200XE	319
NEC P5200	489
NEC P5300	649
NEC 39XL	899
Okidata 380	359
Okidata 172	199
Okidata 182 Turbo	224
Okidata 183 (Wide Carriage)	249
Okidata 320	329
Okidata 321	469
Okidata 390	469
Okidata 391	639
Okidata 393	999
Panasonic 1180	159
Panasonic 1191	199

LAPTOPS

NEC Ultralite One Meg.	1749
NEC Ultralite 2 Meg.	1949
NEC Prospeed 286 20 Meg.	3199
NEC Prospeed 286 40 Meg.	3599
Toshiba T 1000	629
T-1000 768K Upgrade Card	249
T-1000 Carrying Case	39
Toshiba 1200 2 Drive (Backlit)	1399
Toshiba 1200 20 Meg (Backlit)	1899
Mitsubishi 286L (20 Meg.)	2099
Zenith 184-1 Supersport (2 Drive)	1349
Zenith 184-2 Supersport 20 Meg	2049
Zenith Supersport 286 (20 Meg.)	2599
Zenith Supersport 286 /40 Meg.)	2899
Toshiba 301 (24 Pin Portable Printer)	299
Diconix 150 Plus Portable Ink Jet Printer	299
Fast Lynx II (Data Transfer Software 3 1/2 to 5 1/4)	79
Laptop Modem 1200 Baud	139
Laptop Modem 2400 Baud	179



IBM SOFTWARE

Aldus Pagemaker 3.0	489
Lotus 123 Release 3	324
Lotus 123 Version 2.2	324
D Base 4	429
Multimate Advantage II	269
Borland Paradox 3.0	429
Microsoft Exce	269
Microsoft Word 5.0	209
Microsoft Windows 286	Sale Sale Sale 49
Microsoft Windows 386	129
Word Perfect 5.0	214
Word Perfect Library 2.0	89
Q & A 3.0	209
PFS Professional Write (2.1)	129
PC Tools Deluxe 5.5	79
Norton Utilities 4.5	59
Fastback Plus	99
Norton Utilities Advanced 4.5	99
Copy 2 PC Deluxe Board	109
Microsoft Mouse	99
Microsoft Mouse w/Windows	139
Logitech Scanman Plus	189
Genius 3 Button Hi Res Mouse	139
Logitech New Hi Res mouse (320 DPI)	84
Logitech Publisher	49
Logitech with Cad	39
Wordstar Professional Rel. 5.5 (After \$55 Rebate)	159
Ventura Desk Top Publishing ver 2.0	469
Managing Your Money - Release 5	119
Fast Lynx II (Data Transfer Software and cables)	79
MS DOS 3.3 w/Basic	89
MS DOS 4.01 w/Basic	89

MODEMS

Hayes 1200 External	269
Hayes 1200B w/Smartcom 2	179
Hayes 2400 External	324
Hayes 2400B w/Smartcom 2	269
Hayes 2400P (PS 2 50,60,70,80)	429
Hayes Smartcom II Software	89
ATI 2400 Internal	169
ATI 2400 External	199
Everex Internal 1200B	79
Everex 2400 Plus Internal	159
Everex 2400 E Plus External	199
Everex Macintosh 2400 External	229
Packard Bell 1200 External	89
Prometheus 2400 External	169
Prometheus 2400 Internal	139
Prometheus 2400 Plus Internal	199
Laptop Modem 1200 Internal	139
Laptop Modem 2400 Internal	179
Cardinal 2400 Internal	109
Falcon 2400 External	129



Panasonic 1124	269
Panasonic 1592	354
Panasonic 1595	399
Panasonic 1524	499
Panasonic 3131	299
Star XR-1000	329
Star XR-1500	429

Star NX 1000R (color)	209
Star NX-2400	284
Star NX 1000 II	79
Star NX15	299
Toshiba 301 (24 Pin Portable Printer)	299
Toshiba Expresswriter 311	349
Toshiba 321 SL	419
Toshiba 341 SL	589
Toshiba 351 SX	149



HARD DRIVES

Seagate 20 Meg. w/contoller	249
Seagate 20 Meg.	229
Seagate 30 Meg. w/contoller	274
Seagate 30 Meg.	254
Seagate 40 Meg. #251-1	339
Seagate 80 Meg. #4096	579
Western Digital XT Controller (20, 40, 80 Meg.)	79
Western Digital (AT) Controller	149
Miniscrite 20 Meg. Hard Drive Card	299
Miniscrite 30 Meg. Hard Drive Card	319
Mountain 30 Meg. Hard Drive Card	315
Tandon 20 Meg. Hard Drive Card	274
Seagate 20 Meg. External (for Macintosh)	479
Seagate 20 Meg. 3 1/2 inch #125N SCSI Adapter	295
Seagate 20 Meg. 3 1/2 inch #125	259
Seagate 30 Meg. 3 1/2 inch #138N SCSI Adapter	339
Seagate 30 Meg. 3 1/2 inch #138MFM	399
Seagate 50 Meg. 3 1/2 inch #157NS SCSI Adapter	365
Seagate 50 Meg. 3 1/2 inch #157	345
Seagate 80 Meg. 3 1/2 inch #296N SCSI Adapter	519
Host Adapter for IBM PS/2	49



FAX MACHINES

Ricoh RF-850	699
Ricoh RF-900	829
Sharp UX-180	639
Sharp FO 220	639
Sharp FO 330	869
Sharp UX 350	1029
Sharp FO 420	1029
Sharp FO 550	1449
Panafax #120 w/Answering Machine	879
Panafax #135	599
Panafax #140	799
Panafax #145	699
Panafax #250	1169
Panafax #260	1349
Toshiba #3300	769
Toshiba #3600	999
Cardinal Faxboard with 2400 Modem	149
Epson Priority Fax #1000	799
Epson Priority Fax #2000	899



PCBOARDS, DRIVES, MEMORY CHIPS

IBM Original 5 1/4 Disk Dr (360K)	89
Toshiba 5 1/4 Floppy Disk Dr (360K)	89
Toshiba 3 1/4 Floppy Disk Dr (720K)	89
Toshiba 3 1/4 Floppy Disk Dr (1.44 Meg)	109
Toshiba 5 1/4 Floppy Disk Dr (1.2 Meg)	99
PS 2 5 1/4 360K External Drive	199
PS/2 5 1/4 1.2 Meg External Drive	249
AST Six Pack Plus 64K	129
AST Rampage Plus (286) 512K	379
Intel above board 286 plus w/512K	379
Intel above board 286 Plus I/O Parallel/Serial	429
Intel above PS-2 (50,60)	299
AST Rampage PS-2 (50,60)	324
64K DRAM chips	Call
256K DRAM chips	Call
256K Simm Module	Call
One Meg. DRAM chips	Call
One Meg. Simm Module	Call

INTEL MATH COPROCESSORS

Intel 8087-3 (PC, PC XT up to 6 MHZ)	89
Intel 8087-2 (PC, PC XT up to 8 MHZ)	119
Intel 8087-1 (PC, PC XT 10 MHZ and faster)	159
Intel 80287-3 (PC, AT up to 8 MHZ)	129
Intel 80287-8 (PC, AT up to 10MHZ)	189
Intel 80287-10 (10 MHZ and Faster)	224
Intel 80387-16 (PCAT up to 16 MHZ)	339
Intel 80387-20 (PC AT up to 20 MHZ)	379
Intel 80387-25 (PC AT 25 MHZ and faster)	479
Intel 80387 SX (All 80387 SX Computers)	299
Intel 80C287	274



Master Card and Visa welcome at no additional charge. For your protection we check for stolen credit cards. Shipping & handling extra. Defective merchandise will be replaced or repaired at our discretion within the terms of our warranty. Price and availability subject to change without notice. We do not allow non-defective returns. For defective merchandise inquiries call customer service at (718) 692-2828.

The Cream.

The Crop.



There are plenty of places to get information in this industry. Too many. But if you want the best quality information, there's only one that rises to the top: **BYTEWEEK**.

BYTEWEEK is a weekly newsletter from the same professionals who produce **BYTE Magazine**. Each week, the most important news and information from the previous week is presented in a readable and concise manner. **BYTEWEEK** offers you what no other publication can: timely news on the rapidly-evolving computer industry as it happens with the interpretation and evaluation that only **BYTE's** experienced editorial staff can provide.

Subscribe now and take advantage of a special subscription rate of \$395 (\$495 outside the U.S. and Canada). Your subscription to **BYTEWEEK** also includes a free subscription to **BIX**, **BYTE's** exclusive on-line conferencing system. *Don't miss this opportunity!*

For fastest service, call toll-free 1-800-258-5485 (in N.H., call 603-924-9281) and charge to a major credit card or we'll bill you.

BYTEWEEK

One Phoenix Mill Lane, Peterborough, NH 03458

BYTEWEEK offers a money-back guarantee if you are not completely satisfied.

YES! Sign me up as a subscriber to the Cream of the Crop, **BYTEWEEK at the special subscription rate of \$395 a year for 50 issues (\$495 a year outside the U.S. and Canada).**

MC VISA Check enclosed Bill me

Card # _____ Exp. _____

Signature _____

Name _____

Title _____

Mail Address _____

City/State/Zip _____

Business Phone _____

BYTEWEEK

One Phoenix Mill Lane
Peterborough, NH 03458

Adtech's 33 MHz* 286... 386 Performance at a 286 Price!



16 MHz* 286

\$699

- 8 / 16 MHz selectable
- 1 MB Exp. to 4 MB on board
- 80287 socket
- Space saving AT style minicase
- 200 watt P/S
- 1.2 MB Teac floppy

27 MHz* 286

\$899

- 80286 C.P.U. Running at 20 MHz
- 1 MB Exp. to 8 MB on board
- 80287 Socket
- Shadow RAM Enable
- Space saving AT style minicase
- 200 watt P/S
- 1.2 MB Teac floppy

33 MHz* 386

\$1399

- 80386 ΣΣ C.P.U. running at 25 MHz
- 1 - 32 bit, 5 - 16 bit, 2 - 8 bit slots
- 80287 and 80387 sockets
- 1 MB Exp. to 8 MB on board
- Shadow RAM Enable
- Space saving AT style minicase
- 200 watt P/S
- 1.2 MB Teac floppy

33 MHz* 286

\$999

- 80286 CPU running at 25 MHz
- 1 MB Exp. to 8 MB on board
- 80287 socket
- Shadow RAM Enable
- Space saving AT style minicase
- 200 watt P/S
- 1.2 MB Teac floppy

Standard System Features

- 1:1 Dual floppy / HD cont.
- Parallel, 2 serial, game, clock
- Keytronics 101 keyboard
- 24 hour burn-in

System Options

Includes Monitor & Adapter Card	
Monographics (Hi-Res)	129
Color Graphics (RGB)	249
EGA (640 × 350)	449
VGA (16 bit)	499
Multisync (16 bit)	599

Mother Boards

16 MHz* 286	209
33 MHz* 286	399
33 MHz* 386	749

System Upgrades

1:1 RLL	25
Full Size Case	25
Full Size Vertical Case	100
Mini Vertical Case	50

Hard Drives

20 Meg - Seagate ST-125 (30ms)	249
30 Meg - Seagate ST-138 (30ms)	299
40 Meg - Seagate ST251 (38ms)	329
40 Meg - Seagate ST251-1 (28ms)	339
66 Meg - Toshiba (23ms)	439
66 Meg - Seagate ST-151 (23ms)	399

Miscellaneous

5.25" 360k (Fujitsu)	59
5.25" 1.2 MB	85
3.5" 1.44 MB	89
Logitech Hi-res Mouse (New)	89
2400 Baud Modem	99
16 bit VGA (1024 × 768)	179

Adtech

(408) 954-8038 1 (800) 326-6548

(408) 954-1647 FAX

2003 O'Toole Ave., San Jose, CA 95131

Circle 528 on Reader Service Card (DEALERS: 529)

Terms and conditions. Returns subject to 20% restocking fee. Prices and availability subject to change without notice. RMA # required for all returns. CA residents add 7% sales tax. No surcharge MasterCard and Visa. * Landmark speed test.



ONE YEAR PARTS AND LABOR WARRANTY ON ALL SYSTEMS!

World Radio History

UltraDrive Your Mac Without Frills

GCC Technologies' UltraDrive series for the Macintosh offers no-frills hard disk drives with 20- to 80-megabyte capacities.

The drives are available in standard internal configurations and in unconventional "zero-footprint" configurations to fit directly beneath a Mac Plus, SE, or SE/30. They measure 3 by 10 by 11 inches.

Every UltraDrive includes software for installation, partitioning, securing partitions (through passwords), and testing.

Price: 20-megabyte external, \$549; 30-megabyte internal and external, \$529 and \$629; 45-megabyte, \$599 and \$699; 80-megabyte, \$849 and \$949.

Contact: GCC Technologies, 580 Winter St., Waltham, MA 02154, (617) 890-0880.

Inquiry 1000.

Intex Upgrades Trans, PanaView for Lotus 1-2-3

Intex recently upgraded Trans and PanaView, two Lotus 1-2-3 and Symphony add-on products. Trans, which integrates ASCII data into Lotus spreadsheets, has two new command-line options in version 1.04. The first one eliminates multiple copies of page headings in the worksheet file that Trans creates, and the second option cuts the memory required to run the product by matching the minimum number of lines to the column structure in the source file.

PanaView lets you manage large spreadsheets by being

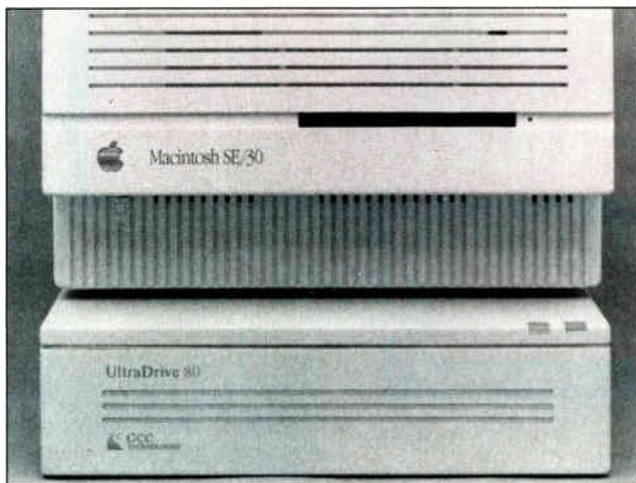

When GCC says that its UltraDrive has a "zero footprint," the company means that it fits under your Macintosh.

able to view up to 43,000 cells on a screen. You can use a zoom window for a close-up look. PanaView 1.1 flags blank formatted cells, so you can find and fix them. The program highlights unprotected ranges and adds more colors to the screen to help you distinguish among formulas, values, and text.

Trans 1.04 works with Lotus 1-2-3 up to release 3.0. PanaView works with release 2.2; a version for release 3.0 is expected by the end of this year, the company reports.

Price: Trans, \$95; PanaView, \$145.
Contact: Intex Solutions, Inc., 161 Highland Ave., Needham, MA 02194, (617) 449-6222.

Inquiry 1001.

Do-It-Yourself Calculator for the Mac

Calculator Construction Set (CCS) 2.0 lets you build a calculator as simple as a basic adding machine or one complex enough to handle your financial and scientific

problems in a MacPaint-like environment on the Macintosh.

You start with a basic calculator window, drag tools onto it, and assign functions to the tools. A key can be a number or any of 245 functions for statistics, math, or trigonometry. Once you have the calculator the way you want it, you can save it as a stand-alone application, desk accessory, or work file. Finished calculators can run in standard algebraic or reverse Polish notation.

The program can cut, copy, and paste data between the calculator and applications. An on-screen "paper-tape" display can hold up to 32K bytes of text, and you can edit this by clicking on the tape. Displays can show up to 24 characters.

The program comes with 61 ready-to-use calculators and 10 template files. Developer Dubl-Click reports that the program will run most HP-41C calculator programs, and it runs on systems as basic as the original 128K-byte Mac.

Price: \$89.95.
Contact: Dubl-Click Software, Inc., 9316 Deering Ave., Chatsworth, CA 91311, (818) 700-9525.

Inquiry 1003.

View AutoCAD Drawings Without AutoCAD

Not everyone who needs to view an AutoCAD drawing needs to be a CAD user. A program called Viewstation from Sirlin Computer lets you view, rotate, print, zoom, and even add a personal note to an AutoCAD drawing on a standard IBM PC without requiring you to have AutoCAD on the system. The program will read AutoCAD drawing files directly, including release 10 drawings, in a read-only format.

Viewstation can zoom drawings, turn layers on and off, and restore named views. The company reports that the program draws up to 10 times faster than AutoCAD.

Since the program treats AutoCAD files as read-only files, you can use it to archive drawings on a WORM (write once, read many times) drive, a CD-ROM drive, or a network server. The program's Hyper-Link capability lets you tie sets of drawings together. You can look at a map of a region, for example, point to the region, and load a detail of a particular subdivision of the region onto your screen.

Viewstation runs on the IBM PC with 512K bytes of RAM. A coprocessor is optional. Sirlin reports that next year it will release database drivers for the program, letting you use it as a graphical front end for database systems.

Price: \$295.
Contact: Sirlin Computer Corp., 225 Lowell Rd., Hudson, NH 03051, (603) 595-0420.

Inquiry 1002.

continued

Up to date. Down to earth.

Changing the world. UNIX is changing the world of computers, the world of business—quite simply, changing the world. It's revolutionizing office automation. It's required for U.S. government computer contracts. It's the backbone of information strategies worldwide.

The information you need. That's why you need *UNIXWORLD*—the magazine that keeps you up to date on the rapidly changing world of open systems computing. Each issue brings you the latest product trends and technical advances that can affect your business. The inside story on some of the world's

biggest high-tech companies. Easy-to-understand programming tips and tutorials that can help you and your company use UNIX to its fullest. And unbiased hardware and software reviews to help you invest wisely when you buy.

The whole UNIX-verse.

UNIXWORLD's in-depth features go beyond dry technical facts, to show how the pieces fit together—to tell you what's important about the advances and the strategies that are changing your world. And *UNIXWORLD* consistently offers the freshest, most down-to-earth writing you'll find in any computer publication.

Subscribe and Save. Subscribe today, and receive the next 12 issues of *UNIXWORLD* for just half the regular newsstand price. Save even more by ordering for two or three years. You can't lose—every subscription to *UNIXWORLD* comes with a no-risk guarantee.*

1 year \$18.00 (save 50%)
2 years \$32.00 (save 55%)
3 years \$42.00 (save 60%)

Subscribe now! Call toll-free:

1-800-341-1522

UNIXWORLD

If you're into UNIX, you need *UNIXWORLD* MAGAZINE.

UNIX is a registered trademark of AT&T. UNIX WORLD is not affiliated with AT&T.
*The magazine's no-risk guarantee: If not satisfied, cancel and receive a full refund for the balance of your subscription.
A McGraw-Hill publication

World Radio History

COMPUTERS

AST	
PREMIUM 286, MODEL 70	\$1175
386 - MODEL 300C	\$2625
386/33 - MODEL 5	\$3999
BRAVO, MODEL 5	\$855

EVEREX (AGI)	
AGI 1700A, 10MHZ	\$799
AGI 1800C, 12MHZ	\$1199
AGI 30000, 20MHZ	\$1929

COMPATIBLES	
12MHZ, 80286, 1MB	\$899
15 MHZ, 80386SX, 1MB	\$999
20 MHZ, 80386, 1MB	\$1159
25 MHZ, 80386, 1MB	\$1259

COMPATIBLES ARE 0 WAIT,
EXPANDABLE TO 8MB,
230W POWER SUPPLY

DRIVES

SEAGATE	
ST 225	\$199
ST 251-1	\$349
ST 4096	\$579
FLOPPYS	OTHERS CALL

LAPTOP/PORTABLES

TOSHIBA	
1000/1200F	\$689/\$1395
1200/1600	\$1859/\$3269
3100E/3200	\$2699/\$3395
5200-40/100	\$4899/\$5229

MITSUBISHI	
MODEL 210/220	\$2029/\$2425

NEC	
PROSPEED 20/40	\$2749/\$3299
ULTRALITE 1/2 MB	\$1995/\$2359

ZENITH	
SUPERSPORT 286	\$2650/\$2899

COMPAQ.....CALL

SOFTWARE

PAGEMAKER	\$479
CLIPPER	\$429
0 BASE IV	\$459
FOXBASE	\$219
LOTUS	\$319
MS WORD	\$219
MS EXCEL	\$249
SYMPHONY	\$419
WORD PERFECT	\$229

OTHERS.....CALL

PRINTERS

EPSON	
LX810	\$195
FX850	\$365
FX1050	\$499
LQ510	\$349
LQ850	\$545
LQ1050	\$769
LQ2550	\$999

NEC		
OKIDATA	P1180	\$189
	P1191	\$279
	P1124	\$319
	PT524	\$559
OTHERS	4450 LASER	\$1399
CALL	HP LASER SERIES II	\$1759

MONITORS

SAMSUNG	
14" AMBER	\$119
14" EGA	\$359
14" VGA	\$389

NEC	
MULTISYNC 30	\$709
MULTISYNC PLUS	\$949

OTHERS.....CALL

NUMEROUS OTHER PRODUCTS ... CALL FOR PRICES

- *BEST PRICES
- *TOLL FREE SERVICE
- *REPEAT CUSTOMER DISCOUNTS

- *SATISFACTION GUARANTEED
- *NO CREDIT CARD SURCHARGE
- *NO GIMMICKS-NO HASSLES

- *BIGGER SELECTION
- *SERVICE LINES OPEN 24 HOURS

DISCOUNTS AVAILABLE EVERYDAY - CALL FOR MOST CURRENT PRICES



HOURS (EST)
MON - FRI 8:30am - 6:30pm
SATURDAY 9:00am - 2:00pm
SERVICE ANYTIME

1310-E PINE LOG ROAD AIKEN, S.C. 29801 1-800-284-4919 FAX 1-803-642-6521

CALL FOR FREE CATALOG

1-800-284-4919



POLICY: Add 2% Freight - S.C. Residents Add 5% Sales Tax - Prices Subject to Change and Availability - We Cannot Guarantee Compatibility

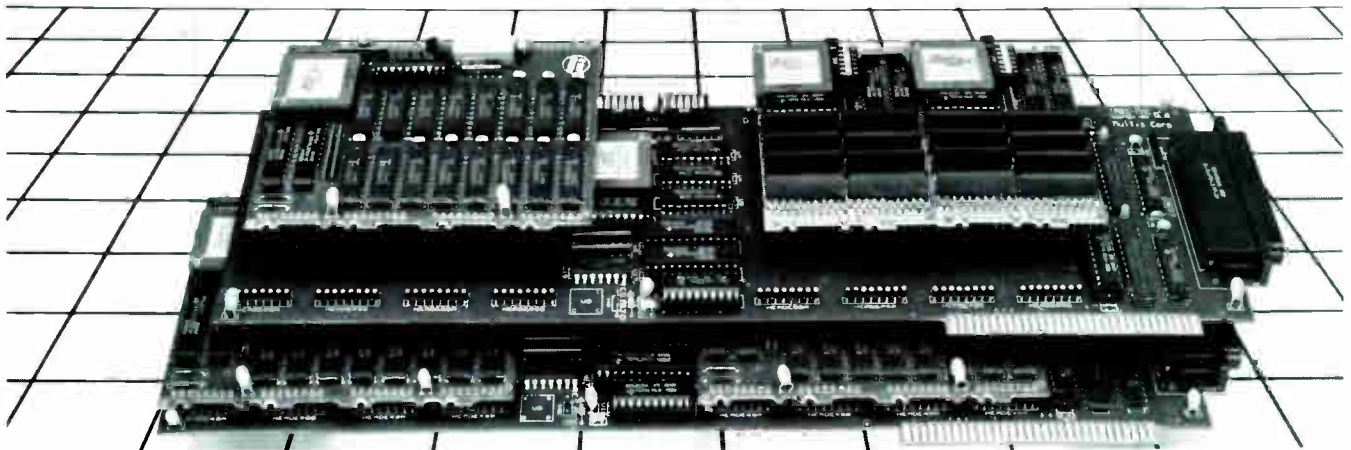

Transform Your PC into a Personal Supercomputer with MULTIS Parallel Processing Cards

Harness supercomputer power for your IBM PC, XT, AT or compatible with the MULTIS TABS (Transputer Architecture Board Series) parallel processing cards.

A single TABS-MMC supplies power and communication switching control for up to two TABS-SPD or four TABS-SPZ processor modules, yielding up to 50 MIPS of processing power. Each SPD or SPZ processor module provides one or two megabytes of ram for a T425 or T800 Transputer.

IBM PC, XT, and AT are trademarks of IBM. TRANSPUTER is a trademark of Inmos. CRAY 1 is a trademark of Cray Research.

Add up to sixteen TABS-MMC's and dramatically expand your systems capacity. With room for 64 processors, the TABS-MMCs will provide you with 640 MIPS of processing power, — equivalent to the CRAY 1 supercomputer.

With the MULTIS TABS design, your system is never obsolete. As applications demand more processing power, simply plug in additional processor modules. Or, customize your own expandable system with high resolution video and other

peripheral modules.

MULTIS TABS series products are fully compatible with other B004 Link boards. Each MULTIS product comes with a full year warranty and complete technical support. To find out about these and other upcoming products call (508) 459-9303. FAX # (508) 937-8051.



99 Willie Street, Lowell, MA 01854

Now build easy-to-use workstations in Microsoft® Windows™ for *any* job function.

Announcing the easy way to integrate Windows and DOS applications without programming in C.

With the interactive control language called Bridge, developing in Windows takes a fraction of the time of C.

Bridge makes it easy to build easy-to-use workstations for any job function. Design dialog boxes and menus faster than you ever thought possible.

"Seamlessly" integrate multiple Windows and DOS applications with multitasking. Automate repetitive tasks. Easily customize and revise applications. Quickly create working prototypes. Simplify every step of every user application!

In this sales manager's workstation, Bridge integrates Windows and DOS productivity tools to help manage accounts and sales reps, and track sales performance.

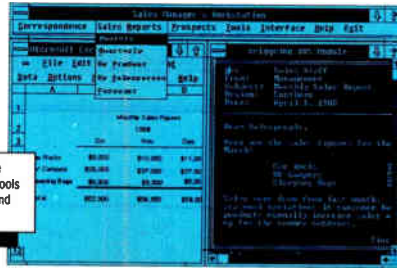

Create prototypes to make complex desktops seem simple.

Bridge makes it easy to quickly create working prototypes. Use prototypes to involve users throughout the development process—and assure quality. Prototyping is so fast with Bridge, you can make revisions on-the-spot while running demos with users.

"Bridge/286 and Bridge/386 allow corporations and programmers using the Windows environment to automate tasks and functions easily...Bridge provides users with tight control over their Windows environment."

PC Week

"Bridge/286 and Bridge/386 are impressive programs. If you use Windows with a variety of applications and have any facility with languages, you'll want a copy..."

PC Magazine

Become a Windows and DOS integration hero.

With Bridge, build workstations for sales reps, secretaries, financial analysts—any job function. Select the best custom and off-the-shelf Windows and DOS software to do a job. Integrate and enclose them within a user-defined interface.

Bridge helps you give users productivity tools to *exceed* their job descriptions. And keep them insulated from the technology. This frees users to discover the full capabilities of their PCs. Which in turn helps them do their jobs better. This increases your company's profits—even its competitiveness. And this leads to greater recognition for you.



This is a sample of a batch file from Bridge. These scripts make it easy to develop workstations in Windows.

Solve 80% of your PC problems with 20% of your resources.

With Bridge you get to fully exploit the capabilities of the hardware, Windows, and applications. It enables you to build standardized workstation environments that boost productivity of entire functional areas. The workstations' functionality and ease-of-use means I/S members will respond to fewer mundane requests. This will give I/S members the opportunity to put their skills to best use.

Compare the advantages.

	Bridge	Acro®	Command Post™	Windows Express®
User-defined menus	X	X	X	X
Custom dialog boxes	X	X		
Iconic interface creation	X			X
User-defined hot keys	X			
Interpretive batch language	X			
Debugging support	X	X		
Support of DDE	X	X		
Application launcher	X		X	X
Simulate keystrokes to DOS & Windows applications	X			
Interprocess control over NetBIOS LAN	X			
Control of/communication to DOS applications	X			

Get the benefits of Windows without sacrificing your investment in DOS!

With Bridge, you're not locked into any particular type of software to develop in Windows. Integrate *any* Windows and DOS software with multitasking in a unified graphical interface. Get all the benefits of Windows without giving up your company's investment in DOS!

Training and support represents roughly two-thirds of automation expense. Easy-to-use workstations designed with Bridge will significantly reduce this expense.

Bridge will support OS/2 Presentation Manager.

Phone for a Free Information Kit.

Phone now for a free Bridge Information Kit including brochure, demo disk, and product reviews.

Or order Bridge for a 30-day no-risk trial.

Try the Bridge Tool Kit for 30 days without risk. If you aren't completely satisfied, return it for a full refund. The Bridge Tool Kit contains everything you need to build workstations under Windows including Bridge/286 and Bridge/386 program disks and documentation, the Bridge Editor to create dialog boxes interactively, an icon program, an encryption program, examples of DDE capabilities, and documentation for messaging.

The Bridge Tool Kit sells for \$695. Please inquire about volume discounts.

No-Risk Guarantee

Try Bridge for 30 days. If you aren't completely satisfied, return it for a full refund.

1-800-955-9190



The Softbridge Group

Softbridge, Inc.
125 CambridgePark Drive
Cambridge, MA 02140

Acro is a registered trademark of The Whitewater Group. Command Post is a trademark of Wilson WindowWare. Windows Express is a trademark of hDC Computer Corporation. Bridge/286 and Bridge/386 are trademarks of Softbridge Microsystems Corporation. The Softbridge logo is a registered trademark of Softbridge, Inc. Microsoft is a registered trademark and Windows is a trademark of Microsoft Corporation.

Better Parts. Better

*The package you're
looking for, with
unbeatable
service coverage!*



EPS 80286 - 12 MHz

Intel 80286 12 MHz Microprocessor Hardware and Software Switchable Between 6 MHz and 12 MHz

MS DOS, OS/2 Compatible

1 Meg O-Wait State RAM

80287 Math Co-Processor Socket

Phoenix ROM BIOS Plus V-3.10 with Built-in Set Up

2-Serial/1 Parallel/Game Port

Eight Expansion Slots (6-16 Bit and 2-8 Bit)

200 Watt Power Supply

Real Time Clock/Calendar, with CMOS RAM Buffer and Battery Back Up

Both Teac 1.2 MB and 1.44 MB Floppy Disk Drives

High-Performance Toshiba 60 Meg Hard Drive (25MS)

1 to 1 Interleave 2 Hard/2 Floppy Controller (800 KB/Sec Transfer Rate)

High-Res Amber Displays with Tilt/Swivel Base

Hercules Graphics Controller Card

101 Enhanced Keyboard (3-Year Warranty)

MS DOS 3.3 or 4.01 with GW Basic

FCC Class B Approved

Norton S.I. Test 15.3

Full 1 Year Warranty (30 Day Money-Back Guarantee)

\$1,595⁰⁰

VGA add \$595.00

EPS 80286 - 20 MHz

Intel 80286 20 MHz Processor Hardware and Software Switchable Between 8 MHz and 20 MHz

MS DOS, OS/2 Compatible

80287 Math Co-Processor Socket

2 Meg O-Wait State RAM

Phoenix ROM BIOS Plus V-3.10 with Built-in Set Up

2-Serial/1 Parallel/Game Port

200 Watt Power Supply

Eight Expansion Slots (6-16 Bit and 2-8 Bit)

Real Time Clock/Calendar, with CMOS RAM Buffer and Battery Back Up

Both Teac 1.2 MB and 1.44 MB Floppy Disk Drives

High-Performance Toshiba 60 Meg Hard Drive (25MS)

1 to 1 Interleave 2 Hard/2 Floppy Controller (800 KB/Sec Transfer Rate)

Mitsubishi 14" Diamond Scan Monitor 800 x 600 Resolution

Paradise 16 Bit Plus VGA Card

101 Enhanced Keyboard (3-Year Warranty)

MS DOS 3.3 or 4.01 with GW Basic

FCC Class B Approved

Norton S.I. Test 28.2

1 Year On-Site Service Contract

Full 1 Year Warranty (30 Day Money-Back Guarantee)

\$2,595⁰⁰

EPS 80386/SX

Intel 80386 SX Processor Hardware and Software Switchable Between 8 MHz and 16 MHz

MS DOS, OS/2 Compatible

1 Meg O-Wait State 80 N/S RAM

80387/SX Math Co-Processor Socket

AMI 386SX — BIOS with Extended Set-Up Program

2-Serial/1 Parallel/Game Port

Eight Expansion Slots (6-16 Bit and 2-8 Bit)

200 Watt Power Supply

Real Time Clock/Calendar with Battery Back Up

Both Teac 1.2 MB and 1.44 MB Floppy Disk Drives

High-Performance Toshiba 60 Meg Hard Drive (25MS)

1 to 1 Interleave 2 Hard/2 Floppy Controller (800 KB/Sec Transfer Rate)

Mitsubishi 14" Diamond Scan Monitor 800 x 600 Resolution

Paradise 16 Bit Plus VGA Card

101 Enhanced Keyboard (3-Year Warranty)

MS DOS 3.3 or 4.01 with GW Basic

FCC Class B Approved

Norton S.I. Test 18.0

1 Year On-Site Service Contract

Full 1 Year Warranty (30 Day Money-Back Guarantee)

\$2,495⁰⁰

Order Toll Free 1-800-447-0921

* * The brands or product names mentioned are trademarks or registered trademarks of their respective holders.

Prices and specifications are subject to change without notice.

Circle 542 on Reader Service Card (DEALERS: 543)

Prices. That's EPS.



Oh, and while we're at it, better service too. You see, EPS Technologies knows that giving top-quality parts at a great price isn't good enough. In today's market, you have to truly build a better mousetrap... one that combines the best parts at realistic prices and has a full service program — a *full service program*.

When you purchase an EPS system, our service company, Memorex-Telex can service your office's system with the same efficiency as the one in your home. That's right, your home. Some companies think that it's sufficient to leave the responsibility of service with you. Not EPS. We provide on-site service for our customers. If the rare possibility that you need service arises, don't pack it up... we'll be there.

EPS Technologies. Better parts, better prices and better service. Come to think of it, that's better *value*. Plain and simple.

EPS 80386 - 20 MHz

Intel 80386 20 MHz Microprocessor Hardware and Software Switchable Between 8 MHz, 16 MHz and 20 MHz

MS DOS, MS-OS/2, SCO XENIX and PC-MOS Compatible

1 Meg O-Wait State RAM Standard On Board Memory Up to 8 MB, 1 MB/2 MB when using 256K DRAM, 4 MB/8 MB when using 1 M Bit DRAM, Expandable to 16 MB

Socket Support for 80287, 80387 and Weitek Co-Processors

AMI 386 BIOS with and In ROM Set-Up Routine

200 Watt Power Supply

One 32 Bit Slot (5-16 Bit Slots and 2-8 Bit Slots)

2-Serial/1-Parallel/Game Port

Real Time Clock/Calendar with Battery Back Up

Both Teac 1.2 MB and 1.44 MB Floppy Disk Drives

High-Performance Toshiba 60 Meg Hard Drive (25MS)

1 to 1 Interleave 2 Hard/2 Floppy Controller (800 KB/Sec Transfer Rate)

Mitsubishi 14" Diamond Scan Monitor 800 x 600 Resolution

Paradise 16 Bit Plus VGA Card

101 Enhanced Keyboard (3-Year Warranty)

MS DOS 3.3 or MS DOS 4.01 with GW Basic

1 Year On-Site Service Contract

FCC Class B Approved

Norton S.I. Test 22.7

Full 1 Year Warranty (30 Day Money-Back Guarantee)

\$2,795⁰⁰

4-Meg add \$395.00

EPS 80386 - 25 MHz

Intel 80386 25 MHz Microprocessor Hardware and Software Switchable Between 8 MHz, 20 MHz and 25 MHz

MS DOS, MS-OS/2, SCO XENIX and PC-MOS Compatible

4 Meg O-Wait State RAM Standard On Board Memory Up to 8 MB, 1 MB/2 MB when using 256K DRAM, 4 MB/8 MB when using 1 M Bit DRAM, Expandable to 16 MB

Socket Support for 80287, 80387 and Weitek Co-Processors

AMI 386 BIOS with and IN ROM Set-Up Routine

220 Watt Power Supply, Tower Case

One 32 Bit Slot (5-16 Bit Slots and 2-8 Bit Slots)

2-Serial/1-Parallel/Game Port

Real Time Clock/Calendar with Battery Back Up

Both Teac 1.2 MB and 1.44 MB Floppy Disk Drives

High-Performance Toshiba 105 Meg Hard Drive (25MS)

1 to 1 Interleave 2 Hard/2 Floppy Controller (800 KB/Sec Transfer Rate)

Mitsubishi 14" Diamond Scan Monitor 800 x 600 Resolution

Paradise 16 Bit Plus VGA Card

101 Enhanced Keyboard (3-Year Warranty)

MS DOS 3.3 or MS DOS 4.01 with GW Basic

1 Year On-Site Service Contract

FCC Class B Approved

Norton S.I. Test 28.1

Full 1 Year Warranty (30 Day Money-Back Guarantee)

\$3,695⁰⁰

Call for Cache

EPS 80386 - 33 MHz

Intel 80386 33 MHz Microprocessor Hardware and Software Switchable Between 8, 10, 12, 16, 20, 25 & 33 MHz

MS DOS, MS-OS/2, SCO XENIX and PC-MOS Compatible

32 KB of Highspeed (15NS) State RAM Cache

4 MB of 32 Bit DRAM On Board using 1 MBIT DRAMS

32 Bit Memory Expansion Slot for up to 16MB of Fast Memory

One 32 Bit Slot (5-16 Bit Slots and 3-8 Bit Slots)

Shadow RAM for ROM and Video BIOS

Sockets for 33MHz Intel 80387 and Weitek

WTL 3167 Floating Point Accelerator

AMI BIOS

220 Watt Power Supply, Tower Case

2-Serial/1-Parallel/Game Port

Both Teac 1.2 MB and 1.44 MB Floppy Disk Drives

High-Performance Micropolis ESDI 150 Meg Hard Drive (16MS)

Micropolis 1 to 1 Interleave 2 Hard/2 Floppy Controller

Mitsubishi 14" Diamond Scan Monitor 800 x 600 Resolution

Paradise 16 Bit Plus VGA Card

101 Enhanced Keyboard (3-Year Warranty)

MS DOS 3.3 or MS DOS 4.01 with GW Basic

1 Year On-Site Service Contract

FCC Class B Approved

Norton S.I. Test 42

Full 1 Year Warranty (30 Day Money-Back Guarantee)

\$5,295⁰⁰



P.O. Box 278
Jefferson, SD 57038
605-966-5586
800-447-0921

Terms and Conditions

- Full 30-Day Money Back Guarantee
- MasterCard, Visa and Discover Accepted — No Surcharge
- Allow 2 Weeks for Personal and Business Checks to Clear
- Leasing Available — Call for Details



World Radio History

Value, Quality, & Service to Mar & Corporate Accounts

SYSTEMS

AA44 CEI 286/12MHz Baby (0 wait) \$849
 • 1MB memory, 2 serial and 1 parallel ports
 • Hard and floppy drive controller
 • 1.2MB floppy drive, 101 key enhanced keyboard
 • FCC class B, UL listed, base system made by DTK

AA46 CEI 386/20MHz (0 wait) \$1799
 • 1MB SRAM, expandable to 4MB, AT size
 • Hard and floppy drive controller
 • 1.2MB floppy drive, 101 key enhanced keyboard
 • FCC class B, base system made in USA by CSS

AA51 CEI 386/20MHz Baby \$1399
 • 1MB RAM, expandable to 4MB, AT size
 • Hard and floppy drive controller
 • 1.2MB floppy drive, 101 key enhanced keyboard
 • FCC class B, base system made in USA by DTK

AA52 CEI 386/28C \$1999
 • 1MB RAM, expandable to 4MB, 64K Cache
 • Hard and floppy drive controller
 • 1.2MB floppy drive, 101 key enhanced keyboard
 • Base system made by DTK

AA53 CEI 386/33C \$3499
 • 2MB RAM, expandable to 6MB, 64K Cache
 • Hard and floppy drive controller
 • 1.2MB floppy drive, 101 key enhanced keyboard
 • Base system made by DTK

AA16 CEI 386/33C (0 wait) \$4299
 • 4MB static column memory
 • Hard and floppy drive controller
 • 32K cache, expandable to 64K
 • 1.2MB floppy drive, 101 key enhanced keyboard
 • Also available at 25MHz (AA15 \$3999)
 • FCC Class A, base system made in USA by CSS

AA86 Chicom Laptop 286-16MHz \$3199
 • Gas Plasma, NEAT Chipset
 • 600x400 EGA Mode, 1MB RAM
 • Par, Ser Ports, 1.44MB FDD
 • 40MB Hard Drive, HFDD
 • FCC Class B

• All systems have 6 months limited warranty on parts and labor.
 • After 20 days from shipping date, all monitors & printers warranties are carried out by the manufacturer

MOTHER BOARDS

A07 88 MHz Phoenix BIOS, 1MB (DK) (VIP) \$82
A08 88 10MHz Phoenix BIOS 1MB (DK) (VIP) \$85
A10 286-10MHz Baby Size, Award BIOS (DTK) \$219
A17 286-12MHz Baby Size, w/P. Port, (DTK) \$259
A11 286-10MHz AT* Size, Phoenix BIOS (VP) \$229
A18 286-12MHz Baby Size, Phoenix BIOS (VIP) \$219
A19 286-12MHz AT* Size, NEAT Chipset (OTK) \$319
A20 286-16MHz Baby Size, NEAT, AMI BIOS (DTK) \$299
A21 286-16MHz Baby Size, NEAT, AMI BIOS (DTK) \$299
A22 286-20MHz Baby Size, NEAT, AMI BIOS (DTK) \$399
A44 386SX 16MHz Baby Size, Phoenix BIOS (DTK) \$429
A56 386SX 16MHz Baby Size, Phoenix BIOS (ELT) \$399
A32 386 20MHz AT* Size, 4MB (1MB) Using SCRAM, Award BIOS (CSS) \$1299
A47 386 20MHz Baby Size, BIOS, RAM CARD (ELT) \$749
A55 386 20MHz Baby Size, Phoenix BIOS (DTK) \$699
A60 386 25MHz AT* Size, Award BIOS, 32K cache, 4MB SCRAM on 8MB 32-bit ramcard (CSS) \$3299
A49 386 25MHz AT* Size, Award BIOS, 32K cache (DTK) \$399
A35 386 33MHz AT* Size, Award BIOS, 64K cache, 4MB SCRAM on 8MB 32-bit ramcard (CSS) \$3799
A54 386 33MHz BIOS, 64K cache (DTK) \$2499

ADD-ON CARDS FOR XT*

B05/24/65 Clock/Game/Printer Card \$18/14/14
B15 EMS Card 2MB (OK) (Everex) \$65
B30 I/O Card w/P.S.G.C (DTK) \$45
B40 MultiFunction 384K (OK) (DFI) \$75
B50 Multi I/O (w/P.S.G.C, FDD) (DTK) \$52
H70 RAM CARD 640K (DTK) \$28
H75/76 RS232 (1's, DTK/4's, DFI) \$20/79
H85 2nd Serial Port Kit for B80 and B50 DTK \$16
H91 Turbo Speed Hub at 286-12MHz (Everex) \$269

ADD-ON CARDS FOR AT*

C02 EMS/RAM-3MB (OK) (Everex) \$105
C03 EMS/RAM-8MB (OK) (UM) 4.0 (Everex) \$299
C05/1/6 I/O P. S.P., S. G. Ports (DTK) \$334.39
C07 I/O + MGA P.S.G.C. Mono w/ CGA Emulation (DFI) \$99
C08 I/O + P.S.G. Port, COM1, 4 configurable (DFI) \$49
C10/12 I/O + (25-pin, I/O, PS, I/O) \$45/41
C24/25 RS232 2's/4's (DFI) \$75/99
C31 2nd Serial Port Kit for C08 & C24 (DFI) \$21

HARD/FLOPPY CONTROLLERS

E03 FDC 2's Run 1.44M, 1.2M, 720K, 360K \$49
E04 FDC 4's Run 1.44M, 1.2M, 720K, 360K
 4 Int or 2 Int & 2 Ext w/ In-Cable for 2 drives
 Can Co-exist with FDD or FDDC \$89
E07 FDC 2's Ext or Int Run 1.44M, 1.2M, 720K, 360K
 Can Co-exist with FDD or FDDC \$65
E11/09 XT* HD controller (WD) MX1-Gen \$65/\$55
E10 XT* HD Controller ST225, 251, DTC5150 \$65
E22 XT* RLL HDC WD1002A-27X \$65
E35 AT* H/FDC 2' 1 MFM, WD1003V-Interlake (WD) \$109
E46 AT* H/FDC WD chipset, 2, 1 Interlake \$79
E47 AT* H/FDC WD chipset, 1, 1 Interlake \$109
E35 AT* HD Controller MFM, WD1003V-M1 (WD) \$99
E18 AT* HD Controller MFM, 1, 1 Interlake, WD1006V-M11 \$119
E19 AT* H/FDC MFM 1, 1, WD1006V-M1 \$129
E30 AT* HD Controller MFM, 1, 1 Interlake, WD1007-WAA \$169
E31 AT* H/FDC ES01, 1, 1 Interlake, WD1007-WAA \$129
E40 AT* H/FDC ES01, WD Chipset, 1, 1 Interlake \$199
E40 AT* HD SCSI Host Adapter 8 bit for D61 \$65
E42 AT* HD SCSI Host Adapter 16 bit (WD) \$439

STAR ARNET

K72 Plus & Plus Arnet 8 bit \$89
K35/37 Cnet Arnet 8 bit/16 bit \$99/209
K11 25' Arnet Cable 90 Ohm RG62, Coaxial \$25
K08/03 Hub Active 8's/Passive 4's \$289/30

BUS ARCENT

K71 Plus & Plus Arnet 8 bit \$109
K36/39 Cnet Arnet 8 bit/16 bit \$119/219
K09 Bus Terminator 93 ohms \$8

TWISTED PAIR ARCENT

K34/38 Cnet Arnet Adapter 8 bit/16 bit \$129/\$239
K46 Active Hub 8's \$499

ETHERNET

K70 3COM EtherLink II #3C503 \$379
K77/73 Plus & Plus Ethernet 8 bit/16 bit \$179/\$339
K32/33 Cnet Ethernet 8 bit/16 bit \$179/\$299
K10/05 Ethernet (25' Cable)/(Terminator) \$30/6

COAX ACCESSORIES

K04/14 BNC T Adapter/Crimping Tool \$6/25
K13/15 BNC Crimp Connector for Arnet/Ethernet \$6/6

MULTIUSER

K06/16 4 RS232 for Xenix (DFI)/AST \$169/\$429
K07 Terminal Wye-60 with KBD \$469
K18/17 Compute RS232 8088-8/4'8's \$399/\$599
K51/52 Compute 80186 8/8'18's \$999/\$1599

TOPS

K40 Tops Network Software for Macintosh to connect to PC, Unix, & Minotaur \$189
K41 Tops Network Software for DOS Systems to connect to PC, Unix, & Minotaur \$149
K42 Tops Flashcard PC or Appletalk Network \$199
K43 Tops Netprint PC shares Appletalk printers \$159

OTHER NETWORK

K20 Balun 50 Ohms BNC \$8
K80/50 Token Ring Card Compatible WD/Genetic Cell/3399
K51/53 Token Ring (IBM) Adapter/Adapter II \$699/799

FLOPPY DISK DRIVES

D01/02 Fujitsu 360K for XT/AT* (Rain-5S) \$65/\$68
D03/05 Fujitsu (1.2MB Gray Plate)/(1.44MB GB) \$80/85
D10/11 Teac 360K (XT* black)/(AT* gray) \$72/76
D12 Teac 1.2MB Gray Plate \$85
D13/15 Teac w/ Mounting Kit 20K/1.44MB \$79/\$89
D20/22 Toshiba 720K with Mounting Kit/No Kit \$79/74
D21/23 Toshiba 1.44M with Mounting Kit/No Kit \$89/84
D30/32 Ext. 1.44M/720K (w/ contr)/(no contr) \$249/199
D35 External 1.2M/360K for Toshiba laptop \$249

HARD DISK DRIVES

D42 Micropolis 1375 150MB, SCSI, 23MS, w/C \$1499
D43 Micropolis 1570 300MB, SCSI, 18ms, w/C \$2199
D44 Micropolis 1555 320MB ESDI w/C \$2099
D46 Maxtor 4380E ESDI 320MB, 29MS w/C \$2399
D48 Maxtor 2190 150MB, 28ms, w/C \$1699
D47/48 Maxtor 155MB (ESDI/SCSI) \$1699/1799
D79 CD 701B MFIM \$659
D80/81 CDC ESDI, 16ms, w/ C, 90MB/150MB/1299/1899
D82 CDC-38H3120M ESDI, 14.5ms, w/ C \$2899
D50/51 Seagate ST225 20MB KII Drive \$259/219
D52 Seagate ST238 w/ Contr. 30MB, 85ms, for XT* \$279
D57 Seagate ST138 w/ Mounting Kit, 30MB, 40ms \$299
D58 Seagate ST125 20MB, 40ms, HH Drive \$249
D56 Seagate ST251-1 40MB, 28ms, for AT* \$349
D60 Seagate ST277N SCSI, 60MB, 28ms, HH \$599
D61 Seagate ST296N SCSI, 80MB, 28ms, HH \$659
D55 Seagate ST4096 80MB, 25ms, for AT* \$629
D95 Plus Hard Card 40MB \$719
D96 Plus Passpart 40MB Removable HD \$659
D97 Passpart PC Adapter & Base Kit \$519
D10/11/11 CD-ROM 540MB (NEC) Ext \$1099/1029
D12 WORM SC1 200MB w/ Adapter (Panasonic) \$2599
D113 DCL Cartridge 400MB for D12 \$119

VIDEO DISPLAY ADAPTERS

V01/05 Color Graphic CGA/CGA w/ printer port/41/43 \$44/53
V20/22 Mono Graphic w/P (DTK)/Genetic \$46/\$35
V30 EGA Autoswitch, 640x480, 132col. (Everex) \$109
V33 EGA Autoswitch, 640x480, Paradise Chip \$99
V44 VGA 16 Bit, Paradise Chipset (Pis & Pus) \$169
V46 VGA 16 bit (Everex) \$199
V50 Super VGA 1024 x 768, Tseng Chipset \$199
V66 VGA Wonder 800 x 600, 16 bit (ATI OEM) \$219
V73 VGA Wonder w/ Mouse 1024 x 768, 16 bit, 256K (ATI OEM) \$279
V74 VGA Wonder 1024 x 768, 16 bit, 256K (ATI OEM) \$259

KEYBOARDS

101/04 BTC (84 keys)/(101 keys) \$44/\$44
102 101 Keys Enhanced, Click \$55
111 Chicony 101 keys \$65
120 KeyTronic 101 Keys \$65
118 Mitsumi 101 Keys Made in Japan \$65
105 Mitsumi 101 Keys \$64
131/32 Keyboard Drawer tabletop/underdesk \$49/\$35

FOR PS/2

P04 EMS 4MB (OK) (Everex) \$319
P19/20 Ext 360K for (PS/2)/(PS/2M30-286) \$179/209
P16/17 Ext 1.2MB for (PS/2)/(PS/2M30-286) \$199/229
P10 Ext 1.2MB for PS/2/502.55X.70.80 \$279
P45/46 Ext 1.44MB for (PS/2)/(PS/2M30-286) \$249/269
P50/51 Irwin 40MB Tape Driv w/ Adap Int \$599/759
P56/57 Archive 60MB Tape Driv VPro Int \$999/1199
P127 HD Int, for Model 30 (CMS) 20MB/30MB/399/479
P22/26 HD Int, for Model 50 (CMS) 40MB/50MB \$599/999
P35 60MB Int 27ms HD for Model 50z, 70 (CMS) \$399
P42/28 HD ESDI, for Mod 60.80 70/115MB \$899/1359
P30 60MB HD 23ms for Model 60 (Prism) \$399
P31/32 HD ESDI, 20ms, for Model 60, 80 (Prism) \$799/2499
P40 CD ROM 540MB (NEC) \$1699

COPROCESSOR & CHIPS

M11/12 80287-8/10 \$219/239
M08/09/07 8087-3-2-1 \$99/139/179
M11/15/16/17 80387-16/20-25/33 \$339/399/499/599
M18 80387SX-16 \$319
M20/21 V20-8/10 \$10/14.50
M60/61 2764-200/27128-250 \$4/75
M30/31/33 DRAM 64-15/12/10 \$2.20/2.65
M32/34 4464-12/10 \$5/5.50
M40/41/42 256-12-10/8 \$3.35/3.69/5.20
M45/46 256K DRAM 8-10 \$1.50/2.01/1.50
M78/79 1MBx16 DRAM -10/8 for A18 \$11.50/12.50
M83/84 1MBx16 DRAM Set for CSS \$279/279
M55 1MB Set for CSS \$339
M80/87 SIPP 1MBx8 20-8 \$139/149
M81/75 SIPP 256K 10-8 \$49/55
M90/91 SIMM 256K for PS/2 Mod 30 -12/10 \$67/79
M98 SIMM 256x8 80ms \$65
M92 SIMM 1MBx9-10 for PS/2 Mod 30-286 \$179
M93/70 SIMM for PS/2 50 & 60 1MBx9/8MBx2/625/949 \$99
M94/95 SIMM 1MBx9 for Mod 70 \$259/259
M96 SIMM 1MBx9 for PS/2 Mod 80 \$279
M97/71 SIMM 2MBx9 (M) for PS/2 70 \$429/499
M98/72 SIMM 2MB (M) for PS/2 80 \$499/499

MODEMS

G10/14 Everex 2400 Int/Ext (OEM) \$59/98
G11/12 Everex 1200 Int/Ext \$129/169
G17 Everex 2400 Int for PS/2 \$219
G118 Everex 2400 with MNP Level 5 Int/Ext \$149/199
G19 Everex 9600 \$Call
Q01 Everex Faxmodem External \$259

SCANNERS

Y13 DFI 4" Handy Image Scanner (HJ33000-1) \$199
 Portable Size w/ PC Paintbrush, 400DP \$199
Y12 DFI 4" Handy Image Scanner for PS/2 \$279
Y30 OCR for DFI Handy Scanner for Y12 \$89
Y31 OCR Deluxe: Can Read Most Magazine Text for Y13 DFI Handy Scanner \$189
Y27 Genius® Handy Image Scanner \$599
Y15 Video Catcher: Grab Picture from TV, VCR, or Camera into Computer: Mono Mode (DFI) \$229
Y18 Everex Flatbed Scanner \$1399

MOUSE & DIGITIZERS

Y01A Genius Mouse GM16GS Serial w/Driver \$38
Y20 Genius Mouse GM1600 D. Halo III, HI Res, 3500PI, 200-800 Dynamic DPI \$53
Y25 Genius Mouse GM-10U for PS/2 \$65
Y03/05 Logitech Mouse Serial/Bus \$69/75
Y06 Logitech Hi-Res Mouse Bus \$89
Y22 Genius Digitizing Tablet GT-1212A
 Summagraphic Compatible, 12"x12"
 Dr. Photo III, 1000 lines/line, works with Autocad \$299
Y26 Numsketch 12"x12" (Summagraphic) \$379

BAR CODE READERS

Y45 BTC Wand & Decoder Emulates Keyboard \$299
Y44 BTC Slot Reader & Decoder Emulates KB \$339
Y43 Software for BTC Bar Code \$269
Y50 Techway 8W410 Bar Code Keyboard Emulator \$249
Y51 Techway 8W420 RS232/422 Bar Code Reader \$269
Y52 Techway 8W430 Portable Bar Code Reader
 48K Memory of Data Storage \$499
Y56 Techway 8W435 4 Line LCD, Programmable \$659
Y53 Techway 8W440 Bar Code Online Reader \$369
Y54 Techway 8W607 EZ Barcode II Software Package for printing barcodes \$119

TAPE BACKUP

F10/11 Colorado Mem Nys 40MB Int/Ext \$279/379
F08/09 Irwin Int (120MB 210)/(150MB 615) \$799/1199
F23/29 299 Irwin Ext (745 400B)/(765 60MB) \$699/799
F30/31 Irwin AT* Kit (200 20MB)/(400 40MB) \$439/579
F34/35 Irwin Kit Ext (400 20MB)/(254 40MB) \$499/729
F40/41 Everex 60MB Int/Ext \$799/899
F42/43 Everex (150MB Int)/(120MB Ext) \$1199/1199
F24/25 Archive 60MB (FT60 Ext)/(ST60 Int) \$699/699
F26 Archive ST600N5 125MB Int, 5MB/8M \$899
F60/61 Archive 60MB (VPro Int)/(VPro Ext) \$899/1099
F62/63 Archive (5540E 40MB)/(5580I 60MB) \$549/579

ACCESSORIES

R01 Joystick \$17
R03/R04 MS DOS 3.3/4.01 \$79/89
R50 10 Piece PC Tool Kits w/Zipper Case \$18
R54/51 Adj. Mon. Arm/Vertical CPU Stand \$89/14

SWITCH BOX

T01/02 2 Way (2CN36F, 1DB25F)/(1CN36F, 2DB25F) 16/18
 T03/04/11 2 Way (3 CN36F)/(3 DB25F) (3 DB9) 20/20/20
T05/06 2 Way Cross (4 DB25F)/(4 CN36F) \$335/35
T10 2 Way 2-9 Pin F & 2-5 Pin F (Monitor, KBD) \$35
T07/08 2 Way (3 RJ11)/(3 RJ45F) \$30/30
P70/71/2 2 Way 4 Way (Monitor & Kbd) for PS/2 \$35/50
T12/13/16 4 Way (5CN36F)/(5DB25F)/(5DB9F) \$335/35/35
T14 ABCD Multiserial (4DB25M, 1DB25F) \$45
T15 4 Way (4CN36F, 1DB25F) \$45
T20/21 4 Way (5RJ11F)/(5RJ45F) \$50/50
T18/19 W Type 2 in 3 out (DB25F)/(CN36F) \$55/55
T31/33 Printer Buffer 256K Parallel/Serial \$199/269
T40/41 4 Way Auto-Scan Switch, Parallel/Serial \$129/149
T30/32 8 Way Auto-Scan Switch, Parallel/Serial \$179/199
T50/51 Converter (Par to Ser)/(Ser to Par) \$69/69

PRINTER CABLES/ADAPTERS

N01/12/3/7/4 Printer 8/10/15/25' \$712/20/30
N35/54 6' to HP Laser Printer from AT*XT* \$15/15
N04 6' Centronic 36P M/M Parallel switchbox \$10
N39/37 DB25F-CN36M/DB25M-CN36M \$8/8
N36/38 DB25F-CN36F/DB25M-CN36F \$8/8

SERIAL CABLES/ADAPTERS

N05/06 6' Modem Cable DB25-F-M XT*/AT* \$7/7
N44/45 6' Serial Adapter DB25M-DB9F/DB25F-DB9M \$5/5
N90/91 Adapter DB25M-DB9M/DB25F-DB9F \$7/7
N80/81 Adapter RJ45-D25/RJ11-DB9 \$5/5
N82/83 Adapter RJ45-DB25/RJ45-DB9 \$9/9
N02/77 DB25 M/M Serial Switchbox 6/15' \$7/23
N78/79 DB9 M/M Serial to monitor switchbox 6/15/27/33 \$9/23
N03/70 DB25 M/F Serial Extension 6'15' \$7/23
N71/72 DB25 M/F Serial Extension 25/50' \$30/45
N16/19 1925 SP Connector (for DTK) XT*/AT* \$7/7

DRIVE CABLES/ADAPTERS

N09/13 XT HD Cable/AT H&F D Cable \$7/10
N20/21 FDC Cable XT*/AT* \$5/5
N65/64 Y Twin Drive Power Adapter 5.25/3.5 \$7/7
N66 5.25" to 3.5" Drive Power Adapter \$7
N55 SCSI Flat Cable (iDSC0iDSC50) \$12
N67 External Floppy Drive Adapter for 2 drives \$25
N68 40 to 34 Pin Floppy Adapter for PS/2 \$50

MONITOR & KBD CABLES

N17/14 DB9 M/F Monitor Extension 6'10' \$7/10
P14 6' PS/2 Monitor Ext Cable high density DB9 \$14
P05/06/07/13 6' VGA Adapter Cable for Mitsubishi/Sony/Samsung/NEC \$20/20/20/20
N11/50 Monitor (Power Cord)/(Adapter) \$7/7
N51 6' Monitor/PC Power Adapter Cable \$7
N52 6' Monitor/Power Extension Cable \$7
N18/10 Keyboard Ext. Cable 6'10' \$7/10
N69/112 PS/2 Kbd Cable Adapter/Extension \$12/15

GENERATOR CHARGERS

N40/41 DB9 M-M/F-F \$5/5
N42/43 DB25 M-M/F-F \$5/5
N48/49 Centronics 36P M-M/F-F \$8/8

NULL MODEMS

N46/47/57 DB25 NM Adapter M/M-F-F/M-F 510/10/10
N95/96/97 DB9 NM Adapter M-M/F-F/M-F \$8/8/8
N60/61/62 DB25 NM Cable M-M/F-F/M-F \$12/12/12

OTHER WIRINGS

N15 Power Supply Cord \$7
N26 Jumper Box DB25 M/F \$10
N29 RS232 Mini Tester with LEDs DB25 M/F \$10
N3

DragonSlayer!!

Turn your LAN into a **COMPLETE BUSINESS** and **TIME MANAGEMENT** system!

Most Accounting software does basic bookkeeping,
BUT WHAT ABOUT:

- ★ SALES LEAD GENERATION?
- ★ QUOTE PREPARATION?
- ★ SALES MANAGEMENT?
- ★ QUOTE TRACKING?
- ★ HANDLING TELEPHONE INQUIRIES?
- ★ STAFF SCHEDULING?
- ★ MAILING LIST CREATION?
- ★ COLLECTION ACTIVITIES?
- ★ WARRANTY TRACKING?
- ★ SPECIAL CUSTOMER PRICING?
- ★ COMMISSION CALCULATIONS?
- ★ TRAINING NEW EMPLOYEES?
- ★ CASH FLOW MANAGEMENT?

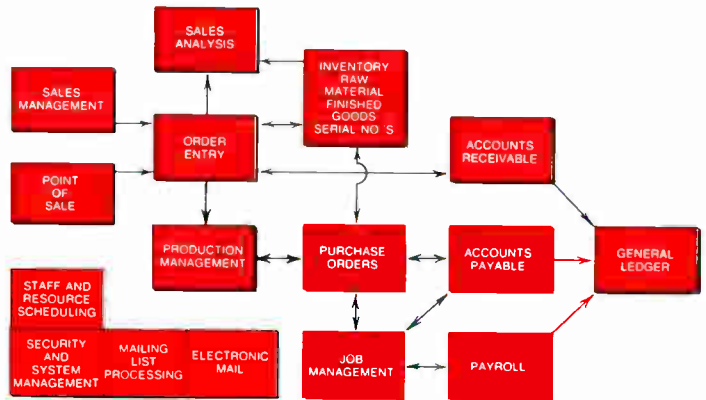

EASY-TO-USE

USER CUSTOMIZABLE on-line HELP reduces installation, training.

Easy-to-use. INTUITIVE menus and data entry screens.

USER specific ON-LINE TICKLER file provides electronic desk.

Inter-user MESSAGING eases scheduling pains.

CONCISE manuals provide installation and reference sections.

RECALL vendors, customers, items, employees, prospects, or other data by FULL or PARTIAL NAME.

FAST DATA ENTRY for high transaction environments.

DISTRIBUTION

Process sales orders for SERIAL, one-of-a-kind, or CATALOGUE items with full integration.

AUTOMATICALLY prepares QUOTES, CONVERTS quotes to orders.

EASILY process COMPLEX PRICING and COMMISSION CALCULATIONS.

ON-LINE PURCHASE and QUOTE HISTORY by customer by item.

UNLIMITED SUBSTITUTE and ALTERNATE item codes.

Analyze SALES or PROFIT by salesperson, customer, or line.

MANUFACTURING

SPLIT sales orders among up to three sales reps.

AUTOMATICALLY create COMMON CARRIER freight invoices.

EXPLODE or CREATE Bill-of-Materials at Order Entry. STORED PHRASE RECALL and DIRECTABLE COMMENTS allow complex crate marking or shipping instructions.

Comprehensive JOB COST and STANDARD COSTING.

WARRANTY TRACKING by customer and item.

Comprehensive CASH MANAGEMENT facility calculates AVERAGE DAYS TO PAY based on customer payment history and forecast cash flow.

RETAIL

POINT-OF-SALE allows for serialized and catalogue items.

POP-UP window provides secure TIME CLOCK function.

POS transaction SUSPEND and RECALL function speeds customer checkout.

Recall customer account data by NAME or PHONE NO.

Supports MULTIPLE ELECTRONIC CASH DRAWERS, BAR CODES.

POP-UP window for shelf location, pricing, quantity, for any item by full or partial name search.

AND MORE!

For more detailed information, or diskette based demonstrations, call

800-447-2522

(in PA 412-279-8882)

DragonSlayer is actively seeking authorized resellers.

DragonSlayer Systems

"Comprehensive — Not Complex"

2275 Swallowhill Road, Building 900 • Pittsburgh, PA 15220

(412)279-8882

Mac II Coprocessor Uses 88000 RISC Architecture

Software applications on a Macintosh II with the new Tektronix RP88 graphics coprocessor board will operate up to 30 times faster than on a 68020-based Mac II, Tektronix claims. That's because the RP88 has a Motorola 88000 RISC processor as its engine.

The RP88 also contains a 20-MHz 88100, 2 megabytes of DRAM, a 32K-byte cache, and a built-in floating-point coprocessor, resulting in a claimed rating of 17 million instructions per second.

Applications that take advantage of the coprocessor will split duties between it and the native 68020. Access to the screen, keyboard, disk, and user interface is managed by the 68020 to take advantage of the Mac OS and Toolbox. Computationally intensive math and graphics are shifted to the 88100.

Price: RP88, \$9575; developer's kits for C and FORTRAN, \$995 and \$1995, respectively.

Contact: Tektronix, Inc., Tektronix Industrial Park, P.O. Box 500, Beaverton, OR 97077, (503) 627-7111. **Inquiry 1004.**

Two Programs for the Legal Profession

Client Management and Docket Control from LegalBYTES lets you customize its rules of procedure to fit your requirements. Once you've defined your rules, CMDC will recommend dates (e.g., a statute of limitations) by which you should accomplish a task.

With CMDC, you can manage an unlimited number of clients and matters per cli-

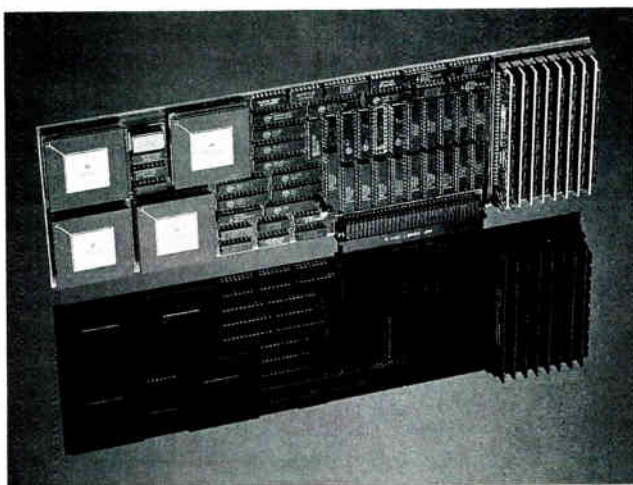

The RP88 coprocessor board provides up to 17 million instructions per second.

ent, court appearance dates, and other deadlines. It has an opposing counsel database, and you can view dockets in several ways through Agenda-like views. A utility lets you transfer names and addresses from Timeslips, North Edge Software's time and billing program. CMDC can also import data in fixed and comma-delimited ASCII format. CMDC works on the IBM PC with 512K bytes of RAM and a hard disk drive.

Price: \$299. **Contact:** LegalBYTES, Inc., 9700 Richmond Ave., Suite 230, Houston, TX 77042, (713) 787-0090. **Inquiry 1006.**

TSC Computing recently released PC Constitution 1.0, a database of the U.S. Constitution. The database includes the Bill of Rights and all amendments. Using Supra II (a substantive system that lets you assemble documents by searching for and retrieving essential text) and PC Constitution, you can quickly assemble legal documents and briefs to retrieve information in a HyperCard-like fashion and assemble sections of text into a complete document.

Browsing, pasting, printing, and word searches are possible with pull-down and pop-up menus. The program runs on the IBM PC with 256K bytes of RAM. The Plus Edition has indexed word-search capabilities, TSC Computing reports.

Price: Standard Edition, \$24.95; Plus Edition, \$49.95. **Contact:** TSC Computing, Inc., P.O. Box 872687, Wasilla, AK 99687, (907) 373-6550.

Inquiry 1007.

Modify Text in HyperCard Stacks Sans HyperCard

Symmetry's HyperDA, the HyperCard stack browser, now lets you modify text fields in HyperCard stacks without requiring HyperCard itself. With HyperDA 1.2, you can search and retrieve HyperCard stacks, modify the text, and save it to disk.

You can also use HyperDA 1.2 to put HyperCard stacks on a Macintosh with as little as 512K bytes, because the program needs only about 67K bytes.

Symmetry reports that it has also added an auto-open feature and enhanced the Find function.

Price: \$89.

Contact: Symmetry Corp., 225 East First St., Suite 107B, Mesa, AZ 85201, (800) 624-2485 or (602) 844-2199.

Inquiry 1005.

Nutrition Planner Helps You Eat Healthier

The Nutrition Prospector is for professional dietitians, nutritionists, and health-conscious consumers who want to analyze and improve diets.

The program's database is derived from the USDA's *Agriculture Handbook 8* and some of its supplements. The database has more than 2500 entries, and you can add more. The program tracks basic nutrient variables such as fat, protein, cholesterol, sodium, calcium, and fiber.

Nutrition Prospector lets you enter in a recommended diet. You can compare foods actually eaten to recommended foods and see the effects of the substitution on nutrient values, totals, and goals on a per food, meal, or daily basis. You can also produce summary reports for one or several days.

The program comes in two versions. With the Professional version, you can track and maintain client and organization information. The Personal version lets you track all the members of your family.

Both versions run on the IBM PC with 640K bytes of RAM, DOS 2.1 or higher, and a hard disk drive.

Price: Personal version, \$79; Professional version, \$185. **Contact:** Constructive Solutions, Inc., 5506 Mercedes, Dallas, TX 75206, (214) 826-4327.

Inquiry 1008.

continued

How does FOUNTAIN 386SX compare with a true 386?

	Landmark	SI advanced	Integer Add Loop	Integer Multiply Loop	String Sort and Move	Prime Number Sieve	802086 Instruction Set
FOUNTAIN 386SX	21.2	18.0	.88	.60	1.20	1.76	4.07
COMPAQ 386/16	20.0	17.6	.99	.60	1.37	1.87	4.23

PC Magazine Benchmark Tests (Time in Seconds)
Compaq is a trademark of Compaq Computer Corp.

FOUNTAIN 386SX. The Smart Choice.

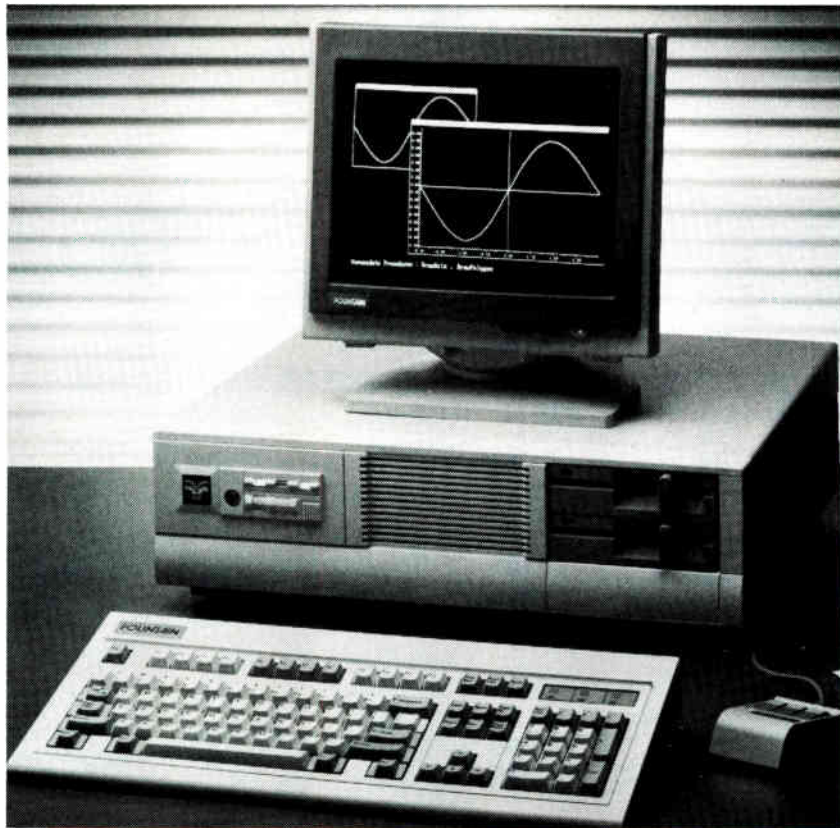

PROCESSOR Intel 32-bit 386SX at 16 MHz; socket for Intel 387SX coprocessor; real time clock/calendar.

MEMORY 1 MB of DRAM standard, zero-wait state; maximum 4 MB on board; expandable to 16 MB.

EXPANSION Six 16-bit and two 8-bit expansion slots.

POWER SUPPLY 200 watts standard; 110 VAC at 60 Hz; 220 VAC at 50 Hz.

KEYBOARD Enhanced 101-key layout.

FIXED-DISK CONTROLLER High-performance AT-type 1:1 interleave or ESDI controller.

STORAGE 5 1/4" 1.2 MB floppy disk drive standard; 3 1/2" 1.44 MB optional; choice of 40, 80, 110 or 320 MB hard disk drive.

OPTIONS Monochrome display: FTN Hercules-compatible display board, FTN 1451 14-inch flat-screen monitor; VGA display: FTN VGA Extender™ with 800x600 resolution.

\$1995.

FTN-386SX with

- 1 MB memory at zero-wait state;
- 1.2 MB floppy disk drive;
- 1:1 interleave hard-disk controller;
- 40 MB hard disk drive; and
- Monochrome display package.



FOUNTAIN TECHNOLOGIES INC.

12K WORLD'S FAIR DRIVE
SOMERSET, NJ 08873
TEL: (201) 563-4800



Magitronic's Basic XT Starter Package

CGA, 20MB Hard Drive

\$1429

BASIC SYSTEM COMES WITH THESE GREAT FEATURES:

- 8088-12 Processor
- 4.77 MHz Hardware/Software Switchable Speeds
- 640 KB RAM on Board
- 8 Expansion Slots
- 20 MB Hard Drive
- 360 KB, 5.25" Floppy Drive
- Hard Disk Controller
- Multi I/O w/ 1 Serial, 1 Parallel, 1 Game Port & Floppy Disk Controller
- CGA Card
- XT Case with Turbo, Reset Switches
- 150 Watt Power Supply
- 101 Key Enhanced Keyboard



MONITOR SAMSUNG CK4644

- 14" Color Monitor
- 640 x 200 Resolution
- 0.41 mm DP

PRINTER, STAR NX1000 MULTI-FONT

- 9 Pin Dot Matrix
- 144 CPS Draft, 36 CPS NLO
- High Resolution Text and Graphics
- Four Built-in Fonts
- Standard Friction and Tractor Feeds
- Paper Parking Mechanism

MOUSE PROCORP MOUSE PACKAGE

- Setup & User's Guide
- Setup Disk & Drivers
- ProCorp Mouse Dr. Halo III Program Disk and Manual
- 9 - 25 Pin Adapter

MS-DOS 4.01 OR 3.3 WITH GW BASIC

DISK STORAGE BOX

- Holding 100 pcs. of 5.25" Diskette
- 3M 5.25" DS/DD Diskette (10 Pcs)

6 OUTLET UL LISTED SURGE PROTECTOR

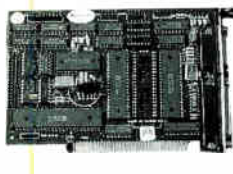

VIDEO CARDS

- AA-MAGITRONIC
- A-B133H Mono Graphic Card \$47
- A-B103H Mono Graphic w/PP \$49
- A-B104H Color Graphic Card \$42
- A-B111H Color Graphic w/PP \$44

VIDEO SEVEN

- A-VRAM-VGA Full length, VGA compatible, 256K VRAM, 800x600 4-color, 800x600 16-colors, and 640x400, 256 colors \$413
- A-FW-VGA Full Length VGA Compatible, 256K DRAM, 800x600 16-color & 640x400 256-color \$289
- A-VEGA-VGA Short Card 800x600 & 720x540 16-color \$259
- A-VEGA-DELUXE Short Card 40x480 & 752x410 16-color \$199

PARADISE

- A-EGA302 EGA Auto Switch 640x480 \$195
- A-VGA402 VGA Plus, 800x600 Resolution in 16 Colors \$269
- A-VGA403 VGA Plus 16 Card 800x600 Resolution in 16 Colors \$309
- STB
- A-EGA301 EGA Card, Auto Switch, 640x350 \$169
- Renaissance
- A-VGA405 16 Bit VGA, 800x600 Resolution in 16 colors \$255

KEYBOARDS

- D-K151L 84 Key XT/AT Switchable \$45
- D-K156 101 Key Enhanced XT/AT Switchable \$55
- D-K158 Small Footprint, 101 Key Full Function, PC/XT, AT Compatible \$54

INTERFACE BOARDS

- AA-MAGITRONIC
- A-B208 AT 2 5MB RAM Card \$59
- A-B231 AT I/O Card P/S/G \$39
- A-B231-2 AT Serial/Parallel Card \$35
- A-B1324 Multi I/O Card, w/S/P/G/CLC/FDC/2 Drives \$45
- A-B131 XT I/O Plus II Card with S/P/G/CLC \$37
- A-B113 640KB RAM Card \$29
- A-B235 XT/AT 2 MB EMS Card \$79

TAPE BACK-UP SYSTEMS

- COLORADO NEWTRON SYSTEMS INC.
- D-DJ10 40MB, Runs Off Floppy Interface PC/XT/AT Compatible \$259
- D-TU-40 40MB, DC2000 Data Cartridge \$24
- D-TU-60 60MB, DC2000 Data Cartridge \$29
- B-KE-10 External Kit for DJ-10 \$99
- B-AB-10 Tape Adapter Board \$85

SYSGEN Bridge Series

- B-SYS2260 External 5 1/4" 360 KBIT 1 2 MB Floppy Drive \$219
- B-SYS2261 External 3 1/2" 720 KB/1 44 MB Floppy Drive \$229
- B-SYS2294 Adapter Card to Interface Bridge Drive on PC/AT & Compatible \$52
- B-SYS2381 Adapter Card to Interface Bridge Drive on PC/XT & Compatible \$52

RELIANT SERIES

- B-SYS310 Internal 5 1/4" 60MB \$465
- B-SYS315 External 5 1/4" 60MB \$685
- B-SYS350 Internal 5 1/4" 125MB \$770
- B-SYS355 External 5 1/4" 125MB \$899

MONITORS

- AA-SAMSUNG
- C-S5-MA2565 12" Amber, Monochrome Monitor w/Swivel \$75
- C-S5-CW4644 14" RGB Monitor, 640 x 200 \$229
- C-S5-CM4531 14" EGA Monitor, Tilt & Swivel Base, 640 x 350 \$339
- C-S5-MZ4571 14" Paper white, Flat Screen Mono Monitor, 720 x 350 \$109
- C-S5-CN4551 14" Multisync Monitor, w/Tilt & Swivel Stand, 800 x 580 \$439
- C-S5-MP5671 15" Full Page Monochrome Monitor w/Video Board, Tilt & Swivel Stand, 1006 x 1048 \$839

Seiko

- C-SK-CM1430 14" VGAS Monitor, 1024 x 768 \$609

POWER SUPPLY

- AA-MAGITRONIC
- D-P150 150 Watt for XT \$45
- D-P200 200 Watt for AT \$59
- D-P900 200 Watt for Baby AT \$59
- D-P500 230 Watt for AT Vertical Case \$69
- D-P103 6 Outlet Surge Protector \$99

Standby Power System

- D-TPBC450 450 Watt, 5 ms Transfer Time, 34 mins Backup Time @ 1/2 Load, 76 Ah Battery \$339
- D-TPBC325 325 Watt, 5 ms Transfer Time, 55 mins Backup Time @ 1/2 Load, 76 Ah Battery \$275
- D-TPIB6 6 Outlet with 3 Individual Filters, 6' Cord \$54
- D-TPIB4 4 Outlet with 2 Individual Filters, 6' Cord \$45

DISK DRIVES

- Seagate Hard Drives
- B-HD-225 20MB, 65 ms, MFM, B-HD-225 w/Western Digital Controller \$219
- B-HD-238R 30MB, 65ms, RLL, B-HD-238R w/Western Digital Controller \$275
- B-HD-251 40MB, 40ms, MFM, B-HD-251-1 40MB 28ms, MFM \$239
- B-HD-277R 60 MB, 40ms, RLL, 1/2 Ht \$299
- B-HD-4096 80MB, 28ms, MFM, Full Ht \$339
- B-HD-4144R 122 MB, 28ms, RLL, Full Ht \$389
- B-HD-4144R 122 MB, 28ms, RLL, Full Ht \$399
- B-HD-4096 80MB, 28ms, MFM, Full Ht \$599
- B-HD-4144R 122 MB, 28ms, RLL, Full Ht \$679

TOSHIBA Floppy Drives

- B-FD-04DT 360KB, DS/DD XT Only Black \$69
- D-FD-04DEG 360KB, DS/DD XT/AT Beige \$69
- B-FD-08DEG 1.2 MB High Density \$85
- B-FD-352 3 1/2" 1 MB Formatted with Installation Kit \$80
- B-FD-356 3 1/2" 2 MB (1 44 MB Formatted) with Installation Kit \$95

MOUSE

- LOGITECH Serial Mouse with Software \$69

MODEMS

- AA-MAGITRONIC
- A-MD1200-I 1200 Baud Internal \$59
- A-MD2450-I 2400 Baud Internal \$99
- A-MD2400-EX Cardinal 2400 Baud External \$129

PRINTERS

- starline
- E-NX1000 Multifont 9 Pin, 144 CPS Draft, 36 CPS NLO \$159
- E-NX1000 Rainbow 9 Pin, 144 CPS Draft, 36 CPS NLO, 7 Color Printing \$229
- E-NX115 9 Pin, 120 CPS Draft, 30 CPS NLO \$290
- E-NB2410 24 Pin, 216 CPS Draft, 72 CPS NLO \$419
- E-NX2400 24 Pin, 170 CPS Draft, 57 CPS NLO \$339
- E-NX1000 Black Ribbon \$695

Panasonic

- E-P1180 9 Pin, Narrow Carriage, 192 CPS Draft, 38 CPS NLO \$179
- E-P1191 9 Pin, Narrow Carriage, 240 CPS Draft, 48 CPS NLO \$245
- E-1592 9 Pin, Wide Carriage, 216 CPS Draft, 45 CPS NLO \$389
- E-P1595 9 Pin, Wide Carriage, 388 CPS Draft, 61 CPS NLO \$445
- E-P1124 24 Pin, Narrow Carriage, 192 CPS Draft, 63 CPS NLO \$315
- E-P4450 Laser Printer 11 PPM, 300 DPI, 5 Emulations, Standard Serial or Parallel Interface \$1345

CONTROLLERS

- WESTERN DIGITAL
- A-WDXT-GEN2 Winchester XT Controller with Dynamics Bios \$59
- A-WDXT-GEN2R XT RLL Controller \$69
- A-WD27X XT Compatible Winchester RLL Controller \$69
- A-WD-V-MMZAT Compatible Winchester/Floppy Controller, 8/20 MHz \$119
- A-WD-V-SR2 AT RLL Enhanced Winchester/Floppy Controller \$139

Orders Only 1-800-227-5454

TERMS

All prices reflect cash discount. We accept Mastercard and Visa, cashiers check, cash or certified check. Personal and company checks require 3 weeks to clear. Add \$3 handling charge per box plus additional shipping charges. COD orders - add \$3 per carton. All defective merchandise must have RMA number. Allow 2 to 3 weeks for replacement. All defective items will be replaced or repaired at our discretion within the limits of the manufacturer's warranty. All return items must be shipped prepaid and insured. Complete 1 year Warranty on system. 1-year Warranty on Floppy Drive. Full service in-house technical support throughout and beyond Warranty.

CALL FOR SPECIAL MAGITRONIC DEALER PRICES ON ORDERS OF 10 SYSTEMS +

All systems fully assembled, tested, burned in & shipped in computer shipping carton. IBM, PC, XT, AT, Samsung, Toshiba, Microsoft, Seagate, Video Seven, Paradise, Renaissance, Triplate, Seiko, Colorado, Star, Panasonic, Western Digital, Sysgen are registered trademarks of their respective companies.

Prices and availability subject to change without notice.

NEW YORK ORDERS & GENERAL INFO CALL 516-454-8255

FOR TECHNICAL SUPPORT ONLY CALL 1-800-347-5454 516-454-8255

LEASING PROGRAM AVAILABLE TO CORPORATE ACCOUNTS 516-454-8255

MAGITRONIC TECHNOLOGY INC
10 HUB DRIVE, MELVILLE, N.Y. 11747

CALL 1-800-227-5454 IN NY CALL 1-516-454-8255 FAX NO. 1-516-454-8268

MAGITRONIC TECHNOLOGY INC.



We Trump the Competition with On-site Service!

GE Computer Service



SST Systems are Covered by  One Year On-Site Service.

Extended On-Site Service Contracts Available.

286 10 MHz SST

- Intel 80286-10 Processor
- 640K RAM
- 1.2Meg or 1.4Meg Floppy Drives
- Hard Drive Floppy Controller
- Phoenix Bios
- Clock with Battery
- 80087 Math Co-Processor Socket
- 2 Serial and 1 Parallel Port
- Digital Display Panel
- III Enhanced K.E.
- FCC Class B Approved

Choice of Hard Drive & Monitor Size

Price includes optional 3.5" Floppy Disk

TTL Monochrome 750x320 Monitor	20 Meg Hard Drive	\$1699
	40 Meg Hard Drive	\$1849
CGA RGB Color Monitor	20 Meg Hard Drive	\$1847
	40 Meg Hard Drive	\$1995
EGA Enhanced Graphics Monitor 640x350	20 Meg Hard Drive	\$2099
	40 Meg Hard Drive	\$2269
VGA Graphics Monitor 640x480	20 Meg Hard Drive	\$2159
	40 Meg Hard Drive	\$2349

286 16 MHz SST

- True 16MHz CPU
- 640K RAM Expandable to 1Meg on Board
- 1.2Meg or 1.4Meg Floppy Drives
- Hard Drive Floppy Controller
- AWARD Bios
- Clock with Battery
- 80087 Math Co-Processor Socket
- 2 Serial and 1 Parallel Port
- Digital Display Panel
- III Enhanced K.E.

Choice of Hard Drive & Monitor Size

Price includes optional 3.5" Floppy Disk

TTL Monochrome 750x320 Monitor	40 Meg Hard Drive	\$1899
	80 Meg Hard Drive	\$2199
EGA Enhanced Graphics Monitor 640x350	40 Meg Hard Drive	\$2399
	80 Meg Hard Drive	\$2699
Multisync EGA Monitor 640x880	40 Meg Hard Drive	\$2499
	80 Meg Hard Drive	\$2799
VGA Graphics Monitor 640x480	40 Meg Hard Drive	\$2499
	80 Meg Hard Drive	\$2799

386 20 MHz SST

- Intel 80386-20 CPU
- 1Meg RAM
- 1.2Meg or 1.4Meg Floppy Drives
- Hard Drive Floppy Controller
- Phoenix Bios
- Clock with Battery
- 80087 Math Co-Processor Socket
- 2 Serial and 1 Parallel Port
- Digital Display Panel
- III Enhanced K.E.
- FCC Class B Approved

Choice of Hard Drive & Monitor Size

Price includes optional 3.5" Floppy Disk

TTL Monochrome 750x320 Monitor	40 Meg Hard Drive	\$2499
	80 Meg Hard Drive	\$2799
EGA Enhanced Graphics Monitor 640x350	40 Meg Hard Drive	\$2999
	80 Meg Hard Drive	\$3249
Multisync EGA Monitor 640x480	40 Meg Hard Drive	\$2895
	80 Meg Hard Drive	\$3195
VGA Graphics Monitor 640x480	40 Meg Hard Drive	\$2815
	80 Meg Hard Drive	\$3195

Purchase a SST System and receive **\$150 Off**

When You Buy 2 or More SST Systems

Buying a SST System now makes you a member of the  **COMPUTER WHOLESALE CLUB**

This enables you to receive an additional savings of 20% Off your next accessory purchase from our Catalog.

Join Now!

Receive a Membership Card and start saving 20% Off all our Catalog Products. For more details just call:

1-800-347-4778



COMPUTER WHOLESALE CLUB

70847 Richmond, Suite 1111
Houston, Texas 77062



SPECIAL

MS DOS 4.01 . . . \$69.00



Pointech Distributors

36 West 22 Street, New York, NY 10010

Orders: (800) 666-8324 (212) 633-1530

Tech Support: (212) 633-1531 Fax: (212) 633-1532

NOVELL AUTHORIZED DEALER

S Y S T E M K I T S

XT SYSTEM

10 MHz 8088 Motherboard
AT Style Case with LED
150 Watt Power Supply
256K RAM
360K Floppy Drive
Multi I/O with FDC
Clock and Calendar
84-Key Keyboard

\$339

AT SYSTEM

12 MHz Baby 286 Motherboard
AT Style Case with LED
200 Watt Power Supply
512K RAM
1.2M Floppy Drive
Dual Hard/Floppy Controller
Clock and Calendar
101 Enhanced Keyboard

\$599

386 SYSTEM

20 MHz 386 Motherboard
AT Style Case with LED
200 Watt Power Supply
1 MEG RAM
1.2M Floppy Drive
Dual Hard/Floppy Controller
Clock and Calendar
101 Enhanced Keyboard

\$1499

PRINTERS

Panasonic KXP 1180	169
Panasonic KXP 1124	309
Okidata 183 (132 Col)	250
Brother M1709 (132 Col)	359
Fujitsu DL3400 (132 Col)	549
HP DeskJet Plus	899
HP LaserJet IIP	1059

HARD DRIVES

20M Seagate ST225 w/Ctrl	249
30M Seagate ST238 w/Ctrl	269
40M Seagate ST251-1	349
60M Seagate ST277RP	399
80M Seagate ST4096	599
20M CMS Hardcard	329
30M CMS Hardcard	399
80M CDC	639
155M CDC (ESDI)	1199
330M CDC (ESDI)	1999

FLOPPY DRIVES/CONTROLLERS

360K TEAC 5.25"	66
1.2M TEAC 5.25"	82
720K TEAC 3.50"	70
1.44M TEAC 3.50"	82
40/120M Colorado Tape Back Up	289
360/720K Controller	24
1.2/1.4M Controller	49
Dual Hard/Floppy Ctrl (MFM)	69
SR2 Hard/Floppy Ctrl (RLL)	109
Dual 1:1 Hard/Floppy Ctrl (MFM)	109
ESDI Controller	249
SCSI Controller	399

MONITORS

GoldStar Amber 12"	75
GoldStar VGA Multi Sync 14"	449
Imtec PaperWhite 14"	119
Imtec CGA 14"	239
Imtec VGA 14"	349
Imtec EGA 14"	339
Imtec VGA Mono 12"	127

KEYBOARDS

84 Key	39
101 Key Enhanced	49
101 Key Tactile	59

CASES

XT Slide Case	32
AT Slide Case	45
Tower Case	119

MICE

Genius GM w/DrHalo	29
Genius GM6000	
Hi-Res w/DrHalo	49
Logitech Bus w/Software	89
GeniScan GS4500	
Scanner w/OCR	199
Joystick (IBM/Apple)	25

I/O CARDS

Mono Graphics Printer Card	39	Serial Card	23
Color Graphics Printer Card	39	2nd Serial Chip Set	20
GTK EGA Card	109	XT Multi I/O (w/FDC & Clock)	39
GTK VGA Card (8 Bits)	119	Clock Card	39
Smart One VGA (16 Bits)	179	XT 640K RAM Card	23
Serial/Parallel/Game Card	39	Everex 3MEG RAM Card	99
		Parallel Card	19

MODEMS

2-Year Warranty	
Turbo 4X Software	15
Smart One 1200 Int.	45
Smart One 2400 Int.	89
Smart One 2400 Ext.	109
Smart One 2400 Mac Ext.	189
Smart One 2400 PS/2 Int.	179
Made in USA	

POWER SUPPLY

150 Watt XT (110/220)	49
200 Watt AT (110/220)	69
250 Watt UPS	219
500 Watt UPS	399

TERMS AND POLICY

Prices based on COD Cash or Certified Check. Everything shipped Factory Fresh and Warranted.

No non-defective returns. No returns without a RMA #. Minimum S/H \$5.00 per order.

VISA - MC - AMEX

Microcomputer News On-Line

In this fast paced industry, can you afford to wait a week or a month for information that may affect you today?

MicroBYTES Daily is an electronic news service covering the latest developments in the microcomputer industry. If it concerns MS-DOS machines, Macintosh, Unix workstations, Amigas, Atari STs, peripherals, networks or software, you will find it in MicroBYTES.

Fast and Easy

Read the items as they break or use the powerful search command to quickly locate your information. Best of all you can download the text and print it or use it in your favorite word processor.

Whether you are a developer, marketer, or researcher, you need reliable information and you can count on MicroBYTES. Backed by the combined resources of BYTE Magazine, BYTEweek, and BIX, MicroBYTES gives you access to our world-wide network of reporters and the integrity and experience of our editorial staff.

In your position as a leader in new technology, you cannot afford to be just one of the crowd. Get ahead with Micro-BYTES.

Call now and subscribe today.



One Phoenix Mill Lane, Peterborough, NH 03458 1-800-227-2983

IF YOU ARE LOOKING FOR QUALITY, RELIABILITY, AND SERVICE



LOOK NO FURTHER!!! WE ARE PC-PLUS TECHNOLOGIES, INC.

We accept MasterCard, Visa, American Express, and Discover (no surcharge)

PC-PLUS XT 8088-12

- * 4.7712 MHZ Motherboard
- * Phoenix Bios
- * 8 Expansion Slots
- * 150 Watt Power Supply
- * 640K of Memory
- * 360K Floppy Drive
- * 12" Monochrome Monitor
- * Monographics Card (Hercules Compatible)
- * Parallel-Serial-Game Ports
- * Clock Calendar
- * 101 Key Keyboard
- * MS DOS 4.01 & GWBasic
- * 2 Year Warranty

\$699

XT Mono

- * 20MB Seagate Hard Drive \$989
- * 30MB Seagate Hard Drive \$1019
- * 40MB Seagate Hard Drive \$1129
- * 65MB Seagate Hard Drive \$1219

XT CGA Color System

\$859 with:

- * 20MB Seagate Hard Drive \$1159
- * 30MB Seagate Hard Drive \$1189
- * 40MB Seagate Hard Drive \$1299
- * 65MB Seagate Hard Drive \$1389

XT EGA Color System

\$1099 with:

- * 20MB Seagate Hard Drive \$1399
- * 30MB Seagate Hard Drive \$1429
- * 40MB Seagate Hard Drive \$1539
- * 65MB Seagate Hard Drive \$1629

PC-PLUS AT 286-12

- * 6/12 MHZ Motherboard (0 wait state)
- * Phoenix Bios
- * 8 Expansion Slots
- * Landmark 15.9 MHZ
- * 220W Power Supply
- * 640K of Memory (exp. to 4MB)
- * 1.2MB 5.25" or A 1.44MB 3.5" Floppy Drive
- * 12" Monochrome Monitor
- * Monographics Card (Hercules Compatible)
- * Parallel-2 Serial-Game Ports
- * 101 Key Keyboard
- * MS DOS 4.01 & GWBasic
- * 2 Year Warranty

\$889

286/12 Mono

- * 20MB Seagate Hard Drive \$1229
- * 30MB Seagate Hard Drive \$1279
- * 40MB Seagate Hard Drive \$1399
- * 65MB Seagate Hard Drive \$1489
- * 80MB Seagate Hard Drive \$1689

286-12 EGA Color System

\$1279 with:

- * 20MB Seagate Hard Drive \$1629
- * 30MB Seagate Hard Drive \$1679
- * 40MB Seagate Hard Drive \$1799
- * 65MB Seagate Hard Drive \$1889
- * 80MB Seagate Hard Drive \$2069

286-12 VGA Color System

\$1529 with:

- * 20MB Seagate Hard Drive \$1679
- * 30MB Seagate Hard Drive \$1929
- * 40MB Seagate Hard Drive \$2049
- * 65MB Seagate Hard Drive \$2139
- * 80MB Seagate Hard Drive \$2319

PC-PLUS 386-20

- * 6/20 MHZ Motherboard
- * Supports 80387 Math Co-processor
- * 8 Expansion Slots
- * Landmark 26.7 MHZ
- * 220W Power Supply
- * 1024K of Memory (Exp. to 8MB)
- * 1.2MB 5.25" or A 1.44MB 3.5" Floppy Drive
- * 12" Monochrome Monitor
- * Monographics Card (Hercules Compatible)
- * Parallel-2 Serial-Game Ports
- * 101 Key Keyboard
- * MS DOS 4.01 & GWBasic
- * 2 Year Warranty

\$1649

386/20 Mono

- * 20MB Seagate Hard Drive \$1999
- * 30MB Seagate Hard Drive \$2049
- * 40MB Seagate Hard Drive \$2169
- * 65MB Seagate Hard Drive \$2259
- * 80MB Seagate Hard Drive \$2439

386-20 EGA Color System

\$2039 with:

- * 20MB Seagate Hard Drive \$2389
- * 30MB Seagate Hard Drive \$2439
- * 40MB Seagate Hard Drive \$2559
- * 65MB Seagate Hard Drive \$2649
- * 80MB Seagate Hard Drive \$2829

386-20 VGA Color System

\$2289 with:

- * 20MB Seagate Hard Drive \$2529
- * 30MB Seagate Hard Drive \$2589
- * 40MB Seagate Hard Drive \$2709
- * 65MB Seagate Hard Drive \$2799
- * 80MB Seagate Hard Drive \$2979

PC-PLUS 386-25

- * 6/25 MHZ Motherboard
- * 32K Cache Memory
- * 8 Expansion Slots
- * Landmark 41.7 MHZ
- * 220W Power Supply
- * 1024K of Memory (Exp. to 8MB)
- * 1.2MB 5.25" or A 1.44MB 3.5" Floppy Drive
- * Monographics Card (Hercules Compatible)
- * 12" Monochrome Monitor
- * Parallel-2 Serial-Game Ports
- * 101 Key Keyboard
- * MS DOS 4.01 & GWBasic
- * 2 Year Warranty

\$2209

386/25 Mono

- * 20MB Seagate Hard Drive \$2559
- * 30MB Seagate Hard Drive \$2809
- * 40MB Seagate Hard Drive \$2729
- * 65MB Seagate Hard Drive \$2819
- * 80MB Seagate Hard Drive \$2999

386-25 EGA Color System

\$2599 with:

- * 20MB Seagate Hard Drive \$2949
- * 30MB Seagate Hard Drive \$2999
- * 40MB Seagate Hard Drive \$3119
- * 65MB Seagate Hard Drive \$3209
- * 80MB Seagate Hard Drive \$3389

386-25 VGA Color System

\$2849 with:

- * 20MB Seagate Hard Drive \$3199
- * 30MB Seagate Hard Drive \$3249
- * 40MB Seagate Hard Drive \$3369
- * 65MB Seagate Hard Drive \$3459
- * 80MB Seagate Hard Drive \$3639

**TOLL-FREE
TECHNICAL SUPPORT**

**MONEY-BACK
SATISFACTION
GUARANTEE**

**2 YEAR
LIMITED WARRANTY**

**QUALITY AND
RELIABILITY**

TWO-YEAR WARRANTY

**PC-PLUS TECHNOLOGIES
CALL TOLL FREE 1-800-422-4947**

**Loft Plaza ■ 65 Southbridge Street ■ Auburn, MA 01501
PHONE: (508) 831-9826 ■ FAX: (508) 799-9941**

PAYMENT TERMS:

We accept MasterCard, VISA, Am Ex., Discover, Certified Checks, Money Orders, Personal Checks (allow 7-10 days for processing). We also accept Corporate, Equivalent, Governmental P.O.'s.
*Massachusetts residents add 5% sales tax.
*Prices subject to change without notice.



Document-Comparison Program

DocuComp, a document-comparison program for the Macintosh and the IBM PC, can directly compare files from two different word processors in their native file formats and save them in a third format, while preserving 99 percent of the character formatting, the developer reports.

According to Advanced Software, DocuComp converts the word processor's format into its own format and then converts it back to the original (or a different) format, while comparing the versions of the document or program. A mode for programmers shows changes made in source code listings. The new version shows changes in documents that are periodically updated, but it can also serve as a word processor file conversion program.

DocuComp presents the results of the comparison in three ways. A two-panel comparison window shows corresponding sections of the compared documents, in which you scroll both documents in sync or jump to the next or previous change. Each change is highlighted. In another form of display, a saved or printed document shows inserted, deleted, replaced, and moved text. The program identifies changes within moved text. And finally, a comparison summary gives you each revision made by page and line number.

DocuComp 1.0 deals mostly with the words, ignoring character attributes such as boldfacing, underlining, and changes in fonts. Version 2.0 for the IBM PC should be available by the time you read this; the upgrade for the Mac should be available in January, the company reports.

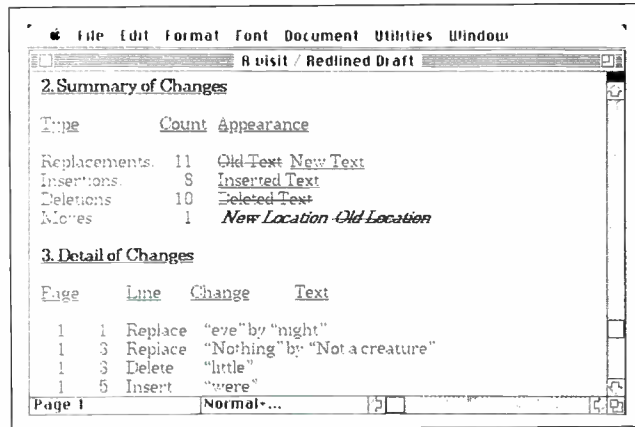

DocuComp shows you precisely the changes in your document.

The program requires at least 384K bytes of RAM in both IBM PC and Mac versions. **Price:** \$159.95. **Contact:** Advanced Software, Inc., 1095 East Duane Ave., Suite 212, Sunnyvale, CA 94086, (408) 733-0745. **Inquiry 1009.**

Develop Systems at the Design Level

Aplaud lets you develop and maintain multiuser IBM PC-based systems at the design level without writing one line of programming code, according to Interna-

tional Consulting Enterprises (ICE). Once you've finished designing the application, Applaud will analyze the design specifications and produce a customized user's manual. You can customize the manual for individual users, so that only the features they are permitted to access are documented. The manual includes a data dictionary, database specifications, application specifications, and a system cross-reference list.

Applaud uses a building-block technique. Components include a screen generator, a screen painter, five report generators, and import/export functions. When you develop a

system, windowing technology, bar menus, password security, and context-sensitive help are automatically included.

ICE reports that Applaud works with any CASE methodology, or no methodology at all. Applaud analyzes the design specifications and performs record locking and file locking as required by a network. Applaud is written in Realia COBOL and runs on the IBM PC with DOS 3.0 or higher, 640K bytes of RAM (485K bytes free), and 3 megabytes of memory on a hard disk drive.

Price: \$2495.

Contact: International Consulting Enterprises Ltd., 10 South Riverside Plaza, Chicago, IL 60606, (800) 426-0428 or (312) 454-3200.

Inquiry 1010.

Mac Printing on HP Laser Printers

The Grappler LX is an expensive printer interface for HP-compatible laser printers, DeskJet printers, and Epson 24-pin printers that works with your Macintosh Plus, SE, SE/30, II, IIX, or IICx.

It includes AppleTalk compatibility and five fonts (Swiss, Courier, Dutch, Garamond, and Zapf Chancery Medium Italic). For quick installation, you use the Auto-Installer software.

Price: \$199.

Contact: Orange Micro, Inc., 1400 North Lakeview Ave., Anaheim, CA 92807, (800) 223-8029 or (714) 779-2772.

Inquiry 1011.

continued

Business Calculator for Maximizer

Richmond Software has introduced an add-on business calculator for the company's contact-management program, Maximizer. With MaxCalc, all calculations are visible on a scrollable tape, and you can insert them into a note or diary entry in Maximizer or paste them into a letter using Maximizer's cut-and-paste routine.

Two modes, standard and reverse Polish notation, are available. The calculator can handle discounted cash flow analysis, annuities, actuarial, depreciation, bonds, simple and compound inter-

est, loan amortization, statistics, and interest rate conversion.

Maximizer itself can handle writing, note taking, diary entries, expense accounts, and label printing. Maximizer runs on the IBM PC with 640K bytes of RAM and a hard disk drive.

Price: \$24.95; Maximizer, \$195; Maximizer for LANs, \$495.

Contact: Richmond Software, Inc., 6400 Roberts St., Suite 420, Burnaby, BC, Canada V5G 4C9, (604) 299-2121.

Inquiry 1015.

SUPER BOWL 34.5 Mhz

\$945

Super Bowl Bare Bone

- Vertical Case, Speed Display, Turbo Reset Buttons, 4 LED, Light, Fan, 5 Opening, 1 Full High Hidden, 1 Half High Hidden, Security Lock Diskette Holder, 8" x 27" x 17"
- Intel 386-20 CPU Motherboard Landmark = 34.5Mhz (2Mb) 8 Mb Expand on Board AMI BIOS, 80287, 80387 Socket Chips Tech. Chipset

FCC Class A\$945

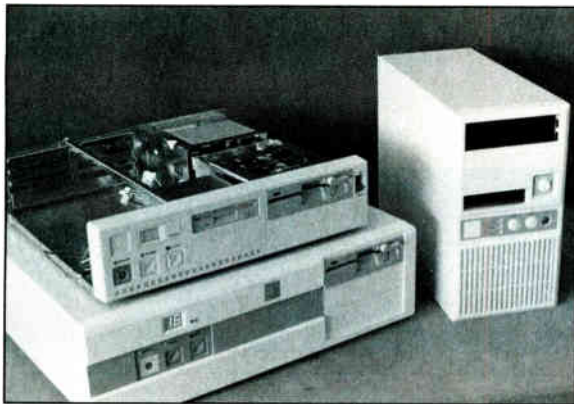

Best Quality

We use Name Brand Parts, Fancy Case, Heavy Duty Components Only.

- We accept Master & Visa, 3% surcharge.
- COD Order based on Cashiers Check, Money Order.
- 10% Restocking fee within 30 days from invoice date.
- All returns are subject to our approval.

Best Service

18 Months Labor & Parts Warranty. We issue UPS "Call Tag" to Pick Up Computer for Repair.

We build computers for Consultants, VARS, Resellers, Dealers, Corporate Buyers, Universities, APO, FPO. All Fancy Case, Top Quality Motherboard, Reliable add-on cards, Teac Floppy Drive, Keyboard Networking Supply, ARcent Card, Ethernet Card, Diskless Workstation, Large Quantity in Stock!

Mascot Computer Corp.

Wholesale: Tel: (718) 321-1944 Fax: (718) 321-0136
42-20 College Point Blvd., Flushing, NY 11355 (5 minutes from Shea Stadium)
Retail: Tel: (212) 766-0955 Fax: (212) 385-4010 Open: Mon.-Sat. 10-6:00

Micro to Mainframe Data Exchange for IBM PC, PS/2 and RT.

Interface Data offers 9-track tape systems for IBM micros and compatibles, enabling convenient data exchange with practically any mini or mainframe computer.

Our 1/2" streamers are self-loading, desktop systems complete with tape controller and easy-to-use menu-driven software. Multiple options include 800, 1600, 3200 and 6250 bpi. And for back-up, industry standard 1/2" tape is the most reliable medium available.

When data exchange and fast back-ups are the question, Interface Data has the answer. Nobody knows more about 9-track tape. For the most complete line of 1/2" streamers, with local service and support, call us today.



Series 3 9-track tape sub-system

- XT/AT or PS/2 Microchannel connection
- DOS, OS/2, AIX or other drivers
- IBM/ANSI/ECMA tape format
- Automatic ASCII/EBCDIC conversion
- High-performance tape drives



Interface Data, Inc.
800 West Cummings Park #6900
Woburn, MA 01801
617-938-6333
Fax 617-938-0626

Exclusive Software

High Quality Software! Great Prices!
Zephyr Originals, NOT Public Domain
Pick the Ones You Want:

- **Financer Plus**™ - 16 most needed financial calculations. Menu selectable for: amortization schedule, present values, future values, simple & compound interest, installment loan, & much more. Output to screen or printer. *FINANCER is best". G.W., Montana IBM & compat. \$24.95
- **AstroInfo**™ - High accuracy data for the Sun, Moon and all planets. Most results accurate to seconds of arc. Select any date from 9999BC to 4000AD and any latitude and longitude. Provides position in sky, brightness, rise/set times, & much more. Do searches for conjunctions of objects, distances, and locations in the sky. Generates location tables to screen, printer or ASCII files on disk for later use. IBM & compat. \$49.95
- **FormMachine**™ - Easily create, print and save forms for later use. Ideal for message forms, expense reports, invoices, personal data records, etc. Just design what you need on screen and then you are ready to print and use. Include text with regular or condensed print, add boxes, lines, drawings. Create the forms you need as you want them! IBM & compat. \$29.95
- **MortgageMaster**™ - Analyze mortgage terms for a variety of situations. Specify and printout mortgage tables. Use irregular payments or additional payments. Make yearly, monthly, quarterly, weekly, bi-weekly, etc. payments. Generate tables of rate or term variations. Do 4 factor analysis of interest, length, amount and rate for missing value. IBM & Compat. \$39.95
- **SpanishHelper**™ - Learn the Spanish language with your computer. Developed by language experts to contain the 2000 most essential words and phrases to know basic Spanish. Includes introduction to grammar and syntax. With graphics you get to play a game as reward for your progress (graphics not required to run program). FrenchHelper also available. Each \$29.95
- **AlgeTutor**™ - Teaches you algebra and how to apply it. Starts from the easiest level to more advanced topics. Includes example problems with solutions. Learn as you review concepts and then apply them. Ideal for student or as refresher course. Use at your own pace to master this valuable part of math. IBM \$29.95
- **TimeChecker**™ - Now you can always have high accuracy time on your PC or for other needs. TimeChecker automatically calls, logs on and sets your PC system time using the US government standard time service. Also displays correct time and date for all 25 world time zones. You can also access other data related to time and astronomy. IBM, 1200b modem \$39.95

- **TideMaster**™ - Calculates and prints tide tables and graphs for any U.S. coastal state for any day in 1989 or 1990. Includes all US government tide locations. "If you sail, fish, go to beach, TideMaster is a must! Excellent." PC Magazine. Specify for which state. IBM & compat. \$39.95 per US state
- **ArtPack**™ - Generate 10 types of computer art to provide hours of entertainment for you or your kids. Supports CGA, EGA or VGA color monitors for complex & brightly colored creations. Fractals, Moire patterns, Roses from polar equations, Serendipitous circles, Spirographs, 1 and 2 dimensional "life" patterns, Wallpaper art, Sierpinski curves. Picture generation from names or text. Give your computer a real graphics workout! IBM. \$29.95
- **StatCalc**™ - Key statistical functions for student or experienced user. Includes Correlation & Regression, Normal, T, Poisson, Binomial, Chi-square, distributions, data handling for sorts, mean, standard deviation, range, median. Save data to disk. Manual on statistics and program use with examples. IBM, Apple II \$39.95
- **SuperCat**™ - Professional level cataloging for up to 5,000 books per directory with hard disk or 1000 pef floppy (300 for Apple). Multiple subjects & authors, call #, title, publisher, etc. for 13 field types. Print 3x5 index cards & reports in various formats. Sort & retrieve data by any field. Fast and easy to use. IBM & Compat. Apple II \$49.95
- **HoroScopes II**™ - For your birthdate, time & location sky conditions calculated. Get Natal horoscope chart printed or on screen, with zodiac, sun, moon & all planets. Gives astrological reading, sun & moon sign, ascendant, conjunctions & oppositions, other aspects, table of houses & planets (Placidus & Equal house). "Accurate, a software bargain!" PC Mag. IBM \$29.95
- **MyDraftsman**™ - Create detailed drawings on screen and print in variable scale on dot-matrix or laser printers. Use circles, lines, boxes, arcs in a variety of widths and styles. Add text in different fonts and sizes. Use multiple layers for complex drawings. Create objects to save/use later. Works with or without a mouse. Ideal for design work, illustrations, architecture or creative fun! Supports printers and plotters. IBM CGA/EGA \$39.95
- **GraphMaster**™ - Create bar, line, pie, scatter and text charts or graphs, box, circle & line drawing; correlation & regression analysis & curve fitting; scatter plots. Translate data into meaningful graphic pictures, on screen or printed out, in minutes. Use at pixel level and produce drawings and illustrations or just enter a set of data and have GraphMaster create the chart you need. Plot any math function. Save graphs & revise later. IBM \$39.95
- **LabelWorks**™ - Create and maintain mailing lists. Print labels 1, 2, 3, or 4 across. Get reference listings printed in 9 different formats. Easy to use fill-in form on screen to add, revise, or delete names. Also print general labels as tags, labels, etc. IBM & Compat. Apple II \$29.95
- **SunTimes**™ - Generates monthly or yearly sunrise and sunset tables for any year and for any location on Earth. Get output to screen or printer. Also calculates the times of twilight (civil, nautical and astronomical) the maximum altitude of the sun and the hours of sunshine for each day. Accurate, easy to use. IBM. \$29.95

Do you have a professional quality original program? We may want to publish it. Write for our programmer's guidelines. Please do NOT send any software.

- **Write n' Tell**™ - Analyzes handwriting to reveal personality traits. For business testing or fun with family, friends. Developed by certified graphologist. Easy to answer questions yield multi-page report on personality, drives, intellect, emotions. Analyze signatures or text. Detailed manual & handwriting samples provide guidance for accurate use. IBM/Apple II \$49.95
- **DietHelper**™ - Great for weight control, menu planning, special diets, recipe analysis. Tracks intake of calories, sodium, cholesterol, fiber & 20 others for over 1000 foods, & calories for 100 exercises. Add your own foods or recipes. Tutorial disk included teaches you the program. "Extremely easy to use. Highly recommended." Creative Computing. IBM \$39.95
- **LodeStar**™ - The Ultimate Sky Machine! Get an accurate, variable size view of the sky for any date (9999BC to 9999AD) & location on Earth. Investigate the past, present and future with LodeStar! Includes over 9,000 stars, Messier objects & the Sun, Moon & all planets. Any size view from 180 deg. to 0.18 deg. See solar eclipses, planetary conjunctions, occultations, transits, etc. Zoom in or out. Get printouts for field or desk. IBM or compat., 384K, CGA/EGA/VGA. Works with/without co-processor. \$89.95
- **LifeLines**™ - Input the facts on your ancestors, near and far, from distant generations to the present, then generate various reports and listings to make clear your family heritage. Pedigree charts, descendants charts, marriage lists, family groups, alphabetical listings & more. You needn't be a genealogical expert, just select from menus for reports. IBM \$39.95
- **PhysiCalc**™ - Introduction to Physics for high school/college level. Includes mechanics, gravity, electricity, light, quantum mechanics & relativity. 30 key equations explained with easy on screen calculations. Example problems and answers, physics terms and history. IBM or Apple II \$29.95
- **DiskAtlas-USA**™ - Over 29,000 US cities. Plots cities on state or US maps. Zoom in or out to scale needed. Locates all cities a given distance from another city or along a line specified by user. Includes national parks, monuments, etc. Calculates distances between 2 cities. Practical, educational, fun! IBM CGA/EGA \$39.95



Plus 55 More Excellent Programs!
Order Today!

1-800-533-6666

9-9 MON - SAT Orders Only
For Info or in PA Call 412-422-6600

By phone or mail. Check, M.O., credit card (#&expir.). Add \$3 shipping (\$5 overseas). PA add 6%. Give computer type. Add \$1/prog. for 3.5" IBM. Join tens of thousands of satisfied customers in 50 states & 86 countries. Fast shipment!

ZEPHYR SERVICES
1900 Murray Ave. Dept. E Our
Pittsburgh, PA 15217 8th
FREE Catalog-Call or Write Year





MEMORY PRODUCTS & MORE

ONE STOP SOURCE FOR ALL PC MEMORY UPGRADES

2808 Lafayette • Newport Beach, CA 92663

(714) 723-4510 • (800) 222-8861 • FAX: (714) 723-0732

IBM Memory Upgrades

Model	Memory Added	List Price	End User	Dealer
PS/2 25	128K Kit	\$ 99	\$ 40	\$ 30
PS/2 30-286	512K Kit	215	129	99
	2MB Kit	995	440	360
PS/2 50 and 60	512K Kit	215	129	99
	2MB Kit	995	440	360
PS/2 50Z	2MB Module	1395	575	495
	512K Kit	215	129	99
	2MB Kit	995	440	360
PS/2 55 SX	2MB Module	1345	625	495
P/70 Portable	2MB Module	1395	625	495
PS/2 70 E61	1MB Module	695	325	275
	2MB Module	1395	625	495
PS/2 70-121	1MB Module	1395	325	275
	2MB Module	1395	625	495
PS/2 70-A21	2MB Module	1395	625	495
	(the above module goes on the mother board)	695	325	275
PS/2 80-041	1MB Module	695	325	275
PS/2 80-111	1MB Module	1395	695	595
PS/2 80-311	2MB Module	1395	695	595
PS/2 80	2-6 Board	CALL	CALL	CALL
	2MB Module	CALL	CALL	CALL

IBM Memory Boards

PS/2 50,60,50Z, and 55SX	Board w/1MB	CALL
	Board w/2MB	CALL
	Board w/4MB	CALL
PS/2 50,60,50Z	Board w/1MB	CALL
	Board w/2MB	CALL
	Board w/4MB	CALL
PS/2 70 and 80	Board w/2MB	CALL
	Board w/4MB	CALL
	Board w/8MB	CALL

Hewlett Packard Memory Upgrades

Model	Memory Added	List Price	End User	Dealer
Vectra RS/25C	1MB Kit	\$ 699	\$390	\$228
	4MB Kit	2299	680	620
Vectra RS/25	1MB Kit	699	280	228
	4MB Kit	2299	680	620
Vectra RS/20	1MB Kit	699	280	228
	4MB Kit	2299	680	620
Vectra RS/20C	1MB Kit	699	290	196
	4MB Kit	2299	660	590
Vectra QS/20	1MB Kit	699	240	196
	4MB Kit	2299	660	590
Vectra QS/16-SX	2MB Kit	1195	330	295
Vectra QS/16	1MB Kit	699	240	196
	4MB Kit	2299	660	590
HP Laser Jet II	1MB Kit	699	340	299
	2MB Kit	1299	499	399
	4MB Kit	2299	799	699
HP Laser Jet IID	1MB Kit	699	340	299
	2MB Kit	1299	499	399
	4MB Kit	2299	499	699

DEC Memory Upgrades

Model	Memory Added	List Price	End User	Dealer
DEC Station 3100	4MB Kit	\$2995	\$1500	\$1400
VAX Station 3100	8MB Kit	CALL	CALL	CALL

Epson Memory Upgrades

Model	Memory Added	List Price	End User	Dealer
Equity 386	1MB Kit	\$699	\$240	\$228
	2MB Kit	795	395	350
	We also carry Equity II memory boards			

WYSE Memory Upgrades

Model	Memory Added	List Price	End User	Dealer
WY-2116	2MB Kit	\$1199	\$330	\$295
	4MB Kit	2299	660	590
WY-3216	1MB Kit	499	245	210
WY-3225	4MB Kit	2299	680	620

Compaq Memory Upgrades

Model	Memory Added	List Price	End User	Dealer
Deskpro 386/33	2MB Module	\$1295	\$795	\$ 695
Deskpro 386/25	1MB Module	699	315	265
	4MB Module	2599	895	795
Deskpro 386/20	1MB Module	699	315	265
	4MB Module	2599	895	795
Deskpro 386 S	1MB Board	699	425	350
	4MB Board	2599	1095	995
	1MB Module	699	315	265
	4MB Module	2599	895	795
Deskpro 386/20E	1MB Board	699	425	350
	4MB Board	2599	1095	995
	1MB Module	699	315	265
	4MB Module	2599	895	795
Deskpro 386/16	1MB Kit	599	280	210
	1-2MB Board	1995	1450	1250
	4-8MB Board	2195	1450	1250
	4MB Kit	699	495	395
Portable 386	1MB Kit	2395	1395	1195
	4MB Board	2395	1395	1195
	4MB Add-On	399	144	114
Portable III	512K Kit	995	365	295
Compaq SLT/286	1MB Module	699	465	395
Deskpro 286/E	1MB Module	699	315	265
	4MB Module	2599	895	795
Deskpro 286	512K Kit	159	95	92

AT&T Memory Upgrades

Model	Memory Added	List Price	End User	Dealer
6386/33 WGS	4MB Kit	\$2299	\$680	\$620
6386/25 WGS	4MB Kit	2299	680	620
6386/SX WGS	2MB Kit	1195	330	295
6386 WGS	4MB Kit	2299	660	590
6386 EWGS	1MB Kit	699	240	196
	4MB Kit	2299	660	590
6286	2MB Kit	1195	330	295

Zenith Memory Upgrades

Model	Memory Added	List Price	End User	Dealer
386/25	1MB Kit	\$ 799	\$375	\$295
	2MB Kit	1499	695	595
386/33	1MB Kit	799	395	325
	2MB Kit	1499	750	625
Z-248/12	2MB Kit	1195	330	295
Z-248/LP	2MB Kit	1195	330	295

Intel Memory Upgrades

Model	Memory Added	List Price	End User	Dealer
Model 301	4MB Kit	\$2299	\$660	\$590
Model 302	4MB Kit	2299	660	590
Model 303	4MB Kit	2299	680	620
Model 300 SX	2MB Kit	1195	330	295

Sun Micro Systems Memory Upgrades

Model	Memory Added	List Price	End User	Dealer
Sun 3/60	4MB Kit	\$2199	\$660	\$590
Sun 386/I	4MB Kit	2199	660	590
Sun 4/110	4MB Kit	2299	680	620
Sparc Station	4MB Kit	2199	660	590

Silicon Graphics Memory Upgrades

Model	Memory Added	List Price	End User	Dealer
4D-20	4MB Kit	\$2599	\$680	\$620
4D-70	4MB Kit	2599	680	620
4D-120	8MB Kit	CALL	CALL	CALL
4D-240	8MB Kit	CALL	CALL	CALL

Everex Memory Upgrades

Model	Memory Added	List Price	End User	Dealer
386 IS Step 2701	2MB Kit	\$ 499	\$235	\$216
	4MB Kit	925	475	432
	1MB Kit	455	180	152
386 Step 33	4MB Kit	2299	680	620
286 Step 16	2MB Kit	1195	330	295
	4MB Kit	2199	660	590
386 Step 16	1MB Kit	699	240	196
	4MB Kit	2199	660	590
286 Step 20	1MB Kit	699	240	196
	4MB Kit	2199	660	590
386 Step 25	1MB Kit	699	240	196
	4MB Kit	2199	660	590

AST Memory Upgrades

Model	Memory Added	List Price	End User	Dealer
AST Premium 386/33	1MB Kit	\$ 499	\$295	\$245
	Add-On Board	CALL	CALL	CALL
AST Premium 386/25	1MB Kit	450	260	225
	Add-On Board	CALL	CALL	CALL
AST Premium 386C	1MB Kit	699	240	196
	4MB Kit	2299	660	590
AST Premium 386	1MB Kit	699	280	228
	4MB Kit	2299	680	620
AST Premium 386/16	1MB Kit	699	240	196
	4MB Kit	2299	660	590
AST Workstation	512K Kit	299	120	98
	2MB Kit	1195	330	295
	4MB Kit	2299	660	590
	512K Kit	299	120	98
	2MB Kit	1195	330	295
	4MB Kit	2299	660	590
Bravo/286	128 Kit	125	75	52
	512K Kit	299	120	98
	2MB Kit	1195	330	295
	4MB Kit	2299	660	590
AST Premium 286	512K Kit	195	95	72

We carry all AST memory boards

Dell Memory Upgrades

Model	Memory Added	List Price	End User	Dealer
Dell 200 + 220	512K Kit	\$ 299	\$120	\$ 98
	1MB Kit	699	240	196
	2MB Kit	799	330	295
Dell 310	1MB Kit	699	240	196
	4MB Kit	2299	660	590
Dell 325	1MB Kit	699	280	228
	4MB Kit	2299	680	620
Dell 33MHz	1MB Kit	699	280	228
	4MB Kit	2299	680	620

Apple Memory Upgrades

Model	Memory Added	List Price	End User	Dealer
Mac II CI	4MB Kit	\$1195	\$560	\$504
Mac II	256K x 8 SIM	125	50	45
	1Meg Kit (4 SIMS)	599	200	180
	1Meg x 8 SIM	395	140	126
	4Meg Kit (4 SIMS)	1145	560	504
Mac Plus	256K x 8 SIM	125	50	45
	1Meg Kit (4 SIMS)	395	290	180
	1Meg x 8 SIM	395	140	126
	2Meg Kit (2 SIMS)	699	280	252
	4Meg Kit (4 SIMS)	1195	560	504
Mac SE	256K x 8 SIM	125	50	45
	1Meg Kit (4 SIMS)	395	200	180
	1Meg x 8 SIM	395	140	126
	2Meg Kit (2 SIMS)	699	280	252
	4Meg Kit (4 SIMS)	1195	560	504
Mac IICX	256K x 8 SIM	125	50	45
	1Meg Kit (4 SIMS)	345	200	180
	1Meg x 8 SIM	395	140	126
	4Meg Kit (4 SIMS)	1195	560	504
Mac SE/30	256K x 8 SIM	125	50	45
	1Meg Kit (4 SIMS)	395	200	180
	1Meg x 8 SIM	395	140	126
	2Meg Kit (2 SIMS)	699	280	252
	4Meg Kit (4 SIMS)	1195	560	504

COMPAQ • IBM • APPLE • HEWLETT PACKARD • AST • AT & T and More...
• 5 Year Guarantee • Same-Day Shipping • Full Technical Support

Circle 560 on Reader Service Card (DEALERS: 561)

DECEMBER 1989 • B Y T E 80NE-25

FormalSoft Ships 3-D Spreadsheet

ProQube, the successor to QubeCalc (FormalSoft's shareware program), provides 512 rows by 512 columns by 512 individual pages in its worksheet. The three-dimensional spreadsheet program lets you view your spreadsheet as if it were a cube, with the ability to rotate and slice across multiple sheets. You can view, enter, or manipulate data from multiple worksheets on the same screen.

ProQube's presentation-quality graphics let you generate three-axis bar and area charts with various fonts and colors. The program's application language lets you take advantage of windowing, menus, and error systems. It also offers DOS access. Application programs reside outside the worksheet, and you have the ability to set conditions to start up applications automatically. The spreadsheet can import and export Lotus 1-2-3 and dBASE files across multiple pages. Other features include search and replace, EGA 43-line support, and linking to other spreadsheets.

Novice users will appreciate the Back-Track menus that let you see each level of the menu system, a file manager, and a macro recorder.

ProQube runs on the IBM PC with 640K bytes of RAM, DOS 2.0 or higher, and a hard disk drive.

Price: \$247.50.

Contact: FormalSoft, P.O. Box 1913, Sandy, UT 84091, (801) 565-0971.

Inquiry 1013.

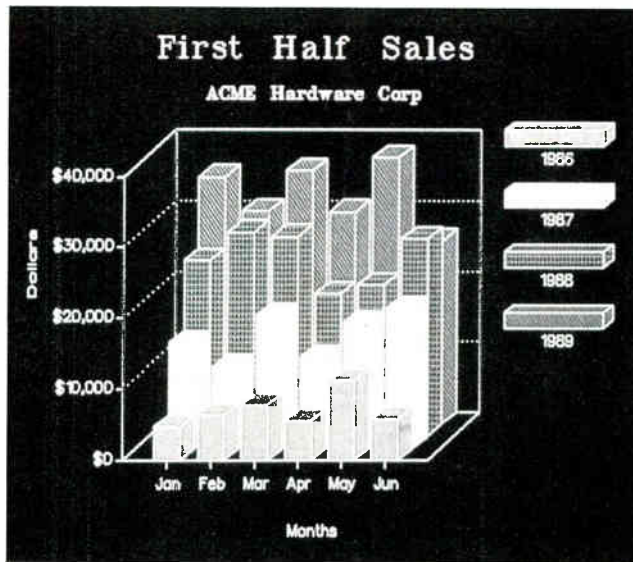

ProQube's three-dimensional capabilities let you create three-axis bar graphs, like this comparison of four years' sales for a six-month period.

Storage Tank Inspections Made Easier

ChemCalc 17:EPA Storage Tank Emissions Analysis is a program for calculating organic liquid tank emissions of storage tanks in accordance with the recommended Environmental Protection Agency standards, Gulf Publishing reports.

All tank configurations found in EPA regulations are supported, as are all nine tank seals and painting combinations of roof and shell color: welded and riveted tanks; fixed, internal floating, and external floating tank roofs; tank diameter and height in feet; and more.

The program calculates the breathing and working losses for fixed-roof tanks and the rim seal and withdrawal losses for internal and external floating-roof tanks.

ChemCalc 17 runs on the IBM PC with 256K bytes of RAM.

Price: \$495.

Contact: Gulf Publishing

Co., Software Division, Dept. F6, P.O. Box 2608, Houston, TX 77252, (713) 520-4444.

Inquiry 1016.



Lock Your Macintosh with KeyLock

The first product from a company called Viking-Tech secures your Macintosh files with software for password protection and a physical lock for your floppy disk drive slot.

The password software of KeyLock is part of the INIT in the system file, and KeyLock rebuilds itself every time you log on, the company says.

The KeyLock password prevents access to the hard disk drive.

Price: \$89.95.

Contact: VikingTech, Inc., 5752 Oberlin Dr., Suite 200, San Diego, CA 92121, (800) 955-5625 or (619) 457-4935.

Inquiry 1014.

Ad-Composition Program Formats Text

With AdWorks 2.0, an ad-composition and full-page layout program for newspapers and ad departments, you can pour ASCII text into a template, and the program automatically converts it to the format in which it should appear. For example, if you must send the same ad to different newspapers, you can set the program up to format the text for each newspaper automatically. In addition to support for color, the program can search and replace for a font, style, point size, or color and replace one or all of them in the entire document or just an area that you specify.

You can scan a photo into the document for FPO purposes. Once in the document, you can crop, rotate, and reduce the photo or graphical image. Thus, when you send it to the printer, there won't be any doubt as to how the photo should appear. Text can flow around or inside irregularly shaped objects, Concept Publishing Systems reports.

AdWorks 2.0 features point-to-point kerning and tracking at up to 0.001 of an em space precision. Also new is an 85,000-word spelling checker. You can create grids and rulers in such increments as pixels, inches, picas, points, and millimeters.

AdWorks 2.0 runs on the Macintosh Plus or higher with 1 megabyte of RAM, but the company recommends that you have at least 2 megabytes.

Price: \$1495.

Contact: Concept Publishing Systems, 809 Park Ave., Beaver Dam, WI 53916, (414) 887-3731.

Inquiry 1012.

Santa's Greetings



DIAL
(617)

L · A · P · T · O · P · S
5 2 7 8 6 7 7

NEW ENGLAND'S AUTHORITY ON LAPTOPS AND PORTABLE COMPUTING

Authorized Service for: Zenith • Toshiba • NEC

We can add portable phone/modem for remote communications

— OFFERING —

NEC • ZENITH • TOSHIBA
Sharp • Altima One • Sanyo ... more
20 models on display



Windows 386

\$50 with 386 purchase

**Attn: MIS Departments
and 386 Users!!!**

TOSHIBA—T-5200, T-1600, T-5100, T-3200, T-3100e,
T-1200 & T-1000

NEC—ULTRALITE, PROSPEED MODELS 286
AND 386

ZENITH—NEW MINISPORT: AVAILABLE

MITSUBISHI—286 Laptop w/Modem & Case:
SPECIAL PRICE

Best Prices in New England

• Massachusetts SOMBA Certified

**Our Laptops come
with more than just
the Box!!**

- Factory trained technicians
- Professional Solution Consultants
- Rent/Lease
- System formatted and tested

SAVE \$\$\$

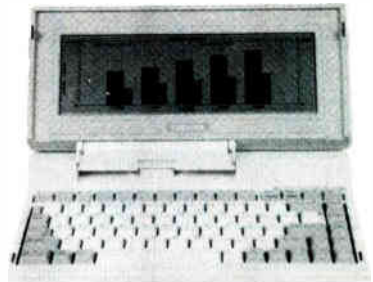

- Richly featured, yet weighs just 6.4 pounds.
- Includes 512KB memory, expandable to 1.2MB.
- 720KB 3.5" floppy drive, reflective supertwist display and MS-DOS®2.11 in ROM standard.
- Runs on NiCad rechargeable battery pack or AC power for continuous operation.

T1000 Reg. \$1,000

Too low to quote. CALL

B12/24/89

**New Zenith Models
Available**

Zenith Preferred Service Center

Toshiba Service Center

NEC Premier Service Center

LAPTOPS, etc. 164 HAMPSHIRE STREET, CAMBRIDGE, MA 02139 (617) 527-8677

In MA dial 1-800-966-METRO for service

Other Store Locations: Falls Church, VA • Washington, D.C. • Baltimore, MD

Circle 553 on Reader Service Card

DECEMBER 1989 • B Y T E 80NE-27



THE COMPUTER DISCOUNT CENTER

FOR INFORMATION:
1-201-444-7367
PHONE ORDERS ONLY:
1-800-631-7111

CDC INTRODUCES

The Ultimate 286-16 MHz System

STANDARD FEATURES:

- 512K Exp. 4MB Dn Mainboard
- 80286 Processor
- 6-16 MHz
- 40 Meg Hard Drive
- 1.2 Meg Floppy
- Clock Calendar/Battery Backup
- Mono Graphics Card
- TTL Monitor
- 101 Enhanced Keyboard
- Parallel Printer Port
- 8 Expansion Slots
- 200 Watt Power Supply
- Floppy & Hard Drive Controller Card
- Made in USA
- 1 year parts and labor

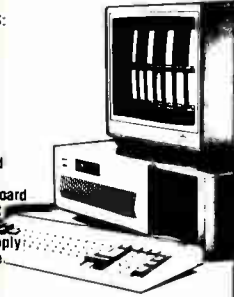

FOR THE LOW PRICE OF **\$1299**

OSICOM XT-Turbo

- 10/4.77 MHz 8088
- Phoenix BIOS
- 640K RAM, 101 enhanced keyboard
- 8087 Co Processor socket
- 150 watt power supply
- Single floppy 360K
- Parallel port
- Serial port
- Clock calendar with battery backup
- 1 year parts and labor warranty

- OPTIONS
- 3.5 floppy drive
 - 8087 co processor
 - Color/mono graphics adapter
 - EGA/VGA adapter
 - 20, 30, 40 MB hard drives available

\$499

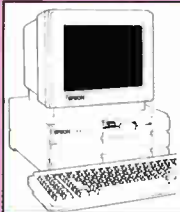

EPSON COMPUTERS

EQUITY I + \$688*
EQUITY IE \$748*
EQUITY II + \$1088*
EQUITY III + \$1288*

CDC INTRODUCES

The Ultimate 386-25 MHz System

- 1 Meg Exp. 4MB Dn Mainboard
- 80386 Processor
- 8-25 MHz
- 40 Meg Hard Drive
- 1.2 Meg Floppy
- Clock Calendar/Battery Backup
- Mono Graphics Card
- TTL Monitor
- 101 Enhanced Keyboard
- Parallel Printer Port
- Serial Port
- 8 Expansion Slots
- 200 Watt Power Supply
- Floppy & Hard Drive Controller Card
- MS & DDS 3.3 & GW Basic 3.2
- Made in USA
- 1 year parts and labor



FOR THE LOW PRICE OF **\$2399**

HEADSTART™ III by Vendex®

ON SITE SERVICE

- 80286 - 12 Microprocessor
- 128 MHz
- 1 MB of Ram exp to 3 MB
- 5 1/4" 1.2 MB Floppy Drive
- 3 1/2" 1.44 MB Disc Drive
- 32 MB Hard Drive / 28ms
- 101 Keyboard
- 6-in-1 VGA Card
- VGA Monitor
- Ports - (2) Serial, Parallel, Mouse, & Game
- 3 Button Mouse
- Software Bundle

\$2199

Headstart II CALL

IBM SYSTEM/2 MODEL 30

\$1149*

Panasonic Printers

KX-P1180 \$175**
KX-P1191 \$235**
KX-P1124 \$319**
KX-P1624 CALL

KX-P1595 \$429**
KX-P1524 \$545**

MANY OTHER BRANDS IN STOCK

MAC DRIVES

MacBEST HARD DRIVE SUBSYSTEMS			
EXTERNAL			
MODEL#	SPEED	MB	
MacBEST 20E	40ms	21.3	\$419
MacBEST 30E	28ms	32.3	\$469
MacBEST 40E	28ms	43.1	\$519
MacBEST 60E	28ms	64.9	\$599
MacBEST 80E	28ms	85.0	\$799
MacBEST 105E	25ms	105.0	\$949
MacBEST 180E	17ms	173.0	\$1499
INTERNAL			
SE, SE30, II and IIx			
MacBEST 201SEs	40ms	21.3	\$349
MacBEST 301SE	28ms	32.3	\$379
MacBEST 401SE	28ms	48.6	\$479
MacBEST 1051SE	25ms	105.0	\$899
MACINTOSH IIcx			
MacBEST 201CXs	40ms	21.3	\$349
MacBEST 301CX	28ms	32.3	\$379
MacBEST 401CX	28ms	48.6	\$479
MacBEST 1051CX	25ms	105.0	\$899
MACINTOSH II and IIx			
MacBEST 60I	28ms	64.9	\$499
MacBEST 80I	28ms	85.0	\$529
MacBEST 150I	17ms	155.0	\$1299
MacBEST 180I	17ms	173.0	\$1399
MacBEST 300I	17ms	300.0	\$1899
MacBEST 600I	17ms	600.0	\$2799

HARD DRIVES

Seagate					
ST 225 Kit	HH	20MB	MFM	65ms	\$229
ST 238R Kit	HH	30MB	RL	65ms	\$254
ST 251-01	HH	40MB	MFM	28ms	\$329
ST 277R-1	HH	60MB	MFM	40ms	\$369
ST 4096	FH	80MB	MFM	28ms	\$539
ST 4144R	FH	120MB	RL	28ms	\$599
MICROPOLIS					
MI 1335K	FH	71MB/SW		28ms	\$699
MI 1355K	FH	147MB	ESDI	18ms	\$1099
MI 1558-15K	FH	338MB	ESDI	18ms	\$1699
MiniScribe					
MN 3053K	HH	40MB	MFM	28ms	\$379
MN 3085K	HH	70MB	MFM	22ms	\$529
MN 3180EK	HH	182MB	ESDI	17ms	\$995
MN 3650K	HH	40MB	MFM	61ms	\$269
MN 8225 XTK	3.5	20MB	W/ADAP	22ms	\$249
MN 8425K	3.5	20MB	MFM	68ms	\$219
MN 8450 XTK	3.5	40MB	W/ADAP	40ms	\$319
MN 9380EK	FH	320MB	ESDI	16ms	\$1599
FLOPPY DRIVES					
EXTERNAL FLOPPY FOR PS-2					\$199
SCANNER					
DFI Handy Scanner					\$199

NETWORKS

WESTERN DIGITAL		
WD LAN-SLTSB	STARCARD/TOSHIBA LAPTOP	\$199
WD LAN-HR	10 PORT ACTIVE HUB	\$319
WD LAN-SPR	STARCARD PLUS	\$169
WD LAN-SHP	STARLINK PLUS	\$219
WD LAN-TRH	TOKEN HUB MEDIA ACCESS UNIT	\$259
WD LAN-TRH PWR	TOKEN HUB W/ AMER P/S	\$ 79
WD LAN TRWS	TOKEN CARD WS W/RAM SOCKETS	\$319
ETHERCARD +	ETHERCARD PLUS	\$229
ETHERCARD + SOC	ETHERCARD + W/RAM SOC	\$259
ETHERCARD + TP	FDR UNSHIELDED TWISTED	\$319
ETHERCARD + PS/2	ETHERCARD + FDR PS/2	\$319
STARLAN	3 USER STARLAN VDMA NET	\$749
WD NET-286	ADV NETWORK FOR WD	\$1499
WD ROM-NOV	BOOTROM FDR ETHERCARD +	\$ 29
WDNET-ELS	ADVANCED NETWORK ELS	\$899
WD NET-ELS	ADVANCED NETWORK ELS	\$439
WD NET-SFT	ADV NETWORK SFT V2.15	\$2999
WD NET-SFT 3.5	ELS II 3/5 IV2.15	\$899
WD NET-SFT 3.5	SFT NETWORK 3.5 V2.15	\$2999
AMIGA ACCESSORIES		
PRD GEN	\$349**	
MINI GEN	\$209**	
AS01 RAM CLDNE 512K Ram	\$139**	(For AMIGA 500)
MEGA BOARD 2000		
w/2 megs Ram	\$499**	
FRAME GRABBER Real Time		
Video Image Digitizer	\$549**	
THE VAULT Hard Drives For Amiga 500 & 1000		
20 MEG	\$499	
30 MEG	\$599	
40 MEG	\$699	
65 MEG	\$799	

OPEN 10 AM to 8 PM MONDAY THRU SATURDAY - TEANECK OPEN SUN. 11-5

PARAMUS 770 RT. 17 NORTH
PARAMUS, N.J. 07652
201-444-7367

TEANECK

506 CEDAR LANE
TEANECK, N.J. 07666
201-836-6666

Prices and availability subject to change without notice. *Must be sold with video card and monitor. In store prices may vary. \$4.95 minimum shipping, handling and insurance charge. All major credit cards accepted.

Instant 3-D PARTS From your CAD drawings

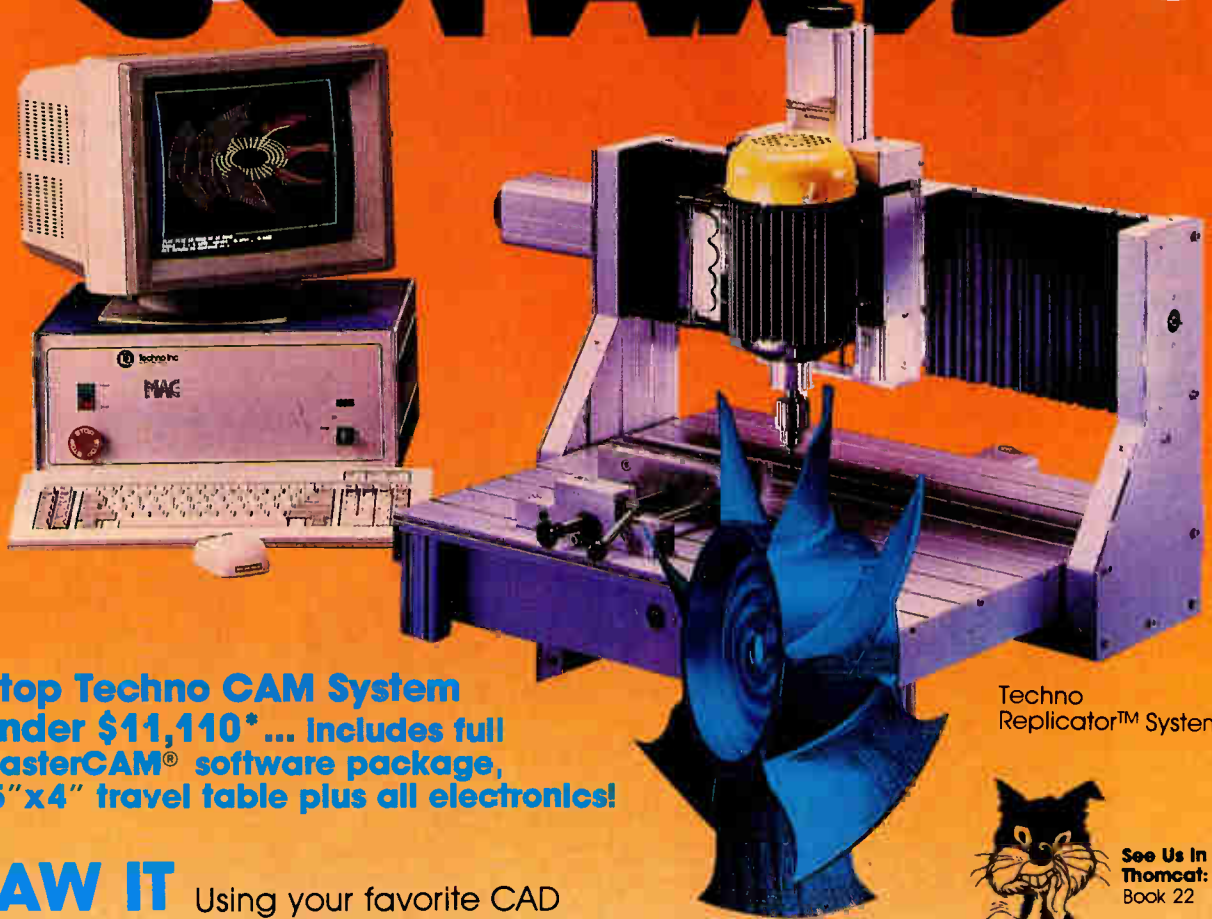

**Desktop Techno CAM System
for Under \$11,110* ... Includes full
3-D MasterCAM® software package,
9"x15"x4" travel table plus all electronics!**

Techno
Replicator™ System

DRAW IT Using your favorite CAD
program: AutoCAD®, VersaCAD®, CadKEY®,
etc. Then simply transfer it to MasterCAM through an IGES file.



See Us In
Thomcat:
Book 22

MAKE IT On the Techno Replicator™ using a variety of materials ranging
from machineable wax, wood and plastic to non-ferrous metals.

ENGRAVE IT Using any font or design from your CAD package.

The MasterCAM program provides full 3-D tool path motions and tool path compensation. Make any 3-D curved surface you can draw using simple menu commands. Seven milling table sizes available up to 4 ft. x 4 ft. Write, fax or call for detailed literature.



*Does not include IBM PC or milling head.

MasterCAM® A registered trademark of CNC Software Inc.

Circle 385 on Reader Service Card (DEALERS: 386)

World Radio History

2101 Jericho Turnpike
New Hyde Park, NY 11040
TEL.: (516) 328-3970
FAX: (516) 326-8827

DECEMBER 1989 • B Y T E 80NE-29

A Message About Buying Futures.

In today's hi-tech marketplace, with moment to moment progress, it is easy to be misled when purchasing a computer system.



Eli Hertz / President

HERTZ

Computer Corporation

The Power of Choice
212-684-4141

A simple rule of thumb can be applied here to safeguard against spending money you don't have to spend for things that it will never do... If it can't work for you 100% TODAY don't buy it.

When PC manufacturers try to rush you into buying an upgradeable system so it "will run 486, 586, 007, or 7-Eleven...", you should send them to your stockbroker... they deal with futures!

It is just plain risky to buy predictions of what hardware will look like, perform like, or fit into when it could all change in a split second. It's like buying a car now that won't be ready to drive for a year!

So be careful out there. Ask questions, shop around, make purchases cautiously.

Call us. We'd be happy to assess your needs.

Eli Hertz

Investigate possibilities ... don't buy them.

Are You Wasting RAM?

If you use any of these popular programs, chances are you are, unless you have Innovative Data Concepts' memory-saving utility programs:

The SWAP Utilities^(TM)

Each of these eight exciting SWAP programs use less than 8000 bytes of RAM, and provide most of the functionality of the full utility program at a tremendous savings in RAM. The following useful but ram-hungry TSRs can be 'tamed' by IDC's utility programs:

SWAPSK^(TM) -- Borland's SideKick
SWAPTN^(TM) -- Micro Logic's Tornado
SWAPSH^(TM) -- PC Tools Deluxe Shell
SWAPMT^(TM) -- Lotus Metro and Express

SWAPSP^(TM) -- Borland's SideKick Plus
SWAPMM^(TM) -- Broderbund's MemoryMate
SWAPDT^(TM) -- PC Tools Deluxe Desktop
SWAPNG^(TM) -- The Norton Guides

Read what people have been saying about The SWAP Utilities:

"Unlike such early TSR managers as Referee, The SWAP Utilities do not need to reserve a large parking lot in DOS, so your applications can use all the RAM that SWAP frees."

Edward Mendelson, PC Magazine First Looks, April 25, 1989

"The Swap Utilities tamp down four large, but highly useful, TSRs ... down to 8-9K ... attacking the problem of memory overcrowding with a program, rather than more hardware."

Jeff Angus, InfoWorld, May 8, 1989

At a cost of just \$25, these programs are ones you can't afford NOT to have! For more information about The SWAP Utilities, call IDC at 1-215-884-3373, or write:

Innovative Data Concepts, 1657 The Fairways, Suite 101, Jenkintown, PA 19046

PERFORMANCE PRICE SERVICE

FIND THEM ALL AT ON LINE COMPUTER



ON LINE 286 MULTISYNC COLOR SYSTEM

- 12 MHz Motherboard
- 80286 - 12 CPU
- Seagate 20MB Hard Drive
- 1:1 Interleave Hard Drive Controller
- 1.2 MB Floppy
- 1MB RAM (Expandable to 4MB)
- 2 Serial Ports • 1 Parallel Port • 1 Game Port
- 8 Expansion Slots • 200w Power Supply
- 101 Key Keyboard • Reset Button
- 14" VGA Multisync Monitor • Keyboard Lock
- VGA Multisync Graphic Adapter Card
- Clock/Calendar with battery backup
- Socket for 80287 Math Coprocessor

COMPLETE SYSTEM ONLY

\$1895

ON LINE 386 MULTISYNC COLOR SYSTEM

- 20 MHz Motherboard
- 80386 - 20 CPU
- Seagate 40MB Hard Drive (28ms)
- 1:1 Interleave Hard Drive Controller
- 1.2 MB Floppy
- 1MB RAM (Expandable to 16MB)
- 2 Serial Ports • 1 Parallel Port • 1 Game Port
- 8 Expansion Slots • 200w Power Supply
- 101 Key Keyboard • Reset Button
- 14" VGA Multisync Monitor • Keyboard Lock
- VGA Multisync Graphic Adapter Card
- Clock/Calendar with battery backup
- Socket for 80387 Math Coprocessor

COMPLETE SYSTEM ONLY

\$2795

BOTH SYSTEMS COME WITH A LIMITED 2 YEAR WARRANTY

On Line Computer is a full service store serving the public for more than 6 years. We carry a large assortment of software for: IBM (and compatibles), Atari, Macs, & Commodore 64. We also carry a full line of supplies & accessories at low prices.

QUANTITY DISCOUNTS FOR SCHOOLS AND CORPORATE ACCOUNTS

AUTHORIZED DEALER FOR:



AT&T



SAMSUNG
Information Systems

AT&T STARLAN AND NOVELL NETWORKING

ON LINE COMPUTER

FULL SERVICE & COMPUTER UPGRADES AVAILABLE AT REASONABLE PRICES

STORE WIDE SAVINGS ALWAYS AVAILABLE AT TWO CONVENIENT LOCATIONS:

280 Main Street (RT 28)
Colonnade Building
North Reading, MA
Across from Atlantic Plaza
(508) 664-1110

450 South Broadway
Newman Plaza
Salem, NH
Next to Newman Ford
(603) 894-6314

多功能 高品質 全相容

COSTS LESS.*

Introducing Minta Computers. Maximum Systems. Minimum Cost.

Listen to the language of Minta – a complete line of powerful, reliable PCs for less. Minta means the maximum PC for the money and higher profit margins for you.

Minta's unique, slim all-in-one design, its high speed performance, its excellent professional service – Minta is the only PC with a 2-year warranty – all have made Minta a best seller in Europe and the Far East for years.

To introduce Minta to America, we're offering incentives to resellers and distributors nationwide: complete advertising and service support and an opportunity to work with the highest possible margins – at a price point you can pass on to consumers to introduce them to the PC people are talking about all over the world.

Because in any language, Minta means more – and costs less.

Add Minta to your product line. Call 1-800-82-MINTA
Make more with Minta today! Tel: (201) 417-0388
Fax; (201) 417-0389



MINTA MEANS MORE.

95 Newfield Ave.
Raritan Center
Edison, NJ 08837
TEL: (201) 417-0388
FAX: (201) 417-0389

Taipei, Taiwan
TEL: 783-3847,
783-6095, 783-6418
FAX: 886-2-7821815,
886-2-7820840

Hamburg,
West Germany
TEL: (040) 51 80 67, 51 80 68
FAX: (040) 51 53 68
TLX: 21 25 96 MINTA



***Powerful. Compatible.
Reliable.**

競爭性強

MANCHESTER & NEC EQUIPMENT COMPANY

WHY NOT THE BEST?



WHY MANCHESTER

- High quality industry standard products at unbeatable prices.
- Multi-million dollar inventory assuring you prompt delivery.
- 16 years of quality and dependability in the computer business.
- Knowledgeable sales reps who help you plan, design, implement and manage your computing environment.
- 15 step burn-in and test procedure on all equipment.
- A service department that maintains your equipment in first rate condition.
- Support specialists in sophisticated applications such as Networking, CAD/CAM, Desktop Publishing and Connectivity.
- Risk free corporate evaluations, both in house and on location; demonstrations on the newest and most innovative products.

WHY NEC

- Recognized as the standard in providing quality products, high performance rates and user reliability.
- An industry leader in the research and development of computer products for the past three decades.
- Outstanding desktop engineering systems designed for high user performance and growth potential.
- Industry Standard Architecture (I.S.A) and Extended Industry Standard Architecture (E.I.S.A)
- 24 Billion dollar a year company with an on-going multi-million dollar commitment to research and development.
- State of the art design with an extensive family of feature rich products.
- All systems designed with the end-user in mind.

DOUBLE YOUR COMPUTING POWER

with the only two names you need to remember, MANCHESTER and NEC. Give us a call today and find out more about the NEC POWERMATES. Why not work with the best! Let MANCHESTER satisfy all your system needs and lead your company through today's computer world and beyond.

Authorized NEC Computer and Printer Dealer

MANCHESTER EQUIPMENT CO., INC.

"The Computer Supply and Equipment Experts"

SYSTEMS INTEGRATION ■ NETWORKING ■ CONNECTIVITY ■ CAD/CAM ■ DESKTOP PUBLISHING
50 MARCUS BOULEVARD ■ HAUPPAUGE, NEW YORK 11788

(516) 435-1199 ■ (516) 434-8700 ■ FAX (516) 435-2113

New York City
(212) 629-6969

Ft. Lauderdale
(305) 491-7660

Tampa
(813) 962-8088

Boston
(617) 739-1555

For additional information, ask for Dan Kalata



Buy with

Confidence

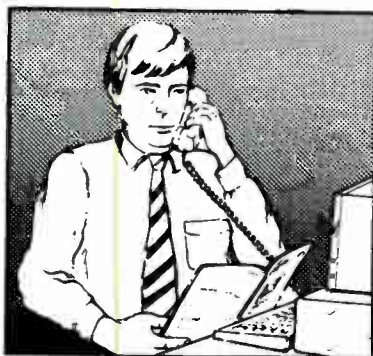

In an effort to make your telephone purchasing a more successful and pleasurable activity, The Microcomputer Marketing Council of the Direct Marketing Association, Inc. offers this advice, "A knowledgeable buyer will be a successful buyer." These are specific facts you should know about the prospective seller before placing an order:

Ask These Important Questions

- How long has the company been in business?
- Does the company offer technical assistance?
- Is there a service facility?
- Are manufacturer's warranties handled through the company?
- Does the seller have formal return and refund policies?
- Is there an additional charge for use of credit cards?
- Are credit card charges held until time of shipment?
- What are shipping costs for items ordered?

Reputable computer dealers will answer all these questions to your satisfaction. Don't settle for less when buying your computer hardware, software, peripherals and supplies.

Purchasing Guidelines

- State as completely and accurately as you can what merchandise you want including brand name, model number, catalog number.
- Establish that the item is in stock and confirm shipping date.
- Confirm that the price is as advertised.
- Obtain an order number and identification of the sales representative.
- Make a record of your order, noting exact price including shipping, date of order, promised shipping date and order number.

If you ever have a problem, remember to deal first with the seller. If you cannot resolve the problem, write to MAIL ORDER ACTION LINE, c/o DMA, 6 E. 43rd St., New York, NY 10017.

This message is brought to you by:

the MICROCOMPUTER
MARKETING COUNCIL
of the Direct Marketing
Association, Inc.
6 E. 43rd St.,
New York, NY 10017

MMC
MICROCOMPUTER
MARKETING COUNCIL
of the Direct Marketing Association, Inc.

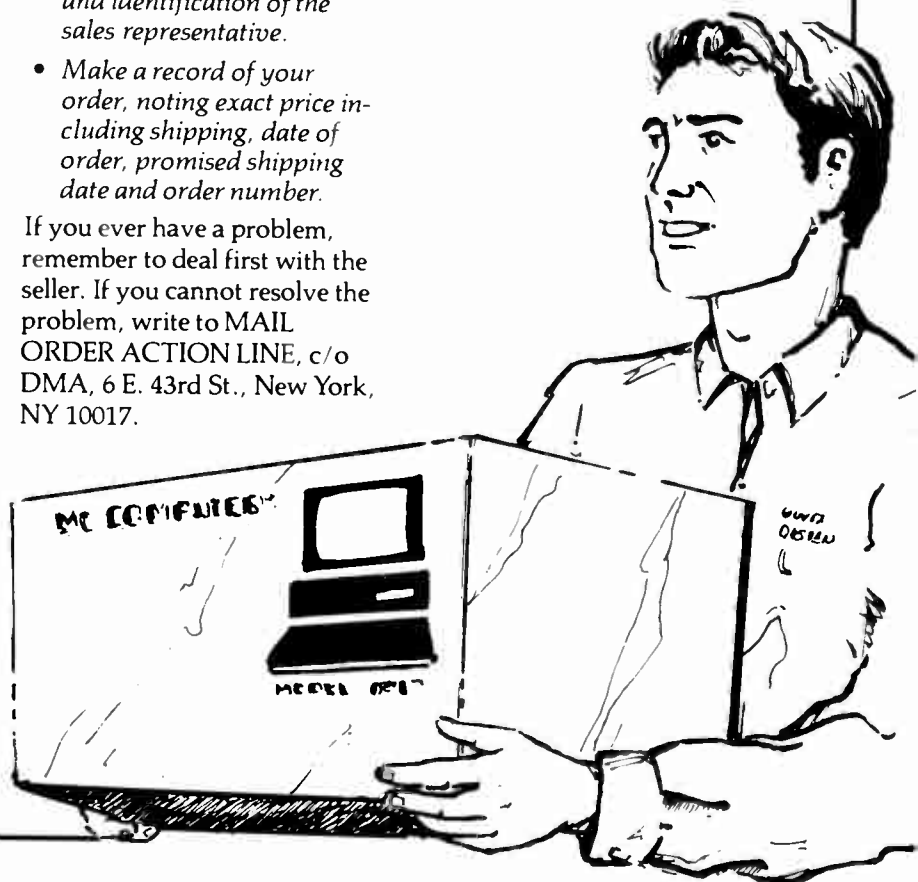

© Direct Marketing Association, Inc. 1988

CD-ROM Products

Available from
Online



CD-ROM packaged software and hardware products for immediate delivery:

- **Packaged Software** Grolier's New Electronic Encyclopedia®, Microsoft's Programmer's Library, StatPac, and Small Business Consultant are all available in one fully integrated hardware and software package for IBM® PC class and 100% compatibles, or the IBM PS/2®. Grolier's New Electronic Encyclopedia is also available for the Macintosh. IBM PC networked version of Grolier's also available.
- **OPTI-NET® Local Area Network (LAN) Package**, developed by Online, provides a software solution enabling CD-ROM applications to run on NET BIOS™ compatible LAN's (including IBM Token Ring, IBM PC Net, 3 COM, Novell, and Ungermann-Bass), and Novell Netware IPX/SPX. Opti-Net for NFS workstations will be released soon.
- **CD-ROM Controllers and CD-ROM Drives.** Online's high performance CD-ROM controllers for the IBM PC AT and compatibles and the IBM PS/2 Micro Channel provide added features not available with standard controllers, including support for OS/2 and multi-tasking. Available for immediate shipment are the CD-ROM controllers as well as packaged CD-ROM drives and controllers.
- **Desktop Optical Storage Units (OSU) in 2, 4, and 8-drive configurations.** Provide ability to access multiple CD-ROM databases and databases spanning more than one drive. Use on a single workstation or for network applications on the file server.
- **Multimedia Data Storage Units (MDU)** are designed to meet your unique workstation needs.

We configure with combinations of CD-ROM, WORM, Erasable Optical, and Magnetic Media. Call to discuss your specific requirements.

- **Optical Publishing Solutions.** Online can provide complete solutions for your product or your in-house publishing needs. Call us to discuss how we can use our Opti-Ware™ value-added software solutions to package your product—whether it be parts and product catalogs, technical documentation, financial and business data, reference works and encyclopedias, multimedia programs, or others. Opti-Ware™ retrieval runs under MS-DOS, OS/2, Unix, and MAC-OS. Opti-Ware can be licensed for your in-house publishing on IBM Mainframes, DEC VAX, and Unix workstations.
- Networked systems are available.
- Other Databases are available. Please call for further information.
- Distributor, OEM, and Reseller inquiries invited.

Ordering Information

To order, call our toll-free number from 9:00 to 5:00 Eastern Time Monday through Friday.

- Visa, MasterCard, and American Express accepted.
- Maryland state residents please add 5% sales tax.

For Immediate Delivery Call

1-800-922-9204

In Maryland call (301) 428-3700

FAX (301) 428-2903



ON
LINE

Products Corporation

20251 Century Boulevard, Germantown, MD 20874

Online Products Corporation is a wholly-owned subsidiary of Online Computer Systems, Inc.

© Copyright 1989. Online Computer Systems, Inc. All rights reserved.

An IBM Certified Education Specialist (CES) and Industry Remarketer (IR). OPTI-NET is a registered trademark and Opti-Ware is a trademark of Online Computer Systems, Inc. Microsoft is a registered trademark of Microsoft Corporation. IBM Personal System/PS/2, OS/2 and Token Ring are registered trademarks of the International Business Machines Corporation. 3Com is a registered trademark of 3Com Corporation. Novell is a registered trademark of Novell, Inc. Electronic Encyclopedia is a registered trademark of Grolier Electronic Publishing. Macintosh is a registered trademark of Apple Computer, Inc. NFS is a trademark of Sun Micro Systems.



World Pacific History

bradbrad's



Thalarctos maritimus

#3 in a series on consumer habits

The polar bear is the great white hunter of the Arctic Circle. Migrating long distances over the vast frozen desert, it tracks large prey such as seals and sea lions. In a sprint, it can reach speeds of up to 25 mph. When it raids the ice box, it doesn't waste energy on small fish. The readers of BYTE magazine are just as selective. For they, too, are relentless hunters with big appetites. They are advanced personal computing experts whose hunger for new product information is insatiable. They seek technical analyses. Extensive reviews. A complete rundown of product comparisons. Which is what they get in every BYTE. Some publications may promise you more paid readers than BYTE's 450,000. But none so voracious.



HELP THE AMERICAN FOUNDATION FOR THE BLIND HELP YOU!

The American Foundation for the Blind's National Technology Center (NTC) maintains a Job Index/User Network which features information from over 1,100 blind and visually impaired people who use adaptive equipment in a variety of jobs.

The NTC is looking for additional participants. Blind and visually impaired individuals of all ages who have hands-on experience with computers, low vision aids, talking products, or other adaptive devices are needed as resource people and/or evaluators.

As a resource person, other users may contact you to share your knowledge and experience. As an evaluator, you may be asked to evaluate both existing and newly developed or adapted devices. Evaluations are published in the "Random Access" section of the *Journal of Visual Impairment & Blindness*.

If you are interested, please fill out the form below or call our hotline, 1-800-232-5463 (New York residents call 212-620-2147). Tell the operator you wish to be part of the Job Index/User Network.

Your response will be followed by a brief, confidential telephone survey. The information you provide will be used for NTC purposes only and will include the equipment you use, your experience with it, training and employment.

Your assistance will enable the Job Index/User Network to continue as a major information and support system for blind and visually impaired people nationwide.

Mail to: American Foundation for the Blind, National Technology Center, 15 West 16th Street, New York, NY 10011, Attn: A. Hypolite

Name _____

Address _____

City _____ State _____ Zip _____

Best time to contact _____ Telephone _____

See us at
COMDEX/Fall '89
 November 13-17, 1989
 Riviera Hotel
 Las Vegas, Nevada
 Booth R 8019

New low price



ATC 386-25

\$1,890

- Intel 80386 Microprocessor
- 25 MHZ M/Board
- 4Mb Installed 8MB Exp.
- 80387 socket on board
- 1.2 High Density Drive
- W.D. 1:1 Hard/Floppy Cont.
- 230 Watt Power Supply
- Vertical case
- Serial & Parallel
- Hi-Res TTL Monitor
- Mono. (Herc.) Card
- 101 Enhanced Keyboard

W/64K CACHE
 25MHZ CPU
\$2,560.00

ATC-386SX

\$1,099

- Intel 80386SX 16 MHZ
- AMI Bios, MS/DOS, OS/Z, Unix compatible
- 1024K on board expandable to 8MB
- 80387SX co-processor socket
- 200 watt power Supply 1.2 or 1.44 drive
- 1:1 Interleave Hard/Floppy Controller
- Serial/Parallel/Clock/Calendar
- 101 Keyboard
- Mono (Herc.) Video Card
- Hi Res TTL Monitor

ATC 286-16

\$859

- IBM AT-286 Compatible
- 10/16 MHZ 0 Wait State
- Tune 16 MHZ Harris CPU
- Phoenix bios
- 512k on Board
- Choice of 1.2/720k Drive
- 1:1 Hard/Floppy Controller
- 200 Watt Power Supply
- On board clock/calendar with lifetime warranty, rechargeable battery
- 101 Enhance Keyboard
- Monochrome card
- Hi Res TTL Monochrome Monitor
- FCC Class B Approved

ATC 286-12

\$699

- IBM AT-286 Compatible
- 6/12 MHZ CPU 0 Wait State
- Phoenix Bios
- 512k memory on Board
- 1.2 High Density Drive
- W.D. 1:1 Hard/Floppy Controller
- 200 Watt Power Supply
- AT 3 Opening Case w/reset buttons
- Clock and calendar on board
- 101 Enhance Keyboard
- Mono Card
- Parallel Printer Port
- Hi Res TTL Monitor
- FCC Class B Approved

ATC TURBO-10

\$459

- IBM XT Compatible
- 4.77/10 MHZ CPU
- Intel 8088
- Phoenix Bios
- 640K on board (1024K expandable)
- 360k Floppy Drive
- 165 Watt Power Supply
- AT Style Case w/LED Power & Turbo Light, Reset & Turbo button
- Monochrome Card
- Clock/Calendar
- Serial/Parallel/Game
- Hi Res TTL Monitor
- AT Style 84k. Key Board
- FCC Class B Approved

This Month Specials:

**PLATINUM VGA-16/
CASPER VGA MONITOR**

- 1024 x 768
- 250K on board
- 512K expandable
- 100% Software, Hardware compatible

\$465

UPGRADE

- Color Monitor w/Graphic Card \$160
- EGA Monitor w/EGA Card \$350
- VGA Monitor w/VGA Card \$410
- Multisync Monitor w/Hi-res. Card \$530

HARD DISK

Seagate SI-225 w/Cont.	\$259	Seagate SI-138	\$279
Seagate SI-238 w/Cont.	279	Seagate SI-4144R	650
Seagate SI-251	339		
Seagate SI-251-1	389	Miniscribe 3085	559
Seagate SI-277R	389	Miniscribe 3650	305
Seagate SI-4096	579	Micropolis w/Controller (150 MB)	1350
Seagate SI-125	235		

Main Office:
 15703 East Valley Blvd.
 City of Industry, CA 91744
 Fax No. (818) 961-4337

Branch: 7150 Beverly Blvd.
 Los Angeles, CA 90036

Tele: (213) 930-2823
 Fax: (213) 930-2826

Order Hot Line **(818) 333-0193**

ORDER BY MAIL: Check and Money Order, California add 6.5% Sales Tax
 ORDER BY PHONE: COD & Cashier Check's

TERMS:

All prices are subject to changes and quantity may be limited and we reserve the Right to Substitute Equivalent Items. Unauthorized Returns are subject to 15% Restocking Fee. Call for RMA Numbers for Returns and Repairs. Return items must be sent shipping prepaid by customer. 1 year parts and labor.

A-TRONIC

COMPUTER



"It takes everything I throw at it and comes back for more..."

YOU'VE BEEN SAYING OUTRAGEOUS THINGS ABOUT OUR 386-33MHZ COMPUTER.

Recently, when customers, potential customers and industry experts called us, they said something strange. They said, "Your PC-Link 386-33MHz computer *works!*" This was hardly cause for celebration. But then we heard that the other 386 machines have bugs. And that they're very expensive. (Now *that's* outrageous.) And that even compared to the Compaq Deskpro 386/33, our computer was the best choice for a 386-33MHz.

Get a Copy of our Report Card
In InfoWorld's 386/33 product comparison, we were rated "Excellent" in categories including CPU Speed and Hard Disk Access (sequential and random). "Very Good" described our software compatibility. And we shared the top rating for Value. Call us for a reprint of the InfoWorld report card and judge for yourself.

Ready to Work at \$5995
PC Link features a 33MHz PC/AT compatible—complete with 4MB of RAM and a 159MByte hard drive with 16ms access time and a 10MHz ESDI interface—for \$5995. For those with a large byte appetite, we also offer a 33MHz system with a 16ms 330MByte hard drive for \$6995*.

Compatibility
Thanks to its data bus speed of 8.33MHz, the PC Link 386-33MHz is fully compatible with IBM PC/AT expansion connectors. Which means our computer runs expansion cards for the PC/AT such as VGA cards, modems, network cards and the Bernoulli Box. Our compatibility list goes on to include DOS, OS/2, Windows/386, UNIX V, DESQview 386 and

off-the-shelf software. This computer takes everything you throw at it!

Speed
With the Intel 80386 microprocessor running at 33MHz, you can make very, very fast work of spreadsheets, desktop publishing and CAD/CAM applications. (To boost your math intensive applications, get our optional 33MHz 387 math coprocessor or Weitek Abacus chip.) Get your hands on our mighty zero wait state system with 64K Cache RAM—and never look back.

Quality
(Look what BYTE Says)
We've assembled an all-star team of Made in U.S.A. components for our 386-33MHz model. It features the acclaimed Hauppauge 386 MotherBoard/33MHz (with one 32-bit, six 16-bit and one 8-bit expansion slot) and the Award Software Modular 386 ROM BIOS. BYTE Magazine wrote: "PC Link has done a good job balancing the price/performance equation. Nothing spectacular, perhaps, but a solid machine at a reasonable price."

—Stanford Diehl,
BYTE, 1989 IBM Special Edition

In addition to our new 386-33MHz PC, we offer the 386-16MHz and the 386-20MHz. All three systems have excellent reliability.

PC LINK

PC Link Corp. 29 West 38th St., New York, NY 10018, (212) 730-8036

*Monitors not included with systems **Reprinted from PC Magazine, May 30, 1989 Copyright ©1989 Ziff-Davis Communications Company
Trademarks: IBM PC, XT, AT, PS/2; IBM, Intel; Windows/386; Microsoft; DESQview; Quarterdeck

33MHz Standard Features:

- Intel 80386-33 microprocessor
- 4MB of RAM expandable to 64MB using a dedicated high-speed 32-bit memory slot
- 159MB 16 ms ESDI Hard Disk
- 64KB of high-speed static RAM cache
- 64K Shadow (BIOS) memory
- 16-bit VGA Adapter
- Sockets for 33MHz 80387 and 33MHz WEITEK 3167 math coprocessors.
- 5.25" 1.2 MB or 3.5" 1.44 MB diskette drive
- Dual diskette and hard disk drive controller
- Enhanced 101 key keyboard
- 1 parallel and 1 serial port
- 220-watt power supply
- MS DOS 3.3 or 4.0

16 and 20 MHz Standard Features:

- Intel 80386-16 microprocessor or 80386-20
- 640K DOS memory
- 320K Extended memory
- 64K Shadow (BIOS) memory
- Award Software connector BIOS
- 4-way interleaved RAM
- 0 wait states
- PC/AT compatible
- One 8/32-bit expansion slot
- Four 8/16-bit expansion slots
- Three 8-bit expansion slots
- 3 Programmable timers
- One 5.25" 1.2 MB or 3.5" 1.44 MB disk drive
- Dual diskette and hard disk drive controller
- Enhanced 101 key keyboard
- 1 parallel and 1 serial port
- 220-watt power supply
- Bundled with public domain utility, disk caching and system set-up software.

PC LINK Warranty

PC Magazine said: "The components are good enough to make you forget about the 1-year parts-and-labor warranty!"** Still, it's here if you need it.

Call PC Link for a true 386-33MHz computer that actually works. Ask for a reprint of InfoWorld's 386/33 Report Card. Call: 1-800-221-0343. In New York: (212) 730-8036. For information on our complete product line, request our brochure!

SHORT TAKES

BYTE editors' hands-on views of new and developing products

Wallaby

WordPerfect 5.1

Vellum

TrackMan
Stationary Mouse

Generic 3D Drafting

KDS-1984 TriSync



A Macintosh-Compatible Laptop from Wallaby

What do you get when you cross a Wallaby with a Macintosh? You get your old Mac Plus or SE without the ROMs (bootable by the Wallaby), and you also get a 15-MHz Mac-compatible laptop that weighs 10 pounds.

We were a little skeptical at first. But when we got our hands on a prerelease Wallaby and ran it through the BYTE benchmarks, we found that it is actually a bit faster than the Mac Portable and about twice as fast as a stock Mac SE. The Wallaby ran all our major well-behaved software (e.g., MacWrite II and Excel 2.2) without complaint.

The system looks like an ordinary laptop at first glance, but it's actually a Mac peripheral in function. When you get the system, you have to take your Mac to a dealer to have the ROM chips removed and then installed in the Wallaby. When you want to boot your Mac, you have to connect the Wallaby to it with a host connector cable. This gives your Mac access to the Wallaby's

15-MHz CPU, 1 to 4 megabytes of system RAM, floppy disk drive, screen, and optional silicon disk.

The internal floppy disk drive can read and write both Mac-formatted 800K-byte floppy disks and IBM-formatted 720K-byte floppy disks. The screen, which can function as a second screen for your Mac, is a backlit, black-on-white 640- by 400-pixel LCD. You configure and operate the Wallaby screen via a control panel on-screen. You can put the same document on

both screens, a menu on one and a document on the other, or have one window spread over both screens.

Besides the 1 to 4 megabytes of RAM, you can add up to 16 megabytes on the silicon disk. Wallaby Systems claims that the disk operates for up to a month between battery recharges. The disk appears as a logical hard disk drive icon on the Desktop, and you can also boot the system from the silicon disk.

The rechargeable battery that comes with the Wallaby

will stay fully charged for about 3 hours. A wall-mount transformer comes with it for recharging. The sealed battery flips out of the screen's back to serve as a stand and as support for the screen.

The design takes some getting used to. When we first saw it, we couldn't figure out how the screen flipped up. And using the battery as a support seemed very awkward.

The Wallaby's wireless infrared keyboard has a Mac SE layout and a built-in Isopoint pointing device. The Isopoint is pencil-shaped, and you roll it up or down, left or right, to move the cursor in those directions. Typing was pleasant using the keyboard of the pre-production unit we evaluated, even with the presence of the Isopoint, which is really a mouse-replacement device. We obtained the best results by using our thumbs to control the Isopoint, but index fingers would work as well. You can use an optional mouse, which you plug into the wireless keyboard.

The Wallaby comes with a host adapter/expansion port, an AppleTalk-compatible printer port, a communications port, and an external LCD port. A SCSI adapter cable is available as an option.

While a formal evaluation must await the final product, we think the Wallaby/Mac combination makes a powerful duo. It provides an interesting upgrade path for current Mac Plus and SE owners, who gain the functionality of a portable Mac with double the clock speed, a second screen, and IBM PC read/write capability. At roughly half the price of the Mac Portable, the Wallaby may be a serious alternative. □

—Anne Fischer Lent and
Laurence H. Loeb

continued

THE FACTS

Wallaby

Base system, \$2995; with 1.44-megabyte floppy disk drive, \$3095; with 20-megabyte hard disk drive instead of a floppy disk drive, \$3995.

Options:

Mouse, \$95; SCSI adapter cable, \$95; spare battery, \$95.

Dimensions:

12½ by 7½ by 3½ inches; weight: 9½ pounds (including battery and hard disk drive).

Wallaby Systems, Inc.
2540 Frontier Ave.
Boulder, CO 80301
(303) 444-4606
Inquiry 981.

Mouse-ified and Feature-Laden

In the past, WordPerfect was one of the few programs that resisted the Macintosh-like simplicity of mice and menus. But that's about to change. **WordPerfect 5.1** will support a mouse and pull-down menus. And eventually—in version 6—the program will support a full graphical user interface. In the meantime, the ease-of-use features shouldn't get in the way of experienced WordPerfect users.

I saw a beta copy of WordPerfect 5.1, which included a spreadsheet-like tables feature, designed to simplify creating boxed tables in a document; an equation editor, for creating mathematical equations; "hot links," for including spreadsheet data or graphics in a document without actually copying the data or graphics into the document file; and the ability to print the hundreds of characters that become visible on-screen with WordPerfect 5.0. Version 5.1 also includes such improvements as dictionary-based hyphenation, better context-sensitive help, and improved merge, tabs, outlining, and justification.

I don't know how snappy



THE FACTS

WordPerfect 5.1
\$495

Requirements:
IBM PC or compatible
with 384K bytes of free
RAM.

WordPerfect Corp.
1555 North Technology
Way
Orem, UT 84057
(801) 222-5600
Inquiry 982.

the performance on WordPerfect 5.1 will be, but I suspect it will be similar to that of version 5.0. Also, WordPerfect Corp. has guaranteed that version 5.1 will still run in well under 640K bytes of RAM.

While some may find fault with the large number of features in the new WordPerfect, I found that those you don't need don't seem to get in the

way, and features you need are likely to be there. As long as the program will run on desktop computers that don't have expanded or extended memory, I agree with the company's philosophy: the more features, the better.

But with so many features, the new versions of WordPerfect are intimidating to new users, and even experienced

users may have trouble figuring out how to get at features they don't often use. That's why I'm glad to see the improved help and the pull-down menus. The menus will help get new users up to speed, and experienced users can turn them off.

WordPerfect Corp. claims it currently holds 60 percent of the word processing market, and its goal is to make WordPerfect the word processor for everyone. I'm not sure that's possible; it smacks of the hubris that once plagued integrated software, which tried to do everything and ended up doing nothing well. WordPerfect 5.1's equation editor, for example, is usable, but I wouldn't want to write a calculus textbook with it. And the hot links for graphics and spreadsheet data are fine, but not as flexible as a true object-oriented system.

This new version of WordPerfect has avoided the bloating that has afflicted the new versions of Lotus 1-2-3 and dBASE. It still fits into an ordinary IBM PC's memory—and runs on an ordinary PC's CPU. As long as WordPerfect continues to work on almost every PC clone ever made and includes almost every feature its users have ever asked for, I don't think the company will go too far wrong. □

—Frank Hayes

Easygoing 2-D CAD on the Macintosh

As the name suggests, **Vellum**, which is a two-dimensional CAD program for the Macintosh, is designed to act as a fine sheet of drawing paper.

The screen is standard Mac (i.e., pull-down menus and icon palettes). When you position the cursor over an icon, the upper left corner of the screen explains what the icon does. To draw an entity, you select from the icon palette, position the mouse, and click. A ghost shape will rubber-band and follow the mouse

around the screen. Most functions work in this way. Point, click, and drag is the essential operation in any Vellum function. A limited gesture-recognition ability lets you zoom in and out of your drawing without going back to the menus.

Perhaps Vellum's most striking feature is the Drafting Assistant. This drawing aid lets you accurately place objects in relation to one another. As the cursor moves across the screen, Vellum compares the cursor to every other object, looking at endpoints, mid-

points, and intersections. If the cursor matches any of these points, Drafting Assistant locks to it, labels it, and shows you a temporary construction line. Getting objects to line up perfectly is a snap.

Vellum's feature list is on a par with those of other mainstream CAD products. Scaling, rotating, layers, dimensioning—they're all included with the standard package. I compared Vellum side-by-side with Claris CAD and AutoCAD for the Mac to get a feel for the differences.

Claris CAD felt a lot like MacDraw. It didn't seem as if I had as precise control over objects as I had with Vellum. The icons were not always intuitive and didn't have the self-explanation feature. Compared to Vellum, Claris CAD had a wimpy feeling.

AutoCAD is perhaps more powerful than Vellum, but it's also much more complicated. I have used AutoCAD before on the IBM PC, and I've never liked it. Vellum gives you the same level of control over

continued



Embedded systems designers have already used CrossCode C in over 577 different applications.

CrossCode C comes with four powerful tools to help you program your 68000-based ROMable applications

From C source to final object, each tool takes you one step closer to your finished ROMable design

CrossCode C is designed specifically to help you write ROMable code for all members of the Motorola 68000 family. Four powerful tools take you from C source to object code:

1. COMPILER: To get truly ROMable code, you have to start with a truly ROMable compiler. Here are three **CrossCode C** features that you won't find in any ordinary C compiler:

- Compiler output code is split into five independent memory sections that you can assign into ROM or RAM as you please.
- You can optimize the code for your application because *you* control the sizes of data types. For example, you can optimize for speed by using two byte *ints*, or get maximum versatility by using four byte *ints*.
- You can easily write assembly language routines that call C functions and vice versa, because the compiler uses simple, well documented parameter passing conventions.

2. ASSEMBLER: **CrossCode C** comes with a Motorola-style assembler that has all the features that assembly language programmers require. In fact,

you could write your whole application with it:

- The assembler features an advanced macro language, conditional assembly, "include" files, and an unlimited size symbol table.
- Detailed cross references show you where you've defined and referenced your symbols.
- After a link, you can actually convert your "relocatable" assembler listings into "absolute" listings that contain absolute addresses and fully linked object code.

3. LINKER: The **CrossCode C** linker is designed to handle truly huge loads. There are no limits on the number of symbols in your load or on the size of your output file. And you can always count on full 32 bit target addressability, because the linker operates comfortably in the highest ranges of the 68030's address space.

4. DOWNLOADER: **CrossCode C** comes with a *downloader* that puts you in touch with all EPROM programmers and emulators. It can convert your load into Motorola S-Records, Intel Hex, Tek Hex, Extended Tek Hex, and Data I/O ASCII

Hex. You can also produce a binary image and convert that image into any format you might want. In all formats, bytes can be split into EPROMs for an 8, 16, or 32 bit data bus.

Why Wait

Once you start using **CrossCode C**, you may just wonder how you ever got the job done before! It's available under MS-DOS for just \$1595, and it runs on all IBM PCs and compatibles (640K memory and hard disk are required). Also available under UNIX, XENIX, and VMS.

CALL TODAY for more information:

1-800-448-7733

(ask for extension 2002)

Outside the United States, please dial

PHONE: 1-708-971-8170

FAX: 1-708-971-8513

SOFTWARE DEVELOPMENT SYSTEMS, INC.
DEPARTMENT 22
4248 BELLE AIRE LANE
DOWNERS GROVE, ILLINOIS 60515 USA

CrossCode™ is a trademark of SOFTWARE DEVELOPMENT SYSTEMS, INC. MS-DOS® is a registered trademark of Microsoft. UNIX® is a registered trademark of AT&T. XENIX® is a registered trademark of Microsoft.

THE FACTS

Vellum
\$995

Requirements:
Mac II or SE with 4 megabytes of RAM, a hard disk drive, and preferably a large color monitor.

Ashlar, Inc.
1290 Oakmead Pkwy.,
Suite 218
Sunnyvale, CA 94086
(408) 746-3900
Inquiry 983.

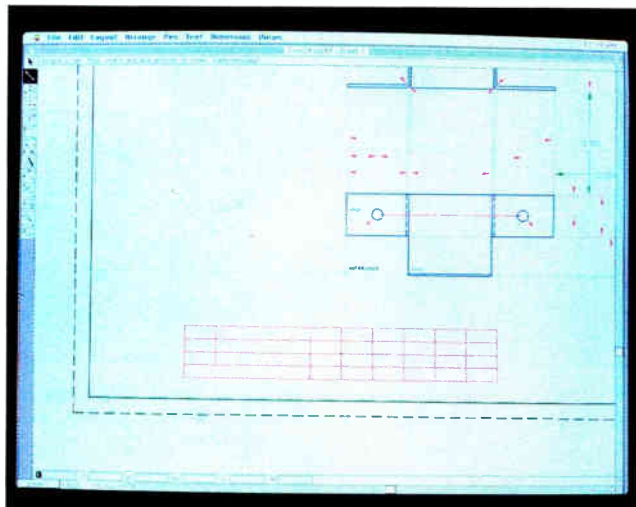

objects while retaining its "Macness." Of course, AutoCAD gives you three-dimensional modeling. Ashlar has announced its three-dimen-

sional add-on, which was not included with the beta version I tested.

The base price is expected to be \$995, which includes all

the features I've mentioned, plus associative detail views, NURB splines, parametrics, symbol libraries, and many others. Hard copy comes from

the standard Mac printing devices or a pen plotter. Plotter drivers should be included in the shipping product.

Unfortunately, this power requires a Mac II or SE/30 with at least 4 megabytes of RAM, as well as the biggest monitor you can scare up. Color is definitely recommended. As for speed, I ran our beta copy on both a Mac IIcx and a standard Mac II, both with 4 megabytes. Vellum was fine on the Mac IIcx, but a bit poky on the Mac II. Ashlar expects to improve the speed by Vellum's release date.

Vellum combines big features, a small price tag, and a terrific interface. It's a package worth looking at if you're serious about CAD. □

—Howard Eglowstein

The Stationary Mouse

Logitech's new input device, the **TrackMan Stationary Mouse**, consists of a rectangular pad with a thumb-operated trackball in the lower left corner and three selection buttons in the upper right area of the pad. Measuring 4 by 3 inches, the pad supports the palm of your hand. You rotate the trackball with your thumb, which moves the cursor or pointer on the screen, and you click the selection buttons with your fingers. You don't need to move your hand or the TrackMan to perform this operation.

TrackMan is an optomechanical device with a default resolution of 300 dots per inch (i.e., 1 inch of rotation moves the cursor 300 pixels). This resolution can be adjusted through software drivers to from 50 to 19,000 dpi. The mechanical part of the design is simply the rolling trackball. As it rolls, LEDs placed on either side of it provide the coordinate data for moving the cursor on the screen.

I tried the TrackMan using



Logitech's Finesse desktop publishing software. I found the trackball to be easy to manipulate with my thumb. Indeed, the cursor followed my thumb movements precisely. When I wanted to click on a menu option, I simply pressed down my index finger. I was amazed how quickly TrackMan felt natural and intuitive to use—much faster, in fact, than my experience when first learning to use a mouse.

TrackMan may be the first mouse-like input device that is as easy to use as a conventional mouse. Because it does not re-

quire a surface on which to roll the trackball (it needs only enough room for the pad), it is ideal for use with laptops or desktop machines in confined areas (e.g., with a keyboard that's in a sliding drawer). An important feature of TrackMan is that you can use it on inclined or vertical surfaces, since the trackball can rotate only as a result of the motion of your thumb (it will not rotate due to external accelerations, as a mouse would).

The product includes Logitech's MouseWare utilities and drivers for adjusting the

THE FACTS

TrackMan Stationary Mouse

Serial version, \$139; bus version, \$149.

Requirements:
IBM PC, XT, AT, PS/2, or compatible.

Logitech, Inc.
6505 Kaiser Dr.
Fremont, CA 94555
(415) 795-8500
Inquiry 984.

trackball's sensitivity and ballistic response (i.e., how much the cursor moves on the screen as you rotate the trackball). I think the Macintosh is an obvious target for TrackMan, but, unfortunately, TrackMan is not available for the Mac due to "contractual problems." (Logitech is an OEM supplier to Apple.)

TrackMan will probably not replace the mouse as the standard pointing device, but it may be the first attractive alternative to it. □

—Nick Baran
continued

VideoShow!

BECAUSE GOOD IDEAS DESERVE GREAT PRESENTATIONS

More Than A Graphics Software Solution

Your desktop computer is one of the best tools around for creating great presentation images. Now VideoShow® can take those images into the conference room where you'll really impress your audience with high-resolution presentations in up to 100,000 simultaneous colors. And it's as easy as pressing a button.

Create impressive images with your favorite graphics presentation software like Aldus® Persuasion™, Lotus® Freelance Plus®, Microsoft® PowerPoint™, and Harvard™ Graphics. Then leave your computer in your office while you're in the conference room. Just connect VideoShow to a color monitor or video projector. Insert your presentation disk, and press the button.

Slides and Overheads At Your Desk

VideoShow lets you express your ideas in a variety of media. Simply add PhotoMetric® SlideMaker® to turn your VideoShow images into quality high-resolution slides. Or use VideoShow with PrintMaker® software and a color printer to produce sharp, brilliantly colored overhead transparencies and hardcopy handouts.



VideoShow's wireless remote control puts you in complete command of your presentation.

Powerful, Dynamic Electronic Presentations

Give your good ideas extra impact with exciting electronic presentations. VideoShow turns your images into superb boardroom-quality presentations with dynamic transition effects, all in brilliant full color. Even if you've created your images on a monochrome system.

VideoShow Is Versatile, Convenient, Affordable

With four models to choose from, there's a VideoShow electronic presentation system to fit every office, every budget, and every presentation need. VideoShow is designed for maximum flexibility -- so your presentations can be as unique as your ideas.

as your ideas.

**VideoShow:
A Great Idea
For Your Next
Presentation.**

**Call today:
800-223-0999**

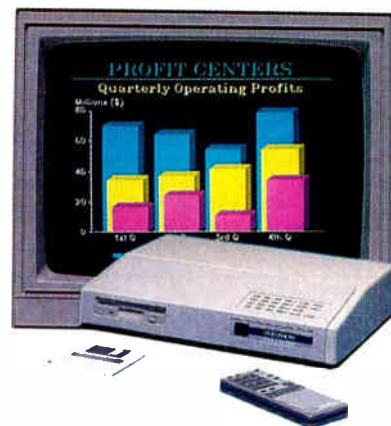

Make great electronic presentations with VideoShow. Presentation images may be created with a PC/AT, PS/2®, or Macintosh®.

General Parametrics Corporation The leader in desktop presentation products

Trademark/Owner: Aldus, Persuasion, Aldus Corporation; Macintosh/Apple Computer, Inc.; PS/2/International Business Machines; PhotoMetric, PrintMaker, SlideMaker, VideoShow/General Parametrics Corporation; Freelance Plus, Lotus/Lotus Development Corporation; Microsoft, PowerPoint/Microsoft Corporation; Harvard/Software Publishing Corporation.

Circle 137 on Reader Service Card

Want to save Time, Money,
& Headaches?

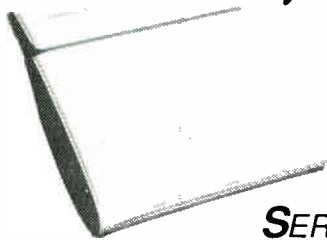

GET SUPERSOFT'S
SERVICE DIAGNOSTICS

All the software, alignment diskettes, parallel/serial wrap-around plugs, ROM POSTs and extensive, professional documentation to provide the most comprehensive testing available for IBM PCs, XTs, ATs and all compatibles under DOS or Stand Alone. No other diagnostics offers such in-depth testing on as many different types of equipment by isolating problems to the board and chip level.

NEW: SuperSoft's ROM POST performs the most advanced Power-on-Self-Test available for system boards that are compatible with the IBM ROM BIOS. It works even in circumstances when the Service Diagnostics diskette cannot be loaded.

NEW: 386 diagnostics for hybrids and PS/2s!

For over nine years, major manufacturers have been relying on SuperSoft's diagnostics software to help them and their customers repair microcomputers. End users have been relying on SuperSoft's Diagnostics II for the most thorough hardware error isolation available. Now versions of Service Diagnostics are available to save everyone (including every serious repair technician) time, money, and headaches in fixing their computers, even non-IBM equipment.

- | | |
|---|--|
| All CPUs & Numeric Co-processors | All Color Graphics & Monochrome Monitors |
| System Expansion & Extended Memory Floppy, Fixed & Non-standard Disk Drives | Parallel & Serial Ports |
| Standard & Non-standard Printers | Mono, CGA, Hercules & EGA Adapters |
| System Board: DMA, Timers, Interrupt, Real-time Clock & CMOS config. RAM | All Keyboards & the 8042 Controller |

NEW: Manufacturer's burn-in diagnostics now available for IBM and compatible PC, XT, AT, 386, 486 and PS 2 systems.

Service Diagnostics for PC, PC/XT, and compatibles only	\$169
Alignment Diskette for PC, PC/XT and compatibles (48 tpi drives)	\$ 50
Wrap-around Plug for PC, PC/XT and compatibles (parallel and serial)	\$ 30
Service Diagnostics for AT and compatibles only	\$169
Alignment Diskette for AT and compatibles (96 tpi drives)	\$ 50
Wrap-around Plug for AT (serial)	\$ 15
ROM POST for PC, PC/XT and compatibles only	\$245
ROM POST for AT and compatibles only	\$245
Service Diagnostics: The KIT (includes all of the above—save \$502)	\$495
Service Diagnostics for 386 or V2, V30, or Harris, etc. (please specify)	\$195
Diagnostics II is the solution to the service problems of users of all CP/M-80, CP/M-86 and MS-DOS computers	\$125
ROM POST for PS/2 and compatibles only	\$245
Alignment Diskette for PS/2 and compatibles (3.5 inch)	\$ 50

To order, call 800-678-3600 or 408-745-0234
FAX 408-745-0231, or write SuperSoft.

your microcomputer repair solution

SuperSoft

FIRST IN SOFTWARE TECHNOLOGY P.O. Box 611328, San Jose, CA 95161-1328 (408) 745-0234 Telex 270365

SUPERSOFT is a registered trademark of SuperSoft, Inc.; CDC of Control Data Corp.; IBM PC, AT & XT of International Business Machines Corp.; MS-DOS of MicroSoft Corp.; NEC of NEC Information Systems, Inc.; PRIME of PRIME INC.; Sony of Sony Corp.

Simple but Elegant 3-D CAD

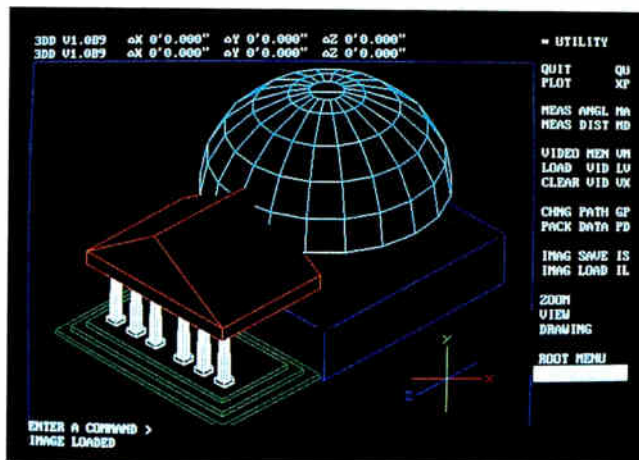

When BYTE's Product Focus looked at three-dimensional modelers in May ("The Third Dimension"), we omitted Generic Software's 3D Solids; it was simply Control Automation's ModelMate Plus under another name. Now there's a new three-dimensional modeler from Generic Software, **Generic 3D Drafting**, which builds on the strengths of the company's two-dimensional CADD products and solves the tricky problem of three-dimensional navigation in an elegant way.

Those using Generic CADD whose fingers automatically perform two-letter commands like ZB (zoom back) and DS (drawing save) will feel right at home in Generic 3D Drafting. If you're new to Generic CADD, that's OK, too. Menus provide a

comfortable introduction; as you pick up speed, you'll find yourself bypassing them and reaching for the commands.

I skipped the tutorial and jumped right into a drawing of the BYTE pantheon. The whole process—from installation to the finished model—took about 5 hours.

Once I got my model off the ground, things went nicely. At first, I worked exclusively in the x, y and x, z planes, using a depth point to control the placement of objects.

Then I discovered tracking, and life got a whole lot easier. Just like VersaCAD Design and CADvance, Generic 3D Drafting works best in the isometric view (see the photo). Tracking works like this: To draw the slab that sits on top of the columns, I started with the BO (box) command and answered its query for a first point with TK (track). The tracking mechanism asks for an anchor; I snapped to the left front corner of the top step.

Then, using a three-dimensional cursor active in all three planes, I moved up 13 feet to the height of the top of the columns, set the slab's first point, moved right 34 feet to set its width, moved back 20 feet to mark its depth, and finally moved up 3 feet to mark its height. A running display of coordinates and a three-dimensional cursor trail make the tracking mechanism one of

continued

THE FACTS

Generic 3D Drafting
\$250

Requirements:
IBM PC AT or compatible with 640K bytes of RAM, EGA or VGA, and a mouse.

Generic Software, Inc.
11911 North Creek Pkwy. S
Bothell, WA 98011
(206) 487-2233
Inquiry 985.

Reach for ultimate portability

Fastest
and Most Reliable!



200 MBytes of power, speed and security in a revolutionary, removable hard drive.

At last, the Disk Pack gives you everything you've always wished for in a data storage system. The speed and high storage capacity of a hard drive. The ease and convenience of a floppy diskette. And the safety of a tape backup. All wrapped up in a state-of-the-art rugged unit, about the size of a paperback book. Designed to make your life a lot simpler and more secure.

True portability is here

Just picture this: With the Disk Pack you carry your whole work environment with you, wherever you go. All your files, all your data stay organized and configured just the way you created them. Between your office and remote sites. Or home. Or another department. You can even mail a Disk Pack. It's that rugged.

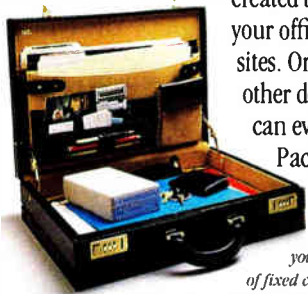

The Disk Pack frees you from the constraints of fixed computers. Your whole work environment fits in the palm of your hand.

Total security for your data

Simply slide out a Disk Pack module and lock away your entire business customer base and payroll figures in a drawer or safe. Same for lawyer,

banker or accountant sensitive data and Uncle Sam confidential information. All fully secured in a snap.

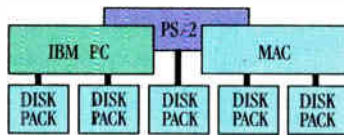

Get full data portability and security on the computer of your choice. Macintosh, PC-Compatible or PS/2.

Blazing speed Rock-solid reliability Limitless expansion

Breakthrough technology makes the Disk Pack four to five times more reliable than other removable products. Access times as low as 13 ms make it one of the fastest hard drives on the market. The Disk Pack doesn't limit you to a single storage capacity either. You can interchange 20-, 40-, 80- or 120-MByte modules in your

system and between systems. Link modules up for a whopping Half-GByte + of on-line data. Store them for unlimited off-line data. And do lightning-fast data backups.

That's not all. The Disk Pack turns a shared computer into your fully personal machine within seconds. It's ideal for space grabbing applications such as color graphics, CAD, or music. One Disk Pack module does the job of 100 diskettes.

Ten times faster. And with a lot less hassle.

And thanks to the Disk Pack's unique architecture, you'll use it equally well on any Mac, Apple, PC-compatible or PS/2 computer. It's that advanced.



The Disk Pack is ideal for data security. Lock it away and forget about accidental or intentional data loss.

Circle 199 on Reader Service Card

For more information call

1-800-322-4744

DISK PACK

The new standard in data storage technology

MEGADRIVE

S Y S T E M S

1908 Avenue of the Stars, Suite 2870
Los Angeles, CA 90067 (213) 556-1663

Disk Pack is a trademark of IEF

World Wide History

20 Valuable Facts About Hard Disk Care and Maintenance

YES! I want to know more about Mega Drive Systems' new data storage technology. Please rush me more information about the Disk Pack and your free booklet "20 Valuable Facts About Hard Disk Care and Maintenance" today.

Name _____

Company _____

Address _____

City _____ State _____ Zip _____

Phone (____) _____

Number of Micros _____ Mac _____ PC _____

Mega Drive Systems, Inc.
1900 Avenue of the Stars, Suite 2870
Los Angeles, CA 90067
(213) 556-1663

MODULA-2

M2VMS™ Release 4.1-2

The Reliable Tool for Software Professionals

The Modula-2 development system for VAX™ by TERRA Datentechnik offers full flexibility within the VMS™ environment.

M2VMS™ 4.1-2 is based on the well-known Modula-2 compiler by LOGITECH that has recently been acquired by TERRA Datentechnik.

Highlights

- supports the VMS™-Debugger
- supports LSE™
- interfaces the operating system
- fully compatible with other languages
- Make Utility
- library as object and source code
- maintenance contract available

Please ask for detailed information.

TERRA Datentechnik also offers a large choice of Modula-2 products for PCs.

TERRA Datentechnik Bahnhofstrasse 33
8703 Erlenbach Switzerland
Tel ++41/1/910 35 55 Fax ++41/1/910 19 92

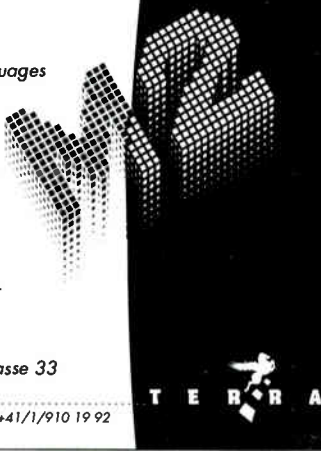

SHORT TAKES

the best three-dimensional navigational aids I've seen.

Generic 3D Drafting isn't perfect. It lacks conveniences like named views, named layers, multiple viewports, and a directory of drawings. It also lacks the horsepower of the best three-dimensional programs. Coons patches aren't supported, so I left the pendentives (arches) as an armature of arcs and Bézier curves. (You can, however, edit Bézier curves inter-

actively.) Memory space is tight, so I had to reduce the number of facets in the model in order to get everything done. Also, hidden-line removal is slow—it took 90 minutes to render the pantheon on an ALR 386/33. Nevertheless, for \$250 you get a substantial CAD program, which is a real deal. Generic 3D Drafting is off to a good start, and I expect that it will get even better. □

—Jon Udell

Large-Screen Eye Relief

Sampo hasn't cut any corners in quality with its 19-inch KDS-1984 TriSync color monitor. Instead of going the route of competitors whose multisynchronous monitors cover the gamut of handling everything from low-end monochrome TTL to high-end analog, the TriSync is an analog-only monitor that handles the three most-popular high-resolution standards: VGA, 8514/A, and Macintosh.

The TriSync is big, weighing 55 pounds. Since the unit I tested was a prerelease version, I got a bit frantic when I didn't find an instruction manual. (It hadn't been written yet.) But not to worry: If you can avoid a hernia while lifting it onto the desk, setting up the TriSync couldn't be simpler.

There are no DIP switches to set. I plugged the TriSync

into my VGA card, turned it on, turned on my system, and voilà: an impressively large and perfect picture. The TriSync automatically sets itself.

It's not hard to get used to a large-screen monitor. I could easily lean back with my feet on the desk and the keyboard in my lap, while having no trouble at all seeing the characters on the screen.



The TriSync is particularly effective for GUIs (graphical user interfaces) like Microsoft Windows or OS/2 Presentation Manager. The windows and pull-down menus jump out at you! And with a maximum resolution of 1024 by 768 pixels (interlaced), the TriSync easily handles IBM's high-end 8514/A graphics card. Used in this configuration, it really shines for CAD applications.

Color quality is excellent. And with a 0.31-mm dot pitch, sharpness is excellent, even under close scrutiny. The TriSync does pull 85 watts of power and generates quite a bit of heat, but that's to be expected with a monitor of this size. The engineering problems involved with designing and manufacturing a large-screen high-resolution monitor aren't trivial, and Sampo has obviously put a great deal of work into making a top-quality product at a more-than-fair price. As far as I'm concerned, the eyes have it. ■

—Stan Miastkowski

386

SPYS





MISSION : 32 BIT

\$49.95 by GENKI

IMAGINATION POWERED BY 386

- * **Blistering Arcade Action.**
- * **3 challenging SPY adventures.**
- * **Superior HI RES EGA Graphics.**
- * **Loaded with Animated ICONs.**

Call 301-997-6333
7 days a week

Send Check or Money Order for \$49.95 + \$3.00 S&H to Genki Software Corp., P.O. Box 2563, Columbia, MD 21045. Maryland residents add 5% Tax. Requirements: 386 PC/AT compatible, EGA/VGA graphics, DOS 3.1 or higher, 1M mem.

THE FACTS

KDS-1984 TriSync
\$1995

Requirements:

Analog graphics card for IBM PC (VGA or 8514/A) or Mac.

Sampo Corp. of America
5550 Peachtree Industrial Blvd.

Norcross, GA 30071
(404) 449-6220
Inquiry 986.

Here's all you need to know about laser printers.



It's really quite simple. Just look for this symbol on printers that include PostScript® software from Adobe Systems; it's your guarantee of quality and compatibility. And call 1-800-952-6300 (Dept. 112) for a complete listing of PostScript laser printers, typesetters and other computer equipment. Then you'll really know it all.

PostScript and the PostScript logo are registered trademarks of Adobe Systems Incorporated in the U.S.A. ©1989 Adobe Systems Incorporated. All rights reserved.

Engineered for the office. Designed for people.

After you ooh-ed and aah-ed over the letter quality output, 3-way paper feed, ease-of-use, 2-year limited warranty, and 9 pin price on our KX-P1124 printer, somebody said, "Great. Now do it with a wide-carriage."



Introducing the Panasonic KX-P1624. Our newest 24 pin wide carriage printer.

It's fast. Flexible. And fully-featured. Everything most offices are looking for in a dot matrix printer. At a price within most office budgets.

The features you'll use most often are available at a touch. Seven resident fonts to vary the look of your documents. Formatting for different document sizes.

Draft Pica
Draft Elite
Courier Pica
Prestige Elite
Bold Proportional Space
Sans Serif Pica
Script Pica

True letter quality, high-resolution graphics, and seven resident fonts, so it's ideal for all your office applica-

tions. You'll find the 1624's letter-quality mode as fast, or faster, than most popular 9 pins. Up to 63 LQ characters per second. With its 360 x 360 dpi bit-mapped graphics, you can incorporate special printed effects into your documents. Like company logos and line art.

20 features, including 4 macros, right at your fingertips. What could be simpler?

Even macros that recall all the settings for a particular document at the touch of a single key.



Done.

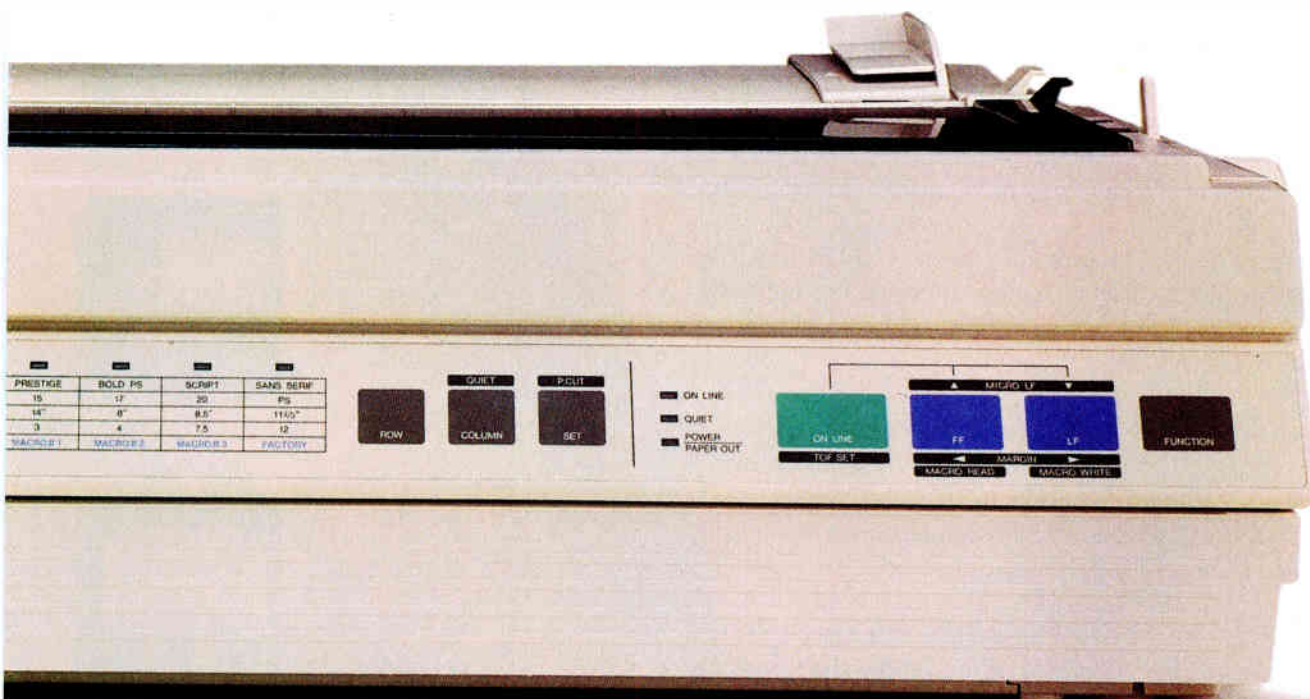

Multiple paper paths mean you can put this printer exactly where you want it. There aren't many places in an office to conveniently put a printer.

So the 1624 gives you a choice of 4 different paper paths: single sheets from the top, and fanfold from the front, bottom or rear.



Only one paper path is available at any given time for continuous paper.

bottom or rear. A special 'Paper Park' feature even lets you feed single sheets from the top, without removing rear-fed fanfold. A 2-year limited warranty in this day and age? That's investment protection, Panasonic-style. You'll find 2-year warranties rather rare in the printer industry. But standard with the Panasonic 1624.

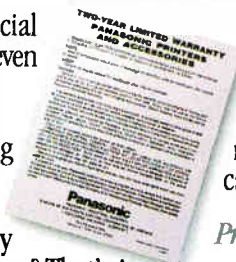

See your dealer for details. So if you've been waiting for the ideal multi-purpose office printer, it has arrived. For the name of your nearest Panasonic printer dealer, call toll-free 1-800-742-8086.

Printers, Computers, Peripherals, Copiers, Typewriters and Facsimiles

Panasonic
Office Automation 

Circle 242 on Reader Service Card

World Radio History

WHETHER REPORT.

Whether you're a software developer writing new applications for the IBM or Mac, or a PC user securing proprietary data files, software and data protection has never had a brighter silver lining. For a number of very good reasons.

Beginning with the 'whether-expert' Rainbow Technologies. And ending with its Software Sentinel family of hardware keys. Starring five models that fit virtually any software program or data file you need to protect.

There's the best-selling SentinelPro for the IBM PC/XT/AT, PS/2 and compatibles, and even the Atari ST. Known worldwide for its virtually unbreakable security. And its ASIC technology. And its invisible operation. A close relation, the Sentinel-C stands at-the-ready for custom configurations and multiple software packages.

In the Apple market, security-minded Mac software developers turn to Eve. For completely transparent operation and world-class security of the protected software. Just by plugging Eve into the Mac ADB connector.

PC users wanting a low cost, user-friendly solution to the problem of securing sensitive data can call on the DataSentry. Using a proprietary Rainbow algorithm or DES, the DataSentry encrypts data files on individual PCs, protects modem transmissions and secures data on local area networks.

Rainbow's latest protection strategy is the SentinelShell—that lets users place a 'shell' around existing, off-the-shelf programs. Because access can be limited to those issued a key, libraries, universities and corporations can very simply guard their software investments.

Whatever your whether, Rainbow Technologies has the software and data protection products that make the difference. For more information, call 714-261-0228 in the U.S., or contact Rainbow Technologies Ltd. in the United Kingdom for the distributor nearest you. Whethercasters are standing by.

• Runs under DOS, OS/2 and Xenix • Algorithm technique (Never a fixed response) • External parallel port installation • Minimal implementation effort • Higher level language interfaces included • 100 times faster than fixed-response devices (1 ms) • ASIC design for reliability

SentinelPro™



• Protects multiple packages with one device • 126 bytes of non-volatile memory programmed before shipment of the software • Rainbow supplies a unique adapter for programming the unit • Higher level language interfaces included • Runs under DOS, OS/2 and Xenix • External parallel port installation

Sentinel-C™



• For the Macintosh SE and II • Complies with Apple Desktop Bus Interface requirements • Rainbow-assigned developer passwords to prevent tampering by other developers or sophisticated "hackers" • 7 locks per key, usable individually or in combination, on one or up to seven applications

Eve™



• Completely user-installable • Pocket-sized external device • Menu-driven, user-friendly interface • Single- or multi-user security system • Audit trail, log-on identifiers and automatic encryption/decryption of entire directories • Secures data transmitted by modems • Prevents recovery of data by utility programs

DataSentry™



• Runs under DOS on IBM PCs and compatibles • Protects without requiring access to the source code • Completely transparent to the end user • User-friendly software • Pocket-size key attaches quickly to any standard PC parallel port • ASIC design for reliability

SentinelShell™



RAINBOW TECHNOLOGIES

18011-A Mitchell South, Irvine, CA 92714 • (714) 261-0228 • TELEX: 386078 • FAX: (714) 261-0260
Rainbow Technologies, Ltd., Shirley Lodge, 470 London Rd., Slough, Berkshire, SL3 8QY, U.K., Tel: 0753-41512, Fax: 0753-43610

© 1989 Rainbow Technologies. All product names are trademarks of their respective manufacturers.

Circle 278 on Reader Service Card (DEALERS: 279)

New laptops from Compaq, GRiD, Toshiba, and Zenith point to the future of small computing

Laptops Forever



E ISA, GUIs, the 80486, and the 68040 are interesting because they are the future. But laptops are the most exciting advancements in micro-computer technology that you can buy today. A look at systems that BYTE has already covered this year—the NEC UltraLite, Zenith MinisPort, Agilis System, Poqet PC, Atari Portfolio, and Macintosh Portable—proves the point.

◆
Laptops are getting smaller, running longer on batteries, challenging the performance of desktop units, and just plain getting

better in terms of functionality. Some are going where no computer has gone before—hostile factory and remote locations, on the road with truck drivers, and in numerous other work environments where, until now, a personal computer has been too unwieldy.

◆
This month, we take an early look at five more small personal computers: GRiD's fascinating GRiDPad, Compaq's notebook-size LTE/286, Toshiba's T1000SE (a refined T1000), and two powerful 80386SX systems from Zenith and Toshiba.

True Notebook Computing Arrives

Frank Hayes

Slapped on everything from toner cartridges to shrink-wrap warranties, the word *revolutionary* is a commonplace label in the computer world. So maybe we need a new word to describe the GRiDPad. GRiD's new portable is the first "notebook computer" that you can really use like a notebook. It's small and light enough to cradle in one arm while you write with the other hand. And, as with a notebook, you can actually write on it—not just type. To make this possible, the GRiDPad is equipped with a touch-screen, a metal stylus, and optional software routines for recognizing handwritten letters and numerals and translating them into ASCII text.

In case you're not quite ready for a full-scale revolution, you can use this system as a fully functional MS-DOS-based laptop. The GRiDPad, with a list price of \$2370, should be shipping by the time you read this.

What It Is

Physically, the GRiDPad is a lightweight portable PC-compatible computer. It's slightly larger than the Tandy Model 100 (12½ by 9¼ by 1½ inches) and weighs 4½ pounds (see photo 1).

The GRiDPad's 8- by 5-inch non-backlit LCD screen takes up most of its top surface. The screen has a resolution of 640 by 400 pixels and normally works in double-scan CGA resolution. Five user-programmable buttons are on the GRiDPad's top surface. A 9-pin serial port is on one side of the pad, and GRiD's standard 2400-bps Hayes-compatible modem with MNP data compression (\$695) mounts inside.

The GRiDPad's 10-MHz 80C86—a fully static CMOS version of the brains behind many laptops—operates at about twice the speed of a PC or XT. (Actual performance figures aren't yet available. We were unable to load the BYTE benchmarks because the prerelease unit that we saw did not have an external disk drive.) Standard RAM is 1 megabyte—640K bytes for DOS, plus 384K bytes of EMS memory. MS-DOS 3.3 is in ROM as drive C; drives A and B are RAM or ROM cards similar to those used with the NEC UltraLite. RAM cards are currently available in two sizes: 256K bytes

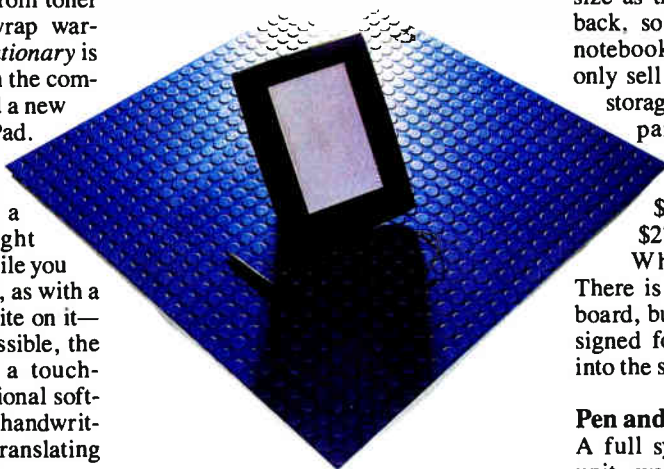

Photo 1: *The revolutionary GRiDPad.*

(\$335) and 512K bytes (\$425).

Power comes from an external AC power supply or a removable battery pack. The battery pack is unusual because it can take either a bank of nickel-cadmium batteries, which automatically recharge when plugged into the power supply, or 10 AA cells. GRiD doesn't recommend trying to run the GRiDPad regularly on AA cells (that could get expensive very quickly), but it's a nice feature to have in case of an emergency.

An internal bridge battery keeps the computer alive for about 5 minutes while you change the batteries. GRiD says the nickel-cadmium batteries will last 8 hours or more between charges, depending on how they're used.

Like most of the recent clutch of portables, the GRiDPad achieves long battery life through a sophisticated power management system. A switch on the front of the machine sends the GRiDPad into "sleep" mode, which stops the CPU and cuts the power to most subsystems except memory. You can also set the GRiDPad to go into sleep mode automatically after a certain period of idleness.

An optional expansion unit (\$1000) adds 3 pounds to the GRiDPad's weight; it includes a 20-megabyte, 29-millisecond hard disk drive, a parallel printer port, its own removable battery, and a port for an external 3½- or 5¼-inch floppy disk drive or tape backup drive. The expansion unit, which is the same

size as the main system, clips onto the back, so the combined unit retains its notebook-size dimensions. GRiD will only sell the GRiDPad with at least one storage device: a RAM card or the expansion unit with its hard disk drive. As a result, although the GRiDPad's list price is \$2370, it will cost you at least \$2705 to own one.

What's missing? A keyboard. There is a port for a conventional keyboard, but the GRiDPad is primarily designed for use with a stylus that plugs into the side of the machine via a tether.

Pen and Display

A full system, including the expansion unit, weighs in at a little more than 7 pounds. Add a keyboard (say, 4 pounds more), and it's a respectable conventional laptop computer, although it would be tough to balance on your lap. The display can be configured as a double-scan CGA screen, and it's sharp and easily readable. GRiD even offers a "stand"—a combination stand/handle for setting the screen upright on a desk.

But the "Pad" in GRiDPad stands for "pen and display," and that's how it's really designed to be used: as a lightweight electronic pad. For example, you can boot the GRiDPad with no keyboard attached and a split-screen display: The top half is a flattened 640- by 200-pixel CGA screen, while the bottom half is a diagram of a keyboard. Touch an on-screen key with the stylus, and the character appears on the command line as if you'd typed it. It's no replacement for touch-typing, but it's perfectly adequate for simple commands.

However, the GRiDPad goes this virtual keyboard one better: Programs written specifically for the GRiDPad can also do limited handwriting recognition. With the right software, you don't have to type at all—just print in block letters, and the system converts what you've written into ASCII text.

It's important not to overestimate the GRiDPad's abilities in this area. GRiD warns that it generally takes a user about 15 minutes to learn to print so that the GRiDPad can understand it. But the day that GRiD representatives showed the computer to us at BYTE, I printed words and numbers immediately with no diffi-

culty. In a few cases, I had to print a word or number several times before the computer translated it properly. But that was not much of a problem; when the GRiD-Pad got it wrong, I just drew a line through it; the software cleared the word or number, and I tried again.

It's eerie to watch block printing turn into typed text one word at a time. And it's amazing to realize that anyone who can fill out a form can use the GRiD-Pad—all you have to do is print clearly. It's also a little disconcerting to write on the textured glass surface of the GRiD-Pad's screen, which uses a capacitance-based system to get a resolution of 1024 by 1024 pixels. GRiD says the surface can't be scratched by the stylus, although the screen itself can break.

Along with the optional handwriting-recognition routines in ROM (\$70 per machine for a run-time license, plus \$125 per machine for a user interface run-time license), there's a complete set of other routines plus an application programmer interface that allows programmers to write software to take advantage of other GRiDPad features. For example, this computer has no "right-side up"; a programmer can design a GRiDPad program to rotate itself from landscape to portrait orientation, or flip itself around so the stylus is more convenient for left-handed users. The stylus can be made to imitate most mouse actions (you can "click" by tapping on the screen with the stylus, or "drag" by drawing on the screen), but there's no need for a mouse pointer on the screen—the stylus is its own pointer. The GRiDPad API also has extensive telecommunication capabilities built in, along with features to simplify designing on-screen forms. (GRiD is offering a developer's kit for programming with the API in Microsoft C and Borland's Turbo C.)

Better Ideas = Better Computers

The GRiDPad demonstrates something that we thought computer makers had forgotten: More powerful computers don't necessarily come from faster CPUs or more memory, but from better ideas. We've seen a whole string of self-styled portable computers over the last few months, ranging from Atari's inexpensive Portfolio to Apple's hefty, bulky Macintosh Portable.

The GRiDPad isn't the fastest or most memory-laden machine in this wave. And with a base price of \$2375, it is certainly not the least expensive. But it may be the first truly portable computer we've seen, and it's certainly the easiest to use. It has Macintosh-style friendli-

ness both on the screen and in its physical design.

In the future, GRiD might offer utilities that would allow off-the-shelf software to take advantage of the GRiDPad's special features. For example, special drivers could let you input handwritten text into Lotus 1-2-3 or use the stylus in place of a mouse. But for now, those special features are limited to use with software that's specially designed for the GRiDPad.

With this custom software, the GRiD-Pad is a unique computer. Because it's so lightweight, it's easy—even natural—to use while you're standing or walking around; you just cradle the computer in one arm and write with the other hand. And the stylus and handwriting-recognition software do away with the need for a keyboard, which poses the biggest barrier to most users. It's worth repeating: Anyone who can print clearly enough to fill out a form can use this computer.

And that's precisely the initial market that GRiD is counting on for the GRiDPad—the largely unautomated world of forms. The GRiDPad can easily mimic anything that a real paper form can do (since the stylus acts and feels like a real pen) while adding the power of a computer. On a sales form, for example, it could let you choose products from a menu while verifying prices, double-checking arithmetic, comparing quantities to previous orders, ensuring that all necessary parts are included in your order, and letting you sign the order form, all about as easily as you'd do it using an ordinary clipboard. That's a good way to use the GRiDPad, but it's far from the only way: Using it just for forms makes about as much sense as using the Macintosh only to run MacPaint.

In a year of innovative portable computers, the GRiDPad is easily the most innovative of the group. It's perhaps the most revolutionary computer of any kind since the Macintosh. And just as the Mac required a whole generation of programmers to consider how a mouse changes the way that software works, the GRiDPad is going to spur some even more fundamental rethinking.

For nearly 20 years, computer designers have tried to match the dream of Alan Kay's "Dynabook"—a portable, powerful, user-friendly computer. Although the GRiDPad isn't it, it brings the millennium a lot closer. □

Frank Hayes is BYTE's West Coast news editor. He can be reached on BIX as "frankhayes."

continued

The Laptop with More Power

16MHz CPU 0-wait (Landmark: 20.8MHz)
1MB Memory (Upgradable to 5MB)
704K DOS RAM (other computers only have 640K)
Shadow RAM increase speed up to 300%
Supports EMS memory, Extended Memory
40MB Harddisk (28 ms), Upgradable to 100MB
1.44MB 3.5" Floppy Drive (Internal)
1.2MB 5.25" Floppy Drive (External)
12" High Resolution Gas Plasma Display
Dual Serial, One Parallel Port
External Tape-Back-up Drive Adapter
16-bit Expansion Slot, External Keyboard Port
Free Protective Carry Bag (\$80.00 Value)

Polywell Computers

61-C Airport Blvd.
South San Francisco
SYSTEMS CA 94080, U.S.A.
Tel: (415)583-7222
Order: 800-999-1CPU
Fax: (415)583-1974



Chicony LT3400

386 Warranty Police
5-year labor, 2-year M/B
1-year for standard parts
30-day money-back Guarantee
Dealer Discount Available
Credit Card Accepted

386 Central

Seagate 42MB Harddisk (28ms)
1.2MB or 1.44MB Floppy Drive
Dual Serial, Parallel, Game Ports
Orchid ProDesigner 16-bit VGA Card
(Upgradable to 1024x768, 4-year warranty)
ADI 14" VGA Monitor (2-year warranty)
Chicony 101-key Tactile Click Keyboard
Digital Display Case w/220Watt Power Supply
Made in U.S.A. FCC Approved

Model	Memory/Dos Ram	Landmark	Price
Poly 386-20A	1MB/640	25MHz	\$2450.00
Poly 386-20B	2MB/736K	26MHz	\$2899.00
Poly 386-20C/Cache	1MB/640K	30MHz	\$2865.00
Poly 386-20D/Cache	1MB/736K	34MHz	\$3075.00
Poly 386-25A/Cache	1MB/640K	41MHz	\$3400.00
Poly 386-25B/Cache	1MB/736K	43MHz	\$3450.00
Poly 386-33A/Cache	1MB/640K	54MHz	\$4350.00

Custom Configurations Available

Compaq and Toshiba Take the Low Road

Michael E. Nadeau

The "Holy Grail" being sought by laptop vendors and users alike is a system that's as small and light as possible, yet sacrifices nothing in terms of performance, functionality, or compatibility. So far, this search has yielded products that compromise on one or more of these attributes.

Compaq and Toshiba have new laptops that represent milestones in this quest, although in different senses. Compaq has squeezed all the power of a 12-MHz 80286 desktop system into a notebook-size box, complete with hard and floppy disk drives. And Toshiba's T1000SE is an improved version of its classic T1000, which is itself a milestone product.

Both computers are aimed at professionals who need to compute on the go: salespeople, executives, field personnel, and journalists, for example. What separate the two are price and power.

Design Philosophies

I can't decide whether Compaq has taken a radical or a conservative approach in designing its small laptop computer, the LTE. Rather than use the new RAM card technology that's currently in vogue for mass storage on laptops, the company maximized the conventional method by minimizing the physical size of the floppy and hard disk drives. Compaq then shrank the circuit boards, making the most of surface mount technology (SMT). The end result is a 6.7-pound (including hard disk drive) AT-class PC that measures 8 by 11 by just under 2 inches (see photo 2).

RAM cards, though expensive and not standardized, have been touted as a breakthrough for small computers, allowing engineers to shrink the laptop ever further. Yet Compaq bucked the trend, and the result is one of the smallest and arguably most powerful mini laptops available (see the benchmark results in table 1). Best of all, the LTE doesn't seem small. Compaq hasn't sacrificed functionality for size.

The Toshiba T1000SE appears to be more conventional than the LTE. Its dimensions, 12 $\frac{1}{2}$ by 10 $\frac{1}{2}$ by 1 $\frac{1}{2}$ inches, come closer to a "standard" laptop size. It's lighter than the LTE: 5 $\frac{1}{10}$ pounds

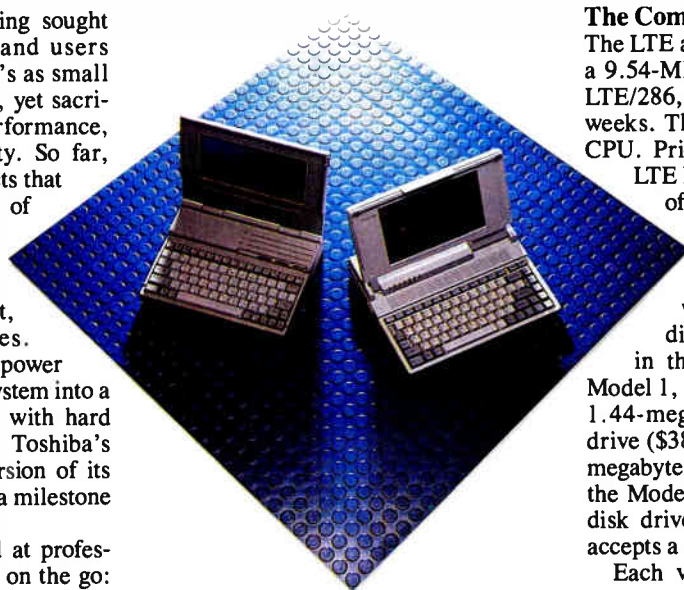

Photo 2: The Compaq LTE/286 (left) and the Toshiba T1000SE.

versus 6 pounds (sans hard disk drive). But Toshiba achieved the light weight by making a compromise that Compaq didn't. The T1000SE won't accept a hard disk drive; instead (and this is where Toshiba broke with conventional laptop design), it is limited to the now-ubiquitous battery-backed RAM card for optional storage capacity. Maximum storage on the RAM card is 2 megabytes—far from the 40 megabytes available on the LTE.

Compaq also provides more power for those who need it. The 80C286-based LTE/286 with an optional math coprocessor runs rings around the T1000SE (see table 1), but Compaq compromised, too. The T1000SE's CGA resolution is 640 by 400 pixels; the LTE's is 640 by 200 pixels. The Compaq's keyboard is a bit more compact with less key travel, too. These are concessions to achieving the smaller form factor.

The LTE is a new addition to Compaq's computer line, filling a hole in the low end of its laptop offerings. Toshiba has positioned the T1000SE between the T1000, long a best-seller among low-end laptop computers, and the hard disk drive version of the T1200.

Compaq will ship the LTE by the time you read this; Toshiba says the T1000SE will be available in January.

The Compaq Twins

The LTE actually comes in two versions: a 9.54-MHz 80C86-based LTE and the LTE/286, which I used for a couple of weeks. They are identical except for the CPU. Prices range from \$2399 for the LTE Model 1 (which has 640K bytes of RAM, a 1.44-megabyte 3 $\frac{1}{2}$ -inch floppy disk drive, and no hard disk drive) to \$2999 for the Model 20, which has a 20-megabyte hard disk drive. The LTE/286 comes in three basic configurations: the Model 1, with 640K bytes of RAM and a 1.44-megabyte 3 $\frac{1}{2}$ -inch floppy disk drive (\$3899); the Model 20, with a 20-megabyte hard disk drive (\$4499); and the Model 40, with a 40-megabyte hard disk drive (\$4999). Only the LTE/286 accepts a math coprocessor.

Each version has two small proprietary expansion slots on the right side—one for either a 2400-bps modem (\$449) or an asynchronous communications card (\$149), the other for memory. The tiny modem card measures only 3 $\frac{1}{4}$ by 2 $\frac{1}{4}$ inches. It has nearly the same design as the modem for Compaq's SLT/286, and it, too, benefits from Compaq's SMT engineering know-how. Maximum total memory for the LTE is 1 megabyte; for the LTE/286, 2.6 megabytes. Other options include a numeric keypad (\$119) and a fast charger for the battery (\$199).

The screen is a CGA-compatible backlight electroluminescent supertwist LCD with 640- by 200-pixel resolution. Its two distinguishing features are its thickness (a quarter of an inch) and the ability to switch from reverse to normal video. You adjust contrast and brightness via slide controls, and you can adjust its position a full 180 degrees. Screen quality is good, and the ability to switch video modes is a nice feature.

A standby button lets you shut down the LTE while maintaining the memory contents in RAM. The LTE comes standard with one serial and one parallel port, a video port, and an external floppy disk drive connector.

The 80-key keyboard is only a half-inch thick, yet it provides good tactile response with a clearly audible click. The keys are not full-travel. All the function keys and most of the non-alphanumeric

continued

Experience the history of aviation.

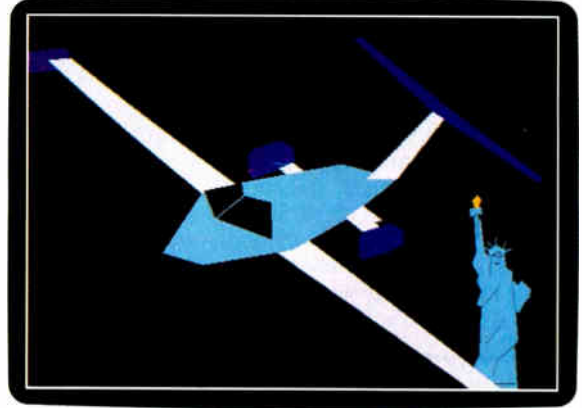

Or make aviation history.

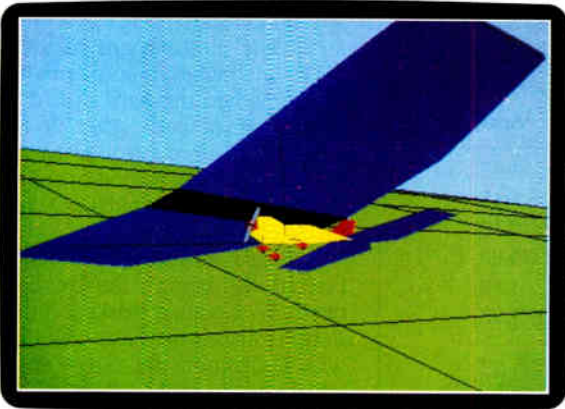

New Flight Simulator lets you put wings more commonly seen on a 747 on a Cessna and redefine the word "lift."

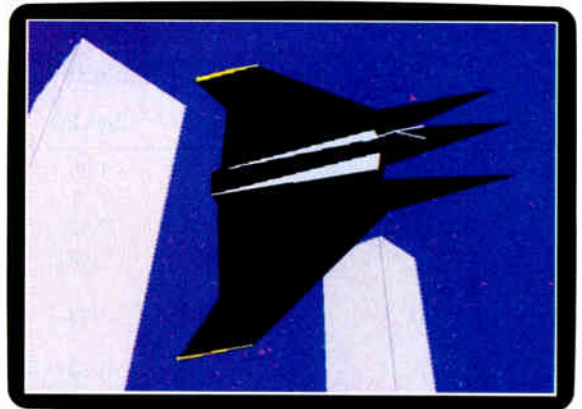

Brave souls can light up the Manhattan skyline with the most radical jet this side of the B2.

It's a known fact that Microsoft® Flight Simulator® provides the most realistic, exhilarating flying experience you'll find on a PC. Desktop pilots have taken to the skies in all kinds of differ-



The control panel lets you know exactly how much control you do, or don't, have.

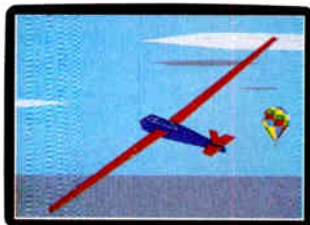

And when you leave the ground, you don't even have to fly. You can glide, in our new sailplane.

ent aircraft, from a WWI Ace to a modern-day jet.

Now we've added features to the new Flight Simulator 4.0 that'll throw you for a loop. Literally.

For starters, you can design your own plane. Which gives you the chance to investigate the acceleration characteristics of a 1000 horsepower

Cessna. Or the lead-balloon characteristics of a wingless sailplane.

Equally adventurous is the weather. New Flight Simulator randomly creates clouds, wind, storms, you name it, when you least expect it.

We've also added an array of air and runway traffic, including a Boeing 767. You even get runway clearance from the control tower, to make every landing a happy one.

To get your flying career off the ground, see a Microsoft dealer.

You could discover that you're an aeronautical engineer. Or a natural pilot.

Or maybe, just maybe, you'll discover that most of your flying should be done at a desk.



Microsoft®
Making it all make sense™

Customers inside the 50 United States, call (800) 541-1261. In Canada, call (416) 673-7638. Outside the U.S. and Canada, call (206) 882-8661. © Copyright 1989 Microsoft Corporation. All rights reserved. Microsoft and the Microsoft logo are registered trademarks and Making it all make sense is a trademark of Microsoft Corporation. Flight Simulator is a registered trademark of SubLOGIC Corporation, used under license by Microsoft Corporation.

keys are about half of normal size—an other trade-off (see photo 3). The key placement took some getting used to, but I found the keyboard to be acceptable.

In the “nice touch” category, Compaq put some thought into designing the LTE’s case. It looks rugged; the cover latches hold firm, and tabs on the cover fit into grooves on both the battery and expansion slot doors, preventing them from opening unexpectedly when you jar or move the LTE. The machine has no

handle, but its slipcover does.

Battery life is rated at 3½ hours, but I got nearly 4 hours on a battery that Compaq had been using for an unknown length of time for demonstrations. Recharge time is 8 to 10 hours (1½ hours with the fast charger). An optional automobile adapter (\$129) powers the system from a car cigarette lighter and can also recharge the battery pack. The LTE comes with an AC adapter.

A power management include utility,

Powercon, lets you set the amount of idle time before the system blanks the screen, puts itself to “sleep,” or turns off the hard disk drive. The LTE’s other standard utilities include the Compaq Extended Memory Manager, an Adapt display utility, and a disk-caching utility. MS-DOS 3.31 costs \$120; version 4.01 is \$150.

Getting Small

Compaq concentrated on reducing the physical size of the system’s motherboard and floppy and hard disk drives. According to David Black, Compaq’s director of product development, the company made use of SMT engineering know-how that it gained from designing the Compaq SLT/286. SMT allows system designers to put a greater density of application-specific ICs in a given board area. The motherboard measures only 7½ by 2½ inches, minus a small notch to accommodate the hard disk drive, and makes use of both sides. It holds the CPU, math coprocessor socket, and supporting chips. A second board on top of the motherboard holds I/O and other miscellaneous circuitry.

But the real stars of Compaq’s miniaturization efforts are the disk drives (see photo 3). Compaq worked with Conner Peripherals on the hard disk drive, and with Citizen on the floppy disk drive, which uses standard 1.44-megabyte floppy disks. Both measure only three-quarters of an inch high, one quarter of an inch shorter than conventional drives. The hard disk drive consumes roughly a half watt less power than the one used in Compaq’s SLT/286.

The Conner hard disk drive is particularly interesting in that most of its ability to withstand shock is internal; the LTE is too small to have much shock absorbency built into the case or drive mounts. According to Compaq, this drive will withstand a shock force of 400 g’s—enough for peace of mind on the road.

Improving an Old Favorite

I’ve had a love/hate relationship with BYTE’s old Toshiba T1000. It’s relatively easy to lug around on trips, but I was going blind trying to read its screen, and growing old waiting for it to load XyWrite from its floppy disk drive. The T1000SE addresses those problems and appears to be a solid upgrade. Compared to what Compaq has done with the LTE, the T1000SE comes up short in the performance-per-pound department. However, it will appeal to users who don’t need the horsepower or a hard disk drive.

continued

Table 1: These BYTE benchmark indexes are preliminary, since we ran them on preproduction units, but the results are interesting. The Compaq is not only the smallest 12-MHz laptop we’ve tested, but it appears to be one of the fastest as well. Both the Toshiba T3100SX and the Zenith SupersPort SX are among the fastest 80386SX systems, including desktops, that we’ve tested. Other systems’ ratings are shown for comparison. None of the units were equipped with math coprocessors.

BYTE BENCHMARK RESULTS

	CPU	Disk I/O	Video
Compaq LTE/286	1.59	1.26	1.43
Compaq SLT/286	1.59	1.77	1.43
Toshiba T1000SE	0.57	3.09	0.79
NEC UltraLite	0.93	1.42	0.80
Toshiba T3100SX	2.12	*	1.79
Zenith SupersPort SX	2.07	1.98	1.82
NEC PowerMate Portable (80386SX)	1.96	1.23	1.27

For all indexes, an 8-MHz IBM PC AT=1. For a full description of all the benchmarks, see “Introducing the New BYTE Benchmarks,” June 1988 BYTE.

* Benchmarks were run under MS-DOS 4.01, which skewed the results of the DOS Seek portions of the Disk I/O tests on the T3100SX.

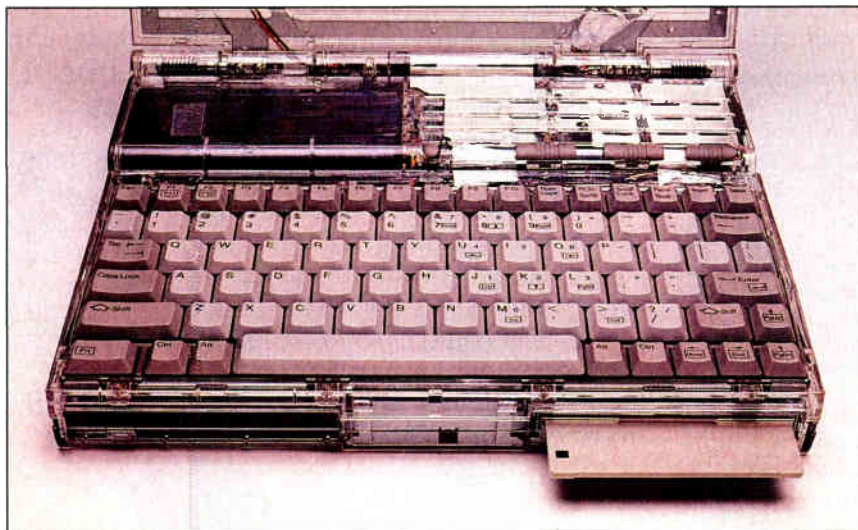

Photo 3: At only three-quarters of an inch high, the Compaq LTE/286’s hard and floppy disk drives are the smallest ever. Note the two sizes of keys on the keyboard.



July 1989
VGA WONDER



VGA WONDER



Fabulous Offer

VGA WONDER Bundle Includes HARVARD Graphics



for an additional \$150.00*

While quantities last
*MSRP \$495.00

FASTER THAN THE AVERAGE BEAR

Are you asking yourself what a bear has to do with super speed, remarkable resolution and fabulous colors? We did, too. How can anyone bear to work with less than incredible speed, we asked ourselves. How can anyone bear to work without extraordinary resolution? Bear to work with less than 256 spectacular colors? We got so beared out, we decided to share one with you. Along with the bear facts about ATI's award-winning board.

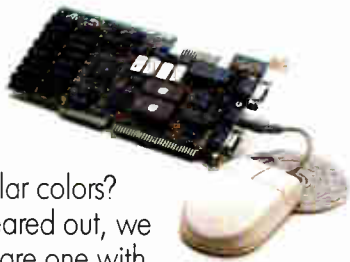

Such as:

- high resolution 800x600 and 1024x768 graphics
 - fast 16-bit bus support
 - 100% register-level compatible in VGA®, EGA®, CGA®, MDA®, and Hercules® modes
 - analog and digital monitor support
 - easy, switchless installation
 - high resolution and 132 column drivers
 - Microsoft® compatible bus mouse and mouse port included
 - available in 256K and 512K versions
- Oh, and bear this in mind – when it comes to VGA WONDER®, you'll be getting a honey of a price!

For more information, contact your supplier or

ATI Technologies Inc.
3761 Victoria Park Avenue
Scarborough, Ontario
Canada M1W 3S2
Tel: (416) 756-0718
Fax: (416) 756-0720



TECHNOLOGIES INC.
Technology you can Trust.

Circle 26 on Reader Service Card

World Radio History

Registered trademarks are as follows: ATI, VGA WONDER - ATI Technologies Inc.; Microsoft - Microsoft Corp.; Hercules - Hercules Computer Technology Inc.; VGA, EGA, CGA, MDA - International Business Machines Corp.

Finesse / F

THE ULTIMATE STRUCTURAL ANALYSIS PROGRAM IN WINDOWS

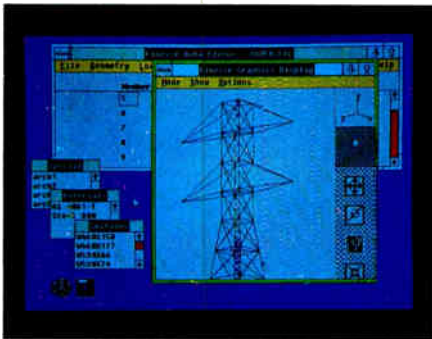

Finesse allows you to Edit, Display and Solve your structure simultaneously

With our stereoscopic 3-D view your structures gain realism and depth



Data input in Finesse is extremely easy and intuitive even for infrequent users

FEATURES

- Virtually unlimited number of elements
- 3-D and Stereoscopic display
- Point and click load selection
- Shear - Moment diagrams
- Steel, Concrete and Timber databases
- Ultra Fast solver
- Expanded memory use
- Math co-processor support
- Microsoft Windows Interface
- Autocad drawing DXF file transfer

CUBE Systems Inc.
77 Metcalfe St. Suite 310,
Ottawa Ontario Canada K1P5L6
(613) 236 7067 tel
(613) 236 7515 fax

COMPANY INFORMATION

Compaq Computer Corp.
(LTE/286)
P.O. Box 692000
Houston, TX 77269
(713) 370-0670
Inquiry 1170.

GriD Systems Corp.
(GRiDPad)
47211 Lakeview Blvd.
Fremont, CA 94538
(415) 656-4700
Inquiry 1171.

**Toshiba America Information
Systems, Inc.**
(T1000SE, T3100SX)
Computer Systems Division
9740 Irvine Blvd.
Irvine, CA 92718
(714) 583-3000
Inquiry 1172.

Zenith Data Systems
(SupersPort SX)
1000 Milwaukee Ave.
Glenview, IL 60025
(800) 553-0331
Inquiry 1173.

A 9.54-MHz 80C86 CPU powers the T1000SE (see photo 2). For its base \$1699 price, you get a 1.44-megabyte 3½-inch floppy disk drive, 1 megabyte of RAM, PC-Kwik Power Pak performance utilities, and on-line documentation. MS-DOS 3.3 comes standard in ROM as drive C. In addition to the single RAM card slot, the Toshiba has a slot for a 2400-bps modem. RAM cards come in 1-megabyte and 2-megabyte capacities. (Toshiba had not released prices for these and other options at press time.) Also standard are serial and parallel ports, as well as an external floppy disk drive port. SMT is used extensively throughout the T1000SE as well.

Toshiba intends the RAM cards to be used as a battery-backed RAM disk. To the user it appears and behaves as a hard disk partition D. You can place your most-used applications on it for quick access. A separate battery in the T1000SE maintains the RAM card's contents when the power is shut off; removing the card erases its memory. If your applications won't fit into 2 megabytes of RAM, you should consider either running some of them from floppy disks or getting a laptop with a hard disk drive.

The screen's greater resolution provides more-readable text and better

graphics than the LTE's. Brightness and contrast controls are on the side. The flip-up screen tilts 120 degrees.

For a computer of its size and price, the T1000SE has a surprisingly nice keyboard. Its 82 keys have the feel of those of a full-size keyboard, and my adjustment to the keyboard was minimal.

The case on the preproduction unit I saw didn't seem as rugged as the Compaq's. The doors for the external connectors were hard to open and close, and the battery door was difficult to remove. The single front latch for the screen looked easy to jar loose. The final production case might be better, but for rough duty, the optional carrying case is a must.

The rated battery life is a meager 2½ hours, which means you better have a spare battery pack for long airplane flights. Recharge time is a reasonable 4 hours. An AC adapter comes standard with the T1000SE, and Toshiba offers an automobile adapter as an option. A power management utility lets you specify how long the system can remain inactive before shutting down the screen and modem. It has an "auto-resume" feature; once it's enabled, you can shut off the computer, and it will pick up where you left off when you turn it back on.

The Outlook

Building smaller laptops is the science of compromise. As a buyer, you look for the system that compromises the least on features that are important to you. Their design goals differ, but Compaq and Toshiba seem to have built two nice laptops.

For me, the choice is easy. There's just no substitute for a hard disk drive—at least not yet. It's cheaper, it holds more data, and there's no worry about future compatibility problems. I'll take the Compaq LTE/286; its size is just right, and it appears built to take a lot of abuse. Other laptops have better screens and keyboards, and some are lighter, but these are picky points compared to the LTE/286's overall functionality.

But many users take a computer on the road to do one or two simple tasks, such as word processing. A T1000SE with 1 megabyte in a RAM disk is more than up to the task. Its large screen and excellent keyboard are good selling points, too, especially to T1000 users looking to upgrade. Prospective buyers must factor in the cost of the RAM cards, carrying case, and spare battery pack, though. □

Michael E. Nadeau is BYTE's associate managing editor for reviews. He can be reached on BIX as "miken."

continued

If Looks Could Kill...



The ViVa24 Modem knocks 'em dead with style and convenience.



Finally! An affordable, state-of-the-art modem designed to maximize any work station or desktop and take up minimal space. The new 2400 baud modem from Computer Peripherals, Inc. is a 100% Hayes compatible external modem which boasts more high-tech features than its competition at an unbelievable price tag. 🖱️

The compact, distinctively sleek tower design simplifies placement, and it's easily accessible, front panel power switch eliminates fumbling around the back of the unit. The handsome weighted base holds the ViVa24 firmly in place, and sharp LED indicator lights are aligned for comfortable viewing, utilizing international graphic icons that make the ViVa24 simple to understand. 🖱️

The small tower design creates a natural flow of air over the surface of the board, allowing the ViVa24 to run cooler and affording you 24-hour, worry-free operation. The Viva24 modem provides the user compatibility with IBM PC, XT, AT, IBM PS/2, Apple Macintosh computers and any computer that supports RS-232C. 🖱️

The ViVa24 modem represents innovation from its footprint up with features such as: use of the Hayes "AT" command set, asynchronous data format, auto-dialing, auto answer, adaptive equalization, non-volatile memory, automatic tone and pulse dialing, remote access while your computer is unattended, self-test and built-in diagnostics. Best, of all, the ViVa24 is fully backed with a five-year limited warranty. 🖱️

Before investing in an ordinary modem, be sure to investigate the ViVa24. 🖱️

Call your nearest dealer or call us for details.

Circle 80 on Reader Service Card (DEALERS: 81)

HIGH FIDELITY™

By Computer Peripherals, Inc.

667 Rancho Conejo Blvd. • Newbury Park, CA 91320

TEL: (805) 499-5751 • Toll Free (800) 854-7600

FAX (805) 498-8848 • TLX: 59299 CPI

Trademarks: IBM, International Business Machines, Corp.; Hayes Microcomputer Products; Apple Macintosh; High Fidelity, Computer Peripherals, Inc.

World Radio History

Lug 'Em or Leave 'Em

Stan Miastkowski

The past few months have seen a veritable flood of both desktop and laptop computers based on the Intel 80386SX processor. Compared to a full-fledged 80386 chip, the 80386SX is a logical choice for a portable computer. It costs less, requires fewer support chips, and consequently uses considerably less power, allowing systems to be battery-powered. And while its 16-bit data path won't set any performance records, the 80386SX's 16-MHz clock speed is faster than that of most AT clones (see table 1), while at the same time providing some of the advantages of the 80386, such as the ability to run 80386-specific applications.

Zenith and Toshiba have just released two of the very first battery-powered 80386SX-based portable computers. We recently had a chance to look at pre-release versions of both.

Commonalities

As you might expect from two of the industry's leading laptop makers, both the Zenith SupersPort SX and the Toshiba T3100SX are impressive and well-built machines that tilt toward the high end of the performance and price scales. They are slower than 80386-based laptops, faster than the top-of-the-line 80286-based laptops, and, at about \$6000 each, not exactly the type of systems you'll find in the hands of every traveler or casual portable computer user.

Both have processors running at 16 MHz (switchable to 8 MHz). Both also come standard with a 40-megabyte 25-ms hard disk drive and a 1.44-megabyte floppy disk drive. Other common standard features include a megabyte of RAM, VGA-compatible displays, and the usual contingent of serial, parallel, keypad, and external disk drive ports.

It still takes a lot of power to run systems like these. The battery packs are substantial in size and weight. If you can't live without battery power, both systems use fast rechargers to bring dead systems back to full power in about 3 hours. Both companies claim their systems will run for a minimum of 3 hours on batteries, and both machines use a variety of sophisticated power-saving features (e.g., turning off the hard disk



Photo 4: *The Zenith SupersPort SX (left) and the Toshiba T3100SX.*

drive) to keep the power flowing.

When it comes to future expansion, both systems also offer similar paths. Among these are memory cards, internal modems, and extra batteries.

Zeroing in on Zenith

The Zenith SupersPort SX is a sleekly designed cousin of the SupersPort 286 (see photo 4). Its distinctive ivory case sets it apart from the competition, which seems to often opt for the more-trendy dark gray or black.

Zenith's computers have always been full of thoughtful touches, and the SX is no exception. As with the 286, the SX's battery pack detaches from the rear of the computer. You often don't need the battery, and you save nearly 5 pounds without it. Sans battery, the SX weighs in at a more reasonable (though still far from light) 12 pounds.

The Zenith's screen is an absolute pleasure for the eyes, with the company's well-known "page-white" LCD screen now made even better with VGA compatibility. The 10-inch screen uses 16 shades of gray for color emulation, has incredibly bright fluorescent backlighting, and tilts through a full 180 degrees.

Keyboards are probably one of the most subjective areas in laptop design.

I've always liked the slightly soft feel of Zenith keyboards, while a fellow editor strongly dislikes it. It really depends on your individual style of typing, which is why "try before you buy" remains the best advice. But I do have a few complaints about the SX's 79-key layout, which remains staunchly quirky. For example, the backslash and single quote keys are located at the far right beyond the Shift key. And the cursor keys *seem* logically placed in the lower right corner, but they are tiny and cramped.

Another singular feature of the SupersPort SX is the built-in monitor ROM. It's a useful feature that includes a setup utility, diagnostics, directable boot-up routines, and a debugging utility. Most users will never need this feature, but it can be a real lifesaver when you do.

Toshiba's Not-So-Trendy Portable

At first glance, the Toshiba T3100SX bears a striking resemblance to the rest of Toshiba's well-known line of laptops (see photo 4). The resemblance remains at second (and third) glance, too. The company's boxy, dark-gray cases have been around for quite a few years now. And while they might not look as sleek as the competitors', they're built like tanks.

The Toshiba's battery pack isn't detachable; you're stuck with the extra weight whether you need it or not. The T3100SX weighs in at just a hair under 16 pounds—not the most ideal weight for hefting through multiple airplane connections.

Like Zenith, Toshiba has added VGA compatibility to the T3100SX, although the company still uses its venerable "low-power gas-plasma display technology" that gives you a black-on-amber display. I've always found gas-plasma screens to be an acquired taste. Although I prefer the Zenith's paper-white screen, the Toshiba's is admittedly easy on the eyes, even after hours of nonstop use.

Toshiba's AutoResume feature is one that every laptop should have. When you turn off the system, the state of the machine is saved in the CMOS memory. Turn it back on later, and you'll be exactly where you left off. This also saves battery power.

The T3100SX has an 86-key keyboard

with a stiffer feel than the Zenith's. Again, although keyboard feel is a subjective call, the layout of the keys on the T3100SX seems cleaner and more logical than the SupersPort SX's. I found that I didn't have to search endlessly for common keys.

Toshiba has also packed in more standard software than Zenith (the SX comes loaded with DOS 3.3 only). Besides DOS 4.01 (which gives you an optional graphical user interface), the T3100SX comes with Quarterdeck's QEMM-386. Although it's not particularly useful if you only have a megabyte of RAM, this software opens up new horizons when you equip your system with more memory.

Trend of the Future

Both the Zenith SupersPort SX and the Toshiba T3100SX are powerful computers. While their performance doesn't meet the full-fledged power of a true 80386 system, that extra edge of the 80386SX can come in handy for users who need a bit more processor muscle for serious spreadsheet or database work in the field.

While the power of the 80386SX isn't exactly overwhelming, these are fleet systems, especially if you're used to an 80286-based system. And while they're useful now, their real power lies in the near future, when applications specifically tuned to the 80386 start to arrive in quantity.

But what's disturbing about both of these systems is that 80386SX-based portables are bringing more weight to the laptop market at a time when users are becoming enamored of lightweight (albeit expensive) small portables. The Zenith's removable battery pack is a feature much in its favor.

Finally, there's cost. Laptops are stubbornly refusing to come down in price. As you'd expect, the 80386SX systems cost more than 80286-based portables, and less than 80386-based laptops. But \$6000 is a significant amount of money in any situation, and when the 80386SX chip was first introduced, the point of it was ostensibly to create powerful and low-cost systems. That hasn't happened yet. Thus, unfortunately, these 80386SX systems seem destined to remain with executives or with other power users. ■

Stan Miastkowski is a BYTE consulting editor, managing editor of K+S Concepts (a documentation and consulting firm), and editor of the OS Report newsletter. He can be reached on BIX as "stanm."

People are talking about us.

F77L-EM/32

Port 4GB mainframe programs to 80386s with this 32-bit DOS compiler. Winner of *PC Magazine's* 1988 Technical Excellence Award. \$895*

F77L

The compiler of choice among reviewers and professionals. New Version 4.0 includes an Editor, Profiler, Linker, Make Utility, Weitek and 386 Real-Mode Support, Graphics. \$595

F77L-EM/16

Address up to 15MB on 80286s with this award winning extended-memory compiler. \$695*

Lahey Personal FORTRAN 77

Full ANSI77, Microsoft C and Borland C interfaces, Debugger, at an unbeatable price. \$95

* Requires DOS Extender (\$195)



Contact us to discuss our products and your needs. (800) 548-4778
Lahey Computer Systems, Inc. P.O. Box 6091, Incline Village, NV 89450
Tel: (702) 831-2500 FAX: (702) 831-8123 Tlx: 9102401256

F O R T R A N I S O U R F O R T E

CODE RUNNER™

Create ultra compact and fast TSRs with full DOS access!

Support for Turbo C® & Microsoft C®

Create MultiTasking Programs

Function level granular

Auto Initialization of all activated modules and automatic recovery of initialization code and data space.

Scheduler supports > 10K events

Access Programs via ≤ 256 Hot-Keys or interrupts.

BCD floating point math library

Free source code for 6 TSR's: Help, Programmers Calculator, Business Calculator, ASCII/Color, Date/Alarm and Trap/Debug.

Great for non-TSR programs too!

Available for only:

\$149.⁰⁰

(ask about our money back offer)

COMPARE CODE SIZE

A TSR clock using Turbo C with CodeRunner vs. Blaise libraries:

CodeRunner	1.6K
BLAISE	90.3K

Microsystems Software, Inc. (508) 626-8511
600 Worcester Road, Framingham, MA 01701

Call our BBS for **FREE** sample TSRs BBS: 875-8009

CodeRunner is a TM of Microsystems Software, Turbo C is a TM of Borland International and Microsoft C is a TM of Microsoft Corporation

Quarterdec

DESQview 2.2 and DESQview 386. The multitasking, windowing environments that work with your favorite software.

DESQview™ is the operating environment that brings OS/2™ power to DOS. And it lets you, with your trusty 8088, 8086, 80286, or 80386 PC, leap into the next generation in PC productivity. For not much money. And without throwing away your favorite software.

Introducing DESQview 2.2

And now, DESQview 2.2 adds capabilities, performance, and compatibility enhancements you've been asking for:

Like being able to fine tune DESQview performance "on the fly." Run Lotus Express and Metro. And the Intel Connection Co Processor. Even use the DOS 4.0 shell with DESQview. Have DESQview automatically install Quattro, Sprint, Aldus PageMaker, Microsoft Excel, Word Perfect, Dataease and as many as 80 other programs. And using the DESQview API, be able to dynamically link them.

More bang; less bytes

While other programs get bigger, we've worked to make DESQview smaller. And we've succeeded in a big way on PCs and PS/2™s with extended, EMS 3.2 (AboveBoard), EEMS and EMS 4.0 memory—as well as on 386 PCs and



DESQview lets you run your favorite programs in windows side-by-side.

PS/2s. For example, DESQview overhead on EMS 4.0 and 386 PCs can be as low as 10K on EGA/VGA PCs. And DESQview actually *increases* memory 30K on CGA PCs; 20K on monochrome and Hercules PCs. That's good news for users of big desktop publishing, CAD and database programs.

Introducing DESQview 386

For users of 80386 PCs and PS/2s (or PCs with 80386 add-in boards, such as the Intel Inboard 386), there's DESQview 386 (a combination of DESQview 2.2 and the new QEMM-386

Quarterdeck Expanded Memory Manager, version 4.2).

DESQview 386 gives you extraordinary power. Run text, CGA, EGA, VGA, and Hercules programs in windows and in the

background. Run 32-bit 386 programs, like Paradox 386, and IBM Interleaf simultaneously with your favorite DOS programs. All with the speed and performance you expect out of your 386. And with protection against 'misbehaved' programs.

Promise and performance

And, of course, both DESQviews have all the features that made prior versions the popular choice in operating environments. The ability to multitask in 640K and beyond. View programs in windows or full screen. Transfer data. Access DOS via menus. Dial your phone. And create key-stroke macros within and between programs.

Our story gets better and better

If there's any doubt about our commitment to your PC and PS/2 productivity, just look at our accomplishments over the years. We think you will understand why GE, Ford, Aetna, Monsanto, and so many other major corporations use DESQview.

And why PC Magazine twice gave DESQview its Editor's Choice Award for "The Best Alternative to OS/2," why readers of InfoWorld voted DESQview "Product of the Year" three times. Why, by popular vote at Comdex Fall for two years in a row, DESQview was chosen "Best PC Environment" in PC Tech Journal's Systems Builder Contest, and just won their "Professional Solutions" Award.

DESQview lets you have it all now.



k Delivers.

QEMM. Break the 640K barrier for \$59.95

Your 80386 PC, IBM Personal System/2 Model 80, PC or AT with 80386 add-in board, as well as your IBM Personal System/2 Models 50 or 60 can all break through the DOS 640K barrier. Now you can have maximum use of your memory—whether you have one megabyte or 32—with the Quarterdeck Expanded Memory Manager. All without having to purchase special expanded memory boards.

QEMM uses hidden features within your existing memory to make it compatible with the Lotus-Intel-Microsoft Expanded Memory Specification (EMS) version 4.0.



Now you can run colossal spreadsheets, databases, and CAD models designed for expanded memory, using Lotus 1-2-3, Symphony, Framework, Paradox, AutoCAD, Excel and more.

And if you'd like to use these programs all together—multitasking beyond 640K—QEMM works with our popular DESQview multitasking environment.

If you are one of the 12 million or so 8088, 8086 or 80286 PC users who feel left out, don't despair. We have options that let you keep your computer and favorite programs and give you today what the newest PCs and operating systems are promising for the future.

Visit your dealer for more information on barrier-breaking Quarterdeck products.

DESQview API Toolkit. New C and Pascal Libraries, Debugger. Panel Designer. And more.

API Reference Manual

The key to the power of the DESQview API, our Reference Manual contains all you need to know to write Assembly Language programs that take full advantage of DESQview's capabilities. And there's an 'include' file with symbols and macros to aid you in development.

API C Library

Here are C language interfaces for the entire set of API functions. It supports the Lattice™ C, Metaware™ C, Microsoft® C, and Turbo C compilers for all memory models. Included with the C Library package is the API Reference Manual and source code for the library.

API Pascal Library **NEW!**

The Pascal library provides interfaces for the entire set of API functions. It supports Turbo Pascal V4.0 and V5.0 compilers. Included are the API Reference Manual, source code for the library, and example programs.

API Debugger

The DESQview API Debugger is an interactive tool enabling the API programmer to trace and single step through API calls from several concurrently running DESQview-specific programs. Trace information is reported sym-

bolically along with the program counter, registers, and stack at the time of the call. Trace conditions can be specified so that only calls of interest are reported.

API Panel Designer

This interactive tool helps you design windows, menus, help screens, error messages, and forms. It includes an editor that lets you construct an image of your panel using simple commands to enter, edit, copy, and move text, as well as draw lines and boxes. You can then define the characteristics of the window that will contain the panel, such as its position, size, and title. Finally, you can specify the locations and types of fields in the panel.

The Panel Designer automatically generates all the DESQview API data streams necessary to display and take input from your panel. These data streams may be grouped into panel libraries and stored on disk or as part of your program.

More Tools are Coming

Quarterdeck is committed to adding tools as needed by our users. To that end we have been working with Ashton Tate and Buzzwords International on dBASE III and dBASEIV translators. And in the works, we have BASIC and DOS Extender libraries.

Quarterdeck

Quarterdeck Office Systems, 150 Pico Blvd., Santa Monica, CA 90405 (213) 392-9851
FAX: (213) 399-3802

Circle 276 on Reader Service Card

World Radio History

The Only Character Recognition System

That Outperforms Ours

Nature's character recognition system can be trained to read any language. Flagstaff Engineering's **SPOT OCR Text Reader** is also trainable. It has read text printed in thousands of typefaces in over 130 different languages!

The SPOT OCR Text Reader works just like a typist who reads a page, then uses a keyboard to transfer the information on the page into a computer file—except SPOT uses a scanner for eyes and outputs the text directly into standard text files. SPOT is also faster. It can read up to 35 characters per second on a 16MHz AT, and up to 65 characters per second on a 25MHz machine (that's 780 words per minute). SPOT supports most major makes of scanners.

Using sophisticated statistical techniques, SPOT recognizes characters like the brain does: by examining their shape and context. Like nature's original, SPOT is very flexible. It can glance over an entire page or zoom in on a few lines of text. SPOT can read newspapers,

magazines, books, manuals, invoices, contracts, government documents, columns, tables . . . just about any printed text. And SPOT keeps getting better. The **new Version 3.0** is faster, more accurate, easier to use, and better documented than its predecessors.

Since 1982, Flagstaff Engineering has provided visionary data conversion solutions for thousands of companies worldwide. SPOT is already increasing productivity and making life easier for many publishers and researchers, accountants and telemarketers, medical and legal offices, archival and transcription services.

Wouldn't *your* business benefit from fast, accurate, and low-cost OCR software? Give us a call and let our application specialists explain how you can save time and money with SPOT, the OCR text-entry solution.

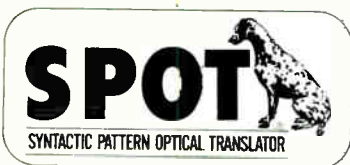

Join Flagstaff Engineering's
BIX conference: flageng

Circle 129 on Reader Service Card

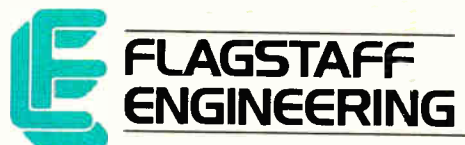

Helping People Read a World of Information

1120 Kaibab Lane • Flagstaff, AZ 86001
602-779-3341 • FAX 602-779-5998



A LOOK BACKWARD AND FORWARD

Jerry reminisces about the beginnings of microcomputers and looks at new products of today

This issue not only marks the end of the 1980s, it's also part of the celebration of BYTE's fifteenth year of publication. When my crack technical editor Stan Wszola reminded me of that, he also reminded me that except for my ace copy editor Warren Williamson, I have the longest service of anyone in BYTE's editorial department. I didn't quite start at the beginning. I did read the first issue of BYTE, but it wasn't until 1976 that I let my mad friend Dan MacLean persuade me that I needed a personal computer and borrowed the money to let Tony Pietsch build it.

I'd always secretly been in love with computers, but the incentive for buying one wasn't to own a computer per se: it was an application called Electric Pencil. The first time I saw Electric Pencil demonstrated, I realized that if I had that, I would never again retype a page of text as long as I lived; and I fell instantly, irrevocably, and irrevocably in love.

It wasn't until after I got Ezekial, my friend who happened to be a Z80 computer, that I realized that computers don't just let you write quicker—they also make your work better. Before small computers, if you made serious changes in a page of text, you ended up retyping not only the changes but the entire page.

That's hard work. The result was the "clean draft" syndrome: you have a nice clean draft of your novel—and you find paragraphs that ought to be rewritten. Sentences that should be recast. Words to be eliminated. You know the work would be improved—but there it is, a clean

draft. If you tear things up, it will have to be retyped, either by you or by a typist who won't at all appreciate having to do that job over yet again. Isn't it good enough the way it is?

But once I had Zeke, this was no problem. I wrote a draft and then printed it out and edited with pen and ink as I always had; but when I had it all marked up, it was no great trick to enter my changes and then tell Zeke to make a new copy. He didn't mind at all.

About that time two things happened: the BYTE editorial staff came to the West Coast for a computer show, and I got to worrying about my taxes. My friend Zeke had cost me \$12,000 (about half that was for the Diablo letter-quality printer). It wasn't at all clear that the Internal Revenue Service would consider a computer a legitimate deduction for a writer; this was, after all, long before "word processors" became common—indeed, before the phrase was invented. I might be able to convince their auditors that I needed the computer—and I might not. But if I could make the machine earn some revenue. . . .

At the computer show my son Alex, still in high school but very much fascinated with computers, came over to me and asked: "Do you want to meet the famous Carl Helmers?" Shortly after that I was talking with Helmers, BYTE's editorial director, and Chris Morgan, the editor in chief; and before the day was out, they had commissioned an article about writing with computers (see "Writing with a Microcomputer," *onComputing*, Summer 1979). I was then the science columnist for *Galaxy Science Fiction*, so the column format suggested itself; the article became a column; and Warren Williamson has been struggling with my semicolons ever since.

The Computer Revolution

In those days, we thought there might be a million small computers by 1987. A few of us predicted there would be even

more, but we were considered mildly insane. After all, these were *computers*. You couldn't just go into a store and buy one. Instead, you had to think about what kind of computer you wanted: one of the all-in-one systems like the Commodore PET or Exidy Sorcerer; a dedicated word processor that might or might not turn into a computer later on, like the Wang; or a general-purpose system with a card cage, bus, and cards, preferably an S-100 bus. Suppose you chose the S-100. Fine. What kind? Imsai, with flashing lights and big front-panel switches? A Cromemco "black brick," with no front panel at all, and thus no flashing lights?

What did you use to communicate with the computer? Larry Niven's wife went out and bought an Altair and a teletype machine, complete with paper-tape reader; but that was for games, not writing. Should writers go with memory-mapped video or a terminal of some kind? And what keyboard would we use?

Even more important, what kind of disk system? Just about every brand of disk drive had a proprietary format—and its own operating system! When I first got Zeke, he came with an incredibly clumsy system known as FDOS.

Then came CP/M, and the world changed.

The Great Power Spike Continued

We were able to fix everything after the 16-kilovolt power spike (see "The Great Power Spike," August). I still don't have a new power supply for the Priam 330-megabyte MacDisk, so that drive continues to sit in a case belonging to a discarded WORM (write once, read many times) drive; but other than that, there are few signs of the devastation—except that every bit of electronic gear is now plugged into surge protectors.

On that score, I find that while most of the protectors we use bear Priority One's brand name Compuguard, they are all made by an outfit named Data Shield

continued

Solid-State Controls, which also makes protection equipment that is sold under BusinessLand's Compu-Guard label. They say they guarantee their work and will send me replacements for any of their units that died while saving my equipment. Let me again emphasize that no equipment that was protected by Data Shield/Compuguard surge protectors was harmed in any way, and that the need for surge protection is no myth.

Second, the Clary people examined

my uninterruptible power supply (UPS) that had survived the spike (the Northgate 386 plugged into it continued running as if nothing had happened) and found it unharmed; it would have been able to protect my equipment even if the unlikely power spike happened again. They sent me pictures of the machine's innards.

Third, three weeks later I did have a minor incident with the TSi UPS 3150: we had a mini power failure, one that just

barely blinked the lights; and while it did no harm at all, the computer that was plugged into the TSi UPS reset itself. The one plugged into the Clary UPS didn't notice that we'd had a problem. Since I've tested the TSi several times by yanking its power cord, I can only conclude that the on/off was just rapid enough to trigger a reset without triggering the TSi's backup power. I like the TSi unit: it's small and compact, and I haven't been able to zap the power on and off fast enough to duplicate the event, so I've left it on-line.

Flash: it's raining, and we have had a dozen microcomputer power failures since I began writing this. Each time the TSi made a slight buzzing noise, but my work was undisturbed. Wonderful.

I've said this before, but it bears repeating: if you do serious work on computers, whether program development or CAD or word processing, and you don't have a UPS, you ought to rethink your situation. If you run Unix and you don't have a UPS, you should see a psychiatrist.

Remote Keyboards

For me it started with a gizmo named Remote Keyboard, a hand-held device that would let you wander about a lecture hall giving a speech and still be able to control presentations on a PCompatible. I used it for a pitch in conjunction with Traveling Software's gadget that projects your PC output through an overhead projector (also a portable I got from Traveling Software's catalog). Then Alex used it in one of his presentations to a client. Worked fine.

Then came a flood of them. There must be a dozen different brands of remote keyboard controllers.

One stands out from the others. It's called SilentPartner (trust me: the unit works better than the name implies), and unlike Remote Keyboard, which plugs into the serial port, this works with the serial port as well as the keyboard port. It can also be used with portables that don't have a keyboard port. I'm particularly impressed by the software that comes with it. It supports macros, and when it's working through the keyboard port, these are keyboard macros: they get their intercept before the computer ever sees the characters. This makes it pretty well guaranteed that they won't interfere with applications software, including Windows and SideKick and various other hot-key stuff. I even had SilentPartner working with DESQview.

The unit has legends that glow in the *continued*

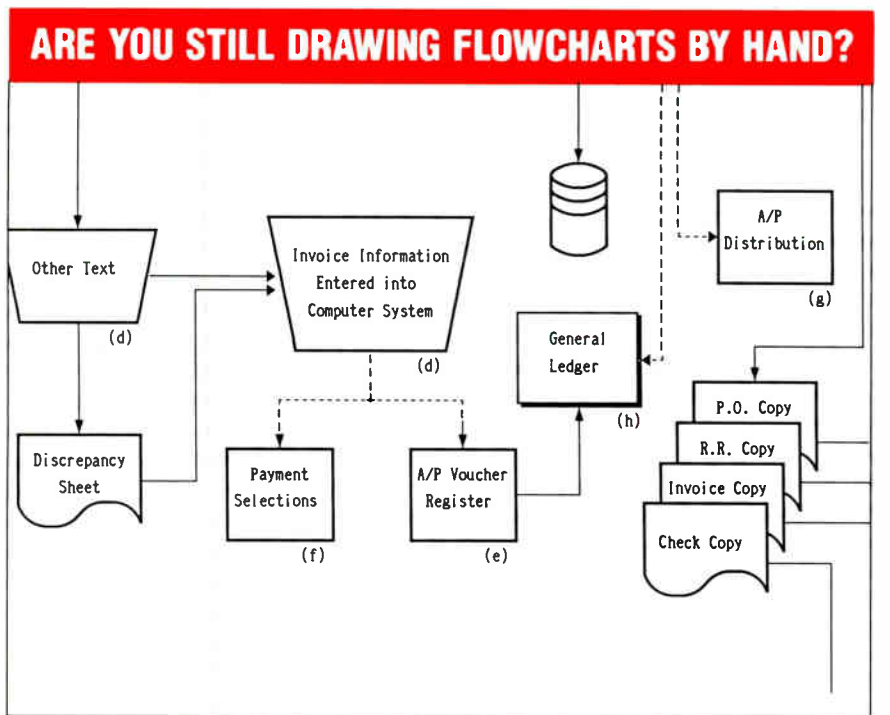

FLOW CHARTING II+

Flow Charting II+ will *amaze* you with its speed, power and simplicity.

- Update and print charts as fast as the situation changes
- See your revisions right away—no long wait for charts to be hand drawn
- Select 26 standard shapes; 10 text fonts
- Tutorial manual makes learning easy
- Runs on IBM or compatibles
- Produces excellent organizational charts!
- Only \$229!

PATTON & PATTON

Software Corporation

Excellence in charting the flow of ideas

For more information, see your local retailer or call
 1-800-525-0082, ext. 47 (outside Calif.) 408-629-5376 (Calif./Int'l.)
 81 Great Oaks Blvd., San Jose, CA 95119

All the advantages of Ampro's Little Board/286. Now in a single slot.

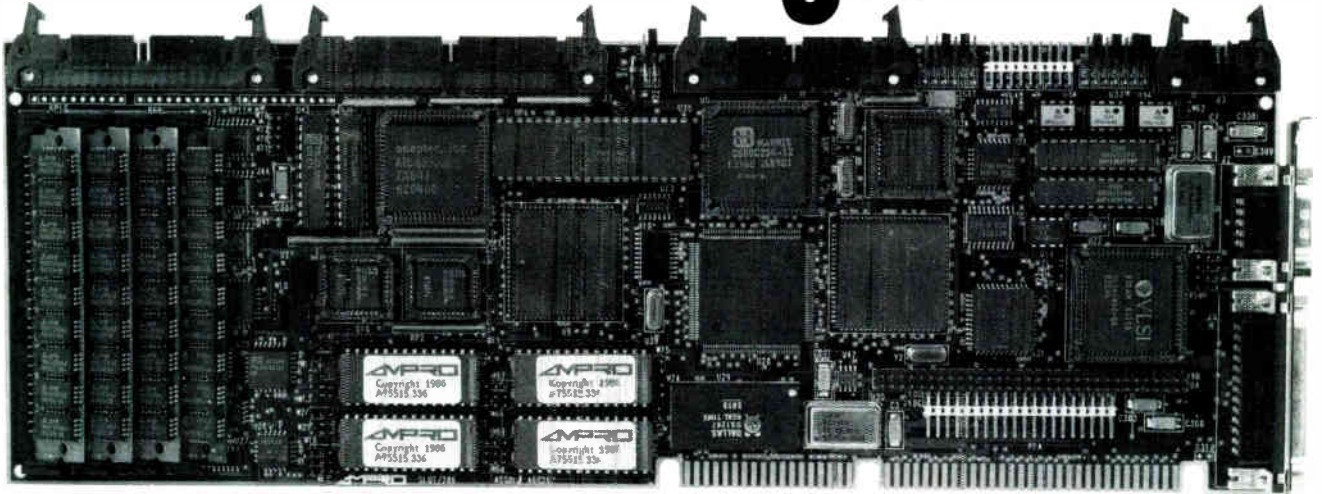

Slot Board/286.

One philosophy. Two systems. Ampro's new Slot Board/286, like the Little Board/286, is a complete AT-compatible single board system. Each is equivalent to an AT motherboard and four expansion cards. Now, you can choose between stackable systems with the Little Board/286 or passive backplane systems with the Slot Board/286. Both are based on the popular 80C286 processor. Both utilize highly integrated CMOS parts to lower parts count, increase reliability and reduce power consumption. Both are available in prototyping and production quantities.

PC/AT Software compatible. Ampro single board systems are compatible with MS-DOS, DR-DOS, UNIX and XENIX operating systems, plus high level languages and applications software. DR-DOS is included with each board.

Everything you need. StackPlane™ or backplane. 512K to 4 MB on-board DRAM. Bootable Solid State Disk. Disk controllers. Display controllers. A selection of I/O ports. All this, stackable with Little Board/286; or, a

complete system in a single slot with Slot Board/286. Ampro also supplies Slot Board/286 card cages and passive backplanes for easier system implementation.

Better answers for embedded systems. Bolt-in or plug-in. Little Board/PC and Little Board/286 with their compact, easy to build-in StackPlane architecture. Slot Board/286 with its passive backplane for I/O and peripheral intensive applications.

Available worldwide. Call Ampro or any of the distributors listed below for complete details on Ampro Little Boards or Slot Board/286.

Slot Board/286 Features

- IBM PC/AT compatible
- 12 or 16 MHz 80C286 CMOS CPU
- Up to 4MB DRAM on-board
- On-board Bootable Solid State Disk
- 2 serial ports (RS232C/RS422/RS485)
- Parallel printer port
- AT Bus hard disk interface
- Floppy disk controller
- SCSI controller
- Enhanced Award ROM BIOS
- Math co-processor support
- Real time clock & watch dog timer
- Low power (approx. 8 Watts)
- Wide operating temp. range: 0 to 60° C
- Low parts count. High reliability
- Optional On-board MiniModules:
EGA/CGA/MDA/Hercules compatible controllers
LCD Display Driver. Serial/Parallel expansion
2400 baud modem ... and more

All trademarks are the property of their respective owners

(408) 734-2800

AMPRO
SINGLE BOARD SYSTEMS

Ampro Computers, Inc., 1130 Mountain View/Alviso Road,
Sunnyvale, CA 94089. Telex: 4940302 FAX: (408) 734-2939

Reps: USA - contact AMPRO for the name of your nearest rep. **Australia** - 61 3 720-3298; **Austria** - 43-1/45 4510-0; **Canada** - (604) 438-0028; **Denmark** - 45 3 66 20 30; **Finland** - 358 0 585-322; **France** - 331 4502-1800; **Germany**, West - 49 89 611-6151; **Hong Kong/PRC** - 5 8613118; **Israel** - 972 3 49-16-95; **Italy** - 39 6 811-9406; **Japan** - 81 3 257-2630; **Netherlands** - 31-10-411 8521; **Sweden** - 46 8 55-00-65; **Switzerland** - 41 1 740-41-05; **United Kingdom** - 0296-435511

dark, although they don't glow brightly enough to make much difference, or didn't at the light levels I'd use for a PC presentation. Oh, well. You can't have everything.

If you're into remote hand-held controllers for your PC, look at Silent-Partner. Recommended.

IPSS

Every now and again I get a program like Interactive Population Statistical System

that makes me want to drop everything and spend a couple of weeks playing with my computer. If this column weren't due this weekend and *Wrath of God* overdue already, I'd probably be fooling around with IPSS yet.

Of course, I've been interested in population projections since the Boeing Co. had me take a seminar with Herman Kahn in 1959. One of the things Herman taught was just how much of the future is not only predictable, but obvious. Popu-

lation projections, for instance: given the age pyramid, certain conclusions follow inevitably.

For example, the U.S. *must* increase productivity: we have a declining work force and increasing numbers of elderly people. The Social Security program of the U.S. is a gigantic Ponzi scheme: the next generation of workers supports the previous one. This isn't necessarily bad—so far no one has gone broke betting on the future of the U.S.—but it does mean that each generation must produce enough to take care of itself and have enough left over to take care of the retired.

The problem is that each generation naturally expects more than the last, meaning that each must produce more. If there are also more workers, productivity per worker needn't rise much; but if there are fewer workers, productivity must rise, or there is no way to pay the current work force and also fund the Social Security obligations to the previous generation (whose Social Security taxes were long ago spent to pay for the generation previous to *that* one). As I said, a Ponzi scheme; and where it runs into trouble is when it's clear there will be *fewer*, not more, workers.

The U.S. has a declining work force, and if it were not for immigration, we would soon have a declining population. Note that even if next year starts a new baby boom, it will be 18 years before that has any effect on the number of productive workers.

When I first got Zeke, I wrote a number of population-study programs in BASIC. They were crude little models, but they were better than anything I'd ever seen, including those used by the Bureau of the Census and the Department of Labor Statistics. I used them to make a number of projections, most of which inevitably "came true," so that in some circles I got the reputation of being a prophet, when all I did was let the computer show me the obvious.

Now there's IPSS for the Macintosh, and anyone can do it.

IPSS is a flexible population-analysis and projection-modeling program that does everything that my old models ever dreamed of doing and more, and does it without fuss or bother. It makes extensive use of the Mac interface for data input and output. It's intuitive to use.

In a word, if you're interested in projecting population data, such as how many female teenagers will be in my state in six years, or how many mature workers will be in the U.S. in the year

continued

Microcomputer News On-Line

In this fast paced industry, can you afford to wait a week or a month for information that may affect you today?

MicroBYTES Daily is an electronic news service covering the latest developments in the microcomputer industry. If it concerns MS DOS machines, Macintosh, Unix workstations, Amigas, Atari STs, peripherals, networks or software, you will find it in MicroBYTES.

Fast and Easy

Read the items as they break or use the powerful search command to quickly locate your information. Best of all you can download the text and print it or use it in your favorite word processor.

Whether you are a developer, marketer, or researcher, you need reliable information and you can count on MicroBYTES. Backed by the combined resources of BYTE magazine, BYTE-week, and BIX, MicroBYTES gives you access to our worldwide network of reporters and the integrity and experience of our editorial staff.

In your position as a leader in new technology, you cannot afford to be just one of the crowd. Get ahead with MicroBYTES.

Call now and subscribe today.

BIX

One Phoenix Mill Lane
Peterborough, NH 03458
800-227-2983
In NH 603-924-7681

THE NEW STANDARD FOR HIGH PERFORMANCE STATISTICAL SOFTWARE

CSS

**COMPLETE STATISTICAL SYSTEM
WITH DATA BASE MANAGEMENT
AND GRAPHICS**

A powerful, comprehensive, elegant, and super-fast statistical package for IBM (PC, AT, PS/2) and compatible computers. ■ The CSS optimized user interface with fast hierarchical menus incorporates elements of artificial intelligence; even complex analyses require only a few keystrokes (batch processing is also supported). ■ CSS features comprehensive, state of the art implementations of: *Basic statistics, Multi-way frequency tables, Nonparametric statistics, Exploratory data analysis with analytic graphs, Multiple regression methods, Time series analysis with modeling and forecasting (incl. full ARIMA), General ANOVA/ANCOVA/MANOVA, Contrast analysis, Discriminant function analysis, Factor analysis, Principal components, Multidimensional scaling, Item analysis/Reliability, Log-linear analysis, Cluster analysis, Non-linear estimation, Logit/Probit analysis, Canonical analysis, Survival and Failure Time analysis (Censored data), Quality Control analysis, and much more.* ■ All statistical procedures are integrated with fast data base management and instant, presentation quality graphics (over 100 types); full support for all mono and color graphics boards (incl. VGA) and over 100 plotters and printers (incl. the HP and Postscript standards). ■ All CSS screen output is displayed via customized Scrollsheets™ (i.e., dynamic, user controlled, multi-layered tables with cells expandable into pop-up windows); all numbers in a Scrollsheet™ can be instantly converted into a variety of presentation quality graphs; contents of different Scrollsheets™ can be instantly aggregated, combined, compared, plotted, printed, or saved. ■ The flexibility of the CSS input/output is practically unlimited: CSS offers an intelligent interface (read/write) to all common file formats (Lotus, Symphony, dBIll, dBIll+, DIF, SYLK, ...) and special utilities to easily access data from incompatible programs; graphics can be saved in files compatible with desktop publishing programs (Aldus, Ventura). ■ CSS data files can be as large as your operating system (DOS) allows; OS/2 version coming soon. ■ CSS precision exceeds the standards of all common precision benchmarks. ■ *Technical note: The CSS user interface and all I/O were written in Assembler and bypass DOS; graphics and data management were written in Assembler and C; the computational algorithms were written in Assembler and optimized Fortran.* ■ \$495 (plus \$5 sh/h); 14-day money back guarantee.

Circle 302 on Reader Service Card



StatSoft

2325 East 13th Street ■ Tulsa, OK 74104 ■ (918) 583-4149
Fax: (918) 583-4376

Overseas Offices: StatSoft of Europe (Hamburg, FRG), ph: 040/4200347, fax: 040/4208724, StatSoft UK (London, UK), ph: 0438/310056 or 316561, fax: 0438/310001, StatSoft Pacific (Melbourne, Australia), ph: 613-663-6580, fax: 613-663-6117, StatSoft Canada-CCO (Ontario), ph: 416-849-0737, fax: 416-849-0918 Available From: CORPORATE SOFTWARE and other Authorized Representatives Worldwide: Holland: Lemax BV 02968-94210; France: Conceptel (1) 45669700; Sweden: AkademiData 018-694201; Korea: Geul Bang (02) 272-1973

World Radio History

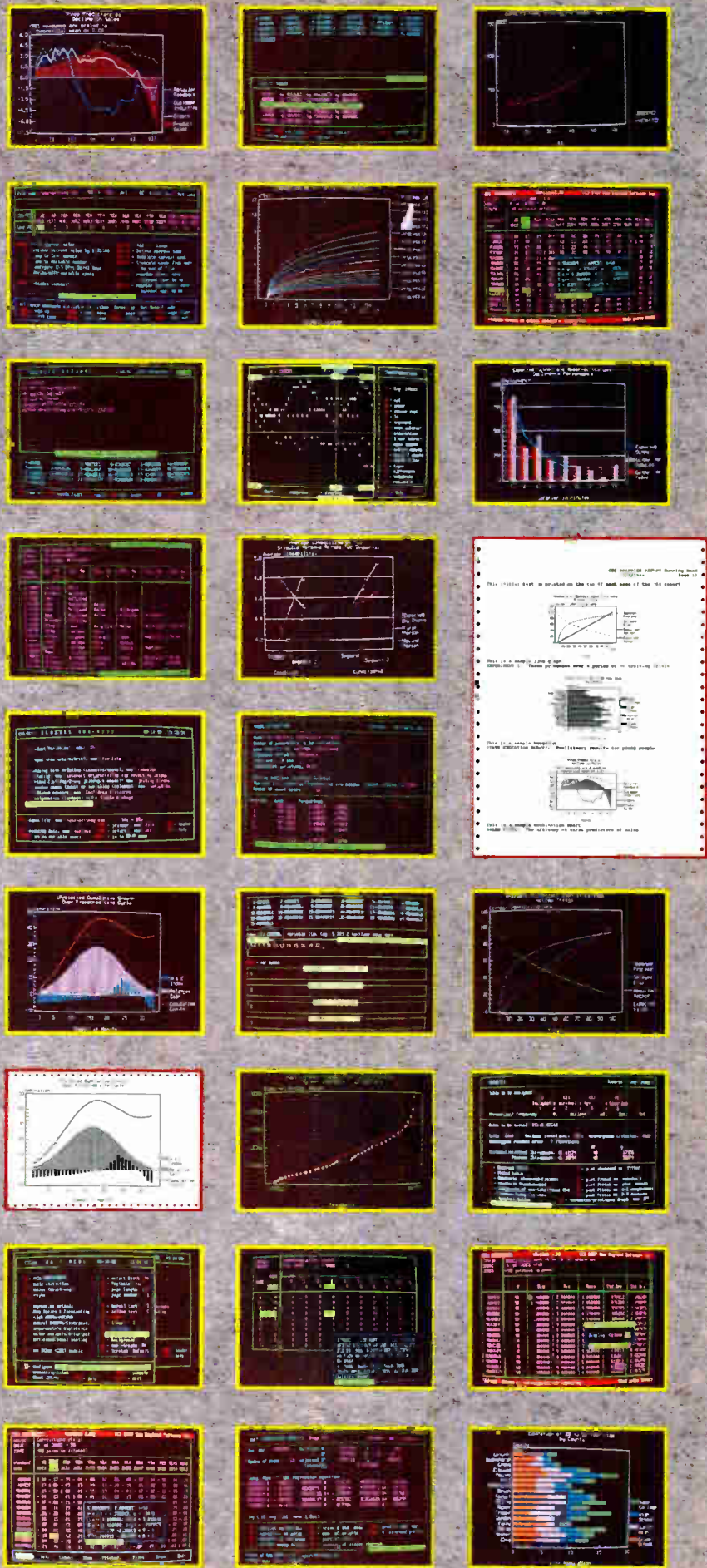

ITEMS DISCUSSED

CPP126 \$56.95 Data Shield Solid-State Controls, Inc. 269 Mount Hermon Rd. Scotts Valley, CA 95066 (800) 877-7844 (408) 439-6600 Inquiry 989.	PT-1.2 \$19.95 EEC Handbook \$14.95 Dali Design P.O. Box 9882 Baltimore, MD 21284 (301) 821-1230 Inquiry 994.
DESQview/386 \$189.90 Quarterdeck Office Systems 150 Pico Blvd. Santa Monica, CA 90405 (213) 392-9851 Inquiry 990.	SilentPartner \$349 Presentation Electronics 4320 Anthony Court, Suite 8 Rocklin, CA 95677 (800) 888-9281 (916) 652-9281 Inquiry 995.
Interactive Population Statistical System for Mac Plus \$295 for Mac II \$395 PSRC Software Population and Society Research Center Office #302, Hayes Hall Bowling Green State University Bowling Green, OH 43403 (419) 372-2497 Inquiry 991.	Sword of Aragon \$39.95 Strategic Simulations, Inc. 675 Almanor Ave. Sunnyvale, CA 94086 (408) 737-6800 Inquiry 996.
Onguard PC-1.25k UPS \$2395 Clary Corp. 320 West Clary Ave. San Gabriel, CA 91776 (818) 287-6111 Inquiry 992.	Tecmar VGA Board \$350 Tecmar 6225 Cochran Rd. Solon, OH 44139 (800) 624-8560 (216) 349-0600 Inquiry 997.
PC General Ledger \$50 Charter Software P.O. Box 70 Monticello, IL 61856 (217) 762-7143 Inquiry 993.	TSi UPS 3150 \$349 Taesung Industries, Inc. 2001 Westside Pkwy., Suite 240 Alpharetta, GA 30201 (404) 664-8944 Inquiry 998.
	WingZ \$399 Informix Co. 16011 College Blvd. Lenexa, Kansas 66219 (913) 599-7314 Inquiry 999.

2005, or how many females of an age to use cosmetics will be in the state of Washington in 1996, you need this program. People who make business plans (and need to predict the customer base); school boards; all kinds of people can use this thing, although they probably won't.

IPSS is a powerful tool, and it will take you a while to master it. No matter. You can begin playing around with it minutes after you load it. The manual is extraordinarily complete—there's even a listing of the Pascal source code of the program—with a complete explanation of the assumptions made in the model. It happens that I don't agree with all of

them, but that's mostly a matter of omission; and it's relatively simple to take the output of the IPSS model and use that as the input for my own models if I really want to do that.

Mostly, though, I just want to play with this. It's elegant, easy to use, and useful. If you have any interest in population, get this for your Mac.

Highly recommended.

Spreadsheet Wars and System Wars

Lotus 1-2-3 release 1.0 was a phenomenon. You can make a good case that this program moved the IBM PC from a home and hobby machine to the business world, simultaneously blowing Apple II

and VisiCalc out of offices and off to the periphery of the computer industry. Software developers—big outfits and garage start-ups alike—have been trying to wedge into the Lotus 1-2-3 market ever since.

The only one that had much success was Microsoft's Excel, which did for the Mac what Lotus had done for the IBM PC: make it a serious contender for business offices. Excel was a completely different kind of spreadsheet, one that incorporated graphics, analyses, and an easy-to-use macro programming language, all features that both VisiCalc and Lotus 1-2-3 release 1.0 lacked. Prior to Excel, the Mac was an interesting little machine, useful for graphic artists, perhaps, great for games, and satisfactory—but no more than that—as a word processor. For real business work, though, you needed a PC and Lotus 1-2-3 until Excel came along; after that, the advantage in power lay with the Mac.

Excel had another effect: by showing just what the Mac could do, it generated a whole slew of powerful programs linking forms generation and the spreadsheet concept. The best known of those was MacInTax, but there are plenty of others. Even with all that, Excel and the Mac still have a relatively small market share, about 15 percent; but that's still not only respectable, but the largest single rival to Lotus 1-2-3 (with a 70+ percent share) in the spreadsheet market.

This situation seems fairly stable, too, which is interesting, because there are now considerably more powerful spreadsheets than either Lotus 1-2-3 or Excel. Apparently they aren't *enough* more powerful to tempt Excel and Lotus 1-2-3 users to make the change.

I can understand that. I don't have a great deal of spreadsheet work, but when I have some to do, I use SuperCalc. This is largely for historical reasons: I've known its authors Richard Frank and Paul McQuesten since they developed one of the first CP/M Pascal compilers, so SuperCalc was the first spreadsheet I tried. I didn't care for Lotus 1-2-3 when it came out because for years it was copy-protected, and I've always believed that anyone who trusts business affairs to copy-protected software ought to have a really good knowledge of the Chapter 11 bankruptcy laws. By the time Lotus came out with an unprotected version, I was up to SuperCalc 3 and was used to it.

I was also used to its limitations, and thus I wasn't tempted to demand of it anything it couldn't do. Indeed, I got so set in my ways that when SuperCalc 5

continued

TOPSPEED® C

The next generation



Multi-Window/Multi-File Editor
Fully Automatic Make
Common Optimizing Code Generator
High-Speed Smart Linker
HyperText Help

TOPSPEED® MULTI-LANGUAGE
ENVIRONMENT

TopSpeed C. Compiler and library conform 100% with proposed ANSI standard. Source compatible with MS C and Turbo C (where ANSI compatible). Library is a superset of both MS and Turbo C's libraries. Extensions include: Time-sliced scheduler for concurrent functions. Powerful text window management. Borland text windows supported. MS's graphics, plus: Bar chart & polygon plotting, standard formatted text IO to graphics windows. Interface to Borland's Graphics Interface (BGI). Mouse support. All BIOS and DOS calls supported. Common UNIX calls. 6 memory models plus user-definable memory models. Smart linker includes only functions and data used in the final program. Optional run-time checks include overflow, stack, array bounds, and pointer checks. Run-time and compilation errors automatically pinpointed in source code.

Common optimizing code generator. All compilers produce highly optimized code using the same code generator. 8086/286/386 specific code. Automatic optimal register allocation. Common sub-expression Elimination. Expand any function as inline code. Pass parameters in registers (optional). Inline 80x87 code or emulation.

Automatic make. Fully automatic make with version control recompiles and rebuilds EXE, LIB and DLL files as necessary without the need of a make script. Make dependencies are described by project files, which simply list the objects to be included, as

well as the names of other dependent projects. One single make can result in multiple compilations using different compilers and/or assemblers, linking and building of libraries, DLLs and an EXE file.

Seamlessly integrated environment. Up to 10 active editor windows, each with a capacity of 1/2 MB source code. Compiler errors and warnings pinpointed in source code; automatic file-switch when stepping between errors or warnings. All menus and hot-keys redefinable. By default, editor commands compatible with Turbo and SideKick. Keyboard macros a la SuperKey. Cut and paste between editors, help system, and directly from screen memory. Multi-file search commands, programmer's calculator, built-in ASCII, key scancode, and color tables. HyperText help system with library reference.

Extended and OS/2 Editions. These editions include: Support for Microsoft Windows. DOS Dynamic Link Libraries. Full source code to libraries. Start-up assembler code. High-speed Assembler is fully integrated in the environment. Disassembler. Program execution profiler. Code locator for embedded systems programming. Watch utility for viewing any selection of DOS calls as they are executed. Programmer's interface to debugger. Post Mortem Debugger. And more. OS/2 Edition has full support for Presentation Manager.

TopSpeed and TechKit are trademarks of Jensen & Partners International. Other brand and product names are trademarks or registered trademarks of their respective holders.

TOPSPEED C:

Standard Edition \$199
(DOS Compiler & VID)

Extended Edition \$395

OS/2 Edition \$495

Call on TopSpeed Modula-2 compiler
(with objects) & toolkits.

TO ORDER:

In the U.S., call:

1-800-543-5202

In Canada, call:

1-800-543-8452

Call on shipping & handling
charges & volume discounts.
VISA/MC accepted.

**30-day unconditional
money-back guarantee.**



Jensen &
Partners
International

1101 San Antonio Road, Suite 301
Mountain View, CA 94043
Phone: (415)967-3200
FAX: (415)967-3288

In England & Europe contact:

Jensen & Partners UK Ltd, 63 Clerkenwell Road, London EC1M 5NP.
Phone: (01)253-4333. FAX:
(01)251-0141. C Standard Edition
£149; C Extended Edition £295;
C OS/2 Edition £370. Call on
handling & VAT charges, and
TopSpeed Modula-2 product prices

File Manager

For **C**

C Programmers choose db_FILE because it's fast and flexible.

The combination of relational B-tree indexing and network model database technology delivers better performance than file managers using relational technology alone. Build simple B-tree/ISAM applications or complex database applications. You decide how to optimize runtime performance.

SQL Support included.

db_RETRIEVE – the SQL-based relational Query and Report Writer is now included in this special offer.

Applications completely portable.

Free lifetime phone support.

C source code is now included!

No royalties.

SPECIAL LIMITED OFFER

db_FILE, db_RETRIEVE and source code for each – at one low price!

Single-User Package \$295.00

A \$1780 value.

Multi-User Package \$595.00

A \$2890 value.

db_FILE™

File Manager 2.2

File Structure: Relational B-tree indexing and network database model. Use independently or in combination for real power.

Transaction processing supported

Not RAM resident

Operating Systems: MS-DOS, UNIX, XENIX

C Compilers: UNIX, XENIX, Microsoft, Lattice, TurboC

Major LANs Supported

For your nearest distributor call:
1-800-db_RAIMA (1-800-327-2462).

RAIMA™

CORPORATION

BY129FM

*Raimea reserves the right to discontinue this promotion at any time without notice, so please check pricing when you call.
Raimea Corporation 3245 146th Place S.E., Bellevue, WA 98007 USA
(206)747-5570 Telex: 6503018237 MCI UW FAX: (206)747-1991
Texas: (214) 231-3131 International Distributors: U.K.: (0992) 500919
Germany: 07127/5244 Switzerland: (01)725 0410 France: (1)46092828
Benelux: 31(02)15946814 Sweden: (013)124780 Italy: 045/584711
Norway: 47 244 88 55 Denmark: (2)887249 Singapore: 468 3888
Australia: (02) 959 5122 Japan: (03)473 7432 Taiwan: (02)511 3277
Mexico: (83) 57 35 94 Brazil: (0192) 52 9770 Colombia: 57 1 218 9245
Argentina: 54 1 313 5371 Chile: 56 2 696-4308 Uruguay: 92 19 37
Caribbean: (809) 834 4069 Central America: (506) 28 07 64
© Copyright Raimea Corporation 1989

114 BYTE • DECEMBER 1989

arrived a few weeks ago, I didn't bother to install it—and I still haven't. I should, of course, but there's no urgency. I can't think of anything I want to do that I can't do now.

It's much the same with Borland Quattro, both the old standard and the new Quattro Pro. I know Quattro Pro is more powerful than Lotus 1-2-3 and SuperCalc, and easier to use to boot. I know very well that if I were starting over, about to set up a spreadsheet for the first time, I'd very likely use Quattro Pro. I'd want to do a playoff between Quattro Pro, SuperCalc 5, Lotus 1-2-3 release 3.0, and Excel 2.2; but from the limited experience I've had with all those, I'm convinced I'd choose Quattro Pro.

Meanwhile, back at the Mac front, it's much the same story. While I do all my financial spreadsheet work on PC-compatibles with SuperCalc 3, when I do scientific modeling using a spreadsheet, it's always Excel on the Mac IIx. That's also partly historical—Dr. Michael Hyson did the first I/O model of a lunar colony with Excel on the Mac, and that's still the most elaborate model available. It's also just plain easier to do elaborate spreadsheets in Excel on the Mac, and if you ask why I haven't long ago abandoned PC spreadsheets entirely and moved my financial operations to the Mac, I haven't got a good answer. Partly it's printers. The PC uses my ancient Hewlett-Packard LaserJet Plus, which warms up faster than the Apple LaserWriter. Mostly it's just inertia and sloth.

More to the point, though: Excel is not, in my judgment, the best of the Mac spreadsheets. Informix Software's WingZ is newer and more useful. But for the same reason that I haven't converted from SuperCalc 3 on the PC, I haven't changed from Excel to WingZ on the Mac. What I've got is good enough, meaning that I have no choice but to live with the limits of what I have.

It should be fairly clear, then, that you shouldn't do as I do. If you're just getting into the spreadsheet business, you don't want SuperCalc 3 for the PC; you want to have Quattro Pro. If you're a Mac user, there's nothing *wrong* with Excel, but WingZ is a considerable advance beyond it and easier to learn in the bargain.

I found that out watching Frank, my number two son, who graduated with a degree in business administration this summer and is now going into telephone communications services. He's grown up in a house full of computers, so they neither intimidate nor fascinate him. They're just tools. He had an AT with Framework while he was in college. He

also had SuperCalc and most of the programs I use. And when I asked him what he wanted to get set up and started in business, he didn't even hesitate. He wants a Mac IIcx with WingZ, Microsoft Works, and Ready-Set-Go!; and he can do things with WingZ that I never even thought of trying with Excel.

Stewart Alsop concluded that the only way that millions of satisfied users can be wooed away from Lotus 1-2-3 release 2.01 is through adoption of radically new systems, either software or hardware. Windows might do it, or Presentation Manager, or a radical shift from the PC to the Mac; but unless something like that happens, users will go on with what they have on the theory that good enough is good enough, and if it ain't broke don't fix it.

There's a lot of inertia in the user community.

The moral of my story is simple: if you're just beginning to learn about small computers for business, don't select your software purely on the basis of what everyone else is using. Look around. There's probably something better.

DESQview Pains

Roberta always gets my older-model computers. She says she doesn't mind. The other day I noticed what she was running: the Kaypro 386i, one of the first 80386 machines ever to come out. It had only 512K bytes on the motherboard; you used Quarterdeck's QEMM-386 to backfill the system memory to 1 megabyte with some of the 2 megabytes of extended memory that came with it.

Kaypro shipped the machine with DESQview, and, indeed, the 386i with DESQview was about as good as any 80386 computer on the market in its day; but that was a couple of years ago. The machine is slow, it has only one floppy disk drive (and that's getting flaky), and there's only a 20-megabyte hard disk drive. Roberta has long since filled it and keeps having to peel stuff off to floppy disks. It's clearly time to set her up with a new system.

I knew just the machine. The Zenith Z-386/15 has a 70-megabyte hard disk drive, and it's twice as fast as the Kaypro, is just as reliable (but no more so: except for that flaky floppy disk drive, we haven't had any glitches at all from the Kaypro, and we've used it *hard*), and, best of all, has both 1.2-megabyte high-density and 360K-byte standard-density 5¼-inch floppy disk drives.

Indeed, Roberta has been using the

continued

4GL or C?

We have an interesting proposition for you.

Don't Choose. Use the Faircom® Toolbox and get both: 4GL development speed and C source code power!

Whether you need the development speed and convenience of 4GL programming or the low-overhead power capabilities of C source code, the Faircom Toolbox can meet the requirements of any professional developer!

The Toolbox contains the industrial strength tools to develop applications the way you want!

- Development Environment by d-tree™
 - Prototype generation
 - Data dictionary
 - Dynamic resource swapping
 - Screen management
 - Overlapped windows
 - File restructuring
 - Runtime portability
 - Menu management
- File Management by c-tree®
 - Variable length records
 - Key compression
 - Client/Server architecture
- Report Generation by r-tree®
 - Ascending/Descending key segments
 - Dynamic space reclamation
 - Portable. Used in over 100 environments
 - Variable length key fields
 - High speed B+ trees
 - Complex multi-line reports
 - Multi-file access
 - Complete layout control
 - Conditional page breaks
 - Nested headers and footers
 - Unlimited control breaks
 - Dynamic format specifications
 - Horizontal repeats
 - Powerful set functions

And NOW Faircom introduces the Toolbox Special Edition with the power and flexibility you need for only \$695!

Now you can create applications using the methods you like — whether it's 4GL convenience or C source code power! And at \$695 you get this power at a price you can afford.

Order today! No risk, money back guarantee!

Order the Faircom Development Toolbox and use it for 30 days. If you don't think it's the best development tool available, just return the entire package for a full refund.

Call 1-800-234-8180 TODAY for your Faircom Toolbox!

The Toolbox Professional Edition . . . \$1095.00
DOS, Unix, Xenix, VMS, OS2
Full source, single and multi-user support

The Toolbox, Special Edition \$ 695.00
Microsoft, Borland, Xenix, OS2
Object libraries, single user only

Upgrade to Professional Edition . . . \$ 400.00
Includes overnight delivery



FAIRCOM
corporation

4006 West Broadway
Columbia, MO 65203
Phone • 314-445-6833
FAX • 314-445-9698

Z-386/15's standard-density floppy disk drive to make the shipping copies of Mrs. Pournelle's Reading Program, which uses a PC to teach anyone from age 4 to 104 to read English (see "Language Sojourn," April). At the moment, the Z-386/15 has the 19-inch Electrohome monitor running off Video Seven's fast RAM VGA board, so it's a lovely thing to see, just right for demonstrating stuff.

Its only problem is that I had never set it up properly with DESQview, and, like me, Roberta is used to DESQview's convenience.

DESQview lets your 80386 system run programs from extended memory. They aren't swapped in and out; they're actually run from high memory. This is possible only with an 80386; with 80286 ATs and 8088 XTs, you can use that memory for fast swapping, but you can't run the programs up there. The trick, then, is to configure your 80386 so that you get large—520K bytes and larger—windows in DESQview so that you can run TSR programs like WordFinder in the same window with your word processor.

This is done on an 80386 with Quarterdeck's QEMM-386 memory manager, which not only lets you make use of memory above 1 megabyte, but also lets you do special things with the memory between 640K bytes and 1 megabyte if you use the RAM switch in the QEMM command line. Thus, if you include the line `DEVICE = QEMM.SYS RAM ROM` in your `CONFIG.SYS`, you can use a Quarterdeck program called `LOADHI.COM` to put things like mouse drivers and buffers, which now run in ordinary system memory, up in the 640K-byte to 1-megabyte extended-memory area. (They won't go into the area above 1 megabyte without being specially written to do that, and most such drivers haven't been.)

The ROM command "shadows" or copies your ROM BIOS into high RAM memory, speeding things up a lot.

In other words, QEMM improves your 80386 even if you don't use DESQview. My problem was that I couldn't get the Z-386/15 to use QEMM properly.

The first thing was to eliminate the ROM command. Zenith more or less invented the trick of shadowing ROM into RAM. They call it Slushware. If you have QEMM do it also, you get conflicts. If there's a way to turn off the Slushware feature, I can't find it in the setup program or the manuals. OK, no ROM command, since it's not needed anyway. Alas, the system still blew up and had to be booted from a floppy disk so that I

could edit the `CONFIG.SYS` file. Sigh. I was used to that: but let me warn you, before you start experimenting with `CONFIG.SYS`, make up a boot floppy disk and keep it handy. You will probably need it.

The next thing was to put `DEVICE = QEMM.SYS` into `CONFIG.SYS` without the RAM statement. That booted fine. Then I ran the program `QEMM.COM`. This shows a memory map of the Z-386/15,

```
A000-AFFF Video
B800-B7FF Mappable
C000-C5FF ROM
C600-C7FF RAMmable
C800-DFFF Mappable
E000-EFFF Page frame
F000-FFFF ROM
```

which told me what I had to do: I needed to use the command line `DEVICE = QEMM.SYS RAM X=A000-AFFF X=B000-B7FF X=B800-C5FF X=F000-FFFF`. This excludes those memory areas so that QEMM doesn't try to take charge of them.

Next, invoke DESQview through the program `XDV.COM`, which loads the main program `DV.EXE` partly into the 640K-byte to 1-megabyte extended-memory area and partly into the area above 1 megabyte. (Most people rename `XDV.COM` to `DV.COM`; then when you enter the command `DV`, DOS chooses the communications program to run first.) The result was that even after loading the mouse driver into high memory (the command is either `LOADHI.SYS MOUSE.SYS` in `CONFIG.SYS` or `LOADHI MOUSE 2` in `AUTOEXEC.BAT`), I got windows with 572K bytes—pretty respectable. Without DESQview, I had DOS free memory of just under 600K bytes, and you don't hardly get no better than that.

Once I had the Z-386/15 running properly, I figured it would be no trick to do the same for the new Z-386/25. This machine is awesomely fast. It comes with the usual Zenith wonders, like their built-in Monitor (not hardware: a program that manages the system for you) and, best of all, the new Zenith DOS 3.3 Plus, which has nearly all the features of DOS 4.01 without the drawbacks. As an example, Zenith DOS 3.3 Plus allows the Z-386/25's hard disk drive to be configured as one single logical drive of 155 megabytes. One warning about the Z-386/25: any memory above the standard 640K bytes has to come from Zenith. Cheetah cards, although fast enough, won't work; the Z-386/25 never finds the

memory. Instead, you must buy single in-line memory modules. There's room for a lot, 16 megabytes or more.

The Z-386/25 is clearly faster than my present Cheetah 386, and since I generally try to use the latest and greatest, it was a candidate to be the main machine here at Chaos Manor. To do that, though, it would have to run big DESQview windows; but that shouldn't be a problem now that I had set up the Z-386/15.

I connected the two machines with the new six-headed cable supplied by Traveling Software and invoked LapLink 3 on the Z-386/15. There wasn't a copy on the Z-386/25, but no matter: LapLink 3 will send itself to the other machine. Once I had the two Zeniths linked, I transferred a number of files from the old Zenith to the new one, including the `CONFIG.SYS` and `AUTOEXEC.BAT` that set QEMM-386 up properly. Now to reset the Z-386/25.

No joy. It locked up, and I had to reboot it with a floppy disk.

Sigh. What now? I could only guess: I changed it from `X=B800-C5FF` to `X=B800-C7FF`, thus excluding that small area that QEMM had called "RAMmable." Booted again. The machine came up fine. Now to load DESQview using `XDV.COM`. Again, no joy. The machine locked tight and had to be booted with a floppy disk.

This was getting annoying. DESQview loaded without XDV worked all right, but the maximum-size window was under 400K bytes, and that just isn't enough. Why would it blow up when I used XDV? I had no clue, but I did have a hunch. The Z-386/25 was running the Zenith Flat Technology Monitor (FTM) with a VGA board that read "Made in Hong Kong" but otherwise had no indication of the manufacturer. Could this be the problem?

Enter Tecmar

I have had a Tecmar VGA video board around for a long time, but we couldn't get it to work. It wasn't the board's fault: when we tried to install it in Big Cheetah, I was still using the Electrohome 19-inch monitor at my own workstation, and, at the time, that had a cable ending in a 9-pin plug; the Tecmar board wants to feed a 15-pin VGA connector. Then there was some other logistic problem, again not the Tecmar board's fault. "Time, and time enough," I thought. "Test my hypothesis about what's making XDV.COM blow up the Z-386/25 and give the Tecmar board a workout in the bargain."

Installing the Tecmar board was no

problem; the switch settings are explained in the manual. The Z-386/25 came right up. I thought the on-screen characters looked a little distorted, and in general I wasn't happy with the aesthetics of the screen, but what the heck, maybe it needed some tweaking. First, though, the test.

XDV.COM loaded. DESQview came up fine. The memory status utility told me I could make a window 550K bytes in size.

Clearly my hypothesis was correct. It was the video board.

Tweaking the Tecmar

So that problem was solved, but I still had an ugly screen. It might not have been so noticeable on some other system, but on the Zenith FTM every flaw in the video stands out because the FTM is capable of really beautiful displays. Moreover, because that monitor screen is truly flat, there is almost no glare from the screen itself. That's the main reason I changed from the Electrohome monitor: my workstation is across the room from a large south-facing window, and in the afternoon the glare on the screen can be fierce unless I draw lightproof blinds. I don't want to draw blinds; south of me are undeveloped hills with coyotes and circling hawks, and I like the view out that window. With the Zenith FTM, I don't have to give up hawk-watching to avoid glare.

The Tecmar board is capable of supporting a whole bunch of monitors. You tell it which ones you're using through software: a program called VGA.COM does the job. It can be run interactively, so I tried that. One of the program's options is to test the hardware: running this produced considerable garbage on the screen, making me suspect that the Tecmar board and the FTM weren't communicating properly.

VGA.COM has a list of monitors the Tecmar board can support. One was "Zenith Analog," which seemed a reasonable choice but wasn't. The display was much worse, fuzzy and unfocused. Another option was "IBM PS/2." For some reason I tried that—and it worked perfectly.

I now have the command line "VGA PS/2" in the Z-386/25's AUTOEXEC.BAT file, and it does the job something wonderful. The combination of the Tecmar board and the Zenith FTM is about the nicest I have ever seen outside MIT's laboratories. It's truly lovely, and fast to boot.

Highly recommended. This thing is

continued

**LightSpeed 9624E
9600 baud modem**



shipping \$7.00

\$799.00

- True 9600 bps modem, V.32, full duplex.
- 9600/4800/2400/1200/300 bps
- MNP Class 5 error correction & data compression for data flow up to 19.2 Kbps
- Fully CCITT V.32/V.22bis/V.22, Bell 212A/103J compliant.
- Auto speed detection
- Extended AT command set
- Non volatile memory storage
- Cable and software included (specify PC or MAC)
- Synchronous and asynchronous modes

**LightFax 9624
superior fax/modem**



shipping \$7.00

\$499.00

- 9600 baud fax compatible with all Group 3 fax machines
- 2400 baud modem 100% Hayes™ compatible. Switch from fax to modem with one command
- Excellent picture quality, superior to standard fax
- Fax directly from application or from flexible text/graphics editor
- Full status lights in fax or modem mode
- Compatible with all PCs and MACs
- Powerful software for scheduled sending, broadcasting, file queuing etc.
- Complete with fax and modem software and cable (specify PC or MAC)

**Never buy another ribbon!
with MacInker™**

Re-ink ANY fabric ribbon

over 100,000 sold

shipping \$4.50

- Universal Cartridge MacInker re-inks most cartridges with appropriate adapter. Universal Spool MacInker re-inks all spools
- Operation is very simple and automatic
- Extra dark, lubricated ink yields better than new print quality
- Ink's cooling and lubricating effect extends printhead life
- Average cartridge can be re-inked 60-100 times at 5 cents/re-inking
- Multicolor Adapters for multiband cartridges (Rainbow, Imagewriter, Epson, NECs, Okidata etc.)
- Dedicated MacInkers available for special cartridges and Band Printers
- Customers vary from individuals to Fortune 500 Corporations, reporting documented savings of \$30,000/year with MacInker

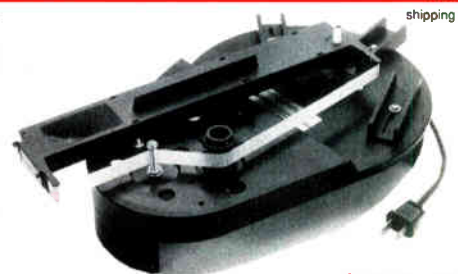

Universal Cartridge MacInker shown with Epson cartridge

\$68.50

- Universal Cartridge MacInker68.50
 - Multicolor Adapter (specify printer)40.00
 - Epson only MacInker mod. 271EP42.00
 - Imagewr. only MacInker mod. 234 IM..42.00
 - Universal Spool MacInker68.50
 - Heat Transfer Adapter25.00
 - Extra Ink bottle, black3.00 pint.....18.50
 - Colored ink bottle4.00 ex. reservoir. 5.00
- All MacInkers delivered complete with bottle of ink, ink meter, reservoir, reservoir cover.
Go color !! Single & multicolor, standard and heat transfer cartridges available: red, green, blue, brown, purple, yellow, orange, white, silver and gold. Indelible and OCR ink cartridges available.

Call for free catalog

Satisfaction or 30 day refund - Immediate shipment - Major credit cards - POs from national accounts

Computer Friends, Inc. Order Toll Free 1-800-547-3303

14250 NW Science Park Dr.
Portland OR 97229

in Oregon (503)626-2291
fax (503)643-5379 telex 4949559 CF

gorgeous. You ought to see what it can do with VGA Paint from RIX SoftWorks.

A General Ledger

The shareware of the month is PC General Ledger from Charter Software, which does in fact produce a pretty standard general ledger bookkeeping system. It's menu-driven and very easy to use. I still prefer the system I wrote, but then I'm used to mine. I'll say this, if I'd had this program, I might not have written

the one that I now use.

Starting this month, the shareware of the month can be found in the "listings" area of the tojerry conference on BIX. Download it and try it.

Gadgets

Gadget lover that I am, I have decided to have a gadget of the month, which this month goes to the Dali Design PT-1.2 pocket tester. This is a tiny thing that you plug into your auto engine's test outlet

and read off all kinds of diagnostics. It works on Ford EEC IV systems from 1984 and later, which includes my 1987 Bronco II (which, incidentally, I love; best four-wheel drive vehicle I ever had, and that includes the International Scout I drove for 15 years).

For another \$20, they'll send you a book on repair procedures, trouble codes, and so on. If the electronics in your Ford bewilder you, this is the thing to have; my mechanic *loves* it.

Winding Down

There's a huge pile of stuff here. We have Palindrome, a tape backup unit that's so versatile I'm stunned; it will be the mainstay of our new network system here.

We have new USRobotics 19,200-bps modems. These include the MNP (ARQ) error-correction protocols used by MCI Mail, BIX direct (alas, not Tymnet), GE's GENie, and a number of other telecommunications systems. More on this next month—but if you do much telecommunications, get the latest MNP modem and forget about line-noise problems. The improvement in throughput is amazing. I love these things. We've discarded all modems but USRobotics models.

The game of the month is *Sword of Aragon* from Strategic Simulations. This is a medieval warfare game with some fantasy role-playing elements, but mostly it's strategy in the age of bows and swords. The only way to win is to develop and deploy combined-arms armies. I cannot remember when I have more enjoyed a computer war game.

The book of the month is *Mazes: Sixty-Four Essays* by Hugh Kenner (North Point Press, 1989), who happens to be BYTE's book reviewer and one amusing writer. There's not a bad essay in the bunch. Try it, you'll like it.

There's a lot more, but I'm out of space, and besides, my army is assembled outside Garnok, the high mountain pass fortress of the orcs, and I've got to put my heavy cavalry in the right place to deliver the decisive charge. . . . ■

Jerry Pournelle holds a doctorate in psychology and is a science fiction writer who also earns a comfortable living writing about computers present and future. Jerry welcomes readers' comments and opinions. Send a self-addressed, stamped envelope to Jerry Pournelle, c/o BYTE, One Phoenix Mill Lane, Peterborough, NH 03458. Please put your address on the letter as well as on the envelope. Due to the high volume of letters, Jerry cannot guarantee a personal reply. You can also contact him on BIX as "jerry."

Now Available PS/2 Version \$119

Finally, A Trackball for your PC

Two High Performance Mouse Alternatives



PC-TRAC™
Serial version \$119
Bus version \$139

The standard in PC Trackballs for direct mouse replacement



FastTRAP™
Serial version \$149
Bus version \$169

Trackball with Trackwheel™ for third axis pointing capability in advanced applications

Attention PC users. Introducing two products that have been quietly appearing on desks of thousands of PC users for over a year: MicroSpeed's PC-TRAC™ and Fast-TRAP™ trackballs.

- Uses 1/2 the desk space of a mouse
Free up your desk space to do what it was designed to do — hold your coffee cup and stacks of incoming work.

- **Plug and play compatibility**

MicroSpeed's advanced pointing device driver is fully compatible with application software supporting Microsoft™, Logitech™, and other popular mice. Also included is a Windows™ driver and a utility for use with non-mouse driven software.

- **PC-TRAC and FastTRAP work where you put them**

No more "row, row, row the mouse" when you run out of desk space before you run out of screen. Scroll across spreadsheets with finger tip

control. Page up and down documents without so much as moving your wrist. Control CAD programs to a single pixel. All in a space less than 4 1/4" wide.

- **Pinpoint accuracy automatically**

MicroSpeed's pointing device driver has "self adjusting" resolution from 50 to 1,000 dpi. Speeding across the screen or working with precision graphics, the MicroSpeed driver automatically adjusts to the resolution you need.

- **PC-TRAC and FastTRAP require no cleaning**

Our quiet, durable opto-mechanical design requires no cleaning or maintenance.

Looking for a proven mouse alternative for your PC? Give us a call. We're rolling!



MICROSPEED™
INCORPORATED

1-800-232-7888
In California call (415) 490-1403
FAX (415) 490-1665
MicroSpeed, PC-TRAC, FastTRAP and Trackwheel are registered trademarks of MicroSpeed, Inc.
Microsoft and Windows are registered trademarks of Microsoft Corporation
Logitech is a registered trademark of Logitech, Inc.

“Xerox this memo.” “FedEx this proposal.” “LapLink these files.”

When something becomes a standard, using it becomes second nature. That's true about LapLink. It's so effective that it has become the most popular laptop-to-desktop and desktop-to-desktop file transfer program ever.

And now Release III improves on the original with added power—while preserving the simple design that has made LapLink the choice of more major corporations.

LapLink III offers both serial and parallel file transfer, and you can take advantage of parallel transfer speeds of 500,000 baud or higher. It comes with a “six headed” universal cable that provides you with everything you need to use both serial and parallel modes.

And LapLink III will even install itself automatically on a remote computer.

That's in addition to ease-of-use and productivity features like our popular split screen design, flexible transfer options, and disk and printer sharing.

For the same fast, error-free file transfers between PCs and Macintoshes, get LapLink Mac. And for more information about any Traveling Software product, call us at (800)662-2652.

LapLink III. The standard in file transfer software.

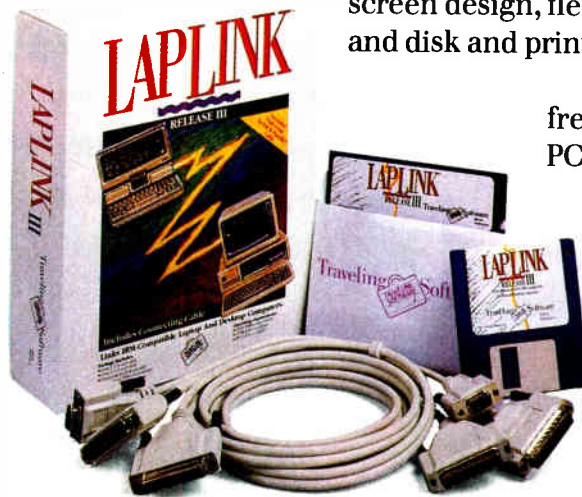

Suggested Retail Price **\$149.95**

LAPLINK III



Traveling Software, Inc.
18702 North Creek Parkway, Bothell, WA 98011
(206) 483-8088

Traveling Software Europe
Lords Court, St Leonards Road, Windsor
Berks, SL4 3DB, England
(44) 0753 831855

LapLink is a reg. trademark of Traveling Software, Inc., Xerox is a reg. trademark of Xerox Corporation, FedEx is a reg. trademark of Federal Express Corporation. © 1989 Traveling Software, Inc. All Rights Reserved

Circle 330 on Reader Service Card

World Radio History



What can a ScanMan™ scan, man?

Virtually anything. Logos or photos. Digits or dingbats. Art or articles. A soda can. How can you get them into your PC? You could play cut and paste with the copier down the hall. Or use your own, do-it-in-a-flash, hand-held scanner. ScanMan.

Images. Select 1, 2, 3, or 400 d.p.i., then pop any image up to 4" x 14" into a file for your publishing program. Or into your Windows™ clipboard. Or use PaintShow Plus™—included with your ScanMan—for editing and coloring.

Text. Our Catchword™ software converts virtually any typeface into ASCII files for your word processor, desktop publisher, or spreadsheet. It reads horizontally or vertically, scans words or numbers from 6 to 20 point, and matches adjacently scanned columns perfectly.

Should you buy it? Once you've got it you'll wonder what you did without it. And it's only \$339*. Backed by our Customer Satisfaction Guarantee, and 7 Days-a-Week Support.

For information, call: 800-231-7717

In California:
800-552-8885
In Europe: ++41
-21-869-96-56

LOGITECH



*For IBM PC and compatibles; includes Paintshow Plus. List price for the IBM Micro-Channel version is \$399. Catchword is an optional extra for \$199.

Circle 190 on Reader Service Card (DEALERS: 191)



Save that tiger.

Save face.

What can a ScanMan™ scan, man?

Virtually anything. Logos or photos. Digits or dingbats. Art or articles. A soda can. How can you get them into your PC? You could play cut and paste with the copier down the hall. Or use your own, do-it-in-a-flash, hand-held scanner. ScanMan.

Images. Select 1, 2, 3, or 400 d.p.i., then pop any image up to 4" x 14" into a file for your publishing program. Or into your Windows™ clipboard. Or use PaintShow Plus™—included with your ScanMan—for editing and coloring.

Text. Our Catchword™ software converts virtually any typeface into ASCII files for your word processor, desktop publisher, or spreadsheet. It reads horizontally or vertically, scans words or numbers from 6 to 20 point, and matches adjacently scanned columns perfectly.

Should you buy it? Once you've got it you'll wonder what you did without it. And it's only \$339*. Backed by our Customer Satisfaction Guarantee, and 7 Days-a-Week Support.

For information, call: 800-231-7717

In California:
800-552-8885
In Europe: ++41
-21-869-96-56

LOGITECH



*For IBM PC and compatibles; includes Paintshow Plus. List price for the IBM Micro-Channel version is \$399. Catchword is an optional extra for \$199.

Circle 190 on Reader Service Card (DEALERS: 191)

Take this job and shove it.

Scan the globe.

Catch a wave.

Save the day.

Can scan.

There goes the neighborhood.

Scan the horizon.

Get reel.

TODAY'S TIMES ONLY

FIELD OF DREAMS (PG) THX Stereo
11:35, 1:45, 4:30, 7:30, 10:05

OSCAR! (R)
11:35, 1:35, 4:50, 7:15, 9:40 Dolby

BARON MUNCHHAUSEN (PG)
11:35, 1:35, 4:50, 7:15, 9:40 Dolby

RENEGADES (R) Dolby
11:35, 2:10, 4:35, 7:40, 10:30

NO HOLDS BARRED (PG-13)
11:35, 2:10, 4:35, 7:40, 10:30

WARM NIGHTS ON A SLOW MOVING TRAIN (R) 1246, 336, 530, 810, 10:10

SPECIAL ADMISSION - SHORT CIRCUIT #10
11:35, 2:10, 4:35, 7:40, 10:30

World Pacific History

The new DigiCHANNEL series out-performs all other leading multi-user communications boards.

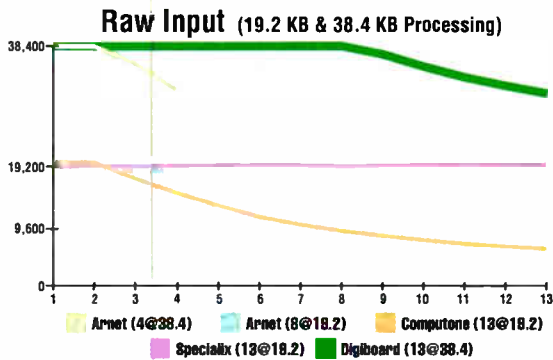

Raw Input: Primarily data received via host-to-host communications. The higher the better.

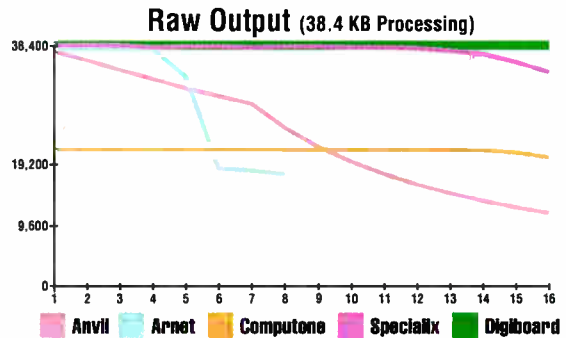

Raw Output: Processed data from host applications to terminal users (spreadsheet, word processing, etc.) The higher the better.

% Host Utilization per Kilobyte/Second

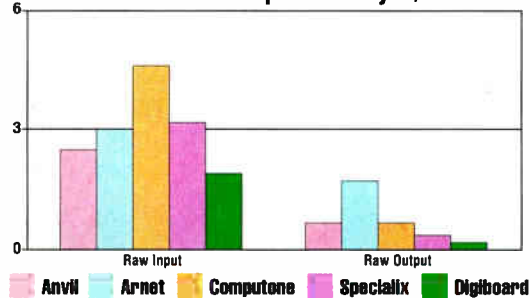

Processor Overhead: Percentage of host CPU time utilized for I/O processing tasks. The lower the better.

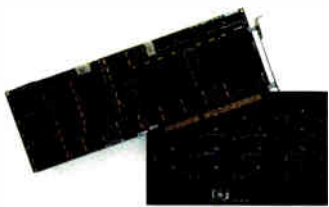

The new DigiCHANNEL series of multi-user communications boards sets the new performance standard for terminal response time, especially under heavy user-load conditions. The key to this performance is the synergy between our hardware and our new Front End Processing real-time Operating System (FEP O/S) software.

The proof is in the numbers, and a good example is the DigiCHANNEL PC/16i. In benchmark tests, it beats every other leading board in the two critical areas that determine board performance: *data throughput* and *processor overhead*.

Data throughput is calculated by measuring the total amount of data that a board can handle per port and per system. The higher the data throughput, the faster the response time for each user on the system.

Processor overhead is the amount of additional

processing imposed on the CPU to handle the data input/output being controlled by the communications board. The less time the CPU needs to spend on I/O chores, the more time it can spend processing applications for terminal users.

Call for our FREE technical white paper with all the details on our benchmark testing. While you're at it, ask for our FREE booklet, *How to Do Multi-User Right*.

No matter how simple or complex your multi-user systems, you can trust DigiBoard to put you at the head of the pack. And keep you there.

DigiBoard
Plugging you into tomorrow

6751 Oxford Street • St. Louis Park, MN 55426
1-800-344-4273 • In Minnesota (612) 922-8055





UNIX WORKSTATIONS CONNECT

If Unix is multiuser, why would you want a Unix LAN?

As new and faster processors reach the computer industry, more powerful computers become accessible to end users. This is a familiar refrain in magazine articles about personal computers. It's even more applicable to Unix workstations, where new technology is dramatically dropping prices to personal computer levels. You might be thinking about adding an Ethernet port to your microcomputer . . . or even running out and buying a workstation! Now is the time to talk about networks and workstations.

What's a Workstation?

Almost anything with more CPU power than a toaster is being called a workstation these days. But my idea of a workstation is a computer with a high-resolution graphics display running a multitasking operating system and window management software, specifically designed to operate on a network. Any workstation worthy of the name would also have an Ethernet port and a mouse.

This definition rules out a PC with an Ethernet card—it's just a PC with the *ability* to use a network. The Macintosh comes a little bit closer, but it's really designed to be a stand-alone machine. A high-resolution terminal designed around an Ethernet connection doesn't qualify—it's not a computer. Some Macs and PCs have been specially configured to use a network. If they have high-resolution screens and multitasking window managers, then they could actually be workstations by my definition.

The key to having workstations is similar to that of eating potato chips: Nobody has just one. A single diskless

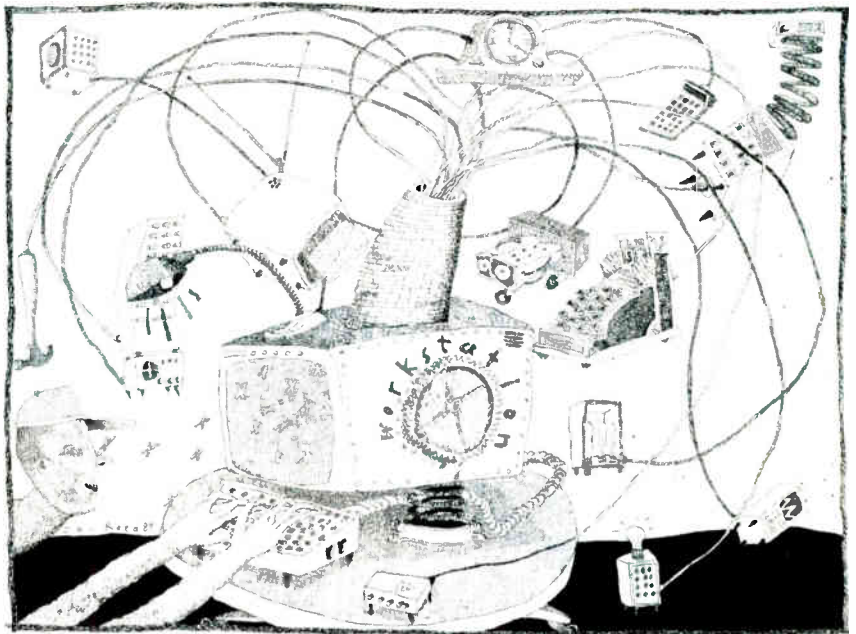

workstation is useless without a file server (basically just a computer with a lot of disk space). File servers are too expensive to dedicate to a single workstation. But add just one more diskless workstation to your first node and server, and you have a network. The cost of adding workstations is relatively low, considering the amount of additional computing power they give you.

How They Work

A network of workstations is comparable to a multiuser computer system. In the old-style "timesharing" setting, you bought a computer with a multiuser operating system, such as Unix, and connected dumb terminals to it, using serial connections at perhaps 9600 bps (roughly 1000 bytes per second).

On a workstation network, the central computer (or file server) generally also runs Unix, but it tends to have more disk storage than the usual departmental computer. The workstations, instead of being

simple terminals, are computers running Unix themselves. Typically, they connect to the server through Ethernet. They communicate at 10 megabits per second (roughly 1 megabyte per second) using TCP/IP protocols. TCP/IP is the de facto industry standard for Unix networking, but it is also the basis for networks on other operating systems (see "The Glue for Internetworking" in the LAN Supplement, September BYTE).

How can a diskless workstation boot up Unix without a disk? The basic startup software is in ROM. When the workstation is powered up, the ROM-based software identifies itself to the file server and requests a file transfer (of the Unix kernel) to its local RAM storage. From then on, you're working with the network, running Unix locally and transferring files transparently as needed—at speeds higher than those of typical PC hard disk drives. And since each workstation on a network is itself a computer,

continued

SUNDAY 10-5 **PROMPT DELIVERY**

<p>COMPUTERS</p> <p>AST 286/386 Drav 979.00 512K 1.2 F 20MB AST PREM 286 512K 1.2 F 40 MB HD 1449.00 005 3.3 K 16.0 AST PREM 386 C 20MB 1 MB 1.2 F D 2449.99 AST 386C/25 MHz 3599.99 2MB Ram 1.2 F D AST 386C/33 MHz 4099.99 2MB Ram 1.2 F D FAX/MODEM World Port 2495 Homes II/3300</p> <p>SOFTWARE</p> <p>M.S. DOS 4.01 74.99 M.S. Windows 286 49.99 M.S. Works IBM 1 99.99 M.S. Excel IBM 2 1 219.99 Lotus 123 2 2 74.99 Lotus Deluxe 5.5 219.99 PC Tools IBM 5.0 329.00 M.S. Word MAC 4.0 399.00 Lotus 123 V.3 0 399.00 Lotus Agenda 119.99 Lotus Symphony 49.99 Manya T. Money 49.99 Norton Util. Adv. 219.99 Norton Cosm. 85.00 Word Perfect 5.0 119.00 Word Pad Library 159.00 Carbon Copy Plus Harvest Graphics d Base IV</p> <p>MONITORS</p> <p>Ming. Diam Scan 489.99 NEC Multisync 2 594.99 NEC Multisync 30 539.99 NEC Mac Sync 1699.00 Multisync XL 489.99 PDS Ultrasync 16 404.99 Seko CM-1430 Zenith 14 Flat</p>	<p>EXECUTIVE ORGANIZER</p> <p>Calla 79.99 SF 4000 199.99 SF 7500 B.O.S.S. CALL SF 6000 B.O.S.S. CALL SHARP Wizard 99.99 Thebanus Dict. 94.99 8 Language Mgm. Time Express</p> <p>NETWORK OPERATING SYS.</p> <p>ELS Level I 449.99 ELS Level II 850.99 Adv. Netw V2 15 1725.99 Sh. Netw V2 15 2999.99 3+ Open Adv 589.99 3+ Open Adv 2049.99</p> <p>Hardware</p> <p>Novell NE-1000 239.99 Novell NE-2000 335.99 3 com Ethernet 195.99 WD Ether Card c 220.99 WD Ether Adapter Kit 435.99 Acnet Hub 399.99 Passive Hub 895.99 3 com Tokenring 299.00 UPS 1000 Watts 399.00 UPS 1000 Watts 399.00</p> <p>SEAGATE DRIVES</p> <p>20 MB w/Ctrl. 239.00 30 MB w/Ctrl. 329.99 40 MB 48 MS 49.00 40 MB 28 MS 49.00 60 MB 48 MS 85.00 80 MB 28 MS 99.00 Tsh. 3 1/2 720K 1 1/4 DR 165.00</p> <p>HAND SCANNERS</p> <p>HS 3000 Plus 189.99 OCR Software DLK 189.99 Logi Scanner Plus 99.99 Logitech for MAC 99.99</p> <p>MOUSE</p> <p>Logitech w/Softr. 79.99 Logi II Res 99.99 Microsoft Mouse 99.99</p>	<p>PRINTERS</p> <p>Diconix 150 plus 299.99 Diconix 300 329.99 Epson FX 850 434.99 Epson FX 1050 494.99 Epson LO 510 699.99 Epson LO 850 699.99 Epson LO 1050 899.99 Epson LQ-2550 184.99 Epson LX-810 464.99 NEC P-2200IE 634.99 NEC 5200 329.99 NEC P-2200IE 454.99 Oki 320 599.99 Oki 390 955.00 Oki 393 184.99 Panas. KXP 1180 199.99 Panas. KXP 1194 199.99 Panas. KXP 1524 499.99 Panas. KXP 1595 316.99 Panas. KXP 1595 316.99 Toshiba 301 Toshiba 311</p> <p>INTEL CO. PROC.</p> <p>80287/8 MHz 124.99 80287/10 MHz 189.99 80287/10 MHz 214.99 80287/10 MHz 359.99</p> <p>LASER PRINTER</p> <p>80367/20 2949.99 NEC LC 690 184.99 HP Desk Writer 664.99 HP Desk Jet Plus 994.99 HP Laser II D 1598.99 HP Laser II w/Tone 224.99 1 MB RAM 1019P 279.99 2 MB RAM 1019P 279.99 Pacific 25 in 1 Pac. Postscript</p> <p>GRAPHIC CARD</p> <p>ATI VGA Wnd 512K 299.99 Para. VGA Pcs-16 244.99 Video 7 Fast VGA</p>
---	--	---

FAX # 212-463-8335
TOLL FREE 1-800-874-1235
FREE (800) 223-6779
IN N.Y.S. (800) 223-6779
IN CANADA TOLL FREE 1-800-666-1668
S & W COMPUTERS & ELECTRONICS
31 West 21 Street, New York, N.Y. 10010
N.Y.C. (212) 463-8330

Hours Sun. 10-5
 Mon-Thurs. 9-6 Fri. 10-2
 Sat. Closed

PRICES HARD TO MEET — SERVICE HARD TO BEAT! World Wide Inquiries Promptly Filled

running a compute-bound task on one node won't slow the others down.

Not Your Ordinary PC

The bare minimum workstation, then, is entirely diskless. The most inexpensive one I am aware of is the Sony NWS-711. It is based on a Motorola 68020 CPU and a 68881 FPU, both running at 16.67 MHz, for a claimed 2.3-million-instruction-per-second processing power. It has 4 megabytes of memory and a 15-inch monochrome monitor with 816- by 1024-pixel resolution (it's a "portrait mode" monitor; the screen is configured like a vertical sheet of paper). The 711 lists for just \$3700, which includes Unix as well as C, Pascal, and FORTRAN compilers.

Apart from being a diskless workstation, the 711 can also be used as an X Window terminal. In fact, since it has no disk, it looks like a graphics terminal, but, of course, it is much more powerful. (For more information, contact Sony Microsystems Co., 1049 Elwell Court, Palo Alto, CA 94303, (415) 965-4492.)

In compute-happy environments, such as semiconductor design, you might see a dataless workstation. It has its own disk drive—up to 180 megabytes—but, since so much system software and swap space is needed on the disk, all applications and user files reside on the server. The local disk drive merely keeps the system going by keeping memory paging local.

X Marks the Spot

Ethernet and TCP/IP are the low-level links common to most Unix networks, and the X Window System is the common base for user and application programs. X Window (as it is almost universally called) was developed at MIT with assistance and support from Digital Equipment Corp. (DEC) and IBM. It's not public domain code, but it is publicly available and free for the asking.

Because TCP/IP is a set of network protocols that are transparent to the operating system, X Window is a network-transparent windowing system. This has several meanings, all of them good. X Window is not tied to any given network protocols, so it is just as happy running on DECnet as it is on TCP/IP. This means you can run applications on any machine on your network and control them all from individual windows on your terminal. Note that I said "machines," not "Unix machines." They don't all have to be made by the same manufacturer, or even have to be running the same operating system. They just have to be in your network and running X Window.

continued

Save Time & Money

Network Your PCs Using Standard Telephone Connectors and Cables!

You get instant access to all your programs, files and printers on all your PCs. Each PC can process multiple jobs simultaneously using NET-127 PC Network.

- Allows Sharing of Hard Disks, Printers, Plotters, Tape Back-ups, etc.
- Supports Spreadsheets, Word Processing, CAD/CAM & More
- Nothing New to Learn
- Up and Running in 15-30 Minutes
- 4000 with Telephone Cable & RJ11 Jacks
- Only 4-32K RAM, Connects up to 127 PCs
- No Need to Reformat Existing Hard Disks
- No File Server Required
- 30 Day Money-Back Guarantee

For FREE Info
Call 800-533-0738

28 Blacksmith Drive
Medfield, MA 02052

Trans-M Corp.

When we started selling MKS products in 1986, the Tax Collectors were among the first to notice. They assessed our promise to bring the power and flexibility of a UNIX environment to the DOS desktop.

And then they came to call.

We're happy to report that the Tax People* quickly decided that MKS products were the perfect way to train users on UNIX operating systems using the PCs everyone was already familiar with. And the perfect way to speed development of new programs and procedures.

Get the new - but don't give up the old

The MKS Programming Platform gives programmers the best of both worlds - virtually unrestricted access to the power and flexibility of UNIX operating systems, and full DOS or OS/2 capabilities. With MKS your PC becomes a powerful and productive UNIX workstation, whenever you need it.

The Platform includes four proven members of the MKS family of software: *MKS Toolkit*, *LEX & YACC*, *RCS*, and *Make*.

The heart of the Platform is the *MKS Toolkit*. It provides a complete set of utility programs and over 150 commands compatible with UNIX System V.3. It also includes the MKS Korn Shell, a command interpreter, MKS Vi editor, and the MKS AWK programming language.

Next is *MKS LEX & YACC*, which work together as a

highly efficient program generator, simplifying the creation of languages and compilers for DOS and OS/2. The set is completed with *MKS RCS* (Revision Control System), which gives total control of text file revisions, and *MKS Make*, which provides an efficient way to automate the production and maintenance of any size project.

All together they are the most efficient, most productive, and friendliest way to cross the bridge between DOS or OS/2, and UNIX.



Beyond multiple platform support

The Programming Platform performs on standard PC networks like Novell NetWare and PC NFS with the illusion of a complete UNIX timesharing system. This means you can hook your PC to PC NFS, allowing it to be used as a UNIX workstation.

MKS is an active participant on the POSIX standards committee, and we track the shell and utilities standard to the fullest extent. We take care to build the underlying POSIX kernel functionality on DOS and OS/2 into MKS software before moving utilities. That's why the Platform gives you 100% UNIX and POSIX compatibility, with no surprises.

Ideal training tools

Fast, painless training is another benefit of the Programming Platform. Developers can use their familiar PC keyboards while moving effortlessly to UNIX on the desktop, and exposure to new commands and functionality becomes part of the novice's working day.

The Taxman odds it up

When you stack up all the advantages of the Programming Platform - access to powerful development tools, time-saving management functions, full portability, easy training, and our unwavering dedication to the POSIX standard - it's no wonder that the people with the toughest jobs to do, like the Taxman, turn to MKS.

To learn more about The Programming Platform and other MKS productivity and development tools, call us today. Maybe we can make your job a little less taxing.

After Long Investigation, The Taxman Came To Talk To Us

30 day money-back guarantee

MKS Programming Platform prices are:

DOS \$665
OS/2 \$1225

In Continental USA call: 1-800-265-2797
Outside Continental USA call: 1-519-884-2251
Fax: 1-519-884-8861

Authorized MKS Dealers:

Belgium 2-736-6064
England 364-53499 or
1-833-1022 or
0763-73455
Netherlands 20-14-24-63
West Germany 551-792488 or
061-214908 or
721-886-664

Head Office:

35 King Street North
Waterloo, Ontario
Canada, N2J 2W9

MKS

More Power to You

*We're not allowed to use their official name. But you know who we mean.
MKS is a trademark of Moritice Kern Systems Inc. Other trademarks have been cited and MKS acknowledges them.

Circle 220 on Reader Service Card

World Radio History

Mixing REAL TIME With REAL UNIX[®] Is Not Magic...

It Is Technology.

VenturCom's real time UNIX product family has the only real time kernel for standard hardware platforms which is AT&T's UNIX System V. Not a simple UNIX clone. Not just UNIX on top of a real time executive.

Real UNIX provides designers with SVID and POSIX standards, RFS and NFS, X-windows, Streams, complete development tools, multiple DOS under UNIX tasks. And early access to future technologies.

Real time adds performance and functionality to UNIX with preemptive and biased scheduling, contiguous file system, average interrupt latency of 50 μ s, bounded context switches, memory locking, asynchronous I/O, and much more.

Ask us about VENTIX[™] for 80286/80386 PCs and Single Board Computers; RTX[™] for other UNIX versions, such as Interactive System's 386/ix[™] and small, diskless, and ROMable UNIX kernels. Find out why Foxboro, Toshiba, GE, and many others are using VenturCom's real time UNIX products.

 **VenturCom**
Real Time/Real Unix
215 First Street
Cambridge, MA 02142
(617) 661-1230
Nippon VenturCom, Inc.
Tokyo 102 Japan 03-234-9381

UNIX is a registered trademark of AT&T
386/ix is a trademark of Interactive Systems Corp.
VENTIX, RTX are trademarks of VenturCom, Inc.

X Window is pretty much hardware-independent at the user's graphical-display end. This means that if you're running an application on a vertical-screen monochrome display this week, you can run it on a horizontal-screen 24-bit color workstation next week with no problems. What all this means is that companies can now design their computing environments around their users' needs, not around the current offerings of a particular manufacturer. The phrase "heterogeneous network" is usually used here by industry reporters, although it sounds too clinical for my taste.

Getting GUI

Although many people are happy to run xterm, the X Window Unix-compatible terminal emulator, X Window is not really a graphical user interface. It does make a terrific basis for one, however, and any GUI written to run on X Window will be highly portable as a result. This is the theory behind the current industry struggle between Open Look (a GUI promoted by Sun, AT&T, and Unix International [UI]) and Motif (promoted by the Open Software Foundation [OSF]). Both of these will be available widely and inexpensively, to the ultimate benefit of users. Of course, every layer of software that you add increases not only your productivity but also your system's complexity and its need for additional disk space and CPU power. But then, that's part of the game: If you want to work with the state of the art, you're going to have to pay for it.

If you don't want to get caught between OSF and UI, you might want to look into X.Desktop, a Macintosh-like, icon-based X Window user interface from IXI Ltd. of Cambridge, England (see the text box "Managing the X Window Desktop," January BYTE, page 356). X.Desktop is an intuitive interface that lets you bypass many typical Unix system commands; it will support both Motif and Open Look styles in the future. It can be obtained in the U.S. from Unipress Software (Edison, NJ). X.Desktop has been adopted by companies such as Locus Computing, Motorola, NCR, Uniplex, and The Santa Cruz Operation (which is including X.Desktop as part of its Open Desktop product).

In fact, if you really get hooked on X Window and don't have a network, you can still run X Window applications on a single machine. The system simply uses Unix interprocess communications instead of network protocols—more proof that programmers are truly happiest when they're talking to themselves.

You Also Need Files

So you have portable industry-standard protocols, windowing, and user interfaces. What's left? How about a way of hooking networked machines together so that you can not only transfer files, but mount an entire file system from a remote machine onto your local workstation and access it transparently? That's the Network File System, developed at Sun Microsystems in 1984 (not at Berkeley, as I mistakenly wrote in BYTE in May). NFS generally uses UDP/IP, a faster (but technically less reliable) set of protocols than TCP/IP.

NFS, like X Window, is portable and publicly available, as well as user- and protocol-transparent. By now, you can guess what's coming: "These factors have led to its becoming an industry standard." And, as a standard, NFS is another piece of software that is found on almost every Unix network. Since users no longer have to worry about where their files reside, it's only the administrators who have headaches. (Just keeping track of user log-ins and machines on a network can be a major task.)

The real beauty of NFS is that it is *not* tied irrevocably to Unix. In fact, machines running MS-DOS, VMS, and IBM VM have all been placed happily in NFS networks, as with X Window. Getting these disparate systems to share files transparently is a magic trick, indeed. By comparison, LANs that work only with DOS machines and nothing else don't seem very sophisticated at all.

Since the Unix kernel itself is just another file, there's no reason why a diskless Sun workstation couldn't boot up by requesting its kernel file from a DEC server. And, in fact, this kind of thing happens every day. This shows the essential nature of today's networks: They stand apart from any quibbling over "small" details like machine architecture, byte ordering, the operating system, or even the network protocols themselves. A properly designed industry-standard network will simply accept any and all of these, so that users can have their favorite hardware as well as their favorite software. After all, making users happy is the name of the game! ■

David Fiedler is publisher of the Unix Video Quarterly and the journal Root, and is coauthor of the book Unix System Administration. He can be reached on BIX as "fiedler."

Your questions and comments are welcome. Write to: Editor, BYTE, One Phoenix Mill Lane, Peterborough, NH 03458.

UNIXHOUSE, Inc.

UH Series - 3000



Uses the Intel 80386 Processor
Model 16: 16MHz CPU, 1Mb Base RAM, expandable to 15Mb.
Model 20: 20MHz CPU, 2Mb Base RAM, expandable to 20Mb.
Model 25: 25MHz CPU, 4Mb Base RAM, expandable to 64Mb, Cache RAM, Weitek 3167 Socket support.
Model 33: 33MHz CPU, 4Mb Base RAM, expandable to 64Mb, Cache RAM, Weitek 3167 Socket Support.
Features for all models: High speed ESDI HD/FD Controller, High Quality Tower Case, Genuine TurboCool™ Power Supply, 80387 support, High quality tactile response keyboard, Choice of 1.2 5.25" or 1.44 3.5" floppy drive. Fully compatible with DOS, IBM's OS/2, but perfected for XENIX/UNIX.

Please Call Us at UNIXHOUSE, Inc. for all of your UNIX/XENIX needs. We manufacture the Highest Quality 80386/80486/80860 Computers, and stock a complete supply of UNIX/XENIX Software. (512) 385-1200 Fax (512) 385-1339

UH Series - 4000

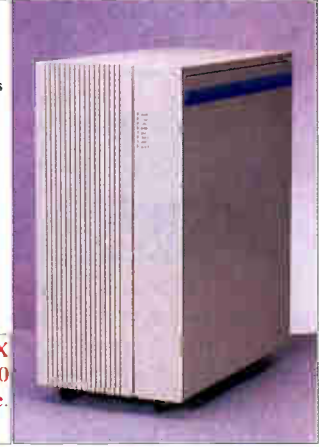

DUAL Processor (RISC/CISC)
 Uses both Intel 80486 and Intel 80860
25 MHz Intel 80486-CPU,
25 MHz Intel 80860 RISC Processor
 Socket for Weitek 4167. Up to 64 MBytes of 64-bit RAM Mother Board memory, shared between i486 and i860 processors. Maximum memory on 64-bit, 182 pin PS/2 style connector expansion is 4 Gigabytes. Socket for optional 2nd level, 128K static RAM Cache.
 High Speed ESDI HD/FD Controller, Extremely High Quality, Sleek Tower Case, 2 TurboCool Power supplies, Alarm, Fully compatible with DOS, IBM's OS/2, Novell Netware, but perfected for XENIX/UNIX. Please call for more information. Thank you.

UNIXHOUSE SERIES 3000 COMPUTER SYSTEMS

	Model 16	Model 20	Model 25	Model 33
List	2772.00	3252.00	4866.00	5319.00
Cost	2079.00	2439.00	3649.00	3989.00

UNIXHOUSE™ SYSTEM OPTIONS

Memory

	4M	8M	12M	16M
List	1499.00	2995.00	3495.00	5995.00
Cost	995.00	1875.00	2795.00	3695.00

MAXTOR ESDI Hard Disks

	4170E (150 Mb formatted)	4380E (320 Mb formatted)	8760E (640 Mb formatted)
List	2995.00	3995.00	5995.00
Cost	1337.00	2126.00	3743.00

Math Co-processors

	16MHz	20MHz	25MHz	33MHz
List	645.00	730.00	920.00	995.00
Cost	379.00	429.00	524.00	695.00

Console Displays (NEC)

	MonoVGA	VGA Color	VGA Pro	BasicVGA	VGA Plus 16	VGA Pro
List	349.00	799.00	1049.00	299.00	499.00	499.00
Cost	261.00	599.00	649.00	224.00	374.00	374.00

Display Boards (Paradise)

	BasicVGA	VGA Plus 16	VGA Pro
List	299.00	499.00	499.00
Cost	224.00	374.00	374.00

COMMUNICATIONS

External Modems 9600 Baud (U.S. Robotics™)

	HST	V.3.1	HST/3.2	HST/ix
List	995.00	1495.00	1595.00	1295.00
Cost	695.00	1121.25	1196.25	971.25

Serial Boards

	Armc 8/16	Digiboard 8/16/32	Anvil 24
List	Please Call. Currently working on new, lower prices. Thank you		
Cost	Please Call. Currently working on new, lower prices. Thank you		

Terminals w/ Keyboards

	Wyse 50	Wyse 90	Wyse 150	Wyse 350
List	499.00	599.00	549.00	Please Call
Cost	449.00	495.00	490.00	Please Call

SAVE 25% on most items

UNIXHOUSE, Inc.
 Tel. (512) 385-1200
 Fax (512) 385-1339
 4204 Felter Ln.
 Travis Industrial Park
 Austin, Texas 78744

UNIXHOUSE is a manufacturer of super micros, minis, engineering workstations, and mainframes. By staying at the leading edge of technology, and utilizing the finest components, we are able to offer high-speed quality systems for the best possible price. We purchase software in mass, in order to pass the 25% savings on to you. At UNIXHOUSE, our motto is, "Our customers never pay list."

UNIX®/XENIX® Software Price List 25% off List

	List	Cost - 25% off!
SCO UNIX OS 3.2, 386, 5.25"	895.00	671.00
SCO UNIX DS 3.2, 386, 5.25"	995.00	746.00
SCO Xenix Operating System - 80386	695.00	521.25
SCO Xenix Text Processing System - 80386	195.00	146.25
SCO Xenix Development System - 80386		
SCO Xenix Complete System, OS, DS, TX - 80386	1595.00	1196.25
SCO VP/ix MS-DOS Emulator for Xenix		
SCO VP/ix 2-user - 80386	495.00	371.25
SCO VP/ix unlimited user - 80386	895.00	671.25
BUSINESS APPLICATIONS		
SPREADSHEETS		
SCO Professional, Lotus 123® compatible - 80386	995.00	746.25
DATABASE		
SCO FoxBASE+, dBase III+® compatible - 80386	995.00	746.25
SCO FoxBASE+, Limited Runtime - 80386	395.00	296.25
SCO Integra - 80386	895.00	671.25
WORD PROCESSING		
WordPerfect for Xenix - 80386	995.00	746.25
Microsoft Word for Xenix - 80286	695.00	521.25
SCO Lyrinx for Xenix - 80386	595.00	446.25
PLANNING AND STATISTICS		
SCO Masterplan - 80286	795.00	596.25
SCO Manager - 80386	695.00	521.25
SCO Statiscian - 80386	795.00	596.25
COMMUNICATIONS		
SCO uniPATH-3270 Prog. interface	1295.00	971.25
SCO uniPATH-3270 MU, I-8 Sessions	1295.00	971.25
SCO Xenix-Net, Single Server - 80386	695.00	521.25
MISCELLANEOUS		
dAnalyst for SCO FoxBase+	505.00	378.75
SCO Xenix Tutor	195.00	146.25

SBT® Accounting Software Price List

	Single User		Multi User	
	List	Cost	List	Cost
General Ledger	295.00	221.25	595.00	446.25
Accounts Payable	295.00	221.25	595.00	446.25
Open Item Billing, & Inventory Control	295.00	221.25	595.00	446.25
Payroll & Labor Accounting	295.00	221.25	595.00	446.25
Sales Order Processing	295.00	221.25	595.00	446.25
Fixed Assets Management	295.00	221.25	595.00	446.25
Professional - Time & Billing	295.00	221.25	595.00	446.25
Manufacturing Planning	295.00	221.25	595.00	446.25
Purchase Order Processing	295.00	221.25	595.00	446.25
Integrated Bar Code Data Entry	295.00	221.25	595.00	446.25
Job Cost Accounting	295.00	221.25	595.00	446.25
Property Management	295.00	221.25	595.00	446.25
Service & Equipment	295.00	221.25	595.00	446.25

UNIX is a registered trademark of AT&T in the U.S.A. and other Terms: C.O.D. Cashiers Check, VISA/MC, countries, XENIX is a registered trademark of Microsoft Corporation (call 1.800 From Qualified Corporations, countries, SCO and the logo are trademarks of The Santa Cruz Financing Available to Qualified Corporations Operation, Inc. SBT is a trademark of SBT Corporation and Individuals. Prices subject to change.

DSC NEXOS 386 LAN BEATS NETWARE!

NEXOS is the clear winner! NEXOS 386 beat NetWare® in operating system benchmark tests performed and guaranteed by the Lanquest Group, an independent test lab for the LAN industry. The results reveal the truth about NEXOS' superior performance over NetWare. In fact, NEXOS proves to be as much as **SIX TIMES FASTER THAN NetWare.**

Fast!

In real-world, user traffic environments on industry standard hardware using well accepted, multi-user applications for database, spreadsheet and word processing, **NEXOS beat NetWare in performance with an advantage of as much as 637%.** You'll work faster and expand your LAN with confidence when you choose DSC NEXOS 386.

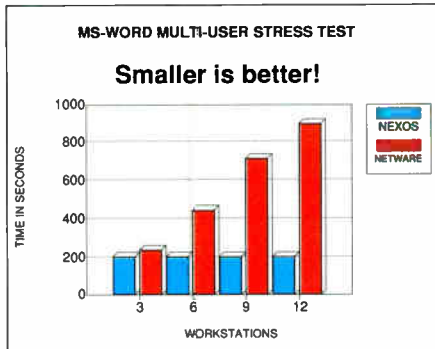

NEXOS' fast, reliable and consistent performance is clearly shown using a Compaq 386/25 server and 12 IBM PS/2 workstations running the Lanquest Group's MS-Word benchmark.

Secure!

It's important to protect fast moving data from corruption. NEXOS features a complete data integrity and protection system so powerful that your data is protected even if your power fails—**without the expense of a mirrored system or UPS.** NEXOS always writes completed transactions to disk. If hardware problems occur during a transaction—your data will remain intact. Just restart the transaction with the original—unchanged data. NEXOS is prepared with a continuous audit trail of entries and updates recorded in real-time by NEXOS' tape transac-

Netware® is a registered trademark of Novell, Inc.

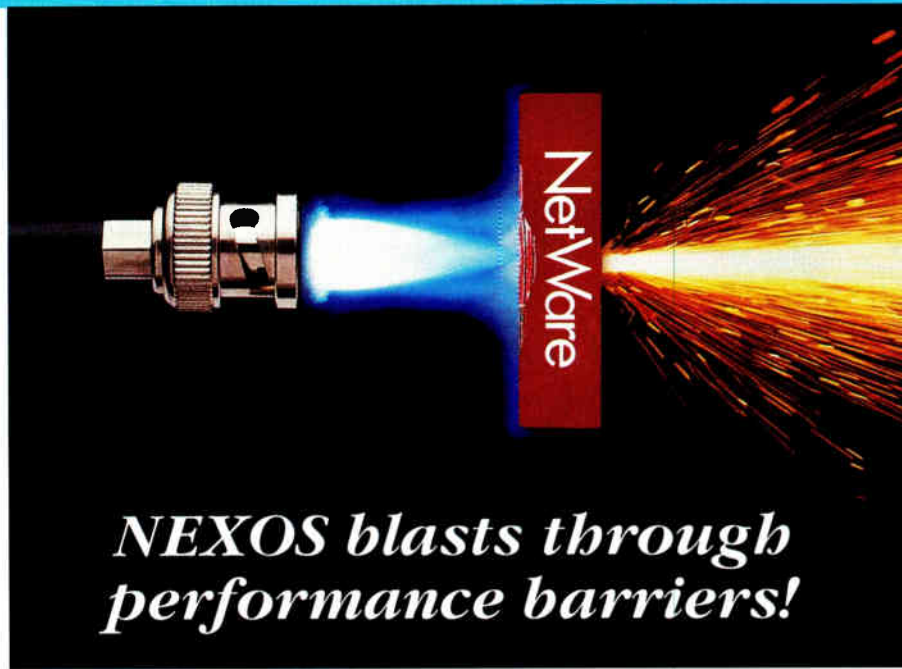

NEXOS blasts through performance barriers!

tion logging to the server's tape drive. With NEXOS your critical data is safe!

Flexible!

NEXOS gives you the flexibility, power and connectivity of **100% DOS and NETBIOS application compatibility.** Run all the applications your users demand and have access to UNIX, SNA hosts and the public network.

With all this power it's likely you'll want to put lots of data on-line. NEXOS' **large-drive support** provides access to virtually unlimited disk storage.

The unique disk handler makes multiple hard drives appear as one, providing contiguous file space across multiple drives.

Connecting to your existing workstations is a breeze. NEXOS supports more than 30 workstation interface cards for PC, XT, AT and PS/2 workstations and your choice of topologies: **Ethernet, ARCnet and Token Ring support is standard with every NEXOS LAN!**



The DSC NEXOS 386 LAN Operating System

Easy!

NEXOS' power has been harnessed with an easy to use menu system that will have the system's administrator and users **up and running in minutes.** Simple instructions, familiar, DOS-like commands and DSC technical support means your NEXOS LAN system will work - for you - for the users - and for your company.

NEXOS 386 is another quality networking product from DSC, a **\$340 million leader in advanced communications.** From your desktop to around the world, DSC is delivering the quality networking solutions you demand!

To learn more about NEXOS or to become an authorized DSC dealer call now. Be sure to ask for a FREE copy of the full series of benchmark results!

**1-800-BUY-NEXOS
1-800-289-6396
Fax: 408-954-5158**



DSC Communications Corporation

Circle 112 on Reader Service Card
World Radio History



A HELPING HAND

A new workstation lets physically challenged people take their place in the high-tech workplace

When small computers first came on the market 15 years ago, they looked like a real boon for handicapped people. Combine machine intelligence, voice control, and a robotic arm, and you've got a way to give disabled people enhanced independence and a greater opportunity to be productive. Handicapped people weren't the only expected beneficiaries of such a system, either. Faced with skilled-labor shortages and federal legislation requiring equal opportunity for the physically challenged, businesses all over the country have been looking for ways to put physically disabled people in front of computers.

But the reality has been a long time coming. The problem is that most of the solutions, including speech-recognition systems and robotic arms, are stand-alone peripherals. You have to do your own system integration, and most businesses don't have the time or the personnel for that. What the industry needed was a prepackaged, integrated solution that would work well, satisfy requirements, and meet the needs of both the employee and the business.

The fact that handicapped people have been bypassed has become a significant problem for many businesses. There are two reasons for this. First, in many areas of significant technological growth, there is also an equally significant labor shortage. Second, the federal government has mandated that facilities must be provided to give handicapped employees a fair chance at doing work.

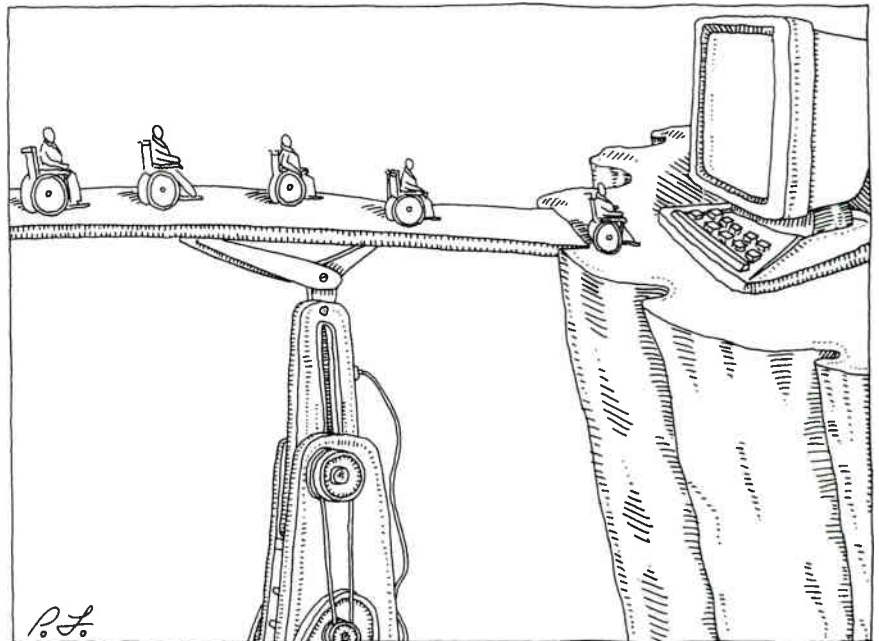

Employing the handicapped is not much of a problem in some businesses. But in others, hiring people with certain handicaps presents a serious problem. To be productive using computers, for example, you have to be able to type. The problem is that many physically handicapped people have limited use of their hands and arms; otherwise, they are perfectly capable of performing work. They just need a way to perform it.

Now Zenith Data Systems, through its Heath subsidiary, and Prab Robotics, through its Prab Command subsidiary, have delivered a workable solution at a reasonable price. It allows the user to perform any required function on a personal computer through the use of voice commands alone.

Included in the Prab Voice Command I package are a Zenith Z-286 LP computer and Zenith's FTM flat-tension monitor, a voice-control keyboard designed by Prab, a robotic arm (also designed by Prab), a Hewlett-Packard LaserJet II

printer, a telephone system, and a specially designed work area. It retails for \$49,500.

The robotic arm looks like an industrial robot, but it is specifically designed for this application and incorporates a number of safety features to ensure that a user would never be hurt by it. The arm can move objects near the desk and handle paper from the printer. It can even remove a soda from a refrigerator.

The voice command system is the star of the workstation, though. I sat next to Jan Ziff of the British Broadcasting Corporation in the Alexandria, Virginia, Heath/Zenith store and watched while she issued orders to the computer in her best BBC broadcaster's voice. A square on the screen followed her commands. "Up, down, left, right, stop," she said. The square on the screen went up, down, left, right, and stopped. "Exit," she said. A menu returned to the screen.

A few minutes later, I gave the same

continued

commands in a mixture of Russian and Spanish, both tinged with a faint hint of Virginia. The square on the screen followed my every order. Then Jan's orders turned to controlling applications on the screen, and finally running the robotic arm. The computer performed without a hitch.

The Sum of Its Parts

The Heath/Zenith-Prab collaboration succeeds where other systems have failed because of the attention that both companies pay to details when it comes to integration. It's clear from the results that a considerable amount of testing has gone into the design and assembly of this product. In short, it works well, even for users unfamiliar with it, such as Jan Ziff and me. We were able to train it to our voices and start work in minutes.

It helps that the components that make up the workstation are carefully crafted to work together. The Zenith Z-286 LP is a fast, 80286-based IBM PC AT-compatible computer. It supports Zenith's superb FTM monitor, an important asset for users who won't be able to adjust the tilt to avoid glare, since the FTM seems impervious to glare. Installed in the computer is Prab's telephone controller, and Prab's keyboard is attached.

The keyboard contains the voice-recognition system, which processes the commands before they ever get to the computer. The keyboard sends what appears to the computer to be a series of keystrokes. This is important because it means that modifications to the computer were not required to support voice recognition. Instead, another computer in the keyboard handles the voice. The Prab keyboard can recognize about 160 words. Those words can stand for individual keystrokes or for macros that can consist of hundreds of keystrokes.

The macro capability means that complex commands can be developed using only a word or two. According to Prab CEO Walter Weisel, users can run Lotus 1-2-3 faster with voice commands than with a keyboard. Weisel said that workers at Prab are able to run AutoCAD and make complex drawings using a collection of only 130 words.

Training the voice-recognition system takes only minutes. The training program takes you through the basics of the keyboard, asking you to pronounce each word displayed. After you've done this two or three times, the software decides that you are trained and stores the vocabulary on the hard disk drive. From that point on, you can operate the computer entirely by voice.

ITEMS DISCUSSED

Prab Voice Command I .. \$49,500
Heath/Zenith
Prab Command
5140 Sprinkle Rd.
Kalamazoo, MI 49002
(616) 383-4400
Inquiry 1079.

Voice Command II \$21,900
Heath/Zenith
P.O. Box 377
St. Joseph, MI 49085
(616) 982-3341
Inquiry 1078.

Independence

There's more to independence than running a computer, whether you're in an office or at home. For this reason, the package includes a phone management system that lets the user make or receive calls. Like the rest of the workstation, it operates under voice control.

I watched as Heath Area Manager Bob O'Neill spoke the instructions to make a phone call. "Special down," he said into his headset. The menu bar on the main menu moved down one place. "Down," he said again, and "return." The menu bar moved down another place, and then the Telephone Management choice was selected. "Return," he said again. The computer asked what number was to be dialed. "Digit one six one six three eight three four four zero zero, return," O'Neill said. The computer dialed the number for Prab Command.

In addition to allowing voice communications, the telephone-control system allows the computer to have modem communications. The operator can communicate with a mainframe to perform file transfers with other computers. According to Weisel, many users have taken advantage of this capability to trade voice-control macros and robotic-arm routines.

The workstation also contains an environmental controller that lets the operator control up to 250 X-10 devices. This gives users the capability to control lighting, appliances, and other electronic equipment. As a result, an assistant is much less necessary.

Modularity

The Heath/Zenith-Prab workstation is designed to be installed in the workplace in modules. A basic version, called the Voice Command II (\$21,900), is available that has everything except the robotic arm, the laser printer, and the furniture. These items can be added later.

The furniture is an integral part of the design. It is built to exacting specifications so that every installation is the same. This is important, because users have indicated that they want to trade programming routines for the arm, and for this to work, everything needs to be in the same place. The workstation is mounted in a cubicle that is designed for wheelchair access. The desk height can be changed to meet the user's needs, and additional items, including refrigerators and microwave ovens, can be added.

Good Business

For the first time, a business no longer needs to be concerned with how it will make provisions for the requirements of a physically challenged employee. The Voice Command workstations enable such an employee to have the same capabilities and productivity as any other employee.

More important, these workstations do not require a massive infusion of capital costs or staff time to implement. They are provided off the shelf in a standard configuration. A business need only purchase the product. This finally places computing for the physically challenged employee within the means of most businesses.

Heath/Zenith eases the transition by providing both installation and training, which will include orienting the employee to the use of the equipment and training the workstation on the voice of the employee. Zenith has added to this package by providing reasonably priced leasing, bringing the workstation into a cost range that individuals can afford.

This product is clearly in the right place at the right time. The shortage of skilled employees has become critical. The government has mandated provisions for the handicapped. Heath/Zenith and Prab Command have provided the best answer so far.

There is, of course, one other reason. This is the best chance we've had for those we have left behind to be allowed to catch up. ■

Wayne Rash Jr. is a contributing editor for BYTE and a member of the professional staff of American Management Systems, Inc. (Arlington, VA). He consults with the federal government on microcomputers and communications. You can contact him on BIX as "waynerash," or in the to.wayne conference.

Your questions and comments are welcome. Write to: Editor, BYTE, One Phoenix Mill Lane, Peterborough, NH 03458.

FINALLY. A debugging tool tough enough to handle the DOS Nasties.

New Version 2.0

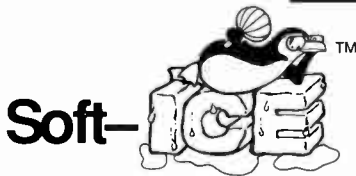

Nasty over-write? No sweat!

Soft-ICE memory range break points help you track down memory over-write problems whether you are doing the over-writing or another program is over-writing you.

Hung program? No problem!

When the system hangs, you now have hope. With Soft-ICE you can break out of hung programs no matter how bad the system has been trashed. And with Soft-ICE's back trace ranges you can re-play the instructions that led up to the crash.

Program too large? Not with Soft-ICE!

Soft-ICE runs entirely in extended memory. This means you can debug even the largest DOS programs. And since your program runs at the same address whether Soft-ICE is loaded or not you can find those subtle bugs that change when the starting address of your code changes.

System debugging? Soft-ICE is a natural!

Soft-ICE is ideal for full source level debugging of TSRs, interrupt service routines, self booting programs, DOS loadable device drivers, real-time kernels, non-DOS O/Ss and ROMs. Soft-ICE can even debug within DOS & BIOS.



How Soft-ICE Works

Soft-ICE uses the power of the 80386 to surround your program in a virtual machine.

This gives you complete control of the DOS environment, while Soft-ICE runs safely in protected mode. Soft-ICE uses the 80386 to provide real-time break points on memory locations, memory ranges, execution, I/O ports, hardware & software interrupts. With Soft-ICE you get all the speed and power of a hardware-assisted debugger at a software price.

Don't want to switch debuggers?

You don't have to!

Soft-ICE can run stand-alone or it can add its powerful break points to the debugger you already use. Use your favorite debugger until you require Soft-ICE. Simply pop up the Soft-ICE window to set powerful real-time break points. When a break point is reached, your debugger will be activated automatically.

MagicCV with Soft-ICE

Using Soft-ICE with CodeView gives you the features necessary for professional level systems debugging. MagicCV and Soft-ICE can work in concert with CodeView to provide the most powerful debugging platform you will find anywhere.

"These may be the only two products I've seen in the last two or three years that exceeded my wildest expectations for power, compatibility and ease-of-use."

—Paul Mace
Paul Mace Software

Soft-ICE	\$386
MagicCV	\$199
MagicCV for Windows	\$199
Buy Soft-ICE & MagicCV(W)	—Save \$86.
Buy MagicCV and MagicCVW	—Save \$100.
Buy All 3	—Save \$186.

30 day money-back guarantee
Visa, MasterCard and
AmEx accepted



New Soft-ICE 2.0 features

- Back Trace Ranges
- Symbolic & Source level debugging
- EMS 4.0 support with special EMS debugging commands
- Windowed user interface

 **Nu-Mega**
TECHNOLOGIES

CALL TODAY (603) 888-2386
or FAX (603) 888-2465

RUN CODEVIEW IN 8K MagicCV



CodeView is a great integrated debugger, but it uses over 200K of conventional memory. MagicCV uses advanced features of the 80386 to load CodeView and symbols in extended memory. This allows MagicCV to run CodeView in less than 8K of conventional memory on your 80386 PC.

NEW—Version 2.0 includes EMS 4.0 driver.
Attention Windows Developers!
Version available for CVW.

P.O. BOX 7607 ■ NASHUA, NH ■ 03060-7607

YOUR CHARGE CARD IS WELCOME

EXECUTIVE PHOTO & SUPPLY CORP.

HOURS: Mon. Tru. Thurs. 9AM TILL 6PM, Fri. 9AM TILL 2:00PM, Sun. 9:30AM TILL 5PM, Closed On Sat.

FOR COMPUTER & ACCESSORIES

CALL TOLL FREE: 1-800-882-2802

FOR FAX, TYPEWRITERS & DICTATION EQUIPT.

CALL TOLL FREE: 1-800-223-7323

IN N.Y. STATE CALL: 1-212-947-5290

LAPTOPS



EPSON
Equity LT-286e
12MHz 80C286, 1MB RAM,
20MB *POP OUT* Hard Drive,
"PAPER WHITE" Display
2879.75

New! Equity LT-286e w/40MB .3119.75
Equity LT w/20MB Hard Drive . . . CALL
SPARK by Datavue
Spark-EL, 640K, 2-3.5 Drives . . . 1059.00
Spark-EL w/20MB . . . 1789.00

MITSUBISHI

288L w/40MB Hard Drive . . . 2269.00
289L w/40MB Hard Drive . . . 2749.00

SHARP

PC-4502 w/640K, 2-Floppy Drives & Backlit Monitor . . . 894.75

TOSHIBA (sold in store only)
T-1000 . . . CALL T-1200HB . . . CALL
T-1800 . . . CALL

New! T-1600 w/40MB . . . CALL
New! T-3100e w/40MB . . . CALL
New! T-3200SX . . . CALL

ZENITH

184-1 . . . 1292.75 184-2 . . . 1969.75
Supersport 286 Model 20 w/20MB Hard Drive . . . 2359.75
286 w/40MB Hard Drive . . . 2839.75

NEC

ULTRALIGHT 2MB . . . 1979.75
PROSPEED 286 w/40MB . . . CALL

BONDWELL

Bondwell Laptop 286, 10MHz, 20MB Hard Drive w/1200 Modem, Rechargeable Battery & Case . . . 2119.00

DESKTOPS



COMPAQ
New! DESKPRO 286e, 12MHz, 1.2 Floppy Drive, 40MB Hard Drive w/VGA .2349.00
COMPAQ SLT . . . CALL



AST
AST PREMIUM 286
10 MHz, 512K, 1.2 Floppy Drive, Seagate 40MB Hard Drive (28ms)
1578.75

New! AST BRAVO 288 8 MHz, 1.2 Floppy, 40MB Hard Drive (28ms) . . . 1198.75
EPSON
New! EQUITY 386SX, 1-1.44 Floppy Disk Drive . . . CALL

COMPATIBLES

IBM-XT Compatible, 1-360 Floppy Drive, 1-20MB Hard Drive . . . 899.95
IBM-AT Compatible, 12MHz, 512K, 1.2 Floppy Drive, Seagate 40MB Hard Drive (28ms) . . . 1114.75
VENDEX Headstart III System w/VGA Color Monitor . . . 2349.75
PACKARD BELL Computers . . . CALL

Laptop Accessories

WORLD PORT 2400 Modem . . . 235.00
PACIFIC RIM 5 1/4 External Drive . . . CALL

PRINTERS

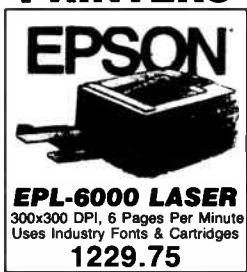

EPSON
EPL-6000 LASER
300x300 DPI, 6 Pages Per Minute
Uses Industry Fonts & Cartridges
1229.75

LX-610 . . . 187.95 LQ-510 . . . CALL
LQ-850 . . . 543.50 LQ-950 . . . 542.50
LQ-1050 . . . 787.95 LQ-2550 . . . 959.99
FX-850 . . . 352.00 FX-1050 . . . 469.75

PANASONIC

KX-P 1181 175.75 KX-P 1191 . . . CALL
KX-P 1124 . . . 279.95
KX-P 1595 . . . 415.75
PANASONIC Laser Printer . . . 1319.00

CANON

BJ-130 . . . 735.00
LB8-3 Laser . . . 1649.00

NEC

New! 2200XE . . . CALL
FS200 . . . 493.95 PS300 . . . 648.95
LD-890XL Postscript Laser . . . CALL

OKIDATA

OKIDATA 182 Turbo . . . CALL
OKIDATA 183 Wide Carriage . . . 217.75
OKIDATA 294 400cps, Wide Carr. 449.00
New! OKIDATA 380 . . . 357.75

PRINTER SALE!

STAR NX-1000 . . . CALL
New! DIXON 150 Plus Printer . . . 309.75
New! H.P. Deskjet Plus . . . 689.90
H.P. Laserjet II w/Toner . . . CALL
New! H.P. Laserjet IIP . . . CALL
APPLE Imagewriter II . . . 439.00

SOFTWARE

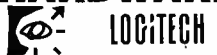

LOGITECH

New! Logitech Bus Mouse . . . 69.99
New! Logitech Serial Mouse . . . 59.75
Logitech Scanman Plus . . . 168.75
INTEC 80387-SX . . . 289.75
INTEC 80387-20 . . . 369.99
DFI HS-3000 Plus Scanner . . . 164.75
AST 6-Pack 286 . . . CALL
MICROSOFT Mach 20 . . . 314.75
New! MICROSOFT Mouse . . . 99.95
PLUS 20MB Card . . . 623.75
TOSHIBA 3 1/2" 720K Drive w/Kit . . . 79.75

Display Cards & Monitors

PARADISE VGA Plus . . . 172.95
PARADISE VGA Plus 16 . . . 229.89
PARADISE VGA Professional . . . 289.75
ATI VGA Wonder 512K . . . 299.00
VEGA V-Ram VGA 256K . . . 329.00
VEGA VGA . . . 199.00
MITSUBISHI Monitors . . . CALL
New! NEC Multisync IIA Monitor . . . 496.75
NEC Multisync 3D . . . 599.00
New! NEC Multisync 5D . . . 2389.00
PACKARD BELL Monitors . . . CALL
SONY 1302 Monitor w/Stand . . . 599.00
SONY 1304 Multiscan Monitor . . . 669.00

Modems/Fax Cards

HAYES 1200 Modem External . . . 258.75
EVEREX Fax/Modem . . . 299.00
QUADRAM Jit Fax Portable . . . 328.75

PRINTER RIBBONS

OKIDATA 292 Ribbon . . . 5.49
STAR NX-10 Ribbon . . . 2.59
NEC P7/P3 Ribbon . . . 4.59

DISKETTES

BONUS 5 1/4 DS/DD . . . 4.99
MAXELL Diskettes . . . CALL

FAX MACHINES



PANAFAX

UF-135 . . . CALL UF-140 . . . CALL
UF-145 . . . CALL UF-155-IN STOCK
UF-250-IN STOCK UF-280-IN STOCK

SHARP

FO-220 . . . CALL FO-300 . . . CALL
FO-330 . . . CALL FO-510 . . . CALL
FO-550 . . . CALL FO-700 . . . CALL

Canon FAXPHONE

FaxPhone 8 . . . CALL FaxPhone 15 . . . CALL
FaxPhone 20 . . . CALL FaxPhone 23 . . . CALL
FaxPhone 25 . . . CALL FaxPhone 35 . . . CALL
FAX 225 . . . CALL FAX 270 . . . CALL
FAX 350 . . . CALL FAX 450 . . . CALL
FAX 630 . . . CALL FAX 705 . . . CALL

RICOH

FAX-25E . . . CALL FAX-35 . . . CALL
FAX-65E . . . CALL FAX-75E . . . CALL

MURATA

M-900 . . . CALL M-1200 . . . 529.90
M-1400 . . . CALL M-1800 . . . CALL

PANASONIC

KX-F 80 . . . CALL KX-F 100 . . . CALL
KX-F 120 . . . CALL KX-F 220 . . . CALL
KX-F 320 . . . CALL

TOSHIBA Price Break
3300 . . . CALL KX 3700 . . . CALL
Model 30100 . . . CALL

BROTHER

FAX 200 . . . CALL
FAX 210 w/Answering Machine . . . CALL

FAX PAPER

8 1/2"x9 1/2" . . . 49.95 8 1/2"x16 1/2" . . . 59.90
8 1/2"x32 1/2" . . . 74.95
FAX Cleaning Kit . . . 29.95

TYPEWRITERS & Word Processors



SMITH CORONAR

WORD PROCESSORS
PWP-2000 . . . CALL PWP-3000 . . . CALL
PWP-5000 . . . CALL PWP-100C . . . CALL
PWP-7000LT Laptop . . . CALL

TYPEWRITERS

XL-1500 . . . CALL XL-4500 . . . CALL
XD-5800 . . . CALL XD-7600 . . . CALL

WP & Typewriter Access.

PWP Start-Rite Kit . . . 39.95
Typewriter Start-Rite Kit . . . 39.95
Printwheels . . . ea. 10.95
Multi Strike Film . . . Dz. 74.95
Correctable Film . . . Dz. 34.95
Lift-Off Correcting Cassette . . . Dz. 44.95
Cover-Up Correcting Cassette . . . Dz. 46.95
Data-Disks . . . Dz. 34.95
CoronaCalc . . . 44.95
Sheet Feeder 1/PWP-5000 . . . 139.90

Panasonic

KX-W1000 Word Processor . . . CALL
KX-W1500 Word Processor . . . IN STOCK
KX-W1510 WP w/Sheetfeeder . . . CALL
KX-R430 . . . CALL KX-R440 . . . CALL
KX-R800 Word Processor Typewriter . . . CALL
Accessories . . . CALL

brother

WP-65 Word Processor . . . CALL
WP-75 Word Processor . . . CALL
WP-90 Word Processor . . . CALL
AX-26 . . . CALL AX-28 . . . CALL
Accessories . . . CALL

Dictation Equipment



OLYMPUS Pearlcoorder

L-200 . . . 129.90 S-907 . . . 35.90
S-911 . . . 59.90 S-930 . . . 99.90
T-1010 Transcriber . . . 169.90
S-904 . . . 119.95 S-911 . . . CALL
T-100 . . . CALL T-2020 . . . CALL

PANASONIC

RN-15 . . . 119.90 RN-36 . . . 179.90
RN-89 . . . 79.90 RN-105D . . . 29.90
RN-106D . . . 34.95 RN-115D . . . 39.90
RN-125 . . . 59.90 RR-90 . . . 179.90
RR-970 . . . 249.90 RR-980 . . . 279.90

SANYO

TRC-6100 . . . CALL TRC-5680 . . . 79.90
TRC-2550 . . . 149.90
TRC-5200 . . . 229.90 TRC-5020 . . . 179.90
TRC-4300 . . . 227.90 TRC-4030 . . . 179.90
TRC-8000A . . . 227.90 TRC-8010A . . . 185.90
TRC-6700 . . . 239.90 TRC-8070 . . . 185.90
TRC-9100 . . . 239.90 TRC-9010 . . . 199.90

SONY

M-100B . . . 219.90 M-740 . . . 35.90
M-750V . . . 49.90 TCN-5000EV . . . 369.90
BM-12 . . . CALL BM-17 . . . CALL
BM-560 . . . CALL BI-500 . . . CALL
BM-75 . . . CALL BM-80 . . . CALL
BM-615T . . . CALL BM-820 . . . CALL

NORELCO

585 . . . 99.90 592 . . . 119.90
NT-ile . . . 134.95 NT-V . . . 199.95
NT-VI . . . 219.90 NT-VII . . . 247.90
MC-III . . . 164.95 MC-IV . . . 199.95
2595 . . . 119.90
205 . . . 287.90 505 . . . 319.90
510 . . . 399.90 805 . . . 629.90
MC-3000 . . . 299.90 MC-4000 . . . 379.90
2505 . . . 399.90 2510 . . . 334.95

COPIERS



Canon (PC)

PC-3 II . . . 359.90 PC-5 II . . . 453.90
PC-5L II Legal Size . . . 619.90
PC-6 . . . 779.90 PC-6RE . . . 859.90
NEW! PC-7 Zoom Copier . . . CALL
Black Cartridges . . . 79.95
8 1/2"x11 Paper (5000 sheets) . . . 49.50

CALCULATORS & DATABANKS



HEWLETT PACKARD

HP-10B Business . . . 38.45
HP-12C Financial . . . 59.90
HP-14B Business . . . 59.90
HP-17B Business . . . 75.90
HP-19B Business Consultant II . . . 125.90
HP-20S Scientific . . . 39.90
HP-22S Algebraic Scientific . . . 43.90
HP-27S Scientific . . . 74.95
HP-28S Advanced Scientific . . . 162.90
HP-32S RPN Scientific . . . 52.95
HP-41CV . . . 119.90 HP-41CX . . . 189.95
HP-42S RPN Scientific . . . 88.90
HP Infrared Printer . . . 99.90

ORGANISER II-XP

198.90

SHARP

OZ-7000 WIZARD . . . IN STOCK
WIZARD Accessories . . . CALL
EL-8230 Auto Dialer . . . 39.90
EL-8250H Dial Master . . . 53.90

CASIO

SF-4000 32K Digital Diary . . . 89.90
SF-7000 B.O.S.S. 32K Digital Diary 179.90
SF-7500 B.O.S.S. 64K Digital Diary 189.90
SF-8000 B.O.S.S. 64K Digital Diary 199.90
FC-1000 Financial Consultant . . . CALL

TELEPHONES

Panasonic Feature Telephones

KX-T 2335 32.90 KX-T 2356 49.90
KX-T 2365 55.90 KX-T 2366 59.95

Multi-Line Phones

KX-T 3122 56.90 KX-T 3145 67.90
KX-T 3155 75.90 KX-T 3170 139.90

KX-T 2385D 85.90 KX-T 2390 79.90
KX-T 2630 107.90 KX-T 2634 134.90
KX-T 2429 135.90 KX-T 2430 108.90

Answering Machines Specials

KX-T 1000 45.90 KX-T 1418 69.90
KX-T 1450 59.90 KX-T 1455 85.90
KX-T 1460 79.90 KX-T 1470 99.95
KX-T 1624 78.90 KX-T 1740 109.90

CORDLESS PHONES

KX-T 3000 119.90 KX-T 3807 59.90
KX-T 3823 70.90 KX-T 3824 89.90
KX-T 3832 93.90 KX-T 3880 125.90
KX-T 3900 w/2-Keypads . . . 123.90
KX-T 4200 w/Answering Machine . . . 145.90

Freedom Phone

FF-1700 Cordless "Top Rated" 109.90

Business Key Systems

PANASONIC

2 Line Integrated Intercom System
VA-9200 System (1-9210, 2-9230) 389.90
VA-9210 Electronic Controller . . . 124.90
VA-9230 2 Line Phone w/Speaker 124.90

VA-614 4-Line System

VA-61410 Key Service Unit . . . CALL
VA-61421 Phone w/Speakerphone . . . CALL
VA-61422 Speakerphone w/LCD . . . CALL
VA-61423 Speakerphone w/BLF . . . CALL

VA-208 2-Line System

VA-20810 Key System Unit . . . CALL
VA-20821 Phone w/Speaker . . . CALL
KX-T616 6-Line System . . . CALL
KX-T6160 Phone w/Speaker . . . CALL
KX-T61630 Speakerphone w/LCD . . . CALL

FREEDOM PHONE

FS-246 6-Line Service Unit . . . CALL
FS-600 Basic Station . . . CALL
FS-900 Executive Station . . . CALL

VISA, MASTERCARD, AMERICAN EXPRESS, OPTIMA & DISCOVER CARDS ACCEPTED

OUR GUARANTEE: Defective goods will be replaced or repaired if returned within 10 Days in original packing, mint condition, blank warranty card, detailed letter of explanation & copy of invoice. No return privilege on software. If found defective, we will advise customer how to consult manufacturer for warranty service. For Customer Service: Please Call (212) 947-5295. Prices are for Mail Order Only. Store Prices May Vary. We reserve the right to limit quantities.

TO ORDER by MAIL: Please send money order or certified check for UPS shipment on most items. Personal check delays your order by 15 days.
Shipping & Handling: Handling Charge; 2% plus 5.95. Shipping Charge; 0.85 per lb. Estimate minimum shipping 5.95. Total charge at time of order. Shipping & Handling charges are not refundable.

INQUIRE about NEXT DAY AIR or 2ND DAY AIR Shipment. N.Y. State Residents add TAX.



EXECUTIVE PHOTO & SUPPLY CORP.

MAIL ORDER: Dept BY 120 West 31st Street, N.Y., N.Y. 10001 (Tel. 1-212-947-5290)
MANHATTAN STORE: 120 West 31st Street, N.Y., N.Y. 10001 (Tel. 1-212-564-3592)
SCARSDALE, NY STORE: 455 Central Ave. (Scarsdale Plaza) SCARSDALE, N.Y. 10538 (Tel. 1-914-723-1331)
N.Y.C. Consumer Affairs License Number: 800193
Circle 125 on Reader Service Card



OS/2 MULTITASKING REVISITED

A simple program that lets you experiment with the priority mechanism

Last month, I looked at how OS/2 manages multitasking, explained that programs get CPU time based on a two-level priority system consisting of *classes* and *deltas*, and mentioned that programs can set their own priorities. This month, I'll examine a simple OS/2 program that can be used to explore how OS/2 divides up time between processes.

When OS/2 came out, Rob Oreglia and I wrote the original version of the programs shown in listings 1 and 2. Listing 1 loads two child programs into the system, sets their priorities to whatever the user wants them to be, and lets them run for a while. When the child programs are done executing, they report what got done. The program with the higher priority should get more CPU time and therefore should get more done.

The main program, called PARENT, takes five parameters:

```
PARENT class1 delta1
class2 delta2 time
```

where *class1* and *delta1* refer to the desired priority class and delta for the first child program, *class2* and *delta2* refer to the same for the second child program, and *time* indicates how long to run the test. For example, executing

```
PARENT 2 0 1 31 30
```

would run the program for 30 seconds, setting the priority class (class is more important than delta, recall) of the first child program to 2 and the delta of that program to 0. The second child would get a class and delta of 1 and +31, re-

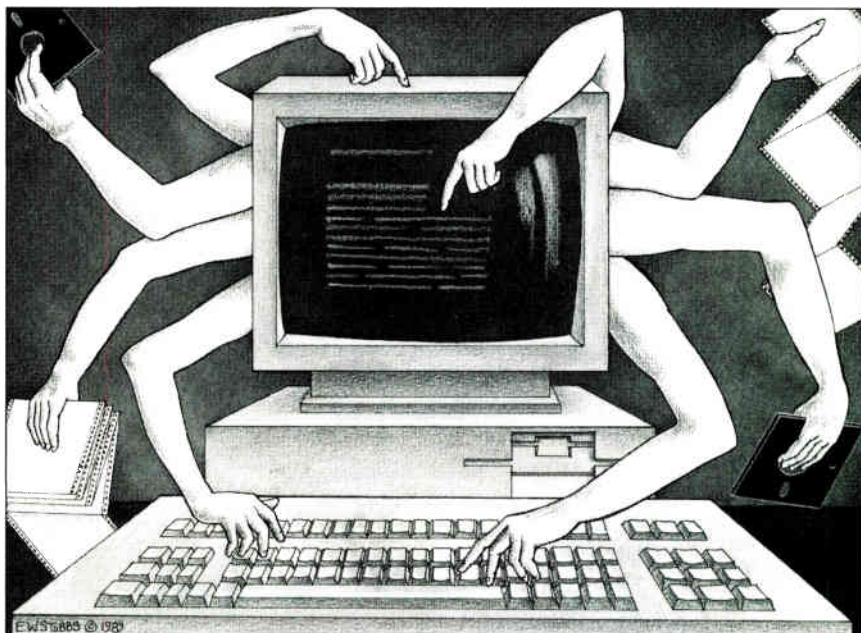

spectively. The effect of this would be to run the first program at a higher priority than the second. Both programs would run, although the second would end up getting practically no CPU time. Remember that class 1 jobs always yield to class 2 jobs regardless of the deltas. A sample run might look like this:

```
Child 1: class=2 delta=0
Child 2: class=1 delta=31
Child 1 Executed with
return code=0 PID=178
Child 2 Executed with
return code=0 PID=179
```

```
Child 1 completed
100,486 iterations.
Child 2 completed 965
iterations.
```

The program echoes back what we've told it to do, reports that both children were successfully launched (return code=0), and reports their process IDs

(PIDs). Every program started under OS/2 has a unique PID. This is necessary because you must have a program's PID to do anything to it (e.g., terminating it or changing its priority). You can't request to change the priority of, say, 123.EXE; you have to know its PID, and the PID varies from run to run.

The children then report how much work they got done (i.e., how many iterations they completed). Child 1, with the higher priority, got over 100,000 iterations done. Child 2 got only a small amount of time, finishing fewer than 1000 iterations.

You can use this program to compare different classes (1=low, 3=high) and deltas (-31 to +31). Some results for a 10-MHz zero-wait-state 80286 are found in table 1. I used *priority=dynamic*, *maxwait=1*, and *timeslice=256* in my CONFIG.SYS file under IBM OS/2 1.1.

How does it do it, and how can you run it on your system? You need just two

continued

things: OS/2 and Microsoft's C Compiler 5.1. (If you haven't got that, the PARENT.EXE file is also available on BYTenet or BIX.) Compiling the program is a piece of cake. You need the source code for the following programs: PARENT.C (listing 1), CHILD1.C (listing 2), and CHILD2.C. (CHILD2.C is

not listed because the only difference between CHILD1 and CHILD2 is the message, "Child 1 [or 2] completed XXXXX iterations.")

When you installed the C Compiler 5.1, it asked you what subdirectory to put source code in; just put the three C programs there. Then compile them by typ-

ing `cl parent.c, cl child1.c, and cl child2.c`—no compiler switches are needed. Then you can run PARENT directly. If you type the source code in directly, be aware that case is important: `DosSleep(1000L)` will work fine, but `DOSSLEEP(1000L)` will not.

Lines 1 and 2 of PARENT.C obtain access to OS/2 header files and kernel functions. I'll be using kernel functions to start and control the child programs. Lines 4 through 7 are a C start-up boilerplate. Lines 8 through 11 define the variables. Two types are not standard C: `RESULTCODES` and `HSYSSEM`.

`RESULTCODES` is a 2-byte structure that receives the PID and returns code for a child process. When PARENT starts CHILD1, PARENT gets back the PID and (eventually) the return code for CHILD1. Ditto for CHILD2, so there are two structures. `HSYSSEM` is a system-defined type for *semaphore handles*. I'll get to them in a minute.

Lines 13 through 30 check that the user supplied the proper number of inputs. Lines 31 to 39 load these inputs into variables and report back to the user.

Next comes some code referring to the semaphores. Semaphores are flags used to control the execution of the children. Using a semaphore involves a semaphore handle. PARENT will create and take control of two semaphores that are called start and stop. (I could call them anything, but start and stop seem most descriptive.)

The children are then programmed to look for these semaphores. The way it works is simple: PARENT creates the semaphores and sets them, in lines 40 through 48. Notice that they're declared `\\sem\\start` and `\\sem\\stop`—all semaphore names must look as if they were filenames within a subdirectory named `sem\`. The `\\` instead of `\` makes C happy.

Now that the semaphores are created and set, it's time for the children. The children start up (lines 49 through 61 in listing 1 start the children) and first look to see if the start semaphore is set. Take a look at listing 2. Lines 11 and 12 in CHILD1.C open the semaphores, and line 16 waits for start to be cleared by the parent. PARENT clears that semaphore in line 64 of listing 1.

The children don't start counting how much time they get until start has been cleared, or unset. Then they count (lines 20 through 23 in listing 2) until stop is cleared. Meanwhile, remember the user-specified parameter `time`? In line 68, PARENT waits that many seconds before

continued

Listing 1: PARENT.C, the main program.

```

1 #define INCL_DOS
2 #include <os2.h>
3
4 main(argc,argv)
5 int argc;
6 char * argv[];
7 {
8     RESULTCODES child_pid1, child_pid2;
9     int rc,duration,cpd1,cpd2;
10    unsigned xypriority,procid,cpl1,cpl2;
11    HSYSSEM stophandle,strthandle;
12
13    /* argument list:
14       1st = priority level child 1
15       2nd = priority delta child 1
16       3rd = priority level child 2
17       4th = priority delta child 2
18       5th = run time in seconds
19    */
20
21    if (argc != 6) {
22        printf("This requires five arguments, all integers.\n");
23        printf("First two are child process 1 priority class and");
24        printf(" delta.\n");
25        printf("third and fourth are priority class and delta for");
26        printf(" proc 2.\n");
27        printf("fifth is run duration in seconds.\n\n");
28        DosExit(1,255);
29    }
30
31    cpl1= atoi(argv[1]);
32    cpd1= atoi(argv[2]);
33    cpl2= atoi(argv[3]);
34    cpd2= atoi(argv[4]);
35    duration = atoi(argv[5]);
36    printf("Test will run for %d seconds.\n",duration);
37    printf("Child 1: class=%d delta=%d\nChild 2: class=%d delta=%d\n",
38           cpl1,cpd1,cpl2,cpd2);
39
40    /* Now create, open, and set semaphores so children know when to stop */
41
42    rc=DosCreateSem(1,&strthandle,"\\sem\\start");
43    rc=DosOpenSem(&strthandle,"\\sem\\start");
44    rc=DosSemSet(strthandle);
45    rc=DosCreateSem(1,&stophandle,"\\sem\\stop");
46    rc=DosOpenSem(&stophandle,"\\sem\\stop");
47    rc=DosSemSet(stophandle);
48
49    /* Start the children */
50
51    rc=DosExecPgm((char *)0, 0, 2, (char *)0, (char *)0, &child_pid1,
52                "child1.exe");
53    rc=DosSetPrty(0,cpl1,cpd1,child_pid1.codeTerminate);
54    printf("Child 1 Executed with return code=%d
55           PID=%d\n",rc,child_pid1.codeTerminate);
56    rc=DosExecPgm((char *)0, 0, 2, (char *)0, (char *)0, &child_pid2,
57                "child2.exe");
58    rc=DosSetPrty(0,cpl2,cpd2,child_pid2.codeTerminate);
59    printf("Child 2 Executed with return code=%d PID=%d\n",
60           rc,child_pid2.codeTerminate);
61
62    /* Clear "start" semaphore so that the children can run */
63
64    rc=DosSemClear(strthandle);
65
66    /* Wait for prearranged time */
67
68    DosSleep(duration * 1000L);
69
70    /* Clear the "stop" semaphore so that the children will stop */
71
72    rc=DosSemClear(stophandle);
73
74 }

```

AW... What the Heck!

We REFUSE to Raise Our Prices!

DesignCAD 3D \$ 399

WE REFUSE TO RAISE PRICES!

We have dealers—even from foreign countries—call and tell us they could sell a lot more DesignCAD 3D at higher prices because some of their customers can't conceive a true 3D solid modeling program costing only \$399. They ask us to raise our prices because they know it's worth more, much more. But look at the history of our company: We just don't believe in inflated prices! An excellent CAD system shouldn't cost any more than a good word processor. So we still say, "Aw...What the heck! We refuse to raise our prices! Let's see the other guys beat this deal!"

WHY BUY THIS ONE?

There is a very important reason to buy DesignCAD 3D other than price: PERFORMANCE. DesignCAD 3D provides complete 3-Dimensional drawing capabilities. It's not a "warmed-over" 2D program. DesignCAD 3D allows you to draw any entity in 3-D space. This means, for example, that you can draw a curve in the shape of a spring. You can draw a circle or arc at ANY angle on ANY plane.

DesignCAD 3-D gives your Personal Computer the power of a mainframe CAD system! With DesignCAD 3-D, you can produce complete 3-dimensional models and drawings that were once considered impossible on a microcomputer!

Complete 3-Dimensional design features make it easy for you to construct realistic 3-D models. With full solid-object modeling capabilities you can analyze your drawing to determine the volume, surface area or even center of gravity! DesignCAD 3-D even permits you to check for interference between objects! Aeronautical Engineers can now find the center of gravity for a new airplane design with a couple of keystrokes. The Architect can determine the surface area of a roof for decking in a matter of minutes. The Civil Engineer can calculate the volume of a lake or dam in seconds. The Mechanical Engineer will know for sure if certain parts fit together without interference. The uses for DesignCAD 3-D are only limited by YOUR imagination!

DesignCAD 3-D supports more than 400 different peripheral devices, including more than 250 printers (dot-matrix, laser printers, color printers, etc.), 80 plotters, most mice and digitizing tablets, and a wide variety of graphics cards and displays.

Once again, American Small Business Computers has proved that you don't have to spend a lot of money to get quality software. DesignCAD 3-D provides features such as Shading, Solid Object Modeling, Hidden Line Removal, and Cross Sectioning capability. All for only \$399. No other 3-Dimensional CAD system can come close to providing the price/performance of DesignCAD 3D.

VERY EASY TO USE!

DesignCAD 3-D has consistently proven itself to be faster and easier to use than most competing CAD systems. In a national competition DesignCAD 3-D was matched in drawing speed by only one other CAD system. It cost \$3,000. DesignCAD 3-D was able to perform a given drawing in nearly half the time as packages costing up to \$5,000.

Customers frequently remark at how quickly they are able to learn DesignCAD. Many also comment about the power of DesignCAD.

Dr. Stephens of NASA states: "One of the things I like best [about DesignCAD 3D] is that I can pick it up and go with it." Dr. Stephens, who evaluates and recommends software for purchase by NASA, says software must meet certain criteria: "One, it must work. Two, it must be user friendly and easy to use. I push it [DesignCAD 3D] as far as I can push it. We're not using it as a toy down here, and I resent the fact that some people believe that a product's ability is substandard because of its price."

Jan Hallett, an engineer at Allied Chemical states: "We use it extensively here and are really sold on it. Plant layouts, pipe runs, fabrications, along with a lot of other things are drawn and designed. I've got AutoCAD, but very seldom if ever use it anymore."

VERY POWERFUL!

DesignCAD 3-D version 2.1 is as powerful as most CAD systems costing \$5000-\$10,000! Features like: Complex Extrusions, a true 3D color-coded cursor, full shading or rendering capability, Blending of Surfaces, Complex Sweeps and Translations, and Boolean Operations make DesignCAD 3-D one of the most powerful 3-D CAD systems available...at any price! Engineers, Architects, and Consultants constantly tell us that they use CAD systems costing thousands of dollars which are not as powerful as DesignCAD 3-D.

BYTE MAGAZINE SAYS...
"At \$399, DesignCAD 3D was the least expensive package we saw, yet it was one of the more powerful. ..Don't be fooled by the remarkably low price, this program can really perform!"

PC MAGAZINE SAYS...

DesignCAD 3D, the latest feature-packed, low-cost CADD package from American Small Business Computers, delivers more bang per buck than any of its low-cost competitors and threatens programs costing ten times as much. For a low-cost, self-contained 3D package... DesignCAD's range of features steals the show."

HOW DO I GET ONE?

DesignCAD 3-D and DesignCAD 2D are available from most retail computer stores, or you may order directly from us. If you have questions about which program to purchase please give us a call. All you need to run DesignCAD 3-D is an IBM PC or compatible computer with 640 K RAM memory and a hard disk. Both products support most graphics cards, printers, plotters and digitizers. Free Information and a demo disk are available.

Circle 21 on Reader Service Card

American
Small Business Computers, Inc.

327 South Mill Street
 Pryor, OK 74361
 (918) 825-4844 • FAX: (918) 825-6359

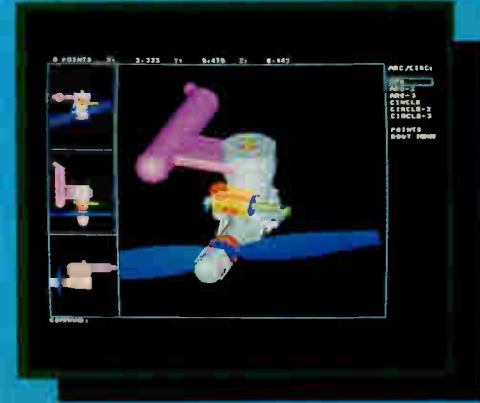
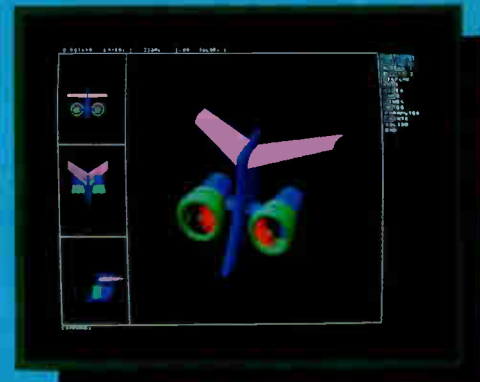

OS/2 *and* DOS? MultiBoot *still* is [^] the answer.

MultiBoot is the flexible, faster dual boot program for OS/2-DOS.

BYTE May 1989

OS/2 NOTEBOOK

Once you've spent thousands of dollars on OS/2 and an OS/2-ready work station, what's another \$49.95 to have easy access to DOS? Highly recommended.

-Mark Minasi

MultiBoot's easy access to both OS/2 and DOS saves time and aggravation.

Installs at any time.

Defaults to your preferred system.

Hot key to second system.

Can't be accidentally deleted.

TO ORDER:

Send \$49.95* + \$3.00 shipping and handling (check or money order) to:

MultiBoot, Bolt Systems, Inc.

4340 East-West Highway
Bethesda, Maryland 20814
or call 1-301-656-7133

FAX: 1-301-907-8736 to order by Visa/Mastercard. Specify 3.5" or 5.25" diskettes.

*Maryland residents add 5% sales tax. Ask about our volume discounts



Listing 2: CHILD.C, the subsidiary program.

```

1 #define INCL_DOS
2 #include <os2.h>
3
4 main()
5 {
6     long int iters;
7     HSYSEM stophandle, strthandle;
8
9     /* Set up semaphore */
10
11     DosOpenSem(&stophandle, "\\sem\\stop");
12     DosOpenSem(&strthandle, "\\sem\\start");
13
14     /* Wait for parent to say it's OK to run */
15
16     while (DosSemWait(strthandle, 0L) != 0);
17
18     /* Loop until semaphore clears */
19
20     iters = 0;
21     while (DosSemWait(stophandle, 0L) != 0) {
22         iters = iters + 1;
23     }
24     printf("\nChild 1 completed %ld iterations.\n", iters);
25
26 }
    
```

Table 1: Sample output from PARENT.EXE.

SAMPLE OUTPUT FROM PARENT.EXE

Child 1			Child 2		
Class	Delta	Iterations	Class	Delta	Iterations
2	0	50,496	2	0	51,222
1	0	50,507	1	0	50,027
1	0	0	2	0	101,838
2	0	29,415	2	1	75,707
2	0	28,437	2	31	74,799
1	31	30	2	-31	100,789

Note: All tests ran in 30 seconds on a 10-MHz zero-wait-state 80286 running IBM OS/2 1.1.

clearing the stop semaphore in line 72. Then everything should stop nicely.

Lines 51 and 52 start up the CHILD-1.EXE program. Programs start up other programs with DOSEXECPGM, a hook into OS/2 (these hooks are called application programmer interfaces). DOSEXECPGM has a number of parameters, but I'm interested in only the last two for now. The penultimate one, &child-pid1, points to where DOSEXECPGM can leave the RESULTCODES structure. The last parameter, child-1.exe, is the program to load and execute. Line 53 changes CHILD1's priority once the child's PID is safely in hand. Lines 54 and 55 report how the whole operation turned out. Lines 56 through 60 do the same for the second child.

OS/2 Tip of the Month: Uppercase CONFIG.SYS

This one is thanks to Doug Hamilton. Members of BIX's ibm.os2 conference

will often hear of strange results now and then from their OS/2s that can't be duplicated. One complains of format failures, another of crashed device drivers, and I experienced protection violations when XCOPYing in the background to a floppy disk. The answer was the same in all these cases: Make sure that your CONFIG.SYS entries are all in uppercase. I know, it's easier to read in lowercase, but apparently OS/2 doesn't think so. OS/2 1.2 will be out by the time you read this, and the problem may be fixed. But to be safe, use uppercase when possible. ■

Mark J. Minasi is a managing partner at Moulton, Minasi & Company, a Columbia, Maryland, firm specializing in technical seminars. He can be reached on BIX as "mjminasi."

Your questions and comments are welcome. Write to: Editor, BYTE, One Phoenix Mill Lane, Peterborough, NH 03458.

A TALE OF TWO OPERATING SYSTEMS



A cross-examination of the features of the up-and-coming Mac and IBM PC operating systems

When you are considering the purchase of a microcomputer these days, it's both the best of times and the worst of times. The best, because never before have you had so many choices: You can pick and choose from a variety of powerful computer systems—IBM PC or Macintosh—and at prices less than a king's ransom. But this is bad simply because of the many choices: You can wander off into a swamp of details and options and disappear without a trace.

This month, I'll try to sort out some of these details for you. Since much of how a computer functions depends largely on the capabilities of its operating system, I'll focus on that. Coming under my scrutiny will be OS/2, the PC's premier operating system, and Apple's Mac OS.

One reason for looking at the operating systems is that when it comes to someone actually using a microcomputer, factors other than million instructions per second, million floating-point operations per second, Whetstones, Dhrystones, and other performance desiderata come into play.

I have nothing against performance, mind you. I'll take a faster machine any day. But in terms of office productivity, more computing power isn't the answer if a clerk has to run several different programs to transfer data from a spreadsheet to a charting program and then transfer this image to a word processing document. Office workers may be able to get through this intricate chain faster, but



they have to know how to use each program first.

The Mac's big win here is that the office worker can simply cut and paste the chart from the charting application into the word processing document with just a few keystrokes. There's no need for format-translation programs or remembering special exceptions. You simply do it. You can concentrate on getting the job done, not fiddling with file formats in the computer. Isn't that what computers are supposed to do for you, anyway?

OS/2 is IBM and Microsoft's answer to the Mac. Although it can run existing DOS software in compatibility windows, OS/2 is a whole new system for 80286- and 80386-class PCs that includes graphical capabilities akin to those of the Mac through an interface called the Presentation Manager (PM).

Roots

The Mac OS is far older and far more advanced in its development than is OS/2

with PM. The Mac OS dates back to work done at Apple in 1980 and 1981. Preliminary efforts were implemented on the Lisa computer in 1983. The first released version of the Mac OS coincided with the introduction of the first Mac in January 1984. Thus, it's six years old.

OS/2 didn't get started by Microsoft and IBM until 1986, although it's based partially on the Xenix and Windows products that Microsoft has been selling since 1984 and 1987, respectively. The first release of OS/2 didn't hit the market until 1987, and the PM wasn't released until 1988.

Because of its development lead and the much larger user base it has enjoyed, the Mac OS is a more refined product. In fact, the difference between using any Mac and an IBM PS/2 running OS/2 with PM is striking. Whereas the Mac works slickly and smoothly in its basic operations (e.g., file copying, renaming, folder management, and file deletion),

continued

OS/2 does not. The Mac OS can run on machines with as little as 1 megabyte of RAM, although the new version, System 7.0, will require 2 megabytes. And it runs on all Macs, from the 68000-based Mac Plus, SE, and Portable on up to the 68030-based Mac IIci.

On a 1-megabyte Mac Plus, the current System (6.0.3) runs quite acceptably, even when you are using heavily graphics-intensive applications. A Mac Plus with a built-in high-resolution monochrome screen, an 800K-byte floppy disk drive, and an external 40-megabyte SCSI hard disk drive will set you back about \$1500 at the deepest discounts available. Mac System software is distributed free of charge through dealers (although special printed documentation can be purchased).

OS/2 is not so refined. It feels clunky, especially its graphics interface. OS/2 with PM won't run on any PC with less than 3 megabytes of memory. It also won't run on any PC, XT, or compatible that's based on the older Intel 8088 or 8086 CPUs. OS/2 needs an Intel 80286 CPU or higher in order to run. Although OS/2 will work on 80286-based PCs

The Mac OS
can run on machines
with as little as
1 megabyte of RAM.

(e.g., the AT) with enough memory, it runs sluggishly on these slower, older machines.

In all my testing, I haven't been satisfied with OS/2 on anything slower than a 16-MHz 80386-based PC. Such machinery doesn't come cheaply, especially when you throw in the 3 megabytes of RAM required, a 40-megabyte internal hard disk drive, a VGA, and a good monochrome monitor. Even if you put together the system yourself from discounted components, this minimally acceptable OS/2 box will cost well over \$3500. And that does not include the cost of OS/2 itself, which is not distributed as a free upgrade to DOS. OS/2 can cost

more than \$500, depending on versions and documentation.

Let's get real now: Some Mac applications require more than 1 megabyte of RAM, particularly those that use color. If you use MultiFinder, you need a minimum of 2 megabytes of RAM, and to have a decent working set of applications loaded, you'll easily need 4 megabytes or more. The same applies for OS/2: To handle a reasonable set of programs will require 5 megabytes of RAM. Fortunately for both camps, the price of RAM is coming down, but you still have to factor in this cost if you expect to get real work done with the computers.

How They Handle

What about performance and ease of use? The Mac OS is faster at the basics of file management than OS/2, because its interface is more intuitive and easier to learn. It's also easier to use, since its windowing interface is smoother and more refined. Apple's head start shows when you sit a Mac next to an OS/2 box and play with both. Start a program, do computer housekeeping (e.g., file copying or deleting, or directory changes),

Word Publishing...Word Processing &

DeScribe™-Word Publisher bridges the gulf between word processing and desktop publishing—the next generation word processor. DeScribe is the first WYSIWYG word processor for IBM's powerful OS/2 Presentation Manager. What's on the screen is what prints on the paper. And you control it all with a friendly point and click

DeScribe, Inc.

IBM® is a registered trademark and Operating System/2™, OS/2™, and Presentation Manager™ are trademarks of the International Business Machines Corporation. DeScribe™ is a trademark of DeScribe, Inc.

Circle 105 on Reader Service Card

World Radio History

cut and paste using the Clipboards, shift from program to program, and you'll see what I mean. While OS/2 is a huge improvement over DOS, it still feels like its interface and graphics were bolted on, rather than designed from the ground up.

To be honest, OS/2 has some facilities that even Apple's System 7.0 won't have. The most important of these is full, preemptive multitasking, which lets many programs run simultaneously (if you have enough memory), so you can switch between them transparently. This is in contrast to MultiFinder, which uses cooperative multitasking to support background processing. In other words, if the foreground task is idle (waiting on a keystroke, perhaps), a background application (say, a print spooler or a terminal application doing a long download) has use of the processor.

Since most people simply want to use multitasking to perform downloads or print in the background, the benefits of OS/2's multitasking are dubious. If your work really needs serious time-sliced, preemptive multitasking, you should consider Unix. Unix is 20 years old, which means that its multitasking kernel

has been beat on, debugged, and refined for a long time, and many of the graphical user interfaces that are being slapped on top of it today are no older or worse than OS/2's PM.

We use computers both to automate tasks we could do by hand and to empower us in ways that we simply can't pull off well without a technology assist. The Mac OS enables you, in many ways, to worry about the work itself and not the gritty details of how to get it done. OS/2, in its present form, does not. Maybe that's the real reason that the Mac is fi-

nally gaining acceptance in the business community, while OS/2 is still on the sidelines two years after its release. ■

Don Crabb is the director of laboratories and a senior lecturer for the computer science department at the University of Chicago. He is also a contributing editor for BYTE. He can be reached on BIX as "decrabb."

Your questions and comments are welcome. Write to: Editor, BYTE, One Phoenix Mill Lane, Peterborough, NH 03458.

ITEMS DISCUSSED

Apple Macintosh System 6.0.3
(System 6.0.3 is freely distributed by Apple dealers. For a complete system kit, including manuals, dealers charge \$45.)
Apple Computer, Inc.
20525 Mariani Ave.
Cupertino, CA 95014
(408) 996-1010
Inquiry 987.

IBM OS/2 Extended Edition with Presentation Manager version 1.1
(The list price varies according to configuration; the developer version is the most expensive. The price is \$395 and up.)
IBM
Old Orchard Rd.
Armonk, NY 10504
(914) 851-0111
Inquiry 988.

Desktop Publishing Together At Last.

mouse and menu interface in multiple windows. Use DeScribe to create professional quality documents—anything from a quick memo to a textbook. Price: \$595. Thirty-day money back guarantee. DeScribe, Inc.; 4047 North Freeway Blvd. Sacramento, CA 95834. Tel: (916) 646-1111 Fax: 923-3447





New application. New network. You know the drill.

You made it. You built a distributed application that takes full advantage of the power of your network. You faced incredible obstacles. And you swore if you survived, you'd never do it again. Guess what?

They want you to do it again.

This time, take a short cut. With Netwise.[®] Our RPC TOOL[™] lets you sidestep the obstacles by providing access to a common platform for the development of distributed applications. You write the application, then specify the network. Netwise automatically generates your distributed processing code. All of it. Every time. That means your application can easily migrate to any environment in the future. Banyan, Novell, Sun, 3Com and major software suppliers have endorsed this technology as a standard for building distributed applications. Now it's your turn.

Call us for a free educational diskette. Or order the RPC TOOL for a free thirty day try out. The development tool that lets your application be all it can be.



Put an end to the grunt work. Call us. 303/442-8280
2477 55th Street, Boulder, Colorado USA 80301

Netwise is a registered trademark. RPC TOOL is a trademark of Netwise, Inc. Banyan is a registered trademark of Banyan Systems Incorporated. Novell is a registered trademark of Novell, Inc. Sun is a registered trademark of Sun Microsystems, Inc. 3Com is a registered trademark of 3Com Corporation.

Call me, I'm interested: Circle 228

Send Literature: Circle 229



WHEN ONE DRIVE IS ENOUGH

Widespread acceptance of diskless PCs could change the way LANs work

One of the key functions of a LAN is centralization. A file server is a central repository for shared applications and data, as well as a central site for regular data backup. As more and more files have migrated to LAN servers, it was inevitable that someone would ask, Do personal computers attached to LANs need hard disk drives? Or, for that matter, do they need disk drives at all?

Well, sometimes no, sometimes yes. Diskless PCs could serve the needs of many LAN users—but first they have to come down in price.

One Concept, Several Packages

A diskless PC eliminates the need for disks by booting from a network server and using that server's files. All diskless PCs operate in basically the same way, but they come in three types of packages.

The first type resembles a small-footprint PC. Samsung's (Santa Clara, CA) PCterminal/286, which Novell sold for years, is a classic example. The PCterminal/286 is a 12-MHz 80286 with four AT-style expansion slots. It includes drive bays and mounting bezels for disk drives, if you want to install one or more. The unit we examined had an Ethernet controller built onto the motherboard.

A second approach is to put all the PC circuitry into the base of the monitor, as TeleVideo Systems (San Jose, CA) does in its TS2 TeleStation. A 2-inch-high base contains a PC on a board. The monitor rises from the base on a neck.

The final approach is to hide the PC circuitry in the keyboard, as Earth Com-

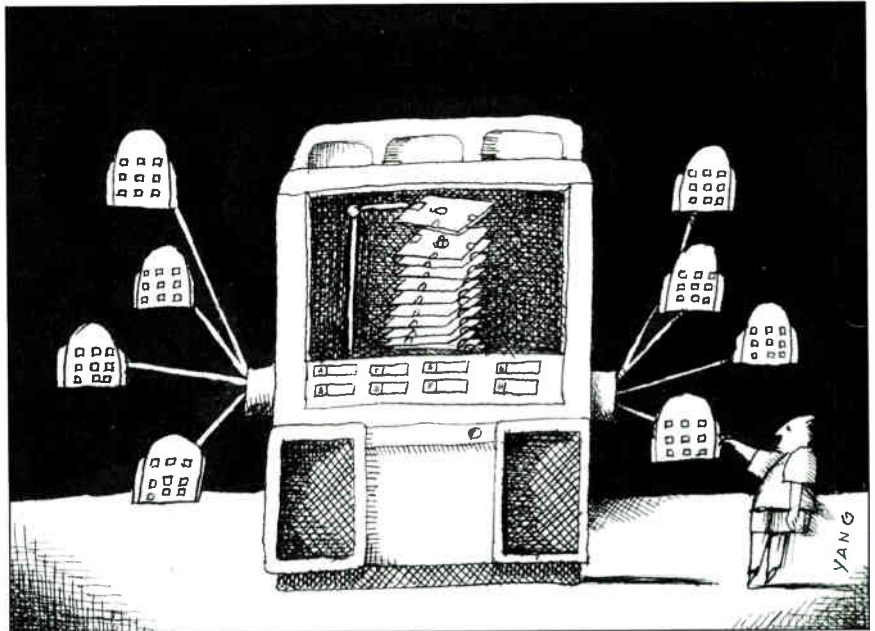

puter Technologies (Fountain Valley, CA) does. Its EarthStation IIe fits a complete 12-MHz 80286 system into its keyboard. It also requires an additional box that supplies the connectors for the monitor and LAN cables.

The diskless PCs in these packages run the gamut from those based on the old 8088 to the new 25-MHz 80386 from U-Tron (San Jose, CA). They can work with several different types of networks, including both ARCnet and Ethernet.

A Diskless Boot

To illustrate the way these systems work, we'll look at how a diskless PC boots on an ARCnet LAN running CBIS's (Norcross, GA) Network-OS, a good MS-Net-based LAN operating system for small-to-medium-size networks. CBIS estimates that as many as 20 percent of its Network-OS nodes are diskless or at least boot from the network. To boot properly, the diskless PC's network adapter must contain a Network-OS boot ROM. That

boot ROM communicates with a Network-OS server via a slimmed-down version of the standard NetBIOS session protocol. You also must configure a boot server. The boot server must have one or more boot-image files. A boot-image file contains an exact image of a boot floppy disk.

You must create that boot-image file on the server. Fortunately, that task is easy: You use a Network-OS program that copies each sector from a valid boot floppy disk. That program copies everything it needs from the boot floppy disk, including the boot sector, the file access table, the hidden files MSDOS.SYS and IO.SYS, and COMMAND.COM. It also typically includes the files that a diskless PC needs to bring up a full version of Network-OS, as well as CONFIG.SYS and AUTOEXEC.BAT.

You can create several different boot-image files for different diskless PCs on the LAN. The server decides which

continued

boot-image file to use for each diskless PC by consulting NWBOOT.DAT in the Network-OS directory (\NW by default). NWBOOT.DAT contains a list of node numbers and their corresponding boot-image file names. If the diskless PC's node number is in that file, the server uses the designated boot-image file; otherwise, the server uses the default image file, BOOTOS. But while many PCs can share a single boot-image file, you still need enough DOS licenses for all the systems on your LAN.

With the server and diskless machine ready, the remote boot process is fairly simple. When you turn on a diskless PC, its ROM BIOS tries to boot the machine. It does not, however, try first to boot from drive A and then from drive C, as usual. Instead, it asks the boot ROM for the boot sector, just as a standard PC's ROM BIOS would ask its disk drive controller for the boot sector.

The diskless machine's boot ROM then uses its stripped-down NetBIOS to broadcast a message that contains its network address and indicates its desire to boot. When the boot server receives that request, it establishes a connection with

the diskless machine and sends the diskless PC the required sectors from the appropriate boot-image file.

When the diskless PC receives those sectors, it boots as if from a floppy disk. The AUTOEXEC.BAT, for example, typically would bring up Network-OS and mount some network hard disk drives, so that the diskless PC would have a complete working environment.

In fact, once MS-DOS is running, you could do a DIR on drive A and see the same files as on the original boot floppy disk. If the file protection attributes of the boot-image file let you change that file, you could even modify your AUTOEXEC.BAT and CONFIG.SYS files.

Then There's NetWare

The boot process for a diskless PC on a Novell NetWare LAN is only slightly different. During the boot procedure, which Novell calls "remote reset," the NetWare boot ROM uses a stripped-down version of Novell's IPX rather than NetBIOS. NetWare handles the problem of multiple boot-image files by using an index file, \LOGIN\BOOTCONF.SYS, that is much like Network-OS's NW-

BOOT.DAT. Each BOOTCONF.SYS entry contains a PC's network number, node number, and boot-image filename. If a diskless PC tries to boot without having an entry in BOOTCONF.SYS, the server uses the default boot image, \LOGIN\NETSDOS.SYS.

Unlike Network-OS, NetWare does not let diskless PCs see the virtual boot disk after they have booted. Instead, it connects each diskless PC to the directory \LOGIN on the server's hard disk drive. This approach can be annoying, because the diskless PC user can't edit the AUTOEXEC.BAT or CONFIG.SYS files; only the system administrator can make such changes.

The High Cost of Diskless PCs

Both of these approaches assume, of course, that you need a diskless PC. One argument for such systems is their packaging: Diskless PCs are typically small and quiet. Because they have no disks, they run cool and don't need the often noisy PC fan. The downside to the small size is that most diskless PCs offer no expansion slots.

continued

IN SOME WAYS WE DON'T STACK UP

FROM 6 REMOTE PCs

MODEMS

"FUSS" BASED

NETWORK CONTROLLER IN EACH PC HUB

IN SOME WAYS WE DO!

QL 1002 - 2 PCs per board

FROM 6 REMOTE PCs

MODEMS

BUS-BASED

NOVELL LABS TESTED AND APPROVED NetWare Compatible

Remote Communications Made Easy

The QL 1000 PC-on-a-board Series is the elegant, low-cost alternative to standalone dial-in, dial-out communication servers for Novell NetWare and CBIS Network-OS networks.

Instead of dedicating noisy, bulky standalone PCs to specific network tasks, QL 1000 Series computers-on-a-card install neatly inside the fileserver chassis — not visible, but ready to process tasks upon demand.

Each user's processor, memory and I/O are on an AT bus based add-in board. Data travels at bus speed. Compatible with Ethernet, ARCnet, or Token Ring.

By using QL 1000 boards, you don't need a stack of money AND a stack of PCs to install remote communications and high speed networking.

Novell NetWare is a trademark of Novell, Inc.
 CBIS Network OS is a trademark of CBIS, Inc.

Call 1-800-648-2130 for details

Cubix Corporate Offices • 2800 Lockheed Way, Carson City, Nevada 89706
 Tel (702) 883-7611 • Fax (702) 882-2407

VIDEO SEVEN™

Seven great reasons to own the newest high-resolution Super VGA graphics card: the Video Seven VGA 1024i.

1 It's sharp. Our new graphics card dramatically improves the performance of all your applications. You can choose up to 800 x 600 or 1024 x 768 resolution with 16 on-screen colors, or 256 colors at 640 x 480*. Plus, 132-column text support helps you get the most from your spreadsheet applications.

*1024 x 768 resolution is interlaced; 1024 x 768 x 16 and 640 x 480 x 256 resolution requires 512K DRAM configuration.

2 It's fast. 50% faster than standard VGA. True 16-bit technology increases the speed of all your graphics and text applications on an IBM PC/AT/XT, PS/2 Model 30 or compatible.

3 It's versatile. It works in an 8-bit or 16-bit slot. You can easily upgrade it from 256K to 512K DRAM. And it lets you get the most out of today's popular MultiSync, Multiscan and 8514 monitors, including the MultiSync 3D and Seiko CM-1430.

4 It's 100% compatible. Guaranteed to run all your VGA, EGA, CGA, MDA and Hercules software applications. It's even easy to install. 3 easy steps is all it takes.

5 It supports more software. No graphics card gives you more high-resolution drivers, including Windows/286, Windows/386, Presentation Manager, AutoCAD, AutoShade, P-CAD, VersaCAD, GEM/3, Ventura Publisher, Lotus 1-2-3, Symphony, WordPerfect, and WordStar.

6 It comes with a full 7-year warranty. We can do that because we build all our products using our own Headland Technology chip and card design capabilities to ensure they will live up to our reputation for quality and performance.

Plus, the new VGA 1024i card comes with the exclusive *Best of Seven* support package that InfoWorld rates a "heartily excellent." You'll get free disk and BIOS updates, bulletin board service, and our unlimited toll-free technical support.

7 And it's affordable. The new Video Seven VGA 1024i, a very sharp, very fast high-resolution Super VGA graphics card for only \$397 with 256K DRAM. \$497 with 512K.

So before you settle for just any VGA card, ask to see the big news in high-resolution graphics: the new VGA 1024i from Video Seven.

For more information and the name of the dealer nearest you, call toll-free (800) 238-0101. From within California, call (800) 962-5700. Or call (415) 623-7857.

Some restrictions apply to Headland Technology's warranty and compatibility guarantee. Video Seven is a trademark of Headland Technology Inc. All other brand and product names may be trademarks of their respective companies.



VIDEO SEVEN

Best of Seven

You would think that by leaving out disk drives and fans, manufacturers would be able to sell diskless PCs very cheaply. Unfortunately, that's not true. For example, the Wyse Technology (San Jose, CA) WD-212 12-MHz 80286 diskless PC costs \$1799 (see "The LAN Terminal Alternative," November BYTE). That price includes a built-in monochrome VGA monitor, but you have to buy a LAN adapter separately. Even the EarthStation I costs \$995. For that, you get a keyboard, an 8-MHz NEC V40 processor, and an ARCnet adapter, but no monitor. You can find many complete AT clones in this price range.

Diskless PC vendors clearly could reduce these prices. The main reason for the high prices is that this is still a niche market with a handful of competing vendors. Expect prices to fall if this market grows or if IBM decides to legitimize it by announcing a diskless PC.

Security Flaws

One feature that many diskless PC vendors tout, perhaps as a partial justification for the high prices of their systems, is security. The idea is simple: Without

floppy disks, you can't steal data.

Unfortunately, the lack of floppy disks stops only the amateur thief. All the diskless PCs we've seen have several security flaws. Chief among them is a serial port. With a serial port, a cable, and a modem, data is only as secure as the nearest phone jack. There's also the ubiquitous printer port. With a laptop and LapLink, anyone can pull all the data off your server in a few minutes.

You can prevent this kind of data theft by not letting diskless PCs use any file transfer software on the server. But while security on diskless PCs is better than on normal PCs, it's still incomplete.

A more important feature of diskless PCs is the control that they return to the network system administrator. That administrator can handle data backups, software updates, and software purchasing, all with no hassle for the user.

Sound familiar? It should; the server effectively becomes a minicomputer. This setup is very attractive to MIS departments, which have traditionally controlled computing resources. It makes installing PCs little harder than installing smart terminals. Users get the simplicity

of a LAN terminal, and the MIS department regains administrative control.

Indeed, diskless PCs can be easy to install. We brought up one system by just plugging in the keyboard, network drop, and power cord, and turning it on. It immediately booted from the network.

That leaves the control aspect. PCs brought with them a kind of democratization of computing—one user, (at least) one computer—along with democracy's potential for chaos. Diskless PCs have the potential for a return to centralization; companies should decide whether they want such an environment.

Of course, the price of diskless PCs must come down. Will the market for them grow rapidly? Guessing the future is always risky, but this market may well become a major one. Diskless Unix workstations are common, and where Unix goes, PCs tend to follow. ■

Mark L. Van Name and Bill Catchings are BYTE contributing editors. Both are also independent computer consultants and freelance writers based in Raleigh, North Carolina. You can reach them on BIX as "mvannname" and "wbc3," respectively.

WT386-25B

- TRUE 25MHz CPU & CHIP SET
- UP TO 8 MB ON BOARD
- BABY SIZE BOARD FIT MOST ANY CASE
- 80387 CO-PROCESSOR SOCKET
- AMI BIOS FOR FULL COMPATIBILITY
- 1 32-BIT 5 16-BIT & 2 8-BIT SLOT
- LANDMARK = 34.5

\$ 725 qty.3

WEDGE-VGA

- TRIDENT SUPER VGA CHIP 8/16-BIT AUTO SWITCH
- UP TO 1024x768 RESOLUTION
- 40,80,132 COLUMN SUPPORT
- ANALOG & DIGITAL OUTPUT
- UP TO 3 TIMES FASTER THEN PARADISE PLUS 16
- EXPANDABLE TO 512K
- REGISTER COMPATIBLE

\$169 qty.3

WT286-24B

- HARRIS 80C286 CPU
- UP TO 8MB ON BOARD
- C&T NEAT CHIP SET
- AMI BIOS FOR FULL COMPATIBILITY
- BABY SIZE FIT MOST ANY CASE
- SUPPORT LIM MEMORY
- LANDMARK = 32.6

\$435 qty.3

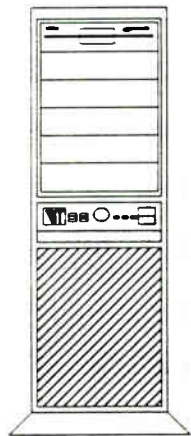

WEDGE SINCE 1981
TECHNOLOGY



1587 McCandless Drive, Milpitas, CA 95035
SALES: (408) 263-9888, TECH: (408) 263-0225, FAX: (408) 263-9886



Our Printer Sharing Unit Does Networking!

An Integrated Solution

Take our **Master Switch™**, a sophisticated sharing device, combine it with **MasterNet™** networking software for PCs, and you've got an integrated solution for printer and plotter sharing, file transfer, electronic mail, and a lot more. Of course you can also share modems, minis, and mainframes or access the network remotely. Installation and operation is very simple.

Versatile

Or you can use the Master Switch to link any computer or peripheral with a serial or parallel interface. The switch accepts over 20 commands for controlling the flow of data. It may be operated automatically, by command, or with interactive menus. Its buffer is expandable to one megabyte and holds up to 64 simultaneous jobs. The

MasterLink™ utility diskette for PCs comes with every unit and unleashes the power of the switch with its memory-resident access to the commands and menus.

Other Products

We have a full line of connectivity solutions. If you just want printer sharing, we've got

it. We also have automatic switches, code-activated switches, buffers, converters, cables, protocol converters, multiplexers, line drivers, and other products.

Commitment to Excellence

At Rose Electronics, we're not satisfied until you're satisfied. That's why we have thousands of customers around the world including large, medium, and small businesses, factories, stores, educational institutions, and Federal, state, and local governments. We back our products with full technical support, a one-year warranty, and a thirty-day money-back guarantee.



 **ROSE**
ELECTRONICS

Call now for literature or more information.
(800) 333-9343

Give a Rose to your computer

P.O. Box 742571 • Houston, Texas 77274 • Tel (713) 933-7673 • FAX (713) 933-0044 • Telex 4948886

Circle 283 on Reader Service Card

ZEOS[®] 386SX

ZEOS Smashes the '386

Your best reason yet to move up to a '386. Now you can own a complete ZEOS '386SX 16MHz hard drive system for less than comparable '286 systems.

The ZEOS '386SX. ZEOS performance, quality and support. ZEOS value. The Choice is Clear.

If you plan to buy a 16- or 20MHz 286 machine, think again.

A fundamental change in computing is about to take place. Systems based on the 80286 processor will be replaced by systems based on the 80386SX.

As America's premier manufacturer of 80386 based systems, we've designed the new ZEOS 386SX to provide everyone with a window to the future. A future of '386 speed and performance at a fraction of what you would expect to pay.

And ZEOS knows '386 systems better than anyone. After all, PC Magazine chose ZEOS above 57 other companies for "For Overall Excellence" in their recent '386 Blockbuster issue.

The new ZEOS 386SX simply runs circles around '286 based machines. PC magazine noted that the ZEOS 16MHz 386SX compares "favorably with the 20MHz '286 machines reviewed in 'The 80286: Unsafe at Higher Speeds?'" (PC Magazine, December 27, 1988).

So forget those 16- and 20MHz '286 machines forever. The ZEOS '386SX-16 "blows 'em right out

of the water." As PC Magazine says, "386SX-based machines are the right choice..." and the new ZEOS 386SX is the right choice for you.

30 Day Absolute Satisfaction Guarantee. One Full Year Limited Warranty.

If a company believes in their product, they should stand Rock Solid behind it. That's why your new ZEOS 386SX hard drive system includes our famous 30 Day Absolute Satisfaction *Money Back* Guarantee, One Full Year Limited Warranty and Express Parts Replacement Policy.

24 Hour a Day Sales and Toll Free Technical Support!

And talk about service! ZEOS is the only computer company in America standing by ready to help you *Toll Free, 24 hours a day, 365 days a year*. Nobody supports their customers like ZEOS!

Order your new ZEOS 386SX now with confidence. Your choice of ZEOS quality and performance is *Guaranteed*. Order now by calling 800-423-5891.

Only \$1395. Price Barrier!

**The New ZEOS
386SX Hard Drive
System. Below
'86 Prices!**

Only \$1,395

The future is now!

Why be left behind with yesterday's '86 technology? This fast new ZEOS 386SX system is your high performance ticket to '86 computing power. It's actually faster and yet less expensive than comparable '86 systems.

- 80386SX-16 CPU, 8/16MHz Dual Speed Keyboard Selectable. Reset/Turbo Buttons.
- 512K DRAM, expandable to a System Total of 16MB.
- Shadow RAM and EMS capability.
- Fast 32MB Seagate 138R Hard Drive with autopark, 1.2MB Teac floppy drive.
- Ultra high speed Hard/Floppy controller. 1:1 interleave, High Speed transfer.
- Genuine Hercules® brand graphics controller. High-Res Amber Display with Tilt/Swivel.
- ZEOS/RS Enhanced Tactile/Click keyboard.
- 2 High Speed Serial Ports plus one Parallel and one Game Port.
- 6-16, 2-8 bit expansion slots. 80387SX support.
- Rugged ZEOS space saver case. Security lock and LED indicators.
- Includes ZEOS 24 Hour a Day Toll Free Technical Support and Customer Satisfaction package.



**Order Now Toll Free
800-423-5891**

FAX Orders Dial: 612-633-1325
In Minnesota Call: 612-633-4591
MasterCard, VISA, ZCARD, COD
Open 24 Hours a day, 365 Days
a year.



ZEOS'386 Systems "For Overall Excellence..."

PC Magazine, May 30, 1989

Complete ZEOS 20MHz '386 System. 80MB SCSI Drive!

Only \$2995

16MHz systems from \$2295!

The standard by which others are measured! Featuring 64K CACHE (twice that of most competitors) providing Zero-Wait State performance vastly superior to page/interleave memory schemes. Incredible Value.

- High speed Zero-Wait 64K read and write-back SRAM CACHE. The fastest method known.
- Genuine 32-bit Intel 80386-20MHz CPU.
- 1MB of Zero-Wait DRAM Expandable to 16MB.
- Fast 80MB, 28ms SCSI Seagate Hard Drive, Teac® 1.2MB Floppy Drive.
- High speed HDD/FDD SCSI Host Adaptor with Software.
- 14" High-Res Amber Display with Tilt/Swivel base. Genuine Hercules® brand graphics controller.



Performance Comparisons using PC Labs Benchmark Series Release 4:

	80386 Instruction Mix	Floating Point Calculation	Conventional Memory
ZEOS 386/16 Desktop	3.58	13.62	0.58
ZEOS 386/20 Desktop	2.87	10.82	0.38
IBM PS/2 Model 70-E61	4.08	16.04	0.75
Compaq Deskpro 386/16	4.12	15.47	0.75

- BIOS and Video Shadow RAM plus EMS support. Software Included.
- 101 Key ZEOS Tactile/Click keyboard.
- 2 High Speed Serial Ports plus one Parallel and one Game port.
- 1-32, 6-16 and 1-8 bit slots.
- 80387 math coprocessor support.
- Rugged ZEOS 5-bay case. Including Security Lock and LED indicators.
- Includes ZEOS 24 Hour a Day Toll Free Technical Support and Customer Satisfaction package.

Options Galore: Including 14" VGA, add only \$495. And an incredible selection of hard drives: SCSI, RLL, ESDI or MFM and virtually any other add-on you could want!

**Order Now Toll Free
800-423-5891**

FAX Orders Dial: 612-633-1325
In Minnesota Call: 612-633-4591
MasterCard, VISA, ZCARD, COD
Open 24 Hours a day, 365 Days a year.

"Out of 104 machines from 58 companies... For overall excellence we selected ZEOS International's 386-16 and 386-20" *PC Magazine, May 30, 1989*

The Editors of *PC Magazine* came to this conclusion after investing "25,000 hours of work by 60 people testing and reviewing 104 '386 PCs." The review was thorough and their conclusion specific. Simply, that out of all the manufacturers in the world, ZEOS offers you the very best '386 Value.

In *all* areas, ZEOS machines are top performers. With uncompromising attention to quality and detail throughout. Not only do ZEOS systems themselves afford you the very best *Values* in computing today, they're backed up by the strongest after sales support in the industry.

At ZEOS we feel that if a company believes in its products it should stand Rock Solid behind them.

That's why ZEOS offers *Toll*

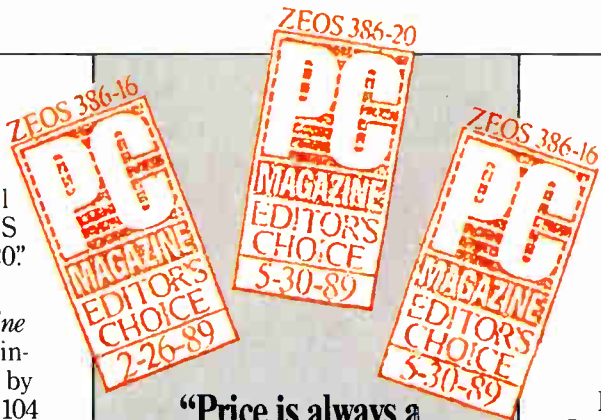

"Price is always a consideration. So are benchmark test results. But both factors can be deceiving, which is why we consider them in the context of other aspects that will make the difference months and years down the road. Things like quality of construction, reliability, expandability, and ease of service."

PC Magazine, On "What Makes an Editor's Choice"

Free Technical Support 24 Hours a day, seven days a week, 365 days a year! At ZEOS, we believe in standing by our customers whenever they need us.

Then add our 30 Day Absolute Satisfaction *Money Back* Guarantee, One Full Year Limited Warranty and Express Parts Replacement Policy. You've got the best.

And when you order your ZEOS '386 you can have your pick from the industry's broadest selection of options. As *PC Magazine* said, ZEOS offers "more options than even the most configuration hungry hound could possibly need!"

Quality, Performance, Reliability and Support. *Overall Excellence.* That's why ZEOS is *PC Magazine's #1 choice.* And that's why ZEOS is *your best choice as well.* So pick out that dream machine today and order it now with confidence. Your choice of ZEOS excellence is Guaranteed. Order now by calling 800-423-5891.

Complete 25MHz '386 Vertical System. 80MB SCSI Drive!

Only \$3495

Complete 33MHz systems only \$4495!

ZEOS 25MHz and 33MHz 80386 systems are the fastest, most advanced available anywhere. Government Computer News calls the ZEOS '386-33 "arguably the fastest MS-DOS and OS/2 micro in the world." Review after review, these ZEOS systems are selected as the best price/performance buys. A power user's dream!

- *Ultra High speed Zero-Wait 64K SRAM CACHE.*
- *Genuine 32-bit Intel '386-25 or 33MHz CPU.*
- *1MB of Zero-Wait DRAM Expandable to 16MB.*
- *Fast 80MB, 28ms SCSI Seagate Hard Drive, Tear* 1.2MB Floppy Drive.*
- *High speed HDD/FDD SCSI Host Adaptor with Software.*



Performance Comparisons using PC Labs Benchmark Series Release 4:

	80386 Instruction Mix	Floating Point Calculation	Conventional Memory
ZEOS 386/25 Desktop	2.29	8.37	0.33
ZEOS 386/33 Desktop	1.67	6.43	0.27
IBM PS/2 Model A	2.27	8.33	0.60
Compaq Deskpro 386/25	2.36	8.59	0.37

- *14" High-Res Amber Display with Tilt/Swivel. Genuine Hercules® brand graphics controller.*
- *BIOS and Video Shadow RAM plus EMS support.*
- *ZEOS Tactile/Click keyboard.*
- *2 High Speed Serial Ports plus one Parallel and one Game port.*
- *1-32, 6-16 and 1-8 bit slots.*
- *80387 math coprocessor support.*
- *Includes ZEOS 24 Hour a Day Toll Free Technical Support.*
- *6-bay Vertical case standard. Deduct \$150 for desktop case.*

Many options available. Including 14" VGA, add only \$495. Plus a large selection of SCSI, RLL, ESDI or MFM hard drives and more.

**Order Now Toll Free
800-423-5891**



Comput

Right Now. Guaranteed!*

Yes, we can ship your new ZEOS® '286 or '386 today! We've built up an extra supply of the hottest selling computers in America. The celebrated ZEOS 286-12 and PC Magazine's Editors Choice—the ultra fast ZEOS 386-20.

Take your pick now for immediate delivery. These are both *complete*, genuine ZEOS Zero-Wait state systems. Both include an ultra-fast Seagate hard drive and all the other goodies. And they're ready to ship. *Right Now.*

Here's how it works. We have these extra systems pre-built and ready to ship. They include both High Resolution Monochrome and VGA systems. While supplies last, we will ship either of these systems to you *the day you order* subject to these conditions:

1. Your order must be received by 1PM Central Time.
2. Credit Cards are subject to credit card authorization.
3. Orders must be for our standard 286-12MHz system or 386-20MHz system, either monochrome or VGA. Any other systems or upgrades are custom built and will take slightly longer.

*Our Guarantee to You:

If we fail to ship your system under the conditions outlined, we will ship it *at our expense* as soon as it is ready. All systems are fully burned in and tested. Each system includes our 30 day Money Back Guarantee and One Full Year Limited Warranty. Plus 24 Hour a day Toll Free technical support and Express Parts Replacement are included too!

This offer is good only as long as these pre-built

Complete ZEOS 12MHz '286 with 32MB Hard Drive!

Only \$1,395

For VGA color add \$495

FREE Shareware Disks Too!
25 Software Programs Included
Every system will include 25 ready to run Shareware programs on free disks. Included are programs for Word Processing, Spread Sheets, Educational, Financial, Business, Games and more. With Shareware you can try the programs first before you register them with the author. What a great idea!

Standard Features Include:

- 80286-12 CPU, 6/12MHz Dual Speed keyboard/hardware selectable. Reset and Turbo buttons right up front.
- Zero-Wait State DRAM, 512K expandable to 4MB on the mother board (16MB System Total). EMS Capability on board.



Performance Comparisons using PC Labs Benchmark Series Release 4:

	80286 Instruction Mix	Floating Point Calculation	Conventional Memory
ZEOS 286/12 Desktop	4.78	18.84	0.72
IBM PC AT (8MHz)	8.96	35.60	1.32
IBM PS/2 Model 50	7.20	28.34	1.05

- Fast 32MB Seagate 138R Hard Drive with auto-park, 1.2MB Floppy Drive.
- Ultra high speed Hard/Floppy controller. 1:1 interleave, 800 KB/sec transfer rate.
- 14" High-Res Amber Display with Tilt/Swivel Base. Genuine Hercules® Brand graphics card.
- ZEOS Enhanced 101 Key Keyboard with our Pleasant Tactile/Click Feel.
- Two Serial Ports plus Parallel and Game Ports.
- Clock/Calendar with Battery Backup.
- 6-16 and 2-8 bit expansion slots.
- 80287 support, up to 12 MHz.
- Heavy Duty Case Complete with Security Lock and LED indicators.

**Order Now Toll Free
800-423-5891**

ers Now! SM

systems remain in stock; please give us a call to verify availability. This offer does not apply to other ZEOS systems or custom configurations.

Immediate shipment is only part of the story.

ZEOS builds Rock Solid computers. That's why we offer you our 30 Day Money Back Guarantee, Toll Free technical support and Full One Year Limited Warranty. Compare that to the others. Then compare performance.

Performance is what ZEOS is all about. If you're buying a computer you may as well buy the fastest. The ZEOS 286-12 is *the fastest* in its class. It features true Zero-Wait state operation with speeds close to many 386 systems!

Or select the ZEOS 386-20. The Editors of *PC Magazine* did. In fact, they said "Out of 104 machines

from 58 companies... for overall excellence in both the 16- and 20MHz categories, we selected ZEOS International's 386-16 and 386-20." And ZEOS '386 systems have racked up *three PC Magazine Editor's Choice awards so far this year!*

PC Resource Magazine put it this way "ZEOS... provides quality comparable with the IBM or Compaq and does so for about 70% of the cost." *Personal Computing* simply says "The best value we've come across so far."

We couldn't have said it better ourselves.

And these are the machines that we have ready to ship to you *right now*. Rock solid block buster ZEOS machines with quality and performance that is, in a word, *Guaranteed*. Order now by calling 800-432-5891.

Complete ZEOS 20MHz '386 with 80MB 28ms SCSI Drive!

Only \$2,995

For VGA color add \$495



Standard Features Include:

- Genuine 32-bit Intel 80386-20MHz CPU.
- High speed Zero-Wait 64K SRAM CACHE.
- 1MB of Zero-Wait DRAM Expandable to 16MB system total.
- Fast 80MB, 28ms SCSI Seagate Hard Drive, 1.2MB Floppy Drive.
- Ultra high speed Hard/Floppy SCSI controller.
- Genuine Hercules® Brand graphics card. High-Res Amber Display with Tilt/Swivel Base.



Performance Comparisons using PC Labs Benchmark Series Release 4:

	80386 Instruction Mix	Floating Point Calculation	Conventional Memory
ZEOS 386/20 Desktop	2.87	10.40	0.39
IBM PS/2 Model 70-121	3.24	12.72	0.61
Compaq Deskpro 386/20e	2.91	10.54	0.40

- 101 Key ZEOS Tactile/Click keyboard.
- Two High Speed Serial plus Parallel and Game Ports.
- 1-32, 5-16 and 2-8 bit slots.
- 80387 math co-processor support.
- ZEOS 5-bay case with security lock and LED indicators.

Order Now Toll Free
800-423-5891

FAX Orders Dial: 612-633-1325
In Minnesota Call: 612-633-4591
MasterCard, VISA, ZCard and COD
Open 24 Hours a day!
ZEOS International, Ltd.
530 5th Avenue, N.W.
St. Paul, MN 55112 USA



Take Your Pick.

Only ZEOS lets you decide between two great keyboard styles. Choose the ZEOS/RS with standard Enhanced key spacing yet a 25% smaller footprint. Or choose the ZEOS/F12 with all the function keys on the left. ZEOS gives you the choice. Two great keyboards, one great price!

Only \$89.95

Please add \$5.00 for shipping & handling. Your ZEOS keyboard comes with the standard 6' coiled cable. For an additional 10' cable extension (16' total) add \$10.00. ZEOS keyboards use the standard DIN type connector as do most compatibles. If you're not sure what you need, contact your computer retailer. For PS/2 style connectors add \$15.00. XT, AT and PS/2 are trademarks of IBM Corporation. Prices are subject to change without notice. Call for complete warranty details. Available in 12 languages, call to verify stock. ZEOS is a publicly traded company, MPLS/ST PAUL Local OTC.



ZEOS/F12



ZEOS/RS

Your favorite Keyboards. Guaranteed.

ZEOS/F12, "F" Keys on the Left!
Many people prefer their function keys on the left. That's why we developed the ZEOS/F12. If you use your "F" keys frequently, then definitely give the F12 a try. You'll never go back.

ZEOS/RS, 25% smaller footprint!
We made it 25% smaller yet kept the standard Enhanced key size and spacing. People love it by the thousands. You will too. Just decide what you're going to do with all that extra desk space!

Who said typing can't be both fast and fun! Now it's both. ZEOS gives you your choice of *two* great keyboards.

Choose the ZEOS/RS (Reduced Size) keyboard. It's 25% smaller! Or select the ZEOS/F12. All 12 function keys are on the left, where a lot of us learned to use them. It's great for Function-intensive applications. It's fantastic for typing!

Either way you get that great ZEOS Mechanical Tactile feel with the perfect "Click!"

Plus, you will also get that extra ZEOS value. Like an anti-static dust cover included at no additional charge. Our famous ZEOS 30 day Money Back guarantee, Full One Year Warranty, Toll Free Technical Support and Expedited Replacement policy are yours too.

So take your pick and start enjoying your new ZEOS keyboard right away. Order yours now by calling 800-423-5891.

Order Now Toll Free
800-423-5891



Open days, evenings and weekends.
Fax Orders Dial: 612-633-2310.
In Minnesota Call: 612-633-4591.
MasterCard, VISA and COD
530 5th Avenue NW, St. Paul, MN 55112

Announcing the Z-CARD!

Apply Now for your own ZEOS® Revolving Charge Account

Send For Your ZEOS Credit Card

Now you can send for your own ZEOS Credit Card. It works just like a MasterCard or Visa for ZEOS purchases. Fill out your Z-CARD Personal Information Organizer and mail it today. We'll give you a call as soon as your credit line is established!

Mail the completed Personal Information Organizer to:
ZEOS International
Z-CARD Processing Center
530 5th Avenue, N.W., St. Paul, MN 55112

a. Your Personal Information

Requested Line of Credit \$ _____

Your Name _____ Date of Birth _____
First Initial Last Mo. Day Yr.

Present Address _____
Street Apt. # City State Zip

Social Security Number _____
() Home Phone

Date of Residence _____ Monthly Payment \$ _____
Month Year Buy Rent Other

Previous Address _____

Dates of Residence _____
From To

Your Employer _____
(If self-employed, see rear panel.)

Date of Employment _____ Position _____
Mo. Yr.

Monthly Income _____
Gross \$ Net \$

Employer's Address _____
Street

City _____ State _____ Zip _____ Business Phone _____

Previous Employer _____ Address _____

Dates of Employment _____
From To

Other Income _____ I have received since (Date) _____
Income from alimony, child support or separate maintenance payments need not be disclosed if you do not wish to have it considered as a basis for repaying this obligation.

Monthly Income _____
Gross \$ Net \$

Name and Address of Nearest Relative Not Living With You _____

Relationship _____

b. Credit Information

Include joint information, if joint account requested.

Bank Account _____
Bank Name Checking Savings

Address _____

Bank Account _____
Bank Name Checking Savings

Address _____

Bank Loan Reference _____
Bank Name Address

Payment _____ Balance _____

Bank Card Reference _____
Bank Name Address

Payment _____ Balance _____
 VISA Mastercard

(please check appropriate box):

- Joint Credit** with another person. Complete all information.
- Individual Credit** but rely on income or assets of another person as a basis for repaying the credit requested. Complete all information
- Individual Credit** Complete sections "a" and "b" only.

Please complete all appropriate sections, *providing at least two years' residence and employment history*. This will enable your information to be processed as quickly as possible. If you are self-employed, please be sure to complete section "d" below.

Other Credit Card Reference _____
Bank Name Address

Payment _____ Balance _____

Other Credit References _____
Payment Balance

Account No. _____ Expires _____

Driver's License No. _____ State _____ Expires _____

c. Joint Personal Information

Joint Name _____
First Initial Last

Date of Birth _____ Social Security Number _____
Mo. Day Yr.

Address _____
Street Apt. #

City _____ State _____ Zip _____

Date of Residence _____ Home Phone () _____
Mo. Yr.

Employer _____

Date of Employment _____ Position _____
Mo. Yr.

Monthly Income _____
Gross \$ Net \$

Employer's Address _____
Street

City _____ State _____ Zip _____ Business Phone _____

d. Self-Employed Information

Complete this section only if you are self employed.

Business Name _____

Business Address _____

Proprietorship Corporation Partnership Business Phone () _____

Description of Business _____

Your Position _____ In Business Since _____

Your annual income from business _____ Business' annual income (gross) (net) _____

You must provide at least one of the following:

1. Business Bank _____

() Telephone _____ Personal Banker's Name _____

2. Accountant's Name _____

() Telephone _____

3. Financial statement on business attached.

(EXC. AK, & HI)



Making a Case for CASE

Ask a dozen people what computer-aided software engineering is, and you'll get a dozen different answers. CASE tools can assist in the planning, analysis, design, documentation, prototyping, and construction of business information systems, in accordance with one or more popular software engineering methodologies. Advocates say that, used properly, CASE tools help produce correct and maintainable software; detractors say that CASE tools produce nothing and end up as shelfware.

Despite the confusion surrounding CASE, there's no shortage of CASE tools. The BYTE Lab looked at a representative sample of those tools that run on the PC platform: DesignAid, DesignMachine and DesignVision, Excelerator, IEW/WS, MicroStep, POSE, and Teamwork OS/2. Reviewing CASE tools isn't like reviewing, say, C compilers. Ultimately, the compilers all do the same job—transforming ANSI C source code into executable programs. But CASE tools tend to favor particular software engineering methodologies and to attack different parts of the software life cycle. Each, to a large extent, defines the context within which it must be judged. Table 1 shows the methodologies and life cycles of each product.



To test the products, we defined a sample software project, paired each CASE product with a BYTE editor, and asked each editor to work through the project using the assigned product's methods and tools. Textbooks and tutorials often teach CASE concepts in terms of accounting and inventory systems. But we chose a business information system that's nearer and dearer to our hearts: the solicitation, editing, and tracking of articles here at BYTE. Such a system would enable staff members to share a database containing information about authors, contracts, and manuscripts.

Our requirements were deliberately vague. Why? CASE proponents argue that correct definition of system requirements and correct database design are the key compo-

nents of quality software. Many software engineering methodologies address the requirements analysis and design phases. In particular, we wanted to examine how the tools can help with these critical parts of the software life cycle. Of course, we were also curious to see how far we'd get toward a working system using each tool.

We'll save you the suspense: Our proposed system remains vaporware. Is that a failure of the CASE tools? We don't think so. The tools, in general, produced specifications—for a database to support our proposed system, and for the processes that perform transactions on that database. That's valuable, especially for large and mission-critical systems (unlike ours) that can't be designed on the back of an envelope.

The accounts that follow detail each editor's experience with CASE tools. There's a common refrain in these seven accounts: The journey is its own reward. CASE suffers from unrealistic expectations. Software development remains a tricky business, and the CASE vendors we spoke to don't pretend otherwise. CASE tools can help define (or, possibly, build) systems, but there's no magic involved. The CASE process, like programming, requires dedication and skill.

continued

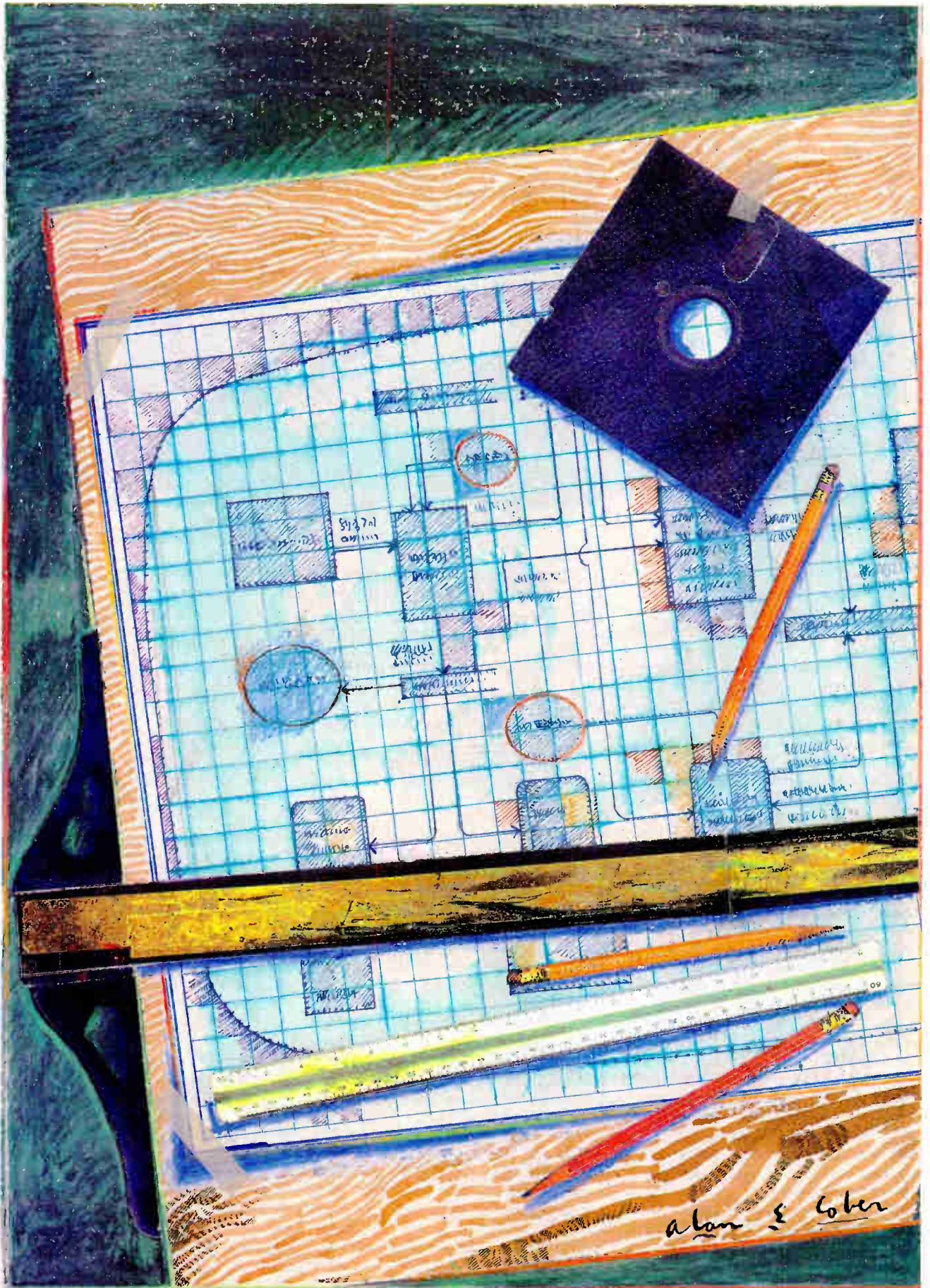

DesignAid

The DesignAid interface resembles an outline processor. This photo illustrates a context-level diagram embedded within a menu file. Filenames enclosed in brackets can be called using the displayed File Management menu.

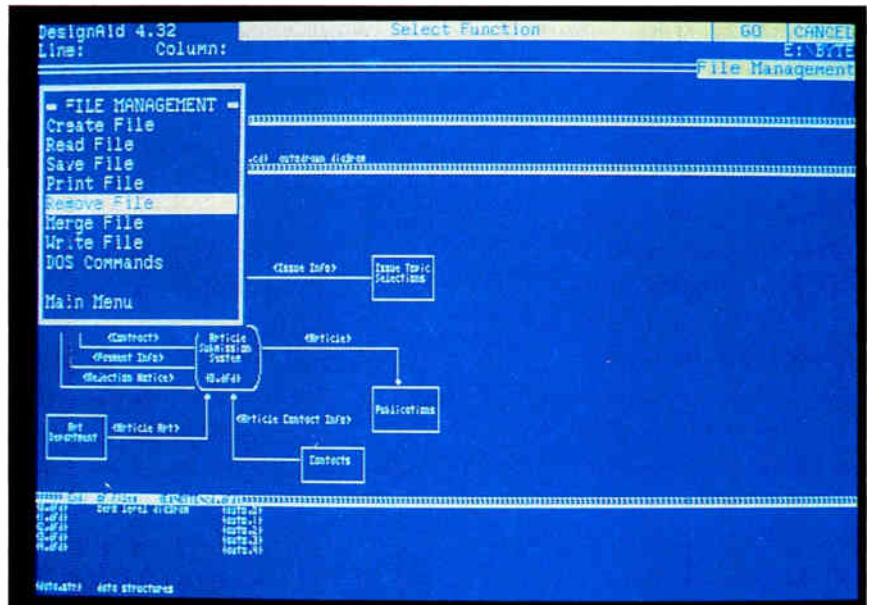

We've all heard the horror stories about good programmers who generate only 10 lines of working code a day. Nastec's DesignAid can enhance that ratio by helping with the organizational up-front work that is vital to any large software project.

At first, I had expected a do-everything product that effortlessly modeled your software needs and then cranked out reams of faultless code—in short, miracle software. For the price (\$6900), it didn't seem like too much to expect. But DesignAid brought me around to a more realistic understanding of CASE tools and, ultimately, a better appreciation of the CASE philosophy.

DesignAid works a lot like an outline processor. You build a project in a menu file. It contains references, enclosed in brackets, that refer to disk files. Each nested file retains its autonomy, so that only the file at the top of the "stack" can be saved. This method still lets you track all components of a project from within one integrated structure.

Once you've created a menu file, you might enter a reference for a top-level Data Flow Diagram. Bracketed file references placed within the flowchart's symbols provide access to further system detail. The tools for drawing and editing symbols are adequate, and the menu interface is easy to navigate, but connecting lines and aligning symbols often took a bit of trial and error.

The diagramming facility supports the full Yourdon/DeMarco methodology. The Data Modeling option (\$1500) generates Chen entity/relationship diagrams, and the optional Real-Time mod-

ule (\$1500) supports Ward/Mellor methodology.

DesignAid has an Autodraw function. The problem is that Autodraw requires either a dictionary containing diagrams you've already drawn and validated, or a Diagram Description File. You create a DDF by entering formatted definition statements into an ASCII file, which you submit to Autodraw. In the end, it's just as easy to draw things yourself. I used validated drawings to test the Autodraw function. It did a creditable job, correctly placing objects and data flows.

Putting DesignAid to Work

I began our model by creating a context diagram showing the Article Submission System and how it relates to external inputs and outputs (e.g., Author and Art Department). An embedded file reference in the Article Submission box referred to a *zero-level diagram* that presented an overview of the system. Included in this diagram were the data stores (Author File, Article File, and Contract File) and the principal processes (Solicit Article, Accept Article, Perform Technical Editing, and Perform Final Editing). Each of the processes also contained references to nested files. With this structure in place, it was easy to traverse the diagram hierarchy.

The next step is to decompose flowcharts into detailed process narratives (pseudocode) and data structures. For example, one of my flowcharts contained an object called Article Text. To this object I attached a data structure and defined its elements—Text, ID, and Version. DesignAid's validation tool checks

diagrams for accuracy and completeness before allowing design information to enter your dictionary. DesignAid checks for proper graphical syntax and verifies that, for example, the inputs to and outputs from a child process match those of its parent. The process ensures that all objects in the diagram are defined.

You can also build your dictionaries manually. In fact, you could start your design by defining the objects in your system and then create a DDF file to automatically generate your diagrams.

The normalizer interrelates the data structures that you've defined and produces a schema that you can easily feed to a relational data manager. After specifying all the objects in our sample system, it was a simple matter to create a data structure list for each object. That was all the normalizer needed. I submitted the structure list, and the normalizer returned a set of tables in first, second, and third normal forms. I then submitted the normalized output to Autodraw, which dutifully charted each of my relational views.

The Network Connection

All this organizational work is a natural for networking, and Nastec does not disappoint. While some packages allow you to download portions of a design dictionary, DesignAid's dictionaries can be truly shared and are thus accessible to everyone on the network. The administrator sets access levels for each team member. With full access, you can view objects in the dictionary as well as modify or delete them. Limited access grants usage of the dictionaries while preventing

CASE TOOLS

Table 1: Each CASE tool has its own mix of methodology and life-cycle support.

METHODOLOGIES AND LIFE CYCLES

CASE tool	Hardware needed	Methodology	Life cycle	Price
DesignAid 4.3	Any PS/2 or AT compatible with hard disk drive, 640K bytes of RAM, EGA (or VGA with an EGA mode) or Hercules graphics card, and DOS 3.1 for LAN support (or DOS 2.1 if stand-alone). A mouse is highly recommended.	Yourdon/DeMarco, Chen (optional), Ward/Mellor (optional)	Planning, analysis, design	\$6900 Data Modeling option: \$1500 Real-Time module: \$1500
DesignMachine 2.0	AT, DOS 3.0, 640K bytes of RAM	DSSD	Planning, analysis, design	\$1995
DesignVision 1.7	AT, DOS 3.0, Windows, 640K bytes of RAM	Yourdon, Gane/Sarson, Warnier/Orr, user-defined Chen	Planning, analysis, design	\$995-\$2995
Brackets	PC, XT, AT, DOS 3.0, 512K bytes of RAM		Structured COBOL programming	\$150
Excelerator 1.84	PC with hard disk drive, 640K bytes of RAM, mouse, graphics board	Yourdon, Gane/Sarson, Chen, Merise	Planning, analysis, design, construction	\$8400
IEW/WS	80286-based system or higher, DOS 3.1 or higher, 5 megabytes of RAM, 20 megabytes of hard disk space, Microsoft Mouse (serial) or compatible	Information engineering	Planning, analysis, design, construction	Planning: \$8625 Analysis: \$8625 Design: \$8625 Construction: \$8625 (volume discounts available)
MicroStep 1.3	AT, 80386, PS/2, or compatible, 640K bytes of RAM, 20-megabyte hard disk drive, EGA or Hercules video card, Microsoft or compatible mouse, DOS 3.1 through 3.3	Yourdon	Design, construction	\$5750, including three days of training (volume prices and site licensing agreements are available)
Teamwork OS/2 3.0	IBM PS/2 or Compaq, OS/2 Standard Edition or Extended Edition 1.1, 5 megabytes of available RAM (6 if used with OS/2 Extended Edition), 7.2 megabytes minimum available on disk	DeMarco, Ward/Mellor, Schlair, Constantine	Planning, analysis, design	\$4995 Teamwork/RT module: \$1500 Optional maintenance: \$750
POSE 4.0	PC or compatible, DOS 3.0 or higher, 640K bytes of RAM, hard disk drive, two- or three-button mouse, CGA or higher, HPGL-compatible plotter or graphics printer	Yourdon, Gane/Sarson, Constantine, Finkelstein, information engineering	Planning, analysis, design, construction	Single module: \$595 Toolkit: \$1195

any modification of them. You can also lock specific dictionary records or prevent access to DesignAid altogether.

DesignAid can be useful for managing large software projects. It's not perfect, of course. The normalized output works well as a database development aid, but I wish the program generated standard schemata that could be plugged directly

into a database front end. Diagramming could be more convenient, and the prototyping facility needs some enhancement.

However, the company appears ready to plug some of the holes. Nastec already supports links to the Telon code generator (you export DesignAid screens and reports, and Telon spits out the code), and the company's merger with Trans-

form Logic Corp. portends more integration (including schema generation) in the future.

I guess I'm a CASE convert. I just can't imagine that dedicated use of such a package wouldn't dramatically increase the productivity of a design team.

—Stanford Diehl
continued

DesignMachine and DesignVision

DesignVision supports user-definable diagrams and a SQL query facility under the standard Microsoft Windows interface.

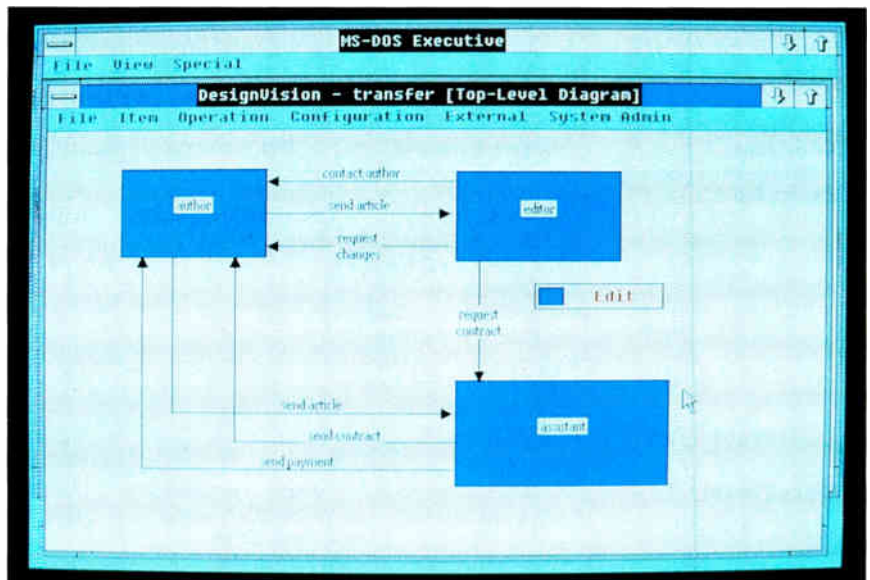

Optima (formerly known as Ken Orr and Associates) offers a family of tools that support Orr's DSSD (for Data Structured Systems Development) methodology. DesignVision is a diagramming tool. DesignMachine guides an analyst through the sequence of activities defined by DSSD, culminating in the definition of a normalized relational database. Brackets is a specialized outline processor used to create and modify Warnier/Orr diagrams and transform such diagrams into COBOL programs.

A DSSD analyst begins by capturing the views of each user of an information system. The analyst then merges the resulting entity diagrams to create a combined diagram that accounts for all users and all transactions. These diagrams enable users to see—and to correct—the representation of a system. The analyst then focuses on the transactions, specifying the order in which they occur, their component data elements, the outputs that incorporate that data, the processes that produce the outputs, and the logical structure of the data. The idea is to help people discover what data they require and how often and in what ways they interact with that data. A database derived from such analysis stands the best chance of serving the needs of its users.

DesignMachine and the DSSD Process

DSSD is a complex algorithm. DesignMachine won't teach you DSSD, but it will ensure that you perform the steps in the proper order and that you complete each one before proceeding to the next. It also automates the production of the multitude of *deliverables*—entity diagrams,

process flowcharts, and database and output specifications—that DSSD mandates.

DesignMachine requires a full 640K bytes of RAM. I had to unload my network shell, which underscores the fact that, although a DSSD project is inherently a shared effort, there's no multi-user support from Optima yet.

I modeled our sample problem with the help of a DSSD trainer. In a day and a half, we worked through a portion of the problem and produced a normalized relational schema.

One of the best things about DesignMachine is that it draws entity diagrams automatically, although they are not fancy. The program's interface is a primitive character-based one that reflects the mainframe style of the applications that CASE tools have traditionally been used to develop. But it does draw the diagrams. Consequently, you don't spend time aligning bubbles and neatening connectors. Instead, you concentrate on defining your system.

The problem, however, is that there's no quick way to pump information into the system. You create a transaction on one screen, specify its source on another, and specify its destination on yet another. Furthermore, you've got to document everything. You can't, for example, add an entity called Art Department without also supplying your name and a one-line description of the entity.

Even more frustrating, when I added the transaction Figures To Art, specifying Editor as source entity and Art Department as destination, DesignMachine refused to let me complete the combined entity diagram. Why? I hadn't specified

the reciprocal transaction. DesignMachine knew this, and it even highlighted a proposed Art Department-to-Editor link; nevertheless, it forced me to go back and add it manually. I'll grant that rigor is desirable, but I wished that the system could have been more helpful.

The system should also be a lot more informative than it is. Frequently, DesignMachine prevented me from completing one phase and continuing to the next, without explaining what I needed to correct. This can't simply be attributed to DSSD inexperience. I worked closely with a DSSD expert who was stumped several times.

Here is a typical example: At one point, I couldn't complete the Main Line Functional Flow Diagram, so I couldn't proceed. This diagram is a high-level view of a system's functional parts—a Warnier/Orr diagram that you might export to Brackets for further decomposition. The diagram depends, I found, on an ordering of transactions established in a previous step. I had added a transaction without saying anything about its sequence. But the only clue that something was amiss was DesignMachine's refusal to present the menu choice that led to the next subphase. There was no error message; I simply poked around until I found the unsequenced transaction, fixed that, and then was able to continue.

Despite these frustrations, I still like DSSD. Its premise—that users of an information system must drive the design of that system—rings true. The methodological approach to the solicitation and elaboration of users' requirements also appeals to me. The real world is messy.

continued

The Five Secrets of Power Programming.

Presenting Matrix Layout 2.0

The secret is out. The first program to offer you the power to create complete, professional-quality software on your IBM PC is now more powerful than ever. Presenting Matrix Layout 2.0, and the secrets of power programming.

Secret #1:

The CASE of the OOP Flowchart

Layout 2.0 is built around CASE (computer aided software engineering) and OOP (object oriented programming). CASE lets you create sophisticated programs simply by drawing a flowchart. OOP allows you to add functions by moving graphic objects within the flowchart. Or use the BlackBox Manager to install pre-programmed capabilities—like telecommunications or dBase file access—in your program.

Secret #2:

The Hypertext File

Layout 2.0 offers you full hypertext capability, allowing you to create Hypercard® like cards containing text, graphics, buttons, and BlackBoxes. Then, link them to related cards in any file. Use your cards to create stand alone hypertext applications or add them to your flowcharts.

Secret #3:

Graphically Speaking

Layout's simple graphic interface makes it easy to learn and simple to use. But more importantly, it allows you to incorporate windows, menus, and other graphical elements in your own programs.

Secret #4:

Our Coded Message

Once you've designed the functions you want, Layout 2.0 will automatically

write the code (real, commented code!) in your choice of Turbo C, Lattice C, Microsoft C, Turbo Pascal, and QuickBASIC languages. Or just create a .EXE file for use with any IBM PC.

Secret #5:

A Fast, Powerful Finish

Creating complete, stand-alone programs with Layout 2.0 can cut your development time by up to 70%, helping you get more programming done in less time. And once your programs are finished, Layout 2.0 supplies the finishing touches by creating the help files and documentation you need to teach your new program to others.

And a Powerful Bargain

For just \$199.95 you get the entire Layout 2.0 package, including free technical support, and more programming power than you've ever had on your desktop. For more information, the location of your nearest Matrix dealer, or a copy of the Matrix Layout 2.0 VHS demonstration video (just \$9.95 for shipping & handling), call today.

1-800-533-5644
(in Massachusetts,
617-567-0037)

The secret to power programming is Matrix Layout 2.0. Order yours today!

MATRIX
MATRIX SOFTWARE TECHNOLOGY

BT89/12

Matrix Software Technology Corporation • One Massachusetts Technology Center • Harborside Drive • Boston, MA 02128 • (617) 567-0037

Matrix Software: UK • Matrix House, Derriford Business Park • Derriford, Plymouth • Devon PL6 5QZ, England • 0752-796-363.

Matrix Software: Europe • Geldenaaksebaan 476 • 3030 Leuven, Belgium • 016202064

The following are registered and unregistered trademarks of the companies listed: Matrix Layout, Matrix Software Technology Corporation: Hypercard.

Apple Computer: IBM, International Business Machines Corporation: dBase, Ashton Tate.

Circle 195 on Reader Service Card

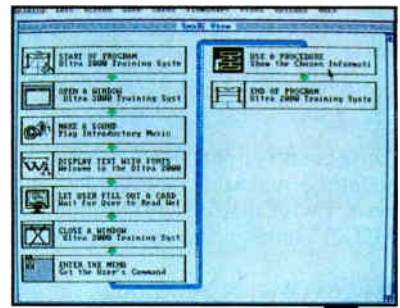

1. Design and build your programs by using a simple flowchart.

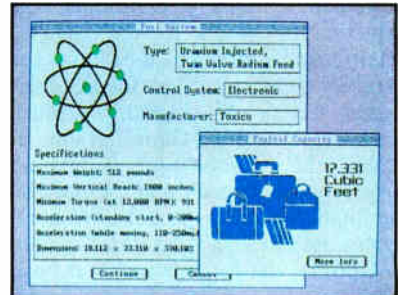

2. Create Hypercard®-like cards, linked to information in any file.



3. Use the Paint tool to create powerful graphics and buttons.

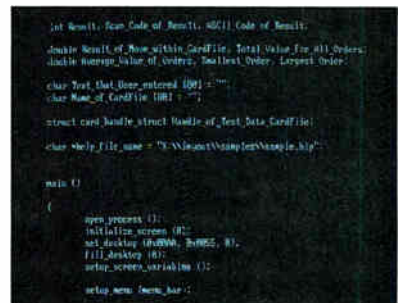

4. Layout creates real source code in five major languages.

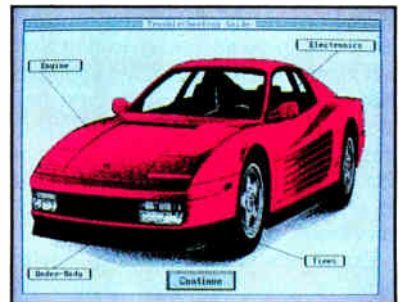

5. The end result: powerful, stand-alone programs, 70% faster!

Consequently, software systems that model the real world are hard to think about. I wish that DesignMachine made DSSD friendlier and more accessible.

DesignVision: A New Look

Apparently, I'm not the only one to make this observation. DesignVision, a Windows-based program, represents a new direction for Optima. DesignVision is an intelligent diagrammer that contains rudimentary support not just for DSSD diagrams, but also for diagrams associated with the Yourdon, Gane/Sarson, and other CASE methodologies. By rudimentary support, I mean that DesignVision can manipulate the symbols, but not the syntax used in such diagrams. According to Optima, the forthcoming version 2.0

will enable users to specify rules that govern diagrams (by the way, it will also support multiple users on a network).

The current version of DesignVision, although it has no knowledge of DSSD and so can't enforce the methodology's conventions, answers the need for a brainstorming tool that can gather a lot of information quickly and then feed it to DesignMachine. Optima hopes to make such exportation unnecessary; the company plans to move the methodology support that is DesignMachine's *raison d'être* into DesignVision.

DSSD aside, DesignVision offers interesting capabilities. In a sense, it is a shell that can potentially support a variety of CASE tools or, more generally, graphical databases. A SQL engine is at

the heart of DesignVision, and a SQL query mechanism affords flexible and convenient access to the data dictionary.

The symbols that can appear in the types of diagrams known to DesignVision appear as objects in that dictionary. You can extend the list of supported diagrams by creating new sets of symbols. These new symbols—which can be stylistic variations of existing symbols, or even bit maps—automatically become menu choices in the drawing system and slots in the database.

If you are thinking about getting started with DSSD, wait for the next release of DesignVision. What's needed is the right mixture of ease of use and rigor. Optima is moving in that direction, but it's not there yet.—*Jon Udell*

Excelerator

Excelerator's presentation graphs help users visualize an existing or proposed information system.

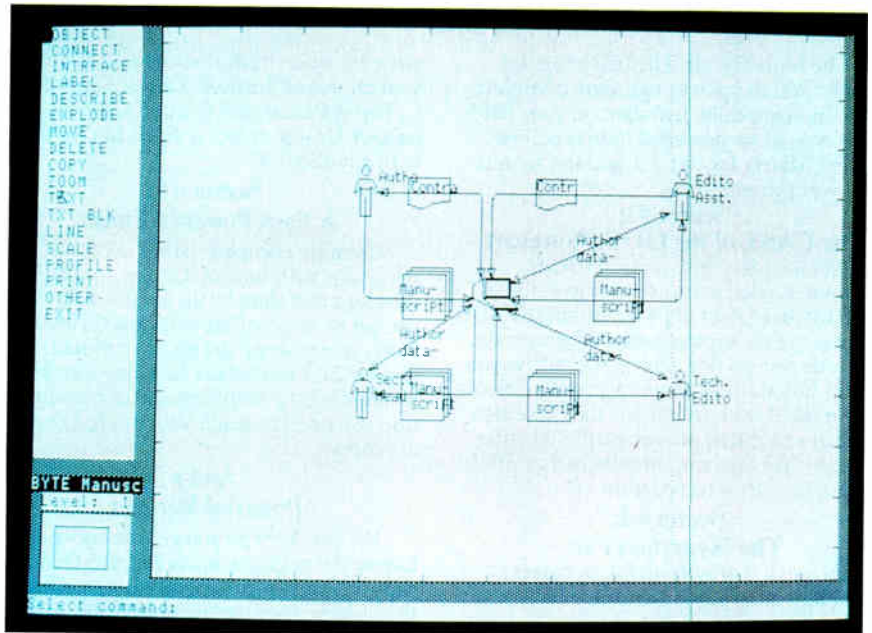

Index Technology's Excelerator provides a multiuser approach to the analysis and design of information systems. It offers the tools necessary to develop an overview of a database and an application that interacts with it. You can design functional "top-down" data-flow diagrams using a central project dictionary. Excelerator also provides detailed analysis reports and can help you prototype screens and reports.

Excelerator works in a LAN environment. A system manager creates projects, assigns users to project tasks, and assigns access levels. Users can read the central dictionary (if granted the privilege to do so), but they must mirror their portions of it to their own workstations in

order to update the contents.

Excelerator's presentation graphs help in the requirements definition phase. With these, analysts can help users to visualize an existing or proposed information system. Unfortunately, these graphs don't link to the analysis modules.

Given a set of requirements, you can model the data in one of two ways: by first building a dictionary of data records and elements, or by drawing a data-flow diagram and defining elements as you go. Excelerator supports Yourdon and Gane/Sarson data-flow diagrams and Chen and Merise entity-relationship diagrams. Constantine structure charts and Jackson structure diagrams are both available to help analyze process logic.

Excelerator provides analysis reports and checks for errors, such as unbalanced levels. Although Excelerator doesn't enforce a methodology that leads automatically to the production of a normalized database schema, one set of reports tells you what you'd need to do to put the tables you've defined into third normal form. The generic version of Excelerator that I worked with can transform database record descriptions into BASIC, C, COBOL, and PL/I. Other versions export to dBASE II or Telon or MicroFocus COBOL. All versions retail for \$8400.

I used Excelerator 1.84 to tackle our sample problem. I started by establishing a dictionary. I defined the records and

data fields and later related them to the diagrams I drew. Unlike some systems that lock you into completing every step, Excelerator let me exit whatever I was doing, go to another task, and return to define an element whenever I wanted. I also tried starting a project before defining a dictionary, and Excelerator let me define elements whenever I was ready.

For the most part, Excelerator lets you jump into a project almost anywhere in the system. If you see that you need a new process, you can add and define one on the fly. The same holds true for data elements. That's part of the real power of Excelerator: You can easily update and modify your project.

Not everything was easy, though. For example, diagramming in Excelerator requires a lot of patience. Although you can select either straight or piped connecting lines, Excelerator does a poor job of managing where they go. I spent most of my diagramming time redrawing crossed lines. Excelerator does offer a choice of either "system" or "user" ports, a function that lets you or the system choose the point on the diagrammed entity to which the line connects. But I found that I had to redraw virtually every connecting line. It would be better if Excelerator could route the connecting lines automatically. It would be better still if Excelerator could draw the diagrams automatically.

Excelerator handles errors well. For example, a level balance check yielded several data-flow errors and related all of them back to the parent process. From there, it was easy to correct the problem by simply adding the missing data flow.

Screen and report prototypes draw information from the data dictionary. If you defined all the data elements completely, Excelerator will handle data fields and filter input data automatically. Excelerator generates the BASIC, C, COBOL, or PL/I code that is necessary to create the screens you design. The prototype screens let you build a simple "screen data file" that you can use to demonstrate the screen. However, you can't connect the screens; each prototype screen stands alone.

Excelerator offers a powerful facility for querying the data dictionary, based on *entity lists*. Every element in the dictionary—data record, screen, diagram connector, and so on—is considered an entity. You can group entities into lists on which you can perform set operations such as union, intersection, difference, and subtraction. Using entity lists, you can answer questions like, "What modules will be affected if I change the name

of this data element?"

Generally, Excelerator is easy to use, although its user interface could be improved. Specifically, when you have to provide an element or record that's already defined in the dictionary, Excelerator usually gives you a list to choose from—usually, but not always. For example, when you add a data element, you normally say to what record it's attached. But Excelerator does not provide a list of the record names in its dictio-

nary, and if you misspell the record that you want the data associated with, the system creates a brand new record.

The company says an upcoming version 1.9 of Excelerator will correct that. Otherwise, I found Excelerator to be a solid tool for analysis and design. Its centerpiece—the data dictionary—cooperates nicely with the analysis modules and features a nice query mechanism.

—Dennis Allen
continued

**HAVING
TROUBLE
FINDING ALL THE
INFORMATION
YOU NEED
ON UNIX®?**

**TAKE THE FIRST STEP . . .
CALL DATAPRO TODAY!**

If you're looking for detailed analysis of the critical issues surrounding UNIX . . . if you need timely information on the products and key players in the industry . . . then turn to Datapro Reports on UNIX Systems & Software.

Updated monthly, this unique new information service is designed to help you discover the opportunities UNIX offers . . . decide how UNIX fits in your organization . . . optimize results while minimizing risk.

UNIX® is a registered trademark of AT&T.

datapro®

Each month, Datapro Reports on UNIX Systems & Software brings you in-depth analyses of everything new and noteworthy in the UNIX market. You receive the most up-to-date, thoroughly researched information available. Information you can put to use in planning your own UNIX strategies.

Find out how much of a difference Datapro can make to your decision-making: call us today at **1-800-DATAPRO** (1-800-328-2776) or use the reader service card.



IEW/WS

KnowledgeWare
IEW/WS: The Action
Diagram details the
processes of your system
in a hierarchical
structure. You can call up
help screens at any time.

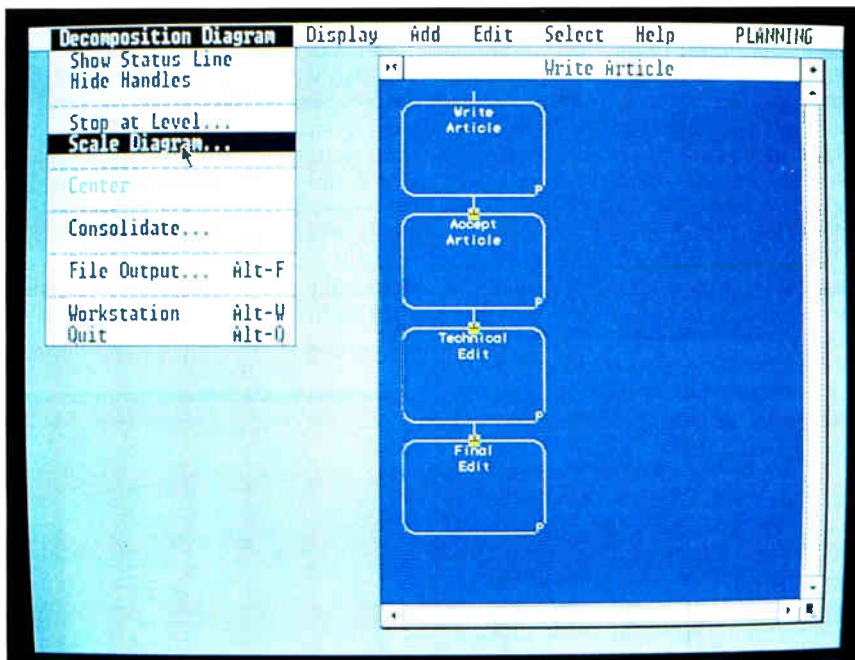

The KnowledgeWare Information Engineering Workbench/Workstation (IEW/WS) is a set of integrated CASE tools that run on microcomputers but are designed to develop mainframe COBOL applications for the IBM MVS environment.

These tools are designed for experienced analysts and developers who are familiar with CASE tools and who want to develop software products for corporate environments. I stress the words *experienced* and *corporate*: The IEW/WS software will not teach you how to use CASE tools.

The documentation is complete, and the program modules are replete with help windows, but that's not enough for an inexperienced user. KnowledgeWare offers optional training seminars.

The set of modules includes the Planning Workstation, the Analysis Workstation, the Design Workstation, and the Construction Workstation. These can be used separately or together. All the modules, except for the Construction Workstation, operate under a run-time version of GEM, Digital Research's graphical user interface. The Construction Workstation uses a run-time version of Microsoft Windows.

The hardware overhead is considerable. The IEW/WS modules require an 80286-based system or higher, a minimum of 5 megabytes of RAM (7 megabytes is recommended), 20 megabytes of hard disk space, an EGA or VGA display, and a Microsoft-compatible mouse.

GEM gives modules a common, intuitive user interface. You use a mouse to

access menu bars and pull-down menus, and to manipulate multiple windows.

Planning, Analysis, Design, and Construction

The Planning Workstation module is used to organize, model, and analyze knowledge about the goals, problems, functions, and resources of an organization. You can use it to model the existing flow of information, resources, or products within a system or to define the goals of a new system.

Information is entered into the Planning Workstation via a set of diagrams. Decomposition diagrams display a hierarchical view of the objects in a system. Matrix diagrams provide a list of the objects in the system and the interrelationship between the processes and the data they require. Entity diagrams provide a graphical display of the people, things, and ideas in the system.

One of the most powerful aspects of the IEW/WS modules is the Knowledge Coordinator. It uses a built-in set of over 1000 diagramming rules to restrict you from entering information that is logically inconsistent or incorrect. When I was building my decomposition diagrams, the Knowledge Coordinator pointed out several logic errors. For example, the Edit Article process produced an output (the edited article) without receiving any input (the rough draft).

This information is stored on the hard disk in the KnowledgeWare Encyclopedia. The Encyclopedia contains all the information and the relationships be-

tween the various objects in all the diagrams. This means that the diagrams will always be consistent.

The Analysis Workstation takes the information you entered into the Planning Workstation from the Encyclopedia and further refines it to create models incorporating the data and processes and showing their interrelationships.

By means of data-flow, entity-relationship, and action diagrams, you define what a particular area of the system does and how information is created, exchanged, and modified by the processes in your system. This module helps you determine which areas in the system need to be automated. For example, I found that the Receive Article function could not lead directly to the Accept Article function, so I returned to the Planning Workstation to modify the design.

The Action diagram is especially useful in detailing the processes of your system. It uses brackets and narrative notation (brackets can be nested) to represent the hierarchical structure of the processes and subprocesses in your system.

The Design Workstation also reaches into the Encyclopedia and, using the further refined information from the Analysis Workstation, models the processes and data in physical detail.

You use the Design Workstation to build screen layouts, physical files, database definitions, menus, and procedural logic. In terms of BYTE's fairly simple sample problem, I could have used the Design Workstation to create an Action

continued

Power

Incredible Value!

Don't take our word for it, take theirs...

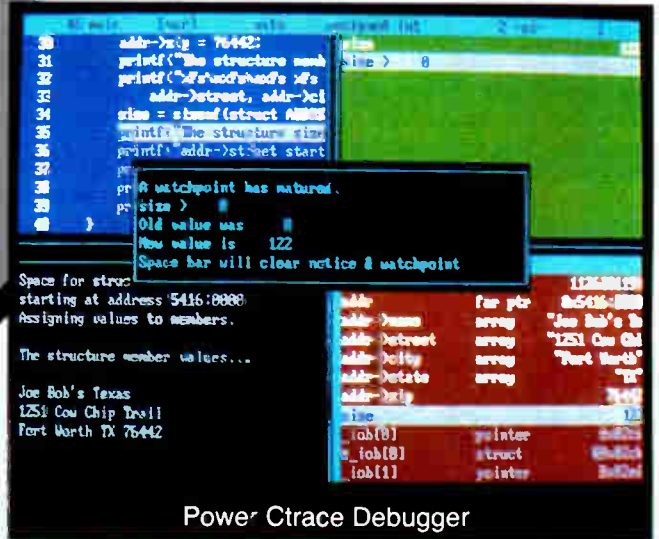

Power Trace Debugger

"Do you know what the underground bargain C compiler of this year is? It's the Mix Power C compiler. For under \$25 with shipping, it is one heck of a good compiler."

Victor Schneider
Dr. Dobb's Journal, June 88 (Letter to the editor)

"Overall, Power C's performance is remarkable for the price. Quite compatible with the Microsoft C and Turbo C "standards", Power C is a heavyweight contender in the educational, hobbyist, and perhaps even the professional market — at a bantamweight price."

Stephen Davis
PC Magazine, September 13, 88 (Review)

"Power C is an unbelievable product for \$19.95, and is very competitive with Turbo C, Microsoft C, and Microsoft's new Quick C in both features and performance. It is excellent for the beginner who wants to learn C, or for the experienced programmer who wants to develop professional applications. The manual alone is worth the price of this package, and the generous library source code and assembler offer adds to the value of it. If you have any desire to program in C, or want a more powerful C compiler, get a copy of Power C!"

Michael Cortese
Computer Shopper, August 88 (Review)

"The Ctrace debugger is where Mix really shines. It is magnificent. It's not only better than the stripped down debugger Microsoft includes with Quick C, it's better than the full debugger Microsoft provides with its high-end compiler (Codeview)."

David Weinberger
Computer Shopper, November 88 (Review)

Circle 219 on Reader Service Card



Technical Specifications

Power C includes: Power C compiler with integrated Make, Power C Linker, Power C Libraries (450 functions), the Power C book (680 pages), and support for...

- ✓ ANSI standard
- ✓ IEEE floating point
- ✓ 8087/80287 coprocessor
- ✓ auto-sensing of 8087/80287
- ✓ automatic register variables
- ✓ unlimited program size
- ✓ mixed model (near & far pointers)
- ✓ graphics on CGA, EGA, VGA, & Hercules

Optional Products:

- ✓ Power Ctrace debugger
- ✓ Library source code
- ✓ BCD business math

Order now by calling our toll free number or mail the coupon to Mix Software, 1132 Commerce Drive, Richardson, TX 75081.

1-800-333-0330

For technical support call: 1-214-783-6001
 Minimum System Requirements:
 DOS 2.0 or later; 320K memory; 2 floppy drives or hard drive.
 Runs on IBM PC, XT, AT, PS/2 and compatibles.

60 day money back guarantee

Name _____
 Street _____
 City _____
 State _____ Zip _____
 Telephone _____

Paying by: Money Order Check
 Visa MC AX Discover

Card # _____
 Card Expiration Date _____

Computer Name _____ Disk Size 5 1/4" 3 1/2"

Product(s) (Not Copy Protected)

<input type="checkbox"/> Power C compiler (\$19.95)	\$ _____
<input type="checkbox"/> Power Ctrace debugger (\$19.95)	\$ _____
<input type="checkbox"/> Library Source Code (\$10.00)	\$ _____
(includes assembler & library manager)	
<input type="checkbox"/> BCD Business Math (\$10.00)	\$ _____

Add Shipping (\$5 USA - \$20 Foreign) \$ _____
 Texas Residents add 8% Sales Tax \$ _____
 Total amount of your order \$ _____

Diagram and layout screens and to define the data structure from scratch.

Actually, I used the Design Workstation to create menus and screen layouts that corresponded to some of the paper forms that now accompany each manuscript. My design mirrored the existing paperwork system.

After you've gone through all the previous modules and refined your system design, you can use the Construction

Workstation to generate source code. The Construction Workstation takes all the design specifications from the Encyclopedia, adds instructions for code generation depending on the type of system you have designed and the target computer system, and generates the code.

The IEW/WS tools do not restrict you to one particular methodology. Rather, they incorporate general principles from many standard software development

techniques. You are free to use Martin, Yourdon, DeMarco, Gane/Sarson, or other methodologies.

The KnowledgeWare IEW/WS tools are sophisticated, powerful, and complex. They are tailored for mainframe software development. This may be the most comprehensive set of CASE tools available for creating mainframe COBOL applications.

—Stan Wszola

MicroStep

MicroStep produces executable application programs based on your data-flow diagrams. These diagrams emerge through simple point-and-click placements of icons.

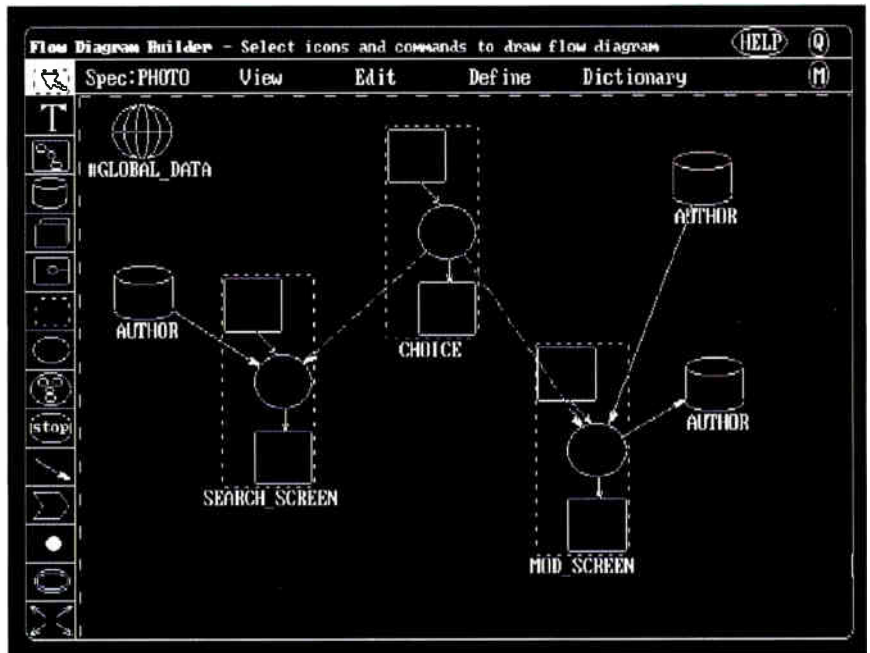

Syscorp's MicroStep offers what many people expected all along from CASE tools: executable application programs generated from graphical specifications. MicroStep creates PC-environment C source code and feeds it to the Lattice compiler supplied with the system.

Syscorp markets the product for business system developers, including MIS managers, who want to speed application development and bypass programming-department backlogs. The trade-off? It's a self-contained system that doesn't support large-scale structured analysis and design, and it can't bridge to external data managers and software development environments.

Syscorp describes the underlying methodology as Yourdon "with extensions," meaning the software shares a Yourdonian penchant for up-front data-flow diagramming, modeling, and analysis, but extends this procedure to include code generation.

Syscorp's three-day training seminars

are held at its Austin, Texas, headquarters. The \$5000 price of the software doesn't include this training, which costs an additional \$750 (customer-site training is available at negotiated rates).

In addition to formal seminars, Syscorp offers an accessible and helpful technical-support staff for telephone questions. Also, tutorial and training manuals arrive with the software. Either can be used as self-guided instruction materials.

Taking the Plunge

After two days of working through Syscorp's comprehensive training materials, I felt comfortable with the interface's icons and the sequence of steps necessary to generate code. But I needed further help from Syscorp's training staff before I could make the leap from training exercises to building pieces of our editorial department model.

You begin with flow diagrams that outline how data will pass through the

application. Flow diagrams emerge through simple point-and-click placement of data-object and connector icons from MicroStep's diagram builder. Some icons, such as those representing databases, invoices, and processes, are easily recognizable. Others, such as the *subspecification marker* (a symbol that links to a submodule), may be unintelligible at first glance.

Next, you define data structures by establishing fields within the databases you created in the flow diagram. Using icons and dialog boxes, MicroStep coaches you through naming fields and notes whether they will hold text or numerical data. New fields are placed to the right or left of existing fields using the appropriate icon. MicroStep enables you to create data dictionaries that can be imported into other applications.

Then you develop the screens and reports that users of your application will see. A simple but adequate text mode lets you enter copy, such as name and address

CASE TOOLS

boilerplate fields on invoices. Text positioning is a simple matter of placing an icon in the desired area. Once your text is entered, you can easily move it around the screen to experiment with various layouts. Creating formats for user screens is similarly flexible. Taking cues from MicroStep dialog boxes, you develop screen elements with the text mode or the drawing icons, which let you "rubberband" boxes and rectangles.

Finally, you describe the application's computations and processing logic using an Activity Builder screen that displays a series of menu choices that you simply point to and click on with your mouse.

When you've completed your specification, MicroStep's analyzer tells you if your specification is incomplete or contains inconsistencies. For example, in my author-lookup function, I added a lookup condition to flag the author-not-found case, but I failed to define it. The checker found the problem and told me how to fix it. Once you have developed and checked your specification, you can instruct MicroStep to generate and compile the code.

Before you attempt to run MicroStep, be sure you have a full 640K bytes of RAM. Syscorp instructs you to remove network software and most TSR utility packages. I ran MicroStep with a 20-MHz 80386 clone and was glad to have the power.

The version that I evaluated (1.3) didn't accommodate either extended or expanded memory. Syscorp plans to support extended memory in future versions but currently has no plans to address expanded memory. MicroStep also requires EGA or Hercules video support and a Microsoft or compatible mouse.

The application that I eventually produced was alarmingly big—nearly a half-megabyte, despite being a small piece of our sample project. (The company says that it's working to reduce the overhead of MicroStep-built applications.) And the functions and variable names in the generated code are cryptic. It's effectively object code rather than source code. Syscorp's approach requires you to maintain your MicroStep application at the specification level.

MicroStep is most suited to non-programmers who want to develop small- to medium-size database applications. The current version doesn't support the development of networked applications. The company says that future releases will generate applications for multiple users and allow multiple users to develop a single application.—Alan Joch

continued

C for the 8051 Compare:

Benchmark Results —Sample program: Eratosthenese sieve
Program from BYTE (1/83) expanded with I/O and interrupt handling.

	Archimedes ICC51 v2.20A	MCC51 v1.2	FRANKLIN C51 v2.1
Compilation time	12 sec ✓	18 sec	17 sec
Linkage time	29 sec	9 sec	6 sec ✓
Execution time	11.45 sec	9.00 sec	0.88 sec ✓
Total code size	5318 bytes	3798	1726 ✓
Sieve module size	736	1021	541 ✓

Call now for your free DEMO disk.



SOFTWARE, INC.

888 Saratoga Ave. #2 • San Jose, CA 95129
(408) 296-8051 • FAX (408) 296-8061

Europe A: (0222) 25 36 26 B: (010) 22 34 55 CH: (032) 41 01 11 D: KEIL (089) 46 50 57 DK: (02) 65 82 00 F: (1) 64 07 85 64 GB: (0962) 73 31 40 NL: (01858) 16133 S: (040) 92 24 25 Far East: Aust: (61) 04 65 41 873 R.O.C.: (02) 76 40 2156 N.Z. (64) 04 694 129 (fax).

NOW!! A high speed stand alone copier for 5¼ and 3½ inch diskettes duplicates virtually any format

When your requirements call for unattended, high speed duplication of virtually any 5¼ or 3½ inch diskette, Victory's Stand-Alone V3200 Duplicator is what you need. The reliable, desk-top design is ideal for both office and industrial use.

- The V3200 features:
- Simple push-button operation
 - Switchable 3½ and 5¼ inch copy drives
 - Support for most formats including IBM, Apple, Amiga, and Atari
 - Copy speed up to 250 disks/hour
 - Batch Processing multiple jobs with different formats
 - Production statistics display
 - Exceptional copy quality

Top quality copying
Victory Duplicators actually improve the quality of copies during duplication. The V3200 validates the integrity of each master disk and verifies copies bit for bit to ensure quality. The system automatically sorts copied disks into an accept or reject output canister.

Do-it-yourself service
Victory systems have built-in diagnostics to test and maintain the system. A preventive maintenance indicator alerts you at regular intervals to check drive alignment and clean drive heads using utilities included with the system.

The modular design of the V3200 and Victory's overnight shipment of replacement parts let's you service the system at your location, avoiding costly offsite repair and downtime. Victory stands behind the V3200 with a four month warranty.

Call (800) 421-0103. And ask about Victory's family of affordable Autoloaders.



Victory Plaza
1011 E. 53½ Street
Austin, TX 78751-1728
(512) 450-0801

In Europe call BFI: Paris (33-1) 45330137, Frankfurt (49-6074) 27051, Milan (39-2) 33100535, England (44-6) 2288246, Loadplan-London (44-1) 200-7733, Loadplan-Australia (61-3) 525 4088



CALL FOR VIDEO

Teamwork OS/2

Teamwork OS/2 smoothly integrates analysis and design tools into a windowing environment. The focus is on data-flow diagrams and DeMarco methodology.

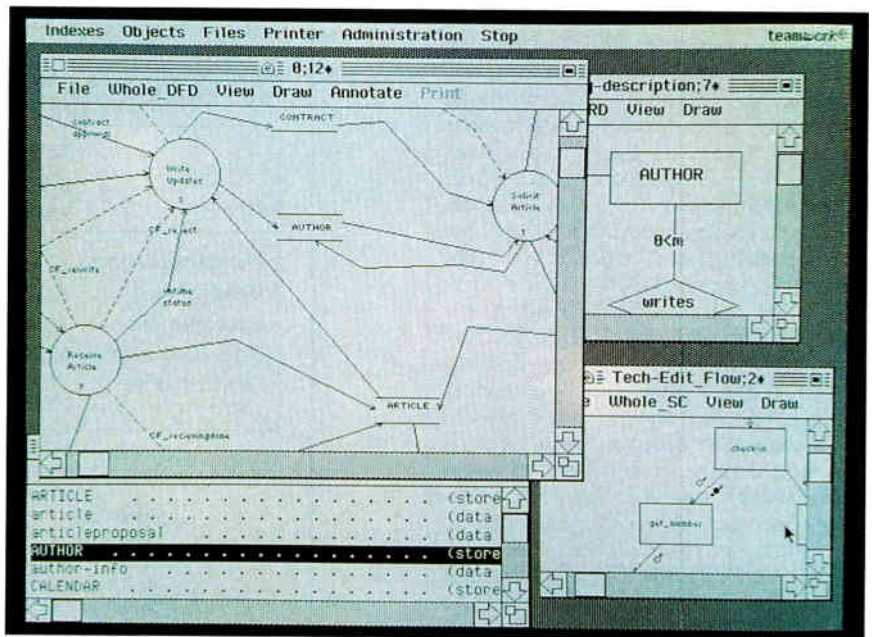

Cadre's Teamwork OS/2 has an edge on the rest of the PC CASE pack. It takes advantage of OS/2 to provide a very comfortable, multiwindowed environment you just couldn't hope to support with DOS. One warning, though: The product likes a lot of memory—I kept getting memory-limit crashes on an IBM PS/2 Model 80 with 6 megabytes of RAM until I set up a large swapping area on disk and disabled all external processes.

Teamwork integrates three modules into this environment: Teamwork/SA, for structured analysis; Teamwork/IM, which supports information modeling; and Teamwork/SD, for structured design. Our review package also included Teamwork/RT, an optional module that adds real-time extensions to SA.

Analysis Tools

The structured-analysis tool enables you to create data-flow diagrams and process specifications according to the DeMarco methodology. The primary interface to this system is the data-flow diagrammer. It's a graphical editor that lets you create processes, stores, and terminators, and link them with data flows. Each store and data flow eventually requires an entry in the data dictionary, but Teamwork does not force you to define each element as you draw. I was able to graphically sketch the data flows of the current editorial system in a few hours; refinements took several days.

To define a data flow or store, you bring up the Data Dictionary Entry (DDE) editor. Unfortunately, each element you define requires that you fire up

a new instance of the DDE editor, which quickly gobbles memory and takes several seconds, even on a PS/2 Model 80. If you try to define a number of objects by this method, the screen quickly fills with DDE editor windows that each describe only a single element. The only efficient way to define multiple elements is to create an external dictionary with a word processor and import the file.

The data-flow diagram editor supports leveled DFDs, allowing you to create child DFDs for each process. But because Teamwork doesn't automatically balance parent and child diagrams, revisions are complex. Instead of just adding a new data flow to a parent and having it appear on a child process, you must add it to both and run a check to ensure that the diagrams balance. Cadre, which promises a multiuser version of Teamwork OS/2 in the near future, purposely designed the diagrammer without the automatic inheritance to facilitate its use in a multiuser environment.

When you've broken a DFD down to its primitive processes, you use a text tool (the P-spec editor) to describe each primitive. A primitive process is a function like Assign Article Number, which cannot be decomposed readily and is easily described in structured English or pseudocode.

Analysts working with real-time systems often have special requirements not covered by formal DFDs. The Teamwork/RT module adds control-oriented extensions: control flows, which are defined in the data dictionary; and control specifications (C-specs), which specify

control-oriented processes.

C-specs describe elements that process control flows. Their child diagrams are either state-transition diagrams (STDs) or one of three matrix types: state-event matrices (SEMs), decision tables (DTs), or process-activation tables (PATs). These matrices are essentially logic tables that describe how control inputs generate control outputs.

A first pass at our sample system did not require C-specs, so I was able to describe the system adequately using only standard structured-analysis elements. RT's extensions would be most valuable for continuous-input, time-critical applications that require building sequence information into the model.

You can look at the system model from another perspective with the entity-relationship diagrams (ERDs) of Teamwork/IM. Entities and relations are defined as DFD stores in the common data dictionary; attributes are defined as data objects. This gives you a link between the ERD and the DFD through the data dictionary.

Key attributes of each entity in the data dictionary are specified with simple syntax; adding a "@" to the beginning of an attribute name designates it as a key. You can specify both logical and physical attributes (e.g., field length).

Teamwork/IM won't normalize your data model for you, but the checking facility can point out the changes that a normalized model would require. The checking facility produces helpful, clear report files, and you can also set the

continued



"A PC based CASE tool
under Microsoft® Windows"

System Architect, a new standard for **CASE** price and performance.

PERFORMANCE

Multiple Methodology Support. Data Flow - DeMarco/Yourdon, Gane & Sarson and Ward & Mellor(real-time); Structure Charts; Entity Relation Diagrams; Decomposition Diagrams; Object Oriented Design(optional); State Transition Diagrams; Flow Charts; Presentation Annotation.

Data Dictionary/Encyclopedia. Comprehensive Data Dictionary/Encyclopedia integrated with diagramming capabilities of the package; Open architecture with dBase III Plus™ file formats (dBase III Plus not required).

Microsoft® Windows. A user friendly standard interface, in a windowed mouse driven environment with drop down menus and pop up windows. (Chosen by IBM to be the basis for the OS/2 User Interface).

Network Version. Available with complete record and diagram locking: Novell; StarLAN; 3Com and others.

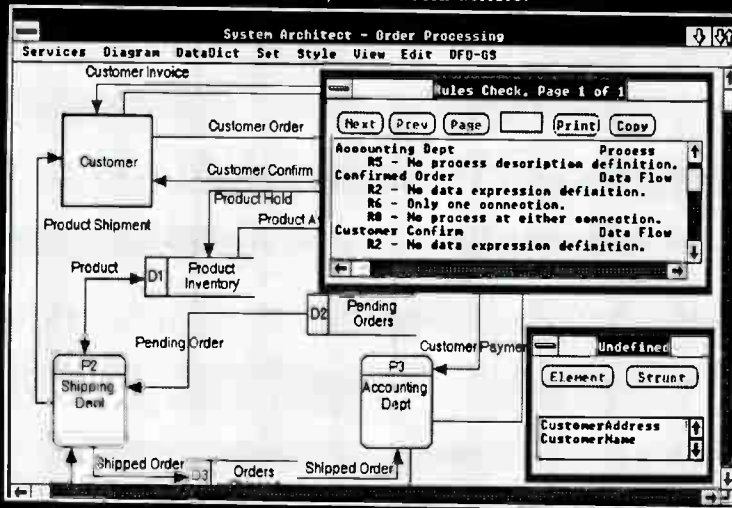

- User Defined Attributes
- Requirements Tracking
- Test Plan Tracking
- Change Requests
- Rules and Balancing
- Automatic Leveling
- On-Line Reporting
- Import/Export Capability
- Graphic Clipboard
- Context Sensitive Help

PRICE

\$1395 for first copy; volume discounts to \$895 for 51st copy.
30 day money back guarantee.

System Configuration: IBM® PC's and compatibles, Microsoft® Windows, 640K main memory, 10 MB Hard Disk recommended. Microsoft® Windows compatible input/output devices.



POPKIN
SOFTWARE & SYSTEMS
INCORPORATED

111 Prospect St., Suite 505
Stamford, CT 06901
(203) 323-3434 FAX (203)327-7652

System Architect logo is a trademark of Popkin Software & Systems Incorporated. IBM is a registered trademark of IBM Corporation; Microsoft is a registered trademark of Microsoft Corporation; dBase III Plus is a trademark of Ashton-Tate; 3Com is a trademark of 3Com Corp.; Novell is a trademark of Novell Inc. All specifications and prices are subject to change without notice at the sole discretion of the company. Product delivery is subject to availability.

thoroughness of each check.

Although I started with the SA tool and continued with IM, no sequence is enforced. IM generally leads you to normalized data, while SA and RT properly define your process requirements. Integration between the three analysis tools (SA, RT, and IM) is solid. You can bring up a window containing a related ERD from a store on a DFD, and you can access the dictionary entry for any diagram element from a pop-up menu. All the modules work from a single model database; you can find all occurrences of each DDE with a query facility.

One soft spot in Teamwork's integration is that elements are linked only implicitly, by name. If you change the name of an element, it loses its associated DDE and all its links.

Structured Design

The result of the analysis phase is a specification document, in the form of a single data dictionary and the various process descriptions. Teamwork's fourth module, Teamwork/SD, aids the designer in converting the specification document into a workable design.

Teamwork/SD follows the Yourdon/Constantine design methodology. It makes use of structure charts (SCs) and module specifications (M-specs), which describe how program modules relate and what functions they perform.

The designer's link between analysis and design is the data dictionary. The dictionary's store definitions define *data-only* modules in the SC, and data- and control-flow definitions define SC *couples*. All the process descriptions from the analysis phase can be viewed, but they have no link to the SC or the M-spec except through the common data dictionary. This is another of Cadre's design choices. The company believes that automatic process diagram conversion does not lead to effective designs.

The final result of structured design is the structure chart and the M-spec that describes each module. Ideally, each module will be single-functioned and as independent as possible. Because the store definitions from the data dictionary loosely represent a database schema, both data and process descriptions can be passed to the implementation phase.

In addition to the analysis and design

modules, Teamwork OS/2 also includes Cadre's IPSE toolkit. The toolkit lets you access all the entities in the Teamwork central database with external code. It also lets you customize menus in the environment. The combination lets you build in your own custom functions. Cadre offers a library of user-contributed functions written with IPSE at no charge.

There are some nice extra touches: automatic generation control, status labels for system objects, and a "baselining" facility that lets you lock in a model version are among them. There are also a few rough edges: Screen updates are not very clean, and the mouse interface runs counter to standard Macintosh, Windows, and Presentation Manager conventions.

Overall, Teamwork OS/2 is a sharp package. Multiuser support through LAN Manager will make it even sharper. Any design or analysis team with a firm background—and a firm belief—in DeMarco and Yourdon methodologies would do well to give Teamwork a close look.—*Steve Apiki*

continued

Computers For The Blind

Talking computers give blind and visually impaired people access to electronic information. The question is how and how much?

The answers can be found in "The Second Beginner's Guide to Personal Computers for the Blind and Visually Impaired" published by the National Braille Press. This comprehensive book contains a Buyer's Guide to talking microcomputers and large print display processors. More importantly it includes reviews, written by blind users, of software that works with speech.

This invaluable resource book offers details on training programs in computer applications for the blind, and other useful information on how to buy and use special equipment.

Send orders to:

National Braille Press Inc.
88 St. Stephen Street
Boston, MA 02115
(617) 266-6160

\$12.95 for braille or cassette, \$14.95 for print. (\$3 extra for UPS shipping)

NBP is a nonprofit braille printing and publishing house.

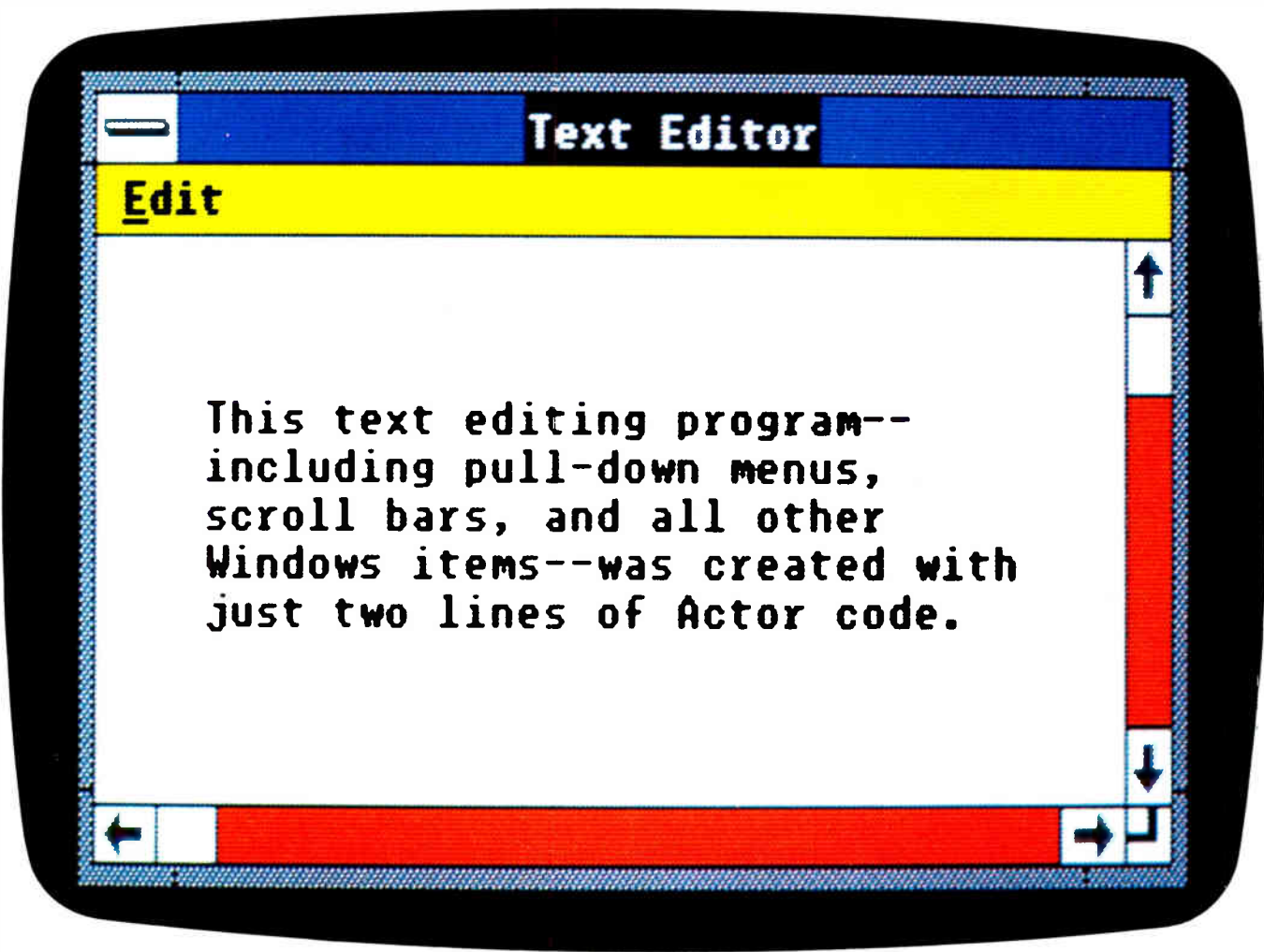

Actor™ is the fastest, easiest way to develop applications for Microsoft® Windows. The reason—Actor's reusable toolkit of objects such as dialog boxes and edit windows. It more than doubles your overall productivity, making Actor an essential part of any Windows development project.

A full-featured, interactive, Windows-based programming environment, Actor provides immediate compilation, interactive testing, and source-code debugging. You can use it to produce fast standalone applications that support all Windows features, including Dynamic

Data Exchange (DDE) and expanded memory.

Actor is a powerful, pure object-oriented programming language. It's all you need to develop complete Windows applications. You also have the option to dynamically link Microsoft C code to your Actor program.

Either way, it's the fastest way to produce everything from prototypes to complete development projects. No wonder so many developers are already using Actor.

Call us now for more information.

The sooner you do, the sooner you can speed up *your* Windows development work.

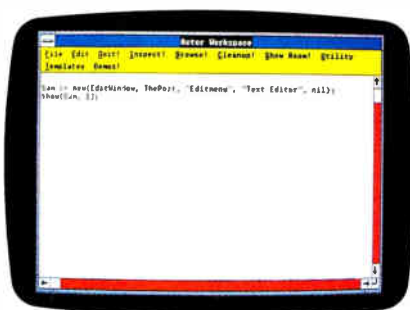

These two lines of Actor code are all it took to produce the Windows text editing program you see above. Just think what you can do with a few more lines.



The Whitewater Group®

600 Davis Street
Evanston, Illinois 60201 U.S.A.
(312) 328-3800
FAX (312) 328-9386

(800) 869-1144

Two New Products For C or Actor Programmers

WinTrieve™

ISAM indexed file manager. Only \$395, no royalties.

Whitewater Resource Toolkit™

Edit dialog boxes, bitmaps, icons and more. Only \$195.

© Copyright 1989, The Whitewater Group

Circle 321 on Reader Service Card
World Radio History

POSE

POSE's data-flow diagrammer in action. Materials (in this case, an article) flow in from the external entity (an author) at left to be processed at step 1. Upon receipt of the article, data flows out of process 1 to update data stores at right.

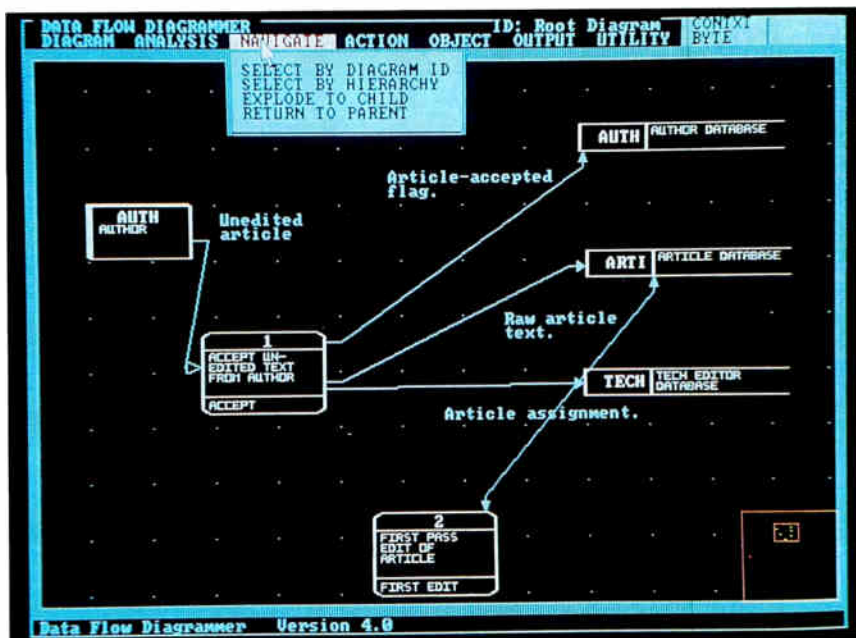

If I may be allowed a pun, POSE (from Computer Systems Advisers) is imposing. It comes in a stack of plastic boxes—each with disks, a tutorial manual, and user's guide—that stood as high as the tower 80386 system I ran everything on. If you install the entire system, you'll need about 10 megabytes of free disk space and most of a morning.

However, one of POSE's strengths is that you don't necessarily have to buy the whole thing. In fact, the company promotes the purchasing of POSE module subsets. The nine components of POSE (which stands for Picture-Oriented Software Engineering) fall into two groups: the data method and the process method.

Members of the data method group are the data model diagrammer (DMD), the data-model normalizer (DMN), the logical-database designer (LDD), and the database aid (DBA). You use these modules to design and analyze the data you need to manipulate. How that data is manipulated is left to the modules in the process method group: These modules are the data-flow diagrammer (DFD), the structure-chart diagrammer (SCD), the decomposition diagrammer (DCD), and the action-chart diagrammer (ACD).

The Data Modelers

DMD is the heart of POSE's data method modules. This is where you do your actual database design. You design graphically; entities are labeled boxes, and relationships are connecting lines anchored to the boxes by special symbols that indicate the type of relationship (e.g., one-to-many and one-to-one). You

"crack open" an entity by pointing and clicking, which takes you to that entity's attributes-definition screen. Here you enter the attribute names, and a point-and-click on an attribute name takes you to a screen where you describe the details of an attribute (e.g., numeric or alphanumeric, field width, and so on).

Once you're satisfied that you have properly defined your database with DMD, it's time to normalize the database. DMN requires that you enter the functional dependencies of attributes within entities. Then you hand it your data model and push a button, and out pops a structured listing of your normalized database, along with any inaccuracies or inconsistencies that DMN was able to locate. If DMN finds errors, you have to return to DMD, fix them, and have another go at normalization.

When I first fed my model to DMN, the output showed a number of attributes tagged as foreign keys. I investigated back in DMD, and I found that I had improperly designated a pair of relations. I made the correction, reran DMN, and all was right with the world.

LDD deserves a better name. Perhaps "transaction analyzer" would be more suitable. The idea is this: Now that you have designed your database, can it support the transactions that your project will generate? Where DMD let you model the database, LDD lets you model the transactions on the database using transaction usage maps.

A TUM is a window onto a portion of the database, consisting of entities from the database connected to one another

via access paths. Each access path indicates an operation on its destination entity. So, using our scenario, the transaction corresponding to logging in an article would modify the article entity, and the article entity would be connected to the contract entity by an update access path. This update path represents the modification to the author's contract data made when an article is received.

LDD's real power comes from its load analysis. As you build access paths, you set up ratios that determine how many accesses of the destination entity would be "triggered" by an access on the source entity. Using LDD, you might discover potential bottlenecks that will require optimization of the database.

When all the database analysis is done and it's time to hand your programmers something to work with, you run DBA. The DBA module generates source-code-ready schemata for a number of the more popular database systems. My system came with dBASE II, SQL/DS, ADA-BASE, and FOCUS.

The Process Modelers

The process-oriented modules aren't as tightly integrated as the data-oriented ones are. DCD is little more than a controlled drawing program. With DCD, you can create hierarchical diagrams of programs, data files, or even chain-of-command trees. This is a good place to organize ideas, to determine what modules you must link together to create a final program, or to build an organizational chart. But DCD doesn't communicate with the data dictionary; any graph-

ics package would do.

DFD helps you analyze how you will be using the database you designed over in DMD. Using DFD to manipulate network diagrams, you define what processes you'll need and how they fit together. Data or materials flow into a process, the process manipulates the data, and the results flow out to be worked on by subsequent processes. What you end up with is a diagram of your project's circulatory system.

It is not necessarily the case that you begin using POSE with DMD. POSE is more informal than that. You might begin by using DFD to simulate how your application works—what processes it consists of—and from that determine what data to put in your model.

SCD decomposes programs into their composite modules and diagrams the interaction between those modules. Where DFD represents sequence, SCD represents hierarchical structure.

ACD is a top-down pseudocode generator. It handles pseudocode in "brackets" that enclose procedures. There is a connection between ACD and the rest of POSE. You can create a procedure that accesses a data file by inserting a "DB-Box." The DB-Box needs to refer to one of the entities you defined way over in DMD, and, sure enough, ACD offers a menu from which you can select from a list of the entities defined there.

The Screen Report Prototyper is the module that POSE includes in both its data method and process method groups. SRP provides a means of rapidly developing prototype entry screens or reports. SRP draws information from DMD so that as you construct a screen display, you can keep track of field widths and data types. The results are handy for users and programmers alike: the mock-up gives users an idea of how data-entry screens will look when the program is complete, and programmers know what to work toward.

The POSE system is consistent. Once you're at ease working in one module, you won't have any trouble mastering the mechanics of the next module. POSE ran smoothly on my Tangent 33-MHz 80386 system, which probably favorably influenced my impression of it. Why? Because I often found myself hopping back and forth between modules, and with all that speed, there wasn't much delay. POSE may not be so swift on a 12-MHz AT. POSE would certainly benefit from a multitasking operating system like OS/2, where you could have several windows open simultaneously.

—Rick Grehan

COMPANY INFORMATION

Cadre Technologies, Inc.
(Teamwork OS/2 3.0)
222 Richmond St.
Providence, RI 02903
(401) 351-5950
Inquiry 1071.

Computer Systems Advisers, Inc.
(POSE 4.0)
50 Tice Blvd.
Woodcliff Lake, NJ 07675
(800) 537-4262
(201) 391-6500
Inquiry 1072.

Index Technology Corp.
(Excelerator 1.84)
One Main St.
Cambridge, MA 02142
(617) 494-8200
Inquiry 1073.

KnowledgeWare, Inc.
(IEW/WS)
3340 Peachtree Rd. NE
Atlanta, GA 30026
(404) 231-8575
Inquiry 1074.

Nastec Corp.
(DesignAid 4.3)
24681 Northwestern Hwy.
Southfield, MI 48075
(800) 872-8296
Inquiry 1075.

Optima, Inc.
(DesignVision 1.7,
DesignMachine 2.0)
1300 Woodfield Rd.
Schaumburg, IL 60173
(312) 240-1888
Inquiry 1076.

Syscorp International, Inc.
(MicroStep 1.3)
9420 Research Blvd.,
Suite 200
Austin, TX 78759
(512) 338-0591
Inquiry 1077.

The key term in the phrase "computer-aided software engineering" is "aided." The current generation of CASE tools provide aid in the form of a data dictionary that describes the components of a software project as it moves through its life cycle. If you're developing a large information system, you may find that using a CASE tool to establish and maintain such a dictionary helps you to analyze the system and keep track of its components during design and implementation.

But which CASE tool? The choice hinges, primarily, on methodology—on the techniques employed to acquire and organize the information stored in the dictionary. If you already favor, say, DeMarco or DSSD methodology, you may want to look at DesignMachine or Teamwork OS/2. But if you're new to CASE, you'll need to explore the different methodologies and determine which suits your needs. Talk to practitioners. For a more complete list of CASE products, see "A CASE Workshop" in the April BYTE; the vendors listed there will put you in touch with users whose experiences you can tap.

CASE tools are expensive, but if you use one, you'll find that your investment

in the underlying methodology—the cost of training and the overhead involved in applying the techniques—far outweighs the cost of the tool.

After methodology, consider your target platform. Systems oriented toward the development of mainframe COBOL applications (e.g., DesignAid, DesignMachine, IEW/WS, and Excelerator) may not be appropriate if you're developing multiuser LAN applications for the PC. A product that targets the PC, such as MicroStep, won't be much help in a mainframe environment. Again, we recommend that you talk with users engaged in projects similar to your own.

Finally, consider the phase of your design/analysis cycle that would benefit most from CASE. IEW/WS can carry you neatly from corporate philosophy to COBOL, but every user won't need every module. MicroStep, on the other hand, will limit you to the design phase.

CASE isn't magic. It's a way to help manage the complexity of large-scale information systems. The tools, like the methods they implement, aren't final solutions; they're aids. Approach the subject with reasonable expectations, and you'll benefit from the assistance that CASE tools can provide. ■

CMO And Access Micro Systems



ACCESS TURBO XT/10

- 8-bit 8088 Main System Board.
 - Dual 4.77/10 MHz switchable CPU speed.
 - 512KB RAM, expands to 640KB on motherboard.
 - Eight 8-bit slots.
 - Supports 8087-10 Math Coprocessor.
 - One parallel port, serial port and game port.
 - 102-key "AT" style enhanced keyboard.
 - 360KB 5.25" floppy disk drive.
 - Four 1/2 height drive bays.
 - Dual floppy controller, supports 720K format.
 - 150 watt high capacity power supply.
 - Desktop case with Turbo and Power LED Display, keyboard lock, hardware and Turbo switch.
 - IBM XT compatible EROS BIOS.
 - Clock/Calendar with Battery Back-up.
 - Monitor not included.
- Low profile case available.*

30 Day Money Back Guarantee
1 Year Limited Warranty.

\$539

See chart below for Video and Hard Drive Options for

ACCESS Turbo XT/10 (Add To Purchase Price)

	1 Floppy	20MB-65m	40MB-28ms
Mono	\$139.00	\$409.00	\$589.00
CGA	\$339.00	\$599.00	\$779.00
EGA	\$499.00	\$769.00	\$959.00

The Workstation

In addition to operating as a stand alone computer system, the ACCESS Turbo XT/10 is an ideal solution for your multi-user applications. The ACCESS Turbo can be configured as a Workstation on the Novell, 3Com, Unix and Xenix environments. Call TOLL FREE 800-233-8950 and talk with our trained and authorized sales and support staff. Look at our Networking section for a sample of products offered in the Novell Networking Arena.

Power System Or File Server



ACCESS 386/20 TOWER

- 32-bit 80386 Main System Board.
- Dual 8/20 MHz switchable CPU speed.
- 1MB 32-bit DRAM subsystem.
- System memory expandable to 9MB.
- Eight slots: Two 32-Bit, Five 16-Bit, One 8-Bit.
- 8MHz bus clock, wait state selectable.
- Supports 80387 Math Coprocessor.
- One parallel port and two serial ports.
- 102-key "AT" style enhanced keyboard.
- 1.2MB Hi-density 5.25" floppy disk drive.
- Five 1/2 height drive bays.
- Western Digital 1:1 interleave controller.
- 200 watt high capacity power supply.
- Vertical Tower case with Turbo and Power LED Display, keyboard lock, hardware and Turbo switch.
- COMPAQ compatible, 32% faster than COMPAQ 386.
- Landmark V0.99: 26.5 - 27.3
- Norton S1 Rating V4.0: 22.5.
- 64K Bios, setup and diagnostic utility built-in.
- Zero Wait State Operation.
- Clock/Calendar with Battery Back-up.
- Monitor not included.

\$2099

See chart for Video and Hard Drive Options For ACCESS 386/20 Tower (Add To Purchase Price)

	40MB-28ms	159MB-23ms	338MB-18ms
Mono	\$599.00	\$1399.00	\$1899.00
EGA	\$899.00	\$1699.00	\$2199.00
VGA	\$999.00	\$1799.00	\$2299.00

FREE ACCESS Software Utilities Provided.

NETWORKING

ACCESS 386/20 Tower File Server with 2MB, 10MHz, 512K Workstations, Monochrome Displays, Arcnet Interfaces, Loaded Novell Network.

ASSEMBLED • TESTED • CERTIFIED

Ready to Turn ON!

4-User 40MB Server ELS I...\$6,899.00

6-User 80MB Server ELS II...\$9,699.00

8-User 159MB Server ELS II...\$12,499.00

For larger systems call us. We can custom configure any size network.

Call Our Trained Networking Staff To Help You Today.

Novell Software

ELS 4-User Level 1...\$549.00
ELS Level-II V2.15...\$1,299.00
Advanced NETWARE 286 V2.1...\$2,399.00
SFT NETWARE 286 V2.15...\$3,499.00

Interface Cards

ARCNET (8-bit) PC/XT...\$129.00
ARCNET (16-bit) 286/386...\$299.00
ARCNET MCA: PS/2...\$299.00
Active Hub...\$299.00
ETHERNET (8-bit) PC/XT...\$239.00
ETHERNET (16-bit) 286/386...\$289.00
ETHERNET MCA PS/2...\$359.00
Standard Micro Systems...Call



Computer Mail Order. Since 1981—Low Prices, Large Selection, Fast Service.

.. Price and Power!

**Great
Packages
Ready
To GO!**



**NO ONE HAS PROVIDED
BETTER SERVICE
TO MORE CUSTOMERS
FOR AS LONG AS CMO.**

**8 YEARS
AND STILL GROWING**

**AT CMO, GOOD SERVICE
AND LOW PRICE
ARE A TRADITION.**

THE COMPANY

CMO is proud to be one of the few companies approved to represent the **ACCESS** Micro System product line. Thousands of **ACCESS** Micro Systems have been sold and they have a proven record of performance in homes and offices just like yours.

Our **ACCESS** systems utilize state-of-the-art components and are custom-assembled to fit your needs, your workstyle, and your budget. Plus all 286's and 386's come with a 3 year limited warranty.

Each and every **ACCESS** system goes through an extensive quality control checklist and is burned-in a minimum of 48 hours, assuring you trouble free performance.

Whenever you have questions or need technical support, our toll free lines put you in touch with **CMO's** knowledgeable computer consultants.

**Call
CMO Today
800-233-8950**

THE COLLEGIAN

ACCESS Turbo XT/10 Computer.
512K Ram installed on the Motherboard.
Dual 360K 5.25" floppy disk drive.
102-key "AT" style enhanced keyboard.
One parallel, serial, and game port.

Epson LX-810 Printer.
9-Pin, impact dot-matrix.

Collegian Monitor.
Monochrome TTL display and adapter.
12" diagonal screen display.

Collegian Software.
PFs: First Choice.

\$979

THE ACCOUNTANT

ACCESS 286/12MHz Computer.
512K RAM installed on the Motherboard.
40MB Hard Disk Drive w/controller.
1.2MB 5.25" floppy disk drive.
102-key "AT" style enhanced keyboard.

Epson FX-1050 Printer.
264cps 136 column dot matrix.

Accountant Monitor.
Monochrome TTL display and adapter.
12" diagonal screen display.

Accountant Software.
Lotus 1-2-3

\$2199

THE SECRETARY

ACCESS Turbo XT/10 8088 Computer.
512K RAM installed on the Motherboard.
20MB Hard Disk Drive w/controller.
360K 5.25" floppy disk drive.
102-key "AT" style enhanced keyboard.

Brother HR-20
Daisywheel 20cps print speed.

Secretary Monitor
Monochrome TTL display and adapter.
12" diagonal screen display.

Secretary Software.
PFS: Write

\$1299

THE PUBLISHER

ACCESS 386/16MHz Computer.
1MB RAM installed on the Motherboard.
40MB Hard Disk Drive w/controller.
1.2MB 5.25" floppy disk drive.
102-key "AT" style enhanced keyboard.

Hewlett-Packard LaserJet II
8 Page per minute.

Publisher Monitor.
Monochrome VGA FlatSquare Display.
14" diagonal screen display.

Publisher Software
PFS: First Publisher

\$4199



Computer Mail Order. Since 1981—Low Prices, Large Selection, Fast Service.

Circle 65 on Reader Service Card

World Radio History

A112

Your Low Price Leader

NETWORKING

CMO HAS THE BEST SOLUTIONS TO YOUR MULTI-USER APPLICATIONS.

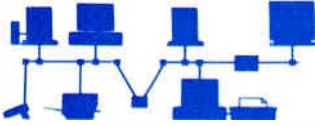

If you are looking for a **Complete Solution**, our trained staff of **Networking Specialists** can assist you in designing your multi-user system. We configure, test and provide on-going support for a full line of **Networking software, hardware and connectivity products** such as:

Novell Netware	
ELS Level-I 4-User	\$499
ELS Level-II V2.15	1099
Advanced NETWORK 286 V2.15	1999
SFT NETWORK 286 V2.15	3099
Orchid	
PCNet Adapter Card	339
Standard Micro Systems	
8-Bit Arcnet PC Boards	179
16-Bit Arcnet Board	399
Tiara	
8-Bit Arcnet Boards	129
16-Bit Arcnet Boards	299
8-Port Active Hub	299
MCA Ethernet Boards	389
Thomas Conrad	
8-Bit Arcnet Boards	179
16-Bit Arcnet Boards	329
16-Port Active Hub	795
Tops	
Tops for Dos 2.1	119
Tops for Mac	149
InBox Starter Kit	339
Western Digital	
EtherCard Plus	249

*Novell trained and authorized sales and support.

Our ACCESS family of 8088, 80286, and 80386 based computers can be configured around your needs for workstations and file servers.

Ask us how to design the ACCESS 386/20 Tower around your networking and/or multi-user application.

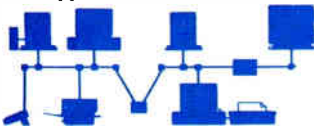

MULTIFUNCTION

AST	
Six Pak Plus Board	\$129
VGA Plus Adapter	389
Rampage/286 512K	399
Boca Research	
Boca TopHat 128K RAM	119
BocaRam/XT 0-1MB Board	119
BocaRam/XT 0-4MB Board	149
Boca MCA Serial/Parallel	145
Boca Dual Graphics Adptr	69
Boca MultiEGA	149
DCA	
Irma Convertible 3	469
Irma 2 3278 Emulation	729
Emerald	
3XTwin Local 5251 Emulation	Call
Everex	
Ram 3000 Deluxe 0-3MB Bd	89
Micro Enhancer EGA	149
View Point VGA 256K	279
5th Generation	

Hot Special



HEADLAND Vega VGA Adapter \$199

Logical Connection 512K	499
Headland	
FastWrite 800x600	319
V-RAM VGA Adapter	389
Hercules	
Graphics Card Plus	169
VGA Card	199
Intel	
AboveBoard Plus w/512K	429
AboveBoard Plus I/O w/512K	499
Visual Edge	449
8087 PC/XT Coprocessor	89
80287-8 8MHz Coprocessor	209
80387-16 16MHz Cop.	369
Orchid Technology	
TinyTurbo 286	229
TinyTurbo Xtra 12MHz	279
Designer 800 VGA	179
ProDesigner VGA 256K	279
ProDesigner VGA 512K	369
Renaissance	
RVGA1 640x480 256K Pal	179
RVGAII 800x600 256K Pal	239
Sysgen	
Omni Board Controller	79

STORAGE DEVICES

Archive	
Archive/XL 40MB Internal	\$339
Archive VP60 External	979
Micropolis	
159MB 23Msec ESDI	1299
338MB 18Msec ESDI	1899
Miniscribe	
8425 20MB 3 1/2" 40Msec	249
3650 40MB 5 1/4" 61Msec	329
6085 70MB 5 1/4" 28Msec	599
Mountain Computer	
TD-4000 40MB Int. Tape	369
TD-8000 80MB Int. Tape	449
TD-7000 150MB Tape	1499
Plus Development	
20MB HardCard	519
Plus 40MB PassPort	579
Seagate	
ST-225 20MB w/cont	249
ST-238 30MB w/cont	289
ST-251-1 40MB 28ms	349
ST-177N 60MB 24Msec	589
ST-1096N 80MB 24Msec	699
Sysgen	
Bridge-File 5 1/2" External	249
Bridge-Tape 40MB External	449
Reliant Model-215 60MB	469
Reliant Model-519 72MB	499
Toshiba	
1.44MB 3 1/2" Floppy Drive	99
WELTEC LapTop Subsystems	
360K 5 1/4" External Floppy	199
1.2MB 5 1/4" External Floppy	219

COMPUTERS

AST	
Bravo 286 Model 5	888
Premium 286 Model 140X	1999
Premium 386/25 Model 5	Call
Compaq	
DeskPro 286 Model 1	1699
DeskPro 386/20e Mdl.-110	5999
SLT-286 Laptop 40MB	4499
IBM	
PS/2 Model-30/286 w/20MB	1999
PS/2 Model-50Z 30MB	2499
PS/2 Model-60 70MB	3899
NEC	
ProSpeed Laptop 286/386	Call
UltraLite Laptop	Call
Panasonic	
Business Partner 1650	599
Business Partner 1750	Call
Toshiba	
T1000 80C86 Laptop	639
T1200 Dual Floppy Backlit	1549
T1200 20MB Backlit	2199
T1600 20MB 286	3499
T3200 40MB 12MHz	3599
T5200 40MB 20MHz 386	4999
Zenith	
MiniSport 1MB Laptop	NEW
SuperSport & SuperSport 286	Call
Z-248/12MHz Model-1	1599
Z-386/16MHz Model-40	4999

MONITORS

Amdek	
Video 210Plus TTL Amber	\$99
Video 410 TTL Monochrome	145
Color 732 PS/2 VGA	399
Color 632 14" VGA	379
SmartScan 735 MultiScan	489
1280 15" Hi-Res White	699
Cornerstone	
Single Page Monochrome	699
Dual Page PC 16 Shade	2399
Magnavox	
7BM623 12" TTL Amber	89
7BM749 14" Flatsquare VGA	149
CM8762 14" Comp/RGB	249
8CM515 14" RGB Analog	279
9CM053 14" HiRes EGA	339
9CM032 14" VGA Color	339
9CM080 14" MAC II Color	489
Mitsubishi	
XC-1410C 14" EGA Display	349
XC-1429C 14" PS/2 VGA	439
DiamondScan 13" Display	499
NEC	
Multisync 2A	499
Multisync 3D VGA	699
Multisync 4D 16" VGA	1299
Multisync 5D 20" VGA	2399

Super Special



PACKARD BELL PB-1272 12" TTL Mono \$85

Packard Bell	
PB-1422EG 14" HiRes EGA	359
PB-1472 14" TTL Mono	99
PB-8541 14" VGA Display	299
Polaroid	
Palette Plus	2199
Proxima	
EGA Data Display	999
VGA Data Display	1599
Seiko	
CM1440 14" VGA Display	629
Taxan	
KX-123 12" Amber TTL	99
Wyse	
Wyse-30 14" ASCII Display	329
Wyse-50 14" ASCII Display	399
Wyse-60 14" 7-page memory	349
Wyse-85 ANSI Data Display	429
Zenith	
ZFM-1490 14" VGA Analog	629

Call Today 800-233-8950

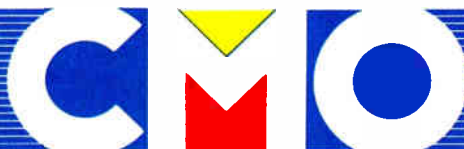

Computer Mail Order. Since 1981—Low prices, Large Selection, Fast Service.

...For Over 8 Years

COMMUNICATIONS

Anchor	
1200 Baud External	\$ 99
2400 Baud External	159
2400 Baud Ext. w/MNP 5	269
Everex	
Evercom 24+ 2400 Baud Int	149
Evercom 24E+ 2400 Baud Ext	269
Hayes	
Personal Modem 1200	129
SmartModem 1200 Baud	275
SmartModem 2400 Baud	369
Intel	
2400B Classic Internal	169
PS/2 2400B Internal	249
2400EX External	199
Murata	
M1200 Facsimile	599
Panasonic	
UF-140 Panafax	799
Practical Peripherals	
1200 Baud Stand Alone	84
2400 Baud Internal	135

PRINTERS

Alps	
ASP-1000 9-Pin Dot-Matrix	\$169
Allegro 24 24-Pin Flatbed	319
P2000 9-Pin 250cps 136 Col.	699
P2100 9-Pin 400 cps 136 Col.	1099
LPX-600 Laser Printer	1399
Brother	
M-1709 240cps, 132 Col.	369
M-1809 360cps, 80 Col.	399
M-1824L 24-Wire 80 Col.	499
HR-20 20cps Daisywheel	329
HL-8 Laser Printer	1999
Epson	
LX-810 200cps, 80 Col.	179
FX-850 264cps, 80 Col.	339
FX-1050 264cps, 132 Col.	Call
LQ-510 180cps, 24-Wire	329
LQ-850 330cps, 24-Wire	Call
LQ-1050 330cps, 132 Col.	Call
LQ-2550 500 cps, 24-Wire	Call
Hewlett Packard	
ThinkJet 2225	329
Pacific 25-in-One HP Font	279
Pacific 1-2-4 HP-LJ Memory	339
NEC	
P2200 Pinwriter 24-Wire	359
P5200 Pinwriter 265cps	519
P5300 Pinwriter 136 Col.	669
LC-890 PostScript Laser	3295
Okidata	
ML-172 180cps, 80 Col.	199
ML-182 Turbo 220cps	239
ML-320 300cps, 80 Col.	359
ML-390 270cps, 24-Wire	499
ML-393 450cps 24-Wire	1049
Panasonic	
KX-P1180 192cps, 80 Col.	185
KX-P1191 280cps, 80 Col.	239
KX-P1124 24-Wire, 80 Col.	299
KX-P1524 24-Wire, 132 Col	559
KX-P4450 Laser	1399
Seikosha	
SP1600AI 160cps, 9-Pin	179
SK-3000AI 300cps, 136 Col.	369
Star Micronics	
NX-1000 II 140cps, 9-pin	169
NX-2400 24-Wire 170cps	349
Toshiba	
ExpressWriter 301	349
ExpressWriter 311	439

Buyers Special



Practical Peripherals
2400 Baud Stand
Alone **\$179**

Sharp	
FO-220 Facsimile Machine	699
The Complete PC	
Complete Fax 4800 Board	259
Complete Answering Machine	269

I/O DEVICES

Chinon	
DS-300 Flatbed Scanner	569
Houston Instruments	
9012 HiPad + 12"x12"	399
PC695 4-Pen A&B Plotter	599
IMSI	
IMSI Mouse	75
Logitech	
New Logitech Mouse M9	79
ScanMan 400DPI HiRes	189
Microsoft	
Serial or Bus Mouse	119
MSC	
PC Mouse Serial	69
Summa Graphics	
Summa Sketch + 12"x12"	389
The Complete PC	
Complete PC Page Scanner	579

Hot Special

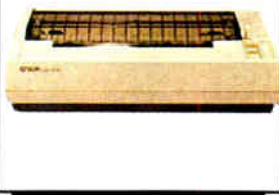

EPSON
LQ-950 24-Wire
\$499

Super Savings Special

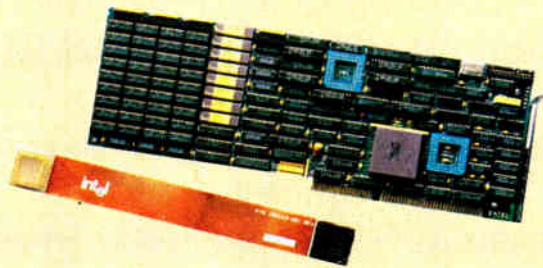

Intel
InBoard 386/PC **\$579**
Enhancement

SOFTWARE

Aldus PageMaker	\$469
Ashton-Tate dBase IV	459
Ashton-Tate MultiMate II	289
BLOC Form Tools	55
Borland Paradox	449
Borland Quattro	159
Borland Turbo Pascal V5.5	99
Broderbund Print Shop	38
Central Pt. PC Tools Deluxe	50
Central Pt. PC-II Opt. Board	119
DAC-EASY Accounting	60
DataStorm ProComm Plus	49
Delrina Per: Form	159
5th Generation FastBack +	98
FoxBase + Development	199
Funk Sideways	40
Harvard Graphics V2.1	289
IMSI TurboCAD	59
Intuit Quicken	33
Lotus 1-2-3	299
MECA Managing Your Money	119

SOFTWARE

Microcom CarbonCopy +	\$109
MicroPro WordStar 5.5	219
Microrim R:BASE For DOS	439
Microsoft Windows 286	70
Microsoft Quick Basic V4.5	69
Nantucket Clipper	419
Nolo Press For The Record	38
PaperBack VP-Planner +	119
Peachtree Accounting	169
Peter Norton Adv. Utilities	80
Peter Norton Commander	89
Quarterdeck DESQView 2.02	80
SPC: 1st Choice 3.0	90
SPC: Professional Write	149
SPC: 1st Publisher 2.0	80
Symantec Q & A	249
Traveling Lap-Link +	85
Lifetree Volkswriter	119
WordPerfect 5.0	219
WordPerfect Office	249
Xerox Ventura Publishing	485

Over 500,000 Satisfied Customers



800-233-8950

In Canada call: 800-233-8949

All Other Areas call: 717-327-9575 Fax call: 717-327-1217

Educational, Governmental and Corporate Organizations

Call toll-free: 1-800-221-4283

CMO, 101 Reighard Ave., Dept. B1, Williamsport, PA 17701

POLICY: Add 3% (minimum \$7.00) shipping and handling. Larger shipments may require additional charges. Personal and company checks require 3 weeks to clear. Credit cards are not charged until we ship.

Pennsylvania and Maryland residents add appropriate sales tax. All prices are U.S.A. prices and are subject to change. All items are subject to availability. We cannot guarantee compatibility. We are not responsible for typographic or photographic errors.



Computer Mail Order. Since 1981—Low Prices, Large Selection, Fast Service.

See the Future.

NANAO fully appreciates the importance of monitor selection to the business professional. The FLEXSCAN® 9060S has been specially designed for today's complex world of windows and graphics applications.

Unlike other 14" monitors, the FLEXSCAN® 9060S uses its Dynamic Focusing Circuit to deliver sharp, bright images to all corners of the screen. This makes it the ideal display for VGA and SuperVGA (800 × 600) applications.

The FLEXSCAN's ergonomic design minimizes static, glare, and magnetic radiation, to provide the most user-friendly environment possible, even during extended operation.

Other monitors meet the standards.
FLEXSCAN® sets them.

NANAO®

NANAO USA CORP.

23510 Telo Ave., Suite 5
Torrance, CA 90505 USA
Phone (213)325-5202
Fax (213)530-1679

Circle 221 on Reader Service Card
(DEALERS: 222)



FLEXSCAN 9060S

14" (13V), 0.28mm dot pitch CRT
Scan Frequency: Automatic Adjustment
H: 15.5kHz-38.5kHz
V: 50Hz-90Hz
Front-mounted controls for easy access.
VGA, SuperVGA (800 × 600), EGA,
CGA, MDA, and Mac II compatible.



Downsizing the Desktop

ADC puts the Powerlite 386 SX's petite motherboard on an add-in card

Stephen Satchell

The Advanced Digital Corp. (ADC) Powerlite 386 SX is at first blush just another entry into the computer sweepstakes.

Closer examination, however, shows that this compact computer performs well and excels in serviceability. Its system-on-a-board design makes this Lilliputian 80386SX computer system easier to repair than systems twice as large. And when you need more computing power, you can upgrade to a new, easy-to-change system board instead of buying a whole new system.

The Powerlite currently comes in two flavors, a 20-MHz 80286-based version and a 16-MHz 80386SX-based version (ADC also plans 80386 and 80486 versions). The 80286-based systems start at \$2565 and the 80386SX-based at \$2795. Users with the 80286-based systems can trade in their system board and receive an 80386SX for an additional \$250. I tested the 80386SX-based Model 141 with extra features that pushed the price up to \$4665.

The entry-level Powerlite systems don't have mass storage devices or controllers. But both 80286 and 80386SX versions pack everything except disk drive controllers on one AT-size expansion board that plugs into a four-slot passive backplane. The system board is packed: The basic system includes a math coprocessor socket for a 10-MHz



ADC's Powerlite offers good performance in a compact, upgradable box.

80287 or 16-MHz 80387SX (my system included an 80387SX), 1 megabyte of zero-wait-state RAM (expandable to 2 or 5 megabytes on a piggyback card), a VGA port with 256K bytes of RAM, an RS-232C serial port, a parallel port, a keyboard port that accepts the standard IBM PS/2 keyboard or an AT keyboard with a suitable adapter, and a mouse port. ADC doesn't sell a monitor.

ADC offers two hard disk drive controller boards: a Western Digital controller and the Konan TenTime Intelligent Caching Disk Controller. My test system included the TenTime unit, which offers a 128K-byte on-board disk cache on the controller board—it doesn't use RAM on the CPU board. The Model 141 includes a 40-megabyte hard disk drive (a 100-megabyte hard disk drive is also available) and a 1.44-megabyte 3½-inch floppy disk drive. If you need to read from

and write to 5¼-inch floppy disks, you can buy an external stacking chassis that can hold an optional 5¼-inch floppy disk drive and a tape backup drive.

With the controller and system boards installed, two 16-bit AT (Industry Standard Architecture) slots are left for standard AT or XT full-length expansion boards. Using an expansion board, you can extend the system RAM to 16 megabytes. The 80-watt power supply can run on either 110 or 220 volts. A switched power connector on the back lets you connect a monitor through the system power switch.

The 16-pound system unit measures 11½ inches wide by 4 inches high by 15½ inches deep; add 2 inches or so to the depth for cable clearance if you back this system up against a wall. The reset switch is in front, and the power switch is

continued

Powerlite 386 SX Model 141

Company

Advanced Digital Corp.
5432 Production Dr.
Huntington Beach, CA 92649
(800) 733-7697

Components

Processor: 16-MHz 80386SX CPU with socket for optional 16-MHz 80387SX
Memory: 1 megabyte of zero-wait-state RAM on system board, expandable to 2 or 5 megabytes via a piggyback board; 128K bytes of BIOS ROM
Mass storage: 1.44-megabyte 3½-inch floppy disk drive, 40-megabyte 28-ms hard disk drive; TenTime 128K-byte disk-cache controller
Display: VGA on motherboard
Keyboard: 101-key AT Enhanced or PS/2 style
I/O interfaces: DB-15 VGA port; RS-232C serial port with DB-9 connector; parallel port with DB-25 connector; keyboard and mouse ports; four 16-bit, full-height, ISA expansion slots (two unoccupied)

Size

11½ × 4 × 15½ inches; 16 pounds

Software

System utilities disk

Documentation

User's guide; technical reference guide; TenTime manual

Price

\$2795
System as reviewed: \$4665

Inquiry 851.

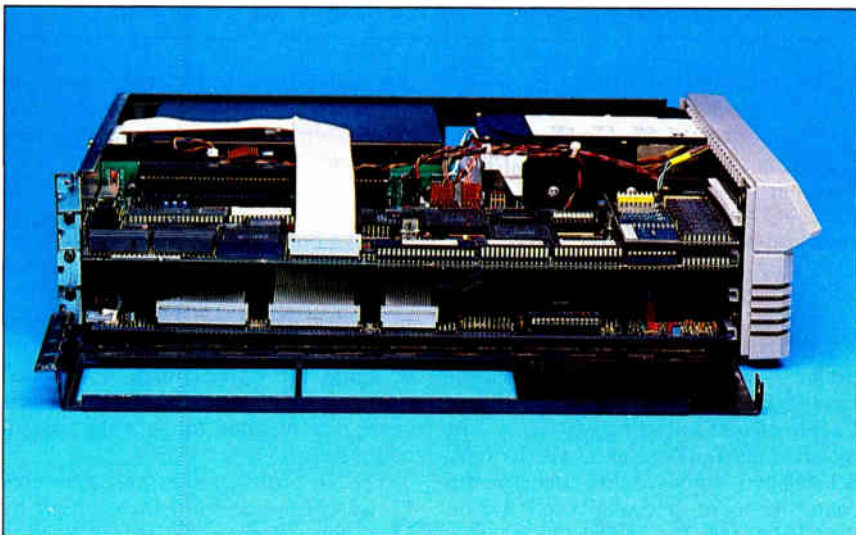

Photo 1: The Powerlite motherboard, mounted in one of four passive backplane expansion slots, is easy to service. A hinged door on the side of the case ensures easy access. A Konan disk drive controller board occupied the bottom slot in my test unit.

located on the rear panel.

ADC supplies a RAM disk, a print spooler, and disk-cache software with every system. For systems with the TenTime disk controller, ADC also provides setup, configuration, and tuning utilities for the controller board.

The Powerlite is strictly an office machine; the unit I tested met FCC Class A (commercial) regulations instead of the more stringent Class B (residential) limits for radio frequency emissions.

Setup

Setup is a breeze. All the programs for setting up the CPU board and hard disk drives connected to the Western Digital controller are built into the BIOS—there is no setup disk. The TenTime board has its utilities on disk, though, and you must have MS-DOS to run them, even if you plan to use a different operating system. Jumpers and switches on the CPU board let you configure the VGA adapter and mouse ports; the configuration for the serial and parallel ports is fixed.

Expansion boards slip in horizontally (see photo 1). The left side of the system unit frame is hinged; you remove one screw and loosen another, and the side swings down. You can then remove the filler plate and install the board.

I don't recommend placing the monitor directly on top of the system unit. The battery connector, in particular, and several other connectors stand too high on the CPU board, hitting the top of the case when the system is assembled. After a few months of use, this could cause problems (I put electrical tape on the under-

side of the cover to prevent trouble). If you're tight for space, consider constructing a monitor platform to keep the monitor off the system cover, or move the CPU board down one slot and sacrifice the top backplane slot.

Test Run

The standards for IBM PC clone making are well enough defined that you don't expect to find many programs that don't work. The Powerlite 386 is no exception. Not only did the machine work flawlessly with the standard applications benchmark suite, but it also worked with many of the old standbys, like Crosstalk XVI 3.60 and Lotus 1-2-3 release 1A. I also tried a smattering of other applications, such as SideKick 1.56A, Professional YAM 17.28, Smartcom III 1.1, XTree-Pro 1.1, and LapLink Mac 1.2. I successfully ran IBM's PC-DOS 3.2 and PC-DOS 3.3.

My ancient Hayes 1200B internal modem wouldn't fit into a 16-bit slot, so I couldn't test 8-bit bus access using a modem. I did use an AST RAMpage AT card with 2 megabytes of memory to look at 16-bit access, though, and I encountered no problems.

In BYTE's benchmark testing, the Powerlite's overall performance was significantly better than that of the IBM PS/2 Model 55 SX and was neck-and-neck with the Compaq 386s. The Powerlite's one weak spot was video: It lost to both competitors in the text portion of the low-level Video tests and in the Scientific/Engineering application tests.

In the low-level tests, the Powerlite came out ahead of the Compaq in CPU performance. But while the ADC cache controller put the Powerlite far ahead of the Compaq in most low-level Disk I/O tests, the Compaq with its 40-megabyte ESDI hard disk drive outperformed the Powerlite by large margins in the large-file tests. The Compaq also edged out the Powerlite in the LINPACK and Livermore Loops tests.

Fit and Finish

The designer who masterminded the Powerlite's CPU board certainly did a beautiful job. There's more open space on a postage stamp than there is on this board. In fact, the board is so packed with chips that ADC had to use surface-mounted resistors and capacitors on the reverse side of the board.

Unfortunately, the height of some connectors makes the board fit tightly into the case, and the backplane is hard-wired into the power supply, so if you have

continued



ADC Powerlite 386 SX

APPLICATION-LEVEL PERFORMANCE

ADC Powerlite 386 SX

11.5*

WORD PROCESSING

XyWrite III+ 3.52	Medium/Large
Load (large)	:05
Word count	:04/:27
Search/replace	:06/:22
End of document	:02/:11
Block move	:11/:10
Spelling check	:11/:24
Microsoft Word 4.0	
Forward delete	:19
Aldus PageMaker 1.0a	
Load document	:13
Change/bold	:32
Align right	:24
Cut 10 pages	:22
Place graphic	:05
Print to file	1:50

Index: 2.38

SPREADSHEET

Lotus 1-2-3 2.01	
Block copy	:04
Recalc	:02
Load Monte Carlo	:17
Recalc Monte Carlo	:07
Load rlarge3	:04
Recalc rlarge3	:01
Recalc Goal-seek	:04
Microsoft Excel 2.0	
Fill right	:07
Undo fill	2:49
Recalc	:02
Load rlarge3	:31
Recalc rlarge3	:01

Index: 2.25

DATABASE

dBASE III+ 1.1	
Copy	:25
Index	:08
List	2:59
Append	:46
Delete	:03
Pack	:47
Count	:07
Sort	:31

Index: 2.48

SCIENTIFIC/ENGINEERING

AutoCAD 2.52	
Load SoftWest	1:00
Regen SoftWest	:52
Load StPauls	:12
Regen StPauls	:07
Hide/redraw	15:49
STATA 1.5	
Graphics	2:17
ANOVA	:23
MathCAD 2.0	
IFS 800 pts.	:22
FFT/IFFT 1024 pts.	:25

Index: 2.24

COMPILERS

Microsoft C 5.0	
XLisp compile	4:39
Turbo Pascal 4.0	
Pascal S compile	:05

Index: 2.13

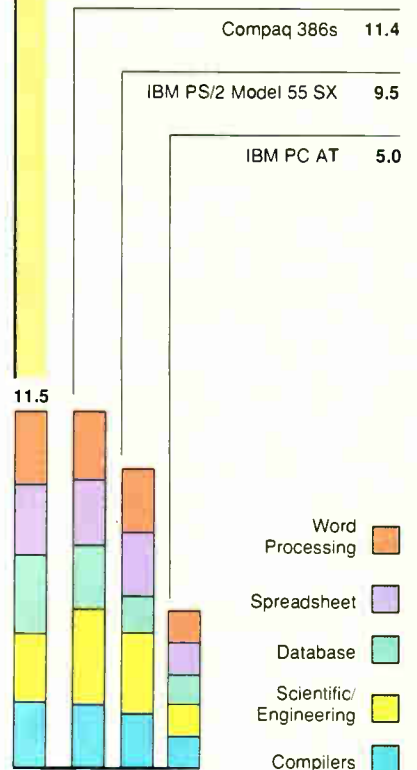

*Cumulative application index. Graphs are based on indexes at left and show relative performance.

All times are in minutes.seconds. Indexes show relative performance: for all indexes, an 8-MHz IBM PC AT = 1.

LOW-LEVEL PERFORMANCE¹

ADC Powerlite 386 SX

CPU	
Matrix	6.66
String Move	
Byte-wide	50.92
Word-wide:	
Odd-bnd.	42.24
Even-bnd.	25.43
Doubleword-wide:	
Odd-bnd.	27.48
Even-bnd.	19.26
Sieve	32.90
Sort	31.54

Index: 1.92

FLOATING POINT	
Math	11.53
Error ²	
Sine(x)	3.29
Error	
e^x	3.64
Error	

Index: 4.88

DISK I/O	
Hard Seek³	
Outer track	0.55
Inner track	0.53
Half platter	0.57
Full platter	0.51
Average	0.54
DOS Seek	
1-sector	1.82
32-sector	47.61
File I/O⁴	
Seek	0.13
Read	0.90
Write	0.72
1-megabyte	
Write	6.55
Read	5.36

Index: 2.64

VIDEO	
Text	
Mode 0	12.49
Mode 1	12.43
Mode 2	12.48
Mode 3	12.49
Mode 7	N/A
Graphics	
CGA:	
Mode 4	1.69
Mode 5	1.67
Mode 6	1.76
EGA:	
Mode 13	3.07
Mode 14	3.33
Mode 15	N/A
Mode 16	3.33
VGA:	
Mode 18	3.48
Mode 19	1.79
Hercules	N/A

Index: 1.37

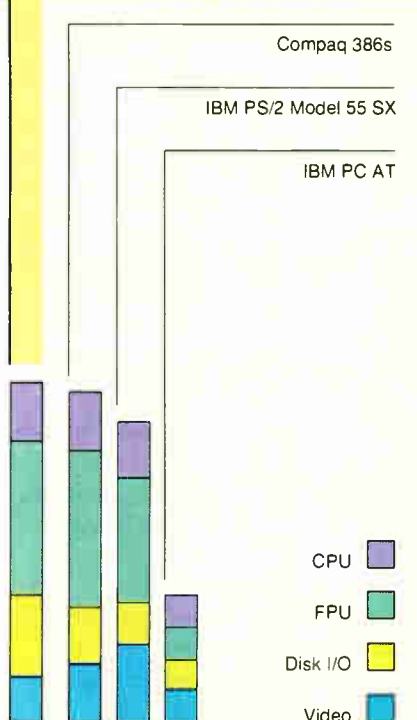

N/A = Not applicable.

¹ All times are in seconds. Figures were generated using the 8088/8086 and 80386 versions (1.1) of Small-C.

² The errors for Floating Point indicate the difference between expected and actual values, correct to 10 digits or rounded to 2 digits.

³ Times reported by the Hard Seek and DOS Seek are for multiple seek operations (number of seeks performed currently set to 100).

⁴ Read and write times for File I/O are in seconds per 64K bytes.

⁵ For the Livermore Loops and Dhystone tests only, higher numbers mean faster performance.

CONVENTIONAL BENCHMARKS

LINPACK	254.80
Livermore Loops⁵	
(MFLOPS)	0.1123
Dhystone (MS C 5.0)	
(Dhry./sec.)	3825

STOP!... FUTURA WILL MEET ANY SYSTEM PRICE IN THIS ISSUE

Join our team of satisfied clients.

286-16

- Full AT case
- 2 MB (exp. to 16 MB)



\$1999.95

- 2p/2s
- 1.2 MB floppy
- 200 watt p/s
- 40 MB/28ms HDD
- 14" VGA MultiSync
- 16 bit VGA Card
- 8 bit ARCNET Card
- DOS 3.3
- Monochrome deduct \$500



\$3399

386-25- "CAD/CAM"

- 64 KB cache on board
- 2 MB (exp. to 16 MB)
- 14" VGA MultiSync
- VGA card
- Standard mouse
- Ideal for CAD/CAM
- 2p/2s
- 1.2 MB floppy
- 200 watt p/s
- 80 MB/28ms HDD
- DOS 3.3
- Monochrome deduct \$500
- ARCNET Card

Order line: (800) 448-1461
Service: (508) 475-5886
Fax: (508) 470-1391

- 1 Year Warranty
- Quick Delivery
- On-site Service Available
- 30-Day Satisfaction Guarantee
- Ask about preconfigured LANS for four and eight users.
- Corporate leasing available



One Of America's Best Run Companies Gives 95% Of Its Money To Charity.

CARE was recently named the best run, best managed charity in America.

We aren't surprised. 95% of every dollar we receive goes to help impoverished people. Only 5% goes to run

our organization.

No other company could survive on margins like that. But a lot of starving people can.

CARE We're Helping People Learn To Live Without Us.

1-800-242-GIVE

problems in one, you'll probably have to replace them both. Overall, however, the workmanship in the Powerlite is far above average for a PC clone. ADC backs the machine with a one-year warranty.

This is one of the easiest computers to fix that I've seen. Since the CPU is on an expansion board, it's easy to pop out and exchange. The trend toward putting I/O ports on the system board means that if you blow a port, you've blown the system board—which in most systems is a pain to replace. There's no pain in replacing the system board in the Powerlite. If you can install an add-in card, you can replace the system board in this machine.

Documentation consists of three manuals: the user's guide, the technical reference guide for the CPU board, and the TenTime manual. The user's guide and technical reference manuals are well written and organized; the TenTime manual was marked "preliminary." Troubleshooting information is incomplete: While trying to get the system to work the first time, I kept getting code signals from the speaker. But ADC's technical support was good; it has a toll-free number, and its technicians did a fine job helping me with some of the strange behavior the Powerlite exhibited after some heavy-handed treatment during shipping.

Value

When you compare the retail prices of the Powerlite 386 SX to the two industry leaders—the IBM PS/2 Model 55 SX and the Compaq 386s—you'll find little difference. My Powerlite 386 SX Model 141 was \$4665. The Model 140, which substitutes the Western Digital controller for the TenTime, is \$3955. Compare that to a similarly equipped Compaq Model 40 (\$4199) or an IBM Model 55 SX, which for \$3895 comes with a 30-megabyte hard disk drive and 2 megabytes of RAM.

The Powerlite gives you at most two available slots; the Compaq and IBM systems can take up to three cards. If you have extra RAM, an internal modem, and a network card, you're out of luck with the Powerlite. But in an office environment where space is at a premium and serviceability is important, this machine is one of the best choices I've seen. ■

Stephen Satchell has evaluated computer products for 17 years. His company, Satchell Evaluations in Incline Village, Nevada, tests microcomputer hardware and software. He can be reached on BIX as "ssatchell."

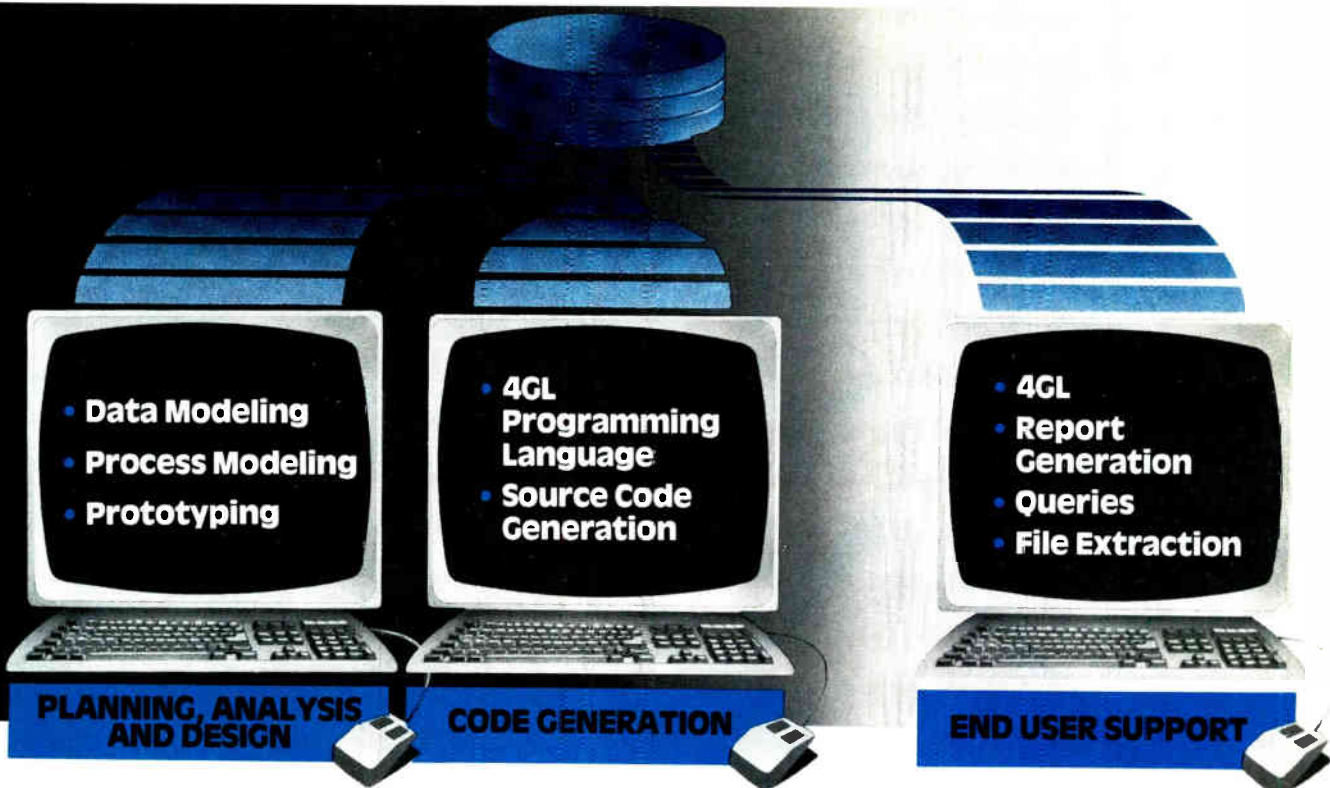

POSE®, the proven leader in affordable CASE technology, takes you beyond conventional CASE...by adding a powerful code generation capability for the DP Professional and an integrated Fourth Generation Language (4GL) for the end user. POSE now has FlexGen®, a unique 4GL application development system with code generation for MS/DOS and UNIX users. Build applications faster, with better precision and documentation.

POSE® takes you beyond CASE!

POSE expands the structured approach of CASE with the productivity of a code generator and the convenience of a 4GL.

Features include an extensive range of planning, analysis and design techniques with powerful graphics, full dictionary capabilities, rapid prototyping, source code generation and end user query/report tools. With POSE and FlexGen, you no longer have to sacrifice the benefits of the structured design approach of CASE when using a code generator or 4GL tool...POSE gives you both!

POSE® modules may be purchased individually or as tool kits*

DATA MODEL TOOL KIT <i>Includes DMD, DMN, LDD, DBA FOCUS • DB2 • SQL/DS • ADABAS • AS/400</i>	\$1195⁰⁰
DMD •Data Model Diagrammer	\$595 ⁰⁰
DMN •Data Model Normalizer	\$595 ⁰⁰
LDD •Logical Database Designer	\$595 ⁰⁰
DBA •Database Aid <i>(FOCUS • DB2 • SQL/DS • ADABAS • AS/400)</i>	\$595 ⁰⁰
PROCESS MODEL TOOL KIT <i>Includes DFD, SCD, DCD, ACD</i>	\$1195⁰⁰
DFD •Data Flow Diagrammer	\$595 ⁰⁰
SCD •Structure Chart Diagrammer	\$595 ⁰⁰
DCD •Decomposition Diagrammer	\$595 ⁰⁰
ACD •Action Chart Diagrammer	\$595 ⁰⁰
SRP •Screen Report Prototyper	\$595 ⁰⁰
PMD •Planning Matrix Diagrammer	\$595 ⁰⁰
FlexGen® Source Code Generator	\$1070 ⁰⁰
POSE/FlexGen Interface	\$1000 ⁰⁰

* PACKAGE DISCOUNTS AVAILABLE

**RISK FREE 30-DAY
MONEY-BACK GUARANTEE**
ORDER POSE OR FREE DEMO DISKETTE
1-800-537-4262
CREDIT CARD ORDERS ACCEPTED

FREE DEMO DISKETTE 5¼" Disk
 3½" Disk

NAME _____
COMPANY _____
ADDRESS _____
CITY/STATE/ZIP _____
TELEPHONE _____

CSA Computer Systems Advisers, Inc.
50 Tice Boulevard • Woodcliff Lake, NJ 07675
ABY 129 **1-800-537-4262**

Circle 83 on Reader Service Card (DEALERS: 84)

Feed this to your PC and it'll think it's an HP BASIC workstation.



Finally, there's a way for serious technical computer users to get the power and features of HP BASIC on a PC. The answer is HTBasic, a real engineering BASIC that turns your PC into an HP 9000 series 200/300 BASIC workstation— at a fraction of the cost.

Like HP's Rocky Mountain BASIC, HTBasic from TransEra is a state-of-the-art BASIC that gives you all the capabilities you need for complex engineering applications. Plus you get important advanced features you won't find with any other PC BASIC. Like the complete set of HP graphic commands. Integrated HPIB (GPIB) syntax for intelligent instrument control. The advanced I/O Path System. And built-in matrix math.

In fact, all the optional HP binaries are built in. There's nothing else to load. You even get the full screen program editing and debugging environment.

Discover the new solution for cost-effective technical workstations. HTBasic from TransEra.

HTBasic
High Tech Basic

DISCOVER
HTBASIC
FOR
YOURSELF

For more
information, write
TransEra Corporation
or call today
(801) 224-6550.

TransEra

3707 North Canyon Road, Provo, Utah 84604 • TEL: 801-224-6550 • FAX: 801-224-0355



Circle 326 on Reader Service Card (DEALERS: 327)

World Radio History



Upscale Acer

Acer's high-performance 1100/33 enters the 33-MHz fray

Jeff Holtzman

Personal computers based on Intel's 33-MHz 80386 CPU have flooded the market. They're fast, expensive, and available from just about every clone maker on the market. But they're not all the same—prices and quality vary—and they're not for everyone. Acer America's entry in this increasingly crowded field attempts to bring users high performance at a moderate price.

Acer's \$7895 base model comes with everything you need to run DOS except a video subsystem and a hard disk drive. It includes 4 megabytes of RAM, a 1.2-megabyte 5¼-inch floppy disk drive, two serial ports, a parallel port, a floppy/hard disk drive interface, a keyboard and mouse, a socket for an 80387 or Weitek math coprocessor, space for five half-height mass-storage devices, DOS 3.3, GWBASIC 3.3, Windows/386, a disk-cache utility, and an EMS emulator. My test system also included an Intel 80387 (\$700), an 8-bit VGA board (\$1005), a 150-megabyte Micropolis ESDI hard disk drive and controller (\$1675), 4 more megabytes of RAM (\$2000), and a copy of OS/2 1.0 (\$325), bringing the grand total to \$13,600.

The floppy/hard disk drive interface card is an Acer design and accepts up to two floppy disk drives and a hard disk drive. Acer includes the parallel and serial I/O circuitry on the motherboard.

The motherboard accepts 4 or 8 megabytes of 80-nanosecond, 1-megabyte



page-mode single in-line memory modules (SIMMs); you can expand the system to a total of 24 megabytes of memory using the machine's two 32-bit expansion slots. The memory subsystem includes a nonexpandable 32K-byte 20-ns static RAM cache with an Intel 82385 controller.

The 1100/33 includes eight expansion slots: one standard 8-bit slot, five standard 16-bit slots, one 32-bit slot for memory, and one slot that can function as either a standard 16-bit slot or an additional 32-bit slot. That gives you a total of seven standard slots. In my review system, the video, floppy disk drive interface, and ESDI hard disk drive controller cards used three slots, leaving four for other expansion options. However, con-

sidering that the I/O ports and as much as 8 megabytes of memory can fit on the motherboard, four free slots shouldn't be too limiting.

Construction

The quality of construction in my test machine was disappointing. The first machine I received was unreliable and eventually refused to boot at all. Acer quickly replaced it with another unit. This one worked properly; to make sure, I kept it running 24 hours a day for several weeks. Neither unit I tested looked finished; both had a dozen or so engineering-change wires on both sides of the system board. In the first unit, those wires were attached quite sloppily; in the

continued

Acer 1100/33

Company

Acer America Corp.
401 Charcot Ave.
San Jose, CA 95131
(408) 922-0333

Components

Processor: 33-MHz 80386; socket for 33-MHz 80387 coprocessor
Memory: 4 megabytes of 32-bit 80-ns DRAM SIMMs; 32K bytes of 20-ns SRAM cache
Mass storage: 1.2-megabyte 5¼-inch floppy disk drive; 150-megabyte hard disk drive
Display: Acer 8-bit VGA adapter; multiscan monitor
Keyboard: 101-key PS/2 compatible
I/O interfaces: 9-pin serial port; 25-pin serial port; 25-pin parallel port; slots: one 8-bit, five 8-16-bit, one 16-/32-bit, and one 32-bit

Size

7 by 17 by 21 inches; 50 pounds

Software

MS-DOS 3.3; GWBASIC 3.3; Microsoft Windows/386 2.1; disk-cache utility; EMS emulator

Documentation

User's manual; MS-DOS manual; GWBASIC manual; Microsoft Windows/386 manual; disk-cache utility manual

Price

Base system: \$7895
System as reviewed: \$13,600

Inquiry 862.

second, the soldering was neater and the wires were glued to the board.

The 1100/33 comes in a standard desktop configuration; you open it by removing five screws from the rear panel. The interior follows the standard AT layout, with the 230-watt power supply in the right rear corner, the drive bays in front, and the motherboard on the left.

At about 12 by 14 inches, the motherboard is fairly large, containing perhaps 40 percent more surface area than typical AT and 80386 motherboards. But that space isn't wasted; it includes the SIMM panels, the serial and parallel I/O circuitry, two Award BIOS EPROMs, the cache memory, and many discrete logic chips. It also contains several jumper blocks and DIP switches, and one block of DIP switches is accessible through a small hatch on the rear of the chassis.

The jumpers and switches set operating parameters (e.g., the type and the

amount of memory, and the presence of a coprocessor). One switch setting enables shadow RAM so that the system BIOS and the video BIOS can run from RAM. A system utility lets you enable and disable shadow RAM on the fly; that utility also lets you switch to an 8-MHz compatibility speed and to disable the cache. A hot-key combination also lets you switch between 8- and 33-MHz operation.

The Acer 1100/33 uses a 101-key, PS/2-compatible keyboard. The keys produce tactile and audible feedback, but they are a little wobbly. The 14-inch multiscan monitor has front-mounted brightness and contrast controls; the vertical size control and the horizontal and vertical position controls are on the back. The CRT image is clean and stable and has a maximum resolution of 600 by 800 dots per inch.

The 1100/33's front panel has a standard keyboard interlock, LEDs to indicate hard disk activity and operating speed, and reset and power switches. The hard disk and floppy disk drives are not secured by screws; instead, they are press-fit into place by flat metal springs. Although this method seems less secure, the springs hold the drives firmly in place.

Acer's documentation is brief and well written and contains such technical information as memory and I/O port address maps, listings of interrupts and direct-memory-access channels, and port pin-outs.

Acer has a good warranty policy: For the first four months after purchase, the company provides guaranteed next-business-day on-site repair or replacement; for the next eight months, no-charge depot service (the customer pays one-way shipping). You can extend the warranty for \$99 per year.

Compatibility Tests

The 1100/33 worked well with everything I tested. On the hardware side, I had no trouble running either the Microsoft-compatible mouse that came with the system or a Microsoft Serial Mouse. A Hayes 2400-bps internal modem also worked fine, as did an Irwin 785 tape backup unit and a Corvus ReadyNet network interface card.

As for software, I ran WordStar 5.5, XyWrite III Plus 3.55, Qedit 2.07, Q&A Write 1.01, Lotus 1-2-3 release 2.01, VP-Planner 1.0, AutoSketch 1.04 enhanced, SideKick 1.56b, Windows/386, Acer's dual-boot version of OS/2 1.0, Turbo Pascal 5.0, 386Max 4.07, OmniView 4.13, GrandView 1.01, KeepTrack

Plus 2.0, and Procomm Plus 1.1A. I also tested LapLink III, which worked reliably only at the 8-MHz compatibility speed.

Performance

The 1100/33 has an extremely fast CPU subsystem; in fact, of all the machines in its class that BYTE has tested, only the Everex Step 386/33 and the ALR Flex-Cache 33/386 Model 150 surpass the Acer (see "Megahertz Madness," *IBM Special Edition*, Fall 1989). Unfortunately, the other subsystems don't live up to the standard set by the Acer's CPU performance, and that keeps the Acer near the bottom of the pack in most other categories.

The Acer 1100/33's FPU index was marginally lower than those of the Compaq Deskpro 386/33 and the Everex 386/33. It was also slower, by about 25 percent, than the Compaq in the low-level disk tests. The Acer's poorest showing was on the video benchmarks; it was less than half as fast as the Compaq and Everex systems.

Based on the low-level benchmarks, it's not surprising that the Acer 1100/33 also scored lower than the Compaq Deskpro 386/33 and the Everex 386/33 in most of the applications tests; its applications index of 20.3 puts it in twelfth place among the 15 33-MHz systems that BYTE has tested to date.

Deciding Factors

The 1100/33 is one of the more expensive 33-MHz machines that BYTE has reviewed. It prices well against the Compaq but lags behind it in terms of quality of construction. Other clone makers offer similarly configured machines for substantially less. A 386/33 from PC Link, for example, includes the same amount of RAM, a 115-megabyte ESDI hard disk drive, and a 16-bit VGA adapter for \$5995.

Better yet, you might want to look into the new crop of 25-MHz 80486-based systems, which should be available by the time you read this. Because the 80486 includes memory management and FPU functions on a single chip, 80486-based systems could be only slightly more costly than the current crop of 33-MHz 80386 systems, and the BYTE benchmarks run on prototype 80486 systems indicate that they will perform much faster, particularly in number-crunching applications. ■

Jeff Holzman is a freelance writer and an analyst at Unisys Corp. He can be reached on BIX as "jholzman."



Acer 1100/33

APPLICATION-LEVEL PERFORMANCE

Acer 1100/33 **20.3***

WORD PROCESSING

XyWrite III+ 3.52	Medium/Large
Load (large)	:12
Word count	:02/:09
Search/replace	:03/:13
End of document	:01/:08
Block move	:08/:07
Spelling check	:05/:29

Microsoft Word 4.0

Forward delete	:10
----------------	-----

Aldus PageMaker 1.0a

Load document	:06
Change/bold	:15
Align right	:11
Cut 10 pages	:12
Place graphic	:03
Print to file	1:41

Index: **4.10**

SPREADSHEET

Lotus 1-2-3 2.01

Block copy	:02
Recalc	:01
Load Monte Carlo	:14
Recalc Monte Carlo	:02
Load rlarge3	:03
Recalc rlarge3	:01
Recalc Goal-seek	:02

Microsoft Excel 2.0

Fill right	:02
Undo fill	:55
Recalc	:01
Load rlarge3	:15
Recalc rlarge3	:01

Index: **4.16**

DATABASE

dBASE III+ 1.1	
Copy	:32
Index	:07
List	:46
Append	1:26
Delete	:02
Pack	1:12
Count	:11
Sort	:59

Index: **2.33**

SCIENTIFIC/ENGINEERING

AutoCAD 2.52

Load SoftWest	:25
Regen SoftWest	:18
Load StPauls	:07
Regen StPauls	:03
Hide/redraw	5:22

STATA 1.5

Graphics	:30
ANOVA	:10

MathCAD 2.0

IFS 800 pts.	:08
FFT/IFFT 1024 pts.	:08

Index: **6.03**

COMPILERS

Microsoft C 5.0

XLisp compile	2:23
---------------	------

Turbo Pascal 4.0

Pascal S compile	:03
------------------	-----

Index: **3.69**

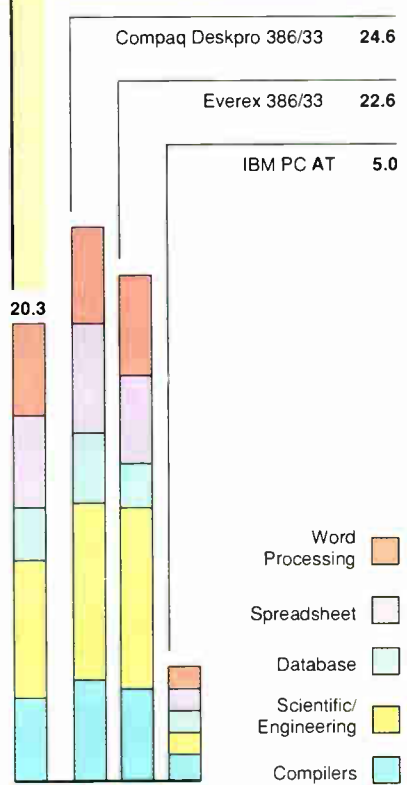

*Cumulative application index. Graphs are based on indexes at left and show relative performance

All times are in minutes.seconds. Indexes show relative performance; for all indexes, an 8-MHz IBM PC AT=1.

LOW-LEVEL PERFORMANCE¹

Acer 1100/33

CPU	
Matrix	2.05
String Move	
Byte-wide	12.66
Word-wide:	
Odd-bnd.	16.43
Even-bnd.	6.34
Doubleword-wide:	
Odd-bnd.	12.47
Even-bnd.	3.17
Sieve	10.53
Sort	8.02

Index: **6.60**

FLOATING POINT

Math	
Error ²	3.52
Sine(x)	1.15
Error	
e^x	1.21
Error	

Index: **14.84**

DISK I/O	
Hard Seek³	
Outer track	3.33
Inner track	3.32
Half platter	6.68
Full platter	10.00
Average	5.83
DOS Seek	
1-sector	11.99
32-sector	21.98
File I/O⁴	
Seek	0.03
Read	0.92
Write	0.80
1-megabyte	
Write	2.91
Read	4.43

Index: **2.29**

VIDEO	
Text	
Mode 0	7.95
Mode 1	7.94
Mode 2	7.74
Mode 3	7.75
Mode 7	N/A
Graphics	
CGA:	
Mode 4	1.02
Mode 5	1.02
Mode 6	1.08
EGA:	
Mode 13	2.56
Mode 14	2.71
Mode 15	N/A
Mode 16	2.71
VGA:	
Mode 18	2.80
Mode 19	0.99
Hercules	N/A

Index: **2.01**

CONVENTIONAL BENCHMARKS

LINPACK	99.20
Livermore Loops ⁵ (MFLOPS)	0.3236
Dhrystone (MS C 5.0) (Dhry./sec.)	11,111

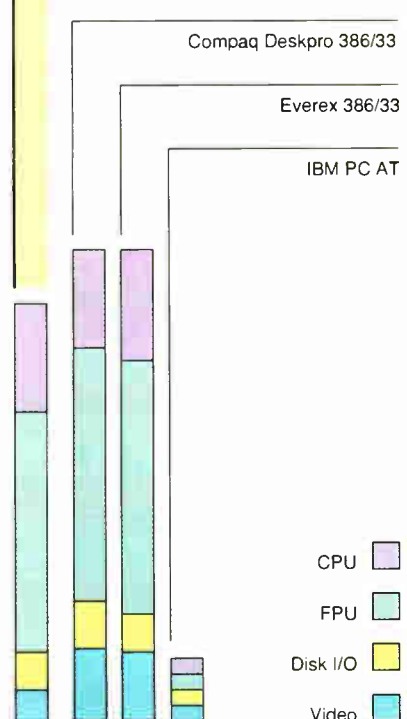

N/A=Not applicable.

¹ All times are in seconds. Figures were generated using the 8088/8086 and 80386 versions (1.1) of Small-C.

² The errors for Floating Point indicate the difference between expected and actual values, correct to 10 digits or rounded to 2 digits.

³ Times reported by the Hard Seek and DOS Seek are for multiple seek operations (number of seeks performed currently set to 100).

⁴ Read and write times for File I/O are in seconds per 64K bytes.

⁵ For the Livermore Loops and Dhrystone tests only, higher numbers mean faster performance.

Table 1: Subtle features distinguish the initial entrants in the 24-bit color video board market.

24-BIT COLOR BOARDS

Board	Screen mode (bits/pixel)	Screen size supported	Pixel clock (MHz)	Refresh rate (Hz)	Zoom	Pan	Upgrade board? ¹	Expanded desktop ²	Other features
Spectrum/24	1, 2, 4, 8, 24	640 × 480 ³ 1024 × 768	30.24 64	66.7 60	2×	Yes	No	4096 × 1536	Home cursor; center dialogs; optional oscillator drives; multiscan or NTSC displays
ColorBoard 224	1, 2, 4, 8, 24	640 × 480 800 × 600 1024 × 768	30.24 50 64	66.7 66.7 60	2×, 4×	Yes	No	4096 × 1024	Center dialogs; pop-up menus; adjust pan border and rate; board switches set screen size
DirectColor/24	1, 8, 16, 24	1152 × 882	100	72	N/A	No	Yes	N/A	Center dialogs; tear-off menus; enlarged menu font; pop-up screen bit-depth changer; cursor locator; adjustable windows for enlarged menu bar; zoom box; options for multiple monitors; screen saver; screen capture

¹ DirectColor/16 board displaying 16-bit colors accepts additional video RAM to convert board to a DirectColor/24

² Maximum size given, with screen in 1-bit mode (2-bit mode for ColorBoard). Expanded desktop is at the expense of pixel depth—that is, the larger the expanded desktop, the fewer colors that can be displayed. Smaller expanded desktop configurations are possible, using more colors.

³ Must change oscillator on board to use this screen size.



Output from the Spectrum/24 (top left), DirectColor/24 (top right), and ColorBoard 224 (bottom right) video boards. These boards use 32-Bit QuickDraw to display as many as 16.7 million colors. The Spectrum/24 accommodates both Apple's MacsBug and ICOM Simulations' TMON debuggers, making it a good choice for software development work. It's also the least expensive of the three boards.

DirectColor/24, when teamed with its two-page monitor, is a candidate for color desktop publishing and CAD/CAM. The ColorBoard 224 supports several display sizes. Its CB 224-II cdev provides zoom and pan features helpful to those who create detailed artwork or CAD images.



Table 2: Video-graphics boards feature image input and output choices.

VIDEO-GRAPHICS BOARDS									
Board	Image capture size (pixels) ¹	Output image format	Output image depth (max.)	Video input	Video output	Genlock display?	Act as Mac mode (bits)	Serves as Mac video board	Zoom ²
ColorCapture	640 × 480 NTSC 512 × 768 PAL ³	TIFF (24-bit), IMAGE ⁴	16-bit	NTSC, PAL ³	RGB, NTSC, ⁵ PAL ³	Yes	No	N/A	2×-10×
NuVista 4M	756 × 485 NTSC 768 × 575 PAL	TGA (32-bit), PICT	32-bit	RGB ⁶	RGB ⁵	Yes	Yes	1, 2, 4, 8, 16, 32	2×, 4×, 8×, 16×

¹ Maximum capture size; can be varied.

² For the ColorCapture, zoom applies to examination of captured image. For the NuVista, zoom applies to the Mac display, which can include the captured image.

³ Requires different version of ColorCapture board.

⁴ Proprietary format.

⁵ Composite.

⁶ Requires a separate video encoder/decoder unit to handle NTSC and PAL video.

The DirectColor/24's II Display cdev provides tear-off menus (the ColorBoard 224 provides pop-up menus), a screen saver, and a screen-capture function. The screen capture is an asset because it allows you to import 16- or 32-bit images to a PICT file. For example, you might run an application simulating complex turbulence flow on a mainframe and then capture the plotted image to a file from the Mac's screen.

If you must change to a different or larger monitor, both the Spectrum/24 and the ColorBoard 224 support several display sizes. However, the Spectrum/24 requires a ticklish oscillator swap that includes prying a component off the video board and plugging in a new one; the ColorBoard 224 manages this feat with a set of switches. The Spectrum/24's advantage is that you can add optional oscillators to drive different monitors, such as a multiscan or National Television System Committee (NTSC) RGB monitor.

The DirectColor/24 drives only a Radius Color Display, an impressive 19-inch monitor with a 1152- by 882-pixel, 82-dot-per-inch screen. The \$4295 Color Display simultaneously shows two letter-size pages, making it valuable for desktop publishing. Because these pages are in 24-bit color, the DirectColor/24 and Color Display combination also suits color preprocess applications.

Deep pixels and large screens make for lots of data for the Mac to draw, so the boards draw screens slower than 8-bit boards do. Fortunately, Apple optimized 32-Bit QuickDraw's graphics routines for speed so that the drawing rates are reasonable. However, Radius is also shipping an accelerator board that boosts the execution speed of certain graphics

operations when used with its DirectColor boards (see the text box "The QuickColor Option" on page 194). Other board vendors have also announced plans to introduce accelerators in the near future.

The boards draw screens slower than 8-bit boards do.

Since debuggers tend to be hardware-specific, I wasn't surprised that Apple's MacsBug 6.1 and ICOM Simulations' TMON 2.8.2 debuggers didn't work with these boards. But I found an easy solution: If the 24-bit color board is the second video board in your system, make sure that the Mac scans the standard video board first when booting. You can ensure this by placing the board in the slot next to the power supply on a Mac II. If you've got only the 24-bit video board, both companies offer solutions: Apple's MacsBug 6.1B1 is compatible with 32-Bit QuickDraw, and ICOM Simulations offers an Extended User Area (EUA) file that configures TMON to operate with a 32-bit display. Contact the companies' technical support to obtain copies.

Because of the debuggers' low-level interaction as they write to the Mac's screen, some boards didn't fare as well as others with the newer MacsBug and

TMON EUA. The Spectrum/24 worked fine with both debuggers. The ColorBoard 224 worked with the new TMON EUA, but it stopped at start-up with MacsBug. For the DirectColor/24 board, MacsBug loads successfully, as does TMON, if the screen mode is 8 bits or less. But once you're in the debugger, the best you can do is engineer a "soft landing" for the system by making the Mac reboot, because you often can't resume execution at the interrupt point.

Tough Choices

These three boards offer similar features and excellent results, so choosing one over the others is tough. However, your decision can be guided by the type of work you want the board to perform. If you're doing color desktop publishing or CAD/CAM, go with the DirectColor/24 and Radius's two-page display. For budget-conscious software development work, use the Spectrum/24—it handles both debuggers and comes in at the relatively low cost of \$3999.

If you do professional artwork or graphics design where you need to zoom in for detail frequently, that's the ColorBoard 224's strength. Or you might want to consider a stripped-down version of the NuVista (see the following section) as a video board in addition to using its graphics coprocessing and image-capture capabilities.

Scene Stealing

In the video-graphics board category, I looked at Data Translation's ColorCapture board and Truevision's NuVista 4M (see table 2 for a summary of features). The ColorCapture board gets you into the

continued

YOUR PROGRAMMERS



JYACC

Authorized Distributors: Australia: 03 899 0063 England: 0491 576 466 Finland: 0 4523 300 Sweden: 8 35 90 60 Switzerland: 021 825 35 85 West Germany: 040 796 1041

REVIEW

HOW TO PUT 16 MILLION COLORS TO WORK

	Spectrum/24	ColorBoard 224	DirectColor/24
Company	SuperMac Technology 485 Potrero Ave. Sunnyvale, CA 94086 (408) 245-2202	RasterOps Corp. 2500 Walsh Ave. Santa Clara, CA 95051 (408) 562-4200	Radius, Inc. 1710 Fortune Dr. San Jose, CA 95131 (408) 434-1010
Price	Spectrum/24: \$3999 19-inch Tritron display: \$4200	ColorBoard 224: \$5195 19-inch Tritron display: \$4195	DirectColor/24: \$4995 19-inch Color Display (includes stand): \$4295 QuickColor Accelerator: \$795
	Inquiry 856.	Inquiry 857.	Inquiry 858.

Note: For all products, required hardware is a Mac II-family computer with 2 megabytes of RAM running System 6.0.3/Finder 6.1 and 32-Bit QuickDraw.

image-capture game quickly with its plug-and-play setup. You simply install the board and software and attach the video cable to the board's video port, and you're set. The software consists of 32-Bit QuickDraw, a diagnostic application that checks the board, and a Color-Capture application.

I used a VCR and some tape recordings of TV programs as my video source. When you launch the ColorCapture application, a Focus on MAC Display menu selection presents a small 320- by 240-pixel window with 32 shades of gray on the Mac's monitor. This window shows a miniature of the video image, which is

updated approximately two to three times a second. The window's limited resolution and the display's slow refresh rate correlate to the overhead required to capture and present an image on the Mac's screen.

In this mode, you can click on the mouse to capture a scene, although there

WILL FLIP OVER OUR TOOLS



JAM has everything your programmers need to **prototype** and build **full-featured** applications. And you'll see application feats performed in half the time. ▶ JAM applications incorporate the **sophisticated** features users demand. Mix text and graphics, pop-up windows and pull-down menus without sacrificing performance or exhausting your budget. ▶ And JAM supports most hardware platforms, operating systems and databases. If you move to a new system, your JAM applications move with you. Nothing is lost and the user interface is **consistent** throughout your organization. ▶ So get JAM into the act. Enjoy added **performance** without added cost or development time. You'll have everybody cheering. ▶ To receive a free demo diskette and find out more about the JAM family of software products, call our toll-free hotline today!

800-458-3313

In NY, call 212-267-7722
or FAX 212-608-6753

JAM

Supported systems: MS-DOS, * OS/2, * XENIX, * UNIX, * VMS,™ ULTRIX, * A/OS/V, * VOS, * Prime, * MPE/XL, * iRMK*

REVIEW

HOW TO PUT 16 MILLION COLORS TO WORK

ColorCapture

Data Translation
100 Locke Dr.
Marlborough, MA 01752
(508) 481-3700

ColorCapture (NTSC and PAL): \$2995
Video I/O cable: \$125
PhotoMac 1.1 software: \$795

Inquiry 859.

NuVista 4M

Truevision, Inc.
7340 Shadeland Station
Indianapolis, IN 46256
(800) 858-8783

NuVista 4M: \$6495
NuVista 2M: \$4495
NuVista 1M: \$2995
VIDI/O Box (NTSC): \$995
VIDI/O Box (PAL): \$1995
RGB cables: \$50
RGB cables with alpha channel: \$60
NuVista 34010 toolkit: \$1500
(NuVista 2M can be upgraded with video RAM to NuVista 4M)

Inquiry 860.

can be a slight delay between the time you trigger the capture and when the image is actually digitized. To catch the exact scene you want, watch the video on a TV set or an external monitor and seize the scene with the Grab Image selection from the keyboard.

You can zoom in on an image to exam-

ine details, but that's about it. The board lets you save the image as a TIFF or IMAGE (Data Translation's own format) file. The company plans a future version of ColorCapture to allow you to crop and change the bit depth of images and save to more file formats. Data Translation's PhotoMac application, normally used for

color image manipulation, offers a capture function that works with ColorCapture. From within PhotoMac, you can grab an image and then work on it with a number of retouching tools or make a color correction.

PhotoMac 1.1 takes about 10 seconds to open a window with the captured image. As with the Focus on MAC Display capture, there's an image lag between the time you initiate a capture and the time an image actually shows up on the Mac's screen. However, PhotoMac gives you the opportunity to work on the image, save it in additional file formats, and print it.

Swiss Army Knife

Although it serves as a frame grabber, Truevision's NuVista 4M video-graphics board is hard to categorize. That's because the NuVista does practically everything. First, it serves duty as a typical Mac video board, handling modes from black-and-white to 32 bits per pixel. Second, it can drive a variety of monitors: interlaced, noninterlaced, NTSC, and PAL. Next, when running

continued

The QuickColor Option

Radius claims that its \$795 QuickColor Accelerator, an optional NuBus board that works in tandem with Radius video boards, boosts the performance of certain 32-Bit QuickDraw operations by 600 percent. Although our tests showed much more modest results overall, the need for an accelerator is apparent to anyone familiar with 32-Bit QuickDraw.

QuickDraw normally takes an application's graphics call and reduces it to low-level graphics primitives. For example, drawing a filled square invokes a procedure that draws a rectangle, then a bit-transfer procedure that fills it. These primitives are called "bottleneck routines" because their efficiency affects how fast objects are drawn. You access them via pointers; this makes it easy to swap out a routine's code by simply changing the pointer's address.

The Mac's CPU must execute large amounts of QuickDraw code and move volumes of data (particularly if an image is 24 bits deep) when drawing to the Mac's screen. The problem is particularly acute for large displays, like the Radius Color Display with over a million pixels.

A major problem involves the data transfer rate from the Mac's main memory to the video board's frame buffer on the NuBus. For the Mac's CPU to write to the NuBus, it must first synchronize this I/O operation with NuBus operations, which are handled by a chunk of complex hardware logic termed the NuBus state machine. Additional clock cycles are required to drive this state machine. Radius has calculated that the transfer rate from main memory to the frame buffer on a NuBus board is 3.8 megabytes per second.

The Solution

The QuickColor board improves data transfer rates by moving the bulk of the drawing operations onto the NuBus. This is done by patching some (but not

all) of the QuickDraw bottleneck procedures and using a 5-million-instruction-per-second Acorn VL86C010 RISC processor on the QuickColor board. When the Mac boots, an INIT loads multitasking code into the RISC processor's static RAM and also patches the QuickDraw bottleneck procedures. When an application performs drawing operations, the patched routines write RISC instructions to the QuickColor board instead of writing pixel data.

The RISC processor executes these instructions and manipulates the video board's frame buffer. With drawing operations occurring on the NuBus, the overhead of the NuBus state machine is eliminated or reduced. Since all Radius video boards can handle NuBus block transfers, the QuickColor board can act as a NuBus master and blasts data to the video board's frame buffer at rates of 27 megabytes per second.

Certain drawing operations don't benefit from this scheme. For example, it can't handle off-screen pixel maps, the color images that reside and are manipulated in the Mac's main memory and then transferred to the board's frame buffer. However, once this data is in the frame buffer, the QuickColor

board can perform other operations, such as scrolling the image in a window.

Test Results

I tested the QuickColor on a Mac IIcx equipped with a DirectColor/24 board and a Color Display. I first constructed a two-page PageMaker 3.0 document loaded with 24-bit scanned images and text. I timed my scrolling about the document with the QuickColor Accelerator enabled, and then with it disabled. The results appear in table A. Results vary because portions of the images had to be fetched from main memory as the document scrolled across the screen. The overall improvement in screen drawing averaged 33 percent.

Text handling showed a noticeable improvement as well: In the 24-bit mode, I scrolled several times faster through a text-only MindWrite 2.1 document. This outpaced scrolling the same document, unaccelerated, in the 8-bit mode, which took 55 seconds. The boost for handling text is significant since 32-Bit QuickDraw performs poorly in this area. These tests indicate that the QuickColor Accelerator's performance boost may be useful for color prepress work.

Table A: The following times (in seconds) gauge video activities with and without the QuickColor Accelerator.

ACCELERATOR TESTS		
	Unaccelerated	Accelerated
Scroll two-page PageMaker document, 24-bit mode		
Scroll left	44	40
Scroll right	41	28
Scroll down	37	22
Scroll up	24	11
Scroll down 10K-byte MindWrite document, 24-bit mode		
Scroll left	180	48

32-bit pixel displays, it can use that spare byte as an alpha channel to overlay video with an image or text. Finally, it offers an on-board 50-MHz TMS34010 graphics coprocessor, which can generate graphics and animations.

Since the board's output is RS-170 RGB, both the Mac Desktop image and the coprocessor graphics can be dis-

played and recorded. However, for the board to handle any sort of composite video input or have its output saved to a VCR, you will need to have a video encoder/decoder unit to convert analog RGB video to composite video signals. Truevision provides an optional two-way encoder/decoder unit called the VIDI/O Box for this purpose.

Installation is a little bit more complicated for the NuVista board than for some of the others. Putting the board in the slot is easy enough, but then you have to install the proper video driver for the monitor that you'll be using. The NuVista SetUp application loads the appropriate driver from a NuVista Driver file

continued



Novell and SCO certified for file server and multi-user UNIX server applications.

If work is hell, here's one personal computer built to take it.

If you want a computer that can take the heat, look at Tatung. Because before we ship any Tatung computer, our engineers roast, test and run every computer board at 117° Fahrenheit for 72 hours. If it doesn't survive, it's not a Tatung.

You don't have to work in hell, of course, to appreciate superior Tatung performance. Let's say you want to work faster.

Our new 386SX is a fast 386 machine that runs all 386-based applications. At a 286-class price.

And because our engineers didn't just wire a 386 processor onto a 286 motherboard, our 386SX design significantly improves system performance.



If you are hot for performance and reliability, look for the Tatung 386SX. It's hot.

See your Tatung dealer, or call us, toll-free, 24 hours for complete information: 1 (800) 765-2345. Tatung Company of America, Inc., 2850 El Presidio Street, Long Beach, CA 90810.



TATUNG
Engineering at its best.

onto the board. These drivers support up to 1536 by 485 pixels (NTSC interlaced) or 756 by 485 pixels (NTSC noninterlaced). Be careful if you're using this one board for your Mac screen and you want to try loading a different driver (perhaps for a larger display). The driver may black out the screen, and relaunching the setup application to reinstall an alternative driver is awfully difficult.

For the test setup, I routed VCR output through a VIDI/O Box to the NuVista board. The NuVista alternately drove an AppleColor RGB monitor and an NEC MultiSync XL monitor. The displays were rock-steady except during image capture.

If you're using a noninterlaced monitor with the board, you won't be able to view live video on the screen while capturing an image. As with the ColorCapture, I most easily obtained images using the Capture Image menu command with the keyboard. Be aware that the display momentarily goes berserk during image capture as the board shifts to interlaced frequencies to capture the image.

You can save the image as a PICT (32, 16, or 8 bits deep) or 32-bit TGA file.

This TGA format is identical to the TARGA file format used by Truevision boards on PCs, and it's useful for sharing images in a shop with different computers. The company provides Apple File Exchange translator files that can convert a PICT file to a TGA file and back.

By routing the Mac monitor's output back to the VIDI/O Box and then to the VCR, I taped scenes of the Mac Desktop. However, the 1-pixel-thick horizontal lines that are present on every Mac window flickered annoyingly. According to the NuVista manual, this happens because these lines are displayed only half the time on an interlaced display. You must carefully adjust the Desktop colors to reduce this shimmering effect.

Spectrum of Opportunities

Both boards did a good job of capturing NTSC video images. The images weren't as sharp as scanned images, but that's due to the limitations of the video signal, not the boards.

The NuVista board is more versatile than the ColorCapture in several areas, and the software seems more mature. But the NuVista requires the encoder/

decoder for composite video. In this respect, the ColorCapture holds the advantage—you can set it up quickly and use it right away with your VCR or camcorder.

Professional artists had contended that computers wouldn't replace conventional materials until they worked with millions of colors. With these boards, the Mac achieves this goal. Artists now have the large pixels required to adequately represent subtle changes in hue. Scanned photos can be displayed realistically, which makes electronic retouching possible. Images can be imported and previewed in page-layout documents, opening up a new market in color desktop publishing.

What can you do with millions of colors? Plenty. Five off-the-shelf boards already capitalize on using that many colors, and these products are just the start. Best of all, this accessible technology isn't rocket science. So I leave image workers with a new question: "What are you waiting for?" ■

Tom Thompson is a BYTE senior technical editor at large. He can be reached on BIX as "tom_thompson."

THE FIRST NAME IN TRUE OEM COMPATIBILITY

NATIONWIDE
1-800-292-6272

FAX MARYLAND LOCAL
1-301-561-4659 1-301-561-0200



WE ACCEPT PURCHASE ORDERS & CHECKS.

Use of equipment manufacturer's names is for identification only. NCRC is in no way affiliated with the OEMs listed.



9566 Deereco Road • Timonium, Maryland 21093

NCRC GUARANTEE

"We will never, knowingly, disappoint you. If for any reason your purchase does not give you complete satisfaction, the full purchase price will be cheerfully refunded immediately upon return of the merchandise."

We have always believed that no sale is complete until the customer has received total satisfaction from our products.
Phillip E. Bontinger, President

Buying from the manufacturer always guarantees the finest quality, best service and lowest pricing.

We manufacture our products with the blackest matrix ink, premium high density nylon, precision engineered plastics and "Rem" air refrigerated loading equipment

COLORS

BLUE - GREEN - PURPLE - RED
Add \$1.10 to your price per unit
Nylon only

Minimum Order 6 Ribbons

CARTRIDGE RIBBONS (NYLON)

No.	Description	Price Ea. [Black]
180	Apple Imagewriter II 4/C.....	8.50
114	Apple Imagewriter/DMP.....	3.25
127	Brother M1509/1709.....	5.75
104	Canan A-1200.....	4.95
109	Centronics 350/351/352/353.....	9.35
118	Citizen LSP 1200/1800.....	4.95
169	Citizen MSP 10/20.....	2.75
167	Citizen MSP 15/25.....	3.85
123	Comrex 420.....	7.55
131D	Data Products B-300/600.....	5.45
280	Epson EX 800/1000.....	4.65
165	Epson FX/MX/RX 70/80/85.....	2.75
167	Epson FX/MX/RX 100/185/286.....	3.85
288	Epson Lq500/Lq800/Lq850H.D.....	3.85
289	Epson Lq1000 H.D./Lq1050.....	4.95
163	Epson Lq1500.....	3.25
281	Epson Lq2500 H.D.....	4.95
283	Epson Lq2550.....	4.95
283C	Epson Lq2550 4 color.....	23.00
287	Epson Lq950.....	4.60
175	Epson LX 80/90.....	2.75
145	Hewlett Packard 2631A.....	12.05

No.	Description	Price Ea. [Black]
181	IBM 3287/3615 SD Loop.....	1.95
195	IBM 3287/3619 SD Cart.....	2.75
188	IBM 4201 ProPrinter II.....	4.15
176	IBM 4202 ProPrinter XL.....	4.95
177	IBM 4207 ProPrinter X24.....	4.95
211	IBM 4208 ProPrinter XL24.....	6.35
184	IBM 4224.....	11.25
875	IBM 4234.....	22.95
286	Mannesmann Tally 85.....	4.35
285	Mannesmann Tally 86.....	4.95
204	Mannesmann Tally 120/160.....	3.35
205	Mannesmann Tally 140/180.....	3.85
660	NEC Pinwriter P1/P2/P6.....	3.95
661	NEC Pinwriter P3/P7.....	4.35
662	NEC Pinwriter P5/P9.....	4.35
663	NEC P2200 H.D.....	6.05
210	NEC 5200/5300 Nylon.....	5.95
210M	NEC 5200/5300 M/S.....	11.75
210C	NEC 5200/5300 4 color.....	23.00
209	Okidata 182/183/192/193/320/321.....	3.95
206	Okidata 292.....	5.35
208	Okidata 293/294.....	6.15

No.	Description	Price Ea. [Black]
212	Okidata 393.....	17.95
217	Panasonic KXP 1080/1091.....	3.95
215	Panasonic KXP 1124.....	4.95
220	Panasonic KXP 1524.....	7.95
226	Radio Shack DMP 400/LPVI.....	3.25
235	Radio Shack DMP100/LPVI.....	4.35
282	Radio Shack/DMP 130.....	4.15
282	Seikosha SP800/1000.....	4.15
261	Star Micronics NB/NL/NP/NX 10.....	3.95
264	Star Micronics NL/NP/NX 15.....	5.75
266	Star Micronics NX1000.....	3.65
266C	Star NX1000 4 color.....	9.85
267	Star Micronics NX2400.....	4.75
262	Star Micronics Radix10/SR10.....	3.95
263	Star Micronics Radix15/SR15.....	4.55
290	Star Micronics SD10.....	4.15
291	Star Micronics SD15.....	4.55
245	Toshiba P321/P351.....	3.45
245	Toshiba P1340/P1350/P1351.....	3.45
246	Toshiba P321SL/P341SL.....	5.05
247	Toshiba P351SX.....	5.70
135	Tritel.....	2.85

No.	Description	Price Ea. [Black]
307	Brother EM200 HR15 M/S.....	4.15
158	Diablo Hytype II M/S.....	2.45
202	NEC 3500/8800 M/S Flip.....	5.85
320	IBM Selectric II H.Y. Corr.....	1.75
334	Olivetti ET 201/121 Corr.....	3.35
334B	Olivetti ET 121/351 M/S.....	4.85
227	Ricoh 1300/1600 M/S.....	3.25
TWIN SPDL (NYLON)		
454	Decision Data 6807/6811/6814.....	7.65
455	Dec writer LA 30/36.....	2.75
462	IBM 3262/5262.....	5.45
465	IBM 3525 T/S.....	3.35
464	IBM 5225/5250/5280.....	15.95
467	Dkidata 80, 82, 92, 93.....	1.35
470	Printronix 150/300/600.....	5.45
470	Star Micronics Gemini 10/10X.....	1.35

CALL US FOR VOLUME DISCOUNT PRICING

See why corporations such as General Motors, Mobil Oil, AT&T, Eastman Kodak, the U.S. Postal Service and thousands more are now using National Computer Ribbons™ brand products. **SAVE 50% or more with our National Computer Ribbons™ brand products.** \$5.00 shipping/handling on all orders under \$50.00. Over \$50.00 actual frt. is charged.

Kodachrome TRANSPARENCY



TRANSPARENCY
Kodachrome

...an image so sharp and bright you'd think you were looking at a color slide." PC World



Superior VGA imagery. One reason why *PC World* selected our CM-1296 VGA monitor as a "Best Buy." There are other reasons, too. Reasons you'll find in every Tatung color monitor. Reasons that come from solid commitment to "Zero Defect" manufacturing and superior quality controls. That's why Tatung is one of the world's largest

manufacturers of color monitors. When you work with a Tatung color monitor, you're working with more quality, performance, and value. The point is, you just can't buy a better monitor.



CM-1296 VGA color monitor. 12" non-glare CRT. Extra-fine 0.28mm dot pitch.

Information about the full line of Tatung monitors is yours for the asking. Simply call our special 24 hour information line: 1 (800) 765-2345.

Tatung Company of America, 2850 El Presidio St., Long Beach, CA 90810



TATUNG
Engineering at its best.

Circle 309 on Reader Service Card
World Radio History

C_talk/Views™



The Microsoft® Windows development tool that delivers from start to finish.

C_talk/Views is a development tool for C programmers that not only reduces the complexity of Microsoft Windows but also slashes development time by up to 75%.

Delivers on the promise of Object Oriented Programming.

Encapsulates more MS Windows functionality than any other tool on the market today. Get MS Windows applications off to a fast start with a framework of over 50 tested and ready-to-go object classes.

Provides support for the entire project.

Comes with *Browsers*, *Intelligent Make*, *Application Streamliner*, and an *Interface Generator*.

Gives you complete control.

Programming is still in C - use existing C libraries or call Microsoft Windows functions directly.

Offers real Object Oriented Programming.

Supports inheritance, encapsulation, and dynamic message binding. It is fully polymorphic - write less code than with other Microsoft Windows tools.

Pays for itself on even the smallest project.

Only \$450.00 with no royalties.
Comes complete with source code.

Watch for: C_talk/Views for OS/2 PM, the Apple Macintosh and X Windows. Develop one program for all platforms.

C_talk/Views

From CNS, Inc.

CNS, Inc., Software Products Dept.
7090 Shady Oak Road, Minneapolis, Minnesota 55344
(612) 944-0170, Fax (612) 944-0923

© Copyright 1989 CNS, Inc. All rights reserved. Microsoft is a registered trademark of Microsoft Corporation. C_talk/Views is a trademark of CNS, Inc. C_talk is a registered trademark of CNS, Inc.

Circle 70 on Reader Service Card
World Radio History



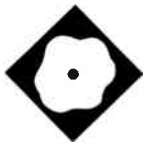

Power to the Programmer

Watcom's new C compiler unleashes the 80386

Fred Hommel

When Novell went looking for a 32-bit compiler for use with the NetWare 386 developer's kit, the company selected Watcom's. That compiler, packaged for use with DOS extenders from Phar Lap and Eclipse Computer Solutions (formerly A.I. Architects), is now available directly from Watcom.

In addition to tapping the full power of the 80386, Watcom C 386 provides library and source compatibility with the de facto Microsoft standard. The prospect of being able to port programs from DOS, as well as Unix, was very exciting. Of course, any programs you port or write will run only on 80386 or 80386SX computers, but if speed and a large address space are what you need, this system can deliver.

All this power isn't cheap. The compiler itself will set you back \$895, but that's not all you need. To run the programs you compile, you'll need a DOS extender—a program that kicks the 80386 into its native protected mode while presenting a DOS-like interface to programs. Phar Lap's 386|ASM/LINK costs \$495; the debugger, 386|DEBUG, costs an additional \$195. Eclipse Computer Solutions' OS/386 sells for \$495 and includes a debugger.

At the Starting Gate

To test Watcom C 386, I used the latest version of OS/386. This version is less well known than the Phar Lap DOS ex-

tender, but it's a powerful product. The operating system is supplied in the form of a TSR program, which is removable should you need the space for other tasks. One intriguing feature is a driver that you can use to run well-behaved DOS programs in virtual 8086 mode. Such programs can then use the device space above 640K bytes and so effectively address 960K bytes of RAM. The GIVEAMEG utility tweaks the header of an otherwise unmodified DOS program to make this possible.

The protected-mode loader, UP (the equivalent of Phar Lap's RUN386), loads and executes such programs, as well as full 32-bit applications that run in protected mode. After you've developed a 32-bit application, you'll want to distribute it. Eclipse Computer Solutions offers its BIND utility, which bundles a DOS extender kernel with your application, on quite reasonable terms. The manual that comes with OS/386 is superb and covers just about everything you need to know.

I used OS/386 because I'm more familiar with it than with the Phar Lap tools. Although Watcom supports both DOS extenders, Watcom C 386 is clearly Phar Lap-oriented, which made getting started a bit tricky. First, because the linker provided with OS/386 doesn't support the Phar Lap object-module format—it's from Lahey, the FORTRAN company—you have to run the Watcom libraries through the Lahey library manager in order to get them into the right format.

Then, because of differences between the two DOS extenders, you have to replace the start-up modules. Since the library manager insists on appending .OBJ to any filename you give it, you must rename the Watcom start-up files—CSTART3R.LBJ and CSTART3S.LBJ—using .OBJ extensions, lest the library manager tells you that it can't find the file CSTART3R.LBJ.OBJ. (I figured this out from a README file in the

OS/386 distribution disk; Watcom should mention it in its own documentation.) Finally, the Watcom compile-and-link tool, WCL386, generates a command file for Phar Lap's linker, so if you're using OS/386, you've got to roll your own compile-and-link batch file. Once I sorted these matters out, I was off and running.

The Watcom C 386 toolkit includes a stand-alone preprocessor (WCPP386), the compiler's front end (WCC386), the compile/link tool (WCL386, which currently supports just the Phar Lap linker), two code generators (386WCG and 386WCGL), a make utility (WMAKE), a patch utility for upgrading the compiler and tools (WPATCH), an object file disassembler (WDISASM), and a text editor (WEDITC). The stand-alone preprocessor is a nice touch; macro expansions can get tricky, and it's a good idea to be able to review the code that's actually fed to the compiler.

The code generators differ only in the memory models they embody: 386WCG is a medium model program (big code, small data), and 386WCGL is a large model program (big code, big data). You'd use 386WCG to coexist with, for example, a resident network shell, and switch to 386WCGL should the medium-model program's optimizer run out of memory.

The documentation includes a user's guide, a C language reference, and a library reference. The library reference is in much the same format as the one that comes with Microsoft C 5.1, except it has a good table of contents with all the functions listed alphabetically. Each function's description has six parts. The Synopsis section tells you what include file you should use, and it gives a function prototype. The Description, Returns, See Also, and Example sections do what their names suggest. The Classification section identifies a function as one of ANSI, POSIX, DOS, or WATCOM.

continued

BLAST[™] Complete Communications, ONE Software Package.



NEW! Remote Control

PC, MAC, UNIX, XENIX, VAX, and more. Link 30 popular operating systems. Connect and manage file transfers around the office or around the world.

RIGHT OUT OF THE BOX

Use regular modems, V.32, new high speed modems, X.25, LANs . . . BLAST links them all.

FOR INSTANT NETWORKS

Link two computers or 2000 . . . with

- One easy, identical interface
- One set of commands
- One powerful script language
- One reliable program

WITH ALL THE FEATURES

- Bulletproof file transfer
- Terminal Emulators - VT 100/220, etc
- Scripting for customized routines
- PC to PC Remote Control
- Fully automated operation
- Unbeatable noise resistance

API HOOKS TO LINK BLAST TO YOUR PROGRAM

- Over 50,000 users worldwide
- Top-Notch technical support

Call 800-24-BLAST

APPLE	MACINTOSH
IBM PC-XT,AT,PS/2	MS-DOS, SCO XENIX, UNIX V
UNIX Systems	UNIX V.3, 4.2, 386
DEC	VMS, RSX, RT-11, ULTRIX
DATA GENERAL	DOS, MPOS, RDOS, AOS/V5
HARRIS	POS, UNIX, XENIX
HEWLETT-PACKARD	MPE, RTE, UNIX
IBM	VM/CMS/MVS/TSO
PRIME	PRIMOS
UNISYS	BTOS, CTOS, UNIX
WANG	VS OS, MS-DOS
. . . plus many more	

BLAST

Communications Research Group
5615 Corporate Blvd. • Baton Rouge, Louisiana 70808
(504) 923-0888 800-24-BLAST

Watcom C 386

Company

Watcom
415 Phillip St.
Waterloo, Ontario
Canada N2L 3X2
(800) 265-4555

Hardware Needed

An 80386 or 80386SX computer with 640K bytes of RAM

Software Needed

Phar Lap's 386/ASM/LINK or Eclipse Computer Solutions' OS/386

Documentation

User's manual; library reference; language reference; text editor manual

Price

\$895

Inquiry 881.

The compiler supports five different memory models: flat (the default), small, medium, compact, and large. However, library support is only provided for two memory models, small and flat. You can use only the small model under OS/386 due to the constraints of the linker provided. Of course, "small" in the 32-bit world means 4 gigabytes, so there's no need to feel cheated. In the flat model, there are, effectively, no segments. In the small model, code and data are referenced by means of near (32-bit) pointers. The far keyword will permit use of far (48-bit) pointers. So, for example, you can access video RAM from within a C routine.

The compiler has two schemes for passing arguments to subroutines: in registers (the default) or on the stack. Each scheme has its own version of the runtime library, and if you switch from the register scheme to the stack scheme (by means of a command-line switch), you have to be sure to also use the stack-oriented library. Watcom also provides an unusual and powerful pragma syntax that you use to gain complete control over which registers can receive arguments and how they're passed.

A word of caution. Routines that take variable numbers of arguments must be written using the macros defined in the ANSI specification, or they won't work

properly. Not all Unix programs do that, so beware.

Off to the Races

To test both the Unix and MS-DOS/Microsoft compatibility of the compiler, I ported a public-domain spreadsheet, *sc*, to the 32-bit DOS environment. The spreadsheet itself is a Unix program; the PCCURSES package (also public domain code) that I used to implement *sc*'s screen and keyboard I/O makes heavy use of DOS and BIOS function calls.

The spreadsheet ported with little difficulty. The only major snag had to do with macro substitution. As it turned out, it wasn't Watcom's fault. The compiler performed per the ANSI draft specification. The problem was that the Unix preprocessor used to develop *sc* had been a bit looser in its enforcement of the rules. In the end, Watcom's technical-support department came up with a workaround, and I was on my way.

The next task was to get PCCURSES running. It's written such that all the actual screen I/O is done through one module; you even get a choice of an assembly or C version. I chose the C version, and in general, things went smoothly. I did, however, have to account for a minor difference between the Microsoft C and Watcom C 386 libraries. Both libraries use a union called REGS in conjunction with software interrupts to the BIOS or to DOS. Watcom alters that union to handle the register architecture of the 80386 and replaces the standard *int86* and *int86x* function calls with *int386* and *int386x*. So I had to rename the *int86* and *int86x* calls and make sure that REGS was set up properly. That didn't take long, though, because only a handful of function calls were involved.

While tracking down the structure changes, I ran into the problem of trying to debug a program written with the compiler. The problem is that there is no source-level debugger. Watcom told me that it is working on both a debugger and a linker. I was able to get by using the CP debugger provided with OS/386.

Once the program was working, its power was quickly evident. I filled a spreadsheet with 3 megabytes of data (from cell a0 to cz198) and was able to recalculate it in seconds.

I also ran a set of benchmarks using Watcom C 386 and MetaWare's High C 386 (under OS/386) and Microsoft C (under DOS and OS/2). The tests were run on a 20-MHz Compaq Portable 386 with 10 megabytes of 32-bit RAM. I tested the Watcom compiler using both

continued

ZORTECH

NEW! AT&T C++ RELEASE 2.0 SPECIFICATION

NEW! MS WINDOWS COMPATIBILITY

NEW! EASY PORTABILITY FROM MICROSOFT C

NEW! C++ DEBUGGER & EXPANDED C++ TOOLS

NEW! OS/2 UPGRADE AVAILABLE NOW!



We listened carefully to what you wanted in a next generation MS DOS C++ compiler. The answer is Zortech C++ V2.0 Developer's Edition.

You wanted the latest AT&T V2.0 features with the power offered by multiple inheritance and type safe linkage, so here it is.

You wanted compatibility with MS WINDOWS, we added it.

You repeatedly asked for easier portability from Microsoft C, we got the message, and have written the library functions you need.

You wanted the world's first MS DOS C++ source level

DEBUGGER, and now the wait is over.

You wanted expanded and improved documentation, we both listened and delivered.

You wanted to be able to upgrade to an

OS/2 version compiler supporting Presentation Manager, you did not want it to cost a fortune, so it's available for \$150.

You want to look at the standard library SOURCE CODE, so we are including it.

SAVE \$200
Get the Developer's Edition for only \$450 comprising:

C++ Compiler	(\$199.95)
C++ Debugger	(\$149.95)
C++ Tools	(\$149.95)
Library Source	(\$149.95)
Total Value	\$649.80

Here is our list of highly recommended C++ books:

C++ Language/Stroustrup	\$32.25
C++ Answer Book/Hansen	\$26.95
C++ for C Programmers	\$29.95
C++ Primer/Lippman	\$30.25

Ask about our new C++ Video Tutorial

For many, EMS programming support, built into the compiler is important, so it's in there too.

You were happy using the 18 classes provided in C++ TOOLS, but we revised and expanded it anyway.

You never asked for a free TSR library to be included, but we knew you'd love to use our neat little package, so we included it free.

You liked our FLASH GRAPHICS package for its speed, but wanted a C++ Class interface, so we've written it.

How To Order:

Already own Zortech C++? Call the order hotline for details of our low cost upgrades.

To order Zortech C++ for the first time, just call the order hotline. We accept payment by Mastercard/Visa/COD.

Alternatively, mail the coupon below with your check or credit card details.

ZORTECH INC.,
1165 Massachusetts Avenue, Arlington, MA 02174, USA
Voice 617-646-6703
Fax 617-643-7969

ZORTECH LTD.,
106-108 Powis Street, London, SE18 6LU, ENGLAND.
Voice (44)-1-316-7777
Fax (44)-1-316-4138

CALL 1-800-848-8408

Yes! Please rush me the following C++ V2.0 items:

Name _____
Address _____
City _____ State _____ Zip _____
Visa/MC# _____
Exp. Date _____ Tel _____

- DEVELOPER'S EDITION \$450 (Save \$200)
- C++ COMPILER \$199.95
- C++ DEBUGGER \$149.95
- C++ TOOLS \$149.95
- LIBRARY SOURCE CODE \$149.95
- COMPILER & LIBRARY SOURCE \$299.95
- OS/2 COMPILER UPGRADE \$149.95
- C++ VIDEO COURSE \$499.95
- C++ Language /Stroustrup \$32.25
- C++ Answer Book/Hansen \$26.95
- C++ for C Programmers/Phal \$29.95
- C++ Primer/Lippman \$30.25

For US orders please add \$5.05 shipping

Overseas orders at international mail rates.

All MicroSoft trademarks are acknowledged.

Table 1: The Watcom and MetaWare compilers, under OS/386, outperform Microsoft C 5.1 under both DOS and OS/2. All times are in seconds.

Benchmark	COMPILER BENCHMARK RESULTS						
	Watcom C 386 7.0			MetaWare High C 386 1.4		Microsoft C 5.1	
	Iterations	Register	Stack	Aligned	Unaligned	DOS	OS/2
Fibonacci	100	34.28	44.38	41.64	40.92	42.18	42.72
Sieve	1000	34.60	34.61	45.70	47.73	46.58	47.13
QuickSort	1000	62.18	63.38	60.48	61.02	111.91	120.22
Eight Queens	1000	40.09	45.48	42.73	41.96	59.15	59.90
Dhrystones/second		7334	6503	7741	7714	606	5950

the register- and stack-oriented argument-passing schemes. Since the MetaWare compiler can align routines and labels on quadword boundaries—an optimization that the Watcom compiler currently doesn't support—I compiled under MetaWare both with and without that option. As table 1 shows, the Watcom and MetaWare compilers (both known for quality optimization) turned in comparable performances. Both significantly outperformed Microsoft C 5.1

under DOS and OS/2, especially on the Dhrystone and QuickSort tests.

I like this compiler. The library support is superb; Watcom even includes the POSIX directory functions. I appreciated the inclusion of a disassembler. The use of registers for passing arguments is clearly a powerful optimization. There are a few wrinkles. The lack of a debugger is the most obvious one. Another is that the only foreign language supported is assembly. If you want to

mix FORTRAN and C in a 32-bit environment, you'll have to find another solution (although Watcom says that it's working on a FORTRAN compiler). But these are minor and correctable problems. It's clear that Novell chose wisely; this product is a winner. ■

Fred Hommel is an independent software consultant specializing in OS/2 conversions. You can reach him on BIX as "fhommel."

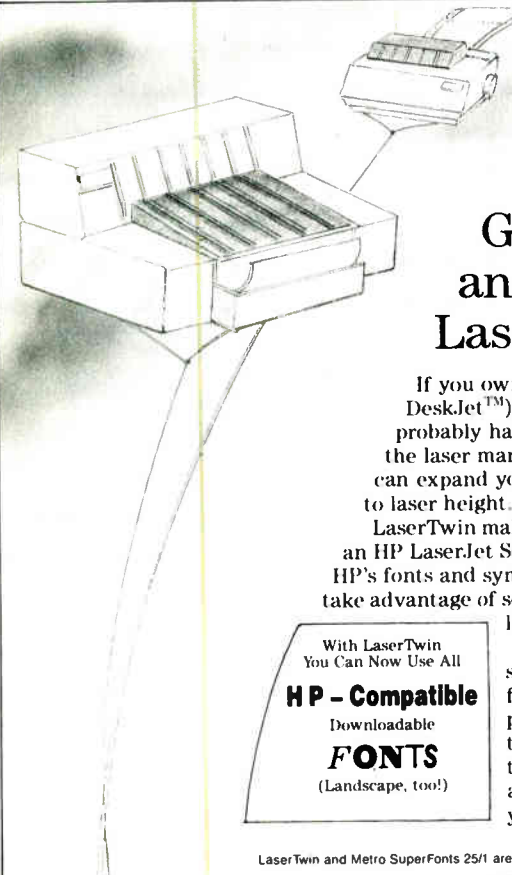

Elevate Your Printer Capabilities!

Get Laser Capability for InkJet and Dot Matrix Printers with LaserTwin™ from Metro Software

Also Available from Metro: Metro SuperFonts 25/1™ gives you HP's 25 cartridges on disks! Introductory Price: \$149

If you own an ink jet (like the HP DeskJet™) or dot matrix printer, you probably have felt left behind from the laser market. With LaserTwin™ you can expand your printer's capabilities up to laser height.

LaserTwin makes your printer behave like an HP LaserJet Series II™ and even includes HP's fonts and symbol sets. Now you can also take advantage of software for the HP LaserJet like downloadable soft fonts.

Using LaserTwin, your software (including tax, forms, and graphic programs) prints at the highest resolution. And with LaserTwin's text formatting language and your word processor, you can access desktop publishing features. You can also print sideways! So you never looked better!

If you've got a mix of dot matrix, ink jet and laser printers, use LaserTwin and see the same results! Plus, LaserTwin lets you print directly from within your application and its spooler speeds up background printing.

So, rather than feeling tied to the ground with your printer, get LaserTwin and expand your horizons. Act before December 31, 1989, and buy LaserTwin at the **SPECIAL INTRODUCTORY PRICE OF \$149!** Call us today at 1-800-621-1137, ext. B.

With LaserTwin You Can Now Use All

HP - Compatible

Downloadable

FONTS

(Landscape, too!)



METRO
METRO SOFTWARE, INC.

2509 N. Campbell Avenue, Suite 214
Tucson, AZ 85719
(602) 292-0313 Fax (602) 292-1563

LaserTwin and Metro SuperFonts 25/1 are registered trademarks of Metro Software, Inc. All other trademarks are of their respective manufacturers. Copyright © 1989.

C THE LIMIT!

MicroWay is your best source for the software and hardware you need to get true 32-bit performance from your 386. Our NDP C compiler takes the original C concept of writing lower level code with a higher level language to the limit by providing an inline assembly language interface that lets the programmer specify the exact register used to hold a variable. This feature makes it possible to use ports or perform interrupts or block moves inline, instead of through calls. The use of register aliased variables to control hardware reduces the size of critical code sequences by a factor of 3 to 10 and keeps the 386's pipelines full by eliminating costly calls. If you are interfacing DOS or the ROM BIOS, or writing graphics routines, a device driver, operating system kernel, or an embedded application, you owe it to yourself to try NDP C-386.

Our Users Report:

Milt Capsimolis of Ithaca Software in Ithaca, NY, developer of HOOPS, the highly regarded 3D, object-oriented graphics library, reports, "We ported a huge library — well over 100,000 lines — without a hitch, in less than a day!...We also liked the enormous advantage it offers through its support of the Weitek coprocessor."

Fred Ziegler of AspenTech in Cambridge, Mass. reports, "I ported 900,000 lines of FORTRAN source in two weeks without a single problem!" AspenTech's Chemical Modeling System is in use on mainframes worldwide and is probably the largest application to ever run on an Intel processor.

NDP C is also the language of choice if you are combining C with FORTRAN or Pascal, are planning to use any one of four coprocessors that run with the 80386, or require the highest globally optimized code attainable. MicroWay's C, FORTRAN and Pascal compilers come with a 70 function, device-independent graphics library that automatically supports Monochrome, Hercules, CGA, EGA, and VGA adapters and makes it easy to interface memory-mapped peripherals such as digitizers or serial devices such as mice. We make it possible for you to write your own numeric exception handler and include examples written in C, FORTRAN and Pascal. Finally, our C is not only one of the easiest to use, but supports two dialects: ANSI and UNIX. In fact, our UNIX implementation is so close to the standard, that our best customer has become AT&T!

Please call (508) 746-7341 for more information.

386 Compilers and Tools

NDP Fortran-386™, NDP C-386™, and NDP Pascal-386™ compilers generate globally optimized, mainframe quality code that runs on the 386 or 486 in protected mode under UNIX, XENIX or Phar Lap extended DOS. The compilers address 4 gigabytes of memory while supporting the 80287, 80387 and Weitek coprocessors. They all come with a library of over 70 device-independent graphics, keyboard and sound routines. Applications can mix code from all three compilers and assembly language. The DOS versions allow the user to write his own numeric error handlers and interface 386 real mode programs from protected mode. The VM versions use Phar Lap's Virtual Memory Manager to run programs which exceed the size of your system memory. **NDP Fortran-386** is a full FORTRAN 77 with FORTRAN 66, BSD 4.2, DOD and VMS extensions. **NDP C-386** is a full K&R C with both MS and ANSI extensions. It is 100% compatible with UNIX C and is substantially faster than the C which comes with UNIX. **NDP Pascal-386** is a full ANSI/IEEE Pascal, with extensions from C and BSD 4.2 Pascal.

DOS versions (require Phar Lap Tools) . . . \$595
 VM version (requires VMM) \$695
 UNIX/XENIX versions \$795
 Phar Lap Development Tools \$495
 Phar Lap Memory Manager (VMM) . . . \$295
NDP Windows™ — 80 functions which create, store, and recall menus and windows. Works with NDP C and drives all popular graphics adapters Library: \$125, C Source: \$250
NDP HOOPS™ — An NDP port of Ithaca Software's HOOPS, this 3D object-oriented graphics library, callable from NDP C, makes it possible to develop full-featured 386 CAD packages and front ends \$575
NDP Plot™ — Calcomp compatible plot package, callable from NDP Fortran. Includes drivers for popular plotters and printers. Works with MDA, CGA, EGA and VGA \$325
NDP/FFT™ — The fastest running FFTs on a PC! 40 hand-coded routines that handle 1 and 2 dimensional data arrays. Includes an in core solver that spills to disk for arrays too large to fit in memory. NDP or 80x87 version ea. \$250
NDP to HALO '88 Graphics Interface — Lets you call HALO '88 from NDP compilers . . . \$100

NEW! C++

NDP C++ is a MicroWay port of the UNIX C++ preprocessor version 1.2. It runs in protected mode on DOS, UNIX or XENIX, and is ideal for writing numerics and graphics applications. The product comes with an example of how to support complex numbers in C++ \$495

Parallel Processing

Videputer™ — The highest performance graphics card on the market. Uses a T800 and TI 34010 in conjunction with an 80 MHz Brook-Tree DAC. With one meg \$4495

Monoputer™ — Includes one T800 and up to 16 meg of RAM for parallel code development. The four MWhetstones T800 makes this the ideal FORTRAN engine for cost-effective execution of your mainframe programs. \$1295

Quadputer™ — This board for the AT or 386 can be purchased with 1 to 4 transputers and 1 or 4 meg of memory per transputer. Two or more Quadputers can be linked together to build networks of up to 100 or more transputers providing mainframe power from \$1995

Transputer Compilers and Applications

These parallel languages are designed for use with either a Monoputer or Quadputer.

Logical Systems Parallel C \$595
3L Parallel C, FORTRAN, or Pascal . . . \$895

ParaSoft EXPRESS Package: — Includes transputer communications libraries, C source level debugger and system Performance Monitor. \$1500

COSMOS/M — Finite element analysis. Comes bundled with a 4 meg Quadputer. Performs at near supercomputer speeds. from \$7,000

T800/NAG™ — Features a library of 268 engineering and scientific numerical algorithms. Callable from 3L Fortran. \$2750

387BASIC™ — Our 16-bit MS compatible compiler introduces numeric register variables to produce the fastest 80x87 code on the market. For "floating-point and other complicated mathematical calculations, you'll appreciate the extraordinary speed with which 387BASIC handles these processes". PC Magazine 10/31/89 \$250

NEW! Cyrix FasMath™

Cyrix 83D87 FasMath™ — Fastest 80-bit Intel compatible processor on the market. Performs transcendentals up to 3 times faster than the 80387. **CX83D87-20:** \$745 **CX83D87-25:** \$925

Weitek-Based Coprocessor Boards

mW1167™ and **mW3167™** coprocessor boards are built at MicroWay using Weitek components. Each includes an 80387 socket.
mW1167-16 \$695
mW1167-20 \$895
mW1167 Microchannel-16/20 . . . from \$995
mW3167 Microchannel-25/33 . . . from \$1795
3167-20 \$995
3167-25 \$1295
3167-33 \$1695
mW3167/80387 Board \$200

Intel Coprocessors and RAM

8087 \$84	8087-2 \$120
80287-8 . . . \$195	80287-10 . . . \$220
80387-16 . . \$330	80387-16SX . . \$310
80387-20 . . \$375	80387-25 . . . \$460
80C287A . . \$280	80387-33 . . . \$550

287Turbo-20™ This coprocessor board runs a specially qualified Intel CMOS 80287 at 20 MHz regardless of the main CPU speed. . \$450
RAMpak™ - one meg 32-bit memory module for Compaq 386 20/25 . . \$295 4 meg . \$995
 Please call for our 100 and 80 ns RAM prices.

386 Your AT

386/387Turbo-AT™ — Plugs into the 80286 socket, allowing your IBM AT to run 32-bit protected mode code written for the 80386. 80387 socket included. **16 MHz:** \$495 **25 MHz:** \$695

Multi-User Accelerators

MicroWay's **AT8™** and **AT16™** intelligent serial controllers run 8 to 16 terminals under UNIX or XENIX without bogging down your AT, 80386 or PS/2. **AT8:** \$895 **AT16:** \$1295

12 MHz PC Accelerators

SuperCACHE-286 12 MHz \$399
FastCACHE-286 12 MHz \$299

World Leader in PC Numerics

Corporate Headquarters: P.O. Box 79, Kingston, MA 02364 USA (508) 746-7341
 32 High St., Kingston-Upon-Thames, U.K., 01-541-5466
 USA FAX 508-746-4678 Italy 02-74.90.749 Holland 40 836455 Germany 069-75-2023

Share the load.



Professional Modula-2 Compiler... Just think what the two of you can do.

Find out what Stony Brook's fully optimizing compiler can do for you. You can use Modula-2 for all your development requirements or you can link with any other language that produces Microsoft object modules. You can engineer the fastest and smallest program possible taking advantage of our highly optimized code generation. You can compile your applications for DOS and OS/2 with no changes in the source code. You can outperform the competition. You can do more than you ever could before.

The Professional Modula-2 package includes an editor, intelligent linker, symbolic debugger, execution profiler, and an automatic make facility. All these functions can be performed from the fully integrated environment or as separate command line utilities.

We also include the best runtime library in the industry, interface libraries for Microsoft Windows, presentation manager, and QuickMod high productivity environments for DOS and OS/2. All for \$295.

The source code for the runtime library is available as an option for those who need it. You can also purchase the QuickMod environment, in DOS or OS/2, without the optimizing capabilities for \$95.

Stony Brook—we design our products specifically to improve developer performance. And we know software engineering. Put us to work for you.

Call us direct and we'll mail product information to you within 24 hours.

800/624-7487
805/496-5837 California and International
805/496-7429 Fax

Stony Brook
SOFTWARE

**Your Partner
in Software Development**

187 East Wilbur Road, Suite 9,
Thousand Oaks, CA 91360

High-Fashion Unix on a PC

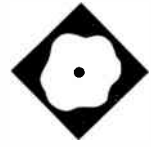

The HP way to make a high-quality color X Window display server out of an IBM AT

Ben Smith

Hewlett-Packard has an excellent budget saver for departments needing quality color X Window user workstations: the Accelerated X Window Display Server (AXDS/PC) for IBM ATs. A quality color X Window workstation usually costs more than \$15,000. For roughly \$5000, though, you can upgrade a LAN-ready, AT-type computer (such as the HP Vectra) to a 1024- by 768-pixel color display server.

Clients and Servers

The X Window System from MIT is the de facto standard graphics window system for Unix. It is designed for environments where the user terminal connects by a network to several computers running the applications running in windows and graphics for the user interface. The X Window System works equally well on systems where application programs are on the user's local computer (see "The X Window System," January BYTE).

In the terminology of the X Window System, the application programs are *client processes*, and the processes that are specific to the keyboard, mouse, and display are *server processes*. The X Window server processes are responsible for interpretation of requests from client processes for activity on the server device. The client processes do not contain

any information about the specifics of the physical location or characteristics of the server.

For example, if a client process wants to be notified of pointer activity within a window associated with that process, it sends a request (*MotionNotify*) to the server. The server is responsible for managing the physical devices (in this

case, the mouse and the screen), moving the display pointer, detecting when the pointer is in the associated window, and keeping track of where in the window the pointer is located, as well as where the window is located in the root window (the full screen) and a number of other data. The server passes the information

continued

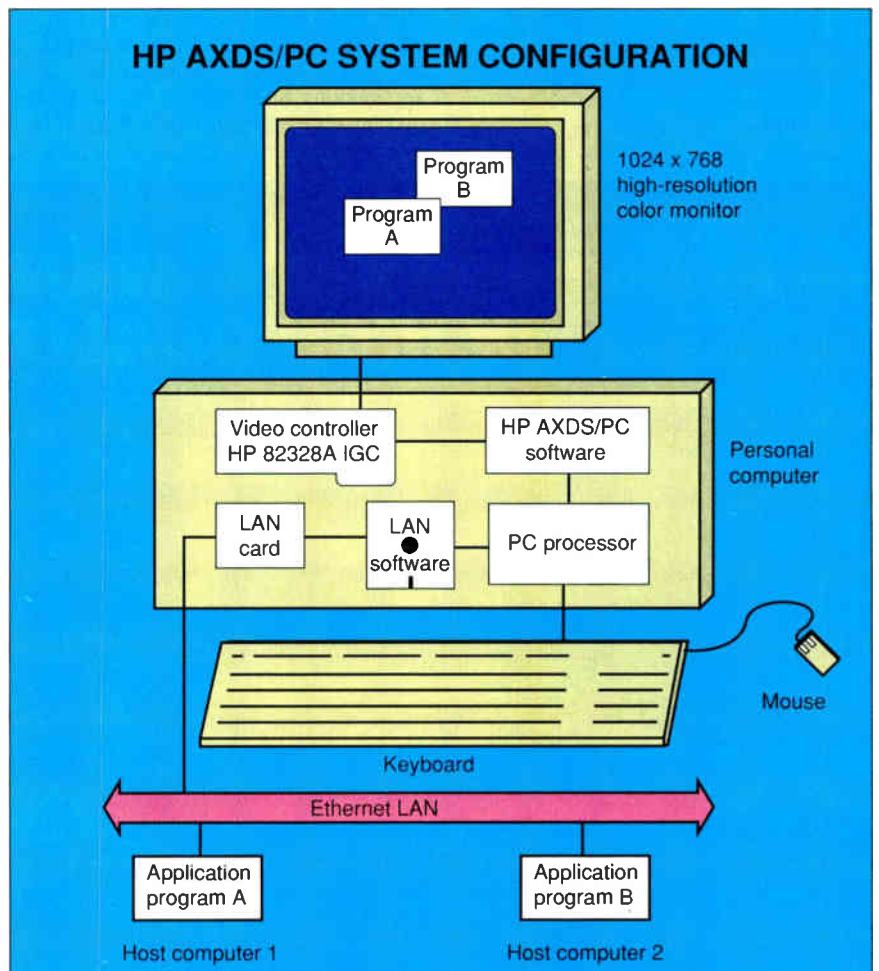

The HP AXDS/PC lets you use your IBM AT compatible as an X Window display server.

Accelerated X Window Display Server

Company

Hewlett-Packard
4 Choke Cherry Rd.
Rockville, MD 20850
(301) 670-4300

Hardware Needed

HP Vectra IBM AT or compatible with 640K bytes of RAM, 6 megabytes of hard disk space, HP 82328A Intelligent Graphics Controller, HP 82329A, LAN card and software, color graphics monitor, and pointing device

Software Needed

MS-DOS or PC-DOS 3.1 or higher

Documentation

Installation guide

Price

HP AXDS/PC software only: \$500
HP 82328A Intelligent Graphics Controller: \$1480
HP 82329A EGA Emulation Module for 82328A: \$415
HP D1188A 16-inch MultiSync Color Graphics Monitor: \$2795

Inquiry 882.

back to the client when an appropriate event occurs. In addition, the server is responsible for handling character fonts and drawing functions and applying them to the specifics of the server hardware.

A machine that is capable of handling both client and server processes fits most of the requirements of a Unix workstation (see "Unix Workstations Connect" on page 123).

Workstation or Display Server

To qualify as a Unix graphics workstation, the AT would have to run Unix as its operating system and be capable of doing some of the client processing. However, the AXDS/PC software is installed under MS-DOS. In fact, even while the network and X Window server are running, you can escape to DOS. Therefore this package does not turn an AT into a complete workstation; it requires a separate Unix machine for running all the client processes (see the figure). But the niche that it fills is an important one: a machine for people who use MS-DOS applications and want to avoid having two separate machines to do their work.

High Speed and High Quality

The design concept is for high speed and high-quality graphics processing using the base platform of the AT. The weakness of the AT design is that the graphics processing speed of the Intel 80x86 processor (especially under DOS) is not sufficient to handle the heavy loads of multiple high-resolution windows. The HP solution is the HP 82328A Intelligent Graphics Controller High-Resolution Graphics Card. By programming the card to perform the X Window operations, the only services that AXDS/PC requires from the DOS machine are program storage and loading and font storage and loading.

To do this, the graphics card has to be fast and smart. The key is the Texas Instruments TMS34010 Graphics System Processor (GSP) chip (see the December 1986 BYTE). This GSP chip runs at 40 MHz providing short-term performance of nearly 5 million instructions per second (MIPS). It can address up to 4 gigabytes of memory. It has an on-board instruction cache for 128 16-bit instructions, and it has 31 32-bit registers.

continued

ARA-TECH WANTS PARTNERS IN HIGH QUALITY PRODUCTS.



OPTIMA VGA 1024+
*1024x768 in 16 color *800x600 in 256 color
*512 KB *16 Bit *with Analog/ TTL connector

High Quality in Video Board, see below;

	IBM VGA	PARADISE VGA	TRIDENT TVGA	ARA-TECH OPTIMA 1024+
MAX. VIDEO SPEED	28 MHZ	44 MHZ	?	65 MHZ
800 x 600 — 16 Color	NO	YES	YES	YES
640 x 480 — 256 Color	NO	NO	YES	YES
800 x 600 — 256 Color	NO	NO	NO	YES
1024 x 768 — 16 Color	NO	NO	NO	YES

* IBM is trademark of International Business Machine.
* Paradise is trademark of Paradise system.

**OEM / DISTRIBUTOR / DEALER'S
INQUIRIES INVITED**

End users; Call (818) 996-8801
for the dealer nearest you.



OPTIMA VGA 800
*8 Bit, 256 KB
*800x600 / 16 Color



PRIMA 480 EGA
*640x480 / 16 Color
*Paradise 480 Compatible



ARA-TECH, INC.
18040 Sherman Way, Suite 105,
Reseda, CA 91335
Phone (818) 996-8801
FAX (818) 996-1946

Circle 25 on Reader Service Card



"If every dollar of your computer budget is critical and you still want top speed, consider the GenTech"

GENTECH 286-20 JUNE 27, 1989



GenTech 286-20

ONE OF THE FASTEST 286'S AROUND

\$1199

Harris 20MHz 80286 CPU
1 MB Zero-Wait RAM
Fast dual hard/floppy disk controller
UM 4.0 EMS support
6-16, 2-8 bit slots
1.2 or 1.44 MB floppy drive
Serial and Parallel ports
Rugged 200 watt p.s., 5 bay case
101 key keyboard with tactile click feel

GenTech 386-25c

386-20C FROM \$1799

\$2299

Intel 25 or 20MHz 80386 CPU
32 KB static RAM cache
1 MB Zero-Wait RAM
Fast 1:1 interleave dual hard/floppy disk controller
2-32, 6-16, 2-8 bit slots
1.2 or 1.44 MB floppy drive
Serial and Parallel ports
Rugged 200 watt p.s., 5 bay case
101 key keyboard with tactile click feel



VERTICAL CASE ADD \$200



GenTech 286-12

\$849

12MHz clock speed
1 MB Zero-Wait RAM
Fast dual hard/floppy disk controller
4-16, 2-8 bit slots
1.2 or 1.44 MB floppy drive
Serial and Parallel ports
Rugged 200 watt p.s., 5 bay case
101 key keyboard with tactile click feel

GenTech 386-20

\$1599

Intel 20MHz 80386 processor
1 MB Zero-Wait RAM
Fast dual hard/floppy disk controller
1-32, 6-16, 2-8 bit slots
1.2 or 1.44 MB floppy drive
Serial and Parallel ports
Rugged 200 watt p.s., 5 bay case
101 key keyboard with tactile click feel



1 YEAR FREE ONSITE SERVICE BY TRW

VIDEO OPTIONS

16 bit Super VGA system	\$645
VGA color system	\$545
VGA monochrome system	\$310
EGA color system	\$479
Monochrome graphics system	\$139

STORAGE OPTIONS

150MB ESDI (18ms)	\$1299
80MB Seagate (28ms)	\$599
40MB Seagate (28ms)	\$379
30MB Seagate (40ms)	\$235
20MB Seagate 225 (65ms)	\$225

- 1 YEAR WARRANTY
- ONSITE SERVICE
- 30 DAY MONEY BACK GUARANTEE
- TOLL FREE TECH SUPPORT

CALL US FOR



HEWLETT PACKARD

SUPPLIES

AST

AST Premium 386/33	from \$4059
AST Premium 386 systems	from \$2299
AST Premium 286 systems	from \$1189
AST BRAVO 286	from \$749

COMPAQ

SLT 286 laptop	from \$4500
DESKPRO 386/33	from \$7699
DESKPRO 386/20E	from \$3750
DESKPRO 386S	from \$2379
DESKPRO 286E	from \$1819

PRINTERS

BROTHER HL8e	\$1799
BROTHER HL8PS	\$3299
QMS PS-810	\$3399
Panasonic 1124 24 pin	\$319
Epson LX-810	\$189
NEC 5300 24 pin 15" carriage	\$679

ZENITH LAPTOPS

SUPERSPORT 286 20MB	CALL
SUPERSPORT 286 40MB	CALL

NETWORKING

8 bit Arcnet card	\$99
Ethernet NE 1000 compatible	\$159
3 port Active hub	\$219
Passive hub	\$39

Tiara 16 bit Arcnet LanCard	\$245
Tiara 8 bit Arcnet LanCard	\$109
Tiara Arcnet LanCard MCA	\$299
Tiara Ethernet Microchannel	\$349

NetWare software	CALL
------------------	------

NETWORK STARTER KIT

Includes 4 user ELS software, 4 Arcnet cards, 1 passive hub, 4 cables

\$945

TO ORDER
800-638-0286

FROM OVERSEAS & CANADA 401-732-5556
FAX 401-732-5518

Monday-Friday 9am to 7pm E.S.T. General Technology
Saturday 10am to 4pm E.S.T. P.O. Box 20555
FAX 24 hours a day Cranston, RI 02920

GenTech

General Technology Corporation

Circle 138 on Reader Service Card

World Radio History

The HP 82328A Intelligent Graphics Controller can produce 16 colors (out of a palette of 4096), with a resolution of 1024 by 768 pixels. You can expand the DRAM used to store the X Window Server programs for the TMS34010 and Window data structures to 2 megabytes, providing enough space for dozens of concurrent windows. The video information is stored in separate RAM. The board will also emulate IBM's EGA for DOS applications.

The Brains Behind the Brawn

All this graphics power is of no use without a good program to use it. The control is provided by the HP AXDS/PC software, an implementation of X Window System 11 release 3 written for the TMS34010. I evaluated the HP AXDS/PC on an HP Vectra ES/12—a 12-MHz 80286-based system. Every function, including font handling, color, and shading, appeared to be the same on the HP AXDS/PC system as on the \$40,000 Unix engineering workstation handling the client processes. The only noticeable degradation was in drop-down menus, with which momentary lags made the

pointer tracking and selection response time uncomfortable to use.

The compatibility between the two systems is complete to the finest detail. The performance was more than adequate for all standard applications. HP claims that the performance is equivalent to a 2-MIPS workstation with 2 megabytes of RAM. Graphics drawing and typesetting applications ran faster than on most PCs, and any professional would be happy with the quality and resolution.

Usability and Price

This is a very usable implementation of the X Window Server design. The cost of the software and graphics controller card is reasonable, especially considering that Hewlett-Packard is noted for reliability. The most expensive element of your upgrade will be buying an HP color monitor, ranging in price from \$2795 up to \$6850. I see little point paying any more for a tube that has image-resolution specifications far above those of the display card. The system I tested used the "low-end" D1188A 16-inch MultiSync Color Graphics Monitor. It was crisp, bright, and sufficient for any color or

form generated by the display board.

HP recently announced the HP Intelligent Graphics Controller 10. This board can reduce the expense by an additional \$2000, because it can accept a VGA graphics card and display in place of the more expensive HP MultiSync Color Graphics monitor. In addition, this new board uses a 50-MHz 34010.

It's reasonable to expect better performance on menus with future releases of X Window, Motif GUI, and the Texas Instruments GSP chips. It's also reasonable to expect greater demands on X Window servers with the development of more software that uses them. The GUI (graphical user interface) is one area where the software design is pushing the hardware design.

In the meantime, HP AXDS/PC software for the TMS34010 is an economical way for the occasional workstation user to get the quality and performance of a truly fine color graphics workstation on an MS-DOS computer. ■

Ben Smith is a BYTE technical editor and resident Unix guru. You can reach him on BIX as "bensmith."

PC Compatible Single Board Computers for the OEM

DR DOS® Now Available

Quark®/PC +

- NEC V-40® Processor
- Video/LCD Controller
- 8 or 10 MHz Frequency
- Up to 768K Memory



4" x 6"



4" x 6"

Quark®/PC II

- 80386 SX based
- EGA® Video/Color LCD Controller
- SCSI Hard Disk Control
- Floppy Disk Control
- Up to 4 Mbytes Memory

To order or enquire call us today.

Megatel Computer Corporation
(416) 245-2953 FAX (416) 245-6505

125 Wendell Ave., Weston, Ontario M9N 3K9

REPS: Italy 39 331 256 524 Austria 43 222 587 6475
W. Germany 49 6074 98031 Finland 358 0757 1711
U.K. 44 959 71011 Sweden 46 40 97 10 90
Netherlands 31 838 529 505 Norway 47 986 9970
Australia 61 03 568 0988 Denmark 45 244 0488

Trademarks: Quark - F.+K. Manufacturing Co.
DRDOS - Digital Research Ltd. EGA - IBM Corp. V-40 - NEC Corp.

megatel

Subscription Problems?



We want to help!

If you have a problem with your BYTE subscription, write us with the details. We'll do our best to set it right. But we must have the name, address, and zip of the subscription (new and old address, if it's a change of address). If the problem involves a payment, be sure to include copies of the credit card statement, or front and back of cancelled checks. Include a "business hours" phone number if possible.

BYTE

Subscriber Service
P.O. Box 555
Hightstown, NJ 08520



Cool, Quiet, Reliable Power.



PC/XT



AT/386/486



COMPAQ

STANDARD 150 **\$69**

Economical This UL approved, fully tested unit is one of the best generic 150s available. Ideal for basic systems.

SILENCER 150 **\$129**

Ultra-Quiet Stop that irritating whine with the Silencer 150. Its large, low speed, West German fan keeps your system 5° to 15° cooler and 84% quieter. Virtually inaudible! Great in the executive suite or home office.

TURBO-COOL 150 **\$149**

High Performance Upgrade your PC/XT with our popular, UL approved Turbo-Cool 150. Its patented twin fan, sloped-cover design keeps your system 25° to 40° cooler and 50% quieter. Prevents intermittent data errors and other heat-related problems. Meets the demands of a fully loaded system.

TURBO-COOL 200 **\$189**

Maximum Performance Put AT power and 200% more cooling under the hood of your PC/XT with our UL approved Turbo-Cool 200. Its twin fans keep your system 30° to 45° cooler for maximum expandibility. Perfect for hot rod PCs and Mini ATs!

Silencer, Turbo-Cool, and Turbo 375 are trademarks of PC Power & Cooling, Inc. Compaq and Deskpro are registered trademarks of Compaq Computer Corporation.

STANDARD 200 **\$99**

Economical This UL approved, fully tested unit is one of the best generic 200s available. Ideal for basic systems.

SILENCER 200 **\$149**

Ultra-Quiet Unrattle your nerves with the Silencer 200. Its high-efficiency, adjustable-speed fan offers 69% less noise with standard cooling. Quieter than most hard drives. Great in the executive suite or home office.

TURBO-COOL 250 **\$189**

High Performance Protect your investment! Upgrade your AT/386 with our powerful, UL approved Turbo-Cool 250. Its high-capacity, adjustable-speed fan keeps expansion cards, hard drives, and other valuable components 20° to 35° cooler for up to three times longer life. Perfect for a fully loaded system.

TURBO 375/450 **\$299-\$369**

Maximum Performance The choice of PC professionals, our Turbo 375 and Turbo 450 feature built-in line conditioning, autoselect input, independent regulation, external DC voltage adjustment, remote switch option, enhanced cooling, UL/CSA/TUV approval, 50,000 Hr MTBF, and 2-year warranty! Ideal for workstations and network file servers.

CP160 **\$169**

Original Portable Upgrade Give your Portable greater reliability and 100% more power with our direct replacement CP160. Allows 286, 386, and hard disk upgrades.

CD270 **\$249**

Deskpro Upgrade The power user's power supply! Our direct replacement CD270 gives your 8086/286/386 Deskpro up to 70% more power and the reliability it deserves. Prevents nuisance rebooting. Advanced design includes autoselect 110V/220V. 2-year warranty.

Our power supplies feature:

- Full-rated power
- UL/FCC compliance
- 110V/220V input
- 4 drive plugs (min)
- Heavy-duty components
- Low output ripple
- OVP, OCP, SC protection
- Installation instructions
- Rigorous testing
- 1-year immediate replacement warranty (2 years where noted)

"You could buy cheaper no-name power supplies almost anywhere, but don't. PC Power and Cooling's units are better made and more reliable than anything in the field."

*PC/Computing
January, 1989*

Most orders shipped same day. We accept Visa, MC, COD or PO on approved credit.

PC POWER & COOLING, INC.

31510 Mountain Way, Bonsall, CA 92003 • (619) 723-9513 • FAX (619) 723-0075

Circle 248 on Reader Service Card

World Radio History

Most good work has an edge to it.

And good work turns into a sharp, 300-dpi, colorful, awe-inspiring PostScript-compatible business weapon on the Tektronix Phaser CP Color Printer.

The Phaser CP works with a color thermal-wax process for IBM PC/XT/AT or bus-compatible computers, in any variety of network configurations. So you can finally put your color, HPGL and PostScript-compatible applications, not to mention every

computer user, to full use.

And in as little as 47 seconds, you print out a document with a virtually unlimited range of bright, clear colors. You print out desk-top presentations. Transparencies. Color layouts or comps. PC/CAD design. Or just about anything your heart desires.

To see a Phaser CP, or to find the best remedy for paper cuts once you get one call for more information, 1-800-835-6100 Dept. 4J, or fax to (503) 682-3408.



Tektronix
The best and the brightest.

The printer for those who like to play with sharp objects.

Trade
ming

Vegetables

ming
anagement
Management

Ginsberg Investigations Detective Agency

Income Breakdown By Percent

Year End Review

Following Spouses
24%



Tracing Thugs
27%



Tailing Politicians
26%



Miscellaneous
26%



Expenses

Equipment
Magnifying glasses
Cigarettes
Wire tap gadgets
Secret decoder ring
Shoe phone
Hospitalization

Expense Account
Staying in sleazy hotels
Paying for busted-up hotel rooms
Whistling lessons
Scriptwriters for TV pilot
Cab fare

BOARDING PASS

BOARDING PASS TARJETA DE EMBA

AIRLINE AEROLINEA COMPAGNIE AERIENNE	FLIGHT VUELO/VOL	CLASS CLASE/CLAS
DELTA	123	Y

DATE
PUERTA/PORTE

Copyright © 1989 Tektronix, Inc. All rights reserved. Phaser is a registered trademark of Tektronix, Inc. IBM PC/XT/AT are registered trademarks of International Business Machines. PostScript is a registered trademark of Adobe Systems Incorporated. The documents in this ad were created by an art director on a bright, sunny Saturday afternoon on a Mac II; with Adobe Illustrator '88; graphics from Postcards,™ © 1987 Activision, Inc. The entire document was then transferred to an IBM PC, and printed on a Tektronix Phaser CP. Working on a weekday and directly with a PC, it'll be even easier for you.

Circle 311 on Reader Service Card

Clipper Applications Get SQL



Planet Software's library of functions includes linking Clipper applications to SQLBase

Marc Schnapp

One reason for developers' intense loyalty to Clipper, the dBASE-compatible compiler, is its thriving aftermarket support. The Library from Planet Software is the latest and perhaps the most heavily promoted third-party library offering for Clipper to date. Both Gupta Technologies (makers of SQLBase) and Nantucket (Clipper's maker) aggressively positioned The Library as a SQL application programmer interface (API) to Clipper. Developers not seeking SQL support might write off Planet's product, but The Library merits a closer look—SQL support comprises less than one-third of the product's 360 functions.

Array of Functions

A sampling of array-handling functions demonstrates the strengths of The Library. The functions range from the obscure to the compelling. Among the selections are `l_argen()`, `l_argtn()`, `l_argles()`, and `l_arltn()`. Respectively, these functions compute how many numeric array elements are greater than or equal to, greater than, less than or equal to, or less than a given numeric value. All are quite useful as they are, but Planet could have also included a more generic function taking a user-supplied comparison operator as a parameter. Such a function would facilitate interactive queries. As implemented, the

developer must place each of the function calls in a CASE block.

Another useful array function, `l_arcount()`, counts occurrences of a designated data type within an array of a programmer-specified value; this could prove useful in building crosstabs.

The Library's best functions lend themselves to statistical analysis, computing mean, median, and mode values. The Library provides trigonometric functions (e.g., cosine, inverse cosine, arcsine, tangent, and arctangent) and financial formulas (e.g., future value, present value, loan amortization, and payments). Statistical functions provide the coefficient of variance, standard deviation, and variance. Other quantitative functions provide hexadecimal-to-decimal (and decimal-to-binary) conversions, prime-number checking, and a routine to bypass divide-by-zero errors.

Planet's product covers a lot of territory in its conversion functions. A British-developed product, The Library has a full complement of imperial-to-metric measure transformations. Among them are pounds to kilograms, inches to centimeters, Fahrenheit to Celsius, gallons to liters, and acres to hectares. For applications requiring geometric calculations, The Library can determine volumes of spheres (or their radii), cylinders and cones, and areas for parallelograms.

Date and time functions perform diverse tasks: calculating differences in dates in weekdays, weeks, months, or years (dBASE date math can calculate days). Other functions validate dates and string equivalents. The Library provides functions for internally calculating time intervals, using strings to nicely make up for that dBASE language deficiency.

Planet provides source code in assembly, Clipper, and C (for all functions but the SQLBase API). The source code gives you the ability to modify and extend the library. It is not only well commented but also compact, with files ranging from 2K bytes to 5K bytes each.

Clipper-coded functions do occasionally make nested references to other functions, making code modification and maintenance a bit more involved. The Library also includes nifty functions to simulate two-dimensional arrays (Clipper 5.0 adds one-dimensional arrays that permit array elements to point to other arrays).

A Few Weaknesses

Many of The Library's functional categories are superficial and are far better handled by the competition. These gaps are evident in the functions for the keyboard, printer, graphics, mouse, disk, file, and memory.

Disk functions include changing, validating, making, and removing directories; obtaining time and date stamps; and checking hard disk drives. What is missing are functions determining total space and storage available on a given hard disk drive. The Library can determine extended and expanded memory configurations, but it makes use of neither (Gupta's engine and router, however, do require extended memory). The manual incorrectly asserts that Clipper uses extended memory for index buffering (Clipper uses up to 1 megabyte of expanded memory for that purpose).

The Library also offers graphics primitives for plotting business charts. Developers can switch display modes, save screens to disk, and examine screen file contents. Routines for fundamental mouse functions are provided—they monitor button presses and movement intervals. However, most Clipper applications are character-based. To use the mouse for menu selections, developers must use a separate TSR program that converts mouse movements into cursor key presses. This does not qualify as robust support for mainline Clipper applications development. And because Nantucket does not provide graphics mode support, these functions provide nothing

continued

more than a tentative starting point—developers will have to build on the 25 mouse functions provided. If your goal is to customize Clipper applications for VGA or EGA support (particularly exploiting The Library's graphics functions), these fill the bill.

On-Line Help

Also included is a Norton Guides data file (Nantucket sells the Norton Guides along with a data file for the Summer 1987 version) and a full disk of sample files.

The Norton Guides memory-resident help system is a modest advance in applications development. Programmers can quickly pop up syntax skeletons and full-text examples while coding. Providing simple cross-referencing, the Norton engine includes a "see also" lookup facility. You can also configure the help engine to automatically look up functions, using the same approach as memory-resident spelling checkers and thesauri. Many developers banish print-reference manuals to the furthest reaches of their offices as a result.

The inclusion of an on-line help system

makes it possible for developers to perform field modifications and upgrades without totting along unwieldy documentation. All products of this kind should include TSR program help, and several other library vendors already do so. I wish that Planet's library help system permitted full categorization. However, once you know which function you wish to use, the Norton data file is an excellent way to confirm function syntax. I also wish that the 28-page extensive error system for SQLBase in the reference guide was in the Norton help file.

A sizable loose-leaf manual with more than 500 pages also details the operations of each function. A quick reference section summarizes the calling conventions for each function. Broken into subsections by functional category, each section includes a category list.

With a library this extensive, developers are likely to scan the function lists as they program. Additional tabs in the documentation, marking off the function categories, would help on that score. The memory-resident help software could also facilitate searches, but the Norton Guides system lacks a means of catego-

rizing its contents. Planet did not assign category-wide prefixes to its function names, so programmers won't be able to track them down alphabetically. (All SQLBase functions are preceded by "S_"; all the others are prefixed with "L_".)

The SQL Story

The transition to SQL is not absolutely seamless. You'll need to work with either the single-user version of the Gupta SQLBase engine or the multiuser router. You will need to dedicate at least 385K bytes of extended RAM to SQLBase for these purposes. Unless Gupta also makes EMS support available, SQLBase support for Clipper applications will rule out the use of CPUs pre-dating the 80286.

Proficient Clipper and dBASE language programmers will also have to negotiate the conceptual differences between their accustomed record-by-record logic and the set model used by SQL. Planet's SQL API supports cursors, stored contexts that the host application manipulates.

continued

For Quicker Program Development the 8051 C Compiler

The 2500 A.D. 8051 C Compiler offers an alternative to Assembly Language solutions. Quicker program development. Simpler program testing. Easier program maintenance.

- Full Kernigham & Ritchie C
- All data types, including Float & Double
- Reentrant Libraries
- Internal, External or Mixed Data Modes
- Special Function Register support
- In-line Assembly Language
- Listings reflect actual linked addresses
- Function prototyping ANSI extensions
- Full math library, including Trig functions
- Interrupt handler support
- Bank switched memory support
- Internal bit field support
- Linked Assembly language
- Generates ROMable code

The 8051 C Compiler package includes the 2500 A.D. 8051 Macro Assembler, Linker, Librarian, Standard Library and Math Library and is priced at \$500.00 for MSDOS systems.

To order call Toll Free:

1 800 843-8144

In Colorado: 1 719 395-8683
Fax: 1 719 395-8206
Telex: 752659/AD

2500ADS SOFTWARE INC

109 Brookdale Avenue
P.O. Box 480
Buena Vista, CO 81211

The Right Software for The Right Micro at The Right Price

PC-MOS

The Multi-User Solution For The Multi-Dimensional Company

Odds are, you're part of a multi-faceted organization, one that's involved in many different projects and activities. Every day you juggle dozens of tasks. So why are your PCs still doing one thing at a time — for one person at a time?

Today's 286 and 386-based PCs provide the power to do much more. PC-MOS is the multi-user, multi-tasking software that unleashes that power, making your PCs as multi-dimensional as your business.

Minicomputer Power For The Cost Of A PC!

PC-MOS lets several users simultaneously run different programs on a single, high-performance PC. One user can run a spreadsheet, while another uses the word processor and several others access a database — all at the same time! So instead of replicating expensive PCs, each user has an inexpensive monitor or terminal. The benefits are lower cost, more control, better security and consistency across applications. And at \$595 for a 5-user version, you can afford to get started today!

DOS Compatibility, NetWare Connectivity

PC-MOS lets users run the popular DOS programs they use now — even Microsoft® Windows 286. Our gateway to NetWare lets you expand your Novell

network inexpensively and easily. And PC-MOS requires no expensive wiring, and no network management headaches.

Proven Reliable With 100,000+ Users

Because PC-MOS was the first DOS-compatible multi-user operating system, it offers broad compatibility and the reliability of time-tested software. More than 100,000 satisfied users trust their work to PC-MOS each day. Our latest version features an easy-to-use install program, lets you re-boot individual workstations, and supports high-resolution, bit-mapped color graphics.

Call us today. We'll show you how to add multiple dimensions to your PC.



THE SOFTWARE LINK

3577 Parkway Lane, Norcross, GA 30092
1-800-451-LINK, (404) 448-5465
FAX: (404) 263-6474 TELEX: 4996147 SWLINK

Circle 317 on Reader Service Card (DEALERS: 318)

GSA Schedule/GSOOK 89 AGS6448

PC-MOS is a trademark of The Software Link. All other products referenced are trademarks of their respective companies. Prices and policies subject to change without notice.

VARs and RESELLERS:
Ask about our Sales Support Program



DOS & OS/2 libraries for C & PASCAL

1-2-3 LIBRARY

A powerful tool containing all the routines necessary to CREATE & READ LOTUS .WKS & .WK1 spreadsheets. Unlike some products this library supports the GRAPH & TABLE commands, in fact it supports the entire LOTUS command set.

Read & Write REALS, INTEGERS, STRINGS & FORMULAE. Create NAMED TABLES & GRAPHS. With this library you can produce the numerical output from your programs in the form of working fully LOTUS compatible spreadsheets—ready for your customers to use.

.PIC LIBRARY

Ever wanted to interface to LOTUS .PIC graphics products like the superb FREELANCE or LOTUS PrintGraph? This library is the answer. Create your own .PIC graphics files, or read & import LOTUS created graphics into your own product.

With this library you can read & write the commands for moving to a point, drawing a line or polygon. Control how objects are shaded. Add and position text in different fonts. This library is a full and complete implementation of the LOTUS .PIC graphics format.

DCA LIBRARY

DCA files are the universal text interchange medium. Text files created with this library contain all the information for importing into high-end wordprocessors and DTP packages. Control the page length & width, store headers & footers, change the text font & attributes (eg BOLD, strikeout etc). With this professional library you can convert your simple ASCII text output into a file ready for importing into virtually all high-end packages, eg. WORD, WordPerfect or SMART. DCA files are compatible with virtually all DTP products.

available for :

TURBO C, QUICK C, MICROSOFT C,
ZORTECH C & TURBO PASCAL

	DOS		OS/2	
1-2-3 Library	\$155	£95	\$195	£120
PIC Library	\$155	£95	\$205	£125
DCA Library	\$205	£125	\$245	£150

Shipping: N.America \$15
U.K. £3 + VAT



TO ORDER



PO's from PLC's and FORTUNE 1000 companies accepted

CALL or FAX :

01144 932 855702 (N.America)

0932 855702 (U.K.)

12 Dale Close, Addlestone, Weybridge
Surrey, KT16 1NS, England.



The Library

Company

Planet Software, Inc.
1040 Marsh Rd., Suite 200
Menlo Park, CA 94025
(415) 688-1088

Hardware Needed

IBM PC or compatible

Software Needed

MS-DOS 2.0 or higher (3.1 or higher for network support) and Clipper (Summer 1987 version)

Documentation

Reference manual; data file for memory-resident Norton Guides help system

Price

\$249

Inquiry 886.

The sequence works something like this:

1. Confirm that SQLBase is installed (S_ISENGINE()).
2. Log onto the database system (S_CONNECT()).
3. Assign a cursor to your query, pass the query to SQLBase, and compile it (S_COMPILE()). Query strings cannot exceed 128 characters. While this might be a limitation, subqueries can always be issued against the prior result table.
4. Allocate a data buffer to hold the result table (S_SETBUFFER()).
5. Execute the compiled query (S_EXECUTE()).
6. Here's where the Clipper programmer can engage in row-by-row processing, performing fetches in a loop (DO WHILE NOT S_EOF()).
7. Within the loop, fetch the next available row (S_FETCHNEXT()).
8. Optionally assign the contents of each field individually to variables (S_READ()).
9. Disconnect from the database (S_DCONNECT()).

The Library supports embedded variables (bind variables) within queries, making run-time substitutions possible. Transaction processing with COMMIT and ROLLBACK is also within the reach of the Clipper developer.

The manual offers straightforward explanations of the fundamentals. A model

three-page edit routine and a three-page append program are also offered for guidance. However, the manual is not a SQL tutorial. Clipper developers lacking SQL experience should tackle formal reference materials such as C. J. Date's *A Guide to the SQL Standard* (Addison-Wesley, 1987).

The Answer?

The Library for Clipper is a massive but spotty addition to the stockpile of Clipper tools. It provides strong support for quantitative functions and a well-documented Clipper API to the Gupta SQLBase database engine. It is not, however, the only library a Clipper developer should ever want to acquire.

The Library from Planet contributes substantially in its quantitative functions and SQL support. Savvy programmers can also adapt the source code as one measure to fill in The Library's gaps. Developers with particular needs might select specialized libraries to supplement Planet's product. For example, a full range of communications functions is found in the SilverComm library from SilverWare; also, NetLib from Communication Horizons extends network support beyond the basic locking included with Clipper. While the Planet library offers rudimentary business graphics, Pinnacle Publishers' dGE offers just about everything a developer might need (including an interactive test shell with a code generator). And FUNCKy from dLesko Associates furnishes support where The Library is weak: disk and file I/O, character-mode mouse support, and keyboard control.

Pricing for The Library is in scale with competitive offerings. And because Planet has chosen to observe Nantucket's extend system, there is little likelihood of version shock as Clipper 5.0 emerges.

The Library should prove invaluable to corporate MIS departments seeking SQL applications support. While Nantucket promises future links with the Sybase/Microsoft/Ashton-Tate SQL Server and IBM's OS/2 Extended Edition, SQLBase is available now on all DOS networks. The Library exploits that fact. ■

Marc Schnapp founded the New York Metro Clipper User Group and is the president of its parent organization, the Professional Association of Database Developers. He operates Micro Business Services, Inc., a training, technical writing, and applications development company in Queens, New York. He can be reached on BIX c/o "editors."

All the power of The Software Link's PC-MOS operating system. All the benefits of both individual and networked PCs.

All in one high-performance, low-cost, multi-tasking system. With no terminals and no additional PCs — unless you want to optionally use your old XTs or ATs.

The UnTerminal™ UnNetwork.™

It's the ideal multiuser system for personal computer users.

UnTerminal monitor-keyboard workstations cost less than terminals. Less than text-only "intelligent I/O" solutions. Less than fiber-optic graphics solutions.

An independently operating UnTerminal workstation outperforms them all. With faster

UnNetwork.

Inexpensive monitor-keyboard workstations replace costly terminals and PCs on the UnTerminal™ UnNetwork.™ Run multiuser and popular PC programs at the same time — with no terminals or PCs — or use any XTs and ATs you happen to have.



The UnTerminal Video Network Adapter supports up to 4 Hercules-compatible workstations.



The UnTerminal Video Network Graphics Adapter™ supports up to two color graphics workstations — resolution up to 800 x 600.



The UnTerminal Connect Card makes an XT or AT into a multitasking, multiuser workstation.

screen refresh — text and graphics. Instant switching between single and multiuser screens. Running popular DOS applications. And making every user feel like the only user.

Just add PC-MOS, monitors & keyboards.

The Software Link's PC-MOS multiplies the power of your PC. Why pay extra just to get the boxes? You can run up to eight color or 16 monochrome UnTerminal workstations per system — and save thousands.

*Distributed by
The Software Link, Inc.*

For more information, call:
The Software Link, Inc. at (800) 451-LINK or (404) 448-5465.



Hercules compatible graphics using the UnTerminal (VNA).



Color graphics embedded in database using the UnTerminal (VGNA).



800 x 600 VGA graphics using the UnTerminal (VGNA).



Now XTs and ATs can be UnTerminals, too. Hotkey between local and host applications using the UnTerminal (VCCA).



The UnTerminal

PC-MOS MULTIUSER SYSTEMS WITHOUT TERMINALS

The Software Link, Inc., 3577 Parkway Lane, Norcross, GA 30092.
Phone: (800) 451-LINK or (404) 448-5465, FAX: (404) 263-6474, Telex: 4996147 SWLINK.

PC-MOS is a trademark of The Software Link, Inc. UnTerminal, UnNetwork, Video Network Adapter, Video Connect Card Adapter and Video Graphics Network Adapter are trademarks of Advance Micro Research, Inc.

Circle 319 on Reader Service Card (DEALERS: 320)
World Radio History

Now Available
Activator/M™
 with
**Programmable
 Memory**



Natural selection provides unique passive protection for the porcupine.

The Activator - Natural Selection For Software Protection



Inventor and entrepreneur Dick Erett explains how "The Activator" provides sane protection for your intellectual property.

In any industry, just as in nature, the process of natural selection raises one solution above another. Natural selection is the most elegant of engineers.

In the area of software protection The Block has been selected by the marketplace as the solution that works. Over 500,000 packages are protected by our device.

For the past 4 years our philosophy has been; *'You have the right and obligation to protect your intellectual property.'*

A New Ethic For Software Protection

In allowing end-users unlimited copies of a software package and uninhibited hard disk and LAN operation, The Block has created a new ethic for software protection.



By removing protection from the magnetic media we remove the constraints that have plagued legitimate users.

They simply attach our key to the parallel port and forget it. It is totally transparent, but the software will not run without it.

A New Technology For Software Protection

Our newest model, The Activator, builds on our current patented design, and establishes an unprecedented class of software protection.

We have migrated and enhanced the circuitry of The Block to an ASIC (Application-Specific Integrated Circuit) imbedded in The Activator.

This greatly improves speed and performance, while reducing overall size. Data protection can also be provided.

Programmable Option

The Activator allows the software developer the option to program serial numbers, versions, or other pertinent data known only to the developer, into the circuit, and access it from the program.

Once you program your part of the chip, even we have no way to access your information.

The ASIC makes emulation of the device
Circle 295 on Reader Service Card

virtually impossible. It also presents an astronomical number of access combinations.

Full 100% Disclosure

Since The Activator is protected by our patent we fully disclose how it works. Once you understand it, endless methods of protection become evident.

Just as no two snowflakes are the same, no two implementations of The Activator are identical. And like the snowflake the simplicity of The Activator is its greatest beauty.



We never cramp your programming style or ingenuity. Make it as simple or complicated as you desire.

Let us help safeguard what's rightfully yours. Please call today for additional information or a demo unit. *It's only natural to protect your software."*

1-800-333-0407 ext.105
 In Connecticut 203-329-8870
 Fax 203-329-7428



870 High Ridge Road
 Stamford, CT 06905

Unlimited Copies • Programmable • No Batteries • Small Size • Fast • Patented • Data Protection

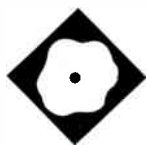

Publish It for the Mac brings new features to desktop publishing on the Mac

Diana Gabaldon

An increasing number of desktop publishing packages are entering the Macintosh market, from the fairly simple Quark XPress to the complex PageMaker, and there's always room for one that adds more features, like TimeWorks' Publish It.

While the MS-DOS version of Publish It is no great competition for either Ventura Publisher or PageMaker on the PC, it's a different story for the Mac version. In fact, Publish It for the Mac just may give PageMaker a run for the money.

New Features

Publish It contains most features found in other desktop publishing packages, as well as a few you won't find anywhere else (including Publish It for the PC). Text can come from virtually anywhere. Publish It will import text from WordPerfect, Microsoft Word, Microsoft Works, MacWrite, Write Now, or any other word processor that produces an ASCII text file. If none of these is handy, you can use the built-in word processor. There's also a 240,000-word thesaurus and a 160,000-word spelling checker.

The layout system lets you wrap text *inside* as well as around objects and use "V" (pyramid and slanted) margin formats, which most other desktop publishing packages don't offer. Text can flow through successive or staggered pages.

Move Over, PageMaker

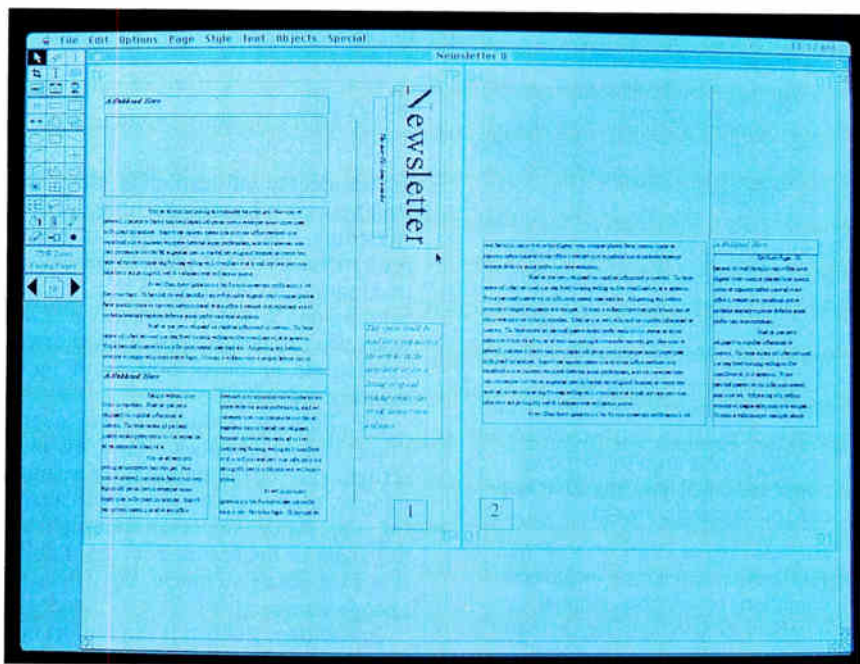

Publish It for the Mac gives you new text formats such as vertical text, used in the headline here.

While you can use clip art created from most of the popular draw or paint programs or commercial clip-art libraries, Publish It also gives you a built-in draw and paint facility, so you can create graphics within the program. It has reasonable graphics editing capabilities, such as rotate, resize, and reshape, that you can use on either imported bit-mapped and scanned graphics or Publish It-created graphics.

Deciding what to do may be more difficult than doing it. You can use either object-oriented or bit-mapped graphics, with 66 pen sizes, 32 brush shapes, and an airbrush. You can size graphics from 12 percent to 800 percent of their original size, which is probably enough of a range for most users. By contrast, PageMaker allows sizing only from 50 percent to 200 percent of the original size.

The color and texture menus are impressive. You can apply seven transparent or opaque color layers, outline letters in one color and fill with another, create dropped shadows, and use multiple overlay modes (e.g., transparent over transparent, transparent over opaque, and opaque over transparent). The usual options for borders, such as box, rectangle, and double line, are all available as well.

Most helpful for the fumble-fingered among us are the Undo feature, which reverses the last step, and the Group Lock and Align feature. The latter feature lets you freeze an element or group of elements in place on the page you're laying out. Even if you try to lay in a new element that overlaps the "locked" ones, your existing layout won't be ruined.

Publish It also works at a somewhat

continued

Needs only
one megabyte!

Mainframe Mathematical Power for the Mac®



Maple puts symbolic computation at your fingertips at a price you can afford! Put **Maple's** speed, reliability, and eight years of development to work on any Macintosh—SE, SE/30, Mac II series—even the Mac +.

Maple combines symbolic and numerical computation with two-dimensional graphics to give you more power per dollar than any other symbolic processing software!

Maple's unique library of more than 1500 built-in functions—including operations on integers, rational numbers, polynomials, tensor manipulation, symbolic and numeric approximation, indefinite integration, statistics, linear algebra, calculus, differential equations, and more—is fully extensible. Add new routines or develop functions to speed your work. Price: \$395



Version 4.2

Symbolic Processing for the Macintosh®

To find out more about this remarkable software, contact:

**Brooks/Cole
Publishing Company**
511 Forest Lodge Rd., BSW001
Pacific Grove, CA 93950
(408) 373-0728

Price subject to change without notice.

REVIEW

MOVE OVER, PAGEMAKER

Publish It 1.0

Company

TimeWorks, Inc.
444 Lake Cook Rd.
Deerfield, IL 60015
(312) 948-9200

Hardware Needed

Mac 512KE, Plus, SE, or II with one 800K-byte floppy disk drive; a hard disk drive is recommended

Documentation

User's manual; reference manual; quick-start guide

Price

\$395

Inquiry 884.

higher degree of resolution than does PageMaker. It handles kerning, leading, stretching, and condensation of text at resolutions of 0.004 inch. PageMaker's maximum resolution is 0.5 to 5 mm, depending on the specific operation. Likewise, you can rotate, split, and otherwise manipulate graphics objects in increments of 1 degree.

But Publish It doesn't have everything. PageMaker does offer a few more refinements in the handling of scanned images, allowing you to control screening (i.e., the density of dots per inch) and the angle of the scanned image. Publish It lets you rotate an image, but it does not change screening.

In addition, Publish It can import only black-and-white TIFF files; it cannot interpret gray-scale or color TIFF images (Publish It also handles PICT files). The program is also missing the "snap to guides" and "snap to rulers" feature found in PageMaker. This PageMaker function causes elements or frames to align with the layout grid or document rulers automatically.

Overlaid Frames

Like most desktop publishing software, Publish It begins with a blank layout page. On that page, you can locate and define various areas or "frames" (also called elements in some packages), in which you place text or graphics.

You can link frames so that text will flow from one frame to another or so that it can be overlaid (graphics image over text frame). You can also flow text from one page to the next to continue a story, as is the case with PageMaker.

Like PageMaker, Publish It shows "thumbnails" on-screen. Thumbnails are tiny representations of laid-out pages.

PageMaker lets you view up to 64 thumbnails at once, so you can see what the bulk of your document actually looks like. Publish It lets you view up to 100 thumbnails (using the scroll bar), but unlike PageMaker, it also lets you edit thumbnails. Granted, the amount of editing you can do on an image that literally is the size of your thumbnail is limited, but you can move frames (e.g., graphics images) from one page to another or re-order pages.

One of Publish It's claims is that it has a fully integrated word processor. It does allow you to type text directly into a defined frame, rather than import it from a text file, but as word processors go, this is nothing to write home about. You can insert and delete, cut and paste, and search and replace text, and you can move around in it with the mouse.

It's far more convenient to construct text files with your favorite word processor and import them. One reason for this is simply the amount of screen space available to work in. You must define a text frame in Publish It before typing in new text, and even in the closest possible viewing mode, you will have less than half the screen available—on a Mac 512KE or SE, this isn't much space.

Also, the cursor keys work oddly in the word processor. Pressing the up arrow always returns the cursor to the beginning of the top line of text, no matter where the cursor is. The mouse, however, lets you move the cursor anywhere in the text frame.

Spelling checking works in either batch mode, checking already typed material or in interactive mode, in which the checker beeps when you type an incorrectly spelled word. You also have the option of checking all "stories" (continuous text pieces, such as newspaper stories) in a document, or checking only selected stories.

The Down and Dirty of DTP

Despite all claims from software vendors, desktop publishing isn't all that easy. It's tedious, messy, and mistake-ridden. However, it is better than doing layout and paste-up by hand.

To make things easier, Publish It has a good on-screen help system with an alphabetically indexed topic list that you can point to and click on. While decent, the help system is not good enough to let you dispense with the user's guide and reference manual. It does, however, include more than 70 sample page layouts that you can use for common publishing jobs, such as newsletters and invoices.

continued



**If these images didn't catch your eye,
then why are you reading this ad?**

Images that leap out at you, especially in a magazine like this, have to be powerful. And whether you need to present your business information more effectively or you want to expand into multi-media, you need strong visuals. Together with Truevision, you can develop that power for presentations, CAD, training, video production and more. And it's easier than you think. You can bring photo-realism and multi-media to your presentations by using a TARGA board with compatible software and peripherals from over 200 companies.

With a TARGA videographics board and your PC, XT or AT-class machine, you can capture images in real-time from a video source, merge them with other images

or add text and graphs, even create stunning broadcast-quality animations, and then output the result to video, tape, slides or paper prints. That's how to maximize your presentation efforts into multi-media.

Truevision videographics cards are ready for you today. Contact us at **800/858-TRUE** for more information, or visit your local Authorized Truevision Reseller for a demonstration. We'll show you how to visualize your data in a way that no one else can.



7340 Shadeland Station, Indianapolis, IN 46256
 INTERNATIONAL: Canada 416/499-9400 France 33-952-13-6253 Italy 39-2-242-4551 Switzerland 41-1-825-0949 U.K. 44-1-991-0121
 West Germany 49-89-612-0010 Other 517-229-6900

PC, XT and AT are registered trademarks of International Business Machines Corp.

© 1989, Truevision, Inc.

Circle 331 on Reader Service Card

World Radio History

You can also use multiple "masters." Most desktop packages—including PageMaker—let you use one master at a time to repeat a standard page design from page to page. With Publish It, you can have up to three master pages: standard (which repeats elements on every page), left-only (which repeats elements on left-facing pages), and right-only (which repeats elements on right-facing pages).

Multiple document windows also let you move elements among several documents. The number of documents that can be displayed simultaneously depends only on available memory. Windows can be tiled or overlaid, and you can size them independently.

The mouse cursor changes its shape to indicate which "tool" (e.g., editing, drawing, or painting) is in use. When a given use is inoperative within a given area of the document, the cursor displays as a heavy black "x" and doesn't do anything when you click the mouse button.

User errors, such as misspelling words or trying to import nonexistent files, are marked only by a beep. Those that required some remedial action from me were adequately explained.

I had minor difficulty, however, in flowing text around a graphical object that overlapped two text frames. Text flowed properly in the second frame, but inside the first frame, the text went inside the graphic, instead of around it.

The problem was apparently due to my not having linked the two text frames together. When I went back several steps (the steps were easily reversible with the Undo feature) and linked the frames, the text flow worked fine.

Better Than PageMaker?

The package comes with 60 days of free technical support. After that, unlimited phone support costs \$100 per year. This extended support package gives you a toll-free number, discounts on upgrades and new releases (an upgrade of Publish It is expected within a few months), and product information updates. (The \$100 annual support fee also covers all TimeWorks programs in the same hardware format you use.)

The package also has an unusual 90-day money-back guarantee, although this description is a little misleading. You don't get your money back if you don't

like the program. But if you find something you like better, TimeWorks says that you can send back your Publish It program disks, your paid receipt, the name of the program you like better, and a check or credit card number for the retail difference between Publish It and the better program; the company will buy the new program for you.

In terms of features and functions, Publish It is nearly the equal of the popular PageMaker. In fact, in view of the built-in draw and paint tools and the extras, such as the spelling checker, thesaurus, and fancy text formatting, this package may offer slightly more to many users.

Of course, not everybody needs to produce, say, "V" text or use many of the other special features in Publish It. Still, at \$395, Publish It is quite a bargain. ■

Diana Gabaldon is the editor of Science Software, which is desktop published, and an assistant research professor at the Center for Environmental Studies at Arizona State University, Tempe, Arizona. You can reach her on BIX c/o "editors."

EXSELSM INC.

DIRECT

IBM Personal System/2 Model 50 Computers

THE PS/2 MODEL 50 FEATURES INCLUDE:

- 1MB Random-access Memory on the System Board
- 101 Key Enhanced IBM Keyboard
- One 3.5" 1.44MB Half Height floppy
- One 20MB, 80MS fixed disk drive
- Microprocessor—Intel 80286 (10.0 MHz) Microchannel
- 90 Day Back-to-Depot Warranty

FREE BRAND NEW AMDEK MODEL 432 VGA MONOCHROME MONITOR

PS/2 SYSTEM AND MONITOR: ORIGINALLY MADE TO SELL FOR \$3840.00

FAX YOUR ORDERS 24-HOURS A DAY. (716) 272-8624



EXSEL LOW PRICE: \$1888.00

TO ORDER BY CREDIT CARD, CALL MONDAY THROUGH FRIDAY 8:30 AM - 6 PM EST. TOLL FREE:

1-(800)-624-2001
IN NY: 716-272-8770

EXSELSM INC.
THE ALTERNATIVE SOURCE FOR THE FUTURE

A MESSAGE TO OUR SUBSCRIBERS

FROM TIME TO TIME WE MAKE THE BYTE subscriber list available to other companies who wish to send our subscribers material about their products. We take great care to screen these companies, choosing only those who are reputable, and whose products, services, or information we feel would be of interest to you. Direct mail is an efficient medium for presenting the latest personal computer goods and services to our subscribers.

Many BYTE subscribers appreciate this controlled use of our mailing list, and look forward to finding information of interest to them in the mail. Used are our subscribers' names and addresses only (no other information we may have is ever given).

While we believe the distribution of this information is of benefit to our subscribers, we firmly respect the wishes of any subscriber who does not want to receive such promotional literature. Should you wish to restrict the use of your name, simply send your request to the following address.

BYTE MAGAZINE
ATTN: SUBSCRIBER SERVICE
P.O. Box 555
HIGHTSTOWN, NJ 08520



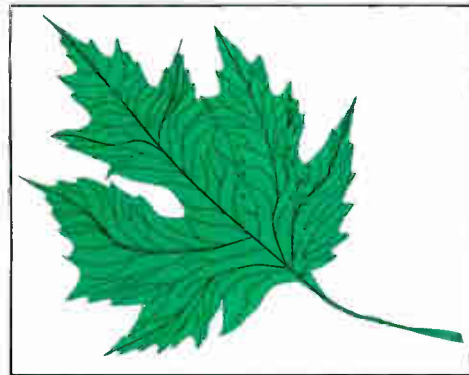
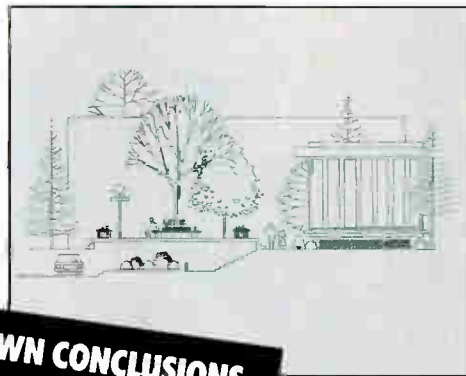
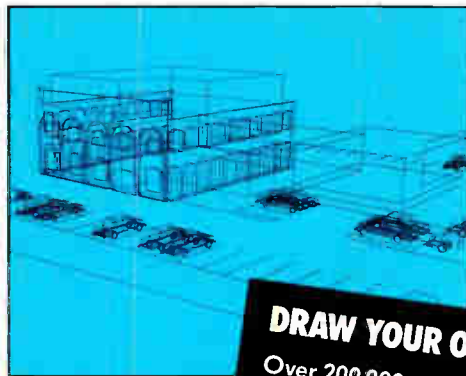
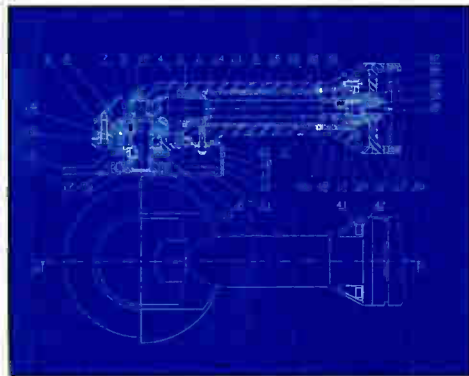
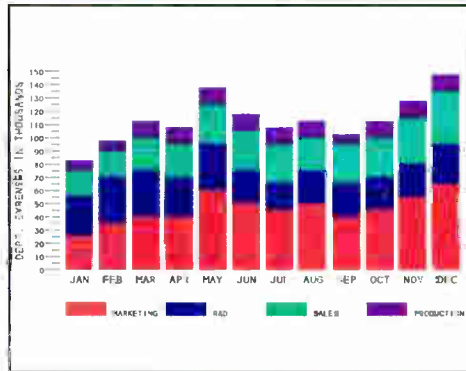
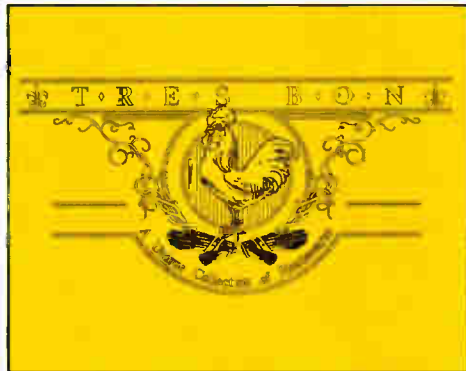
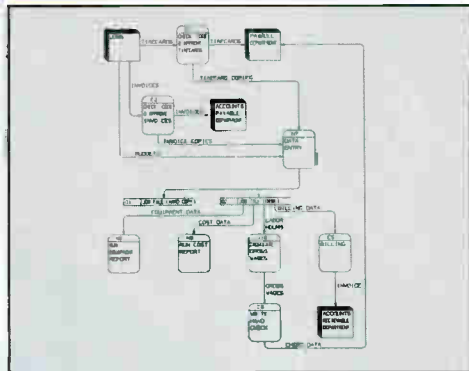
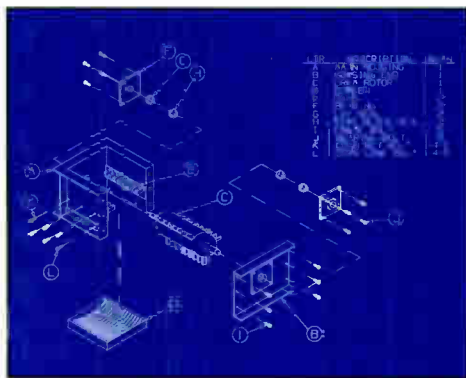
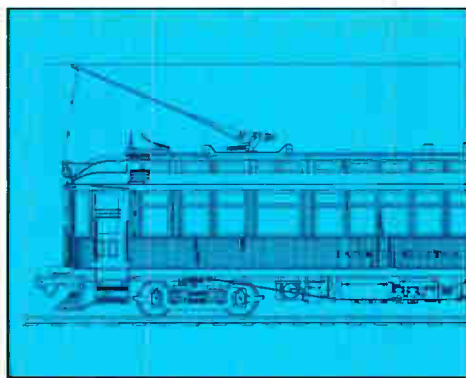
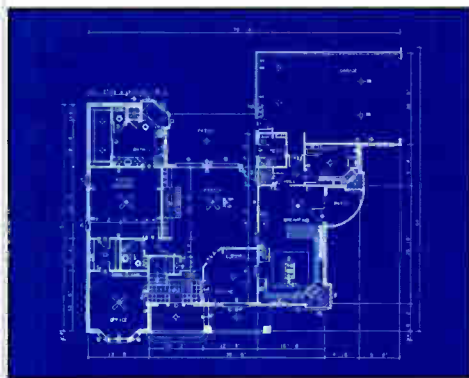

DRAW YOUR OWN CONCLUSIONS.
 Over 200,000 people have discovered that Generic CADD is the most versatile and accurate drawing tool on their desk. Call for our new Generic CADD Sneak Preview™ disk (\$9.95) or our free CADDalog® and see why it's the #1 selling low-cost CADD program. Then start drawing a few conclusions of your own.

1-800-228-3601

Generic
 SOFTWARE

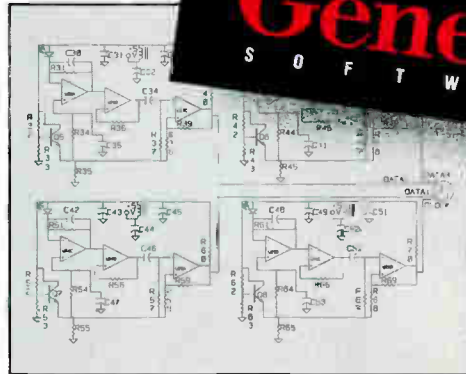
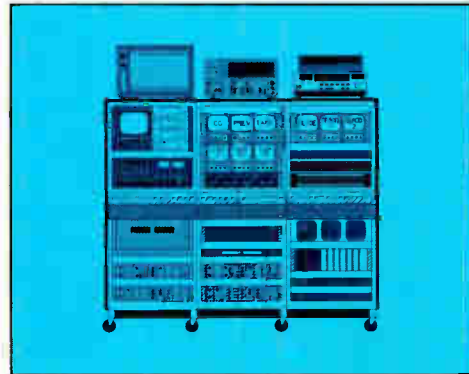



Our standards are the toughest part of our 3.5" diskette.

We've got you covered. The rigid plastic jacket of our 3.5" Micro Diskette is molded to our own specifications for unsurpassed protection. And, our clipping level is 44% higher than industry standards. Call 800-343-4600 for the name of your nearest BASF supplier.

Depend on it.



BASF

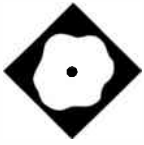

Manage It with Pictures

Project Scheduler 4 is the first midrange, graphically based project management software for the PC

Lamont Wood

With Project Scheduler 4 (PS4) from Scitor Corp., you have the leading example of what project management software users have been looking for, and what the market is moving toward: a graphics-based package with a reasonable price and functionality.

Project management is a complex chore. Unfortunately, most project management software can be equally complex. And while many managers get organized by thinking graphically—charting the events of a project on a blackboard—they must then sit down with the software and fill in tables of tasks, resources, and precedence dependencies (i.e., what jobs precede other jobs).

Eventually, the project management software produces a precisely calculated Gantt or PERT (Program Evaluation and Review Technique) chart—basically a born-again version of the blackboard scrawls that the manager began with.

A computer should, of course, do more than augment a blackboard. PS4 still requires you to fill in tables, and you can't draw your Gantt charts directly on the screen. But for \$685, PS4 generates a chart that you can play with on the screen. It won't handle the construction of, say, a nuclear submarine, but that's

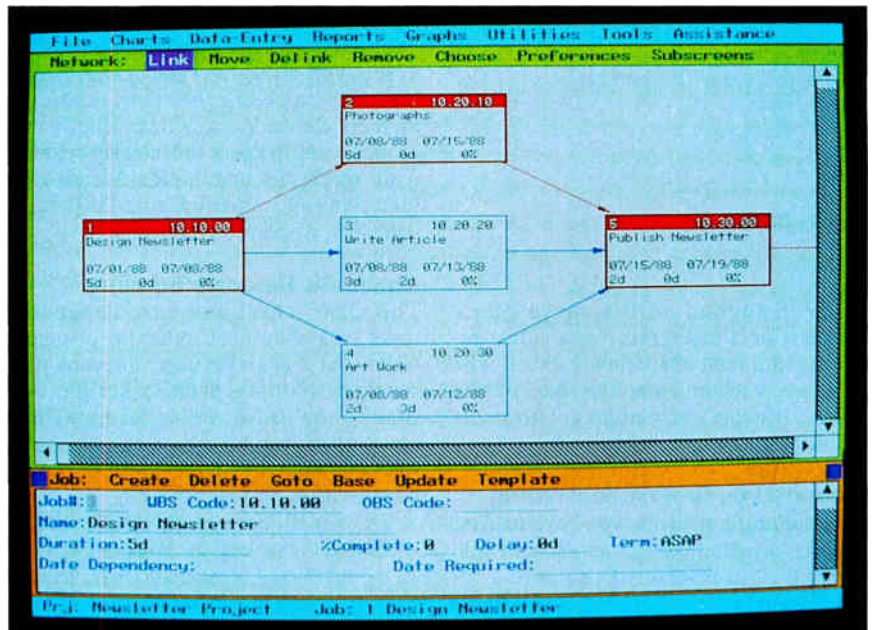

Project Scheduler 4 offers an early vision of things to come: graphically based project management.

because PS4 is geared to the office environment rather than to construction projects.

Interface à la Windows

PS4 is entirely graphics-based—the only time you're in text mode is when you print reports to the screen rather than to the printer. The command interface is reminiscent of many GEM or Windows applications, although it uses neither. There's a list of menu topics across the top of the screen. Clicking on any of them with the mouse pops up a menu with further commands on that theme. (Operation without a mouse is possible using special key combinations.)

The program has data-entry windows and chart windows. You can enter all the task, resource, and dependency data in tables. Or you can call up the chart windows and enter the data in a "template"

that you can invoke in the bottom third of the screen, and watch the chart take form as you go along.

You can set two kinds of charts from PS4: the standard Gantt chart (where horizontal bars represent tasks on a common time scale), and a "network" chart that is basically a PERT chart (where boxes represent charts with connecting lines showing dependencies, with no time scale). Both charts show the "critical path" (i.e., the succession of tasks whose delay would disrupt the entire project) with special highlighting. (Other packages offer variations on this theme—such as Gantt charts with dependency lines—but PS4 sticks to the old war-horse charts.)

PS4 also offers histograms that show consumption of one or more resources over time. You can have either a stand-

continued

Project Scheduler 4 version 1.5

Company

Scitor Corp.
256 Gibraltar Dr., B-7
Sunnyvale, CA 94089
(408) 745-8200

Hardware Needed

IBM XT, AT, PS/2, or compatible,
Wang PC, or Hewlett-Packard 150 with
512K bytes of RAM, a graphics screen,
and a hard disk drive; a mouse is
recommended

Software Needed

DOS 2.0 or higher

Documentation

Reference manual; tutorial manual;
on-line help

Price

\$685

Inquiry 883.

alone histogram with a range of resources, or a histogram for a single resource in a template below a chart. The template version embodies one of the chief advantages of planning with interactive graphics.

Forward and Reverse Scheduling

When doing a project, you have to first specify whether you want to schedule forward or in reverse. If you have a required start date, you schedule forward. If you have a required finish date, you schedule in reverse. Generally, most scheduling is done in reverse.

Then you enter the list of tasks in a table. The data includes a name and an expected duration, in hours, days, weeks, or months. You can also identify each task with a 10-character work breakdown structure (WBS) code or an organizational breakdown structure (OBS) code. You develop these codes yourself to show relationships between tasks, and later sort the tasks. (WBS and OBS are actually the same thing. The idea is that government contractors often have to use the WBS given to them in a contract, and that WBS might differ from their in-house WBS. So they can use the OBS as their in-house WBS.)

You then go to the (still blank) network chart and put the task list in the template on the bottom of the screen, making each task appear as a box at the cursor position in the chart. PS4 handles up to 1500 tasks per project.

You link the boxes together to show dependencies, drawing a line from one

task box to the next. (Actually, you can have standard finish-start dependencies, plus start-start and finish-finish dependencies.) There is a data-entry table for showing dependencies, but it's much more fun drawing lines on the screen. As you draw each line, PS4 recalculates the critical path and highlights the boxes accordingly as you go.

At some point, you call down the project calendar (which actually looks like a calendar) and indicate what days of the week you'll be working, as well as what hours of the day (if you're figuring at the hourly level), and denote what holidays you'll observe.

Finally, you can go to the Gantt chart to see (and print) the tasks as horizontal bars, one preceding the other, according to their dependencies. The length and scope of the project are clearly visible, with weekends and holidays and even lunch hours accurately figured in (and, if you wish, displayed on the chart).

Automatic Resource Leveling

The Gantt chart can have dependent tasks following each other in a logical order, but it can also have the same person doing 10 things at the same time. Assuming you're scheduling for more than one person, you have to worry about resources—and "resource leveling." PS4 handles up to 500 resources.

You can fill out a resource table that is similar to the task table. You can even use an identifying resource breakdown structure, or RBS, in a similar manner to that of the WBS or OBS. Each resource also gets a cost in dollars per hour, day, week, or month. The amount can be zero, but PS4 has to know what time period you want to use for scheduling. Also, you must state the availability—if the cost is per hour, then you might state an availability of 40 hours per week.

Each individual resource can have its own calendar for figuring vacations and other variations. But you have to be careful. If a person assigned to a task goes on vacation during that task, PS4 delays the task's completion until that person returns. This makes sense—by assigning the person, you indicate that the task can't proceed without him.

More complications arise when you start assigning resources to tasks. You can set up PS4 to figure the task duration on the basis of the assigned resources. For example, if the task had an expected duration of 8 hours and eight people are assigned to it, then that task's duration will automatically change to 1 hour. Or it can be set up to figure total input (e.g., eight people working 8 hours on a task

means 64 work hours were spent). You can also have it calculate work rates to show that your eight people will have to work 8 hours a day collectively to finish the 64-hour task in eight days.

The task-duration method might be preferable for scheduling construction-like projects, where tasks can be defined in work hours and scheduling is a matter of covering tasks with enough people to get the tasks done by a certain time. The problem with the task-duration method is that PS4 does not record your original work-hour calculation. If subsequent adjustments in the schedule change the duration again, your original calculation will be lost.

After you assign all your resources, next comes "resource leveling," which means making sure everyone (or everything—a resource can be a bulldozer or a sum of money) is doing only one thing at a time. This can be done manually or automatically.

Manually, you can call up histograms—one for each resource—in a template at the bottom of the Gantt chart and see if any of the bars in the histogram jut above the line (meaning overcommitment for that time frame). The histogram is shown on the same time scale as the Gantt chart, and only the tasks involving that resource are shown. Therefore, any problem task will be just above the line. The histogram template has a useful "search" command that searches the list of resources for overcommitments. Each time you invoke it, PS4 finds the next overcommitment.

You can then use the extend or delay commands to move or lengthen the task in question—actually adjusting the bars with the mouse—to alleviate the problem. (Or you can add a delay value for that task in the task table or change its duration.) As you make each change, the other bars will rearrange themselves according to the precedences.

The automatic resource leveling command removes the overcommitments automatically. The use of automatic resource leveling is somewhat controversial among project management software vendors, since there is no good way to do it, and the resulting schedule may have tasks shoehorned together in ways that would be unmanageable in real life. However, it can quickly provide a workable schedule, which you can then adjust manually.

Baseline Tracking and Analysis

After it makes your schedule, PS4 can generate a "baseline" for a finalized

continued

Now QuickPascal makes this software go even faster.

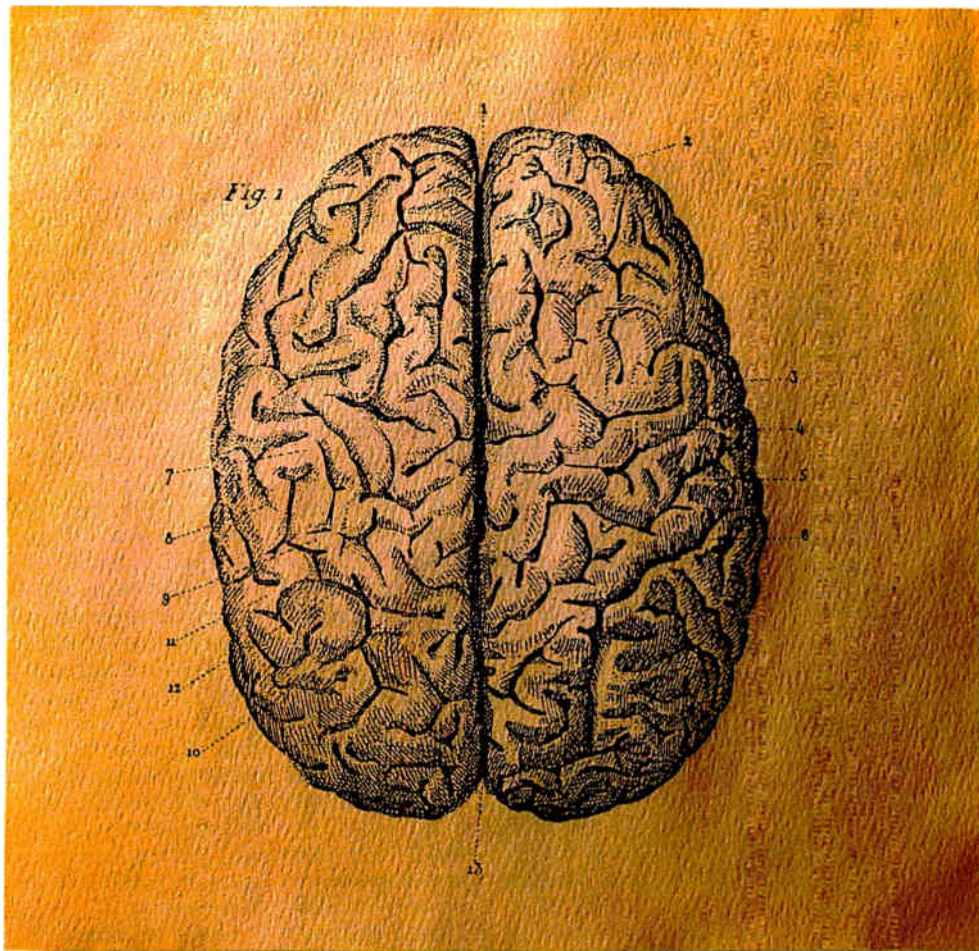

Even the quickest minds tend to brake suddenly when confronting new languages.

Enter new Microsoft® QuickPascal Compiler.

The first Pascal that is not only powerful but easy, intuitive and 100% headache-free.

For example, our new hypertext QuickPascal Advisor offers on-the-job training: by cutting and pasting sample code you can learn to program in Pascal from scratch. And if you do hit a snag, the Quick Advisor can straighten everything out right on the spot.

To accelerate your thought processes even more, all of our processes are seamlessly integrated; no other Pascal offers you easier

access to your editor, debugger and compiler.

What's more, QuickPascal is the first PC Pascal to offer Object Oriented Programming, or OOP. With objects, you can easily assemble whole programs from modular building blocks of code and data. And once you know Pascal, OOP is a snap. Which means, you get maximum productivity with minimum effort.

Naturally, our Pascal is also fully source compatible with Turbo Pascal®.

So stop by your Microsoft dealer soon.

You'll find our software is on the same wavelength as yours.

Microsoft
Making it all make sense.

Customers in the U.S. call (800) 426-9400. In Canada, call (416) 673-7638. Outside North America, call (206) 882-8661. © Copyright 1989 Microsoft Corporation. All rights reserved. Microsoft and the Microsoft logo are registered trademarks and *Making it all make sense* is a trademark of Microsoft Corporation. Turbo Pascal is a registered trademark of Borland International.

BLACKSHIP

Your "BEST BUY" Company

Holiday Specials**386 SYSTEMS**

"A reasonably priced system (Blackship 386/33) that performs well... it's easy to recommend this computer."

— BYTE IBM Special Edition, Fall 1989

"Blackship 386/25: Reliability at a Good Price... the only machine tested that was entirely trouble-free."

— PC WORLD, August 1989

"The Blackship offers low price 33-MHz performance... we rate it a very good value."

— INFOWORLD, July 1989

"Blackship's 386/25 is low price leader."

— INFOWORLD, May 1989

"... one of the 80386-based clones that offer a revolutionary new feature — affordability."

— BYTE, October 1988

"... remarkably strong performance at bargain prices."

— PC WORLD, June 1988

386/33 Mhz System	\$3295	\$3195
386/25 MHz System	\$2595	\$2395
386/20 MHz System	\$1795	\$1695
386/16 MHz System	\$1595	\$1545
386SX/16 MHz System ..	NEW	\$1145

286 SYSTEMS

"Well-built newcomer is value leader among superfast ATs we tested."

— INFOWORLD, February 1989

"... its price/performance ratio easily justifies PC WORLD's Best Buy recommendation."

— PC WORLD, August 1988

286/25 MHz System	\$1295	\$1195
286/20 MHz System	\$1195	\$1095
286/16 MHz System	\$1095	\$995
286/12 MHz System	\$995	\$895
286/10 MHz System	\$895	\$845

SYSTEMS INCLUDE

- 1 Mb Memory
- 2 Serial, 1 Parallel, and 1 Game Port
- 2 FD / 2 HD
- 1.2 Mb 5¼" Floppy Drive
- Keytronic Keyboard
- 8 Expansion Slots
- Math Coprocessor Socket
- Clock/Calendar with Battery Backup
- Room for Up to 5 Half-Height Drives
- 220W Power Supply

OPTIONS

- Memory
- Hard Drives
- Tape Backup
- Video
- Modems
- Digitizers
- Printers
- Plotters
- More... CALL

1-800-877-6249**BLACKSHIP**
COMPUTER SYSTEMS, INC.

4031 Clipper Court
Fremont, CA 94538
415-770-9300
FAX 415-770-8674

schedule. The PS4 shows the original place of each task on the Gantt chart as a dark bar.

At this point, if you scheduled in reverse, you will want to change the setting to forward scheduling, which fixes the start date. Subsequent alterations can push back the end date, which is no longer fixed, but the slippage will be noted on the Gantt chart.

Here you can run into a problem with any task that had a specific start date or deadline. (You enter these dates with the data that goes into the task template.) The start date and the deadline date are simply reversed when you switch from reverse to forward scheduling. But if you must do serious rescheduling during the tracking phase, you'll have to go into the templates and change all those dates—something you might not care to do.

PS4 will also let you do a "PERT analysis" on the schedule. You give three time estimates for each task—optimistic, pessimistic, and most likely. The software then comes up with an average estimate. You can vary the importance given to each of the three estimates.

On the resource table, you can enter expected inflation values and the start dates for those values. You can, for instance, see if stretching out a project will actually save you money if, say, the workers involved are all likely to get raises in the meantime.

PS4 comes with a stand-alone data conversion program (which also uses a GUI) called IMEX. It converts between the PS4 file format and those of Lotus 1-2-3, dBASE III Plus, and comma-delimited ASCII.

On-Line Help

PS4 has so many help features that its printed documentation is superfluous after you finish the installation.

There are three on-screen help modes: standard, terse, and assist. In standard mode, you get a screen message for every error. In terse mode, you get only beeps for most errors. With the assist mode, you get a pop-up message every time you invoke a menu or need to make a choice. I quickly felt pestered by it and switched to the standard mode.

Another command brings up an on-screen version of the reference manual. Its organization closely parallels that of the printed reference manual, but the material is more terse. If you are within a command when you invoke the documentation, it takes you to the start of the section dealing with that command. Otherwise, it opens in the table of contents, and you use its GO TO com-

mand to navigate from there.

If you don't like using on-line help, there is the printed reference manual, plus a tutorial manual that includes a skeletal discussion of project management concepts. Ironically, it could use more graphics—the only key to the Gantt chart symbols I saw was the one that PS4 adds to the printed version of the chart.

A Question of Management

PS4 borrows ideas from some of its more expensive cousins, such as Pertmaster International's Pertmaster Advance, especially the ability to level manually using a split screen. But PS4 remains a midrange package with midrange capabilities. It lacks, for instance, an outlining feature whereby you can add details as they come to mind. There is no way to input actual completion dates for individual tasks during the tracking phase, which can be important when dealing with subcontractors.

Also, the idea of using forward and reverse scheduling seems unnecessarily complicated—most packages will attempt to level a schedule within given deadlines and run up a flag if that proves impossible. PS4 pushes the start or end date if there's a leveling problem, and it flags the variance. The way it handles the duration of tasks may also make you nervous if those durations are the result of complex on-the-side calculations. Otherwise, if the duration needs to be what you say it is, you'll like the precise control PS4 gives you.

On the other hand, the program is very fast; rarely do you have to wait for anything. Running PS4 on even an IBM XT is reasonable. It's also friendly, with its help modes and graphics.

But project management is like word processing. Everyone's needs are so idiosyncratic that you can't have a package that is all things to everyone. PS4 is best suited to middle-level managers who occasionally need a quality project management package with enough friendliness to slash the learning curve. And it's certainly better than a blackboard. ■

ACKNOWLEDGMENT

I wish to thank consultant Daniel Yeh-dav, president of I Soft Decision, Inc., in San Rafael, California, who provided input on this review. He publishes PM Solutions, a decision-making tool for selecting project management software.

Lamont Wood is a freelance writer in the computer and electronics fields and lives in San Antonio, Texas. He can be reached on BIX as "lwood."

We'll take your stats and make you the most valuable player in your league.



CHRIS JOHNSON Data Analyst

CAREER HIGHLIGHTS:

1983
Proposed remap of sales territories based on SPSS analysis of economic and consumer trends. Increased new-customer revenues 38% in 2 years.

1985
Used SPSS data entry/tabulation system to administer employee benefits more efficiently. Eliminated outside costs of more than \$75,000.

1986
Identified current customers likely to need added services, increasing average billings by more than 20%.

1988
Rewarded with special corporate recognition and bonus.

Another Story in the SPSS SUCCESS SERIES



March 14, 1989

Data analysis software from SPSS gives your PC a winning advantage.

It doesn't matter which field you play hardball in. With the right combination of equipment and ability, you can be a hero.

You get that ability with SPSS. Whether your equipment runs on MS-DOS™ or PC-DOS™ OS/2™ or a Macintosh™. So you turn raw data into useful facts. And yourself into a smarter decision maker.

With SPSS and its options, you can interface directly with data from your database, spreadsheet or other

application software. Then manipulate it in countless ways. From data entry to advanced statistics, forecasting, presentation and more.

Voted #1 by the fans.

When the readers of *PC Week* chose the top statistical software for "user satisfaction" (12/5/88), their choice was SPSS. And no wonder.

SPSS is designed not only for your computer's operating system, but also for its operator. With menu and help systems, plus an on-line statistical glossary. So you're always in control. For market research, sales analysis, quality control and more.

And you can always count on the training, support, and ongoing upgrades of SPSS. The team that's come through for over 1 million users since 1968.

Find out how SPSS can make you first in your micro league, by calling **[312] 329-3315.**

We'll give you the numbers to really stand out in your field.

SPSS inc.

Best in the final analysis.

444 North Michigan Avenue, Chicago, Illinois 60611
SPSS International BV: Avelingen West 80,
P.O. Box 115, 4200 AC Gorinchem,
The Netherlands

SPSS is a registered trademark of SPSS Inc. PC-DOS and OS/2 are trademarks of International Business Machines Corporation. MS-DOS is a trademark of Microsoft Corporation. Macintosh is a registered trademark of Apple Computer, Inc. Not all options are available on all operating systems.

Circle 300 on Reader Service Card

World Radio History

Cause®

Effect®



CAUSE introduces personal programming — a new technology that lets you create software without learning a

language. With CAUSE, use a graphical interface and object-oriented programming techniques to build applications in hours instead of months. Without any code or syntax. Users can create those elusive solutions. Programmers can develop as fast as they can prototype.

Naturally, CAUSE implies EFFECT. EFFECTS are applications written with CAUSE, and published by Maxem. Submit your CAUSE-generated applications to Maxem, and publish software without the hassles of marketing and distribution, only the hassle of cashing your royalty check. Get in touch with the future; call Maxem 1-800-336-6296 or write Maxem, 7855 South River Park-
Maxem® way, Tempe, AZ 85284.



Fixed Assets



Loan Processing



Legal Time and Billing



Agency Billing



Personnel



Budgeting



Shipping/Receiving



Order Entry/Invoicing



Point of Sale



Accounts Payable



Payroll



General Ledger



Job Estimating

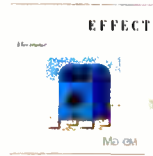

Electronic Mail



Job Costing



Problem Tracking



Tax Preparation



Church Accounting



Medical



Chiropractic

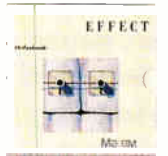

Orthodontic



Dry Cleaning



Rental Store

etc.



What Price Color PostScript?

Thanks to the speedy QMS Model 10, the cost of color PostScript printers continues to wane

Howard Eglowstein

With a fast 68020 processor and color PostScript capability for under \$10,000, the QMS ColorScript 100 Model 10 carves new territory for wax-transfer printers.

Like its big brother, the Model 30, the ColorScript Model 10 produces color images with a roll of Mylar ribbon alternately striped with bands of yellow, magenta, cyan, and black wax. A host computer sends color PostScript commands to the printer through a serial or parallel interface on PCs, or through a DB-9 LocalTalk connector on Macintosh networks. The 68020 processor in the Model 10 runs the commands through the PostScript interpreter and generates four-color separations.

Image for image, the QMS Model 10 matches the print quality of more-expensive printers. The high-performance processor enables the printer to blow the doors off the competition. But color printing doesn't come cheap. Hard copy from the Model 10 costs about eight times as much as black-and-white output from a standard laser printer.

More Expensive Than Crayons

The \$9995 base price includes 4 megabytes of image RAM; the serial, parallel, and AppleTalk connectors; 35 resi-



dent fonts; 30 sheets of coated paper; and a short ribbon. Full-size ribbons cost \$105 each. Coated paper runs to \$125 for 2000 sheets; transparency sheets are \$125 per 100.

Three options are available: extra RAM, external hard disk drives, and Hewlett-Packard Graphics Language (HPGL) emulation software. The extra RAM lets you download more fonts or create larger images in printer memory. The \$1495 4-megabyte upgrade allows for both legal-size printing and more downloaded fonts. The 20-megabyte and 40-megabyte external hard disk drives (\$995 and \$1495, respectively) connect to a SCSI port on the back of the printer. They enable the Model 10 to automatically cache fonts as needed or to store downloaded fonts for quick retrieval.

The HPGL emulation software (\$199) is a PostScript program that you download to the Model 10. From that point on, your application sends plotter commands

that would normally control an HP 7475 or compatible (HPGL) plotter. I had difficulty getting the software to run on our base model printer. It handled simple images, but it choked on fairly complex images. I suspect that I needed more than the standard 4 megabytes of memory to run this emulation.

Blazing Speed

I tested the Model 10 against the ColorScript Model 30, the Tektronix Phaser CP (see "Color by Numbers," July BYTE), and the Apple LaserWriter IINT. Each printed the benchmark files used in our Product Focus on PostScript printers (see "PostScript Printers Come of Age," September 1988 BYTE). The Model 10 converts PostScript commands to an internal bit map with impressive speed, as the PostScript graphics test demonstrates (see table 1). Generally, the Model 10 performed better than the

continued

more expensive Model 30 and held its own against the Phaser in all but the large-text-file print test.

The wax-transfer process requires the Model 10 to roll the paper through the printer several times, one for each color on the ribbon. The printer grabs a sheet of paper from the stack and rolls it in. The paper comes out the output tray, the ribbon advances, and the printer draws the paper in again. When the paper reappears, you see the yellow portion of the image. Successive passes build the image before the paper is finally released

into the output tray. Because our PostScript test files are black and white, the Model 10 had to roll through all four ribbon colors just to use the black band.

After evaluating the printer's speed with the color ribbon, I also tested its performance with an all-black ribbon, which allows you to use the ColorScript without wasting expensive color ribbon. With a monochrome ribbon, the Model 10 ran significantly faster than the LaserWriter on both the large-text-file and the graphics tests. Both printers use Adobe PostScript, so the speed differ-

ence has to be related to processing power—the LaserWriter's 11.5-MHz 68000 is simply no match for the Model 10's 16.7-MHz 68020 processor.

In addition to speed, the Model 10's print quality looked excellent for a wax-transfer printer. I ran Adobe Illustrator and PageMaker 3.0 on both a Mac II and an AT compatible. Both applications took advantage of the ColorScript's full range of colors. Your application will determine the amount of color you get. The fonts could be crisper, but you shouldn't consider this printer as a substitute for laser printing or for generating final color output—it's good, but it's not that good. Still, the output matched that of the Model 30 and proved comparable to that of the Tektronix Phaser CP, which costs about \$2000 more (see figure).

Table 1: Running BYTE's PostScript-printer benchmark files, the ColorScript 100 Model 10 logged impressive speeds, especially when converting PostScript graphics commands to an internal bit map. (All times are in seconds.)

FOUR-COLOR SPEED

Printer	Large text file ¹	Small text file ²	PostScript graphics file
Apple LaserWriter II NT	484	131	203
ColorScript Model 10, mono ribbon	344	127	41
ColorScript Model 10, four-color	874	328	99
ColorScript Model 30	1582	362	297
Tektronix Phaser CP	640	380	285

¹ Consisted of a 125K-byte, 16-page file that contained seven fonts.

² Consisted of a 25K-byte, six-page file with three fonts and small graphical elements.

Who Needs Color?

This printer makes sense for people who need color proofs or small numbers of high-quality color copies. QMS expects the printer to be popular with desktop publishers and others who need quick access to color hard copy. I can imagine it being used, for example, in real estate offices for listings sheets and in businesses that prepare color transparencies for presentations. It's also ideally suited for artists using desktop computers for layout and design. Because it supports PCs and Macs equally well, network installations may be the best application for it.

Accordingly, I envisioned that some of these professionals might print a number of proofs, stuff them into the trunk of a car, and drive off to meet a client. Would the wax on the printed copy melt and stick the pages together if the car were left in the hot summer sun? I stacked some hard copies from the Model 10 in BYTE's environmental chamber and set it at 140°F. After 5 hours in our car-trunk simulation, the color images were as clear and bold as ever, and the stack of wax printouts didn't melt together.

Cashing in on Color

Although attractive, the Model 10's under-\$10,000 price isn't the whole story. A four-color, letter-size copy from the printer costs about 68 cents. By comparison, standard laser printers churn out black-and-white images for 8 cents a sheet or less. Even with the monochrome ribbon, a black-and-white copy from the Model 10 costs about 25 cents, three times the price of a copy from a standard laser printer.

Also, the "optional" 1-megabyte upgrade is necessary if your work re-

continued

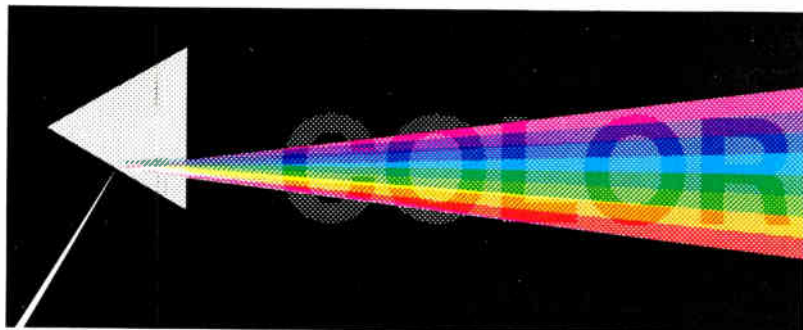
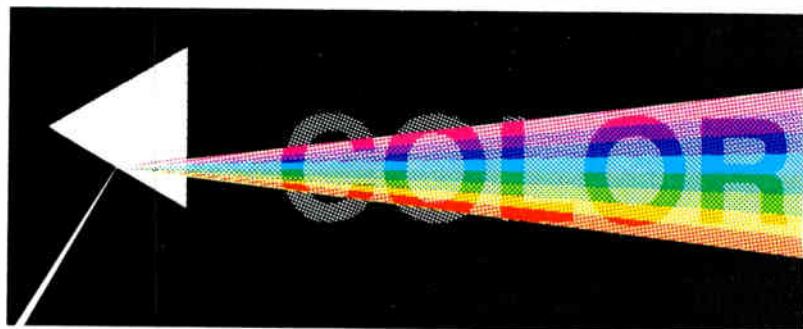

ColorScript Model 10 hard copy (top) matches the quality of that of the more expensive Tektronix Phaser CP (bottom). Both printers use wax-transfer printing technology to achieve superb output.

The Ultimate Business Computers



Model 325CT
80386-25MHz

Model 325C 80386-25MHz

Model 320 80386-20MHz

Model 212D 80286-12MHz / Model 210D 80286-10MHz
Model 316SX 80386SX-16MHz

Sparrow I/16
80286-16MHz

*"...When it comes to the basics, price, performance...capacity...CLUB American Technologies...delivers outrageous value."
PC WORLD September 1989*



The Ultimate Business Computers

In 1986, CLUB American Technologies introduced the first personal computers designed for heavy industrial and commercial use. Since then, over 175,000 CLUB computers have been installed worldwide and have been well accepted by the **Fortune 500**, **Government Institutions** and **thousands of small businesses**.

This overwhelming success in CLUB's computers is a result of excellence in engineering during which no details are overlooked from the initial design to the final product. Also during manufacturing, each system is subject to an intensive SCBI process followed by In-Circuit Simulation Field Testing.

If your business computer that can in today's competitive and find out more about the



is looking for a give you the edge marketplace, call today Ultimate Business Computers from CLUB American Technologies.

(415) 683-6600

In Canada, PC Centre: (416) 470-0560
International: (415) 683-6659
Technical Support: (415) 683-6580

CLUB
American Technologies, Inc.

WHAT PRICE
COLOR POSTSCRIPT?

...and you switch over fully automatically.

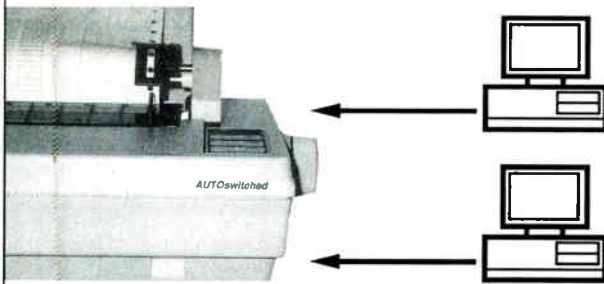

Because you never notice that manual switches are set wrong until it's too late.

Because desktops are full enough anyway.

The automatic switch is integrated into the connector, requires no power supply or manipulation and is attached within a minute. Compatible with all PCs.

Type 25210, 2-to-1, US\$ 115
Type 25410, 4-to-1, US\$ 185
(details of 6 other T switches on request)

PC & UNIX compatible products. Bus System, Error Correction, Interfaces, Line Drivers, Optical Isolators, Printer Buffers, T-Switches. 20mA, C64, Centronics, IEEE488, RS232, RS422, 423, 485, Monitor

Wiesemann & Theis
Winchenbachstr. 3-5
D-5600 Wuppertal 2
West Germany
Tel: +49 202 505077
Fax: +49 202 511050

(A) Basic Merton (0222) 9736360 (B) Brother Int.
(02) 4674211 (CAN) Sicolat (416) 670 1650 (C) Weber & Co (01) 9302003 (D) Wiesemann & Theis (0202) 505077 (E) Jasec (86) 479139 (F) Neol 88.62.37.52 (G) Thor (01) 681500 (H) Telsa 5184500 (I) RamTec (09) 224620 (J) Cat & Korah (010) 4507696 (K) Moretec (9) 1626812 (L) Overseas Trade 2726077



QMS ColorScript 100 Model 10

Company

QMS, Inc.
One Magnum Pass
Mobile, AL 36618
(800) 631-2692

Features

Full four-color printing (wax transfer); standard AppleTalk, parallel, and serial interfaces; SCSI connector for external hard disk drive; 4 megabytes of RAM standard, expandable to 8 megabytes; 16.7-MHz 68020 processor; Adobe PostScript interpreter; 35 resident fonts; 300-dpi print resolution; HPGL emulation available; handles letter, legal, and A4 media sizes (paper or transparency material); Pantone certified

Size

11 1/3 x 17 x 24 1/2 inches; 65 pounds

Hardware Needed

MS-DOS computer with serial or parallel interface; Macintosh II family; any other computer capable of generating PostScript commands to a standard serial or Centronics parallel interface

Documentation

Owner's manual

Price

As tested with 4 megabytes of RAM: \$9995

Inquiry 861.

Protects while you type!



- Remains in Place while you use your computer.
- Avoids Costly Repairs. Protects delicate electronics from dust, spills, smoke, ashes, staples.
- Soft, Flexible, retains normal keyboard feel.
- Washable, Durable High-Tech Polymer lasts years.
- Hundreds of Models. SafeSkin is available for most PCs, laptops, workstations and clone keyboards.
- Office • Home • Factory • Classroom • Laboratory

List Price \$29.95. Please call or write for free color brochure. Dealer inquiries encouraged.

SafeSkin™
KEYBOARD PROTECTOR

Merritt Computer Products, Inc. 5565 Red Bird Center Drive
Suite 150, Dallas, Texas 75234/(214) 339-0753 - FAX (214) 339-1313
In Canada call 1-800-663-1061

quires you to print full 8 1/2- by 11-inch color images. Because of the precision needed to keep the four color passes aligned, the printer takes a 1 1/3-inch bottom margin and a 7/10-inch top margin off each sheet of paper. This crops standard-size pages to an effective printing area of 8 1/10 by 9 inches. You could handle this by using legal-size paper, where the printable area becomes 8 1/10 by 12 inches. I tried this on our base model, but the standard 4 megabytes wasn't enough. If you need to print a full page, 5 megabytes of memory is a minimum configuration.

In general, the ColorScript 100 Model 10 is well built, relatively inexpensive, and reasonably fast. Color PostScript capability is clearly not for everyone. Even at \$9995, the printer's price will keep it out of reach as a personal printer for most people. However, this technology is likely to become more appealing as the price of wax continues to wane. ■

Howard Eglowstein is a testing editor for the BYTE Lab. He can be reached on BIX as "hglowstein."

Road test a Buick in your home.

BUICK
1990



"Let's get it together . . .
buckle up."



© 1989 General Motors Corporation. All rights reserved. Buick and  are registered trademarks of General Motors Corporation.

Send for a free Buick disk.

It's an easy way to discover the exciting new Buick models. Once you test-drive a Buick in your own home, just think how exciting it will be to test-drive one on your favorite Great American Road.

To get your free disk, fill out the attached card, call 1-313-239-5552, or write: Buick Dimensions, P.O. Box 354, Flint, MI 48501-0360. Please specify your disk format.



The Great American Road belongs to

BUICK

Reviewer's Notebook

Reviewer's Notebook is a compilation of brief reviews and updates to previously published evaluations. BYTE will publish Reviewer's Notebook each month on a space-permitting basis.

Update: Standout Graphics Board

In November, BYTE's Product Focus spotlighted coprocessor-based graphics controllers for mainstream PCs. Since then, we've tested another 34010-based board, the Rendition II from Renaissance, which proved itself among the top performers in this product class.

The Rendition II is a medium- to high-resolution (1024- by 768-pixel) graphics controller for IBM ATs and compatibles. The \$1495 base model includes 512K bytes of video RAM, enough for 16 simultaneous colors at full resolution. Renaissance also sells a 256-color board with 768K bytes of VRAM for \$2095. Each model offers a 24-bit color lookup table for a 16.7-million-color palette.

In addition to frame-buffer memory, the board provides sockets for up to 512K bytes of DRAM; the base model comes with 128K bytes installed. DRAM can be used to store 34010 downloadable instructions, or any data shared by the 34010 and the primary processor.

Although Renaissance supports the Texas Instruments Graphics Architecture 340 interface, TIGA drivers for the Rendition II are still in the works. The standard application interface now shipping with the board is IBM's 8514/A AI. Renaissance also offers its proprietary graphics interface to developers.

The board arrives bundled with a wealth of drivers for specific applications, including Gem/3, Ventura Publisher, and Microsoft Windows. Renaissance also provides display-list drivers for AutoCAD releases 9 and 10, VersaCAD, and MicroCADDs GCD. You'll need additional hardware to run under standard graphics modes, because the Rendition II doesn't do emulations. The board can coexist with a standard graphics board, and it supports VGA pass-through for single-monitor operation. You can also buy a VGA daughterboard (\$300) to save an expansion slot.

I ran our AutoCAD release 10 and

PageMaker tests with the Rendition II in the same Compaq 386/20 that we used for our Product Focus. Table 1 compares Rendition's performance with that of two of the best boards from that review, Number Nine's Pepper Pro1280 and Compaq's Advanced Graphics 1024.

The Rendition II keeps the AutoCAD display list in on-board memory, splitting it between available DRAM and video RAM. The unit I tested had 384K bytes of DRAM and 1 megabyte of VRAM, with 768K bytes required for the frame buffer. If EMS memory is available, the board can use both on-board and expanded memory. The driver can also write the information to disk.

CAD performance was excellent. The driver maintained display lists for the large and small drawings. Times approximated those of the Compaq Advanced Graphics 1024 board. The Rendition's PageMaker test performance also came close to the Compaq's, which topped our list of 1024- by 768-pixel boards. The screen display was clear and readable, and the driver had no noticeable flaws.

Overall, the Rendition board is excel-

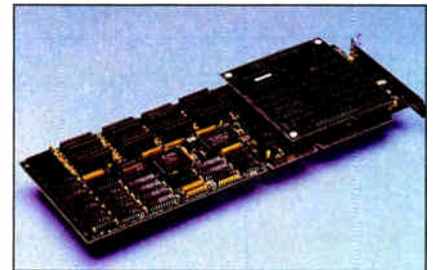

The Rendition II provides 1024- by 768-pixel resolution and some slick extras.

lent for medium- to high-resolution graphics. Besides speed, reasonable price, and a good-looking display, it offers some slick extras. An automatic self-test routine, easy driver-configuration utilities, and solid documentation round out the package.—*Steve Apiki*

Rendition II
Renaissance GRX, Inc.
Cedar Park
2265 116th Ave. NE
Bellevue, WA 98004
(206) 454-8086
\$2993 as reviewed
Inquiry 854.

Table 1: Rendition II holds its own against the top coprocessor-based graphics controllers. (All times in seconds.)

	TOP 34010 BOARDS							
	AutoCAD Small drawing			AutoCAD Large drawing			PageMaker	
	Redraw	Zoom	Pan	Redraw	Zoom	Pan	Scroll	Zoom
Renaissance GRX Rendition II	2	6	5	3	8	7	12	4
Number Nine Pepper Pro1280	2	2	3	5	4	4	9	5
Compaq Advanced Graphics 1024	2	6	5	3	10	8	11	4
Compaq VGA *	7	11	9	12	16	14	21	2

*Results for a Compaq VGA card are shown for comparison.

Mac Color by SCSI

Aura Systems' ScuzzyGraph II brings higher resolution and color to the Mac Plus and SE. ScuzzyGraph is an external graphics display that plugs into the SCSI port and lets you connect with large-screen monitors. To install it, you configure a few jumpers, place the unit under your Mac, connect the SCSI cable, and turn on the power.

ScuzzyGraph is fast. Its dual processors (a 10-MHz 68000 and a 40-MHz 34010) render the QuickDraw eight-color set as fast as the Mac normally displays black and white. The reviewed Model IIm/8a gives 720- by 512-pixel resolution on an NEC MultiSync.

The INIT diverts QuickDraw calls from the screen to the ScuzzyGraph. It works well if your software supports QuickDraw. The list is short; ask Aura if it includes your favorite programs.

Our test unit showed one weird characteristic. When printing to a PostScript

printer, the ScuzzyGraph intercepted the QuickDraw calls meant for the printer driver and rendered the print image on-screen. The Mac printed the image accurately, but the screen image was partially obscured with pieces of the print image.

A more serious problem, and one beyond Aura's control, relates to color printing. Most color printers want to see Color QuickDraw before they can print in color. The Mac SE doesn't have it, and applications will still print in black and white. The ScuzzyGraph will display color, but you may not be able to print it.

I'd like to see a monochrome version—and some protection for the power-supply connections inside the case. If you open the case while the unit is plugged in, you can get a nasty shock.

ScuzzyGraph isn't cheap. The digital-only version starts at \$995 for resolutions of up to 720 by 512 pixels. Aura's most expensive model (\$2495) supports monitors with resolutions of up to 1280 by 1024 pixels. By comparison, Orchid's ColorVue SE display board costs \$695.

The more expensive ScuzzyGraph runs faster and works with the Mac Plus. If you later want to upgrade your Mac SE to an SE/30, the ScuzzyGraph can tag along and provide color for that as well; ColorVue won't fit into your upgraded Mac.

Before investing in a ScuzzyGraph, SE owners may first want to speed up their machine's processor. Apple offers an upgrade from a Mac SE to an SE/30. Then you can choose an internal color board and get real Color QuickDraw.

Mac Plus owners who don't plan to upgrade to a faster Mac may have more reason to take a look at ScuzzyGraph II.

—Howard Eglowstein

ScuzzyGraph II

Model IIm/8a

Aura Systems, Inc.
P.O. Box 4576
Carlsbad, CA 92008
(619) 438-7730
\$1195
Inquiry 852.

Update: Plotter Redux

In our Product Focus on plotters last year ("Plotters in Perspective," December 1988), we voiced serious reservations about the overall poor performance of United Innovations' (UI) wall-mount Mural 8000 plotter. Since that time, the company has embellished its plotter line with options that encouraged us to take a second look.

UI has resolved one of the noted weaknesses, manual pen changing, with the eight-pen Auto-Select option. The \$495 add-on attaches to the side of the Mural 8000 (sizes A-D) and Mural 9000 (sizes A-E) to automate pen changes. A four-pen Auto-Select (\$395) is available for the Mural 7000 (sizes A-C). Auto-Select also includes the Sure-Flo test pad: When a new pen is selected, it draws on a scratch pad, ensuring smooth pen flow before drawing. This slows down a multicolor plot, but you can disable the feature with the flick of a DIP switch.

Another option is a pen holder that attaches to the pen arm and accepts a wide range of writing instruments, including large magic markers. This makes the Mural 8000 ideal for drawing signs.

The Mural 8000's flatbed design and its new options make it one of the most versatile large-format plotters around. It will accept any medium (including posterboard and plywood) up to a quarter of

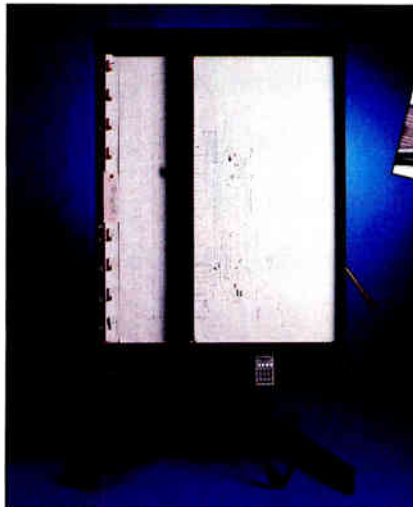

The revamped Mural 8000 plotter now offers optional automatic pen changers and new pen holders (inset).

an inch thick. Its open sides accommodate especially long media. With included software, you can complete part of your drawing, slide the media through to the next section, and then continue the plot. Similar attachments accept drafting pencils or a digitizer sight.

The plotter should appeal to those who require nonstandard media or special

writing instruments, as well as those whose plotters handle a wide range of jobs. Even with the options, the Mural 8000 is relatively inexpensive, with a base price of \$2495. A utilities disk that comes packaged with the plotters includes some useful programs for digitizing, resizing plots, and converting between the Hewlett-Packard Graphics Language and other formats.

Mural 8000 has some weaknesses; it's slow, and mounting the paper with double-sided tape is awkward. But the tradeoffs that UI has made keep the price low.—Stanford Diehl ■

Mural 8000

United Innovations
171 Interstate Dr.
West Springfield, MA 01089
(413) 733-3333
\$2495
Inquiry 855.

Born To Fly.

Introducing the new Swan 386/33.



There's nothing faster or more powerful in personal computing than a 386/33 system. And now there's no better value in this field than the Swan 386/33.

The Swan 386/33 easily manages today's most power-hungry applications such as CAD/CAM/CAE. It's blazing 33MHz speed will especially benefit multi-user and multi-tasking networks running under UNIX* and XENIX*. And because it comes in a vertical case, you can have all this power at your fingertips without taking up all your desk space.

To provide the expandability required for network file servers and multi-tasking systems, this Swan is expandable to 16MB of memory. In addition, the Swan 386/33 also offers an access socket for either the Intel™ or Weitek 3167 math coprocessor.

Like all Swan products, the 386/33 is competitively priced and backed by Swan's unsurpassed customer support services. No wonder the Swan 386/33 is the acknowledged value-leader in the field.



Swan 386/20D

"Tussey's Swan 386/20 flies."

— Computer Shopper, April 1989

Gracefully combining power and performance, this Swan has soared to the upper limits of today's technology.

\$1899

Base System with Single Floppy, No Video

386/20D Drive Options	VIDEO OPTIONS Include Monitor & Video Adapter			
	Mono	14" Flat Mono	VGA Mono	VGA Color
w/48MB (28ms) & 1:1 Interleave	\$2399	\$2448	\$2598	\$2898
w/80MB (28ms) & 1:1 Interleave	\$2749	\$2798	\$2948	\$3248
w/150MB (18ms) ESDI w/1:1 Interleave	\$3394	\$3443	\$3593	\$3893

Vertical Case Option for 386/20 w/230W power supply add \$300



The New Swan 386/33

Fast, powerful, and expandable — soar to the upper limits of today's technology with this Swan.

\$3999

Base System with Dual Floppies, No Video

386/33 Drive Options	VIDEO OPTIONS Include Monitor & Video Adapter			
	Mono	14" Flat Mono	VGA Mono	VGA Color
w/150MB (18ms) & 1:1 Interleave	\$5849	\$5898	\$6399	\$6699
w/300MB (16.5ms) Sync SCSI Interface	\$6649	\$6698	\$7199	\$7499
w/600MB (16.5ms) Sync SCSI Interface	\$7849	\$7898	\$8399	\$8699

Order Now Toll-Free
1-800-468-9044

FAX: 814-237-4450 • International: 814-234-2236

UNIX* is a registered trademark of AT&T
XENIX* is a trademark of Microsoft Corporation
Intel 387 is a registered trademark of Intel Corporation

S=BTL1

Call for additional features & specifications

- 80386-33 33/8 MHz
- Norton SI (ver 4.0) 41.8
- Landmark (ver 0.99) 58.7
- Power Meter (ver 1.3) 7.583 MIPS
- Phoenix BIOS
- 1MB of 32-Bit RAM Expandable to 16MB
- Shadow RAM for Video & BIOS
- 32K of SRAM Cache
- Intel 80387-33 & Weitek 3176 Coprocessor Socket
- 230W Power Supply

- 6 Exposed 5.25" Half Height Device Bays
- 1.2MB 5.25" & 1.44MB 3.5" Floppy Drives
- Ports: 2 Serial, 1 Parallel
- 8 Expansion Slots: 1) 32-bit, 5) 16-bit, 2) 8-bit
- Enhanced 101 Key Keyboard
- Clock Calendar w/Battery Backup
- Swan Setup & Utilities Diskette
- QA+ Diagnostic Benchmark Program
- Micronics EMS 4.0 Software
- Microsoft MS-DOS v. 4.01



Swan 386SX

"Tussey's entry comes in first for expandability and low price, and it still turns in respectable times."

— PC Week, Apr. 10, 1989

\$1399

Base System with Single Floppy, No Video

386SX	VIDEO OPTIONS Include Monitor & Video Adapter			
	Mono	14" Flat Mono	VGA Mono	VGA Color
w/32MB (40ms) & 1:1 Interleave	\$1799	\$1848	\$1998	\$2298
w/48MB (28ms) & 1:1 Interleave	\$1899	\$2048	\$2198	\$2498
w/80MB (28ms) & 1:1 Interleave	\$2249	\$2298	\$2448	\$2748
w/168MB (15ms) ESDI w/ 1:1 Interleave	\$2894	\$2943	\$3093	\$3393

Swan 286/12

"...steady and sure describes Tussey Computer Products' Swan 286/12."

— PC Magazine, Sept. 12, 1989

Reliability ... at an affordable price!

\$899

Base System with Single Floppy, No Video

286/12	VIDEO OPTIONS Include Monitor & Video Adapter			
	Mono	14" Flat Mono	EGA	VGA
w/32MB (40ms) & 1:1 Interleave	\$1299	\$1348	\$1698	\$1798
w/48MB (28ms) & 1:1 Interleave	\$1399	\$1448	\$1798	\$1898
w/80MB (28ms) & 1:1 Interleave	\$1749	\$1798	\$2148	\$2248

Swan XT10

"I've been heavily using my Swan XT10 now for almost five months and I've enjoyed every moment of it... I believe I made an intelligent choice."

— Dexter McGirt, Charleston, SC

\$549

Base System with Single Floppy, No Video

XT10	VIDEO OPTIONS Include Monitor & Video Adapter			
	Mono*	CGA	EGA	VGA
Single Floppy	\$699	\$869	\$1098	\$1198
Dual Floppies	\$779	\$949	\$1178	\$1278
*w/32MB (40ms) Hard Drive	\$979	\$1149	\$1378	\$1478

* Includes Single 360K Floppy Drive

† Upgrade from 12" to 14" Flat Screen, add \$49

Standard Features	386/33	386/20D	386SX	286/12	XT10
CPU	80386	80386	80386SX	80286	8088-1
Speed (MHz)	33/8	20/8	16/8	12.5/6.25	10/4.77
BIOS	Phoenix	Phoenix	Phoenix	Phoenix	Phoenix
Norton SI Rating v 4.0	41.8	22.0	17.6	12.3	2.1
Standard Memory	1MB	1MB	1MB	512K	640K
Shadow BIOS	Yes	384K	Yes	Yes	—
Memory Upgrades	2/4/5/8/16MB	2/4/8/10/16MB	2/3/5/6/8MB	640K/1/2/3/3MB	—
Coprocessor Support	80387 or 3167	80287 or 80387	80387SX	80287	8087
Expansion Slots: 32-bit	1	1	—	—	—
Expansion Slots: 16-bit	5	4	6	6	—
Expansion Slots: 8-bit	2	3	2	2	8
Dual HD/FD Controller	Yes	Yes	Yes	Yes	w/HD systems
5.25" Floppy Drive	Standard	Your Choice	Your Choice	Your Choice	Standard
3.5" Floppy Drive	Standard	—	—	—	Optional
Device Bays (Expansion/Internal)	6 Exp.	3 Exp./2 Int.	3 Exp./1 Int.	3 Exp./2 Int.	2 Exp./2 Int.
Serial Ports	2	2	1	1	1
Additional I/O Ports	1 Parallel	1 Parallel	1 Parallel	1 Parallel	1 Par./1 Game
Power Supply	230W	200W	200W	200W	150W
Keyboard (Track & Click or Silent)	101 Key	101 Key	101 Key	101 Key	101 Key
Additional Features	Clock Calendar w/Battery Backup and Setup/Utilities Disk				
Operating System	Included	MS-DOS & GW BASIC add \$89			

To order: No surcharge on Discover, Visa, MasterCard or AMEX. • Your credit card is not charged until your order is shipped. Shipping: 3% or \$5 minimum for UPS Ground. Call for shipping charges on Express Air, APO, FPO, AK, HI and all foreign orders. • If part of your order is backordered, the remainder will be shipped UPS Ground. • Allow 2 weeks for personal and company checks to clear. • Defective items replaced or repaired at our discretion. • PA deliveries add 6% sales tax. • Prices and terms subject to change without notice.



Open: 8a.m.-11p.m. M-F, 10a.m.-8p.m. Sat, 12p.m.-8p.m. Sun



a division of
tcp

TUSSEY COMPUTER PRODUCTS
3075 RESEARCH DRIVE • STATE COLLEGE, PA • 16801

Circle 334 on Reader Service Card

World Radio History



There's something exciting in the air.

A new value leader has emerged from the personal computer field. And that leader is Swan. Fast, powerful and expandable, Swan's computer products are outstanding performers. But performance alone isn't what makes Swan computers the value-leaders, there's also Swan's attractive pricing and impressive customer support services. Here are a few more reasons why Swan is flying rings around the competition:

- Full 1-Year Warranty
- 30-Day Satisfaction Guarantee*
- Fast, Insured Delivery
- Toll-free Technical Support
- Sorbus® On-Site Service Option

Order Now Toll-Free
1-800-468-9044

FAX: 814-237-4450 • International: 814-234-2236

S=BTL1

* Items returned must be as-new, without modification or damage. Sorry ... shipping charges and upgrade fees are not refundable. 30-Day Satisfaction Guarantee applies to Swan-brand products only.

We've gathered the best

Take your pick from a flock of other quality brand name computer products offered by Swan. When you shop Swan, you'll enjoy unbeatable prices, plus you'll get the benefit of dealing with a leader in customer satisfaction. Here are just a few reasons why:

- We won't charge your credit card until your order is shipped.
- Orders received before 4 PM EST will be shipped same day ... and each order is insured at no cost to you!
- We'll be here after the sale to help you in any way we can, to answer any questions you might have.
- Software orders over \$100 and accessories under 6 pounds will be shipped Federal Express.



PRINTERS



Panasonic

- 1180 (192 cps, 80 col, 9-pin) \$179
- 1191 (240cps, 80 col, 9-pin) \$Call
- 1124 (192cps, 80 col, 24-pin) \$Call
- 1595 (240cps, 132 col, 9-pin) \$449
- 1524 (240cps, 132 col, 24-pin) \$569
- 1624 (192cps, 132 col, 24-pin) \$Call
- 4450 (11ppm laser printer) \$1375

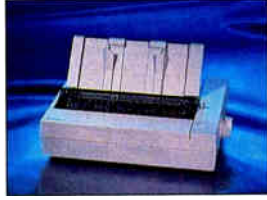

EPSON

- LX-810 (180 cps, 80 col, 9-pin) \$189
- FX-850 (264cps, 80 col, 9-pin) \$Call
- FX-1050 (264cps, 132 col, 9-pin) for
- LQ-510 (180cps, 80 col, 24-pin) Best
- LQ-850 (264cps, 80 col, 24-pin) Price
- LQ-950 (264cps, 110 col, 24-pin) on
- LQ-1050 (264cps, 132 col, 24-pin) Epson
- LQ-2550 (400cps, 132 col, 24-pin) Printers



star

- NX-1000II (180cps, 9-pin) .. \$Call
- NX-1000 Rainbow (144cps, 80 col, 9-pin) \$229
- NX-15 (120cps, 132 col, 9-pin) \$349
- NX-2400 (170cps, 80 col, 24-pin) \$Call

LASER PRINTERS



Panasonic

- KX-P4450 \$1375



- LaserJet Series II
- 8 ppm/512K \$1749
- LaserJet Series IID \$Call
- LaserJet IIP \$Call

Open: 8a.m.-11p.m. M-F, 10a.m.-8p.m. Sat, 12p.m.-8p.m. Sun



MONITORS

— TTL Monochrome —

- Magnavox 7623 Amber \$99
- Packard Bell with tilt/swivel
- Amber or Green \$99
- Samsung 14" Mono Flat \$139
- Swan Monochrome SW525 \$89

— RGB/CGA —

- Magnavox 8762 \$249
- Magnavox 8515 \$289
- Samsung SC452C \$219
- Swan RGB \$219

— EGA —

- Imtec 1453 \$349
- Magnavox 9053 \$359
- Packard Bell 1431 \$349

— Multisync —

- Imtec 1455N Multi \$439
- Mitsubishi Diamond Scan \$499
- NEC Multisync 3-D 14" \$679
- NEC Multisync 4-D/5-D \$Call
- NEC Multisync Plus \$Call
- Swan Multiscan \$429
- Sony 1304 \$699

— VGA —

- Amdek 732 \$429
- Imtec 1453 Q \$349
- Magnavox 7749 (Grey Scale) \$129
- Magnavox 9082 \$429
- NEC Multisync 2a \$Call

PC ADD ON BOARDS

- Boca
- RAM Card XT or AT \$Call
- I/O card XT or AT \$79

Micron

- RAM Card (MB-28-DH) populated w/2MB RAM \$699

TOPS

- TOPS/DOS 2.1 \$119
- Flashcard \$169
- Net Print \$119
- Teleconnector \$39



- 8087 \$84
 - 8087-1 \$159
 - 8087-2 \$119
 - 80287 \$129
 - 80287-8 \$189
 - 80287-10 \$214
 - 80387SX \$297
 - 80387-16 \$339
 - 80387-20 \$379
 - 80387-25 \$479
 - 80387-33 \$Call
 - AboveBoard Plus \$399
 - AboveBoard Plus I/O \$449
 - Connection Co-processor \$Call
 - InBoard 386/PC \$589
- Call for Daughterboard Pricing



- 120D (120 cps/9-pin) \$159
- 180D (180cps, 80 col, 9-pin) \$179

Kodak

- Diconix 150+ (180cps, 80 col) \$345
- Diconix 300 (300cps, 80 col) \$399



- Deskjet (240cps, 80 col) \$599
- Deskjet Plus (240cps, 80 col) \$Call
- Paintjet (167cps, 80 col) \$1049

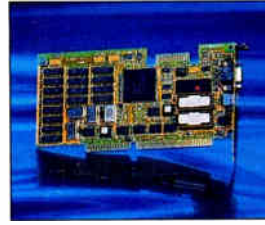

VIDEO CARDS

— EGA —

- ATI
- EGA Wonder 800+ \$199

Paradise

- Autoswitch 480 \$169

Swan

- EGA Card \$149

— VGA —

- ATI
- VGA Wonder (256K) \$299
- VGA Wonder (512K) \$359

Orchid

- Pro Designer VGA \$279
- Pro Designer VGA + \$369

Paradise

- VGA + \$219
- VGA Professional \$349
- VGA + 16 \$269

Swan

- VGA Card (8-bit) \$179
- VGA Card (16-bit) \$Call

Video 7

- VEGA VGA \$249
- Fast Write VGA \$319
- VRAM VGA \$469

MISC.

- Swan
- Switchable (Mono/CGA) \$69

TOSHIBA

LAPTOPS

- T120011B (10MHz) \$1969
 - T1600 (12MHz/20MB) \$3259
 - T3100c (12MHz/20MB) \$2749
- Call for other Toshiba models

DISKS

- | | | | |
|----------|-------|--------|---------|
| BONUS | DS/DD | 3.5" | 5.25" |
| MAXELL | DS/DD | \$1.95 | \$9.95 |
| VERBATIM | DS/DD | \$1.95 | \$9.95 |
| SONY | DS/DD | \$1.95 | \$10.95 |

Call For Pricing on Memory Chips!

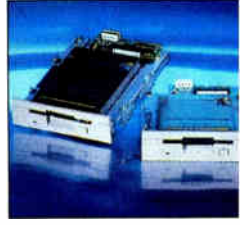

FLOPPY DRIVES

Mitsubishi

- 3.5" (720K) \$219/
- 3.5" (1.44MB) \$249/

Rotec

- 5.25" (360K) \$219/
- 5.25" (1.2MB) \$249/

Sony

- 3.5" (720K) \$219/
- 3.5" (1.44MB) \$249/

Teac

- 5.25" (360K) \$219/
- 5.25" (1.2MB) \$249/



PC HARD DRIVE



- KL320 20MB (40 ms) \$219/
- KL330 32MB (40 ms) \$249/



- 8438 30MB (68 ms) \$219/
- 3650 40MB (61 ms) \$249/
- 3053 40MB (25 ms) \$249/



- ST-225 20MB (65 ms) \$219/
- ST-238 30MB (65 ms) \$249/
- ST-125 20MB (40 ms) \$249/
- ST-151 40MB (24 ms) \$249/
- ST-157R 48MB (28 ms) \$249/
- ST-251-1 40MB (28 ms) \$249/
- ST-4096 80MB (28 ms) \$249/



- 80MB (28 ms) \$219/
 - 150MB ESDI (16.5 ms) .. \$1299/
- *Kit Price - includes cables, cont and mounting screws.

Panasonic

KX-P1124 \$Ca

- 192 cps Draft/63 cps NL
- Push/pull tractor feed
- Multiple paper paths
- Paper parking
- 6K buffer standard/32K optional

Call Today & Ask For Our Free Catalog

Order Now Toll-Free

1-800-468-9044

FAX: 814-237-4450 • International: 814-234-2236

TUSSEY COMPUTER PRODUCTS
3075 RESEARCH DRIVE • STATE COLLEGE, PA • 16801

World Radio History

S=BTL2

values under our wing.



SOFTWARE

AMERICAN	LASERGO
Design CAD 3.0/3-D \$155/\$209	GoScript/GoScript + \$125/\$239
SHTON-TATE	LOGITECH
Base III+ \$Call	Finesse \$89
Base IV \$459	LOTUS
EDFORD	Agenda \$269
Integrated Accounting \$159	123 v 2.2/3.0 \$Call
LOC PUBLISHING	Symphony \$439
Personal Lawyer \$39	MERIDIAN
opdrop \$34	Carbon Copy Plus \$112
ormfiller \$89	MICROGRAFIX
ormtool \$55	Designer \$Call
ORLAND	Draw + \$Call
Paradox 3.0 \$449	Graph + \$Call
Quattro \$Call	MICROSOFT
Turbo C 2.0 \$107	Excel \$Call
Turbo C Professional \$159	Flight Simulator 3.0 \$35
Turbo Pascal 5.5 \$99	MS-DOS & GW BASIC \$Call
Turbo Pascal Professional \$169	Quick BASIC \$67
RODERBUND	Quick C \$67
Print Shop/Companion \$34/\$37	Quick Pascal \$Call
VENTRAL POINT	Windows 286/386 \$64/\$129
Copy II PC \$27	Word 5.0 \$Call
Deluxe Option Board \$109	Works \$99
PC Tools Deluxe 5.5 \$79	PETER NORTON
COMPUTER ASSOCIATES	Norton Advanced Utilities \$87
Hypercalc 5 \$Call	QUARTERDECK
FOREL	DESQView 2.2/386 \$79/\$119
Forel Draw 1.1 \$Call	QEMM \$39
CROSS TALK	REFERENCE SOFTWARE
CrossTalk for Windows \$Call	Grammatik III \$54
PARAC SOFTWARE	SAMNA
Parac Bonus Pack 4.0 \$Call	Ami/Ami Pro \$129/\$Call
Parac Easy Accounting 4.0 \$Call	SOFTWARE PUBLISHING
Parac Easy Payroll 4.0 \$Call	First Publisher \$79
Paraducid 3-D \$69	Harvard Graphics \$Call
Call for Pricing on Tutors	PFS First Choice 3.0 \$89
DELORINA	PFS Professional Write \$135
Perform \$Call	SYMANTEC
FIFTH GENERATION	Q & A \$209
Fastback Plus \$104	Timeline 3.0 \$359
FOX	THREE D GRAPHICS
Foxbase+/386 \$199/\$299	Perspective Junior \$99
HUNK	WORD PERFECT
Highways for 123/Symphony \$89/\$89	Library \$69
Highways \$42	Word Perfect 5.0 \$219
GENERIC SOFTWARE	WORDSTAR
Generic CADD Level 3 \$169	Wordstar Professional v 5.5 \$199
QUINT	Wordstar v 5.5 Upgrade \$Call
Quicken 3.0 \$37	XEROX
	Ventura Publisher 2.0 \$Call



Swan ... for Quality, Selection and Price.

Every Swan-brand product is a solid, reliable performer that's priced to fly — and built so that it won't let you down. But we realize "value" can't be measured in terms of price and reliability alone. Quality, selection and service are important. That's why we provide a wide variety of quality products and unsurpassed customer service — now that's *real* value. And here's more:

- 30-Day satisfaction guarantee • Full one-year warranty
- Toll-free ordering & technical support • Fast, sure delivery



Swan Modems

Make the world your partner. With the Swan Modem, you'll be able to communicate with other PCs and information services around the world through your pulse or touch tone phone. You'll tap into a world of data and broaden your horizons. Every Swan Modem comes complete with communication software and full documentation.

- Hayes* compatible • Auto answer/dial
- Include PC Talk III software
- 2400 bd internal* \$99
- 1200 bd internal \$69
- 2400 bd external \$149
- 1200 bd external \$89

* includes Bit Com v 3.5 software



Swan Video Cards

Different people have different uses for their PC's ... from everyday uses like word processing and spreadsheets to today's more demanding applications, such as desktop publishing and presentation graphics. A Swan video card can help you better meet your needs today... or help you ride the wave of technology into tomorrow.

- Switchable Card** • Hercules* to CGA
- Parallel Port \$69
- EGA Card** • EGA/CGA/TTL
- 640 x 480 Resolution \$149
- VGA Card** • Register-level compatible
- 256K RAM • 17 VGA Modes
- 8-bit VGA/16-bit VGA \$179/\$Call



Swan Tape Backups

Protect that nest of important data stored on your hard drive. Swan Tape Backups store 40MB on a single tape cartridge ... reliably, conveniently and economically.

- 40MB XT or AT Internal \$299
- 40MB XT or AT External \$399

Swan Keyboards

- 101 Key Touch & Click/Silent \$79
- 84 Key Touch & Click \$69



Swan Monitors

Swan offers you the choice of either our economical TTL monochrome or the professional, high resolution multiscan monitor.

- Swan TTL Monochrome** • 12" etched anti-glare screen • 720 x 350 resolution
- Tilt/swivel base \$89
- Swan Multiscan** • 14" anti-glare screen
- Compatible with Mono, CGA, EGA, VGA
- 800 x 600 resolution • .31 dot pitch • Both Analog & digital inputs • Auto Screen sizing & centering • Tilt/Swivel base \$429



MODEMS

ATI
1400 etc Internal/External \$159/\$199
Hayes Smart Modem
200 bd Internal/External \$259/\$289
400 bd Internal/External \$Call
Practical Peripherals
400 bd Internal/External \$149/\$199
400 bd MNP Int./Ext. \$189/\$209
Swan Technologies
200 bd Internal/External \$69/\$89
400 bd Internal/External \$99/\$149



MICE

IMSI
Serial Mouse \$59
Opti Mouse w/Dr. Halo III \$72
Microsoft
Mouse \$109
Mouse with Windows \$139
Logitech
Bus Mouse (320 dpi) \$75
Serial Mouse (320 dpi) \$69
with Paint add \$10
ScanMan \$185

To order: No surcharge on Discover, Visa, MasterCard or AMEX. • Your credit card is not charged until your order is shipped. Shipping: 3% or \$5 minimum for UPS Ground. Call for shipping charges on Express Air, APO, FPO, AK, HI and all foreign orders. • If part of your order is backordered, the remainder will be shipped UPS Ground. • Allow 2 weeks for personal and company checks to clear. • ALL SALES (except Swan products) ARE FINAL. • Defective items replaced or repaired at our discretion. • PA deliveries add 6% sales tax. • Prices and terms subject to change without notice.

Order Now Toll-Free
1-800-468-9044
World Radio History



S=BT1.2



TUSSEY COMPUTER PRODUCTS
3075 RESEARCH DRIVE • STATE COLLEGE, PA • 16801

Circle 335 on Reader Service Card

Sound and Image Processing

- 243 Sounds and Images:**
Sounds
by Gene Smarte
Images
by Walt Penney
- 259 Putting DSPs to Work**
by Bobby Saffari
- 277 Beyond Pattern Recognition**
by Raymond Kurzweil
- 293 Changing Perceptions of Reality**
by Benjamin M. Dawson
- 309 Pepperoni and Paperwork**
by Ira Scherr
- 320 Words and Pictures**

From the sound-and-light spectacles in the Roman Forum to the latest Indiana Jones adventure, sounds and images just seem to go together. Sound adds emotion to simple images, and images create a frame of reference for sound.

You could argue that true art stands alone and that fine music lets your spirit soar on its own journey. Both of these statements are true, but in our normal everyday lives, those of us who can will usually choose to combine the two. How many of us choose silent movies over those with sound as a regular diet?

A while ago, I heard a radio playing some lovely harpsicord music. I went exploring. What I found surprised me. What I had heard wasn't a radio at all—it was the NeXT machine. I really couldn't tell the difference. But I found out what the difference was—a digital signal processor. The NeXT machine has a DSP built in for sound processing.

Times have changed. No more stilted mechanical-sounding output. Until recently, sound and image processing involved very different technologies. Now, DSPs have become the unifying factor between the two. Both can use DSPs to improve output quality.

The first article in this In Depth section, "Sounds and Images," is a series article that provides the "big picture" for both sound and image processing and establishes their relationship to DSPs. The first section, "Sounds" by Gene Smarte, discusses both voice recognition and music. The second part, "Images" by Walt Penney, looks at what is possible in image processing on a microcomputer.

Next, Bobby Saffari goes into more detail about DSPs in "Putting DSPs to Work." He explores floating-point application-specific-IC DSPs, what they do, how they do it, and their relationship to—and uses in—both sound and image processing.

Then, in "Beyond Pattern Recognition," Raymond Kurzweil looks at advances in voice-recognition technology. He shows how voice-to-text systems rely at least as much on knowledge engineering as they do on voice recognition.

In "Changing Perceptions of Reality," Benjamin M. Dawson examines image editing. He provides descriptions, formulas, and in some cases code fragments for various image-editing techniques.

Finally, in "Pepperoni and Paperwork," Ira Scherr ties it all together. He describes a voice-activated document-delivery system that starts with a telephone call and ends with a fax printing out on your desk. From voice recognition to document image processing, this article brings home the practical applications that are possible when you combine sound and image processing.

Few of us are likely to work on the next chapter in the *Star Wars* saga, but we can find practical uses, as well as some fun ones, for various aspects of sound and image processing. Image processing as an industry is taking off. And with DSPs coming into their own, can sound processing be far behind? The uses and combinations of the two are virtually limitless—from science fiction to business fact.

—Jane Morrill Tazelaar
 Senior Technical Editor, *In Depth*

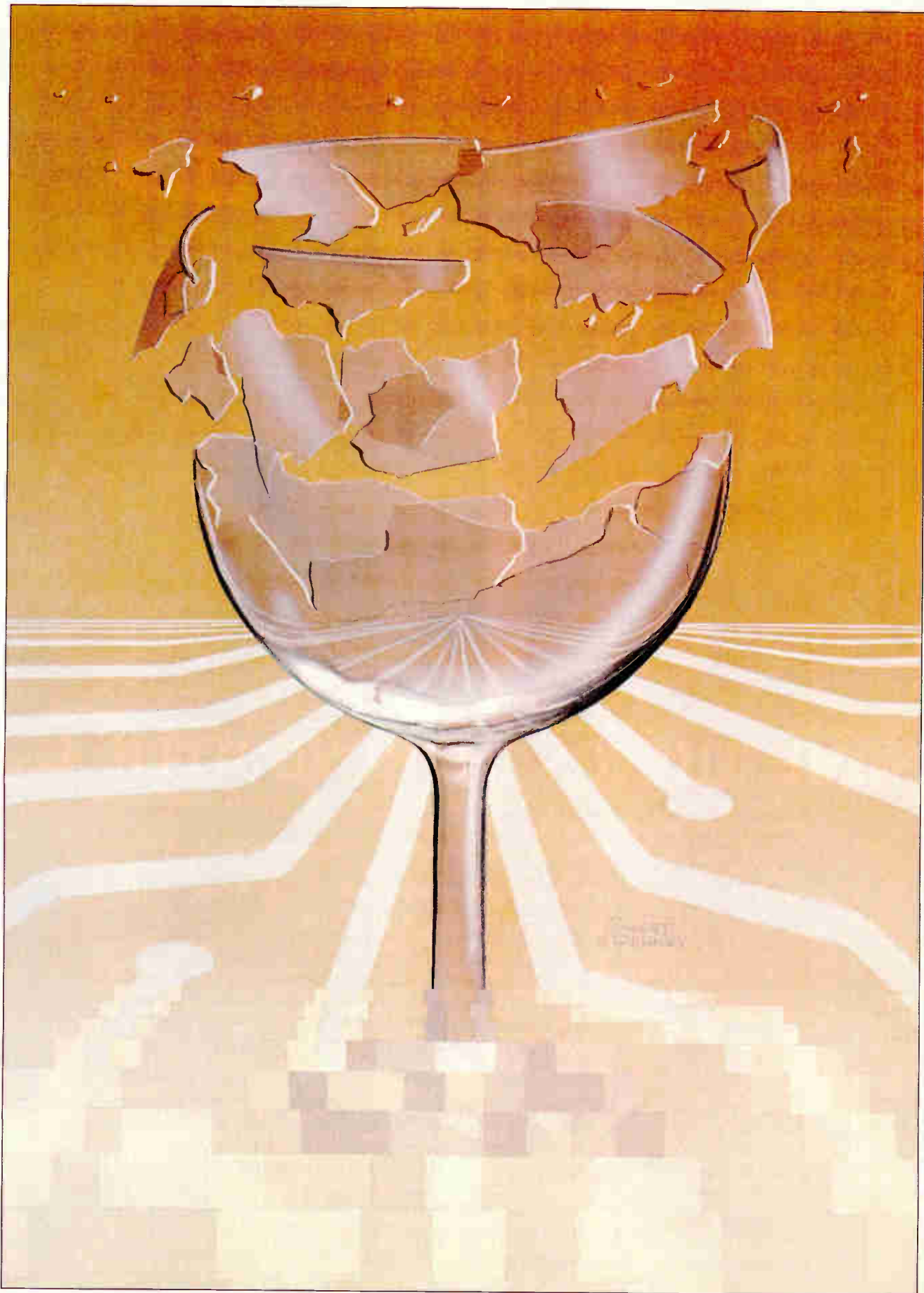



SOME THINGS IMPROVE WITH AGE

Unlike fine wine, few 4GL's improve with age. Especially when so many trendy software products have gone sour in so short a time.

Yet filePro has timeless qualities—staying power, and the kind of growth and adaptability that make it fittest to survive. filePro Plus is a complete Application Development Environment (4GL) whose pioneering efforts and refinements have stood the tests of time.

SIMPLICITY, POWER & PERFORMANCE

What's filePro's secret? filePro Plus makes Application Development easy. Mainly because filePro is easy to learn. (Ask any developer or end user who has experienced it.) A powerful editor, built-in debugger, and built-in capability to prototype screens and reports make the development cycle short. Applications are developed faster, outperforming products like Informix, Oracle, dBASE III & IV, Advanced Revelation and FoxBASE Plus.

FILEPRO'S 4 "P's"—POWER, PERFORMANCE, PORTABILITY, PRODUCTIVITY

Our customers were the first to benefit from portability. (Actually, filePro is portable between DOS, OS/2, Networks, Xenix, Unix, AIX, Ultrix, HP-UX, SUN OS and DEC VMS.) They realized that there is no need to redevelop or redesign applications. That files and applications are so easily transferred. And finally, that filePro saves on two of their most valuable resources—time and money.

filePro Plus. The Timeless Investment.



The Small Computer Company, Inc. 41 Saw Mill River Rd., Hawthorne, NY 10532 (914) 769-3160 • 800-847-4740

filePro is a registered trademark of the Small Computer Company, Inc. Informix, Oracle, dBASE III & IV, Advanced Revelation, FoxBASE Plus, DOS, OS/2, Networks, Xenix, Unix, AIX, Ultrix, HP-UX, SUN OS and DEC/VMS are trademarks of their respective manufacturers.

Circle 315 on Reader Service Card (DEALERS: 316)

World Radio History

Sounds and Images

*From music to medicine, from voice to video,
sound and image processing are now real on microcomputers*

The elusive dream of AI, something that has yet to materialize in a substantial form, is an ongoing quest for both software and hardware designers. But some of our five primary senses have been replicated with mixed results. For some specialized tasks, mechanized sight, hearing, and speech have emerged at levels that are competitive with, and sometimes beyond, those of flesh and blood. For most other kinds of tasks, however, these computer-based "senses" are still woefully inadequate.

Computer-based image enhancement and manipulation are commonplace, enabling us to "see" and record things impossible to see with our eyes. We can look across a galaxy with the aid of charge-coupled devices or electronically delve into the human body via computer-aided tomography. Yet a computer-based machine can have trouble picking out a monkey wrench on a workbench if the wrench's shape differs slightly from that of the one used to train the system.

Computer-based sound processing ranges from automating repetitive messages to giving voices to the verbally disabled. Symphony orchestras can now re-

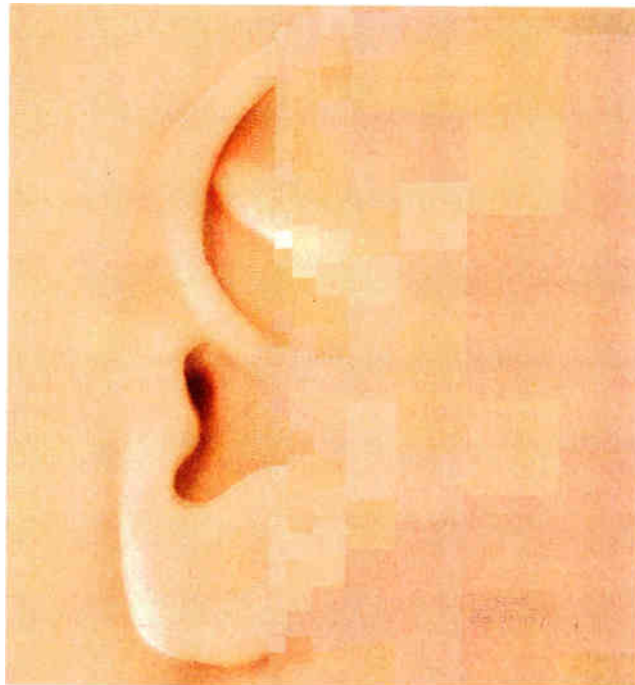

side on silicon chips. Electronic music capabilities have opened doors so that nearly anyone with an interest in music can become more deeply involved in its creation and production than ever before.

Voyager's August flyby of Neptune yielded megabyte after megabyte of digitized photo data. Through noise-canceling techniques, the addition of false color, and other enhancements, intimate

details of Neptune began to emerge. While the computers used at the Jet Propulsion Laboratory generally are not what most of us have on our desks now, a similar degree of image-processing power awaits us in the near future.

A more down-to-earth example of image processing in everyday activities is shown in a legal case involving a disputed claim as to the safety of a rifle's firing mechanism. Evidence submitted included a carefully crafted, precisely scaled, videotape version of the rifle's firing mechanism in action. The mechanism in question had tolerances in the range of thousandths of an inch, and, hence, the CAD-constructed video presentation had to maintain these tolerances as the operating image was enlarged to show details. The court found that

this sort of presentation provided a way of displaying the operation of an intricate mechanism to a nonexpert jury while still satisfying the expert witnesses.

Digital Signal Processing

A very important trend in the manipulation of image and sound information is the emergence of digital signal processor

continued

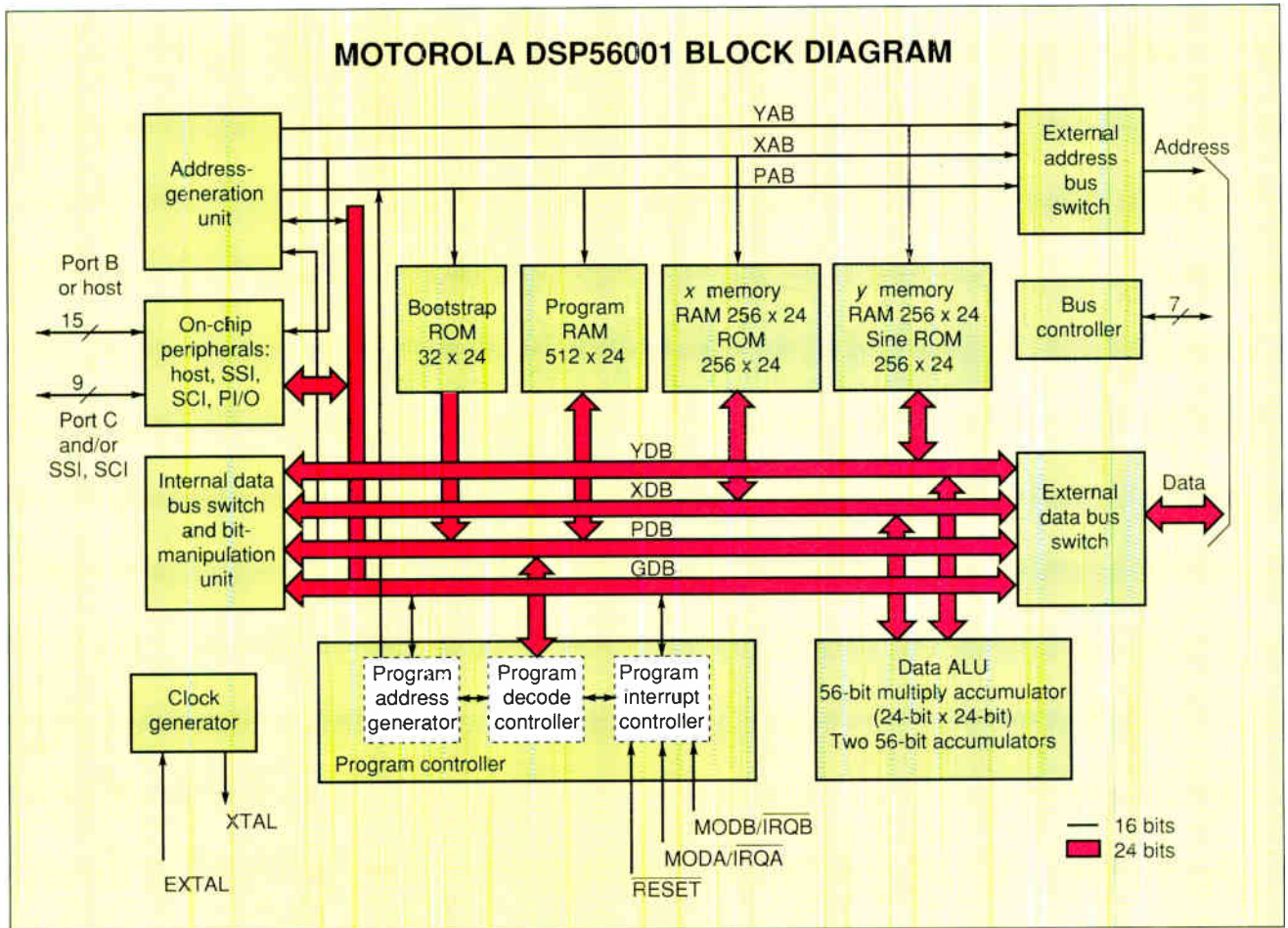

Figure 1: This digital signal processor chip uses a 24-bit data path and operates at 20 MHz to provide 10-million-instruction-per-second performance. (Courtesy of Motorola, Inc.)

(DSP) chips from such companies as AT&T, Fujitsu Microelectronics, Motorola, Texas Instruments, and NEC. You can think of them as siblings of the older and more specialized math coprocessor chips that are becoming more and more commonplace.

Now, for example, instead of off-loading only the math-related computation-intensive parts of a program, you can call on a DSP to massage data while the host processor executes other less-specialized tasks. Companies use DSPs for projects such as real-time data filtering, speech synthesis and voice recognition, and image and graphics processing. The NeXT computer includes an on-board DSP; this might be the beginning of a trend toward flexible and powerful on-board signal processing.

While many differences exist among the various manufacturers' DSPs, more characteristics are common than different. For example, in addition to some

sort of on-board arithmetic processing, they all contain some internal processor control and an interface to the host. Most DSPs have a full-blown instruction set with lots of complicated math and usually some functions unique to each chip. Some have C compilers.

As an example, take a look at a block diagram of Motorola's DSP56001 chip, shown in figure 1. Motorola specifies this 88-pin high-speed CMOS device as a

A DSP
massages data while the
host processor executes
less-specialized tasks.

"56-bit general-purpose digital signal processor." Running at 20 MHz, it's capable of operating at over 10 million instructions per second with 24-bit data. Main sections of the chip are the program controller, data ALU, x and y memories, and interface connections. Its dual-memory configuration simplifies addressing x and y data for graphics, data and coefficients for transformations and filtering, and real and imaginary numbers for arithmetic functions.

Needless to say, this chip is powerful. Motorola provides two examples: It can do real-time stereo, 10 bands per channel (20 bands total), graphic equalization processing 88,200 16-bit samples per second via port C; and in about 3.5 milliseconds, it can do a 1024-point complex fast Fourier transform. Many approaches are possible with these chips. Some companies use a host processor just to interface with the user while the DSP crunches data. Others use the DSPs as

preprocessors, passing filtered data on to the host processor and its applications software.

From Analog to Digital

Most musical sounds, voices, film, and video camera outputs occur in analog forms. But we need to get them into digital forms so we can turn the DSPs loose on them. Once the DSPs are finished, we must then transform these digital forms back to their analog representations for the sake of our ears and eyes. This process of converting data forms enables us to use DSPs, compact disks (CDs), and other digital schemes difficult or impossible in the analog world.

Fundamentally, when we convert an analog signal to a digital one, we sample, as often and with as much precision as possible, the signal in question. Let's take an audio waveform as an example. Figure 2a shows an analog waveform, figure 2b shows the waveform's amplitudes being measured at discrete intervals, and figure 2c shows the resultant values stored as digital "samples" of the original. If the sampling is too coarse (i.e., too infrequent) or if the amplitude sensitivity is not available in sufficiently small gradations, the digital representation of the waveform will suffer.

Nyquist's theorem states that sampling must occur at twice the frequency of the highest waveform present to maintain desirable fidelity. The typical CD takes samples using 16-bit resolution at 44.1 kHz, which is more than twice the upper limit of human hearing.

—Gene Smarte
Special Projects Editor

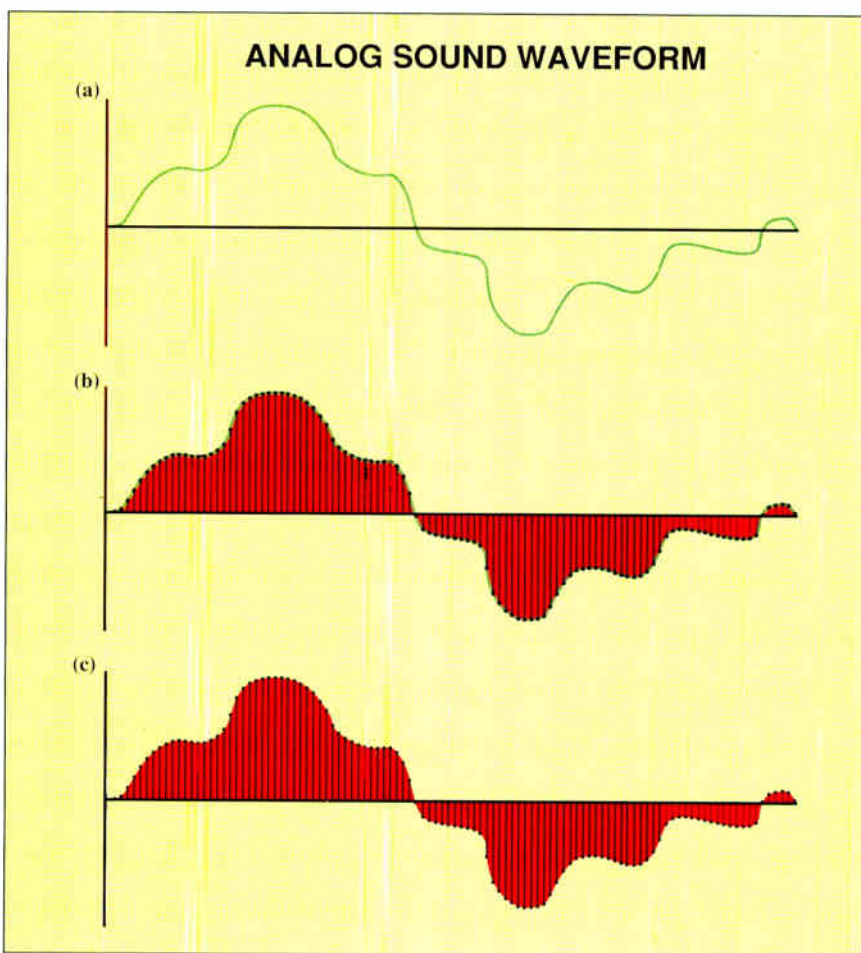

Figure 2: (a) Original sample waveform; (b) waveform with lines indicating samples taken at specific times and at specific amplitudes; (c) waveform reconstructed using digital samples from (b). How often and precisely the samples are taken affects waveform fidelity.

Sounds

Be it voice recognition or music synthesis, sound processing has joined the ranks of microcomputer applications

Gene Smarte

Whether it is produced by a violin, an electronic keyboard, a human voice, a rocket motor, or a tree falling in the woods, sound for us is something we hear. For this discussion, let's define it as the transmission of mechani-

cal energy through the air to our ears via vibrating waves of air. The human ear can usually detect frequencies in the 20- to 20,000-Hz (cycles per second) range.

Most sounds that we hear consist of some fundamental frequency, along with harmonics (multiples of the funda-

mental frequency) that give that sound its identifiable characteristics. If you've ever listened to the pure sound of a sine wave from an audio oscillator (see figure 1a), then you have a good idea of what tone without harmonics sounds like. It's

continued

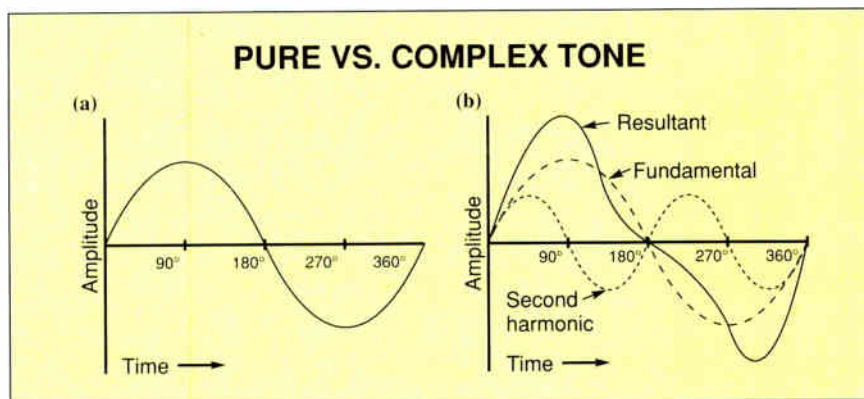

Figure 1: (a) A pure sine-wave tone. This is a graphical representation of the sound produced by an audio oscillator. (b) A complex waveform is more common and includes the harmonics that give a sound its distinctive characteristics.

primarily harmonics that make a flute sound different from a violin.

But the "pure" sound of a sine wave is rare. Much more often, sound is the result of many different waveforms in combination. The simple example in figure 1b shows a fundamental tone, its second harmonic (twice the fundamental), and the resultant waveform that we hear.

Most sound is much more complex, with many harmonics, subharmonics, and noise, compounded by attack, sustain, and decay curves. For an example, compare the start, middle, and end of a certain note on a violin with the sound produced by a xylophone sounding the same note.

For human voices, our vibrating vocal cords produce the primary sounds, excited by air driven past them. The sizes, shapes, and consistencies of our bodies, especially in chest, neck, and head, help make voices unique by reinforcing some frequencies and diminishing others. Add the manipulation of the throat, tongue, uvula, and cheeks, and there is little chance for two voices to be identical.

It's impossible to cover all the subtleties of sound in this article. But it's important to realize that sound processing can be very complicated. Imagine the tonal complexity of a single musical instrument—a violin, for example. Its fundamental sound, created by dragging many bow hairs across one violin string, is in itself complex. Add to that the resonances of the wood, the air within the violin, and the pressure that the violinist exerts.

Waveform analysis of the resultant tone would show a complex makeup. And each violin (or trumpet, or saxophone) is unique. Now, combine all the instruments of a symphony orchestra with the resonances of an auditorium. A

detailed analysis of the sound would be quite an undertaking, yet our human ears can usually pick out and follow specific sections and sometimes even individual instruments.

Voice

Years ago, companies in the voice-and-computer business used to declare regularly how we'd soon have voice-activated systems on every desk. But, like fingerprints, human voices are as individual as the bodies in which they reside, and the all-encompassing voice-actuated systems haven't kept up with the promises. The computing power needed to produce these systems is just starting to arrive. In the meantime, we'll be seeing more specialized systems for narrower applications.

Current voice-recognition experimentation encompasses four areas: speaker dependence versus speaker independence, and continuous speech versus discrete speech. Speaker dependence usually confines a system to use by one person at a time. The system is trained to respond to a single person's voice characteristics. Naturally, this limits the general-purpose nature of a system, but it can be perfectly acceptable in many situations. Speaker-independent systems are much more complicated because you need considerably more analysis of the spoken word to identify a word from a variety of users' voices.

Discrete speech (i.e., words spoken with definite pauses between each one) makes the computer's job easier but burdens the speaker. Continuous speech, like that used in everyday conversation, fits in with how humans interact but plays havoc with the computer system trying to sort out the words.

In a panel discussion at SpeechTech

'89 last May in New York, Ray Kurzweil of Kurzweil Applied Intelligence (Waltham, MA) said that for his company, true speaker-independent systems might be just around the corner. Kurzweil claimed that the company's prototype systems worked beyond expectations and, while not as good as the best "trainer" systems, were better than the worst trainer systems. Kurzweil also said that processing power in the hundreds or possibly thousands of millions of instructions per second is needed to achieve continuous speech recognition. Panelist Jim Baker of Dragon Systems (Newton, MA) agreed that a tenfold increase in computing power is required for continuous speech. As you might expect, speaker-independent, continuous-speech recognition is the pot of gold at the end of the voice rainbow. And right now, the technology is just not here.

But systems with 80386s (and, shortly, 80486s) along with lots of memory, digital signal processor (DSP) boards, and experimentation with neural networks are bringing voice-recognition goals closer. Dragon Systems' speaker-independent DragonDictate includes 16,000 words and can take another 16,000. This \$9000 discrete-speech system includes a speech board, software, a microphone, an on-line dictionary, and documentation. System requirements are a 20- to 25-MHz AT-compatible computer, 0.5 to 1 megabyte of expanded RAM, 5 or more megabytes of extended memory, and Quarterdeck's QEMM-386 memory management software.

For continuous-speech systems, limited vocabulary approaches are more common. For example, a very popular niche application is digit recognition, because about 35 percent of American households still have rotary phones. Voice Processing Corp. (Cambridge, MA) offers an 80386-based AT-bus board, a Texas Instruments TMS320C25 DSP, and 1 megabyte of RAM for \$5500. The company says that the system will have the ability to recognize "yes," "no," and the numbers 0 through 9 over a telephone line.

Future Speak

Alex Rudnicki, a research associate at Carnegie Mellon University's Speech Group (Pittsburgh, PA) confirmed that processing power is a big factor. Currently, researchers at Carnegie Mellon are using the NeXT Computer and Sun and Apollo workstations as they work toward a speaker-independent, continuous-speech system that will enable near-normal speech interaction with a com-

puter. The problem to be solved will become the user's focus rather than the interface.

While Rudnicky believes that a version of Star Trek-type voice communication with a computer is three to five years away, the researchers have made progress. They have a spreadsheet application in which any user can use continuous speech rather than a keyboard or mouse. For example, instead of typing in an equation, you would say, "Let cell c1 equal cell a2 plus cell b3."

Music

Starting with the first Apple computers' squeaks and squawks, we've seen an evolution of sound capability through the Atari, Amiga, IBM PC, Mac II, and

A version of Star Trek-type voice communication with a computer may be three to five years away.

other systems. Coupled with the emergence and public acceptance of the compact disk (CD) standard for sound sampling and reproduction, we can now do more and more sound manipulation with personal computers.

The methodology of producing electronic music has changed a lot over the years. Synthetic music started with analog systems, using oscillators and modifiers cascaded to approximate the sounds of genuine instruments. Further experimentation yielded the "additive" approach: Many discrete oscillators generate harmonic frequencies separately, and then these outputs are added together to greatly improve the realism of the synthesized sound. While more accurate, additive synthesis has the disadvantages of being slow because of all the computation and control circuitry required, and more costly as well.

A whole new approach surfaced when an FM technique invented by John Chowning of Stanford University used one oscillator modulating another to produce realistic sound quality with less work. This FM technique became popular and attractive to synthesizer manufac-

turers looking to reduce complexity and increase performance. Other proprietary approaches, as well as combinations and variations on tried-and-true techniques, also exist.

MIDI

One of the most powerful and exciting things to develop in the music world during the last few years is MIDI. This standard for hardware and software musical information interchange was originally adopted by the electronic music industry in 1983 and has undergone several enhancements as the users and available equipment have become more sophisticated. Basically, it enables many different brands and types of music-related equipment to communicate effectively, much as telecommunications protocols facilitate networking.

MIDI-equipped keyboards, drum synthesizers, personal computers with MIDI add-in boards, recording equipment, and composition and sequencing software share digital data that specifies timing, instrument type, note (frequency), expression, and other related information at 31,250 bps via a common cabling system.

You can also set up a master-to-slave relationship among equipment so you can play, for example, a saxophone note on one machine and have another machine duplicate the note in, for instance, a violin sound. MIDI controllers for guitars and wind instruments are now available, enabling artists in one area to transpose some of their skills and creativity to other "foreign" instruments, with mixed success.

Tom Beckman, president of Roland-Corp (Los Angeles, CA; a company that manufactures electronic music products), said that although there are several commercial DSPs designed for sound manipulation, most electronic-instrument makers use proprietary chips because each company has some variation or specialty that it wishes to herald. Manufacturers often use different techniques across their lines of products to adjust the cost-to-performance equations, using lower fidelity, less complicated synthesized sounds in less expensive equipment, and sampling sounds for their top-of-the-line products as faithfully as possible, under conditions that are as ideal as possible.

At first glance, you might assume that sampling and digitizing a bona fide instrument such as a Steinway grand piano for use in electronic keyboards can't be improved upon. After all, sampling and

continued

ZENITH TURBO SPORT 386 PORTABLE LAPTOP COMPUTER



- 80386 32-bit processor, 12/6 MHz (switchable).
- MB (28rms) hard drive.
- One 3.5" 1.4 MB floppy disk drive.
- 2 MB RAM. • 100% IBM compatible.
- "Page-White" fluorescent backlit LCD display, 10.5" viewing area. • MS-DOS 3.21 included.
- Supports: MS OS/2 version 1.0, Xenix, and also Microsoft Windows/386 environments.
- Zero wait state
- Socket for 80387 numeric co-processor.
- Internal Hayes 2400 baud modem.
- Serial and parallel printer ports.
- Resolution: 640 x 400 pixels.
- 79-key full function detachable keyboard.
- Real time clock and calendar. • AC adapter
- "Fast" charge NiCad battery pack included
- Dim.: 13.25"W x 14.75"D x 4.75"H.
- Weight: 14.7 lbs.
- **One Year Warranty!**

FACTORY NEW! FACTORY PERFECT!

Due to a special arrangement, we were able to obtain a large inventory of these portable computers. As a result, we can now offer them to you at **HUGE SAVINGS!**

Manufacturer's
Suggested Retail
\$8,499.00

DAMARK PRICE:
\$2999

Item No. B-1498-128686
Insured Ship/Hand.: \$19.00

**FOR FASTEST
SERVICE CALL
TOLL FREE
1-800-729-9000**



FEDERAL EXPRESS RUSH DELIVERIES ONLY
\$6.95 plus normal S/H. Ask an operator to "SHIP IT FED EX® Delivery Service!"

DAMARK INTERNATIONAL, INC.
6707 Shingle Creek Parkway, Minneapolis, MN 55430
Customer Service • 612-566-4940

Please rush me: Zenith Laptop
Computer(s) @ \$2999 each, plus \$19.00
s/h each. MN res. add 6% sales tax.

Name _____
Address _____
City, State, Zip _____
 Check/MO VISA MasterCard Discover
Card No _____
Exp. Date _____ Ph. # () _____
Signature _____

Item No. B-1498-128686

playing back at a CD rate can yield excellent fidelity.

The problem is that when the Steinway sound is sampled, however faithfully, it is sampled under specific conditions. The human pianist strikes a key at a certain speed and with a certain velocity. That specific piano under those specific conditions is recorded and appears whenever the electronic Steinway is played. The electronic piano loses much of the mechanical piano's expression capability despite the keyboard sophistication and software of some synthesizers that let you manipulate the sampled sounds.

Beckman concluded that the future of electronic music holds a great deal of promise. Roland is experimenting with voice recognition for possible use by musicians as they perform. Instead of typing commands, flipping switches, or swap-

ping disks, a spoken command would initiate a predetermined series of events to prepare the electronics for the next setup.

One problem does come to mind: Suppose the performer's command word is contained in lyrics to a song. The first time the word is sung, the bank of electronics would switch to an entirely new setup with disastrous results. The old adage of choosing your words carefully would have special meaning here.

BIBLIOGRAPHY

Gordon, Roderick D. *The World of Musical Sound*. Dubuque, IA: Kendall/Hunt Publishing Company, 1979.

Mathews, Max V., and John R. Pierce. "The Computer as a Musical Instrument." *Scientific American*, February 1987.

Moog, Robert A. "Digital Music Synthesis." *BYTE*, June 1986.

Motorola, Inc. "56-Bit General Purpose Digital Signal Processor." *Motorola Semiconductor Technical Data*, 1988.

Powell, Brent. "Image Processing on Target." *MicroCAD News*, September 1989.

Reinhardt, Andrew. "Voice Recognition Holds Promise—Someday." *BYTE-WEEK*, May 8, 1989.

Thompson, Tom, and Nick Baran. "The NeXT Computer." *BYTE*, November 1988.

Westfall, Lachlan. "MIDI Reaches Adolescence." *Electronic Musician*, May 1988.

Gene Smarte is special projects editor for BYTE. You can reach him on BIX as "gsmarte."

Images

Microprocessor-based image processing reduces system cost, but how do you improve performance?

Walt Penney

Digital image processing concerns the input, enhancement, statistical analysis, and output of gray-scale and color-image data. Such data is generated by the sensing of a real-world object, whether it be a scanned image of an x-ray or an image of Neptune transmitted by the Voyager satellite. In a typical application, the objects of images actually exist; the sensing of the image object creates the image data. (For an example of the difference image processing can make in an image, see photo 1.)

Images are typically two-dimensional representations of objects—essentially a digital photograph. (There are imaging applications, such as volumetric reconstruction of magnetic resonance imaging [MRI] data, where image data is three-dimensional, but you can consider a two-dimensional image to be a cut or slice across such an image.)

Image-processing functions operate on the individual pixels (or data elements) of the image data array. In contrast, in the field of rendering as applied

to CAD, mechanical engineering, and other applications, a set of drawing commands and attributes generates the image data. In other words, digital imaging functions can operate directly on raster image data, while CAD or draw-type functions render a synthetic raster image from an image description.

Unique Characteristics

Digital images tend to be very large. Unlike CAD drawings or desktop-publishing pages, where data can be represented as a display list, as a metafile, or in a page-description language, images can only be described by their pixel data. At 8 bits per pixel (256 shades of gray—a standard pixel resolution), a 1024-by-1024-pixel image takes 1 megabyte of storage. A true color image (24 bits per pixel—8 bits each of red, green, and blue) of the same size requires 3 megabytes of storage.

One key to improving image-processing performance is the availability of high-bandwidth pathways to move image data between processing components. In

a typical scenario, image data resident in a frame buffer is moved into host memory for processing and then moved back into the frame buffer for display. The speed of this transfer may have a greater effect on perceived operational performance than on the actual speed of the imaging operation itself.

Image-processing functions tend to fall into two categories: *point* and *neighborhood* operations. Point operators perform on individual image-pixel data, while neighborhood operators work on connected groups of pixels. In either case, applying an operation to an image or a region of interest of an image involves executing the same function repeatedly for each pixel involved.

This type of processing lends itself well to three different approaches for improving performance. First, optimizing the lowest-level processing routines, which are called repeatedly on a pixel-by-pixel basis, will significantly boost processing speed. Second, special-purpose accelerators that perform a few

continued

Out of the World Performance Down to the Earth Price

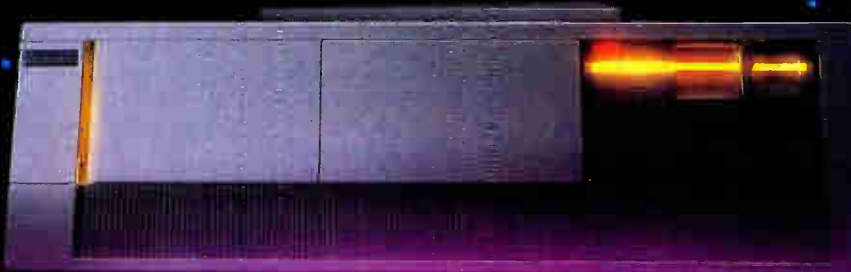

Sky-high benchmarks but Ground-level prices come from Eltech's firm commitment to manufacture high-quality, cost-competitive computer systems. Since 1985, we've been providing affordable XTs, 286s, and 386s as well as the high-level technical support you've come to expect. Plus, our performance has caught the eye of MIPS and InfoWorld reviewers.

The Eltech Model 9970/9870...one small step for your budget, one giant leap in technology.



Eltech Model 9970.....\$5485
33MHz 386 with 64K SRAM write back Cache (Optional 256K Cache available), comes with 4MB expandable to 8MB (16MB with 32-bit memory board), 150MB 16ms EDSI drive, VGA Adapter with 14" Multi-frequency Monitor, Support 80387 / Weitek 3167, 8.3 MIPS Performance Rating.

Eltech Model 9870.....\$4365
25MHz 386 System same features as Model 9970, 6.2 MIPS Performance Rating, FCC class B Approved.

Eltech Model 2160.....\$2250
16MHz 386SX zero wait state with 1MB on board expandable to 8MB, support 80387SX Math Coprocessor, 40MB 28ms Hard Disk, VGA Adapter with 14" Multi-frequency Monitor, FCC class B Approved

ALL SYSTEM INCLUDE INTEL NEXT DAY ON-SITE SERVICE, Microsoft DOS 4.01 and two serial and one parallel as standard.

**Welcome for VAR
Dealers Quantity Discount Available**

**Sales: (408) 942-0990
(408) 945-6383**

Tech Support: (408) 942-1067
Canadian Office: (604) 275-1119
(Topower International Systems)



ELTECH RESEARCH INC.

1725 McCandless Drive, Milpitas, CA 95035

Eltech Research Inc. Topower, VGA, MIPS, InfoWorld, XT, Weitek, Microsoft and DOS are registered trademarks of their respective companies. Photo's courteous of RIX Softworks, Inc. Irvine, CA 714-476-8266 ELT AD1 V1.0 10/89

Circle 118 on Reader Service Card

functions very fast can generate near-real-time performance. And third, parallel-processing techniques, where multiple processors act independently but in parallel on strips of image data, work well for imaging functions. (Various hardware possibilities for improving performance are discussed in the text box "Hardware Solutions" on page 252.)

Input, Process, Output

The input phase consists of bringing image data into the image-processing system. Input sources include video digitization, an optical scanner, other digital-sensor output (such as LANDSAT data), the output of an image rendering, or image data residing in a file. You can also use nonimage data (such as object attributes) as inputs into the system to identify objects within an image through pattern matching.

The processing phase assumes that image data resides within a frame buffer. A frame buffer is typically coupled with a video display processor, but you can also have a virtual frame buffer, which exists in memory independently of a display. The virtual concept becomes



Photo 1: Improvements wrought by image processing. Left: An original image of the moon at 512-by-480-pixel (8 bits per pixel) resolution, shot through a telescope. Right: The result of processing the image by first performing a histogram equalization, remapping the equalized data to frame-buffer memory through the generated lookup table, and performing a 3-by-3-pixel high-pass convolution on the entire image.

very important when managing images larger than standard displays. (Various software possibilities for improving performance are discussed in the text box "Software Solutions" on page 254.)

The output of an image-processing

function can be the image data itself. The output can be solely the display of the image, saving the image data to a file, or generating a hard copy of the image using a printer or film recorder.

continued

"What's your Problem?!!"

Find Out Quickly & Easily with Check✓It® PC Diagnostic Software from TouchStone

You've spent hundreds of dollars on the latest PC equipment, installed the best software, learned to tell the difference between your modem and your mouse... then something goes wrong. And your local dealer can't help you unless you pack up your system and take it down to the shop.

You may waste a lot of time and money before you find out if your PC even NEEDS repair. If any of this sounds familiar, you need Check✓It from TouchStone Software Corporation.

Check✓It will run complete diagnostic tests on your PC's main system board, memory, video subsystem, hard and floppy disks, serial/parallel ports, keyboard, and other components. Check✓It will also tell you exactly what's installed on your PC, and rate its performance in actual throughput. And Check✓It's diagnostics are so thorough, when it finds a memory error it will show you which RAM chip needs to be replaced!

But don't take our word for it, people across the country are telling each other about Check✓It...

"Check✓It is no simplistic, once-over-lightly piece of software... high marks for its performance and capabilities." — Atlantic Tech

"TouchStone Software's computer cavalry rides to your rescue in the form of Check✓It... an easy-to-use, menu-driven program." — PC Magazine.

Call TODAY for information: (800) 531-0450 or (213) 598-7746

TouchStone
Software Corporation

909 Electric Avenue, Seal Beach, CA 90740

Check✓It is a registered trademark of TouchStone Software Corporation. All other trademarks are of their respective manufacturers.

Call me I'm interested: circle 368
Send literature: circle 369

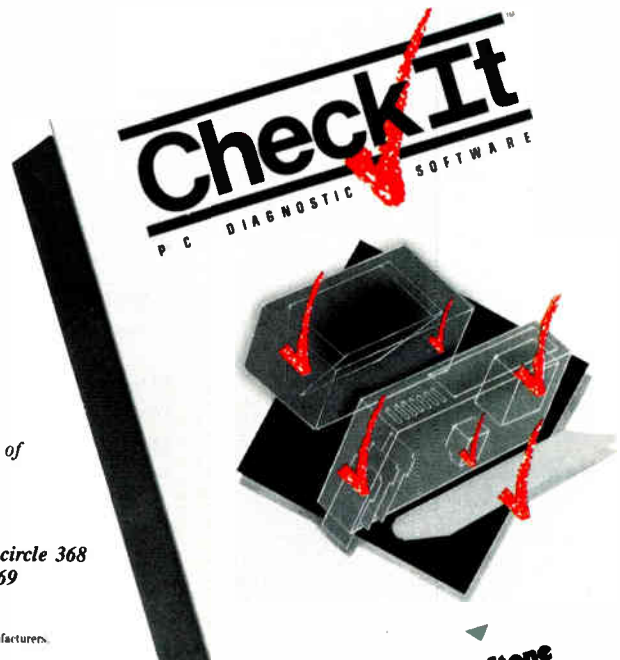

REMOVABLE. ERASABLE. OPTICAL. REMARKABLE!

REO-650 single-drive system

\$4,995

REO-1300 dual-drive system

\$9,990

650/600 Meg optical cartridges:

\$250 each

Interface kits for Macintosh.

Sun. HP. IBM-AT, XT, PS/2

and compatibles:

\$995 each

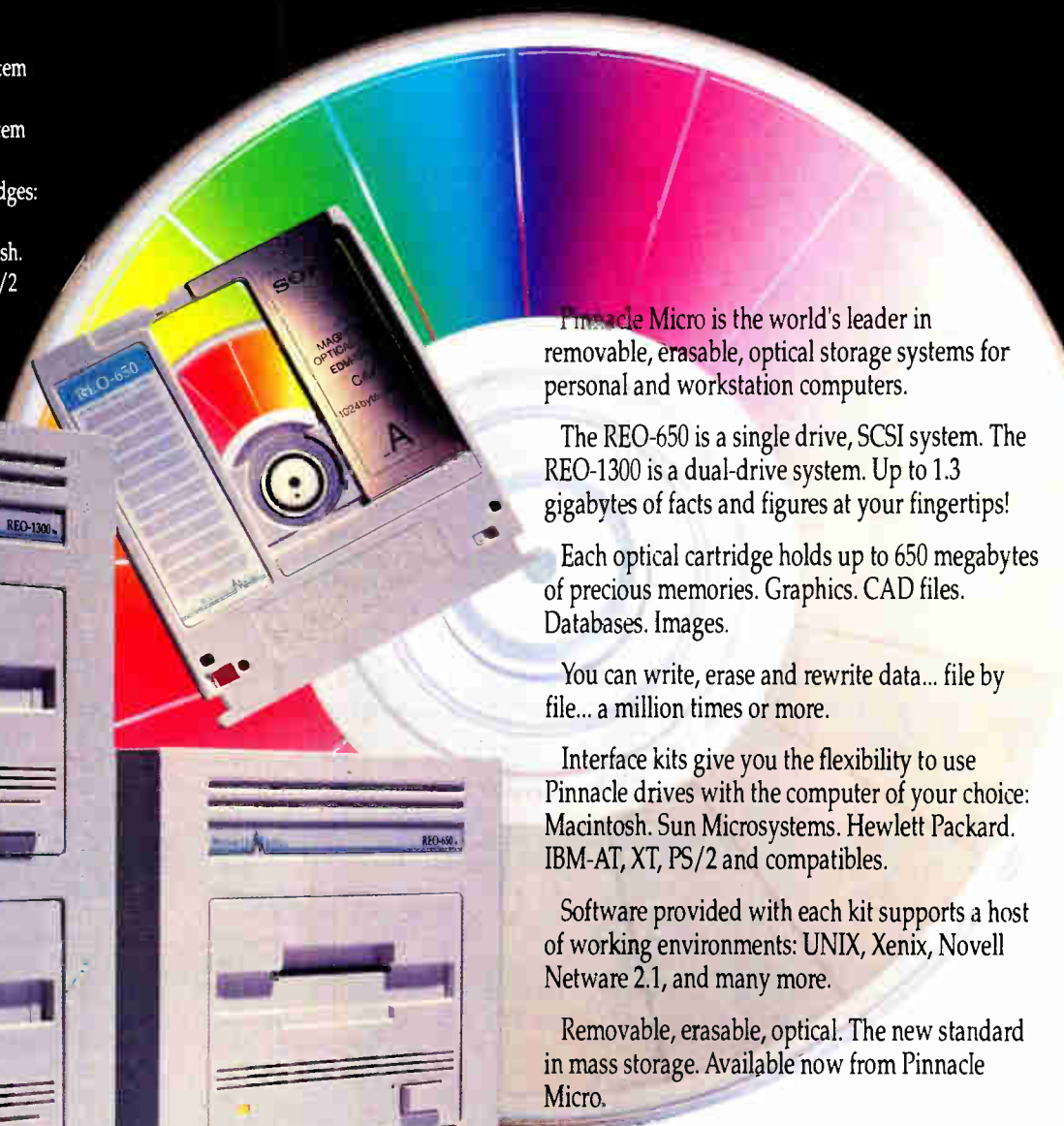

Pinnacle Micro is the world's leader in removable, erasable, optical storage systems for personal and workstation computers.

The REO-650 is a single drive, SCSI system. The REO-1300 is a dual-drive system. Up to 1.3 gigabytes of facts and figures at your fingertips!

Each optical cartridge holds up to 650 megabytes of precious memories. Graphics. CAD files. Databases. Images.

You can write, erase and rewrite data... file by file... a million times or more.

Interface kits give you the flexibility to use Pinnacle drives with the computer of your choice: Macintosh. Sun Microsystems. Hewlett Packard. IBM-AT, XT, PS/2 and compatibles.

Software provided with each kit supports a host of working environments: UNIX, Xenix, Novell Netware 2.1, and many more.

Removable, erasable, optical. The new standard in mass storage. Available now from Pinnacle Micro.

Call today for the location of your sales representative or authorized dealer.

 (800) 553-7070

PINNACLE MICRO

THE ERASABLE OPTICAL STORAGE COMPANY™

Trademark owners: REO-650, REO-1300 and Pinnacle Micro of Pinnacle Micro, Inc. Sun of Sun Microsystems. HP of Hewlett Packard. AT, Xenix, IBM, PS/2 of International Business Machines Corporation. Netware of Novell. Macintosh of Apple Computer, Inc.

15265 Alton Parkway • Irvine, CA 92718 • In CA (714) 727-3300 • FAX (714) 727-1913

Circle 253 on Reader Service Card (DEALERS: 254)

World Radio History

Hardware Solutions

Host CPU

The simplest approach to image processing is one in which the host CPU performs all the imaging functions. You can use the standard system video display memory or a secondary display adapter as the imaging frame buffer.

In a single-tasking environment such as DOS, system performance is determined solely by CPU performance, bus bandwidth, and frame-buffer interface. Under a multitasking operating system such as Unix, task loading and available system memory also affect performance.

Historically, this approach has offered minimally acceptable performance at the lowest cost. However, with 80386- and RISC-based workstations and buses capable of running at 33 MHz, this solution is more viable.

Application Accelerators

Application accelerators can speed up many different processing tasks, including image processing. The accelerator is usually an add-in board that provides hardware assistance for certain functions. Accelerators typically employ one of two approaches: dedicated logic or general purpose.

The dedicated-logic approach involves placing application-specific ICs, digital signal processors (DSPs), proprietary logic, or some combination of technology on the accelerator board. The board is capable of executing a limited set of functions that cannot be modified or expanded without changing the hardware. Dedicated-logic accelerator boards that use off-the-shelf chips cost around \$500; more sophisticated accelerators can range from \$5000 to \$12,000.

Dedicated accelerators generally process only regions of interest that are rectangular. They may even restrict the granularity of a rectangular ROI to 16-pixel horizontal boundaries. The applications software must decide whether the accelerator can process the source ROI and, if not, perform the function using the host CPU, resulting in tremendous performance differences between processing rectangular and irregular-image ROIs.

It often takes longer to transfer the image data to be processed to and from the accelerator than it does to do the actual processing. A high-speed interface

between the frame buffer and the accelerator greatly enhances performance. Several manufacturers have adopted the DT Connect bus protocol from Data Translation (Marlborough, MA), including Mercury Computer Systems (Lowell, MA) and Toshiba (Irvine, CA), while other manufacturers, such as IBM, use proprietary buses for such interconnections.

As an example, the operations in table A (the results are shown in photo 1, right, in the main text) were performed using a DT2851 frame buffer, first alone and then in conjunction with the DT2858 coprocessor, which is connected via DT Connect. The test was performed on both a 6-MHz IBM AT and a 20-MHz Everex Step 386.

The alternative accelerator approach is to use a general-purpose CPU dedicated to imaging. This CPU, along with local code and processing memory, can reside on a separate accelerator board; some current implementations use the 80860 chip from Intel. Or, the CPU can be integrated onto the frame buffer itself, as is typically done with Texas Instruments' TMS34010.

General-purpose CPUs are a double-edged sword for imaging solutions. While they provide a flexible, expandable path for function growth, they require a great deal of chip-level software. Software developers, even those in the driver business, are loath to make such a software investment in nonmainstream-CPU chip-level code. To circumvent this problem, chip manufacturers provide C cross-compilers, but the compiler output often doesn't match the chip's performance capabilities, sometimes to the extent of negating the effect of the chip altogether.

The capabilities of a general-purpose CPU accelerator are completely dependent on the software. As a rule, the more processing done at the chip level, the higher performance the system will yield. An initial implementation might have a limited set of chip-resident imaging functions, while future software versions would transfer more of that capability to the chip itself.

Feedback Lookup Tables

Feedback lookup tables provide a low-cost solution for some applications that require real-time processing of acquired video image data. You can perform any

logical or arithmetic operation by passing source image data through a transformation or LUT, provided that the size of the LUT matches the range of image data. In other words, if the source image data is 8 bits per pixel (the range is from 0 to 255), a 256-entry LUT will suffice.

To add the value 10 to each pixel, simply set the value at LUT location m to $m+10$. To combine each pixel value with the value n using the AND operator, set the value at LUT location m to m AND n . Some implementations also support an input multiplexer, which will combine video input image data with frame-buffer data, generating deeper (more bits per pixel) image data.

By passing this type of data through an equally deep LUT, you can perform arithmetic and logical operations between the source image and the incoming video. By appropriately scaling the two image sources, real-time frame averaging can be supported. Finally, you can use pan and scroll registers to offset image data in the x and y directions during the feedback process. This can be used to accomplish neighborhood operations such as convolutions.

While a clever solution, feedback LUTs present the problem of data clipping. Data output from the LUT transformation may exceed the data bandwidth (in the example above, what will happen to input data values 246 to 255 when added to 10?) and is usually clipped to maximum or minimum values (in this case, 255). This loss of accuracy is compounded with repeated passes through the feedback loop with the same image data—the results of neighborhood operations performed through feedback LUTs may not be accurate.

Parallel Processing

Parallel processing is really an extension of the application accelerator technology. By providing multiple identical processing paths, whether you are using dedicated-logic or general-purpose CPUs, the improved processing times will approach the inverse of the number of processors.

The applications software must take the ROI of the image data to be processed, divide it into equal strips, and feed these strips into the processing engine. Better yet, the processor logic it-

Table A: Notice the difference an accelerator can make in image-processing performance. Also notice the difference the faster computer makes when the host CPU does all the processing (the DT2851 alone). The 2858 coprocessor performed all three of the listed functions when it was present; when it wasn't, the host CPU performed all three. (All times are in seconds.)

IMAGE PROCESSING TIMES

	Histogram equalization	Remap data	3 by 3 high-pass convolution
6-MHz AT			
DT2851	20	16	65
DT2851/2858	2	1	3
Everex Step 386/20			
DT2851	5	5	14
DT2851/2858	<1	<1	2

self could manage the division and routing of image data to all its processors.

Parallel processing of image data differs from rendering graphical images in parallel. Image data takes the same amount of time to process regardless of the source data values; rendering complex objects takes much longer than rendering backgrounds. Decisions as to how to divide image data for parallel processing are much simpler, based solely on size.

While parallel processing is in widespread use for graphics rendering, this is still an emerging technology for image processing.

Pipeline Processing

Another approach to image processing is to couple multiple processing elements together in a hardware processing pipeline. In such an architecture, image data moves through various components or physical boards, each of which can perform a set of functions on the image data. The data throughput rate is very high, typically at or near video speeds, so an image can traverse the entire processing pipeline in one frame time (one-thirtieth of a second). In such a system, the type of boards and the order in which they are installed can completely determine the pipeline's performance.

The pipeline architecture differs from the feedback LUT approach in that full 16-bit data paths are supported for 8-bit source image data, including a 16-bit-wide accumulator frame buffer. In this way, processed data is preserved at

full accuracy, while the user manages clipping at the end of the process.

At the heart of most imaging pipelines is an ALU. The ALU supports arithmetic and logical operations between image data and a constant or between two input images, usually one operation each (arithmetic and logical) in the pipeline, and sometimes several in a series.

Off-Screen Video Memory

An image-processing architecture can have multiple megabytes of video memory on the frame buffer (or make the addition of more frame-buffer memory an option), of which only one frame page can actually be displayed. The off-screen memory can be used to store multiple images to speed up operations between two images or to store images larger than the display to provide quick pan and scroll functions.

This memory can also be used to store many smaller images that make up an image sequence (these images are typically smaller than the frame display). By zooming the display to make the image full-screen, and quickly panning and scrolling around the image data, you can create the effect of the image source in motion, much like flipping the pages of a kinoscope.

To be useful, either the host CPU or a dedicated controller or processor board (if one is present) must be able to access this memory directly. Otherwise, it has no advantage over standard system memory.

Rack & Desk PC/AT Chassis

Integrand's new Chassis/System is not another IBM mechanical and electrical clone. An entirely fresh packaging design approach has been taken using modular construction. At present, over 40 optional stock modules allow you to customize our standard chassis to nearly any requirement. Integrand offers high quality, advanced design hardware along with applications and technical support *all at prices competitive with imports.* Why settle for less?

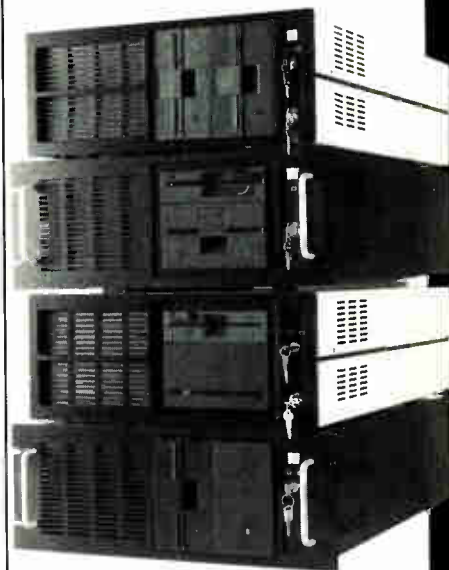

Rack & Desk Models

Accepts PC, XT, AT Motherboards and Passive Backplanes

Doesn't Look Like IBM

Rugged, Modular Construction

Excellent Air Flow & Cooling

Optional Card Cage Fan

Designed to meet FCC

204 Watt Supply, UL Recognized

145W & 85W also available

Reasonably Priced

Now Available

Passive Backplanes



INTEGRAND
RESEARCH CORP.

Call or write for descriptive brochure and prices:
8620 Roosevelt Ave. • Visalia, CA 93291

209/651-1203

TELEX 5106012830 (INTEGRAND UD)

FAX 209/651-1353

We accept Bank Americard/VISA and MasterCard

IBM, PC, XT, AT trademarks of International Business Machines. Drives and computer boards no: included.

Software Solutions

Virtual Frame Buffer

The virtual frame buffer separates the processing functions from the physical display in software. This removes several of the limitations that the display hardware imposes, such as different output lookup tables (LUTs) for multiple displayed images, handling images larger than the display, and managing multiple images of different sizes.

In such an implementation, all image data is maintained and processed in memory—this can be virtual memory when dealing with Unix workstations. The display process is handled independently of the image processing and consists of transferring image data from the virtual frame buffer in memory to a window on the display. During this transfer process, the data itself can be transformed to manage zoom, pan, scroll, and LUT functions.

Graphical User Interface

The trend at both the personal computer and workstation level is toward a graphical user interface. Since image processing is presented either as a stand-alone application or as an integrated part of another application, it must conform to such GUI standards.

Using the host CPU and frame buffer for processing makes this task easier because the GUI tools are already in place. The virtual frame buffer also fits in nicely, because the display process, being separate from the image processing, can be routed through the GUI.

Problems arise when dealing with dedicated imaging subsystems indepen-

dently of the host display, as the standard GUI tools are generally not available. In such cases, you can use two monitors, with control and status enabled through the GUI on the system display and image data displayed on the subsystem.

Imaging Tools and Applications

The typical image-processing solution supplier wants two levels of software support—an end-user application that provides a set of standard imaging functions in an easy-to-use package, and a comprehensive set of imaging routines that allow the use of additional algorithms.

General-purpose imaging software can often become tuned to a specific vertical market by adding market-related functions. Imaging software tools can provide a wider range of options for the value-added reseller and system integrator.

System Solution Approaches

The initial decision for an imaging solution supplier is what to use as the delivery platform, including both the physical host computer and the operating system. While microcomputers provide the lowest-cost solution (and with application accelerators, they can provide high performance), imaging applications under DOS don't coexist well with networks; they function best as stand-alone nodes. Because networking is built into the workstation environment, workstations tend to provide a better framework for workgroup management

and processing of image data.

In years past, high-end imaging solutions consisted primarily of proprietary, stand-alone hardware-and-software boxes. The general state of the art in computer technology dictated this approach; for many real-time applications, it is still the only valid approach. The trend today is away from dedicated imaging subsystems and toward accelerators and software that can be integrated into standard personal computer and workstation platforms.

Another approach is to use device-independent software that can run across a wide variety of hosts and imaging products. Software such as Image-Pro from Media Cybernetics (Silver Spring, MD) is both device-independent and device-intelligent; that is, it will use whatever capabilities are available in the imaging hardware. This allows the systems integrator to select the best hardware that is available for the application, knowing that adding an accelerator will automatically provide an increase in the system performance that the software can handle.

One of the pitfalls in image processing is that new hardware is being developed faster than software support. This is particularly acute in the area of accelerators. Many accelerator manufacturers are working on developing a standardized software interface that will provide a migration path to new hardware while still maintaining compatibility with existing software. Device-independent software can provide a hedge against technical obsolescence.

Nonimage data, such as histogram counts, image statistics, and object information, can also be output from an imaging system.

A Typical System

A typical image-processing workstation has a host computer with some or all of the following components: a frame buffer, a display monitor, a video digitizer, a video source, and an application accelerator (see figure 1).

A frame buffer consists of high-speed video memory coupled with a video display system. It may contain more memory than it needs for a single display; it can use the additional memory for code and data storage or multiple display pages, or to hold a single large image.

The video display system usually consists of output lookup tables (LUTs) for assigning actual colors or gray scales to image-data values, and D/A converters for converting digital image data into an analog video signal for display.

The system usually gains access to the frame buffer in one of two ways: either through a single byte, word, or command interface, or by the host computer accessing the frame-buffer memory directly. Memory-mapped frame buffers mean better performance for systems that rely on the host computer for processing, since it can operate directly on frame-buffer memory. Otherwise, the system must transfer image data from the frame buffer to local memory for host processing and then back again for display.

The characteristics of the display monitor must match the display requirements of the frame buffer. A standard National Television System Committee (NTSC) signal (defined as 512 by 480 pixels interlaced) requires a 15.75-kHz monitor, while a 1280- by 1024-pixel noninterlaced signal requires a 64-kHz monitor. The physical measurements of the monitor have no direct bearing on the input video signal.

Input video can come from an analog video signal generated by a camera or VCR source as an NTSC or RGB signal (at 480 lines) in real time (30 frames per second). Alternatively, video can be input from a variable scan source (higher resolution or slower frame-rate video

continued

Breakthrough \$899 Offer—Now You Can Drive CD-ROM

Until December 31, 1989 Compact Disk Products (CDP) is packaging the just released third generation Hitachi CD-ROM drive with Microsoft's most popular CD-ROM software:

Package A—For \$899, includes **Microsoft Bookshelf**, a coupon to purchase both **Microsoft Stat Pack** and **Microsoft Small Business Consultant** for only \$50 each, a **FREE** copy of **CD-Play Demo** and **FREE** Federal Express delivery.*

Package B—For \$1189 also includes **Microsoft Programmer's Library**



Microsoft



A World Leader in Technology

Hitachi CD-ROM drives retail (\$995): Hitachi's second generation drives, the 1503 and the 3500, captured over 60% of the market with superior functionality and reliability. The third generation 3600 model (internal or stand-alone) released in September 1989 is Hitachi's powerhouse for the 1990's. Superior speed comes from a look-ahead cache and a linear pickup head motor. Powerful standard features include 8 drive daisy chaining, slim vertical or horizontal mounting, and full audio CD capabilities (accessible with CD Play Demo).

Microsoft **Bookshelf** (retail \$295): An indispensable collection of writers' references for word processor users. This is the most popular CD-ROM title published. You get instant access to: **The World Almanac, Chicago Manual of Style, Bartlett's Familiar Quotations, Roger's II: Electronic Thesaurus, American Heritage Dictionary, Business Information Sources, The U.S. Zip Code Directory, Houghton Mifflin Spell Checker and Usage Alert** and more! All Microsoft CD-ROM's are RAM resident and include powerful cut and paste features for popular word processing packages.

Microsoft **Stat Pack** (retail \$125): Now you have easy access to the abundance of statistics published by the Federal Government—census data, business statistics, agricultural surveys and much more, plus Microsoft Excel and Lotus 1-2-3 spreadsheet files for all tables. A must for marketers and planners.

Microsoft **Small Business Consultant** (retail \$149): The most popular publications of the Small Business Administration and Deloitte, Haskins and Sells on running a small business. Answer tax, accounting, legal, personal, AND financing questions in an instant. A gold mine for businessmen, accountants, and consultants.

Microsoft **Programmers Library** (retail \$395): All the critics are raving "...a masterpiece of simplicity and function." **PC World**, May '89. A complete library (over 20,000 pages) of the latest releases of Microsoft's Technical Reference Manuals covering OS/2, Windows MS-DOS, C, MASM, etc. with 8 megabytes of source code. Also includes **FREE** CD ROM Networking software. PC Professionals need this NOW!

YOU SAVE OVER \$670!

Buy CD-ROM now! CDP sells over 200 quality CD-ROM titles for libraries, schools, legal and medical professionals, programmers, and many others. Over 25 new titles are being published each month. With IBM, NEC, and HP announcing new CD-ROM based PC's or Mini's, a CD-ROM drive is becoming as necessary as a floppy drive.

"I believe more than ever that CD-ROM products will be a major force in the expansion of the information industry." **Bill Gates**.

CDP is the largest specialized supplier of CD-ROM products in the U.S. Since 1987, CDP has supplied you with prompt service and expert advice... at the best prices. CDP is committed to CD-ROM and it shows. Our Unconditional Guarantee is unmatched. Our **FREE** Federal Express delivery is an industry first. Call now and tomorrow you will be driving these power CD-ROM products.

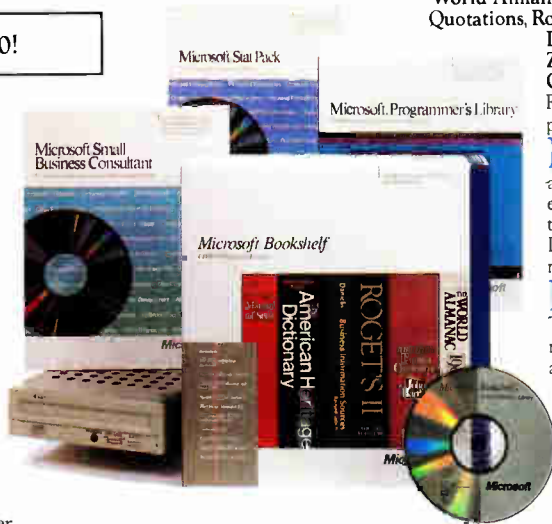

- UNCONDITIONAL WARRANTY**
- 1) If FOR ANY REASON you are unhappy with your purchase you may return it within 30 days for a FULL REFUND.
 - 2) CDP will extend the Hitachi 90 day warranty period to 180 days and, during the warranty period, will ship replacement drives overnight.

ORDER NOW! 800-MEGABYTE (634-2298)

(Order line open M-S, 9AM-9PM EST)

Fax Orders 212-737-8289 • Inquiries/Free tech. Support 212-737-8400

DEALER INQUIRIES WELCOME

FREE CD-ROM: Mail in your order and receive the CD-ROM Source Disk **FREE**. Includes demos of many popular CD-ROM products and retails for \$89.

*Federal Express delivery free for phone/fax orders within continental U.S. only.

Please send the package I've checked below.

- Package "A"**—Complete Hitachi CD-ROM drive kit (internal or stand-alone) plus **Bookshelf** and **CD-Play Demo** (includes a coupon to purchase both **Stat Pack/Small Business Consultant** for \$50 each) for only \$899!
- Package "B"**—Complete Hitachi CD-ROM drive kit (internal or stand-alone) plus **Bookshelf, CD-Play Demo** and **Programmer's Library** (includes a coupon to purchase both **Stat Pack/Small Business Consultant** for \$50 each) for only \$1199!

Please send the following drive configuration with my order:

- Stand-alone Hitachi CD-ROM drive; Select PC/XT/AT/386 or Microchannel (add \$100)
- Internal Hitachi CD-ROM drive (PC/XT/AT/386 Only)



Compact Disk Products, Inc.

223 East 85th Street, New York, New York 10028
(212) 737-8400

- Please send me a **FREE** CDP Encyclopedia of CD-ROM Products
- Corporate / personal check money order enclosed
- Charge my (circle one) American Express Optima VISA
MasterCard Diner's Club

Acct. # _____ exp. date _____

Signature _____

Name _____

Company _____

Address _____

City/State/Zip _____

Phone _____

Prices include Federal Express shipping and handling.

New York residents add 8.25% sales tax.

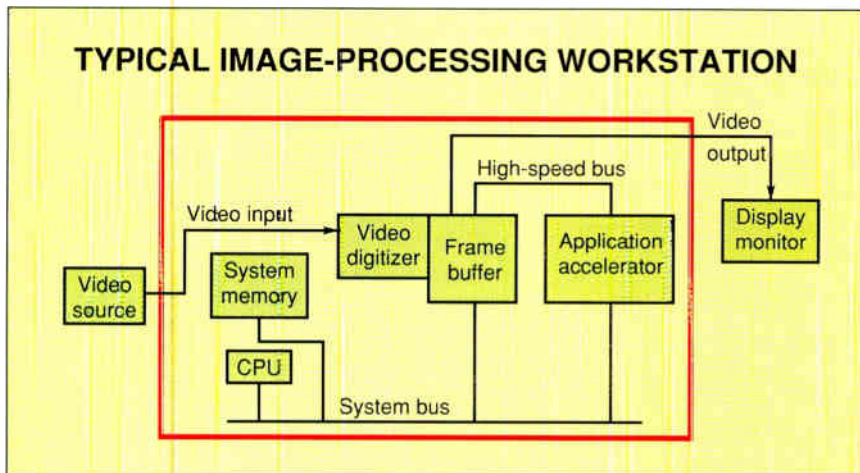

Figure 1: Some imaging workstations will contain only some of the additional image-processing components, while others will have all of them, as this one does.

sources). This analog data is converted, or digitized, via an A/D converter and is placed in the frame buffer. (Video digitizers for the European market have to handle phase-alternate-line input.)

Optical scanning can also be used to generate image data. In this case, a sensor array, typically at 200, 300, or 400 dots per inch, generates digital scan-line output as it moves past a flat source. The paper can move over the sensor, the sensor can move over a fixed piece of paper, or both the sensor and the paper can be stationary while the internal optics move. These scan lines are recomposed as the image data in the frame buffer.

An application accelerator is an add-on hardware card or subsystem that has its own processing capability, independent of the host CPU. As the name implies, the function is to accelerate the processing of the imaging application.

Real-World Applications

The medical field has many uses for image processing, including processing and analyzing MRI, sonograms, x-rays, and CAT scans. Often, the output of devices is direct digital information; when it isn't, a film recording of the image is scanned or digitized. In medical research, the image from a microscope can be fed into an imaging system or stored on a videotape for later processing.

Medical applications typically generate high-resolution images of at least 1024 by 1024 pixels. An accurate analysis of image data often requires pixel accuracy to at least 12 bits, even though only 8 bits can be displayed. Performance is usually critical in medical applications; the imaging workstation is a small and relatively inexpensive component of the diagnostic equipment and

shouldn't be a throughput bottleneck.

When photo interpreters use image processing, source image data is often aerial photographs shot during reconnaissance flights. These photographs are digitized at the highest resolution possible, in the 4096- by 4096-pixel range. Although perhaps only viewing a small piece of the image at a time, the photo interpreter needs the ability to smoothly pan and scroll around the entire image.

In publishing, image data can be two-tone, gray-scale, or color. Images are typically not very large, and the primary concern is usually improving the look of the image. As you move from the desktop publisher to the quick printer to the commercial publisher, the complexity of the imaging system varies correspondingly.

Image processing is used in commercial and industrial applications involving nondestructive testing. A record of an event—the movement of a tire through water, the inspection of the inside of a jet engine, the flow of paint droplets from a sprayer—is captured on videotape. This tape is later played back through the imaging system, and each frame is analyzed and processed. Since the input medium is video, these systems require 480-line imaging frame buffers and displays.

In another class of inspection applications, the analysis of video image data is done on the spot without the intermediate step of capturing to videotape. In such assembly-line-type applications, the video data must be processed in real time using dedicated hardware.

LANDSAT and other satellites orbiting the earth generate remote-sensing image data. This data is multispectral; that is, it contains bands of information digitized at frequencies outside the visible spectrum (such as infrared and near-

infrared). The images generated are very large (again in the 4096- by 4096-pixel range) and require an imaging system that can manage multiple bands of connected large images.

One of the fastest growing applications for image processing is document management and automation. Such systems usually consist of a high-capacity optical scanner with optical character-recognition capabilities, which generates black-and-white image data. A standard 8½-by 11-inch page scanned at 300 dpi generates 1 megabyte of image data.

Traditional processing requirements are small, but image compression and decompression are important. Systems that archive data and rarely access it give a higher priority to compression speeds; those that archive data once but retrieve it many times for review and editing must have an optimized decompression mechanism. Accelerators are often used for compression and decompression.

Imaging Tomorrow

As the processing power of standard 80386 and RISC-based workstations increases and as high-resolution display technology becomes standard, software is all you will need to turn a general-purpose computer into an image-processing workstation. As imaging becomes more integrated into other technologies, such as document management, imaging applications will have to coexist and communicate with database applications and function across network connections.

Both dedicated-logic and general-purpose CPU accelerators will continue to flourish. Dedicated-logic solutions tend to be less expensive and reach the marketplace more quickly, but they also become outdated more quickly. In the long term, the general-purpose CPU is likely to win out. Texas Instruments is currently pursuing this strategy by following the 34010 with the 34020, which is downwardly software-compatible but yields at least a fourfold speed improvement.

Finally, color will become a requirement for imaging applications. As the possibilities of color become more well known, as vendors become more adept at managing color image data, and as hardware technology specifically for color is developed, color will replace gray scale as the accepted medium for many image-processing applications. ■

Walt Penney is vice president of engineering for Media Cybernetics (Silver Spring, MD). He has a B.S. degree in mathematics from the University of Maryland. He can be reached on BIX c/o "editors."



Even This Is More Confining Than Clipper.

Just as the vast expanse of the American West gave its settlers a new perspective on opportunity, Clipper's open architecture lends unprecedented freedom to application development.

Unlike fixed systems, Clipper never forces you to "make do". Its language is fully extensible with user-defined functions and new user-defined commands. You can extend the language with routines written in Clipper itself, or integrate code from other languages like C, Assembler, dBASE[®] and Pascal. Odds are, you already have knowledge you can use with Clipper!

But if a customizable language isn't enough, there's even more elbow room. Database and I/O drivers can be supplemented or replaced. Even Clipper's linker knocks down barriers by allowing you to develop applications larger than available memory, without defining overlays! And when you're done, Clipper's compiler generates stand-alone, executable files for cost-free, unrestricted distribution.

So, don't let the bounds of fixed systems fence you in. Unleash your imagination in the wide-open spaces of Clipper. To find out more, give us a call today.

Clipper 5.0

The Application Development Standard

213/390-7923

 **nantucket** [®]

Nantucket Corporation, 12555 West Jefferson Boulevard, Los Angeles, CA 90066, 213/390-7923 FAX: 213/397-5469 TELEX: 550-2574125. Nantucket, the Nantucket logo and Clipper are registered trademarks of Nantucket Corporation. Other brand and product names are used for identification purposes only and may be trademarks or registered trademarks of their respective holders. Entire content copyright © 1989 Nantucket Corporation.

Circle 225 on Reader Service Card

World Radio History



Every week our subscribers take cheap shots at each other.

The GENie™ service lets you take your best shots without shooting your budget. That's because our non-prime time rates are good and low. In fact, it's just \$6 an hour for 1200 baud access.*

And that means more time for more fun and games. Exciting multi-player games like Air Warrior, Stellar Emperor, Orb Wars and Gemstone. Where you can test your skills against some of the best in the world.

Plus enjoy classics like chess, checkers, backgammon, black jack and Reversi. At rates so good you're sure to come out a winner.

And with GENie signing up is as easy as one, two, three.

- (1) Set your modem for local echo (half duplex), 300 or 1200 baud.
- (2) Dial 1-800-638-8369. When you are connected, just enter HHH.
- (3) At the U#= prompt simply enter XTX99636, GENie then RETURN.

And have a major credit card or your checking account number ready. For information in the U.S. or Canada, call 1-800-638-9636. Or write GE Information Services, 401 North Washington St., Rockville, MD 20850.



We bring good things to life.

*Applies only in U.S. Mon.-Fri. 6PM-8AM local time and all day Sat., Sun., and national holidays. Subject to service availability. Some services may be subject to a surcharge. Prices effective May 1, 1989.

Circle 136 on Reader Service Card

World Radio History

Putting DSPs to Work

*Give your computer
a taste of the human senses*

Bobby Saffari

DSPs are here! Digital signal processors have found their way into our homes in products like compact disk (CD) players and digital videotape players, and into our computers (e.g., the NeXT machine), but the real potential of DSPs has yet to be tapped. They are capable of performing any task that requires a lot of computation power with efficiency, speed, and relative ease. Not only can you use DSPs to preprocess various sounds and images for better quality, but you can also take advantage of their computational power to assist in creating the next generation of computer systems.

The Three Steps

The three hierarchical steps of signal processing are preprocessing, feature extraction, and pattern recognition. Currently, the most widely used application is preprocessing. This group of operations deals mainly with the quality and correctness of the signals. In speech and audio applications, preprocessing includes (but is not limited to) preamplification, equalization, and noise reduction, most of which you can accomplish with digital filters.

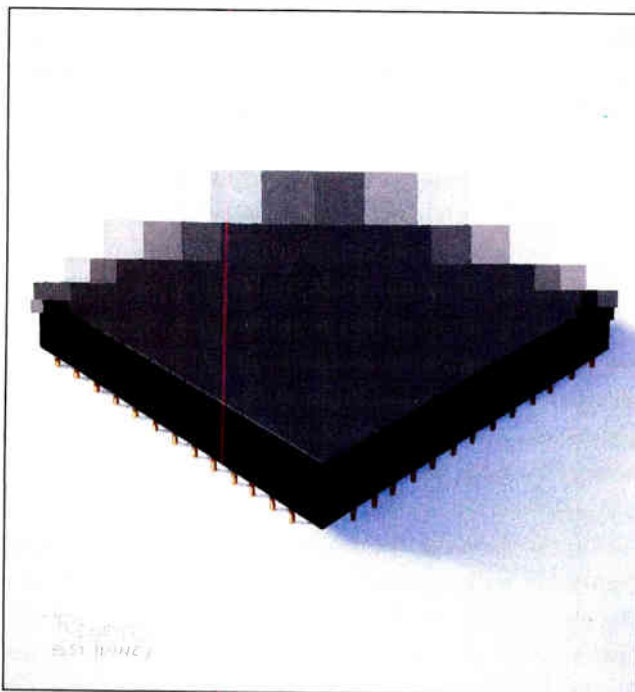

In image applications, preprocessing takes a more complex form. It includes such techniques as intensity and geometric correction, as well as geometric transformation. These techniques require using both digital filters and computations like matrix multiplication and inversion.

In many applications, once the input signal (sound or image) has been prepro-

cessed, the task is considered to be complete. For instance, in the digital recording of a CD, the signals from both the left and right channels are digitized using A/D converters at a sampling rate of 44.1 kHz (the Nyquist frequency for the 20-kHz audio range). The signals are then encoded digitally using error-detection and -correction schemes and modulated so they can be written to a master laser disk. The end result is a superb sound recorded on a laser disk (preprocessing is complete).

Developers can achieve a higher level of processing if they incorporate DSPs into the next generation of computer systems. By adding high-performance floating-point DSPs to existing computers, the average user could have access to features like a voice-activated man-to-machine interface.

A current topic of interest in which intense research and development are under way is pattern recognition, with applications in voice-activated workstations, autonomous vehicles, and factory automation.

To perform any sort of pattern recognition, you first need to extract certain

continued

features or parameters from the preprocessed signal. In speech processing, attributes such as formant frequencies, pitch, and spectra provide for a sufficient and accurate representation of a speaker's voice. Fourier descriptors and invariant moments, on the other hand, are the parameters used in describing an object within an image.

The parameters obtained from feature extraction are collectively used to identify speakers or objects by comparing

them against stored reference features. Based on possible similarities or differences and an acceptance criterion (a threshold), the system decides on the identity of the speaker or object.

Building DSPs

DSPs, until now, have been implemented using one of the following platforms: generic building blocks, function-specific building blocks, and RISC-like general-purpose DSPs. However, a new approach

using application-specific ICs (ASICs) customizes the DSPs.

The first platform, generic building blocks, includes implementations like conventional complex-instruction-set-computer microprocessors and bit-slice processors. CISCs, accompanied by math coprocessors, are the most flexible and readily available platform, but this flexibility comes at an often-unacceptable price in speed performance. CISCs also lack the additional functionality that is needed, such as bit-reversed addressing for fast Fourier transforms (FFTs) and circular addressing for time-domain convolution. Bit-slice processors can be fast, but the necessary microcoding is expensive—in time and money. Moreover, bit-slice processors require the use of multiple devices, such as address sequencers, ALUs, multipliers, registers, and memory, thus reducing the amount of available board space.

The second platform, function-specific building blocks, uses VLSI devices designed for DSP tasks such as 1024-point FFT, 3×3 image convolution, and 64-point correlators. Perhaps the fastest platform for tasks with clearly defined inputs, function-specific building blocks are also known as VLSI distributed processing (each device in the system is responsible for only one task). Such a system can be costly and lack flexibility in architecture and algorithm design.

The third platform uses RISC-like general-purpose DSPs, which have evolved rapidly since their introduction about 10 years ago. Software development with this platform is comparatively easy, and internal architectures dedicated to number crunching, together with a robust DSP-oriented command set, provide better overall performance.

In certain applications, general-purpose DSPs will not perform satisfactorily. You may need a set of specifications that is not embedded within a general-purpose DSP. For example, processing stereo-audio signals in a CD player entails using a special interface that allows for input and output of the right and left channels. This leads to the final and perhaps most advanced form of implementation, called ASIC design.

In ASIC design, you can customize the DSP architecture by optimizing the device for performance, reliability, board space, design security, and cost. Due to advances in micron and submicron CMOS technology, the ASIC DSP can accommodate peripheral functions, memory, random logic, and, eventually, more than one DSP on a single chip. Such

continued

King of Arts

Studio-quality animation comes to your desktop PC with GRASP. Create slide shows, demos, interactive tutorials, and animated performances. Control art, text, color, sound, timing, mouse and keyboard. Use the animation techniques developed for arcade games and television production. Add Grasp animations to C, Pascal, Basic, and Assembler programs.

Now Grasp includes Pictor, a paint program fully integrated with Grasp; and Artools, a unique set of animation generators. Artools creates the in-betweens for professional effects like image warping, transformations, and cross-fades—automatically!

GRASP version 3.5 — \$199.

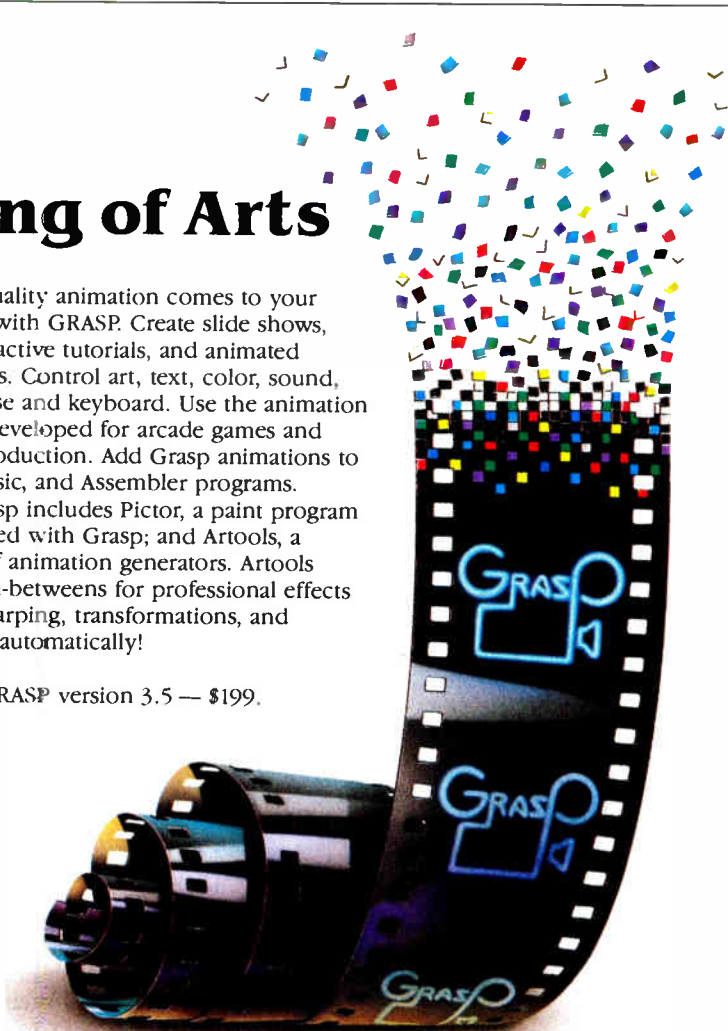

Paul Mace
GRAPHIC SOFTWARE

400 Williamson Way — Ashland, OR 97520
800-523-0258 503-488-2322

"GRASP is clearly the hands-down winner in terms of sheer power, flexibility, and speed. Nothing else even comes close."

—PC Magazine

Words of Caution and Encouragement for Those Choosing a CASE Tool

Your software projects are growing more complex, and maintenance is growing more expensive. You think that CASE tools could help, but some say CASE is more trouble than it's worth. What should you believe? Should you jump in? Be cautious. Expensive CASE tools with rigid methodologies demand a commitment of time and money so large that anything short of revolutionary success can seriously damage your budget and your career. Now, however, you can eliminate methodology grid-lock with an affordable, flexible, world-class CASE tool. Literally every programmer and analyst in your company can have the power of *vsDesigner™* on their PS/2 or PC.

The Price/Performance Leader

vsDesigner costs only \$495 for a single-user license, but don't be fooled by its low price — *vsDesigner* has the features and power of CASE tools costing over ten times more. The Expert version of *vsDesigner* costs \$1,995 for a single-user license and includes all *vsDesigner* features plus LAN support, design database reporting and the ability to modify or create methodologies.

Use Multiple Methodologies

vsDesigner supports the structured design methods you prefer: Yourdon, Gane-Sarson, Warnier-Orr, Ward-Mellor Real-Time, Entity-Relationship, Flow Chart, etc. It supports multiple methodologies or "syntaxes" simultaneously so that a design can contain layers (nodes) using different syntaxes. For example, you can use Data Flow Diagrams for the

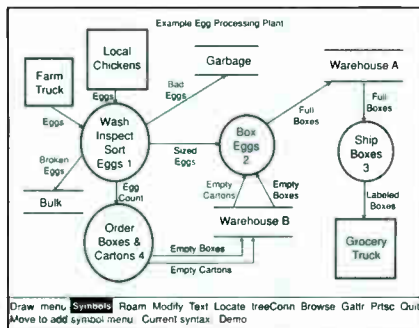

Data Flow Diagrams are just one of the standard methodologies supported

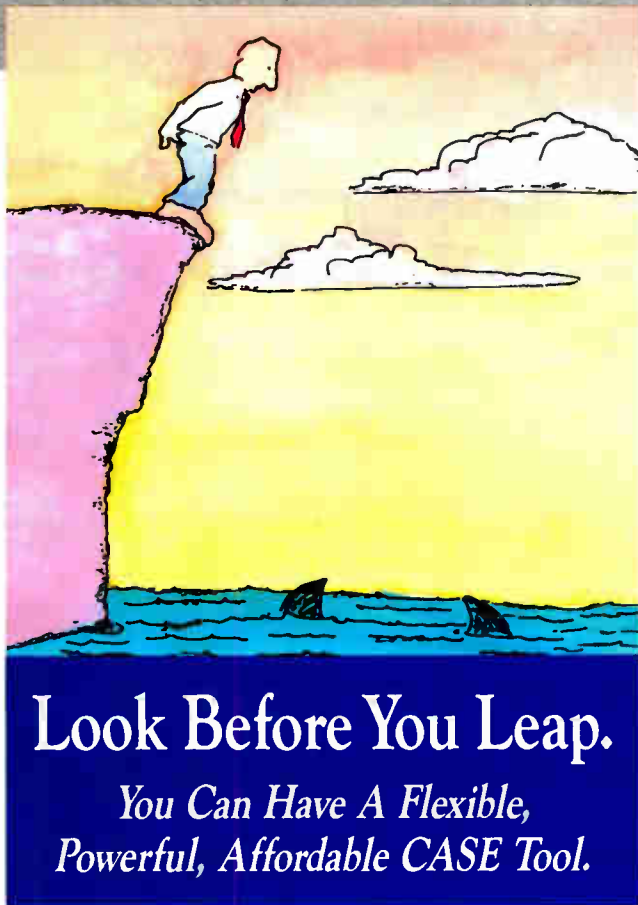

Look Before You Leap.
*You Can Have A Flexible,
Powerful, Affordable CASE Tool.*

top level of your design and then decompose each module into Structure Charts, State Diagrams, Entity-Relationship Diagrams, etc.

Customize Methodologies Or Create Your Own

With the Expert version of *vsDesigner*, you can modify the syntaxes we supply, or you can even create your own syntaxes for ultimate flexibility. We believe that the tool should adapt to and then enforce your team's standards and practices rather than vice versa.

Quality Code From Quality Design

Although many CASE tool users have had significant productivity gains, structured design improves quality even more than productivity. The design checking programs included with *vsDesigner* allow you to check the logical integrity of your designs before you begin writing code. The resulting code will be more reliable, and maintenance costs will be much lower because operations are logically consistent.

Collaborate over a LAN

The Expert version of *vsDesigner* also adds LAN support so that all your designers can simultaneously work on the same design. Node locking allows

vsDesigner

design collaboration while preventing conflicting changes to the shared design.

The Expert version of *vsDesigner* also provides the database and reporting capabilities necessary to predict lines of code, number of modules, completion dates, responsibilities and project complexity.

One Picture Is Worth A Thousand Meetings

vsDesigner enhances the communication among team members by giving managers, team leaders, programmers and analysts a visual picture of your system's architecture making it faster and easier to communicate design changes throughout the team.

Fast Learning Curve

vsDesigner has powerful on-line help, and the User's Manual has an extensive tutorial. Your choice of Lotus-style menus or pop-up menus make command selection easy. The built-in word processor even

emulates popular word processors to reduce learning time. Color graphics make your designs easier to understand.

A World-Class Design/Analysis Tool From The Best-Rated CASE Vendor

When you choose *vsDesigner*, you become a valued customer of Sage Software, the "Best-Rated CASE Vendor" in the Donohue 1989 Fortune 1000 Software Industry Report.

Both versions of *vsDesigner* require an IBM-compatible PC or PS/2 with 640K RAM, EGA monitor and a hard disk. A mouse is recommended. Printers supported are: Epson FX85, FX286 & MX80; HP LaserJet+ and LaserJet Series II.

30-Day Money-Back Guarantee

To Order 1-800-547-4000

Outside North America call (301) 230-3307. Send checks and P.O.s to SAGE/POLYTRON, 1700 NW 167th Place, Beaverton, OR 97006. FAX: (503) 645-4576. Prices are N. American only.

POLYTRON

SAGE
SOFTWARE

Digital Filters

1-D FIR Filter

The following equation describes a one-dimensional finite impulse response (FIR) filter:

$$Y(n) = \sum_{k=0}^{N-1} h(k) X(n-k)$$

where $h(k)$ is the filter coefficients and $X(n)$ is the input data sequence.

FIR implementation is nonrecursive (see figure A) and is therefore always stable (i.e., it converges to a finite number). It exhibits a relatively low quantization error as a result of arithmetic operations and has no limit-cycle problem. FIR filters can independently achieve linear phase with no phase distortion.

Despite these features, FIR filters have deficiencies. They usually use too many multiplications (due to the many required coefficients) to generate a sharp cutoff frequency. Thus, they are suited to applications that need zero phase distortion and don't have too many multiplications. At one time, these filters used registers, multipliers, ALUs, and conventional CPUs.

Circular addressing is another feature that eliminates checking for upper and lower limits of the data structure and allows an incoming sequence $X(n)$ to be automatically inserted into data space. Consequently, very fast and memory-efficient FIR filters can be implemented.

1-D IIR Filter

The following equation describes an infinite-duration impulse response (IIR) filter:

$$Y(n) = \sum_{k=1}^M a_k Y(n-k) + \sum_{k=0}^N S b_k X(n-k)$$

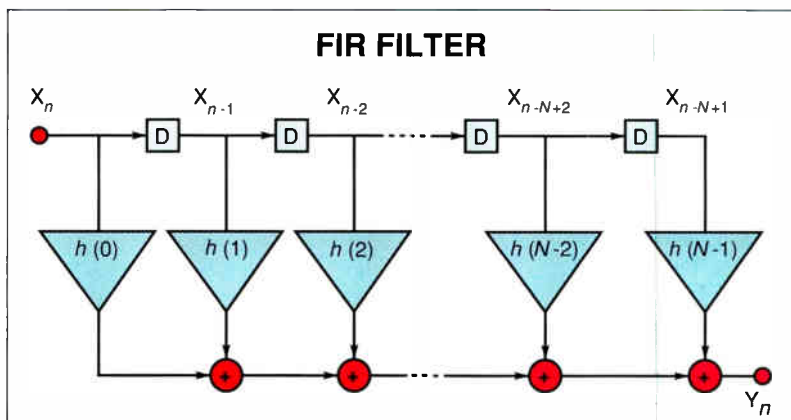

Figure A: The fundamental format used to implement an FIR filter. FIR implementation is nonrecursive and is therefore always stable (i.e., it converges to a finite number). It can independently achieve linear phase with no phase distortion.

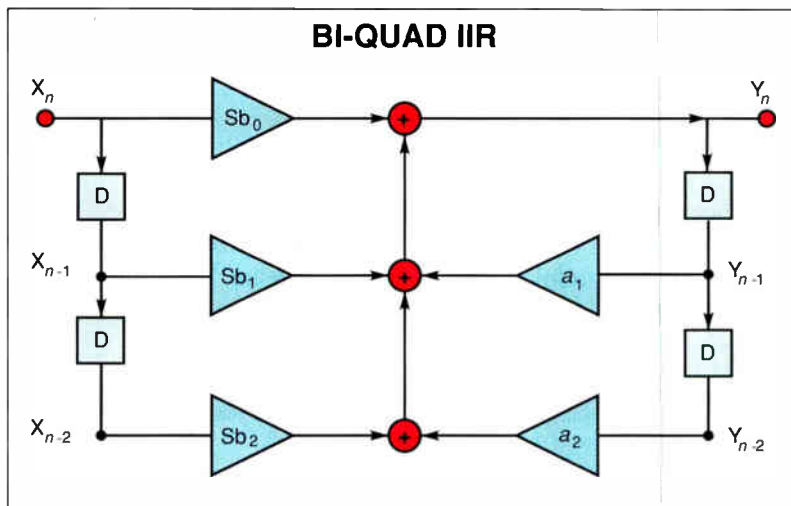

Figure B: The most common method of implementing IIR filters. In digital-filter design using the IIR approach, you would use this format as the fundamental block (bi-quad realization). Therefore, most IIR implementations would use the cascaded second-order bi-quad filters.

a high level of logic integration suits applications that are too complex for a general-purpose DSP. ASIC design could also reduce cost by providing a scaled-down DSP for applications where a general-purpose DSP is overqualified.

To date, several ASIC DSPs have been produced from different "core" macrocells (Type-1, Type-2, and Type-3). Each of the cores is a DSP consisting of four functional modules: arithmetic and logic, address calculation, program sequence and control, and internal memory

(see figure 1). Since all modules communicate with standard signals, you can combine and modify the macros using standard interface signals. Internal programmable logic arrays in the program sequence and control block decode the program instructions, or microinstructions, and generate control signals. You can alter the instruction set by reprogramming the PLAs.

Each DSP core is optimized for a certain application area (see table 1). For example, a Type-2 core provides a spe-

cial I/O interface to comply with the I²C serial-bus standard for digital-audio applications. The I²C bus structure lets you transmit commands, as well as data, through a serial interface that is useful in adaptive filtering applications. As a result, you can substantially reduce the number of components and the cost of the system, as well as increase the flexibility with which you can digitally filter audio signals. The Type-3 core has 16 first-in/first-out I/O registers and a 32-bit IEEE-754 floating-point data format for

IIR filters are typically designed from analog filters, since the techniques and procedures for analog-filter design are well developed and require fewer computations. Analog filters are converted to digital filters using impulse-invariant and bilinear transformation methods. Similar to analog filters, IIRs are preferably realized in a cascaded form of second-order filters (bi-quad IIR) for algorithmic simplicity and low sensitivity to coefficient quantization. (See figure B.)

Compared to FIR filters, IIR filters are more efficient in terms of memory requirements, number of multiplications, and filter response. Their transition band is relatively sharper, and fewer delay elements and multiplications are required. In addition, flexible address pointers and circular addressing mode make IIR design straightforward. However, distortion delay (non-linear phase), instability, limit-cycle problems, and higher quantization error in arithmetic operations are all deficiencies of IIR filters.

2-D Digital Filters

Similar to the one-dimensional case, two-dimensional digital filters consist of two classes: FIR and IIR. In image processing, where shapes and relative distances between objects are important, zero-phase and linear-phase FIR filters are commonly used.

FIR filters in two dimensions exhibit the following I/O relationship:

$$Y(m,n) = \sum_{k=0}^{M-1} \sum_{l=0}^{N-1} h(k,l) X(m-k,n-l)$$

where Y is the output of the filter, X is the input image, and h is the filter's impulse response. Generally, one-dimen-

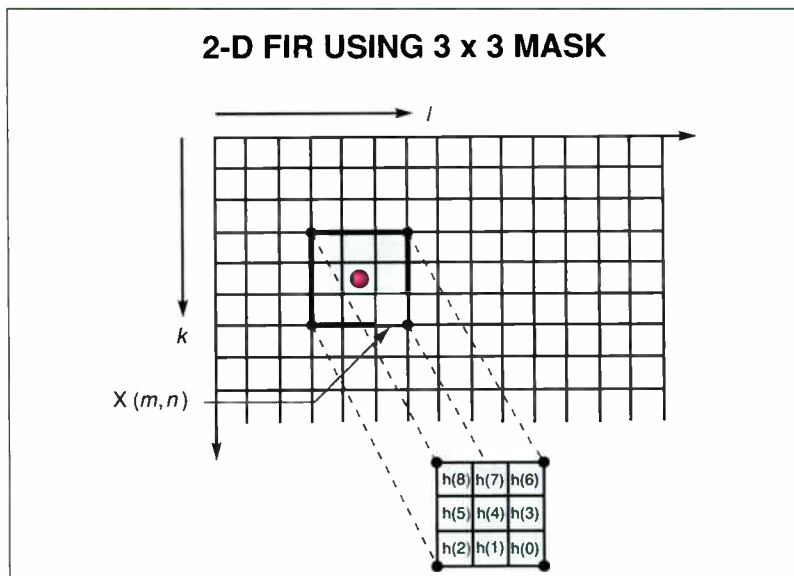

Figure C: How the output $Y(m,n)$ is computed according to the equation in the text. In practice, the center pixel (see the circle) of the 3×3 input image is computed instead of the corner pixel that the arrow points to. The indexes of the filter equation are adjusted accordingly.

sional design techniques are used to compute the coefficients of a two-dimensional FIR filter. The most commonly used two-dimensional FIR filter is a 3×3 coefficient matrix, usually referred to as a 3×3 input mask. There are over 100 different input masks that have known coefficients to produce transfer functions for low-pass, high-pass, and noise-removal filters.

Figure C shows how output $Y(m,n)$ is computed according to the above equation. In practice, however, the center pixel (centered in figure C) of the 3×3 input image is computed instead of the corner pixel that the arrow points to. The indexes of the filter equation are adjusted accordingly.

Similar to one-dimensional FIR, the quantization error is small. If the input image is digitized to 8 bits (shades of gray) or 24 bits (RGB color) and the input-mask coefficients are generated in 8 bits, then you need to accumulate 32-bit products for image-processing applications where you need two-dimensional digital filtering.

DSPs need to perform a 3×3 image convolution over a large memory area. Because the intensity of each pixel is obtained in integer format, it would make the most sense to perform digital filtering using integer operations. A 24-bit integer format is more than sufficient for most typical image-filtering applications.

high-accuracy, high-speed, image-processing applications.

Perhaps one of the most attractive features of ASIC DSPs is that they are software-programmable. The ability to create different functions and tasks is essential in most designs, providing a great deal of flexibility when you need to execute a variety of application programs with a single device.

If you need to create programs for a new DSP, a "chip-definition file" conveys all the necessary information about

memory size, data format, registers, and other device features to the assembler, the linker, the simulator, and, finally, the emulator. Applications that can use floating-point DSPs range from digital filtering (used in preprocessing), to rapid and optimized FFT calculation for feature extraction, to graphics and pattern recognition.

Digital Filters

Digital filters are programmable, reliable, repeatable implementations of a de-

sired frequency response that is usually used to alter the frequency content of an input signal. A low-pass filter, for example, allows only the low-frequency components to pass.

Once the desired spectral characteristics are specified, a digital filter can achieve those specifications with ease, efficiency, and accuracy. Digital filters are implemented on DSPs through various structures (e.g., the finite impulse response and infinite-duration impulse

continued

response filters). (For more details about specific types of digital filters, see the text box "Digital Filters" on page 262.) With the emergence of powerful floating-point DSPs, realizing such structures is no longer the focal point of design. The important issue now is meeting the specific demands of the market, which may include attributes like wide dynamic range, large memory, specialized I/O interfaces, or a combination of several features.

Time and Space Correction

Time and space correction are among the last steps in preprocessing operations and may not be necessary for many applications. However, if your application performs pattern recognition on sound or

images, time and space correction are among the most critical steps. A signal's intensity may be filtered, but its relative position in time or space needs to be corrected so similar features are aligned with each other in preparation for the final computations. I will describe the more complicated of the two operations: geometric, or space, correction. Time corrections for speech applications are quite similar.

In image processing, once a sensor acquires an image, it is subject to intensity and geometric distortions. Thus, in any image-processing task, the first stage, which is part of preprocessing, is to identify the nature of the distortions and rectify them.

Intensity distortions are caused by ex-

ternal lighting variations, sensor imperfections, camera or scanner shading effects, detector gain variations, and so on. You can usually predict intensity distortions and correct them relatively easily using simple table-lookup techniques or digital filtering.

Geometric distortions, on the other hand, occur due to the nonlinearity or misorientation of sensors or to the inherent imperfections in optical instruments. In contrast to intensity corrections, geometric rectifications are complex and computationally intensive.

Synthetic aperture radar (SAR) and aerial imaging demonstrate some of the benefits of floating-point DSPs in implementing geometric corrections. Medical

continued

ARCHITECTURAL BLOCK DIAGRAM OF A CORE DSP

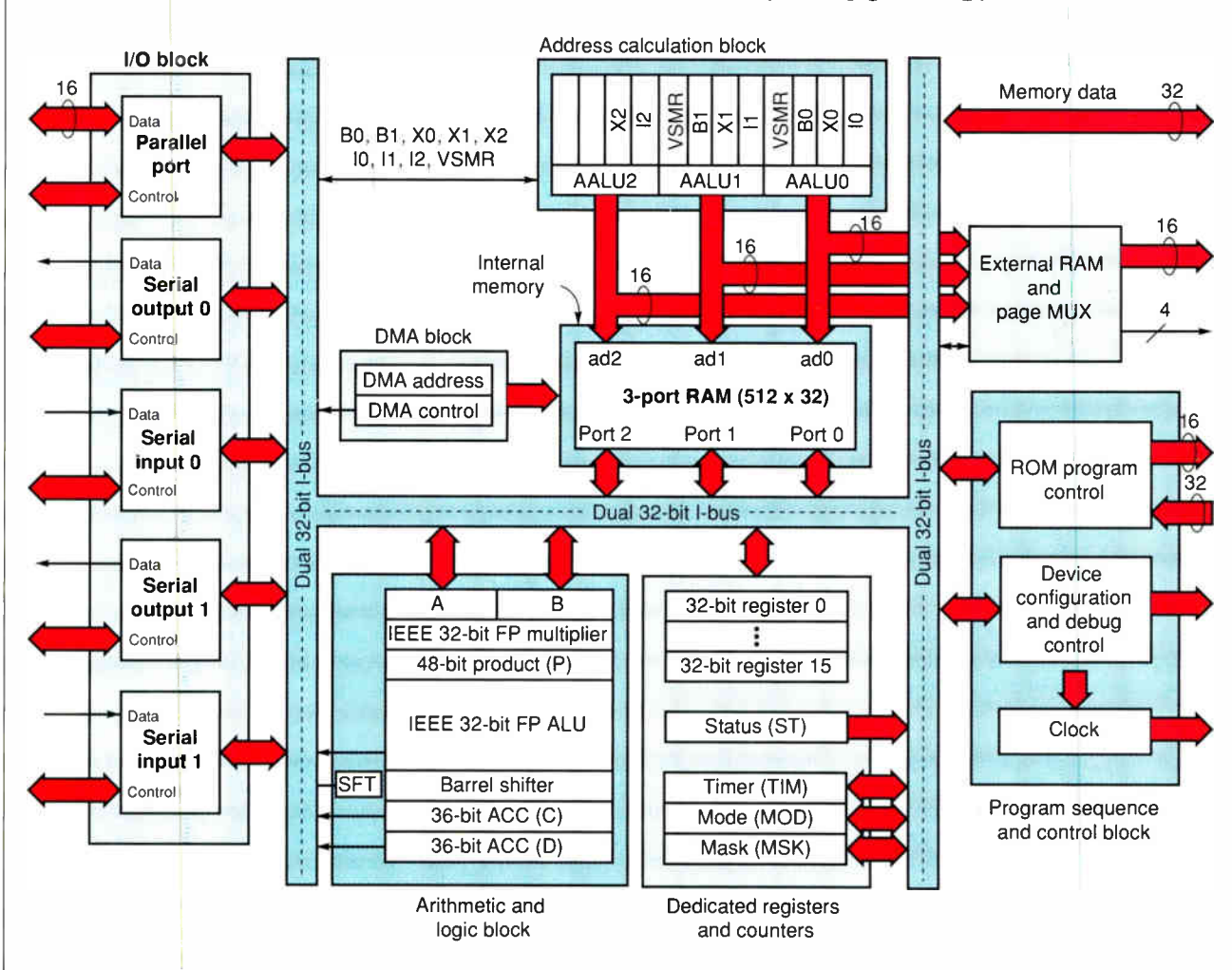
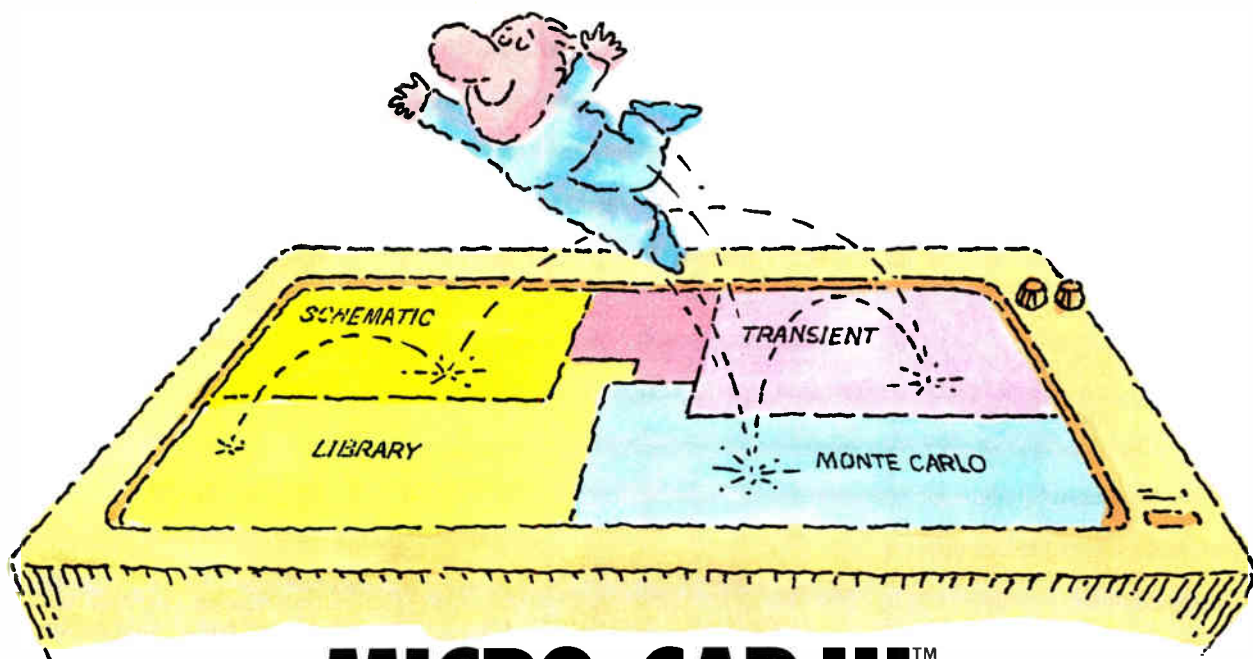

Figure 1: Each core DSP consists of four functional modules: arithmetic and logic, address calculation, program sequence and control, and internal memory. All modules communicate with standard signals. Internal programmable logic arrays decode program instructions and generate control signals.



MICRO-CAP III.™

THIRD-GENERATION INTERACTIVE CIRCUIT ANALYSIS. MORE POWER. MORE SPEED. LESS WORK.

MICRO-CAP III,™ the third generation of the top selling IBM® PC-based interactive CAE tool, adds even more accuracy, speed, and simplicity to circuit design and simulation.

The program's window-based operation and schematic editor make circuit creation a breeze. And super-fast SPICE-like routines mean quick AC, DC, Fourier and transient analysis — right from schematics. You can combine simulations of digital and analog circuits via integrated switch models and macros. And, using stepped component values, rapidly generate multiple plots to fine-tune your circuits.

We've added routines for noise, impedance and conductance — even Monte Carlo routines for statistical analysis of production yield. Plus algebraic formula parsers for plotting almost any desired function.

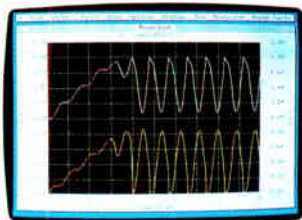

Transient analysis

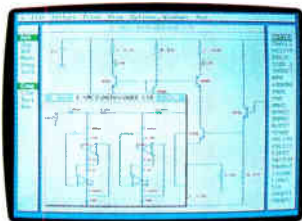

Schematic editor



Monte Carlo analysis

Modeling power leaps upward as well, to Gummel-Poon BJT and Level 3 MOS — supported, of course, by a built-in Parameter Estimation Program and extended standard parts library.

There's support for Hercules®, CGA, MCGA, EGA and VGA displays. Output for laser plotters and printers. And a lot more.

The cost? Just \$1495. Evaluation versions are only \$150.

Naturally, you'll want to call or write for a free brochure and demo disk.

SPECTRUM

1021 S. Wolfe Road,
Sunnyvale, CA 94086
(408) 738-4387

MICRO-CAP III is a registered trademark of Spectrum Software.
Hercules is a registered trademark of Hercules Computer Technology.
IBM is a registered trademark of International Business Machines, Inc.

Circle 298 on Reader Service Card

imaging and machine vision are two other examples.

Aerial imaging and SAR typically use images from two different sensors for scene analysis. A remote sensor, such as an airplane or satellite, usually obtains radar and optical images. Such radar images are usually distorted and need correction before any decision can be made about the identity of the objects appearing in them.

Feature Extraction in Speech

Parameters that provide for a representation of the speech signal include formant frequencies, pitch, and intensity. You can estimate all three accurately and efficiently using techniques such as linear predictive code (LPC) analysis, short-time average magnitude, or homomorphic signal processing.

Formant frequencies, or formants, are the products of a phenomenon similar to the resonance effects observed with organ pipes or wind instruments. As sound propagates down the vocal and nasal tracts, the frequency selectivity of these tube-like organs shapes the frequency spectrum. As a result, certain frequencies are reinforced, and peaks occur in the spectrum of the signal. These peaks are the formant frequencies.

Determining formant frequencies is an essential part of speech analysis, because formants describe the spectral

properties of the speech signal and therefore determine the particular sound that is produced.

When you speak, the glottis generates pulses of air that excite the vocal tract and thereby produce various sounds. The fundamental frequency with which these pulses are released is called the *pitch*; the resulting harmonics are called *pitch har-*

monics. Pitch estimation is one of the most critical problems in speech processing because it provides information about the frequency of the pulses that generate voiced sounds.

The amplitude of the speech signal varies appreciably with time. In particular, the amplitudes of unvoiced segments are generally much lower than the amplitudes of voiced segments. The energy of the speech signal provides a convenient representation that reflects these amplitude variations.

You can use a variety of methods to estimate speech parameters, including LPC analysis. In applying LPC analysis to formant estimation, a set of p predictor coefficients called a_k s are computed by solving a set of linearly independent equations. These equations are represented in matrix form as $A \times x = y$, where A and y are known.

In the popular autocorrelation method, A is a $p \times p$ matrix of the autocorrelation values, x is a size p vector containing the predictor coefficients, and y is a $p \times 1$ vector of autocorrelation values. The autocorrelation sequence is computed directly from sampled speech waveforms.

Independent of the approach used in formulating the above LPC equations, matrix A exhibits useful properties that enable you to compute the predictor coefficient vector x in a robust and efficient manner. For example, if the autocorrelation method is used in setting up the LPC equations, then A is Toeplitz (a symmetric matrix in which all the elements along a given diagonal are equal). This property is exploited to obtain an efficient algorithm with which to solve the LPC equations.

Floating-point DSPs can perform the necessary computations for solving the

continued

P
itch
estimation is
a critical problem in
speech processing.

monics. Pitch estimation is one of the most critical problems in speech processing because it provides information about the frequency of the pulses that generate voiced sounds.

The amplitude of the speech signal varies appreciably with time. In particular, the amplitudes of unvoiced segments are generally much lower than the amplitudes of voiced segments. The energy of the speech signal provides a convenient

Table 1: Each core DSP is optimized for a certain application area. For example, the Type-2 core provides a special I/O interface for digital-audio applications, and the Type-3 core has special registers and a floating-point data format for image-processing applications.

DSP CORES AND FEATURES

Core type	Type-1	Type-2	Type-3
ASIC DSP	MB86220	MB86224	A subset of MB86232
Application	Telecommunications application	Digital audio	Image processing
Machine cycle	75 ns	75 ns	75 ns
Operation speed	13.3 MIPS	13.3 MIPS	13.3 MIPS
Multiplication			
Floating-point:	$(1.8 \times 10^7) \times (1.8 \times 10^7) \rightarrow (2.4 \times 10^7)$	$(1.8 \times 10^7) \times (1.8 \times 10^7) \rightarrow (2.4 \times 10^7)$	$(2.4 \times 10^9) \times (2.4 \times 10^9) \rightarrow (2.4 \times 10^9)$
Fixed:	—	18-bit \times 18-bit \rightarrow 24-bit	24-bit \times 24-bit \rightarrow 32-bit
Internal RAM	256 words \times 24 bits 2-page	256 words \times 24 bits 2-page	256 words \times 32 bits 512 words \times 32 bits
Internal ROM	2 Kwords \times 30 bits	2 Kwords \times 30 bits	2 Kwords \times 32 bits
Package	QFP ¹ 80-pin PGA ² 135-pin	QFP 80-pin	PGA 135-pin
Number of transistors	110K transistors	130K transistors	
Chip size	9.5 mm \times 9.8 mm	9.8 mm \times 10.4 mm	

¹ QFP = Quad flat pack.
² PGA = Pin grid array.

WHAT OUR REMOTE LAN BRIDGE CAN DO FOR YOUR WORLD.



Bringing people and information together is what a Microcom LAN Bridge is all about. And, with our unique MNP[®] Data Compression feature, remote LANs can be connected at unprecedented performance levels. MNP squeezes twice the performance out of your wide-area link compared to other bridges at a fraction of the price.

In fact, the Microcom LAN Bridge is the only remote bridge on earth that uses data compression to move oceans of data between LANs. And, it's the first

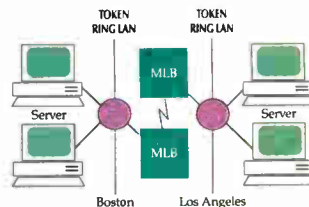

to support Token Ring networks, in addition to the Ethernet LAN standard.

Think about it. A fully integrated transparent MAC-level bridge built around the IBM PC/AT bus. In four fully upgradeable, multi-line models with speeds from 9600 bps to 1.544 Mbps (T-1). And with prices beginning at \$6,198, the only thing a Microcom LAN Bridge can't squeeze is your budget.

The Microcom LAN Bridge. It brings information and people closer together, no matter where in the world they are.

Call toll-free, 800-822-8224 for more information.

500 River Ridge Drive
Norwood, MA 02062

Telex:

710-336-7802 Microcom NWD.

U.S. FAX: 617-551-1006

Worldwide Distribution.

International FAX: 617-551-1007



MNP is a registered trademark of Microcom, Inc. Microcom LAN Bridge and MNP Data Compression are trademarks of Microcom, Inc. IBM Token Ring and IBM AT are trademarks of International Business Machines Corp. Ethernet is a trademark of Xerox, Inc.

Circle 206 on Reader Service Card

Just a Moment

The method of moments is a way of describing the properties of an object in terms of its area, position, orientation, and other noninterpretive parameters (see figure A). Discrete moments are defined by the equation

$$M_{pq} = \sum_i \sum_j x^p y^q f(x,y)$$

where the order of moment equals $p+q$; x,y are pixel coordinates; and $f(x,y)$ represents the pixel brightness function. Zero- and first-order moments can be defined by these equations:

$$M_{00} = \sum_i \sum_j f(x,y)$$

$$M_{10} = \sum_i \sum_j x f(x,y)$$

$$M_{01} = \sum_i \sum_j y f(x,y)$$

In a binary image (black and white), the zero-order moment (M_{00}) is the same as the object's area. Because the object is not usually a single point, a precise definition of the term position must be given. In practice, the center of area, or center of mass (centroid), is used to specify position. The following equations give the centroid:

$$x_c = \frac{M_{10}}{M_{00}}$$

$$y_c = \frac{M_{01}}{M_{00}}$$

Although they are useful for some tasks, zero- and first-order moments prove inadequate when matching objects in the acquired image with objects in the reference image. This is because low-order moments vary according to scale, position, and rotation. Therefore, you must derive invariant moments such as $\phi_1, \phi_2, \dots, \phi_n$ for the object. These moments are unaffected by translation, rotation, and scale change.

Invariant moments also provide more information about the object than do zero- and first-order moments. The added information is useful in helping you to distinguish one object from another that may have similar properties. To compute invariant moments, you need to compute central moments and normalize them. Central moments are

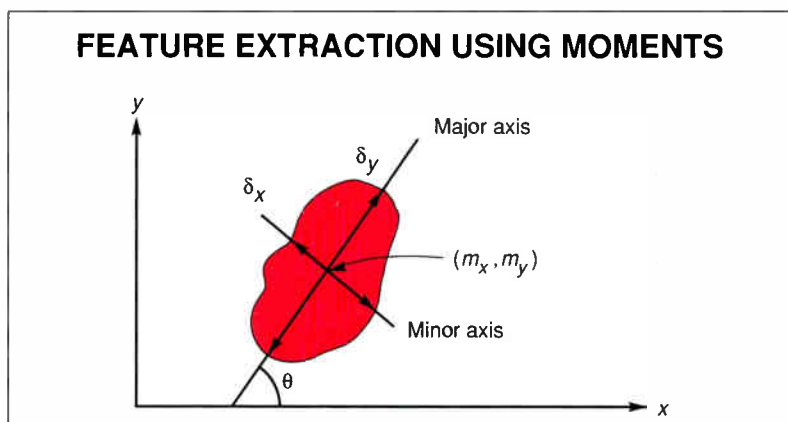

Figure A: The method of moments is a way of describing the properties of an object in terms of its area, position, orientation, and other noninterpretive parameters. Note the calculation for the position of the centroid.

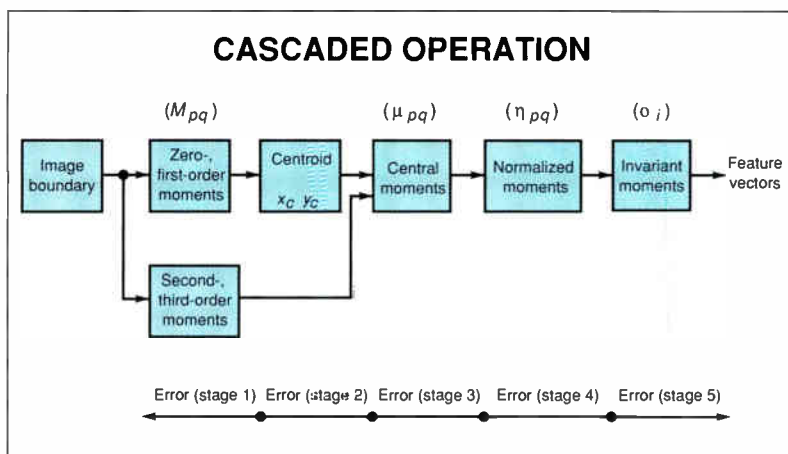

Figure B: Subroutines in computation of invariant moments to create feature vectors. Each subroutine is computationally intensive and sensitive to computational error. However, each stage is connected to the other subroutines; computational errors, propagated through the stages, could have a major impact on system performance.

discrete moments calculated with respect to the centroid. Both central and normalized moments can be derived from the following equations, respectively:

$$\mu_{pq} = \sum_i \sum_j (x-x_0)^p (y-y_0)^q f(x,y)$$

$$\eta_{pq} = \frac{\mu_{pq}}{\mu_{00}^\lambda}$$

where $\lambda = (p+q)/2$.

From second-order normalized moments, you can derive a set of invariant moments:

$$\phi_1 = \eta_{20} + \eta_{02}$$

$$\phi_2 = (\eta_{20} - \eta_{02})^2 + 4\eta_{11}^2$$

Generating invariant moments is a cascaded operation that is particularly prone to generating overflow conditions and is also very sensitive to quantization errors along each stage of computation. As you can see, developing a software program to do these operations would not be a trivial undertaking. The unpredictability of input images and computational inaccuracies also add to the challenge (see figure B).

The large dynamic range provided in

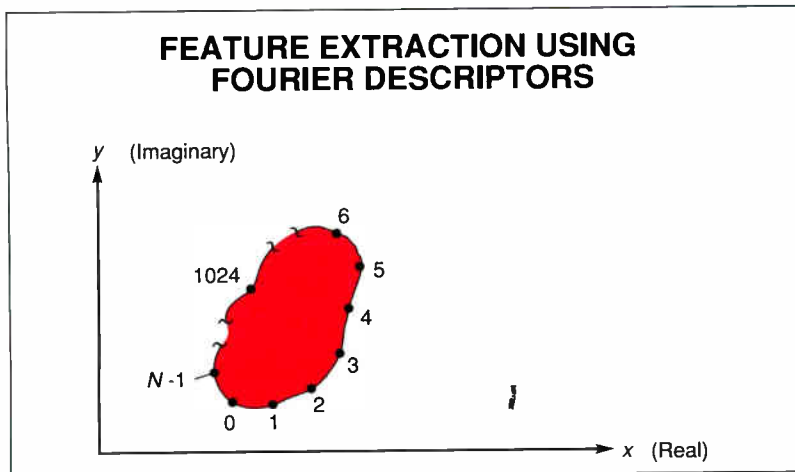

Figure C: Fourier descriptors are a method of extracting information about an object using boundary points. You use the x and y coordinates of these points as the real and imaginary components of a complex number. Then, these complex numbers are used in a Radix-2 fast Fourier transform computation.

IEEE-754 floating-point format (1500 decibels) along with flags for overflow, underflow, near zero, and near infinity, minimize the error along different sections of the system. It also speeds software development time by eliminating the need for scaling routines.

Fourier Descriptors

Fourier descriptors are another method for extracting information about an object. As in moment generation, boundary points are the inputs for Fourier descriptors (see figure C). These boundary points are mapped as imaginary and real points for Fourier analysis. The amplitude spectrum and phase are frequently used as parameters generated by Fourier transformation to distinguish between boundary shapes in the matching process.

The boundary is a series of complex numbers where x and y are the coordinates of points on an object's boundary, and N is the number of points.

$$f(i) = (x_i, y_i); i = 0, 1, 2, \dots, N-1$$

where x_i is the real component and y_i is the imaginary component.

The discrete Fourier transformation of the complex sequence is computed as

$$F(u) = \sum_{k=0}^{N-1} f(k) \exp(-j2\pi \frac{ku}{N})$$

Since $F(u)$ is a complex series, the amplitude spectrum can be computed as

$$|F(u)| = |(\text{Real } F(u))^2 + (\text{Im } F(u))^2|^{1/2}$$

So, the equation of this phase is

$$\phi(u) = \arctan [\text{Im } F(u) / \text{Real } F(u)]$$

For normalized Fourier descriptors, you find the centroid using zero- and first-order moments, then you shift the origin of the existing coordinates to the centroid, and, finally, you compute phase and amplitude.

Fourier descriptors are invariant without requiring further computation. They are also useful because of certain properties in the Fourier domain: easy movement between the spatial and Fourier domains; size changes generated by multiplying by a constant; angle rotations accomplished by a simple multiplication; and translation accomplished by addition.

Broad Applicability

Use of invariant moments has been successfully demonstrated in a wide range of existing applications. In medical technology, there are reports that indicate 98 percent accuracy using invariant moments in identifying malignant tumors in chest x-rays. Similar results are shown in fingerprint recognition and optical character recognition.

LPC equations, arriving at numerical values for predictor coefficients. A sub-routine function that simulates the vocal tract with an all-pole model then calls these coefficients. The output of this model is the spectral estimate of the input speech waveform. You can use lattice filters to implement the model.

If the spectrum is plotted, you should expect to see peaks at the formant frequencies. Thus, LPC analysis can be seen as a method of short-time spectrum estimation. Such techniques are widely applied outside the speech-processing field for this purpose. Once the spectrum is computed, a peak-detection algorithm can be devised to extract the formant frequencies.

LPC analysis is a parametric method of signal processing. In many applications, parametric models exhibit superior performance over nonparametric techniques such as "short-time average magnitude." The steps involved in estimating formant frequencies using LPC (autocorrelation formulation) are autocorrelation sequence calculation, LPC coefficient calculation, system function evaluation, and "peak picking."

In a practical implementation of these steps, most of the number crunching will occur while computing the predictor coefficients. Using the autocorrelation formulation, the number of multiplications required to calculate x is approximately $N + Np + p^2$. The system function is theoretically guaranteed to be stable. Nevertheless, this guarantee may not hold if the autocorrelation function is computed without sufficient accuracy. Then, the round-off encountered in computing the function can cause the autocorrelation matrix to become ill-conditioned.

Shapes and Features in Images

Before you're able to perform high-level image-processing tasks, such as object recognition, you might need several pre-processing steps to improve the quality of the image (i.e., enhancement) and several more to isolate the objects from their background (i.e., segmentation). Usually, segmentation itself involves multiple steps, such as separation, based on intensity, color, and contour edges.

Once you have identified the boundary of an object, you must extract features so that you can describe the object in a form other than that of the set of connected boundary points. In image processing, the most frequently used algorithms in feature extraction are those for invariant moments and Fourier descriptors (for

continued

A Two-Pronged Approach

Sound Processing

Fujitsu Microelectronics' MB86224 uses a floating-point data format (1.8×10^7) that meets typical digital audio requirements (no more than 120 decibels). It is designed to support the I²C bus for high-fidelity digital-audio systems. Its floating-point capability makes it a candidate for carrying out calculations that require high accuracy.

The data format of this chip provides optimum precision and, consequently, minimum round-off error. Its architecture uses pointers to access the data structures. Therefore, it can delay and shift all data points simultaneously by incrementing the address pointer.

Moreover, the MB86224's advanced Harvard architecture and its two-stage pipeline enable the processor to perform floating-point operations at a high speed (6.75 million floating-point operations per second). The chip allows four levels of subroutine nesting in hardware, which increases computation speed by eliminating stack operations.

The MB86224 reduces and eliminates some of the shortcomings of IIR filters, such as limit cycle, quantization error, and instability, by providing 24-bit floating-point and fixed-point arithmetic capability. Also, the MB86224 has an interface that exhibits two-channel I/O capability providing concurrent multiple-speaker identification.

Image Processing

The MB86232 from Fujitsu Microelectronics is specifically designed for graphics and image-processing applications. Based on a two-stage pipeline Harvard-style architecture, it uses separate program and data buses to fetch data and execute an instruction simultaneously. Two internal 32-bit data paths allow faster data transfer within the device.

This chip contains four ALUs: one for arithmetic and logic operations, and three for different address units. These address units can access up to 1 megaword (4 megabytes) of data, 64K bytes of program space, and 512 by 32 bits of internal data memory, all at the same time. The MB86232 also features register files where temporary data can be kept for an immediate operation.

The MB86232 is also a 32-bit floating-point digital signal processor capable of performing 24-bit integer and 32-

bit fixed-point multiply accumulate (MAC) in a single cycle (75 nanoseconds). Thus, for applications where the incoming signal is an integer, you don't need to convert it to floating-point. Using other existing floating-point DSPs requires routines to convert integer data into floating-point and vice versa.

For example, a 512- by 512-pixel image requires a 512 by 512 data-format conversion. Once the image is convolved with a 3×3 mask in floating-point format, the output image needs to be reformatted again (8 bits for gray scale, 24 bits for color) for display purposes. Regardless of the time spent in convolution, extra time is wasted in converting from one format to the other, twice. Consequently, the implementation speed of such preprocessing is half to one-third that of the MB86232.

The MB86232 fully conforms to the IEEE-754 floating-point standard and makes overall system design easier by providing compatibility with existing hardware components and transportability for many software programs that use the standard. It implements moment calculations.

To facilitate complex I/O functions and keep the hardware/software aspect simple, the MB86232 provides two serial inputs, two serial outputs, and one parallel port. The serial ports are programmable for 8-, 24-, and 32-bit data formats.

Up to 16 MB86232s can be linked together via message passing, a unique feature of the MB86232 parallel port for multiprocessing tasks used in pattern-recognition systems.

The MB86232 is Fujitsu's high-end 32-bit floating-point DSP. It offers dual-accumulation capability (i.e., two ALU accumulators), which makes this chip suitable for geometric correction computations. (The MB86232 assembly code for implementing the geometric correction procedure is available from Fujitsu.)

The advantage of having two accumulators for carrying out such computations lies in the fact that the two coordinates can be computed in a semiparallel mode by jumping back and forth between the equations, keeping the intermediate results inside the pipeline, and the sum of individual products in different accumulators. All MAC functions can be done with either accumulator.

more details on these algorithms, see the text box "Just a Moment" on page 268).

DSP ICs

In the past, due to the density of data and the large amount of computation involved, feature extraction was best performed on mainframes or minicomputers. The emergence of VLSI chips that support IEEE floating-point math provides an architecture that supplies feature-extraction capabilities on a microcomputer. This architecture performs parallel operations in a pipelined fashion. It multiplies and adds rapidly (in a 75-nanosecond instruction cycle), which is essential for filtering, moment, and Fourier analysis. It generates complex addressing, such as bit-reversed and circular for complex Fourier transforms. It performs full IEEE floating-point arithmetic and logic operations.

The IEEE-754 format is the accepted standard among 32-bit CPUs, math coprocessors, and many high-performance support ICs. Fujitsu Microelectronics has developed IEEE-standard floating-point ASIC DSPs for sound and image processing. Two of these chips are described in the text box "A Two-Pronged Approach."

Pattern-Recognition Architecture

Floating-point DSPs have been shown to provide enormous benefits in implementing preprocessing and feature-extraction algorithms used for sound and image processing. Some key advantages of floating-point ASIC DSPs in these massive number-crunching operations are high-precision arithmetic capability, special addressing modes (e.g., direct, indirect, bit-reversed, circular, and indexed), and software programmability. Performing pattern recognition with floating-point DSPs also has some advantages.

Pattern-recognition systems require a high data transfer rate, which ASIC DSPs support through multiple data paths within the device (two 32-bit internal data buses), several serial and parallel I/O ports, and direct memory access (DMA) capabilities.

In speech-recognition systems, DSPs have been used for digital simulation of neural networks. Four of them are configured in a ring-lattice, multiple-instruction multiple-data, neural network architecture used in an accelerator board for personal computers. In image-processing systems, you can partition images as well as tasks and assign various parts of them to several DSPs to

continued

Introducing the everything- but-the-kitchen sync.



Presenting a multiscanning color monitor so advanced it's compatible with virtually all the video standards to date. And with video standards to come, like SuperVGA and IBM® 8514/A.

It's the C1391 PanaSync™ color monitor. And whether your office PCs are running Hercules™, CGA, EGA or VGA, this 14" Panasonic® monitor will display each to its best advantage.

Of course, the PanaSync monitor is comfortable in virtually any IBM or [with an optional cable] Apple Mac™ II environment. And we've given as much thought to your comfort, as well. With an ergonomic design. Featuring front-mounted controls. Tilt/swivel stand. And text color switching from green to amber to paper white in TTL modes. The affordable PanaSync C1391 monitor. The future on display.

For more information, or the name of your authorized dealer, call toll-free **1-800-742-8086**.

*Peripherals, Computers, Printers, Copiers
Typewriters and Facsimiles*

Panasonic
Office Automation 

PanaPro™ Monochrome Desktop Publishing Monitors



PanaSync™
Multiscanning Color
Monitor



IBM is a registered trademark of International Business Machines Corporation. Mac II is a trademark of Apple Computer, Inc. Hercules is a trademark of Hercules Computer Technology.

Circle 241 on Reader Service Card

Glossary

Adaptive filtering A class of filters whose coefficients are updated according to a performance criterion.

All-pole model A system model whose characteristics are independent of the numerator, which is constant, but rather are a function of the poles in the denominator.

Autocorrelation A mathematical representation of the degree of correlation between signal samples.

Bilinear interpolation A method by which an interim missing sample is estimated as a combination of known adjacent (i.e., in orthogonal directions) samples.

Bit-reversed addressing An addressing mode that facilitates in-place fast Fourier transform computations by reordering the addresses for input or output data in "butterfly" calculations.

Bit-slice processors A group of general-purpose processors that allow for change in the data and instruction size by cascading several ICs.

Circular addressing An addressing method in which recurrent data is read from the same memory locations previously used, thereby reducing required memory size.

Convolver A hardware device that performs convolution.

Correlation The degree of interrelation between two signals.

Correlator A hardware device that performs correlation.

FIR filter Finite impulse response filter: a class of filters that have finite-duration unit-pulse response. The output of an FIR filter is a function of input data and filter coefficients only.

Formants The resonance frequencies of the vocal-tract tube.

Homomorphic analysis A nonlinear operation using the superposition property of convolution to extract the original components of a signal.

I²C An industry-standard serial-communications protocol developed by Philips Corp.

IIR filter Infinite-duration impulse response filter: Filters whose output is a function of input data, filter coefficients, and previous output values.

Ill-conditioned matrix A matrix whose determinant closely approaches zero. Therefore, small perturbations may cause the matrix to become noninvertible.

Limit-cycle A problem associated with recursion, causing a filter to behave in a nonlinear manner.

Linear predictive analysis A technique by which a signal sample $s(n)$ is predicted from the sum of p linearly weighted previous values.

Moments Statistical parameters that describe the shape of a distribution function. They are used in mechanical physics and image processing.

Nyquist frequency Minimum sampling rate required to prevent aliasing (overlapping) of signal frequencies. It is greater than or equal to twice the maximum input frequency.

128-FIR An FIR filter with $N=128$ (128 "taps").

Parametric method Describing a signal in terms of a set of parameters.

Pitch Fundamental frequency of the harmonics exhibited by the spectrum of the glottal-air volume and velocity.

Quantization error Error caused by representing a number with a limited number of bits, which results in reduced precision.

Radix-2 FFT A fast Fourier transform algorithm that uses two inputs and two outputs for each butterfly computation.

Short-time average magnitude A method of representing amplitude variations of a signal segment in time domain by summing the absolute values of intensities over a finite time interval.

Time-domain convolution A process that modifies a signal by multiplying it with a function, followed by integration over a specified time interval.

increase the overall speed. Communication between different modules can become a significant design hurdle in both software and hardware.

Communication between several DSPs can be accomplished using a parallel port. Each DSP has a unique identification number represented in 4 bits. When the parallel port is receiving, it checks the first 4 bits of the data packet (unit identification). If the internal identification matches this ID number, then it receives the rest of the information. In transmit mode, the DSP sends the ID number associated with the destination DSP, followed by the data. This operation is called message passing.

Maximum Flexibility

Several ASIC DSP devices have been developed for telecommunications, sound processing, and image processing. These devices provide maximum flexibility in system design: They are software-programmable as well as hardware-reconfigurable.

The floating-point capability of these devices provides superb quality of sound and images in existing applications and has paved the way for analyzing sound and images as well. ■

Editor's note: Various DSP assembly language programs are available on BIX. See page 5 for details.

ACKNOWLEDGMENT

I would like to thank my colleagues at Fujitsu Microelectronics, Inc., especially Shervin Kheradpir and Donna White, for their full support in helping me prepare this article.

Bobby Saffari is a senior applications engineer at Fujitsu Microelectronics, Inc. (San Jose, CA), where he is responsible for supporting Fujitsu's digital signal processors and development tools. He holds B.S.E.E. and M.S.E.E. degrees in signal processing and computer architecture from California State University at Northridge. He can be reached on BIX c/o "editors."

This is all
the space
you need
to operate
the new
Microsoft
Mouse.

Here's the first thing you should do with the new Microsoft® Mouse.

Bring up the expanded control panel. Set it for "Fast." And then, with a very slight movement of your hand, watch the cursor scoot all the way across the screen.

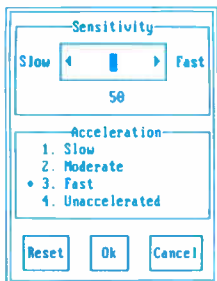

You're in complete and total control with the new, expanded control panel.

To help even more with accuracy, the tracking ball is in front. And the patented design fits comfortably in your hand.

What it all means is you get more out of your software. By being able to quickly and efficiently click through even the most sophisticated applications.

In fact, we put OS/2 support in our up-

graded driver. Making the Mouse ready for whatever the future of software brings.

To complete the package, you also get a choice of Microsoft Windows/286™ or Microsoft Paintbrush™, two valuable Mouse programs.

So visit your Microsoft dealer for more details and a complete demonstration.

Now, you may not want to let your boss know just how little room you need for a Microsoft Mouse. You could lose your shot at a bigger desk.



Microsoft®
Making it all make sense™

The HP DeskJet PL

300 DPI, inkjet printing.

NEW WORLD PRODUCTS CO.

Whisper-quiet.

September 7, 1989

Ms. Vickie Merkel
1010 Battery Street
San Francisco, CA 94111

1845 Broadway Avenue
San Francisco, CA 94109
415 555-4731

Dear Ms. Merkel:

Thank you for your interest in the New World Products Company. I don't normally respond to unsolicited queries, especially in light of the recent decline in venture capital (see chart). But I noticed from your sharp text and graphics that you printed your letter with the HP DeskJet PLUS printer. It made your excellent product suggestions seem even better.

In fact, we're interested in developing many of those products. For example, the new uses for our enormous supply of polymer and the repositioning of our line of insecticides. Your thinking is very impressive as is the presentation of your ideas.

So please call me at your earliest convenience and we can meet to discuss the terms of your contract. Welcome aboard!

Sincerely,

William J. Reiser
William Reiser
Vice President
Research and Development

WR:tm

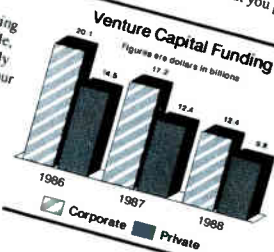

3 pages per minute.

Sharp graphics.

*Suggested U.S. list price. Document created using Microsoft® Word 5.0 and Microsoft Graph Plus. Microsoft is a registered trademark of Microsoft Corp. © 1989 Hewlett-Packard Company PE12924

It prints copy that looks like a connect-the-dots game. And it sounds like a war zone. The dot matrix printer. Why put up with it?

The HP DeskJet PLUS printer uses advanced inkjet technology to deliver

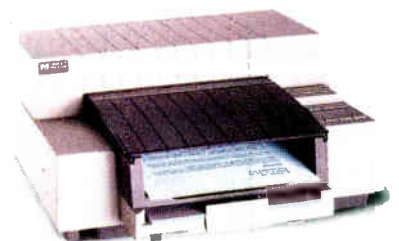

The \$995* HP DeskJet PLUS printer.

JS vs. the dot matrix printer.

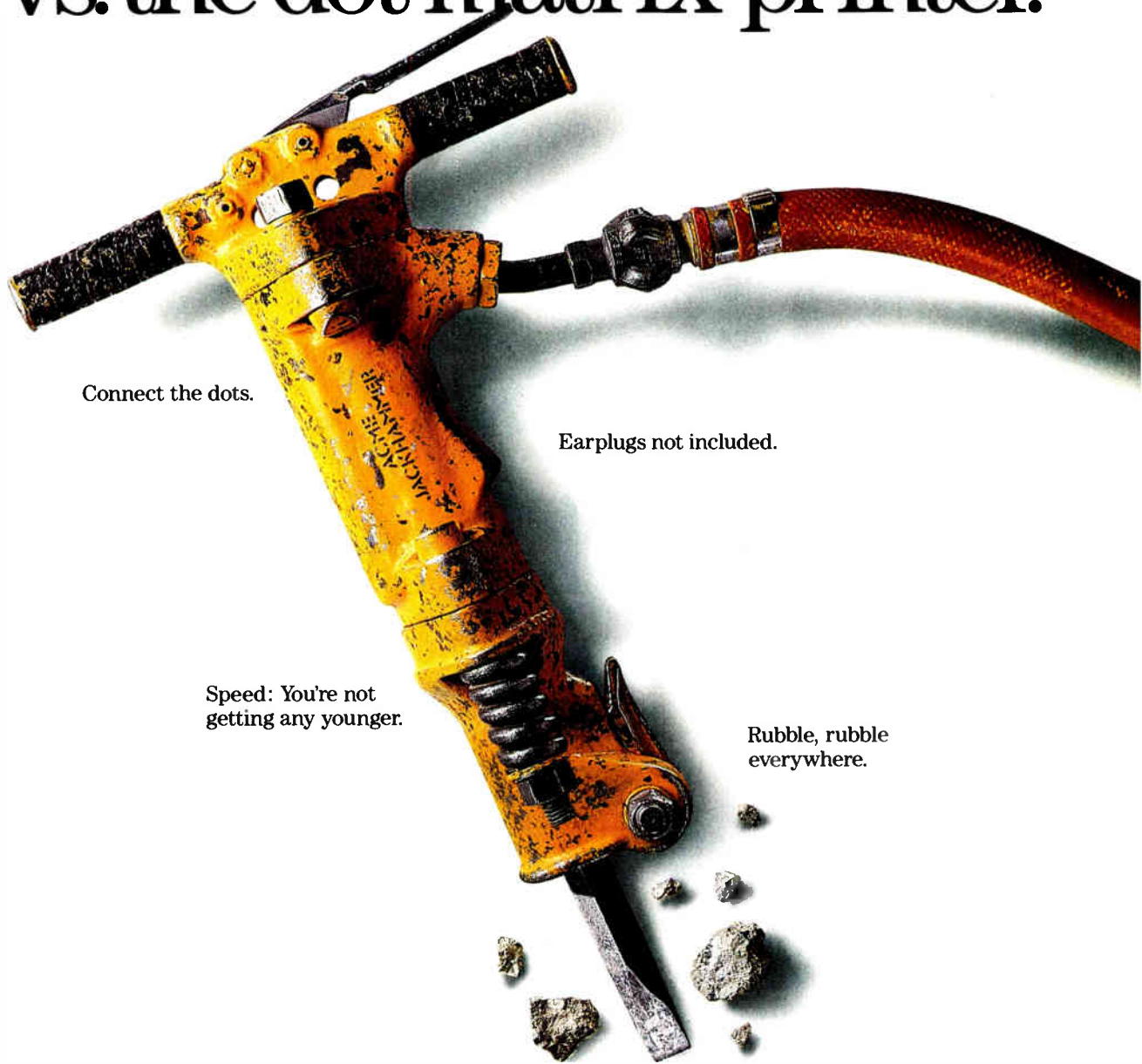

Connect the dots.

Earplugs not included.

Speed: You're not getting any younger.

Rubble, rubble everywhere.

laser-quality text and graphics. It's also compact. And very quiet.

And at only \$995, it could spell the end for most dot matrix printers. Because there's hardly a printing job that DeskJet PLUS can't do

faster, quieter and better. It's even reliable enough to carry a 20,000-hour MTBF rating.

Of course, DeskJet PLUS works with all your major software and with any IBM-compatible PC. So call 1-800-752-0900, Ext. 712J

for your nearest authorized HP dealer and see for yourself. There's no comparison.

There is a better way.



**HEWLETT
PACKARD**

Circle 152 on Reader Service Card

World Radio History



Introducing a better way to protect your whole family.

New network savers from Emerson UPS.

However you use your network, a file server power problem can really cost you. In downtime. Lost data. And frustration.



That's why we've introduced two new Novell-compatible uninterruptible power systems (UPS) designed specifically to protect your file server, your whole network and your data.

They're compact enough to fit under a desk. Powerful enough for a file server or your entire LAN—even those with multiple drives and terminals.

And they're priced less than even one hour of downtime.

Available through your local Distributor: Pioneer Technologies Group (800) 227-1693, Avnet Computer Technologies (800) 877-2226, RMA Microtech (314) 726-0195.

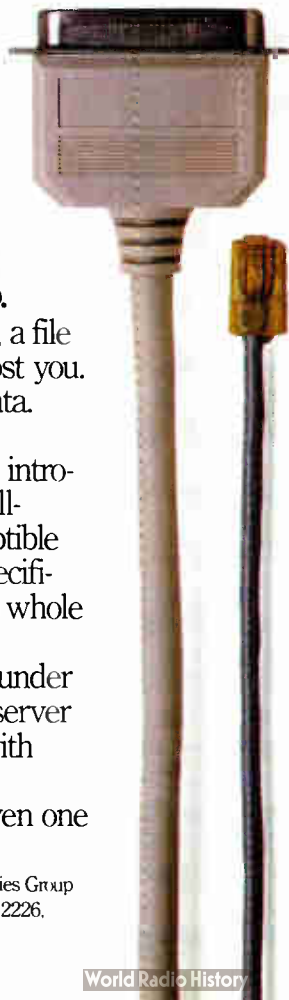

Most important, the UPS 600 and UPS 1250 come from Emerson, the most reliable name in computer power protection. Backed by a network of support from local dealers and distributors. And nationwide service from the leading supplier of UPS systems.



See how easy it can be to protect your whole family. Just call us at 1-800-Back-UPS today.

EMERSON UPS
We protect the ones you love.

© 1989 Emerson Computer Power, a division of the Emerson Electric Co.

Circle 119 on Reader Service Card (DEALERS: 120)

Beyond Pattern Recognition

Practical voice-to-text systems rely as much on knowledge engineering as on speech-recognition technology

Raymond Kurzweil

Creating written documents is an activity practiced by almost everyone in offices, schools, and homes. Tens of billions of dollars are spent each year in creating original written works, from interoffice memoranda to multivolume reference works. In fact, just copying all these documents is a \$25-billion-a-year industry.

For most people, creating written documents is an arduous task. Automating this task by dictating to a computer-based machine and seeing it appear on-screen has obvious advantages over conventional methods in terms of speed, accuracy, and convenience.

A substantial part of many professionals' jobs involves creating routine reports, including memos, letters, and E-mail. A routine report differs from other documents in that it has a predictable—but not rigid—structure and an internal logic to its organization. The underlying framework of structure and logic can be exploited in the design of an automated voice-to-text system.

Hunt and Peck

Current methods for text creation are fundamentally inefficient and often in-

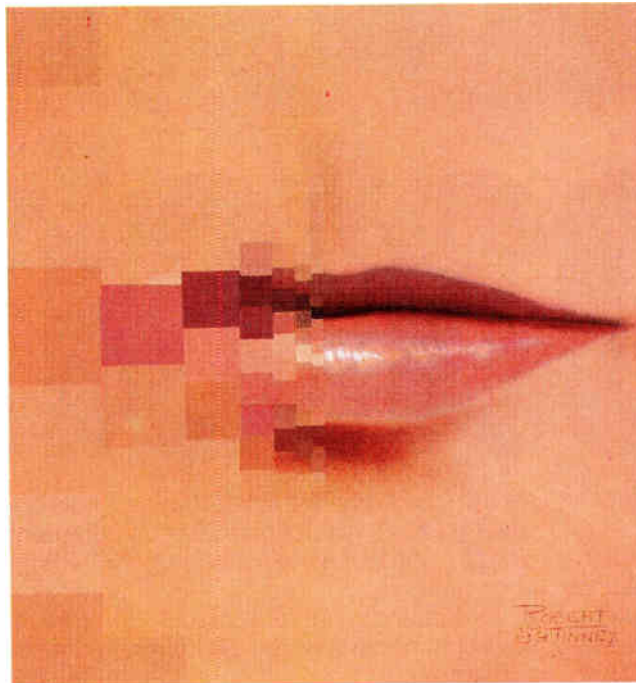

adequate for the job. The vast majority of professionals do not possess good typing skills; they must choose between handwriting, hunt-and-peck typing, or dictating to tape. All these approaches have obvious limitations.

Writing drafts by hand or by hunt-and-peck typing is slow; actual throughput is generally under 10 words per minute. Then comes the time-consuming cycle of

correction and editing as the draft is typed or entered into a word processor. Errors are often introduced due to poor legibility. Turnaround time can be days, depending on the number of correction cycles and the typist's workload and knowledge level.

When dictating to a secretary or tape, most people find it difficult to create text because they can't see what they are doing. It's hard to create a document of even moderate complexity without being able to view the text that has already been composed. In addition, conventional dictation requires substantial clerical time, as well as follow-up edit and review by the text creator. Skilled transcriptionists, especially those in the medical, legal, or technical fields, are increasingly hard to find.

Transcription costs—particularly during evenings, vacations, and weekends—can be prohibitive.

Look Ma, No Keyboard

Report creation on a computer screen with automatic speech recognition (ASR) technology provides significant productivity gains compared with the other methods available.

continued

Quit bitching about batch.

Now you can eliminate 90% of your batch file problems for \$99.95.

The Builder™ is the first compiler that transforms sluggish batch files into blazingly fast .COM and .EXE files. Not only does it give you turbo language speed, it extends the DOS batch language with over 50 new commands and keywords.

For example, menu commands like *DropDown*, *PopUp*, and *LookAndFeel*

are built into the language, so you can quickly produce an unlimited number of programs, and distribute as many copies as you wish.

The Builder also includes a powerful editor to provide an integrated development environment.

And it's the perfect tool for creating installation scripts. The Builder has DOS dexterity that BASIC and C can't match.

And its small compiled code size won't hog memory or disk space.

What's more, by compiling a program with The Builder before you distribute it, you'll have bulletproof security.

Don't keep bitching about batch. Order The Builder today.

Call **1-800-873-9993** for complete details. Visa and Mastercard are welcome. Shipping and handling are free.

THE BUILDER

What batch files should have been in the first place.

Hyperkinetic, inc. 666 Baker Street, Suite 405, Costa Mesa, California 92626 (800) 873-9993 (714) 668-9234 FAX: (714) 979-2813

Circle 157 on Reader Service Card (DEALERS: 158)

World Radio History

AN ASR-GENERATED MAMMOGRAPHY REPORT

SAY	DISPLAY
"today's date" "mammography" "bilateral"	4/11/1989 MAMMOGRAPHY (bilateral)
"routine"	A low-dose film technique was used. Cephalocaudad and modified lateral views were obtained.
"diffuse nodularity"	Both breasts show a very prominent duct pattern with diffuse nodularity throughout. Such diffuse nodularity makes the breasts difficult to evaluate.
"no focal lesions"	There are no dominant masses or clustered calcifications on either side.
"obtain outside study"	The patient gives a history of pre- vious mammography elsewhere. If these could be obtained for com- parison, it would be helpful to ex- clude any interval change.
"signature"	John H. Jones, M.D. 9:18:22 5/25/1989

Using automatic speech recognition (ASR), creating this routine mammography report required less than 30 seconds and only eight spoken words and phrases.

The spoken word is probably the most powerful mode of communication. It is the first method you learn, and human factors studies confirm that it is by far the most rapid form of communication.

Creating reports with ASR combines the speed advantage of dictation with the immediate inspection and correction of handwriting. It is four to six times faster than writing drafts by hand or hunt-and-peck typing. Even for the minority of professionals who type well, ASR is a faster way to get the report-writing job done. It eliminates all the follow-up steps because a final report—the ultimate goal—can be created in a single step. ASR report creation eliminates the cost of transcription and is available around the clock, seven days a week.

ASR report creation is of special value to people hampered by such transcription problems as high cost, slow turnaround, and poor overall report quality. Two fields where ASR has been put to outstanding use since 1987 are radiology and emergency medicine. See the figure for an example of a routine medical report that can now be created in less than a minute using voice technology.

The potential for large-vocabulary ASR is enormous given the number of people who regularly produce routine re-

ports. Other likely application areas for early implementation of ASR include pathology and surgical notes in health care, law, and certain financial services, such as real estate and insurance.

Speech Facts

Speech is created by the human vocal tract which, like a complex musical instrument, has a number of different ways of shaping sound. The vocal cords vibrate, creating a distinctively pitched sound. The length and tautness of the vocal cords determines the pitch in the same way that the length and tautness of a violin or piano string determines its pitch. You can control the tautness of your vocal cords, giving you the ability to sing. You shape the overtones produced by your vibrating vocal cords by moving your tongue, teeth, and lips, which has the effect of changing the vocal tract's shape.

The vocal tract is a chamber that acts like the pipes in a pipe organ; the harmonic resonances emphasize certain overtones while diminishing others. You also control a small piece of tissue called the *alveolar flap*, which opens and closes the nasal cavity. When the alveolar flap is open, the nasal cavity provides an

continued

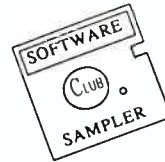

SOFTWARE SAMPLER CLUB

is giving away

\$250,000.00

in Bonus Gifts

to SSC members before Dec. 31, '89

If you own an IBM PC/AT/386 or Compatible computer, you must join the Software Sampler Club.

As an SSC member, you can

- * Save thousands of dollars on your commercial software purchases.
- * Influence the development of future software products.
- * Receive FREE SOFTWARE and SSC NEWS.
- * Be accurately informed about new software being marketed.

Yes, I want more information about Software Sampler Club.

Please send me:

- SSC Demo diskette
- SSC IBM PC Software Product Catalog

FREE - NO OBLIGATION

Name: _____

Address: _____

City: _____

State: _____ Zip: _____

Telephone: _____

Software Sampler Club

16580 Harbor Blvd., Ste. D,
Fountain Valley, CA 92708
(714) 775-0695, Fax: (714) 531-8546

Attention: Computer Dealers please ask us about our "SSC Authorized Dealer Guaranteed Sales" program.

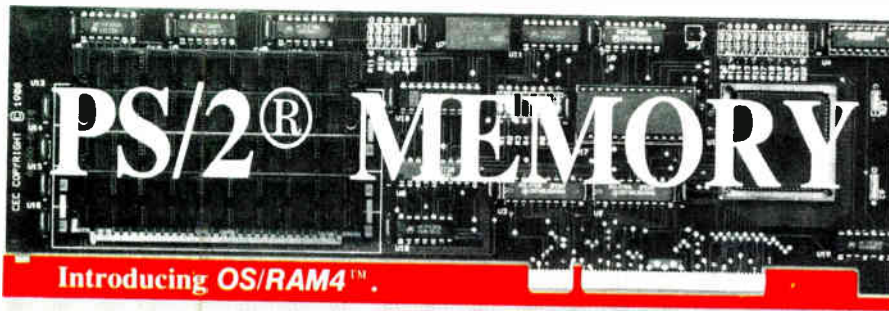

- ✓ 4 megabytes of memory.
- ✓ Extended and expanded memory. LIM 4.0.
- ✓ Works with all of your programs.
- ✓ Run DOS or OS/2 effortlessly.
- ✓ Fast and simple switchless installation.
- ✓ Auto-configuration for all operating systems.
- ✓ Works in all Micro Channel™ computers.
- ✓ Expanded memory 10 times faster than Intel.
- ✓ Risk free guarantee. Two year warranty.
- ✓ IBM approved ID. \$349 0K.

Call today 1-800-234-4232 or 617-273-1818



Capital Equipment Corp.
Burlington, MA. 01803

PS/2 and Micro Channel are trademarks of IBM

additional resonant chamber similar to the opening of another organ pipe.

In addition to the pitched sound produced by the vocal cords, you can produce a noise-like sound by the rush of air through the speech cavity as well as by the action of your tongue and lips. This sound doesn't have specific overtones but is, rather, a complex spectrum of many frequencies mixed together. Like the musical tones produced by the vocal cords, these noise sounds are also shaped by the changing resonances of the moving vocal tract.

The elements of your vocal tract allow you to create the varied sounds that comprise human speech. While many animals communicate with others of their species with sound, humans are unique in their ability to shape sound into language. Vowel sounds (*ahh, eee, etc.*), for example, are produced by shaping the overtones from the vocal cords into distinct frequency bands called *formants*. Sibilant sounds (*s, z, etc.*) are created by the rush of air through particular configurations of tongue and teeth. Plosive consonants (*p, t, k, etc.*) are transitory sounds created by the percussive movement of lips, tongue, and mouth cavity. Nasal sounds (*n* and *m*) are created by resonances of the nasal cavity.

Each of the several dozen basic sounds, called *phonemes*, requires an in-

tricate movement involving precise coordination of the vocal cords, alveolar flap, tongue, lips, and teeth. Humans typically speak about three words per second, so, with an average of six phonemes per word, you make about 18 complex phonetic gestures each second. You do this without thinking about it, of course: Thoughts remain on the conceptual (i.e., highest) level of the language hierarchy. You did, however, think a lot about how to make speech sounds—and how to string them together meaningfully—in the first two years of life. This is another example of the sequential (logical) conscious mind training our parallel (pattern-recognition) mind.

The mechanisms described above for creating speech sounds—vocal-cord vibrations, the noise of rushing air, articulatory gestures of the mouth and tongue, the shaping of the vocal and nasal cavities—produce different rates of vibration. A physicist measures these rates of vibration as frequencies; humans perceive them as pitches. So, while speech is considered to be a single time-varying sound, it is actually a composition of many different sounds, each of which has a different frequency or pitch.

Automated Listening

With this insight into how human speech works, most ASR systems start by break-

ing up the speech waveform into a number of different frequency bands. A typical commercial or research ASR system will produce between three and several dozen frequency bands. The "front end" of the human auditory system does exactly the same thing. Each of the nerve endings in the cochlea (inner ear) responds to different frequencies and emits a pulsed digital signal when activated. Overall, the cochlea differentiates several thousand overlapping frequency bands, giving the human auditory system its extremely high degree of sensitivity to frequency. Experiments have shown that increasing the number of overlapping frequency bands in an ASR system—and thus bringing it closer to the human auditory system—substantially increases the ability of that system to recognize human speech.

Typically, parallel processing is used in this front-end frequency analysis, although not as massively as in vision systems, since the quantity of data is much smaller. (To approach the thousands of frequency bands used by the human auditory system would require massive parallel processing.) Once the speech signal has been transformed into the frequency domain, it is *normalized* (adjusted) to remove the effects of loudness and background noise. At this point, the system can detect a number of features of the frequency-band signals, as well as consider the problems of segmentation and labeling.

One popular detection technique is minimal property extraction. The feature set can be either the normalized frequency data itself or various transformations of this data. In matching such minimal property sets, the system needs to consider the phenomenon of *nonlinear time compression*. When you speak, you change your speed, depending on context and other factors. If you speak a word more quickly, you do not increase the rate evenly throughout the entire word. The duration of certain portions of the word, such as plosive consonants, will remain fairly constant, while other portions, such as vowels, will undergo most of the change.

In matching a spoken word to a stored template, the system needs to align the corresponding acoustic events, or the match will never succeed. This problem is similar to matching visual cues in fusing the stereo images from your two eyes. A mathematical technique called *dynamic programming* has been developed to accomplish this temporal alignment.

High-level features are also used in

BEYOND PATTERN RECOGNITION

ASR systems. Speech is made up of strings of phonemes, which comprise the basic "alphabet" of spoken language. In English, there are about 16 vowel and 24 consonant sounds; for the most part, the Japanese language uses only five vowel and 15 consonant sounds. The nature of a particular phoneme—such as *ahh*—is an abstract concept, just as the inherent nature of a printed character—such as *A*—cannot be simply defined. Identifying phonemes in human speech requires intelligent algorithms and recognition of high-level features similar to the recognition of the loops and concavities found in printed characters.

The task of segmenting speech into distinct time slices representing different phonemes is also formidable. The time-varying spectrum of frequencies characterizing a phoneme in one context may be dramatically different in another. In fact, in many instances, no time slice corresponding to a particular phoneme can be found; the phoneme is detected only by the subtle influence it has on phonemes around it.

As in vision and character recognition, both high- and low-level features have value in speech-recognition systems. In recognizing a relatively small vocabulary (e.g., a few hundred words) for a single speaker, low-level feature detection and template matching—using dynamic programming—is usually sufficient. Most small-vocabulary techniques use this approach. For the more advanced systems, a combination of techniques is usually required—generally multiple experts and an expert manager who knows the strengths and weaknesses of each.

High-level context experts are also vital for large-vocabulary systems. For example, phonemes must appear in a certain order; many sequences are impossible to articulate (try saying *ptkee*). More important, only certain phoneme sequences will correspond to a word or word fragment in the language. On a higher level, the syntax and semantics of the language put constraints on possible word orders. While the set of phonemes is similar from one language to another, context factors differ dramatically. English, for example, has over 10,000 legal syllables, whereas Japanese has only 120.

Learning is also vital in speech recognition. Adaptation to the particular characteristics of each speaker is a powerful technique in each stage of processing. Learning must take place on a number of different levels: the frequency and time relationships characterizing each pho-

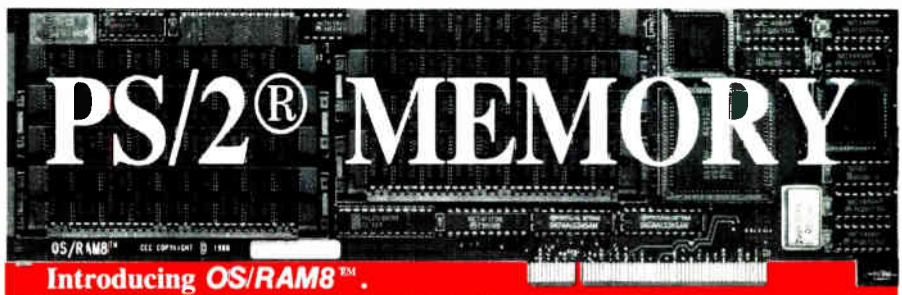

- 8 Mbytes of memory + 2 serial ports.
 - Extended and expanded memory. LIM 4.0.
 - Works with all of your programs.
 - Run DOS or OS/2 effortlessly.
 - Fast and simple switchless installation.
 - Auto-configuration for all operating systems.
 - Works in all Micro Channel™ computers.
 - Expanded memory 10 times faster than Intel.
 - Risk free guarantee. Two year warranty.
 - IBM approved ID. Best price. Fast delivery.
- Call today 1-800-234-4232 or 617-273-1818



Capital Equipment Corp.
Burlington, MA. 01803

PS/2 and Micro Channel are trademarks of IBM

neme, the dialect (pronunciation) patterns of each word, and the syntactic patterns of possible phrases and sentences.

Speech recognition encompasses the full paradigm of pattern recognition: parallel processing in the front end, segmentation and labeling, multiple experts on both high and low levels, expert management, disambiguation by context experts, and learning from actual recognition examples. But while the paradigm is the same, the content is dramatically different. Only a small portion of the technology in a successful ASR system consists of classic pattern-recognition techniques; the bulk of it consists of extensive knowledge about the nature of human speech and language—the shape of speech sounds and the syntax, semantics, and phonology of spoken language.

ASR Parameters

Three fundamental attributes characterize a particular ASR system: vocabulary size, training requirements, and ability to handle continuous speech.

Vocabulary size indicates the number of different words that a system can handle at one time. Text creation requires a large basic vocabulary as well as the ability to add additional words to the active personal vocabulary of each user. For most applications other than free-form text creation, small vocabularies suffice.

Most ASR systems require you to train the system on your own particular pronunciation patterns. Typically, you provide the system with one or more spoken samples of each word in the vocabulary. However, for large-vocabulary systems, speaking every word in the vocabulary is often not practical. It is preferable that the ASR system can infer how you are likely to sound words that you have never actually spoken to the machine. Then, you need to train the system on only a subset of the full vocabulary.

Some small-vocabulary systems have been preprogrammed with all the dialectic patterns anticipated from the population expected to use the system and thus don't require any prior training by each user. This capability, called *speaker independence*, is generally required for telephone-based systems where many users can access a single system.

Most commercial systems to date require you to speak with brief pauses—usually around 100 milliseconds—between words. This helps the system make a crucial segmentation decision—where words start and end. Speaking with such pauses reduces the speed of a typical speaker by 20 to 50 percent. ASR systems that can handle continuous speech exist, but they are currently limited to small vocabularies. Continuous-speech

continued

LAPTOPS FROM QUILL PRICES YOU WANT—BACKED

4 Brands—16 Models to Choose From—All at Big Discount Prices to Save You Hundreds of Dollars!



**TOSHIBA
T1000
AS LOW AS
\$749.99**

TOSHIBA T1000 Truly affordable, truly portable—weighs less than 7 lbs.—and IBM compatible! Expandable to 640KB of memory. Built-in 720KB diskette drive for generous storage capacity with 3½" diskettes. Crisp and bright supertwist LCD display with 640 x 200 bit-mapped graphics. Wt. 6.4 lbs.

NEC ProSpeed™ 286 The fastest 16 MHz 80286 battery-powered portable laptop computer on the market. High performance for the most demanding applications and graphics. Up to 5MB of internal main memory. High-speed 20, 40 or 100MB hard disk options. Advanced VGA display. Brilliant black and white Monograph™ CTN screen. Wt. 15 lbs. with AC adaptor.

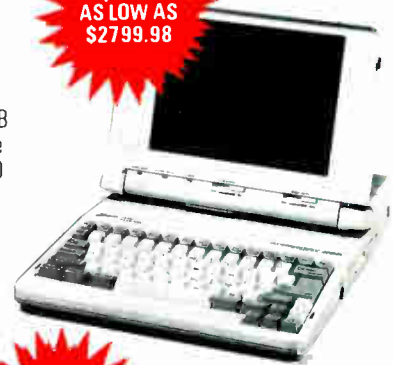

**ZENITH
SupersPort
AS LOW AS
\$2799.98**

ZENITH SupersPort 286 This battery-powered portable laptop computer offers solid performance 12/6 MHz 80286 capabilities. 1MB of RAM expandable to 2MB. Available with one 3½" floppy drive and either 20MB or 40MB hard drive. Backlit supertwist LCD CGA display with 640 x 400 resolution for crisp text. Wt. 14½ lbs. with detachable NiCad battery pack—runs up to 4 hrs.

SHARP MZ-100 Fast 10MHz battery-powered portable laptop is XT-compatible with 640KB of memory. Expandable to 1MB of memory. Two 3½" 720KB floppy disk drives. 5¼" floppy disk drive option. High definition backlit supertwist LCD CGA display with 640 x 400 resolution for clear text and graphics. Wt. 10.8 lbs. without AC adaptor.



**SHARP
MZ-100
AS LOW AS
\$1199.99**



**NEC
ProSpeed
AS LOW AS
\$3749.88**

Backed by one of the nation's best technical support staffs and a 33-year reputation for superior service.

• **Free Professional Support—Before and After You Buy**

According to *Computer Shopper* magazine (September, 1989), laptops are the "hot marketplace right now." So if you've been considering a laptop, Quill's trained staff of Computer Product Specialists can assist you. They will take the time to talk with you and together you can decide which laptop is right for you.

In addition, you can count on Quill for after-sale support. We won't leave you "high and dry" after the sale. Whatever your question or problem—help is as close as your phone. Just call one of Quill's Computer Product Specialists.

• **Fast Shipping—Even Overnight If You Need It**

Every laptop we sell is in stock in our huge warehouse. Your order will be shipped via UPS within 24 hours after you call. Need it quicker? We can rush your order to you overnight. Just ask a Computer Product Specialist when you call.

• **Choice of Models to Solve All Your Business Problems**

You can make your selection from a full array of feature-packed laptops that can readily handle popular desktop functions like word processing, spread sheet, database and time management. Quill has over 16 units from 4 famous name manufacturers available, so there's sure to be one to fit your budgetary needs, too.

• **Deep Discount Prices With Affordable Monthly Payment Plans**

Lower overhead for us means low discount prices for you. Moreover, buying a computer from Quill is easy on your budget. With a small down payment now, you can pay off the balance with low monthly payments. Or you can buy on open account or take 30 days to pay. We'll try to call within 24 hours with your credit approval.

WHO IS QUILL?

Quill is the nation's largest mail order office and computer products dealer with a 33-year tradition of great customer service. Every one of our company officers and our more than 900 employees is dedicated to give our customers sincere, honest, friendly assistance. And, we have 800,000 satisfied customers from coast-to-coast to prove it. So, you know you can count on Quill to deliver top value every time, to stand behind every product we sell and to provide the service and support you expect year after year.

QUILL - THE OFFICE AUTOMATION SPECIALISTS

NO-RISK GUARANTEE

Quill's guarantee inspires confidence—it's one of the best in the business. If there's a problem we can't solve over the phone—or if you're unhappy with your computer for any reason during the first 90 days—return it to us for immediate credit, refund or replacement.

BY9642-G2

QUILL—33 YEAR REPUTATION OF

World Radio History

WITH THE FEATURES AND BY THE SUPPORT YOU NEED!



**Our Computer Product Specialists Will Help You Choose The Right Model
With The Features You Need—At A Price To Save You More!**

1-708-634-6650

COUNT ON QUILL FOR ALL YOUR COMPUTER NEEDS

**QUILL HAS A COMPLETE LINE OF DESKTOPS, TOO!
Over 200 Computer Systems Can Be Custom Assembled For You**

**CALL FOR OUR FREE CATALOG TODAY
QUILL • P.O. BOX 4700 • LINCOLNSHIRE, IL 60197-4700**



**DESKTOPS
AS LOW AS
\$648.88**

SUPERIOR CUSTOMER SERVICE!

World Radio History

The Translating Telephone

Someday, you will be able to call anyone in the world and talk—regardless of the language the other person speaks. Three technologies are necessary to bring this about: automatic speech recognition (ASR), language translation, and speech synthesis. All three exist today, but not nearly in sufficiently advanced form.

The Holy Grail of ASR would feature a large, relatively unrestricted vocabulary; it would accept continuous speech input; and it would provide speaker independence (i.e., the system would not need to be trained by each user). ASR would have to attain this level to implement a translating telephone.

Conceivably, speaker independence could be eased into early versions of this system. Users of this capability might be willing to spend 15 minutes or so training the system on their voices. Such enrollment would be required only once. Combining the first two elements—large vocabulary and continuous speech—will take us to the early 1990s. Adding speaker independence will take us later into that decade.

Language translation would require only the ability to translate text, not speech, since the ASR technology would be translating the speech input into written language. The language-translation capability would not require literary-quality translations, but it would have to perform completely unassisted. Language-translation systems today require human assistance. Completely automatic translation of sufficient quality will probably become

available around the same time that the requisite ASR is available.

Every pair of languages requires different software, and, indeed, going from French to English is a different problem than going from English to French. While many aspects of translation will be similar from one set of languages to another, language-translation technology will vary in quality and availability, depending on the languages involved.

Speech synthesis is the easiest of the three technologies required by the translating telephone. In fact, it is available today. While not entirely natural, speech generated by the better synthesizers is quite comprehensible without training. Naturalness is improving, and speech-synthesis systems should be entirely adequate by the time the necessary ASR and language-translation systems are available.

Thus, you could expect translating telephones with reasonable levels of performance for at least the more popular languages soon after the turn of the century. With continuing improvements in performance and reductions in cost, such services could become widespread by 2010.

The impact will be another major step in achieving the “global village” envisioned by Marshall McLuhan in 1968. Overcoming the language barrier will result in a more tightly integrated world economy and society. We will be able to talk more easily to more people. Of course, our ability to misunderstand each other will remain unimpaired.

systems that can handle large, relatively unrestricted vocabularies are expected by the early 1990s.

Other characteristics that are important in describing practical ASR systems include accuracy rate, response time, immunity to background noise, requirements for correcting errors, and integration of the speech-recognition capability with specific computer applications. The significance of these characteristics can be surprising. Take, for example, accuracy rate and error-correcting requirements. After extensive observation of users of an ASR radiology reporting system, designers concluded that users prefer—and perceive as more accurate—a system that is 95 percent accurate but whose errors can be easily corrected,

over a 98-percent-accurate system whose errors require much more time and effort to correct.

Equally surprising are the problems that occur in integrating speech-recognition capability with specific computer applications, such as medical-report generation. First of all, it is generally not desirable to simply insert a speech-recognition system as a front end to ordinary computer applications. The human-factors requirements for controlling computer applications by voice are substantially different from those of more conventional input devices, such as keyboards. The design of the overall system needs to take this into account. For the integration of ASR with report-generation applications in particular, a proce-

sure known as *knowledge engineering* is almost indispensable.

Enter Knowledge Engineering

At the beginning of the systems development process, a knowledge engineer interviews the appropriate domain experts—individuals with expertise in a particular profession, such as medicine or law. The knowledge engineer writes down the relevant knowledge, vocabulary, and decision-making rules used by that human expert. The result would be a *knowledge base* that includes the words, phrases, and underlying logic used by a particular profession.

While human experts can solve problems within their domains of expertise, they often cannot explain the steps they follow to accomplish these tasks. The skill required of the knowledge engineer is to extract and codify the decision-making process from the domain experts, despite their not being consciously aware of many elements of this process.

Once the knowledge base is designed, end users, such as doctors, lawyers, or other professionals with little or no previous computer experience, can use voice input to generate routine reports in a way that reflects their normal approach to these tasks. The knowledge base allows end users, with little or no typing or computer experience, to use voice productively. By capturing knowledge of the application in the system, the user is free to concentrate on the job at hand. The system knows the basic framework of the task to be performed. This matches the way most professionals already work with their secretary or transcriptionist.

Building a knowledge base for voice reporting required developing these components: domain-specific vocabularies, trigger phrases, and an underlying logical framework.

Domain-Specific Vocabularies

According to vocabulary studies done by Kurzweil Applied Intelligence (which develops voice-to-text medical reporting systems) as well as other published studies, typical text creators use vocabularies of less than 10,000 words in their written work in a given profession. The actual words vary by field (e.g., doctors, lawyers) and by individual specialties within those fields (e.g., within radiology: neuroradiology, mammography, and chest x-ray).

With the current speaker-dependent technology, you must train the system with all the words you will be using, although algorithms have been developed

continued

Strength in Numbers.

Over 500,000 Members. 27,000 Software Programs. 14 Volunteer Firefighters. 2 Irish Tenors. Over 100 Billion Characters of Online Storage. 1 Bluegrass Banjo Player. 3 Beekeepers. 1700 Network Nodes. More than 100 Foreign Countries Accessed. 1300 Information Resources. 43 Mainframe Processors. #1 Computer Information Service Worldwide.

When you join CompuServe, you're joining the largest online computer information service in the world. We have more members, better equipment, greater capabilities, and more knowledgeable experts than anybody else.

And that means we can provide things no one else can. Including more investment information, hardware and

software support forums, shopping services, and research resources; hundreds of different information, communications, and entertainment services; and the most highly qualified intelligent, curious, and interesting staff people anywhere. (We figure we can not only outperform the competition, we can outsing them, too.)

So contact CompuServe. Because when you put it all together, our numbers really add up. To number one.

To join CompuServe, see your computer dealer. To order direct or for more information, call 800 848-8199.

CompuServe®

Circle 76 on Reader Service Card

that can reduce voice training by at least one order of magnitude. Part of knowledge engineering involves determining which words should be provided in the starting core vocabulary.

A knowledge engineer can maximize the vocabulary coverage—that is to say, the probability that the word spoken is in the active vocabulary—by including the words most frequently used by the particular end user. By starting with the right set of words, end users can do their work with minimal interruption. A vocabulary can be easily customized to meet individual needs and style by adding or modifying words as needed.

Trigger Phrases

A single spoken word or phrase can “trigger” an entire predefined report segment, with fill-in-the-blank capability for customization. For example, in a medical report, time-saving triggers allow the doctor to speak a single word or short phrase, such as “soft-tissue swelling,” to place a predefined definitive report entry of many words on the screen.

Using trigger phrases in combination with word-by-word dictation provides the flexibility to generate complete custom reports quickly by using just a few spoken words.

Trigger phrases and their translations

can be customized for each individual with a trigger editor. You can define new trigger phrases by specifying a trigger phrase name and the appropriate translation. Triggers can also include multiple choices of alternatives embedded within them, as well as additional specificity in a highlighted fill-in-the-blanks field. You can fill in these fields using either word-by-word dictation or other triggers, allowing the nesting of trigger phrases.

Underlying Logical Framework

Every report has a structure with a predictable sequencing of information. The

continued

McGraw-Hill Bookstore

McGraw-Hill's J. RANADE SERIES KEEPS YOUR IBM LARGE-SYSTEM USERS FRIENDLY



1. DB2/SQL: A Professional Programmer's Guide By Tim Martyn and Tim Hartley

To access IBM database management systems—DB2, SQL/DS, INFORMIX, or SYBARE—you need to be proficient in Structured Query Language. This hands-on guidebook and tutorial uses a sample query approach, case studies, and solved problems to show you DB2/SQL's basic and advanced concepts. 472 pp., \$39.95

2. VM PERFORMANCE MANAGEMENT By Trevor Eddolls

Improve the performance of your VM system! This invaluable reference offers a wealth of tips on removing paging bottlenecks, improving subsystem performance, maximizing file placement, selecting monitors, and much more. 265 pp., \$39.95

3. IBM MAINFRAMES: Architecture and Design By N. S. Prasad

Emphasizing evolution and continuity, this one-of-a-kind book presents the underlying design concepts and implementation details of the 360, 370, and 370/XA architectures. You'll find unique examples of the wide range of machines built under the same architecture—including specifics on such models as the 3090. 331 pp., \$39.95

4. EXPERT MVS/XA JCL: A Guide to Advanced Techniques By Mani Carathanassis

One of the original JCL development team shows you how to get the most from the advanced capabilities of this often poorly documented language. Helps you avoid such problems as inefficiency of execution, excessive operator intervention, and frequent or intermittent failures. 478 pp., \$39.95

5. DISTRIBUTED PROCESSING IN THE CICS ENVIRONMENT By Arlene Wipfler

A complete guide to CICS Intercommunication! With abundant coding examples, this practical tool addresses design and applications programming issues, internal mechanisms in CICS, resource definitions, and more. Explains command syntax and IBM's System Network Architecture. 466 pp., \$39.95

6. INTRODUCTION TO SNA NETWORKING: A Guide for Using VTAM/NCP By Jay Ranade and George C. Sackett

The first book for anyone new to the Systems Networking Architecture and VTAM/NCP software! Two top experts present up-to-the-minute data on using IBM communication controllers, cluster controllers, and modems, multiplexors, and concentrators plus designing and implementing single domain SNA networks. 394 pp., \$39.95

Clip or copy this coupon and return to:

McGraw-Hill Bookstore

1221 Ave. of the Americas, New York, NY 10020
Tel. 212-512-4100

YES! Please send me —

- ___ copies of book #1 (Martyn/Hartley)
- ___ copies of book #2 (Eddolls)
- ___ copies of book #3 (Prasad)
- ___ copies of book #4 (Carathanassis)
- ___ copies of book #5 (Wipfler)
- ___ copies of book #6 (Ranade/Sackett)

Check, money order, or credit card only:

VISA MasterCard AMEX

Acct. # _____

Exp. Date _____

Name _____

Address _____

City _____

State _____ Zip _____

Please add applicable sales tax, plus \$2.50 for U.S. postage and handling.

BYT12



The Professionals'
Information Center—Since 1961

GET THE PC NETWORK ADVANTAGE

Join Today -- Receive A FREE Surprise Package of Gifts, and More...

9 Reasons Why You Should Join The Club...

Over 100,000 Satisfied Club Memberships. PC Network Members come to us for everything from basic software/hardware to complex computer system needs. We answer tough questions, offer great merchandise selection, and provide excellent service. When you join you receive...

1. Red Carpet Service

Club members receive exclusive privileges, plus special merchandise offers, streamlined 24-hour order processing, shipping, and service.

2. Warehouse Pricing

Club members get low warehouse-to-you prices every day. (Just take a "peek" at our specials.)

3. Personal Credit Card from PC Network.

Now you can apply for a revolving charge account devoted to your computing needs. Great when you need fast warehouse-to-you shipments.

4. Used Computer Hardware Exchange

Sell your used computer hardware to other Club members. Upgrade your system. Available to Club members at a nominal cost.

5. Members ONLINE Bulletin Board

Download "Freeware" and "Shareware" from our massive collection of Public Domain software. Place orders. Get information. Not just a bulletin board, but a complete member information network.



6. Leasing Plans for Businesses

With other computer companies, if you wanted to lease computer hardware, you had to be a big business. Now small businesses and professional Club members have this option available.

7. Dow Jones Information Retrieval

Have access to this information service at members only discount rates plus receive special discount certificates, worth over \$50.00 in FREE services.

8. No Minimum Purchase-EVER!

That's right. Club members have no pre-set purchase requirements. No complicated forms. No unwanted or un-ordered merchandise-ever. You pick and choose what you want-when you want it.

9. Exceptional Service-Unequaled Privileges.

You have toll-free direct lines to PC Network whenever you need to talk to a Technical Consultant or Computer Consultant. Plus, your very own Club Representative to answer your computer questions.

Members Take Advantage Of Specials Like These



*(Requires controller)

Accept Our Invitation

Join today and receive our latest Buyer's Guide and your New Member's kit, with personalized I.D., PLUS--if you're one of the first 1,000 new members, you will automatically receive a special FREE surprise package of gifts. Open a world of exceptional service and unequalled privileges--all for only \$19.95 a year. Join now, find out for yourself why "Personal Computing" magazine ranked PC Network, "Best for Overall Pricing-Overall Value!"

Join Now, 1-800-621-7283



underlying logical framework component of the knowledge base must capture this information flow.

For example, in a voice-to-text medical reporting system, the emergency medical report might begin with the name of the complaint. Then the doctor would describe one or more of the following: past medical history, other symptoms, social and family history, and allergies.

Using a voice-to-text reporting system that incorporates a reporting hierarchy into its software, an emergency medical doctor would move through the text on the screen section by section, inserting the appropriate information or choosing from lists of options. Generating the report is simplified by the fact that the underlying framework defines the format for each report segment, including tabs, spaces, and margin settings.

Since the system knows which exam has been chosen at any given time, a spoken word, such as "normal," can have different translations that vary as a function of the initial complaint. "Normal" means something quite different in an ear exam than it does in an eye exam. The system keeps track of the context.

Furthermore, if a patient came to the emergency room complaining of a headache, the program would prompt the doctor to describe the location of the headache, whether there is blurred vision, and, if so, for how long. It will not prompt him to indicate, for example, swelling in the lower leg, chronic back pain, or other symptoms not normally associated with a headache. In this way, the system actually guides the doctor through the reporting process.

It is important to realize that, within the rules, there is tremendous flexibility. For example, in sections of the report where the predefined triggers are too

limiting, the doctor can use word-by-word dictation. The doctor can also edit the report by voice.

Capturing the underlying logic is perhaps the most difficult step in the knowledge-engineering process, but it is critical in building a system that is natural and fast for the end user.

Digital Interfacing

Routine reports—along with phone calls and meetings—are key tools for communication. Besides making the creation of these reports faster and more efficient than ever before, ASR has an added benefit: Because voice-generated reports can be stored and transmitted in a digital format, it is now possible to distribute the reports electronically within and among organizations faster than was previously possible. This is being done by interconnecting ASR systems to advanced, organization-wide information systems.

In the past, a radiological report might be dictated to tape and then transcribed by a skilled clerical worker, often with a delay of several days. Meanwhile, a referring physician—who needs the report fast to pursue urgent treatment—might be forced to proceed on the basis of a verbal or scribbled handwritten report from the radiologist. By the time it becomes available, the typed report might be just an administrative formality.

By interconnecting an ASR system to a hospital information system, physicians at some U.S. hospitals have completed voice-generated reports printed out on their patients' floor as soon as the radiologists, working in their departments, have finished reading the films. This rapid availability of printed reports eliminates disruptive "call backs"—when referring physicians who can't wait for typed reports call radiology departments to get urgently needed results.

In a further refinement designed to tighten a hospital's information loop, the radiological report—entered on an ASR system and stored as a computer file—can be converted into synthetic speech and read back over the phone to referring physicians who call in for results.

Visions of the Future

While ASR systems continue to fall far short of human performance, their capabilities are rapidly improving, and commercial applications are taking root. As of 1987, there were ASR systems that could either recognize a large vocabulary (10,000 words or more), recognize continuous speech, or provide speaker independence (no user training). None, however, could provide more than one of these capabilities at a time.

By the early 1990s, I expect it to be possible to combine two of these attributes in the same system. In other words, you will see large-vocabulary systems that can handle continuous speech while still requiring training for each speaker; there will be speaker-independent systems that can handle continuous speech but only for small vocabularies; and so on. The Holy Grail of speech recognition is to combine all three of these abilities, just as humans do. (See the text box "The Translating Telephone" on page 284.)

The combination of ASR and knowledge engineering is a practical reality today. And in the future, you can expect to see many more applications of this technology. ■

Raymond Kurzweil is chairman and CEO of Kurzweil Applied Intelligence, Inc. (Waltham, MA). He holds a B.S. from MIT. He was named Inventor of the Year by MIT and the Boston Museum of Science. He can be reached on BIX c/o "editors."

VIDEO FRAME GRABBERS

Turn your PC into a powerful imaging workstation with a Video Frame Grabber by High Res Technologies

Imaging boards that measure UP!

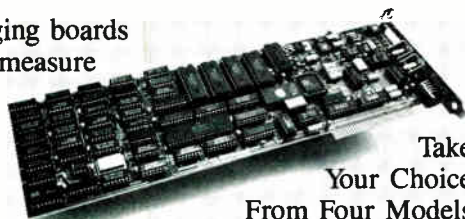

Take Your Choice From Four Models

Model	Resolution	Input	Price
HRT 256-4	256 x 256 x 4	B & W	495
HRT 256-8	256 x 256 x 8	B & W	795
HRT 512-8	512 x 512 x 8	B & W	995
HRT 512-24	512 x 512 x 24	Color	1995

- IBM PC/XT/AT Compatible
- Capture in Real Time, 1/30 sec/frame. 1/60 sec/field
- NTSC (U.S.) & PAL (European) compatible
- Output Look Up Table
- Full credit on upgrade purchase in first year return old board and just pay difference
- Software library of image analysis routines, installation, demo and utilities all included free.
- Free software upgrades to registered owners



See how HRT can get results for you. Talk to an application specialist today.



High Res Technologies
P.O. Box 76, Lewiston, N.Y. 14092
Phone: 416-497-6493 Fax: 416-497-1988

Discover Parallel Processing!

Monoputer/2[™]

*The World's Most Popular
Transputer Development System*

Since 1986, the MicroWay Monoputer has become the favorite transputer development system, with thousands in use worldwide. Monoputer/2 extends the original design from 2 to 16 megabytes and adds an enhanced DMA powered interface. The board can be used to develop code for transputer networks or can be linked with other Monoputers or Quadputers to build a transputer network. It can be powered by a 20 or 25 MHz T800 and is priced from \$1295.

Parallel Languages

Fortran and C Make Porting a Snap!

MicroWay stocks parallel languages from 3L, Logical Systems and Inmos. These include one Fortran, two Cs, Occam, Pascal, and Ada. We also stock NAG libraries for the T800 and ParaSoft's debugger, profiler, and Express Operating Environment. A single T800 node costs \$2,000, yet has the power of a \$10,000 386/1167 system. Isn't it time you considered porting your Fortran or C application to the transputer? It's easier than you think!

For further information, please call MicroWay's Technical Support staff at (508) 746-7341.

Quadputer[™]

Mainframe Power For Your PC

MicroWay's Quadputer is the most versatile multiple transputer board on the market today. Each processor can have 1, 4 or 8 megabytes of local memory. In

addition, two or more Quadputers can be linked to build large systems. One

MicroWay customer reduced an 8 hour mainframe analysis to 15 minutes with five Quadputers, giving him realtime control of his business. Quadputer is priced from \$1995.

COSMOS[™]/M

Finite Element Analysis Running on the Quadputer

One of the most fruitful areas for parallel processing is finite element analysis. Problems which can be broken into small pieces run naturally on systems built up of many processors. **COSMOS/M** running on a Quadputer took just 300 seconds to solve a problem which ran in 12,000 seconds on an AT. Even very large mainframe problems run fast on the Quadputer: a system with 12,000 degrees of freedom took just 806 seconds while another that had 23,000 DOF ran in just 40 minutes. Contact MicroWay for information on COSMOS/M.

Micro Way

Circle 217 on Reader Service Card

World Leader in PC Numerics

Corporate Headquarters: P.O. Box 79, Kingston, MA 02364 USA (508) 746-7341
32 High St., Kingston-Upon-Thames, U.K., 01-541-5466
USA FAX 508-746-4678 Italy 02-74.90.749 Holland 40 836455 Germany 069-75-2023

World Radio History

EUNUCHS

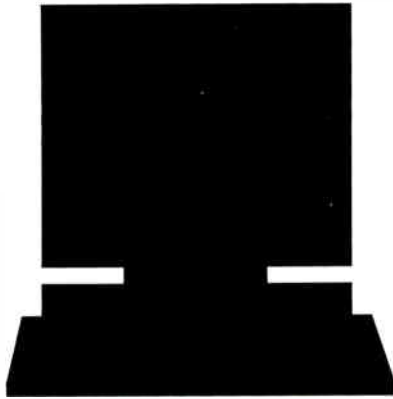

SUN

No POSIX compliance

No symmetric multiprocessing

No commercial-grade file system

No system under \$700/MIPS

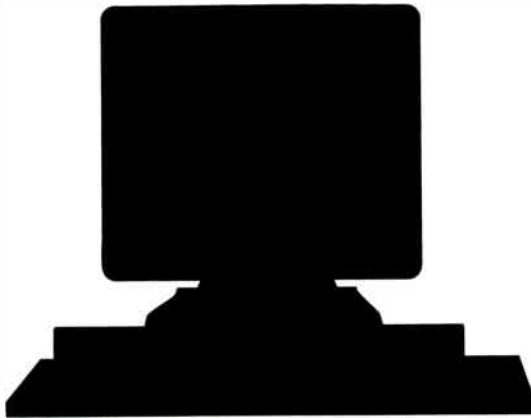

DEC

No symmetric multiprocessing currently available

No system under \$700/MIPS

No multi-vendor binary compatibility

No open I/O bus across product line

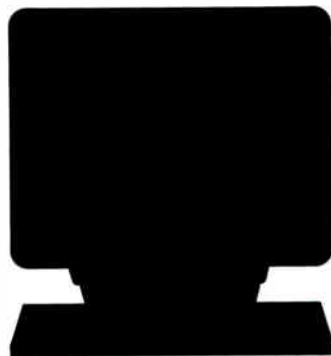

HP

No RISC system under \$1000/MIPS

No single compatible RISC architecture

No POSIX compliance

No desktop RISC system

AViON and DG/UX are trademarks of Data General.
UNIX is a registered trademark of AT&T.
OSF/Motif is a trademark of the Open Software Foundation.
NFS is a trademark of Sun Microsystems.
©1989 Data General Corporation.

The above comparative product data is based on industry newsletters, industry analyst information, vendor price lists, vendor advertising material, and other material available as of September 7, 1989. For a listing of information sources, please write Advertising, M.S. 9/S, Data General Corporation, 3400 Computer Drive, Westboro, MA 01580.

VS. UNIX

**WORKSTATION,
SERVER & MULTI-USER**

**COMMERCIAL-GRADE
FILE SYSTEM**

**SYMMETRIC
MULTIPROCESSING**

**MOTOROLA 88K
RISC CHIP**

**FULL SYSTEM V.3
IMPLEMENTATION**

**STARTING AT
\$500/MIPS**

**SIGNIFICANT
BERKELEY EXTENSIONS**

**MULTI-VENDOR
BINARY COMPATIBILITY
(88OPEN BCS)**

**17-40
MIPS**

**DOS
EMULATION**

Data General's new AViiON Family.

Data General's new AViiON™ Family and the DG/UX™ operating system give UNIX® users what no "Eunuchs" system can: more openness, more value-added.

Our RISC-based AViiON Family's advanced implementation of UNIX supports standards like System V.3, POSIX, Berkeley, ANSI C, 88open BCS, NFS™, TCP/IP, IBM SNA, VME, X-Windows,

OSF/Motif™ and more.

And we've engineered advanced commercial-grade features into DG/UX, such as a highly reliable file system, fully symmetric multiprocessing, and process scheduling that supports large user counts. What's more, you can take advantage of these important features without modifying your application,

because DG/UX added value is transparent to the application.

But don't take our word for it. Call 1-800-DATAGEN today and we'll send you a free copy of "What the Experts say about Data General's UNIX-based RISC Family." Or write to:

Data General

3400 Computer Drive, Westboro, MA 01580

FOR YOUR FREE "WHAT THE EXPERTS SAY" BOOKLET, CALL 1-800-DATAGEN.

Circle 371 on Reader Service Card
World Radio History

The Era of the Personal Workstation

When in 1981 the first personal computer from IBM was introduced to the market, no expert predicted its success. After only one year, this computer set a new standard, the PC standard. Of course, there were other computers, like the Apple II. Some of these computers were faster and more reliable than the IBM PC. But the standard was set by this machine. And it was set by the users, who bought this computer and demanded applications, programs, peripherals and services. A whole industry grew up with this one machine. The personal computers of today are the great-grandchildren of this little computer. One can find its roots in nearly every personal computer that works with MS-DOS. When the IBM PC was introduced, it worked with MS-DOS, too. It was MS-DOS 1.1, the first release. And it became standard as an operating system, just like the PC became standard as THE personal computer.

The technology today is far more advanced than it used to be in 1981. This an effect of the tremendous market power, which was unleashed by the PC standard. But know, the great history of this standard has become a burden, it slows down any development in this industry, which is bound to be "compatible". Today's microprocessors have more processing power than the big mainframe computers in 1981. But they use only 5-10 percent of their real abilities for the users, because of the existing industry standards. We at Bauer Systems think it's time for a new standard, it's time for the PERSONAL WORKSTATION!

Stop! This is not a break with the reported history of computers. It's a break with compromises, which were made to have the highest grade of compatibility. We have found a way to have the best of both sides: Unforeseen processing power and user friendliness and compatibility with existing industry standards. We cannot promise that your most beloved word processor will run on our new machine, and we cannot promise either that your beloved screen will work with our machine. But we can promise you that if you ever try our new system, you will not try another existing computer again.

The TESS IV PERSONAL WORKSTATION is based on the Intel i486 microprocessor. This microprocessor combines the features of the 80386 microprocessor and the 80387 arithmetic coprocessor together with a sophisticated cache management unit on one chip. The i486 microprocessor has a raw processing power of 14-15 MIPS. In the TESS IV PERSONAL WORKSTATION, this microprocessor is combined with 8 Megabyte of 70 ns dynamic random access memory. The system has a clock rate of 25 MHz. Early benchmarks indicated a processing power of 12 MIPS for the whole system. We developed a configuration for this system, which represents the best combination of available options. The TESS IV PERSONAL WORKSTATION is equipped with our i486-computer. We chose a SCSI host adapter as storage interface. In the standard configuration, one 200 megabyte hard disk drive and one 3.5" Floptical disk drive are connected to the host adapter. It offers a sustained data transfer rate of 1 megabyte per second and it can handle up to seven SCSI devices. The hard disk drive has an access time of 16 ms. The Floptical disk drive is a newly developed 3.5" floppy disk drive that is able to store up to 20.8 megabyte of data on a 3.5" Floptical diskette. It can also format, write and read standard 3.5" diskettes in the PS/2 formats. The Floptical disk drive has an access time of 65 ms. The graphics subsystem of our TESS IV PERSONAL WORKSTATION contains its own Texas Instruments TI 34010 graphics processor, clocked at 40 MHz. At this clock rate, the TMS 34010 has a processing power of 6 MIPS. The processor is combined with 1 megabyte VRAM for a maximum screen resolution of 1024 x 768 pixels in 256 out of 262.144 colors. Our display features a 21" flat-type screen offering the user an optimal viewing area. The etched, non-glare 0.31 mm dot pitch CRT allows for brilliant FULLSCREEN graphics and text. A built-in dynamic focus circuit provides crisp images on-screen. The keyboard of our TESS IV PERSONAL WORKSTATION is connected to the screen and contains a standard 102 keys AT-layout. A 3-key mouse is connected to the keyboard as the standard pointing device.

The TESS IV PERSONAL WORKSTATION is equipped with four serial and two parallel external interfaces. It can be expanded by plug-in expansion cards compatible to the ISA-bus interface. The complete system except the desktop devices is mounted in a trim desk-side tower case in a unique design. It is powered by a 300 W switching power supply with build-in battery backup and surge protection.

To unleash the full processing power of the i486 microprocessor, we chose the newly developed Open Desktop from SCO as operating system. Open Desktop features the full 32-bit, multiuser, multitasking capabilities of the UNIX System, a graphical user interface offering Presentation Manager-compatible "look and feel", the industry-standard X Window System, SQL database management, TCP/IP networking to dissimilar systems, full data sharing between DOS and UNIX Systems, and instant access to thousands of existing DOS and UNIX System applications. Open Desktop delivers the multitasking computing power, friendly graphical interface, and seamless connectivity required for today's demanding business and technical professionals who require dedicated personal productivity systems. And it's equally well-suited as a multiuser, multitasking platform for workgroups of 8, 16, 32 or even more users.

To meet the high standards we set ourselves by designing this computer, we developed a sophisticated distribution and service system. The TESS IV PERSONAL WORKSTATION will be distributed by the microtronics Trade Service through field consultants. Your computer will be set up at your site and configured to your demands. The microtronics Trade Service will provide worldwide on-site service for one year. If your system can't be repaired on-site, you will receive a equal replacement for the repair time.

To receive more information or to purchase your TESS IV PERSONAL WORKSTATION, please contact the microtronics Trade Service. We hope you will be with us in the era of the personal workstation!

microtronics Trade Service, Bettendorfer Str. 36, 5173 Siersdorf, Federal Republic of Germany, phone +49-2464-2147, fax: +49-2464-8280

*All trademarks used in this advertisement are property of the respective companies.
All information contained herein is subject to change without prior notice.*

Designed by H. Bauer, set by HGB Druck, Jülich

Circle 214 on Reader Service Card

World Radio History

Changing Perceptions of Reality

Image editing lets you interactively improve, rearrange, modify, and adjust images any way you want

Benjamin M. Dawson

Image processing is the science of analyzing and changing images for human or machine use. It is used, for example, to enhance images from under-seas robots (see "Finding the Titanic," March 1986 BYTE) or to automatically inspect parts. Image processing usually improves the image or extracts information from it rather than modifying the image or adding information.

You can, however, also use the algorithms and methods developed for digital image enhancement and analysis to edit and modify images. I'll explore some image processing methods and how they apply to image editing. (The text box "Imaging Tools" on page 294 describes the hardware and software needed to try some of these methods.)

For the methods I describe, I assume that the images have been sampled into an array of pixels, and the intensity of each pixel has been quantized (sampled in intensity) to at least 6 and preferably 8 bits.

This intensity range generally lets you apply image-processing algorithms based on continuous mathematics to the image. This range is also sufficient to fool the human eye into seeing the image

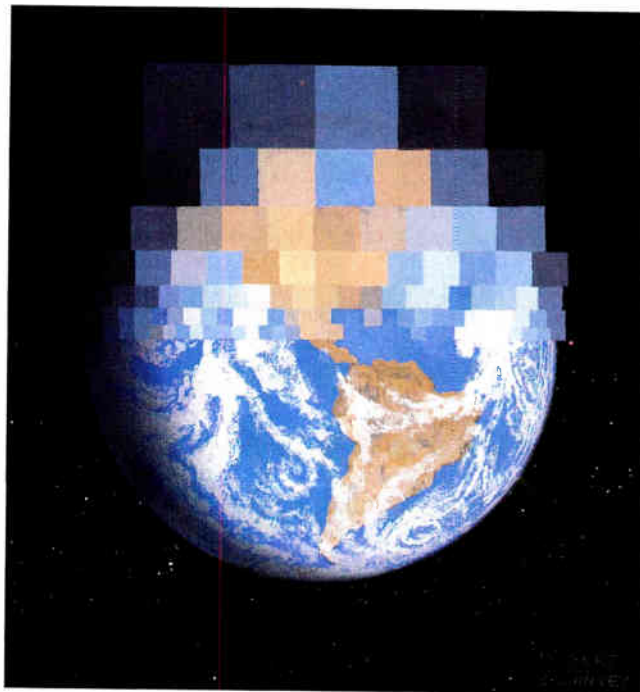

as continuous in intensity when it is displayed. Applying these methods to lower-resolution images, perhaps acquired with a desktop scanner, might give results that are noisy or unsatisfactory due to quantization errors.

Digital Image Editing

Image editing is used to interactively improve, rearrange, modify, and adjust

images for human viewing. You can use image-processing methods to adjust contrast, cut and paste, or change the shape of image areas. Digital image editing is used professionally to replace tedious photographic methods. A digital or computer "darkroom" can do far more than the photographic darkroom, and usually much faster.

Image-processing operations that modify a pixel value based only on its original value are called *point processes*. The point processes change an image's brightness and contrast, make it into a solarized or negative image, and so forth. Listing 1 contains a code fragment for changing a triangular area of an image into its negative, as shown in photo 1. The image is sequentially scanned, and pixel *y* addresses increase downward while *x* addresses increase to the right. This video-coordinate system is commonly used in image frame buffers and matches the way in which a TV is scanned.

In this example, the point process depends on the original pixel intensity and its *x* and *y* locations. The modification occurs only if the image's pixel *y* address

continued

is greater than its x address. Point transforms can be any function of the original pixel intensity and its x, y address. These functions can be quite complex and impossible to do in a darkroom.

Output lookup tables (LUTs) perform point processing independently of the pixel's address and do so without modifying its value. For example, with 8-bit pixels, loading output LUTs (starting at table address 0) with the values 255, 254, . . . , 0 displays the entire image as its negative. LUTs are quick to load and are used to interactively adjust all the pixel values.

Listing 2 contains a code fragment for interactively brightening the entire image by using output LUTs. You can make an LUT transformation permanent by using the LUT values to change the

With a digital "darkroom," you can do far more than you can in a photographic darkroom, and usually much faster.

pixel values in the frame buffer (see `ptransform()` in table A in the text box "Imaging Tools" at right).

Area Processing

If the image-processing method uses small areas of pixels as input, it's called an *area process* or *neighborhood process*. As with point processing, you sequentially scan the image, but rather than using the values of individual pixels, you use the values from each pixel and its neighbors.

Convolution is a powerful area process that can be used to sharpen, blur, and modify images. As you scan the image, each pixel and the pixels in its immediate neighborhood are weighted (i.e., multiplied by a value), and the new (output) pixel value is the sum of these weighted pixels. The set of weights is called the *kernel*. If the kernel k is of size $m \times n$, and $p(x, y)$ contains the pixel

continued

Imaging Tools

A minimum set of hardware for imaging and graphics consists of a camera or scanner, image-acquisition hardware, a frame buffer and CRT monitor for displaying images, and a computer for processing the images. The camera or scanner must be matched to the image-acquisition hardware. The image-acquisition hardware is often built into the frame buffer and usually accepts a standard RS-170 video signal. Some kinds of home video equipment generate standard RS-170 signals, but some generate a modulated signal that must be converted to RS-170. For better-quality pictures, try an inexpensive surveillance camera.

A frame buffer (or frame store) is special memory that stores one or more images and sequentially scans the image's pixel values to generate a video signal for the monitor. The frame buffer is also read from and written to by your computer. For the operations I describe, the frame buffer should store at least 6 bits per pixel (8 bits are preferable). For most of the pictures in this article, I used 8-bit frame buffers and image processors from Imaging Technology, Inc. (Woburn, MA). A "super VGA" with 256 colors or a Macintosh II with an 8-bit display is good for screen output, but you need additional hardware if you want to acquire images from a camera or a scanner.

Two common features on frame buffers are overlay memory and output lookup tables (LUTs), or palettes. Overlay memory provides additional bits for each pixel and is used to display graphics "over" the image, without disturbing the image. An LUT is a small memory element. Pixel values address this memory, and the LUT output is the value in the addressed memory location.

Three output LUTs are used to translate pixel intensity values into red, green, and blue values for the monitor. This allows you to add color to your images or to change the pixel intensity values. On frame buffers with overlays, the overlay memory can also drive the LUTs to allow colored overlays. Some of the operations that I describe are easier to do with the addition of overlays and output LUTs, but there are other (albeit slower) ways to do the operations if you don't have this hardware.

Image processing requires a great deal of computation. For your purposes and for many applications, a good personal computer is fine, if a bit slow on some operations. You will also need a mouse or some other pointing device.

The SIMPP Software

The Simple Image Processing Package (SIMPP) software is a simple program for learning about image processing. I added routines for image editing to SIMPP (see "Introduction to Image Processing Algorithms," March 1987 BYTE) and called it SIMPP2. SIMPP2 is written in C and requires a compiler that supports floating-point arithmetic.

A fair amount of programming is required to use SIMPP2. If you don't care to do this, there are excellent commercial programs that do much of what is described in this article. For the Macintosh II, there is Digital Darkroom from Silicon Beach Software (San Diego, CA) and ImageStudio from Letraset (Paramus, NJ). For the IBM PC AT, there is SnapShot from Aldus (Seattle, WA). You still might look at SIMPP2 to understand how some of these operations are done. I also recommend *Beyond Photography: The Digital Darkroom* by Gerald J. Holzmann (Prentice-Hall, 1988). Holzmann's book contains a good introduction to image editing, examples of edited images, and software for interactive image editing.

Table A shows some of the SIMPP2 routines. You must write the nine interface routines that connect the SIMPP2 software to your hardware.

The `acquire()` routine puts an image into the frame buffer, usually from a video camera. If you can't acquire images, read them from a disk file. The `write_LUT()` routine puts a value into an LUT. If you don't have LUTs, you might use `ptransform()` to permanently change the pixel values. The `write_over()` routine writes a value into the overlay memory, and `read_over()` reads values from this memory.

Writing an overlay value of 0 turns off the overlay at that point. You can simulate overlays by inverting the overlaid image points and then inverting the points again to remove the overlay. As an alternative, you could use 1 bit of each pixel as an overlay if you have output LUTs.

EFFORTLESS EDITING

between files —
across applications —



Vq²™ If you work with more than one file, you need Vq2 — the editor for multi-file processing.

If you begin Monday trying to remember what you were doing Friday, you need Vq. Just a few keystrokes bring up the file set you were working on, with each file positioned where you left it. Even if Friday was so bad you just pulled the plug and ran, Vq will bring back the changes you forgot to save.

Load files by name, location, date, *even file content* — you can search whole disks, directories, or file sets, to find and automatically load just what you want. Simple AND/OR/NOT/WITH/WITHIN pattern specifiers combine to find just about *anything* on a disk. Vq will even search and load word processor and desktop publisher files.

Vq is *EASY* to learn and *EASY* to use. Pulldown menus do the whole job... *instantly*. You probably won't even read the manual. Full multi-window mouse support, of course!

Features include programmable keyboard, 43/50-line and 132-column video modes, hot links to executable programs, compile with find-next-error, and macro compile/decompile. Optional auto-indent, tab, column shift, and margin settings. Your choice of screen colors.

100+ commands include Multiple edit windows with window Zoom and multi-speed scrolling; Block copy, cut, paste, delete, box, fill, print, write, shift left or right, cap and uncap; Mark lines, columns or fragments of text; Search/search-and-replace with token search, find-function, and regular expression options (select block or entire document); Goto/Pop/Restore Line; Find matching $\{[(or)]\}$ levels; Format, Center, and Timestamp; Query, resume query, find next/previous query file/match; Full DOS shell or command execute — Vq *shrinks to 7Kb*. Full Undo capability lets you change your mind — *while editing!*

OS/2 & DOS versions... both for \$150

If Vq2 sounds too good to be true, call for our NO RISK OFFER —

1-800-284-3269



GOLDEN BOW SYSTEMS
2665 ARIANE DRIVE, #207
SAN DIEGO, CA 92117
(619) 483-0901

FAX (619) 483-1924 TELEX 201520 GBSUR
MC/VISA US shpg/hdlg \$5 CA orders add 7%
Vq and Vq2 are trademarks of Golden Bow Systems

DECEMBER 1989 • B Y T E 295

Table A: The SIMPP2 routines used in this article. The arguments x,y specify the start of an image area to process, and dx,dy specify its size.

IMAGE-EDITING ROUTINES

Interface routines

sim_open()	Opens and initializes the frame buffer and mouse.
sim_close()	Closes the frame-buffer access.
acquire()	Puts an image from a camera into the frame buffer.
write_LUT(color, loc, val)	Sets the location, loc, in the LUT specified by color (red, green, or blue) to value val.
write_over(x,y,v)	Set the overlay memory at location x,y to value v.
read_over(x,y)	Returns the value of the overlay memory at location x,y.
write_pixel(x,y,v)	Writes a pixel of value v into frame-buffer location x,y.
read_pixel(x,y)	Returns the value of the pixel at location x,y in the frame buffer.
read_mouse(&x,&y)	Returns the location of the mouse in x,y and the status of the button(s).

Primitive operations

copy_area(x,y,dx,dy,xd,yd,dxd,dyd)	Copies the image area starting at x,y and of size dx,dy into the destination area starting at xd,yd and of size dxd,dyd.
cross_over(x,y,v)	Puts a cross-hair cursor in the overlay memory.
box_over(x,y,xe,ye,v)	Draws a box with corner coordinates x,y and xe,ye in overlay color v.
get_box(&x,&y,&dx,&dy)	Fetches the coordinates of a rectangular area using the mouse.

Point processing

ptransform(x,y,dx,dy,t)	Transforms the area using transformation table t.
rgb_to_his(r,g,b,&h,&i,&s)	Converts an RGB triple into a hue-intensity-saturation (HIS) triple.
his_to_rgb(h,i,s,&r,&g,&b)	Converts an HIS triple into an RGB triple.

Area processing

convolve(x,y,dx,dy,m,n, kernel,output)	Convolve the image area with a kernel of size m,n and specified by array kernel. The output argument controls the treatment of negative convolution values.
median3(x,y,dx,dy)	Performs a 3-by-3 median filter on the area starting at x,y and of size dx,dy.

Geometric operations

rotate(x,y,dx,dy)	Rotates the image area clockwise by 90 degrees.
stretch(x,y,dx,dy,xf,yf)	Stretches the image area by xf and yf.
bwarp4(x,y,dx,dy,u,v,method)	Warp area into area specified by arrays u and v. If method = 0 use nearest-neighbor interpolation, else use bilinear interpolation.
gridwarp(x,y,dx,dy,xdest,ydest,dxgrid,dygrid)	Use bwarp4 to "rubber sheet" warp the source area (x,y,dx,dy) to a destination area (xdest,ydest) of the same size. Control points are spaced by dxgrid in x and dygrid in y.



Photo 1: Conditional point processing converts the image below the diagonal to a negative.



Photo 2: Creating a fog effect. Left: The original image of a mountain meadow. Right: The same image sharpened at the bottom and blurred toward the top of the image to give the effect of fog.



Photo 3: The airplane in photo 1, cut and pasted. The one on the left is not blended into the background; the ones on the right are.

values, then convolution can be expressed as follows:

$$p(x,y) = \sum_{i=0}^m \sum_{j=0}^n p(x+j,y+i)k(j,i)$$

Different operations are implemented by choosing different kernel sizes and values for the weights. (See "Introduction to Image Processing Algorithms," March 1987 BYTE, for more details on convolution and the choice of kernels.) A Laplacian kernel of

$$\begin{matrix} -1 & -1 & -1 \\ -1 & 8 & -1 \\ -1 & -1 & -1 \end{matrix}$$

generates large output values only when the image intensity changes. These changes occur at object edges, so Laplacian convolution amplifies image edges.

Negative values in the kernel mean that the output of the convolution operation could be negative. While mathematically correct, negative pixel intensity is physically meaningless. You often clip

While mathematically correct, negative pixel intensity is meaningless.

negative values to 0 or take the absolute value of the output to remove these negative values.

Adding the Laplacian convolved image to the original image boosts the edges in the image, making it appear sharper. You can do this in one convolution step by changing the 8 in the sample kernel to a 9. In photo 2, an image of a meadow is shown at left. In the photo on the right, I changed the ratio between the Laplacian edge image and the original image to vary the amount of image sharpening. At the bottom of the photo, the ratio is equal (i.e., the kernel center point is 9) for maximum sharpening. The Laplacian contribution, and hence the sharpening, decreases in steps going up from the bottom of the image. Above the center of the image, I started using convolution kernels that cause blurring. The effect is to add fog to a clear original.

To blur an image, you use convolution to average the pixel values in the scanned neighborhood. For example, a kernel of

$$\begin{matrix} 1 & 1 & 1 \\ 1 & 1 & 1 \\ 1 & 1 & 1 \end{matrix}$$

sums the pixels in the neighborhood. Dividing this convolution's output by 9 gives the average pixel intensity in the

neighborhood. This smooths (or blurs) the image intensities. The larger the neighborhood used in averaging, the more blurring. Other kernels modify images in interesting ways, and I encourage you to experiment.

If the area process outputs pixels within the processing neighborhood, then processed pixels will contaminate the input to the transformation. You can solve this problem by ensuring that the output (destination) image doesn't overlap the input (source) image or by buffering the output. Another problem with area processes is what to do at the edges of the image, where the kernel would be partly off the image. The usual solution is simply to scan that part of the image where the kernel is entirely inside the image.

Nonlinear area processes (convolution is a linear process) are also useful for image editing. A *median filter* is nonlinear and is good for removing noise in an image. A median filter sorts the pixels in the neighborhood by value and outputs the median value—the value in the middle position of the sorted values. Image noise tends to have a different intensity from that of neighboring pixels, so the median filter replaces it with an intensity value closer to the average.

Cutting and Pasting

A frequent image-editing operation is to cut out a section of an image and paste it somewhere else. Listing 3 shows how this might be interactively done. The `copy_area()` function allows the source and destination to be different sizes. If the paste operation is fast, you can use the source as a "brush" to paint with.

Photo 3 shows cutting and multiple pasting. You can see a number of problems with this simple approach. The most obvious is that the edges of the pasted image do not blend smoothly into the background image (the airplane on



Photo 4: An example of cut-and-paste. Left: The original image. Center: A mask is drawn over the man's image and is used to guide the pasting. Right: The man is removed by pasting another area of the image into the mask area and smoothing the edges and texture. (Photos courtesy of Dr. Peter Burt, Advanced Image Processing Research Group, David Sarnoff Research Center)

the left). The human eye (much like Laplacian convolution) is very sensitive to local changes in intensity.

The paste looks more natural if its edges are smoothed or blended into the background. Convolution provides one way to do this. I used a blurring kernel (e.g., all 1's) and moved it around the edge of the pasted area (the airplanes on the right) to blend in the cut images.

If the object in the source image is not rectangular, cutting around the object removes source background pixels that would look out of place in the pasted image. The blending operation now must follow the curve of the cut-out object.

If the lighting direction is significantly different on the source and destination areas, then the pasted image will look strange. Changing image lighting, shadows, and shading requires knowledge about the objects in the image and a good bit of work. Sometimes a simple brightness adjustment can make the pasted object look right in the destination image.

A pasted object with a different color or texture pattern than the background may also look out of place. Blending colors between the pasted object and the background may introduce new and unwanted colors. Sometimes, you can blend texture by smoothing at different spatial resolutions.

The three images in photo 4 are skillful examples of cutting and pasting. The mask in the center photo is drawn around the man in the photo at left. The image areas around the masked area are blended with the masked area, as well as with an image cut from an area immediately to the right of the man. This blending is complex but essentially uses many different sizes (i.e., scales) of blurring filters. This process removes spurious edges between the pasted area and the background and provides a smooth texture transition. In this example, the



Photo 5: In this enlargement of a face, the left half was enlarged using nearest-neighbor interpolation, and the right half by a smoother (bilinear) interpolation.

colors and lighting of the cut-and-pasted areas match, so these are not a problem. The man in the photo at left has disappeared in the photo on the right.

Geometric Operations

Geometric operations use equations or rules to map source-image pixels to new positions in the destination image. Geometric operations include image translation, rotation, size change, and warping. Some geometric operations are similar to those used in computer graphics and may be familiar to you.

Mapping images causes problems because of the discrete nature of pixels. Consider changing the x and y scale (size) of an image area by $xfac$, $yfac$. Then, $x_{dest} = x \times xfac$ and $y_{dest} = y \times yfac$. As the source image is scanned, x and y take on discrete integer values. If $xfac = yfac = 2$, then only even destination addresses (x_{dest}, y_{dest}) are generated. Source-pixel values are mapped to every other destination address, and the output image is full of holes. If $xfac$ or $yfac$ is less than 1, then x_{dest}, y_{dest} will



Photo 6: The result of enlargement (mapping) is a function of the source-image x address.

be fractional values, and more than one source pixel can map to the same destination point. This is better than holes, but it can still be a problem. Two tricks reduce these problems.

First, invert the equations and scan the destination image.

$$\begin{aligned} x &= x_{dest}/xfac \\ y &= y_{dest}/yfac \end{aligned}$$

Then loop through all integer x_{dest} and y_{dest} values in the destination image, using these values in the above equations to specify where the source image pixel (x, y) comes from. This guarantees that all destination points will be filled.

When x and y addresses are fractional addresses, a second trick is to approximate or interpolate a source-pixel intensity based on these fractional values. "Nearest-neighbor" interpolation simply fetches the pixel value located at the integer address nearest to the fractional x and y address. This is fast but produces a blocky-looking image. Interpolations

continued

I don't get it!

Right, you *would* say that!

Gee, I wish I could say that.

#%@!.

Got it.

GET IT?

On your left, our competitor...for obvious reasons has asked us to conceal his identity.

On your right, we'd like you to meet our bold new Elite/1600™ monitor, a complete ultra high resolution 20-inch monochrome display system with a 1600 x 1280 pixel resolution.

The same resolution as the Sun-4 workstation monitor. A picture so stable and flicker-free it can only be called extraordinary. For you, this means drawings that are pin-point precise and razor sharp images that are perfectly aligned.

© 1989 Elite Microsystems Inc., Bensalem, PA

Simply put... I have a picture display that is a real knockout the *finest* you'll find on any monitor... Mac or PC.

I didn't say it, Publish Magazine said it...

... and though I'm part of an *elite* class I come with a lower price including a 60 day money back guarantee, 3 year warranty, higher resolution, custom screen fonts... say are — are you OK?

Now do you get it?

Good!

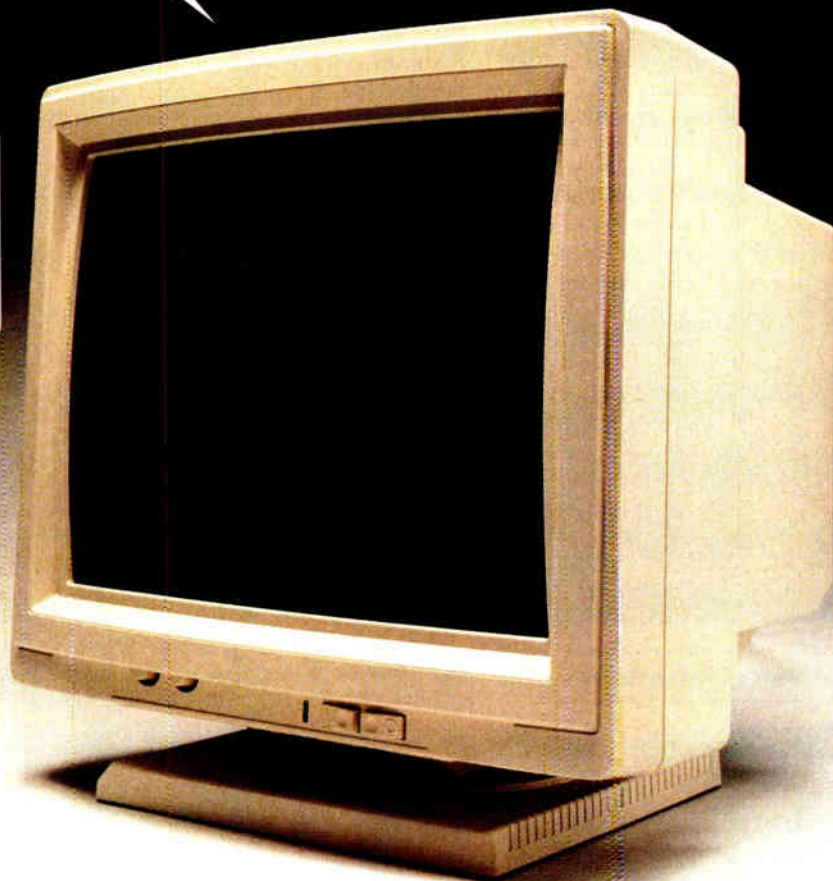

GOT IT! GOOD!

It offers the highest quality two-page display system available for the IBM PS/2 Series, and IBM PC and compatible.

Each display system comes complete with a high resolution monitor, video interface card, and software drivers.

The Elite/1600™ is part of our extensive family of display products for the IBM compatible and Macintosh computers.

We carry a complete line of high resolution monochrome, gray-scale, and color display systems. Any other monitor simply pales by comparison.

So call our toll free number today, for our free information package and discover for yourself how beautiful a big monitor can be.

1-800-343-5532

The monitor you've got in mind is probably in our warehouse right now!

Got the picture?



4201 Remo Crescent, Bensalem, PA 19020 USA
Phone: (215) 639-1636 FAX: (215) 639-3420

Circle 372 on Reader Service Card

that use the weighted sum of pixels surrounding the addressed source point produce better-looking images but require more computation (see photo 5).

With digital images, the geometric-mapping operation need not be smooth or analytic. In photo 6, I made the enlargement-mapping equation a function of the source-image x address. In photo 7, the destination-pixel y address is a function

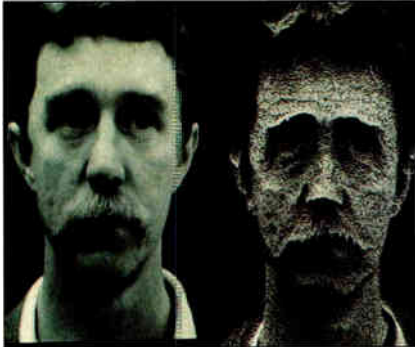

Photo 7: The y destination address is a function of source-pixel intensity.

of the source y address and the pixel's intensity.

Smooth distortions of images are called *warps*. Warping an image stretches or squeezes it to fit (map onto) some shape or surface. Image warping is typically used to remove the distortions introduced by perspective, camera optics, and so forth, but it can just as easily be used to introduce interesting distortions.

In photo 8, the picture at left shows an image before warping. The small blue squares that make up the grid are control points. Think of this image as printed on a rubber sheet with handles attached to each control point. When you move a control point with the mouse, the image point below it moves, and the surrounding image area warps (i.e., stretches and squeezes) to smoothly follow the image point. In the center photo, I made some cosmetic changes to the image in the photo at left. In the photo at right, I set the warp factor to surrealistic mode.

The SIMPP2 routine `bwarp4()` performs this warp, and `gridwarp()` manages the warp and the position of the con-

trol points. The `gridwarp()` routine first copies the source image to the destination image and overlays the destination image with the control points. The source image is divided into rectangles that match the initial position of the control points.

When a control point is moved, only the four polygons that share this control point as a vertex are updated. To do this, scan the four source-image rectangles that correspond to these polygons. In this case, scanning the source rather than the destination is simpler to understand and implement. To prevent holes in the destination image, you need to oversample the source image at fractional pixel addresses and interpolate to generate the pixel intensity value.

The warping function performed in `bwarp4()` is a four-point, bilinear warp that is defined by the following mapping equations:

$$\begin{aligned} x_{dest} &= a \times x + b \times y + c \times x \times y + d \\ y_{dest} &= e \times x + f \times y + g \times x \times y + h \end{aligned}$$

continued



Photo 8: An example of warping. Left: The original unwarped image; the blue squares are the control points. Center: The image is smoothly warped to match the edges of the polygons defined by the control points; there are minor changes to the head, jaw, and ear. Right: This image is truly warped, giving a surrealistic effect.

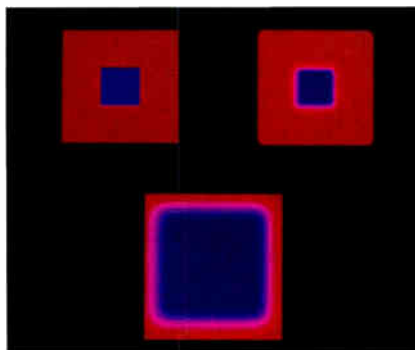

Photo 9: An example of convolution. When a color image (upper left) is convolved to blur its edges, spurious colors may appear (upper right and, enlarged, below).



Photo 10: An example of sharpening. Left: The original image of flowers. Right: The sharpened image. The original image was converted to hue-intensity-saturation space; the I component was sharpened and then converted back to RGB space. (Photos courtesy of Scott Kay, Data Translation)

Compuclassics

...not a turkey among them...

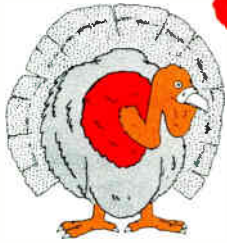

IF YOU DON'T SEE YOUR PRODUCT LISTED PLEASE CALL US!

CALL US FOR FULL CATALOG!!!

WE SHIP TO APO & FPO ADDRESSES



A Gem or Windows based mouse driven Database Manager. The only graphical database with relational power to manage different files and an advanced programming management language. Contains all the features of high end database programs.

Superbase 4 Gem or Windows \$399.00

ACCOUNTING

ACC/PAC BPI (each)	259.00
Dac Accounting 4.0	89.00
Dac Bonus Pack 4.0	175.00
Managing Your Money	129.00
Peachtree w/ Data Query	235.00
Quicken 3.0	48.00
Timeslips III	175.00

CAD

Generic 3D Drafting	192.00
Autosketch	95.00
Generic Cadd Level 3	169.00

COMMUNICATION

Carbon Copy Plus	119.00
Close Up Support	169.00
Close-Up Customer	129.00
Crosstalk Mark 4	142.00
Mirror III	55.00
PC Anywhere III	69.00
Procomm Plus	52.00
Smarterm 240	199.00

DATABASE

Ask Sam	179.00
Clipper 5.0	509.00
R & R Clipper/Fox Base Module	45.00
DB Fast/DOS Plus	179.00
DBMan V	209.00
DBASE III+	419.00
DBASE IV	489.00
DBXL - Diamond	145.00
Data Ease	499.00
Foxbase Plus Multi-user	299.00
Foxbase Plus	199.00
PC File/DB	59.00
Paradox V 3.0	479.00
Clanon Professional Developer	409.00
R & R Relational Report Writer	109.00
RBase For DOS	499.00

REFLEX 2.0

Reflex 2.0	169.00
UI Programmer Release 2	359.00

DISK UTILITY

1 Dir Plus	52.00
Automenu	39.00
Copy II PC	25.00
Disk Technician Advanced	109.00
Fastback Plus	109.00
Fastitax	35.00
Mace Gold	89.00
Norton Commander	89.00
Norton Utilities Advanced	89.00
PC Tools Deluxe 5.5	79.00
PC-Kwik Powerpak	79.00
Q-Dos II	39.00
Speedstor	35.00
Spirinte	52.00
V Cache	49.00
V Feature Deluxe	85.00

GRAPHICS

Arts & Letters Graphic Editor	479.00
Coral Draw Windows	345.00
Design Cad	159.00
Design Cad 3D	209.00
Designer	449.00
Freelance Plus	349.00
GEM/3 Draw Plus	179.00
Gem Presentation Team	289.00
Graph-In-The-Box	75.00
Grapher	145.00
Harvard Graphics	295.00
Hot Shot Graphics	149.00
Lasertorq	79.00
PC Paintbrush IV	65.00
Perspective Jr.	99.00
Print A Plot	105.00
Publisher's Paintbrush	169.00
Show Partner FX	229.00
Surfer	365.00

HARDWARE

Complete Half-Page Scanner	195.00
Complete Hand Scanner/400	169.00
Copy II Option Board Deluxe	119.00
Intel Inboard 386 AT DK	869.00
Masterpiece	89.00
Masterpiece Plus	105.00

Logitech Serial or Bus Mouse C9	85.00
Pacific Data 25 in one Cartridge	295.00
Polaroid Palette Plus (EGA)	2399.00
Prac: Periph 1200 Int	69.00
Prac: Periph 2400 SA w/MNP	215.00
Prac: Periph 2400 w/MNP Int	179.00
Prodesigner Plus 512K	435.00
Scan Man Plus	199.00
Microsoft Serial or Bus Mouse w/Paint	105.00
Microsoft Serial or Bus Mouse w/Window	145.00
Complete Fax 9600	469.00
Paradise VGA Professional Card	435.00
ATI VGA Wonder 512	479.00
Worldport 2400 Modem	259.00
Worldport 2496 Fax	509.00

INTEGRATED

Enable (Incl File Server)	449.00
Framework III	455.00
PFS First Choice	99.00
Q & A 3.0	229.00
Smartware II	475.00
Symphony Works	455.00
Works	105.00

NETWORKING

Novell Netware 286 V 2.15	2020.00
BTrieve Network	385.00
Novell ELS Level II 1-8 User	1165.00
Western Digital Ethercard Plus	239.00
NE1000 Ethernet Card	175.00
NE2000 16 Bit Ethernet Card	209.00
Novell Netware 386	5175.00
Novell SFT V 2.15	3050.00
XQL Relational Data Base	505.00

OPERATING SYSTEMS

IBM DOS 3.3	95.00
IBM DOS 4.01	125.00
OS/2 Standard Edition	295.00

INFORMATION MANAGEMENT

Prime Time	69.00
Tornado W/Library	79.00
Agenda	279.00
IZE	285.00
Who What When	119.00

PROGRAMMING

Brainmaker	149.00
Brief	175.00
Zortech C ++	125.00
MS C Compiler	299.00
C Tools Plus	92.00
MS Fortran	299.00
Graphpak Pro	119.00
Lattice C Compiler	239.00
Macro Assembler	99.00
Norton On-Line Guide	59.00
Quick C	67.00
Quickbasic	67.00
Smalltalk V286	145.00
Turbo C	99.00
Turbo C Pro Pack	169.00
Turbo C Tools	92.00
Turbo Pascal Pro Pack	169.00
Turbo Pascal V 5.5	99.00
Turbo Professional	79.00

PROJECT MANAGEMENT

Harvard Project III	435.00
Scltor Project Scheduler IV	429.00
Superproject Expert	455.00
Timeline 3.0	385.00

DESKTOP PUBLISHING

Formwork with Fill File	89.00
Go Script	139.00
Go Script Plus	259.00
Newsmaster II	49.00
PFS 1st Publisher	79.00
Per:FORM	172.00
Print Shop	39.00
Primmaster Plus	37.00
Ventura Professional Extension	379.00
Ventura Publisher	519.00
Xerox Graph	195.00
Adobe Illustrator Windows	409.00
Bitsream Fonts	45% Off List

SPREADSHEET

Allways For Lotus	89.00
Excel	319.00
Hal	109.00
Lotus 1-2-3 Vers 2.01	319.00
Lotus 1-2-3 Vers 3.0 or 2.2	349.00
Lucid 3D	60.00

WINDOWS

AMI	129.00
AMI Professional	319.00
Crosstalk For Windows	129.00
DB Fast/Windows	179.00
PC Paintbrush Plus for Windows	99.00
Windows 286	67.00
Windows 386	139.00

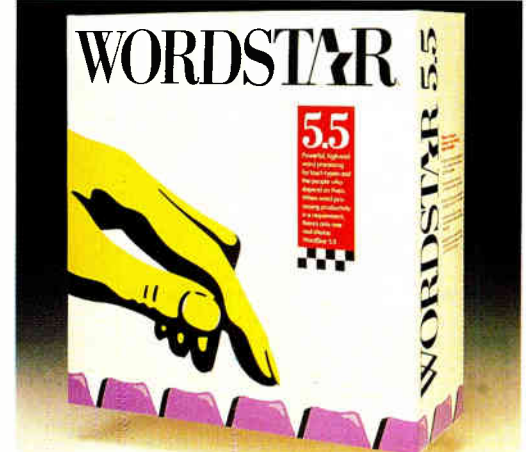

Powerful, high-end word processing specifically designed for the touch typist with commands based on the home row of the keyboard for speed and ease of use. With advanced page preview, import of Lotus, Quattro, dBase files, graphics and style sheets.

Wordstar 5.5 Only \$235.00

Quattro Pro	165.00	Windows Development Toolkit	339.00
See More 1-2-3	49.00	Windows Graph Plus	
Sideways	42.00	HDC Windows Express	45.00
Supercalc V	319.00		

UTILITY

386 To The Max Pro	99.00
Above Disk	55.00
Brooklyn Bridge (Serial or Parallel)	75.00
Copywrite/Zerodisk w/Rescue	65.00
Desktop	99.00
Deskview 386	125.00
Deskview	79.00
Flowcharting II Plus	139.00
Hyperpad	59.00
Intelligent Back Up	79.00
Interactive Easy Flow	125.00
Lap Link Release III	85.00
Limsim 4.0	49.00
Magellan	109.00
Mathematica 386	599.00
Mathcad 2.5	305.00
Memory Mate	45.00
Norton Editor	45.00
Org Plus Advanced	89.00
Pizazz Plus	69.00
Print Q 4.0	89.00
Softbytes	39.00

WORD PROCESSING

Displaywrite IV	289.00
Grammatik III	52.00
PFS Professional Write	145.00
Rightwriter	52.00
The Perfect Addition	39.00
Word 5.0	235.00
Word Perfect Network 5.0	239.00
Word Perfect Net Add-On 5.0	355.00
Wordstar 5.5	245.00
Xywrite III Plus	229.00

XENIX

SCO Foxbase +	539.00
SCO Xenix VPIX 386	679.00
Wordperfect for SCO Xenix 386	509.00
Xenix Complete System 286	949.00
Xenix Complete 386 PS/80	1149.00
Xenix Dev. System 286	405.00
Xenix Dev. System 386	539.00
Xenix Operating System 286	405.00
Xenix Operating System 386	475.00

INTERNATIONAL ORDERS

818.347.2444

FAX YOUR ORDER

818.347.9977

PHONE YOUR ORDER

800.733.3888

- Immediate shipment on purchase orders from government and state agencies, cities, counties, school and universities.
- Prices subject to change with out notice and while stocks last.
- We ship the latest versions.
- We accept Visa, Master Card, and American Express.
- 2% surcharge on American Express.
- 15% restocking fee for all non-defective items returned.
- Please call (818) 347-9400 for an authorization number on defective goods or your return will not be accepted.
- Due to copyright laws we cannot take back any software where the seal has been broken.
- \$5 minimum shipping per item, less on bulk orders.
- \$9 Blue Label shipping.
- \$3.50 C.O.D. charge.
- Heavier items are charged accordingly.
- We do not guarantee compatibility.
- Call for prices for any software item not included in this ad.
- Order desk open 7 A.M. to 5 P.M. Monday to Friday (PST).
- Saturday 10 A.M. to 2 P.M.
- P.O. Box 10598, Canoga Park, CA 91309.
- Showroom: 7959 Deering Ave., Canoga Park CA 91304.

WE WELCOME CORPORATE ACCOUNTS AND INTERNATIONAL ORDERS.

Circle 74 on Reader Service Card

Listing 1: A C code fragment that makes a negative image using a point process.

```

/* Make all pixels below the diagonal into their negative. Frame buffer is of size
XSIZE,YSIZE, and pixels have a maximum possible value of MAXPIX */

for (y = 0 ; y < YSIZE ; y++) {
  for (x = 0 ; x < XSIZE ; x++) {
    if (y > x) write_pixel(x,y, MAXPIX-read_pixel(x,y));
  }
}

```

Listing 2: A C code fragment that interactively changes image brightness.

```

/* Interactively change image brightness. Assumes 8-bit pixels and three output LUTs
(one each for RED, GREEN, and BLUE. */

/* Start with a "linear" LUT -- does not change pixel values */
for (z = 0 ; z < 256 ; z++) {
  write_LUT(RED,z,z); write_LUT(GREEN,z,z);
  write_LUT(BLUE,z,z);
}

/* Wait until all mouse buttons are up (off) */
while (read_mouse(&x,&y));

/* Loop reading mouse x position as the "brightness" control. Exit when a mouse
button is pressed */
while (!read_mouse(&x,&y)){
  for (z = 0 ; z < 256 ; z++) {
    i = z+x;
    if (i<0) i=0;
    if (i>255) i=255;
    write_LUT(RED,z,i);
    write_LUT(GREEN,z,i);
    write_LUT(BLUE,z,i);
  }
}

```

Listing 3: Cutting and pasting an image in C.

```

/* Interactive image copy (cut and paste) */

get_box(&sx,&sy,&sdx,&sd); /* Get source */
get_box(&dx,&dy,&ddx,&ddy); /* Get destination */
copy_area(sx,sy,sdx,sdy,dx,dy,ddx,ddy); /* Copy area */

/***** Fragment of the get_box() subroutine *****/

while (read_mouse(&x,&y)); /* Buttons off? */
/* Put up a cross-hair overlay and use the mouse to move it */
oldx = XSIZE/2; /* Initialize tracking at */
oldy = YSIZE/2; /* the screen center */
cross_over(oldx,oldy,1); /* Put up initial cross hair */
while (!read_mouse(&x,&y)) {
  cross_over(oldx,oldy,0); /* Erase old cursor */
  cross_over(x,y,1); /* New cursor */
  oldx = x; oldy = y; /* New position */
}
i = oldx; j = oldy; /* Save corner position */
cross_over(i,j,0); /* Cross hair off */
while (read_mouse(&x,&y)); /* Buttons off? */

/* Put up a box and use mouse to change its size */
oldx += 5; oldy += 5; /* Start with a small box */
box_over(i,j,oldx,oldy,1); /* Put up initial box */
while (!read_mouse(&x,&y)) {
  box_over(i,j,oldx,oldy,0); /* Erase old box */
  box_over(i,j,x,y,1); /* New box */
  oldx = x; oldy = y; /* New position */
}
box_over(i,j,oldx,oldy,0); /* Remove box */

/* i,j, oldx,oldy are now the corner coordinates */

```

The values for the equations' coefficients (*a, b, c, d*, and *e, f, g, h*) are determined from the positions of the corners of the source rectangle and the corners of the destination polygon. The coefficients are computed for each polygon updated. Listing 4 is a simplified version of `bwarp4()` that maps a square located at (0,0) of size 100 by 100 pixels to an interesting destination shape, using nearest-neighbor interpolation. The `bwarp4()` code uses a more efficient algorithm and a smoother interpolation.

Color Image Processing

Color images are usually represented by arrays of pixels with red, green, and blue values. This might be done with three separate frame buffers or with a frame buffer that had pixels containing red, green, and blue bits.

Suppose you edit a color image by adding a blue square to a red background. If you try to blend the square into the background using convolution methods, a purple fringe can appear in the image (see photo 9). Convolution averages the pixel information in an area, and combining red and blue pixels yields purple. Sharpening a color image using convolution also makes unwanted colors appear.

In human vision, intensity defines object edges, and color is used as a feature that fills the areas that the intensity edges define. The trick, then, is to separate the color information from the intensity information, convolve only the intensity information, and then recombine (i.e., fill) the color information with the intensity information. This separation also makes it possible for you to edit the color information.

There are many different ways to transform an RGB image to separate its intensity and color components. The HIS transformation converts (i.e., maps) each pixel's RGB values into a new triple of values: hue, intensity, and saturation. The I component contains the image intensity, and the H and S components contain the color. You can now convolve the intensity component and manipulate object colors by changing the hue and saturation components. Then you convert the modified HIS components back into RGB components for display. In photo 10, the image at right shows the result of sharpening the intensity and changing the hue of the image on the left.

Real-World Examples

Digital image editing is extensively used in publishing and advertising design. A photo editor can digitally edit an image

continued

Introducing DADiSP 2.0

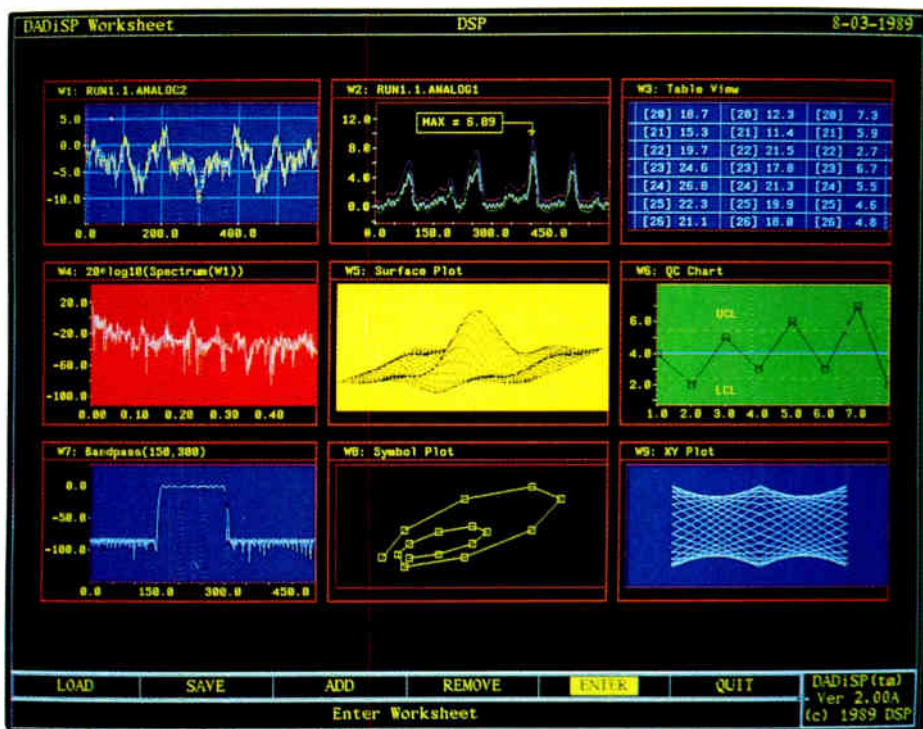

DADiSP. The Big Picture in Data Analysis

DADiSP — interactive graphics and data analysis software for scientists and engineers. DADiSP 2.0 delivers unprecedented power, through easy-to-use menus. Choose from hundreds of analysis functions and graphic views — from tables to 3-D. Simultaneously display multiple windows, each with different data or analyses, for unlimited perspective on your toughest data analysis problems.

Build your own analysis worksheets — build and display an entire data analysis worksheet, *without programming*. And DADiSP's powerful graphic spreadsheet automatically recalculates and updates the entire worksheet if you change your data or an analysis step.

Do serious signal processing... the way you always pictured it! FFTs, digital filter design, convolutions, waterfall plots, and more — all at the press of a key.

Let your instruments do the talking — use DADiSP-488 to bring data from your instruments directly into a DADiSP window for immediate viewing and analysis.

Flexible, expandable, customizable — annotate your graphs and send them to printers, plotters, or publishing packages. Create your own macros, automate routine tasks, and run any program written in any language from within DADiSP. *DADiSP even lets you build your own menus.*

A proven standard — already used by thousands of engineers and scientists worldwide, in a whole range of applications like medical research, signal processing, chemistry, vibration analysis, communications, manufacturing quality control, test & measurement, and more. DADiSP supports the IBM PC and PS/2, SUN, DEC VAX, HP 9000 and Concurrent families of personal computers and workstations.

**GET THE PICTURE!
CALL TODAY 617-577-1133**

Ask for our Evaluation Disk. For more information, write to DSP Development Corporation, One Kendall Square, Cambridge, MA 02139, or FAX: 617-577-8211.



Australia-Interworld Electronics, 03 521-2952; England-Adept Scientific, (0462) 480055; Biosoft (0223) 68622; France-SM2L, (1) 34810178; Sacasa, 69077802; West Germany-Datalog, (02166) 46082; Stemmer Elektronik, 089-809 02-0; Israel-Racom Electronics, 03-491-922; Italy-BPS Computers, (02) 61290221; Japan-Astrodesign, 044-751-1011; Netherlands-Computer Engineering Roosendaal, 01650-57417; New Zealand-GTS Engineering, (09) 392 464; Sweden-Systek, 013 110140; Switzerland-Urech & Harr AG, 61 611325; Taiwan-Advantech, 2-351-2117

Circle 113 on Reader Service Card
World Radio History

IEEE 488

Interfaces & Software

Hardware

IEEE interfaces for PC, AT, 386, PS/2, Macintosh, HP, SUN & DEC. Converters from IEEE to RS-232, RS-422, modem, Centronics, SCSI, digital I/O and analog I/O. IEEE extenders, expanders & buffers.

Software

IEEE device drivers for DOS, UNIX, Macintosh & SUN. Drivers for Lotus 1-2-3 & Symphony. Macintosh IEEE desk accessory. PC menu-driven analysis.

Support

Free applications support. 30 day money-back guarantee. Two year warranty. IEEE seminars available.

Call for your FREE Technical Guide

Demo disks & application notes available



(216) 439-4091

Telex 6502820864 • Fax (216) 439-4093
 IOtech, Inc. • 25971 Cannon Road • Cleveland, Ohio 44146
 London (0754) 861287 • Paris (1) 348 10178 • Milan (02) 4120360
 Brussels (02) 3848062 • Linköping (01) 5110140 • Helsinki (090) 5215288
 Munich (089) 710020 • Zurich (01) 8219444 • Vienna (0222) 253626
 Göttingen (0183) 3035353 • Oslo (02) 6649070 • Copenhagen (02) 804200
 Madrid (91) 4027060 • Lisbon (01) 41013420
 Melbourne (03) 5793622 • Toronto (416) 6740444



Listing 4: A C code fragment demonstrating a bilinear warp.

/* Source image starts at x,y location 0,0 and is 100 by 100. Destination image is specified by the coordinates in destx[] and desty[]. These coordinates are indexed clockwise starting at the top left vertex. */

```
static int u[] = {200,328,264,200};
static int v[] = {136,200,264,392};
double a,b,c,d,e,f,g,h; /* Equation coefficients */
double x,y; /* X,Y index for source */
int iy; /* Input image y value (integer) */
PIXEL z; /* Pixel value */
static double sdx = 100.0; /* Source X size */
static double sdy = 100.0; /* Source Y size */
double ua,va; /* Destination addresses */
```

/* Set up equation coefficients from terms in the transformation matrix */

```
a = ((double)(-u[0] + u[1]))/sdx;
b = ((double)(-u[0] + u[3]))/sdy;
c = ((double)(u[0] - u[1] + u[2] - u[3]))/(sdx*sdy);
d = (double)(u[0]);
e = ((double)(-v[0] + v[1]))/sdx;
f = ((double)(-v[0] + v[3]))/sdy;
g = ((double)(v[0] - v[1] + v[2] - v[3]))/(sdx*sdy);
h = (double)(v[0]);
```

/* Scan the rectangular source image in x and y and use the transformation equations to place source pixel values into the destination (warped) area. Use nearest-neighbor interpolation and simple but inefficient code */

```
for (y = 0.0 ; y < sdy; y+=0.5) {
  iy = (int)y+0.5 /* Nearest-neighbor interpolation */
  for (x = 0.0 ; x < sdx; x+=0.5) {
    /* Get nearest neighbor */
    z = read_pixel((int)(x+0.5),iy);
    /* Get destination X address */
    ua = a*x + b*y + c*x*y + d;
    /* Get destination Y address */
    va = e*x + f*y + g*x*y + h;
    write_pixel((int)(ua+0.5),(int)(va+0.5),z);
  }
}
```

to improve its impact and focus. For example, a newspaper editor might sharpen and blur different areas in an image of a group of people to focus your attention on the people discussed in an accompanying article. You can see how less honest and more creative edits are possible. For examples of creative (and sometimes bizarre) image editing, look at the supermarket tabloids.

High-performance simulators are an impressive example of image editing. Simulators often use a large database of natural images to generate a background image or *gaming field*. For flight simulators, graphics of the cockpit, other aircraft, obstructions, and so forth are combined with gaming-field images to give a realistic simulation.

With a reasonably small investment in time and equipment, you can experiment with digital image editing and perhaps discover a new application. You can edit images without knowing much about image processing, but some understanding helps you get the results you want. ■

Editor's note: The listings from this article and the `rgb_to_his()` and `his_to_rgb()` routines are available from BYTE on disk and in print. See page 5 for

details. The complete SIMPP2 routines and documentation are available from Electronic Media, 89 Overbrook Dr., Wellesley, MA 02181, for \$25 (\$35 U.S. overseas). The SIMPP2 routines for `rgb_to_his()` and `his_to_rgb()` are based on code provided by Scott Kay of Data Translation.

BIBLIOGRAPHY

Castleman, Kenneth R. *Digital Image Processing*. Englewood Cliffs, NJ: Prentice-Hall, 1979.

Holzmann, Gerald J., and AT&T Bell Laboratories Staff. *Beyond Photography: The Digital Darkroom*. Englewood Cliffs, NJ: Prentice-Hall, 1988.

Schacter, Bruce J., ed. *Computer Image Generation*. New York: John Wiley & Sons, 1983.

Benjamin M. Dawson is a research scientist in the areas of computer vision and image processing at MIT (Cambridge, MA) and manager of advanced development at Imaging Technology, Inc. (Woburn, MA). He has an M.S.E.E. in computer engineering and a Ph.D. in physiological psychology, both from Stanford University. He can be reached on BIX c/o "editors."

EDITORS' CHOICE



Northgate™ Computer Systems, Inc.



CALL TOLL-FREE 24 HOURS EVERY DAY
800-548-1993

Circle 232 on Reader Service Card



MAY 30, 1989

ELEGANCE 386 20 MHz

EDITORS' CHOICE



MAY 30, 1989

ELEGANCE 386 25 MHz

EDITORS' CHOICE



AND NOW OCTOBER 31, 1989

ELEGANCE 386 33 MHz

EDITORS' CHOICE

Northgate's 386 Expertise reaches its pinnacle with the introduction of our 33 MHz Elegance model. Northgate 20 and 25 MHz models have already won rave reviews. Each owns an Editors' Choice. And now, our 33 MHz also carries Editors' Choice honors. Quality construction and the thoughtful combination of exclusive features set them apart.

But the hands-down distinguishing factor among 386 systems in this business is S-P-E-E-D. And here's where Elegance rages into the lead. Both the 20 and 25 MHz systems won the special attention of PC Magazine, InfoWorld and hordes of customers for their raw computing power.

Enter Elegance 33. And add more compelling features—industry-topping speed AND a killer total system price. Unmatched among recognized brands,

the Northgate system described at the right simply sweeps away the rest.

IBM, Compaq? Double the price or more. AST, Everex, etc. can't come close. Dell doesn't even have a 33 MHz and their 25 MHz System 325 is more than \$1,600.00 higher than Elegance 33.

Next ... factor in the most CUSTOMER oriented service and tech support programs ever seen in the PC industry; Deskside repair option; TelephoneTech support day, night, every day, every night. No wonder Northgate products win more than their share of awards. And no wonder Northgate is the computer thousands of new users every month are proud to call theirs.

Prices and specifications are subject to change without notice. Northgate reserves the right to substitute components of equal or greater quality or performance. All items subject to availability.

© Copyright Northgate Computer Systems, Inc. 1989. All Rights Reserved. Northgate, OMNIKEY, 102, OmniKey PLUS, and the Northgate 'N' logo are trademarks of Northgate Computer Systems, Inc. All other product and brand names are trademarks and registered trademarks of their respective companies.

CALL TOLL-FREE 24 HOURS EVERY DAY

800-548-1993

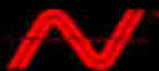

"We hear you!"

NORTHGATE COMPUTER SYSTEMS, INC.
P.O. Box 41000, Plymouth, Minnesota 55441

FINANCING: Use the Northgate Big 'N' revolving credit card. We have millions in financing available. We accept your Visa or MasterCard too. Lease it with Northgate, up to five-year terms available.

COMPARE FEATURES • COMPARE PRICING

\$5995⁰⁰

FOR THIS COMPLETE 386 33 MHz ELEGANCE SYSTEM

- 150MB Hard Drive 16MS
- 4MB Ram
- 64K SRam Read-Writeback Cache (Optional 256K Cache available)
- Zero wait state performance
- 14" MultiFrequency VGA Color Monitor 800x600 Resolution with 16 Bit Controller
- Sleek New Elegance 7 drive-bay custom vertical cabinet. (Desk Top style save \$150.00)
- Exclusive OmniKey Keyboard
- Sorbus Next Day Deskside service or famous Northgate overnight parts shipment policy. One year parts and labor warranty
- Telephone Tech Support Supreme — 24 Hours Every Day, Every Night, Holidays and Weekends, too

NOTE: Tape drive and OmniKey/PLUS shown here are optional at extra cost.

Circle 233 on Reader Service Card



Ask about NEW
OmniKey/PLUS
"THE MAGIC
KEYBOARD"

MONTGOMERY GRANT

BYTE
12 89

**OUTSIDE USA & CANADA
CALL
(718)692-0790**
For Customer Service
Call Mon-Thurs: 9:30am-4:30pm
Fri: 9am-3:30pm (718) 692-1148

Retail Outlet: Penn Station, Main Concourse
(Beneath Madison Square Garden) New York City, NY, 10001
Store Hours: Mon-Thurs, 8:30am-8pm Fri 8:30am-2:45pm Sat. Closed Sun, 9:30am-7pm
FOR ORDERS & INFORMATION IN USA & CANADA CALL TOLL FREE

OR WRITE TO:
Montgomery-Grant Mail Order
Department, P.O. Box 58
Brooklyn, N.Y., 11230
**FAX NO. 7186923372
TELEX 422-132 MGRANT**

1-800-759-6565

**EXTENDED HOLIDAY SEASON ORDER HOURS: Mon-Thur 8:30am-8pm Fri 8:30am-3:30pm Sat. CLOSED Sun. 9:30am-6:30pm
NO SURCHARGE FOR CREDIT CARD ORDERS / WE INVITE CORPORATE AND EDUCATIONAL CUSTOMERS
DISCOUNTS FOR QUANTITY ORDERS TOLL FREE TECHNICAL SUPPORT**

**EPSON EQUITY 1+
IBM XT COMPATIBLE**
• 640K RAM w/Clock Calendar • 477-10 MHz • 360K Drive • Serial & Parallel Ports • MS DOS 3.3 • GW Basic
\$619
SAME w/SEAGATE 20MB HARD DRIVE.....\$689
SAME w/SEAGATE 30MB HARD DRIVE.....\$699
SAME w/SEAGATE 40MB HARD DRIVE.....\$969
SAME w/TWO 360K FLOPPIES.....\$669

**EPSON EQUITY II+
IBM AT COMPATIBLE**
• 640K RAM • 80286 Microprocessor • 1.2MB Floppy Drive • Serial & Parallel Ports • MS DOS 3.3 • GW Basic
\$999
SAME w/SEAGATE 20MB HARD DRIVE.....\$1249
SAME w/SEAGATE 30MB HARD DRIVE.....\$1279
SAME w/SEAGATE 40MB HARD DRIVE.....\$1349

EPSON EQUITY 386/20.....\$2349
WE CAN RECONFIGURE ANY OF OUR COMPUTER PACKAGES TO FIT YOUR SPECIFICATIONS. CALL FOR INFORMATION. ALL COMPUTER SYSTEMS SUPPORT MDX, CGA, EGA, VGA, & MULTISCAN. WE CARRY MODEMS, HARD DRIVES, CARDS, MONITORS, MEMORY UPGRADES & ALL OTHER ACCESSORIES FOR YOUR COMPUTER.

VENDEX HEADSTART III
• 8-12 MHz • 1MB RAM • 5.25" 1.2MB Floppy Drive
3.5" 1.44MB Floppy • 30MB Hard Drive • VGA/EGA/CGA
MDA included • Serial & Parallel Ports • Mouse
MS DOS 3.3 • 12" VGA Monitor
\$2099
\$1000 SOFTWARE INCLUDED

**LEADING EDGE MODEL D
IBM XT COMPATIBLE PKG.**
• 512K RAM Expandable to 768MB • 8088-2 Microprocessor • 360K Floppy Drive • 4.77-7.16 MHz • MS DOS 3.3 & GW Basic • 12" Monitor
\$579
SAME w/SEAGATE 20MB HARD DRIVE.....\$829
SAME w/SEAGATE 30MB HARD DRIVE.....\$859
SAME w/SEAGATE 40MB HARD DRIVE.....\$929

AST 286 IBM AT COMPATIBLE
• 80286 Processor • 512K Expandable to 4MB • 1.2MB Floppy Drive • Serial & Parallel Ports • Video Card
\$799
SAME w/SEAGATE 20MB HARD DRIVE.....\$1049
SAME w/SEAGATE 30MB HARD DRIVE.....\$1079
SAME w/SEAGATE 40MB HARD DRIVE.....\$1149
AST PREMIUM 286 MODEL 70.....\$1199
AST PREMIUM 386/16 MHz.....\$2199

Apple IIGS COMPUTER PKG.
• Apple IIGS Computer • 512K Upgrade
• RGB Color Monitor • Apple 3.5" Disk Drive
\$1499
IMAGewriter II PRINTER.....\$439
ALL OTHER APPLE MODELS.....CALL

LAPTOP COMPUTERS
TOSHIBA 1000.....\$535
TOSHIBA 1600.....\$3179
TOSHIBA 1800 w/40MB.....\$2699
TOSHIBA 3100e.....\$2699
TOSHIBA 3100e w/40MB.....\$2979
TOSHIBA 1200HB.....\$1900
TOSHIBA 3200.....\$2300
TOSHIBA 5100 w/40MB.....\$4190
TOSHIBA 5100 w/100MB.....\$4790
TOSHIBA 5200 w/40MB.....\$4490
TOSHIBA 5200 w/100MB.....\$5290
BONDWELL 286-20.....\$2169
EPSON LT w/20MB.....\$1649
AMSTRAD PPC-512 512K 1 FLOPPY.....\$499
NEC ULTRALITE 2MB.....\$2099
NEC PROSPEED 286-20MB.....\$3299
NEC PROSPEED 286-40MB.....\$3299
NEC PROSPEED 386 w/40MB.....\$4490
ZENITH 184 w/2 FLOPPIES.....\$1390
ZENITH 184-2 w/20MB.....\$2090
w/20MB Modem.....\$2499
COMPAQ SLT 286-20.....\$3790
COMPAQ SLT 286-40.....\$4190

BATTERIES, CABLES, MODEMS, EXTERNAL DRIVES, MEMORY EXPANSIONS, EXPANSION CHASIS & ALL ACCESSORIES AVAILABLE FOR ALL LAPTOPS.

AMIGA 500, 2000, 2500 COMPUTERS
Amiga 500 w/Built-in 5.25" Drive.....\$549
Amiga 500 w/1084 Monitor.....\$629
Amiga 2000 H.D.....\$2099
Amiga 1010 Disk Drive.....\$179
Amiga 2000 w/Built-in 3.5" Drive.....\$1459
Amiga 2500.....\$3199
Amiga 1084 RGB Monitor.....\$289
Amiga 2500 w/1084 Monitor.....\$179

PRINTERS

STAR
NX-1000.....\$154.95
NX-1000II.....\$164.95
NX-1000.....\$209.95
XR-1000.....\$277.95
XR-1500.....\$339.95
XR-2410.....\$429.95
XR-2415.....\$459.95

CITIZEN
180 D.....\$149.95
DICONIX
150+.....\$329.95
OKIDATA
OKIMATE 20.....\$139.95
OKIDATA 180+.....\$219.95
OKIDATA 320.....\$279.95
OKIDATA 321.....\$459.95
OKIDATA 390.....\$439.95
OKIDATA 391.....\$599.95

EPSON
FX-1050.....\$429.95
FX-950.....\$329.95
LQ-510.....\$329.95
LQ-850.....\$509.95
LQ-950.....\$569.95
LQ-1050.....\$709.95
LQ-2550.....\$889.95
LX-810.....\$179.95

NEC
P-2200.....\$309.95
P-5200.....\$479.95
P-5300.....\$649.95
PANASONIC
KXP-1092I.....\$269.95
KXP-1524.....\$519.95
KXP-1595.....\$419.95
KXP-1124.....\$299.95
KXP-1180.....\$174.95
KXP-1191.....\$224.95
KXP-3131.....\$269.95

TOSHIBA
301.....\$329.95
SANYO PR-3000
DAISY WHEEL.....\$59

HEWLETT PACKARD
DESKJET.....\$569
DESKJET PLUS.....\$669
PAINTJET.....\$959

LASER PRINTERS
HP LASERJET SERIES II
NEW
HP LASERJET IIP.....\$999
1MB EXPANDER.....\$279
2MB EXPANDER FOR LASERJET II.....\$399
4MB EXPANDER.....\$699
HP LASERJET IID.....\$2799
PARASOFT KXP-4450.....\$1319
BROTHER HL-8E.....\$1859
BROTHER HL-8EPS.....\$3199

MONITORS
SEIKO 1430 SUPER VGA.....\$499
MAGNAVOX EGA.....\$319
w/EGA Card.....\$419
MAGNAVOX VGA.....\$349
w/VGA Card.....\$499
ZENITH 1430.....\$629
NEC MULTISYNC IIA.....\$499
NEC MULTISYNC IID.....\$619
PARAISOE.....\$279
VIDEO CAROS.....IN STOCK

**NEC POWERMATE 286
IBM AT COMPATIBLE**
• 80286 Microprocessor • 10 MHz • 512K RAM Expandable to 16MB • 1.2MB Floppy Drive • Serial & Parallel Ports • MS DOS 3.3 & GW Basic
\$869
SAME w/SEAGATE 20MB HARD DRIVE.....\$1119
SAME w/SEAGATE 30MB HARD DRIVE.....\$1149
SAME w/SEAGATE 40MB HARD DRIVE.....\$1219

**NEC POWERMATE 286 PLUS
IBM AT COMPATIBLE**
• 1MB RAM Expandable to 16MB • Zero Wait State • 8-12 MHz • 1.2MB Floppy Drive • Serial & Parallel Ports • MS DOS 3.3 • GW Basic • 80286 Microprocessor • VGA
\$1149
SAME w/SEAGATE 20MB HARD DRIVE.....\$1399
SAME w/SEAGATE 30MB HARD DRIVE.....\$1439
SAME w/SEAGATE 40MB HARD DRIVE.....\$1499

NEC POWERMATE 386 SX PLUS
• 80386 SX Microprocessor • 2MB RAM Expandable to 16MB • 1.2MB Floppy Drive • Serial & Parallel Ports • MS DOS 3.3 • VGA
\$1599
NEC HARD DRIVE PACKAGES AVAILABLE
NEC POWERMATE 386/20.....\$2899

Panasonic FX-1750
• 640K RAM Expandable to 768K • 3.5" 720K Floppy • 80286 Microprocessor • Parallel & Serial Ports • MS DOS 3.3 and GW Basic
\$699
SAME w/SEAGATE 20MB HARD DRIVE.....\$949
SAME w/SEAGATE 30MB HARD DRIVE.....\$979
SAME w/SEAGATE 40MB HARD DRIVE.....\$1049
Panasonic FX-1650 IBM XT COMPATIBLE
• 640K • 720K Floppy Drive • Parallel/Serial Ports • MS DOS 3.3 • GW Basic • 12" Monitor
\$499
SAME w/SEAGATE 20MB HARD DRIVE.....\$749

IBM AT
512K Expandable to 8MB • 1.2MB Floppy Drive • 12" Monitor
\$1199
SME PACKAGE WITH SEAGATE 20MB HARD DRIVE.....\$1449
SAME PACKAGE WITH SEAGATE 30MB HARD DRIVE.....\$1479
SAME PACKAGE WITH SEAGATE 40MB HARD DRIVE.....\$1549

IBM PERSONAL SYSTEM 2
ALL MODELS IN STOCK.....CALL
5.25" 360K EXTERNAL DRIVE for IBM PS/II-30.....\$129
PACIFIC RIM 5.25" 1.2MB EXTERNAL DRIVE for IBM PS/II.....\$259

HYUNDAI MODEL 286E
• 640K RAM Expandable to 1MB • 80286 Microprocessor • 12 MHz • 1.2MB Floppy Drive • Serial & Parallel Ports • MS DOS 3.3 • GW Basic
\$899
SAME w/SEAGATE 20MB HARD DRIVE.....\$1149
SAME w/SEAGATE 30MB HARD DRIVE.....\$1179
SAME w/SEAGATE 40MB HARD DRIVE.....\$1249
HYUNDAI 386C w/20MHz.....\$2099

EVEREX STEP 386 IS
• 386 SX Microprocessor • 16MHz • 1MB RAM Expandable to 8MB • 1.2MB Floppy Drive
\$1739
EVEREX 386/20 MHz.....\$2699
EVEREX 386/25 MHz.....\$2999
EVEREX 286.....IN STOCK

COMPAQ DESKPRO 286
• 640K Expandable to 2.1MB • 8-12MHz • 80286 Microprocessor • 1.2MB Floppy Drive • Serial/Parallel Ports
\$1539
SAME PKG. w/SEAGATE 20MB.....\$1789
SAME PKG. w/SEAGATE 30MB.....\$1819
SAME PKG. w/SEAGATE 40MB.....\$1889
COMPAQ 286e \$1849

DESKPRO 386S
• 80386 SX Microprocessor • 1MB RAM Expandable to 13MB • Serial/Parallel Ports • 16 MHz • 1.2 MB Floppy Drive
\$2399
DESKPRO 386-20e
• 80386 SX Microprocessor • 1MB RAM Expandable to 16MB • Serial/Parallel Ports • 20 MHz • 1.2 MB Floppy Drive
\$3699
COMPAQ 386/25 with 60MB.....\$5795
COMPAQ 386/25 with 100MB.....\$7099
COMPAQ 386/33 w/84MB.....\$7499

Certified Check, Bank Check, Money Orders, Approved P.O.s, Visa, Mastercard, Am Ex, Diner's Club, Carte Blanche & C.O.D.s accepted. Please call before submitting P.O.s. No additional surcharge for Credit Card orders. Non-certified checks must wait 4-6 weeks for clearance. N.Y. residents add applicable sales tax. Prices and availability subject to change without notice. Not responsible for typographical errors. Return of defective merchandise must have prior return authorization number or returns will not be accepted. IBM XT AT are registered trademarks of International Business Machines Corp. Please add 5% shipping & handling. Volume orders over \$2000 are discounted to 3% shipping and handling (Canadian orders please add additional 5%). APO/FPO orders please add 10% shipping and handling. All APO/FPO orders are shipped first class priority air. All orders can be shipped Air Express. Call for details. DCA 8800233



RUSH SERVICE AVAILABLE. CALL FOR DETAILS.

Pepperoni and Paperwork

*The dream—and the reality—of voice/document delivery
from off-the-shelf hardware and software*

Ira Scherr

Often, when I'm sitting in my office after 5:00 p.m., after having spent the day in meetings or on the road, I have to get my paperwork ready for the next day's round of meetings. That's when I wish I could pick up the phone, just like ordering a pizza, and say, "Send me all the documents from the January 4th Peterson meeting."

During the past two years there has been a remarkable evolution in products and software, bringing a great deal of fictional "future think" into focus. So, while waiting in the office for a pizza to be delivered at 7:00 p.m. one rainy evening, I dreamed of building just such an automated document-delivery system from currently available off-the-shelf hardware and software.

The script for such a system is simple. You pick up your desk phone and dial the database server. Using voice recognition and Touch-Tone detection, you communicate with the database. It responds with prerecorded (digitized) voice instruction prompts and text-to-speech conversion of the ASCII database information. You zero in on the specific documents that

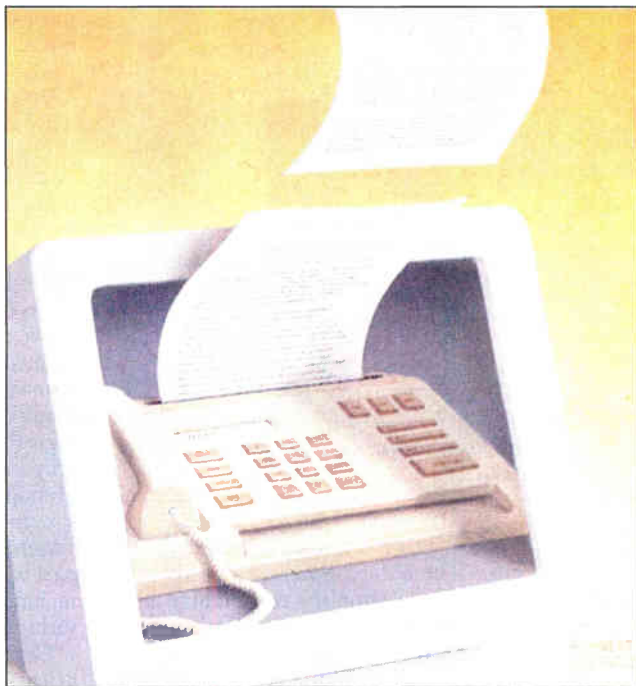

you need and order them after verbally entering an access code and client-billing number. The database requests the files from the document-storage server, which decompresses the compressed-image files and forwards them to the fax server. The fax server dials the fax machine on your desk and delivers the documents a few moments later in PostScript-quality output.

5000 words, and 20,000 words or over (i.e., a large vocabulary). Since voice recognition works by matching voice images on file with each live utterance, the smaller the vocabulary, the more successful the recognition.

Due to the bandwidth of the telephone and normal phone distortion, it makes sense to restrict the vocabulary to the

continued

VOICE/DOCUMENT DELIVERY SYSTEM

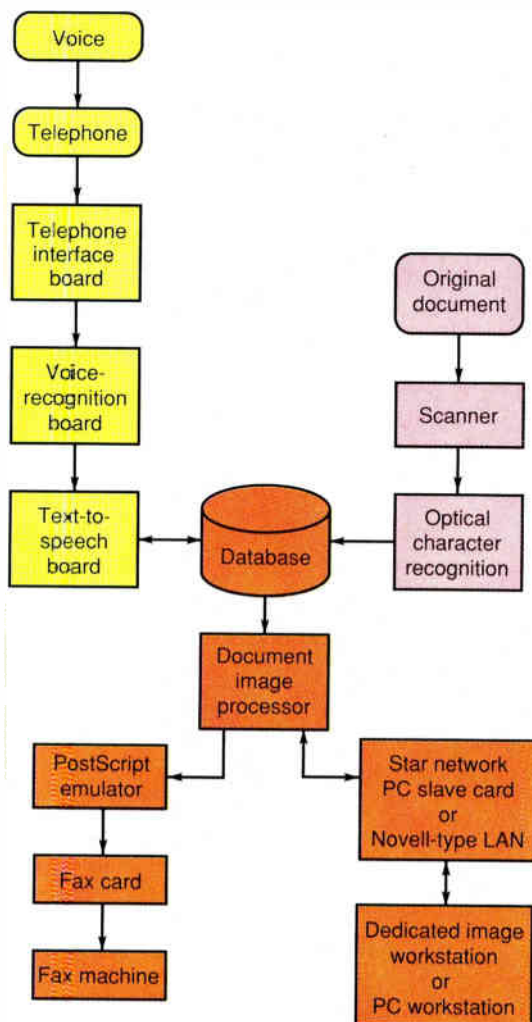

Appropriate voice, speech, optical, image, and fax hardware and software combine to provide verbal document-retrieval capability.

smallest possible size: the numbers 0 through 9 and the words *yes* and *no* constitute the 12-word vocabulary used to power this system.

Then, the voice server needs a text-to-speech module so the database can respond to you over the phone. The hardware requirements for text-to-speech conversion are simple. While there has been a great deal of massaging of the text-to-speech algorithms and exception tables to make the speech understandable, the resulting voice still has a nasal quality and sounds like a computer with a cold. Although strange at first, the speech is accurate and understandable when you get used to the voice.

Next, you must choose a database engine. The database must be easily configurable to simplify the inquiry level and make the voice-server portion of the system work. It must also integrate with the image files. While you can probably use your favorite database, in my office we chose engines that work on several platforms across microcomputers and minicomputers. Once you have built your database, and the volume of images and data stored on the system has grown, reorganizing your database will be a monumental task. With a database that runs on several platforms, your hardware configuration can grow, and you can port your database information upward.

The document server is the heart of the system, and you need rapid input, effective interfacing with the database, and rapid output. In my office, we opted for an image-engine toolkit, although a fully configured image engine would work just as well.

The toolkit approach lets you build your own knowledge base of image-storage and retrieval capabilities, which is more useful for building systems on your own in the future. It doesn't lock you into specific hardware; it allows you to control the integration of scanning, display, and printing hardware.

As the database grows, it becomes more useful, and its use and throughput grow as well. As this activity increases, you may need to upgrade your hardware. In addition, attached to the document server is an optical disk subsystem with large-to-enormous storage capacity.

Finally, you need a fax server. This is one area that has shown remarkable growth and vitality. Fax has become a cultural add-on almost overnight. Here you have your choice of some really quality hardware and software products that produce crisp, clear, PostScript-quality output at the desktop fax-machine end.

Choosing a System

This all sounds wonderful, but is it real? In my office, we have put together a voice/document delivery system (VDDS) based on this design. It works, and because it does, I'll describe our choices for hardware and software, the reasons behind them, and some of our experiences on the way.

We chose an AT-based platform to implement our VDDS because of the sheer number and variety of boards available, thanks to open architecture. This was a logical starting point for reasons of economy, development time, and ease of integration. To speed implementation, the system runs under DOS, still the most-common accepted standard. However, part of our reasoning in selecting vendors included the operating systems and platforms driving their own growth.

Currently, we are migrating many applications to run on 80386 machines under Unix. The Unix connection provides us with the experience necessary to migrate toward more sophisticated platforms, such as DEC workstations under Ultrix, Hewlett-Packard workstations, and others.

A final consideration was one of language. Wherever possible, we have migrated to hardware vendors whose software drivers are written in C or assembly

continued



COMPUTER DISCOUNT WAREHOUSE™



Emerson

CDW™ LETS YOU BRING THE FAMOUS EMERSON EC800 BUSINESS MACHINE HOME

Comes Ready to Use with a 30 Meg Hard Drive. Loaded with the Following Software: Menu/Mic, Home Accountant, Window Works, Borland Quattro and Borland's dBasek

CDW™ price **\$849.53**

Your Choice of Color or Mono Monitor. ADD \$199.00 for Color, \$84.10 for Mono

PACIFIC DATA PRODUCTS

PACIFIC DATA 25 in 1 Cartridge	283.85
PACIFIC DATA Postscript Cartridge	478.80
PACIFIC DATA Plotter in a Cartridge	247.50
PACIFIC DATA 1 Meg Upgrade	263.39

PACIFIC DATA FONTS

WHY PAY RETAIL?

CDW™ Sells For Less

AND SERVICES YOU BETTER



INTEL BOARDS & CO-PROCESSORS

INTEL Above Board Plus	\$410.68
INTEL Inboard 386 PC	559.53
INTEL Visual Edge	448.39
INTEL Connect Co-processor	712.43

SPEED UP YOUR PC UP TO 500%!



INTEL MATH COPROCESSORS

INTEL 80287-8	\$206.55
INTEL 80287-10	223.55
INTEL 80387-16	389.60
INTEL 80387-20	390.65
INTEL 80387-25	541.92
INTEL 80387-SX	362.82
INTEL 80387-33	575.20
INTEL 80C86 A	395.50

HARDWARE, SOFTWARE & PERIPHERALS AT DISCOUNT PRICES

COMPUTERS

AST SPECIALS

MDL 70	CALL CDW™	MDL 390C	IN STOCK
MDL 140	FOR ALL	MDL 3150C	& READY
MDL 300C	AST	MDL 3150C	TO SHIP
MDL 340C	NEW LOW	MDL 386 33	CALL
AST 386 16SX	PRICING		

WORKSTATIONS

AST 105X		ALL AST	
AST 386SX Model 5	Model 45	WORKSTATIONS	
		IN STOCK	
SAMSUNG PC TERMINAL 286			\$1054.60
EARTHSTATION V40 or 286	Arnet or Ethernet	CALL	

PACKARD BELL

PB1000, 12 MHz	\$1219.70	PB800, 12 MHz	\$1198.86
PB1000, 40 Meg	\$1614.61	PB900, 16 MHz	\$1368.70

TOSHIBA

T 1000	\$657.95	T 5100	\$3237.60
T1200, 2 Drive	1455.74	T5100	4238.71
T1200, 20 Meg	1959.60	T5200, 40 Meg	4943.82
T3100e	2688.76	T5200, 100 Meg	5375.50
T3200SX	IN STOCK	CALL FOR ACCESSORIES	

WYSE

MDL 3108	\$895.50	MDL 2214	\$1921.30
MDL 2112	1271.20	MDL 3216	2060.37
MDL 2116	NEW	MDL 3225	CALL

SAMSUNG

S 3000, 4.77 10 MHz	\$592.11
S 550 AT Comp, 8.12 MHz	1056.45
S 550, 20 Meg 40 Meg	1425.80 / 1499.45
S 630 - 286	CALL

PS 2

MDL 60, 40 Meg	3340.15	MDL 55SX, 60 Meg	3178.39
MDL 70, 60 Meg	3747.20	MDL 55SX, 30 Meg	2899.59
MDL 30286, 1 Dr.	1412.10	MDL 30286, 20 M	1710.50
MDL 7361 Port	5440.75	MDL 30286, 40 Meg	3569.37

COMPAQ

286, MDL 1	\$1548.95	5 Mhz 60	\$588.90
286E, MDL 1	1899.50	5 Mhz 40	\$617.99
386, 3.5" Floppy	4911.23	40 Meg	4298.12
386S, MDL 1	2934.49		

VENDEX HEADSTART III

Headstart III w/VGA Monitor & Free Software... TOO LOW TO ADVERTISE

ZENITH data systems LAPTOPS

Minisport	NEW!
Supersport 88, 2 Dr 20 Meg	CALL CDW™
Supersport 286, 20-40 Meg	FOR LOWEST

DESKTOPS

Z 248 12 MHz	ALL
Z 286LP 12 MHz Mod 1	ZENITH
Z 386 25 MHz Mod 1	DESKTOPS
Z 386 33 MHz Mod 1	IN STOCK

TERMINALS

WYSE 50/60 Amber or Green	\$373.40 / \$300.16
WYSE 85 / 30 Amber	375.90 / 294.10
WYSE 99GT	394.82
WYSE 150	272.45

PLOTTERS, DIGITIZERS & SCANNERS

1023	\$3745.38	12 x 12	\$358.12
1043DM	5823.15	12 x 18	719.10
1025	4540.06	16 x 48	3236.15

HURTA

12121S1	\$349.06	36 x 48	\$2891.53
12 x 17	499.35	4 Button Cursor	75.00

LOGITECH

Scanman PC	\$168.89	Scanman PS-2	\$225.50
Summagraphics			
	\$367.40		\$599.50

HEWLETT PACKARD

HP7400A	\$968.30
HP7475A	1389.80
HP750	2926.56
HP7570 LOWEST PRICE	
HP7576 EXL	CALL
HP SCANJET	1049.66

MINI-MINI

HI DMP 52	DMP 52MP2
HI DMP 61D	DMP 61D
HI DMP 62	HI DMP 62
Image Maker	Image Maker

SEAGATE

SEAGATE 20 Meg	\$259.58	SEAGATE 4096 80	559.95
SEAGATE 30 Meg	269.32	SEAGATE ST 251 1	325.23

MICROPLOT

1335 70 Meg	\$542.40	1355 142 Meg	\$1017.40
1375 153 Meg	1469.85	1558 338 Meg	1512.52

PRINTERS

EPSON

LX810	CALL	LQ510	ALL EPSON
LQ850	CDW™	LQ950	MODELS
FX850	FOR BEST	LQ1050	READY
FX1050	PRICE EVER	LQ2550	TO SHIP
CDW™	stocks all cut sheet feeders and ribbons.		

NEC

P2200	\$344.85	P5300	\$685.63
P5200	509.12	P260XL	1039.24

DIAGONIX by KODAK

150P /300	\$309.17 / 418.17
-----------	-------------------

TOSHIBA

3215L	\$468.95	Expresswriter 311	\$377.16
3415L	592.84	Expresswriter 301	328.84
3515SX	949.95	CALL FOR ACCESSORIES	

brother

M-1724L	\$579.64	M 1709	\$384.47
HR20	340.50	HP40	629.12

OKIDATA

ML 172	199.95	ML 390	475.96
ML 320	NEW		639.48
LASERLINE 6	1292.69	ML 393	995.90
ML320	329.68	ML 393 Color	1067.60

Panasonic

1124	\$339.18	1592	\$409.44
1595	453.45	1191	232.12
1180	193.95	1524	562.10

LASER PRINTERS

BROTHER HL 80	\$1799.90
H-P LaserJet Model 2 / HD	1699.95 / 2744.95
H-P Deskjet Plus	679.33
H-P LaserJet III	1034.07
H-P Deskwriter	CALL
NEC LC890	3095.60
PACIFIC DATA 25 in 1 Cartridge	283.86
PACIFIC DATA Postscript Cartridge	478.60
PACIFIC DATA Plotter in a Cartridge	247.50
PACIFIC DATA 1 Meg Upgrade	263.39
TOSHIBA Page Laser 12	2479.58



- Sales
- Services/Support
- Product Knowledge
- On Time Delivery
- Frequent Buyers Program

DRIVES, TAPES & CARDS

FLOPPIES, DRIVES & TAPES

CONNER 40 Meg	\$445.29
CONNER 110 Meg	625.29
GENCO 60 Meg Int. Tape / Ext. Tape	689.60 / 819.10
GENCO 150 Meg Int. Tape	1078.85
IOmega 20x20 External 8"	1658.92
IOmega B1441/B144X	988.65 / 1289.10
IOmega B244X/B120X	1990.25 / 992.80
IOmega B220X, External 5.25"	1619.40
IRWIN 20 M / 40 M Internal Tape	399.10 / 539.20
MOUNTAIN 4440 Int. / Ext.	385.80 / 557.75
MOUNTAIN 150M Filesafe	1398.39
PLUS Passport 40 / 40 System Kit	489.75 / 579.88
PLUS PS/2 MC System Kit	585.58
PLUS THE HELIX/PIRNET 10 Meg, 40 Meg	\$527.44 / 677.80
STORAGE DIMENSION ALL MODELS	CALL
SYSGEN 5 25" Ext. Floppy	225.25
WELTEC 5 25 External Floppy	207.77

MiniScript

MIN 8425	\$298.40	MIN-3085	\$591.40
MIN 8438	239.85	MIN-6085	599.52

Seagate

SEAGATE 20 Meg	\$259.58	SEAGATE 4096 80	559.95
SEAGATE 30 Meg	269.32	SEAGATE ST 251 1	325.23

MICROPLOT

1335 70 Meg	\$542.40	1355 142 Meg	\$1017.40
1375 153 Meg	1469.85	1558 338 Meg	1512.52

NOVELL NETWORKING

SOFTWARE STARTER KITS

Entry-Level 286 Starter Kit, 4 Users	\$429.90
Entry-Level 286 Starter Kit, 8 Users	899.89
NOVELL SFT Netware V. 1.15	1839.65
NOVELL SFT Netware V. 2.15	2986.60
NOVELL NETPRO	1120.50

INTERFACE CARDS

ARCNET PC10 LANboard PS/2	\$375.45
ARCNET PC130 LANboard	412.50
ARCNET PC130E LANboard	164.27
ARCNET PC130E LANboard	189.50
ARCNET SMC 16-Bit File Server Board	437.55
ARCNET SMC 16-Bit Workstation Board	359.25
ETHERNET Interface Connector (NE1000)	298.90
ETHERNET Plus Board for 286 (NP600)	635.25
G NET Interface Card w/Cable	298.52
NOVELL NE2000	394.15
THOMAS CONRAD 16 Port Hub	699.25
THOMAS CONRAD 8 Port Hub	378.65
Ethernet Terminators	39.50

Novell trained and authorized sales and support. See WORKSTATIONS under Computers.

MODEMS & COMMUNICATIONS

EVEREX 1200B / 2400B	\$97.90 / 184.15
EVEREX 2400 Ext. / 2400 PS/2	199.80 / 205.45
INTEL 2400	149.75 / 176.94

HAYES

HAYES 1200	\$278.60	2400B	\$224.45
1200B	163.20	2400 PS/2	387.15
2400	416.08	Personal Modem	109.70

Robotics

Courier 1200	\$189.60	1200 External	\$129.10
Courier 24	279.60	2400B	199.70
1200B	108.45	14 400 HST	586.75
Dual 14 400 HST	952.65		

MEGAHERTZ CORPORATION

2400 for ZENITH	\$167.10	1200 for COMPAQ/SLT	\$259.80
2400 for NEC	225.88	2400 for TOSHIBA	183.74

BATTERY BACKUP & SURGE

AMERICAN

AME-1200VX	\$911.45	AME-520ES	\$377.48
AME-330XT	257.72	AME-600RT	699.19
AME-450AT	321.92		

DataShield

500 Watt	\$555.05	SS700+	\$787.90
800 Watt	628.56	1200 Watt	962.75
S100	59.95	6 Outlet Surge	27.65

Durant Technologies, Inc.

BPS-300	\$314.00	BPS-550	\$454.11
BPS 500	\$465.88	BPS-1200	5698.82
BPS 800	CALL		

BC 400

BC-400	\$349.50	4 Outlet	\$44.25
BC-1200	649.55	LC 1200	158.85
BC-2000	1179.80	LC 1800	196.80

MISC. & ACCESSORIES

A-B Switching Box (Parallel or Serial)	\$39.95
BASF 5 Pack of 10 DS/DD w/Case	28.00
INTELLICOM Long Link	129.70
KENSINGTON Masterpiece	99.99
KENSINGTON Masterpiece Plus	123.40
KEYTRONICS 5151 IBM or AT/8	133.95
KEYTRONICS	94.95
5TH GEN Logical Connection 259K / 512K	447.72 / 514.36
Electronic 4 Way Switchbox	89.85
XT Power Supply 150 Watt	59.00

FAX MACHINES AND BOARDS

CompleteFax 9600	\$399.50	SHARP FO 220	\$659.48
Quadram JT-Fax 9600	\$275.65	SHARP FO 300	1199.10
Quadram JT-Fax Port	329.25	SHARP FO 330	1085.7

SOFTWARE

WORDPERFECT 5.0 5.25" / 3.5"	\$229.90	238.90
ASHTON TATE dBase III+ / dBase IV	424.00	476.10
ASHTON TATE Multimedia Advantage II	</	

language. C's portability offers us an opportunity to rewrite and port this hardware over to other platforms or to link hardware and peripherals with our software drivers. In addition, the market-driven power behind C has increased the number of utilities, add-ons, and support tools available.

The hardware platform we chose was a Compaq Deskpro 386 running at 25 MHz with 4 megabytes of memory. This machine offers us speed, economy, and reliability. Our operating system is presently Compaq DOS 3.31, which allows us to break the 32-megabyte file barrier. Migration to Unix is also available on the Compaq.

Building the Voice Server

The first task in building a voice server is to open a connection between the phone system and the computer system. We chose Dialogic's D/41B multiline communications system, a board that handles all our telephone interface needs. The D/41B can detect and generate telephone Touch-Tones, as well as perform the A/D conversion needed for recording and playing back speech.

Dialogic includes a source code C language library with its boards. It has recently added Unix drivers to its software arsenal. My office uses a special home-grown SCO (for The Santa Cruz Operation) Xenix driver implementation on the Dialogic board. Thus, to remain consistent, we will probably continue to use our own drivers. Since the D/41B also handles outbound calls, it can perform call-backs during peak-activity times and mail documents accompanied by an automatic voice-mail message.

The D/41B board allows us to connect directly to a VPC 1000 voice-recognition board from Voice Processing Corp. that handles the required 0-through-9, yes-and-no vocabulary with a remarkable 97 percent accuracy. The occasional recognition failure is usually with a female voice. Since voice-recognition mirrors Touch-Tone entry, recognition problems allow us to fall back to Touch-Tone communication, with a voice prompt so informing the user.

You need a lot of power to run voice recognition. The VPC 1000 has an 80386 chip, 1 megabyte of memory, and a digital signal processor chip on-board. While the D/41B has four telephone channels on each board, we dedicate one voice-recognition board per channel at present so that each caller receives a positive response. In the future, we plan to use the DSP's speed as well as the board as a whole to multiplex four voice chan-

nels to a single VPC 1000 board. This plan is economical in both cost and slot count.

Text-to-speech technology can electronically transform ASCII text into a human-sounding voice. Its success is usually judged by the naturalness and level of intelligibility that the generated voice portrays. You can often tweak the output somewhat for specific vocabularies with the help of an exception table. But the output of even the better speech-synthesis systems still sounds like a computer voice with a cold.

The key word here, however, is intelligibility. The Speech Plus Prose 4000 voice module board that we use produces excellent synthesized speech but takes a few minutes to get used to. While short utterances can be tuned to sound remarkably lifelike, you soon become acquainted with the special lilt of the computer's synthesized dialogue when it attempts a longer speech.

Selecting a Server

Choosing a database engine is an interesting exercise. While you could probably use a standard microcomputer database such as dBASE III or IV, FoxBASE, or Paradox, we decided to use Unify Corp.'s Unify database because it offers strong fourth-generation language and Structured Query Language support. The Unify products are fully compatible over a wide range of hardware platforms ranging from microcomputers to superminicomputers running under Unix. Furthermore, the C language interface allows us to integrate our other systems' features with the database.

As the size of the document file grows, the care and feeding of the database engine become all-important. The key to offering a consistent user interface to the system lies in the way the filename for each image or document is structured, as well as in the relationship of the descriptive fields of each record in the database. Wherever possible, naming conventions should be intuitive; it quickly becomes tiresome to have to look up names in cumbersome printouts or on inquiry screens.

The Most Important Choice

Because the document image processing (DIP) engine is the heart of the VDDS, choosing an engine was very difficult. We could have chosen a ready-made bundled engine, such as the Optical Filing System from GeneSys Data Technologies for our DOS machines, ImageServer 200 from Document Technologies for Unix, or ImageSystem from

Image Business Systems with its excellent scanning conventions. All work as stand-alone servers and would integrate easily.

For this product, however, we decided to go with the KIPP Image Processing Platform Developer's Toolkit from Ko-Fax Image Products (see "The Paperless Office," July BYTE). The new KIPP Developer's Toolkit offers a fast way of getting up and running painlessly. Ko-Fax upgraded its technology with new hardware and software releases this fall. While the document server runs under DOS, KoFAX has upgraded its software to run under Microsoft Windows, which is fast becoming a standard.

The KoFAX technical staff is porting the software to run under Xenix/Unix, which will make maximum use of 80386 (and 80486) capabilities. In the future, we expect to be able to run KIPP on such diverse engines as the IBM RT, Sun386i, and Data General machines—platforms that have AT or Micro Channel adapter slots.

The KoFAX engine stores files in TIFF as well as CCITT Group 3 and 4 fax formats. It supports a wide range of scanners and printers at 150, 200, 300, and 400 dots per inch. With the KoFAX board, we used the KoFAX KIPP library of software utilities to speed up system development. The speed of scanning and printing to screen is important, as it has an impact on the system in a busy office and the throughput to the fax server. Screen write speed with KIPP is very impressive.

Optics Only

The imaged documents are stored on optical disk. The document-storage server allows you to use 5¼-inch and 12-inch WORM (write once, read many times) drives as well as 5¼-inch erasable optical drives. Implementing a real-life system can in fact involve mixing all three or standardizing on a single format. With the Future Domain SCSI TMC-830 host adapter, we could mix all three.

The Future Domain board arrived with software drivers for DOS, Xenix, Novell, Interactive Unix, and OS/2. To interface with the optical drives, Opti-Driver from Optisys allowed us to use an optical disk as if it were any other magnetic peripheral storage device. Opti-Driver lets us buffer to DOS memory or magnetic memory, streamlining the scanning and writing to disk.

For this application, my office chose Sony's 12-inch WORM drive (the WDD-3000 writable disk drive) and the 5¼-inch SMO-S501 magneto-optical (MO)

ITEMS DISCUSSED

Compaq Deskpro 386
Compaq Computer Corp.
20555 FM 149
Houston, TX 77070
(713) 370-0670
Inquiry 865.

D/41B multiline communications system
Dialogic Corp.
300 Littleton Rd.
Parsippany, NJ 07054
(201) 334-8450
Inquiry 866.

FaxPhone 20 IX-30F image scanner
LBP-8 Mark III R laser printer
Canon U.S.A., Inc.
One Canon Plaza
Lake Success, NY 11042
(516) 488-6700
Inquiry 867.

GammaFax CP
GammaLink Graphics
Communications
2452 Embarcadero Way
Palo Alto, CA 94303
(415) 856-7421
Inquiry 868.

GoScript
LaserGo, Inc.
9369 Carroll Park Dr., Suite A
San Diego, CA 92121
(619) 450-4600
Inquiry 869.

HiJaak
Inset Systems, Inc.
71 Commerce Dr.
Brookfield, CT 06804
(203) 775-5866
Inquiry 870.

ImageSystem
Image Business Systems Corp.
140 East 45th St.
New York, NY 10017
(212) 972-4400
Inquiry 971.

ImageServer 200
Document Technologies, Inc.
2465 East Bayshore Rd.
Palo Alto, CA 94303
(415) 858-0372
Inquiry 872.

KIPP Image Processing Platform Developer's Toolkit
KoFax Image Products
3 Jenner St.
Irvine, CA 92718
(714) 727-1733
Inquiry 873.

LF 5010
Panasonic Industrial Co.
Two Panasonic Way 7F1
Secaucus, NJ 07094
(201) 392-6071
Inquiry 874.

Optical Filing System
GeneSys Data Technologies, Inc.
11350 McCormick Rd., Suite 1300
Hunt Valley, MD 21031
(301) 785-0660
Inquiry 875.

OptiDriver
Optisys, Inc.
8620 North 22nd Ave., Suite 109
Phoenix, AZ 85021
(800) 327-1271
Inquiry 876.

PC-Slave/286
Alloy Computer Products, Inc.
165 Forest St.
Marlborough, MA 01752
(508) 481-8500
Inquiry 877.

Prose 4000 voice module
Speech Plus, Inc.
1293 Anvilwood Ave.
Sunnyvale, CA 94088
(408) 745-1818
Inquiry 878.

RDSP/4232
Rhetorex, Inc.
1671 Dell Ave., Suite 208
Campbell, CA 95008
(408) 370-0881
Inquiry 879.

SMO-S501 magneto-optical erasable drive
WDD-3000 writable disk drive
WDD-600 writable disk drive
WDC-2000-10 disk drive controller
Sony Corporation of America
Sony Dr.
Park Ridge, NJ 07656
(201) 930-6025
Inquiry 880.

StarLAN 10 Network
AT&T Data Systems Group
Call your local AT&T representative for more information.
Inquiry 1176.

TMC-830 host adapter
Future Domain
1582 Parkway Loop
Tustin, CA 92680
(714) 259-0400
Inquiry 1177.

TR112 twin-channel fax card
Brooktrout Technology, Inc.
110 Cedar St.
Wellesley Hills, MA 02181
(617) 235-3026
Inquiry 1178.

Unify
Unify Corp.
3870 Rosin Court
Sacramento, CA 95834
(800) 248-6439
Inquiry 1179.

VPC 1000
Voice Processing Corp.
One Main St.
Cambridge, MA 02142
(617) 494-0100
Inquiry 1180.

erasable drive, plus the new Panasonic LF 5010 5¼-inch WORM drive. The Sony 12-inch WORM drive provides us with 3.2 gigabytes of storage per disk (Sony has also announced the WDD-600 WORM drive, which *doubles* this capacity), while the LF 5010 offers 940 megabytes per disk. Both of these companies

also offer optical jukeboxes for large storage requirements.

The Sony MO erasable drive proved exceptionally easy to address as a SCSI device and looked like a magnetic drive even without a software driver. This erasable optical drive is perfect for situations where archived documents are

stored at another location or where archiving is unnecessary. While the erasable medium is significantly more expensive than the WORM drive, the capability of a million erase and rewrite operations proves cost-effective very quickly.

continued

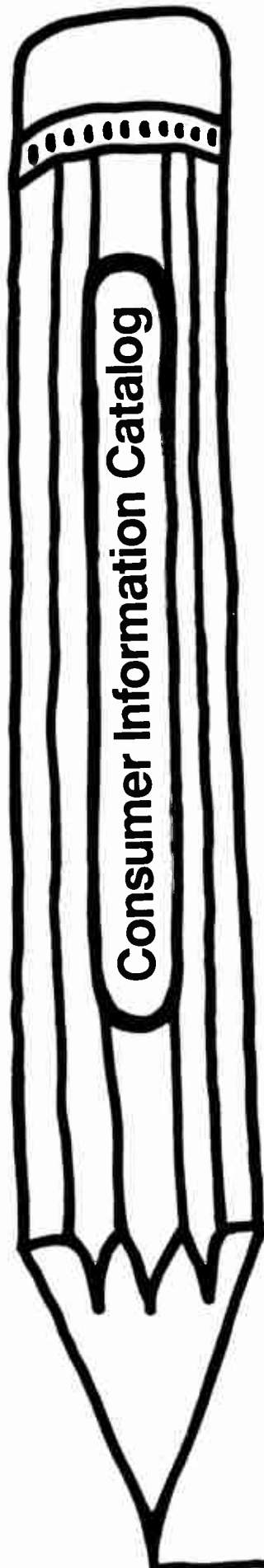

Reading worth writing for.

If you're looking for some good reading, you've just found it. The free Consumer Information Catalog.

The Catalog lists about 200 federal publications, many of them free. They can help you eat right, manage your money, stay healthy, plan your child's education, learn about federal benefits and more.

So sharpen your pencil. Write for the free Consumer Information Catalog. And get reading worth writing for.



**Consumer Information Center
Department RW
Pueblo, Colorado 81009**

A public service of this publication and the Consumer Information Center of the U.S. General Services Administration.

Picking Peripherals

For scanning documents through the KoFax board, we selected the Canon IX-30F image scanner, a gray-scale automatic-feed scanner that the KoFax drivers support. The gray-scale capability offers a range of document functions, including text, graphs, drawings, maps, and pictures at 300 dpi in up to 256 shades of gray. A number of software programs are available to support optical character recognition on the IX-30F. A number of other scanners also use the Canon engine.

We also needed a laser printer so we could print documents at a clerical workstation. KoFax also supports the Canon LBP-8 Mark III R laser printer, which has 300-dpi resolution and 8-page-per-minute output. This particular model prints two-sided documents and has a wide range of font and memory accessories.

The Fax Server

The heart of the fax server is the GammaFax CP board from GammaLink Graphics Communications. Bundled with special communications software, the GammaFax CP board has an on-board 80188 processor and 256K bytes of memory, thus providing an efficient background-automated fax service. Additional GammaLink software converts PostScript language files into 196-dpi fax files.

With the aid of software such as GoScript from LaserGo (which comes bundled with HiJaak from Inset Systems), the fax server can send PostScript-quality documents. The output offers the system high-quality fax and improves the readability of all material.

Several new fax-board products have appeared that add additional automated utilities to a fax server. Some products, like the TR112 twin-channel fax card from Brooktrout Technology, offer two fax boards in one slot and may also add features that automate fax transmission. To remain consistent for hardware support and service, we chose a Canon Fax-Phone 20, because it can be used as both a phone and a fax machine. However, whatever fax hardware you currently have will also work.

Linking to the LAN

The voice server is just one access point for the document server. As a strictly voice-in/document-out system, it would scan in the documents and catalogue them at a systems manager's workstation as part of the basic DIP engine. In a

continued

Cure Hayes fever.



2400etc/e

V.42 compliant

Get fast relief from high prices with AT1's high-performance, error-free modem for a fraction of the price.



Allergic to high modem prices? Here's news that will clear your head, not your budget.

AT1® Technologies' 2400etc/e® external modem* meets the competition feature for feature... and then some! Remarkably, it costs just a fraction of the price.

Relief is fast. With MNP® level 5 data compression, the 2400etc/e's throughput speed exceeds 4800bps, thereby lowering transmission costs.

The 2400etc/e complies with the CCITT V.42 error-control standard, including LAP-M and MNP, for 100% error-

free data transfer. As well as offering synchronous operation, it's fully compatible with the standard and extended Hayes® 'AT' command sets. Plus, AT1's easy-set front panel controls provide convenient access to frequently used commands.

Don't suffer from high prices. The AT1 2400etc/e external modem cures Hayes fever for only **\$299.**** And that's nothing to sneeze at.

You'll be relieved to know that AT1 also offers a high-performance internal modem, the 2400etc/li, at an equally non-allergic price. Only **\$239.****

For more information, contact your supplier or

AT1 Technologies Inc.
3761 Victoria Park Avenue
Scarborough, Ontario
Canada M1W 3S2
Tel: (416) 756-0718
Fax: (416) 756-0720



TECHNOLOGIES INC.
Technology you can Trust.

*Conforms to CCITT V.22, V.22bis, Bell 103 and Bell 212A standards. ©AT1 and 2400etc are registered trademarks of AT1 Technologies Inc.; Hayes is a registered trademark of Hayes Microcomputer Products, Inc.; MNP is a registered trademark of Microcom, Inc. **Manufacturer's suggested retail price.

Circle 27 on Reader Service Card
World Radio History

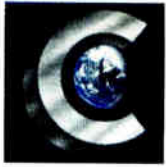

386
Now Available

Experts Agree on WATCOM C:

"We searched the industry for the best 286 and 386 C-compiler technology to incorporate with our developer toolkits. Our choice was WATCOM."

Nancy Woodward, VP & GM Development Products
Novell, Inc.

"WATCOM's latest release of its rising star is a clear winner....It is a clearly superior value when compared to all compilers..."

Richard Relp
INFOWORLD, May 22, 1989



"WATCOM is definitely the leader in object-level optimizations...For flat-out executable speed, WATCOM's compiler was the clear winner."

Steve Apiki and Jon Udell
BYTE, February 1989

"WATCOM C broke with tradition to make a fast, efficient C programming environment that has other C compiler designers rethinking their strategy."

Bill Machrone
PC Magazine, January 17, 1989



"Microsoft library- and source-compatibility makes WATCOM C7.0 /386 ideal for porting DOS applications to 32-bit native mode. This compiler enables full 386 performance without 640K limitations."

Richard M. Smith, President
Phar Lap Software, Inc.

WATCOM C7.0

100% ANSI C optimizing compiler and run-time library, graphics library, windowed source-level debugger, development tools, and Express C integrated environment for DOS and embedded systems. Price: \$395.00

Now WATCOM C7.0 /386

100% ANSI C optimizing compiler and run-time library plus development tools supporting 386 32-bit protect mode for embedded systems and DOS extenders including 80386 software tools from Phar Lap Software and OS/386 from A. I. Architects. Price: \$895.00

For specifications, licensing options and orders, contact:

WATCOM

1-800-265-4555

WATCOM
415 Phillip Street Telephone: (519) 886-3700
Waterloo, Ontario Telex: 06-955458
Canada N2L 3X2 FAX: (519) 747-4971

WATCOM & Express C are trademarks of WATCOM Systems Inc.
© Copyright 1989 WATCOM Products Inc.

departmental configuration, the voice server looks like a terminal on the document-delivery system.

To add departmental workstations on the system, an AT&T StarLAN 10 Network expansion board maintains a high throughput rate (10 megabytes per second). It also includes software optimized for the 80386 under DOS, as well as Unix and LAN connectivity by way of Ethernet.

Alloy Computer Products' PC-Slave/286 cards are also an economical choice, adding two workstations per card in a star network configuration. For document distribution outside the department, you can connect the VDDS to just about any PC LAN or workstation on the network.

With an upgrade path toward the new RISC servers, the growth path of the VDDS in terms of document-storage capacity and power is virtually unlimited.

Other Options

With the sheer volume of products available today, it's possible to customize the VDDS to handle a whole raft of side issues. In our system, we keep track of who placed an order and on which documents, the volume of orders, the time of day, the length of time between placing the voice order and the output, and so on. This statistical information, some of which comes out of the password-security system, can be important in spotting problems and planning for the future. It is my experience that a system like this will be used more and more as people find their way around it and develop shortcuts to the information they need.

With this system, you can mix file formats and store material prepared for WordPerfect, Microsoft Word, PageMaker, Ventura Publisher, and other files and output them to a desktop fax machine. As an alternative, you can interface a low-cost ink-jet or laser printer with a modem and use that setup instead of the fax. The VDDS is designed as a series of stand-alone modules. Thus, you can add a voice server to an existing or planned DIP and a fax server at the end of any DIP.

With the integration of DSPs into systems, many existing board sets will provide remarkable multiple functionality that will help to reduce not only board count but also cost. We have been testing a phone-interface board from Rhetorex, the RDSP/4232, which uses a Texas Instruments 32025 DSP. The on-board DSP provides significant potential for adding speech recognition and text-to-speech capabilities via algorithms in

software or ROM and for eliminating the use of specific boards to perform these functions. Steve Jobs embraced this potential when he included a DSP in the NeXT computer.

A Few Steps Further

Currently, we are working on an approach in which the VDDS is but one building block in a more comprehensive information system. This system, originally designed for law firms with heavy practices in trial law, merges voice and document into a whole new dimension. It lets you store any phone conversation, phone interview, voice-phone message, or voice annotation of any document on the fly. It can take dictation and attach it to any E-mail message, vocalize E-mail, voice-forward comments or conversations to any other user, store voice or commented documents for future reference, or forward voice packets to be transcribed.

VDDS enables a hypertext-like capability between documents and permits a kind of "hyperspeak" function that appends voice comments or voice of any sort to document hypertext buttons. For ultrasecurity situations, if password protection isn't sufficient, voice security can be added: You simply say your name when logging onto the system. The voice-security board can handle up to 3000 voice masks, each mask being a person's voice speaking that person's own name.

Documents to Go

The real world has an awful lot of paper-loaded file cabinets. As data-entry techniques improve and as we learn to rely on the computer terminal instead of hard copy, maybe this mountain of paper will go down.

But even in an optimal situation, we will always need to store images of documents with legal and graphical content or to call up digital data without a screen and keyboard. By adding a voice server and a fax server to any type of system, you increase data-distribution possibilities by the millions of telephones that are currently sitting on desks everywhere, and at a minimal cost per user.

So, the next time I get back to the office after 5:00 p.m. with lots of work still to do, I think I'll just pick up the phone and order some documents along with my pepperoni and extra cheese. Can I get you anything? ■

Ira Scherr is president of Digital Voice Systems, Inc. (Bronx, NY). He has an M.A. from Columbia University and can be reached on BIX c/o "editors."

Now There's a Periscope Board for Your IBM PS/2[®]

With the new Periscope[®] Model I/MC, you now have the same robust Periscope Model I debugging capabilities using a PS/2 with Micro Channel[®] architecture that you already have using a PC, XT, AT, or AT-compatible 80386 machine.

Just like the current Periscope Model I, Periscope Model I/MC has a 32K footprint in system memory, above 640K but in the first megabyte. The board stores the Periscope software and all debugging information (symbols, etc.) in its write-protected RAM.

Designed for use in machines with the IBM Micro Channel bus architecture, the board allows you to add chips to extend the 512K of write-protected RAM to a full two megabytes, if need be. (Most developers find 512K to be quite enough, however.)

Don't worry about trashing your debugger, debugging large programs, or erratic bugs.

With this new board in your IBM PS/2 or compatible, Periscope uses zero memory in the lower 640K. So you don't have to worry about things like a runaway program trashing your debugger, or not being able to debug a very large program, or having bugs appear or disappear when you load your debugger.

Use the break-out switch, which plugs into the board, to break in to your system safely any time. It keeps you from having to power down and back up when your system hangs. You can just press the little red "panic" button to find out exactly what is going on.

Periscope Model I for PCs, XTs, ATs, and AT-compatible 80386s. The manual, disk, and quick-reference card shown come with all models of Periscope.

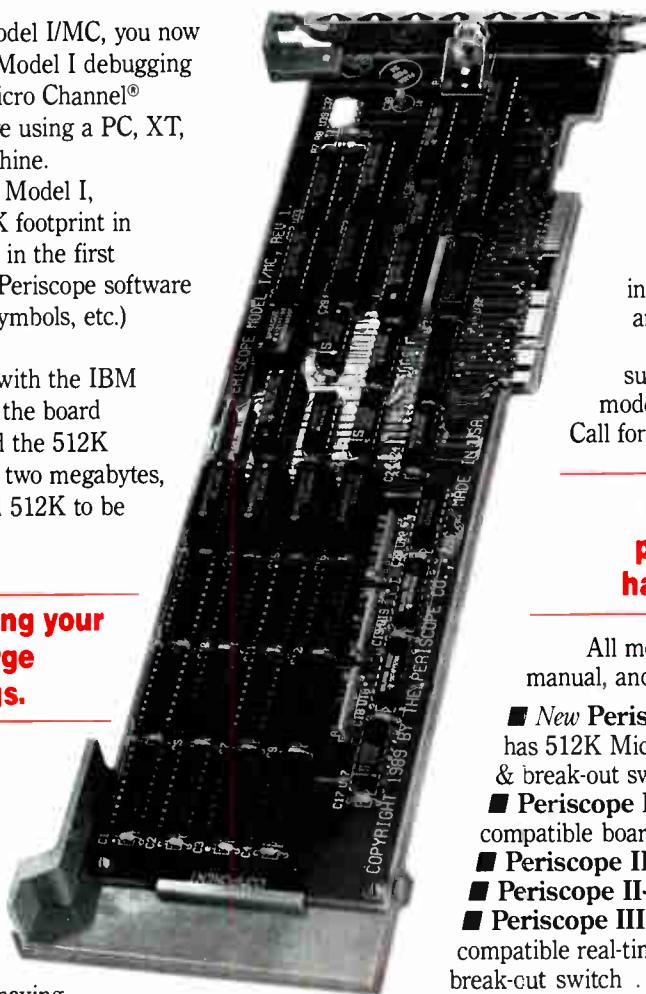

Real-time hardware-assisted debugging of programs running on PS/2s is now possible!

The remote feature of the new Version 4.3 Periscope software enables Periscope IV to support real-time debugging of programs running on DOS-based machines, including those with Micro Channel architecture. The open architecture remote debugging feature will support OS/2[®] and other protected-mode environments in the near future. Call for details.

Choose from a full line of professional software and hardware-assisted models.

All models include Version 4.3 software, manual, and:

- **New Periscope I/MC** (MC Board for short) has 512K Micro Channel-compatible board & break-out switch \$745.
- **Periscope I** has 512K PC- and AT-compatible board & break-out switch \$695.
- **Periscope II** has break-out switch \$175.
- **Periscope II-X** has no hardware \$145.
- **Periscope III** has PC- and AT-compatible real-time board (to 10MHz) & break-out switch \$1395.
- **Periscope IV** has 80286 and 80386 AT-compatible real-time hardware (to 25MHz) & breakout switch \$2195-\$2995.
- **PLUS board** is Model I board (no software), optional with Models III & IV \$500.

Call Toll-Free Today For More Information 800-722-7006

MAJOR CREDIT CARDS AND QUALIFIED COMPANY PURCHASE ORDERS ACCEPTED

IBM, PS/2, OS/2, and Micro Channel are registered trademarks of the IBM Corporation.

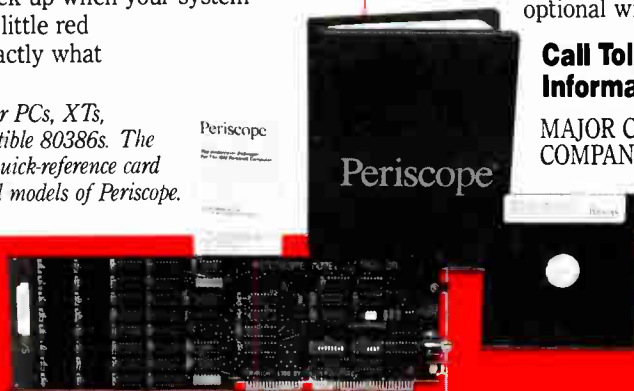

1197 PEACHTREE ST. • PLAZA LEVEL • ATLANTA, GA 30361
404/875-8080 FAX 404-872-1973

The
Periscope
Company, Inc.





Hot
386/20 MHz
System

Scorching
386/20 MHz
Price

\$2599⁰⁰

COMPLETE SYSTEM: 20MHz Processor; 65MB Hard Drive; 800,000 KBS Data Transfer; 1MB RAM (Expandable to 16MB); 1.2 and 1.44 high density floppy drives; 14" Monitor; Herc. Compat. Card; MS-DOS 4.01; Full Size Desktop Case with 5 drive bays; OmniKey Keyboard; 1-Year parts/labor warranty; Replacement parts expressed overnight at our expense or At-Your-Office Next Day Onsite Service, one year at no extra cost. **THE BEST PHONE TECH SUPPORT IN THE COMPUTER BUSINESS.** Toll free, unlimited.

NOTE: Pipeline Page Mode system architecture is preferred in many applications to cache design. It is faster than all but the largest cache systems in certain applications requiring substantial memory calls.

****BUYERS BEWARE!** Northgate charges credit card sales only when your system is in the shipping process. Some others use your money by charging cards at time of sale. We recommend you be aware of this when considering your vendor.



When you want to know
all about a computer
system ... Ask
Dr. Jerry Pournelle.*

Put a machine in Pournelle's workshop. He'll soon tell you everything you want to know about it with no punches pulled.

Recently, Dr. Pournelle looked at Northgate's 80386 Pipeline Page Mode system and reported in BYTE July, 1989 (excerpted):

*Jerry Pournelle holds a doctorate in psychology and is a writer who also earns a comfortable living writing about computers present and future.



"... the case is sturdy, and the motherboard construction is clean and neat. The boards are thick; I've seen some clones with boards so thin they wave in the breeze."

"... I like this machine a lot."

"... The workmanship is superior."

"... there sure wasn't any installation required for this system. I just turned it on, and it came up in MS-DOS 4.01."

[a software program] ... "which is all graphics is almost twice as fast on the Northgate 80386 as on my other machines. So is Windows ..."

"... I rate the Northgate 80386 as better than good enough on CPU and disk speed and wow! on video speed."

"... I have reports from other people who have Northgate computers, and they're happy."

"... All in all, the Northgate 80386 looks like one of the best deals in town."

SUDDEN SERVICE: We Ship All Orders for 386/20 Systems within 4 days! **

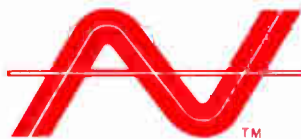

"We hear you!"

CALL TOLL-FREE 24 HOURS EVERY DAY
800-548-1993

NORTHGATE COMPUTER SYSTEMS, INC.

P.O. Box 41000, Plymouth, Minnesota 55441

Canada: 800-338-8383

FINANCING: Use the Northgate Big 'N' revolving credit card. We have millions in financing available. We accept your Visa or MasterCard too. Lease it with Northgate, up to five-year terms available.

Prices and specifications are subject to change without notice. Northgate reserves the right to substitute components of equal or greater quality or performance. All items subject to availability.

©Copyright Northgate Computer Systems, Inc. 1989. All Rights Reserved. Northgate, OMNIKEY/102, OrmiKey PLUS, and the Northgate 'N' logo are trademarks of Northgate Computer Systems, Inc. All other product and brand names are trademarks and registered trademarks of their respective companies.

Circle 234 on Reader Service Card

World Radio History

Words and Pictures

The products listed in the first section of this resource guide are PC board products that bring speech-recognition technology to your desktop. The second section deals with visual information. The hardware products listed let you perform digital image processing on your desktop.

Voice-Recognition Boards

Cherry Electrical Products
3600 Sunset Ave.
Waukegan, IL 60087
(312) 360-3500

Cherry VoiceScribe 1000 Plus \$3400

Speaker-dependent voice-recognition board for DOS computers. Each user can train the system with up to 1000 words and phrases per application.

Inquiry 1181.

Dialogic Corp.
129 Littleton Rd.
Parsippany, NJ 07054
(201) 334-8450

VR/10 \$3695

Speaker-independent voice-recognition board for use with Dialog's Dialog/4X DTMF call-processing boards; recognizes 16 words by any speaker over phone lines; works with the IBM AT and compatibles.

Inquiry 1182.

International Voice Products
14251-B Chambers Rd.
Tustin, CA 92680
(714) 544-1711

VoiceLink SRB-LC II \$350

Speaker-dependent voice-recognition board for DOS computers; provides an alternative to keyboard input for applications.

Inquiry 1183.

Kurzweil Applied Intelligence, Inc.
411 Waverly Oaks Rd.
Waltham, MA 02154
(617) 893-5151

VoiceEM \$18,900

Large-vocabulary speech-recognition system that automatically creates emergency medical reports; uses trigger phrases as shorthand; works with 80386-based systems or, optionally, comes with an 80386-based computer.

VoicePath \$18,900

Speech-recognition system for producing medical pathology reports; features large, application-specific vocabulary and trigger phrases; runs on 80386-based systems or comes

with an 80386 computer.

VoiceRAD \$18,900

Speech-recognition system for producing radiology reports; features large vocabulary and trigger phrases; runs under 80386 systems or comes with an 80386 computer.

VoiceReport \$12,900

Development system that lets you create customized speech-recognition applications for the Kurzweil Acoustic/Phonetic Analyzer Card; features KBEEdit, a knowledge-base editor; runs on 80386-based computers.

Inquiry 1184.

MTI, Inc.
14711 Northeast 29th Place,
Suite 245
Bellevue, WA 98007
(206) 881-1789

Pronounce Plus \$799

Speaker-dependent speech-recognition board for DOS systems that lets you drive applications and launch custom macros under voice control; on-line capacity of 256 words and phrases.

Inquiry 1185.

Scott Instruments Corp.
1111 Willow Springs Dr.
Denton, TX 76205
(817) 387-9514

SIR Model 20 \$1495

Speaker-independent speech-recognition system for the IBM AT and compatibles; can have up to 160 words active at once; also performs digital audio playback.

Inquiry 1186.

Spectrum Signal Processing, Inc.
3700 Gilmore Way, Suite 301
Burnaby, Canada BC V5G 4M1
(800) 663-8986

Model μ PD7763/4 PC Card \$1695

Speaker-dependent speech-recognition and synthesis card with 127 active words; works with DOS computers.

Pro-Audio Interface \$1850

Speech analyzer, pattern comparator, and speech synthesizer for DOS computers.

TMS320C25 Voice Processor Board \$1295

Speech-processing board for DOS computers; features software development system.

Inquiry 1187.

Texas Instruments, Inc.
P.O. Box 655012, Mail Stop 57
Dallas, TX 75265
(800) 527-3500

TI-Speech Hardware \$995

Speech-recognition board for DOS computers; features a dedicated 32-bit processor and 32K-byte dual-port RAM; software toolkits and telephone interface available.

Inquiry 1188.

The Voice Connection
8258 Kingslee Rd.
Bloomington, MN 55438
(612) 944-1334

IntroVoice V \$495

Voice-input system for DOS computers; features 500 words or phrases per resident library.

IntroVoice VI \$695

Voice I/O system for DOS computers; features 500 words or phrases per resident library and unlimited text-to-speech synthesis.

Inquiry 1189.

Voice Control Systems
14140 Midway Rd., Suite 100
Dallas, TX 75244
(214) 386-0300

TeleRec \$2495

Speaker-independent voice-recognition system for DOS computers; uses discrete recognition technology.

TeleRec II \$3495

Connected-speech voice-recognition system for DOS computers.

Inquiry 1190.

Votan
4487 Technology Dr.
Fremont, CA 94538
(800) 288-4756
(415) 490-7600

Voice Card \$1800

Speaker-dependent continuous-speech voice-recognition system for the IBM AT and compatibles; features immunity to interference from background noise, voice output, and optional telephone interface.

Inquiry 1191.

Image-Processing Hardware

DataCube, Inc.
4 Dearborn Rd.
Peabody, MA 01960
(508) 535-6644

MaxVision AT-1..... \$9500
Image-processing subsystem for the IBM AT and compatibles; acquires, processes, and displays 512- by 512-pixel, 8-bit, gray-level images.
Inquiry 1192.

Data Translation, Inc.
100 Locke Dr.
Marlborough, MA 01752
(508) 481-3700

DT2858 \$1695
Image coprocessing board for use with other Data Translation boards.
DT2861-60Hz..... \$4995
Arithmetic frame grabber for the IBM AT and compatibles; features ALU, lookup tables, and 512- by 512-pixel, 8-bit, gray-scale frame stores; also available in a phase-alternate line (PAL) version.

DT2862-60Hz..... \$2995
Arithmetic frame grabber with four frame-store buffers for the IBM AT and compatibles; features ALU, lookup tables, and four 512- by 512-pixel, 8-bit, gray-scale frame stores; PAL version also available.

DT2871-60Hz..... \$3995
Color frame grabber for the IBM AT and compatibles; features 16.8 million colors at 512- by 512-pixel resolution; PAL version available.

QuickCapture \$1995
Frame grabbers for AT- and MCA-bus systems; features include lookup tables, square pixels at 768- by 512-pixel resolution, and 8-bit gray scales; PAL version available.
Inquiry 1193.

Imaging Technology, Inc.
600 West Cummings Park
Woburn, MA 01801
(617) 938-8444

PCVISIONplus Frame Grabber \$1995
Real-time video acquisition, storage, and display board for DOS computers; features 1024- by 512-pixel resolution, 8-bit buffer, square pixels, I/O lookup tables, pseudocolor display, and software support.

VISIONplus-AT Advanced Frame Grabber \$7995

Two-slot, 34010-based image processor for the IBM AT and compatibles; features resolutions up to 1024 by 1024 pixels with 8 bits per pixel.

VISIONplus-AT Color Frame Grabber \$3995
24-bit, 768- by 512-pixel color video frame grabber for the IBM AT and compatibles; features lookup tables, 4-bit overlays, and optional National Television System Committee/PAL decoding and encoding.

VISIONplus-AT Image Processing Accelerator \$4495
32-bit floating-point processor (TI 320C30) for VISIONplus-AT products; resides in an AT slot but uses the VISIONbus.

VISIONplus-AT Overlay Frame Grabber \$2395
8-bit frame grabber for the IBM AT and compatibles; provides 256 gray levels or pseudocolor display; features 768 by 512 square pixels, lookup tables, and 4 overlay bits.

Series 151 Image Processor \$28,990
Image-processing subsystem with bus connections to AT, MCA, and VMEbus systems; features high-resolution acquisition, processing, and display.

VS100-AT Variable-Scan Frame Grabber \$4495
Frame grabber for the IBM AT and compatibles that features a 1024- by 1024-pixel, 12-bit frame buffer; has 12-bit digital input port, feedback processor, external image acquisition trigger, and pseudocolor display.

Inquiry 1194.

IMAGraph Corp.
11 Elizabeth Dr.
Chelmsford, MA 01824
(508) 256-4624

Image 32..... \$8995
1024- by 1024-pixel, 32-bit imaging board for the IBM AT and compatibles; displays 16.7 million colors simultaneously; uses 1-megabit video RAMs.

Inquiry 1195.

Matrox
1055 St. Regis
Doral, Canada QE H9P 2T4
(514) 685-2630

Matrox MVP \$5495
Acquires, processes, and displays 8-bit gray-scale and 24-bit color video

images; features 1024- by 1024-pixel video memory and 512- by 512-pixel display capability.
Inquiry 1196.

Truevision, Inc.
7351 Shadeland Station,
Suite 100
Indianapolis, IN 46256
(317) 841-0332

ATVista \$2995
Video-capture and imaging board for the IBM AT and compatibles; features the TMS 34010 graphics coprocessor.

NuVista \$2995
Video-capture and imaging board for the Mac II family; features the TMS 34010 graphics processor.

Targa Videographic Adapters from \$1595
Line of five imaging boards for DOS computers; features real-time video capture, display, and genlock. Number of displayable colors varies from 256 gray levels to 16 million colors at 512 by 512 pixels.

Inquiry 1197.

Visual Information Technologies
3460 Lotus Dr.
Plano, TX 75075
(214) 596-5600

VITec Image Computer \$39,900
Three-board image-processing subsystem for Sun workstations; features four parallel image processors that supply 172 MIPS, four 107-MHz video processors, a 19-inch 1280- by 1024-pixel display, 10 megabytes of image memory, and imaging software under SunOS.
Inquiry 1198.

This resource guide is intended to provide a reasonable cross-section of available products, companies, and services; due to space limitations, we cannot list all companies and products. Inclusion in the resource guide should not be taken as a BYTE endorsement or recommendation. Likewise, omission from the guide should not be taken negatively. The information here was believed to be accurate at the time of writing, but BYTE cannot be responsible for omissions, errors, or changes that occur after compilation of the guide.

TEN YEARS OF ROWS AND COLUMNS

From a 16K-byte VisiCalc to multimegabyte packages, spreadsheets have come a long way in a decade

Tracy Robnett Licklider



A decade ago, Bob Frankston and Dan Bricklin radically redirected personal computing when they shipped VisiCalc, the first personal computer spreadsheet program. VisiCalc transmuted the Apple II from a hobbyist's novelty into an essential tool for financial analysts. For the next 10 years, spreadsheets evolved steadily. Many technological developments occurred between the advent of VisiCalc, a pioneering program, and today's high-powered packages.

Starting Small

Frankston and Bricklin handcrafted VisiCalc in 6502 assembly language to run on a 32K-byte Apple II. (See the text box "Birthing the Visible Calculator" on page 326.) VisiCalc offered a small spreadsheet of only 254 rows by 63 columns, and its main menu was Spartan; it presented only a stark concatenation of its single-letter commands. On-line help, originally planned, had to be sacrificed to leave enough memory for spreadsheet data. The program offered only basic options for displaying cells.

Furthermore, VisiCalc did not support natural-order recalculation. Instead, it had two fixed recalculation patterns: sweeping across rows (left to right), and down columns (top to bottom). Both methods often produced vexing, unresolvable circular references. You could set the column width, but it had to be the same for all columns, and text could not span columns. In spite of these limitations, however, VisiCalc was a runaway best-seller and was rapidly ported to virtually all major 6502- and Z80-based personal computers.

Ironically, VisiCalc was not ported to the CP/M operating system until well after Sorcim seized that niche with SuperCalc. The first portable computer, the Osborne/1, had SuperCalc bundled with it. While essentially a VisiCalc clone, SuperCalc added disk-based help, column widths that could be set individually, and text that spanned columns.

Microsoft joined the spreadsheet fray with Multiplan, which provided links from spreadsheet cells to external files. It also

had a recalculate-until-done command, which recalculated until no cell changed. This process offered a useful way to get around circular reference problems.

Spreadsheet software desperately needed more memory for new features and bigger spreadsheets. The decade's most significant technical development for spreadsheets was, therefore, the advent of larger-memory personal computers. The 128K-byte Apple III arrived in May 1980, and the 256K-byte IBM PC followed in August 1981. Makers of 8-bit computers engineered bank-switching schemes to reach beyond the intrinsic 64K-byte limits.

VisiCalc Advanced Version used this new memory to restore features dropped from the original. It let users transform spreadsheet results into presentable printed reports by adding cell formatting, page formatting, and printer setup commands. Indeed, spreadsheet add-on programs first emerged to satisfy printing demands. Sideways was one such package; it printed spreadsheets sideways on a printer.

In addition, VisiCalc Advanced Version introduced keyboard macros. Any sequence of keystrokes could be bound to a key as a macro, complete with pauses and points at which to prompt for and accept user input. Macros created a way to use spreadsheets to develop applications. They spawned a new software industry that packaged them for use on everything from taxes to word processing.

All Together Now

In 1981, the now-all-but-forgotten Context MBA tantalized spreadsheet users with the first integrated spreadsheet; it combined windows, graphing, word processing, file management, and a spreadsheet. Context MBA could show a spreadsheet in one window and a graph of selected cells in another. Unfortunately, its developers had implemented Context MBA in the UCSD Pascal p-code system. That made it incompatible with PC-DOS, already the dominant IBM PC operating system.

In early 1983, Apple unveiled its Lisa personal computer

continued



CRITERION BANDS
 \$8 272.86
 \$9 346.58
 \$2 847.75
 CITY NAME
 San Francisco
 Santa Rosa
 Concord
 Napa
 Cupertino
 San Francisco
 Livermore

Salary
 \$8,212.00
 \$9,346.00
 \$2,841.00
 \$2,312.00
 \$6,210.00
 \$4,109.00
 \$527.00
 \$1,527.00
 \$1,482.00
 \$3,913.00
 \$1,650.00

Birthing the Visible Calculator

BYTE's first ad for a product called VisiCalc appeared in the September 1979 issue on page 51. The ad's text compared the time and effort it took to plan, project, write, estimate, calculate, revise, erase, and recalculate figures using a calculator, pencil, and paper, versus carrying out these steps by computer.

Nowadays, we take the spreadsheet for granted. But 10 years ago, there was no way to routinely tweak numbers on a personal computer until they made sense. In 1978 and 1979, two MIT graduates changed all that. Dan Bricklin and Bob Frankston created VisiCalc, the first electronic blackboard. BYTE editor Janet Barron talked with Bricklin and Frankston, the two men who started the "what-if" industry.

BYTE: What kind of background did the two of you have before you started working on VisiCalc?

BRICKLIN: Bob and I met when I was an undergraduate at MIT and he was a graduate student. Both of us were working on the Multics project. Multics was an operating system, a derivative of which later became Unix. Bob had written BASIC for a computer called the MicroMind, and I had worked on a variety of things, such as the APL interpreter and some interactive calculators. From MIT, I went to Digital for three years and worked in computerized typesetting and word processing (screen-based text editing). I designed and wrote software, some of which later became DecMate word processing on the PDP 8, a very small machine.

BYTE: What was the motivation for your creation of VisiCalc?

BRICKLIN: After having worked a few years for a small New Hampshire company that made electronic cash registers based on microprocessors, I went to Harvard Business School. I had my calculator, ran my numbers at home at night, and when I made errors, daydreamed about "word processing" numbers so that I could recalculate them with a new assumption—say, 12 percent instead of 10 percent.

My image was based on a calculator with a mouse and a heads-up display like a fighter plane so you could see the



Photo A: The "what-if" gang, Dan Bricklin (left) and Bob Frankston (right). Bricklin is now president of Software Gardens, and Frankston is chief scientist at Lotus Development Corp.

numbers. I realized you could do it with a video screen (projection TV) and a mouse—some kind of a personal computer device. There weren't many personal computers in those days, but I knew it could be done. I decided that when I got out of school, I'd develop this electronic blackboard for numbers and try to sell it.

BYTE: How did you implement the idea?

BRICKLIN: I told Bob about it. Though many of my Harvard Business School professors were encouraging, my finance professor was very discouraging. But we decided to go ahead with the project anyway. We rented an office in the basement of a Cambridge building and used timesharing at night while Ada was being developed on the same system during the day. Bob wrote all night and went to bed in the morning. I was still going to school, and after I got home in the afternoon, I debugged, did testing, quality assurance, and whatever. Then we bought ourselves our own timesharing system.

FRANKSTON: Eventually we had to write our own assembler and all our own tools. That slowed us down considerably.

BRICKLIN: Later in the cycle, when we began to think about marketing the

product, we talked with Dan Fylstra [BYTE's first new-products editor], who went to Harvard Business School at the same time I did. He had joined a firm called Personal Software, which at that time was the leading seller (and distributor) of personal computer software.

I wrote a prototype in BASIC, which I ran on Personal Software's Apple II. That Apple didn't have a mouse, but it did have paddles that you would turn to move the cursor from column to column. To change it to go from horizontal to vertical, you hit the fire button. Running in BASIC, it didn't respond very well, so I changed it to use the arrow keys to go back and forth, and the space bar to switch you from horizontal and vertical.

BYTE: Where did the concept of an electronic spreadsheet come from?

FRANKSTON: The spreadsheet concept had been around for hundreds of years. Companies used two to three rooms of blackboards or rolls of paper to do their production planning as rows and columns.

BRICKLIN: I came up with the idea of using fixed rows and columns for addressing. I realized you would want numbers in certain places—the columns-and-rows metaphor was for addressing purposes—and I needed some way to name them. Letters for columns, and numbers for rows seemed to be the perfect way to do it. We wanted at least 54 columns—a label, a total, a column for each week—and as many rows as you could get away with in memory.

BYTE: How did you decide on the name VisiCalc?

FRANKSTON: You'll notice that in our first ad in BYTE there's no mention of the word *spreadsheet*. When we were coming up with the product name, we specifically avoided the use of the name.

BYTE: Why? Were you afraid you'd scare people?

FRANKSTON: Yeah, we called it all sorts of things—electronic ledger, electronic blackboard, visible calculator—

that's what we finally based the name, VisiCalc, on.

BYTE: How long did it take to write, develop, and get VisiCalc ready for market?

BRICKLIN: Bob and I sat down with Fylstra, negotiated a contract (as authors and publisher), and started a company (Software Arts) to actually make this product. Bob wrote it; I took care of the specifications and the documentation. Before we shipped, I graduated from business school and went to work as chairman of the board of Software Arts.

The idea hatched in the spring of 1978; our commitment to produce a product with it came about in the summer; the prototype occurred in the fall (done in BASIC); the agreement to produce it was signed in the fall; the decision to do the company was made during the winter. We actually filed incorporation papers on January 2, 1979 (which is why January 2 is Day 1 of VisiCalc's date functions).

BYTE: Why did you write it in machine language?

FRANKSTON: Basically, I write in the highest-level language I can get away with. And on the Apple II, given the severe constraints of size and space and the lack of tools, there was no alternative in a 16K-byte cassette (32K bytes included the operating system, the disk-file system, the screen memory, everything). It was a space/time trade-off. We needed the speed; we needed the code to be small, and it had to bit-twiddle like crazy. The alternative was a much larger machine. I didn't write it in a low-level assembly language—we had macros.

BYTE: How did you decide what features to include and what to leave out? By the available memory?

FRANKSTON: We eliminated the need for almost all help or error messages. The program was meant to have context-sensitive interactive help and live graphics (we wanted the user to be able to split the screen and watch graphics at

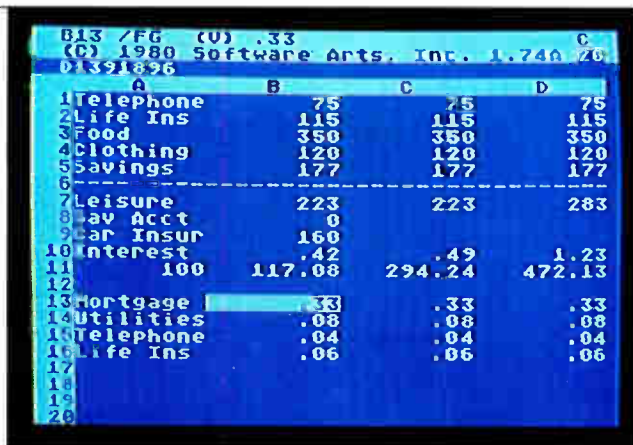

Photo B: A screen shot from an early version of VisiCalc (1980) that ran on the Atari.

the same time), but there was no room. We did split the screen into two text windows and put in the titles. Our assumption was that you couldn't burden the user with anything. If something was complicated, we fixed it. For instance, in the Apple II, you could accidentally hit the Reset key, so we had to let you recover from that. In our design, ease of use and smoothness were more important than ease of learning.

BRICKLIN: We did have competition—our competition was people doing their computations on the back of an envelope. VisiCalc had to be as easy the first time you did something with a spreadsheet as it was the first time by hand. Then the second time was quick. It wasn't just a program we were making—we also had to create and typeset our own reference card and manual.

FRANKSTON: There was a reason why we did everything. We tried to reuse mechanisms. For example, we stored the spreadsheet on disk in keystroke format so we could use the keyboard reader to read it back in. We had to justify all the negatives.

BRICKLIN: That's right. For example, we didn't have commas because there was a bug, and it wasn't worth fixing it then because we had to ship. On the other hand, we had hoped to put in sine and cosine. But because of memory constraints, we decided we wouldn't include that feature. Unfortunately, we had mentioned it to Carl Helmers [BYTE's founder], and he had used that feature as an example in a product preview in BYTE. So we had to put them

in. It cost us memory. Another thing we did, unheard-of then, was to use sound. We had two different sounds—one for error indication and another one for a limit—such as if you're moving the cursor and that's as far as the cursor is allowed to go, it would make a "thud, thud, thud."

FRANKSTON: Since walls aren't made of metal, a thud sounded right when you hit a wall, whereas a bell sounded right when you

make a mistake.

BRICKLIN: When we were just about to ship, Apple told us it had this new language board that could give us 16K bytes more memory. We put in a quick fix to use 10K bytes out of the total. VisiCalc came out October 17, 1979, at \$99, and people paid hundreds of dollars for the board just for the extra 10K bytes of memory.

BYTE: What was the public's reaction to this new "thing"? Did you have to educate them?

FRANKSTON: Nobody even knew what VisiCalc was.

BRICKLIN: It wasn't just the public; first we had to educate the dealers. Personal Software put out a demo script that the dealers stuck in their windows and let run all day. In those days, if you showed it to a programmer, he'd say, "Well, that's neat. Of course computers can do that—so what?" But if you showed it to a person who had to do financial work with real spreadsheets, he'd start shaking and say, "I spent all week doing that." Then he'd shove his charge cards in your face.

BYTE: Is it true that people really bought systems just to get VisiCalc?

BRICKLIN: That's what we've been told. A few dealers knew what they were doing and got their salespeople excited about it. Because of VisiCalc, one of the Burlington, Massachusetts, dealers became the most successful Apple

continued

dealer in the country at that time. Two of its salesmen ended up as two of the founders of Lotus (the original team that brought out 1-2-3). We only sold about 1000 a month for the first few months because we had to get the word out to the primary consumers, who were financial people. [Editor's note: *A total of over 800,000 copies were sold by May of 1985, when Lotus purchased Software Arts and ceased marketing VisiCalc.*]

It finally started selling, and we converted it to other machines—Radio Shack, the Atari, the Commodore, and, later, Sony and IBM. Early on, Hewlett-Packard licensed it and actually did the conversion itself. It took about a year to get them all converted. Tandy actually legitimized the name *spreadsheet*.

BYTE: Where did it go from there? And where, when, and why did the data interchange format DIF come in?

BRICKLIN: We realized we needed to move data in and out—open up this product. There were restrictions in Apple DigiBASIC. We wanted to make [VisiCalc] easy to read and write so nobody would have an excuse for not supporting it. So in February 1980, Bob invented DIF. It wasn't in the first version of VisiCalc. We wrote an article for BYTE explaining what DIF was. Eventually, there were four or five major versions of VisiCalc.

BYTE: But why you two? Why at that particular time? Why the spreadsheet?

FRANKSTON: Ask yourself why there are so many word processors and so few spreadsheets? The answer is because there were a lot more roots to word processing, and the spreadsheet put a heavier demand on the machine. The idea to implement financial forecasting by merging the spreadsheet with word

processing in a commercial way hadn't been done. A lot of people had played with different parts of what later would become the spreadsheet, and there were a lot of things in the labs. IBM had done parts of it, and other people had financial forecasting systems, but the idea of putting it together on a machine that you could take home and fiddle with yourself hadn't been done.

BRICKLIN: When programmers who really knew what was happening saw Bob's code, they would tell us, "This is incredible." It really pushed the machine. Lotus 1-2-3 ran on a 256K-byte machine; VisiCalc ran on a 24K-byte machine, 32K bytes with disk. Each of them in its own world really pushed things and was very competitive.

BYTE: What do you see as today's problems, and what's coming that will change computing?

BRICKLIN: The things that turn me on are the new I/O devices—new physical configurations.

FRANKSTON: The big thing is the Nintendo [laughter]. The reason I'm saying that is—look at the idea of the DataGlove, virtual reality. A lot of this stuff is done only at the very high or very low end—either on a \$100,000 machine or on a \$100 machine.

BRICKLIN: The high-end machines were highly interactive. The midrange machines, such as the normal mainframes and minicomputers, weren't very interactive. VisiCalc was the low-end machine that ran on an Apple. The low-end machines like the personal computers are highly interactive. You can run Space Invaders on them.

FRANKSTON: Computers are part of the woodwork now. You expect them to

be there, and that's a tremendous change. We're still in a pre-coalescent stage. You've got all of these devices—a copier, a fax. They have to play together well. And that's what hasn't happened yet. Fax is like CB. It'll go away by merging with electronic messaging. Fax became cellular phone. I can go both ways from E-mail to fax and back now, but in the long run, most faxes will originate in word processing directly from the computer, and they'll look so much better. But now your computer is your database and your word processing and your fax machine and your telephone answering machine....

BYTE: It'll have to become our central control.

BRICKLIN: I'm thinking of things like a 3- by 5-foot display. Multiple people can watch and interact at the same time. Some information is better shown in a bigger space. Why can't my entire desktop be a screen? Gestures and reflexes are going to be big things. Innovative I/O... sound. Here's a spreadsheet calculation that was all done on a Mac. [*At this point, Bricklin turned on a synthesizer, which "played" the sound of a spreadsheet calculating, the memory running down, and the final computations.*]

Why not sound and voice synthesis to give you positive feedback when you do something right? Why don't we have animation? You could do a spreadsheet and see what happens to profits: When they go down, you could see a ball rolling down a hill and then it goes splat.

FRANKSTON: But they have to have commercial promise. Right now, we're just learning how to share the machine. We're really going back to timesharing—hopefully, not in a stingy way. And, hopefully, we've learned our lessons.

bundled with LisaCalc. The short-lived Lisa and LisaCalc enticed spreadsheet users with its Xerox Star-like graphical user interface (GUI). It provided mouse support, multiple windows, cut and paste, and assorted fonts—personal computer features that were astonishing at that time. The Lisa failed to attract developers, and, by 1984, Apple abandoned it in favor of its Macintosh. Apple dropped LisaCalc and opted not to produce a spreadsheet for the Mac. While Context MBA and LisaCalc were important harbingers, neither succeeded.

In 1983, Lotus swept into the spreadsheet market with 1-2-3.

Like Context MBA, 1-2-3 added graphing. However, a spreadsheet and graph could not share the screen. Furthermore, graphs were not automatically redrawn when the underlying spreadsheet changed.

Lotus 1-2-3 exploited natural-order recalculation, although it also supported VisiCalc's row- and column-order modes. Natural-order recalculation maintained a cell dependency list and recalculated a cell before recalculating cells that depended on it. To conserve memory, 1-2-3 resorted to a sparse matrix of

continued

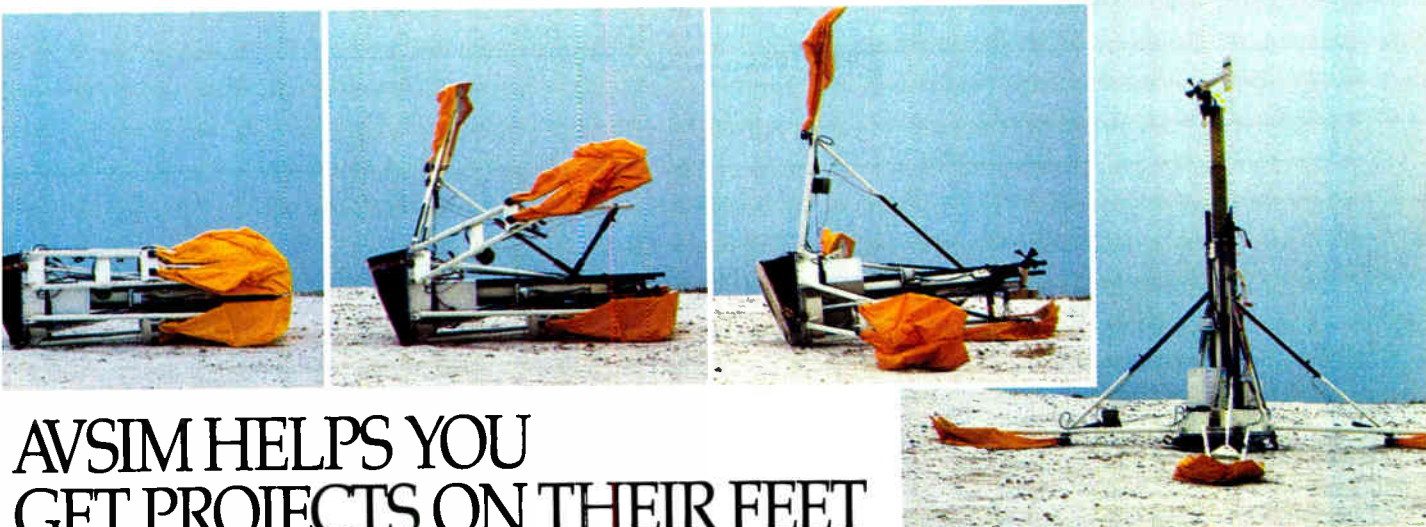

AVSIM HELPS YOU GET PROJECTS ON THEIR FEET

The "creature" shown above doesn't depict a futuristic lunar landing. This is a polar landing of a sophisticated weather monitoring device. Deployed from an aircraft, it unfolds in minutes and begins transmitting vital environmental data.

This Self-Erecting Weather Station, sponsored by the National Science Foundation, was developed by Polar Research Lab. Avocet's AVSIM™ simulator was used on the project.

Stay On Schedule
Using a simulator, you can avoid complications and delays caused by debugging code on unstable target hardware. AVSIM allows you to begin the debug cycle even before the hardware is available.

Keep The Project On Your Desk
Work within your familiar MS-DOS environment. With AVSIM you can check the hardware and operating

system interfaces, all on your PC. You don't have to rely on outside staff and equipment. **At only \$379**, AVSIM is a fraction of the cost of additional hardware.

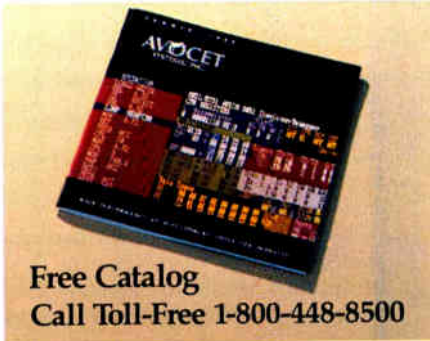

Free Catalog
Call Toll-Free 1-800-448-8500

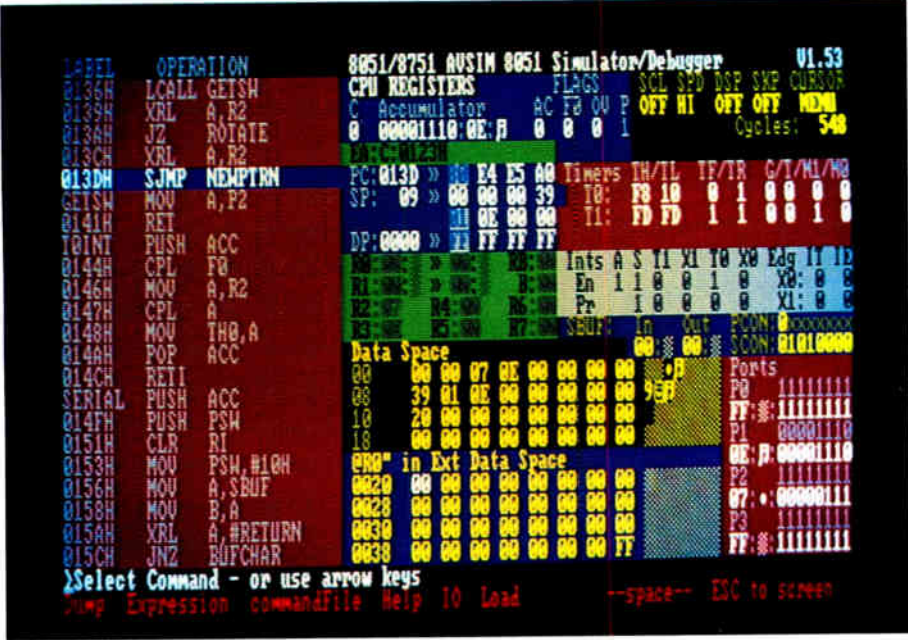

AVSIM Full-Screen Display

Avocet offers a complete line of embedded-system tools including AVOCET C™ compilers, AVMAC™ macro assemblers, AVPROM™ programmers, and AVSIM™ simulators.

Call Avocet today. Discover how we can help you get your next project on its feet, too.

- AVSIM supports:
- Intel 8051, 8048, 8085
 - Motorola 68HC11, 6805, 6800, 6809
 - Zilog Z80
 - Hitachi HD64180, 6301
 - TI TMS32010, TMS32020
 - Rockwell 6502

©1989 Avocet Systems, Inc. All Rights Reserved.



The Source For Quality Embedded-System Tools

Avocet Systems, Inc., 120 Union St., P.O. Box 490, Rockport, ME 04856 / In Maine, or outside U.S., call (207) 236-9055 / TLX: 467210 Avocet CI / FAX: (207) 236-6713

Circle 32 on Reader Service Card
World Radio History

Beyond "What-if?"

David P. Reed

When Dan Bricklin and Bob Frankston built the original VisiCalc, the spreadsheet metaphor was essentially an electronic worksheet that remembered what you did and allowed you to make small alterations to your calculations to see how they affected the results. But the basic spreadsheet metaphor grew rapidly to encompass a much broader range of functions. The parallel evolutions of spreadsheets and personal computer hardware were tightly coupled. Spreadsheets are perhaps unique among major kinds of software in that they push the limits of personal computer technology while letting the user take advantage of all its aspects.

The core of spreadsheet technology is instant response to user input as models and display presentations get more complex. The demand for more spreadsheet calculation cycles has grown faster than the boost in microprocessor speed. Over time, this demand has led to smarter recalculation techniques.

In the past three years, most spreadsheets have come to provide some form of minimal recalc to calculate only those formulas that might be affected by the change. Recent innovations include background recalc, which lets you move

around, print, and so forth while the spreadsheet is calculating, and restartable recalc, which lets you enter new data before recalculation is finished. The next few years will bring techniques that get ever closer to "optimal recalc"—recalc before you perform it.

To provide ever-greater responsiveness, the newest spreadsheets are built around internal multitasking designs that allow instantaneous live display of data as you work, while prioritizing less important activities to background recalculation, print formatting, chart layout, and so forth. Beyond this improvement, we may see further exploitation of concurrency to anticipate what the users will ask next and to provide them with suggestions and other help.

As users tackled more complex problems, spreadsheets supplied more powerful analysis tools. Innovations included tools for repetitive evaluation, such as macros, and two-dimensional and three-dimensional table generation for case analysis. Other aids now include high-powered techniques such as regression and goal seeking. In the next generation, we'll see linear programming and mathematical optimization.

The framework of spreadsheet tech-

nology is the rows-and-columns metaphor, a powerful work organizer. As your other needs grow, so does your need to organize your work better. The desire for a better structure for large models has led to three-dimensional worksheets that allow the user flexibility to put different parts of a calculation on different pages of the worksheet.

Many users need to consolidate information from multiple worksheets. This led to support for multiple active files in memory. To link the worksheets, designers invented various features that transfer values among worksheets and worksheet files on disk. As file sharing on networks becomes possible, modular systems of worksheets, including live sharing of files on LANs among multiple users, becomes possible.

Ever-larger and more-complex worksheet structures bring about the need for better memory management. The LIM/EMS, DOS Extender technology, and OS/2's use of the 80286/80386 protected mode have fed the spreadsheet user's memory appetite. At the same time, spreadsheet programs use ever-more-sophisticated sparse-matrix data structures. In the newest spreadsheets, data compression techniques like Huff-

cell data pointers. With this scheme, it wasted almost no memory on empty cells and could represent bigger spreadsheets, up to 2048 rows by 256 columns. Lotus 1-2-3 added cell display formats, simple but useful commands that treated spreadsheet rows like records in a database, and the ability to name ranges of cells.

After 1-2-3, an all-in-one software fad subsumed spreadsheets. Ashton-Tate launched Framework, Lotus orchestrated Symphony, Apple published AppleWorks, and VisiCorp demonstrated Vision. Lotus also fielded Jazz, an all-in-one for the Mac. Lotus folded Jazz after Microsoft practically monopolized Mac spreadsheets with its Excel. Excel delivered the GUI, windows, and multiple spreadsheets and graphs on the screen presaged by LisaCalc and Context MBA. It also offered user-extensible cell display formats and allowed array references in expressions. Microsoft later ported Excel to the IBM PC.

In 1983, the notebook-size Tandy TRS-80 Model 100 sported Multiplan in ROM. Later, Hewlett-Packard put 1-2-3 in ROM in a laptop. Low-cost shareware spreadsheets appeared. Most exceeded the functionality of the original VisiCalc. Spreadsheets even popped up as TSR programs and Mac desk accessories. Borland shipped source code for a feature-full spreadsheet as tutorial material with its Turbo languages.

Some companies even dissected Lotus 1-2-3 enough to weave their own programs into it. HAL, the first such program, added English-like commands and an undo command. What's

Best! added goal seeking. The next releases of 1-2-3 and Symphony supported an official interface for such add-ins. Other spreadsheet makers followed suit, and a new spreadsheet add-in industry flourished. Yet, as spreadsheets grew richer, memory ran short. For IBM PCs, the 640K-byte barrier was so limiting that Lotus, Intel, and Microsoft coauthored a standard for accessing expanded memory, which most spreadsheets quickly adopted.

Doing 1-2-3 One Better

By 1985, a parade of Lotus 1-2-3-compatible programs had begun, each with idiosyncratic enhancements. Mosaic's TWIN provided better graphs. Paperback Software's VP-Planner directly read dBASE files and created *n*-dimensional spreadsheets. Javelin Software's Javelin understood time periods and allowed graphical input. Borland's Quattro had customizable menus and included a menu set that perfectly mimicked 1-2-3. Several companies released compilers that translated spreadsheets into either stand-alone programs or C code.

SuperCalc5 introduced three-dimensional spreadsheets, making previous spreadsheets into pages in a 255-page spreadsheet block. A SuperCalc5 spreadsheet could reference cells on other pages in memory or on disk. It could display any three such pages. SuperCalc5 accepted 1-2-3 files, commands, and macros, and the program even allowed mixing 1-2-3 commands with its own. Moreover, it added an undo command,

man codes and run-length codes pack more data into fewer bytes internally.

Over the last few years, spreadsheet presentation abilities have expanded dramatically. High-resolution color graphics on printers and personal computer display screens have driven the demand for more effective charting and printing. Live charts provide another way to do "what-if?" Colored cells, grid lines, fonts, and shading in the worksheet are now possible. They have led to a new application area—spreadsheet publishing—producing the best possible hard-copy output to present the results of spreadsheet work to others. As CPU power increases, spreadsheets could drive animated graphics for yet another alternative presentation mode.

Spreadsheets are beginning to provide direct access to external data. As personal computers are hooked up to shared databases, the row/column metaphor has evolved to provide a new kind of viewport on relational tables. Developers have invented database access standards that allow spreadsheets to deal with the diversity of types of external data sources.

In the future, the spreadsheet's ease of use may make it the primary tool for

analyzing large amounts of shared data. Spreadsheet responsiveness also is a powerful capability that can allow the same type of user-programmable analysis of live data feeds as might come from scientific instruments and stock tickers.

Spreadsheets must remain intuitive. Recent innovations include new command modes, such as pull-down menus, setting sheets/dialog boxes, and direct manipulation of spreadsheet layout using a mouse. Natural language and speech input may also be coming. Perhaps more important directions are suggested by AI-based techniques, such as the "graph this" command, which guesses the best way to present a table as a chart. The next generation might see commands like "make this nicer."

The basic spreadsheet metaphor is the epitome of "programming by example." This concept has also been used in newer features, such as the database criterion range, the macro learn mode, and the newer, always-on, macro recording features. A key to ease of use are features that provide a "safety net." The first of these were warnings about destructive commands, such as large erases and automatic file backup. More recently, we have seen undo for single

commands, undo for whole macros, and (in the next generation) multilevel undo features that will reduce the risk of user mistakes and misunderstandings.

A growing area of interest is the use of the spreadsheet as a programming tool to create specialized applications. Macro languages continue to be enhanced to support this area. Two new technologies, spreadsheet compilers and add-ins (and associated add-in toolkits), create the opportunity for developers to base substantial applications on the spreadsheet as a programming tool.

Finally, spreadsheets have begun to incorporate new kinds of debugging aids, such as single-step mode, dependency analysis, and spreadsheet auditing tools. Ultimately, you will use AI techniques to ask why something surprising happened in your spreadsheet.

There's still lots more to do. Personal computer technology will continue to improve, providing users with new domains to explore with ever-more-sophisticated spreadsheet tools.

David P. Reed is vice president and chief scientist/spreadsheets for Lotus Development Corp. (Cambridge, MA). He can be reached on BIX c/o "editors."

minimal recalculation (recalculating only cells dependent on changed cells), LAN support, direct reading of dBASE files, a macro learn mode, and macro libraries that were not tied to a particular spreadsheet.

Lotus's long-awaited 1-2-3 release 3.0 matched most SuperCalc5 features. It added background recalculation, which recalculates spreadsheet cell values while waiting for user input. It also could simultaneously display spreadsheet cells and a graph on the screen. Release 3.0 was the first spreadsheet that ran under OS/2, but it did not work under OS/2's Presentation Manager.

Macintosh spreadsheets remained friendlier and better at presentation-quality printed reports and graphs. Microsoft's Excel 2.2 allowed 256 fonts per spreadsheet. With it, the user could customize menus and help. Excel's help even listed 1-2-3 command equivalents. In addition, it exported warm-link spreadsheet data and charts to Microsoft Word, added color for the Mac II, and affixed notes to cells.

Ashton-Tate's Full Impact and Informix's WingZ staked out the presentation spreadsheet niche with enhancements aimed at presenting spreadsheet results. Both offered scripting languages. Their scripts were like Apple's HyperCard scripts and could be attached to spreadsheet cells and buttons. They went well beyond traditional spreadsheet macros in flexibility and performance.

Other platforms gained Lotus 1-2-3-compatible spread-

sheets. Computer Associates put SuperCalc5 on IBM mainframes. The Santa Cruz Operation supplied SCO Professional, a multiuser spreadsheet for Unix. Access Technologies authored 20/20 for VAX systems. Still, Mac and PS/2 spreadsheets define the state of the art.

Down the Spreadsheet Road

Spreadsheets have grown from humble 32K-byte beginnings to fill 8-megabyte Macs and 16-megabyte PS/2s, yet their core has remained remarkably unchanged. IBM PC spreadsheets will soon drop their old-fashioned character-based interfaces and adopt graphical ones from Microsoft Windows and OS/2 Presentation Manager. Also, most spreadsheet vendors will develop IBM mainframe versions. Largely with Structured Query Language, spreadsheets will improve access to LAN- and mainframe-based database servers (see the text box "Beyond What-if?" above).

Other enhancements will include improved consolidation, goal seeking, compiled recalculation, and the ability to call spreadsheets from outside programs. In another decade, every user's toolbox will supply object-oriented spreadsheet components. For that story, check out BYTE's 1999 articles. ■

Tracy Robnett Licklider is vice president for personal computer systems at AICorp (Waltham, MA) and vice president of the Boston Computer Society. You can contact him on BIX as "trl."

See the Future.

The FLEXSCAN® 6300, our 21" gray scale monitor, has been specifically designed for the Desktop Publishing Professional, because NANA O fully appreciates the importance of monitor selection to the publishing process. Its high resolution (1664 x 1200), Full Square Flat Face Screen, and capability of 256 shades of gray are ideal for facing-pages applications.

The ergonomic design of Model 6300 features an anti-reflection panel CRT, and a high refresh rate on the paper white screen, which allow maximum clarity and viewing comfort, during extended operation.

If you are using an AT compatible, a PS/2 (VGA), or a MAC II, the FLEXSCAN® 6300 is your next step on the road to success.

NANA O®

NANA O USA CORP.

23510 Telo Ave., Suite 5
Torrance, CA 90505 USA
Phone (213)325-5202
Fax (213)530-1679

Circle 223 on Reader Service Card
(DEALERS: 224)

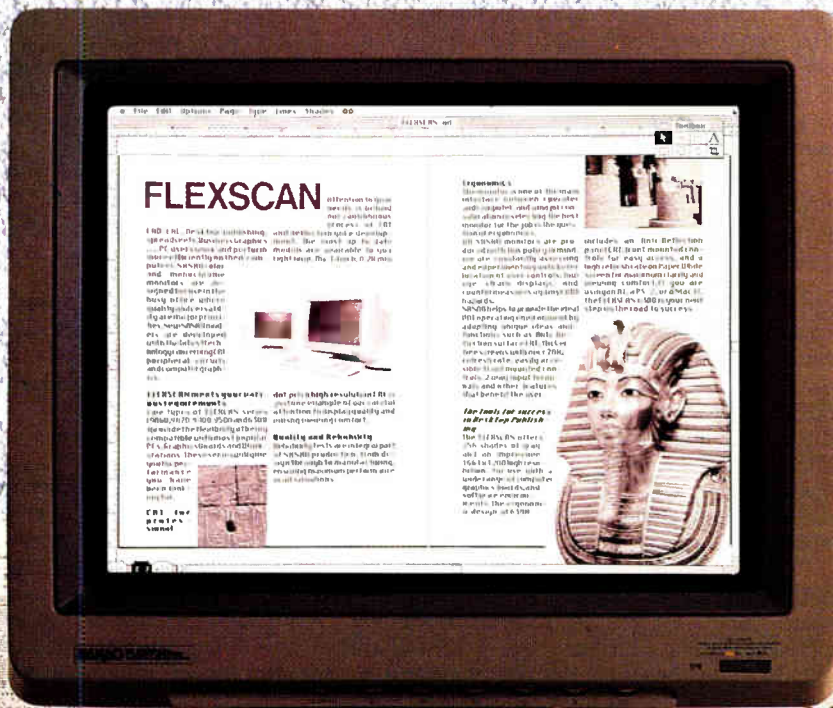

FLEXSCAN 6300

21" (20V) Flat Face Screen

Anti-Reflection CRT surface panel

Scan Frequency: Automatic Adjustment

H: 31.5kHz (VGA)

48kHz-55kHz

64kHz-78kHz

V: 60Hz-80Hz

Analog/ECL Input

Front-mounted controls for easy access

THE INTEL 80860

*Superscalar architectures bring a new level of performance
to microprocessors*

Neal Margulis

Editor's Note: *Earlier this year, Intel announced its first full-scale RISC processor, the 80860. The 80860 operates at up to 50 MHz and has been called a one-chip supercomputer. (See "Intel's Cray-on-a-Chip" in the May BYTE.) We asked Neal Margulis, Intel's chief applications engineer for high-performance processors, to provide us with this in-depth description of the chip.*

The 80860 microprocessor uses an advanced architecture to deliver balanced integer and floating-point performance. With over a million transistors, the 80860 contains a RISC core, an FPU, a memory management unit (MMU), a graphics unit, and separate instruction and data caches.

The RISC core and the MMU allow the 80860 to run multi-tasking operating systems. Its floating-point capability supports advanced modeling, signal and voice processing, and simulation and CAD applications. The processor provides the computation and display support for three-dimensional visualization. Visualization lets a system display an enormous amount of numeric data as computer-generated graphical images, from which users can easily identify patterns.

Unlike a typical system where these capabilities are spread across several chips, the 80860 was designed from the ground up to integrate all these features. The result is a fully defined architecture for handling integer math, memory management, high-performance floating-point math, and 3-D graphics.

The 80860 eliminates the need for support chips such as floating-point accelerators, vector processors, digital signal processor chips, and graphics coprocessors. A fully defined architecture that starts with the CPU eases the software developer's job and results in more powerful applications software.

Analyzing the Architecture

The major functional units of the 80860 microprocessor and the paths between them are shown in figure 1. By incorporating all

the functional units on a single chip, the chip's designers were able to optimize the communication channels between them. The wide internal buses balance data bandwidth with the processing speed of multiple execution units. Separate 32-word register sets for the RISC core and the FPUs provide further support for concurrent execution.

The widespread use of pipelining throughout the chip enhances performance. The RISC core has a four-stage pipeline consisting of fetch, decode, execute, and write stages. The floating-point adder and multiplier also incorporate pipelining with three stages each. In addition, a three-stage load pipeline is matched to the external processor bus, which supports three outstanding cycles.

The RISC core fetches both integer and floating-point instructions from the instruction cache. The CPU allows the programmer to specify two execution modes: single- and dual-instruction.

Single-instruction mode is the traditional execution mode, in which instructions are fetched sequentially. Pipelining allows the sequential instructions to overlap so that multiple instructions are in various stages of completion at any one time.

The 80860 goes a step beyond instruction overlapping with dual-instruction mode. This mode initiates two instructions at once, one for the RISC core and one for the FPU. The FPU achieves one floating-point result per clock cycle and has "dual-operation" instructions, in which an add and a multiply operation execute simultaneously.

Programmers can combine the dual-instruction mode and the dual-operation mode to achieve three operations per clock cycle. With this execution model, the RISC core can execute load, store, and loop-control instructions during floating-point operations.

The result is that peak performance can be maintained while executing the inner loops of common applications. The on-chip data cache or external memory can load data into the floating-point registers.

continued

Graphics

The floating-point hardware of the 80860 processor efficiently performs graphics transformations, including the rotation, scaling, translation, and advanced lighting calculations required for 3-D graphics. Displaying 3-D images requires special operations for shading and for hidden surface removal. The graphics unit hardware speeds these back-end rendering operations (i.e., operations that go from polygons to pixels) using the floating-point registers and wide data paths to operate on multiple pixels simultaneously.

The graphics instructions include intensity interpolation, z interpolation, and z-buffer check. Intensity interpolation allows for smooth linear changes in pixel intensity or color. The z instructions let the programmer determine which objects should be displayed based on their proximity to the viewer. The RISC core also performs a pixel store instruction in parallel with the graphics operations.

Virtual Memory

The 80860 microprocessor supports an address space of 4 gigabytes. The MMU includes a four-way set-associative 64-entry translation look-aside buffer. The TLB translations are per-

formed in one clock cycle and in parallel with the cache accesses.

The MMU implements paged virtual memory management and protection. The Intel 80386 and 80486 microprocessors have the same two-level paging scheme. This commonality allows these processors to interact more easily in a common operating environment, and it facilitates the porting of virtual memory software written in C.

RISC Instruction Set

In the 80860's instruction set, all instructions are 32 bits long and use the three-operand, load/store style typical of RISC processors (see table 1). The three-operand format allows arithmetic, logical, and shift instructions to specify two source registers and a destination register. The only operations that operate on memory are load and store, with arithmetic performed on the registers.

The core unit can execute instructions in one clock cycle. Several techniques allow instructions to execute in one cycle, although their completion may require additional cycles. Loads from memory take one execution cycle, and the next instruction

continued

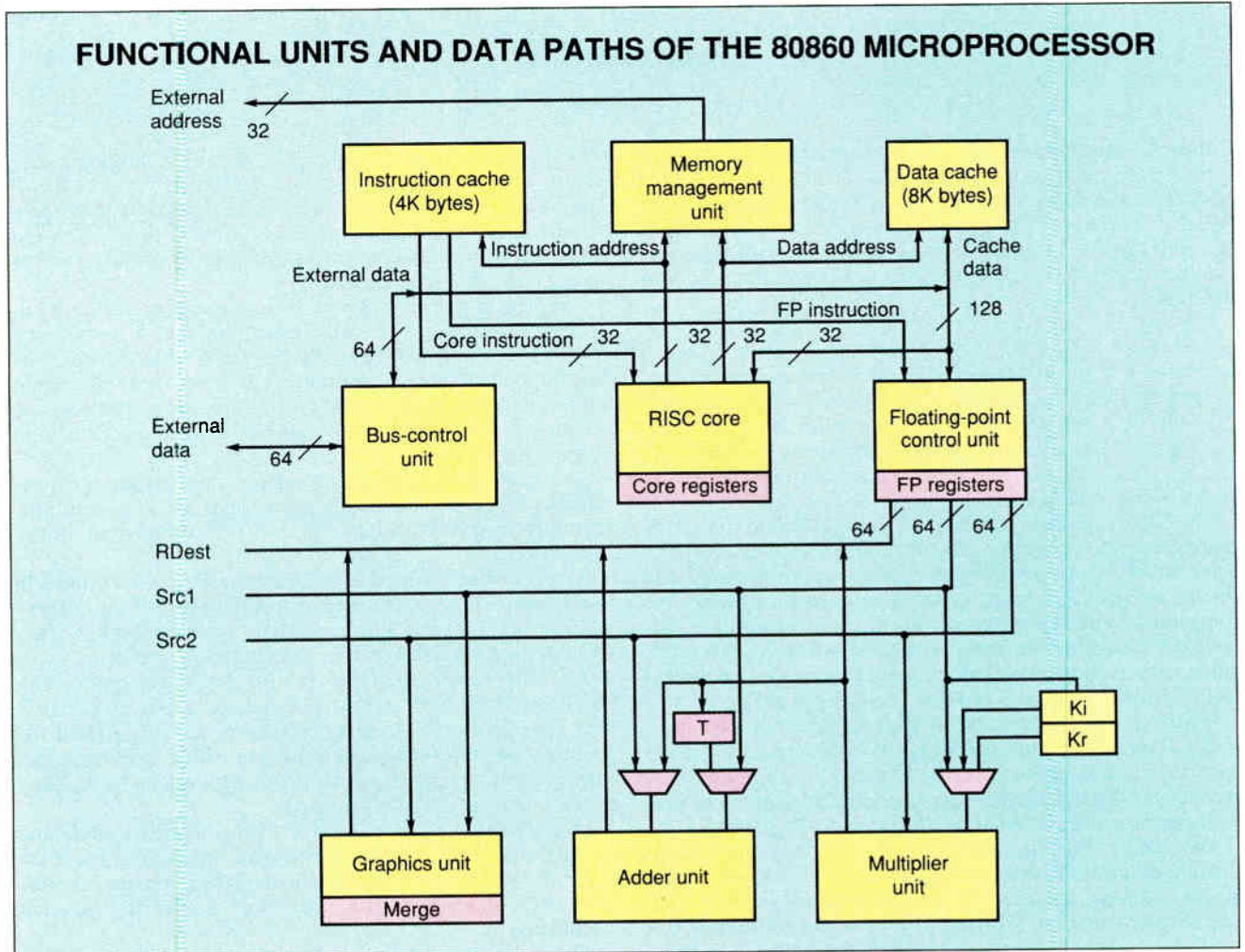

Figure 1: Wide data buses inside the chip and an external 64-bit bus supply the necessary bandwidth to support multiple operations per clock cycle. Four floating-point registers can be loaded in one clock cycle with the 128-bit path from the data cache.



Check out
HI's new DL series

Large format, Big features, Small price.

- ✓ Eight-pen changer **NEW**
- ✓ LCD user interface display **NEW**
- ✓ One-year warranty **NEW**
- ✓ Plot optimization **NEW**
- ✓ "Quick scale" feature **NEW**
- ✓ Standard media up to 36" x 48"
- ✓ Sizzling speed up to 40 ips
- ✓ High resolution of 0.0005 inch
- ✓ Roll-feed option **NEW**
- ✓ Scanner option
- ✓ 1 Mb buffer option

These are just some of the many standard features packed into HI's new DMP-60 DL series of pen plotters. Based on the popular DMP-60 line, the new DL series delivers a blend of proven performance and state-of-the-art innovation. At a surprisingly low price.

Top of the line. Heavy duty. Large format. Loaded with standard features. Priced as low as \$4,895.*

Check it out by calling
1-800-444-3425 or 512-835-0900.

**HOUSTON
INSTRUMENT™**
A DIVISION OF **AMETEK**

8500 Cameron Road, Austin, TX 78753

* U.S. suggested retail price. Subject to change.
Houston Instrument is a trademark of AMETEK, Inc.
Circle 156 on Reader Service Card

Table 1: The 80860 processor's instruction set has a full set of integer and floating-point instructions, each of which is 32 bits wide. The RISC core performs all the processor's loads and stores.

THE 80860 MICROPROCESSOR'S INSTRUCTION SET

Core unit		FPU	
Mnemonic	Description	Mnemonic	Description
Load and store instructions		Floating-point multiplier instructions	
id.x	Load integer	fmul.p	FP multiply
st.x	Store integer	pfmul.p	Pipelined FP multiply
fld.y	FP load	pfmul3.dd	Three-stage pipelined FP multiply
pfld.z	Pipelined FP load	fmlow.p	FP multiply low
fst.y	FP store	frcp.p	FP reciprocal
pst.d	Pixel store	frsqr.p	FP reciprocal square root
Register-to-register moves		Floating-point adder instructions	
ixfr	Transfer integer to FP register	fadd.p	FP add
ixfr	Transfer FP to integer register	pfadd.p	Pipelined FP add
Integer arithmetic instructions		fsub.p	FP subtract
ddu	Add unsigned	pfsub.p	Pipelined FP subtract
adds	Add signed	pfgt.p	Pipelined FP greater than compare
subu	Subtract unsigned	pfeq.p	Pipelined FP equal compare
subs	Subtract signed	fix.p	FP-to-integer conversion
Shift instructions		pfle.p	Pipelined FP less than or equal to
shl	Shift left	famou.p	FP adder move
shr	Shift right	pfamou.p	Pipelined FP adder move
shra	Shift right arithmetic	pfix.p	Pipelined FP-to-integer conversion
shrd	Shift right double	ftrunc.p	FP-to-integer truncation
Logical instructions		pftrunc.p	Pipelined FP-to-integer truncation
and	Logical AND	Dual-operation instructions	
andh	Logical AND high	fam.p	Pipelined FP add and multiply
andnot	Logical AND NOT	pfsm.p	Pipelined FP subtract and multiply
andnot	Logical AND NOT high	pfmam	Pipelined FP multiply with add
or	Logical OR	pfmsm	Pipelined FP multiply with subtract
orh	Logical OR high	Long-integer instructions	
xor	Logical exclusive OR	fisub.z	Long-integer subtract
xorh	Logical exclusive OR high	pfisub.z	Pipelined long-integer subtract
Control-transfer instructions		fiadd.z	Long-integer add
trap	Software trap	pfiaadd.z	Pipelined long-integer add
intovr	Software trap on integer overflow	Graphics instructions	
br	Branch direct	fzchks	16-bit z-buffer check
bri	Branch indirect	pfzchks	Pipelined 16-bit z-buffer check
bc	Branch on CC	fzchkl	32-bit z-buffer check
bc.t	Branch on CC taken	pfzchkl	Pipelined 32-bit z-buffer check
bnc	Branch on not CC	faddp	Add with pixel merge
bnc.t	Branch on not CC taken	pfaddp	Pipelined add with pixel merge
bte	Branch if equal	faddz	Add with z merge
btne	Branch if not equal	pfaddz	Pipelined add with z merge
bla	Branch on LCC and add	form	OR with merge register
call	Subroutine call	pforn	Pipelined OR with merge register
calli	Indirect subroutine call	Assembler pseudo-operations	
System-control instructions		Mnemonic	Description
flush	Cache flush	mov	Integer register-register move
ld.c	Load from control register	fmov.q	FP register-register move
st.c	Store to control register	pfmov.q	Pipelined FP register-register move
lock	Begin interlocked sequence	nop	Core no-operation
unlock	End interlocked sequence	fnop	FP no-operation
		pfle.p	Pipelined FP less than or equal to

can begin on the following cycle.

The processor uses a technique called *scoreboarding* to guarantee proper operation of the code at the highest possible performance. The scoreboard keeps a history of which registers have pending loads. The actual loading of the data takes one clock cycle if the data is in the cache, or several cycles if it's still in memory.

With traditional microprocessors, the next instruction cannot start executing until the data is returned. Scoreboarding allows execution to continue unless a subsequent instruction attempts to use the register being loaded. In this case, the processor will wait for the data to be returned. Optimizing compilers for the 80860 microprocessor organize the code so that such freeze conditions rarely occur.

The 80860's instruction set includes several control flow optimizations. Programmers can code conditional branch instructions with or without a delay slot. A delay slot allows the processor to execute the instruction after a branch while it is fetching the branch target. With both delayed and nondelayed variations, the compiler can easily optimize the code according to whether or not the branch is likely to be taken.

Branches can be performed conditionally based on the condition-code bit (e.g., bc, bnc, bc.t, and bnc.t) or through a comparison of two registers (bte and btne). There is also a branch-loop-and-add instruction, bla, that performs a test, a branch, and an add, all in a single instruction. This instruction reduces program loop overhead.

Floating-Point Instructions

The floating-point hardware can operate on either single- or double-precision IEEE standard 754 floating-point values and on 32- and 64-bit integers. The FPU includes pipelined add and multiply units, which can operate in either scalar or pipelined mode. Source operands for each unit are supplied by the general-purpose floating-point registers, by the special registers (e.g., KR, KI, and T), or by the output of the unit itself.

Scalar-mode instructions specify the operation, the source registers, and the destination register. Once issued, these instructions advance through the unit on each clock cycle until they are completed. Although only one scalar-mode floating-point operation can proceed at a time, it can be overlapped with the execution of RISC core instructions. Scalar-mode execution requires three clock cycles for adds and single-precision multiplies, and four cycles for double-precision multiplies.

Pipelined floating-point instructions advance the three-stage add and/or multiply unit by one stage with each new instruction. This explicit control allows a pipelined floating-point instruction to execute and produce a result with every cycle. Like the scalar-mode instructions, pipelined instructions specify the source registers and the destination register. However, the destination register of pipelined floating-point instructions is the result of a calculation that begins with a prior instruction.

In the example in figure 2, the adder begins by adding the numbers in f2 and f7. Because this is the first instruction of the series and the pipeline is not yet full, the result emerging from the adder is not needed and is sent to f0, which is always 0 and is used as a null destination. On each successive clock cycle, an add instruction is issued to advance the pipeline. When the sum of the first add becomes available at the result stage, it is stored to the destination specified by that instruction.

In this example, three cycles after the f2 plus f7 operation starts, the result is stored to f12 by the instruction that is initiating the addition of f5 and f10. Once all the desired add instructions have started, three dummy adds are used at the end to flush the desired results through the pipeline. When a long

series of numbers is added, the overhead of filling and flushing the pipeline is negligible. When only one or two adds are performed, using scalar mode minimizes pipeline overhead.

Parallelism

Dual-operation instructions allow software to perform add and multiply instructions at the same time. One 32-bit instruction initiates both an add and a multiply operation. Although the two operations require six operands (four source operands and two destination operands), the instruction format specifies only three. The use of special registers KR, KI, and T, along with data-path bypassing, provides the additional operands.

The 32 variations of dual-operation instructions specify the source and destination operands for the adder and multiplier. With these instructions, programmers can efficiently implement applications such as fast Fourier transforms (FFTs), graphics transforms, and matrix operations.

The following example shows the acceleration that the use of pipelined operations makes possible. A series of 100 numbers is multiplied by a constant, added to a second series of 100 numbers, and stored:

```
DO 10, I=1, 100 10 X[I]= A[I] * C + B[I]
```

If the add and multiply are executed in scalar mode, a result is produced every six clock cycles. For example,

```
fmul C, A[I], temp fadd temp, B[I], X[I]
```

First the multiply is performed and the result stored in a temporary register. Then the add is performed with the temporary register, and the result is stored. Each multiply and add take three clock cycles, and the six-cycle sequence is repeated 100 times for a total of 600 cycles of floating-point execution time.

With pipelined, dual-operation instructions, the add and

continued

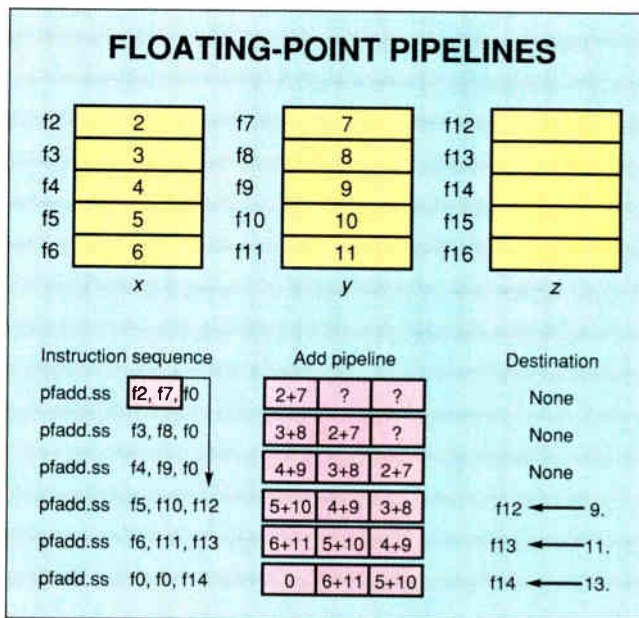

Figure 2: The adder unit has a three-stage pipeline. Each instruction can start an add operation and store the result from a previous add. Every clock cycle produces a new result. Here the adder implements $z \leftarrow x + y$.

multiply are performed in parallel and a new result is produced during each clock cycle. For example,

`r2p1 B[i-3], A[i], X[i-6]`

This illustrates the `pfam` dual-operation instruction variation specified as `r2p1 src1, src2, rdest`. The instruction specifies that the multiply is initiated with the constant register `KR` and `src2` as the operands, that the add is initiated with the result from the multiply and `src1` as the operands, and that the result from an earlier add is stored to `rdest`.

Because the three stages of the add and multiply pipelines are chained in series, the result comes from the operation that began six clock cycles previously. By overlapping the multiply and add, the loop of 600 cycles in scalar mode is reduced to 100 cycles of floating-point execution time.

The FPU's ability to produce new results every clock cycle gives it a tremendous appetite for data. To provide this data, the RISC core can operate in parallel with the FPU to move data in and out of the floating-point registers and to provide program flow control. The processor enters dual-instruction mode if you specify a `d.` prefix in the floating-point instruction mnemonic.

Once in dual-instruction mode, the instruction sequence consists of 64-bit aligned instruction pairs. The upper half contains the integer instruction, and the lower half contains the floating-point instruction. In dual-instruction mode, the 64-bit-wide instruction cache allows the execution of a pair of instructions every cycle. The modes can be changed with no overhead for any number of instructions.

By taking advantage of the 128-bit data-cache path, the RISC core can load up to four floating-point registers per cycle with

the `fld` instruction. Also, a special load instruction called `pfld` loads the floating-point registers from external memory without the data being placed into the cache. This unique instruction allows data that will be referenced only once to be loaded from external memory, while data that is being continually referenced can be kept in the on-board cache.

Like the floating-point execution units, the `pfld` uses a three-stage load pipeline. This instruction specifies a load address and a destination register. Each `pfld` advances the load pipeline one stage and stores the result from the load address that began three instructions previously. Auto-increment addressing avoids using a separate add instruction by automatically incrementing the base register before each load.

Performance Evaluation

One common measure of integer performance is millions of instructions per second. At 40 MHz, the 80860 processor delivers 33 VAX MIPS (based on the Stanford integer benchmark suite) and performs 85,000 Dhrystones on version 1.1 and 80,000 on version 2.1. These results illustrate the RISC core's optimized instruction set and its ability to execute most instructions in one clock cycle. Combined with efficient memory management, the 80860 processor performs well in large applications that use virtual memory.

The Whetstone is a common benchmark used to gauge scalar floating-point performance. The 80860 processor achieves 24 million Whetstones at 40 MHz. The peak million-floating-point-operations-per-second ratings for the 80860 are 80 MFLOPS single-precision and 60 MFLOPS double-precision.

Although peak performance numbers are often misleading,

continued

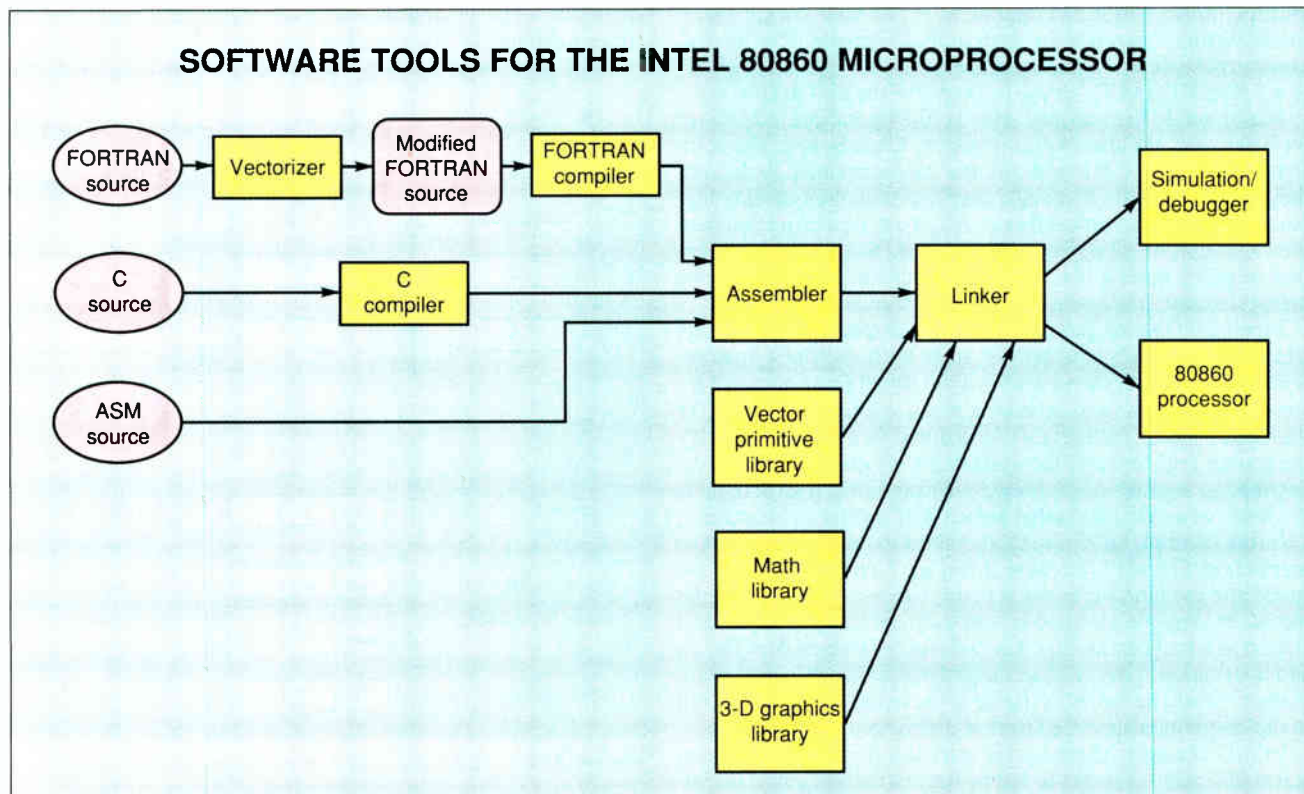

Figure 3: Scientific FORTRAN applications take advantage of the vectorizing precompiler that automatically calls the vector library. C programs also can call the libraries.

Introducing a whole new approach to data storage and retrieval.

If you need to carry information but like to travel light, the Mitsubishi Plastics "BEE CARD" is for you. It's an IC MEMORY CARD offering convenience, versatility and economy that make slow-access cassette tapes and floppy disks obsolete.

Features

- Convenient. Credit card size.
- Durable and economical.
- High-volume memory. From 10 times magnetic card memory to near floppy disk capacity.
- Wide range of applications. Can use it almost anywhere.

Applications

Commercial

- Personal computers (video games, educational and business software).
- Digital sound sources for electronic musical instruments.
- Printer and typewriter font storage.
- Electronic equipment maintenance records.

Industrial

- FA (data logging, machinery process control, industrial robot programs).
- SA (off-line systems).

Other

- Medical chart creation and updating.
- Electronic ID cards.

IBM Compatibility BC Reader/Writer for IBM PC AT/XT

- Designed to implement the IC Memory Card technology available to your IBM PC AT XT.
- Fast-access. Reads and writes all memory types (MASK, OTP, EEP, SRAM).

For further Information

(USA) MITSUBISHI INTERNATIONAL CORPORATION Palo Alto Office

2483 East Bayshore Road, Suite 210 Embarcadero Corporate Center
Palo Alto, CA 94303 Tel: 415-494-1545 Fax: 415-493-0318 (ATTN: JR-P)

(GERMANY) MITSUBISHI INTERNATIONAL GMBH Düsseldorf

Tel: 0211-4397-396 Fax: 0211-4397-397

(ENGLAND) MITSUBISHI CORPORATION (UK) LIMITED

Tel: 01-822-1712 Fax: 01-822-1713 (ATTN: JR-P)

MITSUBISHI CORPORATION

Tokyo Tel: 03-210-3792 Fax: 03-210-3353 (ATTN: JR-P)

Singapore Branch Tel: 321-9126 Fax: 225-6047 (ATTN: JR-P)

Taipei Branch Tel: 2-507-3456 (ex. 205) Fax: 2-504-6264 (ATTN: JR-P)

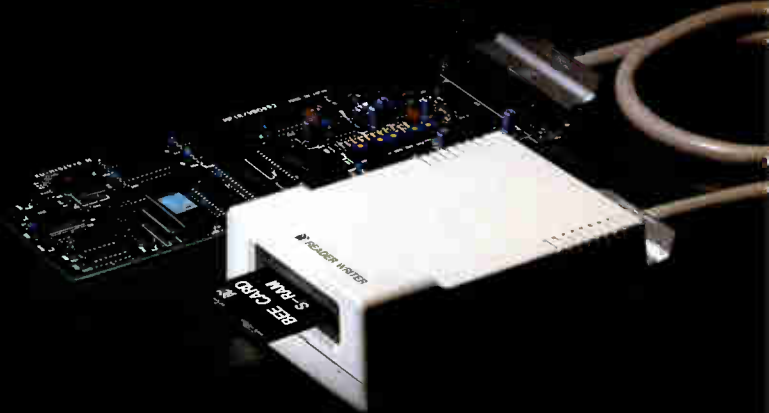

 **MITSUBISHI PLASTICS INDUSTRIES LIMITED**

World Radio History

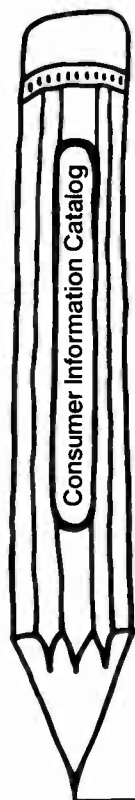

Reading
worth
writing
for.

If you're looking for some good reading, you've just found it. The free Consumer Information Catalog.

The Catalog lists about 200 federal publications, many of them free. They can help you eat right, manage your money, stay healthy, plan your child's education, learn about federal benefits and more.

So sharpen your pencil. Write for the free Consumer Information Catalog. And get reading worth writing for.



**Consumer Information Center
Department RW
Pueblo, Colorado 81009**

A public service of this publication and
the Consumer Information Center of the U.S. General Services Administration.

dual-instruction mode and dual-operation mode allow the microprocessor to achieve peak performance for inner loops of common matrix operations. In the LINPACK benchmark, the 80860 attains over 10 MFLOPS. The inner loop of a complex FFT requires 10 floating-point operations. The 80860 performs the 10 operations in six clock cycles, calculating a 1024-point FFT in 1 millisecond.

Tools of the Trade

Intel's internal development teams and independent vendors are providing a full complement of software development tools and operating systems for the 80860. Figure 3 shows the development tools' environment, including C and FORTRAN compilers, an assembler/linker, a simulator/debugger, and a FORTRAN vectorizer. In addition, there are the mathematical, vector primitive, and 3-D graphics libraries.

The initial development environments use cross compilers hosted on Unix System V/386 and OS/2. The optimizations used in the compilers include coloring for register allocation, register-based parameter passing for calls, interblock common subexpression and loop invariant elimination, constant propagation, strength reduction, extensive peephole optimizations, and instruction scheduling.

Programmers write much of their engineering and scientific applications in FORTRAN because it is so well suited for vectorization. The 80860 support includes a FORTRAN vectorizing precompiler. Vectorization is performed on DO and IF loops, outer loops, and forward-branching conditional operations. The precompiler recognizes these structures and generates calls to a set of highly optimized, hand-coded procedures. These procedures take full advantage of dual-instruction and dual-operation modes, managing the data cache as a vector register.

In addition, programmers can access these procedures from other high-level languages. Work is under way to further increase the degree of parallelism of the processor. A library of assembly language routines for scalar mathematics is also available.

A multiprocessing version of Unix System V 4.0 is under development for the 80860. The project is a joint effort by AT&T, Unisys, Intel, Olivetti, Prime, Okidata, and others. The Intel programming tools will maintain high-level-language source code compatibility between the 80386, 80486, and 80860 microprocessors. A document is available that specifies an application's binary interface standard for the 80860 to allow portability of applications software across systems from different companies.

A Supercomputer on Your Desk?

The 80860 delivers balanced integer and floating-point performance that only a million-transistor processor can provide. Software developed for the 80860 can take full advantage of the architecture, bringing the power of supercomputers into the hands of desktop computer users.

But in addition to providing a new level of performance, the 80860 is the first of a new class of microprocessors. By breaking the one-operation-per-clock-cycle barrier, it has become the first commercial superscalar microprocessor. The advent of superscalar architectures will allow microprocessor performance to work alongside advances in semiconductor technology to bring even greater capabilities to desktop computers. ■

Neal Margulis is chief applications engineer for high-performance processors at Intel Corp. in Santa Clara, California. He can be reached on BIX c/o "editors."

PC BRAND Chosen #1 For Customer Service and Support.

"PC BRAND is the LL Bean of the personal computer mail order.

PC BRAND wants no unhappy customers, and it's service and support policies help to insure that."

-Personal Computing's 10 Best Mail Order Companies, Feb, 1989



PC BRAND™

World Radio History

PC BRAND offers you more...

Welcome to PC Brand. Your *first* place to shop. Your *best* place to shop for top quality IBM compatible systems, custom configured to your exact specifications, and thousands of quality name brand peripherals and accessories.

Choose from over 10,000 items in stock... all at unbeatable prices!

Free Freight, Toll-Free Support, 5-Year Warranty and more...

Everyone promises you great service. We deliver the tangibles.

- Free freight • Fast delivery
- No credit card surcharges
- A 30-day Money-Back Guarantee on every system we sell
- Toll-Free Customer Service and Technical Support that will stay with you until your questions are answered and your problem is solved
- And our exclusive 5-Year Warranty on all PC Brand products, call for details.

Call PC Brand today.

For the best selection... the best products...at the best price, you can't do better than PC Brand.

Call PC Brand today!

TURN PAGE
FOR PC BRAND SYSTEMS
...AND NAME BRAND
PERIPHERALS

Circle 266 on Reader Service Card

Outstanding Quality

PC BRAND Chosen #1 For Customer Service and Support.

"PC BRAND is the LL Bean of the personal computer mail order...PC BRAND wants no unhappy customers, and it's service and support policies help to insure that."

-Personal Computing's 10 Best Mail Order Companies, Feb, 1989

PC BRAND

Your Best Choice
for Quality Systems
Toll-Free Support
Toll-Free Service
Free Freight
5-Year Warranty



PCV20 AD-II

\$539

15 MHz Throughput in an XT. Norton SI 4.0
512K, 360K Drive, 84-Key Keyboard

Standard System Features:

- 10MHz Nec V20 CPU with 1.5 times the power of the 8088!
- 512K RAM standard. Expandable to 640KB
- One 360K Floppy Drive • 84-key AT Style Keyboard
- 8 Slots. Serial, Parallel, Game Ports, and Clock Standard
- AT Style Case with Keylock, Turbo, Power and Hard Drive LEDs.
Accommodates up to 4 HH Mass Storage devices
- Set-up & Operating instructions.

Standard Pre-Built Configurations:

PCV20 AD-II With 512K, Hard Disk Drive, Monitor & Video Card				
Drive Video	1 Floppy	2 Floppy	40MB-45MS	66MB-25MS
Mono	\$664	\$739	\$944	\$1094
VGA/Mono	\$824	\$899	\$1104	\$1254
EGA	\$1004	\$1079	\$1284	\$1434
VGA/Color	\$1054	\$1129	\$1334	\$1484

PC BRAND 286/12

\$799



Now Using C & T
"Neat" Chip Set

12 MHz Clock, Zero Wait Operation,
Norton SI 15.3 • Landmark™ Speed 15.1MHz
512K, 1.2MB or 1.44MB Drive, 101- Keyboard

Standard System Features:

- 80286-12 Processor Operating at 12MHz with Zero Wait States delivering 15.1MHz Effective Throughput
- 512K RAM expandable to 4MB on the System board using 256K or 1MB 100ns RAM
- 1.2MB 5.25" or 1.44MB 3.5" Diskette Drive
- 1:1 Interleaving Dual Hard Drive/Floppy Drive Controller
- Enhanced 101-key AT Style Keyboard
- High Capacity System Power supply
- Real Time Clock/Calendar with 5 Year Battery
- 80287 Co-Processor Support
- AMI BIOS with full MS/DOS, OS/2, XENIX, UNIX, NOVELL, 3COM and PCNET compatibility
- Built-in System Board LIM 4.0 EMS hardware drivers
- User configurable I/O timing permitting compatible operation with older peripherals or faster I/O for newer devices
- 8 Slot motherboard design (5 16Bit & 3 8Bit)
- Medium foot print case with 5 Disk Drive bays

Options:

- Factory Installed RAM Upgrades
- Custom configurations w/Name Brand peripherals of your choice
- Compaq® Style LCD or Plasma Portable
- Mini Size Tower Case®

Standard Pre-Built Configurations:

286/12 With 512K, Hard Disk Drive, Monitor & Video Card				
Drives Video	40MB-45MS 1:1 RLL	66MB-25MS 1:1 RLL	71MB-18MS 1:1 MFM	110MB-25MS 1:1 RLL
Mono	\$1207	\$1432	\$1572	\$1672
VGA/Mono	\$1402	\$1627	\$1767	\$1867
EGA	\$1547	\$1772	\$1912	\$2012
VGA/16Bit	\$1637	\$1862	\$2002	\$2102

Unbelievable Price

PC BRAND 286/20 \$999

PC BRAND 386/SX-16 \$1099



Ideal Novell Server!



20 MHz Clock, Zero Wait Operation
Norton SI 23.0 • Landmark™ 26.7MHz
512K, 1.2MB or 1.44MB Drive, 101-Keyboard

16 MHz Clock, Zero Wait Operation
Norton SI 18.7 • Landmark™ 18.3MHz
512K, 1.2MB or 1.44MB Drive, 101-Keyboard

Standard System Features:

- 80286 Processor Operating at 20MHz w/Zero Wait States in interleave mode delivering 27MHz Effective Throughput
- 512K RAM expandable to 9MB on the System board using 256K and/or 1MB 100ns RAM
- 1.2MB 5.25" or 1.44MB 3.5" Diskette Drive
- 1:1 Interleaving Dual Hard Drive/Floppy Drive controller
- Enhanced 101-key AT Style Keyboard
- High Capacity 200 Watt System Power Supply
- Real Time Clock/Calendar with 5 Year Battery
- 80287 Co-Processor Support
- AMI BIOS with full MS/DOS, OS/2, XENIX, UNIX, NOVELL, 3COM, and PCNET compatibility
- Built-in System Board LIM 4.0 EMS hardware drivers
- User configurable I/O timing permitting compatible operation with older peripherals or faster I/O for newer devices
- 8 Slot motherboard design (5 16Bit & 3 8Bit)
- Medium foot print case with 5 Disk Drive bays

Standard System Features:

- 80386SX Processor Operating at 16MHz delivering 18MHz Effective Throughput
- 512K RAM expandable to 8MB on the System board using 256K and/or 1MB 80ns RAM
- 1.2MB 5.25" or 1.44MB 3.5" Diskette Drive
- 1:1 Interleaving Dual Hard Drive/Floppy Drive controller
- Enhanced 101-key AT Style Keyboard
- High Capacity 200 Watt System Power Supply
- Real Time Clock/Calendar with 5 Year Battery
- 80387SX Co-Processor Support
- AMI BIOS with full MS/DOS, OS/2, XENIX, UNIX, NOVELL, 3COM, and PCNET compatibility
- 8 Slot motherboard design (5 16Bit & 3 8Bit)
- Medium foot print case with 5 Disk Drive bays (Shown with optional Mini Size Tower® Case)

Options:

- Mini Size Tower® Case • Factory Installed RAM Upgrades
- Custom configurations w/Name Brand peripherals of your choice
- Compaq® Style LCD or Plasma Portable

Options:

- Mini Size Tower® Case • Factory Installed RAM Upgrades
- Custom configurations w/Name Brand peripherals of your choice
- Compaq® Style LCD or Plasma Portable

Standard Pre-Built Configurations:



286/20 w/512K, Hard Disk Drive, Monitor & Video Card						
Video	Drives 40MB-45MS 1:1RLL	66MB-25MS 1:1 RLL	71MB-18MS 1:1 MFM	110MB-25MS 1:1 RLL	150-17MS 1:1 ESDI	320-16MS 1:1 ESDI
Mono	\$1407	\$1632	\$1737	\$1862	\$2357	\$2817
VGA/Mono	\$1602	\$1827	\$1932	\$2057	\$2552	\$3012
EGA	\$1747	\$1972	\$2077	\$2202	\$2697	\$3157
VGA/16Bit	\$1837	\$2062	\$2167	\$2292	\$2787	\$3247

Standard Pre-Built Configurations:

386SX-16 w/512K, Hard Disk Drive, Monitor & Video Card						
Video	Drives 40MB-45MS 1:1RLL	66MB-25MS 1:1 RLL	71MB-18MS 1:1 MFM	110MB-28MS 1:1 RLL	150-17MS 1:1 ESDI	320-16MS 1:1 ESDI
Mono	\$1507	\$1732	\$1837	\$1962	\$2457	\$2917
VGA/Mono	\$1702	\$1927	\$2032	\$2157	\$2652	\$3112
EGA	\$1847	\$2072	\$2177	\$2302	\$2797	\$3257
VGA/16Bit	\$1937	\$2162	\$2267	\$2392	\$2887	\$3347

**TURN PAGE FOR MORE PC BRAND SYSTEMS...
FOR NAME BRAND PERIPHERALS SEE OUR AD ON FOLLOWING PAGES...**

To Order Call 1-800-PC BRAND

(Call 1-800-722-7263) In All 50 States FAX# 1-800-722-7392 New Winter Extended Hours   
PC Brand, Inc. 954 W. Washington St., Chicago, IL 60607 Int'l Fax# 312-226-6841 Int'l Voice# 312-226-5200. Open Mon thru Fri.: 8am to 8pm Central. MasterCard, VISA, Discover, Checks, & Approved P.O.s Accepted. Prices and specifications subject to change. Customer Service Inquiries Call: 1-800-662-SERV BYTE 14-12

Amazing Performance

"Faster Than a Speeding Bullet!"

-Computer Shopper Cover Story Nov, 1988

"PC Brand offers the best low cost alternative around"

-PC Magazine Feb.14, 1989

PC BRAND 386/20 \$1489

PC BRAND 386/25 \$1689



20 MHz Clock, Zero Wait Operation
Norton SI 23.0 • Landmark Speed 26.1MHz
1024K, 1.2MB or 1.44MB Drive, 101-Keyboards

Standard System Features:

- True 20MHz Intel 80386-20 CPU Operating with Zero Wait States delivering up to 26.1MHz Effective Throughput
- 1024K RAM standard expandable to 16MB using 256K and/or 1MB RAM
- 1.2MB 5.25" or 1.44MB 3.5" Diskette Drive
- 1:1 Interleaving Dual Hard Drive/Floppy Drive controller, 977.6 KB/SEC Caching Controller w/ESDI Configurations
- Enhanced 101-key AT Style Keyboard
- High Capacity 200 Watt System Power Supply
- Real Time Clock/Calendar with 5 Year Battery
- 80287, 80387 Co-Processor Support
- AMI BIOS with full MS/DOS, OS/2, XENIX, UNIX, NOVELL, 3COM and PCNET compatibility
- 8 Slot motherboard design (5 16Bit & 3 8Bit)
- Medium foot print case with 5 Disk Drive bays

Options:

- Full or Mini Size Tower ® Case
- Custom configurations w/Name Brand peripherals of your choice
- Compaq® Style LCD or Plasma Portable • Weitek Co-processor

Standard Pre-Built Configurations:

386/20 With 1024K, Hard Disk Drive, Monitor & Video Card							
Drives	40MB-45MS	66MB-25MS	71MB-18MS	110-25MS	150-17MS	320-16MS	
Video	1:1 MFM	1:1RLL	1:1 MFM	1:1 RLL	1:1ESDI	1:1ESDI	
Mono	\$1995	\$2095	\$2220	\$2330	\$2860	\$3305	
VGA/Mono	\$2170	\$2270	\$2395	\$2505	\$3035	\$3480	
EGA	\$2280	\$2380	\$2505	\$2615	\$3145	\$3590	
VGA/16Bit	\$2370	\$2470	\$2595	\$2705	\$3235	\$3680	

25 MHz Clock, Zero Wait Operation
Norton SI 28.2 • Landmark Speed 33.6MHz
Norton SI 31.6 • Landmark Speed 43.5 w/Cache
1024K, 1.2MB or 1.44MB Drive, 101-Keyboards

Standard System Features:

- Intel 80386 Processor Operating at 25MHz with Zero Wait States in interleave mode delivering 34 to 44 MHz Effective Throughput
- 1024K RAM standard expandable to 16MB using 256K and/or 1MB RAM
- 1.2MB 5.25" or 1.44MB 3.5" Diskette Drive
- 1:1 Interleaving Dual Hard Drive/Floppy Drive controller, 977.6 KB/SEC Caching Controller w/ESDI Configurations
- Enhanced 101-key AT Style Keyboard
- High Capacity 200 Watt System Power Supply
- Real Time Clock/Calendar with 5 Year Battery
- 80287, 80387 or Weitek Co-Processor Support
- Industry Standard BIOS with full MS/DOS, OS/2, XENIX, UNIX, NOVELL, 3COM and PCNET compatibility
- User configurable I/O timing permitting compatible operation with older peripherals or faster I/O for newer devices
- 8 Slot motherboard design (5 16Bit & 3 8Bit)
- Medium foot print case with 5 Disk Drive bays (Full size case w/cache)

Options:

- 32KB or 64KB Cache Processor • Weitek Co-processor • Tower® Case
- Custom configurations w/Name Brand peripherals of your choice
- Compaq® Style LCD or Plasma Portable

Standard Pre-Built Configurations:

386/25 With Hard Disk Drive, Monitor & Video Card							
Drives	40MB-45MS	66MB-25MS	71MB-18MS	110MB-25MS	150-17MS	320-16MS	
Video	1:1MFM	1:1RLL	1:1 MFM	1:1RLL	1:1ESDI	1:1ESDI	
Mono	\$2182	\$2332	\$2462	\$2592	\$3162	\$3412	
VGA/Mono	\$2387	\$2537	\$2667	\$2797	\$3367	\$3617	
EGA	\$2502	\$2652	\$2782	\$2912	\$3482	\$3732	
VGA/16Bit	\$2577	\$2727	\$2857	\$2987	\$3557	\$3807	

CRT display is courtesy of RIX Softworks, Inc. Irvine, CA.

Exceptional Support

386/33 CACHE

\$2799

*Worlds Fastest
Personal Computer!*



33 MHz Clock, Zero Wait Operation

NortonSI 45.9 • Landmark 58.7MHz w/32K or 64K Cache
1024K, 1.2MB or 1.44MB Drive, 101-Keybaord

Standard System Features:

- True 33 MHz INTEL 80386-33 CPU operating with Zero Wait States Delivering up to 58.7 MHz Effective Throughput
- Intel 82385-33 Cache Processor with 32K 25NS Static RAM Standard, Field Upgradable to 64K
- 1024K RAM Standard Expandable to 16MB
- 1.2MB 5.25" or 1.44MB 3.5" Diskette Drive
- 1:1 Interleaving Dual Hard Drive/Floppy Drive Controller, 977.6 KB/SEC Caching Controller w/ESDI Configurations
- Enhanced 101-key AT Style Keyboard
- High Capacity 200 Watt System Power Supply
- Real Time Clock/Calendar with 5 Year Battery
- 80387 or Weitek Co-Processor support
- Phoenix BIOS With Full MS/DOS, OS/2, XENIX, UNIX, NOVELL, 3COM and PCNET compatibility
- 8 Slot motherboard design
- Full size case with 5 Disk Drive bays
(Shown with Optional Full Size Tower @ Case)

Options:

- Custom configurations w/Name Brand peripherals of your choice
- Weitek Co-Processor • Tower @ Case • Factory Ram Upgrades

Standard Pre-Built Configurations:

386/33 With Hard Disk Drive, Monitor & Video Card						
Drives	40MB-45MS 1:1 MFM	66MB-25MS 1:1 RLL	71MB-18MS 1:1 MFM	110MB-25MS 1:1RLL	150MB-17MS 1:1ESDI	320MB-18MS 1:1 ESDI
Video						
Mono	\$3259	\$3454	\$3554	\$3679	\$4124	\$4634
VGA/Mono	\$3454	\$3649	\$3749	\$3874	\$4319	\$4829
EGA	\$3599	\$3794	\$3894	\$4019	\$4464	\$4974
VGA/16Bit	\$3689	\$3884	\$3984	\$4109	\$4554	\$5064

+ Norton SI 3.0

CRT display is courtesy of RIX Softworks, Inc. Irvine, CA.

PC BRAND

Your Best Choice
for Quality Systems
Toll-Free Support
Toll-Free Service
Free Freight
5-Year Warranty

286/386 PORTABLES from \$1745

286 & 386 Systems
• 512K, 1.2MB Drive,
Combo Controller,
LCD Backlit Display
Optional VGA
Plasma Display



All feature:

- 640 x 400 Backlit Supertwist LCD by TOSHIBA (VGA 16 Grey Scale Plasma version Now Available)
- Monographic & Color operating modes, VGA Optional
- External Monitor Support
- 2 Available expansion slots
- 86-key keyboard
- Accomodates two 5.25" or 3.5" Floppy/Hard Disk Drives
- 200 Watt 112/220 Autoswitch Power
- Serial, Parallel, Game Port, Clock/Calendar Standard



Standard Pre-Built Configurations:

Portable System Processor and Drive Options						
Drive	CPU	286-12	286-20	386/SX-16	386-20	386-25
1 Floppy		\$1745	\$1945	\$2045	\$2595	\$2795
40MB		\$2175	\$2375	\$2475	\$3025	\$3225
66MB		\$2275	\$2475	\$2575	\$3125	\$3325
150MB		\$3140	\$3340	\$3440	\$3990	\$4190

*386/20 and 386/25 Systems come with 1024K.

SAVE ON NAME BRAND PERIPHERALS... SEE OUR AD ON FOLLOWING PAGES...

To Order Call 1-800-PC BRAND

(Call 1-800-722-7263) In All 50 States FAX# 1-800-722-7392 New Winter Extended Hours



PC Brand, Inc. 954 W. Washington St., Chicago, IL. 60607 Int'l Fax# 312-226-6841 Int'l Voice# 312-226-5200. Open Mon thru Fri.: 8am to 8 pm Central. MasterCard, VISA, Discover, Checks, & Approved P.O.s Accepted. Prices and specifications subject to change. Customer Service Inquiries Call: 1-800-662-SERV BYTE 14-12

Shop PC Brand Today.

LAPTOP COMPUTERS*

NEC	
Multispeed HD	Call
Ultralite w/1MB	Call
TOSHIBA	
1000; 512K, 80C88, 1 FDD	\$679
1600 BACKLIT, 80C86-12, 1MG, 20MB HD, FDD	3240
3100E GAS PLASMA 80C86-12, 1MB, 20MB HD, FDD	2805
3200; EGA, 80286-12, 1MB, 40MB HD, FDD	3595
5200/40 VGA, 80386-20, 2MB, 40MB HD, FDD,	6115
ZENITH	
Supersport 286, 20Meg	Call
Supersport 286, 40Meg	Call
Supersport 88, 20Meg	Call
Other Makes and Models Call	

MONITORS*

MAGNAVOX	
7BM623 12" Amber TTL Monochrome	\$79
7BM749 14" VGA White Flat Screen	135
CM8762 13" RGB (640x200) Color	230
CM9043 13" EGA (640x400) Color	339
9CM082 14" VGA (640x480) .31DP Color	415
MITSUBISHI	
XC-1410 14" EGA (640x350)	\$369
AUM-1381 14" Diamond Scan	499
HL6605 15" CAD Monitor	1295
HL6905 19" CAD Monitor	2325
NEC	
Multisync 2A 14" (800x600) VGA	\$499
Multisync GS 14" Mono	249
Multisync 3D 14" (1024x768) EGA/VGA	679
Multisync 4D 16" (1024x768) .28DP	Call
Multisync 5D 20" (1280x1024) .31DP	Call
PRINCETON GRAPHICS	
Max 15 15" Multifreq. Monochrome	\$249
Ultra 16 16" Multifreq. EGA/VGA	879
Ultrasync 14" Multifreq. EGA/VGA	520
PRINCETON PUBLISHING LABS	
Multiview 15" Full Page Monitor w/adapt.	\$890
RELISYS (Top Rated by Infoworld and PC World)	
RE-9513 14" VGA(720x480).31DP Color	\$369
SEIKO	
CM1430 14" (1024x768) Dualfreq	\$549
SONY	
CPD1304 14" .25DP(1024x768) Multiscan	\$689
CPD1320 13" (640 x 480) VGA	485
ZENITH	
ZCM-1490 14" Flatscreen Enhanced	\$619

MODEMS

A.T.I.	
2400ETC Internal Modem w/MNP5	\$165
2400ETC External Modem w/ MNP5	205
HAYES	
1200B Int. w/Smartcom	\$285
2400B Int. w/Smartcom	429
1200 Ext. Modem	285
2400 Ext. Modem	429
PC BRAND 100% Hayes Compatible!	
1200 Baud Internal w/Bitcom	\$49
1200 Baud External	70
2400 Baud Internal w/Bitcom	89
2400 Baud External	129
US ROBOTICS	
Courier HST/9600	\$599
Courier V.32 9600 Baud Ext.w/MNP5	889
Courier HST Dual Standard Modem	995
Courier HST/IX 9600 Modem	925

Internal Modems

100% Hayes Compatible. Free Software!

1200BPS	\$49	
2400BPS	\$89	

TAPE BACK-UP SPECIAL

80/40MB Internal Tape Back-Up*



\$279

Uses DC2000 Series Micro Cartridges
*When used with CMS Backup Software

VIDEO CARDS

ATI	
VGA Wonder w/256K	\$315
VGA Wonder w/512K	469
PARADISE	
Autoswitch 480 EGA	\$139
VGA+	265
VGA+ 16 16 Bit Version NEW	299
VGA Professional w/512K	399
PC BRAND	
Mono Graphics w/Printer Port	\$55
Color Graphics w/Printer Port	49
EGA (640x480) Autoswitch	135
VGA	159
VGA 16 Bit	195
VIDEO SEVEN	
Fastwrite VGA	\$279
VRAM VGA	450
VRAM VGA w/512K	Call

DISK DRIVES

FLOPPY DISK DRIVES:	
360K 5.25" HH Black	\$75
720K 3.5" HH w/5.25" Mounting	80
1.2MB 5.25" HH Grey	85
1.44MB 3.5" HH Grey w/5.25" Mounting	95
PS/2 FLOPPY DRIVES	
CMS 5.25" 360K/PS/2 Ext.Floppy	\$199
HARD DISK DRIVES:	
IOMEGA	
B120I Single 5.25" 20MB Int.	\$765
B144I Single 5.25" 44MB Int.	995
B244X Dual 5.25" 44MB Ext.	1995
MINISCRIBE	
71MB 18MS M3085	\$595
150MB 17MS M3180E ESDI 1/2 Hgt.	1195
320MB 16MS M9380 ESDI Full Hgt.	1550
640MB 16MS M9780 ESDI Full Hgt.	2850
PRIAM	
130MB 20MS ID130AT Full Height ...	\$1395
160MB 28MS ID160EC ESDI w/CNTRL 1650	
330MB 20MS ID330PS INT. for PS/2 ...	1895
330MB 20MS ID330EC ESDI w/CNTRL 2250	
SEAGATE	
20MB 65MS ST225 w/XT Controller ...	\$249
20MB 65MS ST225	209
20MB 35MS ST125 w/XT Controller	299
20MB 35MS ST125	245
30MB 65MS ST238 w/XT Controller	269
30MB 35MS ST138	310
30MB 35MS ST138 w/XT Controller	355
40MB 28MS ST251-1	349
40MB 24MS ST151	419
80MB 28MS ST4096 Full Height	590
TOSHIBA	
66MB 25MS MK134 RLL	429
110MB 25MS MK72 RLL	669
156MB 23MS MK-156FA ESDI Full Hgt.	1095
If the drive you require is not listed here please contact our sales department for a quote!	

TAPE BACKUPS

60MB Archive Int. or Ext. w/Cntrl.	\$590
60MB Maynard Maynstream Portable ..	889
150MB Archive Internal	925
150MB Archive External	1250
150MB Maynard Maynstream Portable	1395
2.2GB Maynard Maynstream Portable	4350

PC BRAND 16Bit VGA

Ultra Hi-performance VGA Card, compatible w/ VGA, EGA, monochrome, and multisync monitors, Analog and Digital output, upgradable to 512K, resolution to 1024x768, many software drivers

\$195



NEC 14" Multisync 2A

800x600 Resolution Super VGA Monitor



\$499

Freight Free!

Save Time. Save Money.

SCANNERS/DIGITIZERS

Complete PC Half Page Scanner	\$189
Complete PC Full Page Scanner	575
DFI HS3000 Plus Gray Scale Hand Scan	219
Hewlett Packard Scanjet Plus	Call
Microtek MS II	1050
Microtek MSF300G w/256 Grey Levels ...	1495
Microtek MSF300Q w/64 Grey Levels	1275
Summasketch 12X12	378
Summasketch 12X18	599

PRINTERS*

BROTHER

HL 8E Laser (HP LJII, HPGL) \$1875

EPSON

LX810 180/30.....189 LQ510 180/60.....329

FX850 330/88.... 345 FX1050 264/54.....445

LQ850 330/88...Call LQ1050 330/88...Call

LQ950 264/88...Call LQ2550 400/108..Call

KODAK DICONIX

150Plus 150/50.. 315 300WP 310/73 439

HEWLETT PACKARD

Deskjet Plus710 Laserjet II1720

Laserjet IIP Call

LASER JET ACCESSORIES

CPI Superfont Cart. adds 150 fonts. 295

CPI 1MB Memory Kit. 319 CPI 2MB MemoryKit. 549

PRINCETON PUBLISHING

PS-388 Postscript board2250

Adds Postscript to your HP LASERJET!

NEC

P2200XE 192/54 335 P9XL 400/140 1030

P5200 265/90530 P5300 Wide675

LC890 Laser3190 LC890XL Laser ..4495

OKIDATA

ML320 300/62 ..345 ML321 300/62479

ML380 180/60.. 359 ML390 270/90475

ML391 270/90 ..655 ML393 450/120.. .995

PANASONIC (New Models Listed)

1180 192/38 189 1191 240/48245

1124 192/63339 1524 240/80545

TOSHIBA

321SL 216/72 ... Call 341SL Wide Carr ... Call

351SX 360/120 .Call Express 311 Call

EPSON FX 1050

15" Carriage 264 CPS Draft 54 CPS Letter Quality



\$445

Other Epson models comparably discounted

PC BRAND-YOUR #1 LAN SOURCE!



Call for Custom Server Configurations

NOVELL NETWORKING

NOVELL

4 User ELS 286 Level 1\$429

8 User ELS Level II (Version 2.15) 899

Advanced Netware 286 (Ver. 2.15) 1795

SFT Netware 286 (Ver. 2.15) 2809

Netware 386 Call

Disc Coprocessor Board 379

NE2000 Ethernet File Server Board 399

NE1000 Ethernet Card 269

GATEWAY (PC Magazines Editors Choice)

G/ Ethernet AT\$435

G/NET 269

G/ Ethernet for PS/2 Call

STANDARD MICRO

PC130 Arcnet Board\$135

PC270 Twisted Pair Arcnet Card 130

PC500-WS 16 Bit Work Station Board 375

PC550-WS 16 Bit Twisted Pair Work Station Bd ... 395

PC550-FS 16 Bit Twisted Pair File Server Bd 495

PS110 Arcnet Board for PS/2 439

PC500-FS 16 Bit File Server Board 449

ARCNET Passive Hub 72

ARCNET Active Hub 359

ARCNET Twisted Pair Active Hub 429

TIARA

4 Port Passive Hub\$49

8 Port Active Hub 285

Lancard/A 8Bit ARCNET Board 89

Lancard/E 8Bit ETHERNET Board 199

Lancard/E 8Bit Twisted Pair ETHERNET 329

WESTERN DIGITAL

Ethercard+ w/Novell Drivers\$219

Ethercard+ Twisted Pair Ethernet Board.....319

Ethercard+ A for PS/2320

UNINTERRUPTABLE POWER

ELGAR

IDS1100 1000 Watt UPS Call

IPS 500 Watt UPS Call

PTI

DataShield Turbo/2 625 Watt 595

PC BRAND™

Free Freight

30-Day Money-Back Guarantee

Toll-Free Service and Support

No Credit Card Surcharges

We carry over 10,000 different hardware and software products, Call for prices on products not listed.

SOFTWARE

ALDUS Pagemaker\$499

ASHTON-TATE DBASE IV 449

BORLAND Quattro 149

CENTRAL POINT PC Tools Deluxe 42

FUNK SOFTWARE Sideways 42

LOTUS 123 3.0 295

MICROSOFT Excel 2.1 235

MICROSOFT Windows 386 125

MICROSOFT Word 5.0 205

WORD PERFECT Word Perfect 5.0 220

XEROX Ventura Publisher 2.0 499

SERIAL MOUSE

High Resolution (250DPI) Microsoft Compatible



\$35

CO-PROCESSORS/BOARDS

INTEL

Aboveboard Plus w/512K\$419

Aboveboard Plus I/O 512K 469

Inboard 386 for PC w/IMB 595

Inboard 386 AT 859

8087-2 129 8087-1 189

80387-16 349 80287-10 229

80387-25 495 80387-20 399

80387-SX 339 80387-33 659

*Oversized Monitors, Laser Printers, Laptops and Plotters are excluded from free freight.

To Order Call 1-800-PC BRAND

(Call 1-800-722-7263) In All 50 States FAX# 1-800-722-7392 New Winter Extended Hours

PC Brand, Inc. 954 W. Washington St., Chicago, IL.60607 Int'l Fax# 312-226-6841 Int'l Voice# 312-226-5200. Open Mon thru Fri :8am to 8pm Central. Master Card, VISA, Discover, Checks, & Approved P.O.s Accepted. Prices and specifications subject to change. Customer Service Inquiries Call: 1-800-662-SERV BYTE 14-12

Circle 269 on Reader Service Card

DECEMBER 1989 • BYTE 347

S Systems for those who want to compute, not complain

S Systems 10 MHz XT

- Intel 8088-1 CPU
- Phoenix BIOS
- 640K on board
- TEAC 360K floppy drive
- Multi I/O w/1P, 1S, 1G, fdc, clock
- Enhanced 101 key keyboard
- XT style case
- 165W power supply

XT/10 Drives	Video Options			
	Mono	CGA	EGA	VGA
Single	650	775	1045	1115
Dual	675	855	1125	1195
20MB	900	1050	1275	1350
40MB	1050	1210	1450	1525

S Systems 286/12

- Intel 80286-12 CPU
- Ami or Phoenix BIOS
- 1MB RAM on board
- TEAC 1.44 3.5" floppy drive
- Hard/floppy drive controller
- Enhanced 101 key keyboard
- Baby AT style case
- 200W power supply
- Multi I/O card w/1P, 2S ports

AT 286-12 Drives	Video options		
	Mono	EGA	VGA
Single	855	1305	1375
20MB	1190	1640	1715
40MB	1345	1795	1865

S Systems 286/16

- Intel 80286-16 CPU
- Award BIOS
- 1MB RAM on board
- TEAC 1.44 floppy drive
- Hard/floppy drive controller
- Enhanced 101 key keyboard
- Baby AT style case
- 220W power supply
- 1P, 1S Port

AT 286-16 Drives	Video options		
	Mono	EGA	VGA
Single	1010	1455	1530
20MB	1345	1795	1865
40MB	1500	1950	2020
80MB	1765	2215	2285

S Systems 386-20

- Intel 80386-20 CPU
- Ami BIOS
- 1MB on board
- TEAC 1.44 & 1.2MB floppy drives
- Hard/floppy controller (1:1)
- Enhanced 101 key keyboard
- AT full style case
- 220W power supply
- 1P, 2S ports

AT 386-20 Drives	Video options		
	Mono	EGA	VGA
	1550	1995	2060
20MB	1665	2085	2150
40MB	2000	2400	2475
80MB	2225	2650	2715

Monochrome Monitors

Amdek V210A	\$85
Amdek V410A	150
NEC Multisync GS 2A	220
Samsung mono-12 flat	105
Samsung mono 14	105

Color/EGA Monitors

Amdek C732	\$445
Amdek C722	515
AST EGA	515
Mitsubishi 1410C	345
Mitsubishi 1430C	405
Samsung EGA 14	375

VGA/CAD Monitors

Mitsubishi 1381A	\$515
NEC Multisync 11A	505
NEC Multisync 3D	675
NEC Multisync 4D	1150
NEC Multisync 5D	2350
NEC Multisync plus	915
NEC Macsync	600
Sony 1302P	Call

Printers

NEC P2200	\$330
NEC P5200	525
NEC P5300	695
Okidata 320P	375
Okidata 321P	520
Okidata 390	520
Okidata 391	705
Okidata 393	1105
Okidata 393C	1185
Toshiba 301	315
Toshiba 311	380
Toshiba 341SL	650
Toshiba 351SX	985

Laser Printers

NEC LC 890	\$3405
Toshiba Pagelaser	2785
HP Laserjet 11/11D	Call
HP Laserjet 11P	1050

Plotters

HI DMP52	\$2495
HI DMP52MP	2945
HI DMP61	3245
HI DMP62	4000

Video Boards

Hercules Colorcard	\$155
Hercules Incolorcard	210
Hercules VGA	189
Paradise EGA-350	195
Paradise EGA-480	210
Paradise VGA-Plus	280
Paradise VGA-Plus-16	320
Paradise VGA-Prof	470
Quadram Quadega	250
Video 7 Vega Deluxe	225
Video 7 Vega VGA	300
Video 7 Fastwrite VGA	380
Video VRAM-VGA	475

Multifunction/Memory Boards

AST Rampage 2-256	\$290
AST Rampage-286	Call
AST Rampage Plus-286	420
Intel Above 286-Plus	435
Intel Above PS286 Plus	485

Accelerator Boards

Intel Inboard 386-PC	650
Intel Inboard 386	900

Floppy Drives

Toshiba 360K	\$70
Toshiba 1.2MB	85
Toshiba 720K	75
Toshiba 1.44MB	90
TEAC 360K	75
TEAC 1.2MB	90
TEAC 720K	80
TEAC 1.44MB	90

Hard Drives

Seagate 20MB	\$225
Seagate 40MB	410
Seagate 80MB	600
Plus Hardcard-20	535
Plus Hardcard-40	670
Plus Passport-20	415
Plus Passport-40	560

Tape Drives

Archive 5240	\$325
Archive 5540	345
Archive VP601	675
Mountain 4340	400

Math Co-processors

Intel 80287-8	\$225
Intel 80287-10	260
Intel 80387-16	415
Intel 80387-20	470
Intel 80387-25	590
Intel 80387SX	375
Intel 80c287	315

Software

Aldus Pagemaker	\$455
dBASEIV	450
Logitech catchword	135
Lotus 1-2-3 v. 3	310
Lotus Symphony	415
Microsoft Windows 286	70
Microsoft Windows 386	130
Microsoft Excell	285
Microsoft Word	215
Microsoft Works	105
Paradox 3.0	415
PFS First Publisher	70
Ventura Publisher	485
Word Perfect 5.0	220
Symantac Q&A 3.0	215

Mice

Logitech Serial Mouse	Call
Logitech Bus Mouse	Call
Microsoft Mice	Call

Modems

US Robotics 1200	Call
US Robotics 2400	Call
Okitel 1200B int	125
Okitel 2400B int	200
Okitel 2400B Plus int	285

Laptop Computers

Toshiba 1600-20	\$3375
Toshiba 1600-40	3775
Toshiba 3100E	2800
Toshiba 3200	3500
Toshiba 5100-40	4275
Toshiba 5100-100	4925
Toshiba 5200-40	5185
Toshiba 5200-100	5475
Zenith Supersport 286	Call
Zenith Minisport 1mb	1395
Zenith Minisport 2mb	1795
NEC Ultralite 1mb	2050
NEC Ultralite 2mb	2595
Toshiba 3200SX	Call
Sharp 4641	2195
Sharp 5541	3375

Scanners

HP Scanjet	Call
Logitech Scan Man	225
Niscan OCR	395

Surge Protectors

Curtis Diamond	Call
Curtis Emerald	Call
Curtis Ruby	Call
Kensington Masterpiece	100

Fax Machines

Sharp FO-220	\$750
Sharp FO-300	1025
Sharp FO-330	1075
Murata 1200	650
Murata 1600	875

To order call 1-800-837-3573

Fax # 708-495-2629; International please call 708-932-0102

ELS ENTERPRISES, LTD.

15 E. Madison, Lombard, IL 60148

Hours: Monday-Friday, 8am-6pm CST
Saturday 10am-4pm

- Lease Available
- Certified & Cashiers Check
- Wire-Transfer, Money Orders
- Personal & Co. checks allow 10 days to clear.

- No returns without RMA#
- 30 Day Return Policy
- No returns on Software
- Prices subject to change without notice.

CONFIGURING PARALLEL PROGRAMS

PART 1

The Occam Transpiler, now under development, will make writing software for parallel processing easier

Dick Pountain

Few people now dispute that parallel processing will ultimately be the way forward in designing faster computers. There is a limit to how fast you can make one CPU go, so to go faster means using more than one CPU. However, parallel processing is by no means a simple panacea.

For the first 40 years of computer history, programmers have been refining the art of writing sequential computer programs, and it's not always easy to see how such programs can be made to run on multiple processors; in other words, it's not easy to spot the inherent parallelism in problems. The philosophers' stone of parallel computing would be a completely automatic programming system that would let the programmer concentrate purely on the problem at hand and would hide all the details of how it is to be executed on a parallel machine.

Much of the current research into parallel-programming languages is directed toward helping the programmer to code problems in a parallel fashion without becoming bogged down in the details of how parallel processes (the concurrently executing parts of a parallel program) communicate with one another. New languages such as Occam, Linda, Parlog, and Strand offer widely different styles of parallel programming that assist the programmer in this way.

Spotting the parallelism inherent in a problem and coding it into a program is only a part of the solution. The parallel program then has to be fitted onto the group of parallel processors available for the job. This is known as *configuring* the program.

One way to tackle the configuration problem would be to build the ideally flexible parallel computer. It would have a huge (ideally infinite) number of processors, each connected to all the others by message channels of huge (ideally infinite) bandwidth. Topologists call this a "completely connected" network. Any program could be run on some part of such a beast.

However, even ruling out the infinities, such a computer is not practical. The total number of connections between the processors grows as the square of the number of processors, so for a machine with thousands of processors you would need mil-

lions of channels. The number of I/O ports on each processor grows linearly, but even a modest machine with 100 processors would need 100 I/O ports per chip; this is true of serial communication links, bus connections, and shared RAM ports.

For comparison, the INMOS transputer has just four serial links, while Thinking Machines' Connection Machine (possibly the most parallel machine made so far) has 64,000 processing nodes but only 12 links per processor, arranged as a 12-dimensional hypercube. The technology of VLSI sets limits to what is possible in this direction.

Another way to tackle, or rather to avoid, the configuration question is to go to the opposite extreme—namely, to fix the architecture of the parallel computer and completely integrate it with the software system. You design a parallel-programming language that assumes a particular layout of processors (e.g., a pipeline, a tree, a hypercube, or whatever) and then sell the compiler and its custom computer as a bundle.

Although this can work, it is unlikely to be acceptable as a general solution. No single parallel-computer architecture has emerged that is better than all the others, and there are convincing theoretical reasons to believe that no such architecture can exist. Each different topology is good for some classes of problems and bad for others—often so bad that it is worse than a conventional sequential computer solution. While you can certainly sell fixed-architecture solutions in specific problem areas, such as image processing or graphics rendering, such machines will not be general-purpose parallel computers.

So in the real world, you are likely to be faced with a finite network of processors and communications channels and with the ability to make only a few of the possible connections between pairs of processors. In these circumstances, you have to make decisions about how to map processes and messages onto processors and communication links. Often there will be more software processes than physical processors, and so you have to choose how many, and which, processes to run on each processor, and the same for messages and links. Choosing the best

continued

network of processors to execute a given program turns out to be an extension of writing the program itself. In this month's and next month's articles, I'll look at two different approaches to solving this problem, known to computer scientists as the *mapping problem*.

The Mapping Problem

Any parallel program can be thought of as being equivalent to a set of sequential programs executing at the same time and communicating with one another over abstract "channels," following Tony Hoare's famous Communicating Sequential Processes model (*Communications of the ACM*, 1978). The structure of a program considered in this abstract way is a network similar in kind, but not necessarily in detail, to the parallel-processor network on which it will be executed. The mapping problem then reduces to ensuring that neighboring processes communicating over a channel are mapped, as far as possible, onto neighboring processors that are directly connected—the goal being to minimize unnecessary communication.

Computer scientists describe these networks by means of *graphs*, which in this mathematical sense are diagrams composed of *nodes* (or *vertices*) connected by *edges* (or *arcs*). Both the parallel program and the processor network can be represented as graphs (see figure 1).

Graph theory is a well-developed branch of mathematics, and the mapping problem can be restated in terms of functions that operate on graphs: Find a function mapping one graph onto another that maximizes the number of edges in the first graph that coincide with edges in the second graph. If there are more vertices in the first graph than in the second, several vertices of the first graph will have to be mapped onto one vertex in the second graph; if there are fewer, then dummy vertices can be inserted in the first.

A formal mathematical treatment is beyond the scope of this article, but suffice it to say that stated in this form the problem becomes recognizable as equivalent to a well-known—and unsolved—problem in combinatorial math, the "graph isomorphism" problem. As with the related "Traveling Salesman" problem, all known algorithms for

C

hoosing the best network of processors to execute a program turns out to be an extension of writing the program itself.

solving it have the disagreeable property of requiring amounts of computing time that rise exponentially with the number of vertices, so that even for quite modest networks, an exact solution becomes impractical. It seems as if the philosophers' stone has been snatched away before we have even started.

Things are not quite so bad, however. Although exact algorithmic solutions are out of the question, there are approximate heuristic solutions that will give pretty good results in most cases. The system that is my subject this month uses such solutions to configure parallel programs written in Occam onto networks of INMOS transputers.

The Occam Transpiler

The Occam Transpiler is the result of a research project at the University of Berne in Switzerland by Daniel Meier and Andreas Wespi. I saw a prototype of the software working at this year's CeBit show in Hannover, Germany, on the stand of Concurrent Technology Systems (CTS), a firm set up by Meier and

Wespi. The name *Transpiler* is meant to suggest a combination of transputer and compiler, in just the same way that *transputer* was coined from *transistor* and *computer* (i.e., a computer that is also a component).

The Transpiler is a software system that takes a source program written in Occam and attempts to configure it to run as efficiently as possible on a network of transputers. The Transpiler system consists of five major modules, themselves parallel programs that execute on the target transputer network (see figure 2).

The first two modules are analyzers that discover the structure of the parallel Occam program and the transputer network, or, in mathematical terms, that extract the software and hardware graphs. The graphs are produced as ASCII text files that can be inspected and edited.

These two output files are then fed to the third module, the mapper module, which attempts to solve the mapping problem for this particular case. The module does this in two stages, first placing processes onto processors and then placing software channels onto hardware links. It can insert dummy processes

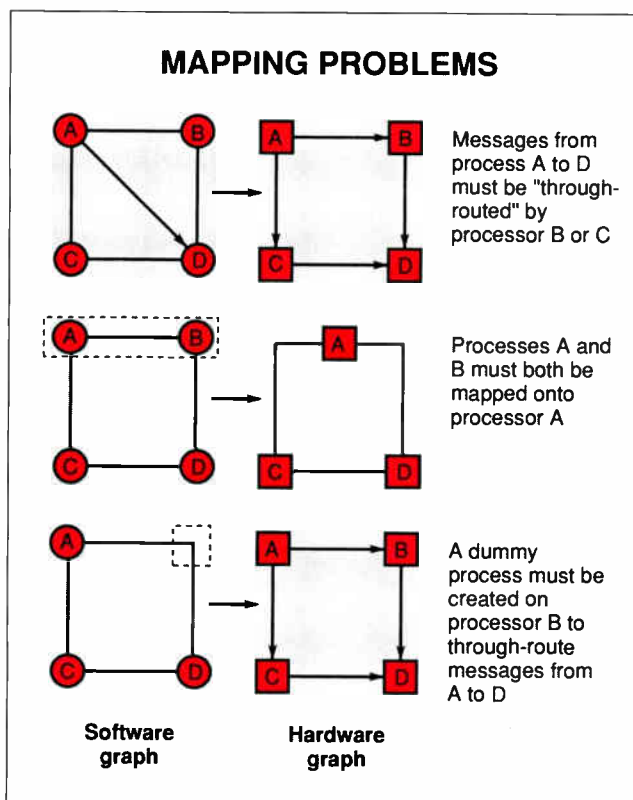

Figure 1: A parallel program and the processor network performing it can be represented as graphs made up of nodes (or vertices) connected by edges (or arcs). The object is to maximize the number of edges in the software graph that coincide with edges in the hardware graph. If there are more vertices in the software graph, several vertices will have to be mapped onto one in the hardware graph, dummy vertices can be inserted in the software graph (bottom).

and/or multiplex several channels onto a single link if the sizes of the networks do not match. The output from the mapper is then compiled by the fourth module.

In the prototype system I saw running at CeBit, the configurer output was a new Occam source program with all the correct PLACED PAR and link-to-channel assignments added to it. This was compiled with INMOS's TDS2 Occam compiler to produce an executable program; the Transpiler acted only as a preprocessor. Eventually, CTS hopes to produce its own transputer code generator so that the Transpiler will become a full compiler.

The fifth module is a performance analyzer that measures the loading of each processor in the network. Its output can be fed back to the mapper and then used to improve the solution of the mapping problem.

Hardware Analyzer

The hardware analyzer is a worm program of the kind now routinely used to explore transputer networks. It works by loading a small program segment onto the first transputer in the network. This segment then inspects all four of the transputer's links by trying to boot the transputer at the other end of it. If it succeeds, it transfers a copy of itself to the next processor, which then repeats the maneuver until the whole network has been covered.

Things are not quite this simple, since it is possible that the network contains circular paths. Like a virus, the worm has to test a key memory location to make sure a copy of itself is not already present at a particular node.

The worm reports the link connections and the amount of memory that each transputer has. Figure 3 gives a simple network and the worm program's output based on that network.

The worm also produces a graphical display of the net-

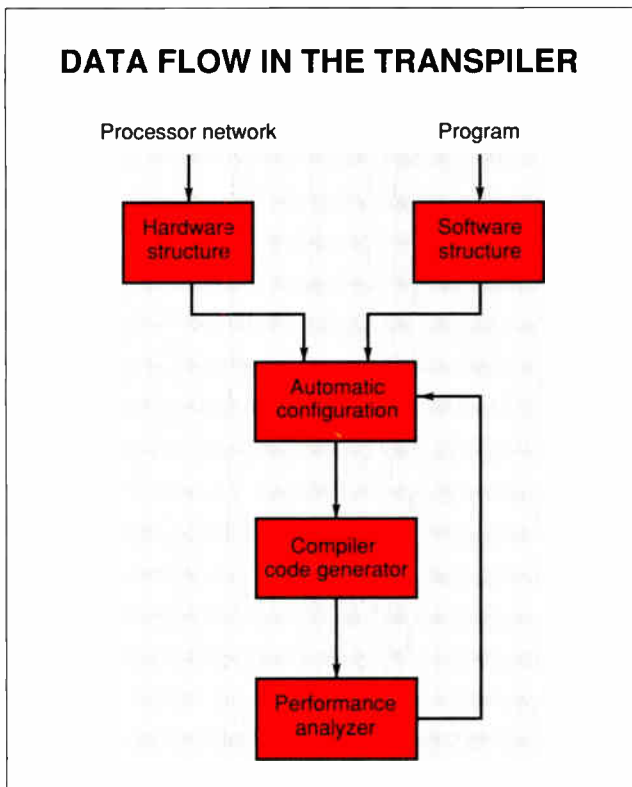

Figure 2: The Transpiler system consists of five major modules, which are themselves parallel programs and execute on the target transputer network.

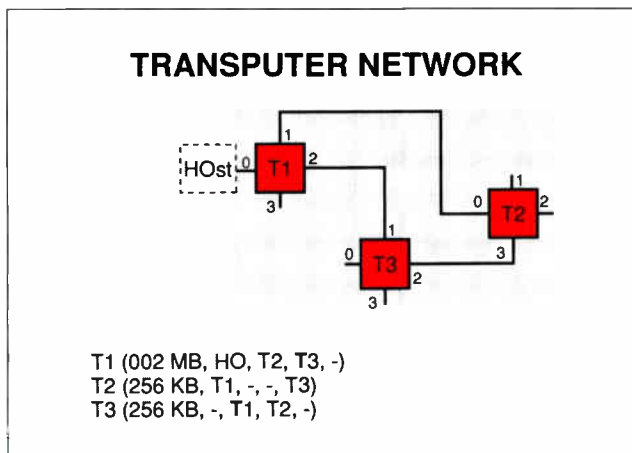

Figure 3: A graphical display of a simple network, produced by a worm program. The program starts with the first transputer in the network (T1) and tests for the presence of additional transputers at all four of the transputer's links (0, 1, 2, and 3). It then transfers a copy of itself over the next link that has a transputer attached (link 1, to T2), and repeats the maneuver until the whole network has been covered. Finally, it produces the graph on the host workstation's screen (HO). The result of this hardware exploration is represented as "Transputer number(memory, link0, link1, link2, link3)," as shown for each of the transputers. A dash indicates that no transputer is attached at that link.

work it has discovered on the host workstation's screen.

Precompiler

The software analyzer is an Occam precompiler that inspects your program in two passes. The first pass collects static information for each procedure in the program: the channels that it uses, with their direction and protocol; the workspace required; and the expected computation time. This last figure is not easy to determine; in general, it is as difficult as the mapping problem itself. CTS uses a simple rule-of-thumb measurement: workspace size \times code size. But this rule is subject to continuous improvement in successive versions.

True communication cost is difficult to determine, too, as it depends on the actual traffic on each channel at run time, and that is not currently measurable. Until it is, each channel has to be counted as a fixed communication overhead for the purposes of mapping.

The second pass identifies processes and their parameters (i.e., instances of calls to the procedures). From all this information a software graph is constructed, with a process at each node and single, undirected edges connecting the nodes; multiple channels between the same processes get reduced to one for the purposes of mapping. The information on channel direction and protocol is used only after the mapping stage, to generate legal Occam configuration statements.

Things are complicated by the fact that Occam allows processes to be built out of nested simpler processes, and it also supports precompiled units. For purely pragmatic reasons, the Transpiler treats a whole precompiled Occam unit as the smallest process that can be mapped, so it cannot split compiled code modules. This restriction allows the workspace requirement to be determined exactly.

continued

Mapper

The crux of the Transpiler idea is the mapper module, which actually does the work of adapting the software graph to the hardware graph. At Hannover, CTS showed three alternative mapping modules that are being evaluated, each of which uses a different strategy.

The simplest of these modules, called ADAPTER, uses a conventional graph-search algorithm. It generates a tree of all the possible mappings and measures for each the interprocessor communication cost and load balancing. The aim is to minimize communication cost and to distribute computing load as evenly as possible. As this is an exponential-time algorithm, the search tree may overflow memory for all but the smallest networks if allowed to grow freely. In ADAPTER, a tree-pruning strategy is used

to reduce the chances of overflow, but it means that the best solution may be missed. ADAPTER can only be used for small networks.

The other two modules, EVALCONFIG and MAPPER, both use variants of a probabilistic, evolutionary algorithm. Since they are conceptually similar, I'll just describe MAPPER, which is the focus of future developments.

Evolutionary algorithms are so called because they resemble the familiar Darwinian evolution of species by natural selection. Such an algorithm finds a valid but less than optimal solution to the problem using some naive strategy. Then it tries to improve this solution by making small random alterations to the parts ("mutations" in the analogy) and then checking to see whether the overall solution has become better or worse. Better solutions are kept and worse ones rejected ("survival of the fittest").

Algorithms like this have been applied to the simulation of thermodynamic systems, the annealing of metals, and neural network research. They can produce excellent, if not perfect, solutions in a short time. The fact that randomness is involved gives them the disconcerting property that they may arrive at a different (though close) solution each time they are run. For an evolutionary algorithm to work, it must be able to measure the fitness of each solution using a so-called "cost function." The Transpiler currently uses a cost function that incorporates both computational load balancing and (approximate) communication cost.

MAPPER is a parallel algorithm that runs on the target transputer network. A first solution is found by assigning processes randomly to processors and then letting each processor optimize its own local connections to its neighbors by applying the cost function. The overall mapping produced by this summing of local optimizations will not, in general, be very good.

The algorithm then moves toward a solution by swapping pairs of processes and measuring the effect of this swap on the fitness of the whole network; such an exchange may increase or

Listing 1: *The pseudocode for an evolutionary mapping algorithm. A program could stop before the best possible solution has been reached because it got stuck in an evolutionary dead end. In this event, the algorithm simulates an environmental catastrophe by randomly swapping a number of processes and taking another pass through the algorithm. If this further evolution does not produce any overall improvement, the algorithm terminates and returns the best mapping that it's found as the result.*

```

Create first mapping by any method;
best := first mapping;
finished := FALSE;
WHILE NOT finished
  REPEAT
    improved := FALSE;
    FOR EACH process in mapping
      Try pairwise swap with all other processes and measure
        resulting fitness
      Select swap that gives best fitness
      If fitness gained >= 0 then make this swap permanent
      If fitness gained > 0 then improved := TRUE
    ENDFOR
  UNTIL NOT improved;
  IF fitness of new mapping < fitness of best
  THEN finished := TRUE;
  ELSE best := new mapping
  Swap n random pairs of processes {Apply 'catastrophe'}
ENDIF
ENDWHILE
OUTPUT best

```

decrease the quality of the overall mapping. Only those swaps that increase the overall fitness are made permanent. When every possible pair of processes has been trial-swapped, the whole business is repeated until no further increase in fitness is obtained; this constitutes one pass through the main body of the algorithm.

Unfortunately, this swapping strategy does not always converge smoothly on the best solution; the fitness may have stopped improving because the best possible solution has been reached, but it might also have become stuck in an evolutionary dead end. To escape such false endings, the algorithm ingeniously simulates an environmental catastrophe—the evolutionary equivalent of a kick in the pants. This is done by simply swapping a random number of processes to give a new map-

ping, which is quite likely to be a step backward, and then letting another pass of evolution work on it. The algorithm terminates if this further evolution does not produce any overall improvement (see listing 1). The best mapping found is then returned as the result.

The Future

Much work still remains to be done on the Transpiler. At this writing, Daniel Meier told me that CTS has decided to delay its commercial launch in favor of another year of research at the University of Berne. The latest version of the MAPPER algorithm can map a program of 100 Occam processes onto an arbitrary network of 32 transputers in about 3 seconds.

One unresolved problem is how to make the worm program detect peripheral devices connected to a transputer network. But the most difficult work concerns improving the cost function, which means more accurately measuring computational load and communication traffic. The favored method is to measure these directly from a simulation of the program's execution running on a single transputer.

Another possible route is to build up libraries of standard program building blocks (e.g., math functions) whose execution costs can be measured in advance. In a similar way, topology libraries for various commonly used hardware configurations (e.g., hypercubes or tori) can be constructed to simplify the mapping process.

Projects such as the Occam Transpiler should ultimately lead to programming tools similar to today's optimizing C and FORTRAN compilers, in which all the hard work of analyzing, mapping, and simulation is hidden inside a black box that the user just sees as the compiler. After that, the philosophers' stone of parallel programming might be within reach. ■

Dick Pountain is a BYTE consulting editor, technical author, and software consultant living in London, England. You can contact him on BIX as "dickp."

THE WIZARDS OF THE MEDIA LAB

At MIT's Media Lab, researchers conjure up futuristic prototypes that could change the way we handle information

Janet J. Barron

In one room, red, yellow, and blue Legos busily build themselves into various shapes and structures, while a Lego robot makes tea. In another room, music emanates from a lump of clay. In yet another room, a minuscule area on a giant-size monitor contains gigabytes of information.

Such scenes—the stuff of science fiction movies—are everyday occurrences at the MIT Media Laboratory, a high-tech think tank dedicated to exploring new ways for humans to interact with every imaginable type of media.

In existence for five years now, the Media Lab was created by a nucleus of people under the direction of interface pioneers Jerome Weisner and Nicolas Negroponte, who saw the need for intensive research directed toward the interface between human beings and technology. Roughly 100 corporate and nonprofit agencies fund the Media Lab's research program, the primary goal of which is to generate innovative prototypes. These funds, grants, and endowments enable the lab to recruit top-notch researchers and give them the resources to tackle a variety of futuristic experimental projects.

Computers are a basic ingredient of this rarefied research atmosphere. If you could wander the halls of the Media Lab, you would see HP Bobcats (Motorola 68000-based workstations that do most of the Lab's heavy-duty

processing), Sun and Lisp machines, minicomputers, five mainframes, and a Connection Machine. By far the most prevalent machine these researchers use is the personal computer. In fact, the Media Lab averages over two of these per person.

As a working, dynamic research facility, the Media Lab's structure is in constant evolution. The lab is loosely organized into 12 functional groups, or *domains*. The domains most interesting to personal computer users include spatial imaging, advanced TV research, the visible language workshop, music and cognition, vision science, film and video, movies of the future, speech research, and the school of the future. Each domain is presided over by one or more nationally or internationally renowned figures.



Photo 1: This digitally modeled "Still Life" illustrates the use of reflection-mapping and texture-mapping techniques to produce striking three-dimensional images. (Photography: Plesniak/Klug, Spatial Imaging Group. All photos courtesy of the MIT Media Laboratory.)

Images and Imagination

The Media Lab's spatial imaging group works under the auspices of Stephen A. Benton, inventor of the rainbow hologram. Holograms can be produced in a variety of ways. The most familiar of these are laser-transmission holography, reflection holography, and rainbow or white-light-transmission rainbow holography. Rainbow holograms lend themselves easily to inexpensive mass production by surface relief embossing. Photo 1 shows a computer-produced hologram.

Most of the innovative holographic applications currently under exploration rely on holographic optics' unique

continued

ability to combine and simultaneously process information that is distributed across a plane or scattered throughout a volume. Consequently, according to Benton, holography will someday be used in applications in scanning technology; fiber-optic multiplexers and demultiplexers; data encryption, storage, and



Photo 2: With hardware rendering of three-dimensional shapes now practical, Media Lab researchers are conducting experiments with 3-D representation of programs. In this 3-D graphical debugger, the boxes represent program elements; they change size, position, and color as the program runs. (Photography: Lieberman, Visible Language Workshop)

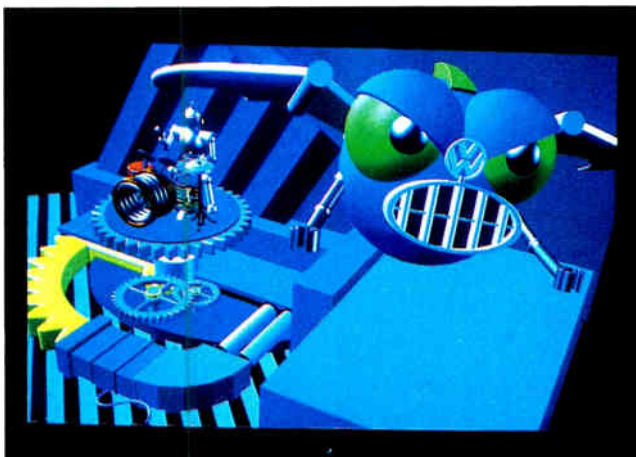

Photo 3: A scene from "Beat Dedication," award-winning animation created with a system that combines a key-frame animation system with a solids-modeling package. (Photography: Sabiston/Small, Visible Language Workshop)

processing in optical computing; pattern recognition; non-destructive testing; holographic movies and video; and three-dimensional laser photography. Some of these uses already exist in rudimentary forms, and all are being researched.

Some problems need to be overcome before we can adopt a medium with images in a fully three-dimensional form. These include developing a process to record true color, the ability to produce larger (1-meter-square) holograms, the advent of a commercial holographic laser printer, and the projection of large-scale moving three-dimensional images.

With the help of computers and video equipment with resolutions approaching 2000 by 2000 pixels, and increases in machine capacities and speed, Benton and his research group are gradually finding ways around these fundamental barriers. One result of Benton's work is the possibility of using personal computers to create holograms. Such a process, heretofore unthinkable, is now feasible thanks to current three-dimensional CAD software and powerful personal computers such as the Mac II. Essentially, there would be two phases of creating a hologram on a personal computer. Given the right kind of rendering software, you would build up a scene by creating objects and adding shading and reflections; you would then make 100 pictures of the scene as seen from side-by-side viewpoints and write all the information to a floppy disk.

In the second phase, you would send the data to a lab, which would optically combine your images on high-resolution film to produce the final hologram. At the moment, one of the logistical problems with this scenario is that, as yet, there are no commercial labs that will do this part of the process.

Talking with Pictures

The Visible Language Workshop, led by Muriel Cooper, researches the uses of graphics in all forms of communications, notably the area of electronic communication. In their research, members of the workshop use film, illustration, typography, images, and sound. Several challenges face the workshop's programmers and graphics designers as they explore design tasks that are amenable to machine modeling, including the need for real-time visualization techniques, rapid prototyping, and organizing materials. Photo 2 shows an example of their work, a three-dimensional graphical debugger, while photo 3 shows a scene from the award-winning animation "Beat Dedication," produced by the Workshop.

Patrick Purcell's work in this area is directed at the way knowledge-based design systems can enhance the design process, whether it involves graphics, architecture, living environments, and so on. Purcell is also involved in the development of electronic image libraries and the technology of image delivery systems. This technology is being created to make image collections easily available to the general personal computer user and those who want to integrate these graphics into electronic publishing environments. The project currently consists of approximately 200,000 images, but it will ultimately embrace the full MIT Rotch Visual Collection of well over 400,000 color and black-and-white images. Using a LAN to query the database and (currently) campus TV cable channels as a delivery system, users will be able to access these images on the same scale and with the same ease of access that people retrieve text today.

Moving Pictures

The Computer Graphics and Animation domain researches issues of dynamic movement of objects in a context of goal-directed animation. Among its current projects is Bolio, software that acts as an environment for developing models for computer

animation sequences. Bolio (derived from the name of an ice cream shop favored by the Lab's researchers) provides researchers with a large library of graphics routines and some standard interfaces for communicating with other embedded applications.

Among the animation and simulation techniques currently in use is an inverse kinematics system that handles the physics of animation (e.g., making balls bounce) as well as the way animated figures move. Here and elsewhere in the Media Lab, researchers use devices known as the DataGlove and DataSuit to plot human activity (see "Between Man and Machine," September 1988 BYTE).

Computer graphics have long been used in architecture, but the results of research by another leader of the group, David Zeltzer, could enhance this productivity tool. To check out specific systems, such as the heat load in various rooms, for instance, Zeltzer's system would allow architects or engineers to use simulated people walking around in a simulated building. Another application of graphical modeling would be simulating dynamic action, such as the movement of a skin transplant on a burn victim.

Future Television

Berndt Girod, a new member of the Media Lab, says, "We are proposing something for TV similar to what happened with personal computers. It's a standard backplane that different manufacturers can make various modules to plug into. Then, when a new standard comes along, you'll be able to plug another card into the backplane." Girod thinks that the adoption of such a "superstandard" will allow manufacturers to integrate the TV and the personal computer. He notes that there are already workstations that have pop-up windows with TV programs running in them.

According to Girod, we may soon be able to transmit digital movies and video with acceptable quality at 64,000 bps (through an enabling technology such as ISDN). We may even be able to integrate visual (face-to-face) communications in a new type of E-mail called *video mail* that will allow you to send and receive video messages on your computer screen. "ISDN is basically here, and one of the nice things we can do with it is transmit pictures," says Girod.

Work is under way on video telephony, the real-time transmission of a sender's image (as opposed to sending prerecorded images), says Girod. This will require improved compression techniques. "A simulation of videophone transmission compressed to 64,000 bps can display only 10 pictures a second, while film displays 24, and TV displays 30 pictures a second."

And for those who dread the thought of people on the receiving end of your computer being able to see you, say, early in the morning, Girod has an answer. He posits that in-progress work on three-dimensional modeling will result in the ability to build a three-dimensional model of a face of your choosing. Then you'll be able to transmit the image of a still face that you like and also animate that face to respond appropriately to the conversation on the transmitting end.

One of this group's long-term goals is to make real three-dimensional holographic TV possible (not just stereo with glasses, says Girod). Workstations will be the first places we'll see this kind of display, but again, problems in signal processing and data compression remain to be solved before the technology will be available.

Speech Research

Chris Schmandt, of the Lab's Speech Research domain, has at least one major research goal, and that is to figure out how

humans and computers can interact by voice, to "get a machine to do what a secretary can do." As Schmandt says, "A personal computer is my node"—his connection to the outside world. Part of this domain's research involves dealing with voice intonation, speaker intent, and natural language input.

Says Schmandt, "The concept that the voice will replace the keyboard is fallacious. The keyboard is a very effective input device. But using the voice to create documents is very difficult, and it's almost impossible to recognize unconstrained speech. In 10 years, if you can sit down and talk to your computer, you'll be lucky."

Currently, the speech research lab is building a program called the Backseat Driver that will run in your car and help you plan your route. Plans are to enhance the program with the addition of timely traffic information.

Film and Video

The Media Lab's film and video department is committed to technological advances in both the content and the medium itself. The department has been involved in bringing the advantages of random access to film via the use of the videodisk—that is, letting users access specific film scenes and information, just as they access data on their hard disks. Photo 4 shows a screen shot of the video storyboard system.

Historically, with a documentary, one person selectively decides what the viewers will see. Researcher Glorianna Davenport is developing an interactive magazine-type format that uses movies, text, graphics, photographs, sound, and video in a system that would allow viewers to orchestrate their own dynamic presentation of the information.

Davenport and Andy Lippmann, of the Lab's Movies of the Future domain, are researching ways to allow viewers to experience information from their particular point of view. Currently, different perspectives of a subject are being filmed and then digitized using an MIT-created video workstation—a hybrid with an IBM 5081 head, a DEC processor, and a parallax frame grabber digitizing at 30 frames per second.

continued



Photo 4: This video storyboarder runs real-time digital video on a Unix-based workstation running X Window. (Photography: Pepe/Sheldon, Film/Video Group)

In the near future, Davenport expects the technology to migrate to where it can be further developed and refined in a Mac environment. "Eventually, we want to be able to use personal computers to view, annotate, reconfigure, and distribute personalized information and entertainment material," she says.

Using specific distance information provided by a range camera and other esoteric equipment, a student of Lippmann's is working on a project to build a three-dimensional database of the objects in a scene. But until we understand how our eyes see, Lippmann says, he probably won't be able to perfect it. "If he does a good job, he graduates," the professor said, laughing.

Electronic Publishing

The Media Lab's Electronic Publishing domain covers a number of research areas that ultimately could change the way we transmit and receive electronic information. One of those areas is *narrowcasting*, the opposite of broadcasting. Narrowcasting could be defined as the production of dedicated electronic information and the communication of that data to only users who have specified it as their particular interest. For instance, the system could direct information having to do with marine biology to a scientist at Woods Hole SeaLab who has requested that subject as his specific interest.

Walter Bender, head of this project, notes that we currently use spreadsheets on personal computers so we can learn, analyze, and manipulate very primitive data types, such as alpha-numeric. But we are inventing new data types, such as images,

movies, and sound. To use current communications metaphors, we want to change the broadcasting of sound and images from analog-facsimile equivalent to digital-ASCII equivalent: With ASCII, you can manipulate information and perform syntactic and semantic analyses denied to you in the analog medium. Photo 5 shows a real image whose three-dimensional aspects have been captured so that the apparent light source of the scene can be changed.

Bender's group is working toward the day when your machine will be on an intellectual par with you and be able to relate to you as an equal. "Right now, it's just an appliance that you manipulate," Bender says. "But one day you'll use your personal computer as an agent, to play devil's advocate—argue with you for or against an issue. Instead of signal processing, we're really after semantic processing, where a machine will be doing stuff with you, instead of your doing stuff to it."

Bender also spends some of his multitasking time "people watching" and believes that computers should be able to do this, too. "Computers need to have a 'presence detector' to know whether or not you are there (at the computer) and paying attention," he says. "That knowledge is important. If you aren't, the computer won't flash important information at you, and it can go off and do maintenance until you turn your attention back to the machine."

Even more interesting would be the computer's ability to understand your facial expressions. "Ultimately," Bender

continued

Photo 5: This series shows computer-graphics manipulation of a real scene. Camera-sensing range information lets the artist change the real image in the photo at right to either of the photos below, in which the position of the light has been synthetically altered. (Photography: M. V. Bove)

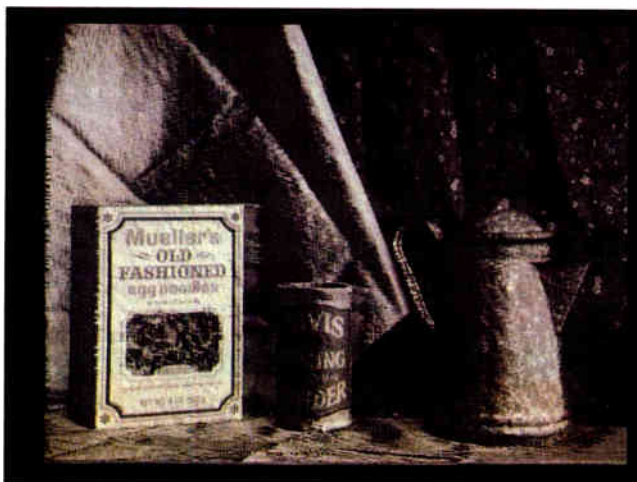

The Cool Machine Cometh



OKIDATA introduces a line of PC modems that run so cool they're guaranteed for 5 years.

Our new 1200, 2400 and 2400 *Plus* PC modems are built around a very simple fact: the cooler they run, the longer they last.

That's important in any modem, and it's vital in the case of an internal board. That's why we engineered a special chip that does the work of three ordinary chips. It also generates less heat—and consumes 50% less power—than the leading brand. Which is why we back our modems twice as long as they do.

But reliability on the inside comes as no surprise when the OKIDATA name is on the outside.

We have over a century of experience in telecommunications all over the world. And you'll see it in everything we make, from tank-tough printers to award-winning PC modems to a full line of high-speed modems.

To see our new "cool machines" in person, visit your OKIDATA dealer. Or call 1-800-OKIDATA for the name of the dealer nearest you.

OKIDATA[®]
an OKI AMERICA company

We put business on paper.

World Radio History

Circle 238 on Reader Service Card

PC DIGEST

... gave five stars to our 1200 bps modem and top-rated our 2400 bps modem.

PC WORLD

... gave our 2400 their coveted "Best Buy" title.

Registered Trademarks: OKIDATA, Oki America, Inc., Marque déposée de Oki America, Inc.

Trademarks: *PC Digest*, National Software Testing Laboratories, Inc.; *PC World*, PC World Communications, Inc.

In Simulation, Pictures...

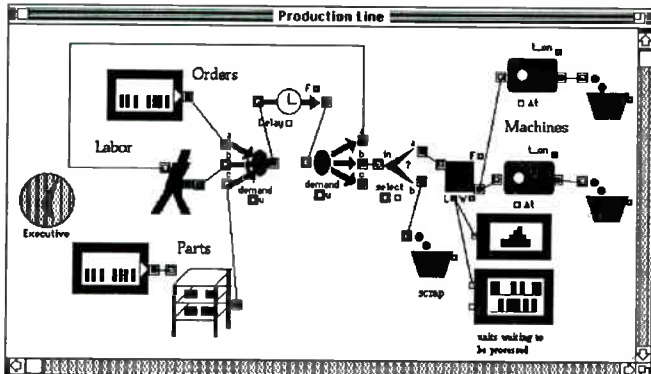

Extend model created using Manufacturing & Discrete Libraries

...Are Worth More!

Announcing 3 New Extend™ Libraries!

Manufacturing Discrete Event Generic (Business)

Use these libraries, or Extend's Engineering Library, for iconic modeling. For full power and flexibility, use Extend's built-in compiled programming language to develop your own libraries. Model the behavior of:

- Factory Production
- Cash Flow
- Signal Processing
- Neural Response
- Biological Systems
- Mechanical Design
- Electronic Systems
- Computer Networks
- Waiting Lines
- Material Handling
- Transportation
- Space Station Freedom
- Continuous, Discrete Event, and Monte Carlo

"Extend is a highly recommended powerful professional simulation modeling tool... it is among the most powerful of such tools, regardless of computational platform."

- David Sternlight, MacWEEK June 20, '89.

"...create some dazzling simulations without the pain normally associated with simulation programming. For my money, Extend lives up to its name."

- Don Crabb, Byte Dec '88.

Extend™

Professional Simulation For The Macintosh- \$495

Imagine That, Inc.

151 Bernal Road, Suite 5 • San Jose, CA 95119 USA
(408) 365-0305

Extend is a trademark of Imagine That, Inc.

The Vision Science domain is also researching new techniques of image data compression.

adds, "each computer will have built-in smile and frown detectors. But it's not clear yet what a smile is. Certainly, it's more than just a visual image—a smile is an emotional feeling, too." Conversely, Bender envisions a portion of your computer screen with a face that would frown at you if it doesn't understand what you want it to do.

Visions of the Future

In the Vision Science domain, one of the projects most likely to see results in the not-too-distant future is involved with computer vision. Computer vision—the adaptation of machine vision systems to personal computers—could have a tremendous impact on how we use our computers. However, this is a difficult area of research, according to Edward Adelson, who chairs this domain along with Sandy Pentland.

"We're coming up with chips appropriate for vision systems, and we already can do simple operations in parallel and do them fast," says Adelson. "Conceptually, and in the hardware world and signal and parallel processing world, we are making lots of progress. But we still have a long way to go."

The Vision Science domain is also researching new techniques of image data compression, such as methods to store gray-scale and color images in as little space as possible.

The Man-Machine Interface

The Human Interface domain is currently researching the interface between people and communications, and the actions that take place at that interface. Richard A. Bolt and his crew are focusing on speech, gesture, and eye contact and the combinations thereof.

According to Bolt, it would be more effective and easier if, instead of having to interface with our machines via a keyboard, mouse, or DataSui, we could use what he calls *subcarriers of communication*. These are actions such as shrugging, smiles, body language, winks, eye contact, gestures, and speech. "Interfaces such as eye tracking won't eliminate the keyboard and mouse," says Bolt. "They'll provide additional ways for you to interact with your computer."

One of Bolt's graduate students is developing a prototype called a *self-disclosing system*. The system, composed of a planet with volcanoes and staircases leading nowhere, is a three-dimensional world in a microcomputer. A host talks in synthesized speech about subjects that you tell it you are interested in, that it infers you are looking at, or that you point to on-screen.

"Most of us can't program in C or Lisp or use Unix, but we all use speech, gestures, and eye tracking," Bolt notes. "In five or 10 years, truly new flavors of dialogue and exchange may be possible."

The Sound of New Music

The combination Music and Cognition domain is directed by Marvin Minsky, Tod Machover, and Barry L. Vercoe. The

continued

PSpice

The Standard for Circuit Simulation



Mixed Analog/Digital Simulation

Available on Popular Computers, Including the New DECstation 3100

Whether your installation uses computers from Apollo, Apple, DEC, IBM, or Sun, PSpice can help your circuit designs. By maintaining consistent file formats across different platforms, PSpice insures that circuit designs, both old and new, can be simulated on all your computers.

In addition, we customize our graphics to get the best performance on each platform. Our drivers span the range from direct writing into refresh memory to higher level interfaces such as X-Windows. Since we use consistent file formats, that means that, for instance, a simulation done on a VAX 8800 can have its results viewed graphically on a Macintosh. Or, if you prefer, you can simulate on the Mac and do the viewing on the 8800.

Since its introduction over five years ago, MicroSim's PSpice has more copies sold than all other commercial SPICE programs combined. Here are some of the features which have made PSpice so popular:

- Standard parts libraries of over 2200 analog models: diodes, bipolar transistors, small-signal JFET's, power MOSFET's, opamps, voltage comparators, transformer cores, and opto-couplers.
- GaAs MESFET devices, BSIM MOS model.
- Non-linear transformers modeling saturation, hysteresis, and eddy current losses.
- Ideal switches for use with, for example, power supply and switched capacitor circuit designs.

These PSpice options are also available:

- **Digital Simulation**, which allows you to simulate mixed analog/digital circuits with feedback between the analog and digital sections. A library of 690 TTL devices is included.

- **Analog Behavioral Modeling**, which allows you to specify arbitrary transfer functions for devices, either by formula or look-up table. This can be done in both the time and frequency domains. In time domain the devices may be non-linear as well as linear.
- **Monte Carlo** analysis to calculate the effect of parameter tolerances on circuit performance. This includes statistical, sensitivity, and worst case analyses.
- **The Probe** "software oscilloscope" provides an interactive viewing environment for simulation results (see photo above).
- **The Parts** parameter extraction program, allowing you to extract a device's model parameters from data sheet information.

PSpice is available on these computers:

- The PC family (including the PS/2) running DOS, DOS with extended memory, or OS/2.
- The Macintosh II and SE30.
- The Sun 3, Sun 4, and SPARCstation families.
- The Apollo DN3000 and DN4000 workstations.
- The VAX/VMS family, including the MicroVAX.
- The DECstation family, running Ultrix.

Each copy of PSpice comes with our extensive product support. Our technical staff has over 100 years of experience in CAD/CAE and our software is supported by the engineers who wrote it. With PSpice, expert assistance is only a phone call away.

For our free information packet, including a PSpice demo diskette, call us **toll free** at (800) 826-8603 or, in California, (714) 770-3022. Find out for yourself why PSpice is the standard for circuit simulation.



MicroSim Corporation

Circle 208 on Reader Service Card (DEALERS: 209)

20 Fairbanks • Irvine, CA 92718 USA • Telex 265154 SPICE UR



Photo 6: A model of a factory assembly line, constructed from "intelligent" Lego elements controlled by an Apple-based Logo program.

internationally known Minsky (author of *The Society of the Mind*) plays a dual role in the Lab's activities. He not only pursues his own specific research in AI, he also pays attention to the field of music as an "epistemological opportunity to understand fundamental properties of the human cognitive system."

Minsky's goal is to make a machine that has common sense. "Someday you'll plug into your computer a big ROM that will know most things that most people know. For instance, it'll know that people get mad if you take their things away from them, or, if you paint something, it stays that color for a while.

"Some work has been done on common sense, but right now, computers can only do things that we can buy applications for. It's much harder for them to provide personal services than commercial services such as standardized widget work."

Tod Machover's goal is to analyze how our minds work when they create or process music and then to see how we can and do use these principles. He carries out this global undertaking in a number of ways.

"The personal computer is the brain of the whole concept," he says. "This kind of thing can't be done on mainframes because they aren't fast enough. For this kind of research, you need immediate feedback." When there aren't traditional ways of doing things, Machover invents new ones, often including new instruments. For a project that he undertook before coming to the Lab, he invented a new type of orchestra consisting entirely of personal computers. Actually, the musicians were people playing a new genre of instrument coupled to the computers.

Among Machover's inventions are *hyperinstruments*, which combine machine-augmented instrumental techniques, knowledge-based performance monitoring, and intelligent music-structure generation. He uses hyperinstruments to research what human performers do well, to study their reactions, to abstract and separate them from the sound, and to get them away from pressing one key with one result.

Machover uses a Mac II for much of his work. He has written one music system in which he coded the knowledge base in Common Lisp and now is working on formalizing the knowledge to continue to build the system. His goal is to have the computer, given a score and performer tolerances, be able to compose its own accompaniment, orchestrate it, and do the sound and color.

Machover's group is also studying what kind of gestures are best suited for what kind of music. With the use of the Data-

Glove, for example, they are working on modeling performers' and conductors' actual physical actions and movements.

"People are very used to fooling around with music on their personal computers," Machover says. "But many of them have hit a brick wall in what they can do. Programs soon will be available that, at the very least, will improvise and play along with you. And eventually, users will be able to see their music graphically and holographically—maybe in real time."

Learning with Logo and Legos

Seymour A. Papert, inventor of the Logo computer language, is director of the Learning Research Group. He spends much of his time researching how the computer can offer opportunities for children to acquire knowledge through informal, personal, experimental, and impromptu processes, as opposed to those routine, structured processes they use today.

One learning tool that Papert's group gave birth to is a phonetic dictionary that addresses the common complaint, "How do you look something up if you don't know how it's spelled?" Another and different approach to learning uses Lego building blocks invested with intelligence (via chips) in combination with the Logo language (see photo 6). Papert calls it the Lego/Logo project. With the Logo programming system, Lego building blocks, and an interface between the two, children can learn differently, in a self-initiated process of discovery that previously they would never have considered or thought possible.

The Media Lab's Crystal Ball

Nicholas Negroponte, the Media Lab's dynamic director, takes issue with people who predict that certain things are impossible for personal computers and technology to attain. "There will be a very fundamental change in what personal computers look like," he says. "Today, the PC is driven by the desktop metaphor, but that scenario will disappear and be replaced by a theatrical metaphor. Users literally will see on their screens little *expert agents* who will do things for them."

Negroponte also predicts that we will eventually see three-dimensional images in real time, and that low-cost graphics will explode in the next few years. "CAD/CAM 3-D will move to the desktop. There will be a major turnaround in speech recognition. People will move from direct manipulation of their machines to delegating them as agents.

"MIPS [million instructions per second] and storage have become inconsequential because gigabits per second are speeds that people just can't comprehend. (In 1 gigabit, you can get a year of the *Wall Street Journal* in 1 second.) Symbolic-encoded data will change the whole picture.

"Computers will be *responsive* and will go massively parallel. The relevant question is, how do you use massively parallel machines? As computer chips get a bit more intelligent and start communicating with each other, people won't have to be computer-literate. With the addition of speech and facial expressions, personal computers will offer a sensory-rich experience. Between now and the early 1990s, there will be speech; between the 1990s and the early 2000s, vision will come to our machines." ■

ACKNOWLEDGMENT

My thanks to Patrick Purcell, the Media Lab's director of communications, for the above-and-beyond help he provided for this article.

Janet J. Barron is a technical editor for BYTE. She can be reached on BIX as "neural."

Up to date. Down to earth.

Changing the world. UNIX is changing the world of computers, the world of business—quite simply, changing the world. It's revolutionizing office automation. It's required for U.S. government computer contracts. It's the backbone of information strategies worldwide.

The information you need. That's why you need *UNIXWORLD*—the magazine that keeps you up to date on the rapidly changing world of open systems computing. Each issue brings you the latest product trends and technical advances that can affect your business. The inside story on some of the world's

biggest high-tech companies. Easy-to-understand programming tips and tutorials that can help you and your company use UNIX to its fullest. And unbiased hardware and software reviews to help you invest wisely when you buy.

The whole UNIX-verse.

UNIXWORLD's in-depth features go beyond dry technical facts, to show how the pieces fit together—to tell you what's important about the advances and the strategies that are changing your world. And *UNIXWORLD* consistently offers the freshest, most down-to-earth writing you'll find in any computer publication.

Subscribe and Save. Subscribe today, and receive the next 12 issues of *UNIXWORLD* for just half the regular newsstand price. Save even more by ordering for two or three years. You can't lose—every subscription to *UNIXWORLD* comes with a no-risk guarantee.*

1 year \$18.00 (save 50%)
2 years \$32.00 (save 55%)
3 years \$42.00 (save 60%)

Subscribe now! Call toll-free:

1-800-341-1522

UNIXWORLD

If you're into UNIX, you need *UNIXWORLD* MAGAZINE.

UNIX is a registered trademark of AT&T. UNIXWORLD is not affiliated with AT&T.
The publisher's no-risk guarantee: If not satisfied, return unused issues for a full refund for the next 30 days of your subscription.
A New-Hill publication World Radio History

KAYPRO COMPUTERS

THE PRICE LEADERS:



**KAYPRO
KC-1**

\$625*

*Base System with Single Floppy Drive, No Video

8088/10 Disk Drive Options	Video Options (includes monitor & video adapter)		
	12-Inch Mono	Color Graphics CGA	EGA
Dual Floppies	845	1075	1345
20MB (40ms)	1100	1333	1600
30MB (40ms)	1125	1355	1625

Affordable computing power, ideal for small businesses or budget-conscious students, featuring Kaypro's rugged, reliable, reputable design.

Standard Features	KC-1	KC-2
CPU	8088 V-20	80286
Speed (MHz)	10	12
Standard RAM	640KB	640KB
Keyboard	101 Key	101 Key
Expansion Slots (16-Bit)	-	6
Expansion Slots (8-Bit)	8	2
Serial Ports	1	1
Parallel Ports	1	1
Device Bays	4	4
Power Supply	150W	150W
Operating System†	Free	Free
Warranty	1 Year	1 Year

Ask about Kaypro's full line of "Price Leaders", including the new KC-3, an 80386, 20 MHz microcomputer.



**KAYPRO
KC-2**

\$930*

*Base System with Single 1.2MB Floppy, No Video

80286/12 Disk Drive Options	Video Options (includes monitor & video adapter)		
	12-Inch Mono	Color Graphics CGA	EGA
20MB (40ms)	1405	1640	1905
40MB (28ms)	1680	1915	2180
70MB (28ms)	1990	2220	2490

THE PERFORMANCE LEADERS:



**KAYPRO
286/20
1MB RAM**

\$3145*

*Base System with Single 1.2MB Floppy, No Video

80286/20 Disk Drive Options	Video Options (includes monitor & video adapter)		
	12-Inch Mono	True .31 VGA	Dot Pitch VGA Plus
40MB (28ms)	4185	5090	5150
70MB (28ms)	4645	5550	5610
150MB (18ms)	6155	7060	7120

No-compromise computing for all those demanding business or scientific applications, featuring Kaypro's rugged, reliable, reputable design.

Standard Features	286/20	386/25
CPU	80286	80386
Speed (MHz)	20	25
Standard RAM	1MB	1MB
Keyboard	101 Key	101 Key
Expansion Slots (16-Bit)	6	4
Expansion Slots (8-Bit)	2	3
Serial Ports	1	1
Parallel Ports	1	1
Device Bays	6	6
Power Supply	200W	200W
Operating System†	Free	Free
Warranty	1 Year	1 Year

Ask about Kaypro's full line of "Performance Leaders", including the 386/33, a new 80386, 33 MHz microcomputer.



**KAYPRO
386/25
32KB CACHE
MEMORY**

\$4170*

*Base System with Single 1.2MB Floppy, No Video

80386/25 Disk Drive Options	Video Options (includes monitor & video adapter)		
	12-Inch Mono	True .31 VGA	Dot Pitch VGA Plus
40MB (28ms)	5205	6115	6175
70MB (28ms)	5665	6575	6635
150MB (18ms)	6995	7895	7955

30-Day Money-Back Guarantee

CALL TOLL-FREE

1-800-289-9899

FAX: 619-481-4369

Phone: 619-481-4302

Hours: Mon - Fri, 8:00 am - 4:30 pm PDT

Payment: MasterCard, Visa, or Cashier's Check preferred. Terms available on approved credit.

Shipping and Handling: Within USA, 3% minimum for UPS Ground. Call for shipping charges with alternate carriers.

Sales Tax: California residents, add 7%.

KAYPRO
COMPUTERS

533 Stevens Avenue
Solana Beach, CA 92075

Dealer & Corporate Inquiries Welcome

†Kaypro computers receive Digital Research DR-DOS 3.41, an MS-DOS-compatible operating system that runs up to 25% faster. Prices, terms, & specifications subject to change without notice.

Circle 173 on Reader Service Card (DEALERS: 174)

World Radio History

MAKING WAVES

Offspring of the personal computer and ham radio, packet radio has come into its own

Mark Waller

Fifteen years ago, the epitome of the electronics hobbyist was the amateur radio operator. Hams were the electronics innovators, the garage-shop inventors in the forefront of technology.

Then came the microprocessor, and kits that let low-budget tinkerers build their own computers. Suddenly, hams became hackers, and the measure of electronic innovation switched from megahertz to kilobytes.

From the very start, however, the radio and the computer have been natural allies. An article in the third issue of BYTE offers the opportunity to communicate information (of all kinds) on a much wider scale." (See "Computers and Amateur Radio" by Michael A. Gipe in the November 1975 BYTE.)

In the intervening years, as computers took over the technology scene, hams have remained hard at work with their soldering irons in their basements and garages. The result has been a marriage of technologies between the personal computer and the radio. The result: an application called "packet radio."

As the name implies, it's a digital system of transmitting information via ham radios (available only to licensed operators). But this simple concept, along with the ability to exchange data from one station to another, has led to a

global network of packet-radio stations. In fact, any packet station can command other packet stations to form a network for the transfer of information. And many networks can operate on the same frequency. So reliable is this new form of communication that American hams sent many packet stations (i.e., computer, transceiver, and packet modem) to their Russian counterparts after the devastating earthquake in Soviet Armenia.

Error-Free Communications

If you've ever listened to amateur radio "QSO" (or conversation), you may have noticed static, noise, and interference from other stations, as well as signals that fade out entirely. Packet-radio pioneers saw the computer as the ideal way to overcome these problems of radio communications.

Packet transmissions consist of small blocks of information called *frames*. There are three types of frames: information, supervisory, and unnumbered (see figure 1). Information frames contain the normal data that one station wants to communicate with another. A supervisory frame provides control of the communications link. Unnumbered frames allow data to be transmitted by one station when there is no destination station. In addition, these frames perform other control functions.

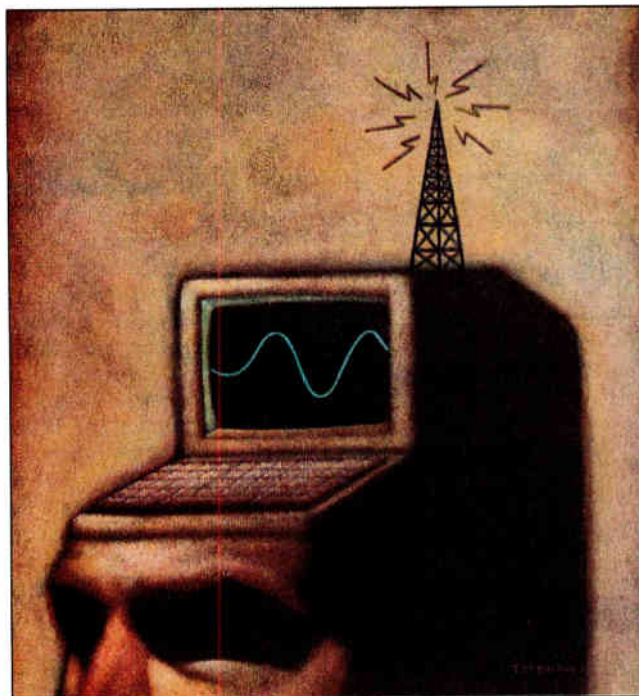

continued

A PACKET RADIO INFORMATION "FRAME"

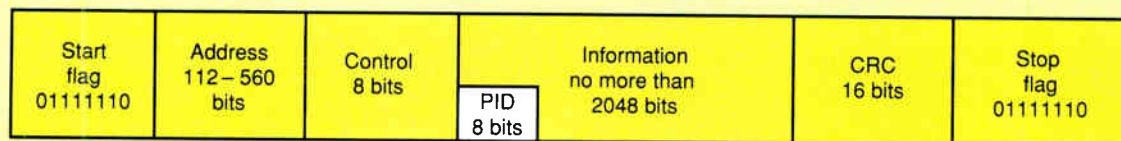

PID = Protocol identification

CRC = Cyclic redundancy check

Figure 1: Packet radios communicate using frames. Each frame is organized using the AX.25 protocol (a version of X.25 modified for amateur radio). Shown here is an information frame; supervisory and unnumbered frames are also used (see text).

A frame has a protocol of bits arranged as flags, control, and address information. Thus, frames can be sent and received in an orderly fashion, and the communication is complete, logical, and error-free. If the frame sent from one station collides with the frame of another station, or if anything occurs to interfere with the successful reception of the packet, the destination station automatically requests a retransmission and the frame is re-sent.

The Problem of Protocols

As with any new form of communication, packet radio underwent a struggle during the evolution of its universal format. A group of Canadian hams created the first successful packet network. It used start-stop ASCII with the Ethernet CSMA/CD protocol.

Nearly two years later, amateurs all over the U.S. entered

the packet world and started work on their own hardware and protocols. Setting up a protocol meant designing the terminal node controller, as well as the way it would communicate. A TNC is the device that actually interfaces between the computer and the radio (see figure 2).

In late 1981, the Tucson Amateur Packet Radio Corp. came into being and worked on the hardware, while another group, the Amateur Radio Research and Development Corp., worked on the protocol. What came out of all this diligence and cooperation was a microprocessor-based TNC using a resident EPROM that contained the instruction set.

Of course, there had to be a way to transmit this digital signal over the air waves. The packet-radio developers decided to shift the transmitting frequency when a 0 or 1 data bit was being transmitted. Soon, modems with either the Bell 202 or 103 standard could generate the proper digital radio signal.

THE MAJOR COMPONENTS OF A TNC

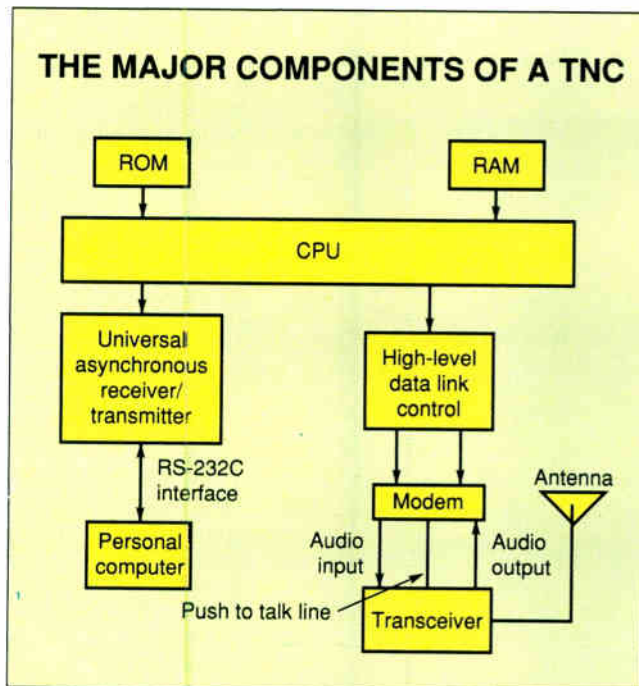

Figure 2: The terminal node controller (TNC) provides the function of interfacing the computer with the ham radio. It is a device that incorporates the packet modem.

The Packet Modem

All this experimentation led to a complete packaged product with a lot of features. Creators of the packet modem provided not only full TNC functions using the latest AX.25 version 2 protocol, but also variations of the original that interface to IBM PCs and many other microcomputers. In addition, many products exist that will decode various other digital formats, including fax and Morse code.

If you tune into specific frequencies where packet radio is active, you hear sudden bursts of oscillating tones—one is called the *mark* and one the *space*. The presence or absence of marks and spaces during the packet's short transmission encodes the synchronous bits of information.

Aside from the error-free exchange of data, the real beauty of packet radio is the marriage of the personal computer with the packet modem. You can obtain menu-driven software to control the packet modem and, by implication, the ham radio transceiver. In addition, it's also possible to transfer data on numerous "channels" at the same time. With available software, the operator can control all data transfer and identify which conversation is which as the information scrolls up the screen.

Many stations can share the same packet frequency, and all conversations can appear on the screen, but you can use commands to have the modem show only those packets relevant to the receiving or linked station. Packet stations can link one-on-one or in network fashion.

A packet station can also be used as a *digipeater*—that is, a digital repeater. Two stations can link to a third station to take

continued

The PERFECT LAN FRONT-END!

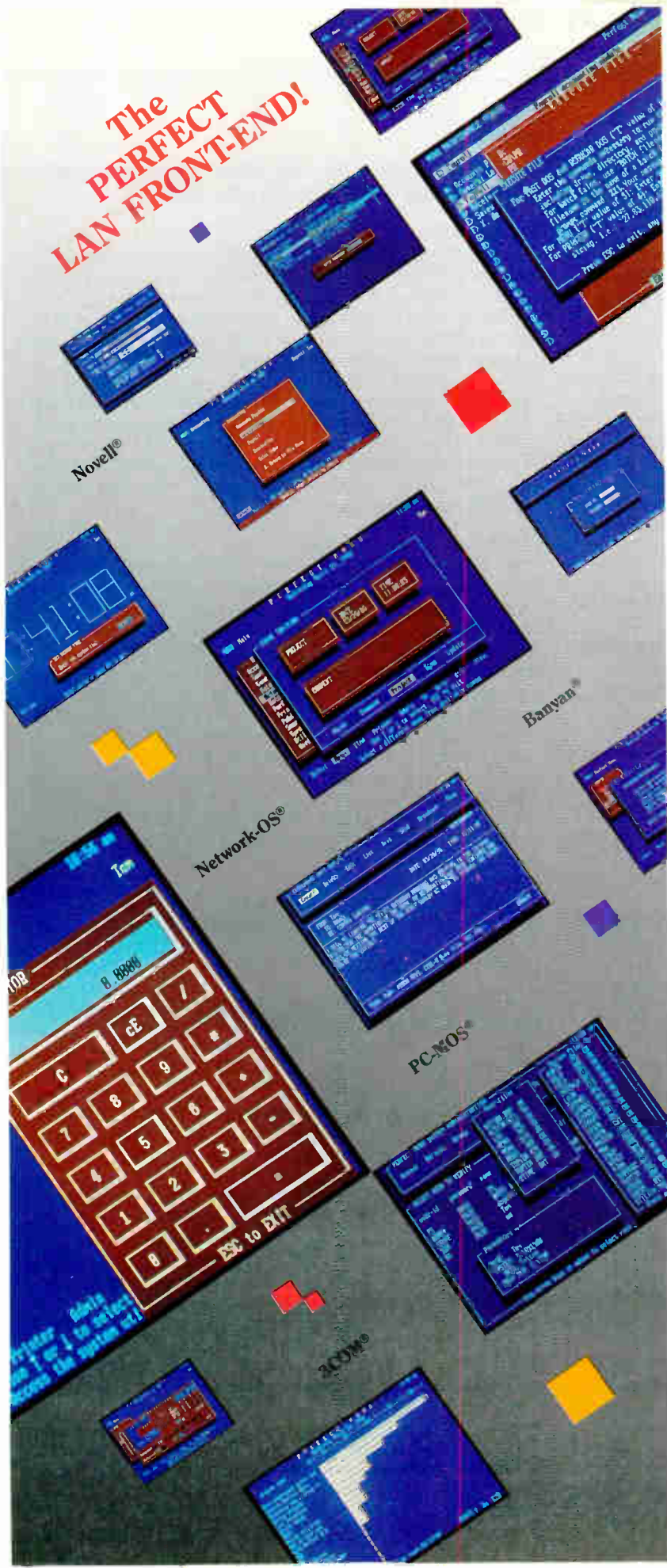

Meet Perfect Menu. The Perfect LAN Front-End.

(Complete with E-Mail!)

Menu Program, System Administrator, Electronic Mail System, Usage/Project Tracker, Security Watchdog, and much more, all in one program for your DOS LAN or stand-alone.

Perfect Menu is a total LAN Front-end solution—compatible with ALL DOS LANs (Novell, 3COM, PC-MOS, Network-OS, Banyan, you name it). For all its power, **Perfect Menu is completely Non-Memory Resident**, and self-installs across any network, to any local, redirected and virtual drive of any size.

Perfect Menu gives you access to 640 individual menu selections with over 10,000 command options for each user. Menus can even be nested up to 32 levels deep! Perfect Menu lets you create a Common Integrated User Interface—tailor it to your specifications and needs.

Perfect Menu gives you System Administrator sophistication, power and ease-of-use with features like advanced security control, innovative usage and project tracking, handy PIM tools and much more. Perfect Menu's autonomous System Administrator program sports more tools than we have room to explore. Suffice to say—it defines power and convenience.

And, if all of the above is not enough, Perfect Menu comes with a full feature E-mail system! You have to see Perfect Menu to believe it, check it out today!

PERFECT MENU Family

◆ LAN PAK/UNLIMITED Users Per File Server.

If you're looking for best value in network front-end, menu, E-mail, usage/project tracking, security and productivity software—then this is the perfect selection! Easy to setup, administer and use, yet completely customizable and extremely powerful and sophisticated. It's simply perfect.

Retail Price: \$349.95

◆ LAN PAK/FIVE User Network.

If you have a PC-based network or applications, then our five user version sets the standard for small networks! Not only is it easy-to-use, it's easy-to-administer and has all the power of its Unlimited Big Brother. Of course, if you have growth in mind, all versions are fully upgradeable.

Retail Price: \$195.95

◆ BUSINESS PAK/Stand-alone.

With our single user BUSINESS PAK, many users share one stand-alone computer. You can have all the power of the PERFECT MENU network versions as you administer productivity—not headaches!

Retail Price: \$84.95

◆ BASIC SYSTEM/Single User.

Want perfection at home? PERFECT MENU BASIC SYSTEM is as powerful as it is easy to use. At a \$49.95 suggested retail, it's one of the best values in its class.



International Computer Group, Inc.
18520 Office Park Drive
Gaithersburg, MD 20879
(800) 833-2324
(301) 670-7007 in MD, (301) 330-7274 fax

*Trademarks are registered per their respective manufacturers

Circle 163 on Reader Service Card

advantage of its strategic location. For instance, if one station wants to communicate with another but is out of radio range, a third station that both can "copy" can act as a repeater, thereby linking the two stations. This can be done without the digipeater station being in on the exchange of information. It is entirely consistent with the technology for an operator to find his station suddenly being used by two or more other stations to pass information.

Uses for Packet

The digipeater capability allows you to transfer messages over distances much greater than the original transmitting station can cover. Now, for the first time, this networking can take place automatically. As long as several local stations can communicate with one another, an effective LAN exists. Some stations are easier to receive than others because of antenna height variations, intervening mountains, and so forth. By construct-

Every kind of file
that can be transferred by telephone
can be downloaded or uploaded
via radio.

ing a well-placed repeater roughly in the center of all these stations, operators can substantially increase the reliability of the network communications. Even mobile and portable stations can become part of the network.

With packet, a central repeater is not usually necessary. Each station in the network can act as a repeater for any other station it can hear. Nor are networks just local. Today, networks exist that pass messages literally around the world. If you tune a shortwave receiver to around 14.1 MHz, you will hear global message transfers occurring at 300 bps.

Gateways to Other LANs

One or more stations in each LAN can operate as a gateway to other LANs. All that is needed for these special stations is a TNC that has two or more ports and a radio and antenna for each port. An amateur in Los Angeles, for instance, has a reliable communications path into the San Francisco Bay area as well as into Phoenix, and the network of gateways is constantly being expanded.

At frequencies such as 145 MHz, radio signals do not bounce off the ionosphere. They travel straight to the horizon until they bump into a building or mountain. Clearly, networks and gateways are a real advantage in large metropolitan areas. But how would a network user in a 145-MHz LAN pass messages around the world?

The answer is crossband gateways: Packet radio uses short waves that have frequencies with the ability to bounce off the ionosphere and land in distant parts of the globe. Thus, gateways operating simultaneously on VHF (very high frequency, line of sight) and HF (high frequency, shortwave) can pass messages from a LAN in Chicago to a LAN in New York. Nor does it stop there. Today's VHF packet is at 1200 bps, but many stations are experimenting at 9600 bps at frequencies in the

200-MHz and 400-MHz bands. The FCC has authorized experimental stations that operate totally unattended.

Bulletin Boards

Packet technology has blurred the lines between radio hobbyists and computer hobbyists. Software is now available to allow amateurs to run their own BBSes. Operators can use their radio, personal computer, and packet modem to check into numerous BBSes that function as mail centers, file storage and access points, and gateways and nodes in various networks.

When you tune in to one of the many packet frequencies, you may hear more than simple text files being transferred. Every kind of file that can be transferred by telephone can be downloaded or uploaded via radio. And what would be called a special-interest group on a conventional on-line service is handled by a wide array of personal BBSes where hams with specific interests congregate to share files.

Packet Radio—What Next?

The combination of inexpensive portable computers and tiny packet modems has created briefcase-size packet stations. The antenna, a 2-meter (145-MHz) quarter-wave whip, is about 18 inches long and can be fashioned from a coat hanger. The smaller modems (TNCs) are about the size of a pocket calculator. The advent of this technology means that, during a crisis, disaster personnel can set up full-scale communications on a moment's notice by installing packet stations and linking them with established networks virtually anywhere in the world.

Of course, hams have been doing this kind of thing for years. Sometimes they have been the only source of information from the scene to the outside world. Packet radio provides an extra dimension to this scheme. Now, packet-radio modems pass streams of data without waiting for a response, and the data arrives error-free.

Space and the Global Community

During the 1960s, hams designed and built their first communications satellite, called OSCAR (orbiting satellite carrying amateur radio). Its initial launch spawned a ham space program that continued to launch OSCARs.

The next project on the drawing board is PACSAT (packet satellite), a compact flying mailbox. PACSAT will upload messages when it flies by and then download when it is over the receiving station's location. At present, operators can communicate via JO-12 (JAMSAT-OSCAR-12), a satellite successfully launched by the Japanese amateur radio community. Dubbed "Fuji," this satellite has an on-board mailbox system that can store 50 messages in its approximately 192K bytes.

Future projects involve a German satellite, the Space Shuttle, and ongoing packet transmissions that use meteor scatter, the technique of bouncing radio signals off the ionized trails left by space debris as it enters the atmosphere. For the future, the implications of packet radio are awesome. Personal satellite communications will soon become reality. Tomorrow, an operator will be able to carry a small laptop computer/transceiver/packet modem and be in touch with friends around the world.

This kind of immediate, close contact throughout the international community could change our attitudes toward one another and bring the notion of a global community down to a level where all of us are full participants. ■

Mark Waller is a computer facilities consultant and the author of Computer Electrical Power Requirements and PC Power Protection (Howard W. Sams). He can be reached on BIX c/o "editors."

CAPTURE CREATE ANALYZE DIRECT

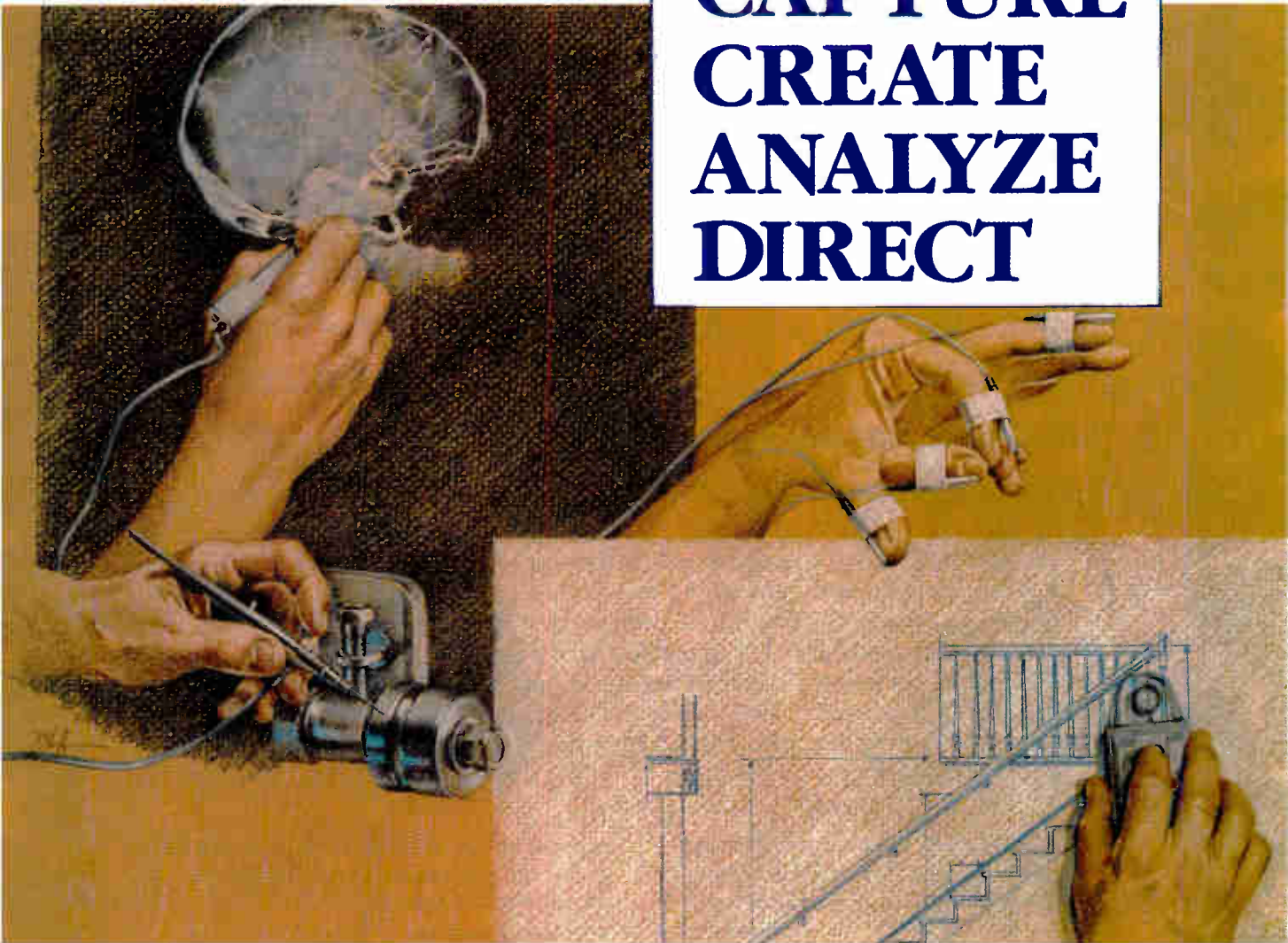

...with sonic digitizers

Capture...

input data from film transparencies, projections, hardcopy, 3-D objects and motion. From any surface in any orientation...with 2-D formats up to 60" x 72" and 3-D objects within a 9 foot cube. In data output formats to suit your specific needs.

Create...

a variety of graphic images. From the simplest of 2-D formats to the most complex 3-D animated images. Generate contour images and dimensions of solid objects. Creates animation databases for use in film production, robotics and a host of other applications.

Analyze...

input data from any source document, drawing, 3-D objects or forms in motion...to provide cost estimates from drawings...generate contour images of solid objects...real-time multipoint analysis of humans and objects in motion.

Direct...

robotics, CAM, CIM and a multitude of other automated and semi-automated systems and equipment. Capture and analyze the input data from its source, then format it to drive your system.

Circle 375 on Reader Service Card

Digitizing Today... With Tomorrow's Technology

In use today, around the world as integrated workstation components or add-on systems to computer devices. Serving business, construction, industrial and medical applications.

Call or write today to discuss your special requirements. We will customize to meet your specifications.

SAC® SCIENCE
ACCESSORIES
CORPORATION

200 Watson Boulevard P.O. Box 587
Stratford, CT 06497
(203) 386-9978 FAX (203) 381-9270 Telex 964300

BIX CALENDAR

DECEMBER

D E C E

Display this month's
BIX activities

R

“On Dasher, on Dancer, on Prancer and BIXen.”

Special Events

THURSDAY, 12/7, 8:30–9:30 PM EST. The case for Ada in CASE.

Does Ada—which was designed to facilitate software engineering—fit in with the latest ideas in CASE? What CASE tools are available for Ada? Hear Randy Brukardt and Dan Stock of R.R. Software answer these questions in their continuing discussion of the Ada language. (join [janus.ada/cbix](#))

SUNDAY, 12/31 and MONDAY 1/1. Send New Year's greetings to your friends.

Once again, this New Year's Eve you'll be able to hoist the electronic glass and bid “Happy New Year” to all your friends on BIX around the globe. And you can do so in two ways: In a special conference called “welcome.90” you can leave permanent messages for people to see as the night progresses. On CBix, our real-time chat system, you can greet and “talk” with other BIXen. But now, let all of us at BIX wish you a happy and prosperous 1990.

All-Month Conferences and Special Events

soft. eng conference—How does software engineering for real-time systems differ from traditional software engineering development? What real-time software engineering techniques are adaptable to other types of development? All month, you can discuss these and other questions with experts, in our soft. eng conference. These experts are Dave Franklin, computer science professor at Southern College of Technology and chairman of the IEEE P1073 (Medical Information Bus) Standards Committee; Dana Hudes, a software engineer at Aerospace Avionics and specialist in embedded real-time software; Bob Harbort, associate professor and chairman of the Computer Science department at Southern Tech; and Ron Schroeder, also a computer science professor at Southern Tech and an industry consultant in real-time systems. (join [soft.eng/real.time](#))

IBM Exchange—Every weeknight this month at 10 PM EST, IBM Exchange CBix sessions will address such issues as Borland vs. Microsoft (which of these companies will win our affection in 1990—or will it be someone else?) MIDI on IBM Computers; OS/2 Programming; Assembler Programming. Watch [ibm.exchange/info.cbix](#) for the names of special guests, their topics and discussion dates.

Macintosh Exchange—The Mac Exchange will be filled with video and sound this month, as a special guest from LightSource, Inc., joins us for an open discussion of the latest

advances in real-time video processing and storage. We'll also be offering gift suggestions to last-minute shoppers for the other Macaholics in their life.

Let The Games Continue—Here's the Interactive Games Exchange schedule for December. Watch for specials, as well: *Sundays, 9PM EST*—Poetry, art, music and stories from by-gone days to yet-to-come days are featured in this conference. (join [fun.n.games/game.room](#))

Sundays, 9:30 PM EST—Learn about role-playing games on line and off line at Fantasy Foundation College. (join [ff/ff.col](#))

Mondays, Thursdays, and Saturdays, 9 PM–Midnight EST—Check into the Meade & Mirth Inn and enjoy free-form, role-playing games that take you back to the Middle Ages—and sometimes far into the future. (join [mnm/inn](#))

Tuesdays, Wednesdays and Saturdays, 9:30 PM EST—Enjoy real-time fantasy role-playing games as well as message-based player interaction in Ledinworld, the *Advanced Dungeons & Dragons* center of the IGX. (join [lworld/ledinworld](#))

Thursdays, 10:15 PM EST—Break in on Pandemonium, the contemporary parlor games and other social activities in the “game.room.” (join [fun.n.games/game.room](#))

Fridays, 9 PM EST—Begin your T.G.I.F. nights in the pursuit of trivia. (join [fun.n.games/game.room](#))

Fridays, 9:30 PM EST—Play a role in a variety of role-playing games. (join [encounters/new.worlds](#))

Finally. An on-line service that doesn't nickel and dime you.

It's BIX's flat-fee service.

BIX is short for BYTE Information Exchange. The on-line information service that's yours for an unheard-of flat fee of just \$39 for three months*—an amount you could easily waste in just two to four hours with an hourly rate, on-line service. (Not to mention the fact that you'd be nickel-and-dimed for its monthly minimums.)

And here's another distinction: BIX is strictly for microcomputer pros; it contains no "fluff." As a subscriber, here's what you've got coming to you:

- All the information and ideas exchanged in more than 150 microcomputer-related conferences—a give-and-take in which you can participate.

- Microbytes Daily*—up-to-the-minute industry news and new product information.
- Plus support from hardware vendors and software publishers, access to extensive software libraries, and the use of our electronic mail service—which allows *binary attachments*.

Subscribe to BIX right now— using your computer and modem.

Set your telecommunications program for full duplex, 8 bits, no parity, 1 stop bit, or 7 bits, even parity, 1 stop bit. Now dial BIX at 617-861-9767, hit the return key, and respond as follows:

Prompt:	You Enter
login (enter "bix"):	bix
Name?	bix.flatfee

You can charge your BIX subscription to major credit cards, or have it billed to your company. You may also purchase unlimited off-peak access via Tymnet for just

\$20 per month, or \$3 per off-peak hour, in the continental US.* For more information, including your local Tymnet access number, call 800-227-2983 (in New Hampshire and outside the United States, call 603-924-7681).

**Based on a \$156 annual fee, billed quarterly — a subscription you may cancel at any time without future charges. You may also subscribe for a 3-month trial at just \$59.*

***For international rates, please consult your local PTT. Our international packet network address is 310690157800.*

No extra charge for 2400 Baud access. Tymnet prices are subject to change.

BIX

One Phoenix Mill Lane
Peterborough, NH 03458
800-227-2983. In NH 603-924-7681.

Large format plotters for designers who want performance, but can't afford expensive.

Best Price Performance

These days more companies are concerned about CAD budgets but don't want to sacrifice quality or performance. That's why more design professionals are turning to Zericon for large format plotting solutions. At 21 diagonal inches per second and advanced speed up features like look ahead vector analysis, you'll fly through curves as well as straight lines. When you buy a Zericon plotter, you get the best throughput for your dollar in the industry today.

\$1695. - \$2995. Factory Direct Pricing

Starting at \$1695. for our ValueLine D size, to \$2995. for our Designer Series A-E model, we make a large format plotter that's just right for your application.

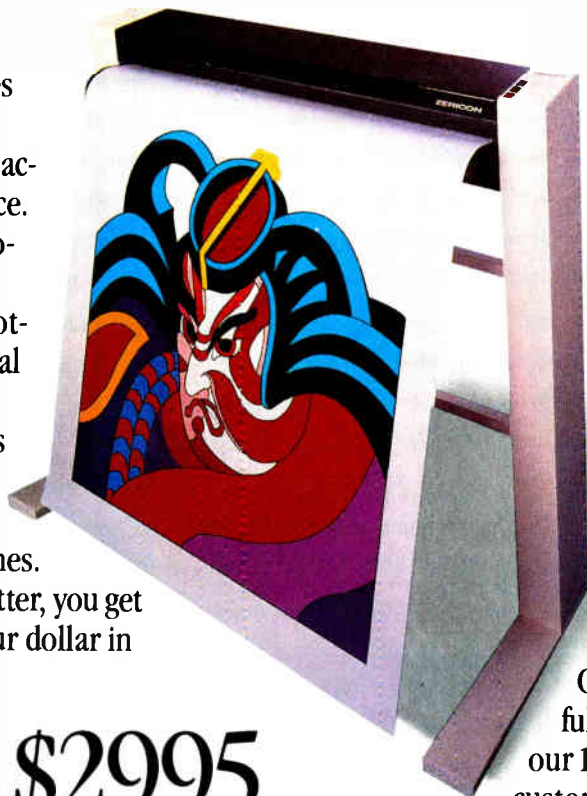

FEATURES	3610	3620	Z3000	Z4000
MEDIA	C/D	C/D	A-D	A-E
PRICE	1695.	1895.	2695.	2995.
8 PEN OPTION			395.	395.
DIA/SPEED	7ips	15ips	21ips	21ips
REPEATABILITY	.004	.004	.004	.004
LCD MENU			X	X
CUSTOM CABLE	X	X	X	X

No Risk Money Back Guarantee

Call Us Today and we'll send you a full-size sample plot and tell you about our 1 year reliability warranty and our customer support program which includes complete product satisfaction or your money back within 10 days of purchase. We'd like to win you over as a Zericon customer. And we've got the products and service to do it. Give us a call. Zericon,

Inc., 40491 Encyclopedia
Circle, Fremont,
CA 94538.

In CA (415) 490-8380.
FAX (415) 490-3906.



(800) 727-8380

Japanese Warrior created on the Zericon Z4000 A-E

ZERICON

More plotter. Not more money.

Made in USA

Circle 378 on Reader Service Card
World Radio History

ELECTRONIC OXFORD

A five-year computerization effort transforms a massive classic—the Oxford English Dictionary—into an on-line speedster

Eric Giguere

The dynamism and adaptability of the English language are evident to anyone who has sat down with a dictionary for an hour of leisurely browsing. As the language evolves, some words fall into disuse, others gain new meanings, and new words are developed to fill the gaps brought about by technological and social change.

Dictionaries are the instruments by which these changes in language are recorded. But dictionaries are out of date as soon as they are published. Computerization offers at least a partial solution to this problem, and few projects have been as ambitious in this regard as the computerization of the *Oxford English Dictionary* (OED).

The Dictionary

The OED is the most comprehensive record of the English language available. As a historical dictionary, the OED's principal goal is to trace both the origins and the subsequent development of English words. Word meanings in the OED are illustrated with extensive quotations drawn from printed sources.

The OED first appeared in installments starting in 1884, and it was finally published in its familiar 12-volume format in 1933. Four volumes of supplementary word definitions, known as the *Supplement*, were added between 1972 and 1986. The 16 volumes contain

almost 306,000 main entries and 156,000 subentries.

In 1984, the Oxford University Press (OUP), publisher of the OED, made the decision to computerize the dictionary. Its reasoning was threefold. First, there was the obvious need to integrate the 12 original volumes with the four of the *Supplement*. Second, computerization would allow for efficient and consistent updating of the dictionary in preparation for the release of future editions. Third, OUP also foresaw markets for electronic versions of the dictionary.

The computerization had three stages. First, the entire text of all 16 volumes was transferred to electronic form by International Computaprint in Fort Washington, Pennsylvania; this took more than a year. Then the Centre for the New Oxford English Dictionary at the University of Waterloo in Ontario, Canada, transformed the data into a structured database format and created a set of software tools to manipulate the database. The final phase was integrating the OED with the *Supplement*, a joint effort between OUP and IBM in the U.K.

The integration was finished in late 1988, and a revised edition of the OED was launched in March of this year. The final result is officially known as the second edition of the *Oxford English Dictionary*, a 20-volume set

continued



BYTE in the Oxford English Dictionary

Dictionary browsing gains a whole new meaning when applied to the on-line version of the *Oxford English Dictionary*. Since Pat, the software that was used to search the dictionary, can search text and tags, pulling a list of quotations attributed to a specific person or publication is a matter of a line or

two of queries and less than a second of search time.

Frank Tompa (one of the directors of the Centre for the New Oxford English Dictionary) and I decided to search for all the entries in the second edition of the OED that included quotations from BYTE. There are 19 such entries: ALU,

assembly, backslash, blind, boot, bulletin, CD-ROM, clone, ego, emulator, enable, hacker, lap, log, personal, transportable, user, warm, and, finally, WYSIWYG (see the figure).

Some of these entries are more obvious than others. The entry for *blind* is in an interview article with Dr. James H. Wilkinson, on the building of a computer designed by Alan Turing (February 1985 BYTE, page 190). The phrase that the word is used in is a colloquialism: "You can swear blind..." In a programming maintenance article, there is a reference to "egoless programming" (May 1984, page 420). *Enable* is used simply to demonstrate the phrase "enable the 80-column screen" (July 1986, page 270), and the entry for *user* is a reference in an article on the Lisa computer system to demonstrate the compound word "user interface" (February 1983, page 36).

As might be expected, BYTE is credited in several cases with having the first known published use of a word or phrase. A caption of a listing in an article discussing structured programming in BASIC uses the word *backslash*. "Arguments enclosed in backslashes refer to disk-file operations" (January 1982, page 413). In addition, OED credits BYTE with the first use of *WYSIWYG*—for "what you see is what you get" (April 1982, page 264). BYTE is also referenced as the first user of the word *personal* in the sense of "personal computer" (May 1976, page 90).

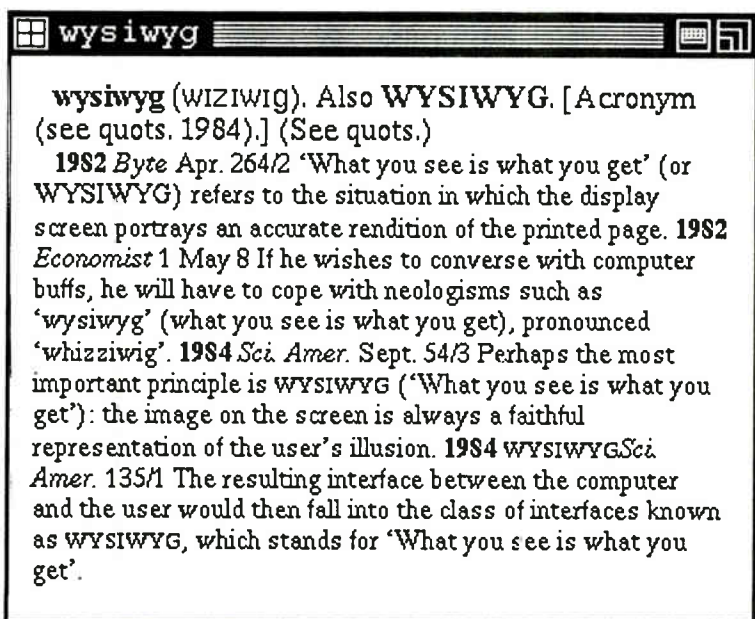

Generated by Lector, the University of Waterloo's display program using X Window, this reference to WYSIWYG is a sample of the dictionary entries produced in the traditional OED format.

that includes the data of the original 16 volumes and about 5000 new or revised entries.

The Centre for the New OED

The computerization of the OED involved more than converting the text into machine-readable form. The dictionary data had to be structured and stored in a database format suitable for the various tasks to be performed, including data integration, consistency checking, entry updating, and general searching. OUP relied heavily on the University of Waterloo for both the technical and theoretical support in this phase of the project.

The Centre for the New Oxford English Dictionary was established in 1985 and is jointly headed by Dr. Frank Tompa and Dr. Gaston Gonnet. They and the other researchers at the Centre developed the theoretical framework for the computerized OED, including several new methods for modeling and searching text data. These theories were then used to create the various software tools needed for the project.

The Centre has taken care to ensure that the software and theories developed for the project are not OED-specific but can be applied to a wide variety of text-dominated databases. (The

university owns all rights to the software developed by the Centre; OUP owns the rights to the OED data.) Software is written portably in C, using the X Window System whenever complex display capabilities are needed. The Centre also supports and encourages interdisciplinary research related to the OED and text-dominated databases within the academic community.

Searching the Dictionary

The OED contains close to 540 megabytes of text and tagging information. Tags describe the structure of the dictionary—entries, subentries, etymologies, quotations, and so on—and are patterned after the International Standards Organization's Standard Generalized Markup Language (SGML) tagging style. The tags can be treated as text in certain contexts.

The Centre for the new Oxford English Dictionary developed several software tools to manipulate and search this data. The primary search tool is known as Pat, so named because it uses *Patricia trees*. Pat searches a prebuilt index implemented using Patricia trees and is considered by the Centre's researchers to be one of the fastest search engines available. A price is paid for

continued

New Dauphin LapPRO-386SX Packs a Powerful Punch for the Price

Dauphin Technology, an aggressive new Midwest-based laptop manufacturer, has come up with a high-performance 386SX-based laptop that offers 386 power at a 286 price. The price alone will turn a lot of heads. But a closer look at the machine itself reveals first-rate engineering, exceptional performance, and loads of standard features that would cost extra on most computers.

With a list price of \$4,995 and an introductory price of only \$3,695, Dauphin Technology has strategically positioned itself to compete head on with rival 286 models in the same price range. Since 386SX technology provides both present and future applications, the choice between a 286 and a 386SX of comparable cost will be an obvious one for many. Users opting for the LapPRO-386SX will have a laptop with more power, speed, memory and versatility along with the technology to serve them through the next decade and beyond.

Among its many prominent features is a 40 M-byte, 28 millisecond hard drive and 2 M-bytes RAM. Its ability to facilitate DOS, multitasking and multiuser functions, plus all the new 32-bit 80386 software makes it a necessity for anyone who requires the power of a high-end desktop model while away from the office.

Last Fall, Dauphin introduced its first laptop model based on an 80286 microprocessor. Though a late-comer to the market, the LapPRO-286 earned considerable praise for combining the most advanced features with quality engineering and price performance.

Both models from Dauphin Tech offer a 40 M-byte, 28 millisecond hard drive, a 3.5" floppy drive, two serial ports, one parallel port, a high contrast blue on white CGA/EGA LCD, an internal power supply offering four power options including battery pack, and a dedicated numeric keypad. Options include a 2400 or 4800 BAUD internal modem, math co-processor, 100 M-byte hard disk drive, and external floppy drive and keyboard ports.

The LapPRO-386SX sports a processor speed of 16 and 8 Mhz with zero wait states. It offers 2 M-bytes of Ram on board expandable to 4 M-bytes. Its



Dauphin Technology has priced its 80386SX laptop to compete head-on with rival 286-based models.

Features include:

- 80386SX Processor, 8 & 16 Mhz, Zero Wait States
- Multitasking Capabilities
- Multiuser Access
- 32-bit Software Compatibility
- 40 M-byte, 28 Millisecond Hard Drive
- 3.5" Floppy Drive
- 2 M-bytes RAM, Expandable to 4 M-bytes
- Internal Modem Option

external monitor port supports CGA, EGA and VGA.

The LapPRO-286 provides 1 M-byte RAM which is expandable to 4 M-bytes and an 80286 processor running at 8 or 12 Mhz with zero wait states.

Both models offer the highly acclaimed Digital Research Operating System (a.k.a. DR DOS) which is similar to and compatible with MS DOS. The more distinguishing advantages of DR DOS include on-line help, system utilities such as file retrieval, special security features and an ability to embed software in ROM. Alphaworks integrated software and LapLink file transfer software are also included with each laptop.

Judging by its first two laptop offerings, Dauphin Technology could very well be on its way to becoming a major player in the hardware arena. Though Dauphin Technology is relatively new to the computer industry, Alan Yong, founder, is not. In 1981, Yong incorporated Manufacturing and Maintenance Systems which is now recognized as the leading manufacturer and distributor of industrial alignment systems worldwide. The MMS REACT Alignment Systems, used to align rotating equipment in manufacturing plants, employ a proprietary portable computer and software for alignment calculations and maintenance records.

Given Yong's prior experience in portable computer development, the shift toward developing laptops seemed like a natural move. Yong is determined to build another successful company and his determination shows in the design configurations of these first offerings, a promising start.

Distribution channels for Dauphin Tech products are indeed far reaching and ambitious and include dealers, VARs, OEMs (for private label distribution), along with corporate, educational and government sales. The private label arrangement offered by Dauphin represents an ideal opportunity for OEMs to get into the fast-moving laptop market quickly. And the discounts on corporate quantity purchases are so generous that corporate managers of information systems will undoubtedly regard Dauphin as a serious contender for their business.

In keeping with its aggressive sales approach, Dauphin Technology is currently offering an unbeatable introductory price on both models. End-users would be well advised to invest in a high-performance laptop from Dauphin Tech now.

For more information on Dauphin Tech's laptop line, contact Dauphin Technology in Lombard, Illinois at 312-627-4004. And in the meantime, watch for more surprises from this up-and-coming manufacturer.

MS DOS is a trademark of Microsoft Corp.
DR DOS is a trademark of Digital Research Inc.
LapLink is a trademark of Travelling Software Inc.
AlphaWorks is a trademark of Alpha Software Inc.
LapPRO is a trademark of Dauphin Technology Inc.
MMS and REACT are trademarks of Manufacturing and Maintenance Systems Inc.

MATHPAK 87 v 3.0 *Now available for Turbo C & MS C*

Over 180 assembler coded routines which are designed to take full advantage of 80x87 math coprocessors.

Designed for Speed

Up to 20 X faster than high level language!

1 K complex FFT on a 386/20 takes 0.25s; real 0.12s (2.0s & 1.1s on an IBM XT); dot product (length 10,000) in 0.08s (0.49s on XT).

MATHPAK 87 provides you with the fastest, most convenient and comprehensive set of tools available.

MATHPAK 87 v3.0 includes: 67 vector/scalar routines; 27 complex vector/scalar routines; 11 matrix utility routines; 22 complex number routines; LU decomposition/back-solving routines for real & complex systems; gaussian elimination; matrix inversion, tridiagonal equation solver routines; EISPACK type eigenvalue/vector routines; statistical routines; FFTs (1-D, 2-D, complex, real, convolution,...); spectral analysis routines (windows: Parzen, Hamming, ...); routines for non-linear equations, numerical integration & solution of differential equations; missing functions for Modula-2 & Pascal (tan, log10, alog10, power, sinh, ...); & more.

Widely used in signal & image processing, simulation, spectral analysis, etc.

Timings (COMPAQ 286, 12MHz)

Execution Time for 100,000 Operations

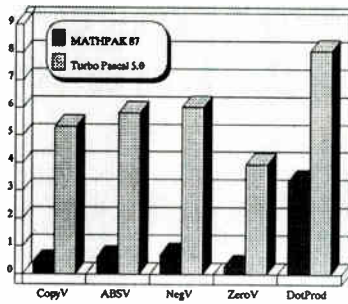

Order Today!
30-day money back guarantee
Precision Plus Software
1239 Sir David Drive
Oakville, Ontario
Canada L6J 6Y9
Tel: 416-829-1511
Fax: 416-829-1742

Users like MATHPAK 87 & take the time to tell us!

\$129US Available for Turbo Pascal, Fortran (MS, IBM Professional or F77L), C (MS, Turbo or Lattice), and Modula-2 (Logitech or ITC).
Add \$69us for complete source code. Add \$5 for shipping. Specify compiler.

International Dealer: SOS Software Service, GmbH, Alter Postweg 101, 8900 Augsburg, West Germany, Tel: 0821/57 1081, Fax: 0821/57 7659.

this speed, however: The OED index takes up 300 megabytes.

More extensive queries are supported using the Goedel language. Goedel, named for the mathematician Kurt Goedel, can also transform the text in a database, a capability that OUP is using to help prepare a version of the *New Shorter Oxford English Dictionary* from the computerized OED.

The Centre's programmers have written auxiliary tools to complement Pat and Goedel. One of these is Lector, a graphics

P Plans

are under way to release
the second edition of the OED
in electronic format.

program currently produced in-house by the University. Lector displays dictionary entries on-screen using X Window in the traditional OED format. The result is a surprisingly simple and responsive system for accessing the dictionary and other large text-dominated databases.

Microcomputer Applications

Plans are under way to release the second edition of the OED in electronic format (on media such as CD-ROM) to the general public sometime in the early 1990s. A version of the original OED came out on CD-ROM in 1988. This version is separate from the work done at the Centre and by OUP/IBM, and its indexing capability is much more limited.

A drawback of current optical and magneto-optical technologies is their slow access times in comparison with magnetic media, a significant factor for a database as large as the OED.

Is there a market for an electronic OED? The OED is unlikely to ever find use as a general-purpose electronic dictionary because of its size and structure. As Tompa puts it, "The OED style of definition would look peculiar in a desktop dictionary." In particular, the OED would be unsuitable for use as a spelling checker; the dictionary is so complete that many common misspellings of current English words are also valid entries. The primary market for the dictionary is likely among researchers in the humanities and the social sciences.

Future Issues

Work on the OED is far from finished. Still to be accomplished is the computerization of the dictionary-making process itself—virtually unchanged since the turn of the century—and a major revision of the OED's style and content. A third edition of the dictionary is expected sometime after the year 2000.

As interest in text-dominated databases grows with the increasing availability of low-cost, high-density mass storage devices, research performed at the University of Waterloo will find other uses as well. Much of the way is already being paved by the NeXT computer and other low-cost workstations. ■

Eric Giguere is a computer science student at the University of Waterloo in Ontario, Canada. He is a freelance writer specializing in the Amiga domain. He can be reached on BIX as "giguere."

EXSEL INC. SM

DIRECT

IBM Personal System/2 Model 50 Computers

THE PS/2 MODEL 50 FEATURES INCLUDE:

- 1MB Random-access Memory on the System Board
- 101 Key Enhanced IBM Keyboard
- One 3.5" 1.44MB Half Height floppy
- One 20MB, 80MS fixed disk drive
- Microprocessor—Intel 80286 (10.0 MHz) Microchannel
- 90 Day Back-to-Depot Warranty

FREE BRAND NEW AMDEK MODEL 432 VGA MONOCHROME MONITOR

PS/2 SYSTEM AND MONITOR: ORIGINALLY MADE TO SELL FOR \$3840.00

FAX YOUR ORDERS 24-HOURS A DAY. (716) 272-8624

EXSEL INC. SM
THE ALTERNATIVE SOURCE FOR THE FUTURE

50% SAVINGS!



EXSEL LOW PRICE:

\$1888.00

TO ORDER BY CREDIT CARD, CALL MONDAY THROUGH FRIDAY 8:30 AM - 6 PM EST. TOLL FREE:

1-(800)-624-2001

IN NY: 716-272-8770

The Pocket LAN Adapters for Token Ring, Ethernet and Arcnet.

Innovation comes in all shapes and sizes. At Xircom we believe it should fit in your pocket. Our Pocket LAN Adapters are revolutionary products developed for PC users who want the most convenient access to Token Ring, Ethernet or Arcnet networks.

What makes the Pocket LAN Adapters revolutionary? They require no internal slots, connecting through the parallel port of any IBM-compatible PC. All come supplied with certified drivers for a trouble-free solution that will have you connected in less time than it takes you to read this ad!

The Xircom approach has left the press full of praise: "The image of perfection—the way computers should be," wrote Steve Gibson in InfoWorld; "Incredibly easy to use...easy to install, easy to carry...a very clever device," according to Aaron Brenner at LAN Magazine.

You may think that all this "perfection" and convenience comes with a hefty price tag. It doesn't—in fact the Xircom family of LAN adapters costs about the same as the more traditional methods which it is quickly rendering obsolete.

It's living proof that with innovation on your side or in your parallel port, a little can take you a very long way.

Call Xircom today at (818)884-8755.

Xircom
LAN solutions for laptops.

22231 Mulholland Hwy., Suite 114
Woodland Hills, CA 91364
(818)884-8755 • FAX (818)884-1719

ARCNET IS A REGISTERED TRADEMARK OF
DATAPOINT CORP.

LAP
TO
LAN
IN
ONE
EASY
CONNECTION

Windows menu system means you'll learn fast. If you can use Windows you can quickly use Windows CAD.

Multiple viewports allow you to work on up to four views of your drawing at the same time.

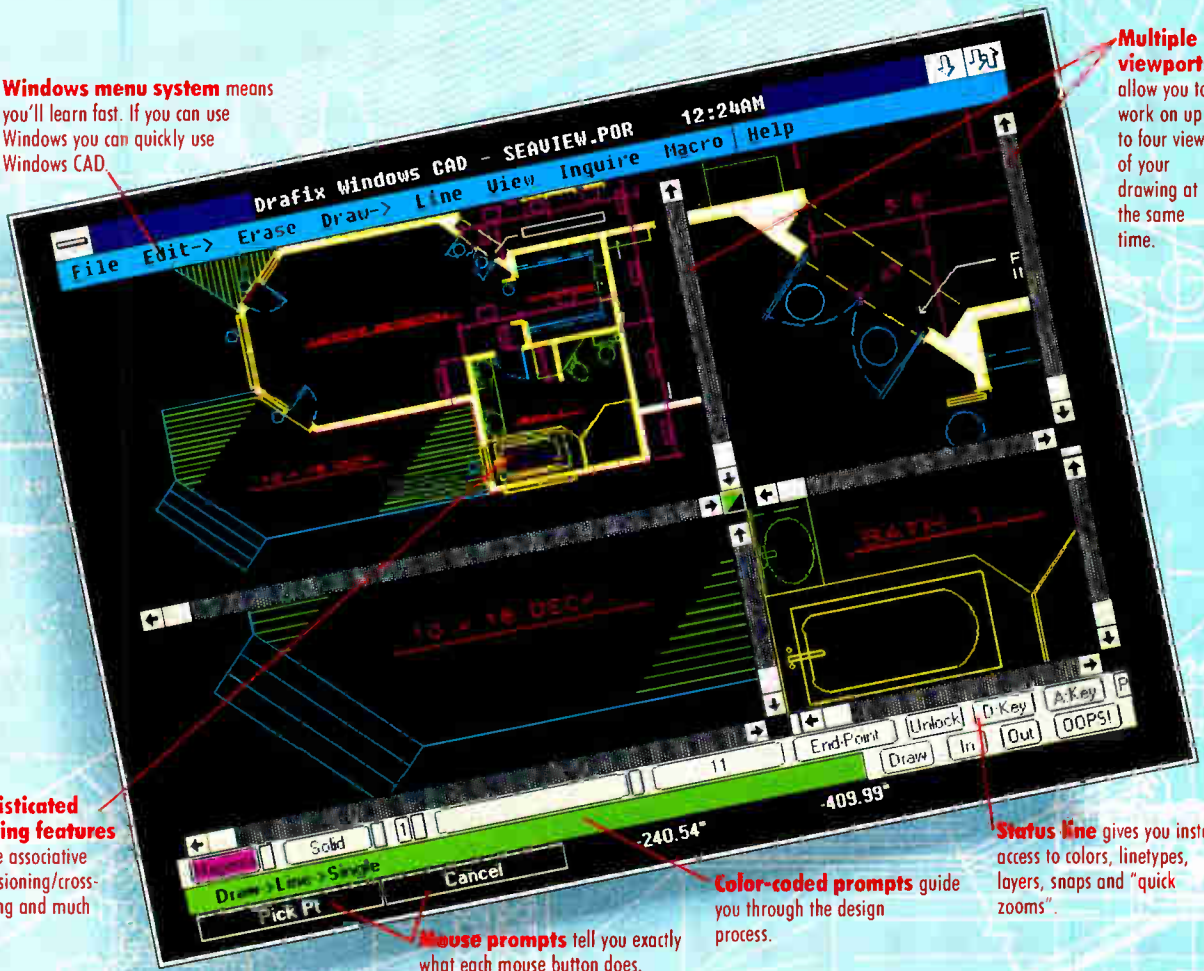

Sophisticated drawing features include associative dimensioning/cross-hatching and much more.

Mouse prompts tell you exactly what each mouse button does.

Color-coded prompts guide you through the design process.

Status line gives you instant access to colors, linetypes, layers, snaps and "quick zooms".

FINALLY, CAD FOR WINDOWS. DRAFIX™ WINDOWS CAD.™

At last the power of true, high performance CAD is available for Windows. Drafix Windows CAD. With features that take you far beyond any Windows drawing package you currently use.

Powerful CAD. Windows CAD is the first and only Windows software to provide all of the designing and editing functions demanded by engineers, drafters, architects and other serious CAD users. It offers multiple interactive viewports, allowing you to work in four views simultaneously. Associative dimensioning, associative crosshatching and a powerful macro programming language are just a few of its features—and that's just the beginning.

Quick to learn, easy to use. Windows CAD lets you take full advantage of your Windows experience. If you already use Excel, Pagemaker, Micrografix Designer, or any Windows package, Windows CAD will have you doing precise, accurate CAD design in no time. And of course you can use all of the plotters, printers and video devices that work with Windows.

From a proven line of CAD products. Windows CAD is the latest in a full line of highly rated CAD software that includes Drafix CAD Ultra, Drafix CAD QwkStart and Drafix 3-D Modeler.

Order your copy of Drafix Windows CAD today! Now if you have Windows, you can have the full power of true CAD. Drafix Windows CAD. Only \$695. For more information call us today at 1-800-231-8574.

Drafix Windows CAD has features you usually find in packages costing 5 times as much!

Item Attributes 256 layers 8 colors
 9 linetypes Up to 60 database attributes to any entity Multiple line widths

Drawing Features Lines: single, double, tangent, parallel, perpendicular, multiple width
 Arcs/Circles Curves/Splines Polygons and Polylines Ellipses Pointmarkers Freehand sketching

Input Methods Windows menu system Keyboard equivalents Ortho lock 10 item and grid snaps, including endpt, midpt, tangent and more Keyboard entry of coordinates OOPS (Undo) feature Dynamic Drag Quick zoom/pan Multiple viewports, all active

Powerful Editing Features Trim entities to each other Stretch Fillet (round) Chamfer (bevel) Erase Copy Move Mirror Rotate Arrays Select items by region, entity, attribute or combinations

Associative Dimensioning Linear, Radius, Diameter Single, Continuous, Baseline Ordinate, Elevation or Bearing format 23 terminator types Any alignment Tolerancing English and metric Fraction or Decimal

Associative Crosshatching and Solid Fill 15 crosshatch patterns, ANSI specs 64 solid fills

Text Editing Word processing window Multiple font styles

On-Line "Help" system

Macro Programming Language

System Requirements 286 or 386 processor Microsoft Windows 2.1 or later 1 Mb internal memory or greater Windows-supported mouse

File Compatibility Autocad DXF Drafix CAD HPGL CDF, SDF for database information



**Foresight Resources Corp.
1-800-231-8574**

Excel, Pagemaker and Micrografix Designer are trademarks of their respective companies

Circle 383 on Reader Service Card (DEALERS: 384)
World Radio History

PROTECTED MODE

More memory and safe multitasking—we have seen the future of Intel microprocessors, and it is protected

As the IBM PC architecture reaches the end of its first decade, more and more software products—operating systems and application programs alike—are being rewritten to run in protected virtual address mode (from here on, I'll call it protected mode), an enhanced operating mode available on the 80286, 80386, and 80486 microprocessors.

Most users want to be able to use protected mode for one reason: greater address reach. The older members of the Intel line—the 8088, 8086, 80188, and 80186—are limited to 1 megabyte of address space. (Actually, a hardware developer could decode the status lines on the chips to provide 1 megabyte each of code and data, but the PC BIOS and DOS, which intersperse the two, would not run in this configuration.)

In contrast, the 80286 can access 16 megabytes, and the 80386 and 80486 microprocessors have a potential 4-gigabyte address space—but only in protected mode. When running in real address mode (often called real mode), the mode most commonly used to run DOS, these microprocessors limit themselves to the same 1-megabyte address space as their forebears.

It is, perhaps, a sign of progress that microcomputer users, once happy with the 64K-byte address space of CP/M, now find it necessary to surmount the 1-megabyte address limit of the 8088 and its kin. One method of doing this, the Expanded Memory Specification, will work with even the oldest chips, but it re-

quires cumbersome bank switching. DOS extenders, available only for 80286 and higher machines, let programs access extended memory in protected mode but switch back into real mode when accessing DOS or the BIOS. And operating systems that operate in protected mode (e.g., Unix and OS/2) are gaining popularity because they can easily accommodate larger programs.

There is, however, much more to protected mode than extended addressing. This mode also offers many other powerful features, including multitasking support, virtual memory, protection of key system resources, and software fault tolerance. This month, I'll look under the hood of Intel's protected mode and survey what it has to offer.

Interim Microprocessor

I'll start with a bit of history. When Intel first introduced the 8086, it was known internally as the "interim microprocessor"—the CPU to which 8080, 8085, and Z80 users could upgrade until the iAPX 432 32-bit microprocessor was ready to ship. Thus, a primary 8086 design consideration—one that probably led to much of its success—was that programs written for the older 8-bit microprocessors be easy to port to the 8086. The designers saw to it that there were direct and simple mappings between the old and new register sets, as well as the old and new instruction sets. In fact, they did so well that it was possible to *mechanically* translate 8080 applications into applications for the new microprocessor.

The largest registers (or register pairs) that could be manipulated as a unit on the older architectures were 16 bits wide. Now, while the 8086 had 20 address bits, ported code might have had to be extensively rewritten if address calculations had to be done in a larger register. This is one of the reasons why Intel chose to divide the address into two parts: a 16-bit *segment selector* and a 16-bit *effective address offset* (or logical address).

The 8086 had four *segment registers*, which were used to map the 16-bit addresses used by a program's stack, code, and data into four potentially disjoint regions of the 1-megabyte address space. Figure 1 shows how the 20-bit address that appears on the address bus is calculated: The segment selector from a segment register is shifted 4 bits to the left and added to the logical address to yield the 20-bit *physical address*.

While this architecture doesn't make it easy to manipulate data structures that are larger than 64K bytes, few people had even that much RAM in their systems at the time. It was easy for many programs (and virtually all applications ported from CP/M) to set the segment registers once at the beginning of execution and forget about them. (It might be said that the contents of the segment registers provided "defaults" for the upper bits of every address.)

From then on, the program dealt for the most part—or entirely—with 16-bit effective address offsets, half the size of the addresses manipulated by microprocessors like the 68000. The instruction set was also more compact and didn't require instructions or data to be aligned on word boundaries. As a result, code and immediate data took up about 30 percent less space. In those days, RAM was expensive, a good reason for IBM to choose the Intel architecture over Motorola's for the IBM PC.

The 80286:

First Try at Protected Mode

Unfortunately, the iAPX 432—a two-chip, 32-bit Intel microprocessor designed for multiprocessing, multitasking, object-oriented programming, and hardware and software fault tolerance—did not succeed in the marketplace. This may have been because it was too far ahead of its time, or because it was designed to run Ada (which didn't achieve the market penetration Intel thought it

continued

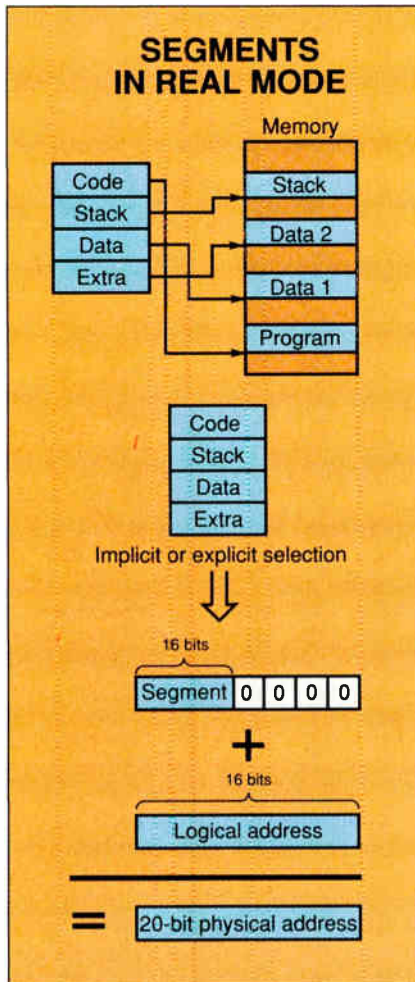

Figure 1: In real mode, the values of segment selectors have numerical significance. They correspond to the base addresses of regions of memory. The base address is added to the offset to create a physical address.

would). Or perhaps the chips were simply too expensive.

But the IBM PC and the 8088 *did* succeed—and users clamored for more memory and more processing power to run their existing software. With the 80286, Intel gave them all this and more. As the remainder of this article will show, the 80286 included many features originally implemented in the iAPX 432.

Two features are essential to any system that provides reasonable protection against errant programs and malicious users: *task isolation* and *system resource protection*. The system needs to prevent tasks from mucking about with one another's memory or hogging the system. System resources (e.g., hardware and file system) need to remain under the exclusive control of the operating-system software. Since most resources are accessible through either memory or I/O addresses, the system must maintain control over the way a task accesses them.

Virtual Addressing

The 80286 and its related family of microprocessors come up from a reset condition in real mode. (An exception is the 80376, a protected-mode-only version of the 80386 marketed specifically for embedded systems.) An initialization routine, which executes in real mode, sets up *descriptor tables*, which govern how memory is addressed, and then switches the CPU to protected mode by setting a bit in a control register. (Intel made this transition nearly irreversible on the 80286. The 80386, however, can be brought back to real mode by resetting

the same bit. This lets OS/2's DOS-mode session switch modes without literally shutting down the microprocessor.)

In protected mode, there's no longer a simple arithmetic relationship between a segment selector, the offset, and the physical address they refer to. Instead, the microprocessor interposes a special mapping operation between a *virtual address* (the protected-mode segment selector and the offset taken together) and the physical address, as shown in figure 2.

In protected mode, a segment selector is not an addend for an address; instead, it's a "magic cookie," or handle. The selector refers to a *segment descriptor*—a record in memory containing information about the segment, including the segment's *base address*, at which the segment starts. The effective address offset is added to the base address to produce a physical address. (The *selector* pointer for all 80x86 chips is 16 bits wide. The *offset* pointer for the 80286 is 16 bits wide. However, the offset pointer for the 80386 and 80486 is a full 32 bits wide.)

Local and Global Address Space

Each task that runs in a protected-mode system can access segments within a virtual address space that consists of two smaller spaces: its *local address space* and a *global address space* (see figure 3). Code and data objects needed by every task in the system are placed in the global address space, while objects used by a single task go in the local address space. Since a task can't access memory for which it doesn't have a selector, the local address spaces are guaranteed to be private unless a segment is intentionally mapped into two or more of them.

Figure 4 shows the format of a protected-mode selector and the way it's used to find the descriptor of a segment in memory. The upper 13 bits of the selector give the location of the descriptor in an array of descriptors called a *descriptor table*. (A descriptor is 8 bytes long, so masking out the lowest 3 bits of the selector conveniently forms the byte offset of the descriptor in the table.)

The lowest 3 bits of the selector are control bits. Bit 2, called the *table indicator* (TI), picks one of two possible descriptor tables: the *global descriptor table*, which holds descriptors for segments in the global address space, or the task's *local descriptor table*, which does the same for the local address space.

The remaining bits—1 and 0—are the *requested-privilege-level* (RPL) field. These bits describe the privilege level a task wishes to be granted when accessing

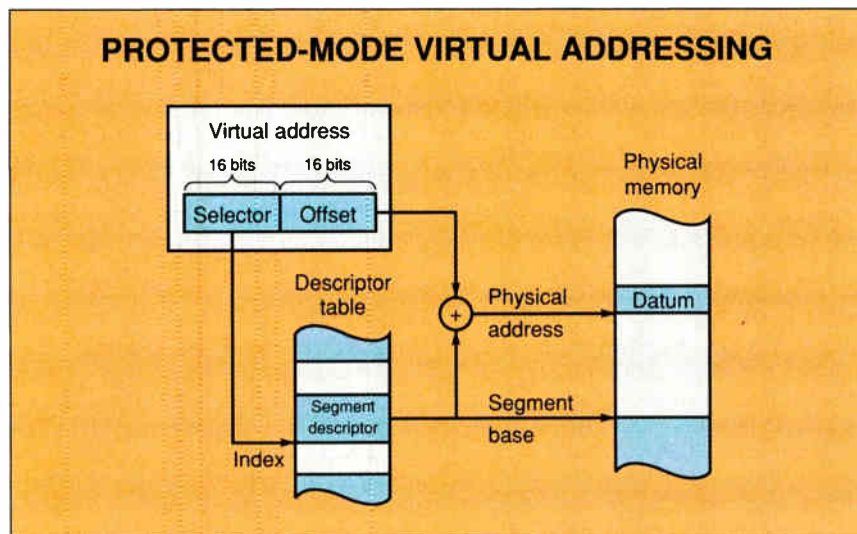

Figure 2: In protected mode, a segment selector specifies an entry in a descriptor table, which in turn gives the base address of the segment. It also contains the size of the segment (not shown).

the segment. (I'll have more to say about RPLs later, when I discuss protection and privilege levels.)

Worry-Free Memory Management

Segment selectors and descriptor tables take much of the worry out of memory management. Those of you who program the Macintosh are doubtless familiar with the concept of a heap "handle"—a pointer that must be doubly dereferenced to get at a block of memory allocated on the Mac heap. Because the Mac Memory Manager performs frequent compaction operations, a serious system error can result when a Mac programmer dereferences a handle but forgets to "lock" it.

Protected-mode programming on the Intel microprocessors doesn't open itself to this sort of error. Because a segment selector is, in essence, a handle that appears to be doubly dereferenced during each memory access, segments can be moved about in physical memory invisibly. And since a segment's descriptor is automatically cached within the microprocessor when its selector is placed in a segment register, two address registers are not needed to access the potentially mobile segment. Loading one 16-bit selector does it all.

A protected-mode segment not only can be moved from place to place within physical RAM, it also can be swapped out of RAM entirely. The segment selector/descriptor mechanism lets the 80286 and its kin provide virtual memory without a separate memory management unit. Each segment descriptor contains a bit that indicates whether or not the segment is physically present in RAM, and the microprocessor generates an exception if an application attempts to access a segment that's been purged or swapped out. Thus, while owners of all but the most recent Macs are limited to the RAM they have in their machines (the Mac II provided a socket for an optional, expensive MMU, and the newer 68030 machines have the MMU built in), owners of 80286 machines manufactured as early as 1984 can overcommit storage when running operating systems like Unix and OS/2.

Finally, while it's possible to run off the end of a block of memory allocated on the Mac heap, it's not possible to access memory beyond either end of a protected-mode segment. Each segment descriptor has a "limit" field that gives the exact size of that segment (up to 64K bytes on the 80286, and up to a gigabyte on later microprocessors). An access outside the allowed space causes a *general protection fault*; the operating system

continued

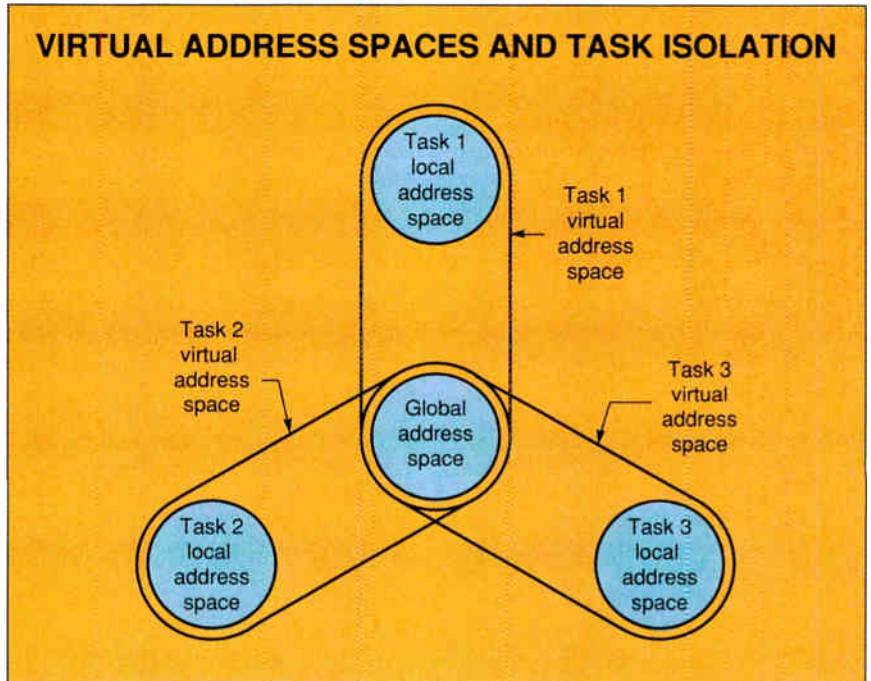

Figure 3: In protected mode, each task can access a virtual address space consisting of its local address space and the system's global address space. In this figure, the local address spaces are disjoint. However, it's possible for local address spaces to share segments if two local segment descriptors map to the same physical address.

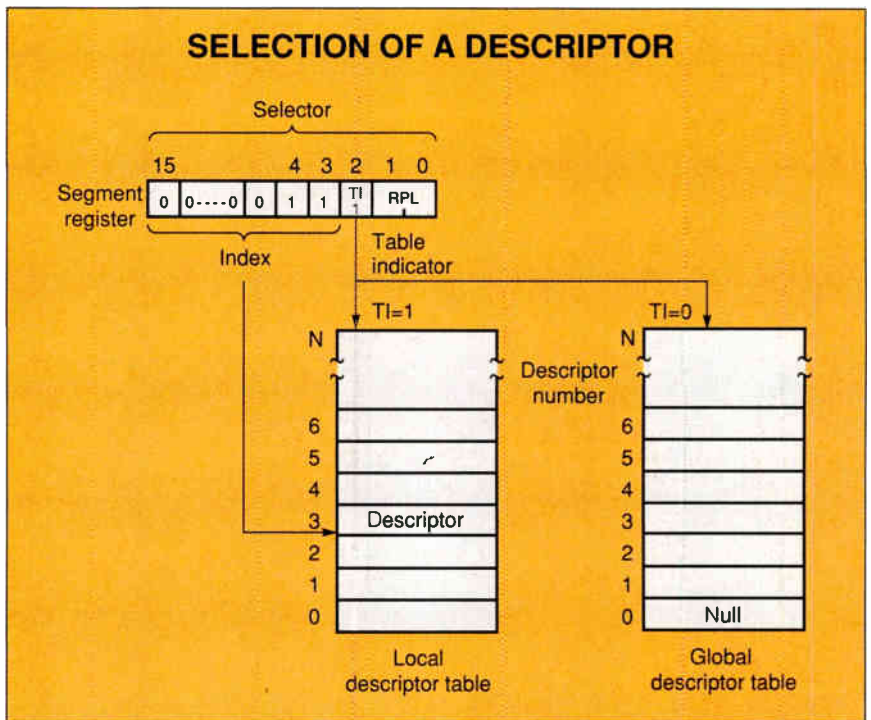

Figure 4: A protected-mode segment selector has three fields: the index field, which gives the index of the segment's descriptor in the local or global descriptor table; a table-indicator (TI) bit, which tells whether the selector refers to the local or global descriptor table; and the requested-privilege-level (RPL) field, which lets the task restrict its own privilege when accessing the segment.

gets control and can disable the misbehaving task before it destroys memory.

In some situations, overrunning the end of a segment might not be considered a fatal error. For instance, suppose a task was allocated a 16K-byte stack but happened to need more. If the stack segment is marked as an *expand-down* segment, the operating system can handle an overflow by making the stack larger and then continue the program. (Unfortunately, a mask error prevented this feature from working on the earliest 80286s, so many operating systems, like OS/2, don't take advantage of it.)

Protection: The Onion Model

The hierarchy of privileges and protection in the Intel microprocessors follows the *ring*, or *onion*, model shown in figure 5. There are four possible privilege levels—numbered from 0 to 3, where level 0 is the most privileged. Every task in the system has a *current privilege level*, which is used to determine whether

it can do I/O, execute privileged instructions (those that do things like halt the CPU), and/or access segments. Each segment selector also has an RPL field, which a task changes if it wants to have less privilege than its CPL would normally allow when accessing the segment. The *effective privilege level* (EPL) is less privileged than the RPL and CPL, and it determines whether a task can access a segment with a given selector.

Why would a task ever want to give itself less privilege than it might otherwise have when accessing a segment? The answer has to do with something called the Trojan-horse problem. Suppose that a protected-mode operating system has a function called `DosRead`, which reads information from an open file (OS/2 actually has such a function). The C header of this function happens to look like this:

```
unsigned int pascal far DosRead
(unsigned short FileHandle,
 void far *PtrBuffer,
```

```
 unsigned int BufferLength,
 unsigned int far *PtrBytesRead);
```

You don't have to be fluent in C for the purposes of this example; the important thing is that, among the arguments, there's a pointer called `PtrBuffer` (declared as `void far *PtrBuffer`). The word `void` indicates that the pointer is typeless (i.e., it can point to an object of any type), and the word `far` indicates that the pointer consists of both a segment selector and an offset. `PtrBuffer` gives the address of the location that's going to receive the data from the read operation.

Now, suppose an application called the function with `PtrBuffer` pointing to a segment that the application wasn't allowed to access (because it didn't have sufficient privilege). The operating system, which presumably would run at a higher privilege level, would have access to that segment—so the application could, in theory, cause the operating system to read arbitrary data into that place in memory!

To prevent this from happening, the operating system adjusts the RPL field within the selector part of `PtrBuffer` so that it has no more privilege than the application when accessing the segment. Then, if the pointer turns out to be a Trojan horse, the privilege violation will be caught by the usual protection mechanisms.

All the information about what can be done with a segment—and by whom—is contained in the segment descriptor. Every segment's descriptor has an *access rights byte*, which in turn contains a 2-bit *descriptor-privilege-level* field. The EPL of the task must give it the same or a higher privilege than the DPL for an access to be allowed. The access rights byte also contains other information about what can be done with the segment—whether it can be read or written, for instance, and whether it contains code, data, or a task's stack.

Enter Through Gate 5

A task that's running an application program will probably stay at privilege level 3 (PL 3) most of the time, which means that it cannot access vital system resources. However, a task can jump to a more-trusted (numerically lower) privilege level when it makes an operating-system call via a construct called a *gate*.

Gates isolate less-trusted code—like a user's program, which may be unintentionally (or even intentionally) destructive—from the more-trusted system code that manages system resources. Suppose

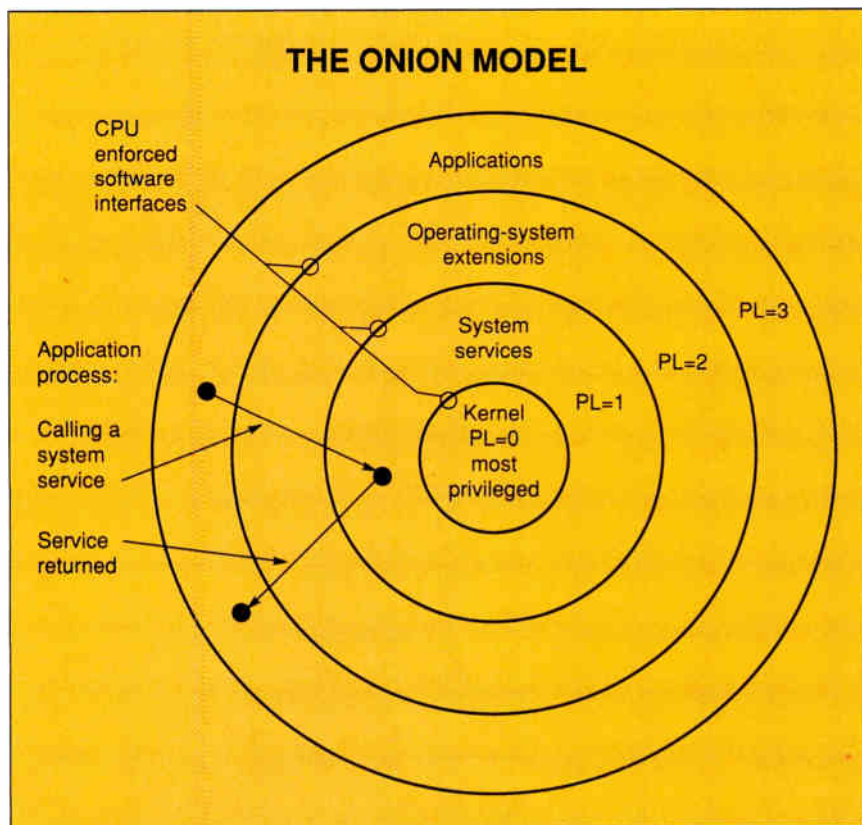

Figure 5: The four-level hierarchical privilege system used by Intel processors in protected mode is sometimes called the onion model because of the concentric rings. Data stored in a segment with a specific privilege level can be accessed only by a task with the same or a higher privilege, while routines in code segments can be called only by routines with the same or a lower privilege. Thus, only trusted routines can access important data, and less-trusted code can call more-trusted code to perform sensitive operations for it.

a task on PL 3 wants to call a routine in the operating-system kernel, which is running at PL 0. To do this, it makes a call to any address in a segment whose entry in the descriptor table contains a special descriptor known as a *call gate* (see figure 6). This record, in turn, furnishes the CPU with necessary information about the routine, including its address (the application knows only the segment selector) and how many bytes of stack space the parameters take.

You may ask why the gate provides this information rather than the caller. The answer is that the caller can't be trusted not to jump to an erroneous address in the middle of a routine, or even inside an instruction. (This could occur by accident by a buggy program or on purpose by a program with malicious intent.) There's also another reason. Because the operating system can modify the descriptor at run time, it's possible to do dynamic binding (i.e., decide on the fly which routine the call goes to) without modifying the object code of the application. This is how OS/2's *dynamic link libraries* work.

The microprocessor's microcode quickly transfers the parameters from the caller's stack to a different stack at the more privileged level (thereby protecting against stack corruption and overflow) and calls the routine at the address in the descriptor.

As well as call gates, three other kinds of gates are found in a protected-mode system: *trap gates*, *interrupt gates*, and *task gates*.

Trap gates and interrupt gates are similar in that they can appear only in a descriptor table called the *interrupt descriptor table* (IDT). They're analogous to the entries in an interrupt vector table in real mode (or on other microprocessors) in that they specify the location of the routine that services a hardware or software interrupt, but they contain more information. Since interrupt service routines often need access to the hardware and to privileged instructions, these gates—like call gates—allow an automatic change of stacks and privilege levels during interrupt service.

It's sometimes useful for tasks to share a subroutine that doesn't need any privileges that the caller doesn't already have. In this case, a call gate might be a wasteful way to access the subroutine, since there's no need to swap stacks or check privilege levels. *Conforming code segments* provide a way to do this. When an application calls a routine in a conforming code segment, the CPL doesn't

continued

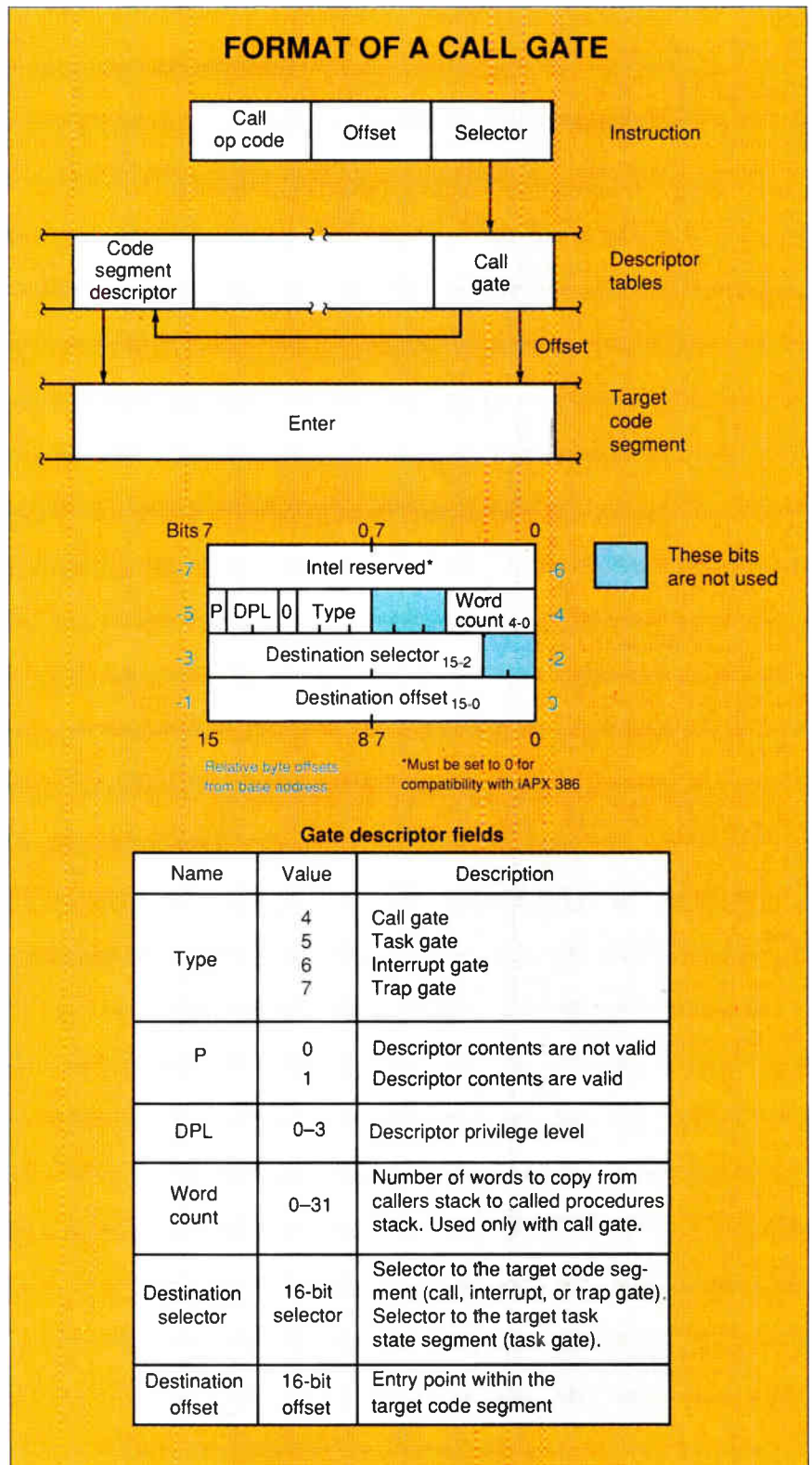

Figure 6: A gate controls access to system subprograms by making sure they're entered at the proper point. It also stores protection information and records how the parameters are going to be handled (a transition to a more privileged level will cause a stack switch).

change; the code executes as if it were part of the application.

Tasks and Task Gates

Protected mode provides explicit support in microcode for multitasking and task switching. Every task on a protected-mode system—or at least one implemented according to Intel's original design—is associated with a *task state segment* (TSS), a large data structure containing the entire state of the machine

when it last ran a particular task. (It's accessed as a segment, with a selector, so all the protection mechanisms I've mentioned so far apply to it.) When a task loses control of the CPU, this segment is stuffed with the contents of all the visible and hidden registers necessary to preserve the task's context.

Alas, that's a lot of information. A TSS is always at least 42 bytes long, and a full task switch requires the processor to save at least 28 bytes of status and fetch

several more than that to resume the next task. This process is slow, even under the control of microcode. For this reason, OS/2 and even Intel's own iRMX operating system don't use TSSes for most of their task switching; instead, they optimize the process by saving and restoring only what's needed. (A few tricks, including the use of an undocumented instruction called LOADALL, make this technique very efficient.)

Systems that do use the 80286 tasking facilities change tasks by making a jump or call to a task gate, which contains a pointer to the TSS of the task to be invoked (see the text box "A Glossary of Protected Mode"). A task gate can be used not only for time slicing but also for interrupt handling. If a task gate appears in the IDT, it causes the associated task to be activated to service the interrupt. When the task executes an IRET (interrupt return) instruction, control is returned to the task that was running before the interrupt occurred.

Restricting I/O: The I/O Privilege Level

Two bits in the flag word of the 80286 control which tasks can and cannot do I/O. Since being able to perform I/O can let a program directly manipulate the hardware and potentially crash the machine, it's important that only trusted code be allowed to do so.

The I/O privilege-level bits are therefore used to specify the least-privileged level at which I/O can be performed—and also at which certain instructions (e.g., ones that enable and disable interrupts) can be executed. OS/2, for example, sets IOPL to 2, and it comes out of the box configured so that no application program can run at this level. However, because some applications (e.g., debuggers) need to be able to execute these instructions and do I/O, it's possible to configure OS/2 to allow it.

When you specify "IOPL=YES" in OS/2's CONFIG.SYS file, an application can have a code segment called an *IOPL segment* that executes at PL 2. You should be aware, however, that this constitutes a serious breach of system security. A program that can do I/O can program the system's direct-memory-access controller and therefore alter any location in physical memory.

Enter the 80386

The 80286's protection mechanisms are elegant, but the microprocessor itself can still do math only 16 bits at a time. And segments cannot be larger than 64K

continued

U.S. POSTAL SERVICE
STATEMENT OF OWNERSHIP, MANAGEMENT AND CIRCULATION
(Act of August 12, 1970, Section 3685, Title 39, United States Code)

1. Title of publication: **BYTE**
2. Date of filing: October 1, 1989
3. Frequency of issue: Monthly plus one additional issue in October
- 3A. Number of issues published annually: 13
- 3B. Annual subscription price: \$29.95
4. Location of known office of publication: One Phoenix Mill Lane, Peterborough, NH 03458
5. Location of headquarters or general business offices of the publisher: McGraw-Hill, Inc., 1221 Avenue of the Americas, New York, NY 10020
6. Names and addresses of publisher, editor, and managing editor: Publisher: J. Burt Totaro—One Phoenix Mill Lane, Peterborough, NH 03458; Editor: Fred Langa—One Phoenix Mill Lane, Peterborough, NH 03458; Managing Editor: Glenn Hartwig—One Phoenix Mill Lane, Peterborough, NH 03458
7. Owner: McGraw-Hill, Inc., 1221 Avenue of the Americas, New York, NY 10020. Stockholders holding 1 percent or more of stock are: Donald C. McGraw Jr.; Harold W. McGraw Jr.; John L. McGraw; William H. McGraw; June M. McBroome; Elizabeth McGraw Webster; all c/o McGraw-Hill, Inc., 1221 Avenue of the Americas, New York, NY 10020. College Retirement Equity Fund c/o Bankers Trust Company, 280 Park Avenue, New York, NY 10015.
8. Known bondholders, mortgagees, and other security holders owning or holding 1 percent or more of total amount of bonds, mortgages, or other securities: None
9. Not applicable.
10. Extent and nature of circulation:

	Average No. Copies Each Issue During Preceding 12 Months	Actual No. Copies of Single Issue Published Nearest to Filing Date
A. Total No. Copies Printed	579,946	617,100
B. Paid Circulation		
1. Sales through dealers and carriers, street vendors, and counter sales	121,749	143,759
2. Mail subscriptions	345,552	370,138
C. Total Paid Circulation	467,301	513,897
D. Free Distribution by Mail, Carrier, or Other Means; Samples, Complimentary, and Other Free Copies	10,341	6,987
E. Total Distribution	477,642	520,884
F. Copies Not Distributed		
1. Office use, left over, unaccounted, spoiled after printing	6,675	3,748
2. Return from news agents	95,629	92,468
G. Total	579,946	617,100

11. I certify that the statements made by me above are correct and complete.

—Daniel T. McLaughlin
Director of Circulation and Direct Marketing

A Glossary of Protected Mode

call gate A descriptor that gives information on the entry point and parameters of a protected-mode subprogram. It isolates the called routine (which may run at a higher privilege level than the caller) from the code that calls it and guarantees that only the correct entry point is used.

conforming code segment A subprogram in a conforming code segment runs at the same privilege level as the task that calls it. A conforming code segment is also the only kind of code segment that can be read directly as data. Conforming code segments are useful for utility routines and for the storage of read-only static data.

current privilege level (CPL) The privilege level of the code segment that a task is currently executing.

descriptor privilege level (DPL) A field within a descriptor that determines the least privilege a task must have to access the associated segment.

descriptor table An array of 8-byte records called descriptors, which in turn contain information about segments (e.g., base address, size, and privilege).

effective address offset The offset from the beginning of a segment where the desired data lies. In protected mode, only the offsets of variables bear a known numeric relationship to one another. The values of segment descriptors don't correspond to the locations of segments in physical memory.

effective privilege level (EPL) When accessing a particular segment, this is equal to the lesser of the task's privilege and the requested-privilege-level field of the segment selector.

expand-down segment This can be used for a stack that may grow to a larger size than originally anticipated. Stacks grow downward on the Intel processors. If the stack pointer drops below the bottom of the space allocated for the segment, the processor generates an exception, and the operating system can decrease the minimum allowable offset into the segment. (This feature did not

work on some early 80286 chips; the contents of the CX register were lost when the exception was generated.)

expand-up segment This works like an expand-down segment, but it can grow upward rather than downward (i.e., the maximum offset can be increased). While not useful for the processor stack, this kind of segment can be useful for high-level-language stacks that grow upward (as in BCPL, a precursor to C) or when the total amount of data space that is used by a program is unknown.

global descriptor table (GDT) This table stores the descriptors of segments that are potentially accessible by every task in the system (subject to privilege constraints). The GDT is a segment itself, containing a self-referential segment descriptor; it also contains descriptors for the local descriptor tables of all the tasks in the system.

interrupt descriptor table (IDT) This table contains descriptors (i.e., task gates, interrupt gates, and trap gates) for the routines that handle hardware interrupts, software interrupts, and exceptions.

interrupt gate A special descriptor, found in the interrupt descriptor table, that gives information about an interrupt service routine. It's identical to a trap gate, except that interrupts are disabled when the service routine is entered.

local descriptor table (LDT) A task's LDT contains descriptors for segments accessible to that individual task (but not necessarily to any other task in the system).

paged virtual memory This lets programs access more memory than is actually present on a given machine. Data is swapped to and from a disk in 4K-byte pages as needed. Only the 80386 and the 80486 implement paged virtual memory; the 80286 offers only segmented virtual memory, in which whole segments (as long as 64K bytes) are swapped.

protected virtual address mode Also called protected mode, this is the mode of the Intel processors in which addresses are virtual (i.e., the numerical value of a pointer's segment selector doesn't correspond to any fixed physical address) and not all tasks can access all parts of memory.

real address mode Also called real mode, this is the mode of the Intel processors in which there is no memory protection and there is a direct arithmetic relationship between segment selectors and physical addresses in memory. The 8088 and 8086 are capable of only real-mode operation.

requested privilege level (RPL) The RPL field of a segment selector lets a task lower its privilege when accessing a particular segment. This feature is used to prevent Trojan horses (see the text).

segment descriptor A record that describes the location of a segment in physical memory, as well as its size and how it can be used.

segment selector A "handle" that designates a particular segment. It contains an index into the local or global descriptor table of a task, as well as a requested privilege level.

task gate This lets one task invoke another. A call to a task gate causes a complete processor context switch.

task state segment (TSS) The processor stores information about a task here. When the task is not running, the TSS holds the complete processor context (e.g., the values of registers and the location of the task's local descriptor table) necessary to reactivate the task.

virtual 8086 mode This mode lets the 80386 and 80486 run programs designed for real-mode operation when the processor is in protected mode. A real-mode program running in virtual 8086 mode is given access to a limited address space that "appears" the same as the 8086's 1-megabyte address space; in fact, this space is mapped into the 4-gigabyte protected-mode address space by the paging unit.

bytes, which means that an application that uses much memory spends a great deal of time loading and reloading segment registers. (Since loading a selector into a segment register also causes the descriptor to be fetched, this apparently simple register operation actually incurs substantial overhead.)

The 80386 therefore added 32-bit general registers, 32-bit math, and segments with 32-bit offsets, while retaining the ability to run 80286 code. (Segment selectors in the 80386 and 80486 are still 16 bits long, so pointers in 80386 protected mode occupy 48 bits, or 6 bytes.) The 80386 also included several new addressing modes. Some of these modes use a barrel shifter to facilitate array access; if the components of the array are 2^n bytes long (where n is an integer), the subscript can be put directly into a register and will be shifted automatically before being added to the starting address of the array.

The 80386 also implements *paged* virtual memory. Unlike the 80286, which can swap only whole segments in and out of memory, the 80386 can swap chunks of memory in increments of 4K bytes. This finer granularity means that there's likely to be less of a wait during a swap; also, the operating system isn't required to shuffle memory to free a contiguous block of memory for a large segment.

Finally, the notion of I/O privilege was expanded in the 80386. Instead of making a blanket prohibition on I/O for tasks that execute without a sufficient amount of privilege, the 80386 lets the operating system create an *I/O permission bit map* that specifies, port by port, which I/O addresses a task can access.

These niceties, however, are generally of interest to systems programmers and compiler writers. Users—concerned primarily with address reach and downward compatibility—appreciate two features the most: 32-bit addressing and virtual 8086 mode.

Big Segments, and More of Them

The 80386's segments can contain up to a gigabyte of memory each—more memory than many microprocessors are able to address. Therefore, the 80x86 instruction set, which is optimized for programs that have one code segment, one data segment, and one stack segment, can be used at maximum efficiency.

Also, besides the set of segment registers included in the earlier Intel processors (CS, DS, ES, and SS), two new ones have been added: FS and GS. These changes reduce the overhead of loading segment registers to a bare minimum for

virtually all applications.

However, the same basic protection rules apply in the same ways, so code doesn't need to be modified much to take advantage of the new architectural features. And since each code segment can be marked as using 16- or 32-bit registers by default (by setting the appropriate bits in the segment descriptor), 80286 code can run concurrently with 80386 code on the same machine.

Virtual 8086 Mode

No one likes to throw out software, especially when you have paid hundreds or even thousands of dollars for it. Unfortunately, the best and most powerful software currently available for the Intel microprocessors runs under DOS and cannot be run in protected mode. OS/2's DOS-mode session lets one (and only one) DOS application be run at one time together with the protected-mode operating system, since the memory accessed by the real-mode program must actually be at the physical address that the program expects.

Furthermore, the real-mode application must be "frozen" unless it has almost complete control of the hardware, including the display. This means that protected-mode programs can run in the background while the DOS-mode session is in the foreground, but not the other way around. Finally, compatibility is not complete. Many programs just won't run in the DOS-mode session due to quirks or memory limitations, and this deters users from switching to OS/2.

The 80386 and 80486 get around this problem by letting tasks run in virtual 8086 mode. In this mode, protected-mode virtual addressing (i.e., descriptor tables, and so on) is turned off, and the 8086 program "thinks" it's running in a 1-megabyte address space where segment selectors have the same arithmetic relationship to physical addresses as they do in real mode.

In reality, however, what is going on is quite different. The 80386's paging hardware is used to map each 4K-byte chunk of that 1-megabyte address space to any 32-bit address in physical (or virtual) memory. This means that multiple virtual 8086s can run at the same time, since none needs access to the "real" address 0. It also means that several virtual 8086 tasks can share a single copy of a real-mode operating system. Finally, none of the virtual 8086 programs can "see" memory that isn't mapped into their address spaces, which guarantees that system security remains intact.

What if a program running on a vir-

tual 8086 wants to do I/O? The result depends on the I/O permission bit map for that task. Any I/O operation that needs to be caught and simulated can be trapped simply by denying the task access to a port. An attempt to do I/O causes the operating-system software that manages the virtual 8086s (usually called a virtual machine monitor) to gain control; this monitor can then take whatever action it deems appropriate.

Putting It All Together

As complex as it all may sound, protected mode provides only a basic framework for an operating-system environment. It takes a lot of ingenuity to apply these concepts to the design of an operating system.

What protected mode does, however, it often does embarrassingly well. Many programs that were assumed to be quite sound have shown major flaws when run with protected mode's strict checks on pointer validity. And environments like IGC's VM/386 can run independent virtual 8086s that are so well isolated that you can literally crash and reboot them individually.

Intel isn't saying much about what direction the 80586 and future microprocessors will take, but it's clear from current trends that the protected-mode architecture won't be retired any time soon. ■

BIBLIOGRAPHY

- 80386 Programmer's Reference Manual*. Santa Clara, CA: Intel Corp., 1986.
- 80386 System Software Writer's Guide*. Santa Clara, CA: Intel Corp., 1987.
- iAPX 286 Programmer's Reference Manual* (including iAPX 286 Numeric Supplement). Santa Clara, CA: Intel Corp., 1985.
- i486 Microprocessor*. Santa Clara, CA: Intel Corp., 1989.
- Letwin, Gordon. *Inside OS/2*. Redmond, WA: Microsoft Press, 1988.

ACKNOWLEDGMENT

Thanks to Intel Corp. for the use of some figures used in this article. Thanks also to Gordon Letwin and Anthony Short of Microsoft for their help with some of the subtler points of protected mode.

L. Brett Glass is a freelance programmer, author, and hardware designer residing in Palo Alto, California. He can be reached on BIX as "glass."

Your questions and comments are welcome. Write to: Editor, BYTE, One Phoenix Mill Lane, Peterborough, NH 03458.

CSR makes the best built, best backed 286 and 386 systems. Period.



Also available in slim line model.

As a national PC repair and maintenance organization, we've repaired every major brand of computer – systems like IBM,[†] Compaq[†] and NEC.[†] Now, after years of fixing their best, we've built ours better.

...and we back them up with the industry's best 2 year warranty.

There's one exclusive feature of every CSR PC that you should know about: CSR's commitment to customer service. Other PC manufacturers don't even come close to matching the support you get with a CSR system – the industry's best 2 year warranty.

For the first year you'll receive complete on-site service on all parts and labor. During the second year we'll repair or replace any parts that fail. Calling our toll-free support hotline connects you to a highly trained Customer Engineer (CE). Your CE will resolve your problem over the phone or dispatch a Service Engineer to your site within 24 hours of your call – guaranteed.

High performance without a high price.

CSR delivers high performance in every machine we make. Like our 286/20: Using an Intel[†]-based 80286 chip running at a blazing 20 MHz, the 286/20 actually outperforms most 386 based PCs.

More proof: Every CSR PC is fully MS-DOS[®] and OS/2[®] compatible. Standard equipment on each system includes a high-speed VGA controller, a 101 key tactile response keyboard and a totally IBM-compatible disk controller featuring the latest in track-buffer technology – boosting drive performance by an amazing 30% to 50%! And, all CSR PCs offer either a 3.5" or 5.25" drive as standard equipment. Take a look at the specification chart. We're sure you'll agree that no one tops our PC's features.

Built for your needs and your budget.

Whether you require a stand-alone system or an advanced LAN installation, want to purchase outright or take advantage of our comprehensive leasing and credit card programs, CSR has the systems and expertise to provide all of your computing needs. Tell us the details. Then tell us your budget. We'll build you a system that's compatible with both.

[†]The brands or product names mentioned are trademarks or registered trademarks of their respective holders. MS-DOS and OS/2 are registered trademarks of Microsoft Corporation.

CSR 286/14 SL CSR 286/14

- 80286 Intel based microprocessor running at 14 MHz.
- 1 MB RAM expandable to 16 MB (8 MB on the system board).*
- Socket for math coprocessor.

- Page mode interleave memory architecture.
- 1 parallel, 1 serial port and 1 mouse port.
- Real time clock with battery backup.
- High-speed 16 bit VGA.
- Track buffer hard disk drive controller.

*SL model features a slimline case.

CSR 286/20SL CSR 286/20

- 80286 Intel based microprocessor running 20 MHz.
- 1 MB RAM expandable to 16 MB (8 MB on the system board).*
- Page mode interleave memory architecture.
- Socket for math coprocessor.

- 1 parallel, 1 serial port and 1 mouse port.
- 3 speed selectable 8 MHz, 16 MHz or 20 MHz speed.
- Real time clock with battery backup.
- High-speed 16 bit VGA.
- Track buffer hard disk drive controller.

NOTE: *Up to 8 MB in SL case.

CSR 386/20

- Intel 80386 microprocessor running at 20 MHz.
- 1 MB RAM expandable to 16 MB on the system board.
- Page mode interleave memory architecture.
- Socket for math coprocessor.

- 1 parallel, 1 serial port and 1 mouse port.
- 200 watt power supply.
- Real time clock with battery backup.
- High-speed 16 bit VGA.
- Track buffer hard disk drive controller.

CSR 386/25c

- Intel 80386 microprocessor running at 25 MHz.
- 1 MB RAM expandable to 16 MB on the system board.
- Advanced Austek Cache memory controller with 32K of high speed static RAM Cache.

- High-speed 16 bit VGA.
- Page mode interleave memory architecture.
- Socket for math coprocessor.
- 1 parallel, 1 serial port and 1 mouse port.
- 200 watt power supply.
- Real time clock with battery backup.
- Track buffer hard disk drive controller.

All models come standard with tactile keyboard and your choice of either 3.5" or 5.25" disk drive.

Call us at:

800-366-1277

We accept MasterCard, VISA and certified checks



Computer Systems Research

We build ours better.

Circle 379 on Reader Service Card

World Radio History

Wise Guide.

Dvorak's Guide to PC Telecommunications

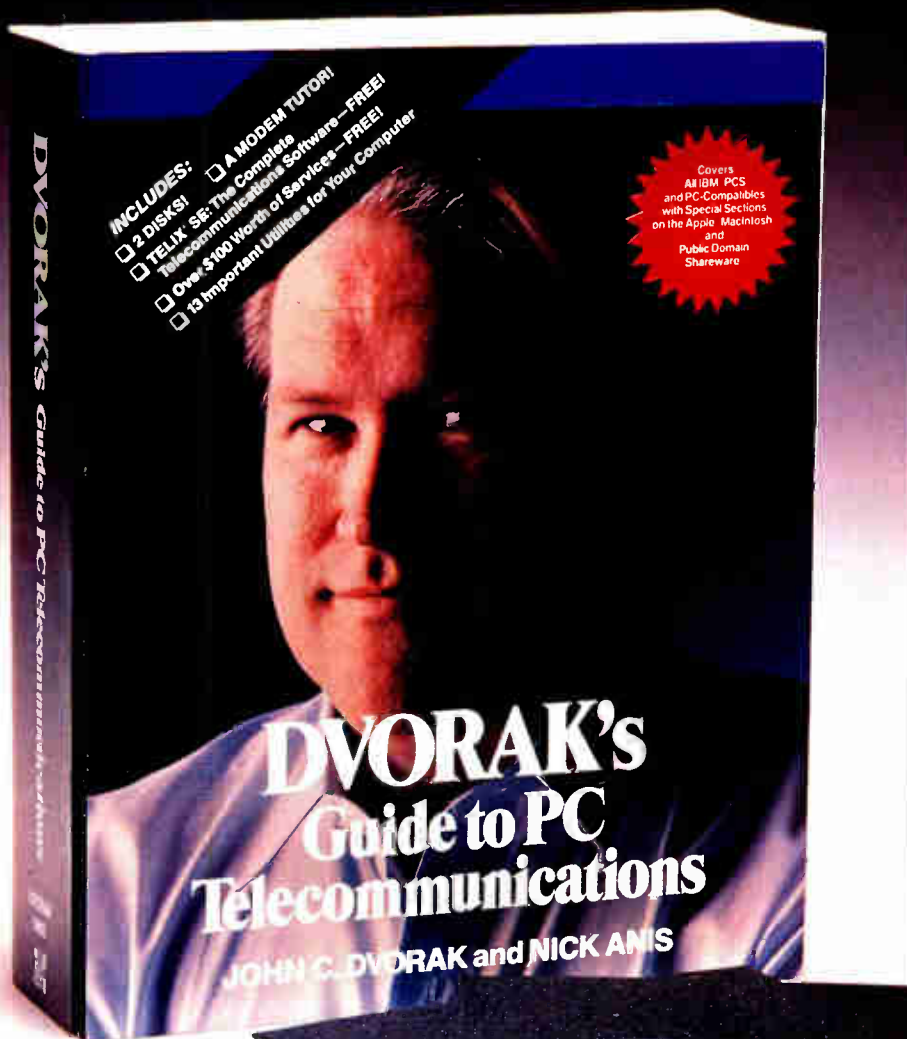

by John C. Dvorak and Nick Anis • Foreword by Peter Norton

Circle 239 on Reader Service Card

"Dvorak's style and humor make this a refreshing and accessible sourcebook with an incredible breadth of coverage." Peter Norton

TELECOMMUNICATIONS JUST GOT SIMPLE—

Plug into the world of electronic databases, bulletin boards, and on-line services. All you need is your computer, a modem, and this outstanding book and disk package by internationally acclaimed columnist John C. Dvorak and programming wiz Nick Anis.

With this book and software package you can:

- Send and receive electronic mail, memos, and reports to and from your office, hotel room, beach resort, or home.
- Set up an efficient home-office.
- Schedule airline reservations electronically.
- Download over 10,000 software programs right into your computer over regular phone lines.
- Get instantaneous stock quotes.
- Tap into most major newspapers and newsletters electronically.

For **Only \$49.95** you get a comprehensive, easy-to-read guide on everything you ever wanted to know about telecommunications plus TWO diskettes loaded with outstanding free programs. This book is written for experts and novices alike.

INCLUDES:

- Two 5-1/4" Disks
- A Modem Tutor
- TELIX/SE—The complete Telecommunications Software - FREE!
- Over \$1500 in Discounts and Services
- 13 Important Utilities for Your Computer—FREE!

\$49.95, ISBN: 0-07-881551-7, 750 pp. Quality Paperback, 2 5-1/4" Disks (IBM PC/Compatible).

(3-1/2" Disks available through a coupon offer.)

Available Now at Book Stores and Computer Stores

ORDER TODAY!
CALL TOLL-FREE
1-800-262-4729



Osborne McGraw-Hill
2600 Tenth Street
Berkeley, CA 94710

(Available in Canada through McGraw-Hill Ryerson, Ltd. Phone: 416-293-1911)

1989 © McGraw-Hill, Inc.



INPUT: KEEP IT CLEAN

A data-entry TSR program and how to use it from six different compiler/interpreters

I got my best lesson in user interfaces while watching a secretary enter a client's name into a field clearly marked "current balance." She was reading from a printout, so she wasn't paying attention to the screen. As she typed, the characters of the client's name escaped the boundaries of "current balance" and overwrote a portion of the neighboring field.

The screen looked pretty messy when she'd finished, and she told me so when she finally looked up from the printout and saw what she'd done. It wasn't her fault, it was mine. I had written the program, and it was obviously lacking in safeguards.

This seems like a small thing, doesn't it? Nothing crashed, so no harm done, right? Wrong. You and I know that the program wasn't trashed, but a user might not. A trashed screen can undermine the user's faith in an application, which spells the difference between a program that sells and one that doesn't.

Even I am occasionally waylaid by this problem. While I'm typing information into a data-entry screen, the phone rings and I hastily put my stack of papers down to answer it. What I don't notice is that my papers rest on an edge of the keyboard, and by the time I've returned, an army of *a*'s has conquered the lower third of the screen. If the program doesn't have a screen redraw capability, I've got to abort and restart it.

Sometimes the results of inadvertently entering improper information for a field can be more than a disfigured display. In C, you typically use the `scanf()` func-

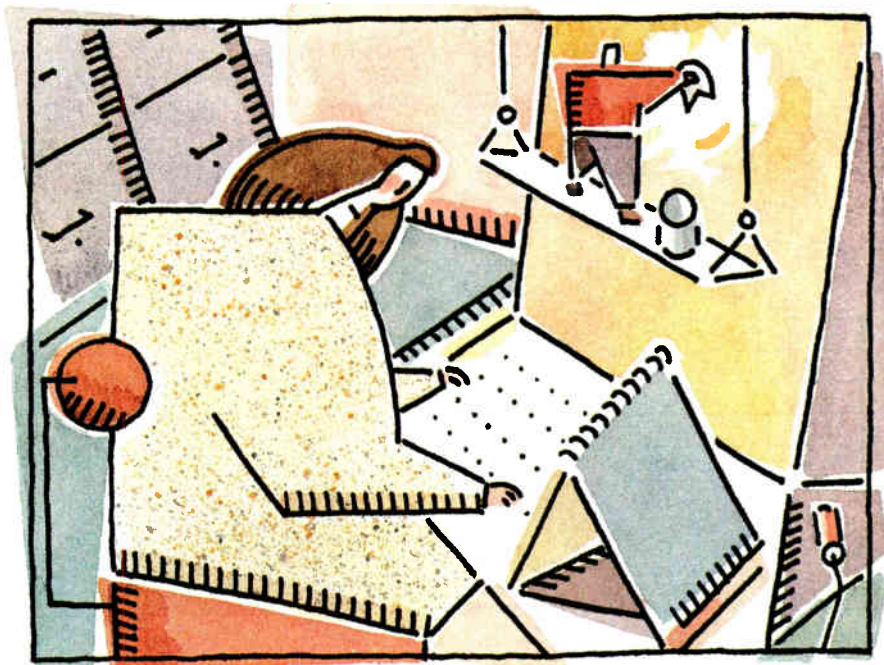

tion to translate input strings into the internal representations of floating-point numbers, integers, and so on. If `scanf()` encounters an alphabetic character when it's expecting a digit, it aborts the scan. The contents of arguments whose values were not successfully input remain unchanged, which in this case is another way of saying "random." Although `scanf()` returns the number of successful conversions, some programs don't check this return value. The results are at least unexpected and at most spectacular.

BASIC programmers will recognize this as the famous "Redo from start" problem—that cryptic message being what most BASIC interpreters respond with if you enter a text string at a prompt that expects numeric input. When this happens, BASIC reissues the input prompt and you get to try again. It's a mixed blessing: The program doesn't bomb, but any orderly data-entry screen

you may have painted is usually mucked up by the error message. I suppose the message comes from the fact that if you enter improper data for *any* argument in a multivariable INPUT statement, you have to reenter all the values—even those you got right. Thus, for example, if the BASIC statement is

```
100 INPUT A,B,C
```

and you enter

```
1,2,HELLO
```

even though BASIC gagged only on "HELLO," you've got to reenter the whole line.

I See the Light

This was a speed bump that I hit no matter what language I programmed in. I needed input formatting at the time the

continued

input was taking place, not after the user had hit the carriage return. Finally, while employed as a programmer a few years ago, I saw what I thought was the best antidote on a Qantel minicomputer.

Qantel used semi-intelligent terminals to which the programmer could download an input template that controlled the location and type of input data. Thus, you could tell the terminal, "Allow the user to enter a 10-digit number here, a 30-character string over there, and a nine-digit floating-point number down there." The terminal did input filtering locally. Users simply could not enter a non-number in a numeric field; if they tried, the system would beep and refuse to echo the character.

Qantel's input template approach had

three benefits going for it. First, it neatly handled the problem of the user entering the wrong type of data. If the cursor was in a field defined to be numeric, the computer would accept only digits, a decimal point, or plus and minus signs.

Second, it gave the user some feedback regarding the precision of a numeric field. For example, say your program has defined an input variable that was used as a percentage, but this variable was expected to be integer only. On a system without input formatting, you might enter 15.95 only to see that figure show up later on some report as 16 (or, if you've used truncation, 15). Using the input template approach, your program could define that percentage field as being integer only, and the terminal would

have refused to accept a decimal point.

Finally, the input handler kept all numbers right-justified. As the user typed digits in, they scrolled to the left, as on a calculator's display. So your program could define a column of numbers, and all the decimal points would line up. Your program could total that column and keep the dollars over the dollars and the cents over the cents without having to redisplay the figures. This resulted in orderly looking displays that the sales people were particularly fond of showing off at demonstration time.

After I'd moved from minicomputers to microcomputers, I was determined to bring that kind of input formatting along with me. Most of my early work on microcomputers was in interpreted BASIC on CP/M machines, so I strung together a machine language USR routine that was a good substitute for the input template. Now I figure it's time to bring it over to the MS-DOS world.

IMAN to the Rescue

The input manager (I'll call it IMAN) gives you the ability to define formatted input fields on-screen. I've tried to make IMAN as language-independent as possible. IMAN is a TSR program. Executing IMAN.EXE installs the input manager at interrupt 62H and returns to DOS. Consequently, you can use IMAN with interpreters as well as with compilers; you don't have to link IMAN into your application. (Aside: This is not a new use for TSR programs; other packages use this technique, so they won't be tied to a particular language. NetBIOS and Btrieve are two good examples.)

Your program sends requests to IMAN via a *message block*. The format for this block is shown in figure 1. In most languages, this block will simply be an array of integers. (I'll give sample call and return interfaces for six popular compilers and interpreters later.) IMAN expects the offset to this array in the BX register, and the array's segment in the DS register.

The first 2 words (each word is 2 bytes) of the message block are the segment and offset to a string buffer. This is where IMAN will put the user's input. Depending on what language you're using, the string buffer will be either a character array or a string in the caller's program. If there's any data in the buffer when you call IMAN, the routine will display it and allow the user to edit the data. So you can use IMAN for data editing as well as data-entry displays.

The next word holds the screen coordinates of the input field. The coordinates

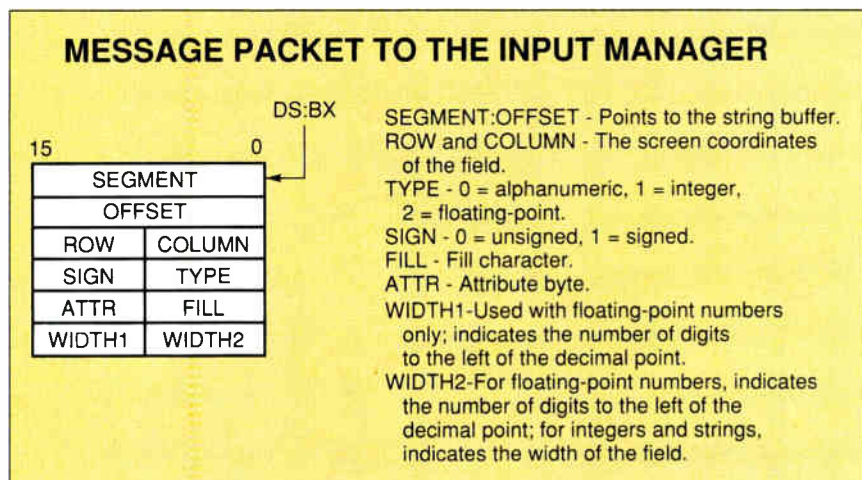

Figure 1: Requests to the IMAN TSR program include a reference to a message block. The first two words point to the location of the string buffer. The rest of the structure describes the attributes of the data-entry field.

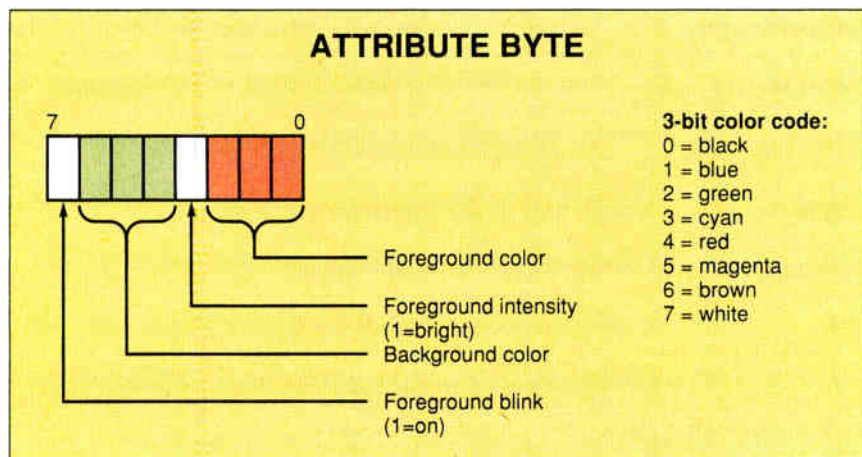

Figure 2: In text mode on the PC display memory, each character occupies 1 word of screen memory: 1 byte for the character and 1 byte for the attribute (the character's color and enhancements). Different types of displays use the attribute byte differently.

are in row/column form, with the low byte holding the column and the high byte holding the row.

The word following the screen coordinates is likewise divided into 2 bytes. The value of the low byte indicates what kind of data IMAN will allow the user to enter: alphanumeric, integer, or floating-point. The high byte pertains only to numeric fields and should be set to either 0 or 1. A 0 indicates that the field is unsigned—IMAN will not allow the user to enter a “+” or “-” character—while a 1 denotes a signed field.

The low byte of the next word holds the fill character. IMAN displays fill characters for vacant portions of the entry field. Typically, you’ll use the underscore character for a fill character, so the user can instantly tell how wide the entry field is. The high byte is the attribute byte, which controls the color and intensity of the foreground and background for each character in the entry field. See figure 2 for a layout of the attribute byte.

Finally, the last word controls the field width. For alphanumeric and integer fields, the low byte determines the field width. For floating-point fields, the high byte indicates the number of characters to the left of the decimal point, and the low byte indicates the number of characters to the right.

Since IMAN returns its results as a string, it’s up to the calling program to convert that string to its actual value. I didn’t want to burden IMAN with ASCII-to-integer and ASCII-to-floating-point routines; support for that would be in the language of the calling application, anyway. In C, you’d use the `scanf()` function; in BASIC and Pascal, you’d use the `VAL()` function; and in Modula-2 you’d use the `StrToInt()`, `StrToCard()`, or `StrToReal` functions.

IMAN expects and returns null-terminated strings, which causes some difficulties for languages that precede strings with a length byte. In the upcoming examples, you’ll see that this is easy to deal with.

Turbo C

Calling IMAN from Turbo C is easily handled by the routine shown in listing 1. The character array `imbuf` holds the null-terminated string that the user types in. Notice that I return the length of the string as the function value. This makes it easy for a calling application to determine whether the user actually entered anything.

The toughest trick to pull off is determining the segment and offset address of

continued

Listing 1: Calling IMAN from Turbo C.

```
#include <stdio.h>
#include <dos.h>
char imbuf[80];
/*
** Interface to IMAN. Assumes a global character
** array called imbuf. The contents of imbuf should
** be terminated with a null.
*/
int
calliman(imrow,imcol,imsign,imtype,imattr,imfill,imw1,imw2)
unsigned int imrow,imcol; /* Screen coordinates */
unsigned int imsign; /* Sign control */
unsigned int imtype; /* Format type */
unsigned char imattr; /* Attribute byte */
unsigned char imfill; /* Fill character */
unsigned int imw1,imw2; /* Field widths */
{
    unsigned int immes[6]; /* Message */
    struct REGPACK cpuregs;

    immes[0]=FP_SEG((char far *)imbuf);
    immes[1]=FP_OFF((char far *)imbuf);
    immes[2]=(imrow<<8) | imcol;
    immes[3]=(imsign<<8) | imtype;
    immes[4]=(unsigned int)(imattr<<8) | imfill;
    if(imtype!=2) imw1=0;
    immes[5]=(imw1<<8) | imw2;

    /* Load the cpu registers */
    cpuregs_r_ds=FP_SEG((unsigned int far *)immes);
    cpuregs_r_bx=FP_OFF((unsigned int far *)immes);

    /* Call IMAN */
    intr(0x62,&cpuregs);

    return(strlen(imbuf));
}
```

Listing 2: The Turbo Pascal interface to IMAN.

```
USES DOS, CRT;

VAR
    IMBUF: STRING[80];

{ This function calls IMAN. It expects that you've already
  defined a global string named IMBUF. }

FUNCTION
CALLIMAN(imrow,imcol,imsign,imtype,
imfill,imattr,imw1,imw2: INTEGER): INTEGER;
VAR
    pereg: REGISTERS;
    IMMES: ARRAY[0..5] OF INTEGER;
BEGIN
    IMBUF:=IMBUF + #0; { Append a null }
    IMMES[0]:=SEG(IMBUF); { Segment }
    IMMES[1]:=OFS(IMBUF)+1; { Offset }
    IMMES[2]:=(IMROW SHL 8) OR IMCOL;
    IMMES[3]:=(IMSIGN SHL 8) OR IMTYPE;
    IMMES[4]:=(IMATTR SHL 8) OR IMFILL;
    IF IMTYPE<>2 THEN IMW1:=0;
    IMMES[5]:=(IMW1 SHL 8) OR IMW2;

    { Set up registers }
    pereg.BX:=OFS(IMMES[0]);
    pereg.DS:=SEG(IMMES[0]);

    { Call the interrupt }
    INTR($62,pereg);

    { Fix the returned string }
    IF POS(#0,IMBUF)=1 THEN
        CALLIMAN:=0
    ELSE
        BEGIN
            IMBUF:=COPY(IMBUF,1,POS(#0,IMBUF)-1);
            CALLIMAN:=SIZEOF(IMBUF);
        END;
END; { CALLIMAN }
```

the string buffer and the message array. (You'll see that this is true for the other languages as well.) Turbo C provides two macros, `FP_SEG` and `FP_OFF`, that return the segment and offset components, respectively, of a far pointer type. Since `imbuf` is an array, and since there's no telling what memory model the final application will be running in, you've got to use coercion—hence the `(char far *)` prefix.

Once the message's contents are properly loaded, you call Turbo C's `intr()` function, which in turn calls IMAN's interrupt. The first argument to `intr()` is the interrupt number, and the second is the pointer to a structure of type `REGPACK` (which is defined in the `dos.h` include file). You can set the contents of the CPU's registers at the time of the interrupt call by storing into the elements of the `REGPACK`, and it holds an image of the registers' states when the interrupt routine returns. Since IMAN terminates the string with a null prior to returning to the calling program, the contents of `imbuf` are C-compatible.

Turbo Pascal

In listing 2, you'll find the Turbo Pascal interface to IMAN. The main difference between how Turbo C and Turbo Pascal handle the call to IMAN—beyond the fact that they are two different languages—springs from the differences in how each language handles strings. In C, a string is an array of characters terminated by a null. In Pascal, a string is an

array of characters preceded by a length byte. Since IMAN handles strings in the fashion of C, you've got to do some front-end and back-end work.

In listing 2, you can see that I've loaded the array element `IMES[1]`—where `IMES[]` holds the message block—with the offset of the string buffer plus 1. In this way, the offset passed to IMAN points to the first character of the string, not its byte count.

Setting the CPU registers in Turbo Pascal looks notably similar to Turbo C's method. Only the nomenclature is changed: C uses structures, while Pascal uses records. Even the name of the procedure call is the same: `INTR()`.

Once IMAN returns, you've got to purge the trailing null character from `IMBUF`. Otherwise, the `VAL()` function, which is Pascal's counterpart to C's `sscanf()`, will refuse to convert numeric entry. I accomplished this with Pascal's `COPY()` function, copying `IMBUF` on top of itself, excluding the final null character. The net effect is to decrement `IMBUF`'s length byte.

GWBASICS

Deriving a working interface to IMAN for GWBASICS requires some programming gymnastics that, if properly accomplished, will really impress your friends. Deep Thought says it best: "Tricky." See listing 3.

To make it through this maneuver, you need to rely heavily on GWBASICS's `USR` function, which allows your program to

call a machine language subroutine. A `USR` function accepts one argument, which is made available to the subroutine in a field referred to as the `FAC` (for floating-point accumulator). Fortunately, GWBASICS sets the `BX` register to point into the `FAC`. The subroutine can send back an integer to the calling BASIC program by placing a value into the `FAC` prior to issuing a `RETF` instruction.

My first `USR` routine appears in lines 50000 through 50005, where I'm using a three-element integer array (`IMCAL%`) to hold a short, three-instruction machine language routine that moves the `DS` register to the location pointed to by the `BX` register and then returns. The `VARPTR(IMCAL%(0))` statement returns the address of the first variable of that array, which, in this case, is the beginning of the machine language subroutine. The end result is that the contents of the `DS` register show up in the variable `BASDS%`. You'll see why I need the `DS` register momentarily.

The actual call to IMAN takes place starting at line 51000, where I redefine the `USR` function to point to another short routine consisting of

```
MOV  BX,[BX] ;Get the integer
                    argument
INT  62H      ;Call IMAN
RETF                    ;Back to BASIC
```

Then I load up the array `IMMES%` with the message information that IMAN expects. Here's where I use `BASDS%`; since that variable holds the value of GWBASICS's `DS` register, it is therefore the segment address of the string buffer that IMAN uses to capture the user's input. (Since GWBASICS keeps all data in a single segment, the `DS` register on entry to IMAN is set to the same value as in `BASDS%`, so you may be wondering why I bothered putting `DS` into `BASDS%` in the first place. The reason is that IMAN doesn't know who is calling, and therefore doesn't know that the caller's `DS` is the same as the string buffer's segment.) Once `IMMES%` is properly set up, I execute the `USR()` function, which transfers to IMAN.

When IMAN returns, the input string is in `IMBUF$`, terminated by a null. It's a simple matter to determine the string's length with an `INSTR()` function. If the input was numeric, you use `VAL()` to convert it from characters to a usable number.

It's important to note that `VARPTR` can be a tricky function, particularly if you use it in conjunction with arrays and

continued

Listing 3: Calling IMAN from GWBASICS.

```
5 DEFINT A-Z
9 'Dimension stuff for IMAN
10 DIM
IMCAL$(3),IMMES$(6)
15 GOSUB 50000 'Initialize IMAN
...Your program goes here...
49999 'Determine BASIC's DS register
50000 IMCAL$(0)=&HD88C:IMCAL$(1)=&H789:IMCAL$(2)=&HCBCB
50005 BASDS%=0:DEF USRO=VARPTR(IMCAL$(0)):BASDS%=USRO(IMCAL$(0))
50009 'Build routine to call IMAN
50010 IMCAL$(0)=&H1F8B:IMCAL$(1)=&H62CD:IMCAL$(2)=&HCBCB
50015 IMBUF$=STRING$(80,0) 'Build buffer
50020 RETURN
50099 'Entry point to IMAN
50100 IMMES$(0)=BASDS% 'Segment
50104 IF LEN(IMBUF$)<80
THEN IMBUF$=IMBUF$+STRING$(80-LEN(IMBUF$),0)
50105 IMMES$(1)=VARPTR(IMBUF$)+1 'Address of offset
50106 IMMES$(1)=CVI(CHR$(PEEK(IMMES$(1)))+
CHR$(PEEK(IMMES$(1)+1)))
50110 IMMES$(2)=CVI(CHR$(IMCOL$) +
CHR$(IMROW$)) 'Screen coordinates
50115 IMMES$(3)=CVI(CHR$(IMFYP$) +
CHR$(IMSTYP$)) 'Sign control and format
50120 IMMES$(4)=CVI(CHR$(IMFILL$) +
CHR$(IMATTR$)) 'Attribute and fill
50125 IF IMFYP$ <> 2 THEN IMW1%=0
50130 IMMES$(5)=CVI(CHR$(IMW2$) + CHR$(IMW1$)) 'Field width
50135 DEF USRO=VARPTR(IMCAL$(0))
50140 IMMES$(0)=USRO(VARPTR(IMMES$(0)))
50150 RETURN
```

Mass Storage Is No Longer A Peripheral Issue.

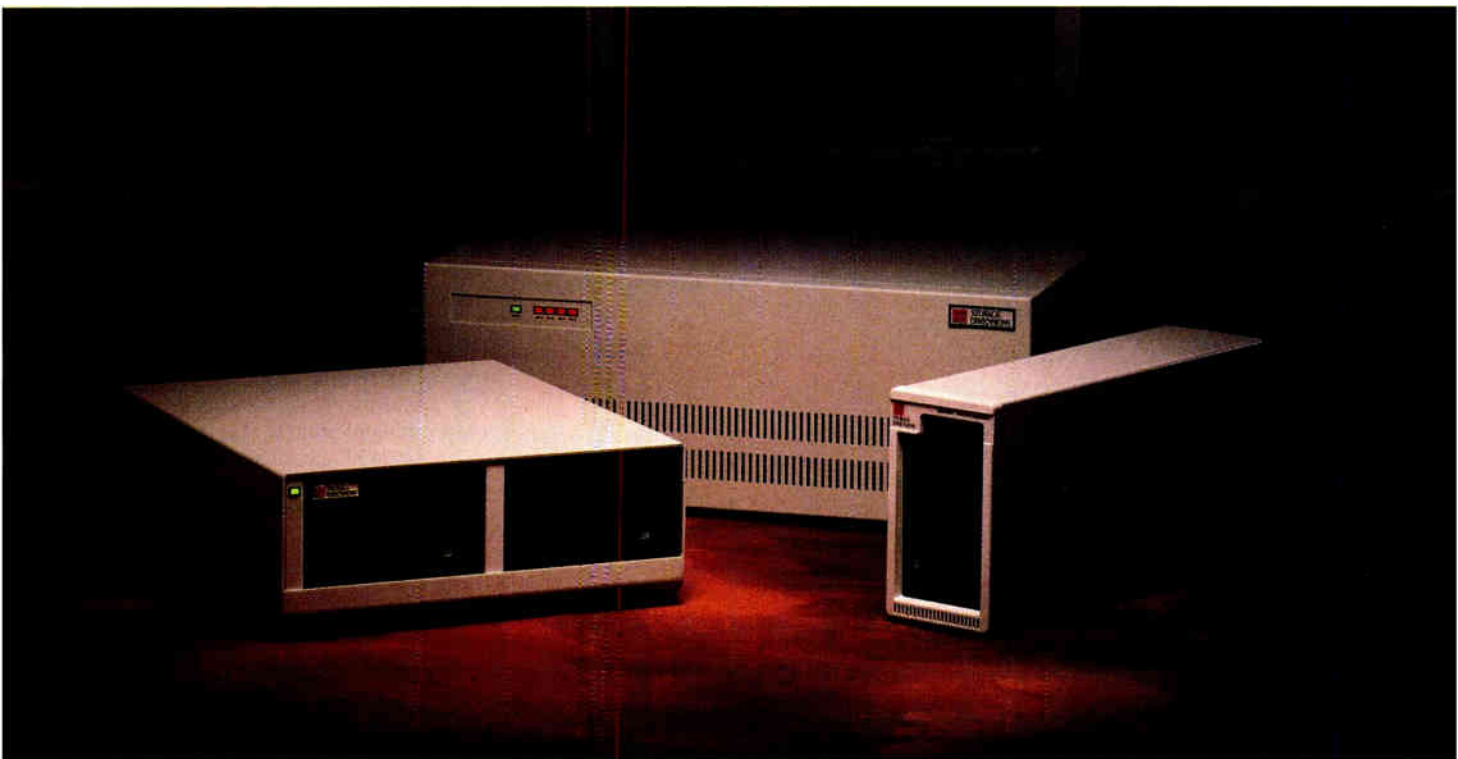

It's The Central Issue.

And it should be. Today's top end computer platforms have created dazzling new dimensions in CAD/CAE, data bases, networking and specialized DOS applications. More than ever, storage performance and capacity are central concerns.

And more than ever, Storage Dimensions is the logical solution.

With our SpeedStor™ hard disk subsystems, you get the best possible performance specs. But you get more than 14 ms access times and 15 Mbit transfer

MICRO CHANNEL™

COMPAQ®

HIGH-SPEED 386s

rates. You get our expertise in translating those specs into maximum system throughput—delivering to your application all of the performance it can handle. And all of the capacity it will ever demand. In configurations that include single 650 MB internal storage systems, external enclosures that expand to four drives and 2.6 GB, and many more.

To get the most from today's most powerful desktops, start at the center. Start with Storage Dimensions. Call (408) 879-0300. Or write us at 2145 Hamilton Avenue, San Jose, CA 95125.



STORAGE DIMENSIONS

A MAXTOR COMPANY

SpeedStor is a trademark of Storage Dimensions, Inc. ©1989 Storage Dimensions

Circle 381 on Reader Service Card (DEALERS: 382)

World Radio History

strings, as I have here. This is due primarily to GWBASIC's being an interpreter rather than a compiler. As a program executes and arrays are created and strings grow and shrink, the interpreter moves variables around in memory. So the results of a VARPTR function may not be valid after the execution of a DIM statement or any string function. All you can do is remain aware of this phenomenon and use the results of a VARPTR function as soon after its execution as possible.

Turbo Basic

The Turbo Basic command set includes members specialized for direct access of the CPU. Consequently, you don't have to perform all the black magic as in GWBASIC. See listing 4.

You'll notice that deriving the contents of the first two entries in the message array has become considerably more complex. Gosh, there are actual PEEK statements in there. In Turbo Basic, it's much more difficult to determine the physical location of a string variable.

Most variables are kept in a segment pointed to by the DS register, and it's a trifle to determine this segment using the VARSEG() operator (identical in function to the OFS() functions of C and Pascal). But when you sic VARPTR() and VARSEG() on a string variable, you end up with the address of a 4-byte string descriptor. This descriptor resides in the DS segment, and its last 2 bytes are the offset to the string body. The string body is kept off in another segment called the string segment, and you can find out where that is by looking in the first memory word of the data segment. Whew!

It's convenient to use Turbo Basic's constants to attach a symbolic name to the values that pick the format type and sign handling. This makes code easier to read and understand, because you can write statements such as

```
IMFTYP% = %ISFLOAT
```

rather than

```
IMFTYP% = 2
```

For all their differences, there are still many similarities between the code in listing 4 and the code that I presented for GWBASIC. Two new statements appear in the vicinity of the actual call to IMAN. The CALL INTERRUPT statement is Turbo Basic's way of calling a software interrupt directly. This statement takes one argument, the interrupt vector number.

But before you call a software interrupt, you need some way of loading the processor's registers. Enter the REG statement. REG takes two arguments. The first argument must resolve to a value in the range 0 to 9 and select which register you want loaded. Your chosen register is loaded with the value given by the second argument. As you execute REG statements, you are actually writing information into a "register buffer" that Turbo Basic maintains internally. When the CALL INTERRUPT statement executes, Turbo Basic first loads the processor's registers from the register buffer before transferring to the interrupt routine.

Once again, I've built the function so that it returns the number of characters that the user actually entered.

Microsoft QuickBASIC

The interface to the input manager for Microsoft's QuickBASIC, which appears in listing 5, looks like an amalgam of all the listings that have preceded it.

continued on page 442

Listing 4: Calling IMAN from Turbo Basic.

```
DEFINT A-Z
%UNSIGNED = 0 'No sign
%SIGNED = 1 'Signed, show plus
%ISALPHA = 0 'Alphanumeric field
%ISINTEGER = 1 'Integer field
%ISFLOAT = 2 'Floating-point field
%IMANVEC = &H62 'Interrupt vector for IMAN

DIM IMMES$(6) 'Message
IMBUF$=STRING$(80,0) 'String buffer

DEF FNCALLIMAN%(IMROW%,IMCOL%,IMSIGN%,IMTYPE%,IMFILL%,IMATTR%,IMW1%,IMW2%)
DEF SEG 'Set segment to start-up
IF LEN(IMBUF$)<80 THEN
IMBUF$=IMBUF$+STRING$(80-LEN(IMBUF$),0)
END IF
IMMES$(0)=CVI(CHR$(PEEK(0))+CHR$(PEEK(1)))
IMMES$(1)=VARPTR(IMBUF$)+2
IMMES$(2)=CVI(CHR$(PEEK(IMMES$(1)))+CHR$(PEEK(IMMES$(1)+1)))
IMMES$(3)=CVI(CHR$(IMCOL%)+CHR$(IMROW%))
IMMES$(4)=CVI(CHR$(IMTYPE%)+CHR$(IMSIGN%))
IMMES$(5)=CVI(CHR$(IMFILL%)+CHR$(IMATTR%))
IF IMTYPE% <> %ISFLOAT THEN IMW1%=0
IMMES$(6)=CVI(CHR$(IMW2%)+CHR$(IMW1%))

REG 8,VARSEG(IMMES$(0)) 'Set DS register
REG 2,VARPTR(IMMES$(0)) 'Set BX register
CALL INTERRUPT &H62
FNCALLIMAN%=INSTR(IMBUF$,CHR$(0))
END DEF
```

Listing 5: Calling IMAN from QuickBASIC.

```
DECLARE FUNCTION IMAN% (IMROW%, IMCOL%, IMSTYP%,
IMFTYP%, IMATTR%, IMFILL%, IMW1%, IMW2%)

DIM SHARED INPUTREGS AS RegTypeX, OUTPUTREGS AS RegTypeX
DIM SHARED IMMES$(6)
DIM SHARED IMBUF$

FUNCTION IMAN% (IMROW%, IMCOL%, IMSTYP%, IMFTYP%,
IMATTR%, IMFILL%, IMW1%, IMW2%)

IF LEN(IMBUF$) = 0
THEN IMBUF$ = STRING$(80, 0)
ELSE IMBUF$ = IMBUF$ + STRING$(80 - LEN(IMBUF$), 0)
IMMES$(0) = VARSEG(IMBUF$) 'Segment
IMMES$(1) = VARPTR(IMBUF$)+2 'Address of offset
IMMES$(1) = CVI(CHR$(PEEK(IMMES$(1))) +
CHR$(PEEK(IMMES$(1)+1)))
IMMES$(2) = CVI(CHR$(IMCOL%) + CHR$(IMROW%))
IMMES$(3) = CVI(CHR$(IMFTYP%) + CHR$(IMSTYP%))
IMMES$(4) = CVI(CHR$(IMFILL%) + CHR$(IMATTR%))
IF IMFTYP% <> 2
THEN IMW1% = 0
IMMES$(5) = CVI(CHR$(IMW2%) + CHR$(IMW1%))

INPUTREGS.bx = VARPTR(IMMES$(0))
INPUTREGS.ds = VARSEG(IMMES$(0))
CALL INTERRUPTX(&H62, INPUTREGS, OUTPUTREGS)
IMAN% = INSTR(IMBUF$, CHR$(0))

END FUNCTION
```

PRODUCT SHOWCASE

■ BUYER'S MART
■ BYTE BITS

■ PRODUCT SPOTS
■ MICRO PRODUCT CENTER



THE BUYER'S MART

A Directory of Products and Services

THE BUYER'S MART is a monthly advertising section which enables readers to easily locate suppliers by product category. As a unique feature, each BUYER'S MART ad includes a Reader Service number to assist interested readers in requesting information from participating advertisers.

Effective January 1, 1990.

RATES: 1x—\$590 3x—\$550 6x—\$525 12x—\$475 24x—\$450

Prepayment must accompany each insertion. VISA/MC Accepted.

AD FORMAT: Each ad will be designed and typeset by BYTE. Advertisers must

furnish typewritten copy. Ads can include headline (23 characters maximum), descriptive text (250 characters is recommended, but up to 350 characters can be accommodated), plus company name, address and telephone number. Do not send logos or camera-ready artwork.

DEADLINE: Ad copy is due approximately 2 months prior to issue date. For example: November issue closes on September 8. Send your copy and payment to THE BUYER'S MART, BYTE Magazine, 1 Phoenix Mill Lane, Peterborough, NH 03458. For more information call Brian Higgins at 603-924-3754.

ACCESSORIES

CUT RIBBON COSTS!

Re-ink your printer ribbons quickly and easily. Do all cartridge ribbons with just one inker! For crisp, black professional print since 1982. You can choose from 3 models:

Manual E-Zee Inker — \$39.50

Electric E-Zee Inker — \$94.50

Ink Master (Electric) — \$189.00

1000s of satisfied users. Money-back guarantee.

BORG INDUSTRIES

525 MAIN ST., JAMESVILLE, IA 50647

1-800-553-2404 Fax: 319-987-2251

Inquiry 576.

APPLICATION GENERATOR

PRODUCE APPLICATIONS \$\$

Now you can produce quality Applications and Reports to your exact needs or customer requirements with absolutely no programming needed! MASTERMIND is fast, simple, very easy to use, reliable and delivers plenty of performance and lots of features. Why buy a shell full of software when all you need is MASTERMIND? Call or write for brochure.

SimuLINK Technology Corporation

15455 N. Greenway-Hayden Loop Rd., C-1
Scottsdale, AZ 85260 1-800-328-4566

Inquiry 581.

ARTIFICIAL INTELLIGENCE

muLISP™ 87 for MS-DOS

Fast, compact, efficient LISP programming environment. muLISP programs run 2 to 3 times faster & take 1/2 to 1/3 the space of other LISPs. 450 Common LISP functions, multi-window editing & debugging, flavors, graphics primitives, lessons & help, demo programs, comprehensive manual.

Soft Warehouse, Inc.

3615 Harding Ave., Suite 505, Honolulu, HI 96816
(808) 734-5801

Inquiry 585.

ARTIFICIAL INTELLIGENCE

MANA

Intelligent Computing for 286/386

Transform your PC into an AI-based workstation. Expert systems, AI, knowledge base applications, rapid prototyping, object oriented, multi-tasking, virtual memory, LISP/PROLOG etc. modes in multi-language compiler, mouse driven, multi-windowed, fully integrated environment.

BMS, Inc.

700 E. Ogden Avenue, Westmont, IL 60559
Tel: (708) 789-9160 Fax: (708) 789-0253

Inquiry 582.

BAR CODE

PRINT BAR CODES/BIG TEXT FROM YOUR PROGRAM

Add bar codes and big graphics characters to your program. Print from ANY MS-DOS language. Bar codes: UPC, EAN, 2 of 5, MSI, Code 39, Epson, Oki, IBM dot matrix text up to 1/2". LaserJet up to 2". Font cartridges not required. \$179-\$239. 30-day \$\$ back.

Worthington Data Solutions

417-A Ingalls St., Santa Cruz, CA 95060
(800) 345-4220 In CA: (408) 458-9938

COMPANION AND EXTENDER

Place a keyboard and monitor up to 600' from your CPU with EXTENDER and COMPANION products. Keep a second Keyboard/Monitor at the CPU with COMPANION. Supports MDA, CGA, EGA, VGA, PS2. Uses single 3/4" cable.

Prices start at \$149.00 for EXTENDER and \$219.00 for COMPANION 25 ft. unit complete.

CYBEX CORPORATION

2800-H Bob Wallace, Huntsville, AL 35805

205-534-0011 International Fax #205-830-1947

Inquiry 577.

FREE CATALOG

A complete source for computer supplies at low prices. Fast Service. Call, write or circle inquiry card for a FREE CATALOG. Use your VISA, MC or COD to order the following bulk diskettes

5.25" DS/DD (Min 50) 26¢

5.25" DS/HD (Min 50) 62¢

3.5" DS/DD (Min 30) 89¢

GAAN COMPUTER SUPPLIES

186 B East Sunnyoaks Ave., Campbell, CA 95008
(800) 523-1238, In Calif. (408) 370-6747

Inquiry 578.

NATURAL LANGUAGE C LIBRARY

Increase your market share! Use JAKE to add a natural language front end to your application. JAKE translates English queries and commands into C function calls and data structures. JAKE offers context-sensitive semantic processing; interfaces easily; <64K mem.

JAKE \$495. INTERACTIVE DEMO \$10

ENGLISH KNOWLEDGE SYSTEMS, INC.

5525 Scotts Valley Dr. #22, Scotts Valley, CA 95066
(408) 438-6922

Inquiry 583.

PORTABLE READER

Battery-operated, handheld reader with 64K static RAM, 2x16 LCD display, 32-key keyboard, Real-Time-Clock. Wand or laser scanner. Program prompts and data checking through its own keyboard. Easy data transfer by RS-232 port or PC, PS/2 keyboard. Doubles as On-Line Reader. 30-day \$\$ back.

Worthington Data Solutions

417-A Ingalls St., Santa Cruz, CA 95060
(800) 345-4220 In CA: (408) 458-9938

REFILL LASER PRINTER & COPIER CARTRIDGES

Don't throw away that used laser printer or copier cartridge. Refill it and save over 75%, it's easy. For use with Canon EP & EPS cartridges, HP LaserJet & LaserJet II, Apple Laserwriter & Laserwriter II, Canon LPB, FAX, and many others. Also kits for Canon Copiers. We have colors for laser printers. Dealers Welcome. VISA/MC

COMPLETE REFILL KIT \$29.95

Includes toner, felt pad, and instructions.

VIDEO TAPE PROGRAM \$45.00

Shows disassembly, cleaning, and remanufacture.

MORACK INC.

9132 Windsor Dr., Palos Hills, IL 60465 (800) 837-9696

For order or information (708) 598-0580 FAX: (708) 598-9203

Inquiry 579.

PROFESSIONAL SEARCH ALGORITHMS

\$79

Five broad-spectrum packages for solving problems requiring search: Depth-First, Breadth-First, Depth-First-Iterative-Deepening, Cheapest-First, Best-First (includes A*). Coded for maximal efficiency in Turbo Pascal for PC/comp. Source code & manual. Written in object-oriented, declarative (problem specification) style to facilitate integration into larger applications.

EXPLORATIONS

6581 Acacia Ave., Garden Grove, CA 92645

Inquiry 584.

PRINT BAR CODES AND BIG TEXT

On EPSON, IBM, OKI dot matrix or LaserJet. Flexible design on one easy screen. Any format/size. Up to 120 fields/label. 13 text sizes to 1" readable at 50'. AIAG, MIL-STD, 2 of 5, 128, UPC/EAN, Code 39. File Input & Scanned logos/symbols (PCX)—\$279. Other programs from \$49. 30-day \$\$ back.

Worthington Data Solutions

417-A Ingalls St., Santa Cruz, CA 95060
(800) 345-4220 In CA: (408) 458-9938

HP LASERJET II M-E-M-O-R-Y

1MB-2MB-4MB MEMORY EXPANSION BOARDS

Save 50%-60%

2-YEAR WARRANTY

STARION CORPORATION

(800) 782-8297 CA: (714) 750-2627

Inquiry 580.

NanoLISP \$99.99

An MS-DOS Common LISP interpreter that supports most Common LISP operations and strictly adheres to the standard. Numerous advanced and extra features, excellent debugging facilities, sample AI programs, fully-indexed manual, free technical support.

Microcomputer Systems Consultants

P.O. Box 6646, Santa Barbara, CA 93160

(805) 967-2270

BAR CODE READERS

For PC, XT, AT, & PS/2, all clones, and any RS-232 terminal. Acts like 2nd keyboard, bar codes read as keyed data. With steel wand—\$399. Top rating in independent reviews. Works with DOS, Xenix, Novell, Alloy, -ALL software. Lasers, magstripe, & slot badge readers. 30-day \$\$ back.

Worthington Data Solutions

417-A Ingalls St., Santa Cruz, CA 95060
(800) 345-4220 In CA: (408) 458-9938

THE BUYER'S MART

BAR CODE

BAR CODE SOFTWARE SOLUTIONS

ISD has software solutions that allow you to use bar codes for most anything. Like identifying products. Labeling packages. Or even managing assets and paperwork. You'll be able to speed and simplify data collection. Track products dock-to-stock. Streamline inventory control. And more.

Integrated Software Design, Inc.

171 Forbes Blvd., Mansfield, MA 02048
TEL: (508) 339-4928 FAX: (508) 339-2257
© 1989 Integrated Software Design, Inc.

Inquiry 586.

PC-Wand Bar Code Solutions

Bar codes are easy with a FULL line of readers & printers. They plug & play with your existing systems. most all makes of CP/Printer/terminal/software in your office, store, truck, factory or warehouse. Our bar code DOS programs print on matrix or laser printers. 30 day refund, 1 year warranty.

International Technologies & Systems Corp.

635-C North Berry St., Brea, CA 92621
TEL: (714) 990-1880 FAX: (714) 990-2503

Inquiry 587.

WHEN EASE-OF-USE COUNTS

Reading bar codes should be as easy as a "quick flick of the wrist." But many bar code readers require you to flick and flick and flick and FLICK until the bar code label is finally read. PERCON designed bar code readers that *really are* as easy as a "quick flick of the wrist."

PERCON

2190 W. 11th Ave., Eugene, OR 97402
Phone: (800) 873-7266 FAX: (503) 344-1399

PERCON: THE BAR CODE SPECIALISTS

If you have questions about bar code technology, it's nice to know an experienced, friendly bar code specialist is only a phone call away. Want to know where to start or where to find hard-to-find bar code accessories? Call PERCON for answers.

PERCON

2190 W. 11th Ave., Eugene, OR 97402
Phone: (800) 873-7266 FAX: (503) 344-1399

5-YR. WARRANTY AT PERCON

PERCON decoders are now covered by a five-year limited warranty. That means you won't spend one cent replacing your PERCON bar code decoder for five full years. That's reliability you can count on!

PERCON

2190 W. 11th Ave., Eugene, OR 97402
Phone: (800) 873-7266 FAX: (503) 344-1399

PC BAR CODE SPECIALISTS

Bar code readers designed for fast, reliable, cost effective data entry. Looks just like keyboard data. Choose from stainless steel wand or laser interface. Also, powerful Bar Code and Text printing software. Great warranty. Dealer inquiries welcome.

Seagull Scientific Systems

15127 N.E. 24th, Suite 333, Redmond, WA 98052
206-451-8966

BAR CODE

BAR CODE READERS

Among the best and most widely used bar code decoders. Reads all major codes (39, 1 2/5, S 2/5, UPC/EAN/JAN, CODABAR, MSI). Connects between keyboard and system. IBM, PS/2, MAC, DEC-VT compatible. OS & software independent. Same day ship. 2 Year Warranty (pen incld).

Large Reseller Discounts.

Solutions Engineering

4705 Langdrum Lane, Bethesda, MD 20815
(800) 635-6533 (301) 652-2738

Inquiry 588.

DATA INPUT DEVICES

Bar Code, Magnetic Stripe Readers & SmartCard Encoder/Reader for microcomputers & terminals, including IBM PS/2 & others, DEC, Macintosh, AT&T, CT, Wyse, Wang. All readers connect on the keyboard cable & are transparent to all software. UPC & 39 print programs, magnetic encoders, & portable readers are also available.

TPS Electronics

4047 Transport, Palo Alto, CA 94303
415-856-6833 Telex 371-9097 TPS PLA
FAX: 415-856-3843

Inquiry 589.

VARIANT MICROSYSTEMS BAR CODE READERS DELIVER

WAND/LASER/MAGNETIC CARD CONNECTIVITY

- Keyboard wedges (Internal/External) for IBM PC/XT/AT, PS/2 and portables.
- RS232C wedges for WYSE, Link, KImtron terminals
- Bar code and label printing software
- Full two-year warranty
- 30-Day Money-Back Guarantee
- Extensive VAR/Dealer Discounts

3140 De La Cruz Blvd., Suite 200/Santa Clara, CA 95054/(408) 980-1880
FAX: (415) 623-1372

Inquiry 590.

BASIC CLIP MUSIC

300 Songs & Sound Effects

The *ENTER-tainer* contains by far the biggest & best collection on the market for DOS machines. Play like a jukebox through your PC speaker or use selections in your own programs.

No royalties required—source code included.

An Excellent Gift!

172-pg. manual, 5.25" or 3.5" disks, BASIC 2.0 or later req'd.
Dealer inquiries welcome. \$29.95 (\$35.00 U.S. s&h) MC/VISA/MC.

(800) 727-4140—Money Back Guarantee

PDI Music Software, 1511 48th St., Boulder CO 80303, (303) 440-4140

Inquiry 591.

BBS/PUBLIC DOMAIN

MedCom BBS

Use your modem to call

800/445-4BBS (800/445-4227)

81 lines, 3/12/24, 8N1

Group & private chat. Many games, including the new multiplayer, fast-action full-color graphics & sound, "Flash Attack" from Galacticomml Chess/Checkers/Othello. E-Mail, 1000s of d/f, message base, online news & entertainment. Free time & downloads.

6312 E Santa Ana Cyn Rd #361, Anaheim, CA 92807
Voice (714) 996-9999

BOOKS

BOOKS-ON-DISKS™

BABY APRIL (2 Disks) Science Fiction novel retelling the Galatea Myth \$10.00
LEFEU (2 Disks) Misadventures of Rene Lefeu, revolutionary, lower, & klutz \$10.00
THE DEER HUNTERS (1 Disk) Horror/SF \$6.00
SERENDIPITY ANTHOLOGY (1 Disk) Demo \$4.00
• IBM-PC 5.25" disks. Shipped Postpaid in USA.
• Mention BYTE and take \$1.00 off per book.
• Fiction manuscripts wanted; query editors.

SERENDIPITY SYSTEMS

P.O. Box 140, San Simeon, CA 93452

Inquiry 592.

BRaille

BRaille PUBLISHING

Whether you have occasional word-processed memos or full-length textbooks, a Duxbury Translator enables conversion to properly contracted and formatted braille. The choice of professional publishers worldwide since 1975. Duxbury software for MSDOS, Macintosh, Unix and other systems supports: English Braille and Computer Braille (bidirectionally). Textbook Format, French, Spanish, Arabic, and others.

Duxbury Systems, Inc.

435 King St., P.O. Box 1504, Littleton, MA 01460 USA
508-486-9766

Inquiry 593.

CASE

FINITE STATE PROGRAM COMPILERS

State programs develop quicker, run faster and use less memory than sequential programs. A few keystrokes can replace hundreds of instructions. The Compiler, a CASE software development tool, forms source state programs in: Ada, BASIC, C, FORTRAN and Pascal. FOR IBM DOS.

Price \$200 per lang. (With Primer and Debugger)

Sampler \$50.00 (With all manuals & credit)

AYECO 5025 Nassau Circle, Orlando
INCORPORATED FL 32808 (407) 295-0930

Inquiry 594.

CD-ROM

CD-ROM Drives & Titles

Largest selection for PC & Mac.
Microsoft Programmers Library & Drive \$995
Computer Library \$695 • Public Domain S/W \$99.

Drives from \$699. Hundreds of titles from \$29.

MC/VISA/AMEX, Money-back Guarantee.

Call or write for free 100-page catalog.

Get it all from "The Bureau"

Bureau of Electronic Publishing

121 Norwood Ave., Upper Montclair, NJ 07043
(201) 746-3031

Inquiry 595.

Hitachi CD ROM 3600 PC/XT/AT internal kit	\$639
Hitachi CD ROM 1503S PC/XT/AT external kit	\$679
NEC CD ROM PS/2 Internal Kit	\$799
NEC CD ROM Macintosh external kit	\$3,995
Laser Drive 510 WORM kit (654MB)	\$5,795
REC-650 Magneto-optical kit (650MB)	\$349
Clip Art by NEC (IBM & Mac)	\$349
Image Folio by NEC (IBM)	\$299
Spectrum Clip Art by Aids (IBM)	\$199
Mac Guide USA by Kava (Mac)	\$299
PC Guide by Kava	\$299

Free Brochures, Dossens and Dossens of DISCS

CD ROM, INC.

1120-B 10th St., Golden, CO 80401 303-278-8550
FAX: 303-279-4322 Computerse 72007-544

Inquiry 596.

CD-ROM/WE'LL BEAT ANY PRICE

All IBM/MAC drives/titles. Call for price list, monthly specials, P.O.s, international orders welcome. Special library, school, government pricing. COD, Visa, MC, Amex

CD-ROM SHOPPER

(201) 866-1666

Fax # 303-279-4322

1168 Elm Terrace

Rahway, NJ 07065

24-HR AUTO ORDER LINE

Inquiry 597.

CD-ROM Publishing Services

Complete CD-ROM publishing services including custom software interface. Reasonable rates, fast turnaround. Call for quote.

Titles published: Food/Analyst, Econ/Stats, Consu/Stats, Agri/Stats.

Hopkins Technology

CD-ROM Publisher
421 Hazel Lane
Hopkins, MN 55343-7117
(612) 931-9376 CIS 74017,614

Inquiry 598.

THE BUYER'S MART

CD-ROM

CD WORM OULET

Call BBS and FAX 716-854-3076
Widest Selection for PC's and MAC's
 Microsoft Programmer's Library & Dev. 960. (STAT PACK & SBC 100.
 PC SIG & DRV 850. CD-ROM DRV from 500.
 BKSHLF wDRV 799.
 For XT, AT's, 386's 1yr. Parts & Labor Free

RBBS in a Box—Be a Sysop in 15 min.
 Portables available with CD-ROM DRVS
 MC/Visa/Amex/COD While Supplies Last!

Jason Enterprises

218 Pine St., Buffalo, NY 14204, CALL 716-852-6711

Inquiry 599.

CD-ROM Developer's Lab

Multimedia production resource for Mac & PC developers & managers. Proven design, management, data prep, programming, premastering, and manufacturing techniques & specs from 18 leading companies. Demos of off-the-shelf tools for imaging, audio, animation (Mac). Real applications using Media-Mixer source tools. CD-ROM XA. PC or Mac \$795; Transportable \$845. Visa or MasterCard.

Software Mart, Inc.

4131 Spicewood Springs Road I-3, Austin, TX 78759
 512-346-7887

Inquiry 600.

COMPUTER INSURANCE

INSURES YOUR COMPUTER

SAFEWARE provides full replacement of hardware, media and purchased software. As little as \$39 a year provides comprehensive coverage. Blanket coverage; no list of equipment needed. One call does it all. Call 8 am-10 pm ET. (Sat. 9 to 5)

TOLL FREE 1-800-848-3469

(Local 614-262-0559)

SAFEWARE, The Insurance Agency Inc.

Inquiry 601.

COMPUTER SUPPLIES

COLOR RIBBONS

COLORS: Black, Red, Blue, Green, Brown

	BLACK	COLOR
NEC P2200	\$7.75	\$12.00
Okidata 390/391	7.00	9.00
Panasonic KXP-1124	6.75	7.75
Toshiba P351	5.00	6.00

PRICE & SPEC. SUBJECT TO CHANGE W/O NOTICE.
 FOR OTHER RIBBONS CALL FOR CATALOG

RAMCO COMPUTER SUPPLIES

P.O. Box 475, Marmion, IL 60950
 (USA) 800-522-6922 * (CANADA) 800-621-5444 * 815-488-8081

Inquiry 602.

COMPUTER UPGRADE

THE COMPLETE XT UPGRADE

The K-311 Upgrade Kit converts your XT to full 32-bit, 20MHz 80386 CPU and high speed disk performance. The K-311 Kit includes 20MHz 80386 w/1Mb RAM, 16-bit Adaptec 1:1 controller, 53Mb 28Ms Mitsubishi disk drive, choice of 1.2 or 1.44Mb diskette drive, Key Tronic 101 Plus keyboard, 200 W PS, new drive cables. Matches or exceeds the performance of a new system but at far less cost. Top quality, easy installation, 1 year warranty. \$1,795

5G Corporation

4131 Spicewood Springs Road A-4, Austin TX 78759
 800-333-4131 512-345-9843 Fax 512-345-9575

Inquiry 603.

COMPUTERS & PRINTERS

LAPTOPS * APPLE * IBM

COMPAQ SLT	IBM PS2
ZENITH	MACINTOSH
SHARP	LASERWRITER
TOSHIBA	IMAGEWRITER
NEC	HP LASERJET
PLOTTERS	EPSON
HARD DRIVES	FAX MACHINES

Call UCC 213-921-8900 For Prices
 13738 E. Artesia Blvd. 150. Cerritos, CA 90701
 Fax 213-802-0831 International Orders Welcome

Inquiry 604.

396 B Y T E • DECEMBER 1989

CROSS ASSEMBLERS

CROSS ASSEMBLERS

Universal Linker, Librarian
Targets for 36 Microprocessors
 Hosts: PC/MS-DOS, micro VAX, VAX 8000

ENERTEC, INC.

BOX 1312, 811 W. Fifth St.
 Lansdale, PA 19446
 Tel: 215-362-0966 Fax: 215-362-2404

Inquiry 606.

YOUR SALES MESSAGE

about the special computer product or service that you provide belongs in print.

THE BUYER'S MART

can help you reach computer professionals and produce valuable inquiries for your company!

Call Brian Higgins for more information

603-924-3754

Inquiry 605.

Professional Series

PseudoCode releases its PseudoSam professional Series of cross assemblers. Most popular processors. Macros, Conditional Assembly, and Include Files. Virtually unlimited size. For IBM PCs, MS-DOS 2.0 or greater. With manual for \$50.00. (MI res. 4% tax). Simulators and disassemblers also available. Shipping \$5. Canada \$10. Foreign \$15. Visa/MC.

KORE Inc.

3510 Plainfield NE, Grand Rapids, MI 49505 616-361-3686
 30-Day satisfaction guaranteed or purchase price refunded.

Inquiry 607.

CROSS ASSEMBLERS/SIMULATORS

Brand new full-function simulator for the 8096 controller, supporting ALL MODES of interrupts plus the HSI, HSO, A/D, and Serial features, with full disassembler, just \$300! Our superb simulators for the 8048, 8051, and 8085 sell for \$200, and those for the 8052 and 280 for \$250 each. Our line of cross assemblers for all above target CPUs are also full PC compatible and sell for \$100 each. We offer discounts for simulator plus assembler packages.

Lear Com Company

2440 Kipling St./Ste. 206, Lakewood, CO 80215
 303-232-2226

Inquiry 608.

MACINTOSH CROSS ASSEMBLERS

ASM™—available for most 8-bit MPUs. Fast. Full Mac interface. S or Hex output downloads to most EPROM programmers. Features macros, conditional assembly, local and auto labels, symbol table cross-reference, module sectioning. Editor included. \$129.95 each plus S/H, MC/VAE. Technical bulletin available. 30 day money back guarantee.

MICRO DIALECTS, INC., Dept B

P.O. Box 30014, Cincinnati, OH 45230
 (513) 271-9100

Inquiry 609.

CROSS ASSEMBLERS

Relocatable
 Macros
 PC Compatible

**GUARANTEED,
 SUPPORTED**

DEBUG SIMULATORS • DISASSEMBLERS
 EPROM PROGRAMMERS

MICRO COMPUTER TOOLS CO.

Phone Toll Free (800) 443-0779

In CA (415) 825-4200

912 Hastings Dr., Concord, CA 94518

Inquiry 610.

World Radio History

CROSS ASSEMBLERS

6800-Family Development Software

Our C Compilers for the 6800, 6801, 6809, & 68HC11 feature a complete implementation (excluding bit fields) of C as described by K&R and yield 30-70% less code than other compilers. Our Assemblers feature macros and conditional assembly. Linker & Terminal Emulator included.

Wintek Corporation

1801 South St., Lafayette, IN 47904
 (800) 742-6809 or (317) 742-8428

Inquiry 611.

CROSS COMPILERS

68000 C Compiler

Available under MS-DOS, UNIX and VMS
 CrossCode C generates ROMable code for all members of the Motorola 68000 family. It comes with an optimizing compiler, Motorola-compatible assembler, linker, librarian, symbol lister, and universal downloader. For more info, see our display ad on page 83

Call today: 1-800-448-7733

Software Development Systems, Inc.

4248 Belle Aire Lane, Downers Grove, Illinois 60515 USA
 Outside USA dial 1-708-971-8170. FAX: 1-708-971-8513

Inquiry 611.

DATA CONVERSION

MEDIA CONVERSION/DATA TRANSLATION

More than just a straight dump or ASCII transfer!
 Word Processing, DBMS, and Spreadsheet data on Diska or Tapes transferred directly into applications running on Mainframes, Minis, Micros, Dedicated Word Processors, Typesetters, and Electronic Publishing systems.
 IBM PS/2 & Macintosh supported
 #1 in the translation industry!

CompuData Translators, Inc.

3325 Wilshire Blvd., Suite 1202, Los Angeles, CA 90010
 (213) 387-4477 1-800-825-8251

Inquiry 612.

DATA/DISK CONVERSION

RESULTS

You Can Depend On!

- Data Conversion
- Disk Duplication
- Optical Scanning

Computer Conversions

9580 Black Mountain Rd., Suite J, San Diego, CA 92126
 619-693-1697

Inquiry 613.

DISK CONVERSIONS

Media transfer to or from: IBM, Xerox, DEC, Wang, Lanier, CPT, Micom, NBI, CT, Exxon, WRDPLEX also WP, WS, MS/WRD, DW4, MM, Samna, DEC DX, MAS 11, Xerox-Writer, ASCII.

FREE TEST CONVERSION

CONVERSION SPECIALISTS

531 Main St., Ste. 835, El Segundo, CA 90245
 (213) 545-6551 (213) 322-6319

Inquiry 614.

FROM MACs TO MAINFRAMES...

Our 12 conversion systems support over 1000 formats

DISK INTERCHANGE SERVICE COMPANY

2 Park Drive • Westford, MA 01886

(508) 692-0050

Inquiry 615.

THE BUYER'S MART

DATA/DISK CONVERSION

BUY YOUR OWN CONVERSION SYSTEM!

With nearly a decade of experience in data conversion, you can work with the industry leader in 9-track tape, cartridge tape and diskette conversion systems. Enjoy the convenience of your own conversion system. Call today to discuss your application!

Flagstaff Engineering

1120 Kaibab Lane, Flagstaff, AZ 86001
(602) 779-3341

MasterCard - Visa - American Express Accepted

Inquiry 616.

THE #1 CHOICE In disk & tape conversion

for many leading corporations, government agencies, law firms, and companies in every industry—world-wide.

Free test • Satisfaction guaranteed

Graphics Unlimited Inc.

3000 Second St. North, Minneapolis, MN 55411
(612) 588-7571 or (612) 520-2345
FAX: (612) 588-8783

Inquiry 617.

10x FASTER EASIER TO USE IBM PC TO HP FILE COPY

Update version uses windows: Call for free demo! IBM PC to HP File Copy allows IBM PCs, PS/2, compatibles to interchange files with Hewlett-Packard Series 70, 80, 200, 300, 1000, 9000s.

Oswego Software 312/554-3567
Box 310 FAX 312/554-3573
Oswego, IL 60543 Telex 858-757

Inquiry 618.

CONVERSION SERVICES

Convert any 9-track magnetic tape to or from over 2000 formats including 3 1/2", 5 1/4", 8" disk formats & word processors. Disk-to-disk conversions also available. Call for more info. Introducing OCR Scanning Services.

Pivar Computing Services, Inc.

165 Arlington Hgts. Rd., Dept. #B
Buffalo Grove, IL 60089 (800) Hi-Pivar

DATABASE MGMT. SYSTEMS

dBASE file access from C

Code Base 4 is a library of C routines which gives complete dBASE or Clipper functionality and file compatibility. Use DOS, Unix, OS/2 or MS Windows.

\$295 with Source! FREE DEMO

Sequiter Software Inc.

Call (403) 439-8171 Fax (403) 433-7460

Inquiry 619.

DEMOS/TUTORIALS

INSTANT REPLAY III

Build Demos, Tutorials, Prototypes, Presentations, Music, Timed Keyboard Macros, and Menu Systems. Includes Screen Maker, Keystroke/Time Editor, Program Memorizer, and Animator. Rec'd Great Reviews! Simply the BEST. Not copy protected. No royalties. 60-day satisfaction money-back guar. IBM and Compat. \$149.95 U.S. Chk/Cr. Crd. Demo Diskette \$5.00.

NOSTRADAMUS, INC.

P.O. Box 9252
Salt Lake City, Utah 84109 (801) 272-0671

Inquiry 620.

DISASSEMBLERS

80x86 .EXE/.COM to .ASM

- Accurately reconstruct, study & modify [84K+] programs with a *minimum* of input or editing of output.
- Assembly language output is MASM 5.x-compatible.
- Exhaustive flow-trace distinguishes code from data.
- Best formats for each. Commented BIOS calls/DOS functions. SEGMENT/PROC/other vital pseudo-ops.

PC-DISnDATA (5 1/4" disk & manual) \$165

PRO/AM SOFTWARE

220 Cardigan Road, Centerville, OH 45459
(513) 435-4480 (9 A.M.—5 P.M. EST M-F)

Inquiry 621.

SOFT-X-PLORE

See "BYTE's May '88 issue pg. 78." Disassemble 500 kb (*) program at 10,000/min. (*) in any file. ROM/RAM memory up to 80386 instruction set (*). SOFT-X-plore:

- * is for MS/DOS 2.0+ systems
- * uses 20 algorithms and seven passes (*)
- * only \$99.95 plus S&H w/30-day guarantee.

To order call (800) 446-4656 or info (203) 953-0236

Or write: **RJSWANTEK INC.**

178 Brookside Rd., Newington, CT 06111
* best on the market MC/VISA accepted

Inquiry 622.

DISK DRIVES

PS/2 DRIVES FOR PCs ATs

CompatiKit/PC \$279
CompatiKit/AT \$219

Built-in floppy controllers—no problem. Supports multiple drives and formats. Lets your computer use IBM PS/2 1.4M diskettes *plus more!* Call for further information or to place an order.

VISA/MC/COD/CHECK.

Micro Solutions Computer Products

132 W. Lincoln Hwy., DeKalb, IL 60115 815/758-3411

Inquiry 623.

DISK DUPLICATION

SOFTWARE PRODUCTION

- Disk duplication
- All formats
- EVERLOCK copy protection
- Label/sleeve printing
- Full packaging services
- Warehousing
- Drop shipping
- Fulfillment
- 48-hour delivery
- Consultation & guidance

Star-Byte, Inc.

2880 Bergery Rd., Hatfield, PA 19440
215-997-2470 800-243-1515

Inquiry 624.

EDUCATION

B.Sc. & M.S. in COMPUTER SCIENCE

The American Institute for Computer Sciences offers an in-depth correspondence program to earn your Bachelor of Science and Master of Science degrees in Computer Science at home. BSc. subjects covered are: MS/DOS, BASIC, PASCAL, C, Data File Processing, Data Structures & Operating systems. MS program includes subjects in Software Engineering and Artificial Intelligence.

AMERICAN INST. for COMPUTER SCIENCES

1704-BY 11th Ave. So., Birmingham, AL 35205
TOLL FREE 1-800-872-AICS

Inquiry 625.

EDUCATIONAL TRAINERS

TMS32010 DSP

COMPLETE EDUCATIONAL TRAINER for the TMS32010 Digital Signal Processor including a MC68000 host processor, power supply, serial interface with software, 32010 and 68000 cross-assemblers (hosted on a PC), documentation, schematic, operating system, cables. Starting Prices—\$735.00

Phone URDA, Inc.

1-800-338-0517 or (412) 683-8732

Inquiry 626.

ENTERTAINMENT

CROSSWORD PUZZLE PROGRAM \$95

Wordsmith automatically constructs symmetrical crossword puzzles from 40,000 words in user modifiable lists. IBM/Compatible, 640K memory. Hard drive recommended. 5-1/4" or 3-1/2" disks. 30-day money-back guarantee.

COLLINS SOFTWARE

J.L. Collins, Box 110, 875A Island Dr., Alameda, CA 94501

Inquiry 627.

NEMESIS™ Go Master®

Go, a game of strategic elegance, has been a way of life in the Orient for over four thousand years. Many consider Go to be the secret of the Japanese businessman's success. "While chess is a game of war, Go is a game of market share" (President of Nikko Hotels).

"If you are interested in Go, buy this program."

Game of the Month J. Pournelle BYTE 7/87

Toyogo, Inc. The Leader in Computer Go.
76 Bedford St. #34-Y, Lexington, MA 02173, (617) 861-0488

Inquiry 628.

FLOW CHARTS

Flow Charting II+

For IBM and compatibles. It will amaze you with its speed, power and simplicity. 26 standard shapes with over 120 sizes — 10 text fonts — 4 line styles. Place text, lines and shapes anywhere on your chart. For only \$229 you'll never draw another chart by hand.

Patton & Patton

81 Great Oaks Blvd., San Jose, CA 95119
1-800-525-0082 Ext. 42 (Outside CA)
408-629-5376 Ext. 42 (CA/Int'l)

See our ad on page 108.

Inquiry 629.

WINDOWS FLOWCHARTER \$79

RFFlow is a professional drawing tool for flowcharts & org charts (requires Microsoft® Windows). 75 shapes automatically adjust in size. Move, copy, delete groups of objects. 7 levels of zoom. Move flowcharts to other applications via the Clipboard. Supports Windows printers, plotters, and cartridge or soft fonts. Call for free trial disk.

RFF ELECTRONICS

1053 Banyan Court, Loveland, CO 80538
(303) 663-5767

Inquiry 630.

STRUCTURED FLOW CHART

NSChart creates Nassi-Shneiderman (structured) flowcharts from a simple PDL. Key words define structures & text strings appear in the chart. Easy to create, even easier to revise! Automatic chart sizing, text centering. Translators from many languages available. For Mac and IBM PC.

SILTRONIX, INC.

P.O. Box 82544, San Diego, CA 92138
1-800-637-4888

Inquiry 631.

FOREIGN LANGUAGES

LEARN SPANISH! LEARN JAPANESE!

A new, easy way to learn a foreign language. Complete interactive learning environment with pop-up dictionary, hypertext language reference, and full mouse support. Conversational emphasis. IBM compatible. Each course includes disks, manual, and pronunciation tape. Call for Demo disk or free brochure!

Traveler's Guild

315 W. Washington St. Dept BY9, Marquette, MI 49855
24-hour order desk: (906) 228-5030

Inquiry 632.

DECEMBER 1989 • B Y T E 397

Inquiry 656.

Inquiry 662.

Inquiry 667.

DECEMBER 1989 • B Y T E 399

THE BUYER'S MART

THE BUYER'S MART

PUBLIC DOMAIN

\$3.00 SOFTWARE FOR IBM PC
Hundreds to choose from, word processors, databases, spreadsheets, games, lotto, communications, business, music, bible, art, education, language and useful utilities for making your computer easier to learn. Most programs have documentation on the disk.

Free 125-page catalog.

BEST BITS & BYTES

P.O. Box 8245, Dept B, Van Nuys, CA 91409

In CA: (818) 764-9503 800-245-BYTE

Inquiry 668.

PUBLIC DOMAIN

FREE CATALOG

\$1 IBM SOFTWARE

For your free 32-page Master Edition catalog featuring the best of IBM Shareware from just \$1 each, call or write today!

1-800-338-2118

SOFSOURCE

Box 828, East Lansing, MI 48826

Inquiry 674.

SECURITY

COP's Copylock II

- Protects on standard diskettes
- Cannot be copied by any device incl. Option Board
- Fully hard disk installable
- Normal back-up of protected programs
- LAN-support
- Creates safe demo version of your software

Standard Version \$975, Automatic Version \$1950

DANCOTEC Computer

In US: 2855 Sierra Rd., San Jose, CA 95132 408-729-8162 or 1-800-344-2545
In U.K.: 2880 Baggvold, Denmark Phone +45-44440322 Fax +4440722

Inquiry 680.

\$1 per DISK Sale

20 TOP IBM PC PD/SW DISKS

(360K) ONLY \$20 + \$3 S&H

QubeCalc, EDRAW, AutoMenu, Math Tutor, PC-DOS Help, Baker's Dozen, Languages, EZ-Form, PC-Style, PackDisk, PC-Stock, KidGames, Best Games, Home Inventory, PC-Outline, Form Letters, ImagePrint, SideWriter, PC-Prompt, Best Utilities.

BRIGHT FUTURES INCORPORATED

P.O. Box 1030, East Windsor, CT 06098

FREE CATALOG (\$1.50 per disk)

Inquiry 669.

FREE SOFTWARE CATALOG

Low as \$1.20/disk

Over 1000 quality IBM software

On 5.25" and 3.5" format

From outside U.S.A., except Canada, please send US \$2.00 refundable with order.

For fast service, write to

SOFTSHOPPE

P.O. BOX 3678, Ann Arbor, MI 48106-3678

313-761-7638

Inquiry 675.

ALL-IN-ONE PROTECTION!

TOTALSAFE gives you total security: access control, virus protection, data encryption, secure directories, and lots more! Req. PC, HD, 1 slot (or socket). Completely transparent. Introductory price: \$12000 + \$8.00 S/H (U.S.). 30-day guarantee. Also available a complete line of PC access and data security products. Call/write for info. MC/VISA/AMEX. Gamma Security Products, 710 Wilshire Blvd., Ste. 609, Santa Monica, CA 90401 TEL: 213-394-8622 FAX: 213-395-4214

Eilashim Inc.

520W Hwy 436, Suite 1190-30, Allamonte Spgs., FL 32714

TEL: 407/682-1587 FAX: 407/774-8103

Inquiry 681.

FREE CATALOG

PUBLIC DOMAIN/SHAREWARE

• 400 IBM PC & compatibles disks •

• 200 Amiga disks • 125 Atari ST disks

PC disks as low as \$1.25 each, Amiga & ST as low as \$1.80 each! Rent or buy. Free shipping! Call toll free, write or circle reader service for FREE BIG CATALOG with full descriptions. Please specify computer—48-hr. turnaround

Computer Solutions

P.O. Box 354—Dept. B, Mason, Michigan 48854

1-800-874-9375 (M-F 10-6 EST) 1-517-628-2943

Inquiry 670.

Find "Hands-on" Reviews in Seconds!

PC Reviews is an easy to use on-line database for NOVICES and PROS who need to locate and read "hands-on" reviews. BYTE, Data Based Advisor, PC Today, PC Magazine, Computer Language, Info World and 35 more included. Natural language front-end helps define search terms. A perfect use for a modem. "Wonderful!", say users.

Compatible Technologies Group, Inc.

88 Fulton St. #2400, New York, NY 10038

(212) 463-8989 (201) 653-7688 8-N-1 for FREE DEMO

Inquiry 676.

REVIEWS

\$1 DOLLAR DISK SALE!

Add \$3 S&H. SHAREWARE — IBM 5¼"

18 DISKS ON SALE: RESUME SHOP, DOS TUTOR, READ-FAST, THESAUR PLUS, PC-STYLE, MENUS for WORD-PERFECT, GRAPHIC CONVERSIONS, EGA DEMO I, SLIMMER, EDRAW, CHARTS UNLIMITED, SPANISH I, AUTOMENU, MEDIAN ACCOUNTING, EZ-FORMS, ZIPKEY, PINBALL, MAZE GAMES. (Reg. \$3.00) FREE 64-PAGE CATALOG! Canada add \$2 S&H, Foreign add \$2 S&H

CWI Information Services

P.O. BOX 4851, Anaheim, CA 92803

Phone (714) 879-5423 or 1-800-777-5636

Inquiry 671.

TOP 10 IBM SOFTWARE—FREE

10 programs on 10 disks — PC Write, PC Calc+, TreeView, DanCad, File Express, Moraff's Revenge, HGCI/MB, Novatron, Home Base, Spacewars, plus 1600+ disk catalog • We accept Visa/MC/Amex

PAY ONLY \$5.00 shipping/handling
limited introductory offer

International Software Library

511 Encinitas Blvd., Ste 184 • Encinitas, CA 92024

order today (619) 942-8988

Inquiry 672.

THE ULTIMATE COPY PROTECTION

- Completely Menu Driven
 - Defeats all Hardware/Software Copiers
 - No Source Code Changes
 - Multiple Layering
 - No Damaged Media
 - Full Hard Disk Support
 - Unlimited Metering
 - FREE Demo Disk
- Quite Simply The Best Way To Protect Your Valuable Software Investment!*

STOPCOPY™ \$325** STOPCOPY PLUS™ \$450**

BBI COMPUTER SYSTEMS® (301) 871-1094

14105 Heritage Ln., Silver Spring, MD 20906 FAX: (301) 460-7545

Inquiry 678.

PC Security "Password"

With All the Computer Security Talk, PASSWORD is the Perfect Security Lock.

Password is a software program providing security for your PC. Password is Easy to understand and Simple to install, requires no reformatting. The boot limit option secures your hard disk. Password provides for up to 100 users with the supervisor controlling access to protected directories. Password is menu-driven with pop-up windows and help screens. The program provides an audit trail of users, and a screen blanking feature.

PASSWORD \$99.00 US Visa, M/C, Amex

Nasdec International Inc.

2704-85 Garry Street, Winnipeg MB Canada R3C 4J5

PH: (204) 956-2798 FAX (204) 943-3702

Inquiry 683.

COPY PROTECTION

The world's leading software manufacturers depend on Softguard copy protection systems. Your FREE DISKETTE introduces you to SuperLock™—invisible copy protection for IBM-PC (and compatibles) and Macintosh.

- Hard disk support
- No source code changes
- Customized versions
- LAN support

• New upgrades available

(408) 773-9680

SOFTGUARD SYSTEMS, INC.

710 Lakeway, Suite 200 Sunnyvale, CA 94086

FAX (408) 773-1405

Inquiry 684.

FREE IBM SOFTWARE

FREE CATALOG also contains SHAREWARE, 5¼ and 3½-inch. All categories ENGINEERING, CAD, DESKTOP PUBLISHING, LANGUAGES, UTILITIES, BUSINESS, GRAPHICS, SPREADSHEETS, WORD PROCESSORS, CHURCH, MEDICAL, HEALTH, EDUCATION, HOME.

SECTOR SYSTEMS COMPANY, INC.

Dept. B11, 416 Ocean Avenue, Marblehead, MA 01945

(617) 639-2625

Inquiry 673.

SECURE YOUR VALUABLE PC

Is your DOS PC secure

against intrusion? Data theft or destruction?

Silicon WatchDog is 100% hardware plus software protection, unbeatable once installed on your PC. For \$49.95 US you get your personal 5-1/4" disk and detailed step-by-step hardware upgrade instructions. Satisfaction guaranteed or your money back (providing all instructions were followed).

CompuSec

Unit 119, 55 Ellerslie Ave.

Toronto, Ontario M2N 1X9 CANADA

Inquiry 679.

HANDS OFF THE BOARD® 1/2 SIZE SECURITY BOARD

Stop floppy boot — Require password to boot PC
Real-time disk encrypt — prevent boot sector virus
Prevent DOS FORMAT/FDISK and low-level formats
Set hard disk READ ONLY or turn ON/OFF
Turn floppies, printers and COM ports ON/OFF
IBM XT, AT Bus — DOS V3.0+ — \$149.95 + \$5.00 S/H

SYSTEMS CONSULTING INC.

PO BOX 111209, Pittsburgh, PA 15238

(412) 781-5280

Inquiry 685.

THE BUYER'S MART

DATA/DISK CONVERSION

BUY YOUR OWN CONVERSION SYSTEM!

With nearly a decade of experience in data conversion, you can work with the industry leader in 9-track tape, cartridge tape and diskette conversion systems. Enjoy the convenience of your own conversion system. Call today to discuss your application!

Flagstaff Engineering

1120 Kaibab Lane, Flagstaff, AZ 86001
(602) 779-3341

MasterCard - Visa - American Express Accepted

Inquiry 616.

THE #1 CHOICE in disk & tape conversion

for many leading corporations, government agencies, law firms, and companies in every industry—world-wide.

Free test • Satisfaction guaranteed

Graphics Unlimited Inc.

3000 Second St. North, Minneapolis, MN 55411

(612) 588-7571 or (612) 520-2345

FAX: (612) 588-8783

Inquiry 617.

10x FASTER EASIER TO USE IBM PC TO HP FILE COPY

Update version uses windows: Call for free demo! IBM PC to HP File Copy allows IBM PCs, PS/2, compatibles to interchange files with Hewlett-Packard Series 70, 80, 200, 300, 1000, 9000s.

Oswego Software

312/554-3567

Box 310
Oswego, IL 60543

FAX 312/554-3573

Telex 858-5757

Inquiry 618.

CONVERSION SERVICES

Convert any 9-track magnetic tape to or from over 2000 formats including 3 1/2", 5 1/4", 8" disk formats & word processors. Disk-to-disk conversions also available. Call for more info. Introducing OCR Scanning Services.

Pivar Computing Services, Inc.

165 Arlington Hgts. Rd., Dept. #B
Buffalo Grove, IL 60089 (800) Hi-Pivar

DATABASE MGMT. SYSTEMS

dBASE file access from C

Code Base 4 is a library of C routines which gives complete dBASE or Clipper functionality and file compatibility. Use DOS, Unix, OS/2 or MS Windows.

\$295 with Source! FREE DEMO

Sequiter Software Inc.

Call (403) 439-8171 Fax (403) 433-7460

Inquiry 619.

DEMOS/TUTORIALS

INSTANT REPLAY III

Build Demos, Tutorials, Prototypes, Presentations, Music, Timed Keyboard Macros, and Menu Systems. Includes Screen Maker, Keystroke/Time Editor, Program Memorizer, and Animator. Rec'd Great Reviews! Simply the BEST. Not copy protected. No royalties. 60-day satisfaction money-back guar. IBM and Compatib. \$149.95 U.S.Chk/Cr. Crd. Demo Diskette \$5.00.

NOSTRADAMUS, INC.

P.O. Box 9252

Salt Lake City, Utah 84109 (801) 272-0671

Inquiry 620.

DISASSEMBLERS

80x86 .EXE/.COM to .ASM

- Accurately reconstruct, study & modify [64K+] programs with a minimum of input or editing of output.
- Assembly language output is MASM 5.x-compatible.
- Exhaustive flow-trace distinguishes code from data.
- Best formats for each. Commented BIOS calls/DOS functions. SEGMENT/PROC/other vital pseudo-ops.

PC-DISnDATA (5 1/4" disk & manual) \$165

PRO/AM SOFTWARE

220 Cardigan Road, Centerville, OH 45459
(513) 435-4480 (9 A.M.—5 P.M. EST M-F)

Inquiry 621.

SOFT-X-PLORE

See "BYTE's May '88 issue pg. 78" Disassemble 500 Kb (*) program at 10,000/min. (*) in any file. ROM/RAM memory up to 80386 instruction set (*). SOFT-X-plore:

- * is for MS/DOS 2.0+ systems
- * uses 20 algorithms and seven passes (*)
- * only \$99.95 plus S&H w/30-day guarantee.

To order call (800) 446-4656 or info (203) 953-0236

Or write: **RJSWANKE INC.**

178 Brookside Rd., Newington, CT 06111

* best on the market MC/VISA accepted

Inquiry 622.

DISK DRIVES

PS/2 DRIVES FOR PCs ATs

CompatiKit/PC \$279
CompatiKit/AT \$219

Built-in floppy controllers—no problem.

Supports multiple drives and formats. Lets your computer use IBM PS/2 1.4M diskettes *plus more!* Call for further information or to place an order.

VISA/MC/COD/CHECK.

Micro Solutions Computer Products

132 W. Lincoln Hwy., DeKalb, IL 60115 815/756-3411

Inquiry 623.

DISK DUPLICATION

SOFTWARE PRODUCTION

- Disk duplication
- All formats
- EVERLOCK copy protection
- Label/sleeve printing
- Full packaging services
- Warehousing
- Drop shipping
- Fulfillment
- 48-hour delivery
- Consultation & guidance

Star-Byte, Inc.

2880 Bergey Rd., Hatfield, PA 19440

215-997-2470 800-243-1515

Inquiry 624.

EDUCATION

B.Sc. & M.S. in COMPUTER SCIENCE

The American Institute for Computer Sciences offers an in-depth correspondence program to earn your Bachelor of Science and Master of Science degrees in Computer Science at home. BSc. subjects covered are: MS/DOS, BASIC, PASCAL, C, Data File Processing, Data Structures & Operating systems. MS program includes subjects in Software Engineering and Artificial Intelligence.

AMERICAN INST. for COMPUTER SCIENCES

1704-BY 11th Ave. So., Birmingham, AL 35205

TOLL FREE 1-800-872-AICS

Inquiry 625.

EDUCATIONAL TRAINERS

TMS32010 DSP

COMPLETE EDUCATIONAL TRAINER for the TMS32010 Digital Signal Processor including a MC68000 host processor, power supply, serial interface with software, 32010 and 68000 class assemblers (hosted on a PC), documentation, schematic, operating system, cables. Starting Prices—\$735.00

Phone URDA, Inc.

1-800-338-0517 or (412) 683-8732

Inquiry 626.

ENTERTAINMENT

CROSSWORD PUZZLE PROGRAM \$95

Wordsmith automatically constructs symmetrical crossword puzzles from 40,000 words in user modifiable lists. IBM/Compatible, 640K memory. Hard drive recommended. 5-1/4" or 3-1/2" disks. 30-day money-back guarantee.

COLLINS SOFTWARE

J.L. Collins, Box 110, 875A Island Dr., Alameda, CA 94501

Inquiry 627.

NEMESIS™ Go Master®

Go, a game of strategic elegance, has been a way of life in the Orient for over four thousand years. Many consider Go to be the secret of the Japanese businessman's success. "While chess is a game of war, Go is a game of market share" (President of Nikko Hotels).

"If you are interested in Go, buy this program."

Game of the Month J. Pournelle BYTE 7/87

Toyogo, Inc. The Leader in Computer Go.
76 Bedford St. #34-Y, Lexington, MA 02173, (617) 861-0488

Inquiry 628.

FLOW CHARTS

Flow Charting II+

For IBM and compatibles. It will amaze you with its speed, power and simplicity. 26 standard shapes with over 120 sizes — 10 text fonts — 4 line styles. Place text, lines and shapes anywhere on your chart. For only \$229 you'll never draw another chart by hand.

Patton & Patton

81 Great Oaks Blvd., San Jose, CA 95119

1-800-525-0082 Ext. 42 (Outside CA)

408-629-5376 Ext. 42 (CA/Int'l)

See our ad on page 108.

Inquiry 629.

WINDOWS FLOWCHARTER \$79

RFFlow is a professional drawing tool for flowcharts & org charts (requires Microsoft® Windows). 75 shapes automatically adjust in size. Move, copy, delete groups of objects. 7 levels of zoom. Move flowcharts to other applications via the Clipboard. Supports Windows printers, plotters, and cartridge or soft fonts. Call for free trial disk.

RFF ELECTRONICS

1053 Banyan Court, Loveland, CO 80538

(303) 663-5767

Inquiry 630.

STRUCTURED FLOW CHART

NSChart creates Nassi-Shneiderman (structured) flowcharts from a simple PDL. Key words define structures & text strings appear in the chart. Easy to create, even easier to revise! Automatic chart sizing, text centering. Translators from many languages available. For Mac and IBM PC.

SILTRONIX, INC.

P.O. Box 82544, San Diego, CA 92138

1-800-637-4888

Inquiry 631.

FOREIGN LANGUAGES

LEARN SPANISH! LEARN JAPANESE!

A new, easy way to learn a foreign language. Complete interactive learning environment with pop-up dictionary, hypertext language reference, and full mouse support. Conversational emphasis. IBM compatible. Each course includes disks, manual, and pronunciation tape. Call for Demo disk or free brochure!

Traveler's Guild

315 W. Washington St. Dept BY9, Marquette, MI 49855

24-hour order desk: (906) 228-5030

Inquiry 632.

THE BUYER'S MART

FORTRAN TOOLS

TAME YOUR FORTRAN CODE!

Programming tools for MS-DOS FORWARN—an invaluable aid to Fortran program development! Finds common programming errors such as mismatched parameter lists and common blocks, and uninitialized variables. Prints detailed cross-references and call-tree diagrams. \$329

FORTRAN DEVELOPMENT TOOLS—includes Pretty (indent, renumbers, changes GOTOs to IF-THEN-ELSEs, etc.) and 6 more tools. \$129.

Qubus Enterprises, Inc.
106 N. Draper Avenue, Champaign, IL 61821
(217) 356-8876

Inquiry 633.

GRAPHICS

Fig.P - The Graphics

IBM PC/PS2 program for superior WYSIWYG graphs/charts/slides. Flexible data input/edit. Lines/curves/regressions/scatters/bars more. Axis breaks/end-segments/error bars, any style. Labels/symbols/boxes/arrows, more. Store fig templates. Fast professional output to lasers/slidemakers/plotters or export to WP5.0/Ventura etc. **FREE DEMO!** \$399

BIOESOFT, PO Box 580, Milltown, NJ 08850
(201) 613-9013 FAX: (201) 613-8660

Inquiry 634.

HARD DRIVE REPAIR

HARD DRIVE REPAIR

WE WILL REPAIR YOUR HARD DRIVE AT A FRACTION OF THE COST OF REPLACING IT. FAST TURNAROUND!!! CALL FOR DETAILS.

H & W micro, Inc.
528-C FOREST PARKWAY
FOREST PARK, GA 30050
(404) 366-1600

Inquiry 635.

**DISK DRIVE REPAIR
DATA RECOVERY**
SALES of new, remanufactured and removable disk drives
**FULL TECHNICAL SUPPORT
ROTATING MEMORY SERVICE**
1506 Dell Avenue, Campbell, CA 95008
(408) 370-3113
We buy used drives good or bad

Inquiry 636.

HARDWARE

BUILD YOUR OWN MACINTOSH FROM CATALOG PARTS—THE CAT MAC

New book shows how to:
• Save \$\$\$ over new or used systems or on upgrades
• Which CAT Mac model to build and why
• Have fun, gain experience, break no laws
Only \$24.95 postpaid. VISA/MC, check, M.O. or send #10 SASE for free info. Bookstore/bulk orders invited.

BRANT ASSOCIATES, Dept B
PO Box 68708, 4420 SE Mark Kelly Ct., Portland OR 97268

Inquiry 637.

CHIP CHECKER

• 74/54 TTL + CMOS • 8000 Nat. + Signetics
• 14/4000 CMOS • 9000 TTL
• 14-24 Pin Chips • .3" + .6" IC widths

Tests/identifies over 650 digital chips with ANY type of output in seconds. Also tests popular RAM chips. IBM-compatible version \$259. C128 + C64 version \$159.

DUNE SYSTEMS
2603 Willa Dr., St. Joseph, MI 49085
(616) 983-2352

Inquiry 638.

HARDWARE

LATEST AWARD BIOS! PC/XT ☆ 286 ☆ 386

Support for:
• Enhanced Keyboards
• EGA & VGA Graphics
• 3.5 inch Floppies
• Custom Drive Tables

Authorized AWARD Distributor

1-800-423-3400 or (412) 782-0384
KOMPUTERWERK, INC.
851 Parkview Blvd., Pittsburgh, PA 15215

Inquiry 639.

Macintosh® Parts & Repairs

Programs for the corporate, government, dealer and educational buyer. Call for kit.

Save up to 55% on Mac II CPU

800-274-5343 / 617-891-6851

Pre-Owned Electronics, Inc.

30 Clematis Ave • Waltham, MA 02154
Macintosh is a registered trademark of Apple Computer, Inc.

Inquiry 640.

NEED AN EXTRA SLOT FOR YOUR 8-BIT PC?

Add: LAN MODEM, Accelerator Card or Fixed Disk and/or 3 1/2" Diskette

RMT's 2001-F2H2 Single Card Controller:
• Uses only one expansion unit
• Supports two 3 1/2" and/or 5 1/4" diskette drives
• Supports two fixed disk drives (up to 140 MB each)
• On-board BIOS, automatically handles any comb. of drives

RMT 2001-F2H2 THE SPACE ODYSSEY
RMT SYSTEMS, INC. (714) 863-1092

Inquiry 641.

HARDWARE/COPROCESSOR

DIGITAL SIGNAL PROCESSOR

DSP products for the IBM PC/XT/AT based on the TI TMS32010 and TMS320C25 up to 12 MIPS operation. Designed for applications in communications, instrumentation, speech, and numeric processing. Offered with 12 bit 110 KHz A/D and D/A and continuous-to-disk data acquisition & playback option. From \$650.

DALANCO SPRY
89 Westland Ave., Rochester, NY 14618
(716) 473-3610

Inquiry 642.

EMBEDDED SYSTEMS CONTROLLERS

SC/FOX® PCS (Parallel Coprocessor System) and PCS32 are PC/XT/AT plug-in boards, 18 and 32 bit, 15 MIPS average, 50 MIPS burst. PCS uses the Harris RTX 2000™ 16-bit RISC CPU with multiplier, 14 interrupts, 3 timer/counters, 8-channel I/O bus. PCS32 uses the new SC32 RISC 32-bit CPU. Prices start at \$2,295.

SC/FOX SBC (Single Board Computer) is an 18 MIPS average, 60 MIPS burst, euro-card size stand-alone computer for \$1,495.

SC/FOX SCSI I/O is a plug-on PCS or SBC daughter board with software for \$995. Forth development software included. Ideal for embedded real-time control, signal processing, and data acquisition.

SILICON COMPOSERS, INC. (415) 322-8763
208 California Ave., Palo Alto, CA 94306

Inquiry 643.

HEAT TRANSFER

Heat™ Transfer 1

QUICK SOLUTIONS TO THERMAL PROBLEMS!

- Optimize Design Selections
- Analyze Thermal Flow Paths
- Improve Performance and Throughput
- Control Warm-up and Stabilization

Johanson Electrotherm Corporation
203-582-1964 Fax 203-589-4993

Inquiry 644.

IMAGE PROCESSING

ZIP Image Processing

ZIP brings affordable, sophisticated image processing to the PC. Capture video from camera/VCR. Versions for ImageWise, Willow Pubs VGA, HRT 512x512, serial ImageWise (for PC/laptop/PS2) frame grabbers.

Call (314) 962-7833 to order (VISA/MC). ZIP starts at \$79, frame grabbers, \$398. 30-day money-back guarantee.

Hogware Company

470 Bellevue, St. Louis, MO 63119

(314) 962-7833

Inquiry 645.

INVENTORY MANAGEMENT

STOCK-MASTER 4.0

Commercial grade inventory management software at micro prices.

- Supports all 12 transaction types
- Trend Analysis
- Quality Control
- Multiple Locations
- Purchase Order Tracking
- Open Order Reporting
- Serial/Lot # Tracking
- Stock Status Reporting
- Activity History Analysis
- Bill of Materials
- Purchase Order Writing
- Order Entry
- Material Requirements
- On Line Inquiry

Applied Micro Business Systems, Inc.
177-F Riverside Ave., Newport Beach, CA 92663 714-759-0582

Inquiry 646.

dFELLER Inventory

Business inventory programs written in modifiable dBASE source code.

dFELLER Inventory \$150.00
Requires dBASE II or III, PC-DOS/CPM
dFELLER Plus \$200.00
with History and Purchase Orders
Requires dBASE III or dBASE III Plus (For Stockrooms)

Feller Associates

550 CR PPA, Route 3, Ishpeming, MI 49849
(906) 486-6024

Inquiry 647.

LANS

The \$25 Network

Try the 1st truly low-cost LAN

- Connect 2 or 3 PCs, XT's, AT's
- Uses serial ports and 5-wire cable
- Runs at 115K baud
- Runs in background, totally transparent
- Share any device, any file, any time
- Needs only 14K of ram

Skeptical? We make believers!
Information Modes
P.O. Drawer F, Denton, TX 76202
817-387-3339

Inquiry 648.

LAPTOP COMPUTERS

Laptop Savings

Laptops: Toshiba • Zenith • NEC • Sharp
• Epson • Mitsubishi • Compaq

Also Laptop Accessories: Modems, Fax Modems, External Drives, Portable Printers, Memory, Key Pads, Hard Drives, Batteries, and Auto Adapters.

Computer Options Unlimited
12 Maiden Lane, Bound Brook, NJ 08805
Phone: 201-469-7678 (Fax: 201-469-7544)
Hours: 9am/10pm 7 days Worldwide sales

Inquiry 649.

LAPTOP PERIPHERALS

LAPTOP BACKLIGHTS

Factory Installed • 90-Day Warranty

Toshiba, Amstrad, Sanyo, DG,
Kaypro, IBM, HP, etc. **\$295**

The Portable Peripherals People

Axonix Corporation
(801) 466-9797

Inquiry 650.

THE BUYER'S MART

LAPTOP PERIPHERALS

TOSHIBA PERIPHERALS	T1000	T1200	T3100	T3100e
Battery AdapterPAK (12V)	PX25T	PX3T	P80	P80+
Vehicle Battery Adapter	X2.5	M24B1	A80	A80+
Built-in 2400bps Modem		M24EC & M24ES		
Internal 2400bps Modem	M24IC			
Single COMMS Port Card	S232T	S232E		
Dual COMMS Port Card		O232E		
SCSI Interface Card		SCSIE		

PRODUCT R&D CORPORATION

1194 Pacific St., Suite 201, San Luis Obispo, CA 93401
(805) 546-9713 or (800) 234-5584

Inquiry 651.

MEMORY CHIPS

FREE
Memory for IBM?

Best Memory
Prices in U.S.A.
SIMMS
DRAM•MATH
CO-PROCESSORS

FREE 24 HRS.—7 DAYS
1-800-338-1531

FREE FAX
24 HRS.—7 DAYS
1-800-242-5751

**McDonald
and Associates**

WHOLESALE DISTRIBUTOR
THE CHOICE OF
INDUSTRY PROFESSIONALS

Inquiry 652.

MEMORY PRODUCTS

LOW LOW PRICES

256K	DRAM	256x8	SIM/SIP
1 Meg	DRAM	1 Megx9	SIM/SIP
256x9	SIM/SIP	1 Megx8	SIM/SIP

All Speeds
INTEL
8087 - 80287 - 80387
All MHz

R & R Electronics
1-800-736-3644

Inquiry 653.

MONITOR INTERFACE

COMPUTER VIDEO GENERATOR

Test EGA, VGA, Multisync & Data Projectors with handheld monitor tester. From 15.7 KHz to 64.0 KHz, battery powered, 4 patterns, all plug-in with no adapter cables.

NETWORK TECHNOLOGIES INC.

800-RGB-TECH In OH: 216-543-1646
UK: 0244-880478 Paris: 01331-476-32789

See our Ad on page 412.

Inquiry 654.

NETWORKING

NETWORK BUSINESS SYSTEMS

Keypad Eliminator	\$99.
D C B Eliminator	\$99.
ELS Utilities	\$59.
Netcrack (lose password?)	\$99.
Getdisk (get BIOS drives)	\$59.
BIOS Tools (patch drive tpls)	\$99.

NETWORK BUSINESS SYSTEMS

1215 Woodhollow Drive, Suite 1104, Houston, TX 77057
(713) 783-4457

Inquiry 655.

So Far Your Computers Have Been Talking to Each Other NOW Your Staff Can as Well!

CHAT — ACCESS

A Complete Chatting and Messaging Solution for 3Com, Novell, and Other NetBOS Networks. CHATACCESS is the ultimate in user friendly software, enabling you to send messages, receive them and engage other logged-in users in full scale conversation. Using only 1 Kbyte of your workstation RAM (for TSR program), CHATACCESS provides a list of logged in users and sends one or all of them a brief message. It also enables you to "CHAT" with another workstation through interactive windows that simultaneously display both sides of the conversation. CHATACCESS operates on 3Com's 3PLUS, 3+ OPEN (MS-DOS workstation), Novell NetWare and all other PC LANs that support NetBOS.

Shany Computers Ltd.

Rechter Building, 4 Smlansky St., Natanya, Israel 42304
Tel: (972) (53) 333931 Fax: (972) (53) 342418

Inquiry 656.

NETWORKING

SHANY COMPUTERS, SOFTWARE THAT MAKES YOUR NET... WORK

CO/FILE+

An essential expansion to your MS-DOS and Network operating system so that you can run your existing single user applications with no modifications as multi-user applications running on your network. Using only 1-2 Kbytes of your workstation RAM, CO/FILE+ enables your single user applications to share common files on any MS-DOS 3.10 and higher LANs. Data is protected by automatic file or record level locking and unlocking. FEATURES/BENEFITS: + Supports all the MS-DOS 3.10 and higher Local Area Networks. + Consumes only 2Kbytes of RAM at each workstation for the TSR program. + Supports 3 levels of file sharing + Read Only Sharing. + Write Sharing. + Create Sharing. + Supports automatic record or file level locking and unlocking for Write and Create Sharing.

Shany Computers Ltd.

Rechter Building, 4 Smlansky St., Natanya, Israel 42304
Tel: (972) (53) 333931 Fax: (972) (53) 342418

Inquiry 657.

NEURAL NETWORKS

MacBrain™ 2.0

MacBrain 2.0 Neural Network Simulation Software for the Macintosh (includes HyperBrain™). Graphical, interactive, menu-driven. Full Range of ready-to-use paradigms. Completely modifiable using HyperBrain. Expert Systems, predictive modelling, combinatorial optimization and more. Plus, SE and II family; HDI-Chorus parallel processing version available. \$995./\$795. educational.

NEURIX

1 Kendall Sq. Suite 2200 Cambridge, MA 02139
(617) 577-1202 FAX: (617) 577-1209

Inquiry 658.

OBJECT ORIENTED TOOLS

OBJECT-ORIENTED TOOLKIT

TRIPLE your productivity with Complete C™

The only object-oriented development utility for C with pre-compiler, foundation classes (source code included), integrated make, real-time debugger, Documentation Generator, Application Streamliner. Versions for DOS (\$449), SCO-XENIX (\$495), QNX (\$449) with full technical support. Other ports available upon request.

Complete Computer Corporation

111 West 57th St., Suite 1400, NY, NY 10019
212-582-2635

Inquiry 659.

PROGRAMMERS TOOLS

LAN Application Development

NPPC: High performance library routines callable from C and Assembler. High level interface permits rapid development of peer-to-peer, client/server, or multi-server NetBIOS applications under DOS. Synchronous or Asynchronous message control. Compact Code. Source Avail. No Royalty. NPPC \$495

Applied Software Technology

PO Box 397, Dpt. N, Los Gatos, CA 95031
(800) 678-1111 ext. N1

Inquiry 660.

HYPERINTERFACE™

Menu Creator™ — A program generator for menu-driven user interface. Excellent for complex menu systems. \$99.95. Advanced Library — Extended capability for data entry and advanced text-display control from your programs. \$99.95. FORTRAN, Pascal, C, BASIC supported. HYPERMATH™ — An application of Menu Creator™ and the Advanced Library. FREE

Avanpro Corp.

P.O. Box 969, Pacific Palisades, CA 90272
(213) 454-3866

Inquiry 661.

TLIB™ 4.12 Version Control

"TLIB" is a great system! — PC Tech Journal 3/88. Full-featured configuration mgmt for software professionals. All versions of your code instantly available. Very compact, only changes are stored. Check-in/out locks, revision merge, branching, more. Mainframe deltas for Pansophic, ADR, IBM, Unisys. Only \$99.95 + S&H, or 5-station LAN \$299.95 + S&H. MS-DOS VISA/MC

BURTON SYSTEMS SOFTWARE

P.O. Box 4156, Cary, NC 27519 (919) 856-0475

Inquiry 662.

PROGRAMMERS TOOLS

Have Same 'C' Source for UNIX and DOS

D-ISAM—Unix standard indexed file management library for UNIX DOS and NETWORKS. Manages all locking, UNIX/DOS source \$595 (for both), DOS libs* \$145.

W—Character windowing with COLORS, Line Graphics, Bells and more. You need not modify DOS code to work WELL on any UNIX terminal. UNIX/DOS source \$295 (for both), DOS libs \$95.

BYTE DESIGNS

P.O. Box F195-76, Blaine, WA 98230

1-800-663-8547 or (604) 278-5200

(*DOS libs available for Microsoft or Borland 'C' compilers)

Inquiry 663.

Bsupport for Btrieve

The "Norton Utilities" for Btrieve users. Bedit: DISPLAY, UPDATE, COPY, and DELETE. EXPORT SDF to dBASE & LOTUS. RECOVER damaged files. Edit/insert using Data Dictionary. Bbug: TSR Btrieve debugger. Displays info in pop-up window. Brun: BUTIL replacement with Run-Time and C source. Bedit/Bbug: \$120. Brun: \$100. VISA/MC/COD/PO

800/359-2721 FAX: 517/887-2366

Information Architects, Inc.

P.O. Box 4184, East Lansing, MI 48826-4184

Inquiry 664.

TURBO PLUS \$149.95

Programming tools for use with Turbo Pascal 5.0 & 5.5. Screen Painter, Code Generator, I/O Fields, Dynamic Menus, Programming Unit Libraries, OOP Support, and Sample Programs included. All routines work in both text and graphics modes! 60-day money-back guarantee. Demo Disk avail. For IBM and compatibles.

NOSTRADAMUS, INC.

P.O. Box 9252, Salt Lake City, UT 84109-0252
(801) 272-0671

Inquiry 665.

Get INSIDE!

The best PC software performance tool is now better than ever with source line timing, caller timing and arbitrary event timing—all with microsecond accuracy and without source modification. The expanded DOS analysis mode identifies I/O bottlenecks. \$125

Call today for a free brochure and the latest list of supported compilers. 30-day guarantee. VISA/MC/COD

Paradigm Systems

P.O. Box 152, Milford, MA 01757
(800) 537-5043 In MA: (508) 478-0499

Inquiry 666.

FREE BUYER'S GUIDE

Programmer's Connection is an independent dealer representing more than 450 manufacturers with over 1000 software products for IBM personal computers and compatibles. We have serviced the professional programmer since 1984 by offering sound advice and low prices. Call or write today to receive your FREE comprehensive Buyer's Guide.

Programmer's Connection US 800-336-1166
7249 Whipple Ave. NW Canada 800-225-1166
North Canton, OH 44720 International 216-494-3781

Inquiry 666.

'C' DOCUMENTATION TOOLS

- C-CALL \$59 Creates graphic-tree of caller/called structures, and files-vs-procedure table-of-contents
- C-HDR \$59 Creates/inserts/updates headers for each procedure showing caller/called and Identifiers
- C-LIST \$39 List, action-diagram, reformat programs
- C-REF \$49 Local/global/parameter cross reference
- SPECIAL \$149 All 4 plus integrated C-DOC version

SOFTWARE BLACKSMITHS INC.

6064 St. Ives Way, Mississauga, ONT Canada L5N-4M1
(416) 858-4466

Inquiry 667.

THE BUYER'S MART

PUBLIC DOMAIN

\$3.00 SOFTWARE FOR IBM PC
Hundreds to choose from, word processors, databases, spreadsheets, games, lotto, communications, business, music, bible, art, education, language and useful utilities for making your computer easier to learn. Most programs have documentation on the disk.

Free 125-page catalog.

BEST BITS & BYTES

P.O. Box 8245, Dept. B Van Nuys, CA 91409

In CA: (818) 764-9503 800-245-BYTE

Inquiry 668.

\$1 per DISK Sale

20 TOP IBM PC PD/SW DISKS
(360K) ONLY \$20 + \$3 S&H

QubeCalc, EDRAW, AutoMenu, Math Tutor, PC-DOS Help, Baker's Dozen, Languages, EZ-Form, PC-Style, PackDisk, PC-Stock, KidGames, Best Games, Home Inventory, PC-Outline, Form Letters, ImagePrint, SideWriter, PC-Prompt, Best Utilities.

BRIGHT FUTURES INCORPORATED

P.O. Box 1030, East Windsor, CT 06088

FREE CATALOG (\$1.50 per disk)

Inquiry 669.

FREE CATALOG

PUBLIC DOMAIN/SHAREWARE

- 400 IBM PC & compatibles disks
- 200 Amiga disks
- 125 Atari ST disks

PC disks as low as \$1.25 each, Amiga & ST as low as \$1.60 each! Rent or buy. Free shipping! Call toll free, write or circle reader service for FREE BIG CATALOG with full descriptions. Please specify computer—48-hr. turnaround!

Computer Solutions

P.O. Box 354—Dept. B, Mason, Michigan 48854

1-800-874-9375 (M-F 10-6 EST) 1-517-828-2943

Inquiry 670.

\$1 DOLLAR DISK SALE!

Add \$3 S&H. SHAREWARE — IBM 5¼"

18 DISKS ON SALE: RESUMESHOP, DOS TUTOR, READ-FAST, THESAUR PLUS, PC-STYLE, MENUS for WORD-PERFECT, GRAPHIC CONVERSIONS, EGA DEMO I, SLIMMER, EDRAW, CHARTS UNLIMITED, SPANISH I, AUTOMENU, MEDLIN ACCOUNTING, EZ-FORMS, ZIPKEY, PINBALL, MAZE GAMES. (Reg. \$3.00) FREE 64-PAGE CATALOG! Canada add \$2 S&H, Foreign add \$2 S&H

CWI Information Services

P.O. BOX 4851, Anaheim, CA 92803

Phone (714) 879-5423 or 1-800-777-5636

Inquiry 671.

TOP 10 IBM SOFTWARE—FREE

10 programs on 10 disks — PC Write, PC Calc+, TreeView, DanCad, File Express, Morff's Revenge, HGCIBM, Novatron, Home Base, Spacewars, plus 1600+ disk catalog • We accept Visa/MC/Amex

PAY ONLY \$5.00 shipping/handling
limited introductory offer

International Software Library

511 Encinitas Blvd. • Ste 184 • Encinitas, CA 92024

order today (619) 942-9998

Inquiry 672.

FREE IBM SOFTWARE

FREE CATALOG also contains SHAREWARE, 5¼ and 3½-inch. All categories. ENGINEERING, CAD, DESKTOP PUBLISHING, LANGUAGES, UTILITIES, BUSINESS, GRAPHICS, SPREADSHEETS, WORD PROCESSORS, CHURCH, MEDICAL, HEALTH, EDUCATION, HOME.

SECTOR SYSTEMS COMPANY, INC.

Dept. B11, 416 Ocean Avenue, Marblehead, MA 01945

(617) 639-2625

Inquiry 673.

PUBLIC DOMAIN

FREE CATALOG

\$1 IBM SOFTWARE

For your free 32-page Master Edition catalog featuring the best of IBM Shareware from just \$1 each, call or write today!

1-800-338-2118

SOFSOURCE

Box 828, East Lansing, MI 48826

Inquiry 674.

FREE SOFTWARE CATALOG

Low as \$1.20/disk

Over 1000 quality IBM software

On 5.25" and 3.5" format

From outside U.S.A., except Canada, please send US \$2.00 refundable with order.

For fast service, write to

SOFTSHOPPE

P.O. BOX 3678, Ann Arbor, MI 48106-3678

313-761-7638

Inquiry 675.

REVIEWS

Find "Hands-on" Reviews in Seconds!

PC Reviews is an easy to use on-line database for NOVICES and PROS who need to locate and read "hands-on" reviews. BYTE, Data Based Advisor, PC Today, PC Magazine, Computer Language, Info World and 35 more included. Natural language front-end helps define search terms. A perfect use for a modem. "Wonderful!", say users.

Compatible Technologies Group, Inc.

88 Fulton St. #2400, New York, NY 10038

(212) 463-8989 (201) 653-7688 8-N-1 for FREE DEMO

Inquiry 676.

SECURITY

EVERLOCK COPY PROTECTION

- * Thwarts ALL Bit-copy Software
- * Protect any COM/EXE w/o Source changes
- * Shut down Debug Tracing & Disassemblers
- * Install to Floppy, Hard Disk, or LAN
- * Remotely reset Program Install-Count, Expire-Date or %Executes
- * No damaged media or I/O plugs

For IBM and clones. \$195 & up. Free Info.

Az-Tech Software, Inc.

305 East Franklin, Richmond, MO 64085

(800) 227-0644 (816) 776-2700
FAX: (816) 776-8398

Inquiry 677.

THE ULTIMATE COPY PROTECTION

- Completely Menu Driven
- Defeats all Hardware/Software Copiers
- No Source Code Changes
- Multiple Layering
- No Damaged Media
- Full Hard Disk Support
- Unlimited Metering
- FREE Demo Disk

Quite
Simply
The Best
Way To
Protect
Your Valuable
Software Investment

STOPCOPY™ \$325.00 STOPCOPY PLUS™ \$450.00

BBi COMPUTER SYSTEMS® (301) 671-1094

14105 Heritage Ln., Silver Spring, MD 20906 FAX: (301) 460-7545

Inquiry 678.

SECURE YOUR VALUABLE PC

Is your DOS PC secure against intrusion? Data theft or destruction? Silicon WatchDog is 100% hardware plus software protection, unbeatable once installed on your PC. For \$499.95 US you get your personal 5-1/4" disk and detailed step-by-step hardware upgrade instructions. Satisfaction guaranteed or your money back (providing all instructions were followed).

CompuSec

Unit 119, 55 Ellerslie Ave.
Toronto, Ontario M2N 1X9 CANADA

Inquiry 679.

SECURITY

COP's Copylock II

- Protects on standard diskettes
- Cannot be copied by any device incl. Option Board
- Fully hard disk installable
- Normal back-up of protected programs
- LAN-support
- Creates safe demo version of your software

Standard Version \$975, Automatic Version \$1950

DANCOTEC Computer

In US: 2835 Sierra Rd., San Jose, CA 95132 408-729-8162 or 1-800-344-2545
Int'l: 2880 Bagstrand, Denmark Phone +45-44440322 Fax -4440722

Inquiry 680.

ALL-IN-ONE PROTECTION!

TOTALSAFE gives you total security: access control, virus protection, data encryption, secure directories, and lots more! Reg. PC, HD, 1 slot (or socket). Completely transparent. Introductory price: \$120.00 + \$8.00 SH (U.S.). 30-day guarantee. Also available a complete line of PC access and data security products. Call/write for Info. MC/VISA/AMEX. Gamma Security Products, 710 Wilshire Blvd., Ste. 609, Santa Monica, CA 90401 TEL: 213-394-8622 FAX: 213-395-4214

Ellashim Inc.

520W Hwy 436, Suite 118-30, Altamonte Spgs., FL 32714

TEL: 4077682-1587 FAX: 407774-8103

Inquiry 681.

BIT-LOCK® SECURITY

Piracy SURVIVAL 5 YEARS proves effectiveness of powerful multilayered security. Rapid decryption algorithms. Reliable/small port-transparent security device. PARALLEL or SERIAL port. Complemented by economical KEY-LOCK™ and multifeatured COMPU-LOCK™ including countdown, timeout, data encryption, and multiproduct protection. (Dos/Unix/Mac)

MICROCOMPUTER APPLICATIONS

3167 E. Otero Circle, Littleton, CO 80122

(303) 922-6410/770-1917

Inquiry 682.

PC Security "Password"

With All the Computer Security Talk, PASSWORD is the Perfect Security Lock.

Password is a software program providing security for your PC. Password is Easy to understand and Simple to install, requires no reformatting. The boot limit option secures your hard disk. Password provides for up to 100 users with the supervisor controlling access to protected directories. Password is menu-driven with pop-up windows and help screens. The program provides an audit trail of users, and a screen blanking feature.

PASSWORD \$99.00 US Visa, M/C, Amex

Nasdec International Inc.

2704-85 Garry Street, Winnipeg MB Canada R3C 4J5

PH: (204) 956-2798 FAX (204) 943-3702

Inquiry 683.

COPY PROTECTION

The world's leading software manufacturers depend on Softguard copy protection systems. Your FREE DISKETTE introduces you to SuperLock™—invisible copy protection for IBM-PC (and compatibles) and Macintosh.

- Hard disk support
- No source code changes
- Customized versions
- LAN support
- New upgrades available

(408) 773-9680

SOFTGUARD SYSTEMS, INC.

710 Lakeway, Suite 200, Sunnyvale, CA 94086

FAX (408) 773-1405

Inquiry 684.

HANDS OFF THE BOARD® 1/2 SIZE SECURITY BOARD

Stop floppy boot — Require password to boot PC Real-time disk encryption — prevent boot sector virus Prevent DOS FORMAT/DISK and low-level formats Set hard disk READ ONLY or turn ON/OFF Turn floppies, printers and COM ports ON/OFF IBM XT, AT BUS — DOS V3.0+ — \$149.95 + \$5.00 S/H

SYSTEMS CONSULTING, INC.

PO BOX 111209, Pittsburgh, PA 15238

(412) 781-5280

Inquiry 685.

THE BUYER'S MART

SECURITY

HANDS OFF THE PROGRAM® OPERATING SYSTEM SECURITY

Secures subdirectories, files, printers and floppies
Keyboard lock — automatic or manual
Log PC boot, program exec, file opens, login/logout
Prevents DOS FORMAT and most viruses
Drive A: Boot Protection / Hard Disk Lock
IBM PC or 100% comp. — DOS V3.0+ — \$8995 + \$3.75 S/H
SYSTEMS CONSULTING INC.
PO BOX 111209, Pittsburgh, PA 15238
(412) 781-5280

Inquiry 686.

SOFTWARE FOR WINDOWS

TOME™ File Tracking

Keeping track of your files has never been easier. Tome creates and maintains a comprehensive list of disks and files. Use with Floppies or Hard Drives — Sort how you want — easy to use — Online Help — Req. Windows 2+. Ideal for business or personal use!

\$79.95 (orders received by December 15, 1989 just \$59.95)
CA residents add 6% sales tax.

CC&C industries

6089 Evelyn Avenue, Rohnert Park, CA 94928

Inquiry 687.

SOFTWARE/ACCOUNTING

PC TIME CLOCK

AutoTime is an Employee Management System that allows you to turn any PC into an Electronic Time Clock. AutoTime provides Time & Attendance, Job Costing, Payroll Interface, and Labor Distribution reporting. Network compatible. Prices start at \$495. Other Business Products: Network FAX, Absence Call-In, db-EDI.

Chase Technologies

1617 Kingman Ave., San Jose, CA 95128
(408) 998-2917

Inquiry 688.

dBASE BUSINESS TOOLS

- GENERAL LEDGER
- PURCH ORD/INVENTORY
- ORDER ENTRY
- ACCOUNTS RECEIVABLE
- JOB COSTING
- JOB ESTIMATING
- BILL OF MATLS
- SALES ANALYSIS
- PAYROLL
- ACCOUNTS PAYABLE

\$99 ea. + S&H

dATAMAR SYSTEMS Cred. Card-Check-COD

4876-B Santa Monica Ave.
San Diego, CA 92107 (619) 223-3344

Inquiry 689.

SOFTWARE/BUSINESS

DATA ENTRY POWERFULLY SIMPLE

Full featured, heads-down data entry with two-pass verification. Designed for the PS/2®, PC, XT, AT or compatibles.

Standalone \$395 LAN version available.

FREE trial.

Computer Keyes Tel: 206/776-6443
21929 Makah Rd. Fax: 206/776-7210
Woodway, WA 98020 USA: 800/356-0203

Inquiry 690.

SOFTWARE/BUSINESS

LOCATE HARD-TO-FIND BUSINESS AND STATISTICAL SOFTWARE

Econometrics • Biometrics • Cluster Analysis • Multivariate Analysis
• Marketing Statistics • Experimental Statistics • ANOVA • Regression
• Linear Programming • Project Planner • Forecasting & Time-Series
• Sales & Market Forecasting • Quality Control and Industrial Experiments
• Parameter and Tolerance Design • And Many More!
SEND FOR FREE PRODUCT GUIDE!

Lionheart Press, Inc.

P.O. Box 379, Alburg, VT 05440
(514) 933-4918 FAX: (514) 939-3087

Inquiry 691.

DATA ENTRY

KeyEntry III®, a complete Data Entry System that provides all the capabilities for designing data entry applications, controlling data flow, & monitoring/reporting operator activity & performance. Supports LAN and stand-alone environments. Evaluation copy (all programs & documentation) available. Call today for information!

Southern Computer Systems, Inc.

2732 Seventh Avenue South
Birmingham, AL 35233
(800) 533-6879/(205) 251-2985

Inquiry 692.

SOFTWARE/CELLULAR AUTO

Want to explore an entirely new way to compute? With Autodesk's Cellular Automata Lab and your IBM® PC, creating dazzling animations, simulating complex physical systems, exploring massively parallel computation, and experimenting with artificial life is just the beginning. CA Lab™ is your passport to the frontiers of computing. Includes a 250-page introduction to cellular automata by award-winning author Rudy Rucker. \$59.95

Autodesk, Inc.

2320 Marinship Way, Sausalito, CA 94965
(800) 525-2763

Inquiry 693.

SOFTWARE/CONSTRUCTION

FREE ESTIMATING SOFTWARE DEMO FOR SMALL BUILDERS & REMODELERS

Precision Estimating Light is brand new spreadsheet-based estimating software that combines powerful features in an easy-to-use package. Complete with 800-item database, you'll be estimating more accurately immediately. Call today for the free demo and literature — 503-644-8155.

Timberline Software

Inquiry 694.

SOFTWARE/DEVELOPMENT

Moby Words™

On 5¼" floppies

<i>Moby Words</i> 530,000 unique words & phrases The largest word list in the world \$78	<i>Moby Part-of-Speech</i> 150,000 words with parts of speech For razor-sharp language parsing \$148
<i>Moby Hyphenator</i> 150,000 syllabified words Never give the user a bad break again \$128	<i>Moby Pronouncer</i> 150,000 words with standard IPA marks For perfect text-to-speech \$198

All Royalty free. Send check or MO (CA add 6%) to:

Illuminid Unabridged

571 Beiden St., Ste. A, Monterey, CA 93940-1307
COD/Info: 1-408-373-1491

Inquiry 695.

YOUR SALES MESSAGE

COULD FILL THIS WHITE SPACE
Call Brian Higgins for more information
6 0 3 - 9 2 4 - 3 7 5 4

Inquiry 696.

SOFTWARE/ENGINEERING

SCADA SYSTEM DESIGN IBM PC or compatible

Supervisory Control And Data Acquisition modular design software includes interactive screens for sizing RTU parameters, modem speed, etc., extensive tutorial, provision for engineering analysis modules, addressing stability & control and alternative technologies for communications subsystems. \$450 Engineering modules priced individually, and described in free catalog.

AURASTAR INFORMATION SYSTEMS, INC.
Suite 620, 12001 N. Central Expressway, Dallas, Texas 75243
(214) 770-1950 Fax (214) 770-1954

Inquiry 697.

Affordable Engineering Software FREE APPLICATION GUIDE & CATALOG

Circuit Analysis • Root Locus • Thermal Analysis • Plotter Drivers • Engineering Graphics • Signal Processing • Active/Passive Filter Design • Transfer Function/FFT Analysis • Logic Simulation • Microstrip Design • PC/MS-DOS • Macintosh • VISA/MC

BV Engineering Professional Software

2023 Chicago Ave., Suite B-13, Riverside, CA 92507
(714) 781-0252

Inquiry 698.

MASS & VOLUME CALCULATOR WITH MATERIALS DATABASE

Calculate the volume of dozens of shapes easily with Mass2. Weights are calculated for over 700 materials. Differential and proportional comparisons made automatically. Flexible Input system accepts Decimal, Fractional, and Exponential notation. For IBM PCs and Compatibles with 384K. \$59

DEMPSEY'S FORGE, Software Division

Rt 2 Box 407, Gladys, VA 24554
Let us FAX you a filer. CALL 804-283-4602

Inquiry 699.

Analog Circuit Simulation

- Schematic Entry
- SPICE Simulator
- Model Libraries
- Monte Carlo Analysis
- Parameter Sweeps
- Plotting/Graphics Output

Intusoft has a complete PC based system including everything from schematic entry through SPICE simulation using extended memory to comprehensive interactive post processing. Starting at \$95 for ISpice, the complete system sells for just \$790.

Intusoft

The leader in low cost, full featured CAE software P.O. Box 8607, San Pedro, CA 90734
(213) 833-0710 FAX (213) 831-3956

Inquiry 700.

MIDNIGHT ENGINEERING™

A new publication for entrepreneurial hardware and software engineers that will encourage and challenge you to personally develop and market your own products.

- PRACTICAL ARTICLES
- INSIGHTFUL INTERVIEWS
- DETAILED PRODUCT REVIEWS

call or write for a FREE copy of the premiere issue of Midnight Engineering.

Midnight Engineering

111 E. Drake Rd., Suite 7041, Fort Collins, CO 80525
303-491-9092

Inquiry 701.

SIMULATION WITH GPSS/PC™

GPSS/PC™ is an MS-DOS compatible version of the popular mainframe simulation language GPSS. Graphics, animation and an extremely interactive environment allow a totally new view of your models. If you are contemplating the creation or modification of a complex system you need GPSS/PC to help you predict its behavior. Call now.

MINUTEMAN Software

P.O. Box 171/Y, Stow, Massachusetts, U.S.A.
(508) 897-5662 ext. 540 (800) 223-1430 ext. 540

Inquiry 702.

THE BUYER'S MART

SOFTWARE/ENGINEERING

Circuit Analysis — SPICE

Non-linear DC & Transient; Linear AC.
 * Version 3B1 with BSIM, GaAs, JFET, MOSFET, BJT, diode, etc. models, screen graphics, improved speed and convergence.
 * PC Version 2G6 available at \$95.

Call, write, or check inquiry # for more info.

Northern Valley Software

28327 Rothrock Dr., Rancho Palos Verdes, CA 90274
 (213) 541-3677

Inquiry 703.

FREE ENGINEERING MAGAZINE

Personal Engineering is a monthly magazine sent free of charge (USA only) to scientists/engineers who use PCs for technical applications. Topics each month include **Instrumentation • Data Acq/Control • Design Automation**. To receive a free sample issue and qualification form either circle below or send request on letterhead to:

Personal Engineering Communications

Box 300, Brookline, MA 02146

Inquiry 704.

SAUNA: Thermal Analysis Made Easy!

The Sauna software package lets you predict temperatures for CIRCUIT BOARDS, HEAT SINKS and ENCLOSURES. Exceptionally easy to use, create and analyze an intelligent 3D model of an entire enclosure in just a couple of minutes.

Sauna Std V1.21: PC/Mac II \$995 FREE DEMO

Tatum Labs Inc.

3917 Research Park Dr. B-1, Ann Arbor, MI 48108
 313-663-8810

Inquiry 705.

SOFTWARE/ENTERTAINMENT

BE FUNNY!

With the new, improved **Humor Processor** Version 2 you can add humor to your speeches, newsletters, or everyday conversation. Create original jokes or select from the indexed, expandable 500-joke database. Only \$49.95 + \$5 S&H. IBM PC or Compatible. 30-day money-back guarantee. Perfect gift. Call today.

Responsive Software

1901 Tunnel Rd., Berkeley, CA 94705
 800-669-4611 VISA/MC

Inquiry 706.

SOFTWARE/GEOLOGICAL

GEOLOGY & GROUNDWATER PROGRAMS

Borehole Logs, E-Logs, Cross Sections, Stratigraphy, Well Drawings Fence, Contours, Isopachs, 3-D Diagrams, Pumping Tests, Groundwater Chemistry, Piper, Stiff, Durov etc. Used by EPA and State Agencies for RCRA & CERCLA. Our software is used by consultants, universities, and oil & coal companies in 26 countries. Free brochure and demo disks.

Earthware of California

30100 town center dr. #196, Laguna Niguel, CA 92677
 Phone (714) 495-5727 FAX (714) 495-4820

Inquiry 707.

GEOLOGICAL CATALOG

Geological software for log plotting, gridding/contouring, hydrology, digitizing, 3-D solid modelling, synthetic seismogram, fracture analysis, image processing, scout ticket manager, over 50 programs in catalog. Macintosh too! Please call, or write, for Free Catalog!

RockWare, Inc.

4251 Kipling St., Suite 595, Wheat Ridge, CO 80033 USA
 (303) 423-5645 Fax (303) 423-6171

SOFTWARE/GRAPHICS

CAD/CAM Programmers!

You save hundreds of hours of programming and debugging time (and the thousands of dollars this time costs!) when you use the CAD/CAM math and DXF routines in the

QuickGeometry Library

All the routines you need for any type of CAD/CAM/CAE program! 250 ready-to-use routines that construct, intersect and offset lines, arcs, circles, ellipses and even splines!

\$199 includes source code and telephone support.

Call (617) 628-5217 today for information or to order!
 Building Block Software, PO. Box 1373, Somerville, MA 02144

Inquiry 708.

PROFESSIONAL GRAPHICS FOR SCIENTISTS AND ENGINEERS

PC/MS-DOS • Macintosh FREE 48-page Catalog

Linear/Log Scaling • Graphs with error bars • AUTO PLOT • BATCH Mode • Multiple Y-axes • Multiple data files • Auto/Forced Scaling • Full labeling • Built-in editor • 1-2-3 Interface • Curve fitting • Statistics • CGA, EGA & Hercules Compatible. 40 pen plotters supported.

BV Engineering Professional Software

2023 Chicago Ave., Suite B13, Riverside, CA 92507
 VISA/MC (714) 781-0252

Inquiry 709.

Technical Report Graphics

EDTECH scientific graphics for PC has new laser printer and dot matrix versions.

- Database, worksheet-style data editing
- Technical X-Y plots from data for reports
- Graphics editing on screen, drawing, text
- Log axes, Greek, symbols, Lotus implex

DIGITAL ANALYTICS

P.O. Box 31430, Houston, TX 77231
 (713) 721-2069

Inquiry 710.

TurboGeometry Library 3.0

New 3.0 upgrade! Now over 300 2D & 3D routines. Surfacing, Solids, HiddenLine, Volumes, Areas, Transforms, Perspectives, Tangents, Clipping, Decomp, & more. IBM PC/Comp. MS-DOS 2.0+. Turbo Pascal, Turbo C, MSC. Manual. 30-Day guar. \$199.95 w/source. Foreign S&H extra. VISA, MC, PO. USA funds only.

Disk Software, Inc.

2116 E. Arapaho Rd., #487, Richardson, TX 75081
 214-423-7288/FAX 214-423-4465/800-636-7760

Inquiry 711.

RAINDROP™

FAST, compact PritScrn Utility for end users AND developers. Hardcopy as fast as 10 secs. Average binary size - 6 kbyte. 12 video graphic standards. Scale, rotate, colorize and more. 'CALL' from user-written programs. Complete 9- & 24-pin dot-matrix, inkjet, and laserjet library \$39.95+\$3 s/h.

ECLECTIC SYSTEMS

8106 St. David Ct., Springfield, VA 22153
 (703) 440-0064

Inquiry 712.

SEGS 2.0

Scientific Engineering Graphics System

- Logarithmic, Time/Date & Linear Axes.
- Easy Curve Fitting and Data Smoothing.
- 1-2-3 Interface & Numeric Spreadsheet.
- Supports all Video & Device Standards.
- 10 Curves with up to 8000 points each.

Edmond Software, Inc.

5900 Mosteller Dr. #1124 405-842-0558
 Oklahoma City, OK 73112 800-284-3381

Inquiry 713.

SOFTWARE/GRAPHICS

POPULAR HGRAPH

SCIENTIFIC 2D & 3D graphic routines for IBM PC, VAX, SUN and Macintosh. Powerful, easy to use. Multiple fonts, device and machine independent. Uses max resolution. Links with FORTRAN, Pascal, C, Modula-2 and QuickBasic. \$119.00

Custom software development.
 UGraph—the graphics editor available now!

HeartLand Software, Inc.

234 S. Franklin, Ames, IA 50010
 (515) 292-8216

Inquiry 714.

GRAPHICS PRINTER SUPPORT

AT LAST! Use the PritSc key to make quality scaled B&W or color reproductions of your display on any dot matrix, inkjet, or laser printer (incl. PostScript). GRAFPLUS supports all versions of DOS with IBM (incl. EGA, VGA, Super VGA), Hercules, or compatible graphics boards. Linkable/OEM versions available. \$99.95.

Jewell Technologies, Inc.

4740-44th Ave. SW, Seattle, WA 98116
 800-628-2828 x527 (206) 937-1081

Inquiry 715.

FORTRAN PROGRAMMER?

Now you can call 2-D and 3-D graphics routines within your FORTRAN program.

- GRAFATIC: screen routines \$135.
- PLOTMATIC: plotter driver 135.
- PRINTMATIC: printer driver 135.

For the IBM PC, XT, AT & compatibles. We support a variety of compilers, graphics bds., plotters and printers.

MICROCOMPATIBLES

301 Prelude Dr., Dept. B, Silver Spring, MD 20901 USA
 (301) 593-0683

Inquiry 716.

COMPLETE NAPLPS/VIDEOTEX SUITE

Fully ANSI X3.110-1983 compliant. Window, view and multiple concurrent device support. Drivers for CGA, EGA, VGA, ICB, TARGA, Hercules and many others.

- MVDI—developer's decoder toolkit \$295
- MGE—graphics editor \$195
- Personality+III—terminal emulation \$95

Microstar Software Ltd.

34 Colonnade Rd. N., Nepean, Ontario K2E 7J6
 VISA U.S. 1-800-267-9975 Canada (613) 727-5696

Inquiry 717.

GRAPHIC TOOLS LIBRARY

XGLIB: Fast Window/vp, thick lines and arcs, splines, figure drawing, fill, text scale, rotate, align, keyb, mouse. Animation. One touch Screen and Image file print. \$75.

PC_VDI: Virtual Device Interface. Draw on screen or printer/plotter at device resolution. Outline fillable font factory. Super text. Rotate, Zoom. Plots, charts and splines. All GKS draw. Includes XGLIB. Compare Quality. \$395. ALL: ANSI compatible. Dot mat./Lasers/Plots. All graphic modes: Hercu. to Super VGA. Most "C", FORTRAN, MS QuickBASIC.

NOVA INC.

PO. BOX 68976, Schaumburg, IL 60168 708-882-4111

Inquiry 718.

GRAPHIC TOOLS LIBRARY

SCANPRO: Image Capture and retrieval from resident (TSR) or your program. Multiple image (.PCX, .KPS, .KPC) formats. EMS support. Fast Bitmap Graphics. Cut, Copy, Paste and more. Auto scale, Rotate, Skew, Mirror, Fold and Tile fill image. Image data base. Text and Line drawing. Virtual Bit-maps. Non-rectangular cut & stencil with PC_VDI. Screen and image file Printplot. \$149. ANSI compatible. Compare Quality. All graphic modes from Hercu. to Super VGA. Most "C", FORTRAN, MS QuickBASIC.

NOVA INC.

PO. BOX 68976, Schaumburg, IL 60168 708-882-4111

Inquiry 719.

THE BUYER'S MART

SOFTWARE/GRAPHICS

PRINTED GRAPHICS

The GraphLink™ Printer Graphics Toolkit lets your Turbo Pascal programs build and print graphics at the printer's resolution! 80+ routines emulate Borland Graphics Interface. Supports the most popular laser and dot matrix printers. Only \$125 (\$250 for Professional version) Soon for TC, MS-C, Quick C.

VISITECH SOFTWARE.

DS 3807 Ridgewood Ct., Pittsburgh, PA 15239
(412) 733-4775

PEN PLOTTER EMULATOR

FPLOT turns your dot matrix or laser printer into an HP pen plotter. Fast hi-res output. No jagged lines. Vary line width, color. Works with Autocad, Drafax, etc. Supports NEC P5/P6, IBM Proprinter, Epson LQ/FX, Toshiba, HP Laserjet, Okidata 29x/39x, Hercules/CGA/EGA/VGA. \$64 check/m.o./VISA/MC

Fplot Corporation

24-16 Steinway St., Suite 605, Astoria, NY 11103
718-545-3505

Inquiry 757.

SOFTWARE/LANGUAGES

DRUMA FORTH-83

Break the 64K barrier without speed/space penalty. Powerful, attractively priced. '83 Standard.

- FMT+ automated memory management
- Full OS interface, extensive utilities
- On-line documentation, ASCII/block files
- Other products: windows, modules, profiler
- IBM PC/XT/AT & all compatibles

Inquire about FREE Features and Example diskettes.

DRUMA INC.

6448 Hwy. 290 East E103, Austin, TX 78723
Orders: 512-323-0403 BBoard: 512-323-2402

Inquiry 720.

EASY TO C

The C Workshop interactive software teaches you C. Do real C program exercises with built-in editor and compiler. Feedback guides you to solution. All you need to learn C, including our 384-page book. \$69.95 + \$5 Ship. PC compatibles.
MC/VISA/AE/check.

Wordcraft

3827 Penniman Ave., Oakland, CA 94619
(800) 762-8003 (PST) (415) 534-2212 In CA

Inquiry 721.

SOFTWARE/MATHEMATICS

MATH EDITING FOR THE PC

$$x_i^2 = \sum_{k=0}^{\infty} [x_k^{2+2i} (i)] + \left(\frac{1}{\sqrt{\alpha \pm \beta x}} \right)$$

- MathEdit constructs math equations to be inserted into WordPerfect TeX and Manuscript documents.
- User-friendly interface—no new word processor needs to be learned.
- MathEdit—\$149

K-TALK COMMUNICATIONS

50 McMillen Ave., Suite 100
Columbus, Ohio 43201
(614) 294-3535

Inquiry 722.

AUTOCalculator: Simultaneously calculates Yards, Ft-In, Metrics—Store, Retrieve, Scan, Modify data. Estimate Conc., Carpet, Wood, etc. All Units Displayed at the same time. \$69 + \$5 SH
Stair Designer: Set to CODE or desired Riser/Run, 20 results shown in Ft-In, Ft-Dec & Metric. Fir to Fir & Nosing to Nosing results. \$29 + \$5 SH
SPECIAL: Both for \$89 + \$5 SH • VISA/MC

Precision Data Processing, Inc.

737 West Central Ave., Winter Haven, Florida 33880
(813) 294-4780

Inquiry 723.

SOFTWARE/MEDICAL

Medical Systems with ECS

PPM offers a complete line of medical software ranging from simple insurance claims processing to comprehensive A/R management. PC CLAIM PLUS—claims processing with ECS to over 100 major insurance carriers—30-day money-back guarantee
THRESHOLD—complete A/R, patient billing, comprehensive practice management statistics
CLAIM NET—Nationwide electronic claims clearinghouse transmits claims to over 100 insurance carriers
Software prices start at \$499.00. Dealer inquiries welcome.

Physicians Practice Management

350 E. New York, Indianapolis, IN 46204
800-428-3515 317-634-8080

Inquiry 724.

SOFTWARE/PACKAGING

HARD TO FIND COMPUTER SUPPLIES FOR SOFTWARE DEVELOPERS & POWER USERS

Cloth binders & slipcases like IBM's Vinyl binders, boxes, and folders in many sizes. Disk pages, envelopes, & labels. Low quantity imprinting. Bulk disks. Everything you need to bring your software to market. Disk and binder mailers. Much more! Low Prices! Fast service. Call or write for a FREE CATALOG.

Anthropomorphic Systems, Limited

376-B E. Saint Charles Rd., Lombard, IL 60148
1-800-DEAL-NOW 312-629-5160

Inquiry 725.

SAVE SAVE SAVE SAVE LET'S TALK PACKAGING

From Disk Labels to Manuals to Shipping Boxes—We are a complete packaging service. Everything you need to market your software. Call for our free catalog.

SOFCOM Printing and Packaging

10305 Reading Rd., Cincinnati, OH 45241
513-563-7136

Inquiry 726.

SOFTWARE/PRINTING

PRINTER GENIUS

Powerful memory-resident printer management • Control printer features from menus or within documents
• Print spool-to-disk files or memory • Background print
• File & directory browse • Edit small text • and more...
• User friendly pop-up screens • 92-page manual • Preset for all printers • Completely flexible • PC MS-DOS • \$89 + \$4 S/H • VISA/MC

Nor Software Inc.

527 3rd Ave., Suite 150, New York, NY 10016
(212) 213-9118

Inquiry 727.

SOFTWARE/PROGRAMMERS

ATTENTION

PROGRAM DEVELOPERS

Have you developed a program that you feel could be marketed to end users, but you need help in packaging & distribution? Send a description of your program or write for information & royalty schedule to:

CJ Software Publishing Co.

2183 Buckingham Rd., Ste. 466, Richardson, TX 75081

Inquiry 728.

SOFTWARE/SCANNERS

Optical Character Recognition

Stop retyping: PC-OCR™ software will convert typed or printed pages into editable text files for your word processor. Works with HP ScanJet, Panasonic and most other scanners. Supplied with 18 popular fonts. User trainable: you can teach PC-OCR™ to read virtually any typestyle, incl. foreign fonts. Proportional text, matrix printer output. Xerox copies OK. \$385. Check VISA/MC/AmExp/COD

Essex Publishing Co.

P.O. Box 391, Cedar Grove, NJ 07009
(201) 783-6940

Inquiry 729.

SOFTWARE/SCIENTIFIC

TableCurve—TableCode

Curve-Fit 211 Equations In a Single Step

TableCurve™ generates printed reports and Lotus, dBase, Quattro, Harvard Graphics, and Pagemaker/Ventura output. TableCode™ generates functions and calling code for C, Pascal, BASIC, FORTRAN, Modula-2 and dBASE languages.

Demo \$5, TableCurve \$159, TableCode \$149 MC/Visa

AISN Software

P.O. Box 32277, Phoenix, AZ 85064
602-266-1925

Inquiry 730.

Chaos/Nonlinear Dynamics

* Ordinary and Delay Differential Equation Solvers * Bifurcation Diagrams * 2- and 3-D Plotting, Sequential Magnification, Poincaré Sections * Next Maximum, 1-D & Circle Maps

* Phase Portraits with Multiple Initial Conditions * Spectral Analysis
Fractal Dimensions, Lyapunov Exponents
DS:I \$250.00 DS:II \$350.00

CHAOS IN THE CLASSROOM \$49.95

DYNAMICAL SYSTEMS, INC.

P.O. Box 35241, Tucson, AZ 85740, 602-292-1962

Inquiry 731.

C SCIENTIFIC LIBRARY

Create scientific & engineering tools with this extensive C programming library of over 600 math, matrix, statistics, and graphics functions. Send \$5.00 for 45-page CSL Buyer's Guide

EIGENWARE TECHNOLOGIES

13090 La Vista Dr., Saratoga CA 95070 (408) 867-1184

Inquiry 732.

Free catalog includes technical application notes

1-800-942-MATH

MicroMath Scientific Software
Salt Lake City, Utah 84121-3144

Inquiry 733.

SOFTWARE/SORT

OPT-TECH SORT/MERGE

Extremely fast Sort/Merge/Select utility. Run as an MS-DOS command or CALL as a subroutine. Supports most languages and file types including Btrieve and dBASE. Unlimited file sizes, multiple keys and much more! MS-DOS \$149. OS/2, XENIX, UNIX \$249.

(702) 588-3737

Opt-Tech Data Processing

P.O. Box 678 — Zephyr Cove, NV 89448

Inquiry 734.

SOFTWARE/VOICE

TURBO WATSON

Turbo Watson is a complete set of tools for Turbo Pascal to access all the functions of the WATSON Speech Board. It is also a high level library of procedures to build voice response systems in minutes. A powerful ANSWERING MACHINE program is given as an example with source code. ONLY 99\$ Canadian. Visa/MC accepted.

ITI Logiciel

1425 Rene-Levesque W. Montreal, Can. H3G 1T7
(514) 861-5988

Inquiry 735.

THE BUYER'S MART

STATISTICS

NEW STATISTIX™ 3.0

PC Magazine Editors Choice!

- Superb Data Management • Excellent manual
- Easy to use • Fast, free support
- Range & Depth of Statistics

Buy the BEST for 1/2 the price of the competition

CALL 612-631-2852 Now

No-risk 30-day money-back guarantee

Analytical Software, Box 13204, Roseville, MN 55113

Inquiry 736.

The BASS System™

Why use up 8 meg and 640K just to run a data step on your PC? Now you can run your data step code and statistical procs with a system that takes only 1 meg and 400K (and costs only \$399)! Free information:

BASS Institute, Inc.

P.O. Box 349, Chapel Hill, NC 27514

(919) 933-7096 or BB: (919) 968-6755 (N,8,1)

Inquiry 737.

SOLO 3.0 from BMDP

Popular statistics and excellent graphics for the PC. Quick and easy to use. For business professionals, researchers, or students. From the leader in statistical software for over 25 years. Top-notch support. Satisfaction guaranteed! \$199 complete with graphics. Call today, VISA or MC.

BMDP Statistical Software, Inc.

1440 Sepulveda Blvd., Suite 316, Los Angeles, CA 90025

(213) 479-7799

Inquiry 738.

STATA

Stata 2.05 Now Available. More statistics, graphics and an all-new manual. Still only \$590. Quantity Discounts Available. New, lower academic price. \$20 Demo. Call toll-free for more information.

1-800-STATAPC

Computing Resource Center

10801 National Boulevard, Los Angeles, CA 90064

(213) 470-4341

Inquiry 739.

DBMS/COPY

CONVERTS YOUR DATA INTO INFORMATION

Now your favorite stat package can access any database. DBMS/COPY can directly convert any database or spreadsheet file (ORACLE, PARADOX, dBASE, LOTUS etc.) into any stat package file (SAS, SPSS, SYSTAT, etc.) and vice versa. The PLUS version allows sorts, selections, and recalculations. \$195. 30-day guarantee. VISA/MC/AMEX/PO/COD. Call for free limited version.

CONCEPTUAL SOFTWARE INC.

P.O. Box 56627, Houston, TX 77256

(713) 667-4222 FAX: (713) 667-3FAX

1-800-STATWOW

Inquiry 740.

Statistical Navigator™

An expert system using AI strategies to help determine appropriate statistical analysis. Based on your answers, Statistical Navigator suggests several analyses ranked by suitability. It explains the analysis and how it fits your research objectives and assumptions. Version 1.1—\$99.95 +s/h. VISA, MC, AMEX, PO, Personal Check accepted.

The Idea Works, Inc.

100 West Briarwood, Columbia, MO 65203

1-800-537-4866 FAX 314-445-4589

Outside USA 314-445-4554

Inquiry 741.

STATISTICS

MINITAB's a PC of cake!

MINITAB's intuitive commands are easy to use and remember. Features descriptive statistics, regression, time series, chi-square, hi-res graphics, much more. PC version incl. LOTUS interface, data editor, network pricing. Call for FREE brochure.

Minitab, Inc.

3081 Enterprise Dr., State College, PA 16801

(814) 238-3280

Inquiry 742.

NCSS

Professional, easy to use, menu-driven statistical system. Used by over 5,000 researchers.

- 5.0 Statistical System —\$99
- 5.1 Graphics (2D & 3D)—\$59
- 5.3 Power Pac Supplement—\$49
- 5.4 Exp. Design/QC—\$49
- 5.5 Survival Analysis—\$59
- 5.6 Forecasting—\$69

We accept checks, POs, Visa, MC. Add \$3 s/h.

NCSS-B 801-546-0445

865 East 400 North, Kaysville, UT 84037

Inquiry 743.

SCA STATISTICAL SYSTEM

The only statistical software encompassing Forecasting & Time Series Analysis Quality and Productivity Improvement General Statistical Analysis

Available on both DOS, OS/2 and Mac operating systems. Call today for more information

Scientific Computing Associates

4513 Lincoln Ave., Suite 106, Lisle, IL 60532, USA

Phone: (312) 960-1698 FAX: (312) 960-1815

Inquiry 744.

StatPac Gold™

StatPac Gold is the award-winning statistics and forecasting package that delivers. It's fast, flexible, easy to use and dependable. Time-tested and loaded with features. You be the judge. Get the facts! Call for your FREE brochure.

1-800-328-4907

Walonick Associates, Inc.

6500 Nicollet Ave. S., Minneapolis, MN 55423

(612) 866-9022

Inquiry 744.

UNINTERRUPTABLE POWER

HOW TO PROTECT YOUR COMPUTER

And Make It Last Longer

FREE money-saving literature. What you need to know about UPS—uninterruptible power supply. How to get complete protection from power line problems. 350VA through 15KVA models from the world's largest manufacturer of single-phase UPS.

Best Power Technology, Inc.

P.O. Box 280, Necedah, WI 54646

(808) 565-7200 ext. 3737

TOLL FREE (800) 356-5794 ext. 3745

See our Ad on page 414.

Inquiry 745.

UTILITIES

Find Text&Code Changes

With speed, accuracy & "intelligence"

DocuComp® compares two versions of a document or source listing and finds changes as minor as an inserted comma and as major as a complete rearrangement in text! Results can be shown on a split-screen, in a printed composite draft, or in a detailed report. \$149.95/IBM, \$159.95/Mac.

Advanced Software, Inc.

1095 E. Duane Ave., Suite 100, Sunnyvale, CA 94086

(408) 733-0745

Inquiry 746.

UTILITIES

Graphics File Conversion

PICTure This™ is a Macintosh™ desk accessory which converts a wide range of graphics file formats to PICT. Ideal for organizations with MAC to PC connections. File formats supported include: Targa-16, CGM, Dr. Halo CUT, IMG, Lotus PIC, PCX, Sun Raster, IFF, GIF, RLE, TIFF, RIFF, X11 bitmaps, Macintosh EPSF, and MacPaint. Price \$99.

FGM Inc.

131 Elden Street, Suite 108, Herndon, VA 22070

(703) 478-9881

Inquiry 747.

COPY AT TO PC—BRIDGE-IT 3.5

"CPAT2PC" RELIABLY writes 360KB floppies on 1.2 MB drives, saving a slot for a second hard disk or tape back-up. Only \$79.00 + SH

"BRIDGE-IT 3.5" is a DEVICE DRIVER supporting 3 1/2" 720KB/1.44MB drives for PC/XT/AT without upgrading DOS/BIOS. Only \$39.00 + SH

BRIDGE-IT 3.5 BUNDLED WITH INTERNAL 1.44MB DRIVE AT

\$129.00 + SH VISA/MC/COD UPS B/R

Inquiry 748.

MAGAZINE INDEXING SERVICE

MicroDex GIVES YOU FAST & EASY DIRECTIONS TO ALL ARTICLES IN THE FOLLOWING: PCWEEK—LOTUS—PC MAGAZINE—PC WORLD—BYTE—INFOWORLD

LOCATE BY KEYWORDS—TITLES—AUTHORS—ON OUR PROPRIETARY SEARCH SOFTWARE. PC COMPATIBLE/HARD DISC REQUIRED.

1YR. SUBSCRIPTION—MONTHLY UPDATES—3 MONTHS DATA TO START ONLY \$183.50

NATLIN ENTERPRISES

P.O. Box 1334, Brea, CA 92622 800-333-5073 or 714-996-1914

Inquiry 749.

Recover deleted files fast!

Disk Explorer now includes automatic file recovery. You type in the deleted files name. Disk Explorer finds and restores it. Disk Explorer also shows what's really on disk; view, change or create formats, change a file's status, change data in any sector. MS-DOS \$75 US. Check/Credit card welcome.

QUAID SOFTWARE LIMITED

45 Charles St. E. 3rd Fl.

Toronto, Ontario, Canada M4Y 1S2

(416) 961-8243

Inquiry 749.

: COPYWRITE

- : CopyWrite
- : Removes
- : Copy Protection
- : No more diskettes,
- : manuals or
- : codewheels.
- : 1000's of products copied.

: QUAID SOFTWARE LIMITED

: 45 Charles St. E. 3rd Fl, Dept B

: Toronto, Ontario, Canada M4Y 1S2

: (416) 961-8243 Fax (416) 961-6448

Inquiry 751.

AppleWorks ↔ IBM

CROSS-WORKS transfers both ways between Apple IIe/IIc/IIgs and IBM PC/XT/AT/PS-2 & compatibles. Exchange AppleWorks with WordPerfect (keeps formatting), Lotus 1-2-3 (keeps formulas), and dBase III/IV! Includes cable plugs in serial ports for 19,200 baud transfers. Easy menu operation.

Phone (919) 878-7725 for free info packet.

SoftSpoken Co., P.O. Box 97623, Raleigh, NC 27624

Inquiry 751.

THE BUYER'S MART

UTILITIES

SAVE TIME and MONEY

with the RED Utilities. Programs include: Batch file compiler speeds batch files. Disk cache speeds hard and floppy disks. Printer spooler. Path command for data files. Wild card exceptions. Sort directories. Over 10 more programs. Only \$79.95. Order today! 30-day money-back guarantee. IBM PC. Visa/MC.

The Wenham Software Company
5 Burley St., Wenham, MA 01984 (508) 774-7036

Inquiry 752.

WORD PROCESSING

We can read 130 languages from Armenian to Zulu

Use SPOT OCR Software with an image scanner and your PC to read 130 foreign languages, typed pages, typeset material, magazines and books into standard text files. Flagstaff Engineering can provide any OCR solution. Call today to discuss your application!

Flagstaff Engineering

1120 Kaibab Lane, Flagstaff, AZ 86001
(602) 779-3341
MasterCard—Visa—American Express Accepted

Inquiry 753.

FARSI / GREEK / ARABIC / RUSSIAN

Hebrew, all European, Scandinavian, plus either Hindi, Punjabi, Bengali, Gujarati, Tamil, Thai, Korean, Viet, or IPA. Full-featured multi-language word processor supports on-screen foreign characters and NLQ printing with no hardware modifications. Includes Font Editor. \$355 dot matrix; \$150 add'l for laser; \$19 demo. S/H in U.S. incl'd. Req. PC, 640K, graphics. 30-day Guarantee. MC/VISA/AMEX

GAMMA PRODUCTIONS, INC.

710 Wilshire Blvd., Suite 609, Santa Monica, CA 90401
213/394-8622 Tlx: 5106008273 Gamma Pro SNM

Inquiry 754.

WORD PROCESSING

DuangJan

Bilingual word processor for English and: Armenian, Bengali, Burmese, Euro/Latin/African, Greek, Gujarati, Hindi, Khmer, Lao, Punjabi, Russian, Sinhalese, Tamil, Telugu, Thai, Ukrainian, Viet, . . . Only \$109+\$5 s/h (foreign + \$12 s/h). Font editor included. For any IBM compatibles with dot-matrix & LaserJet printer. Demo \$9+\$1 s/h. Visa/MC

MegaChomp Company

3438 Cottman Ave., Philadelphia, PA 19149-1606
(215) 331-2748 FAX: (215) 331-4188

Inquiry 755.

PC-Write 3.0 — Shareware

Fast, full featured word processor for IBM PC. Now edits large files & multiple columns. Also spell check, mailmerge, networking, ASCII, and macros. Easy-to-use, optional menus. Supports 500 printers incl. lasers. Software, guide and tutorial on disk: \$19. Registration with manual, support newsletter and 2 free updates: \$99.

90-day money-back guarantee. VISA/MC.

Quicksoft 1-800-888-8088
219 First Ave. N., #224-BYTC, Seattle, WA 98109

Inquiry 756.

YOUR SALES MESSAGE

about the special computer product or service that you provide belongs in print.

THE BUYER'S MART

can help you reach computer professionals and produce valuable inquiries for your company!

Call Brian Higgins for more information

603-924-3754

Inquiry 758.

Issues Available

BYTE BACK ISSUES FOR SALE

	1987	1988	1989
Jan.			
Feb.			
March			
April			
May			
June			
July			
Aug.			
Sept.			
Oct.			
Nov.			
Dec.			
Inside the IBM PCs			
Appl. SW Today			

Rates (postage and handling included):

1987-89 BYTE Issues	\$6.00*
BYTE '83-'84 Index	\$4.00
BYTE 1985 Index	\$4.00
BYTE 1986 Index	\$4.00
BYTE 1988 Index	\$4.00
1985 Inside The IBM PCs	\$4.00
1986 Inside The IBM PCs	\$4.00
1988 Inside The IBM PCs	\$6.00
1989 Inside The IBM PCs	\$6.00
Applications Software Today Special	\$4.00
* June 1988 (Benchmarks)	\$3.00

The above prices include postage in the US. Please add \$.50 per copy for Canada and Mexico; and \$2.00 per copy to foreign countries (surface delivery). European customers please refer to Back Issue order form in International Advertising section of book.

Please indicate which issues you would like by checking (✓) the boxes. Send requests with payment to:

BYTE Back Issues, One Phoenix Mill Lane, Peterborough, NH 03458 (603) 924-9281

Check enclosed

Exp. Date _____

Charge:

Signature _____

VISA

Name _____

MasterCard

Card No. _____

Address _____

City _____

State _____

Zip _____

All orders must be prepaid. Please allow four weeks for domestic delivery and twelve weeks for foreign delivery by surface mail.

3M * FREE! HEADCLEANING KIT on 5.25" 3M diskette order!!

DS-DD	Quantity Discounts Available	DS-HD	
5.69*	5.25" 3M Diskettes 10/Box	10.99	
10.89	3.50" 3M Diskettes 10/Box	23.99	
17.99	8.00" 3M Diskettes 10/Box	19.99	
DC-2000	14.49	DC-600A	19.99
DC-300XLP	17.99	DC-6150XTD	21.49
3M/DEC TK50 Tape			24.95
3M/IBM 3480 Tape			4.95
3M Mag. Tape with seal 2400'			12.50

3M HIGHLAND

5.25" DS/DD	3M Highland Diskettes	5.25" DS/HD	
3.79	10/Box	6.89	
3.50" DS/DD	KAO in Plastic Box	3.50" DS/HD	
8.95	10/Box	Brand Name	19.49

BASF INCREDIBLE VALUE!!

DS-DD	Quantity Discounts Available	DS-HD	
4.89	5.25" BASF Diskettes 10/Box	8.10	
8.99	3.50" BASF Diskettes 10/Box	19.49	
.32	BASF 5.25" DS-DD No-Logo Bulk with Tyvek sleeves, labels & W/P tabs		
	BASF Mag Tape 2400'		10.49

Verbatim DataLifePlus Tefton/Preformatted

DS-DD		DS-HD
5.79	5.25" DataLife Plus 10/Box	10.79
9.99	3.50" DataLife Plus 10/Box	22.99
6.49	5.25" DataLife Color Disks 10/Box	

maxell FREE GAME ON FREE 11th DISK!!

5.25" DS/DD	5.25" DS/HD	3.50" DS/DD	3.50" DS/HD
5.79	11.19	10.49	23.49

Dysan 100% BETTER

DS-DD		DS-HD
6.19	5.25" Dysan 10/box	10.49
9.75	3.50" Dysan 10/box	22.49

KAO Color Diskettes

DS-DD		DS-HD
.34*	5.25" KAD No-Logo Color Disks	*.64
.74	3.50" KAD No-Logo Color Disks	1.85
8.95	3.50 DS/DD KAO Brand in Plastic Box	
	*5.25" Color disks add 4¢ for sleeves and labels	

No-Logo Bulk Diskettes

5.25" DS/DD	5.25" DS/HD	3.50" DS/DD	3.50" DS/HD
.27*	.45*	.59	1.69*
	*Bulk diskettes include Tyvek sleeves, labels & w/p tabs		

TERMS: No surcharge on VISA, Mastercard or AMEX. Order packaging and processing = \$2.95 per order. COD orders add \$3.95. SHIPPING: \$1.95/5 cartridges, \$0.95/50 diskettes. PO's accepted from recognized institutions on Net 30 Bank Draft, T/T or L/C acceptable. Price quoted for case (100 disks or 10 cartridges). For quantities less than 1 case add 5%.

Toll Free Order Line: Information Line:
1-800-523-9681 1-801-255-0080
TLX-9102404712 FAX-801-572-3327

DISKOTECH

DISKCO TECHNOLOGIES, INC.
213 Collage Avenue
P.O. Box 1339 Sandy, Utah 84091

PC Component Headquarters HOLIDAY SPECIALS

386-25 MHZ 25 MHZ 4MB CACHE	ONLY	\$2774
386 SX-16 MHZ 4 MB	ONLY	\$1824
Y.E.S. 286-16MHZ 1 MB	ONLY	\$1174
Y.E.S.-Turbo 10 MHZ 640K - without Hard Disk	ONLY	\$ 409
Y.E.S. 286-12 MHZ 1 MB	ONLY	\$1024
All Systems Include: Case, Power supply, FD/HD Controller, 1.2 MB Drive, 101 Keyboard, 40 MB Harddrive		

★ MONTHLY SPECIALS ★

Mono Graphics Printer Card ..	\$30
Paradise EGA Autoswitch with EGA Monitor ..	400
1.44 MB TEAC Floppy with mounting kit ..	75

VIDEO OPTIONS

Monochrome	ADD	\$125
RBG	ADD	275
EGA	ADD	400
VGA	ADD	525

MODEM

Internal 2400 BD	\$85
External 2400 BD	75
Internal 1200 BD	60

HARDDISK SPECIAL

Seagate 20MB	\$190
Seagate 40MB	310
Toshiba 40MB/60MB	390

MEMORY UPGRADE

XT Memory Card	\$65
AT Memory Card	75
PC Memory Card	30

Click 101 Keyboard	\$45
Maxiswitch 101 Keyboard	60

Complete line of Peripherals available — Call for Products not listed

Y.E.S. Systems Corp.

44829 Fremont Blvd.
Fremont, CA 94538
(415) 657-4888
FAX: (415) 656-0118

All orders shipped UPS—COD or
prepay. PO's are welcome from
universities and qualified companies.
Open: Mon.—Sat. 9-7

9600bps MODEM



OR **FAX** **\$299**

300-9600bps MODEM \$299 \$95-2400bps ALL PRODUCTS...30 DAY FREE TRIAL

The **SPEEDMODEM™** is a knock out for value and performance. It features **DYNAMIC IMPEDANCE STABILIZATION™, DIS™**, (patent pending). **DIS** improves signal quality, assuring maximum speed and data integrity. **DIS** is renowned for superior performance where other modems fail. All products are internal IBM cards, made in USA, 5 year warranty. *If you aren't totally satisfied, return within thirty days for full refund!*

	with DIS	no DIS
• SPEEDMODEM 300-9600-bps	\$299	
• SPEEDMODEM + FAX -9600	\$399	
• FAX-9600 full featured high speed fax card	\$299	
• 2400-4800-bps MNP-5 MODEM	\$193	\$169
• 2400-bps MODEM with SEND ONLY FAX	\$159	
• 2400-bps MODEM	\$119	\$95
• FREE \$69 EASYCOM™ SOFTWARE with modem		

CompuCom Corporation
March '89 p102 **BYTE MAGAZINE***
"Real deal...worked fine...quite a bargain"
CALL (408) 732-4500 (800) 228-6648

Protect Your Copies of **BYTE**

NOW AVAILABLE: Custom-designed library files or binders in elegant blue simulated leather stamped in gold leaf.

Binders—Holds 6 issues, opens flat for easy reading.

\$9.95 each, two for \$18.95, or four for \$35.95.



Files—Holds 6 issues.
\$7.95 each, two for \$14.95, or four for \$27.95.



Order Now!

Mail to: Jesse Jones Industries,
Deprt. BY, 499 East Erie Ave.,
Philadelphia, PA 19134

CALL TOLL FREE (24 hours):
1-800-972-5858

Please send _____ files;
binders for **BYTE** magazine.

Name: _____

Enclosed is \$_____
Add \$1 per file/binder for postage and
handling. Outside U.S.A. add \$2.50 per
file/binder (U.S. funds only please).

Address: _____
(No Post Office Box)

Charge my: (minimum \$15)
____ American Express
____ Visa _____ MasterCard
____ Diners Club

City: _____

State: _____ Zip: _____

Satisfaction guaranteed. Pennsylvania residents add 6% sales tax.
Allow 5-6 weeks delivery in the U.S.

Card # _____
Exp. Date _____
Signature _____



Serial ← → Parallel



**Convert What You Have
To What You Want!**

- RS232 Serial
- 8 Baud Rates
- Latched Outputs
- Centronics Parallel
- Handshake Signals
- Compact 3½" x 4¾" x 1½"

No longer will your peripheral choices be limited by the type of port you have available! Our new High Performance 700 Series Converters provide the missing link. Based on the latest in CMOS technology, these units feature full baud rate selection to 19.2K, with handshake signals to maximize transfer efficiency. Detailed documentation allows simplified installation. Order the Model 770 (Ser/Par) or Model 775 (Par/Ser) Today!

**FREE
CONNECTOR
OPTION!**



New Only **\$79.95**

— Complete —

400 Daily Lane
PO Box 5210
Grants Pass, OR 97527

UPS Shipping \$4.00

Call (503) 474-6700 or 474-6701

For FAST Delivery

Circle 380 on Reader Service Card

REEL 9-TRACK GENIUS

OVERLAND DATA will bring out the GENIUS IN YOU when it comes to connecting your PC to the mini/mainframe world. OUR ENGINEERS DESIGNED the most successful tape drives, controllers and software in use today. Call the experts... ODI!

- PC/XT/AT/386/PS2 & Compat.
- DOS, XENIX, UNIX, NOVELL
- 800, 1600, 3200, & 6250 BPI
- Outstanding Customer Support
- 24-hour delivery available on Cipher, Qualstar, Anritsu & M4



Overland Data
"Experience Makes The Difference"

CALL TODAY AT 1-800-PC-9TRAK!

5600 Kearny Mesa Road • San Diego, CA 92111
TEL: 619/571-5555 • FAX: 619/571-0982

PC COMPATIBLE ENGINEERING

Annabooks gives you the hardware, software, and firmware information you need to design PC-compatible systems faster and better. And you have control of your design from the ground up -- our firmware and software products include source code! Plus all the utilities you need.

AT BiosKit: an AT Bios with source code you can modify. With setup & debug. 380 pages with disk, \$199

XT BiosKit: Includes a debug. 270 pages with disk, \$99

Intel Wildcard Supplement for XT BiosKit: Includes ASIC setup, turbo speeds, also useful with many other modern XT boards. 60 pages with disk, \$49

PromKit: Puts anything in Eprom or SRAM; DOS, your code, data, you name it! With source on disk, \$179

SysKit: Here's a debug/monitor you can use even with a brand X Bios in your desktop. Runs in ROM or TSR in RAM. Includes source, of course. \$69

XT-AT Handbook: The famous pocket-sized book jam-packed with hardware & software info. \$9.95 ea. or 5 or more for \$5 each.

Software tools: You need MS C & MASM 5.1 for modifying the Kit products.

FREE Mention this ad when you order any publication and get a free XT-AT Handbook by Choisser & Foster! Hurry before we come to our senses and change our minds.

Annabooks

12145 Alta Carmel Ct Suite 250-262
San Diego, California 92128

(619) 271-9526 Money-back guarantee



DISC DRIVE REPAIR SPECIAL

Formatted Cap.	Flat Rate	SPECIAL	SHIPPING YOUR DRIVE FOR REPAIR
10-19 mb	\$99	89.10	Pack your drive carefully and fully protected in a sturdy shipping box. Include with the shipment a note with your name, address and daytime telephone number and a brief description of the problem with the drive. If prepaying, allow \$9 for shipping and insurance costs per drive.
20-29 mb	\$125	112.50	
30-39 mb	\$150	135.00	
40-49 mb	\$175	157.50	
50-85 mb	\$210	189.00	
86-120 mb	\$275	247.50	
121-150 mb	\$325	325.00	
151-275 mb	\$425	425.00	
276-380 mb	\$495	495.00	

TEST & EVALUATION \$25

VALID THROUGH 1/31/90

**WE DO DATA RECOVERY
CALL FOR QUOTE**

FLOPPY 5.25" REPAIR \$45

DISC DRIVE SALES

XT/AT FLOPPY DRIVES

3.5".....720k.....new.....	\$105
3.5".....1.44mb.....new.....	115
5.25".....360k.....ref.....	49
5.25".....720k.....ref.....	59
5.25".....1.2mb.....ref.....	89

KITS FOR IBM AT & COMPATIBLES

147 MB.....ESDI.....	\$1395
230 MB.....ESDI.....	1695
320 MB.....ESDI.....	1995

HARD CARDS

10MB/85MS.....	\$185
20MB/65MS.....	225
30MB/65MS.....	295
40MB/65MS.....	345
48MB/36MS.....	395

XT/AT HARD DRIVES

5 MB.....ref.....	\$75
10 MB.....unu.....	89
20 MB.....ref.....	159
30 MB.....ref.....	239
42 MB.....unu.....	295
72 MB.....ref.....	595
120 MB.....new.....	1295

SCSI HARD DRIVES

20 MB.....	\$225	85 MB.....	\$995
30 MB.....	265	147 MB.....	1495
42 MB.....	295	310 MB.....	1995

NOVELL SUBSYSTEMS

150 MB.....	\$1975
320 MB.....	2795
650 MB.....	4295

THOUSANDS OF DISC DRIVES IN STOCK

We Feature Technical Support for Everything We Sell

We Specialize in Disc Drives — Ask for Our Brochure

jb TECHNOLOGIES, INC.

5105 Maureen Lane Moorpark, CA 93021

TEL 818 • 709 • 6400

FAX 818 • 341 • 2935

TELEX 678953

Connectivity Solutions

DCB

Universal converter; high capacity 64KB to 1 MB printer buffer with parallel / serial input and output ports.

Frees computer while doing printing. Converts data if required. Connects more than 1 computer to more than 1 printer.

DCI

Internal converter printer buffer for IBM or compatibles computers.

Built in microprocessor frees computer while printing. Serial and parallel outputs. Features include using any type of printer or using 2 printers software selectable.

MOP

Parallel interface card for PC, XT or AT with up to 4 output ports. Connect up to four different printers or plotters. Software selectable.

DCU

Universal data converter serial/parallel, parallel/serial. Completely programmable with software protocol.

MOS

Multi-serial interface for IBM or compatibles. Up to 8 serial ports. Interconnects computers, modems, printers, plotters, etc.

MIP

Multi-parallel input ports for PC, XT or AT with 8 ports. Allows up to 64 external data lines, 24 input/output control lines.

MAX-E-CON

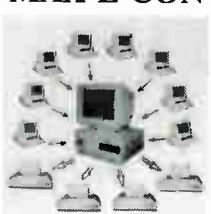

Ultra high storage capacity suitable for LANs and multiple stand alone computers. Share or switch computers, printers, plotters, modems, etc.

Up to 24 serial / parallel input/output ports. System capacity: 512 KB RAM with 20 or 40 MB fast access hard disk. Basic model comes with 512 KB, 8 input ports (serial or parallel) and 4 output ports (parallel). Each port is completely independent and can use different speeds, protocols, etc. System status display (optional).



Maxima Corporation
970 Terra Bella Ave. Bldg. 3
Mountain View, CA 94043

Call today for details
Phone (415) 968-8404
FAX # (415) 968-8390



Dealer's inquiries welcome

SIP & SIMM MODULES

Part No.	Function	Price
5120K1*	IBM PS2 100ns 256K x 9 SIMM (2 each)	159.95
2MEGKIT*	IBM PS2 100ns 1MEG x 9 SIMM (2 each)	469.95
41256A9A-10	262,144x9 100ns 1MEG x 9 SIP (Has Leads)	49.95
41256A9B-80	262,144x9 80ns 256K x 9 SIMM	64.95
421000A9B-10	1,048,576x8 100ns 1MEG x 8 SIMM	164.95
421000A9A-80	1,048,576x9 80ns 1MEG x 9 SIP (Has Leads)	169.95
421000A9B-80	1,048,576x9 80ns 1MEG x 9 SIMM	169.95

*Upgrade for Models 30, 50Z and 60

7400

Part No.	1-9	10+	Part No.	1-9	10+
7400	29	19	7474	39	29
7402	29	19	7475	49	39
7404	29	19	7476	45	35
7405	35	25	7483	59	49
7406	39	29	7485	65	55
7407	39	29	7486	45	35
7408	35	25	7489	2.25	2.15
7410	49	39	7490	49	39
7411	35	25	7493	45	35
7414	49	39	7495	59	49
7416	35	25	74107	29	19
7417	35	25	74121	39	29
7419	29	19	74123	49	39
7427	29	19	74125	49	39
7430	29	19	74147	1.99	1.89
7432	39	29	74150	1.35	1.25
7438	39	29	74151	39	29
7442	49	39	74154	1.35	1.25
7445	75	65	74161	69	59
7446	89	79	74174	59	49
7447	89	79	74175	59	49
7473	39	29	74193	79	69

74LS

Part No.	26	16	74LS139	49	39
74LS00	26	16	74LS139	49	39
74LS02	28	18	74LS151	49	39
74LS03	28	18	74LS153	49	39
74LS04	28	18	74LS154	1.29	1.19
74LS05	28	18	74LS157	45	35
74LS06	49	39	74LS161	49	39
74LS07	59	49	74LS163	49	39
74LS08	28	18	74LS164	59	49
74LS09	28	18	74LS165	75	65
74LS10	26	16	74LS166	89	79
74LS11	29	19	74LS173	45	35
74LS14	49	39	74LS174	49	39
74LS20	28	18	74LS175	39	29
74LS21	29	19	74LS191	59	49
74LS27	35	25	74LS192	69	59
74LS30	28	18	74LS193	69	59
74LS32	28	18	74LS194	69	59
74LS38	35	25	74LS221	69	59
74LS42	49	39	74LS240	59	49
74LS47	85	75	74LS241	59	49
74LS73	39	29	74LS244	59	49
74LS74	35	25	74LS245	79	69
74LS75	39	29	74LS247	49	39
74LS83	55	45	74LS259	39	29
74LS85	55	45	74LS273	89	79
74LS86	29	19	74LS279	49	39
74LS90	49	39	74LS373	79	69
74LS93	49	39	74LS374	79	69
74LS123	49	39	74LS541	1.29	1.19
74LS132	49	39	74LS590	5.95	5.85
74LS138	49	39	74LS688	2.99	2.89

74S/PROMS*

Part No.	25	74S188*	1.49
74S00	25	74S188*	1.49
74S04	25	74S189	1.49
74S32	25	74S240	1.39
74S44	25	74S244	1.49
74S112	25	74S287*	1.49
74S124	1.25	74S288*	1.49
74S138	49	74S373	1.99
74S153	29	74S374	1.99
74S163	75	74S387*	1.29
74S174	29	74S472*	2.95
74S175	39	74S571*	2.49

CD-CMOS

Part No.	19	CD4051	59
CD4002	19	CD4052	59
CD4007	19	CD4053	59
CD4011	19	CD4060	65
CD4012	25	CD4066	29
CD4013	29	CD4069	25
CD4015	29	CD4070	25
CD4016	29	CD4071	19
CD4017	49	CD4072	19
CD4018	49	CD4073	19
CD4020	59	CD4081	19
CD4021	49	CD4093	19
CD4024	45	CD4094	89
CD4027	35	CD4503	39
CD4028	49	CD4511	59
CD4029	69	CD4518	75
CD4030	35	CD4520	69
CD4040	65	CD4522	75
CD4042	49	CD4528	69
CD4043	59	CD4538	79
CD4046	65	CD4543	69
CD4047	65	CD4543	69
CD4049	29	CD4584	49
CD4050	29	CD4585	69

NEC V20 & V30 CHIPS

Replace the 8086 or 8088 in Your IBM PC and Increase Its Speed by up to 30%!

Part No.	Price
UPD70108-5 (5MHz) V20 Chip	5.25
UPD70108-8 (8MHz) V20 Chip	6.35
UPD70108-10 (10MHz) V20 Chip	10.95
UPD70116-8 (8MHz) V30 Chip	10.95
UPD70116-10 (10MHz) V30 Chip	13.49

MICROPROCESSOR COMPONENTS

Z80, Z80A, Z80B, SERIES		8000 SERIES Continued		8000 SERIES Continued	
Part No.	Price	Part No.	Price	Part No.	Price
Z80	1.25	8155-2	3.75	8286	2.29
Z80A	1.29	81C55	4.25	8741	1.49
Z80A CTC	1.95	8205	9.95	8742	9.95
Z80A-DART	4.95	82C11	6.95	8748 (25V)	3.95
Z80A-PIO	1.89	8212	1.99	8748H (HMOS)(21V)	9.95
Z80A-SIO	1.95	8216	1.39	8749	9.95
Z80B	2.75	8224	1.49	8751H (3.5-12MHz)	34.95
Z80B-CTC	3.95	8228	1.49	8755	13.95
Z80B-PIO	3.95	8237.5	4.25	88286 10 (10MHz) LCC	29.95
Z8400HB1 CPU-8MHz	3.95	8243	1.95	88287.3 (5MHz)	109.95
		8250A	4.95	88287.8 (8MHz)	209.95
		8251A	1.95	88287.16 (10MHz)	239.95
		8252	1.89	88386 16 PGA	259.95
		8253	1.95	88387.20 (20MHz)	399.95
		82C53-5	3.95	88387.25 (25MHz)	499.95
		8254	4.95	82284 (8MHz)	5.49
		8255A-5	2.95	82288 (8MHz)	6.95
		82C55A-5	4.49		
		8256	11.95		
		8259	2.25		
		8272	3.49		
		8274	4.75		
		8279-5	2.95		
		8282	2.95		
		8284A	1.95		

STATIC RAMS

Part No.	Function	Price
2016 12	2048x8 120ns	2.95
2102	1024x1 350ns MOS	.89
2112	256x4 450ns	2.49
2114N	1024x4 450ns Low Power	1.49
2114N-2L	1024x4 200ns Low Power	1.49
21C14	1024x4 200ns (CMOS)	.49
5101	256x4 450ns (CMOS)	1.95
6116P-1	2048x8 100ns (16K) CMOS	3.19
6116P-3	2048x8 100ns (16K) LP CMOS	3.59
6116LP-1	16384x1 150ns (16K) LP CMOS	3.49
6264P-10	8192x8 150ns (64K) CMOS	6.75
6264P-15	8192x8 150ns (64K) LP CMOS	6.29
6264LP-10	8192x8 120ns (64K) LP CMOS	6.75
6264LP-15	8192x8 150ns (64K) LP CMOS	6.49
6514	1024x4 450ns (CMOS)	3.25
6256LP-10L	32,768x8 100ns (256K) Low Power	9.95
6256LP-15L	32,768x8 150ns (256K) LP CMOS	11.95
6256LP-12	32,768x8 120ns (256K) LP CMOS	11.25
6256LP-15	32,768x8 150ns (256K) LP CMOS	10.95

DYNAMIC RAMS

Part No.	Function	Price
TMS4416 12	16,384x4 120ns	5.95
TMS4416 15	16,384x4 150ns	5.49
4116 15	16,384x1 150ns (MM5290N-2)	1.09
4116 15	131,072x1 150ns (Piggyback)	4.49
4164 100	65,536x1 100ns	2.99
4164 120	65,536x1 120ns	2.39
4164 150	65,536x1 150ns	2.15
41256 60	262,144x1 60ns	6.95
41256 80	262,144x1 80ns	5.75
41256 100	262,144x1 100ns	3.95
41256 120	262,144x1 120ns	3.49
41256 150	262,144x1 150ns	3.25
41264 12	64Kx4 120ns Video RAM	10.95
41464 80	65,536x4 80ns	5.95
41464 12	65,536x4 120ns	4.49
41464 15	65,536x4 150ns	4.25
511000P 80	262,144x1 100ns Static Column	8.95
511000P 80	1,048,576x1 80ns (1 Meg)	13.95
511000P 100	1,048,576x1 100ns (1 Meg)	12.95
51256P 10	262,144x4 100ns (1 Meg)	14.49
514258 10	262,144x4 100ns Static Column	26.95

EPROMS

Part No.	Function	Price
TMS2516	2048x8 450ns (25V)	4.95
TMS2532	4096x8 450ns (25V)	5.95
TMS2532A	4096x8 450ns (12.5V)	5.25
TMS2564	8192x8 450ns (25V)	6.95
TMS2716	2048x8 2K (1µs)	4.25
2708	1024x8 450ns	6.95
2716	2048x8 450ns (25V)	3.49
2716-1	2048x8 350ns (25V)	3.95
27C16	2048x8 450ns (25V) CMOS	4.25
2732	4096x8 450ns (25V)	3.95
2732A-20	4096x8 200ns (21V)	3.95
27C32	4096x8 250ns (25V) CMOS	4.25
2764-25	8192x8 250ns (21V)	3.95
2764A-20	8192x8 200ns (12.5V)	4.19
2764A-25	8192x8 250ns (12.5V)	3.49
27C64-15	8192x8 200ns (12.5V) CMOS	4.95
27128-25	16,384x8 250ns (21V)	5.95
27128-25	16,384x8 150ns (12.5V)	4.95
27128A-15	16,384x8 150ns (12.5V)	4.95
27C128-25	16,384x8 200ns (12.5V) CMOS	5.75
27256-15	32,768x8 150ns (12.5V)	5.49
27256-25	32,768x8 250ns (12.5V)	4.95
27C256-15	32,768x8 250ns (12.5V) CMOS	7.25
27C256-25	32,768x8 250ns (12.5V) CMOS	5.49
27512-25	65,536x8 250ns (12.5V)	7.25
27C512-15	65,536x8 150ns (12.5V) CMOS	9.95
27C512-25	65,536x8 250ns (12.5V) CMOS	7.49
27C010-15	131,072x8 150ns (12.5V) CMOS (1 Meg)	19.95
68765 35	8192x8 64K 450ns (25V) (Chip Enable)	14.95
68765 35	819	

Now Available...Jameco's NEW 1990 Catalog with 80 pages of Computer Peripherals, Components & More!

Sperry Monochrome Text Card



• IBM PC/XT Compatible • Use for Text only • Great for Network Servers and Dedicated Work Stations

TEXT.....\$12.95

Logitech ScanMan Plus Scanner and Mice



Scanner only:
• IBM PC/XT/AT Compatible
• 4" Scanning Window
• Ideal for DTP and Graphics Programs
• 400DPI

Scanner **\$259.95**
MSER Serial Mouse **\$79.95**
MBUS Mouse w/Bus **\$99.95**
MPS2 PS/2 Mouse..... **\$74.95**

Prometheus 9600 Baud Modem



9600E External 9600 Baud **\$749.95**
1200B Internal 1200 Baud **\$49.95**
2400B Internal 2400 Baud **\$99.95**

Metex Digital Multimeters

Metex General Specs:
• Handheld, high accuracy
• AC/DC Voltage, AC/DC Current, Resistance, Diodes, Continuity, Transistor hFE
• Manual ranging w/overload protection



M3650, 3650B & M4650 only:
• Also measure frequency and capacitance

M4650 only: • Data Hold Switch • 4.5 Digit

M3610 3.5 Digit Multimeter **\$49.95**
M3650 3.5 Digit Multimeter w/Frequency & Capacitance **\$69.95**
M3650B Same as M3650 w/Bargraph ... **\$79.95**
M4650 4.5 Digit w/Frequency, Capacitance and Data Hold Switch **\$99.95**

Jameco Solderless Breadboards



JE24
JE27
JE21
JE23

Part No.	Dim. L" x W"	Contact Points	Binding Posts	Price
JE21	3.25 x 2.125	400	0	\$4.95
JE23	6.5 x 2.125	830	0	\$6.95
JE24	6.5 x 3.125	1,360	2	\$12.95
JE25	6.5 x 4.25	1,660	3	\$17.95
JE26	6.875 x 5.75	2,390	4	\$22.95
JE27	7.25 x 7.5	3,220	4	\$32.95

Jameco 20MHz 80286 Mini-Vertical Computer Kit with NEAT® CHIPSet™

- Fully IBM AT Compatible
- Free! DR -DOS Disk Operating System Software Included
- Free! QAPLUS Diagnostic Software Included!
- Free! WORDSTAR EASY Word Processing Software Included!
- 2Mb RAM Included, Expandable to 8Mb onboard
- 10/20MHz Keyboard Switchable Operation
- AMI BIOS ROMs Included
- Mini Vertical Case w/200 Watt Power Supply
- MiniScribe 3.5" 40Mb RLL Hard Disk Drive
- 1.2Mb Floppy DSHD Disk Drive
- 22.5 Norton SI Rating
- 101-Key (Enhanced) Keyboard



Shown with EGA Option (not included)
JE2057 Multiscan and EGA Card...\$559.95 (See Below)

JE3015 20MHz 80286 Compatible Kit.....\$1499.95

MOTHERBOARDS

20MHz 386 Only \$649.95! • All w/ 0K RAM

JE3520 Pictured

JE1001 Jameco 4.77/10MHz 8088 (PC/XT) **\$89.95**
JE1002 Jameco 4.77/10MHz 8088 (PC/XT) **\$99.95**
JE3005 Jameco Baby 8.12MHz 80286 (AT) **\$199.95**
JE3010 Jameco Baby 8.15MHz 80286 (AT) **\$299.95**
JE3011 Jameco Baby 8.20MHz 80286 (AT) **\$399.95**
JE3020 AMI Baby 16MHz 80386..... **\$999.95**
JE3025 AMI Baby 20MHz 80386 **\$1199.95**
JE3026 AMI Full-Size 25MHz 80386 **\$1899.95**
JE3028 AMI Full-Size 33MHz 80386 **\$2599.95**
JE3520 Jameco Baby 20MHz 80386 **\$649.95**
JE3525 Jameco Baby 25MHz 80386 **\$1299.95**

IBM Compatible Cases and Power Supplies

JE1010 Flip-Top Standard PC/XT Case **\$39.95**
JE1011 Side Standard PC/XT Case **\$39.95**
JE1018 Side Baby AT Case **\$59.95**
JE1030 150 watt PC/XT Power Supply **\$59.95**
JE1032 200 watt Baby AT Power Supply **\$89.95**
JE2011 Vertical Case w/300W Pwr. Supply **\$279.95**
JE2012 Mini-Vertical Case w/200W Pwr. Supply **\$149.95**
JE2014 Flip-Top Baby XT Turbo Case **\$69.95**
JE2019 Flip-Top Baby AT Case **\$69.95**

Display Monitors and Packages

AMBER 12" Amber Monochrome **\$99.95**
HD55H 14" RGB 640 x 240 **\$249.95**
M9070S 16" Multiscan Monitor 1280 x 800 **\$1099.95**
TM5154 14" EGA 720 x 350 **\$369.95**
JE1059 TM5154 EGA Monitor & EGA Card **\$459.95**
JE1556 14" VGA 720 x 480 **\$399.95**
JE2060 TM5156 VGA Monitor & VGA Card **\$529.95**
TM5157 14" Multiscan 800 x 600 **\$469.95**
JE2057 TM5157 Multiscan Monitor & EGA Card ... **\$559.95**



JAMECO IBM PC/XT/AT COMPATIBLE CARDS

JE1043 360K/720K/1.2Mb/1.44Mb Floppy Disk Controller Card (PC/XT/AT) **\$49.95**
JE1050 Monochrome Graphics Card w/Parallel Printer Port (PC/XT/AT) **\$59.95**
JE1052 Color Graphics Card w/ Parallel Printer Port (PC/XT/AT) **\$49.95**
JE1055 EGA Card w/ 256K Video RAM (PC/XT/AT) **\$139.95**
GC1500 Orch'd 8-Bit VGA Card w/256K Video RAM (PC/XT/AT)..... **\$179.95**
JE1057 8/16-Bit VGA Card w/256K Video RAM (PC/XT/AT) **\$249.95**
JE1060 I/O Card w/ Serial, Game, Printer Port & Real Time Clock (PC/XT) **\$59.95**
JE1062 RS232 Serial Half Card (PC/XT/AT) **\$29.95**
JE1065 I/O Card w/ Serial, Game and Parallel Printer Port (AT) **\$59.95**
JE1071 Multi I/O Card w/ Controller & Monochrome Graphics (PC/XT) **\$119.95**
JE1077 Multi I/O Card w/ 360K/720K/1.2Mb/1.44Mb Floppy Controller (AT) **\$74.95**
JE1081 2Mb Expanded or Extended Memory Card (zero-K on-board) (AT)..... **\$109.95**

Jameco IBM PC/XT/AT Compatible Keyboards



JE2015 84-Key Standard AT Style Layout..... **\$59.95**
JE1016 101-Key Enhanced Layout with 12 Function Keys **\$69.95**
JE2016 111-Key Enhanced with Solar Powered Calculator **\$79.95**
JE2017 104-Key Enhanced with Trackball (140 DPI Resolution) **\$99.95**

MiniScribe Hard Drives & CMS Tape Back-Ups

Part No.	Capacity	Style	Average Speed	Format	Drive Alone	W/8-Bit (XT) Controller	W/16-Bit (AT) Controller
M8425S	20Mb	3.5"HH	68ms	SCSI	\$339.95		
M8051S	40Mb	3.5"HH	28ms	SCSI	\$469.95		
M3180S	150Mb	3.5"HH	17ms	SCSI	\$1299.95		
M8425	20Mb	3.5"HH	68ms	MFM	\$224.95		
M8425XT	20Mb	3.5"HH	68ms	MFM	\$269.95		
M8425AT	20Mb	3.5"HH	68ms	MFM		\$339.95	
M8425F	20Mb	3.5"HH	40ms	MFM	\$249.95		
M8438	30Mb	3.5"HH	68ms	RLL	\$249.95		
M8438XT	30Mb	3.5"HH	68ms	RLL	\$299.95		
M8438AT	30Mb	3.5"HH	68ms	RLL		\$389.95	
M8450	40Mb	3.5"HH	46ms	RLL	\$329.95		
M8450AT	40Mb	3.5"HH	46ms	RLL	\$369.95		\$389.95
M8450XT	40Mb	3.5"HH	46ms	RLL		\$429.95	
M3085	70Mb	5.25"HH	20ms	MFM	\$599.95		
M3085XT	70Mb	5.25"HH	20ms	MFM		\$649.95	
M3085AT	70Mb	5.25"HH	20ms	MFM			\$699.95
M3180E	150Mb	5.25"HH	17ms	ESDI	\$1199.95		
M9380E	330Mb	5.25"FH	16ms	ESDI	\$1699.95		

DJ10 40Mb Tape Drive with up to 120Mb capability (includes one TB40 Tape)..... **\$299.95**
QFA500 150Mb Tape Drive with up to 500Mb capability (includes one TC150 tape) **\$1049.95**

3.5" and 5.25" Floppy Disk Drives



MPF11 Pictured

Sony
MPF11 3.5" 720Kb Internal Drive **\$69.95**
SMK 5.25" Installation Kit w/Faceplate ... **\$14.95**

Toshiba
356KU 3.5" 1.44Mb Internal Drive **\$109.95**

TEAC
FD55B 5.25" 360Kb Half Ht. **\$99.95**
FD55G 5.25" 1.2Mb Half Ht. **\$119.95**

Jameco
JE1020 5.25" 360Kb Half Ht. Black **\$89.95**
JE1021 5.25" 360Kb Half Ht. Gray **\$89.95**
JE1022 5.25" 1.2Mb Half Ht. Gray **\$99.95**

Hard & Hard/Floppy Disk Controller Cards

Computer Type	MFM Hard		RLL Hard		MFM Hard/Floppy		RLL Hard/Floppy	
	Part No. / Price	Part No. / Price	Part No. / Price	Part No. / Price	Part No. / Price	Part No. / Price	Part No. / Price	
8088 (PC/XT) @ 3:1 Interleave	XTGEN/\$79.95	1004A27X/\$89.95	JE1044/\$109.95					
80286 (AT)/386 @ 2:1 Interleave	1003VMM1/\$129.95	1003VSR1/\$149.95	1003VMM2/\$149.95	1003VSR2/\$169.95				
80286 (AT)/386 @ 1:1 Interleave	1006VMM1/\$149.95	1006VSR1/\$169.95	1006VMM2/\$169.95	1006VSR2/\$189.95				

1355 Shoreway Road
Belmont, CA 94002
24 Hour Order Hotline (415) 592-8097
FAX's (415) 592-2503 or (415) 595-2664
Telex 176043 - Ans. Back: Jameco Bimt
Data Sheets - 50c each
Send \$2.00 Postage for a FREE 80-Page Catalog
© 1989 Jameco Electronics 12/89
IBM is a registered trademark of International Business Machines



\$25.00 Minimum Order - U.S. Funds Only
CA Residents Add 6%, 6.5% or 7% Sales Tax
Shipping - Add 5% plus \$1.50 Insurance
(May vary according to weight and shipping method)
Terms: Prices subject to change without notice.
We are not responsible for typographical errors.
We reserve the right to substitute manufacturers.
Items subject to availability and prior sale.
Products pictured may only be representative.
Complete list of Terms/Warranties is available upon request.

24-Hour Order Hotline (415) 592-8097 • The Following Services Are Also Available Through (415) 592-8097 From 7AM - 5PM P.S.T.:

- Customer Service
- Technical Assistance
- Credit Department
- All Other Inquiries

Scottsdale Systems — Since 1980 — 1-800-777-2369

COMPUTERS

Altos W/Xenix		SAVE	
WYSE 386 25 MHz		SAMSUNG	
1 Year Warranty	\$5558	2:800 20 MHz	\$2795
WYSE 386	2276	2:550 8 & 12 MHz	1249
WYSE 286-130		2:330 XT 10 MHz	
Model 2200	1449	LAPTOPS	
Model 2108	1032	NEC MULTISPEED E.L.	
Model 2112	1484	TOSHIBA	
MATH CO-PROCESSORS CALL		1:5200 40	
		1:5202 100	
		8194	
TERMINALS/MONITORS			
WYSE TERMINALS		IBM TERMINALS	
Wyse WY 30 Green	\$ 299	IBM 3 Year Warranty	CALL
Wyse WY 50 Green	377	Altos IV	379
Wyse WY 60 Gen/With	405	Altos V	513
Amber	370	Link MC 5	395
Wyse WY 85 Green	370	MONITORS	
Wyse 99G1	168	NEC 2A/30	\$499/644
Wyse 150	387	NEC Monograph	1355
Wysar 212	1489	Mitsubishi Diamond Seal	528
QUME		Sanyo 1430	
QVT 101 Plus G A W	\$316	Sanyo 1303 1302	
QVT 119 Plus G A W	\$395	Hidex Super Scan	
QVT 203 Plus G A W	\$443	Hidex Super Scan	
QVT PCT G A W	\$385	Viewing 19 w/ Card	
TeleVideo	CALL	Viewing 24 Menu w/ Card	
HEWLETT PACKARD		Viewing 21 Color w/ Card	
H P 700 43	\$355	Viewing 21 Color w/ Card	
H P 700 71	\$508	Viewing 21 Color w/ Card	
H P 700 22	\$369	Viewing 21 Color w/ Card	
Call Scottsdale Systems today for quality brand name products and expert service at competitive prices.			

SOFTWARE

CAO SOFTWARE		MULTI USER	
IMAGRAPH 1 Year Warranty	CALL	SCD Xenix 386	\$510
DI SIGN CAD	\$ 220	Conquest DDS 386 10	310
T2 CAD	139	Unifun	CALL
FAST CAD	1459	All software sales are final.	
TURBO CAD	69		

LEASING AVAILABLE

PLOTTERS

CALCOMP		ROLAND DESKTOP PLOTTERS	
1023 Artisan Pen Plotter	\$3528	DXY-1100	\$ 914
1025 Artisan Pen Plotter	4595	DXY-1200 Electrostatic	1339
1043 Dual Model	5856	Paper Hold	1339
1044 GT W/Plot Mg	8717	DXY-1300 Electrostatic	1759
HOUSTON INSTRUMENTS		ROLAND DRAFTING PLOTTERS	
OMP-29 40	\$1687/895	GRX-300 A-D Size	\$3579
DMP-52 52 MP	2423/2795	GRX-400 A-E Size	\$4589
DMP-61	3158	ROLAND FLATBED PLOTTERS	
DMP-62	3077	1 Year Warranty	
IOLINE		DPX-2000 8 Pen w/Stand	
A&D LP 3500	\$2339	DPX-2200 8 Pen w/Elect	
A&D LP 3700	2889	Paper Hold	
LP 3700 B	3129	DPX-3300 8 pen w/stand	
LP 4000-1	3579	ROLAND CAMM MACHINES	
LP 4000 B	3935	Software & Accessories	
HEWLETT PACKARD		OPTICAL SCANNER & SOFTWARE	
H P 7440 A	CALL	Princeton Graphics LS-300	
H P 7475 A	CALL	Scanner	
H P 7550 A	CALL	Data Copy	
H P 7570 A	CALL	Parascan RS-505-506 S1037/S1315	
H P 7575 DXL	CALL	MURAL	
H P 7576 EXL	CALL	Model 7000 A-C	
H P 7595 A Draftmaster I	CALL	Model 8000 A-D	
H P 7596 A Draftmaster II	CALL	Model 9000 A-E	
SP600	\$599	Model 9000 A-E	
KURTA		SUMMAGRAPHICS	
Lifetime Warranty On Kurta IS-1		12x12	
IS-1 12x12 w/ 4 Button Puck & Dual SW Pen		12x18	
IS-1 12x17 w/ 12 Button Puck & Cardless w/ Dual SW Pen		Cal Comp 23120 12x12	
IS-1 12x17 w/ 12 Button Puck & Cardless w/ Dual SW Pen		Cal Comp 9100 Series	
IS-1 12x17 w/ 12 Button Puck & Cardless w/ Dual SW Pen		Cal Comp 9500 Series	
GENIUS TABLET		12x12 Tablet (puck and Stylus)	
GTCC		AutoCAD Template and Menu File	
HITACHI		Genus Menu Maker and Menu Library	
Hi Rez Serial		Dr. Genus Software	
Hi Rez		Adjustable Flip Stand	
Bus		Transparent Cover-Sheet protects and secures the template	
Mouse Pad/Touch Pad		External Power Supply	
Antistatic Mouse Pad/Touch Pad		casCAD II Cad Package	
		3 Year Warranty on Genus Tablet	

DIGITIZERS

PRINTERS		BOARDS	
Qume Laser	\$3199	Alps Allegro	
Oxidata All Models	CALL	Compucon 99 Year Warranty	
OTC All Models	CALL	Genoa	
Gencom All Models	CALL	Intel	
Toshiba All Models	CALL	Vericom All Models	
Citizen All Models	CALL	BOCCA	
		Cobra All Models	
		Paradise VGA Plus	
		Paradise Prof	
		Control Systems	
		Number Nine	
		Vermont Microsystem	
		IOMEGA	
		Bernoulli Box	
		8-120+ 21.4 MB Internal	
		144+1.44 MB Internal	
		Prices do not include interface	
		ALLOY	
		P.C. Slaver/16N	
		NTNX	
		Retriever 40	
		LAPTOPS	
		NEC MULTISPEED E.L.	
		TOSHIBA	
		T-5200-40	
		T-5202-100	
		MITSUBISHI	
		CGA-286 20MB H.D.	
		EGA-286 40MB H.D.	
		POWER PROTECTION	
		Datashield	
		Safe Power Systems	
		TAPE BACKUPS	
		Emerald Systems	
		Genoa	
		Prism	
		Irwin	
		HARD DRIVES	
		CDC IMPRIMIS	
		72 MB thru 600 MB	

Call for pricing on larger digitizers

Scottsdale Systems • 1555 W. University Dr., Tempe, AZ 85281

Prices listed are for cash. MasterCard and Visa add 1.67%; AZ residents add 6.1% tax; add 3% for C.O.D.; add 5% for P.O. and international orders; all items are new with manufacturer's warranty; Returned products subject to 20% restocking fee and in new condition in original packaging, with all warranty cards, manuals and cables; No credit issued after 30 days from date of shipment; We do not guarantee compatibility; Personal and company checks take up to 5 days to clear; Prices and specifications subject to change; Product subject to availability; all applicable trademarks recognized and on file.

602-966-8609 FAX 602-966-8634

LAPTOPS \$385 FAX

TOSHIBA LAPTOPS	NEC LAPTOPS	CANON FAX	EPSON FAX 1000 \$789
• T1000 \$619	• NecUltralite 2meg \$1799	• CANON Fax 20 .. \$745	• EPSON FAX 2000 \$869
• T1200FB \$1365	• Prospeed 286/20 \$2995	• Fax 225 \$1329	MURATA 1200 \$549
• T1200HD \$1855	• 286/40 \$3345	• Fax 270 \$1525	• M 900 \$579
• T1600/20 \$3045	• 386-/40 \$4395	• Fax 350 \$1795	• F30 \$1349
• T1600/40 \$3389	Mitsubishi 286-2F \$1799	• Fax 450 \$1845	RICOH RF850 \$649
• T3100E \$2555	• 286-20MB \$2299	• Fax 630 \$2145	• Fax 15 \$1095
• T3200/40 \$3269	• 286-40 MB \$2795	• Fax 705 \$2479	• Fax 25 \$1249
• T3200SX-386SX \$3795	SHARP LAPTOPS	• Fax 8 \$589	• Fax 35 \$1499
• T5100 \$3999	• 7241/40MB \$1999	PANASONIC FAX	• Fax 65 \$1525
• T5200 40 \$4695	• 4602 \$1359	• KXF 80 \$589	SHARP FO 220 \$649
• T5200 100 \$4999	• 4641 \$2195	• KXF 100 \$625	• FO 300 \$699
ZENITH LAPTOPS	• 5541 \$3499	• KXF 120 \$799	• FO 330 \$849
• Z-184-10 \$1359	PANASONIC PRINTERS	• PANAFAX UF 135 \$559	• FO 510 \$1099
• Z-184-20 \$1999	• KXP1180 \$169	• UF 145 \$679	• UX 350 \$1099
• Z-286-20 \$2699	• KXP1191 \$209	• UF 250 \$1199	• FO 550 \$1399
• Z-286-40 \$2999	• KXP1124' \$298	• UF 260 \$1399	TOSHIBA FAX
• Z-386-40 \$3999	• KXP1592 \$369	SANYO SF-2U \$625	• T3300 \$759
COMPAQ LAPTOPS	• LASERKXP4450 \$1295	• SF 200 \$799	• T3600 \$889
• 286-20mb \$3689	• KXP1595 \$425	• SF 515 \$1145	• T3700 \$999
• 286 40 MB \$3999	• KXP1524 499	• AVATEX 110/220V \$535	• TF111 \$749
PREPAY PRICES: VISA/MC/COD + 2.9% Restock 20% Handling Chg. 5.95 No Exchange>Returns.			
T.P.C. 12603 Hoover St. Garden Grove, CA 92641 • 714/898-8626/FAX 714-891-1202 1-800-383-9915			
			• TF171 \$975
			• TF251 \$1065
			• TF331 \$1349
			• TF451 \$1895

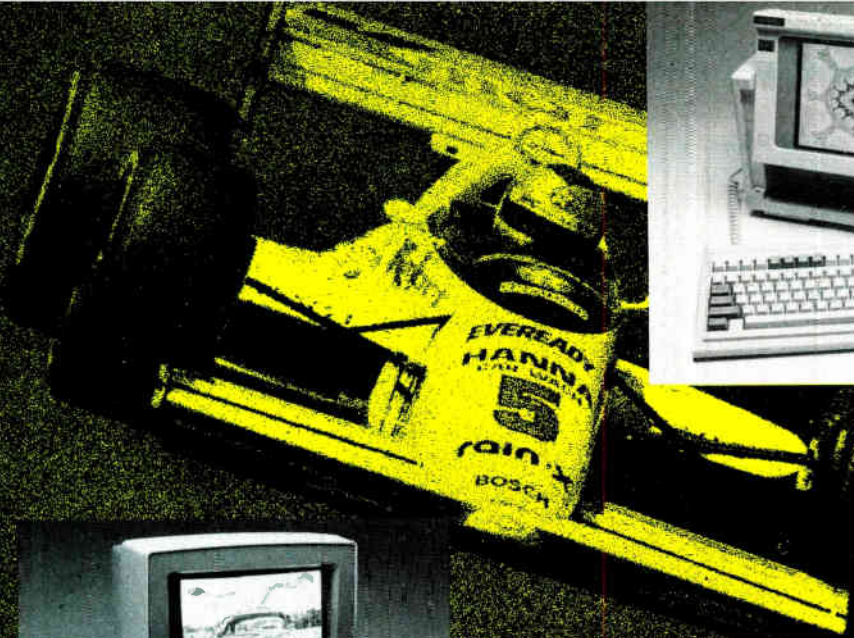

Gentlemen, boot your systems!

When you buy a BitWise system, you get maximum performance for your dollar. Every system is a leader in performance and price. And our pit crew will back you every step of the way - from knowledgeable sales reps to great service. We're so sure you'll be satisfied, we offer a 30 day satisfaction guarantee.

Fast Delivery, Fast Service

When you place an order, you'll get it fast - one week or less on most systems. If you have questions, you'll get answers fast - our entire staff understands every system we sell. And should you require service, you'll get fast results too - we can drop ship a replacement part BEFORE you return the problem part, and factory returns are turned around in 24 hours.

Full 1 Year Parts & Labor Warranty, 30-day satisfaction guarantee. Shipping - You pay UPS Shipping Charges only, F.O.B. Troy NY, no surcharges. These are cash or check in advance prices. VISA, MC, DISCOVER, welcomed (2% surcharge). COD, add 1.5%. Personal Financing and Corporate Leasing Available.

Circle 43 on Reader Service Card (DEALERS: 44)

Model 212
 12 Mhz 0 Wait State 80286
 VGA Color Monitor
 40 Meg 28 ms Hard Disk
 1 Meg 0 Wait State RAM
\$1,645

Model 325
 25 Mhz-rated 80386
 Fast Interleaved 0 Wait
 Design (cache avail.)
 VGA Color Monitor
 40 Meg 28 ms Hard Disk
 4 Megs 80 ns RAM
\$2,795

World's First 486 Portable
 80486-25 CPU w/4 Megs
 VGA Plasma Display (16 grey scales)
 4 Megs, Expandable to 24
 153 Meg 18ms ESDI Hard Disk
Portable Price: \$7,995
Desktop Price: \$6,995
 Ask About 386, 286 Portables

Call for a FREE Catalog

1-800-367-5906
 518-274-0755
 FAX 518-274-0764

BitWise Designs Inc.
 701 River Street
 Troy, NY 12180-1233

SPECIAL SALE PRICING - ALL PCs!

Model	CPU	RAM	Monitor	Hard Disk	Price
333C	386-33 cache	4 Megs	VGA color	40 Meg 28 ms	\$3,595
325C	386-25 cache	4 Meg	VGA color	40 Meg 28 ms	\$2,995
320	386-20	1 Meg	VGAcolor	40 Meg 28 ms	\$2,395
316SX	386SX-16	1 Meg	VGA color	40 Meg 28 ms	\$1,895
212P	286-12	512K	VGA color	20 Meg 28 ms	\$1,395
212M	286-12	512K	Mono	20 Meg 28 ms	\$1,095

All Systems Include:

- Monitor and Hard Disk *INCLUDED* in all prices.
- Choice of 1.2 or 1.4 Meg Teac Floppy
- Fast 1:1 Interleaving Hard Disk Controller
- Keytronics 101 Key US Made Keyboard
- Compact Case 17" w x 7.25" h x 14" d
(200 Watts, 3.5" Half Height, 2-3.5")
- 2 Serial ports, 1 Parallel port, 1 Game port
- Tower Case add \$100
- MSDOS 3.3/4.01 add \$55/75
- Monitor and Hard Disk Upgrades Call for Great prices





Sure it's insured?

SAFWARE® Insurance provides full replacement of hardware, media and purchased software. As little as \$39/yr. covers:

- Fire • Theft • Power Surges
- Earthquake • Water Damage • Auto Accident

For information or immediate coverage call:

1-800-848-3469

In Ohio call 1-614-262-0559



SAFWARE. The Insurance Agency Inc

Circle 285 on Reader Service Card

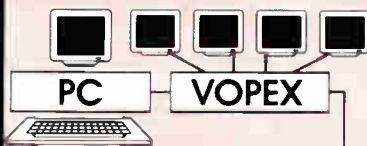

KEYBOARD & MONITOR
500 FEET AWAY - ALSO
DRIVE MANY MONITORS
AT ONCE — CALL FOR
FREE CATALOG

NTI NETWORK TECHNOLOGIES, INC.

19145 Elizabeth St., Aurora, OH 44202
 US 216-543-1646 or 800-RGB-TECH
 UK 0244-880478
 PARIS 331-47632789
 GENEVA 022-431124
 CANADA 416-677-6500
 MUNICH 0130811234



Circle 370 on Reader Service Card

6809 Single Board Computer



6809 MPU, 2 serial ports, 4 parallel ports,
 RAM, EPROM, real-time clock, watchdog
 timer, 44-pin 4.5" x 6.5" PCB
EXPANSION MODULES: RAM, EPROM, CMOS
 RAM/battery, analog I/O, serial I/O,
 parallel I/O, counter/timer, IEEE-488,
 EPROM programmer, floppy disks,
 cassette, breadboard, keyboard/display.



Wintek Corp.
 1801 South Street
 Lafayette, IN 47904
 317-742-8428

Circle 353 on Reader Service Card

200/100MHz Logic Analyzer



- 24 channels, Timing and State
- Optional expansion to 72 channels
- 200 or 100 MHz max sampling rate
- 16 levels of triggering
- 16K samples/channel (6 channel mode)
- TTL, ECL or Variable threshold
- 3 external clocks with 11 qualify inputs
- Data output to disk or printer
- PC/XT/AT compatible
- \$1299 - LA27100 (100MHz)
- \$1899 - LA27200 (200MHz)

Call - 201-994-6669

Link Computer Graphics, Inc.

4 Sparrow Dr., Livingston, NJ 07039 Fax: 201-994-0730

Circle 182 on Reader Service Card

PC-Based Programmer

GAL PAL EPLD EPROM EEPROM MICROCONTROLLER



\$475

TI NS MMI LATTICE CYPRESS ALTERA AMD INTEL SAMSUNG...

- 20 AND 24 PIN PAL/GAL/EPLD
- 2716-27101 EPROMS. (High speed to 35ns)
- EEPROMS up to 28256
- MICROCONTROLLERS (with adaptor).
- DSP TI TMS-320 (with adaptor).
- JEDEC, Intel Hex, Binary, Motorola 'S' Files
- Read, Write, Protect, and Verify
- Full Screen Editing in Hex and Ascii.
- Byte split for 16 and 32 bit systems.

Call- 201-994-6669



Link Computer Graphics, Inc.

4 Sparrow Dr., Livingston, NJ 07039 Fax: 994-0730

Circle 183 on Reader Service Card

Terminal Emulation

TEK 4105/4010

- Tektronix 4105
- Tektronix 4010/4014
- VT220, VT102
- Picture files
- VGA and EGA support
- High resolution hardcopy

VT220

- VT220, VT102 emulation
- File transfer
- 132 column modes
- Color support
- Hot key

Diversified Computer Systems, Inc.

3775 Ins Avenue, Suite 124
 Boulder, CO 80301 (303) 447-9251
 FAX 303-447-7406

Trademark: VT102, VT220, EEC, IBM, and Microsoft, Inc.

Circle 111 on Reader Service Card

DATA ACQUISITION

ALL needs ! ANY computer !

- PC Software Included
- Serial, Modem, & Bus
- Stand Alone Ability
- Laptop & Handheld
- PC & MAC Cards
- Inexpensive
- OEM & VAR
- RTU's



Call for FREE DEMO DISK !

Specialists in portable and battery backed up as well as PC compatible modular systems.



Call for applications info: (201) 299-1615
 P.O. Box 246, Morris Plains, NJ 07950

ELEXOR

MEASUREMENT TO GO

Circle 116 on Reader Service Card

9-Track Tape Subsystem for the IBM PC/XT/AT



Now you can exchange data files between your IBM PC and any mainframe or mini-computer using IBM compatible 1600 or 6250 BPI 9-Track tape. System can also be used for disk backup. Transfer rate is up to 4 megabytes per minute on PCs and compatibles. Subsystems include 7" or 10 1/2" streaming tape drive, tape coupler card and DOS compatible software. For more information, call us today!

QUALSTAR

9621 Irontdale Ave., Chatsworth, CA 91311
 Telephone: (818) 882-5822

Circle 274 on Reader Service Card

PC PRODUCTIVITY

NEW

EMU-TEK™

4200 Plus

Turn your PC into a Tektronix Graphics Terminal

FTG DATA SYSTEMS

(800) 962-3900

10801 Dale St., Stanton, CA 90680

Circle 134 on Reader Service Card

A-BUS™ MAGIC

Classroom to advanced industrial applications.

Be a Wizard in your Lab, Factory, College, Home...

It used to be difficult and costly to do process control, robotics, data acquisition, monitoring and sensing with your computer. Now the low-cost A-BUS system makes it easy to do almost any project you can imagine.

Versatility. A-BUS cards handle most interfacing, from on/off switching, to reading temperatures, to moving robot arms, to counting events, to sensing switches...

Adaptability. The A-BUS is modular, allowing expansion well beyond your needs. It works with almost any computer, or even as a remote data station with the new serial adapters.

Simplicity. You can start using the A-BUS in minutes. It's easy to connect, and software is a breeze to write in any language.

Reliability. Careful design and rugged construction make the A-BUS the first choice in specialized I/O.

An A-BUS system consists of: - An A-BUS adapter plugged into your computer - A cable to connect the adapter to 1 or 2 A-BUS function cards. - The same cable will also fit an A-BUS Motherboard for expansion to up to 25 cards in any combination.

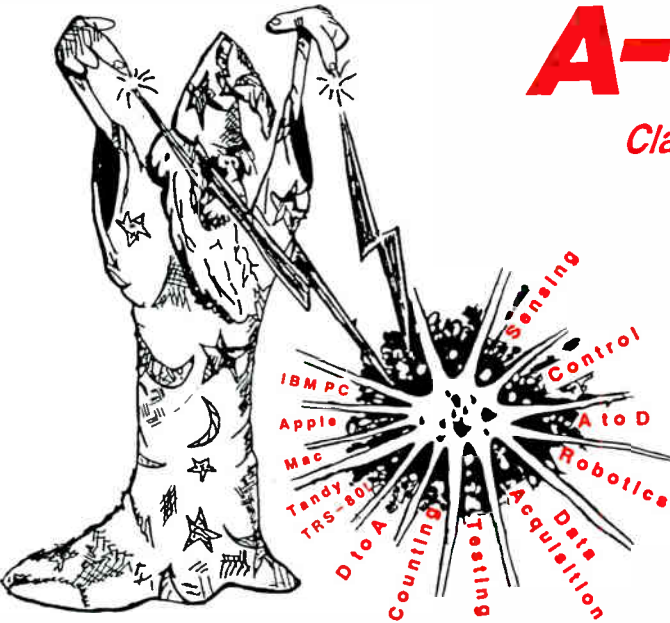

NEW: REMOTE A-BUS! Use the new Serial (RS-232) Adapter or Processor to control any A-BUS system. Cards can be up to 500 ft away using phone type cable, or off premises using a modem. Call or send for the new A-BUS Catalog which covers all the products.

Important

All A-BUS Systems: ♦ Come assembled and tested ♦ Include detailed manuals with schematics and programming examples ♦ Can be used with almost any language (BASIC, Pascal, C, assembler, etc.) using simple "IN" and "OUT" commands (PEEK and POKE on some computers) ♦ Can grow to 25 cards (in any combination) per adapter ♦ Provide jumper selectable addressing on each card ♦ Require a single low cost unregulated 12V power supply ♦ Are usually shipped from stock. (Overnight service is available.)

About Alpha Products

Founded in 1976 for the purpose of developing low cost I/O devices for personal computers. Alpha has grown to serve over 70000 customers in over 60 countries. A-BUS users include many of the Fortune 500 (IBM, Hewlett-Packard, Tandy, Bell Labs, GM...) as well as most major universities. A-BUS products are U.S. designed, U.S. built, and serviced worldwide. Overseas distributors: England: Caldyc Science Assoc. Ltd., Merseyside, 051 342 7033. Australia: Brumby Technologies Pty. Ltd., NSW, 759 1638. France: Coserm, Rungis, 46 86 64 75

Inputs, Outputs, etc.

Analog Input: 8 analog inputs. 0-5.1V in 20mV steps (8 bits). 0-100V range possible. 7500 conversions/second. **AD-142: \$142**

12 Bit A to D: Analog to digital converter. Input range -4V to +4V, expandable to 100V. On-board amplifier. Resolution 1mV. Conversion time 130ms. 1 channel. (Expand to 8 channels with the RE-156 card.) **AN-146: \$153**

Relay Card: 8 individually controlled industrial relays each with status LED's (3A at 120VAC contacts, SPST). **RE-140: \$142**

Reed Relay Card: 8 reed relays (20mA at 60VDC, SPST). Individually controlled and latched, with status LEDs. **RE-156: \$109**

D/A converter: 4 Channel 8 Bit D/A converter with output amplifiers and separate adjustable references. **DA-147: \$149**

24 line TTL I/O: Connect 24 input or output signals (TTL 0/5V levels or switches). Variety of modes. (Uses 8255A) **DG-148: \$72**

Digital Input: 8 optically isolated inputs. Input can be 5 to 100V voltage levels or switch closures. **IN-141: \$65**

Digital Output Driver: 8 outputs: 250mA at 12V. Drive relays, solenoids, stepper motors, lamps, etc. **ST-143: \$78**

Clock with Alarm: Powerful clock/calendar. Battery backup. Timing to 1/100 sec. Alarm relay, LED and buzzer. **CL-144: \$98**

Touch Tone Decoder: Each tone is converted into a number which is stored on the board. **PH-145: \$87**

A-BUS Prototyping card: 4x4.5" card. Will accept up to 10 I.C.s. With power & ground bus. **PR-152: \$16**

Counter Timer: Three 16 bit counters/timers. Use separately or cascade for long (48 bit) counts. **CT-150: \$132**

Motion Control

Smart Quad Stepper Controller: The world's finest. On board microprocessor controls four motors simultaneously. Uses simple English commands like "MOVE ARM 10.2 (INCHES) LEFT". For each axis, you control coordinates (absolute or relative), ramping, speed, units, scale factors, etc. Many inputs for limit switches, etc. On the fly reporting of speed, position... Built in drivers for small motors (such as MO-103 or 105). **SC-149: \$299**
Options: ▶ 5 amp/phase power booster for 1 motor: **PD-123: \$49**
▶ Remote "teach" keypad for direct motor control: **RC-121: \$54**

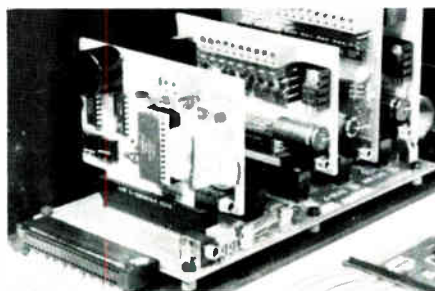

A large A-BUS system with two Motherboards. Adapter in the foreground plugs into PC XT/AT type slot.

Stepper Driver Kit: For experimenting with stepper motors. Includes 2 MO-103 motors and a ST-143 dual driver **PA-181: \$99**

Stepper Motors: (4 phase, unipolar)
MO-103: 2 1/4" dia, 1/4" shaft, 7.5"/step, 12V, 5 oz-in torque. **\$15**
MO-104: 2" dia, 1/4" shaft, 1.8"/step, 5V, 60 oz-in torque. **\$45**
MO-105: 1.7" square, 2" shaft, 3.75"/step, 12V, 6 oz-in. **\$15**

A-BUS Adapters

▶ Can address 64 ports and control up to 25 A-BUS cards.
▶ Require one cable. Motherboard required for more than 2 cards.

A-BUS Parallel Adapters for:

IBM PC/XT/AT & compatibles. Uses one short or long slot.	AR-133: \$69
Apple II, II+, IIe Plugs into any slot inside.	AR-134: \$52
Commodore 64, 128 Plugs into Expansion Port on back.	AR-139: \$48
TRS-80 Model 102, 200 Uses 40 pin "System bus".	AR-136: \$76
Model 100 (Tandy portable) Plugs into socket on bottom.	AR-135: \$75
TRS-80 Model 3, 4, 4D Y-Cable available if 50 pin bus is used.	AR-132: \$54
TRS-80 Model I Plugs into 40 pin expansion bus.	AR-131: \$39
Tandy Color Computers Fits ROM slot, Multipak or Y-Cable	AR-138: \$49

A-BUS Cable: Necessary to connect any parallel adapter to one A-BUS card or to first motherboard. 50 pin, 3 ft. **CA-163: \$24**
Special Cable for two A-BUS cards **CA-162: \$34**

Serial Adapter: Connect A-BUS systems to any RS-232 port. Allows up to 500 ft. from computer to A-BUS. **SA-129: \$149**

Serial Node: To connect additional SA-129/A-BUS systems to a single RS232 serial port (max 16 nodes). **SN-128: \$49**

Serial Processor: same as above plus built in BASIC for off-line monitoring, logging, decision making, etc. **SP-127: \$189**
Use SA-129 or SP-127 with modems for remote data acquisition.

Motherboard: Holds up to 5 A-BUS cards in sturdy aluminum frame with card guides. A sixth connector allows (using cables CA-161: \$12) additional Motherboards to be added. **MB-120: \$108**

Power Supply: Power pack for up to 4 cards. **PS-126: \$12**

Complete Catalog Available
For Orders and Info call (203) 656-1806
Weekdays from 9 to 5 EST or FAX 203 656-0756

Call our application engineers to discuss your project.

Ordering Information: We accept Visa, Mastercard, Checks, and M.O. C.O.D. is \$4 extra. Purchase orders are subject to credit approval. CT residents add 7.5% sales tax. Shipping: \$4 per order (usually UPS ground). UPS 2nd Day Air: \$4 extra. Next Day service available. Canada: \$6 per order (Airmail). Outside US and Canada: Add 10% of order total.

Circle 19 on Reader Service Card



a Sigma Industries Company

ALPHA Products

242-B West Avenue, Darien, CT 06820

DECEMBER 1989 • B Y T E 413

SC 80386-25
Motherboard

6.2 MIPS

64K cache upgradable to 256K cache

LANDMARK
= 43.5 MHz
\$1395

- Intel 80386-25 MHz CPU
- 256K or 1MB SIMM 0 wait
- Advanced Write Back cache
- Max. 8MB on Board
- OS/2, MS DOS, Xenix, Novell comp.

Mono system w/1meg **\$2020**
256K cache upgrade **\$ 250**

Schwab Computer
730-C East El Camino Real
Sunnyvale, CA 94087
TEL (408) 245-6666 FAX (408) 245-3103

Circle 290 on Reader Service Card

EZ-WRITER

(E)EPROM Multiprogrammer®
DATA I/O 212* Performance
For Only **\$995.**
100% USA Made



- Supports (E)EPROMs up to 40-pins.
- Stand-alone or Remote.
- 40-pin Micros Opt.
- SET/GANG 4 (E)EPROMs Opt.
- Parallel port for Fast Up/Down Load.
- 256K bytes, expandable to 16 megabytes.

BYTEK 1-800-523-1565
In Florida (407) 994-3520
Fax: (407) 994-3615

* DATA I/O is a registered trademark of DATA IO Corporation

Circle 55 on Reader Service Card

SIMMS

1 Meg X 9-80 ns **\$109**

PS/2 Memory

1 Meg for 70-E61 & 121 **\$215**
2 Meg for 70-E61 & 121 **\$395**
2 Meg for 70-A21 **\$425**
1 Meg for 80-041 **\$375**
2 Meg for 80-111, 311 **\$875**
2-8 Meg, 32-bit Memory Board **\$595**

COMPAQ

1 Meg & 4 Meg for all models

Laser Jet

1MB **\$245** 2MB **\$375** 4MB **\$595**

SOUTH COAST ELECTRONICS
10920 Wilshire Blvd. Ste 1100, Los Angeles, CA 90017
(213) 208-3260 Fax (213) 208-3282
(800) 289-8801

Circle 297 on Reader Service Card

UNIVERSAL PROGRAMMER

@programs E(E)PROM, PAL, EP1D, GAL, PEEL, FPL, BIPOlar, 8748/51 SERIES.
@tests TTL/CMOS and D/S RAM.
\$545 Complete. (u.s. only)

programs E(E)PROMs upto 2Mbits and 16 Bit wide.
16Bit- and 32Bit- WORD SPLIT & 4-GANG adaptor.
programs PALs (22V10) from AMD,MMI, TI, NS, SAMSUNG.
supports PALASM2/CUPL/ABEL/ORCAD JEDEC files.
supports VERIFICATION using TEST VECTORS.
programs GALs & FPLs from LATTICE,SGS,NS,SIGNETICS.
supports RALs in GAL (16V8,20V8) devices.
programs EPLDs from INTEL,ALTERA,ATMEL,CYPRESS.
programs PEEls from ICT,HYUNDAI,GOULD(253,273).
programs BIPOlar PROMs.
programs SINGLECHIPS: 8748,8751,87C51 SERIES including 87C451,87C751,63701,X/Y/V,63705V with adaptors.
tests ICs (TTL,CMOS) & MEMOR Ys (upto 1MB) with USER-DEFINABLE TEST PATTERN GENERATION.
High-Speed,Parallel Interface & S/W Upgradable for New Parts.

XELTEK 1-800-541-1975 (Toll Free Order)
473 SAPENA CT. #26 TEL: (408) 727-6995
SANTA CLARA, FAX: (408) 727-6996
CA 95054 COD,VISA,MC,AMEX

Circle 354 on Reader Service Card

IEEE 488 Solutions

- Hardware & software interfaces for PC, AT, 386, PS/2, Macintosh, SUN, HP & DEC
- IEEE converters to SCSI, RS-232, RS-422, modem, Centronics, digital I/O & analog I/O
- IEEE extenders, expanders & buffers
- IEEE drivers for DOS, UNIX®, Lotus 1-2-3, Symphony & Quattro.

Call or send for your **FREE Technical Guide**
Demo disks and application notes available

Please see our ad on page 304.

LOtech
(216) 439-4091
Telex 6502820864 • Fax (216) 439-4093
LOtech, Inc. • 25971 Cannon Road
Cleveland, Ohio 44146

Circle 164 on Reader Service Card

8051 68HC11 EMULATORS



For info call:

Australia	(02) 654 1873
Austria	(0222) 38 76 38
Benelux	+ 31 1858-16133
Canada	1-514-689-5889
Denmark	(02) 65 81 11
Finland	90-452 1255
France	(01) 89 412 801
Great Britain	0962-73 3140
Israel	(03) 484832
Italy	(011) 770010
Korea	(02) 784 7841
New Zealand	(09) 392464
Portugal	(01) 83 56 70
Scandinavia	+ 46 40922425
Singapore	065 743-2086
Spain	(93) 217 2340
Switzerland	(01) 740 41 05
Taiwan	(02) 7840215
West Germany	08131-1687
U.S.A. FAX	(408) 378-7869

NOHAU CORPORATION 51 E. Campbell Ave.,
Campbell, CA 95008
(408) 866-1820

Circle 231 on Reader Service Card

How to Protect Your Computer



And Make It Last Longer

FREE money-making literature. What you need to know about UPS — uninterruptible power systems. How to get complete protection from power line problems. 350 VA to 15 KVA models from the world's largest manufacturer of single-phase UPS.

Best Power Technology, Inc.
P.O. Box 280, Necedah, WI 54646
Toll-Free (800) 356-5794, ext. 3784
(608) 565-7200, ext. 3784

Circle 40 on Reader Service Card

FREE CATALOG

RS-232C INTERFACE & MONITORING EQUIPMENT CATALOG



WRITE or CALL for YOUR **FREE** COMPREHENSIVE B & B ELECTRONICS CATALOG TODAY!
Pages and pages of photographs and illustrated, descriptive text for B&B's complete line of RS-232C converters, RS-422 converters, current loop converters, adapters, break-out boxes, data switches, data splitters, short haul modems, surge protectors, and much, much more. Most products meet FCC Part 15J. Your RS-232 needs for quality, service and competitive prices will be more than met by B&B ELECTRONICS. **Manufacturer to you, no middleman!** Money-back guarantee! Same-day shipment! One-year warranty on products! Technical support is available.

Write For Your **FREE** Catalog Today!
B&B electronics MANUFACTURING COMPANY
4002M Baker Road, P.O. Box 1040 • Ottawa, IL 61350
Phone: 815-434-0846

Order direct from manufacturer **TODAY & SAVE!**

Circle 56 on Reader Service Card

Turn your old XT/AT into a WARPSPEED/386

386SX MotherBoard
\$ 369.00



- Intel 16 MHz 80386 SX CPU
- Socket for Intel 80387 SX Coprocessor
- Shadow RAM Support
- 8 Expansion Slots 6-16 bits, 2-8 bits
- I/O Speed at 8 MHz to use existing cards
- Interleave w/1Mb RAM
- Fully AT Compatible

386/20 w/OK \$ 569.00
386/25 w/OK \$ 699.00
386/25 Cache \$1095.00

HomeSmart Computing
1(800) 627-6998

Circle 155 on Reader Service Card

Full Page Scanner ... \$388

Includes Free PC Paintbrush Plus

- 300 Dots Per Inch
- Automatic Sheet Feeder
- Includes PC/AT Interface Card
- Software Selectable 300/200/150/75 DPI
- Fast...7 Seconds Per Page
- Up to 32 Gray Scales
- One Year PGS Warranty

JADE COMPUTER

Turbo-88

\$498



Monitor Optional

—A PROVEN BEST SELLER—

- 8088 microprocessor running at 10 MHz or 4.77
- 640KB
- 5.25" 360KB RAM Drive
- Dual diskette drive controller
- Parallel printer port
- Eight XT expansion slots
- 150 watt power supply
- 8087 socket
- Front panel display
- 101 Key enhanced keyboard
- Serial RS-232C port
- Game port
- Clock/Calendar

Monitor & Hard Drive Options

Floppy Only	20 Megabyte	30 Megabyte
\$598	\$798	\$848
Complete Monographics System		
\$698	\$898	\$948
Complete Color System		
\$898	\$1098	\$1148
Complete VGA System		

JADE COMPUTER

PRO-286

12 MHz

\$798

20 MHz

\$1098



Monitor Optional

—286 POWERHOUSE—

- 80286 processor running at 12 MHz or 20 MHz
- Zero wait state
- 1 Megabyte of RAM
- 1.2 MB or 1.44 MB drive
- Hard/Floppy controller
- Six 16-Bit & Two B Bit expansion slots
- 80287 socket
- Clock/Calendar
- 101-key enhanced keyboard
- 200 watt power supply
- Norton S.I. 13.7/20.3
- Landmark 16/25.9
- One Year Warranty

Monitor & Hard Drive Options (12 MHz)

Floppy Only	40 Megabyte	80 Megabyte
\$898	\$1248	\$1498
Complete Monographics System		
\$1198	\$1548	\$1798
Complete VGA System		

For 20 MHz System Add \$298

JADE COMPUTER

Super-386

20 MHz

\$1498

25 MHz

\$1698



Monitor Optional

25 MHz Cache 33 MHz Cache
\$2198 \$2898

—FIRE BREATHING 386—

- 80386 processor running at 20 MHz, 25 MHz, 33 MHz
- 1 MB RAM expands to 6 MB
- 384K Shadow RAM
- 1.2 MB or 1.44 MB drive
- 1:1 Interleave Hard Disk /floppy Disk controller
- 80387 socket
- Full size case
- One 32-Bit, Five 16Bit Two 8-Bit slots
- 101 key enhanced keyboard
- 200 watt power supply
- Clock/Calendar
- Norton S.I. 23/31.6/31.6 /floppy Disk controller
- Landmark 25.5/32.6/43.5

Monitor & Hard Drive Options (20 MHz)

Floppy Only	40 Megabyte	80 Megabyte
\$1648	\$1998	\$2198
Complete Monographics System		
\$1968	\$2298	\$2398
Complete VGA System		

For 25 MHz Add \$198

For 25 MHz Cache Add \$698 For 33 MHz Cache Add \$1398

EPSON Panasonic

- LX-810 ... \$178
- FX-850 ... Call
- FX-1050 ... Call
- LQ-510 ... \$328
- LQ-850 ... Call
- LQ-950 ... Call
- LQ-1050 ... Call
- LQ-2550 ... Call
- KX-1180 ... \$178
- KX-1191 ... \$238
- KX-1124 ... \$318

- TrippLite Line Stabilizer 600 Watt Line Conditioner ... \$98
- 1200 Watt Line Conditioner ... \$158
- 1800 Watt Line Conditioner ... \$188

- TrippLite Battery Back-up 450 Watt UPS ... \$398
- 750 Watt UPS ... \$498
- 1200 Watt UPS ... \$698

VGA Package

Card **\$178**

Monitor **\$298**



640 x 480 Hi-Res Card

Plotter **\$688**

List Price \$1798

Roland DXY-980

- 8 PEN 230mm/SEC
- .05mm Resolution
- HPGL Compatible
- Electrostatic Hold Down
- Parallel and Serial Input
- Digitizing Capacity

intel

- 8087 ... \$88
- 8087-2 ... \$118
- 8087-1 ... \$158
- 80287 ... \$128
- 80287-8 ... \$198
- 80287-10 ... \$228
- 80287-12 ... \$278
- 80387-SX ... \$318
- 80387-16 ... \$348
- 80387-20 ... \$388
- 80387-25 ... \$488
- 80387-33 ... \$598

Better Than Intel

IIT Coprocessors In Stock _____ Call

- | Hard Disk Sale | Drive Only | Kit w/ Controller |
|------------------------|------------|-------------------|
| 20 MB 60ms | \$198 | \$248 |
| 20 MB 35ms | \$248 | \$298 |
| 30 MB 60ms | \$218 | \$268 |
| 30 MB 35ms | \$288 | \$338 |
| 40 MB 40ms | \$298 | \$348 |
| 40 MB 28ms | \$348 | \$398 |
| 60 MB 40ms | \$388 | \$448 |
| 80 MB 28ms | \$538 | \$598 |
| 120 MB 28ms | \$698 | \$768 |
| 150 MB 23ms | \$998 | \$1098 |
| CMS 40 MB Tape Back-up | | \$268 |

Modem

- 1200 internal w/software ... \$48
- 2400 internal w/software ... \$88
- 1200 baud external ... \$88
- 2400 baud external ... \$148
- 2400 PS/2 internal ... \$198
- Intel 2400B for PS/2 ... \$278

Daisywheel Printer

\$199

40 CPS

Logitech

- LogiMouse Serial ... \$68
- LogiMouse Hi-Rez. Bus ... \$88
- LogiMouse Hi-Rez Serial ... \$98

Mouse

\$29

Opto Mechanical With Software

Scanner

- Complete hand Scanner ... \$98
- Complete Half Page ... \$218
- Complete Full Page ... \$548
- Logitech Scan Man ... \$248
- Diamond Flower HS-3000 Plus ... \$198



California

Torrance, Costa Mesa, Woodland Hills
Kearny Mesa, Sunnyvale

Texas Georgia Arizona

Addison, Houston Smyrna Phoenix

Not all items in stock at our nine retail locations.

JADE COMPUTER

4901 W. Rosecrans Ave. Box 5046, Hawthorne, California 90251-5046 213-973-7707

Continental U.S.A. 1-800-421-5500

Inside California 1-800-262-1710



We accept checks, credit card or purchase orders from qualified firms and institutions. No surcharge on credit card orders. CA, TX, GA, & AZ. residents add sales tax. Prices and

availability subject to change without notice. Shipping and handling charges via UPS ground 50¢/lb. UPS air \$1.00/lb. Minimum charge \$4.00. Fax machine 1-213-675-2522

VOICE MASTER KEY® VOICE RECOGNITION SYSTEM FOR PC/COMPATIBLES & TANDY 1000 SERIES A FULL FEATURED VOICE I/O SYSTEM

GIVE A NEW DIMENSION TO PERSONAL COMPUTING. . . The amazing **Voice Master Key System** adds voice recognition to just about any program or application. Voice command up to 256 keyboard macros from within CAD, desktop publishing, word processing, spread sheet, or game programs. Fully TSR and occupies less than 64K. Instant response time and high recognition accuracy. Voice recognition tool-box utilities are included. **A genuine productivity enhancer!**

SPEECH RECORDING SOFTWARE. . . Digitally record your own speech, sound, or music to put into your own software programs. Software provides sampling rate variations, graphics-based editing, and data compression utilities. Create software sound files you can add to macros for voice recognition verification response. **A complete, superior speech and sound development tool.**

SOFTWARE CONVERSION CODES. . . The **Voice Master Key System** operates a growing list of third party talking software titles using synthesized phonetics (text-to-speech) or digitized PCM, ADPCM, and CVSDM encoded sound files. **Voice Master Key System does it all!**

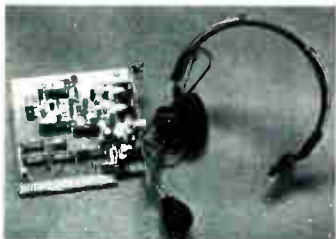

EVERYTHING INCLUDED. . . **Voice Master Key System** consists of a plug-in card, durable lightweight microphone headset, software, and manual. Card fits any available slot. External ports consist of mic inputs and volume controlled output sockets. High quality throughout, easy and fun to use.

ONLY \$149.95 COMPLETE

**ONLY \$89.95 FOR TANDY 1000 SL/TL MODELS—
SOFTWARE PACKAGE ONLY.**

Requires Tandy Brand Electret microphone.

ORDER HOTLINE: (503) 342-1271

Monday-Friday, 8AM to 5PM Pacific Time

Visa/MasterCard, company checks, money orders, CODs (with prior approval) accepted. Personal checks subject to 3 week shipping delay. Specify computer type and disk format (3½" or 5¼") when ordering. Add \$5 shipping charge for delivery in USA and Canada. Foreign inquiries contact Covox for C & F quotes. **30DAY MONEY BACK GUARANTEE IF NOT COMPLETELY SATISFIED. ONE YEAR WARRANTY ON HARDWARE.**

CALL OR WRITE FOR FREE PRODUCT CATALOG



COVOX INC. 675-D Conger St.
Eugene, Oregon 97402 U.S.A.
TEL: 503-342-1271 • FAX: 503-342-1283

SAVE ON

9 TRACK TAPE SYSTEM

FOR IBM PC/XT/AT
& PS-2



- Mainframe to PC Data Transfer
- High Speed Backup
- All Software, Complete System
- Service and Support, easy Installation

call **(818) 343-6505** or write to:
CONTECH Computer Corp.
P.O. Box 153 Tarzana, CA 91355

CONTECH

Circle 87 on Reader Service Card

MARYMAC®



of Discounting
Computers, FAX
& Cellular Phones

**Radio Shack® Tandy®
SCO**

We will meet or beat. . .
GUARANTEED LOWEST PRICES

MARYMAC INDUSTRIES INC.
22511 Katy Fwy.
Katy (Houston), TX 77450
1-713-392-0747 FAX (713) 574-4567
Toll Free 800-231-3680

Circle 193 on Reader Service Card

*Where's the @!#
cursor?*

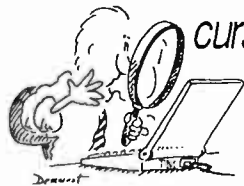

© 1989 Soft Publishing Corp.

Make the cursor **BIG** and **BOLD** and **BLINK** at any rate! The **No-Squint Cursor** "is a lifesaving utility for laptop users." -- Computer Digest. Recommended by Peter Lewis in the **NY TIMES**; Bill Machrone in **PC** magazine; and Jerry Pournelle in **INFOWORLD**. **No-Squint** is \$39.95 + 2.50 shipping from: **SkiSoft Publishing., 1644 Mass. Ave., Lexington, MA 02173 (617)-863-1876 Visa/MC/Amex**

Circle 293 on Reader Service Card

TOSHIBA LAPTOPS!

FACTORY - DIRECT PRICES

Rock-Bottom prices and immediate availability on all Toshiba laptops and accessories. We are Toshiba's largest factory-direct dealer in all of California. All orders ship in 24 hours! Printers, Lancards, both dedicated and non-dedicated modems, tape back-ups, battery packs, memory boards, etc. Just a few samples of options available. Call today for a complete list of all options and most current pricing.

TOTE-A-LAP
1501 El Camino Real
Belmont, CA 94002
415-591-1671

Circle 324 on Reader Service Card

IMAGING CARD

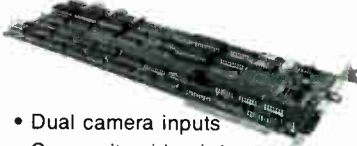

- Dual camera inputs
- Composite video in/out
- 256 x 240 resolution
- Digitize/display at frame speed
- 16 Meg. color palette out (DV-02)
- External trigger input option
- PC/XT/AT compatible
- Complete with software & library

DV-02 8-bit 256 gray levels . \$849
DV-03 6-bit 64 gray levels . \$549
VISA/MC Demo disk available

Control Vision 

PO Box 596 Pittsburg KS 66762
800/292-1160 316/231-6647

Circle 88 on Reader Service Card

THE GENERAL STORE RETAIL OPERATIONS SYSTEM

The premier system for retail store management. Supports cash drawers, barcode readers, receipt printers, customer displays, digital scales and complete online credit card authorization. Controls all types of retail stores both hardgoods and apparel with complete size/color matrix management and reporting. Easy to install and use. Field proven for speed and reliability. Provides all the features needed for today's retail merchant at a price far below comparable systems. Demo system available.



Accounts Receivable
Point of Sale
Inventory Control
Accounts Payable
General Ledger
Mailing List
...Multuser/Network Ready...

\$995 Complete system
Dealer inquires invited.

Crichlow Data Sciences, Inc.
(804) 471-0500
P.O. Box 6420 - Virginia Beach, VA 23456

Circle 90 on Reader Service Card

We've Built Our Reputation on These Factors for 10 Very Successful Years.

CLONE 386

\$1999

20MHz, 32MB HARD DRIVE, 1 MB 0 WAIT RAM, AND 14" MONOCHROME MONITOR.

1Hz, 1MB RAM, base system \$1499
 1Hz, 1MB RAM, 32K cache, base system 1786
 1Hz, 1MB RAM, 32K cache, base system 2094
 1Hz, 1MB RAM, 32K cache, base system 2729

With MS-DOS® 3.3 or 4.01 and QWASIC \$79 or \$99 Extra.

CLONE 386 STANDARD FEATURES:
 On-board 386 CPU's
 16MB Fast 0 Wait State RAM (32K Cache on some models, see chart)
 High Performance 1:1 Interleave, 800 Kb/sec Floppy/2 HD Controller
 2M 5.25" or 1.44M 3.5" Floppy Drive our choice)
 11 Key "Click-Tactile" Keyboard
 Parallel, 1 Serial, 1 Joystick Port
 30/20 Watt Power Supply
 1387/Weitek Coprocessor (Except Base 386)
 On-board Clock/Cal w/Battery Backup
 Expansion Slots
 Setup Utility in ROM
 System Reset Switch on Front Panel
 EMM 4.0 Driver
 PU Speed Switchable
 Fully Expandable to 16MB RAM
 CC Certified
 Overload and OS/2 Compatible
 One Year Parts & Labor Warranty
 Complete Software Pack Including C-Write - QModem - ExpressCalc - Menu - HomeBase - MoneyMaster Index - Hard Disk Cache - Clone Utilities.



Clone 386 20MHz monochrome computer pictured.

CLONE 286

\$1279

12MHz, 32MB HARD DRIVE, 1 MB 0 WAIT RAM, AND 12" MONOCHROME MONITOR.

12MHz, 1MB RAM, base system \$784
 16MHz, 1MB RAM, base system 983

With MS-DOS® 3.3 or 4.01 and QWASIC \$79 or \$99 Extra.

CLONE 286 STANDARD FEATURES:
 1 MB Fast 0 Wait State RAM
 High Performance 1:1 Interleave, 800 Kb/sec 2 Floppy/2 Hard Disk Controller
 1.2M 5.25" or 1.44M 3.5" Floppy Drive (Your Choice)
 101 Key Enhanced Keyboard
 1 Parallel, 1 Serial, 1 Joystick Port
 200 Watt Power Supply
 80287 Math Coprocessor Socket
 On-board Clock/Cal w/Battery Backup
 8 Expansion Slots
 Setup Utility in ROM
 System Reset Switch on Front Panel
 CPU Speed Switchable
 Fully Expandable to 4/8MB
 FCC Certified
 Novell Compatible
 One Year Parts & Labor Warranty
 Complete Software Package including PC-Write - QModem - ExpressCalc AutoMenu - HomeBase - MoneyMaster Findex - Hard Disk Cache - Clone Utilities

CLONE VALUE CHART

CLONE 286	12" MONOCHROME	14" EGA COLOR	14" VGA COLOR
12MHz CPU, 32MB 40MS SEAGATE HD	\$1279	\$1690	\$1813
16MHz CPU, 32MB 40MS SEAGATE HD	1479	1890	2013

Add \$20 for "Click/Tactile" 101-key Keyboard.
 Add \$20 for 14" Monochrome Monitor.

CLONE 386	14" MONOCHROME	14" EGA COLOR	14" VGA COLOR
20MHz CPU, 32MB 40MS SEAGATE HD	\$1999	\$2393	\$2516
20MHz CPU, 32K CACHE, 32MB, 40MS SEAGATE HD	2299	2693	2816
25MHz CPU, 32K CACHE, 32MB 40MS SEAGATE HD	2604	2998	3121
33MHz CPU, 32K CACHE, 32MB 40MS SEAGATE HD	3240	3634	3757

OPTIONS FOR CLONE 286/386 COMPUTERS:
 Add \$27 for 32MB, 28MS Seagate HD. Add \$496 for 122MB, 28MS Seagate HD. Add \$42 for 48MB, 20MS Seagate HD. Add \$30 to VGA price for 18 bit VGA card. Add \$148 for 65MB, 40MS Seagate HD. Add \$49 to VGA price for 14" Multi-frequency Monitor. Add \$203 for 85MB, 28MS Seagate HD. Add \$125 for 6 drive tower case.

OPTIONAL EQUIPMENT FOR CLONE COMPUTERS

Star NX-1000 Printer, 144/36cps, N.L.Q.	\$179	192/63 cps, L.Q. 24 pin	\$349
Star NX-1000 Rainbow Printer, same as above w/color	239	Panasonic KX-P1191 Printer, 240/48 cps, N.L.Q.	259
Star NX-2400 Printer, 170/57 cps, L.Q. 24 pin	339	Star XB-2410 Printer 240/80 cps, super L.Q. 24 pin, 16 fonts	469
Star NX-1000 Printer, 300/76 cps, N.L.Q. 8 fonts	359	Star XB-2415 Printer (same as above with wide carriage)	599
		1200/300 baud int. modem	519

SATISFACTION GUARANTEED!
 We get a rock-solid one year guarantee on parts and labor, plus a 30 day money-back satisfaction Assurance guarantee (except software and shipping).

SERVICE AFTER THE SALE!
 Your Clone equipment will be promptly and expertly serviced by our specially trained, knowledgeable technicians who know what they are doing.

FAST DELIVERY!
 Clone Computers are custom-manufactured to their buyers' specifications, burned-in and shipped within one week of their order, in most instances.

TURBO CLONE

\$699

AT Style Keyboard

Standard Features:
 60MB RAM standard
 8087 Socket
 150-watt power sup
 360K Floppy Drive with Disk Controller
 Hercules® Compatible Video Card
 HiRes TTL monitor (green or amber)
 2-Parallel print ports
 1-Serial port (2nd optional at \$29)
 Game-Joystick port
 Clock/Calendar
 Fully Expandable
 PC-Write - QModem
 ExpressCalc - Home Base - MoneyMaster - Findex - Clone Utilities - AutoMenu
 FCC Class B Certif
 Keyboard Lock
 LED's for Power, Turbo and Hard Disk Access
 1 yr parts, lab w/warranty



NO ORPHANED CUSTOMERS
 We have been supplying our customers with high quality hardware and software since 1980. We enjoy an excellent industry-wide reputation built on providing top quality merchandise, a no-risk guarantee, low price, expert service and fast delivery. Our customers expect and receive no less.

Save with Confidence! Our Guarantee Removes All the Risk from Your Buying Decision!
 The Clone guarantee is simple and straightforward. You have 30 days after receipt of your Clone to see if you and it are going to be compatible. If you are not satisfied with your Clone for any reason within that time, you may return it for a full refund, less shipping charges.

Save Your Data and Money, Too! Peripherals Sale!

SOFTWARE SALE!

LOWEST PRICES - FAST DELIVERY
 This list is only a small portion of our inventory! Call us for all of your software needs!

MS-DOS® BUSINESS SOFTWARE	Other MS-DOS	Books
Aldus Pagemaker 3.0 \$549	Copy II PC (need two copies) 25	MS-DOS Users Guide 16
Always 87	Copy II PC Option Board Deluxe 113	Running MS-DOS 19
Borland Quattro (1-2-3 Clone) 109	Fastback Plus 118	Using Autocad 21
Borland Relx 2.0 179	Grammatik III 53	Using Managing Your Money 15
Borland Sprint, Word Processor 170	Microsoft C Compiler 5.1 299	Using Symphony 10
DAC Easy Acctg (all version 3) 61	Microsoft Macro Assembler 5.1 289	
DAC Easy Payroll 61	Microsoft Quick Basic Compiler 67	
DAC Easy Bonus Pack (includes accounting, payroll, both tutors) 120	Microsoft Windows 286 67	
DAC Easy Light 42	Microsoft Windows 386 127	
dBase IV 479	Norton Commander 53	
Design CAD 162	Norton Utilities 4.5 Advanced Edit. 88	
Design CAD 3D 214	PC Tools Deluxe 5.5 79	
dBase III 176	Procomm Plus 46	
Desqview with OEMM 386 114	Sideways 72	
Formtool 359	X Tree Professional 70	
Framework III 59		
Generic CADD, Level 3 (includes DoPlot and DeskConvert) 282		
Lotus 1-2-3 version 3.0 309		
Lotus Agenda 175		
Lotus Symphony 459		
Microsoft Multiplan 126		
Microsoft Word 5.0 235		
Paradox 3.0 446		
Peachtree Complete System II 174		
Peachtree Double Bonus Bundle (pkts: First Choice 239		
pkts: First Publisher 83		
pkts: Professional Write 144		
Printshop Bundle 136		
Q & A 215		
Quicken 3.0 319		
Rightwriter 83		
Wordperfect 5.0 242		
Wordstar Professional Release 5.5 216		
MS-DOS LANGUAGES/UTILITIES		
Autoshell \$99		
Borland Turbo Basic 99		
Borland Turbo C 96		
Borland Turbo Pascal 103		
Bor. Turbo Assembler/Debugger 99		

Easy to install! This is the fastest floppy interface tape drive around!

60MB TAPE DRIVES

Up to 150MB Capacity

Add \$10 for Shipping

40MB Tape \$18
 60MB Tape \$30

External model now available for only \$99 extra!

Works on PC, XT, AT's and 100% compatibles. Connects to the internal floppy (B:) connector or the optional adapter card (\$77). Comes complete with installation instructions and the data compression software that allows up to 100MB data storage on a 40MB tape—150MB on a 60MB tape. Easy to install. Order now at this low price and save.

Low Time Only! Fantastic Prices Now On LIMITED COST HARD DRIVES For IBM and Tandy

5.25MB 95ms ST-506 MFM XT KH	\$149	21.4MB 65ms ST-225 MFM XT KH	\$239
32.7MB 65ms ST-238 12LL XT KH	\$259	42.8MB 60ms ST-251 MFM XT KH 28ms Optional	\$369
48.1MB 40ms ST-157R RLL Bare 28ms Optional	\$319	65.5MB 40ms ST-277R RLL Bare 28ms Optional	\$419
60.2MB 28ms ST-4096 MFM Bare	\$579	64.9MB 28ms ST-296N SCSI KR	\$539
65.5MB 40ms ST-277R RLL Bare 28ms Optional	\$639	122.7MB 28ms ST-4144R RLL Bare	\$639

We provide the best low cost, high quality, fast access hard drives for your IBM, 100% compatible or Tandy computer. Our XT and SCSI kits are complete with drive, controller, cables and installation instructions. We use only brand new genuine Seagate drives so you can be assured of long trouble-free drive life. Data transfer rates as fast as 500KB per second MFM, 800KB RLL and 1MB using SCSI. We provide software to park the heads (some drives self-park). Tandy 1000 requires DMA and ROM 1.01+. Not for EX/4X. Please specify the computer brand and model when ordering. ST 506, 4096 and 4144 are full size 5.25". ST 157R is 3.5". All others are half height 5.25". Sizes listed are after formatting. One year parts and labor warranty. Satisfaction guaranteed or your money back, less shipping.

UNINTERRUPTABLE POWER SUPPLY

As Low As \$279

250 Watt Model Add \$23 shipping in the over 48 states.

250 Watt	120 Volt	\$ 279
300 Watt	120 Volt	399
500 Watt	120 Volt	499
600 Watt	120 Volt	639
1200 Watt	120 Volt	1099
1600 Watt	120 Volt	1444*

230 volt units also available. Specify exact input voltage. Shipped minus freight collect.

Protects Against:
 Brownouts
 Blackouts
 Overvoltage
 Overload
 Spills/Surges
 EMI

Features:
 Two Audible Alarms.
 LED Displays.
 Optional Network Port
 Transfer Times As Fast As 1 Millisecond (Depends on Model)

VISA, MasterCard, American Express, TeleCheck

ORDER TOLL FREE!
 Mon.-Fri. 9-7; Sat. 10-3
 Call from anywhere in the lower 48 states and Hawaii.

1-800-527-0347

AD V7

Save on 32MB & 49MB Hard Cards

32.7MB 40ms RLL \$329
 49.1MB 40ms RLL \$429

These units are completely assembled with brand new drives and come ready to install. For IBM XT's, 100% compatibles and Tandy 1000/1000A, SL, SX, TL, TX. Please specify the exact make and model of your computer. One year parts and labor warranty.

Circle 62 on Reader Service Card

Save on Low Cost Floppys!

Select the drive or drives you want, pick the enclosure and appropriate cable and we will assemble and test at no additional cost to you. All drives are brand new, factory seconds, and carry a full one year part and labor warranty. Add \$5 shipping and handling per drive.

360K 5.25" TEAC 55B bare	\$59
720K 5.25" TEAC 55F bare	85
1.2M 5.25" TEAC 55FG bare	79
360K 3.5" TEAC 35B bare	59
720K 3.5" TEAC 35F bare	85
1.44M 3.5" TEAC 35FG bare	79
5.25" mounting bracket for 3.5" drives (Includes rails, signal and power adapter. Specify beige or black faceplate)	10
Dual 3.5" external case/power supply use with one or two 3.5" drives (horizontal)	\$49
One 5.25" same as above except vertical	59
IBM external floppy cable for C/O, DB37 required	39

(Add \$10 for brushed Stainless Steel cover.)

IIT's 2C87 and 3C87 Math Co-processors

- 100% Intel Compatible
- Twice the Speed of Intel
- Lower Power for your laptop
- CMOS/NMOS Compatible
- Various Speeds
- Visa, MC, AMEX accepted

800-622-1722
408-559-8544

PSI
2005 Hamilton Ave. #220
San Jose, CA 95125

DYNAMIC RAMS

SIMM 80/100	\$CALL
1MBIT 100ns	\$10.10
514256 100ns	\$10.75
41464 150ns	\$ 3.25
41256 120ns	\$ 3.35
✓ 41256 150ns	\$ 2.70
51258 100ns	\$ 3.95
✓ 4164 150ns	\$ 2.00

* For high-speed, Zip, Picc, Simm. Please Call!

MATH COPROCESSORS		E PROMS	
80387-33 33MHz	\$560.00	27C101 250ns	\$ 23.00
80387-25 25MHz	\$450.00	27C512 200ns	\$ 13.00
80387-20 20MHz	\$360.00	27512 250ns	\$ 8.00
80387-16 16MHz	\$305.00	27C256 250ns	\$ 5.25
803876X	\$290.00	27256 250ns	\$ 4.75
80C287A 12MHz	\$265.00	27128A 250ns	\$ 4.50
80287-10 10MHz	\$209.00	27C64A 200ns	\$ 4.25
80287-8 8MHz	\$186.00	2764 250ns	\$ 3.50
8087-1 10MHz	\$160.00	GPU	
8087-2 8MHz	\$125.00	V-30 8MHz	\$ 12.75
		V-20 8/10MHz	\$ 8.5/15

I.C. EXPRESS

15358 Valley Blvd., City of Industry, CA 91746 Tel: 818 369-2668
ORDER TOLL FREE (Mon-Fri 8-5 PST)
(800) 892-8889 • (800) 882-8181
Division of California Microelectronics

CALL FOR CURRENT PRICES & VOLUME DISCOUNTS
Price Shown for cash. MasterCard/Visa add 3%. Prices are subject to change.
Minimum order: \$10.00. Shipping & handling: UPS Ground \$5.00. Air \$7.00 (10)
ALL MERCHANDISE IS 100% GUARANTEED WITH PROMPT DELIVERY.

Circle 159 on Reader Service Card

SuperSound



Easy to Use!

SoundCard™

DISCOVER the POWER of SOUND in YOUR IBM-PC/AT from \$19.95!

Best Digital Audio Software/Hardware SuperSound - Engr \$650, Stereo \$339, Mono \$239

30 Day Money-Back Guarantee if not Satisfied

- With SoundFX™ - Friendly GUI / Graphical Editor for Fast Easy Record, Play and Special Effects (Uses Mouse or Keyboard) and iWeb SoundCard™
- Full Flexibility - Adjustable Sampling Rate / Recording Time - 4/8/16/32/64/128/256
- 82 Functions - Special Effects - 84 Page Manual w/ Digital Audio Tutorial
- 4 Diskette Starter Set of SoundBytes™ - 14 Sample Sounds
- For Business: Training, Point-of-Sale Shows - Works with Grasp, QBasic, C...
- For Engineering: AM/FM Function Gen., Clear Voice Alarm, Storage Scope...
- For Fun: Create Your Own Mac-like Boot-up Sounds, Alter Your Voice...

Tech: (408)-446-4521 **Silicon Shack** FAX: (408)-374-4412

5120 Campbell Ave. #112, San Jose, CA 95130.
ph: 1 - 800 - 969 - 4411 VISA - MasterCard

SuperSound, SoundFX, SoundCard, and SoundBytes are trademarks of Silicon Shack, Ltd.

Circle 292 on Reader Service Card

8051/8052 BASIC COMPILER!

*MCS BASIC52™ compatible
Runs on IBM-PC or compatible*

\$ 295.00

Call Now! 603-469-3232



Binary Technology, Inc.
Main Street • P.O. Box 67 • Merriden, NH 03770

Circle 42 on Reader Service Card

World Radio History

RS232 - RS422 BIDIRECTIONAL DATA CONVERTERS

Exceptional quality at low prices!



DC1709/AA1709 RS232-DB25S/ RS422-DB9S	DC2170 RS232-DB9S/ RS422-DB9P	DC2102 RS232-DB25S/ RS422-DB9P
--	--	---

Anaheim Automation's expanded line of bidirectional data converters change RS232 data streams into RS422 compatible data—and also make RS422 data look like RS232 signal levels. These modules make it possible for RS232 equipped devices, such as IBM PC's to interface with an RS422 equipped device. Among the many uses for these converters includes the ability to communicate with Anaheim Automation's step motor motion controls. Each unit includes a power supply. Call or write for brochure and prices.



ANAHEIM AUTOMATION
910 E. Orangefair Lane, Anaheim, CA 92801
(714) 992-6990 • FAX (714) 992-0471 • Telex 2978217 MCI

Circle 23 on Reader Service Card

FAX / Phone Switch II

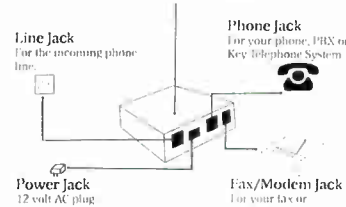

- * Connects your fax and phone to a single line
- * Works with all telephones, PBXs, Key Systems, Modems, Answering Machines or Fax Machines.
- * Fully Automatic, only \$179

To order or hear a demo,
call: (415) 547-2902

ESS
1900 Powell Street, Suite 205
Emeryville, CA 94608

Circle 115 on Reader Service Card

ULTIMATE COMPUTER AIDED PCB DESIGN



The ULTIMate PCB layout package featuring:

■ Real-Time Design Rule Check	■ Curved and angular traces
■ Trace Shove and Route-While-Move	■ Full SMT support
■ Autoroute by window, component or net	■ Powerful placement tools
■ 32 layer support; blind & buried vias	■ Backannotators; pin/gate swap

Extended memory versions with unlimited design size and 32 bit performance are available.

USA/Canada: ULTIMate Technology Corp. • Tel: (608) 43 98 944 • Fax: 439-8900
UK/Ireland: ULTIMate Technology (UK) Ltd. • Tel: (07341) 812030 • Fax: 815523
Int. Headquarters: ULTIMate Technology B.V. • Tel: (+31)2159 - 44424 • Fax: 43345



ULTIMATE TECHNOLOGY ASK FOR YOUR FREE DEMO DISK

Circle 339 on Reader Service Card



PS/2 model 30/286	1895
PS/2 model 50/30 meg	2395
PS/2 model 70/60 meg	3695
PS/2 model 80/40 meg	4395
PS/2 model 70/120 meg	5595
PS/2 model 80/115 meg	Call
Call for other models	



386 S 40 meg	Call	Call
386 20E - 40 meg	4195	
286E 40 meg	Call	
386 110 meg/25 MHz	7295	
386 60 meg/25 MHz	5895	
Portable III 40 meg/12 MHz	3995	
CARD & MONITOR EXTRA		
Call for other models		

Macintosh

Mac IICX/80 Meg, 40 Meg RAM	5095
Mac-II/40 Meg	4095
Mac-SE 30/40 Meg	3595
Call for 60 and 100 Meg	
Lazer NT	3495
Lazer NTX	4795

LOW PRICE LEADER

SINCE 1983

LAP-TOP

Compaq SLT 286-20/40	3795/Call
Toshiba T1000	619
T1200F	Toshiba 619
T1200HB	Sale! Call
T1600-20/40 Meg	Call
T3100E-20/40 Meg	Call
T3200-40 Meg/SX40	Call
T5100-40/100	Call
T5200-40/100	Call
Zenith 286-20/40 Meg	2985/Call
Zenith 8088-20 Meg	Call
Mitsubishi 286-20/40	2395/Call

Pacific Data (For HP)

25-N-1 Cartridge	265	Pacific Page	459
1 Meg. Memory Board	219	Plotter Cartridge	239

Everex

Step 286 - 12 & 16 MHz & 20 MHz
1 Meg RAM
Set up utility in ROM
S/P, C/C
Enhanced keyboard
1.2 MB floppy
DOS/BASIC

Call! for your configuration

Everex

Step 386-20 MHz & 16 MHz & 25 MHz & 33 MHz
Up to 256K cache of very high speed RAM
2 Meg RAM, expandable to 16 Meg
S/P, C/C
Enhanced keyboard
1.2 MB floppy
DOS/BASIC

Call!



AST 286 model 140X	Call
AST 286 model 70	1249
AST 386 model 300c	2695
AST 386 40 Meg	3095

CARD & MONITOR EXTRA
CALL FOR OTHER MODELS

WE STOCK

CITIZEN
OKIDATA
EVEREX
GOLD STAR

TOSHIBA
NEC
WYSE
HITACHI

PRINCETON GRAPHICS
SONY
ACER
HOUSTON INSTRUMENTS

AMDEK
HAYES
SAMSUNG
CALCOMP

PC MOUSE
MICROSOFT MICE
LOGITECH
MITSUBISHI

IRWIN & ARCHIVE
TAPE BACK
TAXAN
MAGNOVOX

BOARDS

Paradise VGA +	219
Vega VRAM	409
ATI VGA Wonder	259
Everex EGA	149
Tatung 16 bit	239

SOFTWARE SPECIALS

dBase IV	455
Wordperfect	229
Aldus Pagemaker	495
Ventura Publisher	495
Clipper	435
WordStar 5.5	219



NOVELL
Authorized Dealer

PRINTERS

EPSON	
LX-810/LQ-510	199/339
LQ-850/1050	545/749
FX-850/1050	359/479
OKIDATA	
320/321	359/490
390/391	490/649

LASER PRINTERS

HP Laser II	1695
HP Desk Jet ±	695
HP Laser 2P	1059
Panasonic 4450	1395
Brother HL-8-E	1895
Nec LC 890	3195
Toshiba Laser	Call

MONITORS

Nec Multisync IIA	499
Nec Multisync 3D	639
Magnavox EGA	339
Nec Multisync 5D	2350
Samsung EGA	359
Sony 1302	619

FAX MACHINES

Sharp FO 220	729
Sharp UX 350	1149
Canon	Call
Toshiba	Call
Richo	Call
Murata	Call

Intel Coprocessors

8087-3	105
8087-2	145
80287-8	225
80287-10	249
80387-16	395
80387-20	425
80387-25	495
80387-33	599

TOSHIBA	
321-SL/341-SL	399/595
351-SX 350 CPS	929
PANASONIC	
1524	529
1124	319
Call for others	

MODEMS

Everex 1200 Int	79
Everex 2400 Int	149
Hayes 2400 B	299
More in Stock Call	

WE ACCEPT CASHIER CHECKS, MONEY ORDERS, VISA, MC, AmEx
3% charge on VISA, MC & 5% on American Express

EXPORTS Available

COMPUTERLANE

HOURS:
M-S 9-6

1-800-526-3482 (Outside CA)
(818) 884-8644 (In CA)
(818) 884-8253 (FAX)

22107 ROSCOE BLVD.
CANOGA PARK
1/2 BLOCK W. OF TOPANGA
CA 91304

CORPORATE ACCOUNTS WELCOME
CALL FOR VOLUME DISCOUNTS
CONSULTANTS CALL FOR PRICING

Prices subject to change without notice

Compaq is a Registered Trademark of Compaq
IBM is a Registered Trademark of International Business Machines

HARD DRIVES

20Mb
ST225
65ms
\$229

Seagate

Hard Drive Kits
for IBM PC/XT & Compatibles

Each kit includes drive, cables, controller, How-To manual and mounting hardware.

32Mb
ST238R
65ms
\$249

MiniScribe 40Mb Kit for IBM PC/XT & Compatibles
Solutions for Data Storage



30,000 hour Mean Time Between Failure
46ms Access Time

COMPLETE KIT includes a half-height 3 1/2" MiniScribe 8450 drive, controller, cables, How-To Manual, mounting hardware and partitioning & formatting software. Autolock!

\$299

Why Buy HDI?



That's Why!

ST296N
80Mb
28ms

Seagate



HIGH SPEED THROUGHPUT!!

\$499

SCSI hard drive with 8 bit High Speed Host Adaptor for your AT/386. Hook up to 2 drives off ONE adaptor. Autopark.

w/ Hard Only Controller

w/ Hard/Floppy Controller **\$529**

40Mb Seagate
MFM ST251-1
28ms ... **FAST!!**
Bare Drive **\$319**

M3085 MiniScribe M9380E
71Mb **340Mb**
Solutions for Data Storage
With ESDI "1 to 1" High Performance Hard/Floppy Controller.
\$569 **\$1795**
18ms Access Time 16.5ms Access Time

160Mb 17ms Access Time
M3180E

Half-Height With ESDI Controller
\$1295



Happy Holidays!
65Mb RLL ST277R-1
Seagate
Bare Drive **\$369**
28ms Access Time

Kits for IBM PC/XT & Compatibles
Includes 65Mb ST277R-1 hard drive, controller, cables, mounting hardware and How-To manual. 28ms. **\$419**

Kits for IBM AT/386 & Compatibles
Includes all standard kit items plus hard/floppy "1 to 1" high speed controller and cables. **\$499**

HARD DRIVES International

Insight Another Insight Company
Distribution Network, Inc.

1912 West Fourth Street
Dept. BY
Tempe, AZ 85281
Local Sales: (602) 967-5128
FAX: (602) 829-9193

S
A
L
E
S

Never a Surcharge for Visa or MC!

In the U.S. and Canada
(800) 234-DISK
24 hr. Order Status: (800) 776-3472

Corporate
Sales: (800) 729-3472

International
Sales: (602) 967-7435
FAX: (602) 921-8312

APO/FPO (602) 967-5128



Prices and availability subject to change without notice. All items are NEW. 5% surcharge for COD orders. P.O.s accepted from qualified buyers - 2/10 Net 20 - 5% surcharge. Add \$11 shipping for EXPRESS APO/FPO orders. 30 Day Guarantee conditions: shipping & handling charge is not refundable; product must be undamaged and in original condition. Hard Drives International is a division of Insight Distribution Network, Inc. XT and AT are trademarks of the International Business Machines Corporation.

All Products come with a **30 Day "Worry-Free" Guarantee and Replacement Policy!**

BY1289

NEW

Add some FUN to your PC!



EYE-GARD is a great novelty for your home or office! The EYE-GARD vision sensor detects anyone simply walking up to your PC. Then it . . .

- ... displays any PCX-format picture.
- ... displays any message YOU choose.
- ... plays music or sound effects.
- ... requests a password before letting anyone use your PC.

EYE-GARD can even run other programs. It is perfect for sales or software demos!

EYE-GARD runs on all IBM-compatible computers. Comes with EYE-GARD sensor, software, sound and picture files.

EYE-GARD is a great gift for you . . . or anyone! . . . who uses personal computers.

Order NOW for Christmas!
Only \$19.95
 (plus \$3.50 p/h)

CUS RESEARCH
 P.O. Box 140005
 Dallas, TX 75214
 (214) 826-3353

VISA/MasterCard Accepted

Circle 130 on Reader Service Card

SONY

2D

SONY \$10.50

3.5" SONY High Density 1.44 MB
 1-4 BOXES OF 10: \$29.50 ... 5+ BOXES: \$28.90



5.25" DS/HD 1.2 MB INCL. Sleeves & tabs. BLACK
 Lots of 100 - 49¢ Lots of 50 - 59¢

5.25" DS/DD 360K, INCL. Sleeves & Tabs
 Lots of 1,000 - 21¢ Lots of 200 - 25¢

3.5" DS/DD 800KB BULK (1MB)
 Lots of 100 - 59¢ Lots of 50 - 79¢

3.5" DS/High Density 1.44MB (2MB)
 Lots of 100 - \$1.95 Lots of 25 - \$2.50

AMERICAN GROUP

800-288-8025
 12132 Sherman Way, N. Hollywood CA 91605
CALL OR MAIL  

Circle 20 on Reader Service Card

3M

Authorized Distributor: Magnetic Media Division

5 1/4" DD 6²⁵ PER BOX	5 1/4" HD 11³⁰ PER BOX
3 1/2" DS 11⁹⁵ PER BOX	3 1/2" HD 25⁹⁵ PER BOX

Dysan

3.5 DS 9⁹⁵ PER BOX	5 1/4" DS 6⁴⁰ PER BOX	3.5 HD 22⁹⁵ PER BOX
	5 1/4" HD 10⁹⁵ PER BOX	

LASER TONER

- *HP LaserJet 2 & 2D
- *CANON 2
- *HP LaserJet Plus & 500+
- *CANON LPB
- *APPLE LaserWriter

84⁹⁵ ea.

Ricoh Toner Kit 80 "CALL"
Ricoh OPC 80,81 or 150 \$139⁹⁵

Qume Toner
 KYOCERA F1000A, F1010
 BROTHER LP 10
 UNISYS 37

21⁹⁵

the Diskette Connection™

Delaware 1-800-451-1849
 P.O. BOX 10247, WILMINGTON, DE. 19850

Oklahoma 1-800-654-4058
 P.O. BOX 1674, BETHANY, OK. 73008

Nevada 1-800-621-6221
 P.O. BOX 12396, LAS VEGAS, NV. 89112

Minimum order \$20.99 No Surcharge on Visa MasterCard™ COD orders add \$3.99 Surface Shipping UPS add \$4.00 per 100 for 3 1/2" or 5 1/4" add \$4.00 per 100 for 8" US Mail delivery add 9% *Prices subject to change without Notice.

  FAX-405-495-4598

DYNAMIC ELECTRONICS SIMMS

8087-2	119.00
80287-8	185.00
80278-10	212.00
80387-20	369.00
80387-25	473.00
803875X	299.00
80C287A	295.00
4464-12	5.25
1 MEG-100	12.85
1 MEG-80	13.75

CALL: (714)
855 - 0411

FAX: (714) 855 - 8504

23552 COMMERCE CENTER DR. # L
 LAGUNA HILLS, CA, 92653

Circle 114 on Reader Service Card

E/EPROM & MICRO PROGRAMMER

\$895



- EP-II40 includes: software, cable, user's manual, 2 free software update coupons, toll-free technical support, one-year warranty & a unconditional 30-day money back guarantee
- Programs 24-, 28-, 32- & 40-pin E/EPROMs
- Supports 874X & 875X series microcontrollers
- Connects to a standard parallel port
- 32-pin model, EP-II32, available for \$695

The Engineer's Programmer™

CALL TODAY 800-225-2102

BP MICROSYSTEMS
 10681 Haddington, #190, Houston, TX 77043
 713/461-9430 FAX 713/461-7413

Circle 51 on Reader Service Card

ALL NEW !!!

9 TRACK TAPE SUBSYSTEM
 for IBM PC/AT/386
 complete for only
\$2,595.00
1 YEAR WARRANTY



- IBM/ANSI compatible at 800*/1600/3200 bpi
- Controller, cables and software included
- Interfaces for PS/2*, Xenix* and DEC*
- SCSI*, AT or MCA* Bus I/O at 25/50/100 ips.

* optional

AKSystems Inc.
 20741 Marilla St. Chatsworth CA 91311
 TEL: 818/709-8100 FAX: 818/407-5889

Circle 18 on Reader Service Card

8051 SBC \$99 oem qty 1

Single Board Computer

FEATURES: 8031, RAM and ROM Sockets, 8 bit I/O, RS 232 port, optional UART, and Expansion Bus. Size: 3.5" x 6.0", +5Vdc only. OPTIONS: 8032, CMOS, 18 MHz, NV Memory, Monitor Firmware and High Level Languages. Development Board.....\$199

8031 ICE \$199

Our emulator provides most of the features of an 8031 In-Circuit-Emulator at a significantly lower price. It assists in integration, debug and test phases of development. Commands include: disassembly, trace, breakpoints, alter register/memory, and load Intel Hex file.

8051 Simulator Program..... \$99
 IBM PC/XT/AT Software simulation of 8051 µC.

HTE HiTech Equipment Corporation
 9400 Activity Road
 San Diego, CA 92126
 (619) 566-1892

Circle 154 on Reader Service Card

Worlds Lowest Priced Ram Expansion

CAT™ 10MHZ BASE SYSTEM

- 256K (Opt. 640K) • 150 Watt Power Supply • AT Style Keyboard & Case
- 4.77 or 10 MHz Keyboard Selectable
- Floppy Disc Controller
- 8087 Socket • 360K Floppy Drive
- 1 Year Warranty

\$34900

IBM XT COMPATIBLE



CAT 386 SYSTEM

- 12" Amber Monitor with Graphics Interface Card
- 1.2 Meg Floppy Drive
- 1 Meg of Memory
- Parallel, Serial & Clock
- 20MHz DTK Motherboard
- Xenix, Unix, Novell Compatible

20MHz **\$152300**

CAT™ 286-10MHZ BASE SYSTEM

- 512K Exp. to 1 MEG • 200 Watt Power Supply • AT Style Keyboard
- Western Digital Controller • 1.2 Meg Floppy • Legal Bios w/manuals • Systems Documentation • 1 yr war. • Clock/Calc
- 10MHz DTK Motherboard

\$64900

IBM AT COMPATIBLE

11.3 NORTONS SL



8088 XT Compatible
640 K Upgrade 12900
12" Amber Monitor w/Interface 13900
DOS 4.01 w/GW BASIC 8900
Clock Calendar 2400
Parallel & Serial Ports 3900
Additional Drives See Below

SYSTEM OPTIONS

286, 386 AT Compatible
640 K Upgrade 4900
512K Upgrade 10800
12" Amber Monitor w/Interface 13900
14" EGA Monitor w/Interface 54900
Novell Network . Call 12 Mhz add 10000
14" Color Monitor w/Interface 28900

COPROCESSORS

8087	5MHz or less	8800
8087-2	8MHz	12900
8087-1	10MHz or less	17900
80287	6-8MHz	13900
80287-8	8-10MHz	19900
80287-10	10MHz	23900
80C287-12	12MHz	29900
80387-16	16MHz	36900
80387-20	20MHz	43900
80387-25	25MHz	54900
90387-33	33MHz	64900
80387SX	16MHz	39900

RAM CHIPS

Description	150NS	120NS	100NS	80NS
64 x 1	200	250	285	375
64 x 4	475	525	575	675
256 x 1	300	375	385	485
1 Meg x 1	1100	1175	1225	1325
256 x 4	1200	1400	1500	1700
64kx4 Video	600	700	800	1100
1 Meg Video	—	2400	—	—
8K x 8 Static	700	800	900	1100
NEC V-20 — 8MHz	—	—	—	700

MEMORY FOR ALL COMPUTERS

Description		Part #	For Model #	Meads Low Price
512K Upgrade		30F 5348	30/286	44900
2MB Upgrade		30F 5360	30/286	45900
1MB Module		6450603	70-E61 & 121	23900
2MB Module		6450604	70-E61 & 121	49900
2MB Mem. Board		6450608	70-A21	59900
1MB Mem. Board		6450375	80-041	41900
2MB Mem. Board		6450379	80-111 & 311	89900

COMPAQ

Description	Equiv. Part #	For Model #	Meads Low Price
1MB Add-on Module	113131-001	386/20/25/20e/286E	35900
1MB Add-on Module	113136-001	Deskpro 386S	36900
4MB Add-on Module	113132-001	386/20/25/20e/286E	89800
4MB Add-on Module	112534-001	Deskpro 386S	99800
1MB Memory Exp. Bd.	113644-001	Deskpro 386/20e	49900
1MB Memory Exp. Bd.	113633-001	Deskpro 386S	49900
4MB Memory Exp. Bd.	113634-001	Deskpro 386/20e	139900
4MB Memory Exp. Bd.	107651-001	Deskpro 386S	49900
1MB Mem. Upgrade Kit	107651-001	Portable 386	49900
1MB Memory Exp. Bd.	117428-001	286E	49900
4MB Memory Exp. Bd.	117429-001	286E	139900
1MB Upgrade Bd.	110235-001	SLT/286	59900
4MB Upgrade Bd.	108070-001	386/16	139900

IBM & Compaq boards & Modules come with 1 year warranty and are manufactured on a 2nd party board.

SIMM MODULES

Description	150NS	120NS	100NS	80NS
64 x 9 IBM & Compatibles	1900	2900	3400	3900
256 x 8 For Apple Products	3900	4400	4900	5900
256 x 9 IBM & Compatibles	4200	4800	5900	6400
1Meg x 8 For Apple Products	10900	11400	11900	12900
1Meg x 9 For IBM & Compatibles	11900	12400	12900	13900

HP LaserJet II & IID

1Meg	29900
2Meg	39900
4Meg	69900

Memory Boards

0-3Meg	10900
0-3Meg PS2	24900
0-10Meg	17900
0-8Meg PS2	39900

Seagate HARD DRIVES

ST125 20Meg 40 Mil 1/2 Ht 3 1/2" Drive only	25900
ST138 30Meg 40 Mil 1/2 Ht 3 1/2" Drive only	29900
ST225 20Meg w/cont. & Cables	25900
ST238 30Meg w/cont. & Cables	28900
ST251 40Meg 1/2 HT 40 Mil w/software, Drive only	34900
ST251-1 40Meg, 28 Mil Sec, Drive only	35900
ST277R 60MB 40 Mil Full Ht	44900
ST4038 30Meg 40 Mil Full Ht	39900
ST4053 40MB 28 Mil Full Ht	51900
ST4096 80Meg Full Ht w/software 28 Mil Sec.	63900

WESTERN DIGITAL CONTROLLERS

WX-1 8 Bit 1/2 Sized for XT	7900
WD-2 16 Bit Full Sized Hard/Floppy	11900
WD-2TX 8 Bit RLL 1/2	8900
WAH 16 Bit Hard Drive Controller	12900
RAZ 16 Bit RLL Hard/Floppy for AT	15900
MEAD Floppy Disk Controller for XT	1900
MEAD 1.2 Meg & 360K Controller for XT, 720K-1.44	6900
Cable Set for Hard Drive Only	500

Mitsumi FLOPPY DRIVES

360K 1/2 Ht. PC Compatible — Mitsumi	6900
1.2 Meg 5 1/4 Mitsumi	8900
720K 3 1/2" Drive w/5 1/4" mounting — Mitsumi	8900
1.44 Meg 3 1/2" Drive w/5 1/4" mounting — Mitsumi	10900
360K Tandon TM100-2 Full Ht (The Original IBM)	8900
160K Tandon TM100-1 Full Ht	5900
External Case w/Power Supply 2, 1/2 HTs or 1 Full	14900

EVEREX™ TAPE BACKUPS

40MB Mini Cartridge, 1.8MB/min, XT (DC 2000)	33900
40MB Mini Cartridge, 3.6MB/min, AT (DC 2000)	33900
60MB Streaming Cassette, 5MB/min w/cont (DC600)	64900
60MB Streaming 600A, 5MB/min w/Full cont (DC600)	84900
125MB Streaming Cartridge, 5MB/min w/Full cont	11900
DC2000 24" External Add 19500	DC600 24" 4900

MODEMS BY EVEREX™

EV-923 EverCom 12 300/1200 bps Bitcom Software	6900
EV-941 EverCom 24 2400 Baud Int. Bitcom Software	13900
EV-945 External 2400 Baud	19900
EV-942 2400 PS2	22900
EX-955 FAX Card	34900

MORE MODEMS

1200 Baud Internal w/Software CPI	5400
1200 Baud External fully Hayes Compatible	9900
2400 Baud Internal 1/2 card w/software CPI	9900
2400 Baud External Fully Hayes Compatible, Zoom	12900

Imtec/SAMSUNG MONITORS

1256A 12" Amber w/Tilt & Swivel Base	8900
1257 12" Amber Flat Screen 720 x 350	10900
1464 14" Color 640 x 200, 16 colors	23900
1453 14" EGA 640 x 350, 64 colors/31	36900
1455N EGA 720x480 Multisync Compatible	44900

VIDEO CARDS BY EVEREX™

EGA EV659, 640 x 350, Auto Switch	11900
VGA Viewpoint 16 Bit 256 Exp 512k	26900

MORE VIDED CARDS

MonoGraphics (Hercules Compatible)	3900
Color Graphics with Par. Port	4900

MEAD has done it again!

We Have Located The Following New Equipment Below Everybody's Cost!

LETTER QUALITY PRINTER

DAISYWHEEL PRINTER MANUFACTURED BY C.I.TOH
Why pay \$1149 for a C.Itoh
STARWRITER™ F-10
When our 40 cps letter quality daisywheel printer from the same manufacturer is only

\$39900 ea.

OPTIONS

- 6 ft. Serial Cable \$ 1900
- Bidirectional Tractor 14900
- Cut Sheet Feeder 19900
- Serial to Parallel Converter 9900

KRPT MONITOR



FREE TILT SWIVEL BASE

- 14" Flat Screen • Paper White Phosphorus
- TTL Monochrome & RGB Interface

List \$199 Mead **\$9900** 10 for \$890

HIGH SPEED SCANNER

PRINCETON™ GRAPHIC SYSTEMS

Desktop LS300 Scanner
List Price: 109500 Meads: 39900

STANDARD FEATURES

- 300 DPI - Allows for the creation of high resolution graphics/text.
- Automatic Sheet Feeder - Efficient document handling.
- Image Input - Sheet or card (up to 5 sheets can be set with the built-in Automatic Document Feeder)
- Scanning Speed - 12 seconds/page (at 300 dot/inch)
- 6 seconds/page (at 150 dot/inch)
- Gray Scale - 32 shades either pattern or 2 shades.

Quantity Discounts Call

OPTIONS

- PC Paint Software 4900
- OCR Software 19900
- Macintosh Interface 4900

SERIAL MOUSE

- DexMouse by Logitech
- 2 Button Dpto-Mechanical
- 200 DPI
- Pacemaker, Driver & Menu Software
- PS, XT, AT PS/2 Compatible

List: 9900 Mead: 4900

SIDEKICK PLUS

- By Borland Version 1.0
- Professional Desktop Manager

List: 19900 Mead: 7900 10 for 5900 ea.

PARADISE MONO EGA CARD

Auto Switch Monochrome EGA Card, 640x350
EGA, MDA, CCA, Herc. List 31900 Mead 9900

MONOCHROME TEXT ONLY CARD

- IBM Compatible
- 1 Year Warranty New in Box

List 8900 Mead: 1400 100 for 900 ea.

MICROSOFT MACH 20 MEMORY CARD

- Works with Mach 20 Only
- Memory Plus OK or Memory
- OEM Packed No Box or Manual

List: 39900 Mead: 4900 100 for 2900 ea.

WORDSTAR PROFESSIONAL 5.0

- Write or Edit Text Based Business Reports as Documents
- Advanced Page Preview To Save Time
- Organize Format & Merge Info From Other Software

List: 48500 Mead: 14900 10 for 12900 ea.

800-654-7762

SALES: 7 a.m. - 6 p.m. PST
702-294-0204

TECHNICAL / CUSTOMER SERVICE / ORDER STATUS:
9 a.m. - 4 p.m. PST

FAX 702-294-1168

Trademarks are registered with their respective Co.'s. Prices Subject to Change
All Products 90 Day Warranty unless stated otherwise.

WE ALSO PURCHASE EXCESS INVENTORY - FAX LIST



- Quantity Pricing Available - CALL
- We Accept International Orders
- Purchase Orders from Universities, Government Institutions, Fortune 1000 and Qualified Firms.

NO SURCHARGE FOR MC/VISA

TERMS:

- MC • VISA • COD • CASH
- Purchase Orders from Qualified Firms
- Personal Checks • AE add 4% • COD add \$5.00
- 20% Restocking Fee on Non-Defective Returns within 15 days



SHIPPING: (min 60) UPS

1000 Nevada Hwy. • Unit 101 • Boulder City, NV 89005

BLAST Your Message Thru!



**Voice Messaging • Call Processing
Audiotex • Telemarketing
Order Processing • Call Distribution**

Powerline transforms your personal computer (PC/XT/AT/386) into a multi-line voice processing command center capable of controlling 16 telephone lines. Intelligently process your sales, inquiries and messages in the background. Give your computer some Punch!

Blast your message through with Powerline! Package includes hardware, software, cables, speaker, 2 year warranty.

**Single Line device \$295.00
Multi-Line \$695.00**
(Developer/SEM packages available)

VISA—MC—AMEX—COD
For Information or Sales Call
(415) 652-9600
FAX (415) 652-5291

TALKING TECHNOLOGY, INC.
4383 PIEDMONT AVE., OAKLAND, CA 94611

SEE US AT COMDEX

Circle 307 on Reader Service Card

Modular I/O board

Single-slot Qua Tech PXB-721 for PC-AT has 72 digital I/O lines. Connect three choices of data acquisition modules. Supports Labtech Notebook™.

For order info, call:
1-800-553-1170



QUA TECH, INC.
478 E. Exchange Street
Akron, OH 44304

Labtech Notebook is a trademark of Laboratories Technologies Corp.

Circle 272 on Reader Service Card

EZ-ROUTE VERSION II

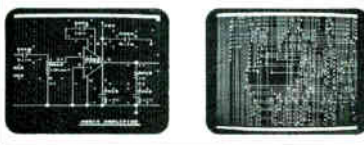

**SCHEMATIC TO PCLAYOUT \$500
INCLUDES AUTO ROUTER**

EZ-ROUTE Version II from AMS for IBM PC, PS/2 and Compatibles is an integrated CAE System which supports 256 layers, trace width from 0.001 inch to 0.255 inch, flexible grid, SMD components and outputs on Penplotters as well as Photo plotters and printers.

Schematic Capture \$100, PCB Layout \$250, Auto Router \$250
FREE EVALUATION PACKAGE
30 DAYS MONEY BACK GUARANTEE
1-800-972-3733 or (305) 975-9515

ADVANCED MICROCOMPUTER SYSTEMS, INC.
1321 N.W. 65 Place - Ft. Lauderdale, FL 33309

Circle 22 on Reader Service Card

9-Track Tape For Your IBM PC/XT/AT/PS-2™

Read 1600 bpi 9-track tapes from a micro, mini or mainframe in EBCDIC or ASCII as mirror image or by individual files.

Use the 2000 PC™ for disk backup, data interchange or archival storage.

PC/XT/AT/PS-2 are trademarks of IBM. 2000 PC is a trademark of Digi-Data.



DIGI-DATA CORPORATION
8580 Dorsey Run Road
Jessup, MD 20794-9990
(301) 498-0200
FAX (301) 498-0771
First In Value

Circle 109 on Reader Service Card

2 parallel, 2 serial, 1 board

Qua Tech DSDP-402 for PC-AT has two parallel ports, and two serial ports for any combination of RS-232, 422, and 485 communication. All ports address selectable. Interrupts sharable and selectable.

For order info, call:
1-800-553-1170



QUA TECH, INC.
478 E. Exchange Street
Akron, OH 44304

Circle 273 on Reader Service Card

EPROM PROGRAMMER CROSS ASSEMBLERS



MODEL SX151

RS232C OR STAND ALONE (all models), Communication protocol; XMODEM, HEX, and BIN. Programs: EEPROMS, 2716 - 27512 and CMOS. Programs (w/adaptor): 25XX, 27101 (and above), 68701, 68705, 68764/6, 87412, 8744, 8748/9, 8751/2, 8755, 87252, 870751, 870752 and CMOS. More available soon.

Model SX151 \$214 (assembled with case). Other models are available from \$49 (kit).

Cross assemblers by Pseudocorp for IBM-PCs, \$50. Z80, 1802, 6502, 68001/1/2/3/5/8/9/11, 68000/8/10, 8048/9, 8051/2, 8080/5, 8096, and more soon. Simulators and disassemblers also available.



KORE, Inc.
3150 Plainfield N.E.
Grand Rapids, MI 49505
(616) 361-3666

\$5 for shipping (USA), plus \$3.00 COD.

Circle 180 on Reader Service Card



PC BASED UNIVERSAL DEVICE PROGRAMMER \$595-845

- Programs EE/EPROMs, PALs, GALs, IFLs, EPLDs, MICROS, BIPOLARS.
- Software drives pin drivers. D/A generated programming voltages.
- Upgradable for virtually any future programmable devices up to 40 pins.
- Self-subsistent operation. No additional modules or plug-in adapters required.
- Includes user friendly MEMORY BUFFER FULL SCREEN EDITOR.
- Friendly Menu-Driven interface. Device selection by P/N and manufacturer.
- Supports 8/16/32 bit word, Intelligent I & II, Quick Pulse programming.
- Functional testing: Register-Preload, FUSEMAP EDITOR for logic devices.
- File formats accepted: Intel Hex 8086, Tektronix Hex, Motorola S, JEDEC.
- Customer support via voice line, dedicated BBS or fax. Full 1 year warranty.
- Base price includes Interface card, cable, Memory device library and 1 year free updates. Additional Device Libraries (Logic, Micros, Bipolars) \$95 ea.
- Libraries updates available every 6 mo. and can be received via floppy or BBS.

PC BASED 8-SOCKET GANG PROGRAMMER \$595

- Handles all memory devices to 32 pins. (Upgradable up to 8 megabit parts).
- FULL SCREEN BUFFER EDITOR plus all applicable features from above.
- Customer support via voice line, dedicated BBS or fax. Full 1 year warranty.
- Includes PC Interface card, Memory device library and 1 year free updates.



UNIVERSAL RS-232 PROGRAMMER \$345-595

- Programs EE/EPROMs, FlashEPROMs, ZFRams, Intel Micros, Memory Cards.
- Stand-Alone Mode for EE/EProm and Memory Card Duplication / Verify.
- All 24/28/32 pin EE/EPROMs to 4 MBits (upgradable to 32 megabits).
- Micros: 8741A, -2/A, -4, -8, -9, -51, -C51, -C51F/A/B, -52, -53, -55, -C521, -C541, 9761.
- Memory Cards: Seiko/Epson/Fujitsu (Integrated Adapter included)
- Modular design: Firmware easily upgradeable; 4 socket Gang module available
- On-Board Programming capability. Custom interface modules available.
- User friendly Menu-Driven Interface Program for IBM-PC and Macintosh.
- Can be operated with any computer containing an RS-232 serial port.
- Optional built-in Eraser/Timer module (\$50); Top cover conductive foam pad.
- OEM open board programmer configurations available (from \$245).
- Customer support via voice line, dedicated BBS or fax: Full 1 year warranty.



INTELLIGENT PC ROM EMULATOR \$395

- Emulates 2716 through 27512 EPROMs (2k to 64k bytes) with a single unit.
- Connects to the standard parallel printer port. Uses standard printer cable.
- Intelligent features include: Reset Output, Address Compare, Address Snapshot, Trigger Input. Memory buffer editing capability. Selectable wordsizes.
- User friendly software. Command set includes: Load, Write, Display, Run, Type, Edit, Fill, Run-Command-File, Monitor, Port, Reset, Help, Calculator.
- FAST data loading via parallel printer port (65k bytes in less than 10 seconds).
- Cascadeable up to 8 units. Includes interface cable with Trigger and Reset clips.
- CMOS model with NiCad rechargeable 9V battery backup - \$495.
- Built-in battery recharging circuitry. After code downloading from the host computer, this model can be disconnected and used in stand-alone mode.
- File formats accepted: Binary, Intel Hex, Motorola S.

MC / VISA / AMEX

Call today for datasheets!



B&C MICROSYSTEMS, INC.

355 WEST OLIVE AVE., SUNNYVALE, CA 94086
TEL: (408) 730-5511 FAX: (408) 730-5521



Unitex, Inc

Established 1976

Mon-Fri 7am - 5pm
Sat 8am - 2pm

Corporate Headquarters

2852 F Walnut - Tustin, CA 92680

4025 S. Industrial Blvd. - Las Vegas, NV

Phone: 714/730-5232 • FAX#: 714/838-8593

California Residents call toll free :1-800-843-8414



Customer Service #: 714/730-9527
TOLL FREE OUTSIDE CA: 1/800/533-0055



SIMM / SIPP MODULES

1 MG X 9- for IBM TYPES
1 MG X 9-120NS ... \$109
1 MG X 9-100NS ... \$118
1 MG X 9- 80NS ... \$125
1 MG X 9- 70NS ... \$149

DIP



256 X 9- for IBM TYPES
256 X 9-120NS ... \$35
256 X 9-100NS ... \$45
256 X 9- 80NS ... \$55
256 X 9- 60NS ... \$65

ZIP



APPLE SIMM MODULES
1 MG X 8-120NS ... \$125
1 MG X 8-100NS ... \$140
256 X 8-120NS ... \$39
256 X 8-100NS ... \$49

SIMM



PS-2 PRODUCT
256 X 9 (FOR PS2)
256 X 9-120NS ... \$65
30F5348(KIT-2EA.) \$130

PS-2
SIMM



MODEL 30-286
1 mg x 9-100 ... \$235
30F5360 (KIT-2EA.) \$360

50Z SIMM
6450603 (1MG) ... \$249
6450604 (2MG) ... \$549

**PS-2
MODEL 70&80
SIMM**

1 MG X 9-100NS ... \$219
1MG X 9- 80NS ... \$249
2 MG X 9-80NS ... \$495
(6450608) (For 70A21)
2 MG X 9-80NS ... \$549
(6450604)
(For 70E61/ 70-121/ all
models)

1 MG X 9-80NS ... \$249
(6450603)
(For 70E61 / 70-121)
1 mg(6450375) ... \$429
2 mg(6450379) ... \$929

MATH-CO



Warranty-
1 year on parts

D - RAM

1 MG X 1
1 MG X 1-120NS \$10.50
1 MG X 1-100NS \$11.00
1 MG X 1- 80NS \$11.75
1 MG X 1- 70NS \$13.75

256 X 1
256 X 1-150NS ... \$2.95
256 X 1-120NS ... \$3.20
256 X 1-100NS ... \$3.75
256 X 1- 80NS ... \$4.75
256 X 1- 70NS ... \$6.00
256 X 1- 60NS ... \$6.80

256 X 4
256 X 4-120NS ... \$13.50
256 X 4-100NS ... \$14.00
256 X 4- 80NS .. \$18.00

64 X 1
4164-150NS ... \$1.20
4164-120NS ... \$1.99
4164-100NS ... \$2.20

64 X 4
4464-150NS ... \$4.00
4464-120NS ... \$4.50
4464-100NS ... \$5.00
4464- 80NS ... \$6.50

256 X 4 STATIC COL
514258-100NS ... \$25

256 X 1 STATIC COL
51258-100NS ... \$4.50
51258- 80NS ... \$6.00
51258- 70NS ... \$6.50

ZENITH 386 MODULES
1 MG X 9-80 NS ... \$249

AST 386 MODULES
386/25 ... \$295
386/33 ... \$329

HEWLETT-PACKARD LASERJET MODULES

1 MB (for Laserjet II & IID) ... \$249
2 MB (for Laserjet II & IID) ... \$379
4 MB (for Laserjet II & IID) ... \$599

MATH CO-PRO

8087-3(5MHZ) ... \$85
8087-2(8MHZ) ... \$118
8087-1 ... \$165
80287-6 ... \$120
80287-8 ... \$195
80287-10 ... \$218
80C287-12 ... \$295
80387-16 ... \$310
80387-20 ... \$360
80387-25 ... \$460
80387-33 ... \$590

ADVANCED MATH- CO PRODUCTS

*Faster than standard
MATH CO-Processors
*5 year Warranty
for 286 Machines
2C87-10 ... \$239
2C87-12.5 ... \$300
2C87-20 ... \$329
for 386 Machines
3C87-16 ... \$329
3C87-20 ... \$369
3C87-25 ... \$499
3C89-33 ... \$539

CPU CHIPS

8088 ... \$5.00
80286-8 ... \$49
80286-10 ... \$59
80286-12 ... \$69
80386-16 ... \$180
80386-20 ... \$240
80386-25 ... \$330
V-20 (8MHZ) ... \$7.50

VIDEO RAM FOR VGA CARDS

64 x 4 (150NS) ... \$5
64 x 4 (120NS) ... \$7
64 X 4 (100NS) ... \$10

BOCA RESEARCH

TOPHAT II- Tophat II has 128 soldered on the board which results in a lower profile. Maintains the ability to backfill conventional memory from 512 to 620K in a 16-bit AT type machine. Operates at CPU speeds up to 10 MHz ... \$129

BoCARAM/AT PLUS - Offers conventional, expanded and/or extended memory for the IBM AT and 16-bit compatibles. Operates in a system up to 33MHz and is set up through software, with the configuration stored in EEPROM. Uses 120NS 1 Meg RAM chips. Available in four configurations, OK up to 8 Meg ... \$149

BOCARAM/AT I/O PLUS - Offers conventional, expanded and/or extended memory as well as other I/O capabilities for ATs and compatibles. Provides up to 4 Meg of memory using 120NS 1Meg RAM chips, 1 parallel port and up to 2 serial ports per board. ... \$189

ORCHID

RAMQUEST IIZ -Up to 2MB of 0 wait state memory for the IBM PS/2 Models 50, 50Z & 60 • Guaranteed EMS 4.0 and OS/2 Compatible • Easy 4-keystroke installation. Uses 1MG Dip s ... \$199

RAMQUEST EXTRA -The only multifunction card that provides up to 8MB and two serial ports on one board for the IBM PS/2 Models 50, 60 and 80. • Guaranteed EMS 4.0 and OS/2 Compatible. • Easy to install with only 4 key strokes. Uses 256 and/or 1MB SIMM'S. ... \$249

RAMQUEST EXTRA 16/32 -The only 0-8MB, 0 wait state card for PS/2 Models 50, 50Z, 60, 70 and 80 which fully supports both 16-bit and 32-bit memory access. Includes one serial and one parallel port plus a free serial cable. Guaranteed EMS 4.0 and OS/2 compatible. Easy 4-keystroke installation. Uses 256 and/or 1MB SIMM'S ... \$319

RAMQUEST XT/AT -A full size, 0-8 MB, zero wait state card for IBM PC, XT, AT, PS/2 25, 30 and compatibles. Uses 256K and/or 1MB SIMM'S. Automatically supports either 8 or 16-bit bus. ... \$259

RAMQUEST XT/AT with I/O - Same as above plus 1-serial and 1-parallel port ... \$319

COMPAQ MEMORY

ADD-ON MODULES

MODEL	1MG	4MG
386/20	\$299	\$799
386/25	\$299	\$799
386/20E	\$299	\$799
386/S	\$299	\$799
286 E	\$299	\$799

MEMORY EXPANSION BOARDS

MODEL	1MG	4MG
386/20E	\$479	\$1349
386 S	\$479	\$1349
386/16	--	\$1429
286 E	\$479	\$1329
SLT/286	\$479	--
PORTABLE 386	--	\$1429

D-RAM TESTERS

UNI-001RT ... \$99
Tests all parameters but speed
64 X 1 / 256/1 / 1M X 1
64 X 4 / 256/4 / 4M X 1

UNI-002 RT ... \$149.95
Tests speed plus parameters
64 X 1 / 256 X 1 / 1MG X 1

UNI-003 RT ... \$199.95
Tests standard SIMM Modules
1 year Warranty

IBM

1497259 - For PS-2 MOD 50/60 ... \$439
with OK Expands to 8MB
Uses 256K SIMMS (IBM only)
6450605 - For PS-2MOD 70/80 ... \$1299
with 2 MG Expands to 8 MB
Uses 2MG SIMMS (IBM only)
6450203 - For AT - Has 512K RAM ... \$129

TERMS AND CONDITIONS

No Surcharge for MC / VISA • Terms: MC • VISA • COD • CASH • AMEX add 4%
Purchase Orders from qualified firms • 20% restocking fee on non-defective returns
Prices Subject to Change

PC/XT/AT BUS DATA ACQUISITION

Free Catalog!

AD1000 12-Bit A/D, D/A, Counters \$295
 ADA300 8-Bit A/D, D.A, DIO \$239
 DG24/96 8255-based D O \$95/\$239
 TC24 Am9513 Counter, DIO \$189
 DA600 2/4 Channel 12-Bit D/A \$179/\$239

All cards made in USA!

We offer a wide range of A/D, D.A, DIO, counters, prototype, extender cards, interfacing books & accessories. 30 day NO RISK return and 1 year warranty on all cards

Real Time Devices, Inc.
 531 E. Marilyn Avenue
 P. O. Box 906
 State College, PA 16804 USA
814/234-8087

Circle 281 on Reader Service Card

TurboFlow \$69

Flowchart drawing for IBM PC/XT/AT/PS2

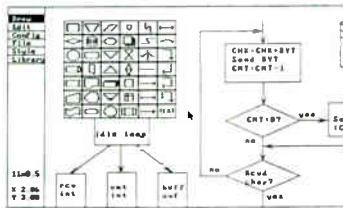

\$89 with Logitech mouse!

- Pop-up icon menus
- Variable size symbols
- Paper size to 34" x 44"
- Hercules mono, CGA, EGA
- HP-GI, DM/PL, SweetP Plotters
- Automatic PANning to scan drawing quickly
- IBM/EPSON, NEC, OKIDATA, HP LaserJet

Daytron Electronics Inc.
 610 S. Sherman #104, Richardson, TX 75081
 Add s&h (\$4 USA, \$15 foreign), Texas residents add 8% sales tax
 for technical information call 214-669-2137
Order Today! 1-800-882-5822
 Money-back guarantee

Circle 102 on Reader Service Card

PAL™ /PLD SOFTWARE
 Sets The Standard



CUPL™ PLD compiler, the most powerful language for state machine logic design, now allows OrCAD™ schematic software as the front end design entry. CUPL supports all PLDs and carries the most extensive update program. Available on MS-DOS™, Apollo™, Sun™, VAX™ and most UNIX™ based platforms.

1201 N.W. 65th Place
 Ft. Lauderdale, FL 33309
 FAX: (305) 974 8531
1-800-331-7766

Circle 184 on Reader Service Card (DEALERS: 185)

WELCOME TO THE 16 BIT WORLD
 Turn your Turtle into a Rabbit for only **\$189.00 OKB INSTALLED**

You do not need to buy a new computer!!! Trade in your slow XT mainboard for a new AT 80286, which includes:

- Microprocessor Intel 80286 CPU, socket for 80287.
- 12 MHz speed, selectable between 6 and 12 MHz.
- 0/1 Wait state, clock calendar, reset button.
- 512KB, 1MB, 2MB, 4MB mem. Upgrade, 640/384 mapping.
- Six 16-bit slots & two 8-bit slots, 16 level IRQ.
- Fits in the XT and AT cases.

with 512 KB. \$245.00
 with 1024 KB. \$299.00



ICROCHIP TECHNOLOGY
 2900 N.W. 72 Ave., Miami, FL 33122
 (305) 592-5739 • FAX (305) 592-5738

Circle 204 on Reader Service Card

LOW-LOW-LOW

hp Laserjet Printer Series II \$1650
hp Scanjet Scanner \$1355
 + interface kit

IBM COMPAG APPLE ACER
EVEREX AST & other

XT/AT Compatibles & 386 Computers
CALL for LOW PRICES

Gov't, Corporate, Schools, Dealers, & Export INQUIRIES WELCOME.

SUPRAH inc.
 44862 Osgood Road, FREMONT, CA 94539
 PH: (415) 651-5101 FAX: (415) 651-5241
 1-800-543-1001
 VISA, Master Card accepted. w/sc

Circle 306 on Reader Service Card

UNIVERSAL/GANG PROGRAMMER
 made in U.S.A.

\$695.00 includes One Year Update and Warranty



HUSKY™ programs EE/EPROMS, CMOS PLDS, and Micros. It is your best bet when low cost and quality are both important. From the people who make CUPL and ALLPRO

1201 N.W. 65th Place
 Ft. Lauderdale, FL 33309
 FAX: (305) 974 8531
1-800-331-7766

Circle 186 on Reader Service Card (DEALERS: 187)

World Radio History

LOW COST INTERFACE CARDS FOR PC/XT/AT

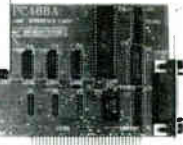

RS-485/422 Card [PC485] \$95/125

- Serial Async. Communication up to 4,000ft; 2 or 4 wires; NS16450 UART;
- Can be configured as COM1-COM4; Maximum Baud Rate 56KB.
- Flexible configuration options. RTS or DTR control of transmission direction.
- Full/Half duplex operation. Supports hardware handshaking (RTS,CTS).
- Dual drivers/receivers; Handles 64 devices; Compatible with most comm. software.
- High speed version available (supports baud rates up to 256KB) - \$165

Dual-Port RS-485/422 [PCL743] \$175

- Two independent channels /UARTs; 2 or 4 wire operation. Max. Baud 56KB.
- Dipswitch configurable as COM1-4 (IRQ2-7). On board terminator resistor.

IEEE-488 Card [PC488A] \$145

- Includes INSTALLABLE DOS DEVICE DRIVERS and support for BASIC.
- Additional Support for ASSEMBLY, C, Pascal and FORTRAN - \$50.
- IRQ (1-6), DMA channel 1 or 2. Up to 4 boards per computer.
- Compatible with most IEEE-488 Software packages for IBM-PC (e.g. ASYSTANT-GPIB, Lotus Measure). Compatible with NI's GPIB-PC1A.

IEEE-488 Card [PC488B] With Built-In Bus Analyzer \$345

- Software Support for BASIC, QuickBASIC and GWBASIC.
- Additional libraries for C, Pascal, FORTRAN, Assembly available - \$50 (all Full range of Talker, Listener, Controller, Serial/Parallel Poll, SRQ, etc...)
- Powerful menu-driven BUS ANALYZER can be run in the background while 488 programs or commands are executed; Features Program Stepping, Break points, Real Time Bus Data Capture (4K Buffer), Instant Screen Toggling.
- Complete Controller / Talker / Listener capability. Based on TI's TMS-9914.
- Memory-resident Printer Port Emulation Utility included. (LPT1-3).
- NEC-7210 based card (compatible with NI's GPIB-PC11) - \$445.

DIGITAL I/O Card [PCL720] \$175

- Input: 32 TTL compatible channels; Input load is 0.2 mA at 0.4V.
- Output: 32 TTL compatible channels; Sinks 24mA(0.5V); Sources 15mA(2.0V)
- Counter/Timer: DC to 2.6MHz; 3 channels; 16 bit counters; 6 counting modes.
- Breadboard area for prototyping. Dipswitch I/O port selection (200-378 hex).

LOW COST DATA ACQUISITION & CONTROL CARDS FOR PC/XT/AT



12 BIT A/D & D/A [PCL711s] \$295

- A/D converter: 8 single-ended channels; Device: AD574; Conversion time less than 25µsec; Input range: ±5V; Software Trigger Mode only.
- D/A converter: 1 channel; 12 bit resolution; 0 to +5V/10V Output Range.
- Digital I/O: 16 Input / 16 Output channels; All I/Os TTL compatible.
- External Wiring Terminal Board with mounting accessories included.
- Utility Routines and Demo/Sample Programs for BASIC and Quick-BASIC.

12 BIT A/D & D/A [PCL812] \$375

- A/D converter: 16 single ended inputs; Device: AD574; Conversion time less than 25µsec; Built-in programmable pacer; Input ranges: ±10V, ±5V, ±1V.
- D/A converter: 2 channels; 12 bit resolution; Output Range 0-5V.
- Digital I/O: 16 Input / 16 Output channels; All I/Os TTL compatible.
- Counter: 1 channel programmable interval counter/timer; Uses Intel 8254.
- DMA and interrupt capability. Utility software for Basic included.

FAST 12BIT A/D/A [PCL718] \$895

- A/D converter: 16 single ended or 8 differential channels; 12 bit resolution; Programmable scan rate; Built-in interrupt and DMA control circuitry; Conversion speed 60,000 samples/sec (standard), 100,000 samples/sec (optional).
- Input ranges: Bipolar ±10V, ±5V, ±2.5V, ±1V; Unipolar 10.5, 2.1V.
- D/A converter: 2 channels; Resolution: 12 bits res; Settling time: 5µsec; ±5V.
- Digital I/O: 16 I/O; 16 IN; TTL compatible; All I/Os TTL compatible.
- Counter: 16 bit prog. interval counter/timer; Uses Intel 8254; Pacer clock; Software: Utility software for BASIC and QuickBASIC included. Supported by LabDAS (\$195/495), ASYST, LABTECH, UnkelScope

6 Channel 12 bit D/A [PCL726] \$495

- Output Ranges: 0 to +5V, 0 to +10V, ±5V, ±10V or sink 4-20mA.
- Settling time: 70µs. Linearity: ±1/2bit. Voltage output driving capacity: ±5mA
- Digital I/O: 16 digital inputs and 16 digital outputs; TTL compatible.

STEPPER MOTOR CARD \$395

- Capable of independent and simultaneous control of up to 3 stepper motors.
- Speed: Programmable from 3 PPS to 3410 PPS; Built-in acceleration control.
- Output Mode: One clock (Pulse, Direction) or two clock (CW, CCW pulses)
- Step position Read-back; Opto-isolated outputs; Crystal based timing.
- Includes 8 bit digital input/output port. Order P/N [PCL-738B]

MC/ VISA / AMEX **Call today for datasheets!**
 Circle 59 on Reader Service Card

B&C MICROSYSTEMS INC.
 355 WEST OLIVE AVE., SUNNYVALE, CA 94086
 TEL: (408) 730-5511 FAX: (408) 730-5521

ATTENTION!
DEALERS/VOLUME BUYERS
SAVE \$\$\$



PS/2 Model 30-021	1539
PS/2 Model 30-286	1789
PS/2 Model 50-031	2149
PS/2 Model 60-041	3049
PS/2 Model 70-E61	3369
PS/2 Model 80-041	3979



MAC PLUS	1239
MAC SE/30 1 F/D	2989
MAC II 40 MB	3949
IMAGEWRITER II	429
LASERWRITER II NT	3489
LASERWRITER II NTX	4689



DESKPRO 286E Model I	1759
DESKPRO 286E Model 40	2339
DESKPRO 386/20E Mod I	3569
DESKPRO 386/20E Mod 110	5669
PORT SLT/286 Model 20	3629
PORT SLT/286 Model 40	3789



LASERJET II W/TONER	1599
LASERJET IID W/TONER	2669
DESKJET PLUS	679
SCANJET	979
HP 7475A PLOTTER	1289
HP 7550A PLOTTER	2779

SOFTWARE

PAGEMAKER /IBM	449
PAGEMAKER /MAC	349
LOTUS 1-2-3	289
LOTUS SYMPHONY	399
MICROSOFT "EXCEL"	199
MICROSOFT "WORD"	199

MEDIA PRODUCTS *Branded Diskettes*

BASF	5.25" DS/DD	10/BOX	4.59
3M	5.25" DS/DD	10/BOX	5.49
MAXELL	5.25" DS/DD	10/BOX	5.29
DYSAN	5.25" DS/DD	10/BOX	6.29
VERBATIM	5.25" DS/DD	10/BOX	5.29
PRECISION	5.25" DS/DD	10/BOX	3.29

(Call for other products)

- AST • CALCOMP • CANON • DEC • OKIDATA • EPSON • NCR • TOSHIBA • INTEL • NEC • NOVELL • ZENITH STAR • SEAGATE • PANASONIC
(Call for lowest prices!!!)
QUANTITY DISCOUNT AVAILABLE



8604 Samantha Lane
Spring Valley, California 92077 USA

TEL 619-466-9110 FAX 619-466-9932 TLX 415779



Z80 Specialists
Embedded Systems

C Compiler
Assembler/Linker
Remote Debug
Realtime Kernel
Emulator
PC Coprocessors
Proto Board

Integrated Software/Hardware Targeted
for Z80/64180 Development on PC/XT/AT



Introducing DYNAMIC C™ - The new integrated C programming environment for embedded systems development.

Edit, Compile, Debug, and Run in one user friendly environment. Unleash the full power of C for your next Z80/HD64180 project. Ask for free demo and manual.

Z-World Engineering

1340 Covell Blvd, Suite 101
Davis, CA 95616

(916) 753-3722 fax: 753-5141

Circle 358 on Reader Service Card

Professional

8086 ROM Development

with C_thru_ROM and ROM-DOS

C_thru_ROM works with Microsoft C or Turbo-C to comprise a complete ROM development package: comprehensive debugger, remote debugging, startup code, full 80x86 locator, ROMable library, etc.

C_thru_ROM, \$495

ROM-DOS, a ROMable operating system, provides functionality of DOS 3.2 less networking. Runs PC programs and EXE files. Supports AUTOEXEC and CONFIG.SYS. Uses only 29K ROM and little as 6K RAM. \$6 each in quantity.

ROM-DOS Developer's Kit, \$495

Call for info and demo disk

1-800-221-6630

Datalight, 17505 - 68th Ave NE, Bothell WA, 98011
(206) 486-8086, fax (206) 486-0253

Circle 98 on Reader Service Card

VT240 Keyboard for your PC

Turn your PC into a VAX workstation with the PowerStation™.

- an exact VT200/VT300 layout keyboard to plug into your PC, and
- KEA's ZSTEM 240 or 220 terminal emulation software



2150 West Broadway, Suite 412
Vancouver, B.C. Canada V6K 4L9

Tel: 604-732-7411 Fax: 604-732-0715
Toll Free Order Desk: 800-663-8702

ZSTEM and PowerStation are trademarks of KEA Systems Ltd.

Circle 175 on Reader Service Card

Specials!

Micropolis New 1335
\$535 ea. MOQ 5 ea.

<p>SEAGATE New ST251-1 \$296 MOQ 10 ea</p> <p>SEAGATE Full Line All New ST238 ST251 ST251-1 ST296-N MAXTOR-New XT-2190 XT-4170E XT-4170S XT-4380E XT-4380S XT-8380E XT-8380S XT-8760E XT-8760S Others COMPAQ/CONNER New CP3024 CP3100 CP3104 CP340 CP340A CP344</p>	<p>IMPRIMIS (CDC) New Full Product Line PRINTERS Fujitsu Epson C. Itoh Toshiba Others TAPE DRIVES Wang-Tek Archive Mountain Syngen Others LAPTOPS Mitsubishi Toshiba Others VIDEO BOARDS Amdek Paradise Quadram Others</p>	<p>MAXTOR New XT2190 \$1,310 MOQ 10 ea</p> <p>MICROPOLIS All New 1588-15 765S 1588-15 765E 1578-15 382S 1578-15 382E 1375 170S 1355 171E</p> <p>MITSUBISHI PRIM Others Available</p> <p>Special! Limited Time MAXTOR XT 8760E 675 MB for \$2,575</p>
---	--	---

Call us last for best pricing
713-240-4800
FAX: 713-240-3350
Datatronics

Circle 99 on Reader Service Card

**SOFTWARE DEVELOPERS:
Are Your Products Too
Hard To Install?**

INSTALL 2.31 is an automatic installation program you can distribute—royalty free—with your product.

Features: File compression • Up to 4.3 Gigabyte file sizes • Elegant user interface • Full C Source • CRC Disk integrity verification • Handles all installation errors (open disk drive doors, unformatted and full disks, etc.) • Free tech support • NEW: Can intelligently modify CONFIG.SYS and AUTOEXEC.BAT files • 30-day money-back guarantee.

INSTALL offers over 3 years of proven reliability that is being used to install some of the most prestigious products in the industry. We would like to add your name to that list.

KNOWLEDGE DYNAMICS CORP.

HC4 Box 185-H, Canyon Lake, TX 78133
1-800-331-2783 MCVISA/COD/PO
1-512-964-3994 (International)
1-512-964-3958 (24-hr FAX) **\$149.95**

Circle 178 on Reader Service Card

BLOW OUT SALE

EVEREX EGA
AUTOSWITCH \$124.95

VIDEO BOARDS, MONITORS
COMPLETE SYSTEMS, AND MORE

GIORDANO'S PC'S
Ph. (315) 735-0655
FAX (315) 831-2300

Circle 143 on Reader Service Card

ULTRA:BASE TOTALLY USER FRIENDLY

BRANDYWARE presents ULTRA:BASE

Finally a database you can use without timely manuals, and have fun doing it! Features include. Help windows, Mailing labels, Calculator, Memo pad & alarm, Faskeys, Amortization, Up to twenty numeric fields, Scan twenty records at a time, Snapshots of the complete record to the printer, Global update and delete, Auto-date, Grand totals, Running totals, List of matching records, Auto fill-in of all deleted records, and records the last time the folder was used.

Plus all the standard features like searching, updating, sorting, dos shell, printing records to the printer or screen, printing results of amortization to printer or screen, rename fields or folders, delete folders, All this and NO manual required. All the help you need is provided for you, at the time you need it, with on screen help and pop-up help windows. Guaranteed to be the easiest database (with power) to use, or your money back.

requires CGA, EGA, VGA, Hard drive
Send check or money order to:

BRANDYWARE
24 North Hibbert suite 6
Mesa, Arizona 85201

602-644-1067

ONLY
119.90

C.O.D.
OK

Circle 106 on Reader Service Card

33 MHz 80386 Motherboard

Faster than the Everex Step™
8.3 MIPS! \$2,299 (Ok) Qty 1



Features:

- 64K/256K Write Back Cache
- Dual Read/Write Cache
- 100% Faster DMA Throughput than Standard AT
- Transparent Refresh
- True 32-Bit Memory Exp to 16MB
- Support 80387/Weitek
- UNIX OS/2 & Novell Compatible
- 1 Year Full Warranty
- Complete Documentation

	MIPS	Cache	Ok	4M
386/33	9.3	256K	2699	3149
386/33	8.3	64K	2299	2749
386/25	6.2	64K	1499	1929
386/20	4.9	64K	1299	1729

Technology Power Enterprise, Inc.

46560 Fremont Blvd #118, Fremont CA 94538
Tel (415) 623-9162 FAX (415) 623-9462

Circle 310 on Reader Service Card

REAL-TIME MULTITASKING KERNEL

8086/88, 80x86/88
80386

68000/10/20
Z80, 64180, 8080, 85

- Fast reliable operat on
- Compact and ROMable
- PC peripheral support
- DOS file access
- C language support
- Preemptive scheduler
- Time slicing available
- Configuration Builder
- Full documentation
- InSight™ Debugging Tool
- Intertask messages
- Message exchanges
- Dynamic operations
 - task create/delete
 - task priorities
 - memory allocation
- Event Manager
- Semaphore Manager
- List Manager

No Royalties
Source Code Included

Qemo Disk \$25 US
Manual only \$75 US
AMX 86 \$3000 US

KADAK Products Ltd.

206-1847 West Broadway
Vancouver, B.C., Canada
V6J 1Y5

Telephone (604) 734-2796
Fax (604) 734-8114

Call for prices for
other processors
AMX, AMX 86, InSight are trademarks
KADAK Products Ltd
Z80 is a trademark of Zilog, Inc.

Circle 172 on Reader Service Card

WINDOWSTOOLS FOR DISTRIBUTION

WindowsTools is a new application for Microsoft Windows. It consists of 22 invaluable aids for the daily use on your PC like: Program Starter, Album, Camera, Print Clipboard, Scientific Calculator, Unit Conversion, Screen Saver, Ascii Table, Free Memory, Hardware Info, Backup/Restore, Wake Up, Calendar, Clock, Stopwatch, Countdown, Comment Files, Search Files, Attribute Change, Move Files, Show Directories. WindowsTools is presently available in English and German. French, Spanish and other languages are in development. **For marketing and distribution enquiries word-wide please contact:**

GESYS Software Consulting GmbH,
Rebenring 33, D-3300 Braunschweig, West-Germany.
Phone: (49)-531-38011-68; Fax: (49)-531-38011-52; Teletex: (49)-531-8216-TECHP8S

GESYS

Microsoft is a registered trademark of Microsoft Corp

Circle 142 on Reader Service Card

ROM Based PC Systems

For complex stand alone applications



High Performance! Low Power! Compact!
AT equivalent systems and CPU cards.

- Boot up MS-DOS and applications software off EPROM for diskless operation using our BIOS.
- Run DOS applications. Our CPU cards use NEC V50 highly integrated micros that run 8088 286 code. Use PC-AT cards on a passive backplane.
- Software: Bioses for stand alone diskless use, Kbios for disk based systems; Ebios downloads DOS off a host PC. Debug Monitor with source code.
- CPU Cards: KS-5 with 1 Meg RAM, 256k ROM, 5 serial ports, AT bus, 2 watts; KS-3 CMOS card, 128k ROM, 64k static RAM, 1 watt. Piggyback card KS-21 with SCSI, Floppy, Printer, Keyboard.

Kolla

CPU Cards \$299
Systems \$449

CALL (303) 444-7737

685 Hawthorne Ave. Boulder, CO 80304 Tel: (303) 444-7737

Circle 176 on Reader Service Card

INSTANT PRODUCT! *** just add software ***

TDS9090
FORTH
control
computer



Powerful 4" x 3" single-board computer, based on the CMOS HD6303Y. High-level easy Forth language on board - REAL-TIME DEBUG! 30K RAM, 16K RAM/PROM, 2K EEPROM. Attach keyboard, lcd, I/C peripherals. Built-in interrupts, multi-tasking, watchdog timer, editor and assembler. 32 I/O lines, two RS-232 ports. 6 - 16 volts operating at 3ma. Low-power mode lasts one year on 9v battery! Optional data-logging module: 10-channel, 10-bit or 8-channel, 12-bit A/D, 128K RAM, D/A, date/time clock. Includes lots of ready-made software solutions. Made in England, over 3000 are in use in Europe for machine control, data-logging, inspection, factory automation, robotics, remote monitoring, etc. Available on 30-day free trial.

\$219 (25 qty inc shipping)

SAELIG Company

1193 Moseley Rd, Victor, NY 14564
(716) 425 3753 • fax (716) 425 7381



Circle 284 on Reader Service Card

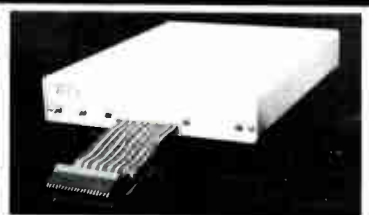

68HC05 In-Circuit Emulator

The TECICE-HC05 is a low cost real time emulator for the Motorola 68HC05 family of single chip microcomputers. Any host computer with serial port and terminal emulation software can be used with TECICE-HC05. Base price is \$195.00. Complete development system software is available for MS-DOS computers including the Byte Craft Limited C6805 Code Development System which includes a 6805 C compiler with Integrated Development Environment.

TECI THE ENGINEERS
COLLABORATIVE, INC.

RR#3, BOX 8C Barton, Vermont 05822
Phone (802) 525-3458 FAX (802) 525-3451

Circle 121 on Reader Service Card

ICs PROMPT DELIVERY!!!

SAME DAY SHIPPING (USUALLY)
QUANTITY ONE PRICES SHOWN FOR OCT 29, 1989

OUTSIDE OKLAHOMA: NO SALES TAX

DYNAMIC RAM			
SIMM	AST Prem386	33MHz	\$300.00
SIMM	(1) 256Kx36	80 ns	300.00
SIMM	1Mx9	80 ns	120.00
SIMM	(2) 256Kx9	100 ns	35.00
1Mbit	1Mx1	100 ns	10.99
41256	256Kx1	60 ns	4.75
41256	256Kx1	80 ns	3.75
41256	256Kx1	100 ns	2.80
41256	256Kx1	120 ns	2.65
4464	64Kx4	120 ns	3.75
41264 (3)	64Kx4	100 ns	7.50
EPROM			
27C1000	128Kx8	200 ns	\$20.75
27512	64Kx8	200 ns	7.80
27256	32Kx8	150 ns	6.50
27128	16Kx8	250 ns	3.95
STATIC RAM			
62256P-10	32Kx8	100 ns	\$11.95
6264P-12	8Kx8	120 ns	4.50
6116AP-12	2Kx8	120 ns	4.25

OPEN 6 1/2 DAYS, 7:30 AM-10 PM: SHIP VIA FED-EX ON SAT.

SAT DELIVERY INCLUDED ON FED-EX ORDERS RECEIVED BY Th: \$2 \$6.25 Fri: \$14.25

MasterCard VISA or UPS CASH COD
MICROPROCESSORS UNLIMITED, INC.
24 000 S. Peoria Ave
BEGGS OK 74421
(918) 267-4961

No minimum order. Please note prices subject to change shipping insurance extra up to \$100 packing materials

Circle 207 on Reader Service Card

California Digital

17700 Figueroa Street • Carson, California 90248



OPTICAL WORM
\$895

Write Once Read Many... California Digital has just purchased from **PRIAM CORPORATION**, 300 hundreds of Information Storage's ISI/525WC optical WORM drive. The WORM's were manufactured by Priam and bare the Priam logo. Chosen "Editors Choice" by PC Magazine, (March 29, 1988) the 525 provides 230 megabytes of random accessible data on each double sided floppy cartridge. (manually flipped).
Optical storage is the perfect medium for maintaining "on line" programs or other static data. Ideal for catalogs, part lists or any application where random accessibility is required.
The ISI/525 is available in IBM internal configuration but an external enclosure may be added. Supplied with one cartridge, ESD/PC controller, cable and transparent optical software. For additional information, contact Steven in our technical support department (213) 217-1947. The ISI/525 is a current production drive.



Dest Scanner \$559

Image scanning for OCR text, photographs, and line art. High resolution 300 DPI, the DEST PC Scan 561 is capable of rendering photographs to 32 half-tone shades. Also inputs text directly from printed pages to ASCII files or directly into most word processing programs. Electronic status display. Available for both the Macintosh (SCSI) or the IBM/PC. Please specify 115 or 230 volt. Original price was over \$3000, now is your chance to purchase a DEST scanner for only \$559.



NEC/890 Laser \$3095

PC Magazine has chosen the NEC-890 best laser printer of the year. (Jan. 12, 1988) And its obvious why... the printer is Postscript, Hewlett Packard, and Apple compatible, and comes standard with three megabytes of memory. The 890 accepts data from parallel, serial and Apple-Talk devices.



Hitachi "B" Plotter

Automatic Paper Feeder
FAST... 22 inches per second. Size "B" four pin with auto pen capping and 128K/byte buffer. HPGL compatible. 19 built-in character fonts and automatic sheet feeder make the Hitachi 673 a super buy at only \$795. RS/232 and centronics parallel.

PRINTERS

HEWLETT PACKARD		
Laser Printer II, 300x300	2595	1659
Lasir Printer II, D double sided	3995	2995
QMS PS/810 2 Meg., 35 fonts, Post/S	5495	3879
APPLE Laser Writer NT	4550	3659
NEC890 Postscript, 3 meg	4975	3095

PLOTTERS

HOUSTON INSTRUMENTS		
DMP 41 single pen, 3 ips, C&D	2995	2295
DMP 52 single pen, 16 ips, C&D	3295	2495
DMP 56C size A-E, 16 ips	5695	3095
DMP61 single pen, 32 ips, A-D	4295	3095
PC695A 4 pen, size "B" 3 ips	799	595

DIGITIZERS

HITACHI		
HDG 1212 Puma 12x12"	595	359
HDG 1515 15x15	969	659
Tiger 1111C, 12x12 stylus extra	727	487
HDG 3648, 36x48	5357	3995
SUMMAGRAPHICS		
Summa 1201 plus 12x12"	599	379
TK 3648, 36x48"	4748	3729
KYE Genus Tablet w/4 but. mouse	599	279
CALCOMP		
25180, 12x18"	1275	999
91480, 36x48"	4118	3389



\$539

CD-ROM Complete Kit

Doctor, lawyer, Indian chief... Virtually every industry and profession is disseminating information on CD-ROM. One compact disk, the same size as an audio disk, can store over 500 megabytes of data in High Sierra format.
Below is a listing of some of the CD-ROM drives currently available from California Digital. The best value is the Eclipse 430 external drive. The 430 includes PC/XT interface, cables, sampler software and MS/DOS extension. It also offers an audio output feature for multimedia presentations. The system is manufactured in Japan by one of the Worlds largest producers of magnetic storage equipment. A super value at only \$539.

Eclipse 430 external system	5539	NEC interface kit for above	159
Hitachi 1500S External system	695	Sony CD/510 internal drive only	559
Hitachi 3500 Internal system	595	Sony 6101 external drive only	795
Hitachi internal drive only	519	Sony 230B interface kit	159
IEC CDR/77 External drive only	695	Panasonic LF5000 "write once"	1895
IEC CDR/80 Internal drive only	639	Panasonic interface kit for above	359



Saba Scanner \$359

The Saba Scanner inputs a printed page of evenly spaced text in less than three seconds. Included OCR software allows your computer to transfer printed pages into ASCII files or directly to spreadsheets and most word processing programs. Archival data, legal briefs... No problem. Simply insert the page into the Saba and in seconds the document is digested into your computer and ready for editing. Also does line drawings that do not require gray tones. Limited quantities available. Original price \$1299; now only \$359.

SCANNERS

SABA SCANNERS		
page scanner with OCR software	1299	359
hand held scanner with OCR soft.	799	159
PC SCANNERS		
DFI 6" scan # 32 shades	3995	559
2000 edge lead scanner	935	719
MICROTECH H3000 255 gray scales	2195	1759
DFI HandScan 300 with Halo	359	199
PRINCETON GRAPHICS LS-300	1095	789
PANASONIC		
RS505 image page scanner	1499	999
RS506 Page scanner	1899	1259

MicroSoft Mouse

Your choice, MicroSoft "Import Buss Mouse" or "Serial Mouse". The industry standard, list price \$150, now available for only \$59. Includes software and manual. Packaged in OEM boxes.



\$59



Build Your Own Computer
\$35
AT Case Only

California Digital has all the components needed to customize your own computer. Buy as much computing power as you need now, and up grade when the need arises. Here are some examples of components available:

8 slot 10 MHz Mother board	589	Monochrome card, printer port	19
8 slot 12 MHz baby AT Motherboard	229	MonoGraphics (hercules) printer port	45
Full size live drive AT case	35	Color Graphics card	49
Four drive XT case	25	EGA Color Multi Resolution II	139
101/102 AT/XT German mfg. Keyboard	57	I/O card, serial & parallel	35
200 watt AT power supply	59	I/O PLUS, Ser/Par I, clock, game	59
TEC 360K/Byte disk drive	49	Disk I/O, disk control, clock, game	59



EGA Color Monitor
\$219

Ideal for CAD/CAM and Desk Top publishing applications. The Roland CD/240 color monitor has a resolution of 720 pixels by 400/480 lines on a 31mm dot pitch 12" non-glare screen. VGA specifications in text mode EGA in graphic mode. California Digital has made a special purchase and is able to offer the CD/240 EGA/VGA RGB color monitor for only \$219. Full featured, 132 column, multi-resolution video color adapter card available for only \$139 additional. Comparable card package would retail for \$195.

40 Megabyte Hard Disk Kit

Forty megabyte internal hard disk drive, controller and cables all for only \$359. The kit includes the a 40 millisecond Miniscribe 3650 drive and a half slot Western Digital controller.



\$359



40 Meg. Tape Back-up
\$179

Head Crash, Power Spikes or just poor disk maintenance... Don't loose data because you didn't back up. The Alloy/40 is an inexpensive way to save and restore files in the event that your data has been destroyed. This 40 megabyte half height tape back is manufactured by North Americas largest producer of data retrieval equipment... The Alloy/40 attaches directly to your existing floppy disk controller. Supplied software allows your computer to back up any time Day or Night. Come back in the morning and 40 megabytes of irreplaceable data has been stored on one Scotch DC/2000 data cassette. Back up entire hard disk, modified files only, or by file name. Loss of data is inevitable but when you are backed up on an Alloy/40 its not a catastrophe. Model 250 for PC/XT \$179; Model 500 for AT \$239.



DISK DRIVES

\$29

5" DISK DRIVES		
TECS01 1/2 height sgl. sided	29	
TECS04 1/2 ht. double sided	49	
TANDEM 101/4 full ht. 96 TPI	61	
TEAC FOSSBR half height	89	
TEAC FOSSFR 96 TPI, half ht.	119	
TEAC FOSSFR for IBM AT	109	
PANASONIC 455 Half Height	89	
PANASONIC 475 1.2 Meg./AT	39	
Fujiitsu 5 1/4" double sided	69	
Qual enclosure for 5 1/4" drives	69	
3 1/2" DISK DRIVES		
SONY MP-73W, 1.44 Meg	139	
TEAC C25HF 1.44 Meg	99	
5 1/4" Form Factor Kit	20	
8" DISK DRIVES		
OUME 842 double sided	189	
OUME 841 single sided	99	
SHUGART 851R dbl. sided	319	
SHUGART 801R sgl. sided	259	
SIEMENS 100/8 sgl. sided	119	
REMX RFD4000 dbl. sided	189	

Five Inch Winchester Disk Drives		
Price does not include controller.	each	two+
SEAGATE 225 20 Meg. 1/2 Ht.	239	229
SEAGATE 238 30 Meg. RLL	259	249
SEAGATE 251/1 51 M. 28mS.	459	445
SEAGATE 4096 96 M. 35mS.	559	539
MINISCRIBE 8425 25 M 65ms.239	227	
MINISCRIBE 3650 50M 61 ms.	319	309
MINISCRIBE 6085 90 meg.	459	435
MINISCRIBE 3053 25 ms. 1/2 ht.	359	339
FUJITSU 2242 55 M. 35mS.	1299	1229
FUJITSU 2243 86 M. 35mS.	1695	1619
RODDME RO-204E	53 Meg.	895 859
MAXTOR XT1140 140 Meg.	1495	1450
MAXTOR XT2190 192 Meg.	1919	1875
TOSHIBA MK56 70 M. 30mS.	1289	1229
CONTRDL DATA WREN "V"	call	

• Winchester Controllers for IBM/PC •
DTC 6280 AT/ESDI 1:1 interleave 229
DTC 5150 XT/MFM hard drive 69
DTC 7280 AT/MFM 1:1 interleave 189
ADAPTEC 2072 RLL controller 89
ADAPTEC 2372A 1:1 interleave 159
WESTERN DIGITAL WD/1002GEN 89
WESTERN DIG. 1006VMM2 1:1 & tpy.139
WESTERN DIGITAL 1007VMM2 ESDI 239

• SCSI/SASI Winchester Controllers •
ADAPTEC 5 1/4" foot print 259
WESTERN DIGITAL 1002-05E 5 1/4" 229
DMTI 20L 89

• Winchester Accessories •
Dual floppy enc. and powersupply 59
Winchester enclosure and supply 139
Switching power supply 49



8:00 AM to 5:00 PM Pacific Time

Every year since 1973, customers from virtually every nation in the free World have chosen California Digital for their data processing requirements. If its computer, California Digital has it... complete minisystem or just one microchip. California Digital offers over 10,000 unique computer products. Regardless of how specialized your data processing requirements... California Digital is your one stop shopping solution.

TECHNICAL & CALIFORNIA
(213) 217-0500

TOLL FREE ORDER LINE
(800) 421-5041

Telefax • (213) 217-1951

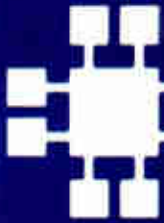

JDR Microdevices

MMC
MICROCOMPUTER
MARKETING COUNCIL
of The Direct Marketing Association, Inc.

30 DAY MONEY BACK GUARANTEE • 1 YEAR WARRANTY ON ALL PRODUCTS • TOLL-FREE TECHNICAL SUPPORT

DYNAMIC RAMS

NEW LOW PRICES!

PART#	SIZE	SPEED	PINS	PRICE
4116-150	16384x1	150ns	16	.99
4164-150	65536x1	150ns	16	2.49
4164-120	65536x1	120ns	16	2.89
4164-100	65536x1	100ns	16	3.39
TMS4464-12	65536x4	120ns	16	4.29
41256-150	262144x1	150ns	16	2.59
41256-120	262144x1	120ns	16	2.95
41256-100	262144x1	100ns	16	3.15
41256-80	262144x1	80ns	16	3.75
41256-60	262144x1	60ns	16	5.25
414256-100	262144x4	100ns	20	12.95
414256-80	262144x4	80ns	20	13.45
1 MB-120	1048576x1	120ns	18	11.95
1 MB-100	1048576x1	100ns	18	12.35
1 MB-80	1048576x1	80ns	18	12.95

SIMM MODULES

NEW LOW PRICES!

PART#	SIZE	SPEED	FOR	PRICE
41256A9B-12	256K x 3	120ns	SIMM/PC	36.95
41256A9B-80	256K x 3	80ns	SIMM/PC	49.95
421000A8B-10	1MB x 6	100ns	SIMM/MAC	109.95
421000A9B-10	1MB x 6	100ns	SIMM/PC	113.95
256K9SIP-80	256K X 9	80ns	SIP/PC	54.95
256K9SIP-60	256K X 9	60ns	SIP/PC	64.95
1MBx9SIP-80	1MB x 9	80ns	SIP/PC	124.95

STATIC RAMS

NEW LOW PRICES!

PART#	SIZE	SPEED	PINS	PRICE
TMM2016-150	2048x8	150ns	24	3.25
HME116L-20	2048x8	120ns	24	5.49
HME264LP-15	8192x8	150ns	28	6.95
HME264LP-12	8192x8	120ns	28	7.95
HMA3256LP-15	32768x8	150ns	28	19.95
HMA3256LP-12	32768x8	120ns	28	17.95
HMA3256LP-10	32768x8	100ns	28	18.95

MATH COPROCESSORS

8-BIT COPROCESSORS

8087	5 MHz	89.95
8087-2	8 MHz	129.95
8087-1	10 MHz	169.95

16-BIT COPROCESSORS

80287	6 MHz	139.95
80287-8	8 MHz	209.95
80287-10	10 MHz	239.95
80C287	12MHz	299.95

32-BIT COPROCESSORS

80387-16	16 MHz	359.95
80387-SX	16 MHz	319.95
80387-20	20 MHz	399.95
80387-25	25 MHz	499.95
80387-33	33MHz	649.95

intel 5 YEAR WARRANTY



INCLUDES MANUAL & SOFTWARE GUIDE

74 SERIES LOGIC

PART#	PRICE	PART#	PRICE	PART#	PRICE
7400	.19	74LS32	.18	74LS245	.79
74LS00	.16	74LS73	.29	74LS273	.79
74LS02	.17	7474	.33	74S288	1.69
7404	.19	74LS74	.24	74LS322	3.95
74LS04	.16	74LS74	.49	74LS367	.39
74504	.29	74LS138	.39	74LS373	.79
7406	.29	74LS155	.59	74LS374	.79
7408	.24	74LS163	.39	74LS393	.79
74LS08	.18	74LS240	.69	74LS682	3.20
7432	.29	74LS244	.69	74LS568	2.40

C.P.U.'s

8000

8052AH		
BASIC	34.95	
8088	5.99	
8250	6.95	
8251A	1.95	
8253-5	1.95	
8254	9.95	
8255-5	2.49	
8741	9.95	
8748	7.95	
8749	9.95	
8755	14.95	

6500

65C02	7.95
6522	2.95

V-20

V20	6.95
V20-8	8.95
V20-10	11.95
V30	13.95

MISC

DAC0800	3.29
1793	9.95
COM16115	8.95
MC146818	5.95
MMS8167	9.95
20L8	2.95
INS8250	6.95
NS16450	10.95
LM317T	.69
NE555	.29
LM741	.29
7805T	.49
7812T	.49
75150	1.95
75154	1.95
14411	9.95

CRYSTAL OSCILLATORS

1.0MHz	5.95
1.8432	5.95
20.0	4.95
24.0	4.95

PALS

16L8	2.95
16R4	2.95
16R6	2.95
16R8	2.95
20L8	4.95
20R4	4.95
20R6	4.95
20R8	4.95
20X8	4.95

PAL KIT

AN ENTRY-LEVEL COMPLETE PAL DEVELOPMENT KIT FROM CUPL. FULL SUPPORT FOR 16L8, 16R4, 16R6, 16R8, 20L8, 20R4, 20R6, 20R8, AND 20X8. MOD-MPL-SOFT \$99.95

Derick's HIGH-TECH SPOTLIGHT



Call our BBS: (408) 559-0253 for more info in SIG file "Hitech"

If you've been thinking about replacing your XT motherboard with an AT, this is the optimum time! Prices on AT type motherboards are about as low as they'll ever get. Your initial investment need be no more than the cost of the motherboard.

If you have at least 512K of memory (using 41256 chips), then all your current peripherals (with the possible exception of serial ports and keyboard) will be usable on a replacement motherboard. This includes your case, power supply, display, floppy drives and hard disk drives. To use your current memory, you may have to run at a slower clock setting, but even then you'll get 4-5 times your current throughput.

Board replacement is easy. Begin by unplugging the power connector and all peripheral cables. Open the case and remove the cards from their slots. Then remove the screws holding the motherboard and slide the board out. Reverse this procedure to install the new board.**

Later, to enhance performance, you can replace some of the peripherals with their faster AT counterparts, like a 1:1 Interleave AT FWH controller, more and/or faster memory, and a 16-bit display card.

Derick Moore, Director of Engineering

*Original PC keyboards need replacement; some serial ports may be too slow. **Some cases may require minor modifications to accommodate the additional 1 inch of board length and new mounting holes.

PROTOTYPE CARDS

FR-4 EPOXY GLASS LAMINATE WITH GOLD PLATED EDGE CARD FINGERS AND SILK SCREENED LEGENDS



JDR-PR1	WITH +5V AND GROUND PLANE	27.95
JDR-PR2	ABOVE WITH I/O DECODING LAYOUT	29.95
JDR-PR2-PK	PARTS KIT FOR JDR-PR2 ABOVE	8.95

JDR-PR10	BIT WITH I/O DECODING LAYOUT	34.95
JDR-PR10-PK	PARTS KIT FOR JDR-PR10 ABOVE	12.95

JDR-PR32	32 BIT PROTOTYPE CARD	69.95
JDR-PR16	16 BIT WITH I/O DECODING LAYOUT	49.95
JDR-PR16-PK	PARTS KIT FOR JDR-PR16 ABOVE	15.95
JDR-PR16V	16 BIT FOR VIDEO APPLICATIONS	39.95

EXT-8088	8-BIT FOR 8088 MOTHERBOARDS	29.95
EXT-80286	16-BIT FOR 286/386 MOTHERBOARDS	39.95
EXT-16	MICROCHANNEL 16-BIT	69.95
EXT-32	MICROCHANNEL 32-BIT	99.95

PC BREADBOARD-ON-A-CARD



- 62 BUS LINES
 - USE UP TO 24 14-PIN ICs
 - 1940 TIE POINTS
 - DB25 D-SUB CONNECT.
- PDS-604 \$49.95

SOLDER STATION



- UL APPROVED
 - ADJUSTABLE HEAT SETTING
 - TIP TEMPERATURE READOUT
 - REPLACEMENT TIPS @ \$2.95
- 168-3C \$59.95

IC SOCKETS/DIP CONNECTORS

SOLDERTAIL	WIREWRAP	ZIF SOCKETS
8 PIN ST .11	8 PIN WW .59	ZIF-14 5.95
14 PIN ST .11	14 PIN WW .69	ZIF-16 5.95
16 PIN ST .12	16 PIN WW .69	ZIF-20 6.95
18 PIN ST .15	18 PIN WW .99	ZIF-24 7.95
20 PIN ST .18	20 PIN WW 1.09	ZIF-28 7.95
24 PIN ST .20	24 PIN WW 1.49	ZIF-40 10.95
28 PIN ST .22	28 PIN WW 1.69	
40 PIN ST .30	40 PIN WW 1.99	

VOLUME DISCOUNTS CALL!

SOLDER-CUP D-SUBS

MALE	FEMALE	IDC'S
DB09P .45	DB09S .49	IDE20 .55
DB15P .59	DB15S .69	IDS34 .89
HD815P 1.49	HD815S 1.59	IDS200 .65
DB19P .69	DB19S .75	IDB09P 1.39
DB25P .69	DB25S .75	IDB09S 1.45
DB37P 1.35	DB37S 1.39	IDB25P 2.25
DB50P 1.85	DB50S 2.29	IDB25S 2.35

EPROM ERASERS

DATASE II \$39.95

- SHIRT POCKET SIZE!
- ALL SIZES UP TO 4 AT A TIME
- ERASES MOST EPROMS IN 3 MINUTES



SPECTRONICS CORPORATION

Model	Timer	# of Chips	Intensity (uW/Cm ²)	Unit Cost
PE-140	NO	9	8,000	\$ 89.95
PE-140T	YES	9	8,000	\$139.95
PE-240T	YES	12	8,600	\$189.95
PL-265T	YES	30	8,600	\$255.95

POWER SUPPLIES

135 WATT

- FOR XT • 110-220V SWITCH
- UL APPROVED
- +5V @ 15A, +12V @ 4.2A, -5V @ .5A, -12V @ .5A
- PS-135 \$59.95
- PS-150 150W SUPPLY \$69.95
- PS-200X 200W SUPPLY \$89.95



200 WATT

- FOR AT • 110-220V SWITCH
- UL APPROVED
- +5V @ 20A, +12V @ 7A, -5V @ .5A, -12V @ .5A
- PS-200 \$89.95
- PS-250 250W SUPPLY \$129.95



CABLES AND GENDER CHANGERS

MOLDED; GOLD-PLATED CONTACTS; 100% SHIELDED

CBL-PRINTER	6 FT. PC PRINTER CABLE	9.95
CBL-PRNTR-25	25 FT. PC PRINTER CABLE	15.95
CBL-PRNTR-RA	RIGHT ANGLE PRINTER CABLE	15.95
CBL-DB25-MM	DB25 MALE-DB25 MALE 6 FT.	9.95
CBL-DB25-MF	DB25 MALE-DB25 FEMALE 6 FT.	9.95
CBL-9-SERIAL	DB9 FEMALE-DB25 MALE 6 FT.	6.95
CBL-KBD-EXT	5 FT. KEYBOARD EXTENSION	7.95
CBL-CNT-MM	36-PIN CENTRONICS-MM	14.95
CBL-FDC-EXT	37-PIN EXT. FLOPPY CABLE	9.95
CBL-MNT-9	9-PIN MONITOR EXTENSION	6.95
CBL-MNT-15	15-PIN MONITOR EXTENSION CABLE	9.95
CBL-MODEM	MODEM-DB25-DB25 FEMALE	6.95
GENDER-VGA	DB9-DB15 ADAPTOR	4.95
GENDER-9-25	DB9-DB25 SERIAL ADAPTOR	4.95

PARTIAL LISTINGS ONLY—CALL FOR FREE 100-PG CATALOG!

COPYRIGHT 1989 JDR MICRODEVICES

JDR MICRODEVICES AND THE JDR MICRODEVICES LOGO ARE REGISTERED TRADEMARKS OF JDR MICRODEVICES. IBM, AT, PS/2 ARE TRADEMARKS OF INTERNATIONAL BUSINESS MACHINES.

MINI UPRIGHT CASE

\$199⁹⁵

- SMALL FOOTPRINT (12" H X 16" L X 8" W)
- COMPATIBLE W/ 8088 OR MINI 286/386 MOTHERBOARDS
- ROOM FOR 6 INTERNAL EXPANSION CARDS
- HOLDS THREE 5.25" DRIVES AND ONE 3.5" DRIVE (HALF HEIGHT)
- 200 WATT POWER SUPPLY
- 2-DIGIT LED SPEED DISPLAY
- LEDS FOR HARD DISK, TURBO AND POWER ON



UPRIGHT CASE

\$249⁹⁵

- SLEEK DESIGN SAVES DESK SPACE. ADDS STYLE!
- ACCOMMODATES ALL SIZES OF MOTHERBOARDS
- INCLUDES 250 WATT POWER SUPPLY
- MOUNTS FOR 3 FLOPPY AND 4 HARD DRIVES
- TURBO AND RESET SWITCHES
- SPEED DISPLAY, POWER, DISK LEDS
- MOUNTING HARDWARE, FACEPLATES AND SPEAKER INCLUDED



CASE-100

CASE-200 \$499.95
SUPER UPRIGHT CASE



STANDARD CASES

- CASE-70 FULL SIZE SLIDE CASE \$89.95
- CASE-50 FOR 8088 OR MINI-86 MOTHERBOARDS \$59.95
- CASE-FLIP FLIP-TOP XT-STYLE CASE \$39.95
- CASE-SLIDE SLIDE TYPE XT-STYLE CASE \$39.95
- CASE-JR \$149.95
- WITH 150W POWER SUPPLY FOR 8088 OR MINI-286 BOARDS.
- CASE-JR-200 \$189.95
- WITH 200W POWER SUPPLY FOR 8088 OR MINI-286 BOARDS.

NOTE: CASES DO NOT INCLUDE DRIVES

"I have been a customer of JDR for about 5 years now, and I would like to tell you how pleased I am with the quality of products you sell, and the courteous service I have received..."

-Dave Keener, Tulsa, OK

EPROM PROGRAMMER

\$129⁹⁵

- PROGRAMS 27XX AND 27XXX EPROMS UP TO 27512
- SPLIT OR COMBINE CONTENTS OF SEVERAL EPROMS OF DIFFERENT SIZES
- SUPPORTS VARIOUS PROGRAMMING FORMATS AND VOLTAGES
- READ, WRITE, COPY, BLANK CHECK AND VERIFY
- SOFTWARE FOR HEX AND INTEL HEX FORMATS

MOD-EPROM



MODULAR CIRCUIT TECHNOLOGY

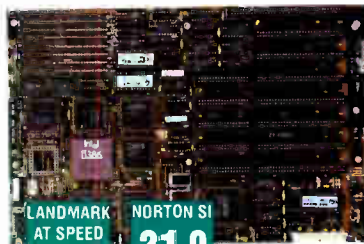

LANDMARK AT SPEED
26.3 MHZ

NORTON SI
21.0
X FASTER THAN AN XT

MINI 20MHZ 386

\$629

- MEMORY INTERLEAVING FOR NEAR ZERO WAIT STATES. 6 LAYER PCB FOR QUIET OPERATION.
- SOCKETED FOR 80387 COPROCESSOR • USES 80NS OR 100NS, 256K OR 1MB SIPP/DIP RAMS • 16MB RAM CAPACITY: 8MB ON BOARD 8MB USING OPTIONAL RAM CARD (OKB INSTALLED) • FIVE 16-BIT SLOTS, TWO 8-BIT SLOTS, ONE 32-BIT SLOT FOR PROPRIETARY RAM CARD • STANDARD XT HOLE SPACING • AMI BIOS • MEASURES 8.5" X 13"

MCT-M386-20
MCT-M386-M 8MB RAM CARD, OKB INSTALLED \$99.95

MINI 25MHZ 386CACHE

\$1299

- NORTON SI 30.5 • LANDMARK AT SPEED 40.5 • 25MHZ 80385 CPJ • REQUIRES ONE ADDITIONAL MEMORY CARD LISTED BELOW
- USES MEMORY CACHING FOR SUPERIOR PERFORMANCE • MEMORY INTERLEAVING FOR NEAR 0 WAIT STATE OPERATION
- SOCKETED FOR 80387 OR WEITEK 3167 COPROCESSORS

LANDMARK AT SPEED
40.7 MHZ

- MCT-C386-25 \$1199.00
- 4MB RAM CARD USING 256K X 4 DRAMS (OK INSTALLED)
- MCT-C386-M4 \$99.95
- 8MB RAM CARD USING 256KX1 OR 1MBX1 DRAMS (OK INST)
- MCT-C386-M8 \$99.95
- 16MB RAM CARD USING SIP MEMORY MODULES (OK INST)
- MCT-C386-M16 \$99.95

FULL SIZE 25MHZ 386

\$999

- 25MHZ 80386 MPU • 10MHZ/25MHZ KEYBOARD SELECTABLE SPEEDS
- 16MB ON-BOARD RAM CAPACITY USING SIMMS (OKB INSTALLED)
- SHADOW RAM FOR BIOS AND VIDEO
- SOCKETED FOR 80387 OR WEITEK 3167 COPROCESSORS • EIGHT EXPANSION SLOTS (FIVE 16-BIT, THREE 8-BIT) • ADJUSTABLE BUS SPEEDS • INTERLEAVED MEMORY • NEAR 0 WAIT STATE OPERATION • AMI BIOS

NEW LOW PRICE!

MCT-386MB25
MCT-336MB20 20MHZ VERSION \$799.00

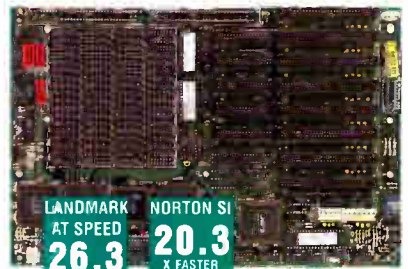

LANDMARK AT SPEED
26.3 MHZ

NORTON SI
20.3
X FASTER THAN AN XT

20MHZ 286

\$389⁹⁵

- NEAT CHIPSET HAS POWER TO COMPETE WITH 386 SYSTEMS • USES J1PS OR SIPS, EXPANDABLE FROM 512K TO 8MB • 20/10MHZ KEYBOARD SELECTABLE SPEEDS • AMI BIOS • SHADOW RAM AND PAGEINTERLEAVED MEMORY FOR SUPERIOR PERFORMANCE
- FAST 0 WAIT STATE OR 1 WAIT STATE FOR SLOWER RAM
- 8.5" X 13" FITS MOST XT, MINI-AT AND FULL SIZE AT CASES • FIVE 16-BIT & THREE 8-BIT EXPANSION SLOTS
- SOCKETED FOR 80287-12 MATH CO-PROCESSOR

NEW LOW PRICE!

MCT-M286-20N

- MCT-M286-16N 16MHZ VERSION \$289.95
- MCT-M286-12N 12MHZ VERSION \$269.95



10MHZ 286

\$189⁹⁵

- AT-COMPATIBLE • NORTON SI 11.2 • 6/10MHZ KEYBOARD SELECTABLE SPEEDS • EXPANDABLE TO 4MB ON BOARD USING 1MB DRAMS (OKB INSTALLED) • USES 64K, 256KX1, 256KX4 OR 1MB DRAMS (120NS FOR 1 WAIT, 100NS FOR 0 WAIT STATES) • 0 OR 1 WAIT STATE OPERATION • FOUR 16-BIT & THREE 8-BIT EXPANSION SLOTS • MEMORY INTERLEAVING • SOCKETED FOR 80287 8 CO-PROCESSOR
- 8.5" X 13" FITS MOST XT, MINI-AT AND FULL SIZE AT CASES

MCT-M286-10
MCT-M286-12 8/12MHZ VERSION \$199.95

10MHZ 8088

\$99⁹⁵

- NOW USES LOW-COST 256K X 4 1MB DRAMS • NORTON SI 2.1 • XT COMPATIBLE; OPERATES AT 4.77/10MHZ
- KEYBOARD SELECTABLE CLOCK SPEEDS • SOCKETED FOR 8087 1 COPROCESSOR • 8 EXPANSION SLOTS
- MCT BIOS • 640K RAM CAPACITY (OKB INSTALLED)

MCT-TURBO-10
MCT-TURBO 8MHZ VERSION \$89.95
MCT-XMB STANDARD 4.77MHZ MOTHERBOARD \$87.95

MODULAR PROGRAMMING SYSTEM

ALL THE MODULES USE A COMMON HOST ADAPTOR CARD, SO YOU CAN USE JUST ONE SLOT TO PROGRAM EPROMS, PROMS, PALS & MORE!

COMMON HOST ADAPTOR CARD \$29⁹⁵

- UNIVERSAL INTERFACE FOR ALL THE PROGRAMMING MODULES!
- SELECTABLE ADDRESSES PREVENTS CONFLICTS
- MOLDED CABLE

UNIVERSAL MODULE \$499⁹⁵

- PROGRAMS EPROMS, EEPROMS, PALS, BI-POLAR PROMS, 8748 & 8751 SERIES DEVICES, 16V8 AND 20V8 GALS (GENERIC ARRAY LOGIC) FROM LATTICE, NS, SGS • TESTS TTL, CMOS, DYNAMIC & STATIC RAMS • LOAD DISK, SAVE DISK, EDIT, BLANK CHECK, PROGRAM, AUTO, READ MASTER, VERIFY AND COMPARE
- TEXTBOOK SOCKET FOR 3" TO 6" WIDE IC'S (8-40 PINS)

MOD-MUP



EPROM MODULE

\$119⁹⁵

- PROGRAMS 24-32 PIN EPROMS, CMOS EPROMS & EEPROMS FROM 16K TO 1024K • HEX TO OBJ CONVERTER • AUTO, BLANK CHECK/PROGRAM/VERIFY
- VPP 5, 12.5, 12.75, 13, 21 & 25 VOLTS • NORMAL, INTELLIGENT, INTERACTIVE & QUICK PULSE PROGRAMMING ALGORITHMS

MOD-MEP

- MOD-MEP-4 4-EPROM PROGRAMMER \$169.95
- MOD-MEP-8 8-EPROM PROGRAMMER \$259.95
- MOD-MEP-16 16-EPROM PROGRAMMER \$499.95

ADDITIONAL MODULES:

- MOD-MPL PAL MODULE \$249.95
- MOD-MIC DIGITAL IC TESTER MODULE \$129.95
- MOD-MBP BI-POLAR PROGRAM. MODULE \$259.95
- MOD-MMP MICROPROC. PROG. MOD. \$179.95

CUPL SOFTWARE

\$99⁹⁵

- COMPLETE ENTRY-LEVEL PAL DEVELOPMENT KIT
- MOD-MPL-SOFT



ORDER TOLL-FREE 800-538-5000

MON.-FRI. 7 A.M. TO 5 P.M., SATURDAY, 10 A.M. TO 3 P.M. (PST)

COPYRIGHT 1989 JDR MICRODEVICES

JDR MICRODEVICES 2233 BRANHAM LANE,
SAN JOSE, CA 95124 (408) 559-1200
FAX (408) 559-0250 TELEX 171-110

RETAIL STORE: 1256 S. BASCOM AVE.,
SAN JOSE, CA (408) 947-8881
HOURS: M-F 9-7, SAT. 9-5, SUN. 12-4

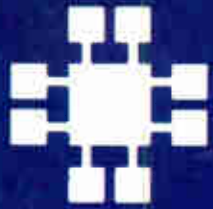

JDR Microdevices

MMC
MICROCOMPUTER
MARKETING COUNCIL
of the Direct Marketing Association, Inc.

• 30 DAY MONEY BACK GUARANTEE • 1 YEAR WARRANTY ON ALL PRODUCTS • TOLL-FREE TECHNICAL SUPPORT



RELISYS VGA \$359.95

14" ANALOG VGA MONITOR WITH GLARE-RESISTANT SCREEN • 720 X 480 MAXIMUM RESOLUTION • TILT/SWIVEL BASE • CONTRAST AND BRIGHTNESS CONTROLS
VGA-MONITOR

RELISYS MULTISYNCH \$429.95

AN EXCEPTIONAL VALUE ON AN OUTSTANDING DISPLAY! • 14" NON-GLARE SCREEN • 1024 X 768 MAXIMUM HIGH RESOLUTION • CGA/EGA/VGA COMPATIBLE • TTL OR ANALOG MODE OPERATION
JDR-MULTI

NEC MULTISYNCH 3D \$649.95

• 1024 X 768 MAX RESOLUTION • CGA/EGA/VGA/MCGA/PGC COMPATIBLE • HERCULES & OTHER STD. ADAPTORS
NEC-MULTI-3D

SEIKO CM-1430 \$599.00

• 1024 X 768 MAXIMUM HIGH RESOLUTION • SONY TRINITRON SINGLE GUN TUBE • 14" NON-GLARE SCREEN • DUAL FREQ FREQUENCY MONITOR
CM-1430

EGA MONITOR \$339.95

• 14" NON-GLARE SCREEN WITH 640 X 350 MAXIMUM RESOLUTION • DISPLAY 16 COLORS SIMULTANEOUSLY
EGA-MONITOR

RGB COLOR \$239.95

• CGA MODE DISPLAYS UP TO 16 COLORS, MONOCHROME MODE FOR TEXT • 4" GLARE-RESISTANT SCREEN • 640 X 200 MONOCHROME • 320 X 200 COLOR RESOLUTION
JDR-RGB



CGA CARD \$44.95

IBM-COMPATIBLE ADAPTOR FOR RGB MONITORS • 640 X 200 MONO, 320 X 200 COLOR RESOLUTION • DISPLAYS 4 COLORS SIMULTANEOUSLY • LIGHT PEN INTERFACE
MCT-CG

MCT-CGP WITH PRINTER PORT \$49.95
CG-COMP COMPOSITE ADAPTOR \$4.95

MONO GRAPHICS \$49.95

XT AND AT-COMPATIBLE • HERCULES COMPATIBLE MONOGRAPHICS • SUPPORTS LOTUS 1-2-3 • HIGH RESOLUTION 720 X 148 DISPLAY • VLSI CHIPS • CONFIGURE THE PARALLEL PRINTER PORT AS LPT1 OR 2
MCT-MGP



VGA graphics

VGA PACKAGE \$499.95

VGA COLOR AND CLARITY AT AN EGA PRICE! • 8-BIT VGA CARD IS FULLY COMPATIBLE WITH IBM VGA • 720 X 540 MAXIMUM RESOLUTION, 640 X 480 IN 16 COLORS • 528 X 480 RESOLUTION IN 256 COLORS • HIGH RESOLUTION ANALOG MONITOR • EGA/CGA/MONochrome AND HERCULES COMPATIBLE • DRIVERS FOR WINDOWS, GEM, 1-2-3, SYMPHONY, AUTOCAD AND VENTURA
VGA-PKG

PAPER WHITE VGA \$139.95

GRAY SCALE MONITOR— PERFECT FOR DESKTOP PUBLISHING! • ULTRA HIGH-RESOLUTION 800 X 480 • 14" GLARE RESISTANT SCREEN • TILT/SWIVEL BASE
MONO-VGA

14" SCREEN MONO \$139.95

• GLARE-RESISTANT 14" SCREEN WITH AMBER DISPLAY • 720 X 350 RESOLUTION • TILT/SWIVEL BASE
GM-1488

SAMSUNG FLAT \$129.95

• 12" FLAT SCREEN REDUCES DISTORTION • AMBER DISPLAY • 720 X 350 RESOLUTION
MONO-SAMSUNG

LOW COST MONO \$69.95

• COMPACT AND LIGHTWEIGHT TTL MONITOR WITH 12" SCREEN • 720 X 350 MAX RESOLUTION • CHOOSE AMBER OR GREEN DISPLAY
JDR-MONO GREEN DISPLAY
JDR-AMBER AMBER DISPLAY

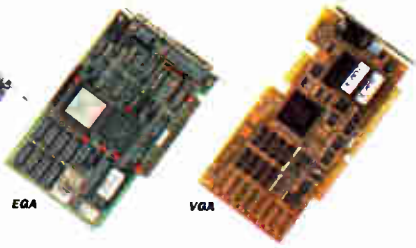

EGA CARD \$149.95

• 640 X 350 HIGH RESOLUTION • DISPLAYS 16 COLORS AT A TIME • COMPATIBLE WITH HERCULES, CGA AND IBM MONOCHROME • SOFTWARE DRIVERS FOR WINDOWS, LOTUS, CAD, AND MORE • 256K VIDEO RAM
MCT-EGA

16-BIT VGA \$199.95

• 640 X 480 IN 16 COLORS • 256K VIDEO RAM EXPANDABLE TO 512K • 64 LEVELS OF GRAY SCALE
MCT-VGA-16
MCT-VGA-8 8-BIT VERSION \$169.95



\$74.95

ENHANCED KEYBOARD WITH SOLAR CALCULATOR

• NUMERIC KEYPAD DOUBLES AS A SOLAR-POWER MULTI-FUNCTION BUSINESS CALCULATOR, WITH MEMORY FUNCTIONS AND TILT-UP DISPLAY • 101-KEYS • 12 FUNCTION KEYS • XT-AT & PS/2 COMPATIBLE
FC-3001

ENHANCED KEYBOARDS

BTC-5339 101-KEY WITH 10 FUNCTION KEYS \$69.95
BTC-5339R 101-KEY, 30% SMALLER FOOTPRINT \$79.95
MAX-5339 101-KEY MAXI-SWITCH \$84.95
K103-A AUDIBLE "CLICK" 101-KEY KEYBOARD \$84.95

STANDARD KEYBOARDS

BTC-5060 84-KEY WITH 10 FUNCTION KEYS \$59.95
MAX-5060 MAXI-SWITCH 84-KEY \$64.95
BTC-5150 XT-STYLE 83-KEY \$59.95

MODULAR CIRCUIT TECHNOLOGY

DRIVE CONTROLLERS

FLOPPY DISK \$29.95

• INTERFACES UP TO 4 FLOPPY DRIVES TO IBM PC OR COMPATIBLE • DS/DD AND DS/DO COMPATIBLE
MCT-FDC

1.44MB FLOPPY \$49.95

• XT OR AT COMPATIBLE • SUPPORTS 2 FLOPPY DRIVES (360K, 720K, 1.2MB & 1.44MB) • "SMART CARD" RECOGNIZES OTHER CONTROLLERS—AUTOMATICALLY ASSIGNS DRIVE ADDRESSES, ALLOWING EASY ADDITION OF 3RD/4TH DRIVE
MCT-FDC-HD
MCT-FDC-HD4 4 DRIVE CONTROLLER \$59.95

HARD DISK \$79.95

• SUPPORTS 16 DRIVE SIZES INCLUDING 10, 20, 30 AND 40MB • CAN DIVIDE 1 LARGE DRIVE INTO 2 LOGICAL DRIVES
MCT-HDC

RLI HARD DISK \$89.95

• SUPPORTS 2 RLL HARD DRIVES • 50% FASTER DATA TRANSFER • DESIGNED FOR XT-COMPATIBLES
MCT-RLL

286/386 FLOPPY/HARD \$149.95

• FLOPPY/HARD DISK CONTROL IN AN AT DESIGN • FOR UP TO 2 FLOPPIES (360K/720K/1.2MB/1.44MB) & 2 HARD DRIVES
MCT-AFH

286/386 1:1 INTERLEAVE \$169.95

• CONTROLS 2 HARD & 2 FLOPPY DRIVES (360K/720K/1.2MB/1.44MB) • CONCURRENT ACCESS TO HARD & FLOPPY DRIVES
MCT-FAFH

286/386 RLL HARD DISK \$199.95

• IMPROVES AT COMPATIBLE'S SPEED & STORAGE • FOR UP TO 2 RLL HDD'S & 2 FDD'S (360K/720K/1.2MB/1.44MB)
MCT-AFH-RLL

MULTIFUNCTION I/O CARDS

MULTI I/O CARD \$59.95

• SERIAL PORT • CLOCK/CALENDAR WITH BATTERY • PARALLEL PORT IS ADDRESSABLE AS LPT1 OR LPT2
MCT-IO

MULTI I/O FLOPPY \$79.95

• SUPPORTS UP TO 2 360K FLOPPIES • SERIAL, PARALLEL, GAME PORT AND CLOCK/CALENDAR
MCT-MIO

MONOGRAPHICS MULTI I/O \$119.75

• CONTROL 2 FLOPPIES • SERIAL, PARALLEL, GAME PORT, CLOCK/CALENDAR • RUNS COLOR GRAPHICS SOFTWARE ON YOUR BLACK AND WHITE MONITOR
MCT-MGMIO

286/386 MULTI I/O CARD \$59.95

• SERIAL, PARALLEL, AND GAME PORTS • USES 16450 SERIAL SUPPORT CHIPS FOR HIGH SPEED OPERATION
MCT-AIO

COPYRIGHT 1989 JDR MICRODEVICES. IBM, AT AND PS 2 ARE REGISTERED TRADEMARKS OF INTERNATIONAL BUSINESS MACHINES. APPLE AND MACINTOSH ARE TRADEMARKS OF APPLE COMPUTER INC.

\$99⁹⁵

**1.44MB
3-1/2" DRIVE**

- 80 TRACKS • 135 TPI • ULTRA HIGH DENSITY
- READ/WRITE 720K DISKS, TOO
- INCLUDES ALL NECESSARY MOUNTING HARDWARE

- FDD-1.44X BLACK FACEPLATE
- FDD-1.44A BEIGE FACEPLATE
- FDD-1.44SOFT SOFTWARE DRIVER \$19.95
- FDD-3.5X 3-1/2" 720K (BLACK) \$97.95
- FDD-3.5A 3-1/2" 720K (BEIGE) \$97.95
- MF355A 3-1/2" MITSUBISHI 1.44MB, BEIGE \$129.95
- MF355X 3-1/2" MITSUBISHI 1.44MB, BLACK \$129.95

**5-1/4" FLOPPY
DISK DRIVE \$69⁹⁵**

- FDD-360 5-1/4" DOUBLE-SIDED DD 360K \$69.95
- FD-55B 5-1/4" TEAC DOUBLE-SIDED DD 360K \$89.95
- FDD-1.2 5-1/4" DOUBLE-SIDED HD 1.2M \$89.95
- M2553K 5-1/4" FUJITSU DOUBLE-SIDED HD 1.2M \$97.95
- FD-55G 5-1/4" TEAC DOUBLE-SIDED HD 1.2M \$129.95
- FD-55F 5-1/4" TEAC DOUBLE SIDED, QD720K \$119.95

ARCHIVE TAPE BACK-UPS

- AR5240X 40 MB TAPE DRIVE FOR XT'S & AT'S ... \$369.95
- AR5540A FAST 40 MB TAPE DRIVE AT'S ONLY ... \$369.95



HARD DISKS

- 21.4 MB **\$199** 65.5 MB **\$389**
- 32.7 MB **\$219** 80.2 MB **\$569**
- 42.8 MB **\$339**



KITS INCLUDE HARD DRIVE, DRIVE CONTROLLER, CABLES & INSTRUCTIONS.

SIZE	MODEL	AVG. SPEED	FORM FACTOR	DRIVE ONLY	XT KIT	AT F/M KIT
21.4MB	ST-225	65 MS	5-1/4"	\$199	\$249	\$309
32.7MB RLL	ST-238	65 MS	5-1/4"	\$219	\$279	\$379
42.8MB	ST-251-1	28 MS	5-1/4"	\$339	\$389	\$449
65.5MB RLL	ST-277-1	28 MS	5-1/4"	\$389	\$449	\$549
80.2MB	ST-4096	28 MS	5-1/4"	\$569	---	\$679
122.7MBRLL	ST-4144R	28 MS	5-1/4"	\$699	\$759	\$859
21.4MB	ST-125	40 MS	3-1/2"	\$269	\$299	\$373
32.1MB RLL	ST-138	40 MS	3-1/2"	\$289	\$339	\$429

KITS

- 21.4 MB **\$249**
- 32.1 MB **\$279**



JDR's exclusive detailed manual makes installation worry-free!

Seagate SCSI DRIVES

SIZE	MODEL	AVG. SPEED	FORM. FACTOR	PRICE
21.5MB	ST-125N	40 MS	3-1/2"	\$299
32.2MB	ST-138N	40 MS	3-1/2"	\$339
48.6MB	ST-157N	40 MS	3-1/2"	\$389
21.3MB	ST-225N	65 MS	5-1/4"	\$329
43.1MB	ST-251N-1	28 MS	5-1/4"	\$419
64.9MB	ST-277N-1	28 MS	5-1/4"	\$469
85MB	ST-296N	28 MS	5-1/4"	\$499

DRIVES HAVE EMBEDDED SCSI CONTROLLER

**GeniScan
400 DPI
SCANNER**

\$199⁹⁵

new!



- UP TO 400 DPI
- 32 LEVELS OF GRAY SCALE • SPEED OVERRUN WARNING LIGHT • AUTO MERGE FOR LARGE IMAGES • INCLUDES INTERFACE CARD INCLUDES SCANEDIT II, PRODIGY OCR AND DR. GENIUS SOFTWARE
- GS-4500

MODULAR CIRCUIT TECHNOLOGY

**2400/2400 BAUD
FAX/DATA MODEM \$119⁹⁵**

- 2400/4800 BAUDE COMBINED DATA/FAX MODEM FOR LESS THAN MOST 2400 BAUD MODEMS ALONE! • 4800 BAUD TRANSMIT-ONLY FAX TO ANY GROUP III FAX MACHINE • 2400 BAUD V.22BIS DATA MODEM • XT/AT COMPATIBLE HALF CARD • CONVERTS DOS TEXT, PCX & TIFF FILES FOR FAX TRANSMISSION • MENU-DRIVEN SOFTWARE



2400 BAUD MODEM \$89⁹⁵

- 2400/1200/300 BAUD INTERNAL • FULL HAYES COMPATIBILITY • BUILT-IN SPEAKER • CONFIGURABLE AS COM1, COM2, COM3 OR COM4 • INCLUDES PROCOMM COMMUNICATIONS SOFTWARE

MCT-241
MCT-121 1200 BAUD VERSION \$59.95

PROMETHEUS



9600 BAUD MODEM \$699⁹⁵

- MICROCOM NETWORK PROTOCOL (MNP) AND V.32 COMPATIBILITY • 9600/4800/2400/1200 BPS OPERATION • FULL DUPLEX • CALL BACK SECURITY • NON-VOLATILE RAM STORAGE FOR 10 PHONE NUMBERS • ASYNCHRONOUS/SYNCHRONOUS • FULLY COMPATIBLE WITH CCITT V.32/V.22BIS/V.22, BELLS/212A • MNP-5 FOR 100% ERROR-FREE TRANSMISSIONS • DATA COMPRESSION FOR THROUGHPUT TO 19.2K BAUD

**INTERNAL
2400 BAUD
\$99⁹⁵**



- AUTO DIAL/ANSWER • SELF-TEST ON POWER-UP • FULL OR HALF DUPLEX • TOUCHTONE OR PULSE DIALING • HAYES AND BELL SYSTEMS COMPATIBLE • HALF CARD • PROCOMM COMMUNICATIONS SOFTWARE

PRO-241
PRO-121 1200 BAUD 1/2 CARD \$69.95

EXTERNAL 2400 BAUD \$149⁹⁵

- 2400/1200/300 BAUD • REQUIRES SERIAL PORT & CABLE

PRO-24E
PRO-12E 1200 BAUD EXTERNAL MODEM \$99.95

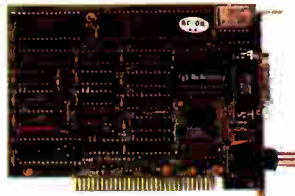

**DFI 300
LOW-COST
ETHERNET CARD \$199⁹⁵**

- USE THIS LOW-COST NETWORK CARD WITH JUST ABOUT ANY LAN SOFTWARE DESIGNED FOR ETHERNET PROTOCOLS.
- 100% HARDWARE COMPATIBLE WITH NOVELL NE-1000 ETHERNET CARD • COMPATIBLE WITH THICK OR THIN ETHERNET • 15-PIN ETHERNET CONNECTOR • BNC CONNECTOR FOR THIN ETHERNET • INCLUDES ADDITIONAL DRIVERS FOR OPTIONAL CONFIGURATIONS
- DFINET-300 8-BIT VERSION \$239.95
- DFINET-400 16-BIT VERSION



**MICROPOLIS
HIGH SPEED HARD DRIVES**

157.5MB 23MS \$949

- 1355 ESDI INTERFACE
- 1355-PKG ESDI DRIVE & CONTROLLER \$1049.00
- 1375 SCSI DRIVE \$999.00
- 1375-PKG SCSI DRIVE & CONTROLLER \$1099.00

338.1MB 18MS \$1695

- 1558 ESDI INTERFACE
- 1558-PKG ESDI DRIVE & CONTROLLER \$1799.00
- 1578 331.7MB SCSI DRIVE \$1619.00
- 1578-PKG SCSI DRIVE & CONTROLLER \$1799.00

676.8MB 16MS \$2499

- 1568 ESDI DRIVE
- 1588 667.6MB SCSI DRIVE \$2499.00

LOGITECH MICE

- THREE-BUTTON SERIES 9
- 320 DPI RESOLUTION
- SERIAL PS-2 COMPATIBLE.
- LOGITECH
- LOGC9 SERIAL MOUSE \$98.95
- LOGC9-C* SERIAL MOUSE \$79.95
- LOGC9-P SERIAL MOUSE WITH PAINTSHOW \$109.95
- LOGC9-PC SERIAL MOUSE WITH PAINTCAD \$154.95
- LOGB9 BUS MOUSE \$89.95
- LOGB9-P BUS MOUSE WITH PAINTSHOW \$104.95
- LOGB9-PC BUS MOUSE WITH PAINTCAD \$149.95
- *NOT PS-2 COMPATIBLE



**JIM'S BARGAIN
HUNTERS CORNER**

**SAVE UP TO 63% ON
FACTORY REFURBS!**

- MULTI/O WITH FLOPPY CONTROLLER \$39⁹⁵**
- SUPPORTS 2 FLOPPIES, SERIAL, PARALLEL AND GAME PORTS, PLUS CLOCK/CALENDAR. FACTORY REFURB
- MCT-MIO IF NEW \$79.95
- MONOGRAPHS PRINTER CARD \$29⁹⁵**
- 720 X348 DISPLAY, SERIAL PORT OPTIONAL.
- MCT-MG FACTORY REFURB. IF NEW \$79.95
- EXPIRES 12/31/89



Jim Wharton
JDR's VP Sales



CALL FOR OUR FREE 100-PAGE CATALOG!

ORDER TOLL-FREE 800-538-5000

MON.-FRI. 7 A.M. TO 5 P.M., SATURDAY, 10 A.M. TO 3 P.M. (PST)

Terms: minimum order \$10.00. For shipping & handling include \$3.50 for ground and \$4.50 for air. Orders over 1 lb. and foreign orders may require additional shipping charges —contact the Sales department for the amount. Ca. residents must include applicable sales tax. Prices subject to change without notice. We are not responsible for typographical errors. We reserve the right to limit quantities and to substitute manufacturer. All merchandise subject to prior sales. A full copy of our terms is available upon request. Items pictured may only be representative.

EDITORIAL INDEX BY COMPANY

Index of companies covered in articles, columns, or news stories in this issue
Each reference is to the first page of the article or section in which the company name appears

INQUIRY #	COMPANY	PAGE	INQUIRY #	COMPANY	PAGE	INQUIRY #	COMPANY	PAGE
862	ACER AMERICA	185		DRAGON SYSTEMS	243	1196	MATROX	320
851	ADVANCED DIGITAL	179	1109	DSP DEVELOPMENT	66		MATSUSHITA ELECTRIC	17
	ADVANCED MICRO DEVICES	17		EARTH COMPUTER			MAXEM	17
	ALDUS	17		TECHNOLOGIES	141	1118	MEGA KNOWLEDGE	66
877	ALLOY COMPUTER			ENCYCLOPAEDIA		1136	MEGASCAN TECHNOLOGY	49
	PRODUCTS	309		BRITANNICA	17		MEMOREX	17
987	APPLE COMPUTER	137, 316		FORRESTER RESEARCH	17		MERCURY COMPUTER	
983	ASHLAR	81		FREMONT COMMUNICATIONS	17		SYSTEMS	243
	ASHTON-TATE	316		FUJITSU		1111	MERIDIEN DATA	17
	AST RESEARCH	17		MICROELECTRONICS	243		MICROMATH SCIENTIFIC	
1176	AT&T, DATA SYSTEMS GROUP	309	1177	FUTURE DOMAIN	309		SOFTWARE	66
852	AURA SYSTEMS	234					MICROPROCESSOR FORUM	17
1122	AUTODESK	66					MOSAIC	17, 316
							MIPS COMPUTER SYSTEMS	17
	BIPOLAR INTEGRATED		868	GAMMALINK GRAPHICS			MIT	353
	TECHNOLOGY	17		COMMUNICATIONS	309		MOLTECH	17
	BORLAND INTERNATIONAL	316	985	GENERIC SOFTWARE	81		MOSAIC	316
1178	BROOKTROUT TECHNOLOGY	309	875	GENESYS DATA			MOTOROLA	243
	BUREAU OF ELECTRONIC			TECHNOLOGIES	309	1185	MTI	320
	PUBLISHING	17	1171	GRID SYSTEMS	93			
1110	BV ENGINEERING PROFESSIONAL		1078	HEATH/ZENITH	129	1075	NASTEC	154
	SOFTWARE	66	1079				NATIONAL INSTITUTE OF	
							STANDARDS AND	
1071	CADRE TECHNOLOGIES	154	882	HEWLETT-PACKARD	49, 205, 316		TECHNOLOGY	17
867	CANON U.S.A.	309	1127				NEC	243
1119	CARNEGIE GROUP	66	1141					
	CARNEGIE MELLON			HOPKINS TECHNOLOGY	17		OPTICAL PUBLISHING	17
	UNIVERSITY	243	1146	HORIZON ENTERTAINMENT	49	1076	OPTIMA	154
	CBIS	141				876	OPTISYS	309
993	CHARTER SOFTWARE	107	988	IBM	17, 137, 377			
1181	CHERRY ELECTRICAL		971	IMAGE BUSINESS SYSTEMS	309	874	PANASONIC INDUSTRIAL	309
	PRODUCTS	320	1194	IMAGING TECHNOLOGY	287, 320		PAPERBACK SOFTWARE	316
1102	CIRCLE SYSTEMS	66	1195	IMAGRAPH	320	1101	PERFECT COMPLEMENT	66
	CLARIS	17	1073	INDEX TECHNOLOGY	154		PERGAMON COMPACT	
992	CLARY	107	999	INFORMIX	107		SOLUTION	17
865	COMPAQ COMPUTER	93, 309		INMOS	17, 349	1161	PERSOFT	49
1170			870	INSET SYSTEMS	309	1135	PERSONAL COMPUTER	
	COMPUTER SCIENCE PRESS	444		INTEL	17, 333, 377		PRODUCTS	49
1072	COMPUTER SYSTEMS		1138	INTERFACE DATA	49	886	PLANET SOFTWARE	211
	ADVISERS	154	1157	INTERNATIONAL COMPUTER		1158	POWERCORE	49
	CONCURRENT TECHNOLOGY			GROUP	49	1137	PRACTICAL SOLUTIONS	49
	SYSTEMS	349	1183	INTERNATIONAL VOICE		995	PRESENTATION	
1164	CONSUMERS SOFTWARE	49		PRODUCTS	320		ELECTRONICS	107
1140	CUMULUS	49		IXI	123	991	PSRC SOFTWARE	107
994	DALI DESIGN	107		JAEGER + WALDMAN			QANTEL	387
989	DATA SHIELD SOLID-STATE			PUBLICATIONS	17	861	QMS	229
	CONTROLS	107		JAVELIN SOFTWARE	316		QUANTA PRESS	17
859	DATA TRANSLATION	189, 243, 320				990	QUARTERDECK OFFICE	
1193				KNOWLEDGE SET	17		SYSTEMS	107
1156	DATABASE & DATACOM		1074	KNOWLEDGEWARE	154			
	SOLUTIONS	49	873	KOFAX IMAGE PRODUCTS	309	858	RADIUS	189
1192	DATACUBE	320	1184	KURZWEIL APPLIED		1148	RAPID SYSTEMS	49
1128	DAUPHIN TECHNOLOGY	49		INTELLIGENCE	243, 320	857	RASTEROPS	189
1139	DESIGN TECHNOLOGY	49				854	RENAISSANCE GRX	234
866	DIALOGIC	309, 320	1123	LANDCADD	66	879	RHETOREX	309
1182			869	LASERGO	309		ROLANDCORP	243
	DIGITAL EQUIPMENT	17	1117	LATTICE	66			
1116	DIGITALK	66	984	LOGITECH	81			
1103	DILG PUBLISHING	66		LOTUS DEVELOPMENT	316			
872	DOCUMENT TECHNOLOGIES	309						

COMING UP IN BYTE

PRODUCTS IN PERSPECTIVE:

Short Takes for January include Fremont Communications' Fax Board, Fox Software's FoxPro, Hewlett-Packard's intelligent graphics controller, Artisoft's LANtastic, and a "portable mainframe" from Opus systems.

New product coverage continues with our **What's New** section. As you can see from this issue, What's New has been revamped to provide expanded communications coverage in a special, continuing section—Connectivity. Regional What's New coverage will also be undergoing some changes in the months ahead, with more input from local users groups in each of our major geographic areas. Watch for the news reflecting activities near you.

People who spend a lot of time working with their computers necessarily depend on them to work at peak performance all the time. One of the major frustrations of all computer users, then, is a malfunction in the disk drive. What's causing the problem? How do I fix it? Indeed, can it be fixed at all? Our **Product Focus** on disk utilities brings a ray of hope to the afflicted by examining an array of the most widely used self-help products on the market.

Reviews: After BYTE's landmark first coverage of the NeXT computer, we promised a full-scale review when we'd had time to really take the machine apart and delve into its capabilities. The time has come to deliver on that promise, and a system review will deliver the full story of this unique machine.

We'll also be looking at a selection of low-end introductions in computing's fastest-growing segment, the laptop market. Hardware reviews will include a piece on high-capacity hard disk drives for the Macintosh, low-cost PostScript printers, and Macintosh Ethernet adapters. Language reviews include PC Macsyma and GoldWorks II from Gold Hill Computers; in the applications section, we'll look at PageGarden. The short reviews in our Reviewer's Notebook lineup for January include the Fortron 386/33, Dr. Pascal, and TimeScribe.

IN DEPTH:

The In Depth section focuses on the **state of chips**, with pieces covering the current level of development in integrated circuitry. Our authors and editors will let you in on what the latest developments are, what they will mean to you in the coming months and years, and even how to go about creating your own IC designs in case there's nothing on the market that will do what you have in mind.

FEATURES:

January is the time for the big **BYTE awards** feature. It's the issue in which we have a chance to look back at the hardware and software of the previous year and deliver our hindsight verdicts on those products we think are the most significant. And 1989 was a good year for that. Given that there are always strong opinions on what introductions had the most merit, we're having a fine time putting this one together, and we think that will be reflected in our choices.

On top of that, we're working on features detailing the **state of Macintosh AI and expert-systems software**, a look at a **new C programming language for parallel processors**, and a survey of the **BBS nation**—what is it that we're doing on-line, all the time, everywhere?

Our columnists continue in fine form, with tips, observations, and opinions in our **Expert Advice** section, while the **Hands On** columns provide more lengthy coverage of specific areas of interest.

And here in the back of the book, **Print Queue** and **Stop Bit** give us back-to-front readers the chance to show everybody else that the way we look at a magazine has been right all the time.

INQUIRY #	COMPANY	PAGE
986	SAMPO OF AMERICA	81
	SAMSUNG	141
883	SCITOR	223
1186	SCOTT INSTRUMENTS.....	320
	SILICON BEACH SOFTWARE.....	287
	SOLBOURNE.....	17
880	SONY OF AMERICA	123, 309
1187	SPECTRUM SIGNAL PROCESSING	320
878	SPEECH PLUS	309
1121	STRATA	66
996	STRATEGIC SIMULATIONS.....	107
	SUN MICROSYSTEMS	17, 123
856	SUPERMAC TECHNOLOGY	189
	SYBASE	17
1077	SYSCORP INTERNATIONAL.....	154
998	TAESUNG INDUSTRIES.....	107
1143	TALL TREE SYSTEMS.....	49
1147	TANDY	49, 316
997	TECMAR	107
1149	TEKTRONIX	49
	TELEVIDEO SYSTEMS.....	141
1188	TEXAS INSTRUMENTS	243, 320
1189	THE VOICE CONNECTION.....	320
	THINKING MACHINES.....	349
1106	TIMESTAR SYSTEMS.....	66
884	TIMWORKS	217
1155	TOSHIBA AMERICA INFORMATION SYSTEMS.....	49, 93
1154	TOUCHBASE SYSTEMS	49
860	TRUEVISION	189, 320
1197	U-TRON	141
1179	UNIFY	309
	UNIPRESS SOFTWARE	123
855	UNITED INNOVATIONS.....	234
	VISICORP	316
1198	VISUAL INFORMATION TECHNOLOGIES	320
1190	VOICE CONTROL SYSTEMS	320
1180	VOICE PROCESSING	243, 309
1191	VOTAN.....	320
981	WALLABY SYSTEMS	81
1129	WANG LABORATORIES	49
881	WATCOM.....	199
982	WORDPERFECT	81
1112	WORLD PRECISION INSTRUMENTS	66
	WYSE TECHNOLOGY	141
1153	XIRCOM.....	49
1173	ZENITH DATA SYSTEMS	17, 93
1124	ZSOFT	66

READER SERVICE

To get further information on the products advertised in BYTE, fill out the reader service card by circling the numbers on the card that correspond to the inquiry number listed with the advertiser. This index is provided as an additional service by the publisher, who assumes no liability for errors or omissions.

* Correspond directly with company.

Alphabetical Index to Advertisers

Inquiry No.	Page No.	Inquiry No.	Page No.	Inquiry No.	Page No.	Inquiry No.	Page No.	
10	2500 AD SOFTWARE	212	110	DISKETTE CONNECTION	421	208	MICROSIM	359
11	ABACUS SOFTWARE, INC.	46	111	DIVERSIFIED COMPUTER SYS.	412	209	MICROSIM	359
12	ABACUS SOFTWARE, INC.	46	112	DSC COMMUNICATIONS	128		MICROSOFT	67
	ADOBEE SYS. INC.	89	113	DSP DEVELOPMENT CORP.	393		MICROSOFT	19
14	ADVANCED LOGIC RESEARCH	2,3	114	DYNAMIC ELECTRONICS	421		MICROSOFT	43
15	ADVANCED LOGIC RESEARCH	2,3		ECOSOFT	72		MICROSOFT	97
18	AKSYSTEMS	421	116	ELEXOR, INC.	412		MICROSOFT	225
19	ALPHA PRODUCTS	413	372	ELITE MICROSYSTEMS	298,299		MICROSOFT	273
20	AMERICAN GROUP	421	117	ELS ENTERPRISES LTD	348	210	MICRO SPEED	118
21	AMERICAN SMALL BUS. COMP.	135	118	ELTECH RESEARCH	249	211	MICRO SPEED	118
	AMPRO	109	119	EMERSON	276	212	MICROSYSTEMS SOFTWARE	103
22	AMS	423	120	EMERSON	276	213	MICROSYSTEMS SOFTWARE	103
23	ANAHEIM AUTOMATION	418	121	ENGINEERS COLLABORATIVE	428	214	MICROTRONICS TRADE SERV.	292
24	ANNABOOKS	407	115	ESS	418	215	MICROWITEC	73
25	ARA TECH	206	122	EVEREX SYSTEMS	48,48A	216	MICROWITEC	73
26	ATI TECHNOLOGIES	99	123	EVEREX SYSTEMS	48,48A		MICROWAY	203
27	ATI TECHNOLOGIES	315	124	EXCELLENCE MULTILAYER	80	217	MICROWAY	289
28	ATLANTIC AUTOMATION	214	125	EXECUTIVE PHOTO & SUPPLY	132	218	MITSUBISHI PLASTICS	339
31	AT&T NETWORK SYSTEMS	23-25	126	EXSEL, INC.	220	219	MIX SOFTWARE	163
32	AVOCET SYSTEMS	329	127	EXSEL, INC.	374	220	MKS	125
34	BA5F	222	128	FAIRCOM	115		MONTGOMERY GRANT	308
35	BAYTECH	188	129	FLAGSTAFF ENGINEERING	106	221	NANAO	178
36	BAYTECH	188	130	FOCUS RESEARCH, INC.	421	222	NANAO	178
39	BEST COMPUTER	447	383	FORESIGHT RESOURCES CORP.	376	223	NANAO	178
40	BEST POWER TECHNOLOGY	414	364	FORESIGHT RESOURCES CORP.	376	224	NANAO	178
41	BINARY ENGINEERING	36	131	FOX SOFTWARE	20,21	225	NANAO	332
42	BINARY TECHNOLOGY	418	132	FOX SOFTWARE	20,21	226	NANTUCKET	257
43	BITWISE	411	133	FRANKLIN SOFTWARE, INC.	185	226	NATIONAL COMPUTER RIBBONS	198
44	BITWISE	110	134	FTG DATA SYSTEMS	412	227	NATIONAL INSTRUMENTS	CIH
450	BIX	368,369	378	FUTURA	182	228	NETWISE	140
45	BLACKSHIP COMPUTER SYS.	228	377	FUTURA	182	229	NETWISE	140
46	BLAISE COMPUTER, INC.	48C	135	GATEWAY 2000	48E-H	370	NETWORK TECHNOLOGIES	412
47	BOLT SYSTEMS	136	136	GE INFO SERVICES (GENIE)	258	230	NEXT COMPUTER	28,29
48	BOLT SYSTEMS	136	137	GENERAL PARAMETRICS CORP.	85	231	NOHAU	414
49	BORLAND	13	138	GENERAL TECHNOLOGIES	207	232	NORTHGATE COMPUTER	305
50	BORLAND	13	139	GENERAL SOFTWARE	221	233	NORTHGATE COMPUTER	306,307
51	BP MICROSYSTEMS	421	140	GENERIC SOFTWARE CORP.	221	234	NORTHGATE COMPUTER	318,319
106	BRANDYWARE	428	141	GENKI SOFTWARE CORP.	88	235	NU-MEGA	131
52	BROOKS/COLE PUBLISHING	218	142	GESYS SOFTWARE CONSULTING	428	238	OKIDATA	357
53	BUICK	233	143	GIORDANO'S PCS	428		ORACLE	63
	BUICK	232A-B	144	GOLDEN BOW	295	239	OSBORNE/MCGRAW-HILL	386
	BUYERS MART	394-405	145	GOLDEN BOW	295	240	OVERLAND DATA, INC.	407
	BYTE BACK ISSUES	405	146	GTE DATA SERVICES	48B	241	PANASONIC (MONITORS)	271
	BYTE SUB MESSAGE	220	149	HARD DRIVES	415	242	PANASONIC (PRINTERS)	90,91
	BYTE SUB SERVICES	208	151	HEWLETT-PACKARD PERIPH.	14,15	243	PATTON & PATTON	108
55	BYTEC COMPUTER CORP.	414	152	HEWLETT-PACKARD PERIPH.	274,275	244	PAUL MACE SOFTWARE, INC.	260
	BYTEWEEK/NEWSLETTER	445	153	HIGH RES TECHNOLOGIES	288	245	PAUL MACE SOFTWARE, INC.	260
56	B&B ELECTRONICS	414	154	HIGH RES TECHNOLOGIES	288	246	PC DESIGNS	37
57	B&C MICRO	423	155	HTECH EQUIPMENT CORP.	421	247	PC NETWORK	287
58	B&C MICRO	425	156	HOME SMART COMPUTING	414	248	PC POWER & COOLING	209
59	B&C MICRO	425	157	HOUSTON INSTRUMENTS	335	249	PC POWER & COOLING	209
29	CADRE	31	158	HYPERKINETIX	278	250	PERISCOPE	317
	CALIFORNIA DIGITAL	429		HYPERKINETIX	278	251	PERISCOPE	317
60	CAPITAL EQUIPMENT	280		IBM-LASER PRINTER	39-41	253	PINNACLE MICRO	251
61	CAPITAL EQUIPMENT	281		IBM-OS/2	70,71	254	PINNACLE MICRO	251
62	CLONE COMPUTERS	417	159	IC EXPRESS	418	258	POLYWELL	95
83	CLUB AMERICAN TECHNOLOGIES	231	160	IMAGINE THAT	418	259	POPKIN SOFTWARE	167
64	CMO	172,173	161	INTERGRAND	253	261	PRECISION PLUS SOFTWARE	374
65	CMO	174,175	162	INTELLIGENCEWARE, INC.	257	262	PROGRAMMERS PARADISE	57
86	CMO	176,177	163	INTERNATIONAL COMPUTER GR.	385	263	PROGRAMMERS PARADISE	58,59
70	CNS	198,197	164	IO TECH	414	284	PROTECH MARKETING, INC.	75
71	COMMUNICATIONS RESEARCH	200	185	IO TECH	304	285	PROTECH MARKETING, INC.	75
72	COMMUNICATIONS RESEARCH	200	166	JADE COMP. PRODUCTS	415	257	PSI	418
73	COMPACT DISK PRODUCTS	255	167	JAMECO	408,409		PUBLISHERS STATEMENT	362
	COMPAQ COMPUTERS	136A-H	188	JB TECHNOLOGIES	407	268	P.C. BRAND	341
74	COMPUCLASSICS	301	189	JB TECHNOLOGIES	407	269	P.C. BRAND	342,343
75	COMPUCOM	406		JENSEN & PARTNERS	113	288	P.C. BRAND	344,345
78	COMPUSEVIE	285	170	JYACC, INC.	192,193	289	P.C. BRAND	348,347
77	COMPUTER DIRECT	322,323	171	JYACC, INC.	430-433	270	QMS/LASER CONNECTION	45
78	COMPUTER DISC WAREHOUSE	311		J.D.R.	430-433	271	QMS/LASER CONNECTION	45
79	COMPUTER FRIENDS	101	7	J.D.R.	430-433	272	QUA TECH, INC.	423
80	COMPUTER PERIPHERALS	101	172	KADAK PRODUCTS LTD.	428	273	QUA TECH, INC.	423
81	COMPUTER PERIPHERALS	101	173	KAYPRO	362	274	QUALSTAR CORP.	412
83	COMPUTER SYSTEMS ADVISORS	183	174	KAYPRO	362	275	QUANTUM SOFTWARE	87
84	COMPUTER SYSTEMS ADVISORS	183	175	KEA SYSTEMS LTD	428	276	QUARTERDECK	104,105
379	COMPUTER SYSTEMS RESEARCH	385	178	KILA SYSTEMS	428		QUILL	282,283
85	COMPUTERLANE, INC.	419	178	KNOWLEDGE DYNAMICS	428	277	RADIO SHACK	55
86	CONNEXPERTS	89	179	KNOWLEDGE GARDEN	428		RAIMA	114
87	CONTECH COMPUTER CORP.	416	180	KORE, INC.	423	278	RAINBOW TECHNOLOGY	92
88	CONTROL VISION	418	181	LAKEY COMPUTER SYSTEMS	103	279	RAINBOW TECHNOLOGY	92
89	COVIX	418	182	LINK COMPUTER GRAPHICS	412	280	RAYTON COMM. INC.	428
90	CRICHLAW DATA SCIENCES	416	183	LINK COMPUTER GRAPHICS	412	281	REAL TIME DEVICES	425
91	CSS LABS	18	184	LOGICAL DEVICES	425	283	ROSE ELECTRONICS	145
92	CSS LABS	18	185	LOGICAL DEVICES	425	284	SAELIG COMPANY	428
93	CUBE SYSTEMS, INC.	100	187	LOGICAL DEVICES	425	285	SAFEWARE, INC.	412
94	CUBE SYSTEMS, INC.	100	188	LOGITECH	52,53	288	SAGE/POLYTRON SOFTWARE	261
95	CUBIX CORPORATION	142	189	LOGITECH	52,53	287	SAMSUNG	84,85
96	CUBIX CORPORATION	142	190	LOGITECH	120,121	289	SAMSUNG	84,85
	DAMARK	247	191	LOGITECH	120,121	289	SANTA CRUZ OPERATION	81
	DATA COMMUNICATIONS	441	192	MAP INFO	34	290	SCHWAB COMPUTER	414
371	DATA GENERAL	290,291	193	MARYMAC INDUSTRIES	418	375	SCIENCE ACCESSORIES	367
79	DATA TRANSLATION	79	194	MATHSOFT, INC.	51	291	SCOTSDALE SYSTEMS	410
98	DATALIGHT	426	195	MATRIX	159	292	SILICON SHACK	418
99	DATAPRO	161	198	MAXCIMA	407	293	SKISOFT PUBLISHING CORP.	416
99	DATATRONICS	428	197	MAXEM CORP.	228	294	SN'W COMPUTERS	124
100	DAUPHIN TECHNOLOGY	373		MCGRAW-HILL BOOKSTORE	288		SOFTWARE DEVELOPMENT SYS.	83
101	DAUPHIN TECHNOLOGY	373	198	MEAD COMPUTER	422	8	SOFTWARE SAMPLER CLUB	279
102	DAYTRON ELECTRONICS	425	199	MEGA DRIVE	87	9	SOFTWARE SAMPLER CLUB	279
104	DELL COMPUTER	CI,1	200	MEGATEL	208	295	SOFTWARE SECURITY	278
103	DELL COMPUTER	32,33	201	MERRITT COMPUTERS	232	296	SOLUS SYSTEMS, INC.	74
	DELL COMPUTER	32A-B	202	METRO SOFTWARE, INC.	202	297	SOUTH COAST ELECTRONICS	414
105	DESCRIBE, INC.	138,139	203	METRO SOFTWARE, INC.	202	298	SPECTRUM SOFTWARE	285
107	DIGIBOARD	10	204	MICRO SOLUTIONS COMP. PROD.	44	299	SPJ DISTRIBUTING CO.	77
108	DIGITALK	12,11	204	MICROCHIP TECHNOLOGY	425	300	SPSS	228
109	DIGI-DATA CORPORATION	423	206	MICROCOM, INC.	267	301	STARTECH	428
389	DISKOTECH TECHNOLOGIES	405	207	MICROPROCESSORS UNLIMITED	428	302	STATSOFT	111
303	STONY BROOK SOFTWARE	204	208	MICROSIM	359	303	STONY BROOK SOFTWARE	204
304	STONY BROOK SOFTWARE	204	209	MICROSIM	359	381	STORAGE DIMENSIONS	391
381	STORAGE DIMENSIONS	391		MICROSOFT	67	382	STORAGE DIMENSIONS	391
305	SUPERSOFT	88		MICROSOFT	19	305	SUPERSOFT	88
306	SURAH, INC.	425		MICROSOFT	43	308	TALKING TECHNOLOGY	423
307	TALKING TECHNOLOGY	423		MICROSOFT	97	307	TATUNG	195
308	TATUNG	195		MICROSOFT	225	309	TATUNG	197
309	TATUNG	197		MICROSOFT	273	310	TECHNOLOGY POWER ENT.	428
310	TECHNOLOGY POWER ENT.	428		MICROSOFT	273	311	TEKTRONICS	210
311	TEKTRONICS	210		MICROSOFT	273	374	TELEMAT	72
374	TELEMAT	72		MICROSOFT	273	312	TELETEK	72
312	TELETEK	72		MICROSOFT	273	313	TELETEK	72
313	TELETEK	72		MICROSOFT	273	314	TERRA DATENTECHNIK	88
314	TERRA DATENTECHNIK	88		MICROSOFT	273	315	THE SMALL COMPUTER CO.	242
315	THE SMALL COMPUTER CO.	242		MICROSOFT	273	316	THE SMALL COMPUTER CO.	242
316	THE SMALL COMPUTER CO.	242		MICROSOFT	273	317	THE SOFTWARE LINK	213
317	THE SOFTWARE LINK	213		MICROSOFT	273	318	THE SOFTWARE LINK	213
318	THE SOFTWARE LINK	213		MICROSOFT	273	319	THE SOFTWARE LINK	215
319	THE SOFTWARE LINK	215		MICROSOFT	273	320	THE SOFTWARE LINK	215
320	THE SOFTWARE LINK	215		MICROSOFT	273	321	THE WHITEWATER GROUP	406
321	THE WHITEWATER GROUP	406		MICROSOFT	273	380	TIGERTRONICS	406
380	TIGERTRONICS	406		MICROSOFT	273	322	TOSHIBA	76,77
322	TOSHIBA	76,77		MICROSOFT	273	323	TOSHIBA	76,77
323	TOSHIBA	76,77		MICROSOFT	273	324	TOTE-A-LAP	416
324	TOTE-A-LAP	416		MICROSOFT	273	325	TOUCHBASE SYSTEMS, INC.	36
325	TOUCHBASE SYSTEMS, INC.	36		MICROSOFT	273	388	TOUCHSTONE SOFTWARE	250
388	TOUCHSTONE SOFTWARE	250		MICROSOFT	273	389	TOUCHSTONE SOFTWARE	250
389	TOUCHSTONE SOFTWARE	250		MICROSOFT	273	328	TRANS ERA	184
328								

READER SERVICE

Inquiry No.	Page No.	Inquiry No.	Page No.	Inquiry No.	Page No.	Inquiry No.	Page No.
430 I X LTD	IS-56	INT'L DIRECT RESPONSE POSTCARDS		536 COMPUTER EXPERT	NE-14	367 U S MICRO	NE-10
431 INES GMBH	IS-24			537 COMPUTER WHOLESAL CLUB	NE-19	368 ZEPHYR SERVICES	NE-24
433 INTERQUADRAM	IS-5			540 DRAGONSLAYER SYSTEMS	NE-15		
435 JB-MICRO SALES	IS-22			541 ELECTRIFIED DISCOUNTERS	NE-1	Pacific Coast	60 PC1-16
436 JC INFO SYSTEMS	IS-14			542 EPS TECHNOLOGY	NE-12,13	491 3-F ASSOCIATES	PC-1
437 KADOR	IS-54			543 EPS TECHNOLOGY	NE-12,13	* BYTE PUBLICATIONS	PC-14,15
438 KAYPRO	IS-31			544 FOUNTAIN TECHNOLOGIES	NE-17	494 CDS	PC-16
439 K.E.M. ELECTRONIC	IS-58			545 HARMONY	NE-5	495 CIRCO	PC-4
440 MASHOV	IS-65			546 HARMONY	NE-5	496 CIRCO	PC-4
441 MICRO TECHNOLOGY	IS-69			547 HERTZ COMPUTER	NE-30	497 COMPUTER DISC.WAREHOUSE	PC-13
442 MITSUBISHI CHEMICAL	IS-16			548 INNOVATIVE DATA CONCEPTS	NE-30	498 HEALD INSTITUTE OF TECH	PC-9
443 OLIVETTI	IS-21			549 INTERFACE DATA,INC	NE-24	* MEDCOM INFORMATION SYSTEM	PC-2
444 OSICOM TECHNOLOGIES	IS-47			550 INTERFACE DATA,INC	NE-24	499 METAWARE	PC-11
445 PACIFIC DATA PRODUCT	IS-2			553 LAPTOPS, ETC.	NE-27	500 RESOURCE CONCEPTS,INC	PC-3
446 PACIFIC DATA PRODUCT	IS-2			554 MAGITRONIC TECHNOLOGY	NE-16	501 RESOURCE CONCEPTS,INC	PC-3
447 PACIFIC DATA PRODUCT	IS-29			555 MANCHESTER EQUIPMENT	NE-33	502 STARPATH SYSTEMS,INC	PC-5
448 PACIFIC DATA PRODUCT	IS-29			556 MASCOT COMPUTER CORP	NE-23	503 STARPATH SYSTEMS,INC	PC-5
449 PACIFIC DATA PRODUCT	IS-55			557 MICCASOFT,INC	NE-3	504 WAREHOUSE DATA	PC-7
452 PHILIPS MONITORS	IS-11			558 * MICCASOFT,INC	NE-3		
453 PHOTRAX	IS-50			* MICROCOMPUTER MKTG. CNCL	NE-34	South	60 SO1-16
454 PROCOMP USA INC	IS-50			559 MINTA TECHNOLOGY	NE-32	507 A-TRONIC COMPUTER	SO-13
455 PROCOMP USA,INC	IS-50			560 MPM	NE-25	508 DAKOTA COMPUTER	SO-11
456 PROGRAMMERS ODYSSEY	IS-43			561 MPM	NE-25	509 EPS TECHNOLOGY	SO-6,7
457 QUOITA 32	IS-58			562 MULTIS CORPORATION	NE-10	510 EPS TECHNOLOGY	SO-6,7
* SCANDEC TRIBUTOR	IS-70			563 MULTIS CORPORATION	NE-10	511 MICCASOFT,INC	SO-1
470 SIEMENS AG	IS-87			564 OCTAGON TECHNOLOGIES	NE-4	512 MICCASOFT,INC	SO-1
458 SIREX	IS-40			565 OCTAGON TECHNOLOGIES	NE-4	513 MIGHTY MICRO	SO-16
* SOFTLINE CORP	IS-25			566 ON LINE COMPUTER	NE-31	514 MIGHTY MICRO	SO-16
460 SOFTTEK COMP	IS-54			567 ON LINE COMPUTER	NE-31	515 OCTAGON TECHNOLOGIES	SO-2
459 SOLUTION SYSTEMS	IS-27			568 ON LINE PRODUCTS CORP.	NE-35	516 OCTAGON TECHNOLOGIES	SO-2
467 SUPERTRON ELECTRIC CO	IS-68			569 ON LINE PRODUCTS CORP.	NE-35	517 PAO-KU INTERNATIONAL CO	SO-3
461 TRI GEM	IS-81			570 PC LINK CORP	NE-40	518 PAO-KU INTERNATIONAL CO	SO-3
462 TRIANGLE DIGITAL SERVICES	IS-54			571 PC-PLUS TECHNOLOGIES	NE-21	519 PHOENIX COMPUTER	SO-9
463 TWINHEAD INT'L CORP	IS-36			572 PC-PLUS TECHNOLOGIES	NE-21	520 POINTECH DISTRIBUTORS	SO-4
464 T.P. ENTERPRISE LTD.	IS-62			573 POINTECH DISTRIBUTORS	NE-20	521 POINTECH DISTRIBUTORS	SO-4
* USA SOFTWARE	IS-23			574 POINTECH DISTRIBUTORS	NE-20	522 RESOURCE CONCEPTS,INC	SO-5
465 WAREHOUSE DATA PRODUCTS	IS-33			575 SOFTBRIDGE,INC	NE-11	523 RESOURCE CONCEPTS,INC	SO-5
466 WORLD WIDE COPIER PARTS	IS-58			385 TECHNOCOMPANY	NE-29		
				386 TECHNOCOMPANY	NE-29		
				* UNIXWORLD	NE-9		

* Correspond directly with company.

BYTE ADVERTISING SALES STAFF:

Steven M. Vito, Associate Publisher/V.P. of Marketing, One Phoenix Mill Lane, Peterborough, NH 03458, tel. (603) 924-9281
 Arthur Kossack, Eastern Regional Sales Manager, 645 North Michigan Ave., Chicago, IL 60611, tel. (312) 751-3700
 Jennifer L. Bartel, Western Regional Sales Manager, 8111 LBJ Freeway, Suite 1350, Dallas, TX 75251, tel. (214) 644-1111
 Liz Coyman, Inside Sales Director, One Phoenix Mill Lane, Peterborough, NH 03458, tel. (603) 924-2518

NEW ENGLAND
 ME, NH, VT, MA, RI, ONTARIO
 CANADA & EASTERN CANADA
 (617) 262-1160
 McGraw-Hill Publications
 575 Boylston Street
 Boston, MA 02116
 FAX: (617) 262-6430

ATLANTIC
 NY, NJ, CT, NJ (NORTH)
 Kim Norris (212) 512-2645
 McGraw-Hill Publications
 1221 Avenue of the Americas—
 28th Floor
 New York, NY 10020
 FAX: (212) 512-3520

EAST
 PA, NJ (SOUTH),
 MD, W. VA, DE, D. C.
 Thomas J. Brun (215) 496-3833
 McGraw-Hill Publications
 Three Parkway
 Philadelphia, PA 19102
 FAX: (215) 496-3828

SOUTHEAST
 NC, SC, GA, FL, AL, TN, VA, MS
 (404) 252-0626
 McGraw-Hill Publications
 4170 Ashford-Dunwoody Road
 Suite 420
 Atlanta, GA 30319
 FAX: (404) 252-4056

MIDWEST
 IL, MO, KS, IA, ND, SD, MN,
 KY, OH, WI, NB, IN, MI
 Kurt Kelley (312) 751-3740
 McGraw-Hill Publications
 Blair Building
 645 North Michigan Ave.
 Chicago, IL 60611
 FAX: (312) 751-3767

**SOUTHWEST,
 ROCKY MOUNTAIN**
 CO, WY, OK, TX, AR, LA
 Karl Heinrich (713) 462-0757
 McGraw-Hill Publications
 7600 W. Tidwell Rd.—Suite 500
 Houston, TX 77040
 FAX: (713) 462-6526

SOUTH PACIFIC
 SOUTHERN CA, AZ, NM,
 LAS VEGAS
 Ron Cordek (714) 557-6292
 McGraw-Hill Publications
 3001 Red Hill Ave.
 Building #1—Suite 222
 Costa Mesa, CA 92626
 FAX: (714) 557-2219

Tom Harvey (213) 480-5243
 McGraw-Hill Publications
 3333 Wilshire Boulevard #407
 Los Angeles, CA 90010
 FAX: (213) 480-5249

NORTH PACIFIC
 HI, WA, OR, ID, MT,
 NORTHERN CA,
 NV (except LAS VEGAS),
 W. CANADA, UT
 (415) 362-4600
 McGraw-Hill Publications
 425 Battery Street
 San Francisco, CA 94111
 FAX: (415) 954-9786

Bill McAfee (408) 879-0371
 McGraw-Hill Publications
 1999 South Bascom Ave.
 Suite #210
 Campbell, CA 95008
 FAX: (408) 879-9067

BYTE BITS (2x3)
 Mark Stone (603) 924-6830
 BYTE Publications
 One Phoenix Mill Lane
 Peterborough, NH 03458

The Buyer's Mart (1x2)
 Brian Higgins (603) 924-3754
 BYTE Publications
 One Phoenix Mill Lane
 Peterborough, NH 03458

Regional Advertising
 Larry Levine (603) 924-2637
 BYTE Publications
 One Phoenix Mill Lane
 Peterborough, NH 03458

Barry Echavarría (603) 924-2574
 BYTE Publications
 One Phoenix Mill Lane
 Peterborough, NH 03458

Jonathan Sawyer (603) 924-2665
 BYTE Publications
 One Phoenix Mill Lane
 Peterborough, NH 03458

National Sales
 Scott Gagnon (603) 924-2651
 Mary Ann Goulding
 (603) 924-2664
 Patricia Payne (603) 924-2654
 BYTE Publications
 One Phoenix Mill Lane
 Peterborough, NH 03458

BYTE Deck Mailings
 Ed Ware (603) 924-6166
 BYTE Publications
 One Phoenix Mill Lane
 Peterborough, NH 03458

**A/E/C Computing Deck
 Computing for Engineers**
 Ellen Perham (603) 924-2598
 BYTE Publications
 One Phoenix Mill Lane
 Peterborough, NH 03458

Peterborough, NH Office
 Inside Sales Fax: 603-924-2683
 Advertising Fax: 603-924-7507

International Advertising Sales Staff:

Frank Tanis, European Sales Manager, BYTE Publications,
 Batenburg 103, 3437 AB Nieuwegein, The Netherlands, tel: 31 34 02 49496, fax: 31 34 02 37944

Ros Weyman
 McGraw-Hill Publishing Co.
 34 Dover St.
 London W1X 4BR
 England 01 493 1451
 FAX: 01 493 9896

Alessandro Coari
 McGraw-Hill Publishing Co.
 Via Flavio Baracchini 1
 20123 Milan, Italy
 (2) 89010103
 FAX: (2) 879 400

Mrs. Maria Sarmiento
 Pedro Teixeira 8, Off. 320
 Iberia Mart I
 Madrid 4, Spain
 I 45 52 891

Masaki Mori
 McGraw-Hill Publishing Co.
 Overseas Corp.
 Room 1528
 Kasumigaseki Bldg.
 3-2-5 Kasumigaseki,
 Chiyoda-Ku
 Tokyo 100, Japan
 3 581 9811
 FAX: 81-3-581-4018

Seavex Ltd.
 503 Wilson House
 19-27 Wyndham St.
 Central, Hong Kong
 Tel: 5-260149
 Telex: 60904 SEVEX HX
 FAX: 852 5 810 1283

Seavex Ltd.
 400 Orchard Road, #10-01
 Singapore 0923
 Republic of Singapore
 Tel: 734-9790
 Telex: RS35539 SEAVEX
 FAX: 65 732 5129

Mr. Ernest McCrary
 Empresa Internacional de
 Comunicaciones Ltda.
 Rua da Consolacao, 222
 Conjunto 103
 01302 Sao Paulo, S. P., Brasil
 Tel: (11) 259-3811
 Telex: (100) 32122 EMBN

FREE 1-YEAR SUBSCRIPTION TO DATA COMMUNICATIONS

If you are responsible for the use, planning, design or implementation of data and information systems...**you need Data Communications magazine!**

The leading networking magazine since 1972, DATA COMMUNICATIONS is the *only monthly publication devoted solely to networking*. It will keep you fully informed on the latest technology, equipment, services, opportunities and challenges that affect your network. No other publication delivers the timely, technical analysis that is crucial to you.

You'll see how you can *cash in on profitable new strategies and applications* for factory and office automation, distributed processing, and electronic mail. Plus, DATA COMMUNICATIONS *warns you of the dramatic changes ahead in tariffs, regulations and standards* - and what they'll mean to you and your company.

Here is a preview of what you'll be seeing:

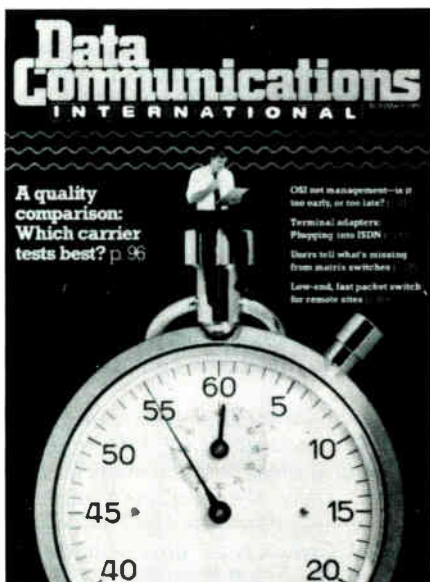

October issue - Our editors will lay out the technical and market trends for TI in this issue.

November issue - OSI products, prospects, and services. Which vendors are offering real solutions and which are only offering lip service - Find out.

November LAN Strategies Special Issue - Includes LAN operating systems and applications, gateways, bridges, routers and cabling schemes.

December issue - A report from the field outlines how integrated network management works and doesn't work.

1990 Buyers' Guide issue - The powerful, year-round reference that provides vital product and vendor information networking decision-makers need when they are ready to buy.

Don't get left behind! Stay on top of the rapid changes in technology and discover how you can take full advantage of the latest advances with DATA COMMUNICATIONS.

Fill in and mail your subscription application **today!**

continued from page 392

Building the contents of the message array proceeds in much the same way as the GWBASIC version. (Is this any surprise? Both languages come from Microsoft.) The only difference is in the use of the VARSEG function that I've already introduced in the Turbo Basic interface and whose operation is similar. I say "similar" because here VARSEG returns the proper segment of the string. Note that, as in Turbo Basic, VARPTR() returns the offset of the 4-byte string descriptor, so you've got to execute a couple of PEEK() functions to get the address of the string body.

The heart of the function lies in the CALL INTERRUPTX() function, a specialized version of QuickBASIC's CALL INTERRUPT. It allows you to set the contents of the DS and ES registers prior to the CALL (a procedure that CALL INTERRUPT does not permit).

The CALL INTERRUPTX() function requires three parameters: the interrupt vector to be called, a record structure

(called a Type in QuickBASIC) defining the contents of the CPU registers going into the function, and a record structure to hold the contents of the registers coming out of the function. You define

A trashed screen can undermine the user's faith in an application.

records using the trusty DIM statement (see the listing), and in this case the record type is internally defined as RegType. (When you execute QuickBASIC, be sure to include the /L switch at the command line. This loads the library

that holds the definition for the CALL INTERRUPTX routine.)

TopSpeed Modula-2

Just when you think you've got the whole court covered, someone puts a spin on the ball that you didn't expect. Take TopSpeed Modula-2's treatment of strings, for example. Its strings do not use a length byte, as Pascal's do. Instead, strings are defined as character arrays and use a termination character—but not a null as in C; they use a formfeed character (decimal 12).

Listing 6 is the source code for the Modula-2 interface to IMAN. Once again, you've first got to get the string into a form IMAN will accept—which amounts to replacing the formfeed with a null. And when IMAN returns, you put the string back into a form Modula-2 will accept—which amounts to replacing the null with a formfeed.

TopSpeed Modula-2 uses Intr() to call an interrupt, and, as with most other languages, the creators have defined a record type that lets you set the CPU's registers. For the most part, the Modula-2 routine looks like a cross between the Pascal version and the C version.

Listing 6: The IMAN interface for TopSpeed Modula-2.

```
(* IMAN interface for TopSpeed Modula-2 *)
FROM Str IMPORT Length,Insert,Pos;
FROM SYSTEM IMPORT Seg,Ofs;
FROM IO IMPORT WrInt,WrLn;
FROM Lib IMPORT Intr;
IMPORT IO,Str,SYSTEM,Lib;

VAR
  imbuf: ARRAY [0..79] OF CHAR;

(*
** This procedure calls IMAN and returns the number of
** characters in the field. It expects a global character
** array imbuf.
*)
PROCEDURE
CALLIMAN(imrow,imcol,imsign,imtype,
  imfill,imatr,imw1,imw2: INTEGER) : INTEGER;

VAR
  pregs : SYSTEM.Registers;
  immes: ARRAY [0..5] OF INTEGER;

BEGIN
  Insert(imbuf,CHR(0),Length(imbuf));
  immes[0]:=Seg(imbuf); (* Segment *)
  immes[1]:=Cfs(imbuf); (* Offset *)
  immes[2]:=(imrow << 8) + imcol;
  immes[3]:=(imsign << 8) + imtype;
  immes[4]:=(imatr << 8) + imfill;
  IF imtype<>2 THEN imw1:=0
  END;
  immes[5]:=(imw1 << 8) + imw2;

  (* Set up registers *)
  pregs.BX:=Ofs(immes[0]);
  pregs.DS:=Seg(immes[0]);
  (* Call the interrupt *)
  Intr(pregs.62H);

  IF Pos(CHR(0),imbuf)=0 THEN
    RETURN 0;
  ELSE
    Insert(imbuf,CHR(12),Pos(CHR(0),imbuf));
    RETURN Length(imbuf);
  END;
END CALLIMAN;
```

End of Field

It's nice to see that at least some degree of compatibility isn't all that difficult to achieve, even across languages. Of course, I owe a lot to the fact that everything this month is running on the IBM PC family of machines. It would be a chore—and probably a pointless one—to convert IMAN to the 68000 and do the same thing with Macintosh packages.

Although IMAN is small compared to other projects I've presented here and embodies almost nothing theoretical, it's one of those seemingly trivial tools that can make a great deal of difference in any final application. Your entry screens will look clean, and you won't have to "Redo from start" ever again. ■

Editor's note: *The source code for IMAN is available as IMAN.ASM on disk and on BIX, along with the examples used in this article. See page 5 for details.*

Rick Grehan is the director of the BYTE Lab. He has a B.S. in physics and applied mathematics and an M.S. in computer science/mathematics from Memphis State University. He can be reached on BIX as "rick_g."

Your questions and comments are welcome. Write to: Editor, BYTE, One Phoenix Mill Lane, Peterborough, NH 03458.

Knowledge Processing

**Don't leave your users
lost in a maze of
information!**

A knowledge processor communicates knowledge - the natural extension of everything we do on a computer.

It's the intelligent integration of everyday resources like data, text, logic, graphics, and video that turns information into knowledge.

KnowledgePro is the first knowledge processor. It combines a high-level, object-oriented programming language with hypertext and expert systems technology.

KnowledgePro gives you a total development environment with the tools you need to create intelligent multi-media applications.

PC Magazine, Holland... *"KnowledgePro is the first of a new generation of software, the knowledge processor...it has the power of, for example, Pascal or PROLOG, but the programmer isn't troubled with the technical details."*

PC Week, USA... *"It's rare, but every so often a PC application comes along that breaks new ground and creates a fundamentally different way to use computers. According to its corporate users...KnowledgePro does just that."*

Infoworld... *"We don't live in a computational world. If we're going to move knowledge around we need tools...The same person who will learn macros in Lotus can learn this."*

KnowledgePro costs \$495 with no runtime fees. It runs on IBM PC, XT, AT and PS/2 compatible machines with 640k of memory and a hard disk. A working demo with a 100 page manual is available for \$33 including shipping (\$38 foreign) with credit towards purchase of the full system.

Find out what knowledge processing is all about. Call 518-766-3000 (FAX 518-766-3003) or write to Knowledge Garden Inc., 473A Malden Bridge Rd., Nassau, NY 12123, USA. Amex, Visa or M/C accepted.

KnowledgePro®
The intelligent way out

Circle 179 on Reader Service Card

Another
intelligent
tool from



KnowledgePro is a registered trademark of Knowledge Garden Inc. IBM, PC, XT, AT and PS/2 are trademarks of International Business Machines Corp.

World Radio History

PRINT QUEUE

Hugh Kenner

Sixty-One Diamonds for the Mind

THE TURING OMNIBUS:
61 Excursions in Computer Science

by A. K. Dewdney

Martin Gardner's monthly "Mathematical Games," which dated from before some present-day readers of *BYTE* had begun to learn to count, was for years and years *Scientific American's* single most popular feature. Gardner prided himself on *not* being a mathematician. One of his strengths was a transparent expository manner.

Another strength was the trust he'd earned from a network of professionals, for some of whom being reported on by Gardner could often be preferable to journal publication. John Horton Conway's game of Life—"automaton" structures that mutated, spawned, and vanished to the baton of just two rules, even as they modeled vast themes of self-replication—that game, later a mainstay of recreational computing (not to mention MIT hacking), was first described in a 1970 Gardner article.

One of his sources, the late Rufus Isaacs, once told me about Gardner's idiosyncratic files, which included a folder for each "interesting" number. An example would be 407, the largest number expressible as the sum of the cubes of its digits. (Apart from 1, by the way, the smallest such number is 153, and just two others exist. Also by the way, such files as Gardner's are potentially infinite, thanks to the proof that no uninteresting number exists. For more about that, stick around.)

I also learned from Isaacs how, as late as the mid-1970s, as the priesthood of numeracy was getting thoroughly hooked on silicon, a principled Gardner was still keeping hardware at bay. Like the fly-fishing gentleman who routinely releases the fish once he's taken his pleasure in the exercise of elegant skill, he recoiled from such mechanized number crunching as simply gets you a number, and he tended to identify machinery with that. He never did yield, not even to the trifling extent of buying—let alone mastering—a pocket calculator.

But such purism couldn't

last; computation was shouldering in. Since his retirement, Gardner has had three successors: computer metaphorist Doug Hofstadter, computer connoisseur Brian Hayes, and, currently, computer virtuoso A. K. ("Kee") Dewdney. Kee's Toronto-based brother Christopher is a poet with scientific interests, whose *The Immaculate Perception* (University of Toronto Press, 1986) is worth hunting out: the only prose-poem book I can imagine that has need for a drawing of the cerebral cortex. Their forebear Selwyn was a minor novelist. Kee teaches computer science at the University of Western Ontario, in a town called, grandly, London. Altogether an interesting family, resistant to specialization in a way perhaps nowadays peculiar to Canada. (Let me not conceal my own Canadian origins.)

Back in August 1988, *BYTE* ran my review of Dewdney's *The Armchair Universe*, a collection of *Scientific American* pieces. *The Turing Omnibus* is something quite different. Although loyal readers will recognize embedded excerpts from columns, its material is mostly new. And it displays computer science at ease in a Gardnersque terrain where rigor consorts with play.

Dewdney-watchers will spot a familiar method. His initial moves generally exploit the no-man's-land between computer science and what universities fund as "mathematics." The latter, said Bertrand Russell, is a domain where you never know (a) what you're talking "about," nor (b) whether what you're saying is true. G. H. Hardy at Cambridge was famous for his joy in professing a subject that had no applications whatsoever. Computerdom, though, does have its tests of truth (a crude one: stake your money on the printout). Also, it's constantly flirting with "about."

Thus a spreadsheet: That's "about" accounting? Yes; the very name is rooted in accounting. Yet join the top edge to the bottom, the left edge to

continued

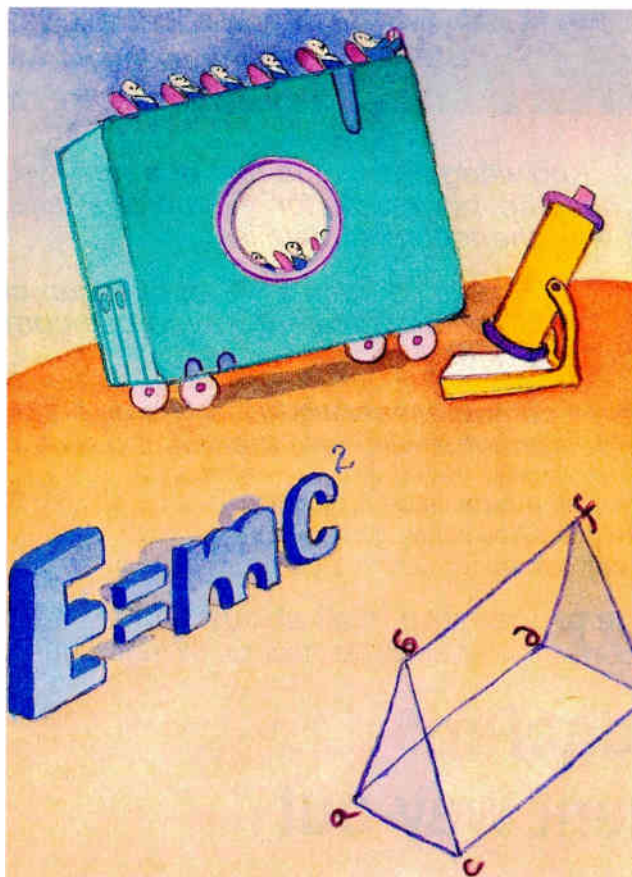

The Cream.

The Crop.



There are plenty of places to get information in this industry. Too many. But if you want the best quality information, there's only one that rises to the top: **BYTEWEEK**.

BYTEWEEK is a weekly newsletter from the same professionals who produce **BYTE Magazine**. Each week, the most important news and information from the previous week is presented in a readable and concise manner. **BYTEWEEK** offers you what no other publication can: timely news on the rapidly-evolving computer industry as it happens with the interpretation and evaluation that only **BYTE's** experienced editorial staff can provide.

Subscribe now and take advantage of a special subscription rate of \$395 (\$495 outside the U.S. and Canada). Your subscription to **BYTEWEEK** also includes a free subscription to **BIX**, **BYTE's** exclusive on-line conferencing system. *Don't miss this opportunity!*

For fastest service, call toll-free 1-800-258-5485 (in N.H., call 603-924-9281) and charge to a major credit card or we'll bill you.

BYTEWEEK

One Phoenix Mill Lane, Peterborough, NH 03458

BYTEWEEK offers a money-back guarantee if you are not completely satisfied.

YES! Sign me up as a subscriber to the Cream of the Crop, **BYTEWEEK at the special subscription rate of \$395 a year for 50 issues (\$495 a year outside the U.S. and Canada).**

MC VISA Check enclosed Bill me

Card # _____ Exp. _____

Signature _____

Name _____

Title _____

Mail Address _____

City/State/Zip _____

Business Phone _____

BYTEWEEK

One Phoenix Mill Lane
Peterborough, NH 03458

the right, and though you've done something of little use to an accountant, you've coped with a demon that besets programmers of Conway's Life, where the cellular automaton may try to shift itself clear off the edge of the paper. The way you've coped is by eliminating all edges. For the Life game demands, ideally, an infinite sheet, and by defining edges as joined, you could simulate certain properties of that boundless page—its unboundedness if not its infinite extent—with a spreadsheet like Multiplan. I've not seen it done, though Brian Hayes did suggest the idea in 1983.

Most of
the book's excursions
contain no formal
algorithm whatever.



And once you've centered your attention on that Multiplan Life game, lo, "spreadsheet" has receded to the status of metaphor. You next realize that in buying Multiplan software, you acquired a way to think about manipulating symbols in space, never mind what its designers thought it was "for."

You see how such a line of thought can work us toward a domain exempt from the obsession with special-case "results" that distressed Gardner. Such is the domain through which the book is driving. There, principles are at play in cascading generality, though "applications" are never unthinkable.

A neat example is tour 20, headed Generative Grammars. It begins by stating that "the growth of certain types of plants can be modeled, to an extent, by a formal scheme known as a *Lindenmeyer system*." But "such systems are really a special kind of generative grammar," since "words in a formal system are produced by a stepwise process of replacement," symbols being "replaced by certain words given in a list of 'productions'" until growth has ceased, at which point a new "word" has been generated by the grammar. Compiler writers understand that already. The rest of us may wonder whether we're reading about plants or languages. The answer is, both.

Do not be deterred. Most of the 61 tours in *The Turing Omnibus*'s repertory are as simple in principle as the two rules of Life. Thus, starting with the general concept of algorithms (tour 1), Dewdney gives us a recipe for enchiladas complete with a REPEAT...UNTIL loop (that's when you sauté chopped onion and clove *until* golden). Then within a page we've a "wallpaper" algorithm, nine lines long including a FOR loop, that uses the enchilada method to place intricate patterns on your screen. That in turn is followed by a skeletal Pascal translation, just to illustrate how, the way you can implement enchiladas at the stove, you can implement wallpaper at the terminal. At the end, we find two problems and a short bibliography. It all takes seven pages exactly.

Granted, the recipe/algorithm analogy has been used before. What's peculiar to Dewdney here is his crisp economy, his compactness of notation, and his way of handing the details over to you. No more than Gardner is he a hardware buff, nor even, in any way Borland or Microsoft would want us to understand, a software buff. He's happy weaving patterns of pure

concept, stating them compactly, and letting us take it from there. If we choose to remain with just a firm understanding, aglow like a diamond in the mind, nothing suits him better. Or if we undertake a workable program in our language of choice, he'll want us to enjoy the process and the results.

Most of *The Turing Omnibus* excursions contain no formal algorithm whatever, though often, as when game trees (minimax method) get lucidly expounded in five pages, an algorithm does lurk just offstage. (Minimax, after all, underlay a 1962 program by Arthur Samuel that once beat a U.S. state checkers champion.)

Or here's tour 11, error-correcting codes, something we were hearing about at the time of the Neptune flyby a few months back. As those pixel-by-pixel images traversed millions of miles, they faded toward the level of background noise. A pixel embraced 32 possible levels of gray; since 32 is 2^5 , the Jet Propulsion Laboratory used 5 bits per pixel? No, 32 bits per pixel; then redundancy could catch up to seven errors.

Dewdney's wonderfully lucid diagram shows how this works: all meaningful combinations of 32 white and black squares, from which it's evident that any two differ in exactly 16 places. (My "meaningful" swamps much detail spelled out by Dewdney.)

If only 1 bit is wrong, the transmitted pixel will differ from a row in the diagram by only 1 bit "and cannot be mistaken for any other word." The same is true for up to seven errors. We're quite safe in simply selecting the closest match. But if eight errors have occurred, the received word may differ from some other row in the diagram just as much as it differs from the intended row. Then we have two choices, equally plausible. What's more, we are not stumbling forward blindfolded; we know about a local undecidability. (That's a reason to transmit the picture more than once, random errors being unlikely to recur exactly.)

Or here is the fast Fourier transform (tour 29), devised in 1965 by Colley and Tukey and now compressed to an 11-line algorithm. It's drawn on in tour 26 (CAT scanning), which deals with the problem of nonredundantly recovering a three-dimensional image.

Or, here's the formidable predicate calculus (tour 54), "one of the most powerful languages known for the expression of mathematical ideas and thought." Dewdney's exposition has recourse to the old problem of ferrying wolf, goat, and cabbage across a river in a rowboat that will hold just two at a time; but wolf left alone with goat means an eaten goat, goat with cabbage an eaten cabbage. (Here, by the way, I'll register my one complaint. Though fluent with +, -, *, and /, I'd welcome a table specifying signs I'm less used to, such as an inverted A and a reversed E.)

Oh—the proof that there's no uninteresting number? Well, 2 is the first even, 3 the first prime (and all primes are interesting), 4 the first square. . . . Keep moving along till you come to a number about which you can't think of anything to say. So here's the first uninteresting number! That makes it interesting. Now check tour 21 (recursion, via the Sierpinski curve) and apply such a principle recursively. QED. ■

Computer Science Press, New York: 1989, 415 pages, \$24.95

Hugh Kenner is a professor of English at Johns Hopkins University. His reviews have appeared in publications like the New York Times and Harper's. His recent books include A Sinking Island and Mazes. He can be contacted on BIX as "hkenner."

Your questions and comments are welcome. Write to: Editor, BYTE, One Phoenix Mill Lane, Peterborough, NH 03458.

BEST-386/25 W/387/25**\$4,695****"CAD/CAM WORKSTATION SPECIAL"**

SI 28.7 LM 36.7

80386 25 MHz system board w/32 KB static cache**80387 25 MHz Math Co-processor INCLUDED****4 MB SIMM RAM****ATI VGA Wonder card/512K 1024 × 768 res.****ATI Bus Mouse****NEC 3D Multisyn Color Monitor 1024 × 768 res.**

5.25" 1.2 MB floppy drive (Teac)

3.5" 1.44 MB floppy drive (Teac)

90 MB SCSI hard disk

SCSI Host Adaptor

Floppy drive controller

2 serial, 1 parallel and 1 game port

Tower case w/275 W power supply

101 Enhanced keyboard

MS DOS 4.01, GW Basic

AMI BIOS with full MS-DOS, OS/2, SCO Xenix

Novell, 3COM and PCNET compatibility

**BEST-386/20 Tower System****\$2,795**

SI 23.0 LM 22.6

80386 20 MHz system board**1 MB SIMM RAM 100ns****Super 16 Bit VGA card 800 × 600 res. (Tatung)****14" Color Multisyn Monitor 800 × 600 res. (Tatung)**

Clock calendar with battery backup

5.25" 1.2 MB floppy drive (Teac)

3.5" 1.44 MB floppy drive (Teac)

80 MB hard disk (Seagate ST-4096 28ms)

1:1 interleave Hard disk/Floppy drive controller

2 serial, 1 parallel and 1 game port

Tower case w/275 W power supply

101 Enhanced keyboard

MS DOS 4.01, GW Basic

Support 80387, Weitek Math Co-processor

AMI BIOS with full MS-DOS, OS/2, SCO Xenix

Novell, 3COM and PCNET compatibility

BEST-286/16 Laptop System**\$2,645****LCD PORTABLE System****640 × 200****\$1,395****640 × 400****\$1,445****EGA COMPATIBLE****\$1,745****CRT PORTABLE System****MONOCHROME****\$1,325****EGA COMPATIBLE****\$1,475****BEST-286/12 Laptop System****\$2,495**

286/16 (286/12) MHz 0 wait system board

1 MB RAM expandable to 8 MB

10.25" Gas Plasma Screen (720 × 400 res., 4 level gray)

EGA compatible with external adaptor

1.44 MB Floppy drive

40 MB Hard disk 25ms (Connor)

1 serial, 1 parallel ports

85 key tactile keyboard w/ external keyboard connector

MS DOS 4.01, GW Basic

Size: 15" × 14.25" × 3.5" Weight: 16 lbs.

30 DAYS MONEY BACK GUARANTY

ONE YEAR P/L WARRANTY

CALL FOR QUANTITY PRICE

BEST

COMPUTER INC.

5017 Telegraph Road
Los Angeles, CA 90022

Tel: (213) 265-0900

Tech: (213) 265-0300

Fax: (213) 265-4234

Toll: **(800)634-7920**

Outside Cal.

Credit Card Purchase Subject to Service Charge

Mon.-Fri. 8:00 - 6:00 Sat. 9:00 - 6:00 Pacific Time
PRICE & SPEC. ARE SUBJECT TO CHANGE WITHOUT NOTICE

To Order Call 1-800-634-7920

Circle 39 on Reader Service Card



HEARD IT THROUGH THE HELP LINE

You don't have to be crazy to do customer support, but it helps

No, the manuals aren't lost," said the client on the other end of the line. "It's just that we can't find them anywhere."

I waited for her to laugh at her own joke before I politely joined in. But she just kept talking. Then it dawned on me that she was completely serious.

Ever since I took a job providing nationwide personal computer support through a telephone help line, I have found myself in a state of bewildered amazement over the things I hear being said and the situations I find myself involved in day after day.

Once a client called in and complained that ever since a power surge was installed in the computer, nothing was working right.

Another time, a client called in to get someone to tell her how to "floormat" a disk.

Then there was the woman who got upset after I repeatedly tried to get her to tell me the exact kind of personal computer she was having trouble with. "I told you I don't know what kind of machine it is," she told me heatedly. "All I know is that it's an IBM that was made into a Compaq."

I remember the time an excited client called in to demand that someone come out and fix his computer *now*. When he

had powered the machine on, he had gotten the message "Bad or Missing Command Interpreter" instead of the main menu of his accounting package, as expected. When I took the call, I thought that such a simple problem should take no more than 3 minutes to solve. Little did I know.

"Do you have a DOS disk available?" I asked.

"DOS disk?" he asked.

I explained to the client—after repeated efforts—what a DOS disk was, and I convinced him that he probably had one lying around somewhere. Then I waited while he thrashed through piles of disks and stacks of user manuals (most, if not all, probably still wrapped in factory-fresh plastic). I listened to the sound of objects being tossed to and fro and hitting the floor. Eventually, the client found the elusive and mysterious DOS disk.

I said, "Sir, could you please put that disk into drive A and then reboot the machine?"

"I've got to have this machine running today," he raged. "I'm losing thousands of dollars' worth of business because this !\$?/*@*#! machine won't work. I want somebody out here right now to fix this !%@?!@*#! machine. I can't afford to wait another hour. It has to be running today, do you understand me?"

"Yes, sir, we'll get you up and running in a minute. Would you *please* put the DOS disk in drive A and reboot the machine?" I responded, ignoring his outburst.

"Reboot?" he asked, puzzled.

I explained the process to him, and he was finally able to get the system booted. I wanted to make sure the hard disk drive was accessible and that his files were still there. The simplest way to do that was to execute a DIR C: directory command. Since this client (and many, many others who call in) obviously had not had a whole lot of personal computer training, I reasoned that I had better give him

some practice and have him do DIR all by itself first, saving the exotic things like "C:" for later.

"Sir, we need to see what files are on that disk. Would you please type DIR and then press the Enter key?"

"What?"

"Please just type the letters D, I, R and then press the Enter key," I repeated patiently.

"Type P, R, and do WHAT?"

"Please just type the letters D, I, R and then press the Enter key," I responded in a controlled voice.

"Type D, I, R, E, N, T, E, R?" the client asked.

"No, sir. Please type D, I, R and then press the Enter key," I said, my voice rising.

"Type D, I, R and press Enter?" the client asked.

"Yes, yes, press the D key, then the I key, then the R key, and then press the Enter key—four keystrokes in all," I begged.

"OK, OK," he bellowed.

Through the phone line I clearly heard the sound of keys being pressed, as the client followed the instructions. First I heard four very slow clicking sounds. Then I heard a faster volley of six clicks, then five slower clicks, then a burst of profanity. Then a loud, pounding, keyboard-destroying, machine-gun crescendo of clicking sounds too fast to count blasted across the line. Then all I heard was silence.

"What's that you said to type?" the client demanded belligerently.

Situations and conversations like these are an everyday occurrence on the help line. It's a tough job, but somebody has to do it.

As soon as I find that somebody, I'll gladly let him or her have my place. ■

William Lee is employed by a large, nationwide personal computer dealer (at least, he was the last time we checked). He can be reached on BIX c/o "editors."

Stop Bit is an open forum for informed opinion on topics related to personal computing. The opinions expressed are those of the author and not necessarily those of BYTE or its staff. Your contributions and comments are welcome. Write to: Editor, BYTE, One Phoenix Mill Lane, Peterborough, NH 03458.

DOS + QuickBASIC or C + Instrumentation Code Generation = ?

There's only one solution...

LabWindows



VXI

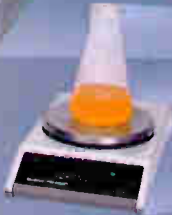

RS-232



GPIB



Plug-in Boards



Call for a **FREE**
LabWindows 1.2
Demo Disk

Are you using a DOS-based personal computer for controlling instrumentation? Do you want the best available software tools for acquiring and analyzing data using standard DOS programming languages? If your answer to these questions is *yes*, LabWindows® is just the solution you're looking for. The unique LabWindows function panel interface lets you interactively control your instrumentation hardware and collect data, as well as automatically generate Microsoft® C or QuickBASIC program code for your application.

With LabWindows you can control GPIB, RS-232, or VXI instruments, or plug-in data acquisition cards for PS/2 and PC-AT computers. For standalone instrument users, the LabWindows instrument library has over 50 ready-to-use instrument drivers so you can program your instrument using intuitive instrument-specific function panels, without knowing the instrument inside-out.

Because acquiring data is only one element of your application, LabWindows has a complete set of QuickBASIC and C compatible libraries for data analysis, presentation, and storage. Manipulate arrays, create a histogram, or use the optional Advanced Analysis Library to perform operations such as Fast Fourier Transforms, digital filtering, and curve

fitting. Give your programs a big performance boost using the specially optimized LabWindows analysis routines for computers with an 80387 numeric coprocessor. For your data presentation and storage needs, use the LabWindows Graphics Library to create multiplot graphs, bar charts, or scatter plots, and use the Data Formatting Library for data logging and file operations.

If you're looking for the right tools to take maximum advantage of your DOS computer using QuickBASIC or C for data acquisition and analysis, there is only one solution...LabWindows. Call National Instruments at (800) IEEE-488 to speak with a sales or applications engineer about how LabWindows can help you.

Ask for a **FREE** Catalog



**NATIONAL
INSTRUMENTS**®
The Software is the Instrument™

12109 Technology Blvd.
Austin, Texas 78727-6204
(512) 794-0100

Circle 227 on Reader Service Card

NATIONAL INSTRUMENTS OF JAPAN (03) 788-1922 ·
NATIONAL INSTRUMENTS OF FRANCE (1) 486 53370 ·
NATIONAL INSTRUMENTS UNITED KINGDOM (06) 355-23545 ·
ARGENTINA (1) 46-5776 · AUSTRALIA (2) 736-2888 · BELGIUM (2) 466-8199 · CANADA
(416) 890-2010, (613) 596-9300, (514) 747-7878, (403) 295-0822, (604) 988-2195 · CHILE (2) 225
3689 · DENMARK (2) 251-122 · FINLAND (0) 372 144 · GREECE (1) 361 1283 · HONG
KONG (2) 0426-2707 · IRELAND (846) 661414, (3) 427-2382 · ISRAEL (3) 324 298 · ITALY
(2) 984-91071-2-3 · KOREA (2) 776-5340 · MEXICO (5) 660-4323 · THE NETHERLANDS (7)
099-6360 · NEW ZEALAND (9) 444-2645 · NORWAY (2) 53-1250 · PORTUGAL (1) 545-313 ·
SINGAPORE (65) 336-4713 · SOUTH AFRICA (011) 787-0473 · SPAIN (1) 455-8112 ·
SWEDEN (8) 792-1100 · SWITZERLAND (6) 552 8949 · TAIWAN/THE REPUBLIC OF
CHINA (02) 703-6280 · THAILAND (2) 234-9330 · WEST GERMANY (89) 80-7081

WORKGROUPS

Tandy[®] Business Products

Team up for success.

The question is productivity. How can you keep expanding your business, coordinate your employees and still keep costs down?

By working together. Powerful Tandy 386™-based business computers make ideal file servers for proven 3Com and Novell workgroups. Everyone in your office can access the same software. Cut costs by using shared peripherals.

With E-mail, you can send memos without shuffling papers, and put an end to telephone tag.

And we're on your team, too. Radio Shack provides the best support services available in the industry.

Put together a winning game plan. Team up with Tandy business systems.

Radio Shack[®]
COMPUTER CENTERS
A DIVISION OF TANDY CORPORATION

386/TM licensed from Intel Corp.

Circle 277 on Reader Service Card