

BYTE

THE SMALL SYSTEMS JOURNAL[®]

PRODUCT FOCUS:
The Best
24-pin Printers

FIRST IMPRESSION

Microsoft's New OS/2 Languages:

- BASIC 6.0
- C 5.1
- FORTRAN 4.1
- MASM 5.1
- Pascal 4.0



IN DEPTH

How OS/2, Unix 386, and the Mac Manage Memory

Paradox is the best

There's no power like Paradox Power

PROGRAM	Overall Power	Overall Versatility	Search without an Index (sec.)	Subtotal on 100 Groups (sec.)	Subtotal on Two-File Join (sec.)	Three-File Join (sec.)	Four-File Join (sec.)	Many-to-Many Join (sec.)	Single-Record Search (sec.)	Group Search (sec.)	Indexed Single-Record Search (sec.)	
Paradox	8.4	9.2	7.5	1.0	6	100	221	325	459	364	322	18
dBASE III PLUS	7.9	8.9	6.9	0.5	17	93	525	1013	646	449	445	39

Source: Software Digest*

Paradox saves you from future shock

Trends for the future with Paradox

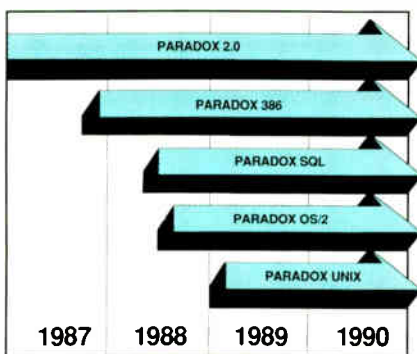

Paradox 386 allows users to take advantage of 16 Megabytes of Memory on a 386 machine. This allows Paradox users to work with databases that could in the past only be handled by minicomputers and mainframes.

Your investment today in Paradox applications is protected as new hardware and operating systems are used in your company. Paradox 2.0 applications will run unchanged on Paradox 386, Paradox OS/2, Paradox Unix and Paradox SQL! All versions of Paradox will be completely application and menu compatible. Paradox SQL will allow access to remote databases via SQL. Users will just type in a query as they normally would, and Paradox will translate that Query to SQL.

“ Paradox 2.0 will do for the LAN what the spreadsheet did for the PC

David Schulman,
Bendix Aerospace ”

Paradox makes your network run like clockwork

Paradox is just as valuable to multi and network users as it is to single users. It runs smoothly, intelligently and so transparently that multiusers can access the same data at the same time—without either being aware of each other or getting in each other's way. It works exactly the same way whether you're flying solo or as part of the crew.

“ Anyone who hasn't seen the network version of Paradox should take a look. Ansa has dramatically advanced the state of the art in multiuser network databases

Phil Lemmons,
BYTE 8/87

Paradox was a delight to use, both as a stand-alone product and from a local area network server.

Don Crabb,
InfoWorld ”

How to make your network network

To run Paradox 2.0 or the Paradox Network Pack on a network you need:

- Novell with Novell Advanced Network version 2.0A or higher
- 3Com 3Plus with 3Com 3+ operating system version 1.0, 1.1 or higher
- IBM Token Ring or PC Network with IBM PC Local Area Network Program version 1.12 or higher
- Torus Tapestry version 1.4 or higher
- AT&T Starlan Network with AT&T PC 6300 Network Program version 1.0
- Other network configurations that are 100% compatible with DDS 3.1 and one of the listed networks

System Requirements for Single User:

- DOS 2.0 or higher
- IBM® PS/2 and PC, Compaq® PC families and other 100% compatibles
- 512K RAM
- Two disk drives, 3½-inch and 5¼-inch supported
- Compatible monochrome, color, or EGA monitor with adapter

System Requirements for the Network Workstation:

- DDS 3.1 or higher
- 640K RAM
- Any combination of hard, floppy, or no disk drives
- Compatible monochrome, color, or EGA monitor with adapter

Optional Equipment:

- EMS and EEMS Boards: AST RAMpage Board,™ Intel Above Board™ or other expanded memory adapters
- Printers: Compatible dot matrix, letter quality, or laser printer

*Reprinted with permission by Software Digest from its July 1987 report covering 12 relational database programs.

†Test was designed and executed by NSTL. A 1,000-record and a 10,000-record file were joined. A short text field from the 1,000-record file and a numeric field from the 10,000-record file were selected (using the 1,000-record file indexes). The short text field was grouped and sorted in ascending order, the numeric field was subtotaled for each group, and the results output to a null printer. Test times from the last keystroke on the command sequence until return of program control were recorded and averaged.

Paradox is a registered trademark of Ansa Software. Ansa is a Borland International company. Other brand and product names are trademarks or registered trademarks of their respective holders. Copyright © 1988 Borland International, Inc. BI 1205A

Circle 39 on Reader Service Card (DEALERS: 40)

Paradox:
the top-rated
relational
database
manager
in the world...

PARADOX
Introduction



Ansa

Why Paradox

"Paradox[®] is once again the top-rated program, with the latest version scoring even higher than last year's top score." (Software Digest's July 1987 Ratings Report—an independent comparative ratings report for selecting IBM PC Business software).

All tests for the Ratings Report were done by the prestigious National Software Testing Laboratory, Philadelphia, PA, and the message is crystal clear: there is no better relational database manager than Paradox.

NSTL tested 12 different programs and amongst other results, discovered that Paradox is 3 times faster than dBASE; 6 times faster than R:BASE on a two-file join with subtotals test†.

Paradox does the impossible: combines ease-of-use with power and sophistication

Even if you're a beginner, Paradox is the only relational database manager that you

can take out of the box and begin using right away.

Because Paradox employs state-of-the-art artificial intelligence technology, it does almost everything for you—except take itself out of the box.

If you've ever used 1-2-3[®] or dBASE[®], you already know how to use Paradox. It has Lotus-like menus, and Paradox documentation includes "A Quick Guide to Paradox for Lotus users," and "A Quick Guide to Paradox for dBASE users."

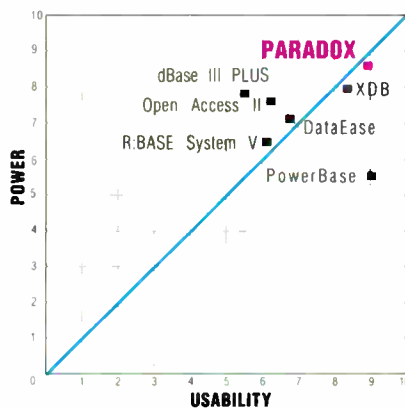

Source: Software Digest*

Ideal programs have high levels of both power and usability. Programs plotted in the upper righthand portion of the diagram above come closest to achieving that ideal.

“ Paradox still offers superior import/export facilities using Lotus 1-2-3, dBASE, ASCII and other file types. It transfers between formats with stunning speed

Rusel DeMaria, PC Week ”

Paradox responds instantly to "Query-by-Example"

The method you use to ask questions is called Query-by-Example. Instead of spending time figuring out *how* to do the query, you simply give Paradox an example of the results you're looking for. Paradox picks up the example and automatically seeks the fastest way of getting the answer. Paradox, unlike other databases, makes it just as easy to query multiple tables simultaneously as it is to query one.

Source: Software Digest*

Software Digest Rating	Overall Evaluation	Program Name	Version Tested	Ease of Learning	Ease of Use	Error Handling	Performance	Versatility	Memory Requirement	Price
☆☆☆☆	8.7	Paradox	1.1	■	■	■	■	■	512K	\$495
☆☆☆☆	8.2	XDB	1.10	■	■	■	■	■	320K	\$750
☆☆☆	7.6	PowerBase	2.3	■	■	■	■	■	384K	\$349
☆☆☆	7.0	Open Access II	2.0	■	■	■	■	■	256K	\$395
☆☆☆	7.0	DataEase	2.5/2	■	■	■	■	■	384K	\$600
☆☆	6.6	dBASE III PLUS	1.1	■	■	■	■	■	384K	\$695
☆☆	6.4	R:BASE System V	1.1	■	■	■	■	■	512K	\$700

RATINGS KEY
(On a scale of 0 to 10)

Overall Evaluation

- ☆☆☆☆ 9.0 or higher
- ☆☆☆☆ 8.0 - 8.9
- ☆☆☆☆ 7.0 - 7.9
- ☆☆ 6.0 - 6.9
- ☆ 5.0 - 5.9

All Other Ratings

- 7.0 - 9.9
- 5.0 - 6.9
- UNDER 5.0

Paradox: the new corporate standard

Paradox automatically updates your data and lets you control access to information

In "Co-Edit" mode, changes made by anyone are automatically updated to everyone. You can pre-set a "Screen-Refresh" interval to occur anywhere from 1-second to 1-hour intervals. (If you don't make a pre-set choice, Paradox automatically updates every 3 seconds so that your screen always shows you updated data).

While Paradox 2.0 lets everyone share and update information simultaneously, you can configure it to keep secrets secret.

You can restrict others' rights in a variety of ways with safeguards protecting confidential files and/or giving someone "Read Only" rights which is to allow "View," but prevent "Change." The Paradox technique—automatic file and record locking—ensures data accuracy and integrity in any multiuser environment.

For a brochure or the dealer nearest you call (800) 543-7543

“ With Version 2.0, Paradox becomes a sophisticated multiuser product that boasts an impressive selection of data-protection features and password-security levels

Rusel DeMaria,
PC Week ”

Get serious support for serious Paradox application programming

When you subscribe to the Paradox Developer's Resource Program (PDRP), you get all the resources and support you need for sophisticated Paradox application development: unlimited access to our toll-free PAL programmers support line; the Paradox Developer's Toolkit; a subscription to *Turbo Technix*, Borland's bi-monthly technical magazine; and a 20% discount on the Paradox User's Journal published by the Cobb Group.

Call our Customer Service Department at (408) 438-8400 for your free PDRP information kit with all the details.

PARADOX

by Ansa

A Borland Company



Circle 41 on Reader Service Card (Dealers: 42)

World Radio History

PARADOX



Product Focus/118

Contents

65 PRODUCTS IN PERSPECTIVE

67 What's New

89 Short Takes

Sharp PC-4521, a laptop with a hard disk drive
Sprint 1.0, Borland's third-generation word processor
Quad386XT, Quadram's booster board for the PC
DeskJet, a quiet ink-jet printer from HP
WordStar 2000 3.0, an upgrade with 662 features
ZCM-1490, Zenith's high-resolution color monitor
Microsoft Windows 2.0, a step toward OS/2

FIRST IMPRESSIONS

103 Microsoft Languages Update

by the BYTE Staff

These new versions of five language products offer a bridge to OS/2.

113 dBASE IV: A Paradox Killer?

by Nicholas Baran

The new version of Ashton-Tate's package is going to make life tougher for competitors like Paradox and R:base.

REVIEWS

118 Product Focus: The Best of the 24-pin Printers

by George A. Stewart

Dot-matrix printers are now good enough that you don't have to apologize for using one. BYTE Labs looks at 37 of the finest.



131 The WYSEpc 386

by Ed McNierney

Price, performance, and design highlight this 80386-based system.

137 Commodore Opens the Amiga

by Charlie Heath

The expandable Amiga 2000 can provide MS-DOS compatibility.

144 Laser Printing Without Lasers

by Rick Cook and Paul Schauble

The Taxan Crystal Jet and the Data Technology CrystalPrint VIII demonstrate the potential of liquid-crystal-shutter printers.

150 Getting the Bugs Out

by Ross M. Greenberg

AT Probe and Periscope III—two hardware-assisted debuggers with some unique features.

163 Two Fast C Compilers for PCs

by Namir Clement Shammass

Microsoft introduces an improved version of its C Compiler and QuickC.

168 New Power for FORTRAN

by Carl Byington

SVS FORTRAN from SAIC and MicroWay's NDP FORTRAN take advantage of the 80386 and its coprocessors.

181 Interleaf Publisher for the Macintosh II

by Paul Kahn

This publishing system includes good and bad features from the personal-computer and workstation worlds.

189 Review Update

COLUMNS

193 Computing at Chaos Manor:

Memories, Memories

by Jerry Pournelle

Jerry looks at Fastback Plus, Golden Bow products, extended versus expanded memory, and new items from Logitech.

211 Applications Only: Two Big Winners

by Ezra Shapiro

Ezra highly recommends both Decision Pad and QuicKeys.



In Depth/217



Features/261

217 IN DEPTH: Memory Management

218 Introduction

219 Overview of Memory Management

by Randall L. Hyde

Many of the memory management techniques for mainframes are migrating to the world of microcomputers.

227 OS/2 Virtual Memory Management

by Vic Heller

A look at how OS/2's hardware and software data structures work together to provide virtual memory, dynamic linking, and sharing of code.

237 Marrying Unix and the 80386

by Carl Hensler and Ken Sarno

How a Unix kernel design takes advantage of the 80386's memory management hardware.

249 Macintosh Memory Management

by Alan Anderson

With the Mac's generalized design, you can use the same software on a Mac 512KE or on a Mac II.

256 Resource Guide

261 FEATURES

263 Ciarcia's Circuit Cellar: The SmartSpooler Part 1: The Spooler Hardware

by Steve Ciarcia

SmartSpooler improves computing throughput with slow peripherals.

273 Dynamic Linking in OS/2

by Gordon Letwin, Chief Architect, Systems Software, Microsoft Corp.

Dynlinks make OS/2 programs smaller, more efficient, and easier to upgrade.

285 When Facts Get Fuzzy

by Bradley L. Richards

Add fuzzy logic to your Turbo Prolog programs and they'll be able to cope with the uncertainties of real-world situations.

293 Faster Than Fast Fourier

by Mark A. O'Neill

The fast Hartley transform is twice as fast as the fast Fourier and uses only half the computer resources.

DEPARTMENTS

6 Editorial: The New BYTE Lab

11 Microbytes

22 Letters

32 Chaos Manor Mail

36 Ask BYTE

51 Book Reviews

339 Coming Up in BYTE

READER SERVICE

338 Editorial Index by Company

341 Alphabetical Index to Advertisers

343 Index to Advertisers by Product Category

Inquiry Reply Cards: after 344

PROGRAM LISTINGS

From BIX: see 282

From BYTenet: call (617) 861-9764

On disk or in print: see card after 320



BYTE (ISSN 0360-5280) is published monthly with an additional issue in October by McGraw-Hill Inc. Founder: James H. McGraw (1860-1948). Executive, editorial, circulation, and advertising offices: One Phoenix Mill Lane, Peterborough, NH 03458, phone (603) 924-9281. Office hours: Monday through Thursday 8:30 AM-4:30 PM, Friday 8:30 AM-1:00 PM, Eastern Time. Address subscriptions to BYTE Subscriptions, P.O. Box 7643, Teaneck, NJ 07666-9866. Postmaster: Send address changes, USPS Form 3579, undeliverable copies, and fulfillment questions to BYTE Subscriptions, P.O. Box 7643, Teaneck, NJ 07666-9866. Second-class postage paid at Peterborough, NH 03458 and additional mailing offices. Postage paid at Winnipeg, Manitoba. Registration number 9321. Subscriptions are \$22 for one year, \$40 for two years, and \$58 for three years in the U.S. and its possessions. In Canada and Mexico, \$25 for one year, \$45 for two years, and \$69 for three years. \$69 for one-year air delivery to Europe, 31,000 yen for one-year air delivery to Japan, 15,600 yen for one-year surface delivery to Japan, \$37 surface delivery elsewhere. Air delivery to selected areas at additional rates upon request. Single copy price is \$3.50 in the U.S. and its possessions, \$4.25 in Canada and Mexico, \$4.50 in Europe, and \$5 elsewhere. Foreign subscriptions and sales should be remitted in U.S. funds drawn on a U.S. bank. Please allow six to eight weeks for delivery of first issue. Printed in the United States of America.

Address editorial correspondence to: Editor, BYTE, One Phoenix Mill Lane, Peterborough, NH 03458. Unacceptable manuscripts will be returned if accompanied by sufficient postage. Not responsible for lost manuscripts or photos. Opinions expressed by the authors are not necessarily those of BYTE.

Copyright © 1988 by McGraw-Hill Inc. All rights reserved. Trademark registered in the United States Patent and Trademark Office. Where necessary, permission is granted by the copyright owner for libraries and others registered with the Copyright Clearance Center (CCC) to photocopy any article herein for the flat fee of \$1.50 per copy of the article or any part thereof. Correspondence and payment should be sent directly to the CCC, 29 Congress St., Salem, MA 01970. Specify ISSN 0360-5280/83, \$1.50. Copying done for other than personal or internal reference use without the permission of McGraw-Hill Inc. is prohibited. Requests for special permission or bulk orders should be addressed to the publisher. BYTE is available in microform from University Microfilms International, 300 North Zeeb Rd., Dept. PR, Ann Arbor, MI 48106 or 18 Bedford Row, Dept. PR, London WC1R 4EJ, England.

Subscription questions or problems should be addressed to: BYTE Subscriber Service, P.O. Box 7643, Teaneck, NJ 07666-9866.

BYTE

THE SMALL SYSTEMS JOURNAL

EDITOR IN CHIEF
Frederic S. Langa

OPERATIONS
Glenn Hartwig *Associate Managing Editor*

REVIEWS (Hardware, Software, Product Focus)
Cathryn Baskin *Associate Managing Editor*, Dennis Allen *Senior Technical Editor, Software*, Curtis Franklin Jr. *Senior Testing Editor*, BYTE Lab, Stephen Apiki, *Testing Editor*, BYTE Lab

NEWS AND TECHNOLOGY (Microbytes, What's New, Short Takes)
Rich Malloy *Associate Managing Editor*, D. Barker *Senior Editor, News and Technology*, Anne Fischer *Lent Senior Editor, New Products*
Peterborough: Martha Hicks *Associate News Editor*, Jeff Merron *Associate News Editor*, Stan Miastkowski *Associate News Editor*
West Coast: Gene Smarte *Bureau Chief*, Costa Mesa, Jonathan Erickson *Senior Technical Editor*, San Francisco, Nicholas Baran *Associate Technical Editor*, San Francisco, Jeffrey Bertolucci *Editorial Assistant*, San Francisco

SENIOR TECHNICAL EDITORS
Ken Sheldon *Features*, G. Michael Vose *In Depth*, Richard Grehan *At Large*, Jane Morrill Tazelaar *At Large*, Tom Thompson *At Large*

TECHNICAL EDITORS
Janet Barron, George A. Stewart, Eva White, Stanley Wszola

CONSULTING EDITORS
Steve Ciarcia, Jerry Pournelle, Ezra Shapiro

CONTRIBUTING EDITORS
Jonathan Amsterdam *Programming Projects*, Mark Dahmke *Video, Operating Systems*, Mark Haas *At Large*, Rik Jadrnicek *CAD, Graphics, Spreadsheets*, Robert T. Kurosaka *Mathematical Recreations*, Alastair J. W. Mayer *Software*, Alan R. Miller *Languages and Engineering*, Dick Pountain *Algorithms*, Roger Powell *Computers and Music*, Phillip Robinson *Semiconductors*, Jon Shiell *High-Performance Systems*, Ernest Tello *Artificial Intelligence*

COPY EDITORS
Lauren Stickler *Chief*, Susan Colwell, Judy Connors-Tenney, Jeff Edmonds, Nancy Hayes, Cathy Kingery, Margaret A. Richard, Warren Williamson

EDITORIAL ASSISTANTS
Peggy Dunham *Office Manager*, L. Ryan McCombs, June N. Sheldon

ART
Nancy Rice *Director*, Joseph A. Gallagher *Assistant Director*, Jan Muller *Assistant*, Alan Easton *Technical Artist*

PRODUCTION
David R. Anderson *Director*, Denise Chartrand, Michael J. Lonsky, Virginia Reardon

TYPOGRAPHY
Sherry Fiske *Systems Manager*, Selinda Chiquoine, Donna Sweeney

ADVERTISING/PRODUCTION (603) 924-6448
Lisa Wozmak *Supervisor*, Lyda Clark *Senior Account Coordinator*, Karen Cilley, Linda Fluhr, Jeanne Gatcombe, Brian Higgins, Rod Holden, Wai Chiu Li *Quality Control Manager*, Julie Murphree *Advertising/Production Coordinator*

ADMINISTRATION
Beverly Jackson *Publisher's Assistant*

MARKETING COMMUNICATIONS
Horace T. Howland *Director*
Laurie MacMillan *Promotion Manager*, Wilbur S. Watson *Marketing Services Manager*, Lisa Jo Steiner *Marketing Assistant*, Stephanie Warnesky *Marketing Art Director*, Sharon Price *Associate Art Director*, Julie Perron *Market Research Analyst*

PLANNING AND RESEARCH
Michele Perron *Director*
Faith Kluntz *Copyrights Coordinator*, Cynthia Damato *Sands Reader Service Coordinator*

FINANCIAL SERVICES
Philip L. Penny *Director of Finance and Services*, Kenneth A. King *Business Manager*, Christine Monkton *Assistant*, Marilyn Haigh, Diane Henry, JoAnn Walter, Jaime Huber

CIRCULATION
Dan McLaughlin *Director*
James Bingham *Newsstand Sales Manager*, Vicki Weston *Assistant Manager*, Claudette Carswell *Distribution Coordinator*, Karen Desroches *Direct Accounts Coordinator*, Louise Menegus *Back Issues*

PERSONNEL
Patricia Burke *Personnel Coordinator*, Donna Healy *Receptionist*

BUILDING SERVICES
Tony Bennett *Manager*, Cliff Monkton, Mark Monkton, Agnes Perry

BIX

BYTE INFORMATION EXCHANGE

ACTING DIRECTOR
Edward A. Reno Jr.

EXECUTIVE EDITOR
George Bond

SENIOR EDITOR
David Betz

ASSOCIATE EDITORS
Tony Lockwood, Donna Osgood *San Francisco*

MICROBYTES DAILY
D. Barker *Coordinator*, Peterborough, Rich Malloy *New York*, Gene Smarte *Bureau Chief*, Costa Mesa, Nicholas Baran *San Francisco*, Rick Cook *Phoenix*, Jonathan Erickson *San Francisco*, Martha Hicks *Peterborough*, Anne Fischer *Lent Peterborough*, Larry Loeb *Wallingford, CT*, Brock N. Meeks *La Mesa, CA*, Jeff Merron *Peterborough*, Stan Miastkowski *Peterborough*, Wayne Rash Jr. *Washington, DC*, David Reed *Lexington, KY*

GROUP MODERATORS
David Allen *Applications*, Frank Boosman *Artificial Intelligence*, Leroy Casterline *Other*, Marc Greenfield *Programming Languages*, Jim Howard *Graphics*, Gary Kendall *Operating Systems*, Steve Krenek *Computers*, Brock N. Meeks *Telecommunications*, Barry Nance *New Technology*, Donald Osgood *Computers*, Sue Rosenberg *Other*, Jon Swanson *Chips*

BUSINESS AND MARKETING
Doug Webster *Director (603) 924-9027*, Patricia Bausum *Secretary*, Denise A. Greene *Customer Service*, Brian Warnock *Customer Service*, Tammy Burgess *Customer Credit and Billing*

TECHNOLOGY
Clayton Lisle *Director, Business Systems Technology*, MHS, Bill Garrison *Senior Business Systems Analyst*, Jack Reilly *Senior Business Systems Analyst*, Bob Dorobis *Business Systems Analyst*

PUBLISHER/GROUP VICE PRESIDENT
J. Burt Totaro

ADVERTISING SALES
Dennis J. Riley *Director*, (603) 924-9281
Sandra Foster *Administrative Assistant*

NEW ENGLAND
ME, NH, VT, MA, RI, ONTARIO, CANADA & EASTERN CANADA
(617) 262-1160

ATLANTIC
NY, NYC, CT, NJ (NORTH)
Leah G. Rabinowitz (212) 512-2096
Dick McGurk (203) 968-7111

EAST
PA, KY, OH, NJ (SOUTH), MD, VA, W.VA, DE, D.C.
Daniel Ferro (215) 496-3833

SOUTHEAST
NC, SC, GA, FL, AL, TN
Carolyn F. Lovett (404) 252-0626

MIDWEST
IL, MO, KS, IA, ND, SD, MN, WI, NE, IN, MI, MS
Bob Denmead (312) 751-3740

SOUTHWEST, ROCKY MOUNTAIN
CO, WY, OK, TX, AR, LA
Karl Heinrich (713) 462-0757

SOUTH PACIFIC
SOUTHERN CA, AZ, NM, LAS VEGAS
Jack Anderson (714) 557-6292
Tom Harvey (213) 480-5243

NORTH PACIFIC
HI, WA, OR, ID, MT, NORTHERN CA, NV (except LAS VEGAS), UT, WESTERN CANADA
Mike Kisseberth (415) 362-4600
Bill McAfee (415) 349-4100

TELEMARKETING
L. Bradley Browne *Director*
Susan Boyd *Administrative Assistant*

BYTE BITS (2x3)
Dan Harper (603) 924-6830

THE BUYER'S MART (1x2)
Mark Stone (603) 924-3754

REGIONAL ADVERTISING SECTIONS
MID-ATLANTIC, METRO NY & NEW ENGLAND, SOUTHERN CALIFORNIA, SOUTHEAST
Elisa Lister (603) 924-6830

MIDWEST, PACIFIC NORTHWEST, SOUTHWEST, METRO NY & NEW ENGLAND
Scott Gagnon (603) 924-9261

BYTE DECK MAILINGS
National
Ed Ware (603) 924-6166

A/E/C COMPUTING DECK
COMPUTING FOR ENGINEERS DECK
Mary Ann Goulding (603) 924-9281

EDITORIAL AND BUSINESS OFFICE:

One Phoenix Mill Lane, Peterborough, NH 03458, (603) 924-9281.

West Coast Branch Offices: 425 Battery St., San Francisco, CA 94111, (415) 954-9718; 3001 Red Hill Ave., Building #1, Suite 222, Costa Mesa, CA 92626, (714) 557-6292.

New York Branch Editorial Office: 1221 Avenue of the Americas, New York, NY 10020, (212) 512-3175.

BYTEnet: (617) 861-9764 (set modem at 8-1-N or 7-1-E; 300 or 1200 baud). **Fax:** (603) 924-7507. **Telex:** (603) 924-7861.

SUBSCRIPTION CUSTOMER SERVICE: Non-U.S. (201) 837-1315; inside U.S. (outside NJ) 1-800-423-8272; (inside NJ) 1-800-367-0218.

Officers of McGraw-Hill Information Systems Company: President: Richard B. Miller, Executive Vice Presidents: Frederick P. Jannott, Construction Information Group; Russell C. White, Computers and Communications Information Group; J. Thomas Ryan, Marketing and International. Senior Vice Presidents—Publishers: Laurence Altman, Electronics; David J. McGrath, Engineering News-Record. Group Vice Presidents: J. Burt Totaro, BYTE; Frank A. Shinal, Dodge; Peter B. McCuen, Communications Information. Vice Presidents: Robert D. Daleo, Controller; Fred O. Jensen, Planning and Development; Michael J. Koeller, Human Resources; Julia Lenard, Systems Planning and Technology.

Officers of McGraw-Hill Inc.: Harold W. McGraw Jr., Chairman; Joseph L. Dionne, President and Chief Executive Officer; Robert N. Landes, Executive Vice President, General Counsel, and Secretary; Walter D. Serwatka, Executive Vice President and Chief Financial Officer; Shel F. Asen, Senior Vice President, Manufacturing; Robert J. Bahash, Senior Vice President, Finance and Manufacturing; Frank D. Penglass, Senior Vice President, Treasury Operations; Ralph R. Schulz, Senior Vice President, Editorial.

BYTE, BITE, and The Small Systems Journal are registered trademarks of McGraw-Hill Inc.

smARTWORK® Keeps Getting Smarter

NEW

**Autorouter Included
Still \$895**

Smarter Artwork

Three years ago, Wintek engineers created smARTWORK to reduce the time and tedium of laying out their own printed-circuit boards. Thousands of engineers have since discovered the ease of use and sophistication that makes smARTWORK the most popular PCB CAD software available. And thanks to them, smARTWORK keeps getting better.



smARTWORK transforms your IBM PC into a PCB CAD system

Interactive routing, continual design-rule checking, pad shaving, and production-quality 2X artwork have always been a part of smARTWORK. And now that many customer suggestions have become a part of the software, smARTWORK is an even better value. *That's why we offer it with a thirty-day money-back no-nonsense guarantee.*

Using an Epson or IBM dot-matrix printer, you can create 2X artwork and 1X or 2X checkplots in a fraction of the time hand-taping requires

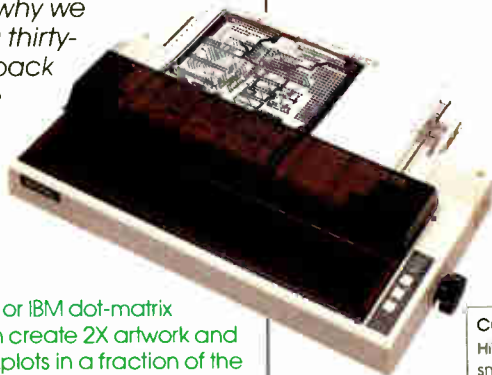

New smARTWORK Features

- Silkscreen layer for component placement and identification
- Text capabilities for all three layers
- Selectable trace widths and pad shapes and sizes
- User-definable library
- Ground planes created with a single command
- Solder-mask and padmaster plots generated automatically
- Quick printer 2X checkplots
- Additional drivers for printers and plotters
- Optional drill-tape and Gerber photoplotter utilities
- AutoCAD® .DXF file output
- Completely updated manual
- 800 number for free technical assistance

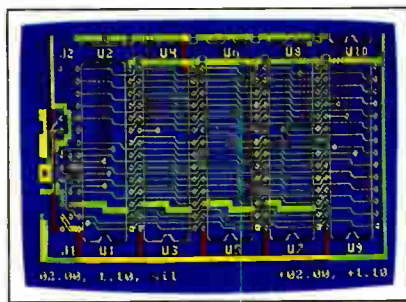

2" by 4" section of a 10" by 16" double-sided board with silkscreen layer

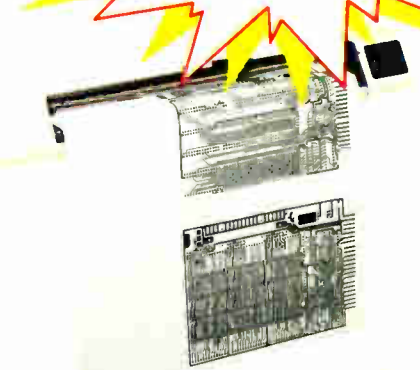

Camera-ready 2X artwork from an HI or HP pen plotter

The Smart Buy. Guaranteed.

Still priced at \$895, smARTWORK is proven, convenient, and fast. Our money-back guarantee lets you try smARTWORK for 30 days at absolutely no risk. Call toll free (800) 742-6809 today and put smARTWORK to work for you tomorrow. That's smart work.

System Requirements

- IBM PC, PC XT, or PC AT with 384K RAM, and DOS V2.0 or later
- IBM Color/Graphics Adapter with RGB color or B&W monitor
- IBM Graphics Printer or Epson FX/MX/RX-series printer, and/or
- Houston Instrument DMP-40, 41, 42, 51, 52, or Hewlett-Packard 7470, 7475, 7550, 7580, 7585, 7586 pen plotter
- Optional Microsoft Mouse

Wintek Corporation
1801 South St.
Lafayette, IN 47904
Telephone: (800) 742-6809
In Indiana: (317) 742-8428
Telex: 70-9079 WINTEK CORP UD



smARTWORK®, Wintek, and the Wintek logo are registered trademarks of Wintek Corporation. AutoCAD is a registered trademark of Autodesk, Inc.

Current Versions	
HIWIRE	V1.1r1
smARTWORK	V1.3r5

Europe: RNA Terminals Ltd., England, Phone: 04862-71001, Telex: 859502 / Australia: Entertainment Audio Pty. Ltd., Phone: (08) 363-0454 or (008) 98 5414 / Brazil: Comico Informatica E Tecnologia Ltda., Phone: (041) 224-5616

EDITORIAL

The New BYTE Lab

We've never done much horn-blowing or flag-waving about our original microcomputer lab, which we've had for years, because it seemed obvious that any publication purporting to offer authoritative test results would have a well-equipped place in which to run tests and examine equipment without interruption or distraction. A basic computer lab should be standard equipment for any microcomputer publication—a basic lab is really no big deal.

Of course, BYTE isn't a "basic" computer publication, and as of late winter, neither is our lab. In order to provide meaningful and reliable analysis of increasingly sophisticated hardware and software, we're in the process of assembling a truly unique and innovative testing facility—one that will let us run tests that no other publication is doing, and that will let us present you with information of unmatched depth and accuracy on state-of-the-art computer systems and subsystems.

Senior Testing Editor Curt Franklin heads the new lab. Here's what he says about the capabilities the new facility will give us:

"How reliable is your equipment? It's almost impossible to know, prior to purchase, how your new hardware will work after extended operation—or how it will react to temperature fluctuations. Some hard disk drives, for example, are notorious for seek errors caused by thermal expansion and contraction. Our Despatch environmental chamber will let us examine equipment in a controlled environment and look at how well the equipment performs after extended operation near the limits of its operating parameters.

"BYTE readers expect us

to open up computer systems for them, giving them information they can't find anywhere else. The Hewlett-Packard 16500A logic analysis system will let us do just that. We'll be able to do 25-MHz state analysis, timing

analysis to 1 gigahertz, and look at waveforms at a rate of up to 400 megasamples per second. The capabilities of this equipment mean that we'll be giving our readers more accurate information than ever before on computer buses, memory and storage systems, and computer architectures.

"Modems and other communications equipment are increasingly important parts of most computer systems. The ability of a modem to deal with noise, dropouts, and other real-world problems may have more to do with communications throughput than the modem's maximum rated data transfer rate. We want you to know how well a modem really works. With a computer-controlled, automated test set (i.e., the Autotest 1A from AEA), we'll be giving BYTE readers objective, comparative test information on the next generation (or two or three) of modems.

"Each of us spends more time working with the computer monitor than with any

other piece of personal computer equipment. In our February issue, George A. Stewart analyzed and compared a number of monitors using the Superspot 100 CRT analyzer from Microvision—the first truly objective monitor tests ever to appear in a microcomputer magazine. We now have a Superspot 100, so you can expect in-depth, accurate reviews of monitors like you've never seen before.

"In addition to the 'big' pieces of equipment in the lab, we've added numerous other items, like power line monitors (for testing uninterruptible power supplies and letting us factor power fluctuations into our other test results), hard disk and floppy disk analyzers, and other equipment that lets us bring readers the technical depth and accuracy they've come to expect from BYTE."

Curt's right. What's more, the lab we're building now is not a one-shot deal. We've made a major commitment to keep up with developing technology and to develop our own capabilities to look at the products you're interested in. For example, we are now looking into ways to objectively test and report on local-area networks, and we'll be adding a LAN test facility and other technology testing to our lab in the future.

Last—but certainly not least—are the people Curt has hired for our lab. Steve Apiki and Stan Diehl are electrical engineers who have joined us as testing editors; they'll help BYTE keep and improve its reputation as a magazine written by experts for experts.

Once the last pieces of equipment have been delivered and installed (as I write this, several of the large items, like the environmental chamber, are being built to our specifications), you'll start seeing the results of our new lab in the Reviews section.

The lab will also play a major role in helping us to analyze and examine brand-new architectures—like machines based on the 68030 and 80486 chips—as soon as they emerge.

It's all part of our commitment to keep BYTE your premier source of detailed, objective, authoritative information on both the state of the market and the state of the art.

You deserve nothing less.

—Fred Langa
Editor in Chief

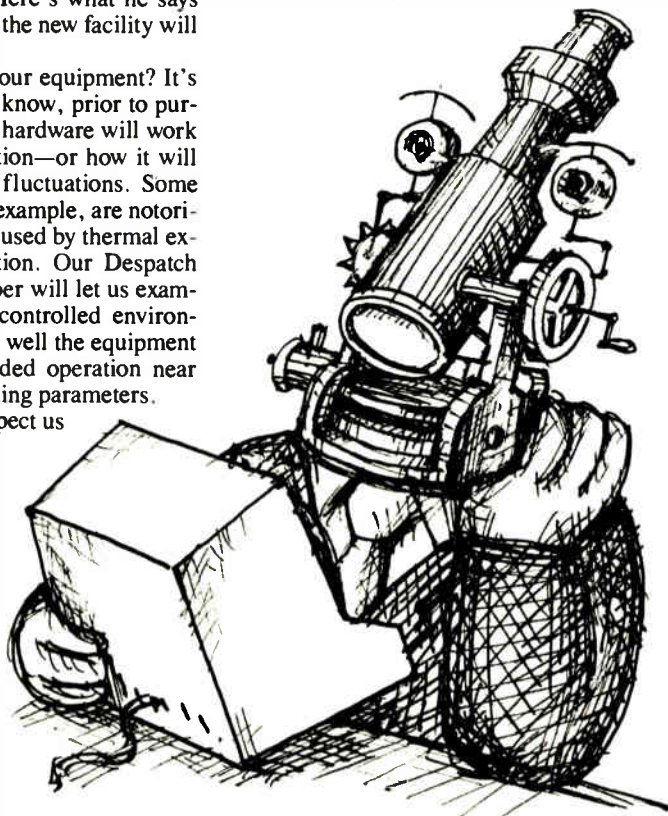

And then...
Maxell created
the RD Series.



The
Evolution
of the
Floppy Disk

Maxell Corporation of America, 22-08 Route 208, Fairlawn, NJ 07410

Never before has this level of Reliability
and Durability been available in floppy disks.
Introducing the new RD Series from Maxell.
Twice the durability of the disks you're now using.
Twice the resistance to dust and dirt.
And the RD Series is ten times more reliable
than conventional floppy disks.
The Gold Standard has always meant maximum
safety for your data. Now it means even more.



maxell
THE GOLD STANDARD

The new Diconix 300 Desktop and 300w Wide-Carriage
mistake them for Diconix 150s. Before you



Plain paper printers. So quiet, so small, so fast, you could
decide on a PC printer, reflect on these.



DICONIX

A Kodak Company

3100 Research Boulevard
Dayton, Ohio 45420
1-800-DICONIX

- Semi-automatic paper handling
 - 308 characters per second
 - IBM & Epson emulation
- Circle 80 on Reader Service Card

Discover a new world of C performance.

IMMEDIATE DELIVERY!
1-800-265-4555

At a special low introductory price!

WATCOM announces a new team of high-performance C language development systems that deliver proven superior results. Both are available now, at low introductory prices, for IBM PCs, PS/2s, and compatibles.

Best of Both Worlds.

Both systems are optimizers. Express C optimizes your time, WATCOM C6.0 optimizes your code. You win both ways!

WATCOM C6.0 Optimizing Compiler and Tools For the Fastest Tightest Code.

This unique development system produces the fastest execution speeds and smallest code available, as shown in benchmark tests against Microsoft C5.0 and Turbo C. It includes the new WATCOM VIDEO Debugger which quickly diagnoses elusive bugs without the need for extended memory even in very large programs. WATCOM C6.0 comes with a copy of Express C and offers a broad spectrum of advantages including: Extensive fine-tuning capabilities. A sophisticated register allocation scheme that eliminates many costly memory references. True register variables. Flow analysis. Altogether it allows your code to run its quickest.

Without a doubt, WATCOM C6.0 is the ideal choice for all memory models, small to huge, and on systems with or without 80x87. Its flexible run-time conventions also allow efficient interfacing with a wide range of libraries and language processors.

Superlative Performance

- Full ANSI C Optimizing Compiler
- Visual Interactive Debugger
- Full ANSI C Run-time Library
- Source Editor
- WATCOM C and Express C User's Guides
- WATCOM C Language and Library References
- WATCOM Editor User's Guide

- On-line Help Text
- Disassembler
- Overlay Linker
- Object Librarian
- MAKE
- Express C

List Price:
\$495

Introductory
Price:

\$295*

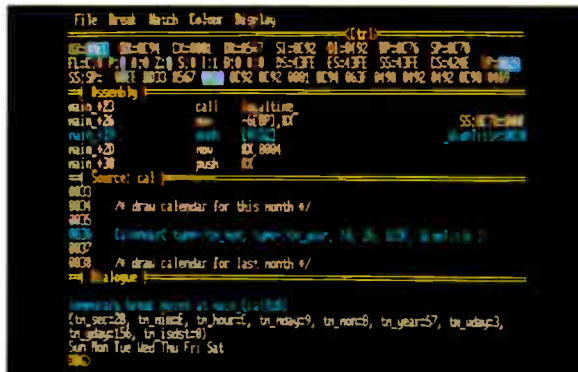

With the WATCOM VIDEO debugger you can debug large applications without extended memory.

Software Credentials

WATCOM C6.0 is the product of 20 years of computer language experience dating back to the creation of WATFOR in 1965. Our commitment to technical support matches our commitment to deliver the world's fastest and

most productive programming tools. With more than 400,000 software products in worldwide use and site licensing available for multiple machines and networks, you simply cannot find a better source of software development tools.

The fastest, tightest code
(small memory model*)

141	182	154	25 Iterations Sieve
11.4	13.0	14.1	
992	1246	1144	Dhrystone
89.0	98.0	121.0	

WATCOM C6.0 IBM PC XT Microsoft C5.0 Turbo C

The fastest, tightest code
(medium memory model*)

150	184	159	25 Iterations Sieve
2.7	3.0	3.4	
1001	1232	1156	Dhrystone
18.0	19.0	24.0	

WATCOM C6.0 IBM PS/2 Model 60 Microsoft C5.0 Turbo C

Turnaround Time (compile + link/load)

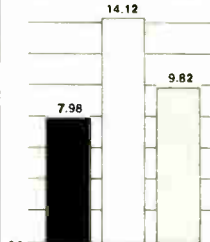

Floating point computation

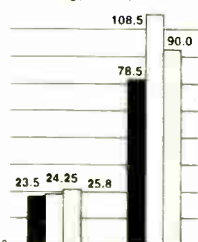

WATCOM Express C For the Fastest Development Environment.

This seamless development environment offers high speed compilation and the ultimate in programming ease. It is an integrated editor, compiler, debugger, linker and run-time system. With unexcelled diagnostic capabilities, it quickly checks apparently correct code and uncovers common or difficult bugs that other compilers miss. Express C provides you with reliable code and exceptional productivity.

Unparalleled Productivity

- Full ANSI C Compiler
- Integrated Source Editor
- Integrated Debugger
- Full ANSI C Run-time Library
- Integrated linker/loader
- On-line Help Text
- WATCOM C Library Reference
- WATCOM Express C User's Guide
- WATCOM C Language Reference
- Overlay Linker
- Object Librarian
- MAKE

List Price:

\$125

Introductory
Price:

\$75*

SPECIAL INTRODUCTORY OFFER!

- ___ C6.0 at introductory price \$295
- ___ Express C, at introductory price \$75
- ___ Please send product information.
- ___ Please contact re: site licensing and corporate price quotes.

*Limited time introductory prices apply only to prepaid orders. (VISA/MasterCard) Shipping and handling extra.



Dept. BY-04, Suite 306-21
1430 Massachusetts Ave., Cambridge, MA 02138

Available now. For immediate delivery in the USA and Canada Call:

1-800-265-4555

Name _____
Title _____ Tel. # _____
Company _____
Street _____
City _____ State _____ Zip _____
Visa ___ MasterCard ___ Card # _____
Exp. Date _____ Signature _____
WATCOM and Express C are trademarks of WATCOM Systems Inc.
Copyright 1988 WATCOM Products Inc.

MICROBYTES

*Staff-written highlights of developments
in technology and the microcomputer industry*

New Approach Could Bring Good Color to Micro Printers

While color display technology has sped forward, the printer technology needed to get color from screen to paper has not. But that could change in the near future if printer makers can successfully implement a new color technology, called Cycolor, being developed by Mead Imaging (Miamisburg, OH). Several well-known computer printer companies, including Brother and Seiko-Epson, have become "hardware partners" with Mead and are developing Cycolor-based printers.

The most immediate application for the technology will be color copiers and 35mm slide printers, with products expected to be available within the year. Chuck Davis, director of Mead Imaging's System Group, told Microbytes that color computer printers using the Cycolor process are at least 2 years away. Davis said some new printer designs will have to evolve, and he suggested that the use of fiber-optic CRTs and liquid crystal shutters are likely candidates for bringing reasonably priced Cycolor-based printers to the desks of personal computer users. He declined to speculate on end-user pricing.

Mead calls the Cycolor process a "photographic-like" film technology. Unlike conventional color photographic materials, which contain silver halide light-sensitive salt crystals, the Cycolor film is coated with millions of light-sensitive microcapsules called cyliths. Each cylith is about 1/10 the diameter of a human hair and contains a liquid monomer in which a color-forming substance called a leuco dye is dissolved. Individual cyliths are sensitive to either red, green, or blue light.

In a process close to normal photography, when the cyliths are exposed to visible light, a latent image is formed. But unlike conventional color film, developing the image involves no messy chemicals or precise temperatures. The Cycolor film and either special paper or transparency film are compressed together through rollers. In an additive color process, unexposed cyliths release dyes that mix together and react with a special coating on the paper or transparency film, producing a positive image. One final step—heating the positive image—"fixes" the image and brings out the maximum color brightness.

Microsoft Plans Object-Oriented Enhancements

We may not see a "Quick Smalltalk" in the near future. But Microsoft (Redmond, WA) does plan to add object-oriented enhancements to its language products. This is necessary in part, chairman Bill Gates said, because of the difficulty programmers are having, and will continue to have, writing sophisticated graphics-based applications.

"Because we've been using classic programming languages, it is particularly hard to write these applications," Gates explained. "That's something that Apple and the Macintosh market has not yet overcome, and that's something we've not overcome either. What we are going to do is extend our classic languages like BASIC and C to be object-oriented in the same strong sense that Smalltalk has been."

As an example, Gates described a

word processor that allowed users to insert generic "objects" into a document. In the past, a programmer's task was relatively easy, said Gates. A programmer working on a word processor simply decided in advance exactly what sorts of things would be allowed inside a document, and nothing else mattered.

With the advent of objects like voice data, new image formats, drawings, charts, and so on, the programmer's job became more complex. The document might contain, for example, a voice object that takes advantage of the dynamic linking capabilities inside OS/2. When the user encounters the voice object, he or she clicks on it, the voice code is run through a hardware device, and the user listens to the object.

continued

Nanobytes

- Despite developers' pleas, **Apple Computer** (Cupertino, CA) continues to snub **Display PostScript** for its video monitors. Developers contend that QuickDraw-based images on the Macintosh screen don't match the printed output of PostScripted LaserWriters. If the screen used Display PostScript instead of QuickDraw, they say, users could have true WYSIWYG. But "Apple has no intention of supporting any imaging models other than QuickDraw at this time," says Apple vice president Jean-Louis Gassée. "We'll keep improving QuickDraw but there's no confusion; we won't support it [Display PostScript]."

- **Gallium arsenide (GaAs)** chips promise smaller, faster computers. New GaAs dynamic RAMs being licensed by **Research Corporation Technologies** (Tucson, AZ) could bring that promise closer to reality. The DRAMs, developed by James Cooper and colleagues at Purdue University, are one-transistor devices that take up 1/5 the space required by multitransistor static RAMs and can operate at up to 125 degrees C. The nonprofit RCT says the chips also make high-density dynamic memory available to GaAs designers.

- **Motorola** has published its **68030** user's manual, chock full of descriptions of those data and instruction caches, the memory management unit, applications information, and electrical specs. The manual costs \$6. Contact Motorola's Literature Distribution Center, P.O. Box 20924, Phoenix, AZ 85036.

- **Anza Research** (Cupertino, CA) has put a **bibliography of neural network** references on disk. NeuralBase contains more than 2700 annotated entries. Fortunately, the program lets you

continued

search for information using 177 keywords. The disks, which run on the IBM PC and compatibles with at least 512K bytes of memory, sell for different prices, depending on which year you want; the entire set costs \$300.

- **Migent** (Incline Village, NV), maker of that cute little Pocket Modem, has not had an easy first year. Lawsuits and layoffs tend to put a damper on things. The company had hoped to get some positive publicity with its **advanced publishing package**, Impact, which we've heard combines editing, graphics, and page composition. But at MacWorld Expo, where Impact was to make its debut, the company nixed the intro.

- Thirteen companies so far have signed up to participate in studies of electronic applications of **superconductors** at the Microelectronics and Computer Technology Corp. (Austin, TX). MCC said the baker's dozen consists of Bellcore, Boeing, Control Data, Digital Equipment, E. I. du Pont, Eastman Kodak, General Electric, Harris, 3M, Motorola, NCR, Rockwell, and Westinghouse.

- **Logitech** (Fremont, CA) has started shipping its package aimed at turning regular old PCs into **spiffy graphics systems**. The Logitech Graphics Subsystem provides a mouse, EGA board (640- by 480-pixel resolution), AutoSync monitor (normally \$699), and Logitech Plus and PaintShow software. All that for \$999.

- **IBM** (Rye Brook, NY) is offering a hardware setup that hooks to a PS/2 and voices what's on the screen. The **\$600 Screen Reader**, designed for blind and visually impaired people, consists of a keypad, program, and documentation in disk or audiocassette form. A text-to-speech synthesizer is required. For more information, telephone (800) 426-2468.

- **CalComp** (Anaheim, CA) and **Minolta Camera** (Osaka, Japan) are teaming up to design and sell **color plotters** that fit on desktops. The A- and B-size plotters will use thermal-transfer technology. The companies say they'll start shipping the units soon.

For such applications to be developed, the operating system will have to provide object support. OS/2 will have added functionality that will enable the operating system to better help applications manage data, Gates said.

"In an object-oriented development environment," he explained, "the operating system has to get involved. You want the operating system to help you find things and keep track of where things are moved or tell you that you are deleting something that is being used in other places." He added that "the real hard part of this is sending around linked data, and nobody has been able to make that easy. You are not going to get the full leverage of applications working with applications until we get this inside the operating system."

Gates said Hewlett-Packard's New-

Wave system (see February Microbytes) is an embedded object system but that it falls short because the lack of a common subroutine library level prevents the object management capabilities from being fundamental to the system.

Although object-oriented languages like Smalltalk are available, Gates has doubts about introducing any new languages. "I question anyone's strategy of introducing new computer languages after 1988 and trying to get people to write applications in them," he said. "I really think that our current languages with object management extensions can permit us to deal with the graphical world. I think over the next year, we'll be able to make development of these new applications virtually as easy as normal types of development with older applications."

PostScript Will Get Faster

For those of you who've complained about how long it takes your PostScript printer to produce copy, be patient. Adobe Systems (Mountain View, CA) has come up with ways to speed up execution, and users should begin to reap benefits before the end of the year.

Adobe president John Warnock told Microbytes that the company realized a year ago that the version of PostScript used with laser printers simply wasn't fast enough for Display PostScript, the version of the language that creates images on a video monitor.

Instead of patching PostScript to work on the display, Adobe developed new algorithms that reduce overhead and reorganize the way Adobe PostScript works. Because of these changes, the program doesn't have to go into and out of the interpreter when performing low-level operations, said an Adobe programmer. Warnock said that later this

year, the revised technology will be moved to the printer version of the language.

Adobe programmers would not comment on how much performance improvement users would enjoy, stating that there are too many variables (such as type of printer and complexity of image) involved to state speed gains definitively.

How soon will the faster version be available to end users? That depends on printer manufacturers, said one Adobe spokesperson. Warnock said it's scheduled to be delivered to printer makers in the fall but that he wants to make it happen sooner than that if possible. How current owners of PostScripted printers benefit from the performance increases will be left up to the individual printer manufacturers. Conceivably, manufacturers could produce new ROMs that would then be installed in their printers.

Chips Brings PS/2 Clones One Step Closer...

Chips & Technologies (San Jose, CA) has brought clones of IBM's PS/2 computers one step closer to reality with two new chip sets that it says are fully compatible with IBM's Micro Channel Architecture. Although he wouldn't name any specific PS/2 clones, C&T chairman Gordon Campbell told Microbytes that users will begin seeing Model 50 and 60 clones by the end of the second quarter, perhaps by Spring COMDEX in Atlanta. He said Model 80 clones will be "a little behind" but should be available by the third quarter.

Personal computers that are compatible with IBM's PS/2 Model 80 and built around C&T's new Chips/280 chip set will be able to run at up to 25 MHz, will use memory of up to 16 megabytes, will provide better graphics than IBM's PS/2, and will be cheaper to build and sell, the company says. One reason a C&T-based Model 80 compatible will be less expensive is that it will require 75 devices on the system motherboard, 117 less than IBM's. Less-expensive 100-nanosecond dynamic RAM chips

continued



AnthroCart®

The original AnthroCart. Mobile. Incredibly strong. So many ways to solve your space and equipment problems. Choose different sizes. Move shelves around. Add space saving options.

AnthroCart. Well designed technology furniture. Look for our name.

Call us: 800-325-3841



*Made in U.S.A.
Holds up to 150 lbs*



Anthro Corporation
Technology Furniture
3221 N.W. Yaon St.
Portland, OR 97210
503-247-7112

Anthro Corporation is a subsidiary of Technics Inc.
Anthro is a registered trademark of Technics Corporation.
Only 20 on Reader Service Card

running at 16 MHz with 0.5 to 0.7 wait states can be used (as compared to the more expensive 80-ns, 16-MHz, one-wait-state DRAMs used by IBM) to further lower system costs.

C&T's new Model 80-compatible chip set, called the Chips/280, consists of a CPU/Micro Channel controller, an advanced memory controller, an advanced direct-memory-access (DMA) controller, data address buffers, a system peripherals controller, a multi-function controller, a hard disk controller chip set (from Adaptec), and a custom or standard micro chip.

C&T claims that its 280 chip set provides several enhancements over the IBM Micro Channel implementation, including multilevel arbitration control on the Micro Channel and high-perfor-

mance DMA. On 16-MHz systems, for instance, Chips/280 DMA runs at 10 MHz, while IBM DMA runs at 8 MHz.

C&T says that machines built around its Model 50/60-compatible chip set, the Chips/250, will be able to run at up to 20 MHz and use memory of up to 8 megabytes. A C&T-based PS/2 compatible will require only 68 devices on the system motherboard, 51 less than IBM's. The chip set uses less expensive 200-ns 10-MHz DRAMs as compared to IBM's 120-ns 10-MHz memory chips. (The 250 can also use either 150-ns 12-MHz DRAMs or 120-ns 16-MHz memory.)

The 16-bit Chips/250 set uses a "matched memory" implementation that C&T claims provides 50 percent faster Micro Channel memory cycles than on

the IBM equivalents. Because the 250 is tightly coupled with VGA, a fast VGA cycle cuts I/O and memory cycles by 50 percent as well, C&T engineers say.

Memory above 1 megabyte is treated as LIM 4.0 expanded memory, and applications requiring large amounts of memory can incorporate up to 8 megabytes. This includes on-chip EMS support with four mapping registers and up to four external EMS mapper chips for full implementation. Memory cycles that run at 187.5 ns are supported. A four-way page interleave memory architecture allows for slow DRAMs that can operate at higher clock speeds with wait states between 0.5 and 0.7. Address recovery and memory remapping logic are included, as is automatic BIOS reallocation of bad blocks.

... But Who Will Be First to Take That Giant Step?

The \$40 Million Question is: Who will be the first to produce a Micro Channel clone? C&T's chief, Gordon Campbell, would not comment on who the company's customers might be for its Micro Channel-compatible chip set. But it's a good guess that C&T's current crop of OEM customers—companies like Tandy, for instance—would be possible cloners.

Tandy certainly seems like a good bet. Recently, a member of Tandy's R&D department told us that the company has big plans concerning product announcements in the third quarter, the time when the Texas company tradi-

tionally introduces new products. When asked what could be bigger than a 386 clone and a laser printer, which the firm introduced last year, the Tandy staffer would say only that those previous announcements would "pale in comparison" with the coming introduction. Industry watchers have said that the first to produce a PS/2 clone will be a company with enough money to fund the required research and engineering, as well as any legal fees that might arise if IBM claimed its property was being infringed upon.

With the tools now available to readily put together PS/2 clones, PC

manufacturers—at least those who are C&T OEM customers—can now begin making more concrete plans and announcements. Manufacturers have privately told Microbytes Daily that they plan to introduce Model 60 clones first because they believe these machines offer the greatest sales potential. According to what potential cloners have told us, the second most popular PS/2 compatible will be the Model 80, while they see the Model 50 as offering the least market potential of the three systems. So far, only one manufacturer has indicated that it will focus first on a Model 80-type machine.

Game That Inspired *Red October* Coming to Computers

Back in 1981, a Maryland insurance agent by the name of Tom Clancy took some time out one weekend to play a board game called Harpoon, which involved naval warfare between NATO and the USSR. Within the next few weeks, Clancy became friends with Larry Bond, the game's author and a member of the Naval War College. Out of their friendship came *The Hunt for Red October* and *Red Storm Rising*, two of the best-selling books in this decade.

Bond's latest project is a computerized version of his board game, which we saw demonstrated at the winter Consumer Electronics Show. Bond is working with software developer Three-Sixty Inc. (Campbell, CA) to bring out both an MS-DOS and a Macintosh version of the game, which should be on the market soon and will sell for around \$50.

As with the original game, the basic premise of the computer edition is NATO versus USSR in North Atlantic warfare. You act as commander of a major NATO task force. Soviet and American battle platforms (e.g., ships, planes, and missiles) in use today are part of the game, which is so up-to-date that simulated Soviet submarines incorporate the screw/drive mechanisms sold to the Soviets by Toshiba and Kongsberg Vaapenfabrik. You must learn about the strategy and tactical weapons at your disposal and acquaint yourself with the Soviet strengths and weaknesses.

To develop the software, Three-Sixty programmers transferred information relating to strategy and other necessary data from Bond's database (created with Odesta's Double Helix program) into Microsoft Excel for conversion to MSF format. They then loaded the data into McMax, a dBASE-

like package for the Macintosh from Nantucket Corp., for manipulation and development.

Much of the work now under way at Three-Sixty involves data compression, particularly of the images of ships, aircraft, and submarines digitized from photos and scaled to size. To generate graphics, programmers created a library of high-resolution pictures (digitized from photos) of military hardware.

Although none of it is classified (the FBI regularly checks Bond's database), the game contains information rarely, if ever, seen by the general public, particularly the digitized photos and details of Soviet ships and submarines. For this reason, Three-Sixty president Tom Frisina told Microbytes, the game is in many ways a lesson in current events. "Harpoon is not a war-gamer's product. It is for the general public," he said.

continued



It looks good on paper.

You expect excellent letter-quality print from a 24-pin printer. And Citizen's new precision-built Tribute™ 124 delivers.

With razor-sharp letter definition at 66 cps. Attractive correspondence quality at 132 cps. As well as crisp, impressive draft printing at 200 cps.

You might be surprised, however, to find that the versatile Tribute 124 offers quite a bit more. Like a built-in push or pull tractor with top, rear or bottom feed. Automatic paper loading. Outstanding compatibility. Push-button convenience of a front control panel. Even optional color printing.

It also provides a wide selection of typestyles via available font cards. And produces striking high-resolution graphics.

With all these value-added features and an exceptional 12-month warranty, the Tribute 124 is very affordable. So, not only does it look good on paper, it looks good for less paper.

For the Citizen printer dealer nearest you, call 1-800-556-1234, Ext. 34. In California, call 1-800-441-2345, Ext. 34.

© 1988 Citizen America Corporation. Citizen, the Citizen logo and Tribute are trademarks of Citizen Watch Co., Ltd.

 **CITIZEN™**
Printers that run like clockwork.

Circle 53 on Reader Service Card

World Radio History

Better Color Displays Through Chemistry

Research into photochemical reactions of color dyes applied to semiconductor materials could lead to the development of very thin flat-screen color displays. Chemists at the University of California at Irvine have found that by coating a substrate with a thin layer of dye and shining light on the surface, the dye reacts and changes color. Their studies are also pointing toward more efficient means of semiconductor processing.

John C. Hemminger, professor of chemistry at UCI and director of the recently formed Institute for Surface and Interface Science, said that one experiment consists of electrochemically depositing Prussian white dye on the

surface of common semiconductor substrates, such as strontium titanate. Normally, electrons in the dye and semiconductor remain stable because they do not have enough energy for migration. But when light strikes the dye, the added energy causes electrons to migrate into the semiconductor material.

The loss of these electrons from the dye initiates a chemical reaction that changes the white dye into blue wherever the light hits the dye film. Applying a small neutralizing voltage returns the dye and substrate into their previously stable condition and changes the Prussian blue back to Prussian white. "What we are able to do is modify a dye film in a reversible manner and use it to write

images on its surface," Hemminger said. Experiments have indicated that other dyes and wavelengths of light might react to produce a full color system.

The chemistry also shows promise for semiconductor processing. Experiments have shown that passivating—placing a protective coating on—semiconductor material can be accomplished without using complex masking and etching procedures. In the future, laser light might activate thin chemical films to produce protective coatings on a wide variety of materials. Hemminger said that already chemists have experimented successfully with passivation of the material used in infrared sensors.

Computer Companies Think There's No Place Like Home

Home offices and home-based businesses are quietly emerging as a major segment of the mass-market computer and electronics business. Companies like Blue Chip, Sharp, and NEC are all vying for a share of it. Sharp and NEC

have already set up divisions targeting the home-office market.

What attracts companies is the size of the potential market. Most manufacturers believe the basic hardware requirements of a home office include a

personal computer, printer, fax machine, copier, voice mail, and telephone. "People involved in home-based businesses spend an average of \$5200 a year on business equipment and software,"

continued

With MapInfo, More Ways Than Ever To Map Your Data



Pin Map. Automatically use your existing database (from dBASE III or others) with street maps that we can supply. Maps from over 300 U.S. cities and towns contain all addresses, accurate to the correct block and side of the street. Type any address and MapInfo will find it for you. Call to the screen your complete record.



Thematic. Use our boundaries (state or county) or draw your own (sales regions, election districts, etc.). Create a database for the region (population, average income, etc.) Color code boundaries or entire regions based on parameters you define.



Presentation. Use powerful graphics commands to add your own titles, legends and text. Create arrows, windows or callouts. Turn on or off labels of points, streets, bridges, regions, etc.



Visual Database. Draw anything from a floor plan to aircraft design. Store data on any point or region. Create multiple layers to add flexibility to your display.

And that's just a sample. If you need to map your data, MapInfo can do it for as little as \$750. IBM PC or 100% compatibles, with 640K memory, a hard disk drive, and graphics capability.

To order, call 1-800-FASTMAP. In New York State, call 1-518-274-8673 (Telex 371-5584). MapInfo Corp., 200 Broadway, Troy, NY 12180

dBASE III is a trademark of Ashton-Tate. IBM and IBM PC are trademarks of International Business Machines Corp.

MapInfo

FROM CREATION

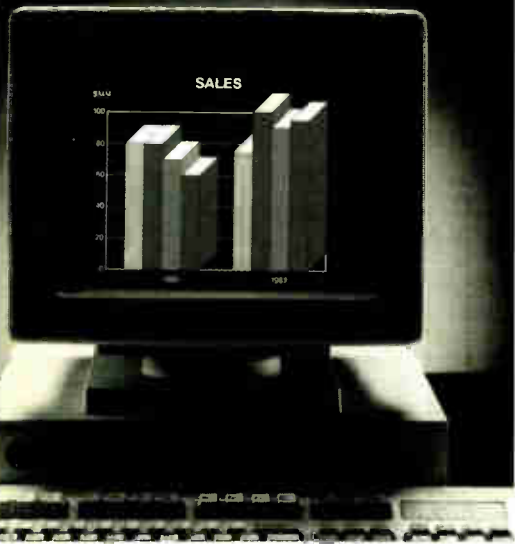

You've created a file or document on your PC. Now what?

Because most business information needs to be communicated, most people print the computer file and send the papers by mail, courier or fax. Or maybe send a floppy disk.

If the recipient needs to manipulate or revise the data, it must be rekeyed.

That's the time-honored—and the time-consuming—way of doing business.

What's a faster, cheaper, better way? Western Union EasyLink® service.

TO COMMUNICATION



Western Union EasyLink lets you send and receive data and documents between computers. Without a detour onto paper or the inconvenience of a courier. And you can be sure what you send is exactly what's received.

You can use EasyLink to move the information that moves your business in seconds. You can move orders and text files. Receive reports and graphics. Even send product specs and spreadsheets.

Fast revisions—without rekeying

EasyLink connects the computers you use, regardless of type or location. Files on one computer can be sent to other computers, eliminating the need to rekey data.

More than just computer communications

EasyLink even lets you send messages to fax machines. Reach your company's

mainframe. And communicate *between* offices or businesses.

Best of all, the cost of sending a message is comparable to a postage stamp. And unlike telephone, the distance makes no difference.

Western Union—a leader in electronic communication

With EasyLink, we're bringing proven reliability to today's technology. And you'll get added value with EasyLink services like InfoMaster®, the largest electronic library with more than 800 databases.

Let EasyLink take your PCs from creation to communication. To learn how *your* business can benefit, return the coupon. Or call:

1-800-624-9000, ext. 7182

IF YOU CREATE IT ON A PC SEND IT ON A PC WITH EASYLINK

YES, tell me more

Show me how EasyLink can turn my company's PCs into an efficient, economical new way to communicate.

Name _____
Title _____ (please print)
Company _____
Bus. Address _____
City/State/Zip _____
Bus. Phone (____) _____

Mail to: Western Union EasyLink
P.O. Box 37472
Omaha, Nebraska 68137

Or call: 1-800-624-9000, ext. 7182

HARMONY COMPUTERS

2357 CONEY ISLAND AVE. (BET. AVES. T & U) BKLYN, NY 11223
ORDER DEPT. ONLY 800-441-1144 OR 718-627-1000 — INFORMATION 718-627-8888



**NO ADDITIONAL CHARGE
FOR CREDIT CARDS**

**IBM PS II MODEL 30 (20 Meg) \$1679.00
EPSON LX 800 \$189.00**

**PANASONIC 1091 i II \$184.00
COMMODORE 128D \$449.00**

Apple Image Writer II	454
Citizen 1200	139
Citizen 1800	159
Citizen MSP 10	239
Citizen MSP 15	319
Citizen MSP 40	283
Citizen MSP 45	399
Citizen Premier 35	429
Dalmeida Ink Jet 150	289
EPSON LX800	189
LX 80 and 86 Cutsheet Feed	24
EPSON LG500	319
EPSON LG 1000 Tractor	39
EPSON LG 850	499
EPSON LG 1050	669

IBM AND COMPATIBLES

IBM PS/2 Model 30 (2 Drives)	1229
IBM PS/2 Model 30 (20 Meg.)	1879
IBM PS/2 Model 50 (20 Meg.)	2629
IBM PS/2 Mono Monitor	199
IBM PS/2 Color (8513) Monitor	409
Hertz II (10 MHz) 840 K. w/Drive	539
Hertz II 286 w/12 Meg Drive	899
AST Rampage 288 (40 Meg)	2289
AST Rampage 288 (70 Meg)	2799

PC BOARDS, DRIVES, CHIPS

Toshiba 5 1/4 Desk Dr (360 K)	99
Toshiba 5 1/4 Desk Dr (720 K)	129
Toshiba 5 1/4 Desk Dr (1.44 Meg)	149
AST Set Pack 84K	189
AST Set Pack Premium 256 K	309
AST Rampage (288)	309
Hercules Color Card	139
Hercules Monographic Plus	169
NEC EGA GB1	199
Quad Prosync (with mouse)	219
Quadram Ultra VGA (with mouse)	299
Video 7 Deluxe	139
Video 7 VGA	189
Genoa II Res Card Plus w/Gem Graph	189
ATI Wonder EGA	189
ATI VGA Wonder	269
ATI Small Wonder	119
Paradise (350)	155
Paradise Auto Switch (480)	155
Paradise VGA	149
Everex Auto Sync (480)	249
Everex VGA	209
Intel 8087-3	168
Intel 8087-2	169
Intel 80287-6	269
Intel 80287-6	269
Intel 80287-10	299

AT&T

ATT 6300 Drive, 640K w/Keyboard	849
ATT Monochrome Monitor	179
ATT 301 Keyboard	119
ATT 302 Keyboard	149
AMDEK 725 Color Monitor (720 x 400)	399

"PRINTER SPECIALS"

EPSON FX 86E	299
EPSON FX 860k	439
EPSON EX800	399
EPSON EX 1000	459
EPSON L22500	849
IBM Proprietary II	359
IBM Proprietary 24	539
IBM Proprietary XL24	699
NEC 3550	719
NEC 8850	1039
NEC 2200	329
NEC P6	427
NEC P7	599
NEC Color P6	529
NEC Color P7	699

SEAGATE HARD DRIVES

20 Meg. w/controller	289
30 Meg. w/controller	319
30 Meg. AT #4038	499
40 Meg. #251	445
Tandon 20 Meg. Hard Card	329
Microscribe 30 Meg. Hard Card	379
Tandon 40 Meg. Hard Card	494
Plus Hard Card (20, 30 or 40 meg.)	Call
(Microscribe) MAC 20 Meg. External	559

MODEMS

Hayes 1200	274
Hayes 1200B w/Smartcom 2	274
Hayes 300	139
Hayes 2400	429
Hayes 2400B w/Smartcom 2	429
Hayes Smartcom II	89
Micromodem 2E	139
Everex Internal 1200B	99
Everex 2400 Internal	179
Everex 2400 External	184
Everex Mac 2400 External	269
Capitron 1200 External	199

APPLE

2GS with 256K	729
Apple Drive (5 1/4)	249
Apple Drive (3 1/2)	329
MAC Plus	1599
MACSE (2 Drives)	2049
MACSE (20 Meg.)	2599
MACSE Keyboard	99
MACSE Extended Keyboard	159
ImageWriter II	454
Apple Color Monitor (RGB)	399
Apple Black & White Monitor	118
Misc Drive (2E, 2C, MAC) 5 1/4	139
Microscribe MAC 20 Meg Ext Drive	559
Everex MAC Modem 1200 Ext	269

Hewlett Packard Laserjet II 1599

Judata 182 Plus	226
Okidata 192 Plus	329
Okidata 193 Plus	434
Okidata 292 w/ITFC	434
Okidata 293 w/Intfc	549
Okidata 393	559
Panasonic KXP 1080 i Model 2	184
Panasonic KXP 1091 i Model 2	184
Panasonic KXP 1092 i	294
Panasonic KXP 3121	263
Panasonic KXP 3131 Tractor	79

PORTABLES

NEC Multispeed	1199
NEC Multispeed EL	1429
NEC Multispeed H.D. (20 Meg.)	2199
Toshiba T 1000	765
Toshiba T 1100 Plus (2 Drives)	1349
Toshiba T 1200 (20 Meg.)	2225
Toshiba T 3100 (20 Meg.)	2949
Sharp 4502 (2 Drive) E1 Screen	1199
Zenith 181 (2 Drive)	1499
Zenith 183 (20 Meg.)	2225
Digicos Ink Jet Post Printer	289
Eastere II (Date Transfer Software)	79

MONITORS

Amdek 300 A	99
Amdek 310 A	109
Amdek 410 A	149
Amdek Color 722	419
Princeton HK12E	127
Princeton Max 12E	127
Princeton Ultra Sync	509
Scan Doubler Video Card	159
NEC Multisync G S	199
NEC Multisync II	589
NEC Multisync Plus	859
Thompson Ultra Scan (800 x 600)	399
Gold Star TTL Amber	289
Gold Star RGB Color	389
Color Composite	179
Magnavox (RGB Composite) 8562	249

MACINTOSH SOFTWARE

Microsoft Excel	228
Microsoft Word 3.01	223
Microsoft Works	167
AppleLink	44
More (Symantec)	154
Supersync	42
D Base Mac	298

Panasonic KXP 3151	409
Panasonic KXP 1582	399
Panasonic KXP 1595	429
Panasonic 1524	529
Sakkohe 1200	234
Star NX 1000	159
Star NX 1000F (color)	159
Star NX 1000C	169
Star NX15	299
Star ND 10	259
Star ND 15	164
Star NB 2410	419
Star NB 2415	569
Toshiba 341 SL	639
Toshiba 351 SL	469
Toshiba 351 SX	949

NEC POWERMATE

Power Mate II w/NEC 20 Meg Hard Drive	1449
Powermate II w/NEC 40 Meg Harddrive	2159

COMMODORE

Commodore 128D (Built-in Drive)	449
Commodore 128	234
1571 Drive (5)	217
Commodore 54C	176
1541C Disk Drive	179
1581 Disk Drive (3 1/2)	199
Comm 1804 Monitor	269
1351 Mouse	49
Star NX 1000C	189
Amiga 500 with 1084 Monitor	848
Amiga 1084 Color Monitor	289
Amiga 500 Computer	589
Amiga 512 RAM Upgrade (for Amiga 500)	159

IBM SOFTWARE

Lotus 123	429
Lotus Symphony	299
D Base 3+	375
Framework 2	299
Microsoft Word 4.0	219
Microsoft Excel (IBM)	296
Microsoft Windows 2.03	59
Word Perfect 4.2	194
Word Perfect Library	60
Q & A 2.0	184
PFS Professional Write	109
Norton Utilities 4.0	99
Norton Utilities Advanced	79
Microsoft Mouse	49
Logitech Mouse	79
Logitech Paint	20
Logitech with Publisher	109
Logitech with Cad	119
Northern Professional Rel 4	209
Multimate Advantage Rel 2	247
Ventura Desk Top Publishing	479
Managing Your Money Release 4	119
Feel Write II	79
(Data Transfer Software and cables)	79
3 1/2 Inch Software	Call

Master Card and Visa welcome. For your protection we check for stolen credit cards. Shipping & handling extra. Defective merchandise will be replaced or repaired at our discretion within the terms of our warranty. All sales final. Price and availability subject to change without notice. We cannot guarantee compatibility.

MICROBYTES

Julian Cohen, chairman of the American Home Business Association, told Microbytes.

With over 13 million home businesses in operation today, that translates to a possible \$67 billion industry. Cohen conceded that not all home-based businesses currently use personal computers, but he did claim that 70 percent of them do, up from 50 percent just 3 years ago.

Blue Chip president John Rossi said his company, which markets low-priced IBM-compatible computers and peripherals through mass-merchant channels such as Target and Wal-Mart, has made a major commitment for 1988 to attack the home-business/home-office market. Blue Chip will introduce a laser printer, a fax card, and a voice-mail card over the next few months.

Cohen and Rossi agree that software remains a stumbling block for home-based businesses. "The industry is not

writing software for the comprehensive needs of the home business," said Cohen. "There are software programs to help individuals keep track of their personal investments. Why not programs designed specifically to help home-business owners keep track of the generic functions of their enterprises?"

"How does someone justify paying \$500 for a software package when they only paid about \$500 for the computer?" Rossi asked. (Blue Chip's entry-level personal computer sells for \$599.) He added, however, that when the performance benefits justify it, home-business owners do buy the high-end word-processing and spreadsheet programs, even if they will be running them on low-price computers.

While there might be no place like home for working, the costs of setting up an office are not trivial. Some operators of home businesses estimate an outlay of \$5000 to \$7000. "You can get by

pretty cheaply if you settle for used furniture," said one man who runs a business out of his house. "You can spend the money on a fax machine or a laser printer instead."

Some observers expect those costs to drop. As more companies get into the business of fax boards for personal computers, for example, they could drive the prices down.

However, some members of the computer industry, many of whom work at home, said they've heard it all before: another big booming business that goes bust. One industry watcher said, "Sure, there are lots of people who want to set up shop at home and who'd like to buy this equipment. But all it takes is one recession, or a couple months of less work than usual, to wipe out the savings that these people would use to buy this equipment. In their enthusiasm, some of the prognosticators forget to factor in things like reality."

TECHNOLOGY NEWS WANTED. The news staff at BYTE is always interested in hearing about new technological and scientific developments that might have an impact on microcomputers and the people who use them. We also want to keep track of innovative uses of that technology. If you know of advances or projects that involve research relevant to microcomputing and want to share that information, please contact us. Call the Microbytes staff at (603) 924-9281, send mail on BIX to Microbytes, or write to us at One Phoenix Mill Lane, Peterborough, NH 03458.

Upgrade Your Technology

We're Programmer's Connection, the leading independent dealer of quality programmer's development tools for IBM personal computers and compatibles. We can help you upgrade your programming technology with some of the best software tools available.

Comprehensive Buyer's Guide. The CONNECTION, our new Buyers Guide, contains prices and up-to-date descriptions of over 600 programmer's development tools by over 200 manufacturers. Each description covers major product features as well as special requirements, version numbers, diskette sizes, and guarantees.

How to Get Your FREE Copy: 1) Use the reader service card provided by this journal; 2) Mail us a card or letter with your name and address; or 3) Call one of our convenient toll free telephone numbers.

If you haven't yet received your copy of the Programmer's Connection Buyer's Guide, act now. Upgrading your programming technology could be one of the wisest and most profitable decisions you'll ever make.

USA..... 800-336-1166

Canada.....800-225-1166
Ohio & Alaska (Collect).....216-494-3781
International.....216-494-3781
TELEX.....9102406879
FAX.....216-494-5260

Business Hours: 8:30 AM to 8:00 PM EST Monday through Friday
Prices, Terms and Conditions are subject to change.
Copyright 1988 Programmer's Connection Incorporated



386 products	List	Ours
386 ASM/386 LINK by Phar Lap Software	495	377
386 DEBUGGER by Phar Lap Software	195	129
NOP C-386 by MicroWay	595	529
NOP For Tran-386 by MicroWay	595	529
PC-MDS/386 Single-User by The Software Link	195	155
PC-MDS/386 5-User by The Software Link	595	539
PC-MDS/386 25-User by The Software Link	995	869

blaise products	List	Ours
ASYNCH MANAGER Specify C or Pascal	175	135
C TOOLS PLUS/5.0	129	99
PASCAL TOOLS/TOOLS 2	175	135
Turbo ASYNCH PLUS/4.0	129	99
Turbo C TOOLS	129	99
Turbo POWER TOOLS PLUS/4.0	129	99
VIEW MANAGER Specify C or Pascal	275	199

borland products	List	Ours
EUREKA Equation Solver	167	105
Paradox 1.1 by Ansa/Borland	495	359
Paradox 2.0 by Ansa/Borland	725	525
Paradox Network Pack by Ansa/Borland	995	725
Quattro: The Professional Spreadsheet	195	125
Reflex: The Analyst	150	99
Sidkick	85	57
Superkey	100	64
Turbo Basic Compiler	100	64
Turbo Basic Support Products All Varieties	100	64
Turbo C Compiler	100	64
Turbo Lighting	100	64
Turbo Lightning Word Wizard	70	47
Turbo Pascal	100	64
Turbo Pascal Database Toolbox	100	64
Turbo Pascal Developer's Toolkit	395	259
Turbo Pascal Editor Toolbox	100	64
Turbo Pascal Gameworks Toolbox	100	64
Turbo Pascal Graphix Toolbox	100	64
Turbo Pascal Numerical Methods Toolbox	100	64
Turbo Pascal Tutor	70	41
Turbo Prolog Compiler	100	64
Turbo Prolog Toolbox	100	64

c language	List	Ours
C talk by CNS	150	119
Eco-C88 Modeling Compiler by Ecosoft	100	69
Lattice C Compiler vers. 3.2 from Lattice	500	265
Mark Williams Let's C with FREE csd	75	54
Uniware 68000 C Cross Compiler by SDS	995	829
Uniware Z-80 C Cross Compiler by SDS	995	829

database management	List	Ours
Clipper by Nantucket	695	379
dBASE III Plus by Ashton-Tate	695	389
dBFast dBASE III Plus Comp by dBFast	69	59
dBXL by WordTech Systems	169	99
FoxBASE+ by Fox Software	395	249

FoxBASE+/386 by Fox Software	New	595	399
Geniter by bytel		395	249
QuickSilver by WordTech Systems		599	349
R:Base 5000 by Micromin		495	359
R:Base System V by Micromin		700	439
Tom Rettig's Library by Tom Rettig & Assoc		100	79
UI Programmer by Wallsoft		295	239

digitalk products	List	Ours	
Smalltalk/V	100	84	
EGA/VGA Color Option	50	45	
Goodies Diskette #1	50	45	
Goodies Diskette #2	New	50	45
Goodies Diskette #3	New	50	45
Smalltalk/Comm	50	45	
Smalltalk/V 286	New	200	159

golden bow products	List	Ours
Vcache	50	47
Vfeature Hard Disk Utility	80	74
Vfeature Deluxe	120	111
Vopt Hard Disk Optimization Utility	50	47

komputerwerk products	List	Ours
Finally BASIC routines	99	85
Finally Modules	99	85
Finally XGraf	99	85

logitech products	List	Ours
LOGIMOUSE All Varieties	CALL	CALL
LOGITECH Modula-2 Development System	249	199
Modula-2 Compiler Pack	99	75
Modula-2 Toolkit	169	139

microport products	List	Ours
DOSMerge286 Specify 2-Users or Unlimited	149	129
DOSMerge386 2-Users	395	345
DOSMerge386 Unlimited Users	495	429
System V/386 Complete Package	799	669
System V/AT Complete Package	549	465

microsoft products	List	Ours
Microsoft C Compiler 5 w/CodeView	450	285
Microsoft COBOL Compiler with COBOL Tools	700	439
Microsoft Excel	495	319
Microsoft FORTRAN Optimizing Compiler	450	285
Microsoft Macro Assembler	150	99
Microsoft Mouse All Varieties	CALL	CALL
Microsoft Pascal Compiler	300	189
Microsoft QuickBASIC 4	99	66
Microsoft QuickC	99	66
Microsoft Windows	99	66
Microsoft Windows 386	195	129
Microsoft Windows Development Kit	500	299
Microsoft Word	450	285
Microsoft Works	195	129

ORDERING INFORMATION

FREE SHIPPING. Orders within the USA (including Alaska & Hawaii) are shipped FREE via UPS. Call for express shipping rates.

NO CREDIT CARD CHARGE. VISA, MasterCard and Discover Card are accepted at no extra cost. Your card is charged when your order is shipped. Mail orders please include expiration date and authorized signature.

NO COD OR PO FEE. CODs and Purchase Orders are accepted at no extra cost. No personal checks are accepted on COD orders. POs with net 30-day terms (with initial minimum order of \$100) are available to qualified US accounts only.

NO SALES TAX. Orders outside of Ohio are not charged sales tax. Ohio customers please add 5% Ohio tax or provide proof of tax-exemption.

30-DAY GUARANTEE. Most of our products come with a 30-day documentation evaluation period or a 30-day return guarantee. Please note that some manufacturers restrict us from offering guarantees on their products. Call for more information.

SOUND ADVICE. Our knowledgeable technical staff can answer technical questions, assist in comparing products and send you detailed product information tailored to your needs.

INTERNATIONAL ORDERS. Shipping charges for International and Canadian orders are based on the shipping carrier's standard rate. Since rates vary between carriers, please call or write for the exact cost. International orders (except Canada), please include an additional \$10 for export preparation. All payments must be made with US funds drawn on a US bank. Please include your telephone number when ordering by mail. Due to government regulations, we cannot ship to all countries.

MAIL ORDERS. Please include your telephone number on all mail orders. Be sure to specify computer, operating system, diskette size, and any applicable compiler or hardware interface(s). Send mail orders to:

Programmer's Connection
Order Processing Department
7249 Whipple Ave NW
North Canton, OH 44720

periscope products	List	Ours
Periscope I with Board	345	275
Periscope II with NMII Breakout Switch	175	139
Periscope II-X Software only	145	105
Periscope III 8 MHz version	995	795
Periscope III 10 MHz version	1095	875

peter norton products	List	Ours	
Advanced Norton Utilities	150	89	
Norton Commander	75	55	
Norton Editor	New Version	75	59
Norton Guides Specify Language	100	65	
Norton Utilities	100	59	

sco products	List	Ours	
SCO FoxBASE+	New	795	595
XENIX System V for PS/2 by SCO	New	CALL	CALL
XENIX System V 286 by SCO		1295	979
XENIX System V 386 by SCO		1495	1145

soft warehouse products	List	Ours
muLISP-87 Interpreter	300	199
muLISP-87 Interpreter & Compiler	400	259
muMATH-83	300	199

other products	List	Ours	
Brief by Solution Systems	195	CALL	
Carbon Copy Plus by Meridian Technology	195	135	
Cross Assemblers Various by 2500 AD	CALL	CALL	
Dan Bricklin's Demo II by Software Garden	195	179	
Desquiver from Quarterdeck	130	105	
Disk Optimizer by Softlogic Systems	70	59	
Disk Technician by Prime Solutions	100	89	
Disk Technician+ by Prime Solutions	130	119	
Flow Charting II+ by Patton & Patton	New	229	189
Instant Replay III by Nostradamus	New	150	129
MiniProbe by Atron	395	369	
Mace Utilities by Paul Mace Software	99	85	
MathCAD by MathSoft	New	349	269
Opt-Tech Sort by Opt-Tech Data Proc	149	99	
Peabody by Copia Int, Specify Language	New	100	89
Quinn-Curtis Products All Varieties	CALL	CALL	
STATGRAPHICS by STSC	895	649	
TLIB by Burton Systems Software	100	89	
Turbo Programmer by ASCII	New	289	229
Ventura Desktop Publisher by XEROX	New	895	499
XenoCopy-PC by XENOSOFT	80	69	

CALL for Products Not Listed Here

Circle 217 on Reader Service Card

World Radio History

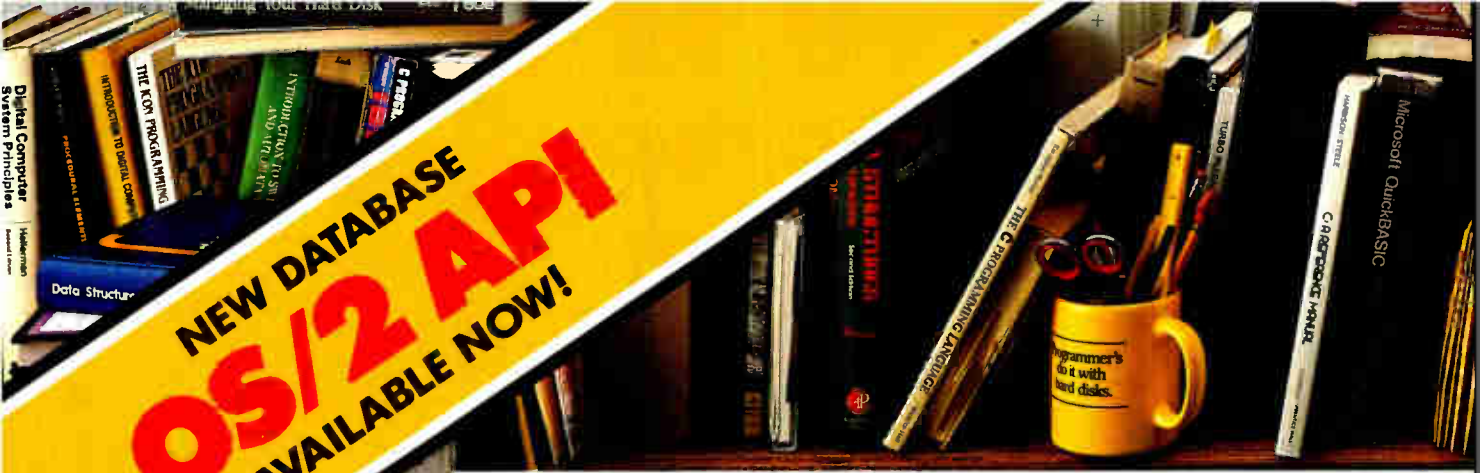

**NEW DATABASE
OS/2 API
AVAILABLE NOW!**

Finally. A pro for people who h

Nobody ever said programming PCs was supposed to be easy.

But does it have to be tedious and time-consuming, too?

Not any more.

Not since the arrival of the remarkable new program in the lower right-hand corner.

Which is designed to save you most of the time you're currently spending searching through the books and manuals on the shelf above.

It's one of a quintet of pop-up reference packages, called the Norton On-Line Programmer's Guides, that actually *gather your data for you*—on OS/2 Kernel API or your favorite programming language.

Each package comes complete with a comprehensive, cross-referenced database crammed with just about everything you need to know to write applications.

Not to mention a wealth of wisdom from the Norton team of top programmers. (PC Week used the words "massive" and



"authoritatively detailed" to describe the information

DATA AND FEATURES

OS/2 KERNEL API (1M of data)

- Kernel API: Describes all OS/2 API services: DOSx, KBDx, MOUx and VIOx.
- Structure Tables: Lists all of the OS/2 data structures used in the Kernel API.
- Conversion Guide: DOS-to-OS/2 table shows which OS/2 calls replace DOS and ROM BIOS services.

ASSEMBLY (600K of data)

- DOS Service Calls: All INT 21h services, interrupts, error codes and more.
- ROM BIOS Calls: All ROM calls.
- Instruction Set: All 8038/86 instructions, addressing modes, flags, bytes per instruction, clock cycles and more.
- MASM: Pseudo-ops and assembler directives.

BASIC (270K each database)

- IBM BASICA, Microsoft QuickBASIC and TurboBASIC.
- Statements and Functions: Describes all statements and built-in library functions.

C (600K each database)

- Microsoft C and Turbo C: Describes the C language.
- Library Functions: Detailed descriptions of all functions.
- Preprocessor Directives: Describes commands, usage and syntax.

PASCAL—Turbo (360K of data)

- Language: Describes statements, syntax, operators, data types and records.
- Library: Describes the library procedures and functions.

FEATURES (all versions)

- Memory-resident—uses just 71K.
- Full-screen or moveable half-screen view, with pull-down menus.
- Auto lookup and searching.
- Tools for creating your own databases.
- More data: All five Norton Guides feature a variety of tables, including ASCII characters, line-drawing characters, keyboard scan codes and much more.
- Includes both OS/2 protected mode and DOS versions.

contained in the Guides. If you'd rather see for yourself, you might take a moment or two to examine the data box you just passed.)

You can, of course, find most of this informa-

Designed for the IPM® PS/2® and PC families, and 100% compatibles. Available at most software

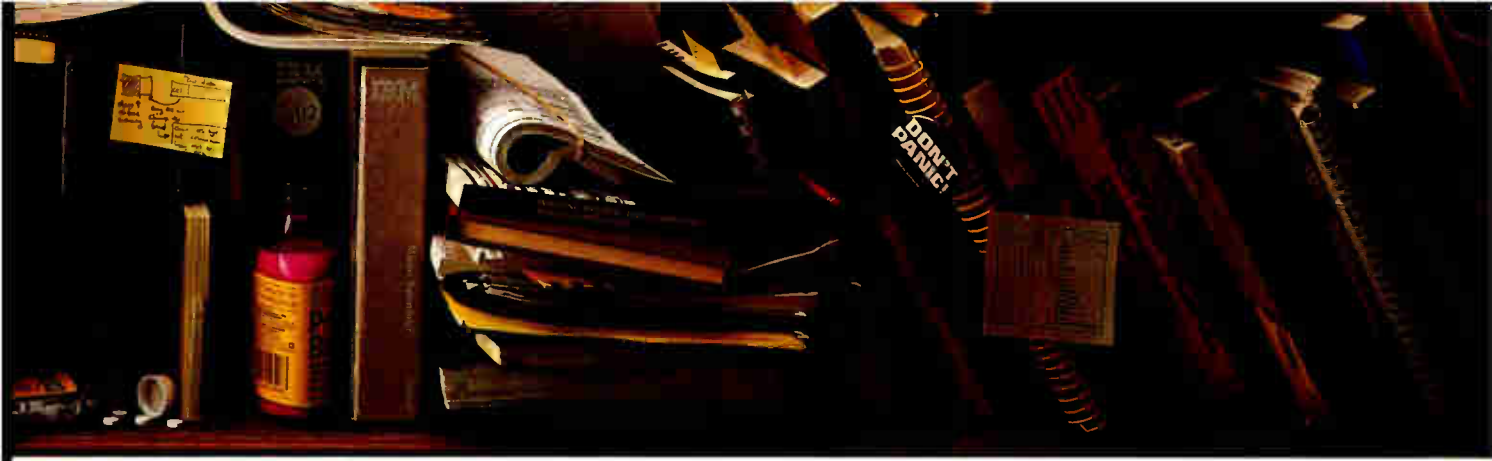

programming tool ate manual labor.

tion in the books and manuals on our shelf.

But Peter Norton — who's written a few books himself — figured you'd rather have it on your screen.

Instantly.

In either full-screen or moveable half-screen mode.

Popping up right next to your work. Right



A Guides reference summary screen (shown in blue) pops up on top of the program you're working on (shown in green).



Summary data expands on command into extensive detail. And you can select from a wide variety of information.

where you need it.

This, you're probably thinking, is precisely the kind of thinking that produced the classic Norton Utilities.

And you're right.

But even Peter Norton can't think of everything.

Which is why each version of the Norton Guides comes equipped with a built-in com-

piler — the same compiler used to develop the databases contained in the Guides.

So you can create new databases of your own, complete with electronic indexing and cross-referencing.

No wonder *PC Week* refers to the Guides as a "set of programs that will delight programmers."

Your dealer will be delighted to give you more information. All you have to do is call. Or call Peter Norton Computing.

And ask for some guidance.

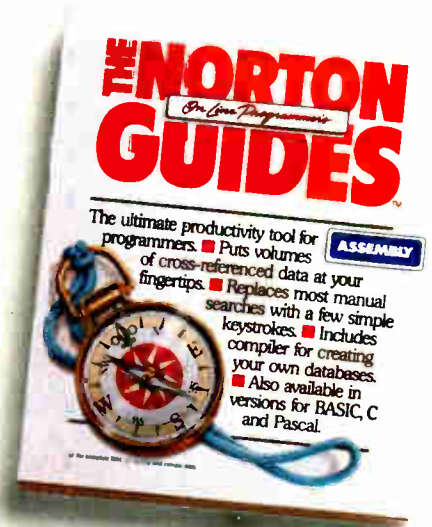

Peter Norton
COMPUTING

dealers, or direct from Peter Norton Computing, Inc., 2210 Wilshire Blvd. # 186, Santa Monica, CA 90403. 213-453-2361. Visa and MasterCard welcome. ©1988 Peter Norton Computing

LETTERS

This Time for Sure

Thank you for printing my letter ("Forth and the NC4016," Letters, December 1987). However, in transcribing the code from my letter to your magazine, numerous errors appeared. See listing 1 for the correct code.

When writing Forth code, it is important to keep the spacing between "words." If this code was entered as it appeared in the magazine, it would not run, because the interpreter would not be able to recognize the "words" defined. Also, in the word FIBTEST, the letter O was used instead of the number zero (0), which, of course, would play havoc with the interpreter.

Also, the last statement in the word FIBTEST would be better written in columnar form, as follows:

```
CR ." Fibonacci("
NUM 2 U.R ." ) = "U. ;
```

Douglas Ross
Greenbelt, MD

Listing 1: Reader Douglas Ross's correct Forth code.

```
100 CONSTANT NTIMES ( NUMBER OF TIMES TO COMPUTE FIB VALUE )
24 CONSTANT NUM ( BIGGEST ONE WE CAN COMPUTE IN 16 BITS )

: FIB ( U1 -- U2 ) RECURSIVE
  DUP 2 > IF DUP 1 - FIB SWAP 2 - FIB +
  ELSE DROP 1
  THEN ;

: FIBTEST ( -- )
  CR NTIMES U. ." ITERATIONS: "
  0 ( MAKE SURE SOMETHING IS ON STACK )
  NTIMES 1 - FOR DROP NUM FIB NEXT
  CR ." Fibonacci("
  NUM 2 U.R ." ) = " U. ;
```

A Tale of Two Integers

As a delighted user of QuickBASIC versions 2.0 through the incredible 4.0, I find it an increasingly valuable programming tool. However, while running some existing GWBASIC programs through QuickBASIC 4.0, I found the following problem:

```
10 B%=30
20 A=B% * B%
```

will work perfectly, but changing B% to 300 will not. It seems that multiplying any two integers forces the product variable to integer type, regardless of declaring or implying it, using double-precision floating point, or whatever else you can think of. The same thing happens with addition if the sum is outside acceptable integer range. This turns out to be true in QuickBASIC 2.0 and 3.0 also, though it's not a problem in various "street" BASICS.

I wrote the people at Microsoft about this problem and asked if they had any solutions. A very pleasant fellow called, and, after going over it a bit, he guessed that it was a storage problem and said that the company would look into it.

I dislike modifying any debugged, lengthy programs unnecessarily; it takes so long to get the new bugs out. The best kludge I have found so far is to convert the integers to floating point before the calculation, as follows:

```
10 B%=300
15 B=B%
20 A=B * B
```

When this popped up, it drove me crazy until I remembered that an elderly PDP-11 FORTRAN compiler did something similar and, fortunately, was documented. I pass this along to apprise others of the problem and to see if anyone can suggest a more elegant solution.

Peter Crosby
Claremont, NH

Thanks for the IBM Issue

Congratulations for an uncommonly excellent IBM special issue (*Inside the IBM PCs*, Fall 1987). I have seldom seen a magazine issue that contains so many original features.

I concur with the tone of the lead editorial. Systems Application Architecture will be accepted when there are applica-

tions that use it, and these applications provide benefits that are not realized in any other way.

Michael Geary's "Spying on Windows" gets my vote as the best article. I know of at least six Windows developers who got a copy of Spy and put it to work immediately. Greg Weissman's "Comparing Disk-Allocation Methods" described differences between the DOS 2.x and 3.x file-allocation schemes that are little known outside of Redmond, Washington, and they're useful to me in my work. Ray Duncan's, Jeremy Sagan's, William J. Claff's, and Cohen and Hanel's articles all provided useful insights in their respective areas. Richard

continued

LETTERS POLICY: When submitting a letter for publication, double-space it on one side of the paper and include your name and address. Express your comments and ideas as clearly and concisely as possible. We can print listings and tables along with a letter if they are short and legible.

Because we receive hundreds of letters each month, we cannot publish all of them. We cannot return letters to authors. Generally, it takes four months from the time we receive a letter until we publish it.

Who Says FoxBASE+ is Better than dBASE®?



The Experts!

Nicholas Petreley, *InfoWorld Review Board:*

"FoxBASE+ has outdone itself. Once again, FoxBASE+ earns an "excellent" in performance, with kudos for responding to user suggestions. For sheer productivity, there is no other choice."

P.L. Olympia, *Founder & President, National Dbase Users Group / Government Computer News:*

"FoxBASE+ is a supercharged dBASE, with all the features Ashton-Tate forgot. If you're into serious dBASE development and have not tried FoxBASE+, you are living in the dark ages and wasting your company's money."

George F. Goley IV, *Contributing Editor, Data Based Advisor:*

"The product is fast, very compatible, fast, easy to use, fast, relatively inexpensive, and very fast. In every test, FoxBASE+ outperformed the other products. And people who answer the phone at Fox know what they are talking about."

David Irwin, *Former President/CEO, Data Based Advisor:*

"From the dBASE compatibility standpoint, FoxBASE+ is flawless. From the speed standpoint, FoxBASE+ is unbelievable. From the "lazy factor" standpoint, FoxBASE+ is perfect."

Glenn Hart, *Contributing Editor, PC Magazine:*

"Initial tests of FoxBASE+ were simply stunning. In many ways, FoxBASE+ gives you the best of both worlds: all the benefits of interactive development and debugging, plus the speed and code protection of a compiler."

Pat Adams, *Founder, National Dbase Users Group/NYPC Consultants SIG:*

"Imagine a dBASE without bugs! Imagine a dBASE that is at least six times faster and comes with its own runtime 'compiler.' Imagine a company whose tech support department is reachable on the first telephone call, and whose staff knows what it is talking about. Imagine all that—and more—and you have FoxBASE+."

Adam Green, *Contributing Editor, Data Based Advisor, dBASE Author:*

"For the PC, FoxBASE+ has consistently set the performance standard for dBASE compatible languages. For the Macintosh, FoxBASE+/Mac will set standards for innovation and leadership in a new dBASE implementation."

Don Crabb, *Contributing Editor, InfoWorld:*

"You can expect blazing speed on the Mac. FoxBASE+/Mac breezes past tests that have proven stumbling blocks for Macintosh databases in the past. FoxBASE+/Mac combines complete dBASE compatibility with a genuine Macintosh user interface."

Why not join the experts—get your copy of FoxBASE+ now! Visit your nearest quality software dealer, or order directly from us by calling (419) 874-0162.

Because when it comes to speed, compatibility and value, nothing runs like a FOX!

Fox Software
Nothing Runs Like a Fox.

FoxBASE, FoxBASE+ and FoxBASE+ Mac are trademarks of Fox Software, dBASE and dBASE III PLUS are trademarks of Ashton-Tate. Macintosh is a trademark of Apple Computer, Inc.

Fox Software, Inc. Perrysburg, OH 43551
118 W. South Boundary (419) 874-0162

Circle 106 on Reader Service Card

APRIL 1988 • BYTE 23

UTAH

COBOL™

NEW
VERSION 4.0 (3)

\$69.95

For IBM® PC's, XT's, AT's and other DOS machines. This is the one you've heard so much about – with fast compile times, small object code modules, no royalties, and clear error messages. Version 4.0 is based upon ANSI-74 standards with new features including:

- Indexed files (ISAM) with up to 24 keys. This advanced feature requires the software package Btrieve™ which is optionally available @ \$190.00.
- Windowing, pop-ups, color and overlays. This advanced feature requires the software package Saywhat?!™ which is optionally available @ \$45.00.
- ACCEPT (1,5) numerics with decimal point alignment, numeric checking, AUTO-SKIP, SECURITY, LENGTH-CHECK, EMPTY-CHECK.
- Fast memory mapped DISPLA's (1,5) ERASE, BEEP, ATTRIBUTE.
- An easy-to-use, COBOL source code EDITOR with auto line numbering, A-margin, B-margin tabbing with full screen cursor control.

Also available: Utah SuperSort® @ \$39.95, a fast sort program callable from Utah COBOL; Utah FORTRAN @ \$39.95; Utah BASIC @ \$39.95; Utah PASCAL @ \$39.95; Utah PILOT @ \$39.95. Used by 50,000 professionals, students and teachers in 40 countries.

 
To order call:
(702) 827-3030



Since 1977
Ellis Computing, Inc.
5655 Riggins Court, Suite 10
Reno, Nevada 89502

IBM is a registered trademark of International Business Machines, Inc. Btrieve is a registered trademark of Novell, Inc. Saywhat?! is a trademark of The Research Group. SuperSort is a registered trademark of Micropro International Corporation. Utah COBOL is a trademark of Ellis Computing, Inc. © 1987 Ellis Computing, Inc.

Wilton's article on PS/2 video displays is commendable, too. More of the same!

Ben Myers
Harvard, MA

Byte, Dyte, Fyte

Whenever I read "16-bit word" or "32-bit word," I wonder, "Why not use something else instead of these cumbersome expressions?" My solution is to make new words. How about "dyte" for "16-bit word" (double byte) and "fyte" for "32-bit word" (four bytes)?

Wasya Maslyuoff
Irkutsk, East Siberia, USSR

Electronic Pen Pals

Congratulations to your editorial team for the well-written Microbyte on electronic mail at Coopers & Lybrand (January, page 12).

Your staff was able to highlight the content and capture the spirit of a lengthy address informatively, interestingly, and succinctly. E-mail is growing rapidly and will become increasingly visible over the next 3 years. The role of the personal computer has been and will continue to be vital to E-mail's success.

Walter E. Ulrich
*Coopers & Lybrand
Houston, TX*

Fascinating Fractals

"A Better Way to Compress Images" by Michael F. Barnsley and Alan D. Sloan (January) was fascinating, but the accompanying BASIC program didn't work under Microsoft QuickBASIC. I have made a few changes to automate x and y scaling for each IFS code sequence, handle sequences of any length, and speed up the program in general. The updated version (see listing 2) contains a section that needs to be run only once for any IFS code sequence. It calculates the x and y scale and offsets. In-line documentation explains its use.

P. Leslie Aldridge
Milltown, NJ

... Provocative, Too

I found "A Better Way to Compress Images" interesting. The concept of using fractals to reduce image storage by finding underlying patterns is provocative. It seems to me that in a large database there should exist compressible patterns, and Barnsley and Sloan's technique seems to be a good way to find those patterns.

With database compression, the object is also not just compression but to find an insert faster than before. I have begun to use this technique in experiments on small databases, and, even in the worst

continued

What is a Best Western?



"My home
office
wherever
I travel."



The right place at the right price.

Make reservations at any Best Western,
see your travel agent, or call toll-free
1-800-528-1234

*"World's largest chain of
independently owned
and operated
hotels, motor inns and resorts"*

See us at Booth 1732
COMDEX/Spring '88



More Network Guts Than Most Network Boards

With advanced power and five times more speed, LANLink 5X™ has emerged.

Coming from award-winning, state-of-the-art technology, the new LANLink 5X™ boldly stands up to the challenge posed by costly, hardware-dependent networks.

That takes guts for a software-driven network. But we're confident.

Because we've discovered a high-speed networking channel that's already built into most PCs...the standard parallel port.

The High-Performance Alternative to Network "Boardom." Half a Megabit per second, with over 500 feet between connections. That's the astonishing rate at which LANLink 5X™ transfers data between PCs or PS/2s using ordinary parallel ports.

But you're not restricted to parallel ports. The very same sockets you'd use for modems... connect PCs at 115 Kbps. Plus, you get remote access support and multi-tasking performance under PC-MOS/386™ or PC-DOS.

Superior Results at Inferior Costs.

LANLink 5X™ lets network users share data, 1000s of DOS programs, files, and printers. For about the same cost as one network board, you can install a *five-user* LANLink network. Without special hardware...and in less than two hours.

Get Network Guts Without Network Boards. LANLink 5X™ is immediately available and comes with a money-back guarantee. Its price of \$595 includes a server and a satellite module plus the network operating system.

Call The Software Link TODAY for complete details on the fastest software-driven network that's ever been available.

CALL: 800/451-LINK

In Georgia: 404/441-2580	International/OEM Sales: 404/263-1006	Resellers/VARS: 404/448-5465	FAX: 404/263-6474
-----------------------------	--	---------------------------------	----------------------

3577 Parkway Lane, Atlanta, GA 30092 Telex 4996147 SWLINK
The Software Link/Canada CALL: 800/387-0453



THE SOFTWARE LINK

DEALER INQUIRIES INVITED

Circle 258 on Reader Service Card (DEALERS: 259)

LANLink, LANLink 5X, & PC-MOS/386 are trademarks of The Software Link, Inc. PS/2 & PC-DOS are trademarks of IBM Corp. Prices and technical specifications subject to change. Copyright ©1988. All Rights Reserved.

OUTSTANDING SOFTWARE

For IBM PC's and Compatibles

\$350 PER DISK**\$300 PER DISK**

Small Quantities

For Ten or More

SHIPPED WITHIN 24 HOURS!**Satisfaction Guaranteed or Money Back!**

- BUSINESS 1**—EZ-FORMS business form generation, completion and printing program.
- CAD 3**—The PC-Flow 1.0 computer aided flow-chart generation program. Color graphics required.
- COMM 4a,b,c,d,e**—(5 disks) Join the world of sysops with RBBS Bulletin Board System 14.1D.
- DATABASE 1a,b**—(2 disks) File Express 3.8 menu driven general purpose database manager.
- EDUCATION 1**—Interactive DOS tutorial for new PC users. Makes learning DOS painless.
- FINANCE 1a,b**—(2 disks) PC Accountant 2.0 personal bookkeeping and finance management.
- GAMES 1**—3-D Pacman, Kong, Spacewar, Janit-Joe, futuristic Flightmare and more. Color required.
- GAMES 2**—Oubert, Pango, Centipede, dungeons and dragons style Zoarre, etc. Color req.
- GAMES 3**—Blackjack with customizable rules, Armchair Quarterback (you call plays), and more.
- GAMES 4**—Star Trek, the Castle adventure game, and the original Colossal Caves Adventure.
- GAMES 5**—The Hack adventure game from the universities. Like Rogue, only much richer.
- GAMES 6**—Pinball, Othello, Dragons, Sopwith (fly a Sopwith Camel) and more. Color required.
- INFO 1a,b**—(2 disks) Cooking recipes database with keyword/ingredient retrieval. Add your own.
- MUSIC 2a,b**—(2 disks) PianoMan 3.0 polyphonic music recording and playback program.
- ORGANIZER 1**—DeskTeam, a Sidekick clone, and the Judy personal calendar program.
- PRINTER 1**—Resident print control and font utility, intelligent spooler, banner maker, and more.
- SIMULATION 1**—Maze making program, MIT's Life simulation, starfields, etc. Color graphics req.
- UTILITIES 1**—A collection of invaluable general purpose DOS utilities. An absolute must for all.
- UTILITIES 2**—More invaluable DOS utilities including screen burnout, ram disk, and more.
- UTILITIES 3**—A comprehensive set of debugging and diagnostic utilities for monitoring your computer.

BY 4/88

NEW RELEASES/UPDATES

- BUSINESS 2**—Expressgraph business graphics. Chart your data and find trends. Color graphics req.
- CAD 1a,b**—(2 disks) Fingerprint 1.2 advanced painting and Altamira object oriented design. Color.
- CAD 2a,b**—(2 disks) DanCad3d, an advanced 2D/3D drafting program w/animation. 640K, color.
- COMM 2a,b**—(2 disks) Procomm 2.42, an excellent modern program with terminal emulation.
- EDUCATION 3**—PC-Fastype 1.20 typing tutor, ideal for beginners and advanced students alike.
- FINANCES 3a,b**—(2 disks) Express Calc 3.12, a powerful and user friendly spreadsheet program.
- GAMES 8**—Striker helicopter attack and Risk, the game of world domination. Color required.
- GAMES 12**—Backgammon (play the computer) and Wheel of Fortune based on the gameshow.
- GRAPHICS 1**—Record and play back screen images! Excellent for demo, etc. Color required.
- GRAPHICS 2a,b,c**—(3 disks) An excellent 3-D surface modelling and shading program. Color.
- INFO 2a,b**—(2 disks) Zip-Phone, national areacode/prefix to zip-code cross reference.
- LANGUAGE 3a,b**—(2 disks) The A86 3.09 macro assembler and debugger for 8088/86/286s.
- SHELL 4a,b**—(2 disks) Automenu and HDM II 4.04 hard disk prog. for custom full-screen menus.
- UTILITIES 5**—Hard disk utilities for verifying, formatting, parking and optimizing your disk drives.
- UTILITIES 6**—Advanced utilities including Mark/Release (remove resident progs w/o reboot!)
- UTILITIES 7**—More advanced utilities including Masterkey (undeletes files from hard disks).
- WORD 1a,b**—(2 disks) PC Write 2.71, a powerful word processing system w/spell checker, laser supt.

Most software listed is shareware or user-supported.

3.5" format add \$1 disk. 125 page directory, add \$2.

MicroCom Systems Cost of items _____
 3673 Enochs Street Shipping \$3.00
 Santa Clara, CA CA res tax _____
 95051 Total encl. _____

**(408) 737-9000**

Mon-Fri 7am-9pm, Sat-Sun 8am-5pm



LETTERS

Listing 2: Automated scaling program.

DIM a(4), b(4), c(4), d(4), e(4), f(4), p(4) DATA 4

```

DATA      a      b      c      d      e      f      p
DATA      .85,   .04,  -0.04, .85,   0,    1.6,   .85
DATA      .2,   -0.26, .23,   .22,   0,    1.6,   .07
DATA     -0.15,  0.28,  0.26,   .24,   0,    .44,   .07
DATA      0,    0,    0,    .16,   0,    0,    .01

```

```

READ m%
pt = 0
FOR j% = 1 TO m%
  READ a(j%), b(j%), c(j%), d(j%), e(j%), f(j%), pk
  pt = pt + pk
  p(j%) = pt

```

```

NEXT j%
SCREEN 2

```

x = 0

y = 0

maxy = 0: maxx = 0: miny = 0: minx = 0:

,

For each new set of IFS codes:

,

```

To get the proper values for xscale, yscale,
xoffset, yoffset remove the comment
characters from the FOR loop below and run
breaking at the end of the loop after the
calculations for scaling.

```

FOR n% = 1 TO 2500

pk = RND

FOR k% = 1 TO m%

IF pk <= p(k%) THEN EXIT FOR

NEXT k%

newx = a(k%) * x + b(k%) * y + e(k%)

newy = c(k%) * x + d(k%) * y + f(k%)

x = newx

y = newy

IF x > maxx THEN maxx = x

IF x < minx THEN minx = x

IF y > maxy THEN maxy = y

IF y < miny THEN miny = y

NEXT n%

xscale = 640 / ABS (maxx - minx)

yscale = 200 / ABS (maxy - miny)

xoffset = ABS(minx * xscale)

yoffset = ABS(miny * yscale)

,

```

To get the proper values for scaling and offset
breakpoint here

```

```

xscale = 132.5282: xoffset = 288.6708: yscale =
20.00657: yoffset = 0

```

x = 0: y = 0

CLS

FOR n% = 1 TO 10

pk = RND

FOR k% = 1 TO m%

IF pk <= p(k%) THEN EXIT FOR

NEXT k%

newx = a(k%) * x + b(k%) * y + e(k%)

newy = c(k%) * x + d(k%) * y + f(k%)

x = newx

y = newy

NEXT n%

FOR n% = 1 TO 10000

pk = RND

FOR k% = 1 TO m%

IF pk <= p(k%) THEN EXIT FOR

continued

Did You Know?

Everex supplies a complete line of modem products

Whether you own IBM® PCs, XTs™, ATs® or compatibles, PS/2™ systems or Apple® Macintosh™ computers, our complete line of Evercom™ modems will work for you.

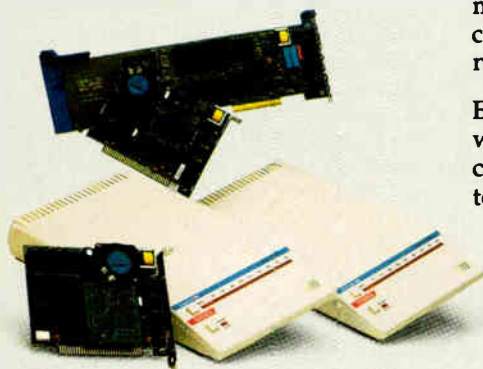

From the early days of the IBM PC, Everex has delivered quality add-on products at affordable prices. Our most recent introductions are the pocket size, full-featured Mini Modem and one of the first internal modems for PS/2 systems.

Quality and Features at Affordable Prices

If you need an internal modem for your home system, a Mini Modem™ for the road, or a rugged external modem for work, an Everex modem can satisfy all your data communications needs.

Everex modems are a cost effective way to add data communications capability to your personal computer. Being a large volume supplier of modems, Everex has extensive experience in developing and supplying modems.

Industry Compatible

Each Everex modem assures you of compatibility with existing standards no matter where you are in the world. Our Everex engineers are active on national and international committees developing communications protocols and the latest standards. This involvement strengthens our commitment to the industry and assures our customers 100% compatibility with other modems.

The Latest Technology

The Everex family of data modems now includes FAX capabilities with our EverFax™ product. The EverFax 12/48 offers the simplicity of Fax communication through your PC with over two million facsimile machines. When you can't afford any transmission errors, Everex has MNP™ error correction modems (internal or external) at 2400 bps for PC/XT/AT and PS/2 computers.



Our Commitment to Data Communications

The name Everex has come to mean quality, reliability and outstanding customer support in modems. So whatever your data communications needs, Everex has the right product for you.

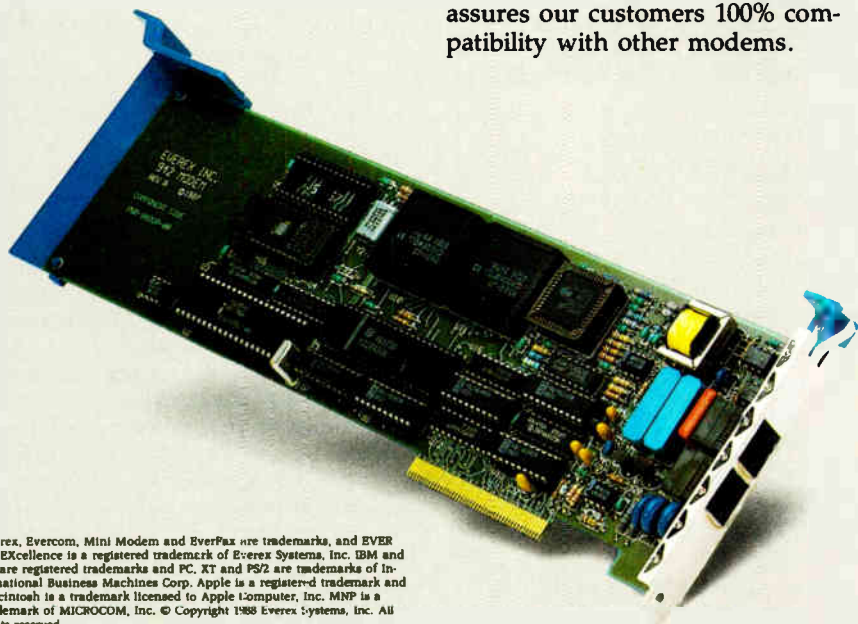

Everex, Evercom, Mini Modem and EverFax are trademarks, and EVER for EXcellence is a registered trademark of Everex Systems, Inc. IBM and AT are registered trademarks and PC, XT and PS/2 are trademarks of International Business Machines Corp. Apple is a registered trademark and Macintosh is a trademark licensed to Apple Computer, Inc. MNP is a trademark of MICROCOM, Inc. © Copyright 1988 Everex Systems, Inc. All rights reserved.

For more information or the name of your nearest Everex dealer please call:

in USA **1-800-821-0806**

in Calif. **1-800-821-0807**

EVEREX
EVER for EXcellence®

48431 Millmont Drive, Fremont, CA 94538

Circle 95 on Reader Service Card (DEALERS: 96)

```

NEXT k%
newx = a(k%) * x + b(k%) * y + e(k%)
newy = c(k%) * x + d(k%) * y + f(k%)
x = newx
y = newy
PSET (x * xscale + xoffset, y * yscale + yoffset)
NEXT n%
LOCATE 24, 35
PRINT "End.";
WHILE INKEY$ = ""
WEND

SCREEN 0
END

```



NOW THERE'S AN EXPERT SYSTEM EVEN THESE GUYS CAN USE.

Expert systems aren't just for experts anymore. Thousands of our customers use 1st-CLASS® to help troubleshoot complex equipment, assist with telephone support, analyze financial applications, and prepare complex documents.

1st-CLASS Expert Systems are the recognized industry leaders in ease of

use. They require no training to use, and no royalty payments when you distribute your work.

Whether you're saving money for your company or making money selling knowledge systems, we'll make your performance 1st-CLASS.

For IBM® PC and DEC VAX® computers. Priced from \$495 to \$1295.

1st-CLASS
Expert Systems, Inc.

For more information, or to order, call toll-free today: 1-800-872-8812
(1-617-358-7722 in MA) 286 Boston Post Road Wayland, MA 01778

case, compression seems to be 100 to 1, which translates into access times being sped up at least 100 to 1. I wonder if anyone with a truly large database would be interested in helping out with such experiments.

Robert McLaughlin
Leesburg, VA

Fast Data Access

In response to the article entitled "Fast Data Access" by Jonathan Robie (January), I would like to offer the following suggestions:

Any programmer competent in BASIC, dBASE, or other languages can build indexes to a large database where an index requires only 2 bytes of memory and/or disk per record, even when the index represents several fields and hundreds of characters of data. Virtually any number of indexes can be "open" at the same time, since all the index stacks can be written to a single file.

These are known as "string-stack" indexes, and their performance is easy to calculate. Using a 20-millisecond access hard disk drive, the time needed to add a record to an existing 60,000-record database is less than 0.5 seconds per index. Finding the first record in a sequence takes about 0.3 seconds, and subsequent records in indexed order are retrieved at the rate of 50 records per second.

Flat-file management takes on a whole new meaning when a user can feasibly maintain 10, 20, or more multifield indexes on-line at all times. Even the relational systems could use this technique by including an extra byte to point to different files.

Fully implemented examples of this system are available in a number of BASIC dialects and should convert easily to other common languages.

Dale Thorn
Ventura, CA

From Humber Beginnings

Thank you for "Managing Immense Storage" by Theodor H. Nelson (January). I found the concept of "humongous numbers," or "humbers," as the author termed them, intriguing. After finishing the article, I sat down and started playing with humbers at my computer.

As of this writing, I have implemented algorithms in Modula-2 that provide the basic arithmetic and I/O operations for humbers. I am willing to make available my source code to any BYTE reader who cares to write to me.

I did the programming in Workman & Associates' FTL Modula-2 (Large Memory Module), but it should be usable in any Modula-2 environment because I

continued

. . .and a complete line of graphics adapters

Everex is the only graphics board vendor you need. Whether you are selecting your first personal computer or buying hundreds for your office, choosing the right graphics card is easy with Everex. With PGA, VGA, EGA, CGA, MDA, or ultra-high monochrome resolution, Everex has just what you need.



Everex has been there From the Beginning

Everex introduced the Graphics Edge™ graphics card for the IBM® PC in 1983, providing the then unique capability to run CGA and Hercules® programs on the same monochrome monitor. Since those early days of the PC, Everex has continued to innovate graphics technology, bringing new products to the marketplace.

Compatibility with Existing Standards

All Everex graphics adapters are fully compatible with all the existing graphic modes established by IBM. And while we include unique features on many of our graphics products, we make sure that none of the established standards are compromised.

Advanced Engineering

The Everex dedication to excellence has led us to develop our own proprietary chip sets. This allows us greater control in the design of our graphics cards. Our use of ASIC (Application-Specific Integrated Circuit) technology reduces chip count for cooler operation and improved reliability.

Most important, our own chip sets enable our design teams to incorporate the many special features you have requested, while maintaining the standard features you have come to expect from Everex products.



Fully Tested with a Human Touch

We hand test every Everex graphics card for true color and tone on a video monitor in our factory before it's shipped. So before you ever install your Everex graphics card, we've made sure that it's just right for you.

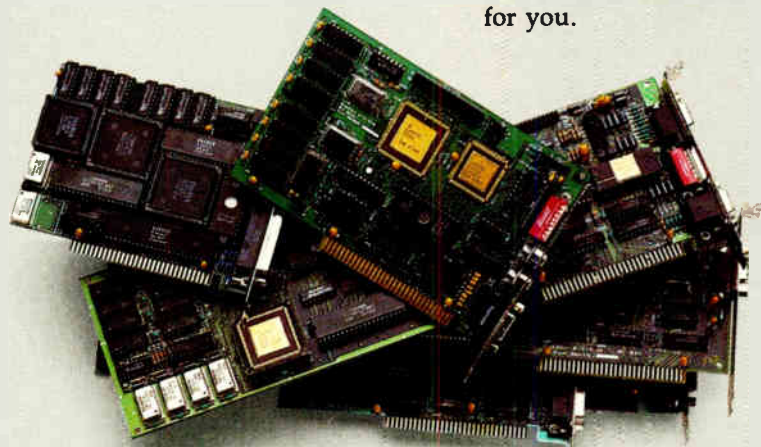

For more information or the name
of your nearest Everex dealer please call:

in USA **1-800-821-0806**
in Calif. **1-800-821-0807**

Everex and Graphics Edge are trademarks, and EVER for EXcellence is a registered trademark of Everex Systems, Inc. IBM is a registered trademark and PC is a trademark of International Business Machines Corp. Hercules is a registered trademark of Hercules Computer Technology, Inc. © Copyright 1988 Everex Systems, Inc. All rights reserved.

EVEREX
EVER for EXcellence®

48431 Milmont Drive, Fremont, CA 94538

Circle 97 on Reader Service Card (DEALERS: 98)

World Radio History

didn't use extensions. My system runs on IBM PC-DOS 3.3, so the disks will be DOS-compatible. Readers should enclose a check for \$7.95 to defray the cost of the disk, postage, and so on.

Mark S. Niemczyk
Arete Systems Inc.
2431 Aloma Ave., Suite 111
Winter Park, FL 32792

Context Sensitivity

In "Natural-Language Processing" (December 1987), Klaus K. Obermeier, in discussing whether English is a properly

context-sensitive language, gives the following example string: "The programs compile slowly." He then comments, "You can add additional rules to the grammar that would disallow such sentences, but these rules would destroy its present simplicity." This is both incorrect and irrelevant. It is incorrect because all the grammar types under discussion are monotonic—addition of rules can only increase (or leave unchanged) the set of strings generated, not decrease it. And it is irrelevant, since the simplicity of a grammar for a language has no bearing

on whether the language is, or is not, properly context-sensitive. Nor is the size of the set of rules required relevant. If a grammar with a finite set of context-free rules can be given for a language, then that language is not properly context-sensitive.

Obermeier also refers to the grammar in his figure 2 as "a simple context-sensitive grammar," which is true, but misleading. The grammar concerned is, in fact, a context-free grammar and thus trivially also a context-sensitive grammar. However, referring to it as a "context-sensitive" grammar, as Obermeier does, implies that it is not (merely) context-free.

Gerald Gazdar
Professor of Computational Linguistics
The University of Sussex
Brighton, UK

FIXES

• In the February BYTE on page 236, we labeled XLISP as "public domain," and we neglected to mention its author, David Betz. XLISP is actually a copyrighted program that is freely distributable for noncommercial use.

• The phone number we published for Toshiba America in the review of the Toshiba T3100/20 (January) is wrong. The correct number is (714) 583-3000.

• The NEC MultiSync Plus, which we included in the review of multisync monitors (February), is not intended for use with CGA. The unit worked fine in our CGA test, but NEC says the unit might not work with all CGAs. The same holds true for the MultiSync XL. NEC says its MultiSync II (\$899) is intended for use with CGA and higher-frequency adapters, such as EGA and PGC.

We said the Mitsubishi AUM 1371A had a 17 percent change in line displacement, and the NEC MultiSync Plus and Conrac 7250 monitors had 0 percent change. That should be a 0-millimeter change for the NEC and Conrac and a 0.17-mm change for the Mitsubishi.

Finally, Taxan's Multivision 770 Plus monitor has a maximum resolution of 800 by 600 pixels, not 640 by 480 as stated in the review.

• SuperMac Technology's phone number that we published in "Screening Macintosh II Color Monitors" (March) is incorrect. The correct number is (415) 964-8884, and the scanning frequency of its monitor is 48 KHz by 60 Hz. ■

If you think you can buy a better C compiler, don't. We'll buy it for you.

Buy Let's C[®] with *csd*[™] for just \$75. If you're not satisfied, get Turbo C or QuickC. Free.*



Why are we making this incredible offer? Because we're absolutely certain Let's C and *csd* C Source Debugger are the best C programming tools you can own.

Rest assured that, like its competition, Let's C features incredibly fast in-memory compilation and produces extremely tight, high quality code. The differences lie in how much faster you can perform other programming chores.

Our debugger, for example, can cut development time in half. But that's not all:

"csd is close to the ideal debugging environment... a definite aid to learning C and an indispensable tool for program development."

—William G. Wong, BYTE

And comparatively speaking: *"No debugger is included in the Turbo C package... a serious shortcoming."*

—Michael Abrash, Programmer's Journal

Unlike our competition, Let's C includes its own full-featured assembler, features documentation with complete examples and technical support with complete answers—the first time you call.

LET'S C:	LET'S C AND <i>csd</i> FEATURES	<i>csd</i> :
<ul style="list-style-type: none"> • Now compiles twice as fast • Integrated edit-compile cycle: editor automatically points to errors • Includes both small and large memory model • Integrated environment or command line interface • 8087 sensing and support 	<ul style="list-style-type: none"> • Full UNIX compatibility and complete libraries • Many powerful utilities including make, assembler, archiver • MicroEMACS full screen editor with source code included • Supported by dozens of third party libraries 	<ul style="list-style-type: none"> • Debug in C source code, not assembler • Provides separate source, evaluation, program and history windows • Ability to set trace points and monitor variables • Can interactively evaluate any C expression • Can execute any C function in your program • Trace back function

So if you're thinking about buying any other C compiler, think again. But you only have until Feb. 29 to order and take advantage of this special offer. So think fast. And call 1-800-MWC-1700 soon. (1-312-472-6659 in Illinois.)

*Offer available on telephone orders only from Feb. 1, 1988 to Feb. 29, 1988. To exchange Let's C and *csd* for Turbo C or QuickC, re-turn registration card within 15 days of purchase date, notify Mark Williams Company that you are returning products and receive a return authorization number. Products must be returned within 30 days from shipping date.



1430 West Wrightwood, Chicago, Illinois 60614, 312-472-6659

© 1988 Mark Williams Company

. . .and a complete line of tape backup products

Since 1984, Everex has been an industry leader in the PC tape backup market. Every day, Everex tape products are used to protect data on IBM® PCs, XTs™, ATs® or compatibles, PS/2™ systems and Apple® Macintosh™ computers.



A Wide Selection

Because we know that everybody's backup requirements—and budgets—are different, Everex provides a wide selection of tape drive models. You can choose from cassette, mini-cartridge, or cartridge tape drive models that have capacities ranging from 40MB to 125MB.

And, to reduce your overall backup equipment costs, you can share one external tape drive among several PC systems by installing controllers in each system and rotating the tape unit from PC to PC.

PC to PS/2 and Back—Effortlessly

With our Micro Channel™ tape controller, Everex provides backup capability for the PS/2 family of personal computers. And, because we maintain the same data recording format between PCs and PS/2 systems, you are assured of error-free data migration between PCs and PS/2s.

Backup Software that Thinks for You

Everex supplies easy to follow, menu-based software with all of its tape systems. You can save or restore an entire mirror image of your disk, including non-DOS information. Or you can restore individual files from a tape that contains a complete image backup. Backup and restoration of data over



Novell® networks, including the Bindery and Trustee files that contain Novell network security information, is another standard feature.

And, our software-guided installation and configuration of both hardware and software makes installing our tape system a breeze. The tape diagnostic utilities are the most extensive available, and if you get lost, we offer context sensitive on-line help information.

Friendly, Knowledgeable Support

In case you might need help, our knowledgeable Technical Support Staff is ready to answer your questions. They know our products inside and out and are ready to provide expert assistance whenever you need it.



For more information or the name of your nearest Everex dealer please call:

in USA **1-800-821-0806**

in Calif. **1-800-821-0807**

Everex is a trademark and EVER for EXcellence is a registered trademark of Everex Systems, Inc. IBM and AT are registered trademarks and PS/2, PC, XT and Micro Channel are trademarks of International Business Machines Corp. Apple is a registered trademark and Macintosh is a trademark licensed to Apple Computer, Inc. Novell is a registered trademark of Novell Inc. © Copyright 1988 Everex Systems, Inc. All rights reserved.

EVEREX
EVER for EXcellence®

48431 Milmont Drive, Fremont, CA 94538

Circle 102 on Reader Service Card (Dealers: 103)

World Radio History

Create Powerful Programs with Blaise TOOLS

Whether you're an expert or a novice, you can benefit from using special tools to enhance your programs, make them reliable, and give them a professional look. With windows, menus, pop-up memory resident programs, and communications support, Blaise Computing offers you a wide range of programming tools to let you take full advantage of the Microsoft and Borland programming environments. All language support packages include fully commented source code, complete comprehensive manuals and sample programs.

C TOOLS PLUS/5.0 \$129.00

Full spectrum of general service utility functions including: windows; menus; memory resident applications; interrupt service routines; intervention code; and direct video access for fast screen handling. Specifically designed for Microsoft C 5.0 and QuickC.

Turbo C TOOLS \$129.00

Windows and menus; ISRs; intervention code; screen handling including EGA 43-line text mode support; direct screen access; and memory resident applications. Carefully crafted specifically to complement Turbo C.

Turbo POWER SCREEN \$129.00

NEW! General screen management; paint screens; block mode data entry or field-by-field control with instant screen access. Now for Turbo Pascal 4.0, soon for C and BASIC.

Turbo POWER TOOLS PLUS \$129.00

NEW VERSION! Now supports Turbo Pascal 4.0. Screen, window, and menu management including EGA support; DOS memory control; ISRs; scheduled intervention code; and much more.

Turbo ASYNCH PLUS \$129.00

NEW VERSION! Now supports Turbo Pascal 4.0. Interrupt driven support for the COM ports. I/O buffers up to 64K; XON/XOFF; up to 9600 baud; modem and XMODEM control.

ASYNCH MANAGER \$175.00

Full featured interrupt driven support for the COM ports. I/O buffers up to 64K; XON/XOFF; up to 9600 baud; modem control and XMODEM. For Microsoft C, Turbo C or MS Pascal.

KeyPilot \$49.95

"Super-batch" program. Create batch files which can invoke programs and provide input to them; run any program unattended; create demonstration programs; analyze keyboard usage.

PASCAL TOOLS/TOOLS 2 \$175.00

Expanded string and screen handling; graphics routines; memory management; general program control; DOS file support and more. For MS-Pascal.

EXEC \$95.00

NEW VERSION! Program chaining executive. Chain one program from another in different languages; specify common data areas; less than 2K of overhead.

RUNOFF \$49.95

Text formatter for all programmers. Written in Turbo Pascal: flexible printer control; user-defined variables; index generation; and a general macro facility.

**TO ORDER CALL TOLL FREE
800-333-8087!**

BLAISE COMPUTING INC.

2560 Ninth Street, Suite 316 Berkeley, CA 94710 (415) 540-5441

32 B Y T E • APRIL 1988

CHAOS MANOR MAIL

Jerry Pournelle answers questions about his column and related computer topics

Wants Electronic Support

Dear Jerry,

I have been reading BYTE and other computer magazines since 1984, and I have noticed one very large problem with computer manufacturers. They rarely electronically support their software, and when they do, it's usually through a service that costs lots of money. Only one commercial company that I know of supports its customers via a free service: USRobotics, the founder of the FidoNet National Communications Echo.

Why don't other companies get involved in such phenomena? Certainly they're cheaper, and you probably get a larger segment of the *human* communicating population. It certainly would be nice if, once the companies have got our money, we didn't have to pay even more money to ask them questions.

I have also read your gripes about Microsoft Word. I wrote this letter using Word, and I like it. I think I know why you have a problem with it and I don't. I use the original IBM PC keyboard, and I *don't* use a mouse. I also type with 5.33 fingers. This means that all the keys are easy to reach (to delete this parenthetical remark, I'd reach over with my left pinky, hit the F6 and F8 keys in rapid succession, then reach over with my right pinky and hit the Delete key). Maybe the new keyboard is not so enhanced after all.

I also don't like the cost of sending you this letter. If you had (or, at least, published) a FidoMail or Usenet address, it would cost me only 14 cents. If the folks at BIX gave us FidoNet people a link into their mail system, it would still cost only 14 cents. As it is, this letter costs 22 cents. Eight cents can add up quickly.

Garrett A. Wollman
Burlington, VT

It's a lot easier for me to deal with paper mail when the time comes to select mail for replies. I doubt that I could handle the volume I'd get on FidoNet or Usenet.—Jerry

Merely a Z-100

Dear Jerry,

A while back, you were looking for an IBM PC-compatible that could read your 8-inch disks. I am writing this letter on just such a machine. In earlier times, it

was a *mere* Z-100. Now, with the Scottie board and the Heath User Group ZPC software, it runs most IBM PC programs right out of the box, giving me adequate compatibility with the IBM PC XT at work.

The text processor is the IBM PC version of Galahad, originally made for the Zenith at Clarkson College and ported to the PC. I regularly run VP-Planner, VP-Info, and the PC version of Turbo Pascal using the ZPC simulator. With a few keystrokes, the machine again becomes the old reliable 768K-byte Z-100. The 8-inch disks can be used from either side.

I know you have mentioned this machine before. It will be some time before I outgrow it. When I bought the 8-inch disk drives, they were less expensive than a hard disk drive. Also, I was sharing the machine with other family members. As long as each one of us kept our world on a pair of 8-inch disks, we could never harm each other's worlds.

For disk-intensive activity, I pay a penalty. But other than that, I have 2.5 megabytes available at any time, and when a long session is over, a simple COPY C:*.* D: does a neat job of creating a second, reliable copy of everything that happened.

This machine is what we euphemistically call "mature technology"—not the very latest, but it works and works and works. And for a few of us mavericks, that is what counts.

Leon R. Case II
Portland, CT

The Z-100 is still one of the best machines around, provided that you know something of what you're doing. Of course, Zenith brought it out just before IBM decided to saturate the market with its DOS machines, and it took a long time before the need for, and the ability to have, PC compatibility was achieved. By then, even Zenith had sort of given up on the Z-100; but it's sure a nice machine.—Jerry

continued

Jerry Pournelle holds a doctorate in psychology and is a science fiction writer who also earns a comfortable living writing about computers present and future. He can be reached c/o BYTE, One Phoenix Mill Lane, Peterborough, NH 03458.

Everex has the Answer

Whatever you need for your PCs, XT[™], AT[®] or compatibles, PS/2[™] systems and Apple[®] Macintosh[™] computers, Everex has the answer. Everex designs and manufactures products to enhance the power and capability of your system.



From modems to graphics adapters and tape backup, Everex makes more than 100 products—including our popular hard disks, tape backup and memory/multifunction boards. Everex can provide the right solution—at the right price. And Everex products support the newest technologies, from OS/2[™] to EMS 4.0. We also have advanced 20 MHz/80386 and 16 MHz/80286 personal computers.

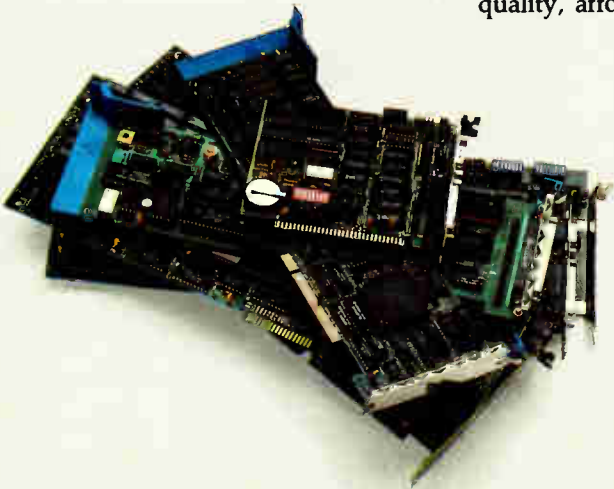

From our beginning in 1983, the people at Everex have provided quality products at affordable prices, with a commitment to personal service. Our honest, straight-forward approach has transformed Everex into a multi-hundred million dollar company employing over 1300 people worldwide.

With more than 175 engineers involved in research and development, we consistently develop the innovative PC products that you need. And because 100% of all Everex products undergo final assembly and test in our 250,000 square foot headquarters in Fremont, California, we offer unparalleled quality, response and service to our rapidly growing family of dealers.

A staff of over 200 service-oriented people is available to answer your questions and insure that orders are processed and ready to ship within 48 hours. Everex also has knowledgeable people to help with technical support, too.

From initial design through manufacturing, testing, and after-sale support, Everex's complete dedication to quality, affordability,



innovation, and service assures you of the best value in personal computers and enhancement products.

So, whatever your personal computing needs, *Everex has the answer.*

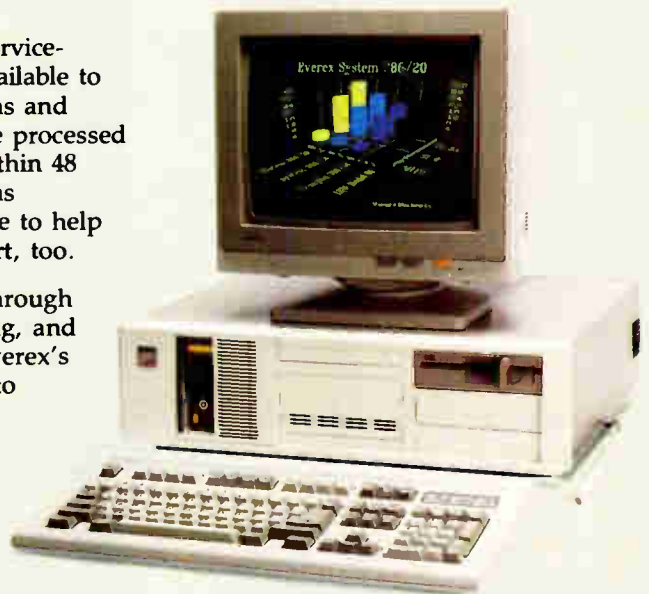

For more information or the name of your nearest Everex dealer please call:

in USA **1-800-821-0806**

in Calif. **1-800-821-0807**

Everex is a trademark and EVER for Excellence is a registered trademark of Everex Systems, Inc. PC, XT, PS/2 and OS/2 are trademarks and AT is a registered trademark of International Business Machines Corp. Apple is a registered trademark and Macintosh is a trademark licensed to Apple Computer Inc. © Copyright 1988 Everex Systems, Inc. All rights reserved.

EVEREX
EVER for Excellence[®]

48431 Milmont Drive, Fremont, CA 94538

Circle 104 on Reader Service Card (DEALERS: 105)

Another RAM-Resident Solution

Dear Jerry,

In the September 1987 column, you wrote about having troubles with your resident software and gave an example of a batch file that rewrites the AUTO-EXEC.BAT file. I think I've got a better solution.

The Norton Utilities (at least the advance edition) includes a program called Ask, which can be used to solve problems like yours in a tidy way. Ask lets you build menus in a batch file, input into the batch file, and set the error level according to your input. A better solution to your problem could look like this:

```
ECHO 1. Ready!, SuperKey, SideKick
ECHO 2. Lightning, SideKick
ECHO 3. DESQview
ECHO 4. Windows
ASK "What shall I load", 1234
if errorlevel 1 then goto ____
if errorlevel 2 then goto ____
```

If you want to stick to your method, you could write a little program that reboots the system via interrupt 25.

I do almost all my editing with the Norton Editor, which can do all you need and is very small. It also supports a mouse if one is connected. Just press the left mouse button, and you can move the cursor around; press the mouse again, and you drop the cursor at the new location. I find that very useful.

When it comes to output, I use TEX. My second choice is MicroStar from the Turbo Editor Toolbox; it cooperates with Lightning nicely.

Konrad Neuwirth
Vienna, Austria

Your solution is more elegant. Among other things, it takes up a lot less memory, since the minimum size file under DOS 3.x is 2K bytes.

I fear you are beyond me with TEX; I have so far found it to be a black art.
—Jerry

WordStar 4.0 Wrinkles

Dear Jerry,

I wrote to you previously to describe a problem with WordStar 4.0 not properly supporting the extended character set when used for program source codes. Further investigation shows that WordStar 4.0 assigns three characters for each extended character. A hexadecimal dump of a WordStar 4.0 file that has the extended characters shows that each extended character is preceded by hexadecimal 1B and followed by hexadecimal 1C.

MicroPro has notified me that it will provide a program to take a file having the extended character set and print it to disk so that the offending 1B and 1C codes surrounding each graphics character are removed. This solution should be workable, but it seems awkward. A better solution seems to be to use a program such as WordStar 2000, which does not have this feature. Other than this anomaly, I have found WordStar 4.0 to be an excellent program.

One other point that is somewhat frustrating is that the version of Word Finder supplied with WordStar 4.0 supports only WordStar 4.0. Microlytics's generic version of Word Finder does not support WordStar 4.0, so if I want to use Word Finder with other programs, such as SideKick, I have to maintain two Word Finder programs and dictionaries on my

hard disk. This seems ridiculous, since the dictionaries appear to be identical. I suppose this is another form of copy protection.

Thomas S. Cox
Greenville, SC

I expect it is some kind of publication protection scheme. The chaps at Microlytics are generally good guys and don't use copy protection. I'll have to ask about this.

People who like WordStar seem to like WordStar 4.0 a lot. There's a dance in the old girl yet.—Jerry

CP/M Plus Source?

Dear Jerry,

I bought a TeleVideo I Portable with CP/M Plus, and although I wrote to the Professional Computer Group in Bangor, Maine, no one ever answered. (I have written several letters—even one with receipt requested, which was received but not answered.)

The problem is that the CP/M Plus software is for a different machine, so the 128K bytes is useless!

Is there anybody in the U.S. who is willing to support the old CP/M? Is there anything like the Norton Utilities for CP/M?

Alex Korth
Buenos Aires, Argentina

Workman and Associates (1925 E. Mountain St., Pasadena, CA 91106, (818) 791-7979) and Spite Software (4004 Southwest Barbur Blvd., Portland, OR 97201, (503) 228-8223) try to support CP/M systems. There are probably others, but I don't know who.—Jerry ■

BYTEK's NEW 135 MULTIPROGRAMMER™ OFFERS 18/12 PROTECTION PLAN

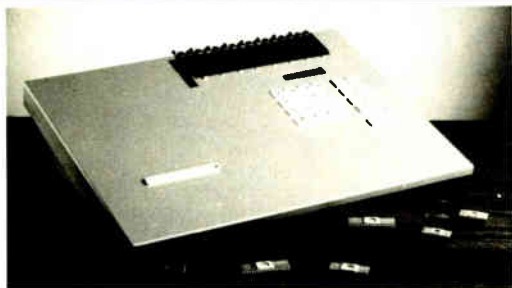

BYTEK

Call us today at:
1-800-523-1565

In Florida: (305) 994-3520
FAX: (305) 994-3615
TELEX: 4998369 BYTEK

BYTEK's 135 programs virtually any 24-, 28-, & 32-pin (E)EPROM from 16K to megabit devices. Sets of devices, 16- & 32-Bit Wide, can be downloaded into RAM via the RS232 & programmed in one easy operation. As a stand alone Gang Duplicator, up to 8 EPROMS can be copied at one time, (optional 16 EPROMS).

UNIVERSAL: With standard 256K x 8 RAM, expandable to 2 MegaByte, the 135 supports more devices than any other production programmer on the market today. Options available to program 40 pin EPROMS, (E)PLD/GALs, Bipolar PROMs, & 40 pin Micro Computer Devices.

18/12 PROTECTION PLAN: BYTEK offers a full 18 Month Warranty, & 12 Month FREE Device Updates.

BYTEK

CORPORATION
INSTRUMENT SYSTEMS DIVISION

1021 South Rogers Circle, Boca Raton, FL 33487

One for all.

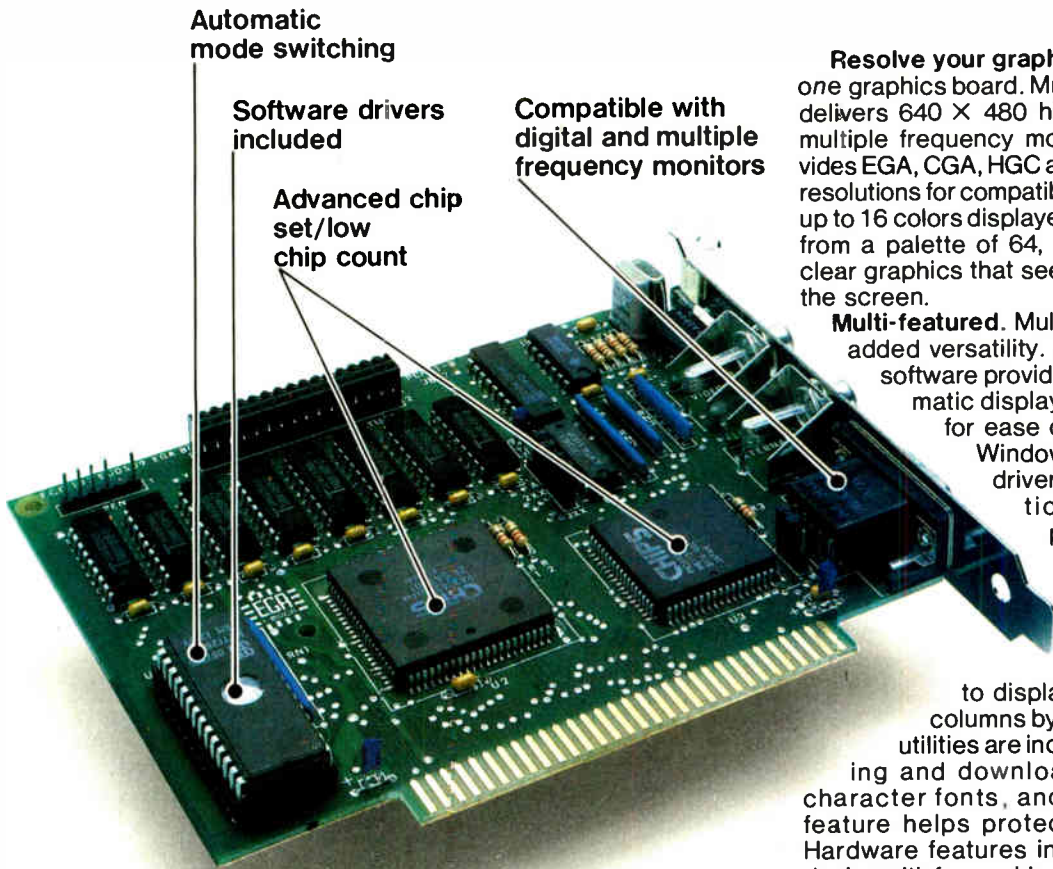

Resolve your graphics needs. With one graphics board, MultiEGA by BOCA delivers 640 X 480 high resolution to multiple frequency monitors, and provides EGA, CGA, HGC and MDA standard resolutions for compatible monitors. With up to 16 colors displayed simultaneously from a palette of 64, you'll get sharp, clear graphics that seem to jump out of the screen.

Multi-featured. MultiEGA also brings added versatility. Just a sample of software provided includes automatic display mode switching for ease of use; Microsoft Windows and AutoCAD drivers for high resolution, 640 X 480 pixel graphics: plus four Lotus 1 - 2 - 3 and Symphony text modes and one for WordStar to display text up to 132 columns by 43 lines. Special utilities are included for designing and downloading your own character fonts, and a screen save feature helps protect your monitor. Hardware features include advanced design with fewer chips, allowing greater speed while reducing the chance of component failure. MultiEGA also includes 256K of onboard video memory, a light pen port, two RCA video jacks and a feature connector.

Built-in quality. MultiEGA is made, serviced and supported in the USA using high-quality, high-reliability components. It requires one expansion slot of any IBM PC, XT, AT or compatible. Installation is easy, and if you have a problem or question, MultiEGA's two-year warranty includes free technical support.

When you add up all these features, you'll get one answer: MultiEGA. To order your own MultiEGA, see your dealer or contact us directly.

MultiEGA is a trademark of Boca Research, Inc. All other references to computer systems, software and peripherals use trademarks owned by their respective manufacturers.

BOCA

RESEARCH INC

6401 Congress Ave., Boca Raton, FL 33487
 Phone: 305-997-6227, TELEX: 990135
 FAX: 305-997-0918

\$299.

Manufacturer/ Product	768x410	640x480	132 Column	Supports:				Chip Count	List Price
				EGA	CGA	HGC	MDA		
Genoa Systems Super EGA	Y	Y	Y	YES				21	\$399
Video Seven VEGA Deluxe	Y	Y	Y	YES				22	\$379
Paradise Systems AutoSwitch EGA 480	N	Y	Y	YES				27	\$349
Boca Research MultiEGA by BOCA	Y	Y	Y	YES				14	\$299

Chart information accurate as of 1/14/88
 © Copyright 1988 Boca Research, Inc.

Circle 37 on Reader Service Card (DEALERS: 38)

ASK BYTE

Circuit Cellar's Steve Ciarcia answers your questions on microcomputing

Seeing-Eye Computers

Dear Steve,

Practical speech synthesis appears to be lagging behind image processing. A blind social worker here at Texas A&M University would benefit greatly from a talking computer. We can easily access the hospital mainframe, but we've had difficulty locating a good speech-synthesis system. Those that have been called to our attention seem outdated.

Do you know of any hardware or software that will enable a sightless person to effectively use a computer? Just making it talk is not enough. The system must be able to use word-processing and data-management software—preferably under MS-DOS—and possibly interface with a high-level language. We might start with a desktop model, but a laptop is our ultimate goal.

David Lemper
Temple, TX

I think the current state-of-the-art speech-synthesis hardware is quite capable of generating understandable speech. The real problem you are referring to is the ability to use this hardware technology in an integrated fashion to remove the barriers a sightless person has in using a computer. Perhaps the real need is for software, such as a word processor, to function with a speech module as an output device to replace the visual information normally received from the screen.

There is far more involved here than merely echoing the screen information. In fact, the words on the screen represent only part of the information, since positioning and other visual clues are just as important.

While I have seen some limited demonstration software, I have not seen a truly general-purpose solution to your problem. I think this type of question deserves a broader research effort than I can give you. But let me make some specific suggestions about where you can look.

Two computer retrieval databases cover your area of interest: ABLEDATA and REHABDATA. Both are supplied by the National Rehabilitation Information Center, located at the Catholic University of America in Washington, DC. You can access these databases through commercial on-line research services, such as Dialog Information Services (3460

Hillview Ave., Palo Alto, CA 94304, (800) 334-2564; in California, (415) 858-2700) or BRS (1700 Route 7, Latham, NY 12110, (518) 783-1161). You may want to contact a research librarian at Texas A&M for more information.—Steve

Hand-Holding for a Hand-Held

Dear Steve,

I have a Texas Instruments CC-40 hand-held computer. Unfortunately, there are no service manuals available for it—at least not here in Austria. According to the user's manual, I could program the computer in assembly language, but I don't have any information about how to do this. Do you know the address of a TI retailer or computer club that I could write to? I've already written to TI's customer service department, but I've received no reply.

Walter Schrabmair Jr.
Salzburg, Austria

For the most part, TI has been out of the retail computer business for some time. However, users groups still flourish here in the U.S. to support TI machines.

TI PPC Notes (P.O. Box 1421, Largo, FL 34294-1421) supports programmable calculators made by TI. The Houston TI Users Group (c/o Kim Peterson, 3107 Bafing, Houston, TX 77099-2244) primarily supports the TI99-4A computer. I think you might be able to get some useful information for your machine from these sources.—Steve

Bit by Bit

Dear Steve,

I have tried for a long time to buy a computer, but I can't come up with the big chunk of cash necessary. I have therefore decided to buy it piecemeal, component by component. I would like to end up with something more than an IBM PC XT, or at least something that I could simply upgrade by just a motherboard replacement. This precipitates several questions.

First, do XT and AT cases accept different motherboards? If so, do you know of an XT-compatible motherboard (preferably with an 8088-1) that fits in an AT case, has keyboard-selectable 10-MHz speed, and uses an AT power supply so

that I can turn my system into a 286/386 machine with a simple motherboard swap? Finally, what is the difference between regular ATs and so-called mini- or baby-ATs?

Jim Freeman
Salt Lake City, UT

For the most part, XT and AT cases accept different-size motherboards. However, some firms do sell AT motherboards that fit into XT cases. I can't make any recommendation on particular boards because I am not familiar with them. However, if you search through Computer Shopper magazine, you will find many clone vendors.

Regarding your second question, I am not aware of any XT motherboards that fit your exact description. But consider that an XT clone motherboard might sell for \$100 to \$200 and an AT motherboard for \$300 to \$500. You might be better off to bite the bullet and get the AT right from the start.

A regular AT has a larger motherboard and case compared to a mini- or baby-AT. The intent is to have a smaller footprint on your desk. Functionally, they are the same, though the mini-AT may have fewer expansion slots.—Steve

It's All in the Handshaking

Dear Steve,

I need to know how to test my printer's status—whether it is on-line, off-line, turned off, or otherwise unavailable—

continued

IN ASK BYTE, Steve Ciarcia, a computer consultant and electronics engineer, answers questions on any area of microcomputing and his Circuit Cellar projects. The most representative questions will be answered and published. Send your inquiry to

*Ask BYTE
c/o Steve Ciarcia
P.O. Box 582
Glastonbury, CT 06033*

Due to the high volume of inquiries, we cannot guarantee a personal reply. All letters and photographs become the property of Steve Ciarcia and cannot be returned.

The Ask BYTE staff includes manager Harv Weiner and researchers Eric Albert, Tom Cantrell, Bill Curlew, Ken Davidson, Jeannette Dojan, Jon Elson, Frank Kuechmann, Tim McDonough, Edward Nisley, Dick Sawyer, Robert Siek, and Mark Voorhees.

NO FOOLIN'!

WE'RE PRINTER EXPERTS!

Printers Plus has been satisfying customers since 1982 by exclusively concentrating on computer printers. We're not just order takers - we're experts! Call today!

IT'S TIME YOU SAW THE ALPS ALQ 218

Features:

- Full color dot matrix printer
- 240 cps draft/120 cps correspondence/80 cps letter quality
- Optional snap in/out 24-pin print head
- Easy front panel control



LIST PRICE: \$595

PRINTERS PLUS PRICE:

\$395

NEC LC-890

Features:

- 8 pages per minute
- 35 fonts
- Post Script/HP compatible



LIST PRICE: \$4795

CALL

FOR PRINTERS PLUS PRICE

THE WORLD'S LARGEST SELECTION OF PRINTERS! We guarantee to match the lowest in-stock prices in this issue of PC MAGAZINE! If you don't see it, CALL!

PRINTERS

- ALPS
- FUJITSU
- OLYMPIA
- BROTHER
- NEC
- PANASONIC
- CITIZEN
- MLQ*
- PRIMAGES
- EPSON
- OKIDATA
- TOSHIBA

WE'RE LASER EXPERTS

- APPLE
- HEWLETT-PACKARD
- PANASONIC
- AST
- KYOCERA
- PRINTERS PLUS
- BROTHER
- CANON
- Epson
- GENERAL COMPUTING
- OASYS
- OKIDATA
- QMS
- QUE
- TOSHIBA
- XEROX

GREAT PRICES WITH A GUARANTEE TO MATCH™

PRINTERS PLUS

THE NATION'S ONLY COMPUTER PRINTER SPECIALISTS™



FAX NUMBER:
(703) 734-3859

PRINTERS PLUS, INC.
8486-C TYCO RD., VIENNA, VA 22180
HOURS: MON-THUR: 10 AM-7 PM EST
FRIDAY: 10 AM-5 PM

(703) 734-0236

WE'LL CREDIT COST OF LONG DISTANCE TELEPHONE CALL WITH ANY PRINTER PURCHASE.

This offer good only through mail order division. Visit our 7 retail showrooms for best local prices. 15% restocking fee applies to all returned or refused merchandise.

PRINTERS PLUS AND COMPUTER PAPER DESIGN ARE REGISTERED TRADEMARKS OF PRINTERS PLUS, INC., VIENNA, VA.

ASK BYTE

Listing 1: Skeleton of Turbo Pascal code needed to query printer status.

```

Program...
type
  Register_Type = record
    case integer of
      1: (AX, BX, CX, DX, BP, DI, SI, DS, ES, Flags :
          integer);
      2: (AL, AH, BL, BH, CL, CH, DL, DH : byte);
    end;
var
  Registers : Register_Type;
  Status : integer;
...
with Registers do begin
  AH:= $2;
  DX:= $1ptn; { 0 for LPT1, 1 for LPT2,
              etc. }
  Intr($17, Registers); { Call the BIOS }
  Status:=AH; { Get result byte }
end;
    
```

Table 1: Bit settings and their significance for the Status variable returned in listing 1.

Bit	Indication
7	Not busy
6	Ack has been received from printer to acknowledge last character sent
5	Paper out
4	Printer selected, on-line
3	I/O error
2	Not used
1	Not used
0	Time-out error

from within a program. It's irritating to have the system hang up while attempting to send a command to the printer when it turns out the printer was off-line.

I am using Turbo Pascal 3.01. My printer is a Star SG-10, set up as LPT1:, and my computer system is an XT clone with 640K bytes of memory and two floppy disk drives.

Bruce Bauder
Tillamook, OR

You need to call a BIOS routine to return the printer status. In Turbo Pascal, the code would look like that in listing 1. The variable Status will have certain bits set, based on the printer's condition (see table 1). By decoding these bit combinations, you can alert the operator to the printer's condition. Also, although this is undocumented, bit 1 seems to indicate a nonexistent device.—Steve

Not a Good Day for Printers

Dear Steve,

Recently, I tried to use my IBM PC compatible with my Smith Corona TP2

daisy-wheel printer. After printing a certain number of characters (about 260 to 320), the printer loses two characters, always in the same place. If I use the MS-DOS PRINT SCREEN command, the printer loses one character.

If I execute mode lpt1:, p, the problem goes away. As explained in the DOS manual, the p option causes the operating system to continually try sending output if the printer is not ready. I thought the parallel interface protocol required an acknowledgment from the printer before the computer would send another byte.

The problem occurs when I'm running the computer at 8 MHz or 4.77 MHz. The printer has a 256-byte buffer. What is it about the Centronics interface that I don't understand?

Robert Ziller
New Richmond, WI

Troubleshooting a problem from a distance is sometimes difficult. Your IBM compatible/Smith Corona TP2 problem could be due to several possible causes.

The lost characters (every 260 to 320), coupled with the fact that the TP2 has 256 bytes in its buffer, indicate a buffer overflow condition (the difference in the error position may be due to varying line lengths and return time). Thus, the primary failure is probably in the handshaking between the computer and the printer.

The Centronics format actually supplies three possible controls to the printer:

- ACK (pin 10): A low on the pin indicates that the printer has finished processing the current character.
- BUSY (pin 11): A high on this pin indicates a buffer-full condition.

continued

Aztec C

*Power to go the distance...
Whatever that distance might be*



From real time embedded applications to comprehensive commercial applications on Macintosh, IBM PC, Amiga, Atari, and others, Aztec C has earned a well-deserved reputation as an innovative, tough to beat, rock-solid C development system.

But don't just take our word for it—try it yourself. We know that the best way to understand what puts you ahead with Aztec C is to use it. That's why Aztec C

systems purchased directly from Manx come with a 30-day, no questions asked, satisfaction guarantee. Call for yours today.

We can also send you information that details the special features and options of Aztec C. Plus information on support software, extended technical support options, and all of the services and specialized support that you may need when you're pushing your software to the limits and ... beyond.

Aztec C Micro Systems

Aztec C is available for most micro-computers in three configurations: The Professional; The Developer; and The Commercial system. All systems are upgradable.

Aztec C68k.Am Amiga
source debugger—optional

Aztec C68k.Mac Macintosh
MPW and MAC II support

Aztec C86 MS-DOS
source debugger • CP/M libraries

The following have special pricing and configurations. Call for details.

Aztec C68k.At Atari ST

Aztec C80 CP/M-80

Aztec C65 Apple II & II GS

Standard System \$199

- C compiler
- Macro Assembler
- overlay linker with librarian
- debugger
- UNIX and other libraries
- utilities

Developer System \$299

- all Standard System features
- UNIX utilities make, diff, grep
- UNIX vi editor

Commercial System \$499

- all Developer features
- source for run time libraries
- one year of updates

MS-DOS Hosted ROM Development Systems

Host + Target: \$750 Additional Targets: \$500

Targets:

- 6502 family
- 8080-8085-Z80-Z180-64180
- 8088-8086-80186-80286/8087-80287
- 68000-68010-68020/68881

Components:

- C compiler for host and target
- Assembler for host and target
- linker and librarian
- Unix utilities make, diff, grep
- Unix vi editor
- debugger
- download support

Features:

- Complete development system
- Fast development times
- Prototype and debug non-specific code under MS-DOS
- Compilers produce modifiable assembler output, support inline assembly, and will link with assembly modules
- Support for INTEL hex, S record, and other formats
- source for UNIX run time library
- processor dependent features
- source for startup



C.O.D., VISA, MasterCard, American Express, wire (domestic and international), and terms are available. One and two day delivery available for all domestic and most international destinations

Circle 154 on Reader Service Card

Manx Software Systems
One Industrial Way
Eatontown, NJ 07724

Aztec C is available on a thirty-day money back guarantee. Call now and find out why over 50,000 users give Aztec C one of the highest user-satisfaction ratings in the industry.

Call 1-800-221-0440

In NJ or outside the USA,
call 201-542-2121

Telex: 4995812 Fax 201-542-8386



Ultrasync.

You're looking at the new star
in display technology.

Actual unretouched screen image.

A screen star is born.

Introducing Ultrasync. The high-resolution, autosynchronous color monitor that's PC and PS/2 series compatible.

Ultrasync, with its exceptionally fine (.28mm) dot pitch, creates a picture of incomparable clarity. Capable of displaying infinite shades of brilliant color with striking contrast and dimension.

But the real beauty of Ultrasync is its versatility. It has the greatest autosynchronizing frequency range combination available with 45Hz to 120Hz vertical scan range (NEC's Multisync starts at 50Hz and peaks out at 75Hz) and 15KHz to 35KHz horizontal scan.

Plug Ultrasync into any IBM PC/PS series, Apple Mac II, or practically any computer system and it will adjust automatically to the standard you are using. There's no fiddling with switches or knobs. Our automatic picture sizing feature prevents display distortion and shrinkage. A simple built-in text switch is provided for your convenience. What's more, you'll enjoy the ease and comfort of Ultrasync's ergonomically advanced design.

Nobody but Princeton Graphic Systems could bring you an image with such star quality at a suggested retail price that's remarkably affordable. \$795. After all, we've been doing it all along.

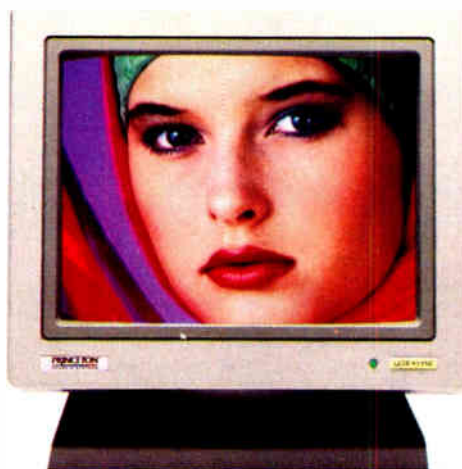

PRINCETON
GRAPHIC SYSTEMS
THE VISIBLE EDGE

601 Ewing Street, Building A, Princeton, New Jersey 08540 (609) 683-1660

Circle 212 on Reader Service Card

World Radio History

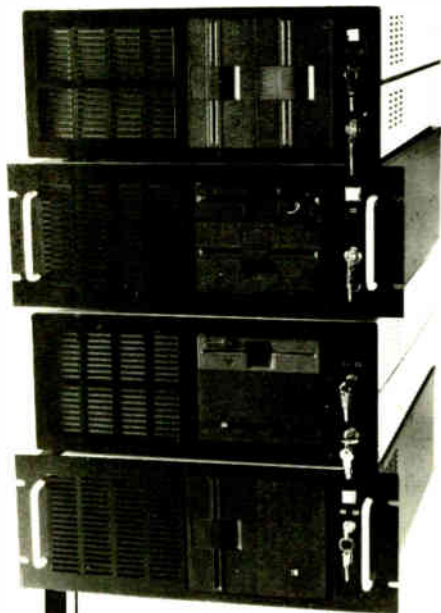

Integrand's new Chassis/System is not another IBM mechanical and electrical clone. An entirely fresh packaging design approach has been taken using modular construction. At present, over 40 optional stock modules allow you to customize our standard chassis to nearly any requirement. Integrand offers high quality, advanced design hardware along with applications and technical support *all at prices competitive with imports.* Why settle for less?

Rack & Desk PC/AT Chassis

Rack & Desk Models

Accepts PC, XT, AT Motherboards and Passive Backplanes

Doesn't Look Like IBM

Rugged, Modular Construction

Excellent Air Flow & Cooling

Optional Card Cage Fan

Designed to meet FCC

204 Watt Supply, UL Recognized

145W & 85W also available

Reasonably Priced

INTEGRAND

RESEARCH CORP.

Call or write for descriptive brochure and prices:
8620 Roosevelt Ave. • Visalia, CA 93291
209/651-1203

TELEX 5106012830 (INTEGRAND UD)
EZLINK 62926572

We accept BankAmericard/VISA and MasterCard

IBM, PC, XT, AT trademarks of International Business Machines.
Drives and computer boards not included

ASK BYTE

• **FAULT (pin 32):** A low on this pin indicates that some problem exists (sometimes this pin goes low when the buffer is full; it depends on printer design). **Note:** This pin's data is valid only for some custom-made cables; the standard IBM Centronics-to-DB-25 cable leaves this pin open.

Your printer manual will show the DIP-switch configuration changes necessary to implement handshaking. First, check the configuration of the printer, then verify the cable connections (pins 10 and 11 correspond to the connections on each end of the standard IBM cable. If the pin 32 connection is implemented, it should be DB-25 pin 11).

You can't rule out a failure of either the port or the printer hardware. Ask a friend (or your friendly local computer store) to test the printer on another machine (try to use WordStar with a document that you know fails). This will let you determine which is at fault—the printer or the computer.—Steve

Cheap 200-watt UPS Wanted

Dear Steve,

How about coming up with a 200-watt uninterruptible power supply (UPS) for us IBM XT/AT users? It should use gel-cell batteries of the type widely available in the surplus market and should cost less than \$100.

William Schreiber
Kailua-Kona, HI

The world seems to be afflicted with power problems, if my mail is an accurate reflection. There is considerable interest in such devices as constant voltage transformers and uninterruptible power supplies.

Small uninterruptible supplies with 60-Hz sine-wave output are relatively easy to design and build (see the January issue of Radio-Electronics for a 40-watt UPS construction project). As the supplies get larger, the linear amplifiers needed to support the output grow larger and more complex, and they generate more heat. These factors increase the expense to an extent that is most efficiently countered by the economies of high-volume production. Thus, I'm afraid your desire for a 200-watt UPS for less than \$100 is a bit unrealistic.

The economies of volume production have made such supplies available at prices much lower than in the past. SM Industries (535 West Wise Rd., Schaumburg, IL 60193, (312) 894-5331) is currently advertising a 200-watt unit for \$179, for example. The advertisements in publications such as Computer Shopper magazine show comparable prices

for similar units from various other sources. These units make more sense than something I could design and feature as a Circuit Cellar project.—Steve

Dialing for Digits

Dear Steve,

I plan to build and use your ImageWise video digitizer (May 1987 Circuit Cellar) to transfer pictures over the telephone with modems, and I have a few questions in this regard. What is the most economical modem I can use? How long will it take to transmit a picture (at various data transfer rates)? Finally, can you give me some idea of the transmission time you save by compressing the image?

R. Blau
Brooklyn, NY

You'll find that 2400-bit-per-second modems are getting cheaper all the time. Many are now priced at under \$200.

At 1200 bps, an uncompressed picture requires about 8.6 minutes of transmission time; at 2400 bps, it's 4.3 minutes; and at 9600 bps, it's about 1 minute. But 300 bps is out of the question—the transmission time is about 40 minutes. The 2400-bps modems with MNP (Microcom Network Protocol) error correction have an additional advantage: they prevent nearly all errors from phone-line noise from garbling the picture.

Data compression reduces the size of the image 2 to 4 times, so a 1200-bps transmission would take 2 to 4 minutes. The compression factor depends on the complexity and detail of the image, as well as the amount of noise in the video camera. A well-lit scene produces less noise in the camera, so ultimately it reduces transmission time.—Steve

Meteorology on the Micro

Dear Steve,

I have a couple of unrelated problems that I hope you can help me with.

I have an Amiga 1000 (512K bytes of RAM) with one external 3½-inch floppy disk drive and one external 5¼-inch floppy disk drive. I am using one of the old Epson MX-80 printers (circa 1982 to 1983) with Graftrax installed. I have Amiga BASIC, True BASIC, Lattice C, and Amiga Pascal as programming languages.

I am a weather forecaster with the U.S. Air Force stationed in Myrtle Beach, South Carolina. Myrtle Beach is a typical tourist town with more fast food, beachwear stores, and golf courses than you can shake a stick at. Unfortunately, the amount of research material available is severely limited.

I am interested in receiving the Navy

continued

"The Compatibility is Guaranteed..."

"The Stanford is a solid performer... offers top speed and support for a very good value."

January 27, 1988

INFO
WORLD



SYSTEMS

Basic System Features

HD/FD Controller • 1.2 MB floppy drive • **Serial port (Com 1) and parallel port** • **Optional 2nd serial port (Com 2) & optional game port** • 200 Watt P/S • **High quality metal case** • **Hardware reset switch and turbo L.E.D.** • **Optional digital L.E.D.** • **Clock/calendar w/battery back-up** • **Complete documentation** • **Enhanced keyboard (101 keys)** • **Heavy duty packaging.**

Stanford 386-18

9/18 MHz 21 MHz Throughput

Intel 32 Bit 80386 CPU (18 MHz) 9/18 MHz software (keyboard) switchable clock • Norton SI (Ver 3.0): 23 (processor speed) • CMOS memory, 16 channel Interrupt, 7 DMA channels • 512K interleaved 32 bit RAM on board • RAM can be expanded to 16 MB of 32 bit high speed interleaved memory • 2-32 bit, 4-16 bit and 2-8 bit expansion slots • Supports 80387 Math co-processor • Award BIOS • (Phoenix BIOS optional) • Plus basic system features.

\$2149

Stanford 386-16

Same configuration as in system 386-18 except: socket for 80287 math co-processor • Plus basic system features.

\$1999

Stanford 286-16

8/12 MHz - 16 MHz Throughput

Intel 80286-12 cpu, 8/12 MHz software (keyboard) switchable clock • Award BIOS, Norton SI (Ver 3.0): 15.8 • DRAM can be expanded to 1 MB on M/B • Selectable between 0 wait state or one wait state • 8 expansion slots (5-16 bits, 3-8 bits) • Socket for 80287 math co-processor • Plus basic system features.

\$1119*

Stanford 286-12

6/8/10/12 MHz 1 Wait State

Same configuration as in 286/16 except: Intel 80286-10 CPU, 6/8/10/12 MHz software (keyboard) Switchable clock • Plus basic system features.

\$989*

*System price does not include memory (DRAMS).

NETWORKING

Stanford Intelligent Net-II Card

Ether Net/Cheaper Net specification • 80186 processor & 82586 LAN co-processor • Data transfer rate: 10 MB/S. Network software compatibility: PC-NET, MS-NET, Novell.

\$499

Xenix Multi-Terminal Card

Microprocessor-based intelligent terminal controller. Z-80B CPU • 16 KB dual port RAM, 8 KB local RAM • 6 asynch. serial channels.

\$599

OS/2
compatible

Stanford 386-18 System

9/18 MHz
21 MHz Throughput



Special Offer w/System Purchase!

Dr. Halo III... \$49.99 (retail value \$139.95)
or Desktop Publishers' Graphics... \$59.99 (retail value \$195.00)

Stanford Systems will run OS-2, MS DOS, Xcp-x, Unix, MicroSoft Excel, AutoCad Ver. 6.0, Lotus and D-Ease III. If you're not satisfied, return the system with original published version of the software mentioned within 30 days of invoice date. We will replace with a compatible system, or at our option, refund purchase price. Prices, terms of sale, and specifications are subject to change without notice. We reserve the right to substitute equivalent or better products. Errors and omissions are excepted. All trademarks are copyrighted by their respective owners.

World Radio History

SYSTEM OPTIONS

- Seagate/Miniscribe/Micropolis HD Drives
- Thomson/Samsung Monitors
- EGA/VGA/CGA Video Graphic Cards
- EEMS Memory Expansion Cards
- 300/1200/2400 Baud Modems
- Optical Mouse/No Slot Clock
- Panasonic Printers
- Panasonic Facsimile Cards

International
Dealer Inquiries Welcome.

Call us for Volume/ Dealer/
Reseller Discounts

Ask us for our **Optional On-Site Service**

FREE Shipping and credit card usage

TO ORDER CALL:

1-(800)248-4786

IN CALIFORNIA: (415) 651-3300

Tech Support: (415) 651-3330

FAX (International Sales): (415) 651-3388

TELEX (International Sales): 4943373 WASAE

Hours: Mon-Fri 8:00 am - 5:30 pm P.S.T.

Circle 264 on Reader Service Card



STANFORD SYSTEMS

THE COMPUTER COMPANY

1887 O'Toole Avenue, C 108, San Jose, CA 95131

Assemblers/Simulators/Compilers

Series 3

Series 3 runs under CP/M 80, CP/M 86 and MSDOS. This Series has Full Listing Control, Conditional Assembly & Built in Cross Reference. There is Unlimited Program Size, Number of Symbols and Macros. The Linkers output: Intel Hex, Extended Intel Hex, Tektronix Hex, and Motorola S19, S28 and S37 formats.

Series 4

Series 4 requires at least 640k of memory. These products have all the features of Series 3 plus: 32 Character Labels, User Defined Sections, Local Labels and a Librarian. The Linker outputs Intel Hex, Extended Intel Hex, Tektronix Hex, and Motorola S19, S28 and S37 formats as well as Global, Abbreviated Global, Microtek and Zax Symbol Table Formats. Listings can be relocated to reflect run-time addresses.

Simulator-Debuggers

The Simulator has 16 Breakpoints with optional Counter Field. The Symbol Table is limited only by the amount of memory. Buffers of 256 bytes may be opened for I/O ports. The Simulator-Debuggers run with 512k of memory.

C Compilers

The C Compilers support in-line assembly language and ROMable code, and includes the following: Macro Processor, full Floating Point support, complete Assembler, Linker, Librarian and Libraries. Library Source Code Purchases require a signed license agreement.

Software Product	Macro Cross Assemblers			Simulator-Debuggers		C Compilers		C Libraris	C Library Source
	Series 3		Series 4	MSDOS	VMS ULTRIX SUN	MSDOS	VMS ULTRIX SUN	All-Systems	
	CP/M 80	CP/M 86	MSDOS						
Super 8			199.50	995.00	149.50	499.50			
Z-8	199.50		199.50	995.00	149.50	499.50			
Z-80	199.50		199.50	995.00	149.50	499.50	500.00	2000.00	150.00 250.00
Z-280			299.50	1250.00			600.00	2250.00	150.00 250.00
Z-8000	299.50		299.50	1250.00					
1802	199.50		199.50	995.00					
6301	199.50		199.50	995.00	149.50	499.50	500.00	2000.00	150.00 250.00
64180	199.50		199.50	995.00	149.50	499.50	500.00	2000.00	150.00 250.00
6501	199.50		199.50	995.00					
6502	199.50		199.50	995.00					
65c02	199.50		199.50	995.00					
65816			299.50	1250.00					
6800,2,8	199.50		199.50	995.00	149.50	499.50			
6801,3	199.50		199.50	995.00	149.50	499.50	500.00	2000.00	150.00 250.00
6804	199.50		199.50	995.00					
6805	199.50		199.50	995.00					
6809	199.50		199.50	995.00	149.50	499.50	500.00	2000.00	150.00 250.00
68c11	199.50		199.50	995.00			500.00	2000.00	150.00 250.00
68000,8,10	299.50		299.50	1250.00					
68020			399.50	1500.00			700.00	2500.00	150.00 250.00
8400/c00	199.50		199.50	995.00					
8044/51/52	199.50		199.50	995.00	149.50	499.50	500.00	2000.00	150.00 250.00
80451	199.50		199.50	995.00			500.00	2000.00	150.00 250.00
80515	199.50		199.50	995.00	149.50	499.50	500.00	2000.00	150.00 250.00
8080	199.50		199.50	995.00	149.50	499.50			
8085	199.50		199.50	995.00	149.50	499.50			
8086/88			99.50	1250.00					
8096	199.50		199.50	1250.00					
80186/286	199.50		199.50	1250.00					
80386			299.50	1250.00					
83351	199.50		199.50	995.00	149.50	499.50	500.00	2000.00	150.00 250.00
8748	199.50		199.50	995.00	149.50	499.50			
740	199.50		199.50	995.00					
Cops 400	199.50		199.50						
F8/3870	199.50		199.50						
NCR32	199.50		199.50						
NEC7500	199.50		199.50						
NSC800	199.50		199.50	995.00	149.50	499.50	500.00	2000.00	150.00 250.00
32000	199.50		199.50						

More formats available

Name _____ (Please Print)

Company _____

Address _____

City _____ State _____ Zip _____

Phone _____

Product _____ Operating System _____

Series _____ Amount \$ _____

Shipping \$ _____ Total \$ _____

Signature _____

Check COD (U.S. Only)

MC/VISA # _____

Expiration Date _____

Educational discount available.

To order, call toll free in U.S. (including HI, PR and VI):

1 800 843-8144

In Colorado: (719) 395-8683

TELEX: 752659/AD

For more details, ask for a free brochure.

(Shipping is \$31.00 per unit for overseas orders. Toll Free number does not apply to overseas. 2500AD pays COD charges.)

2500AD SOFTWARE INC

109 Brookdale Avenue
P.O. Box 480
Buena Vista, Colorado 81211

Circle 3 on Reader Service Card

Now there's a smart way to connect more than one printer

Forget those dumb A/B boxes and those expensive switching devices.

Now you can connect up to six parallel printers to your computer and let your programs do the switching intelligently for only \$119.

SmartPrint automatically sends your output to the correct printer.

You just add a simple code to your program or printer setup string.

Or, select a printer from a pop-up window utility that's included.

SmartPrint recognizes the code and makes the switch.

So, call now and use your Visa, MasterCard or AmerEx.

It's smart!

New!

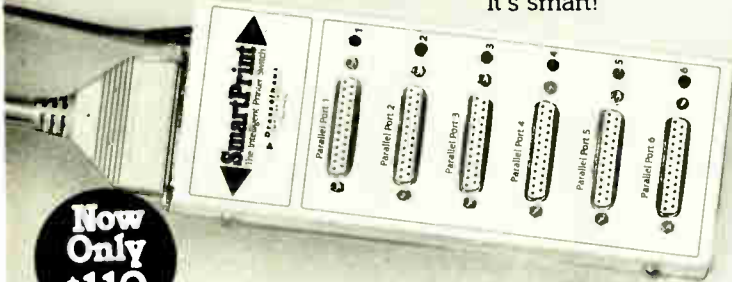

Now Only \$119

1-800-368-7737
(Anywhere in the United States or Canada)

SmartPrint
The Intelligent Printer Switch™

Dresselhaus COMPUTER PRODUCTS 8560 Vineyard Avenue, Suite 405, Rancho Cucamonga, CA 91730
A software-controlled printer switch for IBM PCs and compatibles

tively couple to a phone line to enable use of a modem, various methods have attempted to accomplish this feat, with minimal success. The connection is simply not reliable enough to warrant the specialized circuitry required.

Finally, my new publication, *Circuit Cellar Ink*, is running a series of articles on just this subject. Volume 1, issue 3 has an article that deals exclusively with weather facsimile services and techniques for displaying these weather photos on a personal computer. —Steve

Hot-Rodding the Apple

Dear Steve,

In the August 1987 Ask BYTE, Bernard Paul Sypniewski asked if it was possible to switch the 65802 and 6502 processors to get more power from his Franklin ACE computers. You answered that he would have timing difficulties and would not notice any difference unless he did his own programming.

JDR Microdevices advertises a 3-MHz version of the 6502 called the 6502B. Can I replace my 6502 (or 65C02) with a 6502B and make my Apple run 3 times faster?

Michael de la Maza
Irvine, CA

While a 6502B microprocessor will run at 3 MHz, you have to feed it a 3-MHz clock signal to make it do so. The Apple computer provides a nominal 1.023-MHz clock speed that you cannot change without messing up the video timing. Thus, while you could plug a faster 6502 into your motherboard's microprocessor socket, it would execute programs no faster than what you have now.

The most practical way to speed up your Apple computer is to add an accelerator board containing a faster processor and separate RAM; this would avoid the video timing problems that you would encounter if you changed the main Apple board. Several good speed-up cards use processors ranging from fast 6502s to 68000s. One of the more popular cards is the Transwarp from Applied Engineering (P.O. Box 798, Carrollton, TX 75006), which contains a 3.6-MHz 65C02 and fast RAM, with an optional 65816 processor upgrade.

As with any hardware changes, software compatibility problems are a distinct possibility, and you should run tests to be absolutely certain that the software you want to use is compatible (prior to purchasing the upgrade, of course).

The November 1987 issue of *The APPLE Review* contains a report on Transwarp, including a discussion of known software compatibilities and incompatibilities. —Steve ■

OUR PLUG-IN CARDS GIVE YOU PLUG-IN CONTROL.

Your IBM PC/XT/AT or compatible can control any IEEE-488 instrument.

You can:

- Plug-in to BASIC, C, FORTRAN, or Pascal.
- Use HP-IB plotters, printers, and instruments.
- Spend less time programming.
- Call (617) 273-1818 and put us to the test.

Complete hardware and software solutions for just \$395.



Capital Equipment Corp.
99 South Bedford Street
Burlington, MA. 01803



Dot, Daisy and Laser.

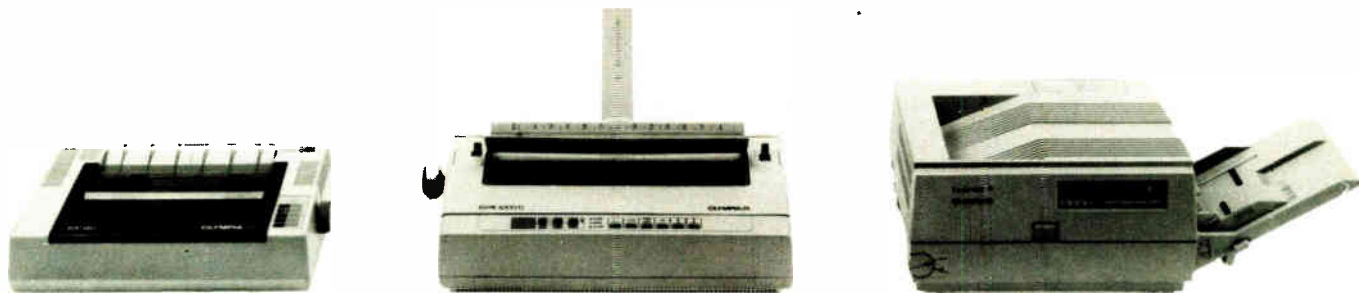

The new family of Olympia printers with a prestigious technological heritage.

Olympia is first in making lasting impressions for a good reason. For over 80 years we've been a leading innovator in typing technology for the office. Now everything has changed. And nothing has changed. Our technology is as new as the dew. Our commitment to reliability, efficiency

and service is as solid as ever.

The Olympia dot matrix printers produce clean, crisp printing at speeds from 130 CPS to 240 CPS for a wide range of applications. And our daisy wheels are unsurpassed in printing quality.

Our new Laserstar 6 is compact, versatile, compatible and

offers the latest in desktop printing technology.

In short, whatever you need we've got. So don't go shopping without the big new name in printers on your list.

Olympia. We'll make a good impression on you.

Then for you.

OLYMPIA

The Competition

Advanced Engineering from Germany

Get acquainted with our family. And a gift for you: The fabulous Fisher Space Pen!

See all the Olympia models in our brochure "Printers That Make Quality Impressions." Along with our brochure we'll tell you how to get a Fisher Space Pen—free! The pen that went to the moon—from the finest Mr. Mrs. Ms. (Please Print)

printers on earth. Call 1-800-999-6872 or send this coupon to: (USA) Olympia, P.O. Box 22, Dept. Adv., Somerville, N.J. 08876 (or Canada) Olympia, 58 Prince Andrew Place, Don Mills, Ontario, Canada M3C3A2.

Name	First	Last	Title	() Phone
Company	Address			
City	State	Zip		
Printer make(s) used now		I plan to make a printer purchase in month/year		

934

© 1988 OLYMPIA

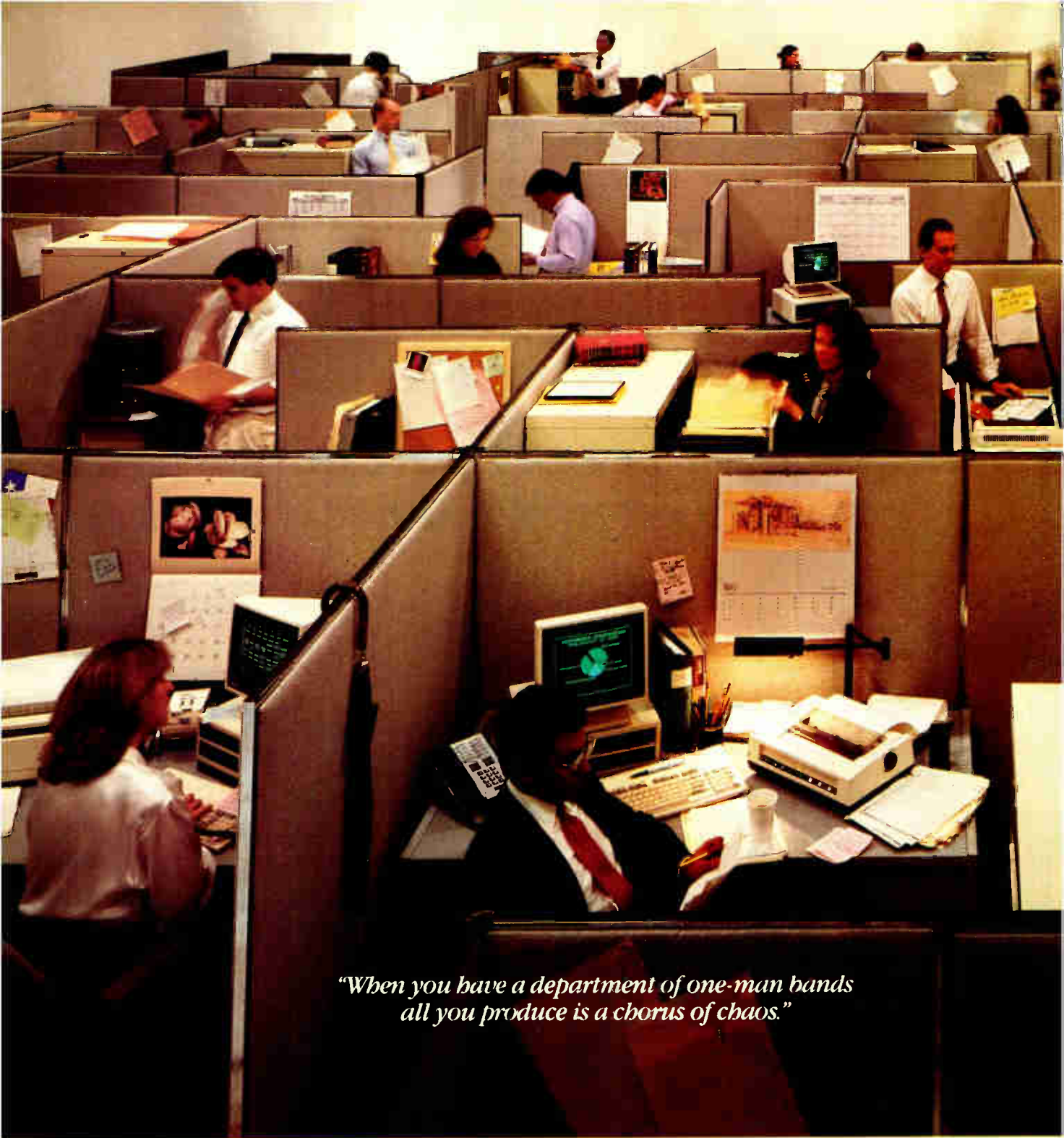

*"When you have a department of one-man bands
all you produce is a chorus of chaos."*

If you manage an organization with more PCs and peripherals than you care to count, maybe you should consider tying them together — with a STARLAN Network from AT&T.

Supporting a wide range of DOS and UNIX® servers for workgroups of all sizes, a single STARLAN

Network can link from 2 to over 100 DOS PCs, so independent-minded standalones can effectively function as one. Which means users can share printers, retrieve and edit common documents, update centralized databases and send or receive messages electronically.

AT&T's modular architecture and twisted-pair

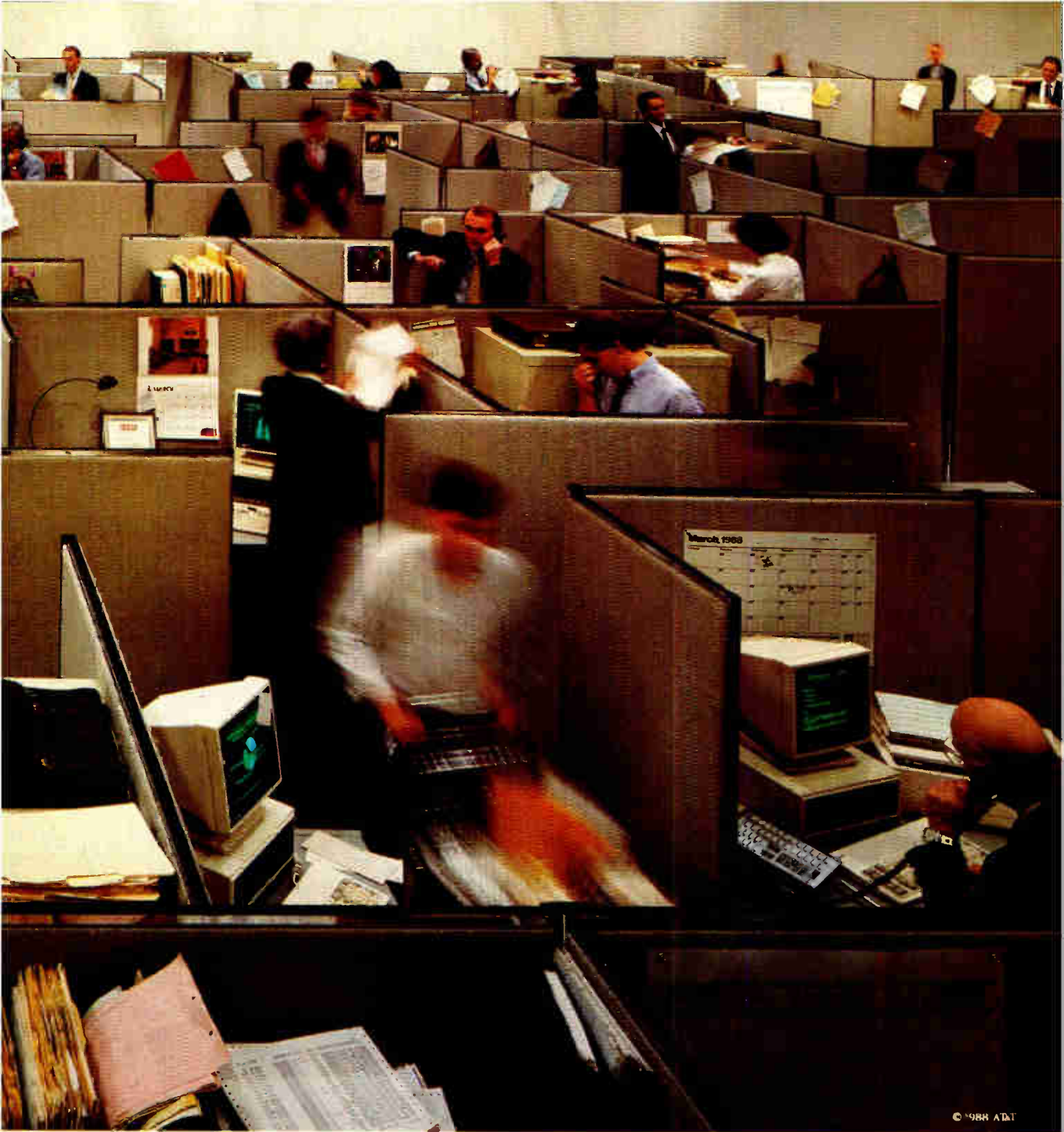

© 1988 AT&T

wiring make it easy for you to add voice and data stations the same way you add staff: as needed.

And by connecting your STARLAN Network to AT&T's Information Systems Network, virtually all the information-processing equipment in your company can become a fully integrated, cost-efficient system.

To find out more, call 1 800 247-1212.

From equipment to networking, from computers to communications, AT&T is the right choice.



AT&T
The right choice.

APRIL 1988 • BYTE 49



HALO

The Graphics Toolkit for Contemporary Software Developers

Already the fastest and most powerful graphics toolkit on the market, the new HALO[®] delivers subroutines and device support for exciting, contemporary applications in publishing, office automation, vision, and image processing.

HALO '88 is a device independent library of 190 graphics subroutines. It is compatible with 18 programming languages, and over 140 hardware devices such as image scanners; graphics, vision, and imaging boards; printers and plotters; and mice. HALO '88 is designed for the complete IBM compatible microcomputer line including the PS/2 and VGA.

Today's Tools for Tomorrow's Applications

HALO '88 has new subroutines which control scanners and scanned images — even images which are larger than screen resolution and available memory. Extended character set support enables software developers to address IBM's

full 255 characters in graphics and to design foreign language fonts. Among contemporary HALO '88 applications are CAD, Computer-Based Training, Presentation Graphics, Graphic Arts, Mapping, Machine Vision, Silicon Wafer Manufacturing, Sound System Design, Vehicle Scheduling and Routing, and Real Estate.

Join the HALO Family

HALO has an installed base of 60,000+ end-users, hundreds of site-licensed corporations, government agencies, universities, and national laboratories and most importantly, over 220 Independent Software Developers (ISVs) who market applications written with HALO.

HALO '88 provides the software designer with the richest environment of graphics functions; the programmer with reliable and

well-documented tools, and DP managers with continuity of user interface and database format.

Reach for the Future

If you need high performance graphics development software that provides a migration path to OS/2 and other future technology, follow the industry leaders — call (800) 992-HALO (4256).

HALO '88 is just \$325 and includes all device drivers, 20 fonts, your choice of one compiler binding, completely new documentation, an interactive tutorial and free 800# technical support. Update from HALO for \$150.

Ask about the new HALO Programmers' Workbook which provides C program examples for HALO '88 applications developers.

media cybernetics
8484 Georgia Ave.
Silver Spring, MD 20910
(301) 495-3305, (800) 992-HALO

HALO is a registered trademark of Media Cybernetics, Inc. IBM PS/2, VGA and OS/2 are registered trademarks of International Business Machines Corp.



BOOK REVIEWS

DEBUGGING C
Robert Ward

THE PROGRAMMER'S
GUIDE TO WINDOWS
David Durant, Geta
Carlson, and Paul Yao

FAST ACCESS\
WORDPERFECT
Rhyder McClure

DEBUGGING C
Reviewed by Rudy Bazelmans

Que Corp., Indianapolis, IN:
1987. ISBN 0-88022-261-1,
400 pages, \$19.95

In *Debugging C*, author Robert Ward says, "To write programs that work, you must know how to debug. It's that simple. In fact, if you produce working programs, you will spend at least half your time debugging." He goes on to say that "good debugging skills are requisite to successful programming." With regard to C programming, this statement seems especially true.

Debugging C discusses general techniques for debugging programming errors and, specifically, how to debug the most common C programming errors. The author accomplishes this with an easy-to-read writing style that includes numerous examples and just the right amount of metaphorical references.

The information is easily accessible. Ward's examples of actual executions and transcripts of debugging sessions use such tools as static analyzers, debuggers, and interpreters. He also uses charts, itemized lists, and clear diagrams. He clearly has a good understanding of C and the problems of programming.

But *Debugging C* is not without its faults. In a book on debugging, it's a shame to find numerous examples of poor programming style, which leads to programming errors. For example, page 175 of the book contains four examples of poor programming style: the use of multiple statements on a single line, especially if statements; poor indentation style used for control constructs; poor use of white space to separate lines of related function; and a scarcity of in-line comments. Ward should have read Thomas Plum's book *C Programming Guidelines* (Prentice-Hall, 1984), which spells out a more readable and less error-prone coding style.

Ward begins *Debugging C* with a discussion of the founda-

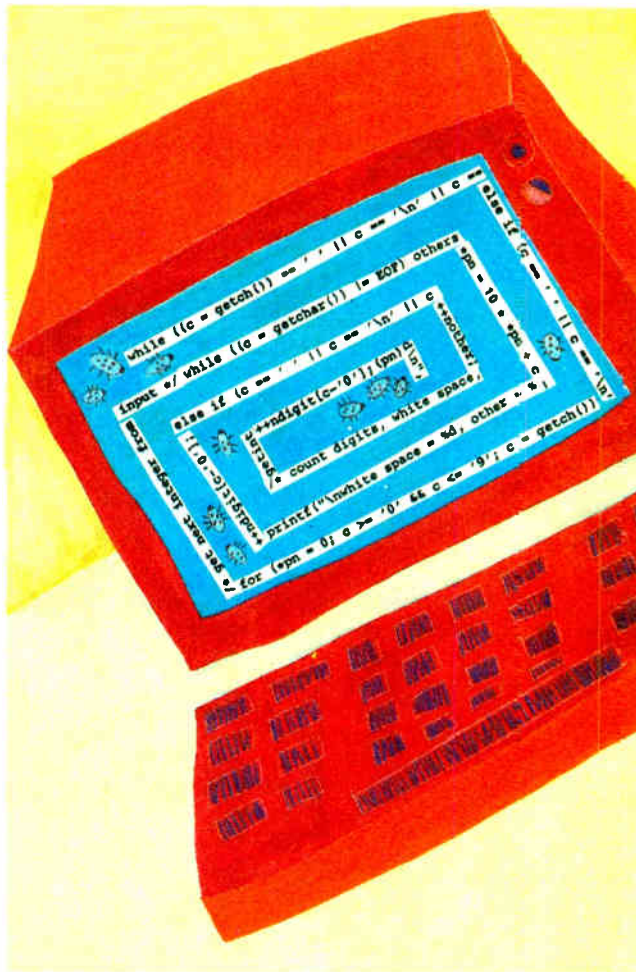

tions used in the debugging process. He then describes program testing and how to recognize bugs. Three chapters concern language-independent techniques for locating bugs, and they are followed by three chapters that discuss why debugging C is difficult and how to apply to C the general techniques described in the previous chapters. The final two chapters discuss several commercial debuggers and an interpreter and how to use them in debugging.

Although this organization of the material makes sense, the links between chapters are weak. As I read the book, I had very little sense of its progression. This flaw is particularly obvious because the book does not clearly follow the taxonomy of debugging described in the chapter on foundations.

According to Ward, at varying levels, *Debugging C* is for everyone, and I agree. Beginners will find the book useful, even though some of the advanced sections are confusing. Experienced programmers will also find a number of chapters worth reading. Readers will need a good

understanding of C to comprehend the entire book. I think non-C programmers will also find parts of this book interesting—particularly the introductory chapters on foundations, testing, and general debugging techniques.

A Four-Step Process

Ward divides the task of debugging into four phases: testing, stabilization, localization, and correction.

Testing, the process of discovering which bugs exist, should precede debugging (the actual process of removing the bugs). As such, I think Ward made a mistake in including a chapter on testing. He should have relegated the topic of testing to other texts, as he did with other topics, such as design techniques. His 20-page discussion on testing is completely inadequate, especially compared to a definitive discussion on testing such as Glenford Myers's *The Art of Software Testing* (John Wiley & Sons, 1979). Ward's discussion on testing would be more appropriate if he reduced the scope to testing as it specifically relates to debugging.

continued

dB Fast™ -VS- Clipper™

\$69
Limited time offer!

New dBase III Plus™ Compiler

- Smaller EXE's
- Faster compilation
- Faster execution
- Lower price!

OPERATION	dB Fast	Clipper
Minimum .EXE file size	1kb	140kb
Compiling/Linking	2 Seconds	4 Minutes
Execution time	6 Seconds	17 Seconds
PRICE	\$149 \$69	\$695

d-Smallest! With Clipper™, the smallest program you can create is 140k. And it goes up from there! **dB Fast™** creates programs as small as 1k with typical program sizes from 5 to 10k. Just think, now it's possible to fit all your programs on one floppy disk. And if you send files via modem — look what happens to your modem phone bill... it almost disappears!

d-Fastest! **dB Fast** compiles and links in a blistering 3 seconds. Clipper slugs along at 4 minutes. **dB Fast** compiled programs also run faster. A program that took over 1 full minute to run using dBase III Plus and an additional 17 seconds using Clipper, ran in just 6 seconds with **dB Fast!**

d-Cheapest! See for yourself why **dB Fast** is d-Biggest Bang for d-Buck! Nowhere can you get all these features for such a low price:

- dBase III Plus compatible
- LAN compatible
- Unlimited runtime
- Protected source code
- No need to modify your .PRG files
- Speed, efficiency, price



60 day Guarantee

Try **dB Fast** for 60 days. If you're not totally satisfied for any reason, just send it back for a full refund (less \$10 handling fee).

Call today! 1-800-356-6356

sales information call 1-206-392-0368

Dealer inquiries welcome

VISA MasterCard
 dB Fast _____ @ \$69 _____
 Shipping: \$4 U.S., \$25 outside U.S. (add \$4 for each additional package)
 WA residents add 8.1% sales tax. _____
 Total _____ (U.S. funds only)

Name: _____
 Company: _____
 Address: _____
 City: _____ St: _____ Zip: _____
 Phone #: _____
 Payment (circle one): VISA MC AMX Check
 Card #: _____
 Expires: _____



Name on Card: _____
 dB Fast is a trademark of dB Fast Inc.
 dBase III Plus and Clipper are registered trademarks of Ashton Tite Corp
 and Nantucket Corp. respectively

1420 Gilman Blvd.
 Suite 2857
 Issaquah, WA 98027-5399

Stabilization, the act of producing an easily reproducible test case to demonstrate a bug, is a prerequisite to finding a bug. Unfortunately, the discussion on the stabilization of bugs is lost in the chapter on testing techniques.

Localization involves narrowing down the test cases sufficiently to find the problem, and Ward's separation of this topic from stabilization makes sense.

The final phase of debugging is correction, during which the bug is fixed. Ward trivializes this phase by first saying that most bugs are easy to fix and then by devoting only two paragraphs to the topic. If correction is a phase of debugging, then Ward should have devoted at least a small chapter to it. I also consider it a mistake to ignore the retesting requirements during the correction phase. I'm sure I'm not the only person to add one or more new bugs while attempting to remove an existing bug.

Ward introduces another useful concept, that of proximity: Every effect (problem) in a program is proximate (near) the cause. The proximity can be based on the distance between the source code of two routines, the distance between the execution of two routines, or the distance between two references to a data item. These principles are well defined, and the concepts are used throughout the book.

How to Spot a Bug

Ward divides his discussion on bug searching into finding compilation errors and finding coding errors.

For beginners, the chapter on finding compilation errors is particularly helpful. I haven't seen this material discussed anywhere else, and the chapter has some good advice. In addition to the compiler, Ward describes several other programs that can help programmers find compilation errors. These include a brace checker (used to find mismatched or incorrectly nested braces), a lint program (used to find examples of poor coding style or obscure bugs), and the compiler's preprocessor (used to find macro processing errors).

Ward also describes techniques that you can apply with little or no tool support. Much of the discussion surrounds tracing program execution through the instrumentation of control structures with print statements and the clever use of the C macro facility to control levels of trace output. Although tracing source code is a useful technique, Ward seems preoccupied with it.

Advanced Techniques

Debugging C does an excellent job of addressing the issues involved in C debugging. The process is difficult for a number of reasons: C is a weakly typed language that allows mismatched variables on expressions and mismatched function parameters; the use of pointer variables is error-prone; uninitialized variables are not flagged by the compiler; subscripts on arrays are not checked at run time; and in unprotected environments, stray pointers can accidentally modify code.

Ward discusses how to recognize and find each of these problems. In a table on page 209, he has the start of a great debugging aid. The table lists the commonly observed program behaviors, their probable causes, and suggested debugging techniques for each one. Ward should have expanded this gem to include more entries.

Particularly informative is the section on organizing the stack during the execution of C programs. The diagrams and related text are clear and well organized.

Debugging Tools

In the tools section, Ward discusses three popular debugging tools: sdb (the source-level debugger for System V Unix by AT&T), CodeView (the new multiwindow source-level debugger for MS-DOS from Microsoft), and C-terp (the interpreted C

continued



Leprecard



from **\$329**

FAST 28-65 ms. access. **BIG** Up to 49MB

LOW POWER Less than 10 watts of power means less strain on the power supply, lower operating temperatures, and long component life.

QUALITY Leprecards feature controllers & drives made by the biggest names in the business - including Seagate & Western Digital. 1 year warranty. 35 page illustrated User's Guide.

FREE SOFTWARE including **TakeTwo**, the backup utility named PC MAGAZINE Editor's Choice in 1986 & 1987.

20MB 65ms
\$329

30MB 65ms
\$349

20MB 40ms
\$389

49MB 30ms
\$579

TANDY 1000 Leprecards add \$20



2400 modems with MNP

\$239/\$229

- Hayes Compatible
- 300/1200/2400 Speeds
- MNP level 4 error correction increases throughput up to 20%
- Automatic Adaptive Equalization
- External has Non-volatile memory to retain configuration
- **FREE MIRROR II** Software, a \$69 value
- Internal model \$229, fits in short slot
- PC/XT/AT/PS2 Modem Cable \$15 (specify model)

PC/XT disk kits

- Drive & controller pre-installed & formatted
- Genuine Western Digital short slot controller
- 30 page installation guide & reference manual
- Cables, mounting screws, full & half-height bezels
- **TakeTwo** backup software, PC MAGAZINE "Editor's Choice"
- 1 year Warranty, 30 day Money Back Guarantee
- Optional: 150 watt, UL/FCC approved power supply, **\$69**



TANDY 1000 kits add \$20

20MB KIT Seagate ST225 **\$289**

21.4MB/65ms./Half-Height/14.8 watts

30MB KIT Seagate ST238 **\$329**

32.7MB/65ms./Half-Height/14.8 watts

40MB KIT Seagate ST251 **\$487**

42.8MB/65ms./Half-Height/11 watts pre-formatted into a pair of 21MB/28ms. partitions.

65MB KIT Seagate ST277R **\$579**

65.5MB/65ms./Half-Height/11 watts pre-formatted into a pair of 32MB/28ms. partitions.

3.5" floppy kits



Instant Laptop & PS/2 compatibility. All kits include bracket to mount in 5 1/4" drivebay, black & grey face plates, and mounting rails. 1.44MB XT kits include replacement floppy controller that doubles the data transfer rate.

Now included: **TakeTwo**, the backup utility PC MAGAZINE named as their Editor's Choice.

\$119

720K Internal for PC/XT/AT, Requires DOS 3.2 or optional \$15 driver software

\$149

1.44 MB internal for AT only, Includes driver software

\$249

1.44MB Internal for PC/XT, Floppy Controller & cables with 500,000 bit per second data transfer rate. Supports two drives.

External Case for XT kits add **\$119**



AT hard disk kits

- Includes IBM AT rails & cables
- **SpeedStor** or **OnTrack** large drive software
- Formatted, Partitioned & Tested

Size	Model	Speed	Capacity	Price
HH	Seagate ST251	40ms	42.8MB	\$439
HH	Seagate ST251-1	30ms	42.8MB	\$519
FH	Seagate ST4053	28ms	44.5MB	\$599
FH	Seagate ST4096	28ms	80.2MB	\$849
FH	Micropolis 1335	28ms	71MB	\$849
FH	Maxtor 1140	27ms	117MB	\$1669

FAX modem

- 9600 bps Operator
- CCITT Group 3 compatible
- Send ASCII or word processing files
- Background receiving
- Unattended sending & receiving
- Prints on Epson or Laserjet compatible printers
- Use as 9600bps synchronous modem with other FAX/96 modems
- Requires 512K, Hard Disk, DOS 3.x, & Hercules mono or color graphics adapter

\$499

Western Digital filecard

\$399

- 32 Megabytes, 62 msec Access
- Low power consumption
- High Speed WD RLL controller
- X-TREE, & SpeedRead Disk Cache software
- Requires 1 1/2 slots
- **TakeTwo** backup software

Super EGA-VGA

Paradise Autoswitch 480 **\$169**

Auto480/NEC Multisync II **\$738**

Orchid Designer

VGA 1024x768 **\$399**

NEC Multisync Plus **\$949**

Designer VGA &

Multisync Plus **\$1339**

1200 internal modem

\$69

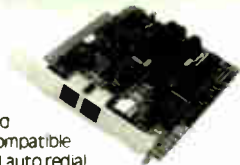

- Short Slot size
- 300 or 1200 bps speed
- Hayes Smartcom II compatible
- Line-busy detect and auto redial
- **FREE MIRROR II** software, a \$69 value!
- Made in USA, 1 year Warranty

WESTERN DIGITAL controllers

Hard/Floppy Controller 1003-WA2 **\$139**

above with RLL Encoding 1003-RA2 **\$149**

Hard only for 12Mhz & up AT's, 1.1 Interleave 1006-WAH **\$179**



Toll Free
800-722-AT-XT

California
805-373-7847

FAX
805-379-9345

2524B Townsgate Road, Dept. B
Westlake Village, CA 91361

No extra for Visa/Mastercard (AMEX add 3%). Prices include UPS Shipping & Insurance. Federal Express shipping just \$1.25 per pound. 30 Day Money Back Guarantee Corporate & Institutional PO's accepted.

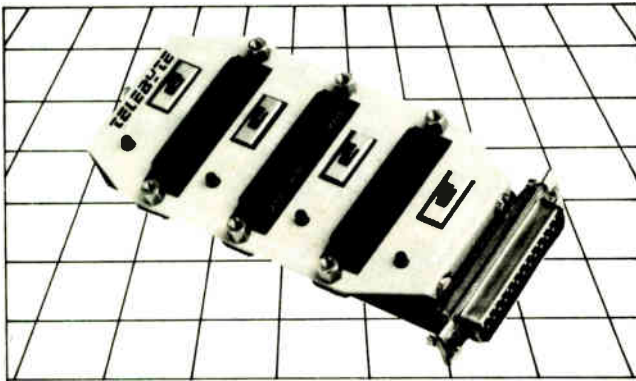

PORT SHARING DEVICE

- Model 31—\$114
- Expands RS-232 port by three
- Share a modem with multiple terminals
- Share a printer with multiple computers
- Operation to 19200 baud

TELEBYTE

A PUBLIC COMPANY

Remark Division • Telebyte Technology, Inc. • 270 E. Pulaski Rd.
Greenlawn, NY 11740 • (516) 423-3232 800-835-3298

BOOK REVIEWS

environment for MS-DOS from Gimpel Software).

Here, the book is weak. The coverage of sdb should have been an overview of the capabilities; instead, it is a poor tutorial with a description of each debugger command, which seems unnecessary in a general book on debugging C. The author would do better to talk about features and leave the description of the command set to a more complete tutorial.

Compared to the 40 pages that Ward devotes to sdb, the 8-page discussion on the more interesting debugger, CodeView, seems to be an afterthought. Nor are the discussions of sdb and CodeView structured alike.

I found the discussion of C-terp more interesting than those of sdb or CodeView. Ward discusses the differences between interpreters and compilers, along with the debugging functions of C-terp and some of the commands. The relevance of the commands and functions to finding particular bugs is clear and supported by short examples.

Source Code and Other Resources

Debugging C contains an annotated resource list of texts on C and software development. Although the books and articles referenced are popular, the list is inappropriate for a book on debugging. The only ones that seem somewhat appropriate are the sections related to C.

Ward also provides the source code for a full-featured debugging system. The debugger is a small command interpreter that is linked with your program. The commands control the watch and stop points that you code into your program. Ward also includes the source code to a poor man's Ctrace, a text filter that you can insert into your program calls to a debugging system like the one supplied. It is amusing to note that the coding style requirements on the programs input to Ctrace will not accept the author's programs because the break and return statements are concatenated on the ends of other statements. This is contrary to the statement in the text that says that the programs comply with Ctrace's input requirements.

The book contains 30 pages of source code listings in the appendixes and a reference to a public domain brace checker. The publisher should have considered offering readers a copy of the source code on disk.

Since I am interested in doing further reading on debugging, I checked out the bibliography. To my disappointment, there wasn't a single reference to an article or book on debugging.

A Good Buy

Although *Debugging C* has flaws, it contains many useful insights for C programmers. Many of the topics it covers—the discussion on finding C bugs, the discussion on proximity of errors, the explanation of tracing techniques, and the explanation of the organization of the stack during run time—are difficult to find elsewhere. In sum, the book is worth its cost.

Rudy Bazelmans, a software engineer for Wang Laboratories, lives in Nashua, New Hampshire.

SOFTERM PC

HOST SYSTEMS
DEC[®]
Data General[®]
IBM[®]
Hewlett-Packard[®]
and others

**“50 Exact Emulations,
7 File Transfer Protocols,
and Multi-port Background Communications”**

PC APPLICATIONS
WordPerfect[®]
Lotus 1-2-3[®]
dBASE[®]
and others

- Seamless Remote Virtual-Disk integrates file transfers between remote systems and your favorite PC application using local disk syntax
- Supports IBM[®] PS/2, PC, XT, AT compatibles
- Operates over any NetBIOS LAN, and the DEC LAT, Banyan, Bridge, Novell, and Allen Bradley Asynchronous Servers

SOFTERM PC

With All Features and

- 50 Exact Emulations
- Block and Conversational

\$195.00

For Information Call
800/225-8590

SOFTERM PC *Special*

With All Features and

- 50 Exact Emulations
- Block and Conversational
- DEC VT 240, VT 241

\$345.00

SOFTRONICS
303/593-9540 Telex: 450236

THE PROGRAMMER'S GUIDE TO WINDOWS

Reviewed by David Hart

Sybox, San Francisco, CA: 1987, ISBN 0-89588-362-7, 645 pages, \$21.95

If you are a programmer working with Microsoft Windows, or you'd like to be working with it, *The Programmer's Guide to Windows* is for you. An introduction to and explanation of the complex world of Windows programming, the book is meant to

continued

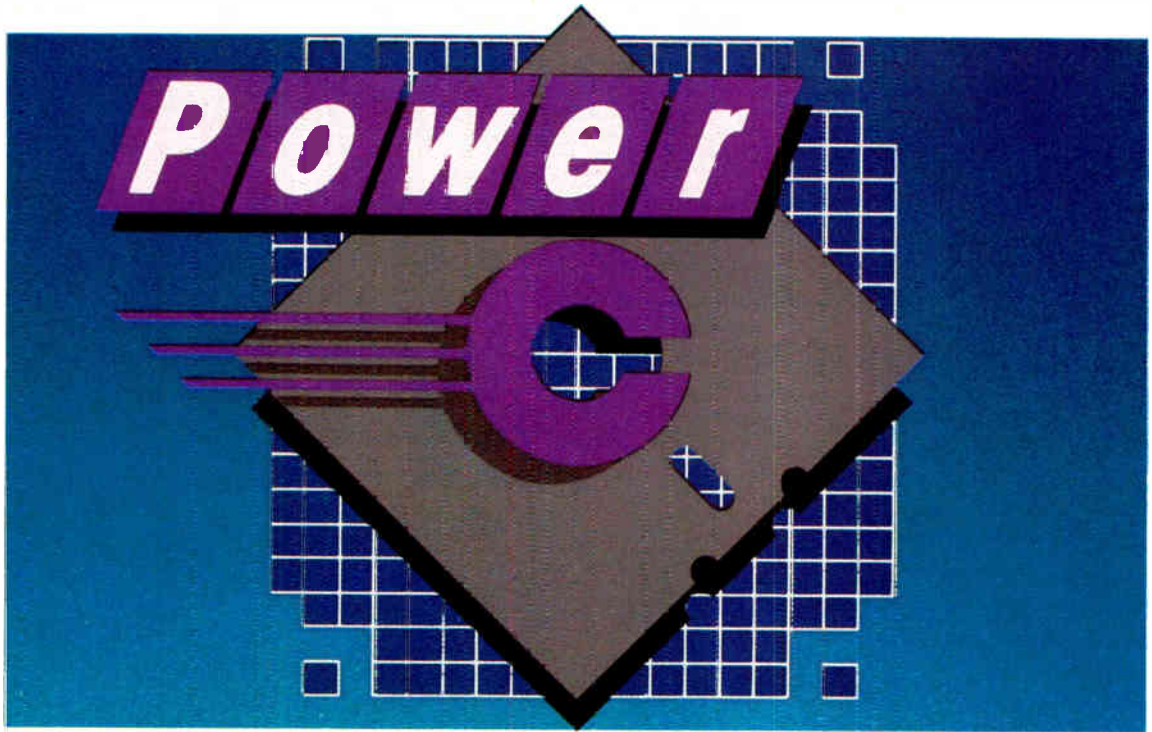

The \$19.95 High-Performance C Compiler

Mix Software presents Power C... Our new cost-efficient alternative to high-priced C compilers. Now you can create high-performance programs without spending all your hard-earned money. But price isn't the only reason to choose Power C over the competition.

Compare the performance. Power C's integrated Make saves you time and effort by automatically managing your large programming projects. And with Power C, your programs can be as large as available memory. As for speed, the performance chart speaks for itself. Power C executes most of the benchmarks faster. And Power C creates smaller EXE files, out-performing the competition.

Compare the functions. With over 400 functions, the Power C library is vastly superior. Our library is a superset of Microsoft C and Turbo C. Plus, we've added an extensive set of graphics functions for drawing lines, boxes, circles, pie charts, and more.

Compare the portability. Power C supports the latest features of the proposed ANSI C standard. Plus, Power C is compatible with both Microsoft C and Turbo C. All of which makes it easier to move programs to and from Power C.

Compare the documentation. Our competition assumes that you're already a C wizard. We don't. Power C includes a step-by-step tutorial and sample programs with every function. With our complete documentation, programming in C couldn't be easier.

Power C is factors less expensive. And the source code to our function library is available at a fraction of their price.

Performance Chart
(execution times in seconds)

	Power C	MS C	Turbo C
1) fib*	23.8	47.0	26.4
2) sieve*	27.6	40.2	25.5
3) tdb1*	35	9.0	9.6
4) diskio*	13.5	14.2	14.3
5) report**	11.0	86.3	60.7
6) drystone**	36.6	38.2	31.8
Compile/Link	73.9	187.6	81.4
EXE File Size	25120	29008	27184

Price Chart

C Compiler	Power C	MS C	Turbo C
	\$19.95	\$450.00	\$99.95
Library Source Code Option	\$10.00	N/A	\$150.00
Total Cost with Source	\$29.95	N/A	\$249.95

Benchmarks from Dr. Dobb's Journal* & Computer Language**. First four programs test 1) function calling, 2) loops/integer math 3) floating point math, & 4) disk I/O. Programs 5 & 6 simulate typical applications. Tests compiled from command line using Make supplied with each compiler. Tests run on 8 MHz AT with medium model of Power C 1.0, MS (Microsoft) C 4.0, & Turbo C 1.0.

Circle 179 on Reader Service Card

Technical Specifications

Power C includes: Power C compiler with integrated Make, Power C linker, Power C Libraries, Power C book, and support for...

- ✓ ANSI standard
- ✓ IEEE floating point
- ✓ 8087/80287 coprocessor
- ✓ auto-sensing of 8087/80287
- ✓ automatic register variables
- ✓ mixed model (near & far pointers)
- ✓ CGA, EGA, & Hercules graphics

Options are...

- ✓ Library source code
- ✓ BCD business math

Order Power C now by calling our toll free number or mail the coupon to Mix Software, 1132 Commerce Drive, Richardson, TX 75081.

1-800-523-9520

For technical support and for orders inside Texas call: 1-214-783-6001

Minimum System Requirements:

MSDOS or PC DOS 2.0 or later, 256K memory, 2 floppy drives or hard drive recommended, Runs on IBM PC, XT, AT, and compatibles, and IBM PS/2 model 25, 30, 50, 60, or 80.

60 day money back guarantee

Name _____
Street _____
City _____
State _____ Zip _____
Telephone _____

Paying by: Check Money Order
 MC/Visa# _____ Exp _____

Computer Name _____ Disk Size _____
 5 1/4" 3 1/2"

Product(s) (Not Copy Protected)

Power C (\$19.95) \$ _____
 Library Source Code (\$10) \$ _____
(includes an assembler)

BCD Business Math (\$10) \$ _____
Texas Residents add 8% Sales Tax \$ _____

Add Shipping (\$5 USA - \$20 Foreign) \$ _____
Total amount of your order \$ _____

Power C is a trademark of Mix Software.
Microsoft C is a registered trademark of Microsoft Corporation.
Turbo C is a registered trademark of Borland International, B





If you want the best there's only

Whether you want the best portable or desktop, the best 80286- or 80386-based personal computer, there is only one choice: Compaq. Because COMPAQ personal computers are consistently rated the best in each class by both industry experts and sophisticated users.

For instance, the COMPAQ DESKPRO 386/20 and the COMPAQ PORTABLE 386 are the most powerful personal computers in the world. Both are based on the 32-bit Intel® 80386 microprocessor, running at a blazing 20 MHz. Both offer the most storage and memory in their classes. And both feature performance enhancements such as concurrent bus architecture, disk caching, and high-speed coprocessor options. All of these features work together to deliver system performance that rivals minicomputers'.

The groundwork for these innovations was laid by the industry's first 80386-based personal computer, the 16-MHz COMPAQ DESKPRO 386. Still outperforming most 80386 machines, it offers high-performance capabilities to users moving up to this class.

In the arena of 80286-based personal computers, the 12-MHz COMPAQ DESKPRO 286 runs your software up to 20% faster than most of its 10-MHz competitors.

No one even comes close to Compaq in portable computing. Because no one but Compaq builds portables with all the features sophisticated users need. The 20-lb. COMPAQ PORTABLE III is the smallest full-function 80286-based computer that truly gives you the power of a desktop. And the COMPAQ PORTABLE II still offers more internal expansion capabilities than any other portable.

*Based on an independent survey of major brands. †Based on an independent survey of 209 FORTUNE 1000 companies.



personal computer, one choice.

Computer users at every level will find that COMPAQ computers represent the best solutions. We've consistently expanded the limits of personal computer technology with advanced features that optimize overall system performance. All while preserving your investment in industry-standard hardware and the world's largest library of business software. Compaq also works to engineer each computer to meet exacting quality and reliability standards, so it's ready to withstand the rigors of the real world.

These are all reasons why Compaq earns the highest quality ratings from computer experts. And unsurpassed satisfaction ratings from computer users.* It's also why, this year, more FORTUNE 1000 corporations plan to add Compaq to their approved vendor lists than any other brand.†

If you want the best personal computer, you have only one choice. Call 1-800-231-0900, Operator 50. In Canada, 1-800-263-5868, Operator 50. We'll give you a free brochure or the location of the Authorized COMPAQ Computer Dealer nearest you.

COMPAQ®, COMPAQ PORTABLE III®, COMPAQ DESKPRO 286® and COMPAQ DESKPRO 386® are registered trademarks of Compaq Computer Corporation. ®Registered U.S. Patent and Trademark Office. COMPAQ PORTABLE III™, COMPAQ DESKPRO 386/20™ and COMPAQ PORTABLE 386™ are trademarks of Compaq Computer Corporation. Intel is a registered trademark of Intel Corporation. ©1988 Compaq Computer Corporation. All rights reserved.

COMPAQ

It simply works better.

Image Processing.

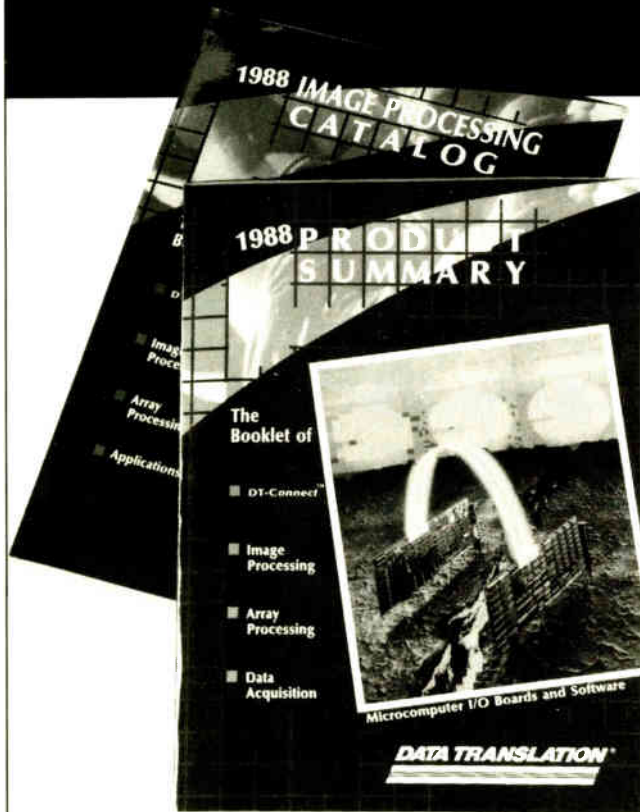

Free Handbook Set.

Data Translation invites you to receive the premier edition of our 1988 Image Processing Handbook Set.

The Book

Our first ever Image Processing Catalog—featuring full product information and 28 documentary stories on image processing and array processing applications.

The Booklet

Our 1988 Product Summary—a summary on pricing, frame grabber and processor boards, and application software.

R.S.V.P. to receive an edition (while they last) by calling: (617) 481-3700

DATA TRANSLATION®

100 Locke Drive, Marlboro, MA 01752-1192 USA

complement, rather than replace, the documentation included with the Microsoft Windows Software Development Kit.

Authors David Durant, Geta Carlson, and Paul Yao have divided the book into three major sections. The first section introduces the Windows system and emphasizes the programmer's concern with the various features. The discussion is lucid and complete, so readers gain a basic understanding of the Windows system necessary to begin learning the specifics. This kind of explanation isn't available elsewhere.

The Microsoft documentation, on the other hand, written by those who know the system inside out, assumes that you are familiar with parts of Windows not yet introduced. As a result, gaining a working understanding is a difficult and frustrating challenge. The overview in *The Programmer's Guide to Windows* alleviates most, if not all, of that frustration.

Sample Programs

The last chapter of the first section presents a program named Skeleton. As its name suggests, Skeleton is a framework upon which to build full-blown Windows programs. All the sample programs in the book are based on Skeleton, which generates an empty window and displays an "About..." dialog box on request. The program to accomplish that is over 500 lines long. While it doesn't do much useful work, Skeleton takes care of the housekeeping—opening, displaying, repainting windows, and so on—that all Windows programs require. Skeleton also provides a sound structure with places clearly marked to add code for initialization, repainting, and responding to messages.

The bulk of *The Programmer's Guide to Windows* is the second section, a collection of chapters that introduce specific features of Windows with a sample program. The authors discuss each topic briefly, then present a program to illustrate the feature. They explain in detail each element of the program's code not previously introduced. This example-rich approach makes understanding the topic much easier than the dry explanations of the Microsoft manuals would have us believe.

This section covers all the topics of interest to Windows programmers: text display, menus, dialog boxes, mouse input, graphics output, child windows, file and printer I/O, memory management, dynamic libraries, and data transfer. The description of dialog boxes in particular is especially revealing because it is so much more understandable and detailed than the coverage in the Microsoft documentation. As is too often the case, the Microsoft manuals describe each function well but fail to provide an adequate overview. The explanation of Microsoft's much-touted Dynamic Data Exchange (DDE) also stands out for the same reason. DDE isn't mentioned in the Microsoft documentation, but it is fully explained with a set of sample programs in *The Programmer's Guide to Windows*.

All the examples from the book—along with a few extras, including a Windows version of the Game of Life—are available separately from the authors on one 1.2-megabyte floppy disk for \$25 or on four 360K-byte disks for \$30.

The disk does have some irritating minor errors. For one thing, all the programs were developed from the Skeleton program, and many of them still have comments identifying them as the Skeleton program. Printer, the sample printing program, contains in its resource script file a reference to Graphics.h that should be a reference to Printer.h. As a result, the program doesn't compile. The authors should have taken more time to double-check their disk.

Programming Tools

The last section of *The Programmer's Guide to Windows* explains the operation of the programming tools used to develop Windows programs. Sample command lines are given for the

continued

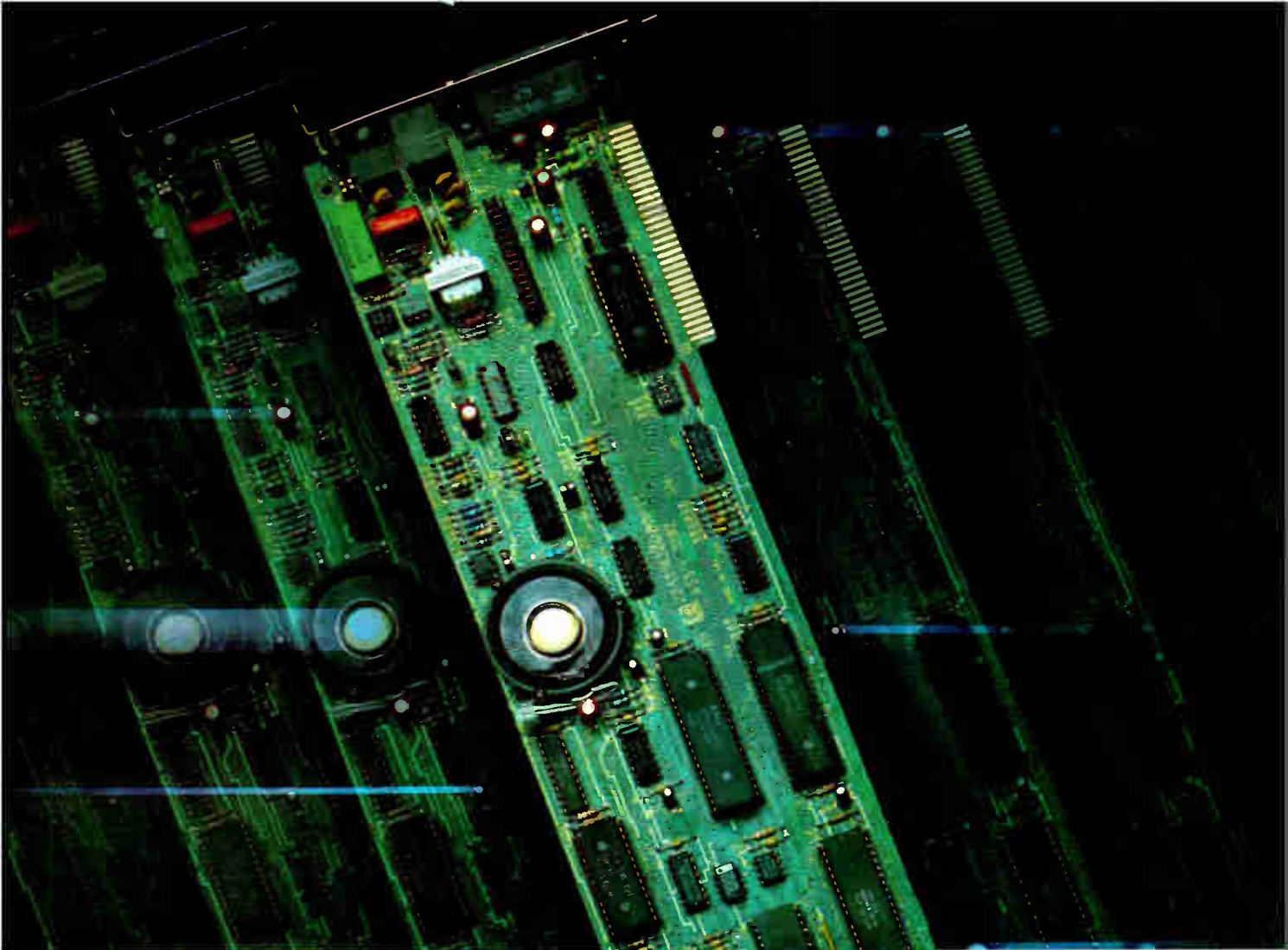

MERGER!

UDS Puts Sync & Async Protocols on a Single Board

One expansion slot on your IBM PC or compatible can now do double duty. UDS has packaged *both* synchronous and asynchronous protocols, plus a V.22 *bis* compliant modem, on a single Sync-Up™ card. The unit also provides *true* synchronous autodialing via bus-directed commands and responses. In the asynchronous mode, the unit is compatible with the AT command set.

For the user, this means unparalleled flexibility in micro-to-mainframe, micro-to-mini and micro-to-micro communications. Data rate (2400, 1200 or 600 bps synchronous; 2400,

1200, 600 or 0-300 bps asynchronous), private line or dial-up operation and RTS/CTS delay are software selectable options.

The device provides full-duplex operation over either two-wire private or dial-up circuits; 2780/3780/3270 BSC and 3270/3770/5251 SNA software is available. The unit is compatible with most asynchronous communication packages, including *Mirror II*.

For additional specifications, quantity prices, and information on other Sync-Up products, contact Universal Data Systems, 5000 Bradford Drive, Huntsville, AL 35805.



Universal Data Systems



MOTOROLA INC.
Information Systems Group

PHONE 800/451-2369

C programmers are talking about C_talk™

The easy way to add the POWER of OBJECT-ORIENTED Programming to C

C_talk extends your C compiler to a real Object-Oriented Language (OOL). It is not a new language; it simply adds Smalltalk-like features to C:

- Encapsulation
- Messaging (Dynamic Binding)
- Inheritance

C_talk offers all of the advantages of OOLs:

- A highly modular software design methodology
- Reusable software components
- Extendable software components

Plus the advantages of C:

- Speed, size, flexibility
- Ease of application delivery
- Access to C libraries and C tool sets

C_talk consists of an application development environment with:

- A powerful Smalltalk-like Browser for browsing, defining and editing an application's object class hierarchy
- A Preprocessor for converting object class descriptions into standard C programs that are compatible with popular C compilers
- An integrated, semiautomatic Make utility for controlling the preprocessing, compiling and linking of an application, object classes, C files or libraries

C_talk is designed to run on an IBM® PC (or compatible) with one of the following C compilers: Microsoft® C, Lattice C, Turbo C, or C86. A system configured with a hard drive and mouse is highly recommended.

To order:
CNS, Inc.
 Software Products Dept.
 7090 Shady Oak Road
 Eden Prairie, MN 55344
 (612) 944-0170

Credit Cards: Master Card, Visa
 Shipping: \$5 US
 \$25 International

IBM is a registered trademark of IBM Corp.
 MICROSOFT is a registered trademark of MICROSOFT CORP.
 C_talk is a trademark of CNS, Inc.

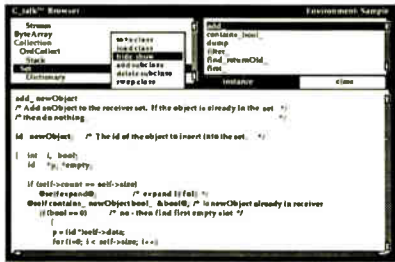

ONLY \$149.95



Microsoft C Compiler, the Windows Linker (Link4), and the Windows Symbolic Debugger (Symdeb).

The Microsoft C command lines given in the book are different from those on the optional disk, though they are functionally equivalent. The Link4 command lines in the book are also different from those on the disk. In this case, however, the book's version is incorrect. One of the command-line switches (parameters) is in the wrong place, so the linker gives an uninformative error message. Most of the Link4 command lines on the disk are correct, but a few follow the example of the book, and therefore they don't work. The Symdeb command lines are all correct. The moral here is to follow the examples from the Windows Software Development Kit disks.

The Programmer's Guide to Windows is a useful book that can save many hours in training programmers new to Microsoft Windows. It is also a useful reference for a quick brush-up on a particular topic. The optional disk costs more than the book, but its cost isn't difficult to justify if you plan on doing much Windows programming, since it could save hours of typing in examples. The erroneous Link4 command lines in the book and the errors on the disk are irritating, but if you're doing serious Windows programming, you don't want to be without the book or the disk.

David Hart lives in Chestertown, Maryland, and writes frequently about Windows and Windows applications.

FAST ACCESS \ WORDPERFECT

Reviewed by John Unger

Brady Books, a division of Simon & Schuster, New York, NY: 1987, ISBN 0-13-307489-7, 200 pages, \$12.95

Fast Access \ WordPerfect by Rhyder McClure takes advantage of the fact that WordPerfect, like other powerful word-processing programs, is not easy to learn to use in an intuitive way. The book is designed to help beginning WordPerfect users overcome some of the hurdles that prevent them from getting the most from this software. Experienced WordPerfect hands will not get much from the book; there are no arcane secrets to be learned here.

McClure's writing style is light and easy to read. The book is organized alphabetically into separate chapters from one to six pages long. The chapters describe major WordPerfect commands, such as Cut/Copy a Column, Go to Key, or Undelete. Each chapter follows the same format: First the author presents a clear explanation of the WordPerfect command, then at least one easy-to-follow example and a description of the result of the command's action.

The final 40 pages of the text contain step-by-step examples of 11 useful WordPerfect macros; this section will give readers the confidence to use this powerful feature of WordPerfect for their own applications.

Presumably, because of the book's A-to-Z structure, McClure decided that an index would be superfluous. This was an unfortunate oversight, because the absence of an index seriously reduces the book's usefulness. An index should be an essential part of a reference text like *Fast Access \ WordPerfect*. If WordPerfect's on-line help is too terse for you and the WordPerfect manual is too difficult and time-consuming to use routinely, then a book like *Fast Access \ WordPerfect* may be just what you need to get the most out of WordPerfect. ■

John Unger lives in Hamilton, Virginia. He writes graphics software and uses computers to study the structure of the earth's crust.

720K & 1.44MB Drivers Available For DOS 2.1 & Up!

NOW! 2MB Model Available



THE 3.5" CONNECTION!

This internal 720K 3.5" disk drive is a "drop-in" replacement for 5.25" drives! It's the ideal solution for exchanging data between your PC/XT/AT and the new generation of laptops. Disk format is compatible with IBM, Toshiba and Zenith portables. The Model 853W drive kit contains everything you need, including interface adapters, premium SONY drive, and complete documentation. Uses your existing disk controller (no additional slots required). Requires DOS 3.2 for maximum performance. Ask about our Model 873W (1.44MB).

\$\$ SAVE \$\$ SONY DISKS



\$159.95 + FRT. & TAX



400 Daily Lane
 P.O. Box 5210
 Grants Pass, OR 97527



WE'VE MOVED!!

IMMEDIATE DELIVERY!

Call 503-474-6700 or 503-474-6701

COMPUTER EXPO

TEXAS' #1 IBM COMPATIBLE COMPUTER CENTER



ORDERS LINE ONLY
1-800-622-EXPO
INQUIRE
(713) 784-0990
SERVICE
(713) 784-7817

EXPO SUPER TURBO

Seagate **\$875**



30MB SYSTEM

FCC APPROVED SYSTEM INCLUDES:

- 640K RAM
- 360 FLOPPY DRIVE
- AT STYLE KEYBOARD
- MONO GRAPHICS PARALLEL
- GREEN/AMBER MONITOR
- MINI AT STYLE CASE W/RESET
- OPERATING MANUALS
- 30 MB SEAGATE

--Additional Options--
CGA w/ Samsung

Color Monitor **Add \$199**

40MB SEAGATE \$CALL
AWESOME DEAL

EXPO TURBO 286

Seagate **\$997**



12 MHz THRUPTU 6/8/10 MHZ

SYSTEM INCLUDES:

- INTEL 80286
- 640 K RAM
- 1.2 MB FUJITSU FLOPPY DRIVE
- AT STYLE KEYBOARD
- WD FLOPPY/HARD CONTROLLER
- 200 WATT POWER SUPPLY
- AT STYLE CASE
- OPERATING MANUALS
- 3 HOURS FREE TRAINING

--ADDITIONAL OPTIONS--
Mono/graphic/parallel adapter

w/Samsung Monitor **\$128**

40 Meg Seagate (28 MSC) **\$450**

EGA BOARD & EGA Monitor **\$595**

EXPO PORTABLE 286/10

Seagate **\$1395**



12 MHz THRUPTU
BASE SYSTEM INCLUDES

- INTEL 80286 640K RAM
- COMPACT SIZE 9" AMBER GREEN MONOGRAPHICS 720 X 348 HIGH RES
- 1.2 MB FLOPPY DISK DRIVE
- 7 FULL-LONG INTERFACE CARDS
- 200 W POWER SUPPLY (110-220 V)
- LIGHTWEIGHT, RUGGED CHASSIS
- DIMENSIONS 17 3/4" W X 8 1/2" H X 15 3/4" (D)

• CLOCK /CALENDAR

• WEIGHT 28 LBS

• OPTIONS--

20 Meg. Seagate Drive **\$1697**

40 Meg. Seagate Drive **\$1897**

3 1/2" Floppy 720K **\$139**

PORTABLE 386 **\$CALL**

EXPO 386

Seagate **\$2397**



24 MHz THRUPTU SYSTEM

SYSTEM INCLUDES:

- 80386 CPU (32 BIT)
- KEYBOARD SWITCHABLE SPEED
- 1 MB RAM (32 BIT RAM UP TO 4 MB ON BOARD)
- 64 K CACHE MEMORY 0 WAIT
- 1.2 MB FLOPPY DRIVE
- SERIAL/PARALLEL/CLOCK
- AT 101 KEYBOARD
- 40 MB SEAGATE (28MSC.)

20 MHz IN STOCK *CALL

ALR MYLEX Intel



HARD DRIVE SALE!



ST-225 20 MB KIT

20 MB Hard Drive System

Includes: Controller,

Cables & Instructions

• ST - 238 30 MB Kit

30 MB System Includes:

Controller, Cable & Instructions

\$267

\$297

40 MB High Speed

• AT Drive

• 28 MSC ST-251

ST 4026

20 MB AT DRIVE

(Full Height 38 MSC)

• (Controller Optional)

\$419

\$299

• ST - 4038

30 MB

(Full Height 38 MSC)

• ST - 4096

80 MB

(Full Height 28 MSC)

(CONTROLLER IS OPTION)

\$499

\$895

MotherBoard

8088 - 2 (4.77/8MHz) ØK \$99

8088 - 1 (4.77/10 MHz) ØK \$139

80286 - 10 (6/10 MHz) ØK \$335

80386-16 (6/10/16 MHz) ØK \$1795

80286-12 (INTEL (8/10/12) ØK \$395

80386-16 (MYLEX w/1mb) \$1595

80386-20 (MYLEX w/MB) \$2495

MEMORY BOARD

• 2.5 MB Multi Function ØK

(16 BIT), SERIAL, PARALLEL

GAME PORT \$149

• 2MB LIM CARD (16 BIT) ØK

INTELABOVE BOARD

COMPATIBLE \$139

• 4 MB AT OR 386 Memory Card

(16 BIT) ØK \$275

• 384 K MF CAARD SER/PAR/

CLOCK GAME PORT ØK \$95

I/O CARD

• SERIAL RS - 232 ADAPTER \$40

• SERIAL PARALLEL AT/XT

GAME PORT \$50

• 2ND SERIAL OPTION KIT \$35

• MULTI I/O \$80

FLOPPY /SERIAL PARALLEL/

CLOCK/GAME PORT

• DUAL GAME CONTROLLER \$40

• JOY STICK KRAFT-3 \$20

• GRAVIS SUPER JOYSTICK \$45

VIDEO CARD

• MONO GRAPHICS

W/ PARALLEL CARD

HERCULES COMPATIBLE \$50

• COLOR GRAPHICS

PARALLEL CARD RGB

OR COMPOSITE \$60

• EGA (640 X 400 RES.)

MDA/CGA/EGA \$149

• GENO A SUPER EGA •

800 X 400 RES W/GEM

GRAPH \$226

NEW VGA COMPATIBLE.

MDA, CGA, EGA, VGA

MAGNAVOX MULTI SCAN MONITOR



\$495

14" Diag. Screen • Compatible with all Graphic Cards Including IBM CGA, IBM EGA, AT&T Graphics and IBM PCG • 3 Frequency Modes • Resolution 926 Hor. x 580 Vertical • with Audio Input • Speaker and Headphone Jack • 1 Year Warranty

MONITOR

• MONO, TILT & SWIVEL

GREEN AMBER \$95

• FLAT TILT & SWIVEL

AMBER \$110

• RGB COLOR SAMSUNG \$275

• EGA W/TILT &

SWIVEL - SAMSUNG \$395

• MAGNAVOX EGA \$395

GENIUS MOUSE

FREE \$69
PAINT SOFTWARE

MOUSE

W/ DR.

HALO PAINT

\$95



EXTENDED SERVICE CONTRACT

NOW AVAILABLE

THRU NATIONWIDE!

WE SERVICE:

IBM, COMPAQ, AT&T,

BROTHER, EPSON, NEC,

SEAGATE, EVEREX, AST

WE SELL & SERVICE!

MODEMS



EVEREX 1200 B INTERNAL \$85

ANCHOR 1200B INTERNAL \$75

EVEREX 2400B INTERNAL \$169

ANCHOR 2400B INTERNAL \$179

EVEREX 2400B EXTERNAL \$210

HAYES 2400 B IN STOCK

ALL MODEMS

INCLUDE SOFTWARE

3 1/2" Floppy Drive 720K

OS/2 DATA TRANSFER

\$139

360 K 5 1/4 FLOPPY DR \$85

1.2 MB 5 1/4 HIGH \$110

DENSITY DRIVE \$195

1.4 MB 3 1/2 FLOPPY DR

EXTERNAL DRIVE \$CALL

BROTHER PRINTERS & LASERJET II

• M 1709 (240 CPS)

SINGLE SHEET FEEDER NLQ MODE

LIMITED QUANTITY IN STOCK!

• \$469

FIRST COME, FIRST SERVED BASIS

LASERJET II - W/1 MB RAM

HP LAZERJET COMPATIBLE

FREE TONER CARTRIDGE

\$1845

EPSON SEIKOSHA PRINTERS

MP - 1200

120 CPS

TRACTOR, NLQ

Sug. Ret. \$295

• MP - 5300

300 CPS, 132 Col.

TRACTOR, NLQ

SINGLE SHEET FEED

SUG. RET. \$705

\$195

\$450

60 MB AT/286/386

Model 165D

\$575

10 MB XT/66

Model 110D

\$179



IRWIN TAPE BACKUP

40 MB/286/386

Model 145 D

\$475

IRWIN TAPE BACKUP

EXTERNAL CASE POWER SUPPLY Add \$195

*Seagate, Irwin, XT, AT, IBM, AT & T are all Reg. Trademarks of their respective companies.

Circle 63 on Reader Service Card

World Radio History



Now Apple speaks IBM. Three times faster than IBM.

Introducing PC Transporter.™ The Apple® II expansion board that lets you run MS®-DOS programs.

Now your Apple II can run over 10,000 programs you could never use before. Like Lotus® 1-2-3®, MultiMate®, dBASE III PLUS®, Even Flight Simulator®

With PC Transporter, MS-DOS programs run on your Apple II like they do on IBM® PC's or compatibles. With one important difference. PC Transporter runs most of those programs *three times faster* than an IBM PC/XT®.

Plus, to speed through number-crunching tasks, you can use our optional 8087-2 math co-processor chip. It plugs into a socket on the PC Transporter.

Less expensive than an IBM clone.

Sure, a stripped-down IBM



clone costs about the same as the PC Transporter. But the peripherals it takes to get the clone up and running make the clone cost about three times what our American-made card costs.

You don't have to buy new hardware to use PC Transporter.

Works with the hardware you already own.

With PC Transporter, MS-DOS programs see your Apple hardware as IBM hardware. You can use the same hardware you have now.

With IBM software, your Apple hardware works just like IBM hardware. Including your drives, monitors, printers, printer cards, clock cards and serial clocks.

You can use your IIe® or IIgs™ keyboard with IBM software. Or use our optional IBM-style keyboard (required for the II Plus).

You can use your Apple mouse. Or an IBM compatible serial mouse.

Plenty of power.

PC Transporter gives you as much as 640K of user RAM and 128K of system RAM in the IBM mode.

PC Transporter also is an Apple expansion card, adding up to 768K of extra RAM in the Apple mode. The Apple expansion alone is a \$300 value.

Easy to install.

You can install PC Transporter in about 15 minutes, even if you've never added an expansion board. You don't need special tools. Simply plug it into an Apple expansion slot (1 through 7 except 3), connect a few cables and a disk drive, and go!



PC Transporter taps into the world's largest software library. Now your Apple can run most of the IBM software you use at work. And it opens a new world of communications programs, games and bulletin boards.

A universal disk drive controller.

PC Transporter supports 3.5" and 5.25" MS-DOS and ProDOS formatted diskettes. You'll shift instantly between Apple ProDOS and IBM MS-DOS.

You'll need our versatile 5.25" 360K drive system to run IBM applications from 5.25" floppy disks. Use your Apple 5.25" drive for Apple 5.25" disks.

An Apple Disk 3.5 Drive will support the new 3.5" disks whether they're IBM MS-DOS formatted or Apple ProDOS formatted. The PC Transporter acts like an Apple Disk 3.5 Drive disk controller for IIGS, IIe, and II Plus users.

PC Transporter supports up to 5 drives in a number of combinations.

For example, you can connect a 5.25 Applied Engineering 360K dual-drive system directly to the card. Then plug two daisy-chained Apple 3.5 Drives (not the Apple UniDisk 3.5) to the dual-drive system. For a fifth drive, use a ProDOS file as an IBM hard disk.

PC Transporter controls Apple and IBM compatible disk drives. It supports 3.5" and 5.25" MS-DOS and ProDOS formatted diskettes.



Versatile data storage.
PC Transporter reads MS-DOS and translates it into Apple native ProDOS. You can store IBM programs and data on any ProDOS storage device including the Apple 3.5 Drive, Apple UniDisk™ 3.5, Apple 5.25" drive, SCSI or ProDOS compatible hard drives. (You can use the Apple UniDisk 3.5 with its own controller card for storing programs and data, but not for directly booting an IBM formatted disk.)

You can even use our 360K PC compatible drive for ProDOS

Make your Apple speak IBM.

PC Transporter memory choices.

RAM in Apple mode:	RAM in IBM mode:	Price:
384K	256K	\$489.00
512K	384K	529.00
640K	512K	569.00
768K	640K	609.00

Note: The IBM mode is 128K less because the PC Transporter uses 128K for system memory.

IIGS Installation Kit 49.00

IIe/II Plus Installation Kit 39.00

PC Transporter Accessories

5.25" IBM Format 360K

Drive Systems

Single-Drive System 269.00

Dual-Drive System 399.00

Half-Height Drive 135.00

(add to Single-Drive system to make Dual-Drive)

IBM-Style Keyboard 139.00

(required for Apple II Plus. Requires IBM Keyboard Cable.)

IBM Keyboard Cable 34.00

Sony RGB Monitor 499.00

Analog RGB Cable 39.00

(for use with Sony monitor)

Digital RGB Cable 39.00

(for use with Sony monitor)

Digital RGB Adapter 24.00

ColorSwitch 44.00

(included with IIGS Installation Kit)

128K ZIP 40.00

PC Transporter per set

Memory Expansion

Chip Set

8087-2 Math

Co-processor 229.00

Chip

Heavy Duty 69.00

Power Supply

(IIe and II Plus only)

See your dealer or call or send check or money order to Applied Engineering. MasterCard, VISA and COD welcome. Texas residents add 6 1/4% sales tax.



PC Transporter produces better IBM graphics than IBM. Analog is sharper than digital. So with an analog RGB monitor, PC Transporter's CGA graphics and text are superior to IBM's digital display — even while running IBM software!

And, you can also use an Apple composite monitor in IBM text or graphics mode.

storage and a 143K Apple 5.25" drive for MS-DOS storage.

Created by Apple's original designers.

The brains behind PC Transporter were also behind your Apple II.

The PC Transporter design team includes the former project managers for the creation of the Apple IIe and IIc. The co-designer of the Apple II disk controller. And the first full-time Apple programmer and author of the ProDOS operating system.

So you know the PC Transporter and your Apple were made for each other.

Support and service from the leader in Apple add-ons.

Applied Engineering sells more Apple peripheral boards than anyone else — including Apple Computer. So you know we'll be around after the sale.

PC Transporter comes with a 15-day money back guarantee. If you're not fully satisfied after using it, return it for a full refund. PC Transporter also comes with a 1-year warranty.

How to get your PC Transporter today.

See your dealer. Or call Applied Engineering any day between 9 a.m. and 11 p.m. CST at 214-241-6060.

AE Applied Engineering
The Apple enhancement experts.

P.O. Box 798, Carrollton, TX 75006
214-241-6060

A Division of AE Research Corporation.

WATCH WHAT YOU'RE DOING.



Introducing UniLab 8620 analyzer-emulator with InSight.

■ There's nothing like InSight.™ A feature of the new 8620 that lets you actually watch your program go through its paces. So you can debug faster. And speed up microprocessor development. For demanding applications like the automotive controller shown.

■ An exciting industry first, InSight blends analyzer/emulator techniques to give you continuous, real time monitoring of key processor functions. See changing register contents, I/O lines, ports, user-defined memory windows. With your own labels. And all at once. Interactively. Without stopping your program.



■ InSight is made possible by the 8620's advanced bus state analyzer, its 2730-bus-cycle trace buffer, and a new high-speed parallel interface that eliminates RS-232 bottlenecks.

■ The fast interface also speeds data throughput. From your hard drive, you can load a 64K program into emulation memory in five seconds.

■ On top of that, you get a new, crystal-controlled 1 μ sec clock for super precise event timing.

■ Computer integrated instruments from Orion prove debugging needn't be costly or tedious. For more than 150 processors. Like all our analyzer-emulators, the 8620 debugs by symptom. Via advanced truth table triggering. Always included is enough breakpointing and single stepping (now faster than ever) to assure optimum efficiency. We even provide a stimulus generator and built-in EPROM programmer to help finish the job.

■ Get serious about price/performance. Save big on design, test, and support costs. UniLab 8620 analyzer-emulator.

■ Look into it.

Toll free: 800/245-8500. In CA: 415/361-8883.

ORION
INSTRUMENTS

Computer Integrated Instrumentation
702 Marshall Street, Redwood City, CA 94063
Telex: 530942

*InSight is a trademark of Orion Instruments, Inc.

Circle 197 on Reader Service Card
World Radio History



Products in Perspective

- 67** **What's New**
- 89** **Short Takes**
 Sharp PC-4521
 Sprint 1.0
 Quad386XT
 DeskJet
 WordStar 2000 3.0
 ZCM-1490
 Microsoft Windows 2.0
- First Impressions**
- 103** Microsoft Languages Update
- 113** dBASE IV: A Paradox Killer?
- Reviews**
- 118** The Best of the 24-pin Printers
- 131** The WYSEpc 386
- 137** The Commodore Amiga 2000
- 144** The Taxan Crystal Jet
and the Data Technology
CrystalPrint VIII
- 150** AT Probe and Periscope III
- 163** Two Fast C Compilers for PCs
- 168** SAIC SVS FORTRAN
and MicroWay NDP FORTRAN
- 181** Interleaf Publisher
for the Macintosh II
- 189** Review Update
- 193** **Computing at Chaos Manor**
by *Jerry Pournelle*
- 211** **Applications Only**
by *Ezra Shapiro*



IT'S TIME TO DO SOME SERIOUS 386 BUGBUSTING!

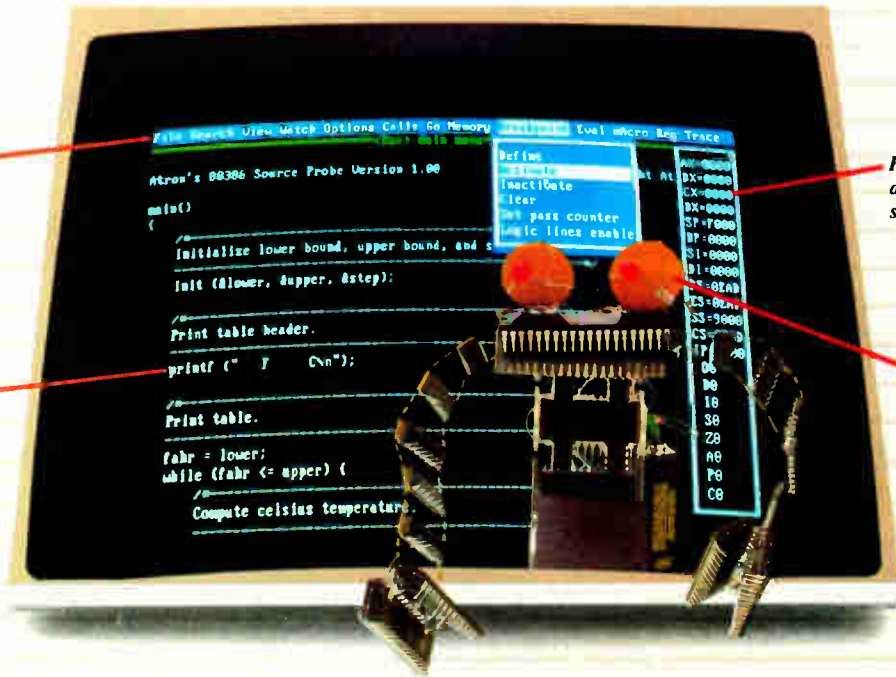

PROBE's menu bar and pull-down menus set a new standard for debugger interfaces.

POP registers up and down with a single key.

PROBE has source-level debugging to let you "C" your program.

This is an out-of-range memory-overwrite bug. Since it is interrupt related, it only appears in real time.

Welcome to your nightmare. Your company has bet the farm on your product. Your demonstration wowed the operating committee, and beta shipments were out on time. Then wham!

All your beta customers seemed to call on the same day. "Your software is doing some really bizarre things," they say. Your credibility is at stake. Your profits are at stake. Your sanity is at stake.

THIS BUG'S FOR YOU

You rack your brain, trying to figure something out. Is it a random memory overwrite? Or worse, an overwrite to a stack-based local variable? Is it sequence dependent? Or worse, randomly caused by interrupts? Overwritten code? Undocumented "features" in the software you're linking to? And to top it off, your program is too big. The software debugger, your program and its symbol table can't fit into memory at the same time. Opening a bicycle shop suddenly isn't such a bad idea.

THIS DEBUGGER'S FOR YOU

Announcing the 386 PROBE™ Bugbuster,* from Atron. Nine of the top-ten software developers sleep better at night because of Atron hardware-assisted debuggers. Because they can set real-time breakpoints which instantly detect memory reads and writes.

Now, with the 386 PROBE, you have the capability to set a *qualified breakpoint*, so the breakpoint triggers only if the events are coming from the wrong procedures. So you don't have to be halted by breakpoints from legitimate areas. You can even detect obscure, sequence-dependent problems by stopping a breakpoint only after a specific chain of events has occurred in a specific order.

Then, so you can look at the cause of the problem, the 386 PROBE automatically stores the last 2K cycles of program execution. Although other debuggers may *try* to do the same thing, Atron is the only company in the world to dequeue the pipelined trace data so you can easily understand it.

Finally, 386 PROBE's megabyte of hidden, write-protected memory stores your symbol table and debugger. So your bug can't roach the debugger. And so you have room enough to debug a really big program.



COULD A GOOD NIGHT'S SLEEP PUT YOU IN THE TOP TEN?

Look at it this way. Nine of the top-ten software products in any given category were created by Atron customers. Maybe their *edge* is — a good night's sleep.

Call and get your free, 56-page bugbusting bible today. And if you're in the middle of a nightmare right now, give us a purchase order number. We'll FEDEX you a sweet dream.



atron
BUGBUSTERS

A division of Northwest Instrument Systems, Inc.
Saratoga Office Center • 12950 Saratoga Avenue
Saratoga, CA 95070 • Call 408/253-5933 today.

*Versions for COMPAQ, PS/2-80s and compatibles. Copyright © 1987 by Atron. 386 PROBE is a trademark of Atron. Call 44-2-855-888 in the UK and 49-8-985-8020 in West Germany.

TRBA

WHAT'S NEW

SYSTEMS

Mac Tower Packs Gigabytes

The Giga Tower from Giga Cell Systems/NuData is a line of ultra-high-capacity hard disk systems that incorporate Apple's complete Macintosh II system, including the monitor and keyboard. Besides the heart of the Mac II, the basic setup includes a 40-megabyte tape backup system, a 10-megabyte removable-media drive, and a single 800K-byte 3½-inch floppy disk drive.

The Tower's hard disk storage is available in five flavors: 270 megabytes, 580 megabytes, 870 megabytes, 1.16 gigabytes, and 1.45 gigabytes. The entire system comes with a full range of software including memory management, hard disk compression and optimization, and full backup software.

Price: From \$18,950 to \$34,950.



The Giga Tower includes a Mac II.

Contact: Giga Cell Systems/NuData Inc., 4201 Burton Dr., Santa Clara, CA 95054, (408) 727-1049.

Inquiry 751.

Unicorn Gallops at 30 MHz

The Unicorn B/200 is Microproject International's multiuser system that runs at 30 MHz using AT&T's WE 3220X chip set. Supporting 50-plus users, the Unicorn is object-code- and media-compatible with AT&T's 3B computers, which have over 1000 applications programs available.

The Unicorn runs Unix System V/VME 3.1, which has new features including shared executable libraries, remote file sharing, media independent networking, and a streams communications interface.

The system includes a VME processor board with the 30-MHz WE 32200 processor, the 3.5-MWHETS WE 32206 math coprocessor, and the WE 32201 MMU/cache, which combines a 99.8 percent hit rate, multi-user, memory management unit with 4K bytes of two-way set-associative, zero-wait-state, physical data cache.

To reduce bus traffic and speed data transfers between peripherals and main memory, the Unicorn also has a 68020-based disk controller



This Unicorn runs Unix at 30 MHz.

that has a 32-bit direct-memory-access (DMA) controller and 128K bytes of buffering. There's also a serial communications module to assist interrupt-intensive tasks.

Unicorn includes 4 to 16 megabytes of RAM, a SCSI interface, multiple hard disk drives with capacities of 85 to 760 megabytes, high-density floppy disk drives, a 9-track or streaming-tape cartridge, 2 to 66 RS-232C serial ports, and Ethernet.

Price: \$20,000 to \$45,000.

Contact: Microproject Corp., 4676 Admiralty Way, Suite 610, Marina del Rey, CA 90292, (213) 306-8000.

Inquiry 752.

Hyundai's First File Server

The Super-286, Hyundai's first LAN-related product, is also configurable as a stand-alone personal computer. It has six 16-bit and six 8-bit expansion slots, and space for five half-height drives.

The speed of the Hyundai is switchable between 8 and 10 MHz with zero wait states. Standard features include 1 megabyte of RAM on the motherboard, a single 1.2-megabyte floppy disk drive, a 101-key keyboard, MS-DOS 3.2, and GWBASIC 3.2. An 80287 math coprocessor is optional, and Hyundai has optional hard disk drives available in capacities of 20, 30, 40, or 70 megabytes.

Price: \$1999.

Contact: Hyundai Electronics America, 4401 Great America Parkway, Santa Clara, CA 95054, (408) 980-7561.

Inquiry 753.

SEND US YOUR NEW PRODUCT RELEASE

We'd like to consider your product for publication. Send us full information, including its price, ship date, and an address and telephone number where readers can get further information. Send to New Products Editor, BYTE, One Phoenix Mill Lane, Peterborough, NH 03458. Information contained in these items is based on manufacturers' written statements and/or telephone interviews with BYTE reporters. BYTE has not formally reviewed each product mentioned.

continued

PERIPHERALS

Remove That Hard Disk

If you own an Amiga, Atari, or Macintosh, you can hook it up to Supra Corp.'s SupraDrive FD-10, a 10-megabyte hard disk system that uses 5 1/4-inch floppy disks.

With an average access time of 80 milliseconds, the company says the FD-10 approaches the speed of a normal (nonremovable) hard disk while letting you easily transport data or make backups. The FD-10 comes with software and cables ready to plug in and use. On the Amiga and Macintosh, it connects to the SCSI interface; on the Atari, it connects to the DMA port. **Price:** For Atari and Macintosh, \$895; for Amiga, \$1095. **Contact:** Supra Corp., 1133 Commercial Way, Albany, OR 97321, (503) 967-9075. **Inquiry 754.**

Apple Wages Laser War

Apple's new laser printers are named the LaserWriter IINTX, the LaserWriter IINT, and the LaserWriter IISC. They range from a \$6599 model to a \$2799 PostScriptless model. In the middle is a \$4599 PostScript model. You can upgrade the low- and mid-range printers for more functionality by simply slipping out and replacing their controller boards.

The three printers each weigh 45 pounds. They are built around the Canon LBP-SX printer engine and print at a maximum rate of 8 pages per minute. The NT and NTX models both come with 2 megabytes of RAM; the SC has 1 megabyte.

Apple has also improved the paper-handling capabilities of its laser printers with these new models; the LWII line has automatic paper handling with a 200-sheet paper cassette with face-up or face-down output trays. Each input cassette can hold up to 200 sheets of 20-pound paper; let-



Add a hard disk drive to your Amiga, Atari, or Mac.

ter, legal, A4, B5, and envelope cassettes are available.

According to Apple, the duty cycle provides for a minimum life expectancy of 300,000 pages with unlimited monthly output.

Price: LaserWriter IISC, \$2799; LaserWriter IINT, \$4599; LaserWriter IINTX, \$6599.

Contact: Apple Computer Inc., 20525 Mariani Ave., Cupertino, CA 95014, (408) 996-1010.

Inquiry 755.

Husky Mac Displays Assault the Old Standard

Two large-screen monitors for the Macintosh are becoming more prevalent. Each takes a vastly different approach for users with different needs.

The MacGenius is a 15-inch full-page display that's designed to work with the Macintosh 512, Plus, and SE. With a black-on-white page display, the monitor displays up to 720 by 1008 pixels at 100 dots per inch using a 1-to-1 aspect ratio.

Compatible with virtually all Macintosh software, you can use the MacGenius in concert with the Mac's built-in 9-inch screen. With both screens active, you can use the

Mac's main screen to hold desk accessories, tool palettes, and document windows.

The monitor is noninterlaced, with a 60-Hz refresh rate. Its horizontal scan frequency is 62.76 kHz, and it has a video bandwidth of 100 MHz.

Price: \$1795.

Contact: Micro Display Systems Inc., 1310 Vermillion St., P.O. Box 455, Hastings, MN 55033, (800) 328-9524; in Minnesota, (612) 437-2233.

Inquiry 756.

The MacLarger takes a slightly different, lower-cost approach to big Mac screens by simply enlarging the image 60 percent over the standard Mac screen while retaining the Mac's standard 512-by-342-pixel resolution.

The monitor is shipped along with a video board that the company says you can install in about 15 minutes without making any major modifications to your Mac 512, Plus, or SE. Another standard feature is that the video board has a composite video output, which you can use to drive a standard monitor or projection television (though, of course, at much lower resolution than the standard Mac screen).

Price: \$449.

Contact: Power R, 1606 Dexter Ave. N, Seattle, WA 98109, (206) 547-8000.

Inquiry 757.

A Duet of Drives for the Mac SE

If you own a Macintosh SE, you now have an increasingly wide selection of hard disk drive options for your electronic beast, with higher and higher capacities fast becoming the norm. Here are two examples:

Jasmine Technologies' InnerDrive 40/SE is a 40-megabyte drive that you install inside the SE's case. It sits above the Mac's dual internal drives, so you don't need to remove a floppy disk drive for it.

According to its manufacturer, the InnerDrive 40/SE has an average access time of 29 ms. It's shipped with a mounting bracket, cables, and other installation hardware, as well as 9 megabytes of public domain and shareware programs, and a backup program.

Price: \$999.

Contact: Jasmine Technologies Inc., 555 De Haro St., San Francisco, CA 94107, (415) 621-4339.

Inquiry 758.

If you have gigantic Macintosh data-storage needs, Relax Technology is shipping what it claims is the fastest and largest hard disk drive for the Mac SE. With a capacity of 91 megabytes, the Relax SE 91 has an average access time of 16.5 ms.

The SE 91 takes the place of the upper 800K-byte drive in the SE, and you'll have to have a dealer install it. The drive comes with firmware self-diagnostics that automatically locate, isolate, and reallocate bad sectors.

You can also install the Relax SE 91 in a Mac II.

Price: \$1795.

Contact: Relax Technology Inc., 3101 Whipple Rd., Suite 22, Union City, CA 94587, (800) 848-1313; in California, (415) 471-6112.

Inquiry 759.

continued

For problems involving engineering calculations or scientific analysis,
the answer is MathCAD.®

Transporting an iceberg to Southern California is a formidable task. Calculating the variables is just as demanding. How many tugboats would be needed to tow the ice mass? At what cost? How much fresh water would be lost?

Innovative solutions require extraordinary tools. For problems involving calculations or what-if analysis, the answer is MathCAD.

MathCAD is the only PC-based software package specifically designed to give technical professionals the freedom to follow their own scientific intuition.

Requires IBM® PC or compatible.

You decide how to solve the problem – MathCAD does the “grunt work.”

- Ends programming and debugging.
- Recalculates as variables change.
- Generates quick plots.

Easy to learn and use, MathCAD operates interactively in standard math notation. And its built-in functions provide all the power you need to solve real-world problems. MathCAD handles matrix operations, solves simultaneous equations, works with real and complex numbers, does automatic unit conversion, displays Greek characters and

other math symbols, performs FFTs and much more.

There's never been a better way to get fast, accurate solutions to analytical problems. That's why 20,000 engineers and researchers are using MathCAD daily in applications as diverse as fluid mechanics, signal processing and molecular modeling.

To find out what MathCAD can do for you, call us today for a **free demo disk: 1-800-MathCAD** (in MA, 617-577-1017). Or write to MathSoft, Inc., One Kendall Square, Cambridge, MA 02139.

MathSoft
Σ + √ - = × ∫ ÷ δ
Software Tools for Calculating Minds

HOW MANY GLASSES OF WATER

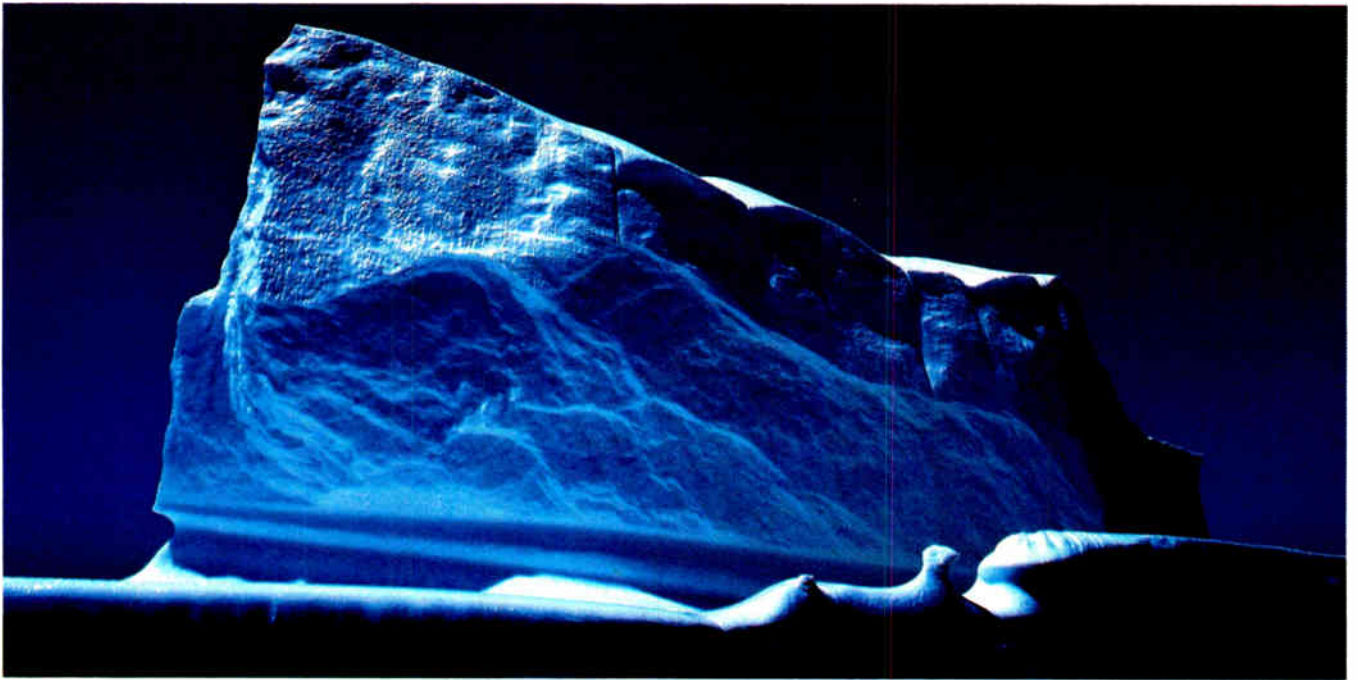

IBM® International Business Machines Corporation. MathCAD® MathSoft, Inc. © Copyright MathSoft, Inc. 1988.

CAN THIS ICEBERG SUPPLY TO L.A.?

Circle 158 on Reader Service Card

APRIL 1988 • B Y T E 69

PERIPHERALS

Draw Easy with EASYL

EASYL PC is a pressure-sensitive 1024- by 1024-pixel tablet that you can use to draw or trace directly into your computer just like using a normal pen or pencil on paper. Typical applications include desktop publishing, presentation systems, design, art, animation, and touch control. It sends coordinate pairs to your computer at speeds of up to 200 pairs per second.

EASYL PC runs on any IBM PC or compatible and is designed to run in either EGA or CGA mode using most graphics software such as PC Paintbrush or Dr. HALO. It also works with software that runs under GEM or Windows.

The tablet comes with its own driver software, but it can also emulate both the Summagraphics MM961 and Bit Pad One. You set all EASYL PC options via software; there are no DIP switches.

With the EASYL PC tablet, you also get a half-length interface card. The card has two ports: one for the graphics tablet, and one for any standard RS-232C serial device such as a mouse, modem, or serial printer.

Price: \$539.

Contact: Inforite Corp., 1670 South Amphlett Blvd., Suite 201, San Mateo, CA 94402, (415) 571-8766.

Inquiry 760.

Laser Printer Tackles the Big Jobs

Outputting 15 pages per minute and with a rated monthly output of 40,000 copies, the Kentek K-2+ laser printer is designed for heavy-duty use. The printer is shipped with a megabyte of internal RAM for full-page 300- by 300-dpi graphics. RS-232C, RS-422, and parallel interfaces are standard. The

K-2+ also has a built-in 1.2-megabyte floppy disk drive that lets you load customized data into the printer's memory, including up to 30 font sets, and macros for images such as forms, signatures, or logos.

Although the K-2+ uses the proprietary Kentek Command language, it also emulates the HP LaserJet Plus, Diablo 630, and Plot 10. GSS/CGI emulation is

optional.

One unique feature of the printer is a job-recovery function that lets you reprint the page that's stored in the printer's memory even in the event of a printer error. A bit-mapped page remains in the printer's internal memory until it receives a signal indicating that paper has exited.

You can feed up to 550 sheets of letter- or legal-size paper from the primary cassette, and up to 250 sheets from the secondary cassette.

Optional 1200-sheet primary and 550-sheet secondary cassettes are available. The Kentek K-2+ weighs 132 pounds and measures 14 by 26½ by 18½ inches.

Price: \$8970.

Contact: Kentek Information Systems Inc., 6 Pearl Court, Allendale, NJ 07401, (201) 825-8500.

Inquiry 761.

Two Color Printers from Honeywell

Honeywell Bull Italia has two new color printers: the 4/40 and the 4/41, which use standard-width and wide-width forms, respectively. Both have three print modes: draft at 300 characters per second, near-letter quality at 180 cps, and letter quality at 70 cps.

Both printers have bottom-feed push tractors that let you load fanfold paper from rear or bottom trays, and a straight paper path that makes it easy for you to use heavy paper stock, multipart forms, or labels. And speaking of multipart forms, the printers use what the company calls a stored-energy print head to handle up to six-part forms with a thickness of up to two hundredths of an inch.

The printers let you feed individual sheets, cut forms, and envelopes without having to unload fanfold paper. If that isn't enough, you can get any of three optional cut-sheet feeders. Both the 4/40 and 4/41 emulate the Epson JX-80, IBM Proprinter XL, and the IBM Graphics Printer. Using the front panel and its alphanumeric display, you can choose the printer setup as well as set the page format and print modes.

Price: 4/40, \$1195; 4/41, \$1395.

Contact: Honeywell Bull Italia, 120 Howard St., Suite 800, San Francisco, CA 94105, (415) 974-4340.

Inquiry 762.

continued

FORCE STICK BORROWS MILITARY TECHNOLOGY

What has to be the Cadillac of joysticks isn't even called a joystick. Tactron Scientific calls its device the Tactron F3 Series Force Stick. More conventional pointing devices such as joysticks, trackballs, tablets, or mice usually employ wheels, mechanical linkages, or optical sensors. But the Force Stick uses semiconductor strain gauges: very expensive yet sensitive

and accurate circuits that are integrated into the Force Stick's apparently rigid control rods.

The strain gauges are virtually identical to those used in military applications, such as the control stick on the Air Force's F-16 fighter jet. Unlike ordinary pointing devices, which sense position, the strain gauges in the Force Stick sense the force applied. The company

says the result is that the Force Stick has the seemingly contradictory capability of being so sensitive yet easy to control and position.

Each Force Stick is 5¾ by 7¾ inches and is housed in a jet-black anodized aluminum case. Two models—2- and 4-axis versions—are available, each with six microswitches. Hidden in the case are an on-board microprocessor and signal-conditioning circuitry that lets you choose linear or accelerated force modes. The Force Stick plugs directly into an RS-232C port and emulates the Microsoft Mouse, Mouse Systems Mouse, and the Summagraphics MM series.

Price: 2-axis version, \$765; 4-axis version, \$965.

Contact: Tactron Scientific Inc., 7265 Mountain Trail, Dayton, OH 45459, (513) 434-4117.

Inquiry 763.

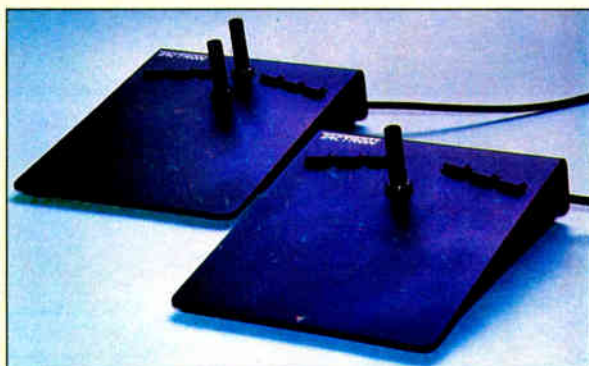

Force Sticks are the closest thing to flying an F-16.

“Those who are considering purchasing 1-2-3 will be better off with Quattro”

—John Walkenbach, InfoWorld

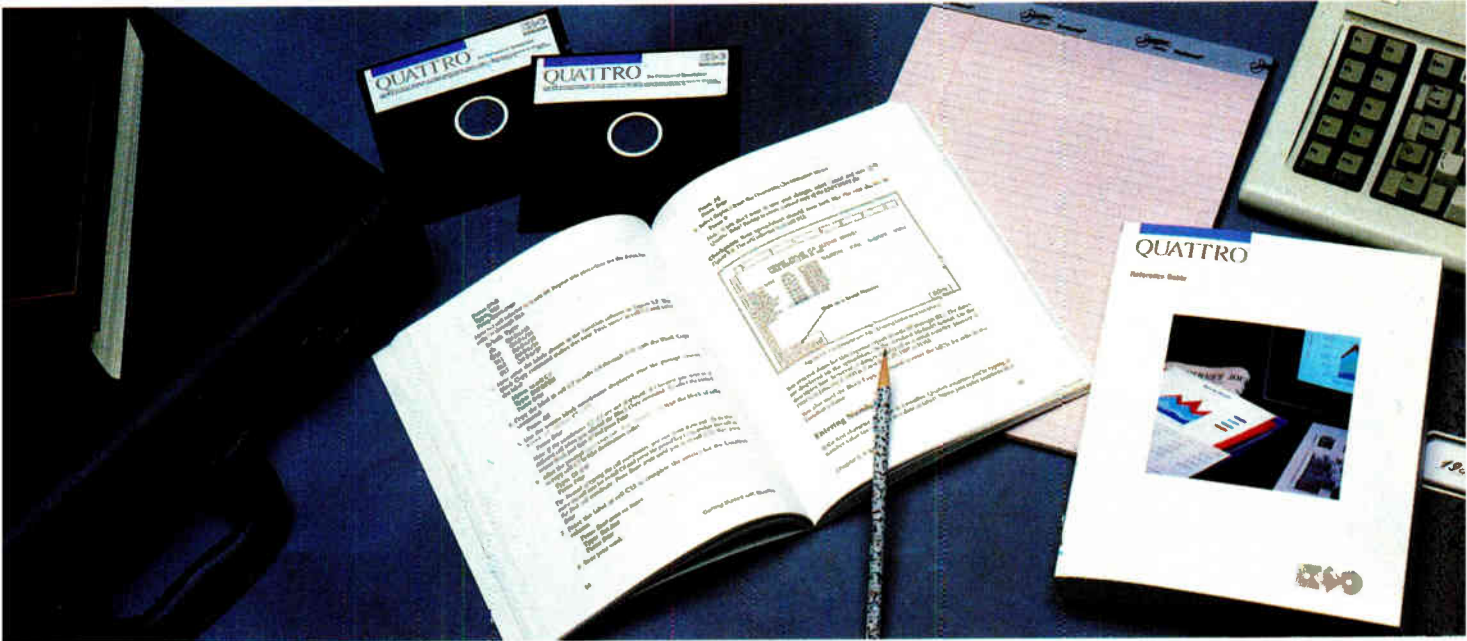

Here's what InfoWorld had to say about Quattro

“There are some clear advantages in choosing Quattro over the 1-2-3 of today: easier installation, no copy protection, improved speed, much better macros, excellent graphics, a customizable command interface, and direct compatibility with industry standard file formats. If cost is a factor, you can get five copies of Quattro for the same money that would buy two 1-2-3 packages.”

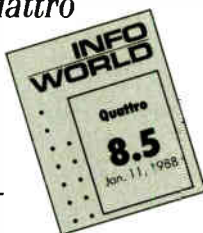

Features: Improving the industry standard

“Quattro takes the industry standard and improves upon it in the areas that count most. It addresses many of the weaknesses of 1-2-3 and adds quite a few of its own unique touches.”

“Perhaps Quattro's main advantage over most other spreadsheets is its minimal recalculation capability. When you make a change in your spreadsheet, only affected cells are recalculated, greatly speeding things up in most cases.”

“Other Quattro features that improve upon the 1-2-3 standard include auto-record macros, vastly superior graphics, and easy installation.”

Performance: Markedly superior to 1-2-3

“Our benchmark tests show Quattro markedly superior to 1-2-3 in file saves and retrieves.”

“Quattro's graphics are a sight to behold.”

“Quattro makes working with macros practically painless. If you're into complex 1-2-3 macros, the debugging feature alone is good reason to make the switch to Quattro.”

“No one can argue that Quattro is anything less than an excellent spreadsheet value.”

Excerpts from John Walkenbach's review of Quattro™ in InfoWorld, January 11, 1988.

60-Day Money-back Guarantee*

For the dealer nearest you or to order,

Call (800) 543-7543

APRIL 1988 • BYTE 71

Reprinted with permission from InfoWorld

*Customer satisfaction is our main concern. If within 60 days of purchase this product does not perform in accordance with our claims, call our customer service department, and we will arrange a refund.

All Borland products are trademarks or registered trademarks of Borland International, Inc. Other brand and product names are trademarks of their respective holders. Copyright ©1988 Borland International, Inc. B 12-2

Circle 43 on Reader Service Card (DEALERS: 44)



World Radio History

Get a Safety Bubble for your PC

Designed primarily for use in harsh environments or where memory downtime would cause critical problems, the PCB-76 PC bubble expansion board from MemTech adds solid-state, nonvolatile bubble memory to your IBM PC, XT, AT, or compatible. The card needs a full-length slot and comes in either 512K-byte or 1-megabyte sizes.

The board is shipped with an I/O driver in EPROM that makes the board look to your computer like a standard hard disk drive, albeit with a much slower access speed. The driver is compatible with versions 2.0 through 3.2 of both MS-DOS and PC-DOS. If your application calls for read-only use, you can use a jumper to write-protect the individual 512K-byte bubble memory devices.

Price: 512K, \$995; 1 megabyte, \$1695.

Contact: MemTech, 3000 Oakmead Village Dr., Santa Clara, CA 95051, (408) 980-5300.

Inquiry 764.

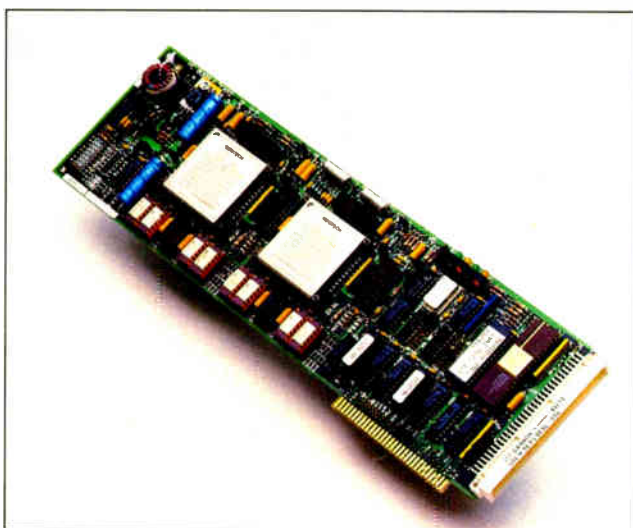

MemTech adds up to 1 megabyte of bubble memory.

ports. Designed for multiuser systems, multiple-point data acquisition, and other multi-I/O applications, the DigiBoard PS-COM/X mounts up to 16 RJ-45 connectors in a compact shielded extension of the board that extends through the card slot.

The board comes with COMWare, the DigiBoard communications device driver, and software utilities.

The Shack Accelerates the 1000

If you own a Tandy 1000 SX or one of the original Tandy 1000 personal computers, you too can join the era of speed and power with Tandy's 286 Express accelerator card. Developed by PC Technologies, Tandy claims the 80286-based board increases the performance of the 8088-based 1000 and 1000 SX between 200 and 600 percent—making its speed approximately equivalent to an 8-MHz IBM PC AT.

The 286 Express is a half-slot card that runs at 7.2 MHz. It has 8K bytes of on-board cache memory and a socket for an optional 80287 math coprocessor. Using keyboard commands, you can choose either 8088- or 80286-based processing modes, and you can turn the cache on and off. Tandy says the card is also compatible with all IBM PC hardware and software, including EGA, expanded-memory-specification (EMS), and LAN boards.

Price: \$399.95.

Contact: Tandy Corp./Radio Shack, 1800 One Tandy Center, Fort Worth, TX 76102, (817) 390-3700.

Inquiry 766.

COMWare lets MS-DOS access up to 64 communications ports. OS/2 support is also available. Software drivers are available for SCO-Xenix/286 and /386, and the company says it's developing drivers for the PS/2 versions of Unix, Xenix, PICK, THEOS, QNX, and PC-MOS.

Price: 8 ports, \$895; 16 ports, \$1295.

Contact: DigiBoard Inc., 6751 Oxford St., St. Louis Park, MN 55426, (800) 344-4273; in Minnesota, (612) 922-8055.

Inquiry 765.

Mac Accelerators Exceed the Speed Limit

Radius, a company known mainly for its large-screen monitors, now has a 68020-based accelerator card that runs at 25 MHz and, the company claims, boosts the performance of a standard Mac SE by a factor of 6. The Accelerator 25 card also supports an optional 68881 floating-point math coprocessor that, when installed, can execute numeric operations considerably faster than a standard SE.

To achieve the performance gains, Radius uses write-through logic with a high-speed cache that consists of 32K bytes of static RAM. This provides a 32-bit-wide data path and zero wait states for high-speed access to the display buffer. Additionally, the company credits some of the performance gains to the software algorithms built into the board's firmware.

Price: Under \$2000.

Contact: Radius Inc., 404 East Plumeria Dr., San Jose, CA 95134, (408) 434-1010.

Inquiry 767.

Meanwhile, Aox claims its DoubleTime-16 accelerator card doubles the speed of a Mac SE. At the same time, the company claims, the board provides complete hardware and software compatibility at a comparatively low price.

The board uses a 68000 microprocessor running at 16 MHz and a proprietary cache system. It plugs into the SE's option-card slot, with no cables to connect or chips to remove. It also has a socket for a 68881 math coprocessor chip. You can switch the accelerator between 16 MHz and the native 8 MHz by using a Control Panel desk accessory.

Price: \$395.

Contact: Aox Inc., 486 Totten Pond Rd. Waltham, MA 02154, (617) 890-4402.

Inquiry 768.

continued



Add 16 serial ports to your PS/2.

A Port Bonanza for the Micro Channel

If the single serial port that's included with your IBM PS/2 Model 50, 60, or 80 isn't sufficient for your I/O needs, the DigiBoard PS-COM/X is a full-length Micro Channel card that comes in two models to add 8 or 16 serial ports to the system.

If even 16 ports aren't enough, you can use up to four boards to provide up to 64

"For students, Microsoft® QuickC™ is the ultimate programming environment."

"For my research work it gives me an all-in-one product for development, while providing interlanguage calling as well as compatibility with Microsoft C5.0."

Dr. Kent Chamberlin, University of New Hampshire, Department of Electrical and Computer Engineering.

"With its integrated debugging and on-line help, Microsoft QuickC was the clear choice as the standard C compiler for our courses."

Greg Tinfow, R & D Engineer, Smart Product Design Laboratory, Stanford University.

"QuickC's built-in graphics, debugger and superb on-line help are formidable features to overcome."

PC AI Magazine (comparing QuickC to Turbo C), Fall 1987, by Brian Flamig, reprinted with permission.

It seems our "C" got an "A."

"If you are new to C, Microsoft QuickC can make the difference between learning C and giving up in frustration."

Jim Nech, President, Houston Area League of PC Users (HAL PC).

"QuickC is better than Turbo C.® It does everything that Turbo C does, and then some, incorporating very good debugging support that is totally absent from Turbo C."

Alan Holub, Columnist, Dr. Dobb's Journal, October 1987.

Not bad, for a \$99 compiler. Call (800) 541-1261, Dept. D51 and we'll send you a free information packet, including details of how to obtain a TurboPascal® to Microsoft QuickC translator program.

And to make QuickC even more irresistible, how does a 30 day money-back guarantee grab you?



Circle 309 on Reader Service Card
(DEALERS: 310)

Microsoft is a registered trademark and QuickC is a trademark of Microsoft Corporation. Turbo C and TurboPascal are registered trademarks of Borland International, Inc. Offer valid in the 50 United States only.

NASA FLIES WITH

To the National Aeronautics and Space Administration, speed, power and reliability are of prime importance.

They picked Proteus computers for their Goddard Space Flight Center in Greenbelt, Maryland.

NASA is a regular customer of Proteus. So are Xerox, RCA, GE, Dupont, GM, Revlon, General Dynamics, the U.S. government, the United Nations, MIT, Harvard and Cornell. And the list doesn't stop there either.

Even leading computer manufacturers like Digital Equipment Corporation, Honeywell, ITT and Prime buy regularly from Proteus.

They know Proteus computers have a price/performance ratio that's light years ahead of IBM and the other desk-top computer makers. And the computer magazines agree.

Personal Computing magazine had this to say, "Prices for the different models and peripherals classify Proteus as a low-ball clone, but its speed, expansion capability and service contract put it in a class with the big boys."

CUSTOM BUILT

What's more, every Proteus computer

is custom built to exact specifications. Your specifications.

Tell us which drives to use, which EGA adapters to put in. And we'll match your needs. Just as we have for NASA.



Proteus computers are engineered and manufactured right here in the USA.

They have the power and speed needed to get big jobs off the ground. Featuring 8088/80286/80386 models ranging from 6MHz to a whopping 20MHz!

This high speed, plus our timing and IBM standard Bus design, give Proteus machines supreme hardware compatibility and adaptability.

Every Proteus computer is guaranteed IBM compatible or your money back!

Proteus computers are also guaranteed compatible with OS/2, UNIX, XENIX, NOVELL, 3COM, PICK, THEOS and all major operating systems.

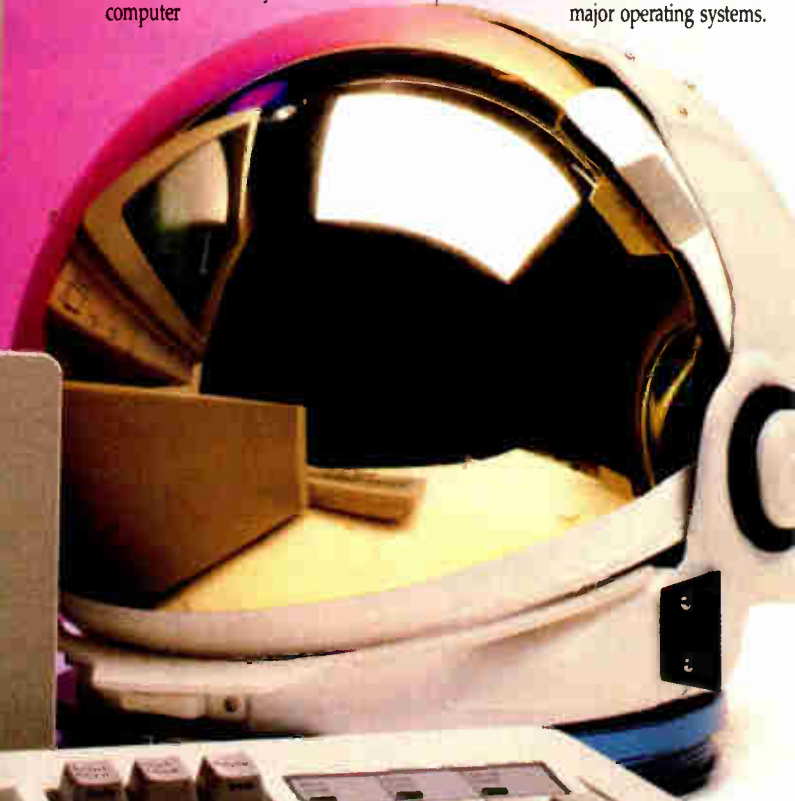
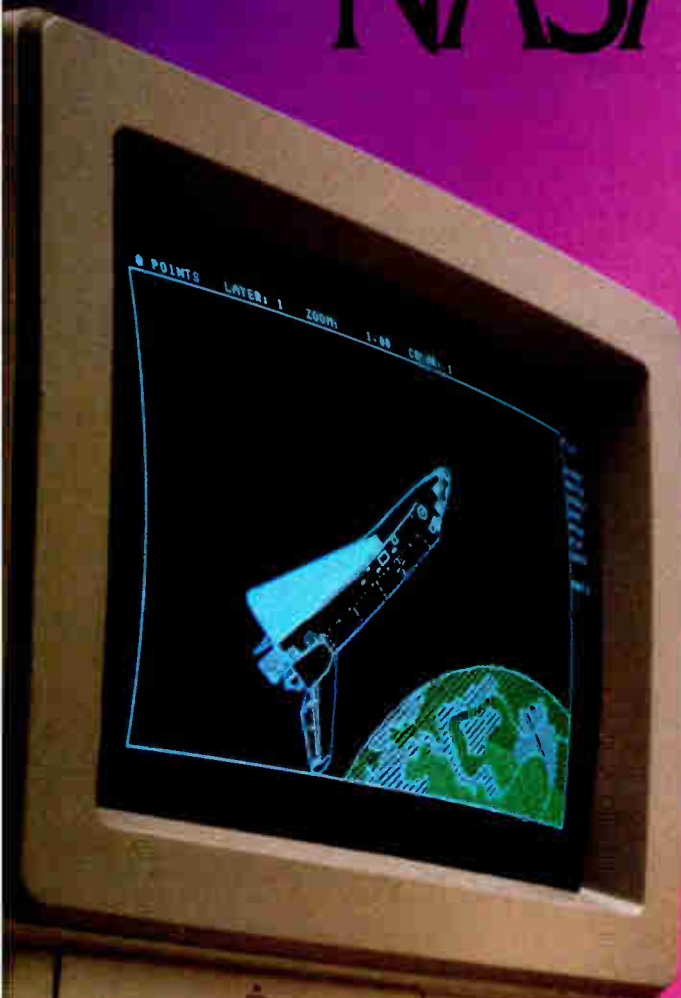

PROTEUS COMPUTERS!

PROTEUS 386A

16MHz / 20MHz, Ø-wait-state

This very fast 80386 based computer utilizes advanced Cache memory and special memory mapping techniques to bring you the power of a minicomputer.

InfoWorld magazine named the Proteus 386A one of the top 100 products of the year! Calling it, "A 16-MHz, Ø-wait-state 80386 hot rod."

The Proteus 386A is perfect for CAD/CAM, desktop publishing, file serving, data base management or multi-user and LAN operating environments.

16MHz **\$2595**
20MHz **\$3190**

386A standard features:

- 80386 CPU, 16/20MHz, Ø-wait-state.
- 64K Cache memory.
- 1024K RAM expandable to 4MB of 32-bit RAM on systemboard.
- Clock, calendar and battery backup.
- Dual floppy and hard disk controller.
- 200 watt power supply, 110/220V.
- ROM based setup and diagnostics.
- Socket for coprocessor.
- 2 serial and 1 parallel port.
- 1.2MB floppy drive. Free replacement with 3.5" or 360K drive.
- Optional hard disk. See chart.
- 101-key enhanced keyboard.
- 15-month warranty on parts and labor.
- Free on-your-site maintenance.
- 30 day, money back guarantee.
- Made in U.S.A.

386A monochrome system **'2842***
386A EGA color system **'3229****

*Monochrome systems include: 14" high res. monitor and a 720x348

Herc. compatible graphics card with an additional parallel port.

**EGA color systems include: High res. EGA color monitor and a 710x420/680x480 EGA adaptor.



PROTEUS 286GTX

12MHz, Ø-wait-state

The 286GTX is perhaps the fastest 12MHz computer around. It provides perfect compatibility with an overall throughput of 16MHz.

InfoWorld said of the Proteus 286GTX, "It is a superb value, scores high in our benchmark tests, and Proteus has the best warranty and technical support."

This high speed 80286 based computer is ideal for networking, CAD/CAM, desktop publishing or business applications.

12MHz **\$1750**

286GTX standard features:

- 80286 CPU, 12MHz, Ø-wait-state.
- 32K Cache memory.
- 1024K RAM.
- Clock, calendar and battery backup.
- Dual floppy and hard disk controller.
- 200-watt power supply, 110/220V.
- ROM based setup and diagnostics.
- Socket for coprocessor.
- 2 serial and 1 parallel port.
- 1.2MB floppy drive. Free replacement with 3.5" or 360K drive.
- Optional hard disk. See chart.
- 101-key enhanced keyboard.
- 15-month warranty on parts and labor.
- Free on-your-site maintenance.
- 30 day, money back guarantee.
- Made in U.S.A.

286GTX monochrome system .. **'1997***
286GTX EGA color system **'2374****



PROTEUS 286F

10MHz, Ø-wait-state

This 80286 based AT compatible is a fast, zero wait state computer roughly 15% faster than our model 286E.

PC Magazine said, "The 286F is an extremely fast 10MHz machine that does what it claims to do and backs that up with an aggressive support plan."

The 286F is perfect for network or business applications.

10MHz **\$1495**

286F standard features:

- 80286 CPU, 10MHz, Ø-wait-state.
- 1024K RAM.
- Clock, calendar and battery backup.
- Dual floppy and hard disk controller.
- 200 watt power supply, 110/220V.
- ROM based setup software.
- Reset switch.
- Socket for coprocessor.
- 2 serial and 1 parallel port.
- 1.2MB floppy drive. Free replacement with 3.5" or 360K drive.
- Optional hard disks. See chart.
- 101-key enhanced keyboard.
- 15-month warranty on parts and labor.
- Free on-your-site maintenance.
- 30 day, money back guarantee.
- Made in U.S.A.

286F monochrome system **'1742***
286F EGA color system **'2129****

THE PROTEUS TOTAL SATISFACTION GUARANTEE

All of our products are guaranteed to give 100 percent satisfaction in every way.

Return anything purchased from us at any time during the first 30 days if it proves otherwise. We will replace it, refund your purchase price or credit your credit card, as you wish. In addition, there is a **15-Month warranty** on labor and parts. Plus **Free on-your-site service**. If something goes wrong with your Proteus computer during the first two months, we'll send a qualified technician. There's also a **toll-free technical support hotline** and a 24-hour electronic support line.

24-HOUR CATALOG

Just dial (201) 288-8577 using your modem set to 1200B/N/8/1.

PROTEUS 286E

10MHz

Our 286E provides performance and value unbeatable by any other comparably priced machine.

InfoWorld magazine said, "For best machine in power, the Proteus 286E is the clear winner. We recommend it."

The 286E is ideal for home or office.

10MHz **\$1295**

286E standard features:

- 80286 CPU, 10MHz.
- 1024K RAM.
- Clock, calendar and battery backup.
- Dual floppy and hard disk controller.
- 200 watt power supply, 110/220V.
- ROM based setup software.
- Socket for coprocessor.
- 2 serial and 1 parallel port.
- 1.2MB floppy drive. Free replacement with 3.5" or 360K drive.
- Optional hard disk. See chart.
- 101-key enhanced keyboard.
- 15-month warranty on parts and labor.
- Free on-your-site maintenance.
- 30 day, money back guarantee.
- Made in U.S.A.

286E monochrome system **'1542***
286E EGA color system **'1929****

HARD DISKS

Choose a hard disk for the computers and you have a complete turnkey system.



Brand/type	Vol. MB	Access time	Price
Seagate	20MB	65ms	\$279.00
Seagate	40MB	28ms	\$595.00
Miniscribe	44MB	28ms	\$665.00
Miniscribe	72MB	28ms	\$965.00
Priam RLL	100MB	24ms	\$Call
Maxtor	140MB	18ms	\$Call
Maxtor/ESDI	150/340MB	15ms	\$Call

TO ORDER

Whether you need 1 or 100 systems, call us toll-free at 1-800-782-8387 (VAR/Reseller volume discounts available).

Your system will be delivered to your door completely assembled and factory tested for 48 hours. All you have to do is power up and blast off into the wild, blue yonder!

Circle 221 on Reader Service Card

IN NJ:(201)288-8629

1-800-782-8387

377 Rt. 17 So., Airport 17 Ctr., Hasbrouck Hts., NJ 07604 • Telex 510-601-0960 • FAX 201-288-9518

PROTEUS®
THE INTELLIGENT CONCLUSION!

Watch My (AC) Line

The slings and arrows of outrageous AC power can play havoc with your valuable computer equipment. And since information is power, the Tasco AC Monitor will give you the power to know all about what's coming out of the outlets on your wall.

The AC Monitor plugs into any AC outlet and has a console that displays a number of present and past conditions. There's a readout of your current voltage in 5-volt increments, lights that lock on when voltage goes above 135 volts or below 105 volts, a light that shows if a high-voltage spike has occurred, and a power-failure light.

Used regularly, the AC Monitor may tell you more than you want to know about your local utility company and the possibility of computer damage.

Price: \$138.

Contact: Tasco Ltd., 2875 West Oxford Ave., Suite 5, Englewood, CO 80110, (303) 762-9952.

Inquiry 769.

Matchbook-Size I/O

Into a package that measures 1½ by 2 by ¾ inches, the Tattletale Model V squeezes 11 10-bit A/D channels, 17 individually programmable digital I/O lines, a UART (universal asynchronous receiver/transmitter), and 28K bytes of RAM. The

A LITTLE MAC MUSIC

Apple Computer now has a MIDI device for connecting the company's computers to electronic musical instruments. The diminutive unit—measuring 3 by 2 by 1¼ inches—is aimed at professional musicians and educational institutions.

The Apple MIDI Interface doesn't need a separate

power supply, and you can connect it to any model Macintosh or Apple IIGS computer using the computer's modem port. The device has one 8-pin DIN connector that attaches to the computer and two MIDI connectors: a MIDI-in plug and a MIDI-out plug.

According to the com-

pany, the Apple MIDI Interface is compatible with most MIDI software currently available for the Macintosh and Apple IIGS.

Price: \$99.

Contact: Apple Computer Inc., 20525 Mariani Ave., Cupertino, CA 95014, (408) 996-1010.

Inquiry 773.

unit's 10-bit converter can sample and store all 11 channels at 100 Hz.

The Tattletale needs a battery-supply voltage of between 6.5 and 15 volts. If you're using it for a typical application with an external current drain of about 3 milliamperes, you can expect about a 5-day battery life from a 9-volt alkaline battery, or 20 days from six AA cells.

If you're familiar with BASIC, you can connect the Tattletale Model V to a computer or terminal and start developing applications immediately. The board's built-in TT BASIC operating system has special functions for data storage and retrieval, analog and digital I/O, and timekeeping and synchronization. There's also an in-line symbolic assembler for developing speed-critical subroutines.

Price: \$395.

Contact: Onset Computer Corp., 199 Main St., P.O. Box 1030, North Falmouth, MA 02556, (617) 563-2267.

Inquiry 770.

ADBridge Bypasses Mac Peripheral Problems

If you own an old-style (pre-II/SE) Macintosh, you don't need to feel left out by the blizzard of new accessories available for the Apple Desktop Bus (ADB). At the same time, if you have a Macintosh II or SE, you don't need to consign your old accessories to the trash heap.

Solutions to both of these problems come in the form of a product called ADBridge, a hardware interface that works both ways. If you're a Mac 512E or Plus owner, you can use the new Apple Desktop Bus mice and new keyboard (including the Apple Extended). If you own a Mac SE or Mac II, you can connect older devices such as trackballs, tablets, and joysticks to your newer Apple computers.

ADBridge has six connections for input and output. If you're a Mac SE or II owner, all you need to do is plug ADBridge into an ADB port and connect your peripherals. If you're a 512E or Plus owner, your setup will vary depending on what you want to do.

The makers of ADBridge claim that it's fully compatible with all software applications and all input devices. It's shipped with a software utility that does automatic configuration and lets older-machine users address the additional function keys that

are available on the new Apple keyboards.

Price: \$129.

Contact: Olduvai Corp., 7520 Red Rd., Suite A, South Miami, FL 33143, (305) 665-4665.

Inquiry 771.

Switch to Your Heart's Content

Patton Electronics says its line of data switches are a new breed that are simple to use and useful for complex applications.

The Micro Matrix Switches come in both 2-input/4-output (Model 24) and 4-input/4-output (Model 44) versions. You can use the two models to connect two or four computers, respectively, to any combination of four printers, plotters, terminals, or modems. The switches are all electronic and have no moving parts. They use DB-25 connectors and work with serial and parallel devices.

You can switch any 4, 8, 12, or 24 conductors on each connector, and the Micro Matrix switch can handle data rates up to 500 kilobits per second. The units handle voltages between +15 and -15 V DC, and there's a momentary-power-loss indicator on the front panel.

Price: Model 24, \$345 to \$595; Model 44, \$495 to \$995.

Contact: Patton Electronics Co., 7958 Cessna Ave., Gaithersburg, MD 20879, (301) 975-1000.

Inquiry 772.

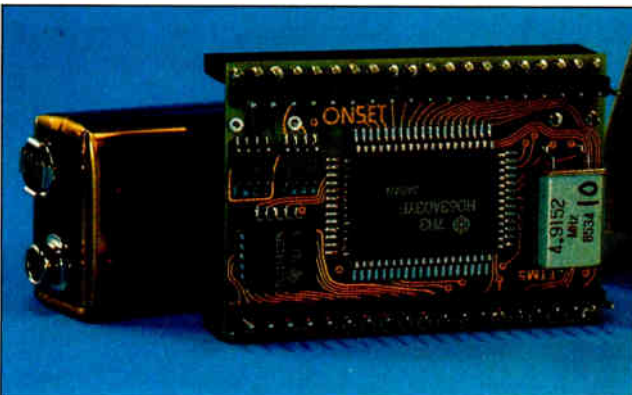

Tattletale Model V communicates with the real world.

continued

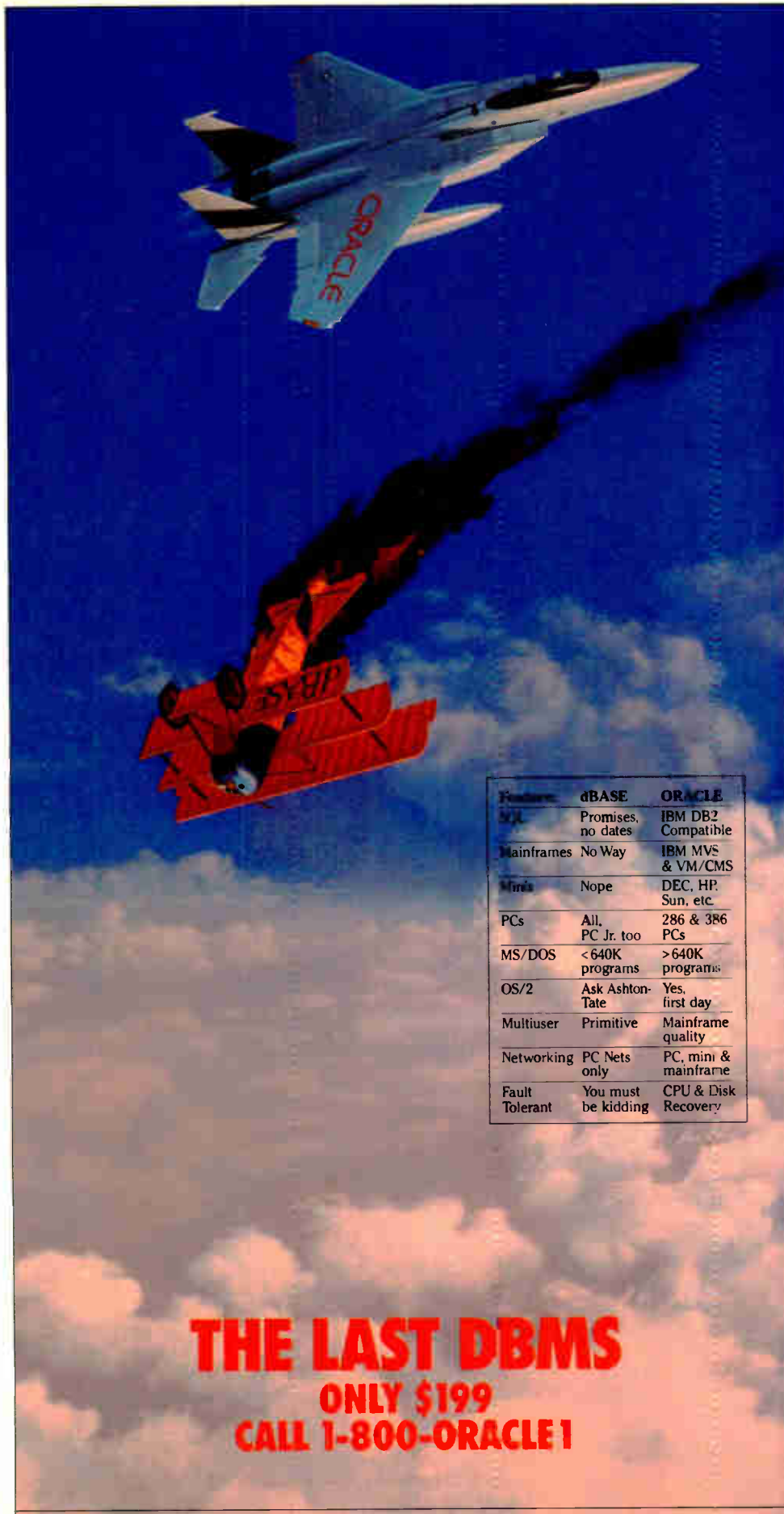

Oracle Corporation, the world's fastest growing software company¹ has just climbed past Ashton-Tate to become the world's largest supplier of database management software and services.²

Why?

- Because ORACLE® runs on PCs, plus mainframes and minicomputers from IBM, DEC, DG, HP, Prime, Wang, Apollo, Sun, etc. — virtually every computer you have now or ever will have. Ashton-Tate's dBASE runs only on PCs.
- Because ORACLE is a true distributed DBMS that connects all your computers — PCs, minicomputers and mainframes — into a single, unified computing and information resource. dBASE supports only primitive PC networking.
- Because Oracle has supported the industry standard SQL language since 1979. Ashton-Tate promises to put SQL into dBASE sometime in the indefinite future.
- Because ORACLE takes advantage of modern 286/386 PCs by letting you build larger-than-640K PC applications on MS/DOS today, and run them unchanged on OS/2, once OS/2 is available. dBASE treats today's 286/386 PCs and PS/2s like the now obsolete, original PC.

Don't go down in flames. Bail out from dBASE. Call 1-800-ORACLE1 and order your \$199-PC copy of ORACLE³ today. Or just ask and we'll send you information on ORACLE, the number one selling DBMS on minicomputers and mainframes.

ORACLE®
COMPATIBILITY • PORTABILITY • CONNECTABILITY

**Call 1-800-ORACLE1,
ext. 149 today.**

Features	dBASE	ORACLE
SQL	Promises, no dates	IBM DB2 Compatible
Mainframes	No Way	IBM MVS & VM/CMS
Minis	Nope	DEC, HP, Sun, etc.
PCs	All, PC Jr. too	286 & 386 PCs
MS/DOS	< 640K programs	> 640K programs
OS/2	Ask Ashton-Tate	Yes, first day
Multiuser	Primitive	Mainframe quality
Networking	PC Nets only	PC, mini & mainframe
Fault Tolerant	You must be kidding	CPU & Disk Recovery

**THE LAST DBMS
ONLY \$199
CALL 1-800-ORACLE 1**

Dear Oracle,

PC ORDER PROCESSING

Oracle Corporation
20 Davis Drive • Belmont, CA 94002

I want ORACLE to be THE LAST DBMS for my 286/386 PC. Enclosed is my Check or VISA MC AMEX credit card authorization for \$199 (California residents add 7% sales tax). I understand this copy is for PC development only. Offer valid only in the US and Canada.

Print Name _____ Date _____
 Title _____
 Company _____
 Street (P.O. Box numbers not acceptable) _____
 City _____
 State _____ Zip _____
 Phone _____
 Credit Card Number _____
 Card Expiration Date _____

Signature _____ BYTE
 I am a value-added reseller (VAR): YES NO

¹ Revenue doubled in 8 of Oracle's 10 years. ² Sales rate over \$200 million in current fiscal year. ³ For PC development use only. Requires a 286/386 PC plus 1-Mbyte extended memory. Offer valid only in US & Canada. © 1987 by Oracle Corp. ORACLE® is a reg. trademark of Oracle Corp. dBASE is a reg. trademark of Ashton-Tate. Microsoft & IBM own numerous reg. trademarks. TRBA

FORTRAN for the 386

Develop programs with up to 16 megabytes and run them in protected mode on 386 systems with SVS FORTRAN-386 from Science Applications International. SVS includes a native-code compiler, a run-time I/O system, a source-level debugger, and VM-RUN, which is a 386 run-time monitor. The program supports the Intel 80287/80387 and Weitek 1167 math coprocessors.

Science Applications International reports that SVS cuts the run time of a typical program by at least half when compared to using a 16-bit compiler running under DOS or OS/2.

The program supports FORTRAN 77 and incorporates IEEE floating-point operations, including single- and double-precision and complex arithmetic. Compiler directives and command-line options let you compile applications that use common, nonstandard FORTRAN conventions. The debugger lets you examine source code, access and modify variables by symbolic names, set breakpoints and tracepoints, and view the traceback environment.

Price: \$895.

Contact: Science Applications International Corp., 5150 El Camino Real, Suite C-31, Los Altos, CA 94022, (415) 960-3322.

Inquiry 774.

Low-Cost Prolog on the Amiga

UNH Prolog, ported from the VAX-11/780 to Sun workstations and the IBM PC, is now running on the Amiga. The UNH Prolog interpreter is based upon the Edinburgh standard with extensions, including real numbers. It supports over 100 built-in predicates, including predicates for debugging and tracing.

To run UNH Prolog, you

GEOS GOES APPLE

Berkeley Softworks has ported GEOS (graphical-environment operating system), originally developed for the Commodore 64 and 128, over to the Apple II. This development provides a graphical interface and operating environment for the Apple IIe, IIc, and IIGS.

The system desktop has one Clipboard for text and one for images. It also organizes folders on pages, with eight to a page. Also included are geoPaint, geo-

Write, and geoSpell: geoPaint is a MacPaint-like program; geoWrite is a WYSIWYG (what you see is what you get) word processor; and geoSpell is a 28,000-word dictionary and spelling checker. Other utilities and programs include a conversion utility for accessing word-processing files, a LaserWriter/PostScript printer driver, and desktop accessories including a calculator, notepad, alarm clock, and disk organizer.

Berkeley Softworks re-

ports that it will release a database, spreadsheet, and programming utility later in the year.

To run GEOS on an Apple II, you need an 80-column card and 128K bytes of RAM. The system is limited, at this time, to monochrome.

Price: \$129.95.

Contact: Berkeley Softworks, 2150 Shattuck Ave., Berkeley, CA 94704, (800) 443-0100; in California, (415) 644-0883.

Inquiry 780.

need an Amiga with at least 512K bytes of RAM, although at least 1 megabyte is recommended.

Price: \$75.

Contact: The Department of Computer Science, University of New Hampshire, Durham, NH 03824, (603) 862-3778.

Inquiry 775.

A FORTRAN Tool for Every Purpose

FORTRAN BASIC Utilities contains two libraries of tools that provide a BASIC-like function for screens or interface control. Each tool is also CodeView-compatible.

One library is assembled for CodeView, and one is without debugging capabilities. The program includes a set of test programs and source code.

To run the FORTRAN BASIC Utilities, you need an IBM PC or compatible, DOS 3.0 or higher, and Microsoft FORTRAN 4.0. The company says that you don't need an assembler.

Price: \$49.95.

Contact: Silver State Software, 1000 East William St., Suite 100, Carson City, NV 89701, (702) 855-8922.

Inquiry 776.

Copernicus Does DOS

Copernicus is a knowledge-engineering tool, according to Tecknowledge, and it has its own programming language and hooks for high-level languages. The knowledge system, previously run only on mainframes and workstations, is now available in a DOS version. It runs under Microsoft Windows on an 80286 or 80386 system and includes a DOS extender that lets you execute in protected mode.

Price: About \$12,000.

Contact: Tecknowledge, 1850 Embarcadero Rd., P.O. Box 10119, Palo Alto, CA 94303, (415) 424-0500.

Inquiry 777.

Find Those Files

Execloc is a utility that helps you find MS-DOS .EXE files. According to Virtual Software, the program relocates all the segments as needed to within the 8088/8086 1-megabyte memory map. And it's not limited to locating just .EXE files, but can use any extension as it checks for a proper header signature in the file itself.

You can operate Execloc from the command line or from menus. The program includes a binary-to-hexadecimal conversion utility.

Execloc runs on the IBM PC and compatibles with DOS 3.0 or higher. The program is not copy-protected.

Price: \$29.95.

Contact: Virtual Software, 51 Oak Ave., Richmond Hill, Ontario, Canada L4C 6R5, (416) 881-7665.

Inquiry 778.

A SANE FORTRAN Compiler for the Mac II

Language Systems Corp. reports that its FORTRAN compiler is the first FORTRAN implementation that fully supports Apple's SANE (Standard Apple Numeric Environment) floating-point routines. The compiler runs on the Mac II and also supports the full ANSI Standard FORTRAN 77 language, plus extensions and engineering number formatting.

Arrays can exceed 32K bytes, limited only by memory available, the company reports. Options let you accept Hollerith and other elements of FORTRAN 66 syntax and specify in-line 68881 object code.

Price: \$295 (includes the MPW shell).

Contact: Language Systems Corp., 463 Carlisle Dr., Herndon, VA 22070, (703) 478-0181.

Inquiry 779.

continued

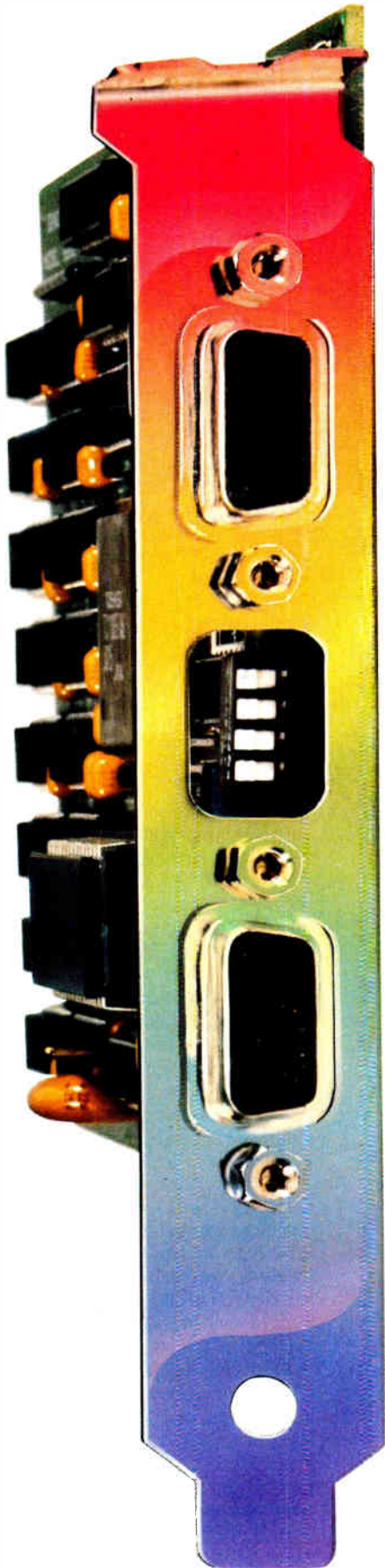

Will The Real VGA Please Stand Up

It's easy to identify the leader in VGA resolution—just look to the company that brought you the *first* 800 x 600 EGA card.

800 x 600 VGA with 256 Colors

1024 x 768, too. Either way, Genoa's SuperVGA HiRes™ is the best way to see VGA. And your spreadsheets will look great, with 132 columns and 60 rows for your viewing pleasure.

Crash-free Windows

Yes, we do Windows—no problem. And SuperVGA HiRes is compatible with both the VGA PS/2 monitors and the EGA Multisync monitors, in VGA and EGA modes.

So don't settle for inadequate imitations. Get the highest VGA performance at the best price, in true Genoa tradition.

For the dealer nearest you, contact: Genoa Systems Corporation, 73 E. Trimble Road, San Jose, CA 95131
FAX: 408-434-0997 Telex: 172319
Telephone: 408-432-9090



Genoa Systems Limited (U.K.) Tel: 01-720-5064

© 1987 Genoa Systems Corporation. SuperVGA HiRes is a trademark of Genoa Systems Corporation.
Windows is a trademark of MicroSoft, Inc. Multisync is a trademark of NEC Home Electronics.

Circle 111 on Reader Service Card

World Radio History

Data-Acquisition and Control Software

Control EG, an automation program for measurement and control systems, works with systems with up to 256 I/O points. Versions of the program are available for PC-based hardware from Analog Devices and MetraByte.

The program combines the features of data loggers, programmable controllers, and closed-loop PID controllers.

You can use Control EG to monitor analog and digital inputs, and you can graph and log temperatures to disk in real time. The program automatically handles linearization and/or engineering unit conversion. You can use your own equations or use PID calculations to set analog and digital outputs. You can define calculated points that are a mathematical function of other analog or digital inputs. Control EG lets you mix transcendental functions, Boolean functions, alarm conditions, and historical values within the same formula.

Displays include 16-channel bar graphs, scrolling history, x,y cross-plot, annunciator, tag summary, operator, and sequencer status.

Control EG runs on the IBM PC, XT, AT, and compatibles with two 360K-byte floppy disk drives or one floppy drive and one hard disk drive. You also need at least 512K bytes of RAM (640K is recommended). A CGA, EGA, or Hercules graphics board is required, along with DOS 3.0 or higher. It supports the

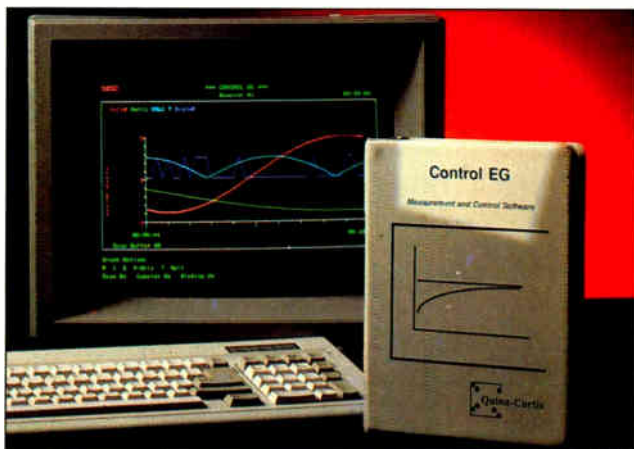

Control EG automates measurement and control systems.

Intel 8087 or 80287, though it does not require either.

Price: \$500.

Contact: Quinn-Curtis, P.O. Box 10, Newton Center, MA 02159, (617) 444-7721.

Inquiry 781.

Survey the Mac Way

Cogo Mac is a land-surveying program from Compuneering, the company previously known as Erez Anzel Software. Cogo Mac is not to be confused with MacCogo, a geometric calculation program from the same company.

Cogo Mac lets you lay out real estate or other area plans and calculate area and elevations. Information is displayed graphically and numerically when you enter it. You can use the mouse or keyboard to change or move points. Its calculations are precise to 15 digits, the company reports.

Cogo Mac is written in MacAPP and is compatible with MultiFinder, Laser- Writers, and networks, according to Compuneering. It runs on Macs with 512K bytes of RAM and will make use of color on the Mac II.

Price: \$595.

Contact: Compuneering Inc., 113 McCabe Crescent, Thornhill, Ontario L4J 2S6, Canada, (416) 738-4601.

Inquiry 782.

A Star Is Born

STAR (structural testing, analysis, and reporting) is a set of four subprograms that work with Microsoft Windows in analyzing structures. The subprograms include a modal system, a structural-analysis system, a dynamics display station, and a computer-aided measurement-acquisition system.

The modal program, STAR

Modal, integrates curve-fitting capabilities with the graphics of the display station and the data-acquisition capability of transferring and saving data acquired with the fast-Fourier-transform analyzer, STAR Test.

The structural-analysis system, STAR Struct, integrates the modal-analysis capability of STAR Modal plus SDM (structural dynamics modifications) and FRS (forced response simulation). With the structural-analysis system you can predict how the dynamic properties of a mechanical structure will be affected by mass, stiffness, and damping modifications.

STAR View is the display station that offers you graphics tools for viewing modal data from modal and finite-element sources. Its capabilities include measurement display, real-time animated-mode shape display, and data handling.

The computer-aided measurement-acquisition system, STAR Test, includes the capabilities of STAR View, plus the ability to transfer and save data acquired with an FFT analyzer. All other STAR system products can access the data acquired with STAR Test.

STAR uses vibration data acquired from a test structure as input, and it then identifies the modes of vibration of the structure from this data. The modes are displayed in a real-time, animated display.

Microsoft Windows enables you to work in STAR and other applications simultaneously by switching between windows. You can also cut and paste STAR graphics displays or data tables into other Windows programs.

STAR runs on the IBM PC AT and compatibles with at least 1 megabyte of RAM. It also runs on PS/2s.

Price: \$6500 to \$20,000.

Contact: Structural Measurement Systems Inc., 651 River Oaks Parkway, San Jose, CA 95134, (408) 263-2200.

Inquiry 783.

FINITE ELEMENT ANALYSIS ON THE MAC II AND SE

MacNeal-Schwendler, a leader in finite-element-analysis (FEA) software, has released version 1.98 of MSC/pal for the Macintosh II and SE. The FEA method breaks a structure into discrete elements that the computer can study for responses to stress, vi-

bration, and pressure.

Running on the Mac II, version 1.98 lets you use up to 256 colors. On both the II and SE, you can make use of shaded contours and hidden-element plots.

The company also announced that a version of its new interactive modeler,

MSC/mod, is in the works for the Macintosh.

Price: MSC/pal 1.98, \$1495; MSC/mod, \$495.

Contact: The MacNeal-Schwendler Corp., 815 Colorado Blvd., Los Angeles, CA 90041, (213) 259-3875.

Inquiry 784.

continued



The LOGITECH HiREZ Mouse—the only mouse expressly designed for high-resolution screens.

With a resolution of 320 dots-per-inch (as compared with 200 dpi or less for ordinary mice), it covers the same area on your high-res screen, but needs less of your desk to do it. More than 50% less. Saving you valuable desk space, and effort: mouse maneuvers that used to require a sweep of the hand are now reduced to a flick of the wrist.



The LOGITECH HiREZ mouse needs 50% less desk space to cover the same amount of screen area as a 200 dpi mouse.

Which makes this new mouse a hand's best friend. And a more reliable, long-lasting companion—fully compatible with all popular software, and equipped with a Lifetime Guarantee.

Equipped, too, with other advantages exclusive to all Logitech mice: A unique lightweight ergonomic design. Low-angled buttons for maximum comfort and minimum fatigue. An exclusive technology that guarantees a much greater life span. An exceptionally smooth-moving, dirt-resistant roller ball. And natural compatibility with all PCs, look-a-likes, and virtually any software.

So if you've got your eyes on a high-res screen, get your hands on the one mouse that's agile enough to keep up with it.

The LOGITECH HiREZ Mouse.

For the dealer nearest you, call 800-231-7717 (800-552-8885 in California), or write Logitech, Inc., 6505 Kaiser Drive, Fremont, CA 94555. In Europe, call or write: Logitech Switzerland, European Headquarters, CH-1111 Romanel/Morges, Switzerland (+41-21-869-9656).

 LOGITECH

Circle 150 on Reader Service Card (Dealers: 151)

Introducing
the most
agile mouse
ever to set foot
on a desktop.

How to pick th



Though most mice out there look pretty much alike, they're not all equal in performance. It pays to be just a little choosy to make sure you end up with the right mouse for your needs.

Starting with software. If you want full compatibility with all of your software, all you have to do is look for a mouse with the Logitech name. There are four in all, each one designed for different hardware needs.

THE HiREZ MOUSE

If you've got your eyes on a high-resolution screen, the mouse to get your hand on is the new LOGITECH HiREZ Mouse.

With a resolution of 320 dots-per-inch (as compared with 200 dpi or less for ordinary mice), it covers the same area on your high-res screen but needs less of your desk to do it. More than 50% less. Saving you valuable desk space, and



The LOGITECH HiREZ Mouse needs 50% less desk space to cover the same amount of screen area as a 200 dpi mouse.



Good instincts run in this family (left to right): the new LOGITECH HiREZ Mouse (\$179), the only mouse designed expressly for high-res screens; the LOGITECH Series 2 Mouse for the IBM PS/2 (\$99, plugs right into mouse port); and the LOGITECH Mouse for standard screens (\$119, in bus and serial versions).

All come with Logitech's own Plus Software, which assures ease of use with virtually any software, mouse-based or not.

effort: mouse maneuvers that used to require sweeps of the hand are now reduced to a flick of the wrist.

Which makes this new mouse a hand's best friend. And a more reliable, long-lasting companion. And, like all Logitech mice, it's fully compatible with all popular software, and equipped with a Lifetime Guarantee.

THE SERIES 2 MOUSE

For those who've chosen the Personal System/2,[™] the most logical choice is the LOGITECH Series 2 Mouse. It's 100% compatible with PS/2, and plugs right into the mouse port, leaving the serial port free to accommodate other peripherals.

e right mouse.

THE ALL-PURPOSE MOUSE: SERIAL OR BUS

Most people find our standard mouse is still the best choice for their systems. It's available in both bus and serial versions, one of which is sure to fit perfectly with your hardware. And with all your favorite software—whether mouse-based or not.

It's hardly an accident that only Logitech offers you such a complete selection—we're the only mouse company to design and manufacture our own products. We make more mice, in fact, than anyone else. Including custom-designed models for OEMs like AT&T, DEC, and Hewlett-Packard.

The three mice pictured to the left come with all this expertise built right in. Which explains an interesting paradox: while you may pay less for a Logitech mouse, you'll surely get more in performance.

And in comfort. With a unique lightweight ergonomic design. Low-angled buttons for maximum comfort and minimum fatigue. An exclusive technology that guarantees a much greater life span. An exceptionally smooth-moving, dirt-resistant roller ball. And natural compatibility with all PCs, look-a-likes, and virtually any software.

All of which leads to an inescapable conclusion: if you want to end up with the right mouse, start with the right mouse company.

Logitech. We've got a mouse for whatever the task at hand.

For the dealer nearest you, call 800-231-7717

Circle 152 on Reader Service Card (Dealers: 153)



A Logitech mouse plus Logitech application software equals a complete solution (all prices include mouse, Plus Software, and application):

LOGICADD...\$189. Turns your PC into a full-featured CADD workstation. Everything you need for dimensioned line drawing and CADD.

PUBLISHER PACKAGE...\$179. PUBLISHER software lets beginners and experts alike produce professional, high-impact documents. Design templates make page layout easy.

LOGIPAIN SET...\$149. Eleven type fonts and a 16-color palette. Creates files that move easily into both LOGICADD and PUBLISHER documents.

(800-552-8885 in California). Or fill out and mail the coupon below to: Logitech, Inc., 6505 Kaiser Drive, Fremont, CA 94555. In Europe, call or write: Logitech Switzerland, European Headquarters, CH-1111 Romanel/Morges, Switzerland (+ +41-21-869-9656).



Logitech, Inc., 6505 Kaiser Drive, Fremont, CA 94555.
Logitech Switzerland, European Headquarters,
CH-1111 Romanel/Morges, Switzerland.

Yes! Please send me the name of the nearest Logitech dealer.

Name _____

Company/Title _____

Address _____

Phone _____



LOGITECH

Personal System/2 is a trademark of International Business Machines, Corporation.

APRIL 1988 • B Y T E 83

A Schematic Design Program for \$395

CapFast CF1000 from Phase Three Logic designs printed-circuit boards and programmable-logic-device applications. The EGA-compatible program includes a schematic editor, symbol editor, symbol library, netlist extractors, a parts-list program, and a plotting utility. The symbol library has over 2000 parts in IEEE and ANSI formats.

Phase Three Logic calls it an entry-level program, but it offers unlimited design levels with multiple-page schematic editing at any level, comprehensive symbol-attribute handling, on-line electrical-rules checking, scalable vector text, split-screen capability, dynamic panning, and keyboard macros. In addition, with its ASCII database, you can integrate files with other applications.

CF1000 runs on the IBM PC AT and PS/2s.

Price: \$395.

Contact: Phase Three Logic Inc., P.O. Box 985, Hillsboro, OR 97123, (503) 640-2422.

Inquiry 785.

Application Design and Modeling Program

PC-Proto II lets you build and change system models and create reports that can become the basis for specifications. The program takes the completed model and extracts the design details, cross-references, source code, views for data modeling, and a data dictionary.

System models are built from subsystems linked by a main menu and submenus. You can invoke and test each subsystem as a stand-alone system model.

You can demonstrate the model without the data files, and the program also supports sequential and keyed file

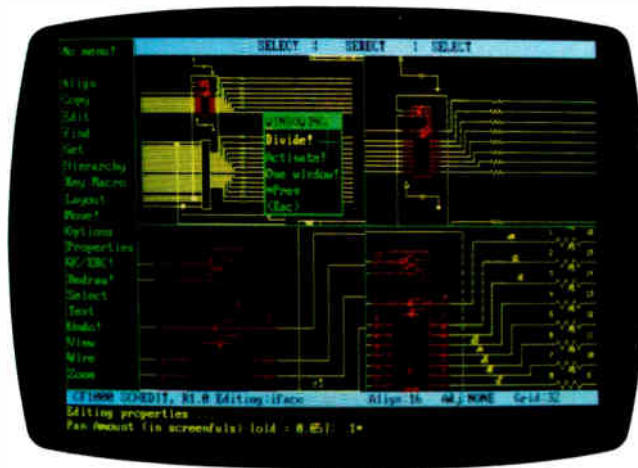

Entry-level schematic design with CF1000.

processing. PC-Proto II supports file inquiry and updates (insert, replace, and delete).

The program includes a screen painter that supports Windows and fill screens, alpha and numeric editing, range checking, variable names, and date and time functions. The program's database manager supports hierarchical and relational databases. A report writer enables you to print reports in external index sequence and to send reports to the printer.

PC-Proto II runs on the IBM PC, XT, AT, and compatibles with 640K bytes of RAM, DOS 2.0 or higher, and two floppy drives or a hard disk drive.

Price: \$1000.

Contact: Kartech Data Services Inc., 165 Pinewood Ave., Toronto, Ontario M6C 2V6, Canada, (416) 656-2032.

Inquiry 786.

Acquire and Control Data with LabLog

LabLog works with the Industrial Computer Source ML-16, an analog and digital I/O card. You can define data-acquisition and control parameters by selecting from a menu. One selection presents a real-time trend line of up to three channels with an animated bar graph of one selected point. Another display

code provides four bar graphs for individual points. When channels are displayed, you can send data to disk or to a printer in either ASCII, binary, or a Lotus 1-2-3-compatible format.

According to Industrial Computer Source, the board that LabLog works with offers 16 single-ended or 8 differential inputs multiplexing into a 10-microsecond, 8-bit A/D converter. It offers two 8-bit analog output channels and eight digital I/O channels. An optional screw termination board and interconnect cable are available.

The software runs on the IBM PC, XT, AT, and compatibles with at least 256K bytes of RAM and a graphics adapter.

Price: \$100 (includes source code); ML-16 I/O card, \$289; termination board and cable, \$99.

Contact: Industrial Computer Source, 5466 Complex St., Suite 208, San Diego, CA 92123, (619) 279-0084.

Inquiry 787.

Filtering Data

HEM Data Corp. added a digital filtering program to its series of data-acquisition, storage, analysis, decision-making, and filtering

software, which includes Snapshot Storage Scope and Snap-Calc.

Snap-Filter offers low-pass, high-pass, band-pass, and band-reject filters. You can specify them as FIR (finite impulse response) filters that produce a linear-phase response, thereby preserving the time relationship of different signal components. Or you can specify them as IRRs (infinite impulse response filters), which emulate common analog filters such as Butterworth and Chebyshev, according to HEM. You can also specify low-pass filters as Hanning moving-average-type filters to smooth data.

To run Snap-Filter, you need an IBM PC, XT, AT, or compatible with at least 256K bytes of RAM.

Price: \$395 for Snap-Filter (for current users of Snap-Calc); \$1185 for entire series.

Contact: HEM Data Corp., 17025 Crescent Dr., Southfield, MI 48076, (313) 559-5607.

Inquiry 788.

Spectrometer Reading

Interactive Microware's Spectrochart-PC works with IMI's Adlab-PC data-acquisition board in recording and analyzing voltage signals from the recorder output of any spectrometer. A method file controls data acquisition and the analysis according to your protocols. You can also analyze ASCII data files from any source. And you can send data and results as ASCII files for use with other programs.

Spectrochart runs on IBM PS/2s.

Price: \$595.

Contact: Interactive Microware Inc., P.O. Box 139, State College, PA 16804, (814) 238-8294.

Inquiry 789.

continued

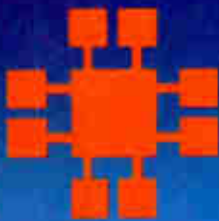

JDR INSTRUMENTS™

Complete customer satisfaction... superior service... friendly, knowledgeable personnel... quality merchandise... providing the best values in leading edge technology.

FULLY OVERLOAD PROTECTED

TRANSISTOR TESTER

9 FUNCTIONS
34 RANGES

CONDUCTANCE TESTER ADDS VERSATILITY

TEMPERATURE TESTER TO 2000° F



Our DMM-300
A remarkable value!

79.95

This full function 3.5 digit DMM offers highly accurate performance and a host of added features to help you do the job—fast. Capacitance, transistor, temperature, conductance and audible continuity in addition to the ranges you'd expect from a DMM of this quality. Temperature probe, test leads and battery included. Input impedance: 10M ohm. Basic DC accuracy: plus/minus 0.25%. Approx. 7" x 3 1/2" x 1 3/4" Wt. 13 1/2 ozs.

DC VOLTAGE TO 1000 VOLTS

AC/DC CURRENT 200µA TO 10A

CAPACITANCE TESTER 2000pF to 20µF

DPM-1000

\$54.95

3.5 DIGIT PROBE TYPE DMM

Custom 80 pin LSI chip provides accuracy and reliability in such a compact size. Autoranging, audible continuity and data hold feature help you pinpoint the problem quickly. Case and batteries included.

- * Basic DC accuracy: plus/minus 1%
- * DC voltage: 2v-500v, autoranging
- * AC voltage: 2v-500v, 2M ranges
- * Resistance: 2k ohms-2M ohms, autoranging
- * Fully over-load protected
- * Input impedance: 11M ohm
- * Approx. 6 1/2" x 1" x 3/4" Under 3 ozs.



- ★ **2 YEAR REPLACEMENT WARRANTY**
- ★ **30 DAY MONEY BACK GUARANTEE**
- ★ **TOLL FREE TECHNICAL SUPPORT**
- ★ **NEXT DAY AIR SHIP AVAILABLE**

MODEL 2000 **\$389.95**

20 MHz DUAL TRACE OSCILLOSCOPE

Model 2000 makes frequency calculation and phase measurement quick and easy. The component tester aids in fast troubleshooting. Service technicians appreciate the TV Sync circuits for viewing TV-V and TV-H and accurate synchronization of the video signal. Blanking, VITS, and W/H sync pulses.

- * Exceptionally bright 5" CRT
- * Built-in component tester
- * TV Sync filter
- * X-Y operation * 110/220 volts



MODEL 3500 **\$499.95**

35 MHz DUAL TRACE OSCILLOSCOPE

Wide bandwidth and exceptional 1mV/DIV sensitivity make the Model 3500 a powerful diagnostic tool for engineers or technicians at a remarkable price. Delayed triggering allows any portion of a waveform to be isolated and expanded for closer inspection. Variable Holdoff allows stable viewing of complex waveforms.

- * Exceptionally bright 5" CRT
- * Delayed and single sweep modes
- * Z axis intensity modulation
- * X-Y operation * TV sync filter
- * Fast 10ns rise time



DMM-200

\$49.95

3.5 DIGIT FULL FUNCTION DMM

Get highly accurate performance at a very affordable price. Rugged construction, 20 amp current capability and 22 ranges make it a perfect choice for various field or bench work. Lo battery indicator and tilt-stand. Probes and 2000 hour battery included.

- * Basic DC accuracy: plus or minus 0.25%
- * DC voltage: 200mv-1000V, 5 ranges
- * AC voltage: 200mv-750V, 5 ranges
- * Resistance: 200 ohms-20M ohms, 6 ranges
- * AC DC current: 200µA-20A, 6 ranges
- * Input impedance: 10M ohm
- * Fully overload protected
- * Approx. 7" x 3 1/2" x 1 1/2" Wt. 11 ozs.

DMM-100

\$29.95

3.5 DIGIT POCKET SIZE DMM

Perfect for the field service technician. Shirt pocket size without compromising features or accuracy. Large, easy to read 1/2" LCD display. Fully overload protected for safety. 2000 hour battery life with standard 9v cell. Probes and battery included.

- * Basic DC accuracy: plus/minus 0.5%
- * DC voltage: 2v-1000v, 4 ranges
- * AC voltage: 200v-750v, 2 ranges
- * Resistance: 2k ohms-2M ohms, 4 ranges
- * DC current: 2mA-2A, 4 ranges
- * Input impedance: 10M ohm
- * Fully overload protected
- * Approx. 5" x 3" x 1". Under 7 ozs.



JDR INSTRUMENTS, 110 KNOWLES DRIVE, LOS GATOS, CA 95030
RETAIL STORE: 1256 SOUTH BASCOM AVE, SAN JOSE, CA (408) 947-8881

ORDER TOLL FREE 800-538-5000

COPYRIGHT 1987 JDR MICRODEVICES



Lotus Tunes Symphony and Jazz

Symphony, the integrated business program for the IBM PC, now includes word-processing enhancements, new spreadsheet and database features, and bundled add-ins.

Symphony 2.0's new word-processing features include automatic word wrap and paragraph reformatting; accelerator keys for editing tasks such as deleting, inserting, and moving blocks of text; and a store-and-paste facility that restores text if accidentally erased.

The spreadsheet in version 2.0 recalculates only cells affected by changes to the worksheet. The database management forms in version 2.0 support up to 256 fields.

Bundled add-ins include Symphony Text Outliner, Symphony Spelling Checker, a network file-locking utility, and a VT-100 terminal emulator.

Symphony 2.0 is not copy-protected and runs on the IBM PC with at least 384K bytes of RAM (512K bytes is necessary to run the spelling checker and other add-ins). The program is available on 3½- and 5¼-inch disks and runs on PS/2 Models 30, 50, and 60 with DOS 3.3.

On the Macintosh front, Lotus is planning the release of

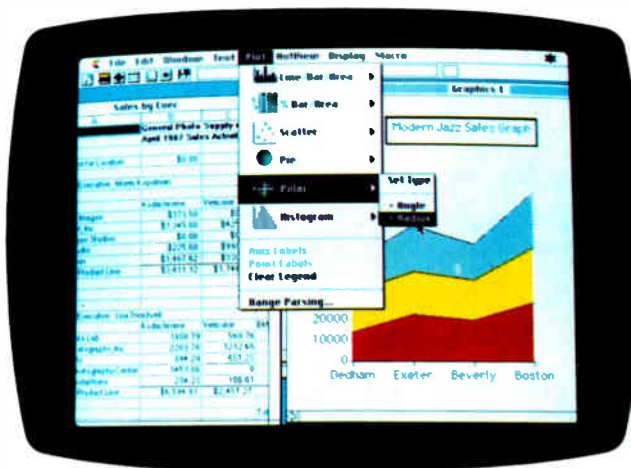

Lotus announces Modern Jazz.

Modern Jazz, an update of the Macintosh business package. The worksheet, graphics, database, word-processing, and communications capabilities are upgraded, and additions include a command language, macros, and a new forms function. In addition, Modern Jazz supports the 68020 math coprocessor, 68881 floating-point coprocessor, and SANE, Apple's numeric package.

The Jazz function HotView is expanded in Modern Jazz. It provides dynamic data integration between worksheets, graphs, databases, forms, and word-processing documents.

The Modern Jazz command language is a library of

more than 200 macro commands.

Other benefits of Modern Jazz include the ability to address all available RAM and to share information with IBM PCs as it reads and writes Lotus 1-2-3, Symphony, Microsoft SYLK, and ASCII files.

Modern Jazz runs on the Mac Plus, SE, or II. An 800K-byte floppy disk drive and a hard disk drive are recommended.

Price: Symphony 2.0, \$695;

Modern Jazz, \$395.

Contact: Lotus Development Corp., 55 Cambridge Parkway, Cambridge, MA 02142, (617) 577-8500.

Inquiry 790.

WORDPERFECT FOR THE MAC

WordPerfect Corp.'s Macintosh word processor takes full advantage of the mouse and Mac graphics interface. The Mac version of WordPerfect offers you all the keyboard functions of the IBM version, and you can access them from the keyboard or from pull-down menus. Keystroke equivalents appear on-screen beside menu options to simplify keyboard access.

Enhancements to the Mac version include the ability to

reconfigure the program without exiting. You can read in and edit graphics images and preview printed output on the screen. Unlike the IBM edition, you can see all fonts and other graphics-based text enhancements directly on the screen. Text appears in all fonts, sizes, and styles that the Mac supports. You can also have an unlimited number of documents open at any one time. You can also read in WordPerfect files from Apple II, Amiga, Atari, IBM, VAX,

and Data General machines.

Other features include a 115,000-word spelling checker, the ability to have up to 24 columns, automatic text formatting and table-of-contents creation, and a macro capability. Thesaurus and merge facilities are also standard WordPerfect features.

Price: \$395.

Contact: WordPerfect Corp., 288 West Center St., Orem, UT 84057, (801) 225-5000.

Inquiry 792.

WYSIWYG Spreadsheet

Innovative Software calls Wingz the first WYSIWYG integrated spreadsheet. It lets you generate numbers, text, charts, and graphs, and lay them out on a page.

The spreadsheet features 32,768 rows by 32,768 columns and offers over 180 functions for business, scientific, financial, and general applications.

The program has 21 chart types, a choice of 256 colors from a palette of 16 million, and three-dimensional rotation of images. You can pop up a graph by defining a block of numbers in the spreadsheet, and define the area where you want to place the graph. You can mix graph types, add text with the word processor, or use images you've scanned into the Mac. Innovative Software reports that Wingz has three times as many basic graph types as Excel.

Wingz lets you use any type font, style, or size in a single cell. You can have as many as 256 custom style sheets attached to any one spreadsheet.

Wingz also has its own programming language called Hypersheet that lets you create any number of new applications as you need them. It offers an unlimited array of colors and type styles.

The program reads and writes in WKS, WK1, SYLK, DIF, ASCII text, and SMART formats.

To run Wingz, you need a Mac Plus, II, or SE. It makes full use of color displays on the Mac II. PostScript drivers will be incorporated into the final release of the program, scheduled for the second quarter of this year, according to Innovative Software.

Price: Between \$395 and \$495.

Contact: Innovative Software Inc., 9875 Widmer Rd., Lenexa, KS 66215, (913) 492-3800.

Inquiry 791.

continued



Perfect matches to DEC user needs. Hip. Hip. And Hooray.

One-size-fits-all is an attribute best reserved for inexpensive socks. In the realm of PC-based emulation and communications software for DEC mainframe users, it's important to match specific user needs with specific product attributes. We have.

SmartTerm® 240 features exact four-color emulation of a DEC® VT241 terminal. Along with delivering full-screen ReGIS® and Tektronix® 4010/4014 graphics, SmartTerm 240 offers precise VT220, VT102, VT100, and VT52 text emulation.

For non-graphics applications, SmartTerm® 220 duplicates virtually every SmartTerm 240 text, communication, and ease-of-use feature. Three error-free file transfer protocols, including Kermit and Xmodem, are provided. Downloading minimizes on-line time requirements to boost overall system efficiency. And an optional network package allows direct LAN access to shared modems, printers, as well as host mainframes.

As SmartTerm 240 and 220 focus on graphics and text, new SmartMOVE® makes PC-to-the-rest-of-the-World communications sharper than ever. Speed connect, auto redial, and background file transfer features make this VT100 emulator a loud and clear choice for advanced communications requirements.

Graphics, text, and communications. If you're looking for a perfect fit, seek the software sized and priced to match your needs. Persoft has it. Period.

See us at COMDEX/Atlanta-East Hall 352,
visit your dealer, or phone us at 608 273-6000.

© 1987 Persoft, Inc. All rights reserved. Persoft, SmartTerm and SmartMOVE are registered trademarks of Persoft, Inc. DEC, VT and ReGIS are trademarks of Digital Equipment Corporation. Tektronix is a registered trademark of Tektronix, Inc.

persoft®

Circle 50 on Reader Service Card

World Radio History

Replacing COMMAND.COM

Command Plus 2.0 replaces the COMMAND.COM in DOS 2.0 and higher. The new version includes enhanced DIR, COPY, and DEL, as well as a block-structured language that has a Pascal-like syntax.

Command Plus 2.0 is compatible with 3Com and Novell networks. It runs on the IBM PC, XT, AT, and compatibles with DOS 2.0 or higher, two floppy disk drives, and 50K bytes of RAM. It also runs on PS/2s.

Price: \$79.95.

Contact: ESP Software Systems Inc., 11965 Venice Blvd., Suite 309, Los Angeles, CA 90066, (800) 992-4377; in California, (213) 390-7408. **Inquiry 793.**

A Collage of Desktop Publishing Utilities

Innner Media's four utilities, combined in one program called Collage, let you connect a variety of applications in

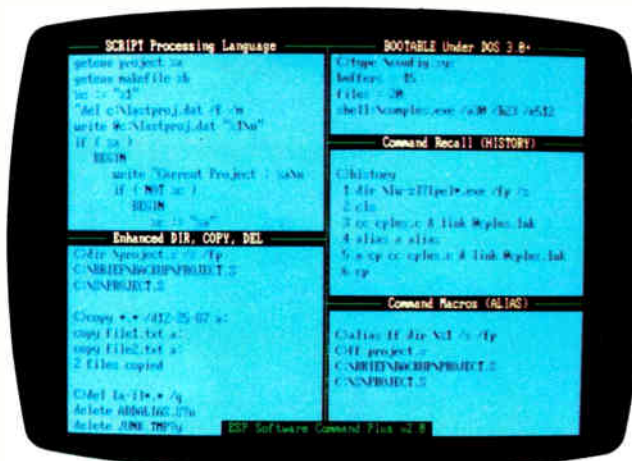

Command Plus 2.0 features a block-structured language.

a PC-based desktop-publishing environment.

Snap is a memory-resident utility that can save screens to graphics or text files without leaving the application you are in. If you save a screen to a graphics file, you can paste it into documents. If you save it to a text file, you can view or edit the screen using most standard text editors. The Snap graphics format (PCX) is compatible with PC Paintbrush and Publisher's Paintbrush.

You can also use Snap with Windows and GEM applications, AutoCAD, Lotus 1-2-3, Framework, and other environments.

The Show utility displays PCX files in color so you can view one or more graphics screens that you saved with Snap or other graphics programs.

Smooth is a file-reading tool that scrolls text forward and backward.

The MultiLine utility lets

you select the number of lines of text you want displayed. When using an EGA or compatible display adapter, you can choose from 16, 25, 35, 43, or 50 lines per screen; using a VGA adapter or a PS/2 system, you can choose from 16, 25, 36, 44, or 50 lines per screen.

Collage runs on the IBM PC, XT, AT, and compatibles with at least 256K bytes of RAM, an EGA or VGA, and DOS 2.0 or higher. It also runs on PS/2s. Inner Media recommends 640K bytes of RAM and a hard disk drive. **Price:** \$89.95.

Contact: Inner Media Inc., 60 Plain Rd., Hollis, NH 03049, (603) 465-3216. **Inquiry 794.**

See the Music

As you play notes on a MIDI keyboard, Coda's program Finale automatically transcribes them to the screen or printer in standard notation. Coda says that built-in transcription and notation intelligence let you manipulate music data. You can play in any tempo, and the program uses a proprietary "time tagging" method to print notes in the proper time signature and cleft.

Finale handles complex time signatures and binding of lyric syllables to notes, according to Coda. It also features automatic placement of hyphens, knowledge of triplets and tuplets, reverse stemming, cross-staff stemming and beaming, angled beaming, and custom stemming and beaming.

The program runs on the Mac and the IBM PC, XT, AT, and compatibles with at least 1 megabyte of RAM.

Price: \$795. **Contact:** Coda Music Software, 1401 East 79th St., Bloomington, MN 55420, (612) 854-1288. **Inquiry 795.**

COMPUTERIZED DARKROOM FOR THE MAC

Silicon Beach reports that Digital Darkroom is the first program that converts bit-mapped images to object-oriented graphics on the Mac, and the first instance of gray-scale bit maps being converted to objects on any personal computer.

The program has image-enhancement features that let you adjust the brightness and contrast with slider controls. You can pass the image through filters that blur, sharpen, remove noise, and enhance edges. You can bring in bit-mapped images from paint programs or scanners and use Auto-Trace to convert them into draw-based objects. The objects you convert the images to, including Bézier curve

information, can be manipulated in draw programs.

You can remap gray values to produce special effects such as posterizing, equalizing, and inverting. You can get more precise effects by manipulating gray values within a graph or a dialog box.

Tools such as the Magic Wand let you select a region according to the gray value by pointing and clicking. You can use the scissors tools for clipping and deleting portions of active selections. You can paste selections in front of an existing image, blend with it, or paste behind it.

Digital Darkroom imports and exports files in PICT, PICT-2, TIFF, Mac-

paint, SuperPaint, and ThunderScan formats. You can also export in the EPS or Adobe Illustrator file format. The program converts 1-bit-deep black-and-white Paint files or multiple-bit gray-scale TIFF files to 7-bit gray-scale images. You can also print halftones on PostScript printers by specifying screen angles, resolution, and screen patterns.

The program runs on the Mac 512, Plus, SE, or II. A Mac II is recommended for gray-scale viewing.

Price: \$295. **Contact:** Silicon Beach Software, 9770 Carroll Center Rd., Suite J, P.O. Box 261430, San Diego, CA 92126, (619) 695-6956. **Inquiry 796.**

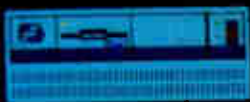

16 color VGA Support



Dual Brush Modes



Smooth Command

EGA PAINT 2005



Airbrush Command



Grid Command

Additional Features

ENGLISH SPEAKING (NO ICONS)

FULL-SCREEN EDITING

DYNAMIC ZOOM (4X or 8X magnification)

EXTENSIVE AIRBRUSH CONTROLS

SMALL COMMAND (reduces files 50 to 90%)

AUTOMATIC PAN (page mode)

AUTOMATIC COLOR SMOOTHER MODE

SOPHISTICATED SLIDE SHOW (w/dissolve-maker)

XLATE UTILITY (translate between resolutions)

34 FONTS (with over 25 control combinations)



360° Rotate Command

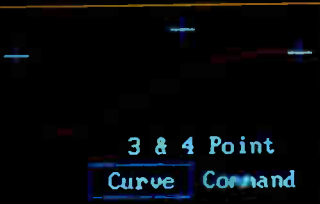

3 & 4 Point Curve Command

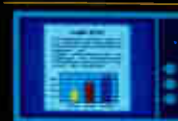

FullPage Printing

Screen Pan



Capture almost any screen



PC QuikArt Support

One Picture Is Worth A Thousand Words!

Step up to state-of-the-art in EGA graphics generation technology. Our 2005 version is not just another paint program or another version of the "same old thing." EGA PAINT 2005 is a complete restructuring of our 2001 program (itself the recipient of the PC TECH JOURNAL award for excellence in program design). We believe the end-user comes first and instead of merely patching on more features (as all the others do) we went to a whole new (much easier and faster) way to create truly startling business presentations & EGA color illustrations. Take another look at some of our features (some of which are available only on programs costing hundreds more) and decide for yourself.

Also available from RIX:

EGA SCREEN ENHANCER

This easy to install device enables older EGA cards to utilize EGA PAINT 2005 in 640x480 & 752x410 resolution modes. Our ESE comes complete with a special test pattern diskette for only \$49.95 (+ \$5.00 for shipping and handling).

All this and more for just:

\$99.00

ORDER NOW!

in CA - (800) 233-5983 out CA (800) 345-9059



RIX SoftWorks, Inc.

18552 MacArthur Bl. Suite 375, Irvine, CA 92715

REGIONAL SECTION

METRO NEW YORK • NEW ENGLAND

Canon's 300-dpi Scanner

You can insert text, graphs, drawings, maps, and pictures directly into an IBM PC AT or compatible using the IX-12F scanner. It enables you to transfer images from books or continuously from sheets.

The IX-12F provides a resolution of 300 dots per inch and scans a page in 16 seconds.

The scanner measures 14½ by 21½ by 3½ inches and includes a board to connect to an IBM PC AT or compatible.

Price: \$1495; automatic document feeder, \$595.

Contact: Canon U.S.A. Inc., Systems Division, One Canon Plaza, Lake Success, NY 11042, (516) 488-6700. **Inquiry 830.**

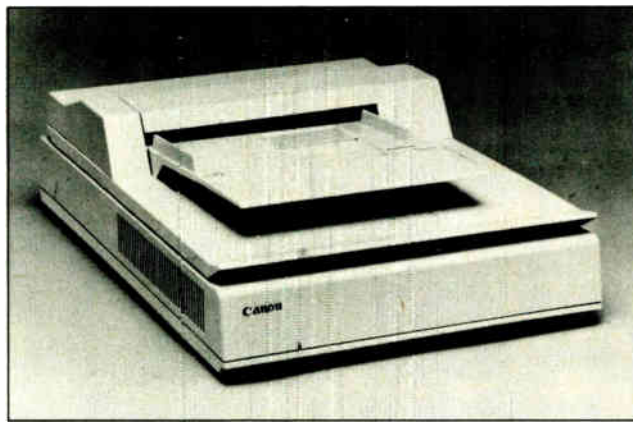

The IX-12F scans a page in 16 seconds.

C'est Un Word Processor

Combining word-processing capabilities with French-language reference materials, système-D is de-

signed for beginning and intermediate French students. The program enables you to look up vocabulary, check usage, refer to grammar notes, and view expanded verb conjugations.

The program provides a 4350-word French-English dictionary, with 2300 French entries supplemented by sentences and notes on usage. About 700 verbs are included in the dictionary; you can view a summary table of 13 verb tenses conjugated in all persons, in negative and affirmative, and in the reflexive when applicable.

To run système-D, you need an IBM PC XT, AT, or compatible with 512K bytes of RAM and 3 megabytes of free hard disk space. It also runs on IBM PS/2s.

Price: \$150.

Contact: Heinle & Heinle Publishers Inc., 20 Park Plaza, Boston, MA 02116, (800) 237-0053; in Massachusetts, (617) 451-1940. **Inquiry 831.**

continued

ORIGINAL KEN GORDON PRODUCTIONS - OUR 9TH YEAR!

**COMPUTER SHOWS
SALES & FLEAMARKETS**



HARDWARE - SOFTWARE - SUPPLIES - ACCESSORIES - PARTS - BOOKS
NEW - USED - SURPLUS - CLOSEOUTS - LIQUIDATIONS - SAVE 20-80%
IBM CLONES - MONITORS - PRINTERS - PUBLIC DOMAIN SOFTWARE

April 10
Sunday 10 to 4

NORTH JERSEY MICRO SHOW & FLEAMARKET - Parsippany, NJ - 300 Tables
Aspen Manor - Rte. 46 Westbound - Near INTERSTATE 80, 280 & 287

April 16
Saturday 10 to 4

BOSTON (WOBURN) MICRO SHOW & FLEAMARKET - Woburn, Mass. - 400 Tables
Northeast Trade Center - I-95 (Rte. 128) Exit #35 - Next to Zayre's Shopping Ctr.

May 14
Saturday 10 to 4

BOSTON (MARLBOROUGH) MICRO SHOW & FLEAMARKET - 350 Vendor Tables
Royal Plaza Trade Ctr./Hotel - INT 495 Exit #24-B in Marlborough, Mass.

June 4
Saturday 9 to 4
BIG SHOW!!!

NORTH JERSEY MICRO SHOW & OUTDOOR FLEAMARKET - 700 VENDORS
William Paterson College - Rec. Center - Wayne, New Jersey - off Rte. 23, 46, 80
300 Outdoor Spots (\$25 each) plus 400 Indoor Tables (\$70) Each

SAVE \$1.00 PER ADULT ON ADMISSION / BRING THIS AD

VENDOR TABLES \$70.00 IN ADVANCE - FOR ADDITIONAL INFORMATION OR DIRECTIONS
CALL (201) 297-2526 OR OUTSIDE NEW JERSEY CALL TOLL FREE (800) 631-0062

BYTE 4/88

LARGEST STOCKED EAST COAST DISTRIBUTOR/DEALER

FULL BOARD LEVEL SERVICE AND REPAIR FACILITY



\$1699
PLUS FREE TONER



The original LaserJet printer is now better than ever! Introducing LaserJet Series II.

LaserJet Series II, the second generation of the world's most popular laser printer, is waiting for you at your local Hewlett-Packard dealer.

Exciting new features make LaserJet Series II the best value in desktop laser printing today.

If you're thinking about stepping up to laser printing, you definitely need to see the remarkable LaserJet Series II printer from HP.



**Super 16T
A Strong Starter**

The Hyundai Super 16-T gives you a head start in MS-DOS computing—with fast, powerful PC performance, and all the features you need to get up and running. The Super-16T even includes Electric Desk, Spellchecker, and Keyworks... all the integrated software you need to get started.

Like the rest of Hyundai's new PC line, the Super-16T comes with an 18-month warranty, plus service and support from a hand-picked nationwide dealer network. And they're backed by one of the world's largest manufacturing organizations—\$14 billion Hyundai corporation.

- ▶ 8088-II microprocessor, keyboard switchable from 4.7 to 8MHz for compatibility and faster performance.
- ▶ 640KB memory on the system board—the Super-16T can run today's biggest application programs.
- ▶ Built-in serial and parallel ports for connection to printers, modems, more.
- ▶ Multi-video display adaptor works with composite monochrome or color graphics (CGA) monitors.
- ▶ Your choice of storage options from one 360KB, 5.25" floppy disk drive to a big 30MB hard disk drive.



**ALSO AVAILABLE
286C
FROM \$1199**

CALL & ORDER NOW
Board Level
Service Facility
1-800-447-1176
NATIONAL WATTS
1-800-553-1176
MASS WATTS

APPLIED • PROGRESSIVE • ELECTRONICS • INC
204 South West Out Ct. Route 20, Northboro, MA 01532
(617) 393-7220 • 1-800-553-1176 (MASS)
1-800-447-1176 (NAT.) • (617) 393-3124 (FAX)
PRICES SUBJECT TO CHANGE WITHOUT NOTICE
CALL & ORDER NOW

\$1699 (List \$2595)
with **FREE**
Additional Toner
Cartridge

**IN STOCK DESKJET
\$745**

Lay Away Available

Ordering Information: We ship anywhere in the continental United States via UPS. Prices are subject to change without notice. We accept VISA, MasterCard, personal and company checks and money orders.

All returns must have prior authorization from our customer service department within 7 days of receipt. All returns must be in like-new condition, complete and in original packaging. Incomplete merchandise will not be accepted for return. Returned products are subject to a 20% restocking fee (\$80 maximum). Defective products will be repaired or replaced at APE's discretion. We do not guarantee compatibility. Not responsible for typographical errors.

HYUNDAI PCs
HIGH POWER, LOW PRICE

\$699
WHILE STOCK LASTS

SAME INCREDIBLY LOW PRICING ON ALL PRODUCTS

QuickBASIC Graphics Routines

Geograf Personal Edition is a programming library that provides 22 QuickBASIC graphics subroutines that help you create graphs and charts. You can produce real-time plots on a screen, a dot-matrix printer, a laser printer, or a plotter, and you can store plot commands in a disk file.

Geograf enables you to implement WYSIWYG (what you see is what you get) screen output. Other functions allow you to draw an axis at any angle, scale the axis, add values, label the axis, and center the title. You can also position alphanumeric characters of any size at various angles and locations.

The Personal Edition of Geograf runs on the IBM PC and compatibles with QuickBASIC. **Price:** \$99.

Contact: Geocomp Corp., 342 Sudbury Rd., Concord, MA 01742, (800) 822-2669; in Massachusetts, (617) 369-8304. **Inquiry 832.**

The Curator Gets the Picture

Solutions Inc.'s new Macintosh program, The Curator, assists you in locating graphics and integrating them into documents utilizing different formats. It supports TIFF, Glue, PICT, PostScript, MacPaint, and encapsulated PostScript formats.

The Curator is both a program and a desk accessory. You can search for graphics using a pictorial table of contents that displays miniature representations of graphics. You can also locate graphics by name or keywords, and convert graphics from one format into another.

mat into another.

The Curator runs on the Mac and is compatible with both HFS and MultiFinder. It is not copy-protected. **Price:** \$139.95.

Contact: Solutions Inc., P.O. Box 989, Montpelier, VT 05602, (802) 229-9146. **Inquiry 833.**

Screen Sender: Don't Leave Your CPU Without It

Consisting of a transmitter and repeater, Screen Sender allows you to place your computer monitor up to 1000 feet away from your computer and connect multiple monitors to one microcomputer.

The transmitter and repeater connections each measure 3 by 6 by 2 inches, and are available separately or as a pair.

Price: \$249 each; \$495 for both.

Contact: Communications Specialties Inc., 6090 Jericho Turnpike, Commack, NY 11725, (516) 499-0907. **Inquiry 834.**

Turbo Shell: MYCIN-based Expert System

Written in Turbo Prolog, the Turbo Shell expert-system development environment is based on the MYCIN model. It lets you create, modify, and consult knowledge bases.

The program comes with source code and runs on the IBM PC and compatibles with 256K bytes of RAM.

Price: \$89. **Contact:** The Berkshire Software Co., 44 Madison St., Lynbrook, NY 11563, (516) 593-8019. **Inquiry 835.**

NeuralWare's Introduction to Neural Computing

FREE

For your free booklet, "Teaching Computers to Learn: Applications for Neural Computing" and for information on our neural computing products, send in this coupon.

Name _____
 Company _____
 Address _____
 City _____ State _____ Zip _____
 Phone _____

Teach your PC to learn with neural computing. Expert system generation, forecasting, noise filtering and process control are just a few of the many exciting and innovative applications for neural computing in industry.

Now you can learn more about neural computing, its history and its applications from the author of the *1987 Annotated Bibliography of Neuro-Computing* and the founder of the industry's largest selling neural computing software company, Casimir C. "Casey" Klimasauskas.

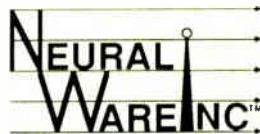

103 Buckskin Court
 Sewickley, PA 15143
 (412) 741-5959

YOUR NEW ENGLAND STORE FOR HIGH QUALITY DISCOUNTS

THE HIGHLY ACCLAIMED ALR 386 COMPUTERS

386/2 Computers

2nd Generation of Fast
Microcomputing • 16 and 20
MHz Versions • 2MB RAM •
Fast 40MB Drive • 1.2MB
Floppy • Serial/Parallel
1:1 Interleave • Floor Stand
\$3,590

INDTECH 12-Slot AT

Industrial Quality 286 Computer •
10MHz 0 Wait State • 640K RAM •
1.2MB Floppy • 40MB Hard Drive •
238W Power Supply • Serial/Parallel
• Monochrome card with H-res
monitor • Makes an excellent
low-cost filesaver
\$2,149



Many Configurations
Available

FlexCache 386 Computers

0 Wait State • 16 or 20MHz •
Uses 82385 Cache controller
and 35 ns Cache memory •
1MB RAM • 1:1 Interleave
controller • Minicomputer
power at PC prices
16MHz with 60MB drive: **\$3,999**
20MHz with 100MB drive: **\$5,499**

100% XT Computer

10MHz • 640K RAM • 360K
Floppy • 20MB Hard Drive •
Serial/Parallel/Clock/Game •
Hi-resolution monochrome
\$999

PRINTERS

Panasonic 1080i 144cps ... **\$199**
Panasonic 1091i 192cps ... **\$239**
Panasonic 1524 24-pin ... **\$645**
NEC P2200 24-pin ... **\$450**

MONITORS

Magnavox Multimode ... **\$569**
Thomson Ultrascan ... **\$469**
CTX EGA ... **\$399**
Thomson 14" Monochrome ... **\$99**

HARD DRIVES

Seagate 20MB Kit ... **\$319**
Seagate 30MB Kit ... **\$359**
Seagate 40MB 40ms ... **\$469**
Seagate 40MB 28ms ... **\$599**

MATH COPROCESSORS

8087-2 ... **\$160**
80287-8 ... **\$260**
80287-10 ... **\$310**
80387-16 ... **\$525**
80387-20 ... **\$900**

EXPANSION BOARDS

Everex Microenhancer EGA/VGA ... **\$159**
Sigma VGA Analog ... **\$399**
2MB Bocaram AT (w/0K RAM) ... **\$159**
Western Digital WD 1006-WAH ... **\$199**
AT 4 port serial card ... **\$129**

FLOPPY DRIVES

5¼" 360K ... **\$89**
5¼" 1.2MB ... **\$119**
3½" 720K ... **\$119**
3½" 1.44MB ... **\$159**

CLOSEOUT SOFTWARE SPECIALS!!

One FREE Program with this ad.
Five FREE Programs with every computer
purchase from this ad. Come and See!

*We stock and sell surge protectors,
cables, connectors, sheet feeders,
stands, switch, boxes, mouses,
joysticks, drives, expansion cards,
modems, and many other accessories.*

HORIZON SALES

59 Fountain St., Framingham, MA 01701

617-875-4433

A UNIQUE WAY TO UPGRADE YOUR COMPUTER

Without Changing Your DOS..!



ASTRO EXT-3.50" Internal and External drives just plug into your computer. Allows you transfer and access data files between 5.25" Desk Top computers and 3.50" Lap-tops, IBM PS/2s. Format, read and write 720Kb, 1.44Mb and all HP150 formats. Fully compatible with Sperry (UNISYS) computers. All external drives come with self-power supply.

ASTRO EXT-140LT 5.25" 360Kb External floppy drive fully compatible with the TANDY 1400LT computer.

ASTRO EXT-TOS31 & EXT-310LT-12 are External drives allows your Toshiba 3100/5100 read, write 3.50" 720Kb/1.44Mb and 5.25" 360Kb/1.2Mb formats. Available 5.25" 360K for Toshiba 1000, 1100+, 1200...



IBM PS/2 models 50/60/80, our ASTRO drives allows you to choose from 5.25" 360Kb/1.2Mb or 360Kb External drives and our drives will NOT take an I/O expansion slot.

Second or third 5.25" 360Kb external drive for PS/2 models 25 and 30 computers have one or two floppy diskette drives.

Contact your dealer or call us for more informations:

ASTRO SYSTEMS, INC. Phone: (408) 727-5599/727-7626 - Fax: (408) 727-8149
807 Aldo Avenue #106 - Santa Clara, CA 95054 (USA)

JUST ONE TOUCH

of an **echoBOX™**

smart keypad

operates ALL programs

in ANY application

• INCREASE PRODUCTIVITY • SLASH LEARNING TIME

SMART FOR PC USERS: The echoBOX keypad gives you instant, pushbutton operation of any PC program or PC function. Plugs into your keyboard line. Install in seconds, master in minutes. No software, no extra hardware. Store 24 sets of your keyboard keystrokes, program commands, or data for automatic input to your PC — just touch a key on your echoBOX!!

SMART FOR PC PROFESSIONALS: The echoBOX's user programmable keys work independently of the PC system. No software, not RAM resident, compatible with all programs. Non-volatile memory. Unlimited applications. NOT JUST ANOTHER KEYPAD!

For IBM PC, XT, AT, PS/2™ and compatibles
INFO / ORDER LINES 800-634-6692



1223 Peoples Ave. • Troy, NY 12180 • (518) 271-6692

Pat. Pend., © 1987 in:mar, inc. IBM, PC, XT, AT, PS/2 reg. TM IBM Corp. echoBOX, inmar TM inmar inc.

The Ultimate!



**EGA 286
386**

• IN PORTABILITY •



SYSTEM INCLUDES:

- 3.5" 720KB DRIVE
- 5.25" 1.2MB DRIVE
- 20MB HARD DISK
- 1200/300 INTERNAL MODEM
- PARALLEL/SERIAL/GAME PORT
- REAL TIME CLOCK/CALENDAR
- 9" EGA OR DUAL SYNC MONITOR
- MODIFIED 84 KEY AT-STYLE KEYBOARD
- RESET AND TURBO SWITCH
- KEYLOCK/DRIVE LED/POWER LED

- 80286-12 CPU Multi-Speed
- Runs at 6/8/10/12 MHz
- 640K Main Memory
- 80287 Math Co-Processor Socket
- 7 Full Expansion Slots
- OS/2 Compatible



- **WE PROVIDE COMPLETE SYSTEMS — NOT BARE BONES •**
- **SYSTEMS ARE READY TO GO — JUST PLUG IT IN.**

Choose From a Full Line of Systems...



FREE \$70.00 Nylon Carrying Case with Purchase

TRIDATA TURBO 8088 SYSTEMS

- 4.77/10 MHz 8088-1 CPU, keyboard or hardware selectable, math coprocessor socket
- 512K RAM on main board
- 8 Expansion slots
- AT style case with keylock, power on LED, turbo switch and LED
- 150W power supply (110/220 V)
- Enhanced AT style keyboard
- Multi I/O card includes 1 parallel port, 1 serial port (2nd serial port optional), 1 game port, 1 real time clock, calendar, battery backup, 2 floppy drive controller
- 2 hard drive controller
- 360KB DS/DD floppy drive
- 20 MB hard drive
- Monochrome Graphics Adapter (compatible with Hercules Graphics Adapter) with parallel port
- High resolution monochrome monitor
- Full IBM PC/XT compatibility
- 2.1 times faster than PC, XT

PRICE: \$1095.00

TRIDATA TURBO 286 SYSTEMS

- 6/10 MHz 80286-10 CPU, 0/1 wait state, keyboard or hardware selectable, math coprocessor socket, real time clock, calendar, battery backup
- 640K RAM on main board
- 8 Expansion slots, 6 16-bit, 2 8-bit slots
- AT style case with keylock, power on LED, turbo LED, reset button
- 200W power supply (110/220 V)
- Enhanced AT style keyboard
- Multi I/O card includes 1 parallel port, 1 serial port (2nd serial port optional), 1 game port
- 2 hard & 2 floppy drive controller
- 1.2 MB Hi-density floppy drive can format both 1.2MB & 360 KB floppies
- 40 MB Hi-speed hard drive
- Monochrome Graphics Adapter (compatible with Hercules Graphics Adapter) with parallel port
- 14" Flat Screen monochrome monitor
- Full IBM AT compatibility
- 7 times faster than PC, XT
- OS/2 Compatible when OS becomes available

PRICE: \$1890.00

TRIDATA 386 TURBO SYSTEMS

- 6/16 MHz 80386 CPU (20 MHz optional) keyboard or hardware selectable, 1 Wait State (0 wait optional), 80287 & 80387 math coprocessor socket, real time clock, calendar, battery backup, 2 serial, 1 parallel ports on main board, 16 interrupts, 7 DMA channels, support up to 16 MB with 32-bit wide memory bus
- 2 MB RAM memory board
- 8 Expansion slots, 2 32-bit, 4 16-bit, 2 8-bit slots
- AT style case with keylock, power on LED, turbo LED, reset button
- 200W power supply (110/220 V)
- Enhanced AT style keyboard
- 2 hard & 2 floppy drive controller
- 1.2 MB Hi-density floppy drive can format both 1.2MB & 360 KB floppies
- 40 MB Hi-speed hard drive
- Monochrome Graphics Adapter (compatible with Hercules Graphics Adapter) with parallel port
- 14" Flat Screen monochrome monitor
- Full IBM AT compatibility
- 9 times faster than PC, XT
- OS/2 Compatible when OS becomes available

PRICE: \$3295.00

SYSTEM OPTIONS

- 14" Color Monitor w/card 250.00
- EGA Monitor w/card 450.00
- Multisync EGA w/ATI card 650.00
- 1200/300 Internal w/software 85.00
- 2400/300 Internal w/software 165.00
- AT 80286-12MHz System 65.00
- 386-12MHz 0 Wait State CALL

- **YOUR ORDER SHIPPED WITHIN 24 HRS •**
- **ONE YEAR WARRANTY AND 24 HRS REPAIR SERVICE •**
- **MONEY BACK GUARANTEE* •**

**FOR YOUR
ORDER
CALL NOW
(617) 655-3434**

**DIGICOM
TECHNOLOGY CORPORATION**
220 W. Central St., Natick, MA 01760 • (617) 655-3434

Prices quoted are for cash.
We accept M/C and VISA
*Notice must be filed with us within 21 days of receipt
Prices, terms and conditions are subject to change w/o notice
Not responsible for typographical errors

PC/XT & AT are registered trademarks of International Business Machines. OS/2 is a registered trademark of Microsoft Corp.

Circle 455 on Reader Service Card

APRIL 1988 • B Y T E 88NE-11

Plug-In To Our Network And Receive A Free Issue Of...



If you're responsible for the use, planning, design and implementation of information networks...YOU should be connected to this magazine.

DATA COMMUNICATIONS is devoted 100% to reporting and exploring developments in digital communications. And it publishes more than half of all networking information printed in the USA!

In it you will find practical ideas to help you enhance productivity in your own environment, build more efficient systems, cut costs and avoid mistakes.

Each issue examines methodologies of computer applications...system design and optimization...message switching...integrated voice, data and video...diagnostics, error detection and testing...digitized voice...common carrier facilities...software and network design...and more.

But don't just take our word for it. Let us send you a free issue to read and evaluate. Simply complete and mail the postage-paid card adjacent to this page. We'll send you a copy of the current issue, along with our invoice for the term you select. If you like what you read, send us your payment. If not, just write "cancel" on the bill, return it, owe nothing and keep the free issue with our compliments.

So plug-in to our network now...and see for yourself why DATA COMMUNICATIONS is recognized as the world's leading networking magazine.



**Data
Communications**

SHORT TAKES

BYTE editors offer hands-on views of new products

Low-Cost Sharp Laptop Sprouts a Hard Disk

As goes the desktop, shortly follows the laptop. Hard disk drives, now de rigueur on desktop personal computers, are rapidly becoming required equipment on laptops. The new Sharp PC-4521 is evidence of this trend.

This new system is currently the high end of Sharp's low-priced crop of IBM-compatible laptops. The system is almost identical to Sharp's dual-floppy-disk-drive system, the PC-4502, but with a 20-megabyte hard disk drive in place of one of the older system's 720K-byte 3½-inch floppy disk drives. The new system also comes standard with more memory (640K bytes), is about 2 pounds heavier (12.4 pounds total), and has a shorter battery time (2 hours compared with 2½ hours on the older system). Naturally, the list price is also higher (\$2995).

All other features of the two systems are the same, including a high-contrast electroluminescent backlit liquid-crystal-display screen, a 7.16-MHz 80188-compatible processor, an 88-key keyboard with separate numeric keypad, a parallel printer port, one 720K-byte 3½-inch floppy disk drive, and a connector for an external 5¼-inch floppy disk drive. Unfortunately, neither system includes a serial port or an RGB connector, although both are available as options.

The 7.16-MHz 80188-compatible processor pushes the system at speeds about 50 percent faster than a standard 4.77-MHz IBM PC. In our Sieve test, the new system was 20 percent faster; in the Dhrystone test, the result was 59 percent faster. The best performance was in our floating-point test, where the new system was 73 percent faster.

The screen on the new system seems a little slow during fast scrolling, for example, during a directory listing. But the dark-blue-on-light-blue characters are easy on the eyes. The resolution is 640 by 200 pixels. The screen does not seem to be able to display shades of gray.

The keyboard differs slightly from a standard IBM PC keyboard. The function keys are arranged in two horizontal rows above the main keyboard. A numeric keypad (lacking the minus and plus keys) appears in the upper right. In addition, an inverted T of cursor keys has wedged itself into the lower right of the keyboard. Strangely, there are two pairs of Insert and Delete keys.



The Facts:

Sharp PC-4521
\$2995

Sharp Electronics Corp.
Sharp Plaza
Mahwah, NJ 07430
(201) 529-8731
Inquiry 859.

Options:

1200-bit-per-second internal modem, \$399; serial I/O card, \$99; expanded memory card (with 1 megabyte), \$599; RGB adapter, \$255.

Inside the 4521 is a short, proprietary expansion slot. Here, you can add one of several options for the system. One problem, of course, is that you cannot add both a serial card and a modem at the same time.

The system I used was in the prototype stage, but it looked sturdy and performed admirably. If you have special needs and require, say, both a modem and a serial port, or a modem and an RGB connector, you should see other systems. But for most situations, the PC-4521 will no doubt be very useful.

—Rich Malloy

A Third-Generation Word Processor

In the beginning there was EMACS, one of the very first word processors for some of the very first small computers (and still going strong in the public domain). EMACS begat FinalWord, an enormously powerful but difficult-to-learn MS-DOS-based word processor. Borland International bought the rights to the FinalWord engine and—with some major upgrading and the addition of an artful, easy interface—produced EMACS' slick grandchild: Sprint.

Sprint retains and enhances its ancestors' power and

flexibility: It lets you produce anything from plain ASCII text files to elaborate desktop-publishing-style documents with text in "snaking columns." Like Microsoft Word, Sprint lets you manually embed formatting commands or use style sheets to clone formats from one document to another. Sprint lets you have up to 24 documents and up to six on-screen windows open at once.

It has a built-in dictionary and thesaurus. It can

continued

semiautomatically generate indexes and tables of contents for long documents. It's fast (on an IBM PC AT-class machine, I jumped from the top to the bottom of a 17,000-byte test file in a few tenths of a second—virtually instantaneously). And it automatically and unobtrusively stores your work every 3 seconds or so (writing to a swap file on disk) to save your bacon in the event of a power failure or similar disaster.

Sprint also retains a few quirks whose origins trace back to the days when RAM cost dearly. For example, Sprint is "partially what you see is what you get," in that you see most, but not all, of your formatting. To preview the final appearance of your document, you load and run a separate formatter routine to—in essence—print it to the screen.

Fortunately, the familiar Borland interface—menus of menus, with in-context help at every turn—makes it all simple. But unlike other incarnations of the Borland interface, Sprint's is reconfigurable, so you can make Sprint appear and act like any other word processor. (The beta version I tested came with alternate interfaces for WordStar- and WordPerfect-like operation.)

Sprint's default interface is logical enough that almost anyone can sit down and poke around the menus to turn out presentable documents with essentially zero learning time; experienced users can access Sprint's advanced features via the menus or more quickly with command-key shortcuts.

Because the interface is reconfigurable, people already familiar with another word processor can use Sprint without having to unlearn one set of commands and relearn another. As a side benefit, an office can use Sprint to standardize on a single word processor (and therefore a single file format) and yet still let people use another interface.

Sprint retains Borland's typical aggressive pricing: Less than \$200 gets you a fast, powerful, flexible, chameleon-like word processor with a built-in dictionary and thesaurus.

I've been looking for a new word processor for some time—and if the production version lives up to the beta version, Sprint may be it.

—Fred Langa

The Facts:

Sprint 1.0 (version tested:
beta E.02)
\$199.95

Borland International
4585 Scotts Valley Dr.
Scotts Valley, CA 95066
(408) 438-8400
Inquiry 858.

Requirements:

Not final at press time, but the beta version required 256K bytes of RAM and a hard disk drive (the program's modules are supplied on five 360K-byte floppy disks); it supported monochrome and color monitors; it was not copy-protected.

A Boost for Your Old System

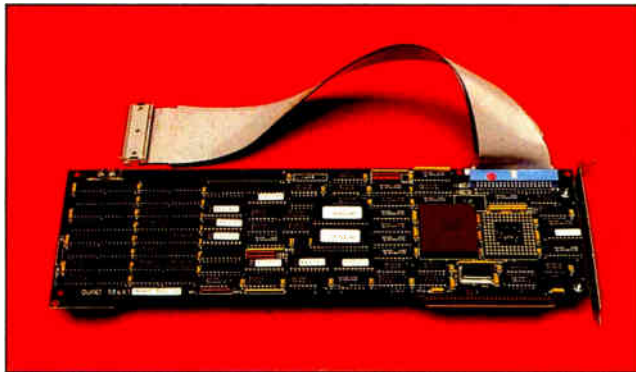

Putting the Quad386XT board in your old IBM PC or PC XT is like putting a much larger engine in your old car. It offers a boost to your old system, but it could leave you feeling delighted or disappointed with the change in performance.

Essentially, the Quad386XT can upgrade your 8088-based PC or XT into an 80386-based computer. You must be familiar with the layout and chip location on the PC motherboard before you can install the Quad386XT. You must remove the 8088 CPU (and, if present, the 8087 math coprocessor) from the PC motherboard. You insert a special adapter module into the 8087 socket and insert the Quad386XT connector cable into the 8088 socket. The full-length Quad386XT board plugs into any empty slot in your PC or XT. You then plug the connector cable from the 8088 socket into the board. The 80386 then becomes the PC's CPU.

The board comes with an 80386 running at 16 MHz, 1 megabyte of 120-nanosecond RAM, the BIOS in two 27256 EPROMs, and a socket for an optional 80287, 80387, or Weitek 1167 math coprocessor. An optional daughterboard containing 2 megabytes of 32-bit RAM is available (for

The Facts:

Quad386XT
\$995

Quadram
One Quad Way
Norcross, GA 30093
(404) 564-5566
Inquiry 856.

Requirements:

IBM PC, XT, or compatible computer

Options:

2-megabyte 32-bit RAM daughterboard, \$775

\$775); an 8-megabyte daughterboard is planned for the future.

Included in the package is a disk with the QVM.SYS driver program and the QVM.COM program for switching from 80386 real mode to the 8086 virtual mode. The disk also includes a selection of diagnostic software, a Dhystone benchmark program, a RAM disk, a print spooler, and other utility software.

In operation, the Quad386XT gives mixed results in speed tests. The BYTE 80386 benchmark programs do not run because of a conflict with the QVM.COM program. The Norton SYSINFO program gives the Quad386XT a rating of 13.3. When I used IBM's BASICA to run the BYTE Calculations and Sieve BASIC benchmark programs, they gave disappointing times: 1 minute, 26 seconds for Calculations, and 4 minutes, 26 seconds for the Sieve. BASICA uses the ROMs on the PC motherboard, thus slowing down the program's execution. When I used GWBASIC, which can reside completely in RAM on the Quad386XT board, the times improved to 7.6 seconds for the Calculations program and 25 seconds for the Sieve program.

—Stan Wszola
continued

WHEN YOU WANT THE BEST, YOU CAN ALWAYS DEPEND ON THE FIRST.



You only want the best. You want it first. And, you work hard to get it. When you choose Wells American's A★Star® microcomputers, that's exactly what you get. Not only the best, but also the first.

Wells American was the first to release a 12MHz AT class computer. The first with 14MHz. The first with a no-hassle 31 day money-back guarantee. And yes—we were even the first in business. We've been making microcomputers longer than IBM, Compaq® and Apple®. In fact, we've probably been making them longer than *anybody*.

Our A★Star computers are the only PC/AT compatibles that can run at 6, 8, 10, 12 and 14/16MHz. The press has rated them as "the best on the market." That's because they not only out-perform the competition, they're also less expensive. A 14MHz model with 20MB of storage sells for under \$1800. Basic unit prices start as low as \$995! But being best is more than just impressive statistics and low prices. It's also a lot of little "extras". Extras like a one year factory warranty, nationwide on-site service from GE and, here's another first, *free* schematics!

What does all this mean to you? Simply put, it means we have the resources and the technology to provide you with the best. And to provide it first. And in a company with so many "firsts," it's not surprising that's how we rate our customers. As one noted computer publication said: "The effort that Wells American takes on behalf of its customers is remarkable, showing a degree of concern that a number of computer companies should copy." Of course, many have tried to do just that. But, according to our customers, no one comes close to matching our 15-year reputation for exceptional customer support. No one.



Don't you think *you* deserve the best? Call us at 803/796-7800 for details on our special one month A★Star trial offer. Do it today and you could have the "best" on your desk tomorrow morning. Isn't that what you really wanted in the *first* place?

 **Wells American.**
3243 SUNSET BOULEVARD
W. COLUMBIA, SOUTH CAROLINA 29169

Compact Disk Products, Inc. CD-ROM/WORM

All Products, Lowest Prices, Expert Advice

INTRODUCTORY OFFERS

- Hitachi 1503S or 3500S* CD-ROM Drive with your choice of:
- McGraw Hill Science and Technical Reference Set . . . \$895
 - Microsoft Bookshelf with CD-ROM Extensions . . . \$895
 - Grolier Electronic Encyclopedia . . . \$895
 - PC SIG Library (Disks #1 - #817) . . . \$895
 - GeoVision U.S. Atlas and Mapmaker . . . \$1495
- * add \$20 for 3500S

CD-ROM SOFTWARE

- Grolier Electronic Encyclopedia . . . \$269
- Microsoft Bookshelf . . . \$269
- McGraw Hill Science and Technical Reference Set . . . \$269
- PC SIG Library . . . \$269
- GeoVision U.S. Atlas and Mapmaker . . . \$795
- Kirk-Othmer Encyclopedia of Chemical Technology . . . \$799
- Registry of Mass Spectral Data . . . \$2595

TOLL FREE ORDER LINE 800-MEGABYTE (634-2298)

CD-ROM/WORM DRIVES

- Hitachi 1503S External CD-ROM Drive w/Audio . . . \$729
- 1503S w/ Digital Audio Output . . . \$929
- Hitachi 3500S Internal Half Height Drive w/Audio . . . \$779
- Optotech Laserbank 400 MB WORM Drive . . . \$2799
- Maxtor 800 MB WORM Drive . . . \$3799
- Portable 286 w/ CD-ROM Drive and Hard Disk . . . \$3795
- AMDEK Laserdrive . . . Call

- CD-Play (\$95) Permits user to play all audio CD's on Hitachi and compatible drives. RAM resident pop-up utility. Output to headphones or amplifier.
- CD-Play Sampler (\$95) Same features as CD-Play plus the ability to play any "slice" of sound from a CD
- CD-AudioFile (\$95) Automatically creates records of all your audio CD's. Lets you choose a preferred play sequence for each disk. Automatic recognition of CD's. Creates DBase compatible records.

CDP

International Orders a Specialty

Compact Disk Products, Inc.
U.S. International Inquiries:
217 E 85th St, Suite 216
New York, NY 10028
(212)996-6999

Australian Agent:
Kewtel
145 Cotham Rd.
Kew, Victoria 3101
(03)817-5933

Credit Cards (Add 3%
and Purchase
Orders Welcome

SHORT TAKES

A Quiet Ink-Jet Printer



The Facts:

DeskJet
\$995

Options:

15 font cartridges, \$75 to
\$125; Epson FX-80 printer-
emulation cartridge, \$75;
128K-byte RAM cartridge,
\$150.

Hewlett-Packard
3000 Hanover St.
Palo Alto, CA 94303
Call your local dealer.
Inquiry 852.

The DeskJet is based on Hewlett-Packard's almost silent ink-jet technology. It has 128K bytes of built-in RAM, a 16K-byte buffer, and both parallel and RS-232C input. It can run at 240 characters per second (draft mode) with a resolution of 300 by 150 dots per inch or at 120 cps (letter-quality mode) with a resolution of 300 by 300 dpi. This provides near-laser-printer-quality output for \$995.

The printer uses a third-generation, thermal ink-jet, drop-on-demand print cartridge. In contrast to previous Hewlett-Packard ink-jet printers that required special paper for the best-quality output, the DeskJet print cartridge can print on regular bond, photocopier, and Hewlett-Packard's special ink-jet papers. One print cartridge can print from 500 to 800 pages, depending on the font selected or the type of graphics printed. Replacement cartridges cost \$18.95.

The printer features an automatic cut-sheet feeder, and the built-in paper tray can hold 100 sheets. It can handle U.S. letter- or legal-size and European A4 paper sheets. You can also manually feed it #10 business envelopes.

The printer is simple to operate. All the diagrams for loading paper and print cartridges and setting function and front-panel keypad switches are located under the printer's front cover. The front panel has switches for formfeed, font selection, draft or letter-quality mode, and forward or backward linefeed. It also has a button to start new printer cartridges and a reset button.

The DeskJet has the Courier, Courier Bold, and Courier Compressed fonts at 10, 16.67, and 20 characters per inch. You can make all font selections from the front panel. Two cartridge slots on the front panel hold optional font cartridges, a printer-emulation cartridge, or a 128K-byte RAM cartridge.

In operation, the DeskJet is almost silent. Print quality is comparable to laser-printer output. The DeskJet appears to be ideal for the small business that wants laser-quality output at a dot-matrix price.

—Stan Wszola
continued



Polishing The Apple

enthusiasts and Polishing The Apple for Macintosh enthusiasts, are available now.

These illusionary images are reproduced for the first time on 100 lb. 15" x 19" acid free book weight coated paper with fade resistant inks to insure precise reproduction of the original watercolors. Each reproduction is signed by the artist.

The price of these exact reproductions is just \$30 each or both for \$50. These introductory prices include shipment via UPS Blue Label (2-day delivery) and an unconditional 30-day guarantee.

NANCY GRAHAM'S RAMBENDERS

Nancy Graham, recognized nationally for her high-precision watercolors of classic cars, is creating a series of original paintings which explore the interplay of the power of the 50's . . . cars, and the power of the 80's . . . computers. Superb quality color reproductions of the first two paintings in this series, Power User, for IBM PC

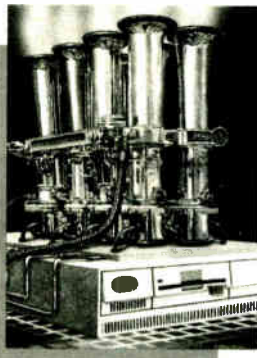

Power User

Order yours from RamBenders, 11100 Leafwood Lane, Austin, Texas, 78750-3409, (512) 258-0785.
acw@rambenders@uunet.uu.net
Mastercard/Visa accepted.



© RamBenders, 1988

CAPTURE YOUR WILDEST IMAGININGS

Come to SIGGRAPH '88 in Atlanta where computer graphics trailblazers will take you on a great adventure. Explore the diverse ways graphics are used in science, academia, industry and the arts. Listen to computer graphics pioneers describe bold, new advances. Learn how to give life to your most daring ideas. Venture into the era of electronic visualization.

ACM SIGGRAPH '88
15th Annual Conference
on Computer Graphics
and Interactive Techniques
Atlanta, Georgia
August 1-5, 1988

Sponsored by the
Association for Computing
Machinery's Special
Interest Group on
Computer Graphics in
cooperation with the
IEEE Technical Committee
on Computer Graphics

Please send a copy of the SIGGRAPH '88 advance program to:

Name _____ Company _____
Address _____
City _____ State/Country _____
Zip Code _____ Telephone _____

Members of ACM SIGGRAPH will automatically receive these materials in the mail in April and need NOT return this coupon.

ACM SIGGRAPH '88
Conference Management
111 East Wacker Drive, Suite 600
Chicago, IL 60601
(312) 644-6610

Get some of the best computer extras from Catalogic



Our range of computer add-ons offer facilities you've always wanted – at prices that will surprise you. Here's just some of the ideas on offer this month.

FastTrap™ The perfect alternative to a mouse. Takes up far less room – and has features never seen on a mouse – like 3D pointer control. Can be used as a direct replacement for Microsoft® serial mouse.

PSION Organiser II A phenomenal hand-held programmable computer. Comes with software for Diary, Filing System and Address Book. Other applications are available. Can be linked to your computer to exchange data in either direction.

Handy Scanner Capable of scanning in various standard graphics file formats at 200 DPI in both directions, this is the perfect add-on for DTP – line or halftones easily input and edited. A must for today's serious computer user.

NumeriKeys™ A perfect extra for portables. Easy to install as it plugs in between the parallel port and the printer and can be configured for special applications through the easy-to-use software provided.

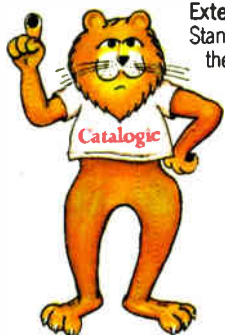

Extended Function Guides Designed to fit either Standard or Enhanced boards, these guides show you all the functions for the most popular software available – together with a mini manual for extra information.

Electrone Dashboard™ A full function "enhanced" board to fit the AMSTRAD PC port that comes with some smart software that allows you to configure any key for virtually any application.

FastTrap is a trademark of Microspeed Inc. Microsoft is a registered trademark of Microsoft Inc. NumeriKeys is a trademark of Genest Technologies Inc. Dashboard is a trademark of Electrone Ltd. Products may vary slightly from those illustrated.

Catalogic

PO Box 300249
1700 Lincoln
Denver
CO 80203

For more information, on these and all other products, send for our color catalog today!
Or phone toll free 1-800-347-3047

WordStar Strikes Yet Again

Since it was first released in 1984, WordStar 2000 has been the serious-business big brother of the venerable old standard WordStar. But despite rave reviews and a huge marketing effort, WordStar 2000 never seemed to reach the level of acceptance of arch competitors like MultiMate, WordPerfect, and Microsoft Word. With WordStar 2000 3.0, that situation may change. MicroPro has taken a shocking approach for a software company: It has actually incorporated user suggestions into the upgrade and has fixed a bevy of complaints.

WordStar 2000 3.0 has 662 features, oodles of them new and improved. But listing even a small subset would take more room than I have for this entire review. If you can think of it, it's probably there, including a spelling checker, thesaurus, and even a telecommunications program. But I'll concentrate on a couple of high points.

First, those control-character commands that have always been the curse and blessing of WordStar are significantly improved in version 3.0. Commands are actually mnemonic now. For example, quit and save is now Control-Q-S instead of the maddening Control-K-D. And in what's still a unique WordStar feature, you can choose whether to have help screens stay or pop up after a time delay that you define. You can also use single-letter commands, which may be simpler when you're first starting out.

The program comes with custom support files for some 400 printers, and laser-printer support places this release plainly several steps ahead of its competitors. Setting fonts and selecting sizes are simple tasks, and the program comes with Inset, a utility that merges text and graphics. Put them together, and you have a more-than-basic desktop-publishing package.

Then there's the speed. When WordStar 2000 first hit the shelves, I gave it up in disgust because doing anything useful with it required patience. But I was pleased to find that version 3.0 is quick and actually functional. Scrolling through long files and doing search/replace functions now are virtually instantaneous, and when you perform a function that requires extensive reformatting, the program does its thing in the background while you keep working away.

The disadvantages? The program is huge. It took me about half an hour to install, and when I was done I had 296 files in various automatically created subdirectories, taking up a total of nearly 4 megabytes of disk space. Even a minimal installation takes 2.5 megabytes. WordStar 2000 does just about everything, and that too is a disadvantage. How do you learn all the ins and outs? The answer is that you don't—right away. As is true with all feature-rich software, it's an evolutionary process. You find and learn the features as you require them. In that regard, MicroPro is now offering toll-free customer support 7 days a week at no extra charge. It's radical for MicroPro, and too long awaited.

—Stan Miastkowski

The Facts:

WordStar 2000 3.0
\$495

MicroPro International
33 San Pablo Ave.
San Rafael, CA 94903
(415) 499-1200
Inquiry 855.

Requirements:

IBM PC, XT, AT, PS/2, or compatible with 320K bytes of RAM (512K bytes for Inset text/graphics integrator); a hard disk drive is recommended.

continued



MICRO CADAM CORNERSTONE.™

Real mainframe-based PC CAD software that beats them all.

Now you can get real mainframe CAD power for your IBM® PS/2,™ PC/AT® and compatibles at a PC price—just \$2,995*.

MICRO CADAM CORNERSTONE beat the competition at the recent "PC CAD Shootout"—a benchmark evaluation of the best PC CAD software, sponsored by the National Computer Graphics Association (NCGA), and witnessed by 170 CAD/CAM professionals and editors.

We not only finished first—we were the only system to completely finish the benchmark exercise in the allotted time.

And when the audience voted, MICRO CADAM CORNERSTONE outpolled

the closest competitor by a 6-to-1 margin.

MICRO CADAM CORNERSTONE isn't just fast, it's also incredibly powerful. It employs the friendly CADAM® user interface famous throughout the industry for being easy to learn and use—even if you've never worked with a CAD system before.

MICRO CADAM CORNERSTONE is upwardly compatible with the whole CADAM family of CAD/CAM/CAE solutions, working today on more than 25,000 CADAM terminals and used by over 100,000 design and manufacturing professionals worldwide. And it features DXF neutral files, so you can exchange drawings with other PC-based systems

and interface to other applications like desktop publishing.

So if you're looking for real mainframe CAD power at a PC price, then ask for the one that beats them all, MICRO CADAM CORNERSTONE. Call CADAM today—toll-free at 800-255-5710.

MICRO CADAM CORNERSTONE . . .
The Ultimate PC CAD Production Tool



CADAM INC

A SUBSIDIARY OF LOCKHEED CORPORATION

*Suggested U.S. retail licensing fee. CADAM is a registered trademark and MICRO CADAM CORNERSTONE is a trademark of CADAM INC. IBM and PC/AT are registered trademarks and PS/2 is a trademark of International Business Machines Corporation.

Circle 48 on Reader Service Card (Dealers: 49)

Dealer Inquiries invited

See us at Comdex, Booth 2716

McInker™, Automatic Ribbon Re-inker



will re-ink your ribbons for less than 5 cents and will pay for itself even in one day depending on printer use. Average cartridge can be re-inked 60-100 times. We support over 12000 printers, cartridges, spools, multicolor cartridges. Ask for complete catalog.

Universal McInker (cartridge or spool) 68.50
 Multicolor Adaptor (4 color ribbons) 40.00
 Dot matrix ink (2oz \$3.00, 1 pint \$18.50 any color)
 Shipping 4.00

>100,000 sold since 1982, satisfaction or return

MERCURY MODEMS

100% Hayes compatible (guaranteed), full lights, autodial answer, repeat, volume control, 2 year warranty

1200 ext 99.00
 1200 int 89.00
 2400 ext 249.00
 cables 19.00



shipping 5.00

ORDER TOLL FREE
 1-800-547-3303
 In Oregon (503)626-2291

Computer Friends, Inc.

14250 NW Science Park Dr.
 Portland OR 97229 telex 4949559 CF
 fax (503)643-5379

Thin Is In

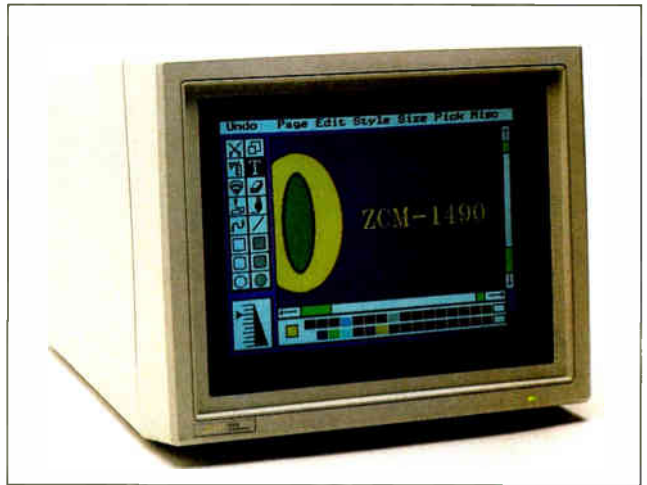

The Facts:

ZCM-1490: Flat Technology Monitor
 \$999

Requirements:
 15-pin analog RGB input

Zenith Data Systems
 1000 Milwaukee Ave.
 Glenview, IL 60025
 (800) 842-9000, ext. 1
Inquiry 853.

Everyone's saying it, and it's true: You have to see the **Zenith Flat Technology Monitor (ZCM-1490)** to believe it. The colors are brilliant, the screen has no glare, and the flatness is quickly addictive. It's hard to go back to the average bulging monitor screen that lets you count the ceiling lights reflected on its surface—very hard.

The ZCM-1490 is a 14-inch high-resolution flat-tension-mask color analog monitor designed to support the VGA output from IBM's PS/2 computers and comparable video cards. It also supports CGA, EGA, Monochrome Display Adapter, and Hercules software via Zenith's Z-449 video card. The monitor handles the standard 80-character by 25-row text output. Its resolution is 640 by 480 pixels. and it has a horizontal-scan frequency of 31.5 kHz.

Two dials on the top control brightness and contrast, and a switch on the back lets you operate at either 120 or 240 volts AC. The on/off switch is located on the rear, as is an IBM PS/2-compatible 15-pin RGB cable connector.

I tested the ZCM-1490 on a PS/2 Model 80 and played with one of the many paint packages. When you first sit down to a flat monitor, your eyes are so accustomed to a curved screen that the flat one appears concave. This deception disappears in a few minutes.

The colors on the Zenith are clear and crisp. I would say they are "true," but I'm speaking subjectively. I didn't actually compare them with color charts. Color selection is governed by the video input to the monitor and is not restricted by the monitor itself. The black background default screen is indeed black instead of the usual dark gray. In fact, the black, added to its lack of glare, gives it almost a matte finish.

I was very impressed with Zenith's ZCM-1490: the colors, the clarity, the lack of glare—and it's easy on the eyes.

—Jane Morrill Tazelaar

continued

NEW!
SafeSkin™
Keyboard Protector

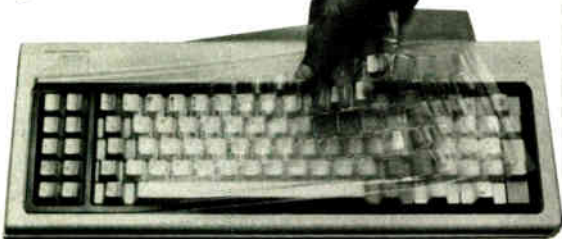

Finally! A Keyboard Protector That:

- **PROTECTS CONTINUOUSLY - 24 HOURS A DAY** - Against computer downtime due to liquid spills, dust, ashes, staples, paper clips and other environmental hazards.
- **REMAINS IN PLACE** during the operation of your keyboard. SafeSkin is precision molded to fit each key - like a "second skin."
- **EXCELLENT FEEL** - The unique design eliminates any interference between adjacent keys, allowing smooth natural operation of your keyboard.
- **SafeSkin IS VIRTUALLY TRANSPARENT** - Keytops and side markings are clearly visible. In fact, SafeSkin is so clear, sometimes you may not know it's there!
- **DURABLE - LONG LASTING** - SafeSkin is not a "throw-away" item. Many of our protectors have lasted over 3 years under continuous daily use, without failure.

SafeSkin is available for most popular PC's and portables including: **IBM, APPLE, AT&T, COMPAQ, DEC, EPSON, KEYTRONICS, NEC, TANDY, TOSHIBA, WANG, WYSE, ZENITH.** Specify computer make and model. Send \$29.95, Check or M.O., VISA & MC include exp. date. Dealer inquiries invited. Free brochure available.

Merritt Computer Products, Inc.

4561 S. Westmoreland / Dallas, Texas 75237 / 214/339-0753

SAVE 50% or more with our National Computer **RIBBONS**™ brand products.

NATIONWIDE
1-800-292-6272

MARYLAND
1-800-442-6272

MARYLAND LOCAL
561-0200



All of our ribbons are manufactured to exceed your original equipment manufacturers specifications.

NATIONAL COMPUTER RIBBONS™

9566 Deereco Road • Timonium, Maryland 21093

NCRG GUARANTEE

"We will never, knowingly disappoint you if for any reason your purchase does not give you complete satisfaction, the full purchase price will be cheerfully refunded immediately upon return of the merchandise.

We have always believed that no sale is complete until the customer has received total satisfaction from our products.

Philip E. Beringer, President

QUALITY
SERVICE
PRICING

BUY DIRECT FROM
THE MANUFACTURER

STOP THROWING AWAY
YOUR DOLLARS



We manufacture our products with the finest matrix inks, premium high density nylon, precision engineered plastics and "Rem" air refrigerated loading equipment.

COLORS . . . BLUE — GREEN — PURPLE — RED (Add \$1.00 To Each Price)
Nylon Only

CARTRIDGE RIBBONS (NYLON)

No.	Description	Price (ea.)
289	Alps 2000	\$4.50
050	Anadex 9500/9600	3.60
180	Apple Imagewriter II 4 color	9.95
114	Apple Imagewriter/DMP	2.95
102	Brother M1409	4.50
127	Brother M1509/1709	5.50
131D	Burroughs B-9246-3/6	4.95
104	Canan A-1200	4.50
113	Centronics 150/152	2.25
109	Centronics 350/351/352/353	8.50
112	Centronics 704/705/753	4.50
118	Citizen LSP 120D	4.50
169	Citizen MSP 10/20	2.50
167	Citizen MSP 15/25	3.50
123	Comrex 420	6.90
114	C. Itoh 1550/7500/8510	2.95
130	Data Products M-100L/120/200	3.50
131D	Data Products B-300/600	4.95
137	Data Products B-900/1000	6.50
135	Data Royal 5000	2.60
990	Datatrol/LRC MP40	4.15
135	Data South 180/220/5180	2.60
160	Dec LA 34/100/210 Letterprinter	2.95
114	Dec LA 50	2.95
156	Diablo 1660/2300 Matrix	3.50
153	Diablo Hytype II Nylon	2.95
280	Epson EX 800/1000	4.20
165	Epson FX/MX/RX 70/80/85	2.50
167	Epson FX/MX/RX 100/185/286	3.50
288	Epson Lq 800/Lq 850 H.D.	3.50
289	Epson Lq 1000 H.D.	4.50
163	Epson Lq 1500	2.95
281	Epson Lq 2500 H.D.	4.50
175	Epson LX 80/90	2.50
226	Facit 2301/4512/4514	2.95
133	Facit 4500/4510/4511/4513	3.75
135	Facit 4520/4525/4526/4528	2.60
991	Fujitsu DMPG 9/DX2100-2200	3.95
171	General Electric 300/341/W/I	35.00
146	Hewlett Packard 2608	18.65
145	Hewlett Packard 2631A	10.95
231	Honeywell 1500/7023/9104 G.P.	2.50
181	IBM 3287/3615 Sil. Dol. Cup/Loop	1.80
195	IBM 3287/3619 Silver Dol. Cart.	2.50
182	IBM 3288 1/2" Harmonica	3.00
185	IBM 3776 3/4" Harmonica	3.50
188	IBM 4201 ProPrinter II	3.75
176	IBM 4202 ProPrinter XL	4.50
177	IBM 4207 ProPrinter X24	4.95
211	IBM 4208 ProPrinter XL24	5.95
198	IBM 5224 Baseball Bat	13.95

No.	Description	Price (ea.)
178	IDS Prism Black 132/2080/2132	3.50
178A	IDS Prism Primary RD/BL/GR/B	9.75
178B	IDS Prism Process CY/MA/Y/BL	9.75
286	Mannesmann Tally 85	3.95
285	Mannesmann Tally 86	4.50
233	Mannesmann Tally 1000/1200/1600	2.75
204	Mannesmann Tally 100/120/160	3.00
205	Mannesmann Tally 130/140/180	3.50
200	NEC 5500/7700 Nylon Cart	2.45
114	NEC 8023 PC/8024 PC/8027 PC	2.95
660	NEC Pinwriter P1/P2/P6	3.60
661	NEC Pinwriter P3/P7	3.95
662	NEC Pinwriter P5 H.D.	3.95
663	NEC P2200 H.D.	5.50
209	Okidata 182/183/192/193	3.95
206	Okidata 292	4.85
208	Okidata 293/294	5.60
217	Panasonic KXP 1080/1091/1093	6.90
226	Radio Shack DMP 400/LPVI	2.95
235	RadioShack DMP100/LPVII/TRS80LPII	3.95
282	Radio Shack/DMP 130	3.75
282	Seikosha SP800/1000	3.75
261	Star Micronics NB/NL/NP/NX 10	3.60
264	Star Micronics NL/NP/NX 15	5.20
262	Star Micronics Radix 10/SR 10	3.60
263	Star Micronics Radix 15/SR15	4.10
290	Star Micronics SD10	3.75
291	Star Micronics SD15	4.10
135	Telex 287D/287D2	2.60
242	Texas Instruments 850/855	3.10
243	Texas Instruments 860/865	3.20
245	Toshiba P321/P341/P351	3.10
245	Toshiba P1340/P1350/P1351	3.10
135	Tritel	2.60
131D	Univac 0789/0790	4.95

CARTRIDGE RIBBONS - FILM

(correctable / multi-strike)		
306-	Brother EM60/100/200 Corr.	3.50
307-	Brother HR15/25/35 M/S	3.75
227-	CPT Rotary 8/9 M/S	2.95
158-	Diablo Hytype II M/S	2.25
317-	Diablo Xerox Memorywriter	3.50
334B-	Epson DX 10/20/35 M/S	4.40
168-	Facit 4560/8000 Corr.	4.75
196OEM-	IBMS218/5219 Displaywriter M/S OEM	11.25
222-	IBM 6240 M/S	1.75
812OEM-	IBM Quietwriter N/C	10.95
740-	IBM Wheelwriter Corr.	3.50
730-	IBM Wheelprinter M/S	7.90
320-	IBM Selectric II H.Y. Corr.	1.55
202OEM-	NEC 2000/3500/8800 Flip M/S	11.60

No.	Description	Price (ea.)
201-	NEC 5500/7700 Spinwriter M/S	2.50
303-	Nakajima Corr.	3.50
304-	Nakajima M/S	5.50
334-	Olivetti ET 201/121 Corr.	3.00
334B-	Olivetti ET 121/351 M/S	4.40
222-	Qume I/Sprint 3/5 M/S	1.75
223A-	Qume III Quick Load	2.40
219-	Qume IV Sprint 7,8,9,10,11,12 M/S	2.95
227-	Ricoh 1300/1600 M/S	2.95
251-	Wang System 5581/6541 M/S Matrix	2.95

TWIN SPOOL RIBBONS - NYLON

445-	Burroughs 9245/9247 5M	15.95
453-	CDC 100/200/300	4.75
450-	Centronics 100/300/500	3.75
453-	Data 100/300/400	4.75
454-	Decision Data 6807/6811/6814	6.95
455-	Dec writer LA 30/36	2.50
456-	Dec writer LA 120/180	3.50
480-	Facit 4540/4542 Black	3.70
462-	IBM 3262/5262	4.95
465-	IBM 3525 T/S	3.00
463-	IBM 5211	3.75
464-	IBM 5225/5250/5280	14.50
470-	Okidata 80, 82, 92, 93	1.25
471-	Okidata 84, 94	2.50
467-	Printronic 150/300/600	4.95
955A-	Seiko Universal Black/Red	1.25
470-	Star Micronics Gemini 10/10X	1.25
455-	Texas Instruments 800/810/815	2.50
456-	Texas Instruments Omni 820	3.50
401-	Wang 2221/5521	2.75

WIDE COMPUTER RIBBONS

0056P-	BST 14"x10 yds	7.95
0106P-	Burroughs 9246 15"x20 yds	15.95
0156P-	Control Data CDC 15"x25 yds	18.75
0256P-	Data Products 2230/2330 15"x15 yds	13.75
0276P-	Data Products 2400 14 1/2"x15 yds	13.75
0356P-	Documation 1200 15"x20 yds	15.95
0456P-	Honeywell Pru 1200 17.6"x22 yds	18.95
0106P-	Hitachi 15"x20 yds	15.95
0556P-	IBM 1403/3203/4245 14"x20 yds	13.25
0656P-	IBM 3211/Documation 17"x20 yds	16.25
0756P-	IBM 4248 w/Imposer Strip 18 1/2"x20 yds	19.50
0956P-	Univac 0770 15"x55 yds	36.00
0976P-	Univac 0776 15 1/4"x20 yds	16.50

*\$5.00 Shipping and handling charge on all orders under \$50.00. Over \$50.00 actual freight is charged.

"CALL US FOR VOLUME DISCOUNT PRICING"

*This is only a partial list of our products.

See why corporations such as General Motors, Mobil Oil, AT&T, MCI, Eastman Kodak, the entire U.S. Postal Service and thousands more are now using National Computer **RIBBONS**™ brand products

Circle 184 on Reader Service Card

World Radio History

Memo 1

To: **HP LaserJet II users and dealers**

- Subject: **GUIS LaserFax 401**, more than just a plain paper fax
- Data: 1. **GUIS LaserFax 401** can be linked between your IBM PC and your **HP LaserJet II** to make the system into a plain paper fax.
- Retail price under US\$3,000
 - Transmission speed of 9600bps, Group III and Group II, with 16 levels of halftone
 - Can also be a second **plain paper copier**

Suggested Action: HP users--Call your HP dealers. HP dealers--Call your HP users.

Memo 2

- To: All persons interested in the future of the telecommunications market.
- Subject: **GUIS** products already available
- Data: 1. Scanner model 321
- specially designed for FAX USE
 - easy to write software for
 - also suitable for DTP (high cost-eff'ness at under US\$1,000)
2. Fax Card
- to use w/Scanner 321 or alone (under US\$800)

All potential distributors, dealers, and OEM welcome.

GUIS

A Little Giant in Telecommunications

Glorious Union Information Systems Inc.
14th Floor, 207 Tun-Hwa North Rd.,
Taipei, Taiwan, R.O.C.
TEL: 2-7153356 2-7168035
TLX: 22651 GUIS FAX: 2-7134572

HP is a registered trademark of Hewlett Packard Co

A Compatibility Step Toward OS/2

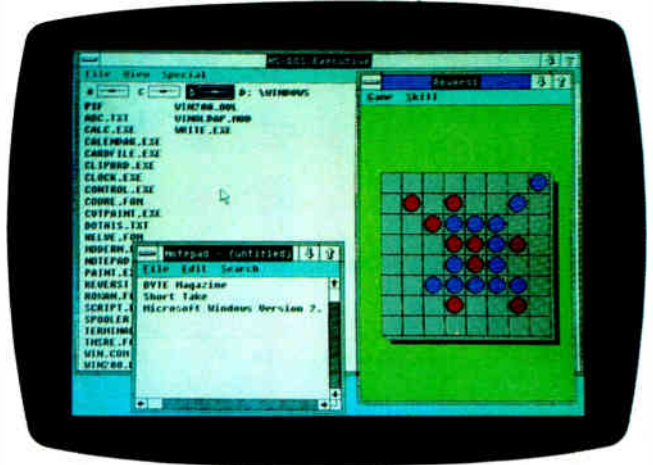

The Facts:

Microsoft Windows 2.0
\$99

Microsoft Corp.
16011 Northeast 36th Way
Redmond, WA 98073
(206) 882-8089
Inquiry 854.

Requirements:

IBM PC, XT, AT, or compatible with at least 512K bytes of RAM; it also runs on the IBM PS/2.

Microsoft Windows 2.0 is an update of the original Windows designed to allow at least limited compatibility among all the Microsoft graphical interfaces.

Most users will see few differences between version 2.0 and earlier versions of Windows. The major feature in the new version is the ability to use expanded memory to swap programs. In older versions, programs were swapped to disk, resulting in slow performance that could degrade if your hard disk became fragmented. Swapping to expanded memory allows programs to swap in times that more closely approximate a genuine multitasking system.

If your system has both expanded memory and extended memory, you can get even better performance by swapping programs to expanded memory and using the SMARTdrive disk-caching program that comes with Windows in extended memory. The other user-apparent changes in version 2.0 are minor, including improvements in the speed and ease of use in the keyboard command "shortcuts" and the ability to size windows from the fat borders.

The major changes in Windows are in the applications programmer level. Microsoft's original intention of having well-behaved Windows applications run unaltered under the OS/2 Presentation Manager has changed, but Windows now has file structures and programming hooks that are similar to those in OS/2, so that ports from Windows to OS/2 will be, if not easy, at least possible.

In all, Microsoft has updated Windows in ways that maintain a great deal of compatibility with earlier versions of the environment, while providing features that make it more useful for many users.

In moving from the Windows Operating Environment to the Windows Presentation Manager, Microsoft has opened a door of new features to applications programmers, but without leaving earlier Windows users standing alone in the cold. ■

—Curtis Franklin Jr.

DesignCAD 3-D

3-D CAD You Can Afford

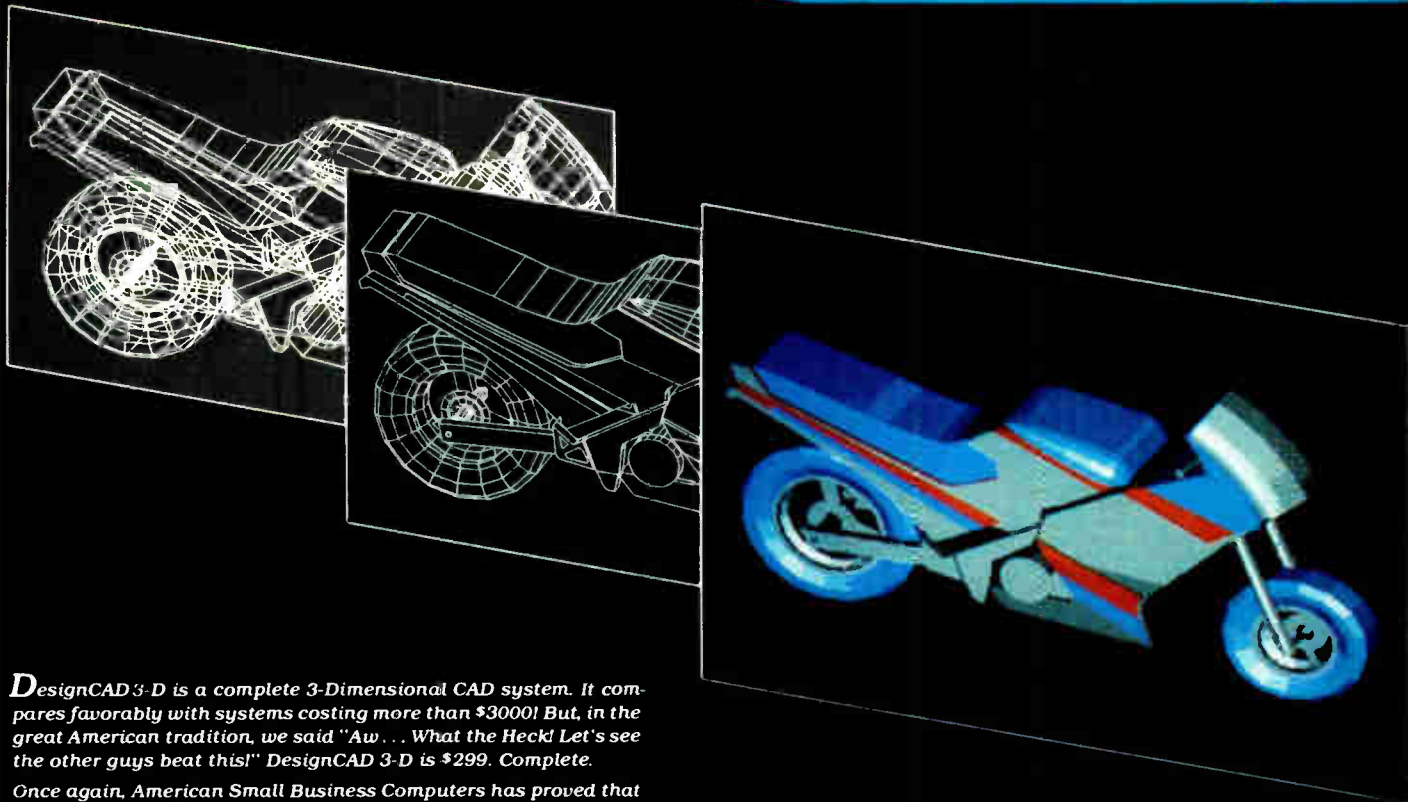

DesignCAD 3-D is a complete 3-Dimensional CAD system. It compares favorably with systems costing more than \$3000! But, in the great American tradition, we said "Aw . . . What the Heck! Let's see the other guys beat this!" DesignCAD 3-D is \$299. Complete.

Once again, American Small Business Computers has proved that you don't always have to spend a lot of money to get quality software. DesignCAD 3-D provides features such as Shading, Hidden Line Removal, Printer and Plotter support, and extensive file transfer capability, all for \$299! No other 3-Dimensional CAD system can come close to providing the price/performance of DesignCAD 3-D.

There is a very important reason to buy DesignCAD 3-D other than price: **PERFORMANCE**. DesignCAD 3-D provides complete 3-Dimensional drawing capabilities. It's not a "warmed-over" 2-D program. DesignCAD 3-D allows you to draw any entity in 3-D space. This means, for example, that you can draw a curve in the shape of a spring. You can draw a circle or arc at ANY angle on ANY plane.

DesignCAD 3-D allows up to 4 simultaneous views - any angle or perspective - on the screen. DesignCAD 3-D also provides complex extrusions - linear, scalar, and circular. Extensive 3-D text capabilities and auto dimensioning are provided - at no extra charge, of course.

DesignCAD 3-D provides the capability to read drawings from most other CAD systems (DesignCAD/ProDesign II, AutoCAD's DXF, and IGES file formats). You can also send a view of a 3-D drawing to other CAD systems. These features are included at no extra charge, of course.

DesignCAD 3-D almost certainly is compatible with the computer system you now own. DesignCAD 3-D supports more than 200 dot matrix printers, at high resolution. DesignCAD 3-D supports more than 80 plotters, and most digitizers and graphics adapters available for "PC Compatible" systems. Shaded and wireframe models can be output to the printer or plotter YOU own.

DesignCAD 3-D does not require expensive graphics adapters and monitors - even shading can be done on ordinary displays such as the Enhanced Graphics Adapter (EGA), Color Graphics Adapter or Hercules monochrome adapter.

However, the best reason to buy DesignCAD 3-D is not the low price. It's not the outstanding performance. It's not the extensive hardware compatibility. The best reason to buy DesignCAD 3-D is for its amazing ease of use!

DesignCAD 3-D provides powerful commands you can use to produce professional 3-Dimensional drawings in less time than you thought possible! DesignCAD 3-D commands can be selected from the menu or entered as fast, single keystroke commands. We have found DesignCAD 3-D to be easier to learn and easier to use than any 3-Dimensional CAD system for the IBM PC, at any price!

What else do you need to know about DesignCAD 3-D? Only this "Included at No Extra Charge." What is included at no extra charge? **EVERYTHING! \$299 BUYS IT ALL!**

How do you get one?

See your local dealer, or contact:

American Small Business Computers, Inc.
118 South Mill Street
Pryor, OK 74361
(918) 825-4844

Telex 9102400302

ALL IT LACKS IS

A choice of snap-in/out, 24- or 18-pin print heads gives you the versatility and ease of maintenance that other printers lack.

With a top speed of 360 cps, it makes most printers seem downright lackadaisical.

ALPS P2400C

But who needs competition when you've got all this?

Namely, the ALPS P2400C™ Dot Matrix Printer.

No other printer in its class can do so much for so many for so little.

For instance, the P2400C can easily take on all the work an office full of busy PCs can dish out.

And take care of it faster. Thanks not only to its talents pointed out above, but to its many others, as well.

Like a choice of draft, correspondence and letter quality print modes. A print buffer expandable to 256K. Multiple font cartridges. And full compatibility with the most popular PCs and software.

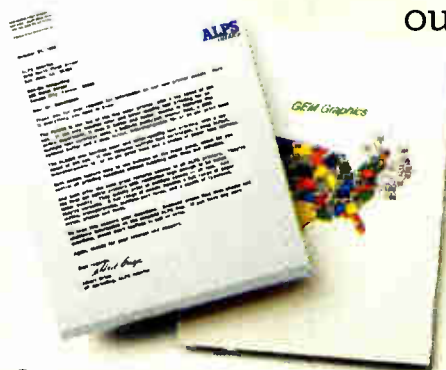

For letters, seven-color graphics, spreadsheets or whatever, its output is so brilliant, everything else appears lackluster.

COMPETITION.

Most printers lack the good sense to include a paper-saving, push/pull tractor for both bottom and rear feed. Not this one.

You also get conveniences that many other printers are lacking. Like control of everything from the front panel, the feature menu, or from software — without using DIP switches.

Not to mention the ability to run quietly. At under 55dBA, the P24000C is one of the least noisy printers around.

One of the most durable, too. It comes with a full, one-year limited warranty. And if you give it normal care, it'll give you over five years of trouble-free performance.

Of course, there's nothing like a live performance to prove there's nothing like the P2400C.

For a free demo, or more information, call us at **(800) 828-ALPS**. In California, (800) 257-7872.

And see what every other dot matrix printer is lacking.

ALPS
AMERICA

IT'S TIME YOU SAW THE ALPS.

Circle 17 on Reader Service Card (Dealers: 18)

P2400C is a trademark of ALPS Electric Co., Ltd. © 1987 ALPS America.

COMPUTER WAREHOUSE

CALL TOLL FREE **1-800-528-1054**

FREE FEDERAL EXPRESS
Air Express Shipping
See Details Below



**LOWEST PRICES
FAST DELIVERY**

HARDWARE

PRINTERS

Alps All Models	Call
AST TurboLaser	\$2829
Brother All Models	Call
Citizen MSP-40	\$269
MSP-45	\$415
MSP-50	\$355
MSP-55	\$450
Premier 35	\$450
Tribute 124	\$445
Tribute 224	\$605
120 D	\$145
Citizen 180D	\$160
Citizen 15E	\$315
Dyconics 150	\$299
300	\$480

EPSON

All Printer Models	Call
Hewlett-Packard LaserJet II	\$1779
NEC P2200	\$335
850	\$1539
860+	\$1950
3550	\$729
8810, 8850	\$1059
P6	\$425
P7	\$610
P9	\$1035

OKIDATA

All Printer Models	Call
Panasonic 1091 Model 2	\$185
1080 Model 2	\$169
1092 I	\$305
1524	\$549
1592	\$405
1595	\$460
3131	\$275
3151	\$420
Laser P4450	\$1635

STAR MICRONICS

All Printer Models	Call
Toshiba 321 SL	\$489
341SL	\$665
351SX	\$979
Laser Printer	\$2330

DISKETTES

Maxell MD2 (Qty 100) 5 1/4	\$82.50
M2S 5 1/4	\$65
MD 2 High Density	\$185
Sony DS/DD (Qty 100)	\$69
HD (100's) 5 1/4	\$150
DS (100's) 3 1/2	\$105
5 1/4 DS/DD	\$69

MONITORS

Amdek All Monitors	Call
Mitsubishi Diamond Scan	\$499
Other Models	Call
NEC Multisync II	\$575
Multisync Plus	\$875
Multisync XL	\$2009
Princeton Graphics All Models	Call
Ultrasync	\$495
Sony Multiscan w/cable	\$665
Thompson Ultrascan	\$539
Zenith 1490 FTM	\$619
Other Models	Call

KEYBOARDS

KB5151	\$119
KB5153	\$149
KB101	\$79

DISK DRIVES

Iomega Bernoulli 10 meg	\$865
Bernoulli 20 meg	\$1260
Bernoulli 40 meg	\$1605
Bernoulli Beta Internal (5 1/4)	\$909
Bernoulli Beta External (5 1/4)	\$1645
Miniscribe Drives	Call
Teac AT 1.2 Meg Drive	\$100
XT 1/2 HT Drive	\$85
Toshiba 3.5 720K	\$95
3.5 1.4 MB	\$115
Magnum Tape Backup	Call
Everex Tape Backup	Call

SEAGATE

20 meg w/Western I/O	\$290
251-1	\$469
Other Models	Call



\$469
MIT TURBO PC/XT

640 Memory, One 360K Brand Name Floppy Drive • 135 Watt Power Supply • AT Style Keyboard • 4-10 MHz Clock Speed, (Keyboard Selectable), 8 Expansion Slots	
Turbo PC/XT w/640K & 2 Drives	\$545
Turbo PC/XT w/640K, 1 Drive, 20 MG	\$749
PC/AT 10 MHz w/1024K, 1.2 Floppy Drive	\$989
PC/AT 12 MHz /1024K, 1.2 Floppy Drive	\$1049
PC/AT 12 MHz/1024K, 1 Drive, 40 MG	\$1549
PC 386 16 Mz 1 DR/40 Meg	\$1979
PC 386 16 Mz 1 DR/40 Meg	\$2479
MonGraphics Card with Parallel Printer Port	\$55
Color Card w/Parallel Printer Port	\$55
Amber Monitor (TTL)	\$89
Amber Monitor w/Swivel Tilt	\$95
Color Monitor (RGB)	\$255
EGA Monitor	\$359
EGA+ Card	\$145
I/O Card (Serial/Parallel)	\$38
I/O Card (Serial/Clock Calendar)	\$39
Enhanced Keyboard	\$69
AT Multi I/O Card	\$69
XT Multi I/O Card	\$55

MODEMS

HAYES	Call
All Modems	Call
Prometheus 2400B w/Soft	\$129
Other Models	Call
US Robotics Courier 2400	\$299
Password 1200	\$149

BOARDS

AST Six-Pack Plus	\$109
Hot Shot 286	\$330
Other Models	Call
ATI EGA Enhanced	\$175
VIP VGA	\$265
Hercules Color Card	\$145
Graphic Card & Graphic Card +	\$175
Intel Above Board PS/PC (11"0)	\$239
Above Board PC 1010	\$205
Above Board AT (4020)	\$305
Above Board PS/AT (4120)	\$329
386 w/Cable	\$719
Inboard w/Cable	\$1005
NEC Multisync Graphic Board	\$275
Orchid Tiny Turbo 286	\$265
Turbo EGA	\$449
Designer UGA	\$239
Paradise Autoswitch 350	\$135
Autoswitch 480	\$150
VGA+	\$239
VGA Professional	\$355
Plus Development	Call
Plus Hard Card 20 & 40 Megabyte	Call
Mountain Hard Cards	Call
Quadram Quad EGA+	\$275
VGA	\$235
Video-7 Vega Deluxe	\$195
VGA	\$279

COMPUTERS

AST Model 80	\$1509
AST Model 120	\$2130
AST Model 140X	\$2335
AT&T	Call
NEC Multispeed	\$1375
NEC Multispeed EL	\$1609
Sharp 4501	\$698
4502	\$1250
7202	\$2025
7221	\$2700
Toshiba T1000	\$785
T3120	\$3068
T-1100 Supertwist	\$1370
T-3100	\$2799
Zenith	Call

VIDEO TERMINALS

Queme 101 Plus Green	\$315
Wyse	Call

MONEY MANAGEMENT

Dollars & Sense w/Forecast	\$92
Tobias Managing Your Money 4.0	\$114

COMMUNICATIONS

CompuServe Starter Kit	\$19
Crosstalk XVI	\$88
Carbon Copy Plus	\$105
Mirror II	\$33
Remote	\$88
Smartcom III	\$136

GRAPHICS

Logi Tech Mice	Call
Newsmaster	\$48
Microsoft Buss Mouse 1.0	Call
Microsoft Chart 3.0	Call
Microsoft Serial Mouse 1.0	Call
Newsroom	\$30
PC Buss Plus Mouse w/Paint	\$83
PFS: First Publisher	\$52
IMS1 Mouse w/Dr Halo III	\$88
PC Mouse w/Paint	\$83
Printmaster Plus	\$28
Master Presentation Pack	\$315
Turbo Graphics Tool Box 4.0	\$58

SOFTWARE

IBM PC and 100% Compatibles

INTEGRATIVE SOFTWARE

Enable 2.0	\$352
Framework II	\$309
Smart Software System 3.1	Best Price
Symphony	\$439
Ability Plus	Call

TRAINING

MS Flight Simulator	Call
PC Logo	\$79
Typing Instructor	\$27
Typing Tutor IV	\$27
MS Learning DOS	Call

LANGUAGES

C Compiler (Microsoft)	Call
Fortran Compiler (Microsoft)	Call
Macro Assembler (Microsoft)	Call
Pascal Compiler (Microsoft)	Call
Quick Basic 4.0	Call
Turbo Jumbo Pack 3.0	\$159
Turbo Pascal 4.0	\$58
Turbo C 1.5	\$58
Turbo Basic	\$58
Turbo Prolog	\$58

PROJECT MANAGEMENT

Harvard Total Project Manager II	\$309
Microsoft Project	Call
Super Project Expert	\$385
Timeline 2.0	\$259

SPREADSHEETS

Lotus 1-2-3	\$295
Multiplan 3.0	Call
Twin	\$32
VP Planner Plus	\$82
Supercalc 4	\$269

DATA BASE MANAGEMENT

Clipper	\$368
Drase III Plus	\$374
Quickcode Plus	\$129
QuickReport	\$129
Rellex	\$78
DB-XL	\$79
PFS: Professional File	\$119
R:Base For DOS	\$425

WORD PROCESSORS

Word Perfect Executive	Call
Leading Edge W/P w/Spell & Mail	\$55
Turbo Lightening	\$52
Microsoft Word 4.0	\$185
Multimate Advantage II	\$249
Wordstar w/Tutor	\$162
Wordstar Pro Pack 4.0	\$205
PFS: Professional Write	\$102

Word Perfect (Ver.4.2) Call
Wordstar 2000 + 3.0 \$189

UTILITIES

MS Windows 2.0	Call
Copy II PC	\$18
1 DIR Plus	\$46
Fastback Plus	\$89
Norton Utilities 4.0	\$46
Printworks For Laser	\$87
Sidekick (Unprotected)	\$44
Sideways 3.2	\$37
Superkey	\$53
Xtree	\$35
SOZ Plus	\$53
Brooklyn Bridge	\$69
Many other titles available.	

COMPUTER WAREHOUSE

To Place an Order: 1-800-528-1054
To Follow-up on an Order: 602-944-1037
8804 N. 23rd Ave.
Phoenix, Arizona 85021

Order Line Hours:
Mon-Fri 7:00 a.m.-6:00 p.m.
Saturday 9:00-1:00
Order Processing:
10:00 a.m.-3:00 p.m. Mon-Fri

* No Charge for VISA and MasterCard • You Pay the Ground Shipping—We Pay the Air • Ground Shipping & Handling \$6.00 • Free Air applies ONLY to orders up to 10 lbs. & Over \$50 • All products carry a manufacturer's warranty. All Guarantees, rebates, trial period privileges & promotional programs are handled by the manufacturer only • NO APO, FPO, or international orders, please • Call before submitting PO Numbers • Personal and Company Checks Will Delay Shipping 3 weeks • Prices, Terms & Availability Subject to Change Without Notice • Add 5% for COD Orders • We Do Not Guarantee Machine Compatibility • We do not charge credit cards until order is shipped.



Microsoft Languages Update

New prerelease versions of old friends offer a bridge to OS/2

It's not every day that a software company unleashes a barrage of language upgrades the likes of which Microsoft introduced earlier this year. The company wanted to provide its languages with OS/2 functionality so that programmers could write applications for use with the new operating system or turn it into a development platform for MS-DOS applications. In doing so, Microsoft has announced new versions of five language products and two development kits:

- C Optimizing Compiler 5.1
- BASIC Compiler 6.0
- FORTRAN Optimizing Compiler 4.1
- Macro Assembler 5.1
- Pascal Compiler 4.0
- OS/2 Programmer's Toolkit
- Windows 2.03 Software Developer's Kit

Furthermore, the company introduced at about the same time a new COBOL Compiler 3.0 (actually developed by Micro Focus but marketed by Microsoft) that also provided OS/2 functionality. The only Microsoft languages not directly affected by the OS/2 upgrades were, in fact, QuickC and QuickBASIC. However, Microsoft has said that it is simply a matter of time before OS/2 versions of these languages are developed as well.

While the basic objective of the revisions was to bring OS/2 functionality to the languages, an added aim was to do so without sacrificing MS-DOS compatibility. The intent behind this plan was to provide programmers with a single implementation of each language instead of separate versions for OS/2 and DOS. To accomplish this, enhancements had to be made that affected all elements of the development cycle, from the editor to the debugger.

One of the most noticeable changes, at least for programmers familiar with past

Microsoft languages, is that a common program editor—the M editor—has been added to each language. (Other than the Quick products, this is the first time Microsoft has delivered languages that have integral editors.) Among other things, the M editor allows multiple windows and multiple files, and it is configurable so that it can look like editors you may already be familiar with. (Configuration files are included that enable emulation of the Brief, Epsilon, WordStar, and QuickC/QuickBASIC-style editors.) The M editor has macro capabilities to automate frequently used operations, and

it creates a history file that automatically logs in the changes made to a program, the type of changes they were, and who made them. Additionally, other programs can be invoked from within the M editor.

On the compiler side, the revised compilers emit Intel 80286 instructions when running in OS/2 protected mode. Also added were special software libraries that take advantage of unique OS/2 capabilities—primarily the ability to work with dynamic linked libraries (DLLs) and multithreaded applications.

Dynamic links are the primary method by which OS/2-system and nonsystem services are obtained. They let you postpone making external references until load time or run time. DLLs allow libraries of routines to be linked to applications at execution time. Since DLLs can be shared among programs, those programs can be much smaller. Multithreading is an OS/2 feature that allows more than one path of execution through the same instance of an applications program. OS/2 allows a maximum of 255 threads in use by the system at any one time.

In general, libraries included in the compiler let system calls be made directly to OS/2 functions. Typical calls might be to open a file, allocate memory, and so on.

Because OS/2 enables you to write much larger programs, the linker was revised so that, among other things, it is easier to make frequent changes to large code modules. You can also specify that programs be linked so that they run under either OS/2 or MS-DOS. (A unique OS/2 utility called BIND.EXE lets you associate a program with either environment. Such a program is said to be "bound" to OS/2 or to MS-DOS.)

Part of the significance of this is that

continued

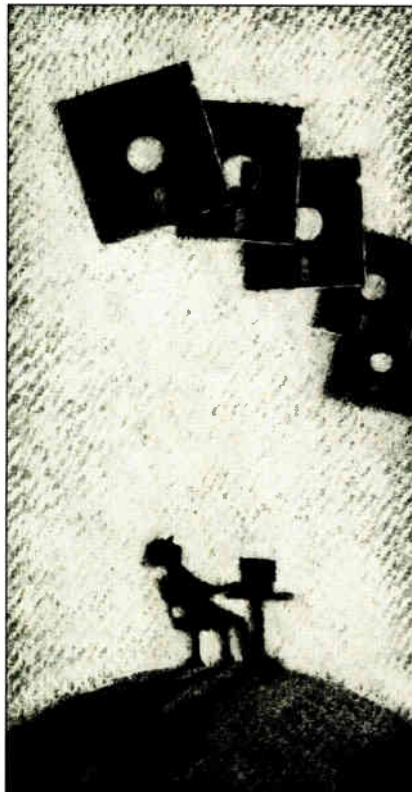

Table 1: Programs created with the Microsoft C Compiler 5.1 and "bound" with a utility program can run under OS/2 and MS-DOS. The same binary image of each sample program was run under OS/2 and then in the MS-DOS window. The programs run 10 percent to 28 percent faster in the MS-DOS window because background processing is suspended. Because we tested prerelease software, these are not true benchmarks; they simply give a rough idea of relative performance.

	OS/2 window	DOS 3.x window
Dhrystone*	3125	4059
Fibonacci	70	62
Sieve	11	8
Sort	21	18

* Larger number indicates better performance. All times are in seconds, except for the Dhrystone, which is in Dhrystones per second. One hundred iterations were run for the Fibonacci, Sieve, and Sort benchmarks. The Dhrystone version is 1.1; no registers were used, and 50,000 iterations were run.

MS-DOS programs can be written under OS/2 with the resulting benefit that programmers can undertake several concurrent development tasks—execution in one window and debugging in another, for instance—and considerably speed the development process. The programmer would then use BIND.EXE to marry that application to MS-DOS. Microsoft says it will also supply prepackaged libraries of code for simple things like I/O access to the operating system, and has indicated that the company will provide additional libraries (e.g., graphics libraries) in the future.

Microsoft readily admits that debugging OS/2 programs can be extremely difficult, particularly with multithreaded programs that can have dozens of threads. CodeView, the Microsoft debugger, now provides thread-level control of breakpoints and tracing. Breakpoints can be set on a program level or on a thread level. If set on a program level, the complete execution sequence stops when a breakpoint is encountered. You can, however, set a breakpoint at the thread level by specifying the thread on which execution is to halt. Similarly, tracing can be applied to either the overall execution sequence or only to the path of a specific thread.

C Optimizing Compiler 5.1

Among the new features included in the Microsoft C Optimizing Compiler 5.1 are run-time library enhancements, OS/2 support, and the BIND.EXE utility that modifies a program so that it can run under either MS-DOS or OS/2. Microsoft C 5.1 itself runs under either OS/2 or MS-DOS 3.x.

We installed a prerelease version of the compiler on a Compaq Deskpro 386 with a 40-megabyte hard disk drive and running Microsoft's OS/2 version 1.0. The

C 5.1 installation package has grown from four 360K-byte 5¼-inch floppy disks that composed the version 5.0 package to thirteen 360K-byte 5¼-inch floppy disks and one 1.2-megabyte 5¼-inch floppy disk. That's the bad news. The good news is that a sophisticated setup program manages the details of getting the software from the floppies to your computer's hard disk.

The setup program asks you questions about the type of run-time support you want (OS/2, real-mode/DOS, or both), types of math libraries desired (coprocessor, emulation, or alternate), the memory models you need (small, medium, compact, or large), and if you want QuickC installed. Once you've answered these (and a few other) questions, it becomes a simple matter of inserting the appropriate disks as the setup program prompts for them.

If you're already using C 5.0, you'll be familiar with the operation of C 5.1. If you're upgrading from C 4.0, however, you're in for some changes. First, the `msc` command you used to invoke the compiler under 4.0 has been changed to `cl`. The compiler switches are still the same, but while you could combine them under 4.0 (e.g., `msc/AL/G2 sieve`), you must separate them with spaces under 5.1 (i.e., `cl /AL /G2 /Gs sieve.c`). Perhaps the most jarring change is that you must explicitly supply the file extension of `.c` for the program file or C 5.1 can't locate it—something that didn't occur under 4.0.

On the positive side, C 5.1 (and its predecessor 5.0) applies powerful code optimization techniques to compile your programs, and it supports the new ANSI C standard. Unlike C 5.0, C 5.1's run-time support has been expanded to include OS/2, and new C keywords let you access

certain OS/2 functions. For example, `spawn()` creates and starts a new child process, and `cwait()` stops the calling process until a specific child process completes. A `signal()` function lets you choose one of several ways for a process to deal with interrupts from the operating system. Some of these signals—floating-point error, for example—can be dealt with under OS/2 or MS-DOS, while others, such as process flags, are applicable only under OS/2.

A new compiler switch, `L`, lets you link code for either OS/2 protected mode (`Lp`) or DOS 3.x real mode (`Lr`). If you compile and link a C program using only the protected-mode options, you can use the `bind` utility to modify the executable so that it can run under either OS/2 or MS-DOS.

However, for BIND 1.0 to locate the required `API.LIB` and `DOSCALLS.LIB` libraries, you have to provide it with explicit path names to these files. Depending on your file directory structure, these path names can get quite involved, so we resorted to a `.CMD` file (OS/2's equivalent of a `.BAT` file) to invoke `BIND.EXE`. The C 5.1 update documentation states that a `/Fb` switch lets you invoke the `bind` utility from the C compiler command line, but try as we may, the compiler insisted that it was an unknown option, and we had to bind the files manually.

To test this dual-mode capability of the C 5.1 compiler, we compiled sample programs using the protected-mode option and then bound them. (In this case, we used several `BYTE` benchmark programs to check dual-mode operation, not to establish benchmark results.) Next, we ran the programs under OS/2 and recorded the times. Finally, we switched to the DOS window, ran the same executable files again, and recorded the times.

No problems were encountered running the programs in either mode. See table 1 for the results. Only one OS/2 screen and the MS-DOS window were present during the timing tests. The programs executed 10 percent to 28 percent faster in the DOS window because background processing is suspended while the program runs in the MS-DOS window.

Despite the minor glitches mentioned here, C 5.1 ran capably in both the OS/2 and the MS-DOS windows. With the added OS/2 support and the `bind` utility, it makes a useful bridge between the old and new operating systems.

BASIC Compiler 6.0

The previous release of Microsoft's generic MS-DOS BASIC compiler (almost 4 years ago) was the no-hardware-hooks `BASCOM 5.36`. The new `BASIC Compiler 6.0`, which sits astride the MS-DOS

and OS/2 operating systems, has features and functions that let you access the world of multitasking.

With OS/2, BASIC leaves the single-threaded, real-mode safe harbor of MS-DOS and enters the turbulent waters of multiple-threaded protected mode where event trapping, interprocess communication, and dynamic linking become important. For BASIC programmers, "OS/2 programming" will become synonymous with "complexity."

Like Microsoft's other updated languages, BASIC 6.0 comes on several disks—seven in this case. However, a prompt-driven setup program makes the installation of the program relatively easy. In addition to new statements and functions to facilitate interprocess communication and multitasking, BASCOM 6.0 lets you call OS/2 functions directly from BASIC. You can use event-trapping functions in either real or protected mode.

BASCOM 6.0 is really QuickBASIC 4.0 in another guise; the BASIC part of BASCOM 6.0 is functionally the same as QuickBASIC 4.0. The QuickBASIC 4.0 environment, including editor and threaded p-code interpreter, comes with the distribution disks for BASCOM 6.0. The documentation for BASCOM 6.0 is the QuickBASIC 4.0 manual set.

Even though BASCOM 6.0 offers two environments, only one runs in protected mode. The QuickBASIC 4.0 environment runs exclusively in real mode; you can create programs in that environment and then compile the resulting source code in protected mode with the BASCOM 6.0 compiler, BC.EXE. You can also invoke BC.EXE in real mode and the compiler automatically emits an object file suitable for real mode; invoked in protected mode, BC.EXE creates an object file for protected mode. The one thing that BC.EXE cannot do, however, is create programs that run in both real and protected mode, programs that Microsoft calls "bound applications."

With the addition of seven new keywords to support OS/2 programming, the new Microsoft Editor, CodeView, and a new segmented linker, BASCOM 6.0 is more than a simple enhancement to QuickBASIC 4.0. With the additional tools, programmers can choose the QuickBASIC 4.0 development environment, or they can opt for using the Microsoft editor and the stand-alone compiler and linker.

The new BASCOM version doesn't support IOCTL/IOCTL\$, INP, OUT, PALETTE/PALETTE USING, PEN, PLAY, SOUND, STICK, or WAIT in protected mode. Some statements—BLOAD/BSAVE, CALL, PEEK/POKE, and VARSEG—func-

The Facts		
Product	Minimum system requirements	Price
C Optimizing Compiler 5.1	448K bytes of RAM One double-sided floppy drive and a hard disk drive OS/2 1.0 or MS-DOS 2.1 (or higher)	\$450 5.0 owners - free 4.0 owners - \$150
BASIC Compiler 6.0	320K bytes of RAM Two double-sided floppy drives OS/2 1.0 or MS-DOS 2.1 (or higher)	\$295 5.36 owners - \$99
FORTRAN Optimizing Compiler 4.1	320K bytes of RAM Two double-sided floppy drives OS/2 1.0 or MS-DOS 2.1 (or higher)	\$450 4.0/4.1 owners - \$50 3.xx owners - \$150
Macro Assembler 5.1	320K bytes of RAM Two double-sided floppy drives OS/2 1.0 or MS-DOS 2.1 (or higher)	\$150 5.0 owners - \$15 4.0 owners - \$75
Pascal Compiler 4.0	320K bytes of RAM Two double-sided floppy drives OS/2 1.0 or MS-DOS 2.1 (or higher)	\$300 3.32 owners - \$40 3.3 (or before) - \$75
OS/2 Programmer's Toolkit	320K bytes of RAM One double-sided floppy drive and a hard disk drive OS/2 1.0	\$350
Windows 2.03 Software Developer's Kit	640K bytes of RAM One double-sided floppy drive and 2 megabytes of available storage MS-DOS 3.0 (or higher) Graphics adapter card Windows 2.0 (or higher) Windows/386 (optional) Microsoft-compatible mouse	\$495

tion somewhat differently in protected mode. BASCOM 6.0 also does not offer EGA, VGA, or Hercules graphics support in protected mode. Otherwise, BASCOM 6.0 mirrors QuickBASIC 4.0. Like QuickBASIC 4.0, BASCOM 6.0 offers two options for arithmetic support in either real or protected mode. One option emits in-line code for use by a math coprocessor, if present, or emulates coprocessor functions in software when no coprocessor is present. The other option offers a software-only math package that uses a subset of IEEE-754 Binary Floating-Point Standard number formats.

The major difference in the two versions of BASIC lies in the way you create programs for real and protected mode. Linking under OS/2 is much more involved than under MS-DOS. BASCOM 6.0's linker can be used in either real or protected mode, but in protected mode the number of linking options is greater.

This increased number of options lets you modify libraries, override default libraries, combine libraries, and create extended run-time modules of your own functions. You can call OS/2 functions from within your BASCOM 6.0 programs by using the DOSCALLS.BI file, added to your program with a #include: DOSCALLS.BI statement. This file contains declarations for OS/2 function calls and type definitions for data structures used by OS/2.

While BASCOM 6.0 lets you use some of OS/2's facilities, it will not let you create multiple threads from within a protected-mode BASIC program. You can call external routines or create a process that creates multiple threads. Multiple threads within a BASCOM 6.0 program are not possible because BASCOM 6.0 run-time routines are not reentrant.

BASCOM 6.0 provides record- and

continued

Table 2: Results of sample program execution with Microsoft's FORTRAN Compiler 4.1. File sizes for the compiled program gauss were slightly larger in the bound version and ran a little slower. When running two copies of the program, the second copy slowed down significantly more than the first.

	File size (bytes)	Execution time (seconds)
Real mode	45818	53
Protected mode	50318	60
Bound version, running under OS/2	61070	60
Bound version, multitasking, first copy	61070	76
Bound version, multitasking, second copy	61070	113

file-locking features in both real and protected modes. These features work well for networked applications in real mode; however, record and file locking are more important in protected mode for multiprocessing file operations.

With BASCOM 6.0, programmers now have a way to port their BASIC programs to the OS/2 protected-mode environment.

FORTRAN Compiler 4.1

Microsoft's newest version of its optimizing FORTRAN compiler lets you create .EXE programs that run under MS-DOS 3.0 or higher (including the DOS compatibility box of OS/2), OS/2 protected mode, or under both operating systems. The package also supports the use of DOS and OS/2 environment variables to specify frequently used command-line options, and it includes switches for compiling and linking under OS/2 or DOS.

As a further convenience for software developers who will be compiling for a wide variety of systems, the FORTRAN compiler lets you specify, on the command line, that a particular default library not be searched during linking. You can even set up code overlays on the command line.

Installation of the 10-disk package takes a few minutes but is fairly simple, thanks to the well-designed installation program. We found it particularly helpful be able to run through the entire setup procedure on a "dry run" basis, using an option presented at the beginning of the setup procedure. At various points during the process, the program gives you the option of learning more about a given subject before making a crucial setup decision; for instance, whether to install for 80x87 hardware or emulation, and

whether to build a medium- or large-memory model library.

While testing a prerelease version of the package on a Compaq Deskpro 386/20 running OS/2 version 1.0, we put many of these new features to use. For instance, the commands to compile, link, and bind a test program called gauss.for were

```
FL /AL /FPc /Od /Zi /c gauss.for
link /NOD:llibfore.lib llib-
fep.lib gauss+c:\lib\apilmr,,;
```

and

```
bind gauss c:\lib\api.lib
c:\lib\doscalls.lib
```

To see how the various compiling options worked, we used the 300-line numerical approximation program gauss.for and compiled the program for real mode, protected mode, and both (using the bind utility). Table 2 summarizes the results. Not surprisingly, .EXE file sizes were largest on the bound version and smallest on the real-mode version. The real-mode version ran 15 percent faster than the OS/2 versions, which is also to be expected due to the greater overhead of the multitasking OS/2 operating system.

Just to demonstrate the latter feature (multitasking), we started a second copy of the program running while the first copy was running. This slowed down the times somewhat, but otherwise everything worked fine. (The second copy ran considerably slower than the first, because the first copy was assigned to the active window group and thus had a higher priority in the multitasking scheduler.)

FORTRAN 4.1 may be the first tool to

open up OS/2 systems to mainframe applications. According to Microsoft spokesman Greg Lobdell, beta testers of FORTRAN 4.1 in the aerospace industry have been especially pleased with the OS/2 version, which lets them run IBM VS and DEC VAX mainframe applications requiring very large memory spaces (up to 128 megabytes) on their 80286/80386 personal computers. (In practice, the upper limit for virtual memory may be less, depending on the amount of free space on the disk drive.)

Macro Assembler 5.1

Gone are the days when assemblers seemed geared to programmers who were apparently happy to work with the software equivalents of flint axes and bone-bladed knives. Microsoft's latest release of its macro assembler, MASM 5.1, arrived on five disks filled to the gunwales with the assembler and supporting utilities: LIB (the library manager), LINK, the CodeView symbolic debugger, Microsoft's program editor, an entire disk of CodeView tutorial, demonstration programs with "glue code" for attaching assembly language routines to high-level languages, and more.

MASM 5.1's foremost improvement over MASM 5.0 is, of course, its support for and ability to run under OS/2. There are actually two versions of the MASM.EXE program provided with 5.1—one that runs only under MS-DOS, and a bound version that executes under DOS 3.x as well as OS/2.

The documentation we received contained about seven pages covering OS/2 and included sample code fragments illustrating OS/2's calling convention. If you're counting on using MASM to create programs that run under either MS-DOS or OS/2, you'll discover most of your work will go into creating judicious macros governed by assembly switches to emit code based on the target operating system.

The update information for MASM 5.1 also boasted that the MS-DOS version of the assembler was faster than its ancestors thanks to a better use of far memory, while the OS/2-compatible version was billed as being slightly slower. Although there's no way we knew whether 5.1 uses memory more intelligently than its predecessors, we did run a sample assembly of the same 62K-byte source file under both MASM 5.0 and a prerelease version of 5.1.

On a Compaq 386 running Compaq DOS at 20 MHz with a 40-megabyte hard disk drive, all assemblies (we ran three—one for 5.0 and one each for the two new 5.1 versions) yielded identical object

continued

Fast database development system with SQL-based db_QUERY and Lotus 123 interface. . . .TM

db.Vista III

C PROGRAMMERS-

We asked what you wanted in a database development system and we built it!

db_VISTA IIITM is the database development system for programmers who want powerful, high performance DBMS capabilities ... and in any environment. Based on the network database model and the B-tree indexing method, db_VISTA III gives you the most powerful and efficient system for data organization and access. From simple file management to complex database structures with millions of records. db_VISTA III runs on most computers and operating systems like MS-DOS, UNIX, VAX/VMS and OS/2. It's written in C and the complete source code is available, so your application performance and portability are guaranteed! With db_VISTA III you can build applications for single-user microcomputers to multi-user LANs, up to minis and even mainframes.

FAST • PORTABLE • ROYALTY-FREE

PROFESSIONAL SERVICES: In addition to 60 days of FREE technical support, we offer complete services to get your development project going and keep it on track:

Training Classes • Extended Support • Applications Development & C Programming Services • Consulting • Database Design & Optimization • Product Modification

We're committed to making your database project a success!

HOW TO ORDER: Call us; we'll help determine your needs and get you started. Add components as you need them. Ask about the new Lotus interface. . . Call today!

The db_Vista Difference

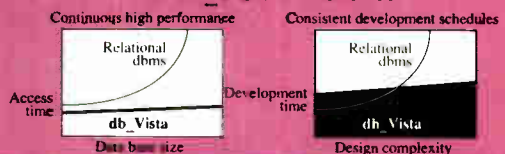

The db_VISTA IIITM Database Development System

- 1 db_VISTATM: The High Performance DBMS**
The major features include:
 - Multi-user support for LANs and multi-user computers.
 - Multiple database access.
 - File and record locking.
 - Automatic database recovery.
 - Transaction processing and logging.
 - Timestamping.
 - Database consistency check utility.
 - Fast access methods based on the network database model and B-tree indexing.
 - An easy-to-use interactive database access utility.
 - File transfer utilities for importing/exporting ASCII text and dBASE II/III files.
 - A Database Definition Language patterned after C.
 - Virtual memory disk caching for fast database access.
 - A runtime library of over 100 functions.
 - 2 db_QUERYTM: The SQL-based Query.**
 - Provides relational view of db_VISTA applications
 - Structured Query Language
 - C linkable.
 - Predefine query procedures or run ad-hoc queries "on the fly".
 - 3 db_REVERSETM: The Database Restructure Program.**
 - Redesign your database easily.
 - Converts all existing data to revised design.
 - 4 WKS Library for Lotus 123.**
 - C-linkable interface to Lotus files.
- Operating systems: MS-DOS, UNIX V, XENIX, VMS, OS/2.
C Compilers: Lattice, Microsoft, IBM, Aztec, Computer Innovations, Turbo C, XENIX, and UNIX.
LAN systems: LifeNet, NetWare, PC Network, 3Com, SCO XENIX-NET, other NET-BIOS compatible MS-DOS networks.

All components feature royalty-free run-time distribution, source code availability and our commitment to customer service. That's why corporations like ARCO, AT&T, Hewlett-Packard, IBM, Northwestern Mutual Life, UNISYS and others use our products.

db_VISTA IIITM Database Development System

db_VISTA III TM	\$595 - 3960
db_QUERY TM	\$595 - 3960
db_REVERSE TM	\$595 - 3960
db_VISTA TM File Manager	Starts at \$195
WKS Library for Lotus 123	Starts at \$195

When high quality data base applications with outstanding performance are important to your company's success:



CALL 1-800-db-RAIMA



(that's 1-800-327-2462)

In the UK call Systemstar Ltd. 0992-500919

RAIMATM
CORPORATION

3055 112th Avenue N.E., Bellevue, WA 98004 (206) 828-4636
Telex: 6503018237MCIUW FAX: (206) 828-3131

BY48

— TURBO G —

Graphics Programming Environment for C

Powerful commands with easy-to-use syntax.

Device Independence allows one program to run on VGA, EGA, CGA, or Hercules without modification. Full support of each adapter.

No memory intensive device drivers required.

Direct video memory access for speed with software switch for BIOS option.

Labelling with any AutoCAD** font. Two fonts included.

Hidden line suppression automatic for 3-D surfaces.

Multiple graphic viewports.

Available for most popular C Compilers. (Specify when ordering)

Source available for customization.

No Royalties!!

Comprehensive Manual.

**AutoCad is a trademark of Autodesk, Inc.

Library \$79.95
Source \$149.95

Order Today!

TXM, Inc.

Box 5142
Cary, NC 27511
(919)467-6855
(919)481-9452

Master Card, VISA, Choice

It could be that the best news about the latest macro assembler is that there is no bad news.

files (that was a relief) in around 8.5 seconds; any difference in the times was immeasurable. We should point out that the code we were compiling did not use any new OS/2 features, so the resulting object file was for MS-DOS only. Had we added the DOS bindings (in the file DOSCALLS.LIB) when we assembled with 5.1, the resulting object code would certainly have been larger.

MASM 5.1's most attractive new features, however, have to be the numerous embellishments its designers have added to macros and compiler directives: extensions to the PROC and MODEL directives to ease interface to high-level languages, a new LOCAL directive for creating and manipulating stack-based local variables, and ELSEIF—which lets you considerably simplify complex IF constructs in conditional assemblies.

MASM 5.1 also adds predefined text macros that allow a program to query its intended environment at assembly time. For example, if you've set the target CPU for an assembly using an assembly language directive (such as .286), you can perform conditional assembly based on the value of @CPU. This value's bit settings indicate which processor and/or co-processor you've selected. Finally, with MASM 5.1 you can explicitly indicate pointers within data declarations; this lets you properly view the data item as a pointer when debugging with CodeView.

Overall, this is an update for MASM that was certainly called for by the oncoming OS/2, and we're happy to see that MASM's designers are paying attention to everyone out there attaching assembly language routines to high-level languages. What we're saying here is "no big surprises," and it could be that the best news about MASM 5.1 is that there is no bad news.

Pascal Compiler 4.0

In Pascal these days, the key number is 4—as in Turbo Pascal version 4, and now the Microsoft Pascal Compiler version 4. Faced with keen competition from the low-cost Turbo product from Borland, Microsoft has enhanced its own Pascal with a number of key features, including OS/2 support, the CodeView debugger, and a text editor.

The new compiler's support for OS/2

will probably be its most noteworthy feature. Most of the significant programs included with the compiler are bound, meaning that they can be run under either MS-DOS or OS/2. In addition, you can choose to have your own programs bound, or you can link them so that they are specifically tailored to either MS-DOS or OS/2. Thus, you can develop OS/2 programs in the familiar MS-DOS environment. Or, you can develop MS-DOS programs under OS/2. The latter approach should not be overlooked, since the OS/2 environment should allow more memory for debugging purposes and multitasking.

Note, however, that one should be careful when programming for multitasking. The procedures and functions in the Pascal library are not reentrant. Thus, you should be careful not to enter a particular function until you are sure that no other part of your program is using it.

The new Pascal also features CodeView for the first time. This version of Microsoft's source code-level debugger now includes the ability to evaluate some Pascal expressions. It also uses virtual memory, which suggests that memory limitations should not occur even under MS-DOS.

Another new feature for Microsoft's Pascal is a text editor. Like the other new language products, the new Pascal includes Microsoft's Editor, a fairly straightforward text editor that reportedly can be linked to the compiler. According to Microsoft, you can run the compiler from the editor and instruct the compiler to pass error information back to the editor. The result should be a rough approximation of the programming environment provided by the Turbo languages. The editor is a bit complicated, however, and many programmers will probably opt to configure it to suit their own preferences or to use their own favorite editors.

The older versions of Microsoft Pascal required two passes to compile a program, each pass performed by a separate program (December 1986 BYTE). Three passes were needed if you wanted an object code listing. The new version still does at least two passes, but you can call all three passes and the linker program with a single driver program called the "PL driver." This obviates the need to construct complex batch files. Note, however, that you can still pass command-line options to the individual passes and to the linker via the command line that invokes the PL driver.

A number of other goodies are probably included in the other new languages. These include a MAKE program, which should automate the process of checking

continued

Introducing

FRONTRUNNER

*New...for dBASE III PLUS Users!
Fast...Resident...Powerful.
FrontRunner offers all this and more!*

- **CREATE MEMORY-RESIDENT dBASE III PLUS™ PROGRAMS** – FrontRunner™ is the first memory-resident applications development tool to contain a large subset of dBASE III PLUS commands and allows you to distribute RunTime™ applications.
- **dBASE III PLUS DATABASE AND INDEX FILE COMPATIBILITY** – Allows you to use FrontRunner immediately.
- **UNIQUE KEYBOARD FEATURE** – Bind commands or entire programs to a single Hotkey for rapid execution from within other applications.
- **PASTE COMMAND** – This powerful command allows you to extract data from your dBASE III PLUS files and paste it into your spreadsheet or word processing application.

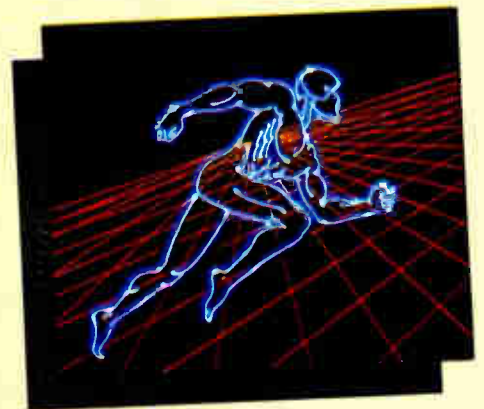

Buy FrontRunner by June 30, 1988 and get a FrontRunner version of RunTime and an unlimited RunTime license for royalty-free applications. FrontRunner is not copy-protected and comes with a 30-day money-back guarantee. The suggested retail price is \$195.

See your local Ashton-Tate dealer now. For more information, or the name of the dealer nearest you, call (800) 437-4329, Ext. 555.*

*In Colorado, call (303) 799-4900, Ext. 555.



ASHTON·TATE

Trademarks / owner: dBASE III PLUS, RunTime, Ashton-Tate / Ashton-Tate Corporation; FrontRunner / Apex Software Corporation. © 1988 Ashton-Tate Corporation. All rights reserved.

Circle 23 on Reader Service Card

World Radio History

High-Performance IEEE-488 Solutions



for your
IBM PS/2

COMPARE THESE BENEFITS

- Runs on Personal System/2 models 50, 60, and 80 (Micro Channel™)
- Most extensive software library – program in the language of your choice
- Highest performance available – up to 1M bytes/sec data transfer rate using NI Turbo488™ gate array
- ON SRQ interrupt response
- Applications Monitor – real-time error checking and program tracing with pop-up windows
- Best price/performance
- FREE technical support with toll free telephone service
- 30-day money back guarantee
- 2-year warranty



**NATIONAL
INSTRUMENTS™**

The Leader in IEEE-488

12109 Technology Blvd.
Austin, Texas • 78727-6204

CALL FOR FREE CATALOG
800/531-4742 • 512/250-9119

to be sure that a program is based on the latest source and object files.

As for performance, we did some tests using a prerelease version of the compiler running under MS-DOS. A full analysis of the speed of the program under both MS-DOS and OS/2 will have to wait for a full review, but Microsoft assured us that any benchmark results we obtained would be similar to those of the shipping product.

On our Sieve test, an MS-DOS program executed in 3.77 seconds on a PC AT clone, about 3 percent faster than the same program compiled under the previous version of Microsoft Pascal (version 3.32). A bound version of the program running under MS-DOS ran at the same speed as the DOS-only version. By contrast, the same program produced by Turbo Pascal version 4 required 33 percent more time.

As for program size, the DOS-only version of the Sieve program weighed in at 31K bytes, while the bound version was 42K bytes. The same program produced by the previous version of Microsoft Pascal was 32K, but the Turbo version was a mere 3K.

For floating-point calculations, the new compiler has a numeric-coprocessor-emulator option similar to that used on the older versions of the compiler. When a program is compiled with this option set, it will use an 8087 or 80287 coprocessor if found, or it will emulate these coprocessors if they are not present. To get a rough idea of the performance in this area of computations, we ran a floating-point benchmark without a coprocessor. The benchmark ran 10 percent faster than a similar program compiled under the previous Microsoft Pascal. The Turbo version, however, was 26 percent faster than the new version.

One other feature of the new Pascal compiler is that it should have less of a tendency to run out of memory. It now uses far memory to store the table of symbol names, instead of storing these names in a single segment along with the stack. This should mean that the symbol table is limited only by system memory and that the stack can grow much larger.

Microsoft Pascal 4.0 comes on nine 5¼-inch floppy disks and, when completely loaded on your hard disk, takes up about 2.5 megabytes. This alone is an indication of significant change—the last version consisted of only two disks.

Development Kits

In addition to OS/2 language functionality, Microsoft has introduced software tools to further encourage the development of OS/2-based applications. For the most part, these development packages

consist of lots of documentation with some accompanying software.

The OS/2 Programmer's Toolkit, for instance, can be used with any of the five language compilers described earlier and is made up of three manuals: The OS/2 Programmer's Reference Manual is a comprehensive description of OS/2 system functions, structures, and file formats; the OS/2 Programmer's Learning Guide describes OS/2 programming techniques; and the OS/2 Programming Tools explains the software tools and utilities provided with the Toolkit. Among those tools are the BIND.EXE utility (described earlier), API.LIB (a library used in conjunction with BIND.EXE, containing the functions for applications that can run in both MS-DOS and OS/2 environments), and IMP.LIB (a utility that helps programmers create DLLs).

The Windows 2.03 Software Developer's Kit (SDK) also consists of three manuals: the Windows Programmer's Learning Guide, the Windows Programmer's Reference Manual, and the Windows Extension Manual. (Version 1.04 of the SDK did not include a Learning Guide.) The SDK provides information ranging from a description of all the Windows functions, messages, data types and structures, and file formats to a step-by-step guide to creating Windows applications. It also provides an exhaustive discussion of the Tag Image File Format (TIFF) and Dynamic Data Exchange (DDE) characteristics.

In terms of the software, the differences between the SDK 1.04 and 2.03 are a new API, which provides 15 new functions and messages; updated utilities, including new font and dialog box editors; and a new screen-capture feature called SNAP that lets you copy selected regions of the screen instead of the entire screen (as did the 1.04 SLAPJR utility). Additionally, a debugging aid called SPY has been added to let you "spy" on messages passed from Windows to the application. This debugging tool is selective in that you can specify the type of message (i.e., DDE, mouse, Clipboard, and so on) to monitor.

Furthermore, a couple of new files have been added, particularly an assembly language include file (1.04 had only C and Pascal include files), new floating-point libraries, and the capability to instill within applications the automatic checking of host personal computers to see if a math coprocessor chip is present. ■

This article was written jointly by the following BYTE editors: Jonathan Erickson, Richard Grehan, Rich Malloy, George A. Stewart, Tom Thompson, and G. Michael Vose.

MINUTEMAN[®]

UNINTERRUPTIBLE POWER SUPPLIES



PROTECTION FROM:

- BROWNOUTS
- SPIKES
- BLACKOUTS
- SURGES
- OVER VOLTAGE
- EMI/RFI

- Fully Automatic Operation
- Sine Wave Output 1 msec maximum switching time*
- Order — ship same day
- Full one year warranty

* 250 Watt and 500 Watt Units offer 4 msec switching; PWM waveform



FREE!

With any UPS purchase from March 15 thru April 30, 1988

TEST TRUE RUN CURRENT BEFORE YOU BUY



A \$90 VALUE

The TS10B Load Tester is designed to measure the exact power consumption of your system. This enables you to select just the right sized UPS model. It also tests for 6 common wiring faults in your wall sockets that can cause computer malfunction.

Suggested Retail

250 WATT	120 Volt	\$ 359.00
300 WATT	120 Volt	\$ 549.00
500 WATT	120 Volt	\$ 699.00
600 WATT	120 Volt	\$ 899.00
1200 WATT	120 Volt	\$1499.00
1600 WATT	120 Volt	\$1999.00

230 Watt Units Also Available

1455 LeMay Drive
Carrollton, Texas 75007

PARA SYSTEMS, INC.

Telephone:
(214) 446-7363

Fax: (214) 446-9011 **1-800-238-7272** TELEX: 140275 OMEGA



PSpice

The Standard for Analog Circuit Simulation Now Available on the Macintosh II

Since its introduction just over four years ago, MicroSim's PSpice has sold more copies than all other commercial Spice programs combined. In addition to running on the IBM PC family, including the new PS/2 and the Compaq 386, the Sun 3 workstation and the VAX/VMS family, PSpice is now available on Apple's Macintosh II.

All these features which have made PSpice so popular are available:

- Standard parts libraries for diodes, bipolar transistors, power MOSFET's, opamps, voltage comparators, and transformer cores.
- GaAs MESFET devices.
- Non-linear transformer devices modeling saturation, hysteresis, and eddy current losses.
- Ideal switches for use with, for example, power supply and switched capacitor circuit designs.

Please call or write today for a free demo copy of PSpice. Find out for yourself why PSpice is the standard in analog circuit simulation.

In addition, all these PSpice options are available on the Macintosh:

- Monte Carlo analysis to calculate the effect of parameter tolerances on circuit performance.
- The Probe "software oscilloscope", allowing interactive viewing of simulation results.
- The Parts parameter extraction program, allowing you to extract a device's model parameters from data sheet information.
- The Digital Files interface, allowing you to transfer data from your logic simulator to (or from) PSpice. The interface performs the necessary D to A or A to D conversions.

Each copy of PSpice comes with our extensive product support. Our technical staff has over 50 years of experience in CAD/CAE and our software is supported by the engineers who wrote it. With PSpice, expert assistance is only a phone call away.



MicroSim Corporation

23175 La Cadena Drive, Laguna Hills, CA 92653 U.S.A. • (714) 770-3022 (800) 826-8603 • Telex 265154 SPICE UR

PSpice is a registered trademark of MicroSim Corporation; Macintosh II is a trademark of Apple Computer, Inc.; Compaq 386 is a trademark of Compaq Computer Corporation; IBM PC, PS/2 are registered trademarks of International Business Machines Corporation; Sun is a trademark of Sun Microsystems, Inc.; VAX and VMS are trademarks of Digital Equipment Corporation.

Nicholas Baran

dBASE IV: A Paradox Killer?

Ashton-Tate's long-awaited new edition of dBASE ups the ante against competitors like Paradox and R:base

Faced with strong competition from rival database managers, Ashton-Tate is reasserting its leadership in the database market with the release of dBASE IV.

In addition to major new features such as Structured Query Language (SQL) support, a source code compiler, and a greatly improved user interface, dBASE IV appears to meet or beat the capabilities of its main competitors while preserving complete compatibility with dBASE III. Indeed, Ashton-Tate claims that all databases, forms, reports, and applications developed in dBASE III will run without modification in dBASE IV.

Ashton-Tate is billing dBASE IV as the crucial first step in developing complete database connectivity between personal computers, "workgroup environments," and mainframe SQL databases. But, although dBASE IV supports a complete set of SQL commands either in interactive command mode or as embedded commands in dBASE programming code, there is no provision for transferring data between dBASE and SQL databases. In other words, the SQL implementation is useful only for developers who want to write code that they can eventually port to SQL environments.

True portability of SQL and dBASE IV databases will have to wait for the SQL Server system planned for OS/2, which was announced in January in conjunction with Microsoft and Sybase. Ultimately, Ashton-Tate's goal is to make dBASE the database of choice on Unix and VMS file servers as well as on MS-DOS and OS/2 systems.

Leaving the Past Behind

While dBASE IV might be a stepping stone to the future, it is also a major break with the past. Until now, dBASE has always had a reputation for being hard to

learn and hard to use, requiring a great deal more programming than its competitors. Ashton-Tate has answered this criticism with a completely redesigned menu-driven user interface (though you can still use the familiar dot prompt if you want) plus an improved applications generator, keyboard macros, and a query-by-example (QBE) feature similar to that found in Paradox.

In addition, new reports and form generators include menu-driven screen designers, calculated fields, data validation, box and line drawing, and other new

features for customizing input and output screens. The new dBASE also includes a facility for automatically generating graphs and charts on Ashton-Tate's Chart-Master graphics software. You do have to exit from dBASE, however, to run Chart-Master.

The dBASE IV database structure is fully compatible with earlier dBASE versions but includes a new floating-point data type with 64-bit numerical precision. Also, you can now manipulate data in memo fields as you would other text

continued

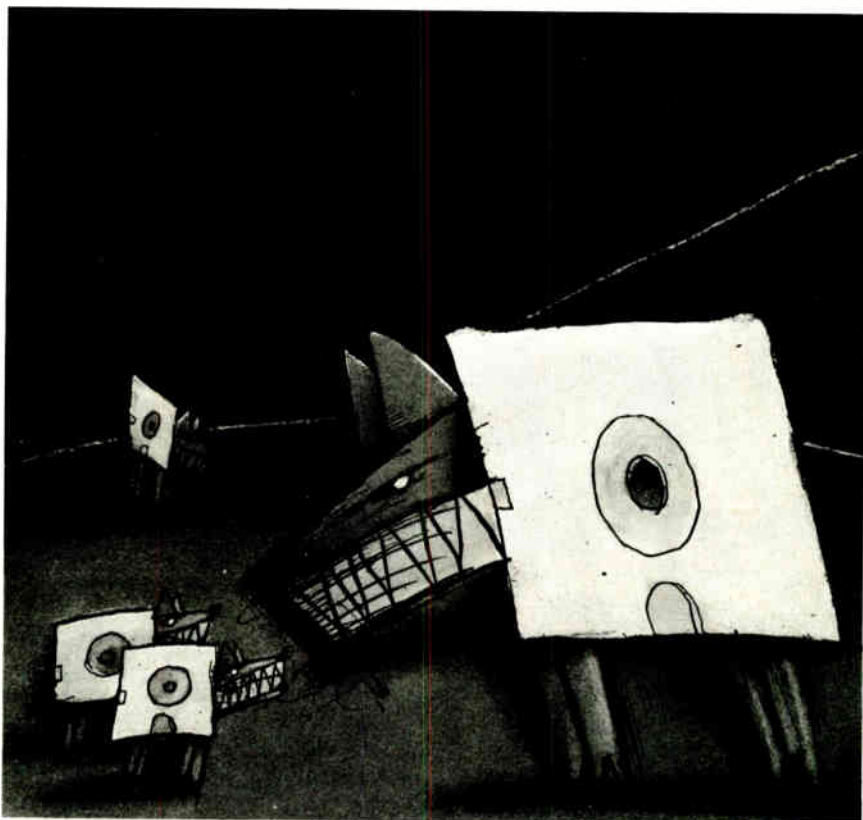

fields, which you could not in dBASE III.

Another enhancement to the database structure is the ability to combine multiple databases into a view or "pseudo" database, which looks like any other database. This means you can work with forms, reports, and application code that access the view and automatically extract and update data from the databases linked to the view. This feature makes relational operations far less complex than in earlier dBASE versions. However, you can have only one view or database on the screen at a given time, unless you resort to programming.

The latest dBASE also has automatic indexing with up to 47 indexes per database file. Although you can still create your own NDX index files, the automatic indexing feature eliminates the need for them in most situations.

The dBASE IV package includes upgrades to the dBASE programming and command language. These include a library of financial and mathematical functions, a "template language" for customizing the applications generator, commands for creating windows with pop-up and pull-down menus, and a new multiple-window debugger. The windowing capability allows applications de-

velopers to create windows on the screen that can display multiple databases simultaneously.

Object-Code Compiler Adds Speed

The new package also includes a compiler of sorts. dBASE IV's new compiler produces a type of object code that, according to Ashton-Tate, makes dBASE programs execute up to 9 times faster than in dBASE III.

The compiler produces files with a .DBO file extension rather than the .EXE or .COM files produced by most other compilers. A special Build utility in a developer's version allows you to link compiled programs together.

Finally, dBASE IV includes improvements for multiuser applications. These include transaction processing, error recovery, password security and encryption, and automatic record and file locking, with an indicator identifying which workstation is locking the file or record.

dBASE IV will be available for both MS-DOS and OS/2. The MS-DOS version requires 640K bytes of RAM and automatically uses extended or expanded memory, if either is present.

When dBASE ships in July, it will be in two editions: the standard dBASE IV

(\$795) for productivity users, and the Developer's Edition (\$1295) for serious programmers and applications developers. The two are the same except that the Developer's Edition includes additional documentation for programmers and developers, plus the Build utility for linking compiled source code, unlimited runtime support, and LAN keys for testing multiuser applications.

A report provided by Ashton-Tate summarizing the differences between dBASE IV and dBASE III is over 50 pages long. There obviously isn't space here to discuss all the other new or enhanced commands and functions. But it is clear that Ashton-Tate's objective is to silence its critics and to expand its already overwhelming share of the database market. ■

[Editor's Note: We based this First Impression on product demonstrations and early documentation provided by Ashton-Tate. We are planning to provide a more detailed review of the product in the near future.]

Nicholas Baran is an associate technical editor of news and technology at BYTE's San Francisco office.

"A NIGHTMARE ON EPROM STREET"



Has your programming turned into one continuous nightmare? Furthermore, are you afraid to sleep at night for the fear of waking up to irate bosses screaming at the top of their lungs for the completion of a program you've been working on for months? If so, **WAKE UP!** GTEK®, Inc. has created four products that are an instant cure for you "sleepy-headed" insomniacs.



GTEK®'s Model 9000 Eprom Programmer is just the nightcap you need. Its quick pulse and intelligent programming algorithms give you **SUPER FAST** programming speed, and you can program the chip of your choice, including MPUs and megabit parts.



Ten Times Faster than GTEK®'s original gang programmer, this New Model 9800 Gang Programmer has **SUPERSONIC** quick pulse programming algorithms. What's more, you'll get your project completed **8 times faster** by programming 8 eproms at a time. Plus, you can program megabit parts. It's a sweet dream come true.



GTEK®'s New ROMX-2 Eprom Emulator will definitely put you to sleep 17 hours early because that's the time you'll save with the ROMX-2 on your first project. Plus, this product comes with free software. It pays for itself, **Satisfaction Guaranteed!**

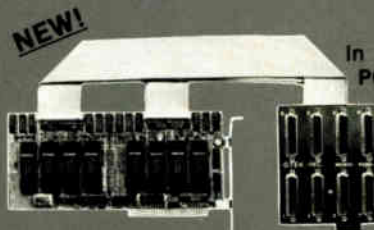

In a class by itself, the New **PCSS-8X Multiport Serial Board** has 100% Dos compatibility on all 8 ports and an enhanced INT 14H Bios device driver, not to mention free software and a number of other fantastic features.

ORDER TOLL FREE 1-800-255-GTEK (4835)
FAX: 1-601-467-0935 TELEX 315814 (GTEK UD)
MS & Technical Support 1-601-467-8048



DEVELOPMENT HARDWARE & SOFTWARE
P. O. Box 2310
Bay St. Louis, MS 39521-2310 U.S.A.



Create a 5.25" Diskette that reads right on any drive.

Pass it around. Never a compatibility problem system-to-system. New 2-piece protective packaging and error-free performance warranted for life accent the BASF commitment to technological leadership and business solutions. Call 800-343-4600 for the name of your nearest supplier.

The Spirit of Innovation.



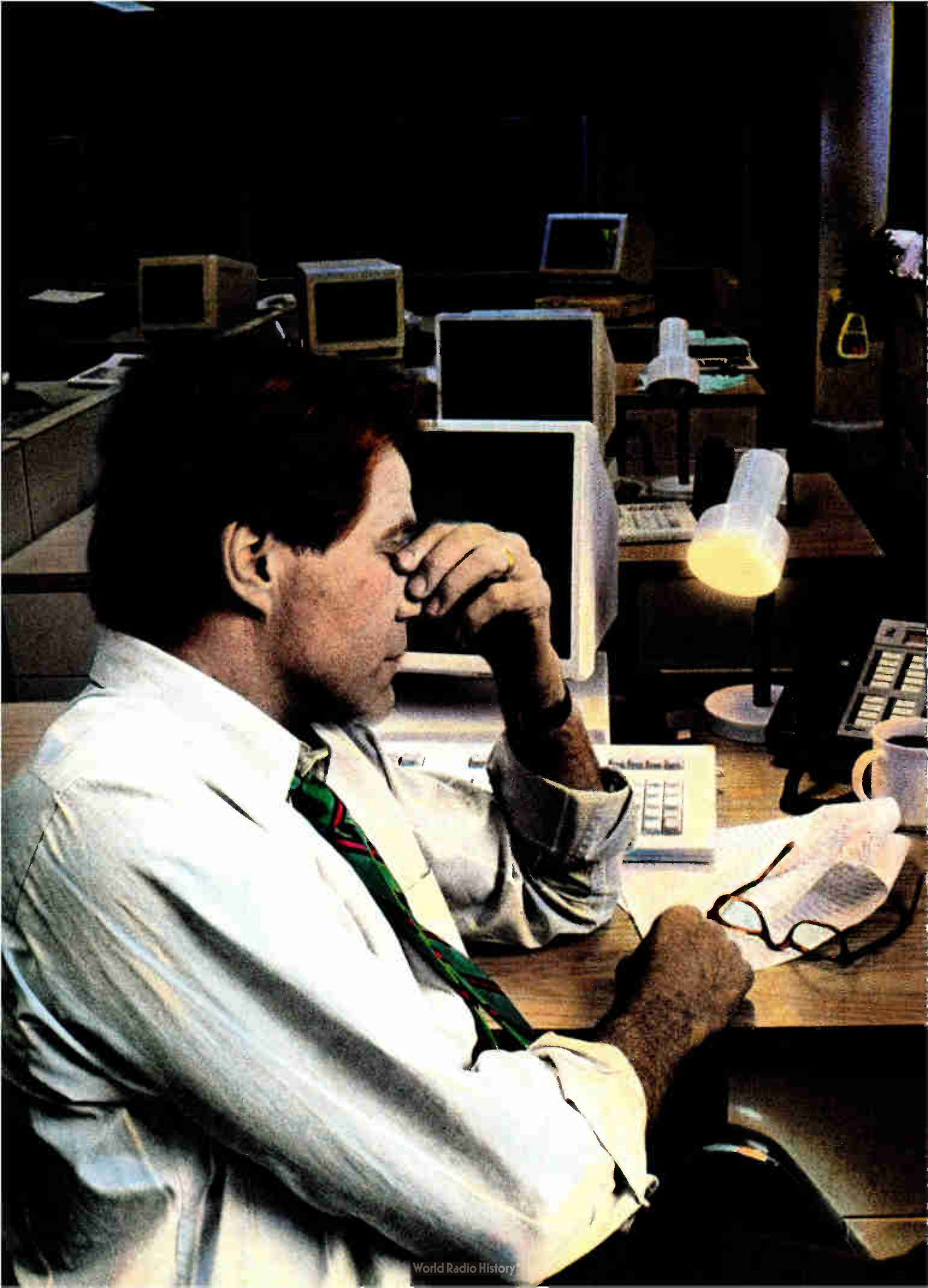

“It's 6:33 pm. The lines are down. And she's the closest thing I've got to a technician.

Meanwhile, I've got a sales guy here waiting to close a half-million-dollar deal, and he's screaming 'why didn't my order go through.' I have no clue. My technical staff is home watching the game. And all I keep thinking is whatever happened to that word reliability? If I could have anticipated the problem, at least I would have had a chance. As far as I'm concerned, somebody at headquarters better start talking to AT&T about getting a network management system. Or they can find themselves a new whipping boy.

AT&T comes through.”



AT&T DATAPHONE® II Network Management System

There's no great mystery to improving your operating efficiencies. You just have to start with fail-proof data communications equipment. As follows.

AT&T's DATAPHONE II System Controller manages a fully integrated network of modems (analog, private line, switched network), multiplexers (statistical, T-1), and digital service units (switched, private line).

Networks of any size can be managed from a single point, so problems can be readily pinpointed and corrected.

Real-time diagnostics and re-routing help anticipate system failures and reduce downtime. Complete monitoring includes customized reports, menus and graphic displays that let you fine-tune your network.

To learn more, contact your AT&T Account Executive. Or call 1 800 247-1212 for the number of our office nearest you.

From equipment to networking, from computers to communications, AT&T is the right choice.

© 1988 AT&T



AT&T

The right choice.



The Best of the 24-pin Printers

George A. Stewart



OUTSTANDING BUYS

Low/Middle Price

*Speed and print-quality tests
reveal the best values
among 37 dot-matrix printers*

Selecting a dot-matrix printer can be a maddening experience. You have to weigh differences in price, speed, and print quality, and then hack your way through a morass of specifications and descriptions of font cartridges, buffer sizes, emulations, and control panels.

But the factors that really matter are speed and quality, and if you insist on having both in one printer, you'd better focus your attention on 24-pin dot-matrix printers. Traditionally the top of the line in terms of price and quality, some of the new models rival 9-pin printers in both speed and price.

To help you in the selection process, we tested 37 of the newest 24-pin dot-matrix printers. We've grouped them into four categories so you can quickly focus on the ones that fit your budget: low (\$499 to \$999), middle (\$1000 to \$1499), high (\$1500 to \$1999), and deluxe (\$2000 to \$2499).

The good news is that bargain hunters have the widest choice: Almost half the units fall into the low-price category. In last year's dot-matrix-printer roundup (April 1987 BYTE), only four 24-pin printers, out of 15 tested, fell into that range. Further good news is that the character-per-second (cps) speeds are up. Last year's top three ratings in "top quality font" throughput at 10 characters per inch (cpi) were 94, 96, and 104 cps; this year, the top three were timed at 103, 118, and 138 cps. Speeds in draft and graphics modes also showed similar increases.

All the printers we tested meet certain minimum standards. For example, character pitches of 10, 12, 17.1, and proportional spacing are universally available. All the units have parallel interfaces; serial interfaces are also available on all the printers, either as an option or standard.

All the printers emulated at least one 9- or 8-pin printer, typically an IBM Proprinter, an IBM 5152 Graphics Printer, or an Epson FX printer. However, these

emulations will not give you the full capability of a 24-pin printer. For that, these printers need to emulate a 24-pin standard like the Epson LQ or the Toshiba P351. All the printers we tested had one or more emulation modes for taking advantage of 24-pin capabilities. When more than one standard was available, we selected the emulation that gave the best results.

For this review, we selected wide-carriage models (using up to 15-inch-wide paper) unless only a narrow-carriage model was available. Narrow-carriage models (using 8½-inch-wide paper) are generally \$200 to \$300 less than their wide-carriage counterparts. Thus, if you don't need the wide-paper capability, you can save some money without sacrificing anything in terms of performance or quality.

Table 1 lists the printers by price category, along with individual specifications and features. One significant specification is the MTBF (mean time between failure) rating, a manufacturer's rating of the durability of a printer.

One relatively new feature for printers is forms parking, the ability to automatically retract one type of paper already in the printer—like multipart forms—to let you insert and print on a single sheet like letterhead, and then to automatically reload the multipart forms. This feature, available on only a few printers we tested, increases the versatility of a printer for office use; 24-pin printers are often called upon to do letters as well as forms printing. Another extra-cost option offered for most of these units is an automatic sheet-feeder bin.

Testing Criteria

We measured throughput, sound level, and print quality on each printer, using an IBM PC AT running at 8 MHz to drive the printers.

80-column text throughput. This is a realistic measurement of print speed using a typical document. Our 80-col-

continued



Epson LQ-500



Fujitsu DL3400



Copal WriteHand 6700

High/Deluxe Price



HP RuggedWriter 480



Okidata Microline 393



Fujitsu DL5600

DOT-MATRIX PRINTERS

Table 1: The 37 24-pin dot-matrix printers we tested vary widely in price. The printers are grouped here according to price category, with other key specifications and features listed.

Manufacturer/Model	Price	Carriage	Resident fonts ¹	Plug-in font cartridge	Draft-quality/top-quality switch ²	Forms parking ³
Price category: Low						
Epson LQ-500	\$499	narrow	3	●	○	●
NEC P2200	\$499	narrow	5	●	●	●
Seikosha SL-80AI	\$549	narrow	1	○	●	●
Copai WH 6700	\$795	wide	1	●	●	○
Epson LQ-850	\$799	narrow	3	●	○	○
Printronix P1013	\$895	narrow	1	●	●	●
Panasonic KX-P1524	\$899	wide	1	●	●	●
Brother M-1724L	\$949	wide	1	●	●	●
Citizen Tribute 224	\$949	wide	1	●	●	○
ALPS ALQ324	\$995	wide	1	●	●	○
Fujitsu DL3400	\$995	wide	1	●	●	○
NEC P7	\$995	wide	2	●	○	○
Sanyo PR-241	\$999	wide	7	○	●	●
Star Micronics NB24-15	\$999	wide	1	●	●	●
Toshiba P341SL	\$999	wide	3	●	○	○
Price category: Middle						
IBM Proprinter XL24	\$1049	wide	1	●	●	●
Dataproducts 9044	\$1099	wide	2	●	●	○
Epson LQ-1050	\$1099	wide	3	●	○	○
Facit B3450	\$1245	wide	2	●	○	○
C. Itoh C-715A	\$1295	wide	1	●	●	○
Nissho NP-2405	\$1295	wide	2	●	○	●
ALPS P2400C	\$1395	wide	1	●	●	○
Okidata Microline 393	\$1399	wide	2	●	●	○
Star Micronics NB-15	\$1399	wide	1	●	●	○
Epson LQ-2500	\$1449	wide	6	●	○	○
Fujitsu DL2600	\$1495	wide	1	●	●	●
NEC P5XL	\$1495	wide	2	●	○	○
Toshiba P351SX	\$1499	wide	4	●	○	○
Price category: High						
Radio Shack DMP-2120	\$1599	wide	1	○	●	○
AT&T 477	\$1695	wide	1	●	●	○
Hewlett-Packard RW 480	\$1695	wide	2	●	○	●
Nissho NP-2410	\$1745	wide	2	●	○	○
NEC P9XL	\$1795	wide	2	●	●	○
Mannesmann Tally MT330	\$1799	wide	1	●	●	●
C. Itoh C-815	\$1995	wide	2	●	○	○
Price category: Deluxe						
Fujitsu DL5600	\$2195	wide	1	●	●	○
Japan Digital Laboratory JDL-850	\$2495	wide	2	●	●	●

Notes

NA—Information not available from manufacturer.

●—Feature is available.

○—Feature is not available.

¹ The number of built-in 10-pitch fonts.

² Draft-quality/top-quality switch implies that each font can print in draft quality or top quality.

umn ASCII document consists of five pages (330 lines) of single-spaced text with 1-inch margins, indented paragraphs and ragged right margins, and with three tables on the last page. The text contains no special attributes like underlining or boldface.

As with all the tests, we transferred the data from a hard disk file to the printer

using the PC-DOS *copy file* command. We started the timer when the command was entered and stopped the timer when the last line was printed.

We timed the printers in draft-quality mode and in top-quality mode (variously referred to by manufacturers as letter quality, near letter quality, or correspondence quality; we always used the highest

quality available).

132-column text throughput. To test the printers on 132-column text, we used a full page (66 lines) of numbers divided into 11 columns, similar to a financial report or spreadsheet. We measured the time for draft quality and top quality at 10 cpi. To allow testing of the narrow-carriage printers, we also ran the test using

DOT-MATRIX PRINTERS

Maximum copies ⁴	Input buffer		MTBF ⁵	Dimensions (Inches) height by width by depth	Weight (pounds)	Comments ⁶
	standard	optional				
3	8	0	4000	6 × 15 × 13	15	Pitch-select by software only
3	8	0	4000	6 × 15 × 11	11	Front-load cut sheets; compact
3	16	0	3200	6 × 16 × 13	1	Pitch-select by software only
3	18	32	4000	5 × 23 × 15	24	Light-duty tractor mechanism
4	6	32	4000	6 × 17 × 14	20	
3	2	0	4000	5 × 16 × 12	19	24-pin hammer-bank mechanism
4	13	2	4000	6 × 24 × 15	35	Versatile paper handling
4	0	32	4000	5 × 20 × 12	19	Versatile paper handling
4	24	0	5000	5 × 23 × 14	1	NC model Tribute 124, \$699
4	7	64	5000	6 × 19 × 16	31	NC model ALQ224, \$695
3	24	0	5000	5 × 23 × 14	27	NC model DL3300, \$799
4	18	32	5000	4 × 22 × 13	25	NC model P6, \$699
4	10	0	5000	4 × 22 × 13	20	Awkward to configure
3	5	16	NA	5 × 23 × 15	33	NC model NB24-10, \$749
3	32	32	NA	4 × 16 × 15	18	NC model P321SL, \$749
2	6	0	NA	5 × 23 × 14	27	NC model Proprinter X24, \$799
4	32	0	5000	5 × 23 × 13	27	NC model 9034, \$899
4	16	32	6000	6 × 24 × 14	26	NC model LQ-850, \$799
4	16	0	4000	7 × 25 × 16	33	Versatile paper handling
4	3	0	7200	5 × 25 × 15	38	Plug-in emulation cards
5	6	30	6000	8 × 24 × 15	33	Full-feature control panel
6	4	252	6000	7 × 25 × 18	44	Versatile paper handling
4	30	0	4000	7 × 16 × 22	37	Versatile paper handling
3		16	NA	5 × 23 × 15	33	
4	8	32	6000	6 × 23 × 15	26	
5	8	0	6000	6 × 22 × 15	40	
4	8	32	7000	6 × 23 × 15	37	
6	32	32	NA	6 × 23 × 16	33	Versatile paper handling
5	0	64	3000	8 × 23 × 15	50	Manual forms parking
5	8	0	6000	6 × 22 × 15	40	Easy configuration dialogue
4	2	16	5000	8 × 24 × 14	35	Front-loading forms
5	6	48	6000	6 × 24 × 17	41	Versatile paper handling
6	8	32	7000	6 × 23 × 15	37	Automatic paper loading
4	0	32	4800	7 × 24 × 17	55	Difficult ribbon loading
4	42	0	7200	6 × 23 × 16	33	
8	24	0	8000	7 × 24 × 15	45	Versatile paper handling
4	128	0	4000	8 × 26 × 17	43	Includes HP plotter emulation

³ Refers to automatic forms parking only.

⁴ Maximum copies includes original and applies to carbonless forms.

⁵ Mean time between failures, in hours, as quoted by manufacturer; the rating systems vary among manufacturer—most are for a 25 percent duty cycle.

⁶ NC stands for narrow-carriage counterpart.

17.1 cpi, draft mode, producing 8-inch instead of 13-inch lines. (At 17.1 cpi, draft mode is of higher quality than at 10 cpi because of the higher dot density.)

Throughput values are inevitably lower than the cps speeds quoted by the manufacturers. The manufacturer's rating is actually the highest speed the printer is capable of on a single line. Our tests take

into account the time required to advance the paper and position the print head to the start of the next line.

Table 2 presents all the throughput figures in cps and lines per minute (lpm). The cps figures are given to ease comparison with last year's results; lpm is a more standard unit of measurement for throughput. Characters per second is

simply the document length in bytes divided by the number of seconds to print it. Lines per minute is the document length in lines divided by the number of minutes required to print it. Keep in mind that 66 lpm is equivalent to one page per minute, in either 80-column or 132-column printing.

continued

Table 2: Throughput ratings for 80-column and 132-column text reveal clear leaders in each price category. Higher numbers signify faster performance.

Manufacturer/Model	80-column throughput				132-column throughput					
	draft, cps	draft, lpm	top, cps	top, lpm	draft, cps	draft, lpm	top, cps	top, lpm	cond., cps	cond., lpm
Price category: Low										
Epson LQ-500	101	124	44	54	*	*	*	*	124	55
NEC P2200	85	105	39	49	*	*	*	*	95	42
Seikosha SL-80AI	56	69	30	37	*	*	*	*	60	26
Copial WH 6700	102	126	50	62	138	61	60	27	130	58
Epson LQ-850	148	183	64	79	*	*	*	*	173	77
Printronix P1013	107	132	42	52	*	*	*	*	130	58
Panasonic KX-P1524	107	132	48	59	140	62	52	23	124	55
Brother M-1724L	107	132	49	60	128	57	48	21	111	50
Citizen Tribute 224	122	151	55	68	149	67	61	27	157	70
ALPS ALQ324	105	130	50	62	147	66	58	26	128	57
Fujitsu DL3400	146	180	58	71	188	84	57	25	155	69
NEC P7	111	137	50	62	138	61	54	24	121	54
Sanyo PR-241	90	111	49	61	130	58	54	24	85	38
Star Micronics NB24-15	113	139	50	61	147	66	55	25	79	35
Toshiba P341SL	110	135	47	58	145	64	53	23	136	60
Price category: Middle										
IBM Proprinter XL24	159	196	64	79	173	77	63	28	147	66
Dataproducts 9044	121	150	61	75	184	82	72	32	149	67
Epson LQ-1050	147	181	64	79	180	80	66	29	176	79
Facit B3450	134	166	56	69	176	79	66	29	149	67
C. Itoh C-715A	131	162	63	77	201	90	74	33	166	74
Nissho NP-2405	139	172	64	79	188	84	73	32	276	123
ALPS P2400C	146	180	73	90	215	96	87	39	188	84
Okidata Microline 393	184	227	89	110	232	104	92	41	315	141
Star Micronics NB-15	140	173	62	77	192	86	72	32	109	48
Epson LQ-2500	128	158	61	76	173	77	73	32	116	52
Fujitsu DL2600	146	180	73	90	188	84	76	34	196	88
NEC P5XL	132	163	57	71	78	35	43	19	82	37
Toshiba P351SX	165	204	77	96	232	104	88	39	221	99
Price category: High										
Radio Shack DMP-2120	150	185	74	91	196	88	77	34	201	90
AT&T 477	146	180	73	90	192	86	76	34	201	90
Hewlett-Packard RW 480	191	236	138	171	253	113	155	69	227	102
Nissho NP-2410	169	208	103	127	239	107	132	59	294	132
NEC P9XL	170	210	82	101	232	104	90	40	196	88
Mannesmann Tally MT330	205	253	72	88	252	113	72	32	**	**
C. Itoh C-815	182	225	91	112	252	113	116	52	184	82
Price category: Deluxe										
Fujitsu DL5600	236	291	118	146	315	141	124	55	368	165
Japan Digital Laboratory JDL-850	169	208	95	117	226	101	106	47	166	74

* Test not applicable on narrow-carriage printers.

** Would not complete test due to software incompatibility.

Complex text printing speed. To compare the printers' speeds on more complicated text, we used a document consisting of various combinations of underlining, bold, italic, superscript, subscript, pica, and elite fonts. We generated the print file using the XyWrite III Plus word-processing program configured with printer drivers for Epson LQ, Toshiba P351, or

IBM 5152 graphics printers, depending on the emulation in each printer.

These results are not directly comparable to the 80-column text throughput results because the style test is an unrealistically dense mix of printing styles. It is definitely not a throughput test. Table 3 lists these results in cps only. What is significant about this test is how it ranks the

printers within the same price category.

Graphics speed. Two tests measured graphics speed. The first test consisted of printing four graphs (two scatterplots containing lines and circles, a bar chart, and a pie chart) on a single page. We produced the print file using STATA 1.5, a statistical-analysis and data-presentation program, configured with a printer

Table 3: Epson and Fujitsu printers, along with several others, did well on the style, graphics, and gray-scale tests (higher numbers are preferable). In the sound-level ratings, where lower numbers are preferable, each 3-decibel increase corresponds to a doubling in the intensity of the sound.

Manufacturer/Model	Style, cps	Graphics, cps	Gray scale, cps	Top-quality sound level, dBA
Price category: Low				
Epson LQ-500	67	850	692	72
NEC P2200	46	830	920	72
Seikosha SL-80AI	*	45	329	68
Copal WH 6700	59	450	312	69
Epson LQ-850	100	1350	1548	71
Printronix P1013	65	683	1173	78
Panasonic KX-P1524	61	850	826	75
Brother M-1724L	65	931	413	72
Citizen Tribute 224	71	917	*	73
ALPS ALQ324	52	562	420	69
Fujitsu DL3400	92	1440	627	63
NEC P7	55	1255	1024	65
Sanyo PR-241	52	955	611	68
Star Micronics NB24-15	39	705	627	72
Toshiba P341SL	38	905	404	70
Price category: Middle				
IBM Proprinter XL24	58	195	299	73
Dataproducts 9044	34	687	371	72
Epson LQ-1050	105	1367	1548	71
Facit B3450	52	1090	790	72
C. Itoh C-715A	39	1186	516	74
Nissho NP-2405	60	650	855	71
ALPS P2400C	70	1000	920	70
Okidata Microline 393	80	2400	*	67
Star Micronics NB-15	45	658	430	75
Epson LQ-2500	78	1459	1192	70
Fujitsu DL2600	105	1588	1399	69
NEC P5XL	66	1421	1276	68
Toshiba P351SX	59	2117	876	70
Price category: High				
Radio Shack DMP-2120	76	465	932	68
AT&T 477	109	1301	1515	69
Hewlett-Packard RW 480	68	542	854	69
Nissho NP-2410	66	683	1039	71
NEC P9XL	87	1928	1914	68
Mannesmann Tally MT330	*	1069	826	63
C. Itoh C-815	100	2823	673	71
Price category: Deluxe				
Fujitsu DL5600	171	3176	2273	68
Japan Digital Laboratory JDL-850	72	497	836	63

*Would not complete test due to software incompatibility.

driver for Epson LQ, Toshiba P351, or IBM 5152 graphics printers. The first two drivers take advantage of the 24-pin high-dot-density capabilities and were used wherever possible. (Only the Radio Shack DMP 2120 required us to fall back to the IBM graphics printer driver, since that unit's 24-pin graphics command set is unique to Tandy.)

The second graphics throughput test consisted of a series of gray-scale patterns written for 9-pin printers with IBM 5152 Graphics Printer emulation. This is a very stressful test because the print head is constantly working. Some printers had to slow down to cool off, reducing their effective throughput. For example, the Brother M-1724L came to a complete

stop several times to cool off during this test.

Table 3 includes cps results for both graphics tests. Keep in mind that, here, cps should more properly be called bytes per second, since the test file is binary, not ASCII.

Sound level. We measured the sound level of each printer during draft-quality and top-quality text printing (80-column ASCII file) and for graphics speed printing (gray-scale test).

Our test device, the Radio Shack sound-level meter (Model #33-2050), was positioned on a tripod 2 feet in front of the test unit, at ear level for a person sitting in front of the printer. We used the meter's A weighting, which models an average person's auditory frequency response.

Our numbers are higher than those quoted in the manufacturer's specifications because we used a small office rather than the standard environment prescribed for sound-level measurements; however, our numbers are consistent and valid for making comparisons. The results for sound levels during the top-quality-mode test are given in table 3; the results were comparable for the draft-quality-mode and graphics tests.

Print quality. Finally, we subjectively evaluated the print quality of text and graphics from each printer. For text quality, we used a few pages from the top-quality-mode 80-column throughput test and the complex text-printing speed test. For graphics quality, we used both graphics speed tests: the four-graph printout and the gray-scale printout.

We posted the 74 samples along two walls, museum style, numbered for reference but unlabeled as to manufacturer. Twenty-two BYTE staff members rated samples on a scale of 1 (worst) to 5 (best) (see figure 1), using the following criteria:

Text:

- Uniform print density (no variation in density)
- Uniform shape of characters (a given letter always looks the same)
- Clarity (easy to read)

Graphics:

- Straight lines and smooth curves
- Solid, uniform filled-in black areas
- Fineness of lines
- Uniform density of filled-in areas (no variation in density)

Each printer's final score was the numeric rating (1 to 5) that its print sample received most frequently from the BYTE staff.

continued



Photo 1: As with most of these printers, the NEC P2200 is small and light, yet it offers numerous advanced features.

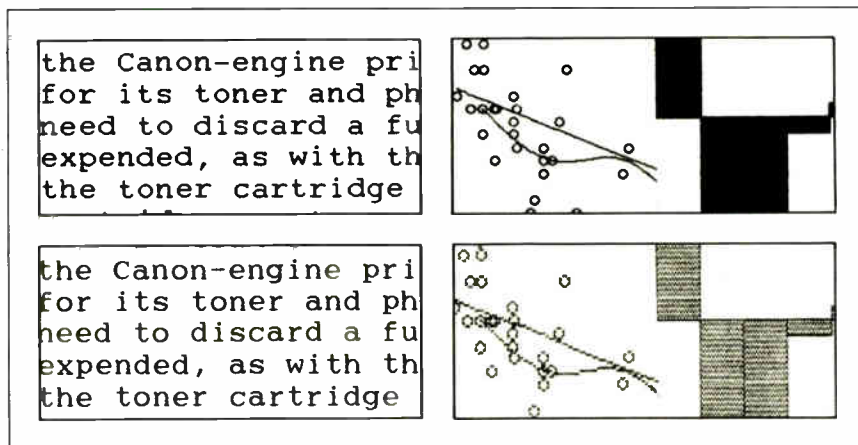

Figure 1: In our ratings of top quality and graphics printing, the two samples on top received a score of 5; the two on the bottom received scores of 3 (left) and 1 (right).

The Proof Is in the Printing

In general, throughput goes up with price; however, a few exceptions are noted below. Sound levels are generally highest in the low-price range. One surprising fact is that text quality is generally highest among the middle-price printers.

Print quality. Among low-cost printers, the Fujitsu DL3400, the Panasonic KX-P1524, and the Printronix P1013 rated highest, with 4s for text and graphics. Among middle-price units, the NEC P5XL had perfect 5s for text and graphics, while the C. Itoh C-715A, the Okidata Microline 393, and the Nissho

NP-2405 had 4s in both categories. Among high-priced printers, the Hewlett-Packard RuggedWriter RW 480 and the Nissho NP-2410 had two perfect 5s. The Fujitsu DL5600 won in the deluxe-price category with a 4 and a 3 in text and graphics, respectively.

Throughput, 80-column, draft quality. As shown in table 2, the Epson LQ-850 and the Fujitsu DL3400 won in the low-price category, with rates of 148 cps and 146 cps, respectively. The Okidata Microline 393 won in the middle-price category by a wide margin, with 184 cps; the Toshiba P351SX followed at 165 cps. The high-price category also had a clear

leader, the Mannesmann Tally MT330 at 205 cps; the Hewlett-Packard RW 480 was second at 191 cps. The Fujitsu DL5600 achieved a blistering 236 cps in the deluxe-price category, equivalent to approximately 4.4 pages a minute.

Throughput, 80-column, top quality. Although the speeds were slower by about half, the fastest printers in this test were the same units that won the 80-column draft test, except in the high-price category, where the Hewlett-Packard RW 480 was the clear winner (138 cps), followed by the Nissho NP-2410. Surprisingly, the Mannesmann Tally MT330, which won the draft test, dropped to last in its category in this test.

Throughput, 132-column, draft quality. The winner list in this category resembled that of the 80-column draft test, except for the narrow-carriage Epson LQ-850, which could do only the condensed-font (17.1 cpi) test.

Throughput, 132-column, top quality. The wide-carriage units in the low-price category ranked close together, with speeds ranging from the Brother M-1724L's low of 48 cps to the Citizen Tribute 224's high of 61. Results in the middle-price range were equally close, except for the NEC P5XL, which turned in a 43-cps rating, less than half that of the Okidata Microline 393's top-rated 92 cps. The Hewlett-Packard RW 480 again won in the high-price category by a wide margin. The Fujitsu DL5600 outperformed the Japan Digital Laboratories JDL-850 in the deluxe-price class, 124 cps to 106 cps.

Throughput, 132-column, condensed font. Rankings followed the 80-column top-quality results fairly closely, except among high-price printers, where the Nissho NP-2410 at 294 cps was almost 30 percent faster than the next-ranked Hewlett-Packard RW 480.

Style test. The only surprises were in the middle-price range, where the Epson LQ-1050 and the Fujitsu DL2600 won by a clear margin at 105 cps, and in the high-price range, where the AT&T 477 won with 109 cps.

Graphics tests. The cps ratings in both tests varied over a wider range than with the other throughput tests, from a low of 312 cps to a high of 3176 cps. For the four-graph printout, the winners were: low price, Epson LQ-850 and Fujitsu DL3400; middle price, Okidata Microline 393; high price, C. Itoh C-815; and deluxe price, Fujitsu DL5600. Gray-scale test winners were: low price, Epson LQ-850; middle price, Epson LQ-1050; high price, NEC P9XL; and deluxe price, Fujitsu DL5600.

Sound level. Low-price units exhibited

continued

DOT-MATRIX PRINTERS

Price range: Low (\$499-\$999) Graphics quality Text quality Throughput (cps)

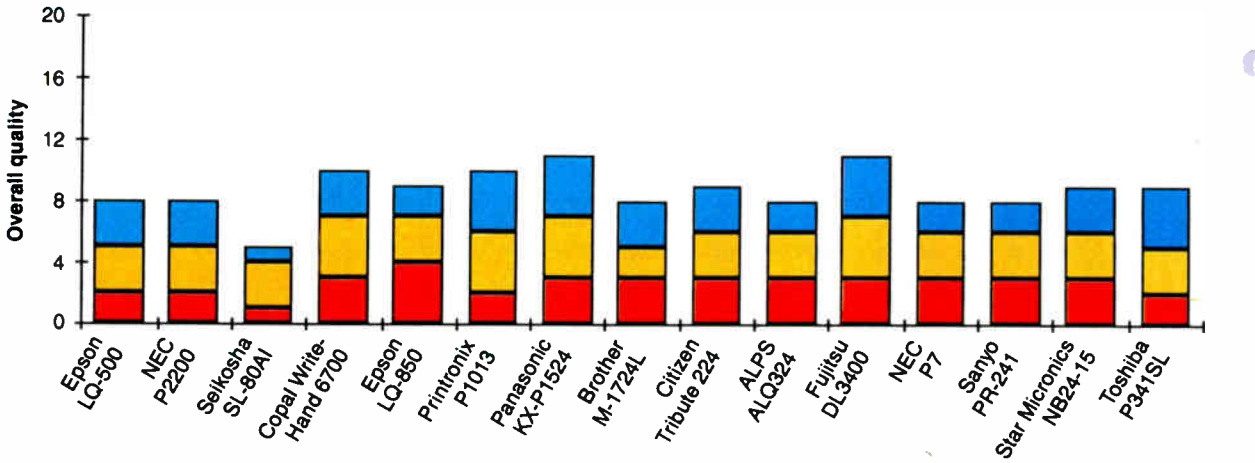

Price range: Middle (\$1000-\$1499)

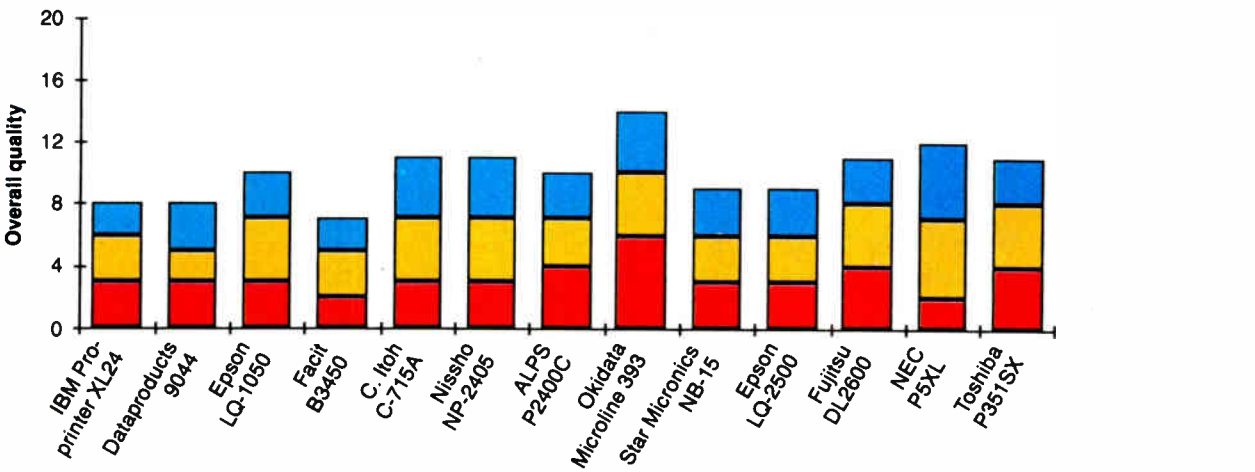

Price range: High (\$1500-\$1999)

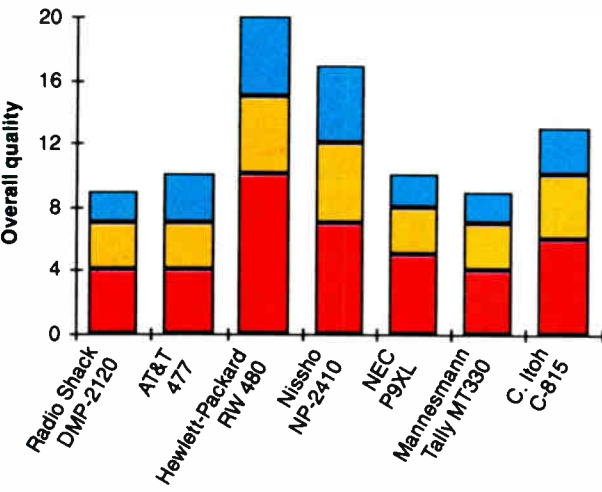

Price range: Deluxe (\$2000-\$2499)

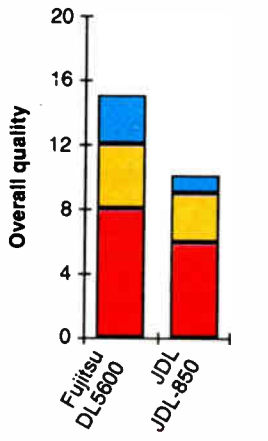

Figure 2: Combined speed (80-column top quality), text quality, and graphics quality ratings give the value performance edge to the Epson LQ-500, the NEC P2200, the Copal WriteHand 6700, and the Fujitsu DL3400 in the low-price range; the Epson LQ-1050, the C. Itoh C-715A, the Nissho NP-2405, and the Okidata Microline 393 in the middle-price range; the Hewlett-Packard RW 480 in the high-price range; and the Fujitsu DL5600 in the deluxe-price range.

Views from BIX: Dot-Matrix Printers

Despite claims of an imminent paperless society, printers are still an essential peripheral for most of us. Everyone has his or her favorite. These comments were taken from the IBM PC conference on BIX and are based on actual user experience.

—Stan Wszola, Technical Editor

LARRY HAMBY [hamby]: "Anybody want to recommend a dot-matrix printer that gives the best correspondence-quality type for the least price? I don't need to type that many great-looking letters, but when I do I hate for them to look so 'computerish.' I want to spend next to nothing, of course. Thanks."

PETE WHITE [petewhite]: "The LQ series of printers from Epson are great. The LQ-800 is reasonable in price, and the LQ-2500 is for me an expensive dream printer."

PATRICIA HENSON [phenson]: "I've read BYTE's April 1987 survey of printers, and from what I could tell it looks as though the Panasonic KX-P1092i is a really good buy if you want good NLQ text. Does anyone have any experience with the KX-P1092i?"

LARRY EMERY [lemery]: "I have owned both a KX-P1091 and a KX-P1592, which are excellent printers for the price. I think the new models (the "i" series, e.g., 1092i) are even better than the old. If so, the NLQ will be real hard to tell from LQ. The 1092 at work is also very nice, but it lacks a compressed print switch on the front panel. They may have corrected this on the 1092i. For all-around quality in construction, print quality, speed, and convenience features, I have yet to see a printer that beats the Panasonics."

NICHOLAS BARAN [nickbaran]: "I highly recommend the IBM Proprinter. I particularly like the single sheet/envelope feeder that you can use without removing the tractor-feed paper. It prints 200 cps in draft mode and about 50 cps in letter-quality mode. You can get a Proprinter for about \$350."

ROEDY GREEN [roedy]: "This is an open letter to the designers of dot-matrix printers describing the sorts of features I would like to see in the new crop of printers and also the blunders in design I would like them to avoid.

"I'm familiar with about a hundred models of printers used in Canada, the U.S., Sweden, India, and Australia. I have written drivers for about 50 of

them. My dream printer is mostly a combination of the best existing features.

"Make sure you fully support the Centronics interface (specifically pins 12 and 13), so the computer can detect whether or not the printer is off-line or out of paper. Roland, Okidata, take note.

"When the user is adjusting the paper or rollers, under no circumstances should the printer start moving. Toshiba, take note.

"When the printer is off-line, the New Page and Line Feed buttons *should* work. Kudos to Hewlett-Packard for inventing the idea and to Roland for copying it.

"The printer manual should show command sequences in ASCII, decimal, hexadecimal, octal, and CHR\$ forms, complete with one realistic example for each form. The examples should show the actual print results of commands.

"For printers with design-your-own fonts, the manual should also show enlarged pictures of the dots on a grid so you can use them as models to design variants. Kudos to Okidata and Epson.

"The paper path should be as straight as possible, with at least 4 pins per side for tractor-feed paper engaging at all times. The paper-threading path instructions should be printed or embossed on the printer where they cannot get lost. Make sure the in and out paper paths are sufficiently separated that the out paper doesn't easily get sucked back in the input. Epson, take note.

"The ribbon cartridge should have no more than 1 cm of ribbon exposed. This makes it almost impossible to misthread the ribbon. Please do not invent yet another cartridge design. Kudos to Toshiba for sticking with a great design through all its models.

"It should be possible to read what the printer has just typed without having to waste a sheet of paper. The Okidata Microline 292 solves this by automatically rolling the paper up for you to look, or tear off, then rolling it back down when you resume printing.

"It should be possible to make micro-alignments both horizontally and vertically while the printer is printing. The Sujata, a printer manufactured in India and designed by Printek, has such features.

"If the printer does not receive any

new characters for a few seconds, it should go ahead and print rather than holding characters in its buffer waiting for a carriage return. Kudos to Okidata.

"If a printer cannot do all possible combinations of attributes, it should use the following priorities: First, get the pitch right. Then worry about getting the type width right. If you don't get these right, things will look a mess because they will not align. Once you've got that right, worry about getting italic and boldface right. Then, finally, handle NLQ. Better still, allow all combinations. Kudos to the IBM 5152.

"Support Epson 8-bit graphics.

"Downloadable character sets should be saved in battery-backed RAM while the power to the printer is turned off to clear a jam or to reset top of form. Kudos to Okidata. Toshiba, take note.

"Make sure there is a way to print every last item in the IBM 256-character set so that a decent Print Screen is possible. Ideally, use the IBM codes untranslated.

"To make single-sheet feeding easy, there should be a simple lever to turn off the paper-out detect. It should not be necessary to remove the tractor and set a DIP switch. Toshiba, take note.

"Redesign the printer until the proper print ribbon thread path is the one naturally selected by naive users 95 percent of the time. Toshiba, take note. Kudos to Seikosha and Sujata.

"When designing your printer, make the presumption it is in a different room from where the computer is. Anything you can do from the printer's control panel, you should be able to do from the computer.

"Finally, what kind of name is KX-P1595C or MP-1300AI for a printer? How are you supposed to pronounce it? Remember it? Do they really plan to manufacture $26 \times 26 \times 26 \times 10 \times 10 \times 10 \times 10 \times 26 = 45,686,760,000$ different models of printer? That's even a little optimistic for a serial number. Get serious, Panasonic and Seikosha."

[Editor's note: *Views from BIX presents a variety of informal, diverse opinions from users of a selected class of products. Messages chosen for publication may be edited for length or clarity. The views expressed are those of each message's author and do not necessarily reflect those of BYTE or BYTE's reviewers.*]

Time is of the essence. The essence of the HP DraftMaster Plotter. The fastest A to E size drafting plotter made by Hewlett-Packard. A plotter so fast, any designer can create big ideas at blinding speeds.

How did we do it? With unsurpassed acceleration. And features like a new pen-sorting algorithm. Bi-directional plotting. And a very fast resident micro-processor. We even offer a model with roll-feed for non-stop plotting.

But the HP DraftMaster doesn't sacrifice output quality for its blinding speed. Every plotter is thoroughly tested to ensure the highest reliability and precision. So you get smooth arcs, straight lines and perfectly-formed characters, time after time. Furthermore, it handles a variety of

pens on drafting film, vellum or paper—all at optimal speeds.

Naturally, it works with just about any computer. Like the HP Vectra PC and IBM PC's. As well as popular PC-CAD software like AutoCAD and VersaCAD. And the DraftMaster brings with it HP's worldwide reputation for quality. Prices start at just \$9,900*.

Why wait? For a brochure and a sample plot, call us at 1 800 367-4772, Ext. 901A.

The drawing shown below was produced on the HP DraftMaster with AutoCAD software.



**HEWLETT
PACKARD**

AutoCAD is a registered trademark of Autodesk Inc. VersaCAD is a registered trademark of T&W Systems *Suggested U.S. list price © 1987 Hewlett Packard Co

Circle 119 on Reader Service Card

*we never
stop
asking*
What if...

How to create monumental plots in a matter of minutes.

Side Exterior
40,962 m
Surface
1,650 m²

Side Exterior
70,695 m
Surface
4,200 m²

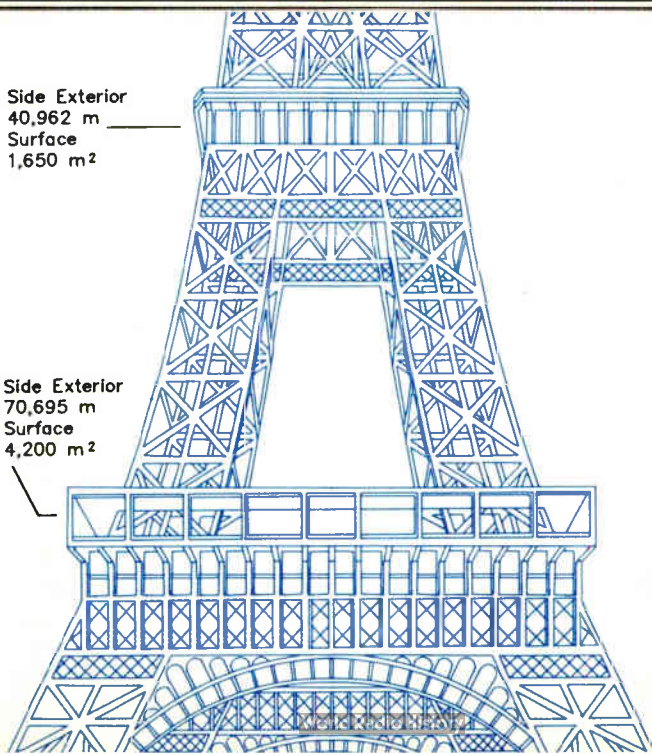

Company Information

ALPS America
3553 North First St.
San Jose, CA 95134
(408) 946-6000
Inquiry 907.

AT&T
4513 Western Ave.
Lisle, IL 60532
(312) 971-6000
Inquiry 908.

Brother International
8 Corporate Place
Piscataway, NJ 08855
(201) 981-3000
Inquiry 909.

C. Itoh Digital Products
2515 McCabe Way
Irvine, CA 92714
(714) 660-1421
Inquiry 910.

Citizen America
2401 Colorado Ave.
Santa Monica, CA 90404
(213) 453-0614
Inquiry 911.

Copal (USA)
2291 205th St.
Suite 105
Torrance, CA 90501
(213) 618-0225
Inquiry 912.

Dataproducts
6200 Canoga Ave.
Woodland Hills, CA 91365
(818) 887-8000
Inquiry 913.

Epson America
2780 Lomita Blvd.
Torrance, CA 90505
(800) 421-5426
Inquiry 914.

Facit
9 Executive Park Dr.
Merrimack, NH 03054
(603) 424-8000
Inquiry 915.

Fujitsu America
3055 Orchard Dr.
San Jose, CA 95134
(408) 432-1300
Inquiry 916.

Hewlett-Packard
1820 Embarcadero Rd.
Palo Alto, CA 94303
(415) 857-1501
Inquiry 917.

IBM
900 King St.
Rye Brook, NY 10573
(800) 426-2468
Inquiry 918.

Japan Digital Laboratory (JDL)
2649 Townsgate Rd.
Suite 500
Westlake Village, CA 91361
(805) 495-3451
Inquiry 919.

Mannesmann Tally
8301 South 180th St.
Kent, WA 98032
(206) 251-5524
Inquiry 920.

NEC Information Systems
1414 Massachusetts Ave.
Boxborough, MA 01719
(617) 264-8000
Inquiry 921.

Nissho Information Systems
10855 Business Center Dr.
Suite 100
Cypress, CA 90630
(714) 952-8700
Inquiry 922.

Okidata
532 Fellowship Rd.
Mount Laurel, NJ 08054
(609) 235-2600
Inquiry 923.

Panasonic
Two Panasonic Way
Secaucus, NJ 07094
(201) 348-7000
Inquiry 924.

Printronic
17500 Cartwright Rd.
Irvine, CA 92713
(714) 863-1900
Inquiry 925.

Radio Shack
1700 One Tandy Center
Fort Worth, TX 76102
(817) 390-3100
Inquiry 926.

Sanyo Business Systems
51 Joseph St.
Moonachie, NJ 07074
(201) 440-9300
Inquiry 927.

Seikosha America
1111 MacArthur Blvd.
Mahwah, NJ 07430
(201) 529-4655
Inquiry 928.

Star Micronics
200 Park Ave.
Suite 3510
New York, NY 10166
(212) 986-6770
Inquiry 929.

Toshiba America
9740 Irvine Blvd.
Irvine, CA 92718
(800) 457-7777
Inquiry 930.

the widest sound-level range of all the categories. Considering the top-quality measurements, as well as the draft and graphics sound levels not shown in the table, the NEC P7, the Fujitsu DL3400, and the Seikosha SL-80AI were quietest. The Printronix P1013 was clearly the noisiest printer, its graphics sound level reaching 84 decibels with the A weighting.

Among middle-price units, the Okidata Microline 393, the NEC P5XL, and the ALPS P2400C were quietest overall, and the Star Micronics NB-15 was loudest. Among high-price units, the Mannesmann Tally MT330 was quietest, and the Nissho NP-2410 and the C. Itoh C-815 were loudest overall. The quietest deluxe-price unit was the Japan Digital Laboratories JDL-850; this is the only rating in which this unit outperformed the Fujitsu DL5600.

No Need for Apologies

The ideal printer should have a high throughput, excellent print quality, and low cost. Are there any candidates among the 37 printers tested?

If you're willing to pay the price, you can definitely find speed and quality in one unit. The Hewlett-Packard RW 480 (\$1695) offers the highest text throughput (top quality) and achieved top ratings in text and graphics quality.

The middle-price category as a whole outperformed the other price ranges in terms of quality ratings (a greater percentage of 4 ratings). The Okidata Microline 393 (\$1399) looks more like a high-price unit in terms of 80-column throughput and quality.

Among low-price units, the Epson LQ-500 (\$499), the Copal WriteHand 6700 (\$795), and the Fujitsu DL3400 (\$995) each offer bargain hunters good

combinations of speed and quality.

Figure 2 shows the relative score for each printer, taking speed and both text and graphics quality into account. This single graph can point you to the best value in each price range.

If quality alone is your consideration, the NEC P5XL (\$1495) may be your best buy; it rated a 5 in both text and graphics quality. Dropping down just one notch in quality, you can look at the Printronix P1013 (\$895), the Panasonic KX-P1524 (\$899), or the Fujitsu DL3400 (\$995), all scored 4s on text and graphics quality.

Finally, you don't have to apologize for using a dot-matrix printer for business communication. ■

George A. Stewart is a technical editor for BYTE. He can be contacted at BYTE, One Phoenix Mill Lane, Peterborough, NH 03458.

Ah, the big idea. Everyone has one. But not everyone can afford a plotter to plot one on. Which got us thinking. What if there was an HP quality plotter so reasonably priced you could afford to hook one up to every PC CAD workstation in the office?

Presenting the HP DraftPro Plotter. For only \$4900 any architect, engineer or designer can create perfect plots time after time.

Consider what the DraftPro can do:

It can draw straight lines, smooth arcs and perfectly-formed characters. All on C and D-size drafting film, paper or vellum, using eight different pen colors.

Furthermore, it works with

just about any PC, such as the HP Vectra PC and IBM PC's. As well as popular PC CAD programs like VersaCAD and AutoCAD.

If the idea of having HP reliability with a low price tag makes sense to you, call us now. For a brochure and sample plot, call 1 800 752-0900, Ext. 901A.

The HP DraftPro Plotter: high-quality drafting for only **\$4900.***

The drawing shown below was produced on the HP DraftPro with VersaCAD software.



VersaCAD is a registered trademark of T & W Systems AutoCAD is a registered trademark of Autodesk, Inc *Suggested U S list price

Circle 120 on Reader Service Card

How to pull off a fantastic HP plot for only \$4900.

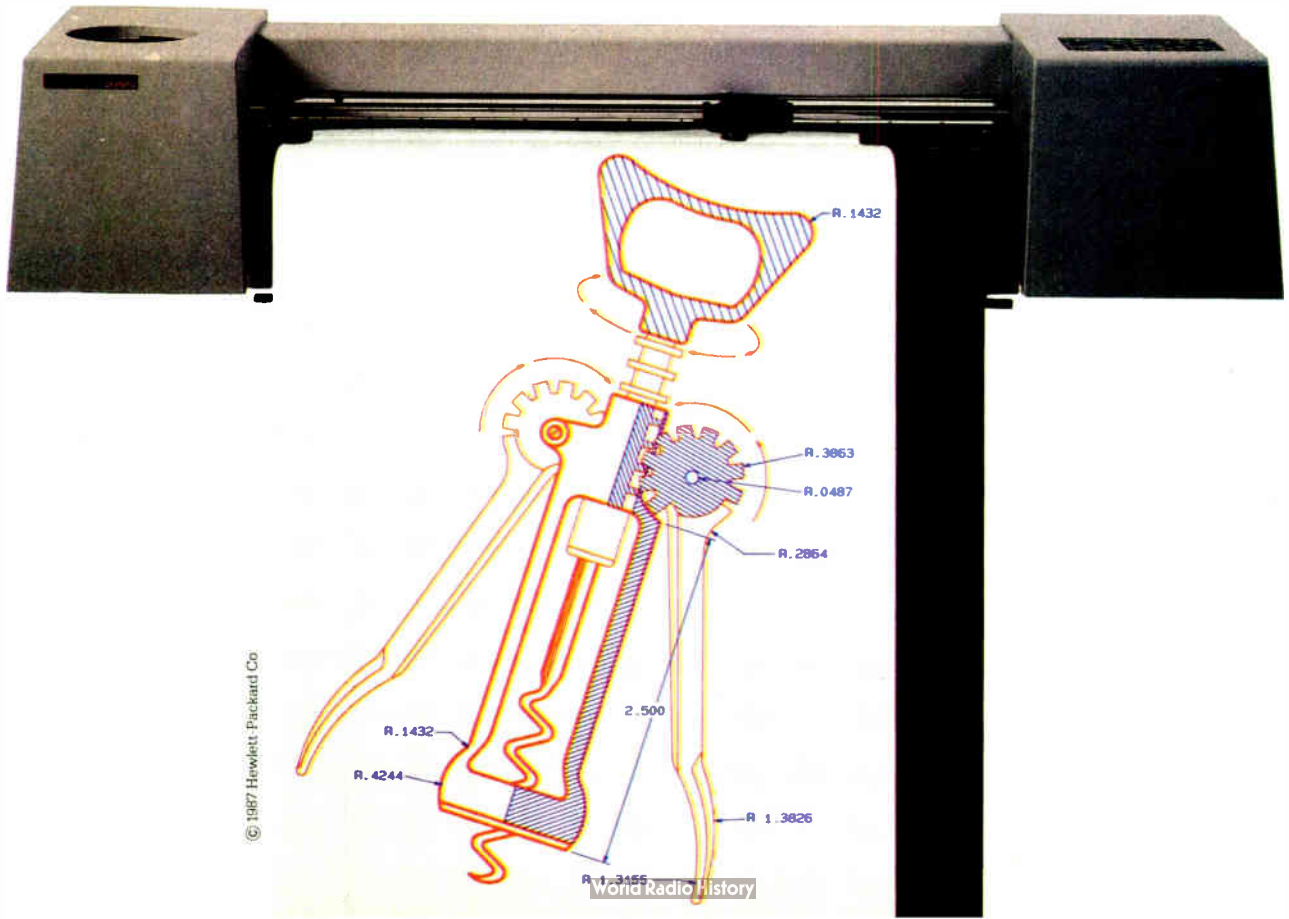

© 1987 Hewlett-Packard Co

World Radio History

Discover Parallel Processing!

Monoputer™

*The Most Cost Effective
Transputer Development System*

MicroWay's **Monoputer** is the best selling Transputer-based PC coprocessor in the world. It was the first board available to run the 20 MHz T414 or T800. As a result, it received many rave reviews in the UK (available on request) and became the standard Transputer software development tool. Parallel code can be executed on a single Monoputer or on an array of Monoputers wired together by their external link lines. The Monoputer includes 2 megabytes of 100 nsec DRAM, a 20 MHz T414 or T800 and the MicroWay stand alone Occam Compiler, which generates Transputer code that runs under MS-DOS. Optional tools include our licensed version of the TDS and a Pascal, Fortran, C, and Prolog.

Quadputer™

*Mainframe Power
For Your PC!*

MicroWay's **Quadputer** is the most versatile multiple Transputer coprocessor on the market today. It can be purchased with 2, 3, or 4 Transputers, each of which has 1 or 4 megabytes of local memory. Two or more Quadputers can be easily cabled together to build larger parallel processor systems. A single Quadputer using four T800s provides 40 MIPS of CPU and 6 megaflops of NDP throughput at one fiftieth the cost of a comparably performing mainframe.

Attend MicroWay's Seminar on Parallel Processing, April 6th in Plymouth, Massachusetts!
For more information please call (617) 746-7341. After July, 1988, call (508) 746-7341.

Micro Way

The World Leader in PC Numerics

P.O. Box 79, Kingston, Mass. 02364 USA (617) 746-7341
32 High St., Kingston-Upon-Thames, UK 01-541-5466
St. Leonards, NSW, Australia 02-439-8400

TRADEMARKS: Quadputer, B.puter and Monoputer of MicroWay, Inc. INMOS, Transputer, TDS, OCCAM of INMOS Corp. MicroWay™ is a registered trademark of MicroWay, Inc.

Circle 174 on Reader Service Card

World Radio History



The WYSEpc 386

Ed McNierney

*A classy 80386-based
system priced to rival machines
from the big boys*

What do you do if you can't afford a top-of-the-line 80386 system like the IBM PS/2 Model 80 or the Compaq Deskpro 386, but you want something a little classier than the 386 systems from the usual clone makers? You could try the WYSEpc 386, a 16-MHz 80386 system with an attractive design, performance to match, and a price tag that beats the 386 systems from IBM and Compaq handily.

At \$4999, the WYSEpc 386 (Model 3216-40) comes with Intel's 80386 processor running at 16 MHz, 1 megabyte of RAM expandable to 6 megabytes, a half-height 1.2-megabyte 5¼-inch floppy disk drive, a half-height 40-megabyte hard disk drive, a 102-key modified AT-style keyboard, one parallel port, and two serial (9-pin male) ports. The review unit also came with an EGA-compatible display adapter and a monitor, bringing its price to \$6247. You can add an 80287 (6-MHz or 10-MHz) or 80387 (16-MHz) coprocessor, but these are not available from WYSE.

Made to Upgrade

The WYSEpc 386 is a standard AT-size unit with a detached keyboard and front-panel controls. The system is based around a backplane design rather than a motherboard system—the CPU and all memory boards sit in expansion slots so they can be repaired or upgraded easily (see photo 1). The system has 10 expansion slots: three 8-bit slots and seven 16-bit slots.

In a standard system configuration, the CPU and the memory board occupy two of the 16-bit slots, and the serial/parallel port board occupies an 8-bit slot. The review unit also had a half-length WYSE EGA-compatible display adapter in one



of the other 8-bit slots. The combination floppy/hard disk controller board lies in front of the backplane board on the bottom of the case and connects to the backplane through a special edge connector, so it doesn't take up any expansion slots.

Missing from the WYSEpc 386 are 32-bit slots. Most manufacturers of 80386-based microcomputers use 32-bit slots chiefly for connecting high-speed RAM expansion boards to maximize system performance. WYSE has taken a slightly different approach, putting the 32-bit extensions on a separate bus that runs across the top of the expansion boards rather than on the backplane. A special rigid connector couples adjacent 32-bit boards together to allow rapid communication.

The standard system comes with the CPU board connected in this way to the

memory board, which holds 1 megabyte of 100-nanosecond (ns) static-column dynamic RAM (DRAM) operating at 16 MHz with zero wait states. You can add an additional megabyte of RAM to the standard board, and you can also plug a second memory board (up to 4 megabytes) into the backplane.

The serial/parallel board connects to the main CPU board with a ribbon cable, and a second serial connector is located on the CPU board. While this makes convenient use of the CPU board's slot space, the two boards are installed as far apart as possible and the cable is strung along the back of the case. The cable gets in the way a bit, but you can remove it if you don't need the second port.

In addition to the basic floppy and hard disk drives, you can install another full or half-height floppy disk drive under the floppy drive, and a second half-height hard disk drive above the original hard disk drive, for a total of four devices driven by the controller board.

The average access time of the 40-megabyte drive is 28 milliseconds (ms), and the Coretest utility showed a slightly slower-than-average data transfer rate of 165K bytes per second. The drive's track-to-track seek time is only 4 ms, and the disk's overall performance is good. The drive is very quiet; when running disk-test software, I had to put my ear to the front panel to hear the disk heads moving—a welcome improvement over many of the scratchy and clattery hard disk drives currently available.

The unit's keyboard connects to the back panel of the CPU board with an RJ-11 telephone jack. The keyboard interface is otherwise compatible with the AT keyboard, and WYSE provides an adapt-

continued

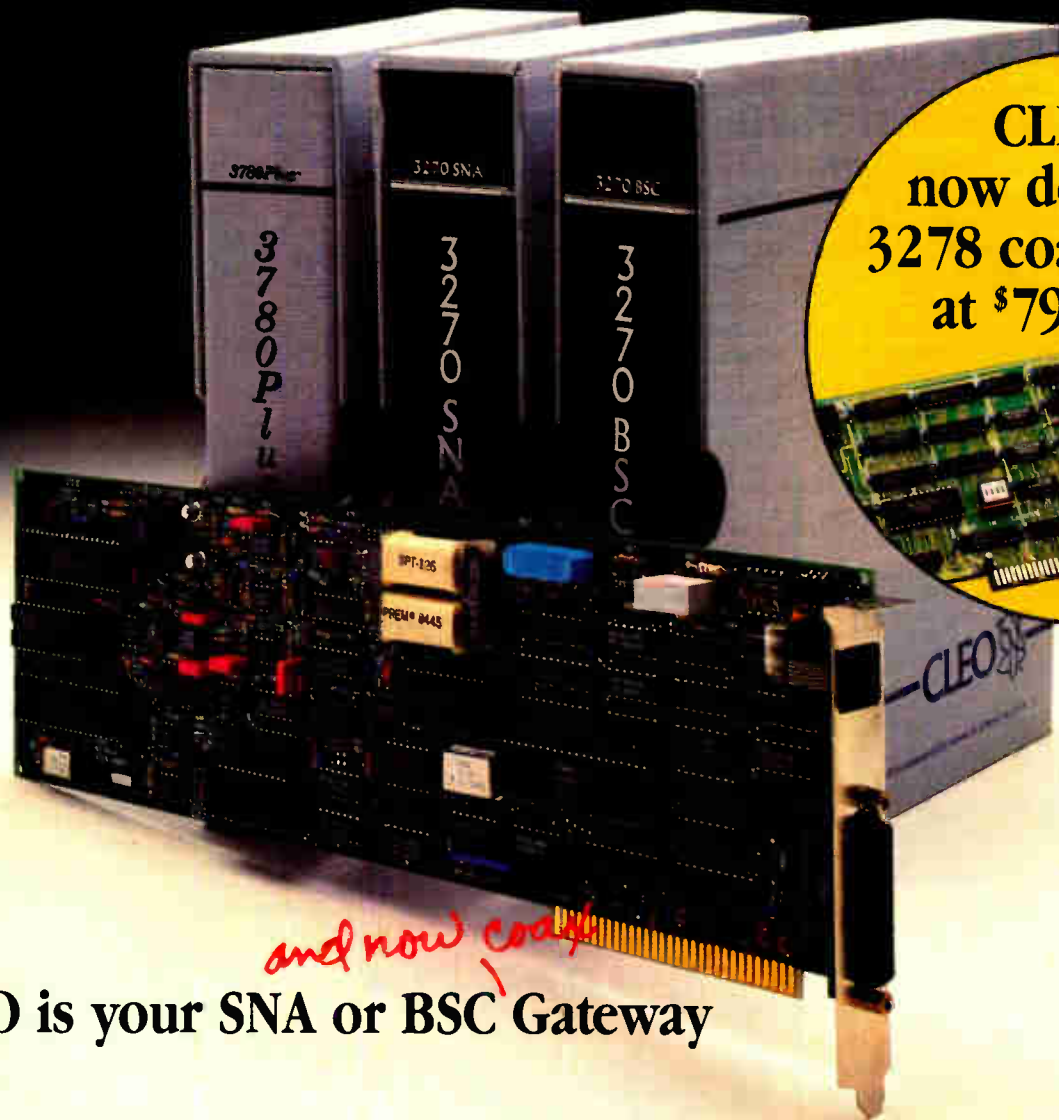

CLEO
 now delivers
 3278 coax cards
 at \$795.00!

and now coax!

CLEO is your SNA or BSC Gateway

Remote Sites Communication

Whatever your industry, your remote computers need to share information with your mainframe. Or, they need to exchange data with other remotes. In either case, you need a total solution at the remote sites. You need software, hardware interfaces and modems that all work together smoothly. You need CLEO!

CLEO software products allow micro-computers to communicate with mini-computers and mainframes, and to emulate their workstations. Since 1981, CLEO has provided remote communications between micros and mainframes for the automotive, insurance, medical and banking industries. Today over 66,000 CLEO users worldwide are running on all major brands of micro-processors. The greatest number of these users run CLEO software on IBM Personal Computers and NETBIOS LANs.

Complete Software/Hardware Package

Every CLEO package contains all the software and hardware accessories needed at the remote site. Your selected CLEO SNA or BSC software is packaged with 1) an internal modem card for dial-up applications, or 2) an interface card and cable for use with your existing modem. There's no waiting for non-CLEO add-ons. And, you get prompt, single-source service.



Package prices range from \$795.00 for most stand-alone packages, up to \$1,995.00 for the 32-user SNA gateway.

Call us today to discuss your application.

CLEO Software
 1639 North Alpine Rd.
 Rockford, IL 61107
 Telex 703639
 FAX 815/397-6535

Headquarters:
 USA: 1-800/233-2536
 Illinois: 1-800/422-2536
 International: 815/397-8110

Sales and Distribution:
 Benelux: 31 (71) 215281
 Canada, East: 800/361-3185
 Canada, West: 800/361-1210
 Canada, Montreal: 514/737-3631
 Colombia, S.A.: 12172266
 Denmark: 1628300
 England: 0908667737
 France: 146861136
 Italy: (0331) 634 562
 Mexico City: 596-5539
 Sweden: 8 740 5070





Commodore Opens the Amiga

Charlie Heath

The Amiga 2000 is poised to be a player in an IBM PC-compatible world. Unlike Commodore's Amiga 1000, the 2000 is expandable through internal slots and space for additional disk drives. Moreover, when equipped with the optional PC-compatible Bridgeboard, the 2000 can run MS-DOS software and use PC peripherals. Commodore has coupled these additions with the Amiga's existing strengths—superb graphics capabilities and a multitasking operating system—and has priced the base system at \$1995.

Based on the same CPU and video hardware as the Amiga 500 and 1000, the 2000 uses a 7.14-MHz 68000 and supports it with a set of custom direct-memory-access (DMA) coprocessors for graphics, audio, and disk I/O. The standard 2000 comes with 1 megabyte of RAM, one 880K-byte 3½-inch floppy disk drive, and 256K bytes of ROM. The machine has

the same display architecture and software compatibility as the 500 and 1000.

The 2000 adds an IBM PC-compatible coprocessor capability to the bus, which has seven expansion slots (see photo 1). Five of the slots form a 100-pin Amiga-compatible bus; two of these also accept AT-compatible boards, and you can place the Bridgeboard in either of them. The two remaining slots are XT-compatible. In addition to the seven main slots, an 86-pin CPU coprocessor slot connects directly into the 68000 bus and is intended for use with enhancements such as a 68020 card. Finally, a custom video slot brings out most of the Amiga's video signals for use with boards such as genlocks or video enhancements.

Also new on the 2000 is space for three drives: two 3½-inch floppy disk drives and one half-height 5¼-inch floppy or

*Will a new open architecture
and IBM PC compatibility
spur the Amiga 2000 to success?*



hard disk drive. The review system had 3 megabytes of RAM, consisting of 512K bytes of 150-nanosecond chip RAM, 512K bytes of on-board 150-ns fast RAM, and 2 megabytes of 150-ns RAM on an expansion card. The system also had a 4.77-MHz 8088-based Bridgeboard with a 5¼-inch floppy disk drive, the A1084 analog and digital RGB/composite monitor, an optional 2090 hard disk controller, and a 20-megabyte ST-506 hard disk drive. (Commodore doesn't sell a hard disk drive for the 2000, preferring to let dealers configure the system.) Depending on the price of the hard disk drive, a comparable system costs about \$4000.

An Improved Design

Commodore designed the original 2000 in Germany but redesigned the unit be-

fore shipping it in the U.S. (For a full technical description of the original 2000, see the preview in the March 1987 BYTE.) The redesigned system uses a custom animation chip, known as the "Fat Agnus," from the 500. This custom chip incorporates several support chips from the original Agnus DMA controller, the heart of the Amiga's coprocessing system.

The redesign also enhances the video slot. The new slot brings out all 12 bits of RGB video data to the edge connector and incorporates control logic from the peripheral bus. In addition, the company redesigned the 86-pin CPU coprocessor slot to improve system stability and to allow a coprocessor to work in a bus-sharing coprocessor mode.

The 2000 has room for an internal hard disk drive and can use relatively inexpensive PC-compatible ST-506 hard disk drives. This solves one of the more difficult problems with

add-on hardware for earlier Amigas: Hard disk drives for the 1000 were expensive and not particularly reliable. Most of the drives for the 1000 use Macintosh-compatible SCSI boxes and a custom controller card.

You still need to add a hard disk controller to the 2000, which has no built-in SCSI port. Commodore's 2090 controller, which has two SCSI connectors, lets you attach up to nine devices (two ST-506-compatible and seven Macintosh-compatible SCSI devices). By the time this review appears, several controllers should be available from other companies, including ASDG and MicroBotics. The delay in getting third-party controllers for the 2000 is partly due to the fact that Commodore is still finalizing the specs for auto-booting devices; the cur-

continued

No other spreadsheet can make this statement.

Multiple type styles and sizes.
People know what they're
looking at - immediately.

Double underlining.
For a strong bottom line.

Boldface.
So the key numbers
make sense faster.

Notes.
When the numbers
alone don't say enough.

Statement of Income		(In thousands, except per share amounts)	
Two years ended September 30, 1988		1988	1987
Net sales		1,918,265	1,515,861
Costs and expenses:			
Cost of sales	\$ 1,057,849	\$ 878,571	
Research and development	72,511	71,121	
Marketing and distribution	470,573	392,851	
General and administrative	110,062	81,825	
Operating income before unusual item	1,710,995	1,424,368	
Unusual item-provision for consolidation of operations	207,270	91,493	
Interest and other income, net	(36,981)		
Income before taxes	9,771	17,722	
Provision for income taxes	180,060	109,215	
Net income	58,807	45,115	
Common and common equivalent shares used in the calculations of earnings per share	\$ 121,253	\$ 64,100	
Earnings per common share	61,880	60,872	
	\$ 1.96	\$ 1.05	

See accompanying notes

The documents on these pages were prepared entirely with Microsoft® Excel. From the calculations to the graphics to the stunningly crisp layout.

What you see here is a clear statement of the difference between Microsoft Excel and every other spreadsheet.

Only Microsoft Excel can give your printed work such power to impress. Because only Microsoft Excel can harness the full power of the new computers, high-resolution displays, and laser printers.

Looks that thrill.

Microsoft Excel brings photographic clarity to everything on screen and in print. Which lets you make even your daily reports look as good as annual reports.

Microsoft Excel works wonders with graphics, too. You can instantly turn its massive spreadsheets into any of 44 charts. Customize them with everything from simple arrows to 3-D labels. And preview pages before you print. So when you finish, what you have in hand is exactly what you had in mind.

In short, Microsoft Excel lets you display what people want to see most. The point.

The best program on television.

Of course, there's much more to show, so call for your copy of our video: **(800) 323-3577 ext. D17**

You'll see twenty minutes of possibilities beyond any other spreadsheet.

The tape goes for \$10, but you get that back when you get Microsoft Excel. Or simply zip to your dealer and try Microsoft Excel firsthand.

And see how it gives even the simplest statement the power to say far more.

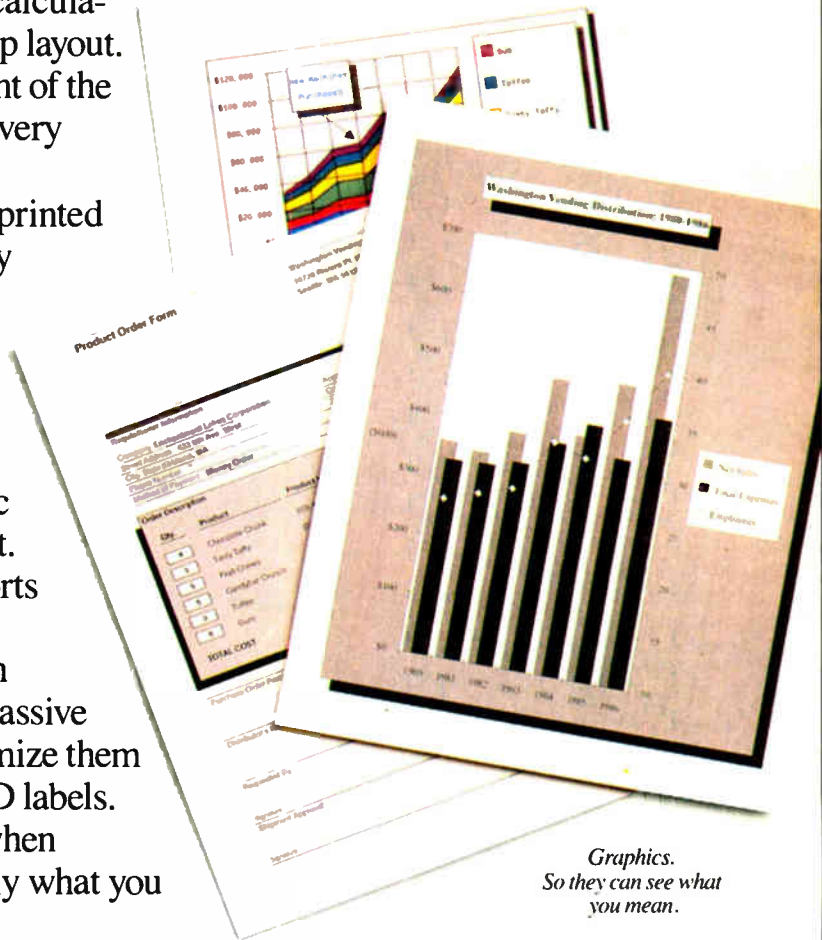

Graphics.
So they can see what
you mean.

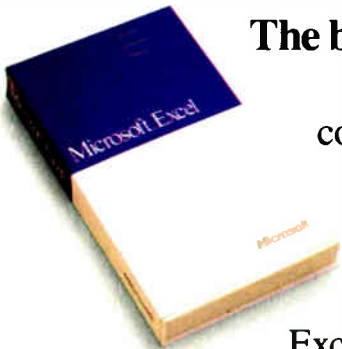

Microsoft Excel

The soul of the new machines.™

Microsoft and the Microsoft logo are registered trademarks and The soul of the new machines is a trademark of Microsoft Corporation. Company names and data used in the output are fictitious.

Laser Printing Without Lasers

Rick Cook and Paul Schauble

They look and act like laser printers, but the Taxan Crystal Jet and the Data Technology CrystalPrint VIII don't use lasers. Both are liquid-crystal-shutter (LCS) printers that use a different xerographic method to produce a printed page.

Laser printers use a laser beam reflected off a rotating mirror to write text or graphics images on a photosensitive drum. LCS printers have a print bar holding 2400 individually controlled liquid crystal shutters. These individual shutters turn on and off to control the high-intensity light that writes text or graphics images onto the photosensitive drum.

In theory, an LCS printer should have a few advantages. The LCS array is smaller, lighter, and more compact than a laser engine, and that means that LCS printers can be smaller. The printers can also be less expensive to make because the basic mechanism is simpler and doesn't require the same precision that a laser printer calls for. A laser printer needs a synchronized, multi-faceted mirror and fairly sophisticated optics to focus the image on the drum; an LCS printer replaces all that with a fairly simple shutter array. (For more information on page printer technology, see the September 1987 BYTE.)

The theory sounds good; in fact, however, the Crystal Jet and the CrystalPrint VIII are no different in size, weight, and price from laser printers in the low-to-medium price range: The Crystal Jet lists for \$3495, and the CrystalPrint VIII costs \$2495. According to Taxan, LCS printers will be cheaper to make than conventional laser printers once the manufacturers get their volumes up.

Both of the reviewed printers are based on the 8-page-per-minute Casio LCS engine, which uses separate drum and toner cartridges. The print quality of both



Data Technology Corp.'s CrystalPrint VIII LCS printer.

printers is fairly good but slightly inferior to the quality of the Hewlett-Packard LaserJet. Inspection under a magnifier revealed that gray scales weren't as good, images were less sharp, and there were more "freckles" in the white parts of images. The grays appeared decidedly washed out compared with the LaserJet's. However, except for the gray scales, none of these differences are likely to be apparent to the untrained observer, and both printers do an excellent job of emulating the LaserJet. Like the LaserJet, neither of these systems is PostScript-compatible.

The Crystal Jet and the CrystalPrint VIII eject their output face up, which is less convenient than the LaserJet's face-down presentation. Each printer has an optional automatic feeder that attaches to a door on the printer's back. The automatic feeder lets work pass straight through the printer, avoiding the 180-degree turn required with the conventional feeder. This is especially convenient for such items as envelopes and transparen-

cies. The back door is also very handy for clearing paper jams, although neither printer jammed during our tests.

Like the LaserJet, the reviewed printers use a two-character LCD readout on the front panel to display error codes and printer status information. This may be the standard, but a cryptic code that you must look up in a manual is decidedly less convenient than a display that tells you exactly what's happening. However, both companies list the most common error codes on a chart that you can place on top of the printer.

About the Tests

We tested the printers using a 30-page text file, measuring the time each took to print the entire file, to print one page from the file, and to print 30 copies

of that single page. For mixed text and graphics, we used a file called SCOOP, supplied as an example file with Ventura Publisher. It contains the now-famous pictures of the space shuttle and the nozzle, as well as a mixture of type sizes and styles laid out in a 1-page newsletter format. Finally, we ran the full Ventura Publisher example file, which consists of 30 pages of material designed to show off everything Ventura Publisher can do.

We printed all test files to a disk file first and then sent them to the printers using the DOS PRINT command and the HP LaserJet emulation; with this procedure, the test timings did not count the time Ventura Publisher took to compose the files. All timings are in hours:minutes:seconds (see table 1).

We ran the tests on PC XT-compatible computers running at 4.77 and 7.1 MHz, and we timed the printers at both speeds. For comparison, we had an HP LaserJet with 512K bytes of RAM connected to an 8-MHz AT compatible driving the printer via a parallel port. The differences in



The CrystalPrint VIII and the Crystal Jet offer alternatives to laser printers

results between the LaserJet and the CrystalPrint are about what would be expected due to the differences in the setups. The Crystal Jet was slower because it depends so heavily on the host computer's CPU.

Taxan Crystal Jet

The Crystal Jet is a solid page printer. It's more flexible than the CrystalPrint VIII; it's also somewhat more difficult to set up. At \$3495, it is more expensive, too, but the price includes the PS2.0 printer controller/scanner interface board—a full-length PC card with 2 megabytes of 120-nanosecond RAM. The Crystal Jet also comes with CrystalControl 3.0 software, the Fontware font program for Ventura Publisher, and a cable to connect the printer to the interface card.

The Crystal Jet can print 300-dot-per-inch (dpi) text and graphics. With 2 megabytes of memory on the interface card, it can easily handle full-page graphics.

The front panel includes a two-digit LCD for error and status messages, six LEDs to indicate various conditions (e.g., ready or data being transmitted), and four push buttons to place the printer on- or off-line, select the mode, and control automatic paper-feed.

The installation process is of average difficulty for a laser printer, and the manuals adequately cover the details. The process involves inserting the PS2.0 interface card in the computer, attaching the cable, and running the installation software. The software consists of a driver program and the CrystalControl program.

The Crystal Jet is designed to work only through the CrystalControl program supplied with the printer; there is no way to run the printer without it. Through the CrystalControl program, you can select



The Taxan Crystal Jet LCS printer.

the printer emulation, set page parameters, and select type fonts and printer ports. CrystalControl comes in both memory-resident and conventional versions. The pop-up version is 91K bytes, while the conventional version is 97K bytes. With the memory-resident version, you can pop into the Setup program from within another program to set page parameters or select an emulation. This is handy, but don't expect to call it from a program that redefines the keyboard, such as SuperKey.

CrystalControl's menus make the Crystal Jet easy to use, but you give up some control over your system parameters. When you install CrystalControl, the program rewrites your AUTOEXEC.BAT file and resets some parameters (e.g., files=15) in CONFIG.SYS. This is fine if you don't mind programs that go tromping through your AUTOEXEC.BAT and CONFIG.SYS files, but we would prefer to set the parameters ourselves.

CrystalControl also creates a dummy printer port called JET. Your computer

thinks it is talking to LPT1, but actually it is running through JET. This means that CrystalControl will not work with the Mode command enabled. It also has the potential for raising sophisticated hell with software that directly accesses the printer port hardware.

The Crystal Jet differs from other printers in that the electronics that control the printer are installed in the host computer. The PS2.0 interface board includes 2 megabytes of RAM (not expandable), the printer interface, and the scanner interface. The board is thick (it's actually two boards joined together), and it may be a tight fit if placed next to a modem or a hard disk drive card.

One unusual aspect of the Crystal Jet is that the PS2.0 board uses the computer's CPU to produce the bit map for printing (see photo 1). Unlike the CrystalPrint VIII or the LaserJet, which have internal microprocessors to handle such jobs, the Crystal Jet's speed depends directly on the processing speed of the host computer. Thus, the Crystal Jet limps when it's attached to a standard IBM PC running at 4.77 MHz. It takes the processor so long to build the bit map of each page that the printer's speed suffers badly, as you can see in the benchmark results in table 1. When we reset the computer to run at 7.1 MHz, the printer's speed improved accordingly, although it still lagged behind the CrystalPrint and the LaserJet, especially on graphics jobs.

Based on the 4.7-MHz and 7.1-MHz timings, we estimate that on an 8-MHz AT the Crystal Jet should be about as fast as the CrystalPrint or the LaserJet. On 80386-based systems, it should run even faster. We would not recommend using this printer with anything slower than an 8-MHz AT-class computer.

continued

CrystalPrint VIII

Type
LCS printer

Company
Data Technology Corp.
2551 Walsh Ave.
Santa Clara, CA 95051
(408) 727-8899

Features
Casio print engine, rated at 8 pages per minute; 1.5 megabytes of RAM; 300- by 300-dpi resolution; serial and parallel ports; four resident fonts; also uses font cartridges and accepts any LaserJet-compatible soft font; built-in LaserJet Plus emulation; 250-sheet paper tray

Size
18½ by 16½ by 13½ inches;
70½ pounds

Hardware Needed
Any computer with a serial or parallel port

Documentation
112-page Getting Started; 120-page Reference Manual

Options
Paper cassettes: \$75
Font cartridges A, C, F, H, Y, and Z: \$195 each
Emulation cartridges for Epson FX and Diablo 630 printers: \$195 each
250-sheet straight-through automatic feeder: \$595

Price
\$2495

Inquiry 886.

Crystal Jet

Type
LCS printer

Company
Taxan USA Corp.
18005 Cortney Court
City of Industry, CA 91748
(800) 772-7491
(818) 810-1291

Features
Casio print engine, rated at 8 pages per minute; 300- by 300-dpi resolution; PS2.0 controller/scanner board with 2 megabytes of RAM; four resident fonts; Epson MX/FX, IBM Graphics Printer, Diablo 630, NEC 3550 and 5510, Qume Sprint 5, HP LaserJet and LaserJet Plus emulation; CrystalControl and Fontware software; 250-sheet paper tray

Size
13½ by 18¾ by 16½ inches;
88 pounds

Hardware Needed
IBM PC, AT, or compatible (PC AT recommended)

Documentation
47-page Fontware Installation Kit for Ventura Publisher; 38-page Instruction Manual; 126-page Crystal Control User's Guide; 43-page Crystal System manual

Options
Dual-feed sheet feeder: No price set

Price
\$3495 (includes controller board)

Inquiry 885.

Like the LaserJet, the CrystalPrint VIII uses optional font cartridges (\$195 each). Although they are not interchangeable with LaserJet cartridges, they follow the same nomenclature and contain the same fonts. The cartridges available are equivalent to LaserJet's A, C, F, H, Y, and Z cartridges. Any LaserJet-compatible soft font will work, too. Emulation cartridges for the Epson FX, the Diablo 630, and the Hewlett-Packard Graphics Language are also available as options.

The printer's two cartridge ports are located beneath the control panel. They are unlabeled, but they are not identical. The emulation cartridge goes on the right, and the font cartridge on the left (as you face the printer). You could easily plug the cartridges into the wrong ports; this would produce an error code 18 on the printer's display. Unfortunately, 18 is not one of the codes on the quick-reference guide on the printer, nor is it imme-

diately obvious in the documentation.

Unlike the Crystal Jet, the CrystalPrint's memory is inside the printer, and the CrystalPrint runs off the computer's standard parallel printer port. There is no special interface card, and the LaserJet emulation is built in; this makes the CrystalPrint easier to set up than the Crystal Jet. You simply install the drum and toner cartridges, connect the cable, and turn the machine on.

On the tests, the CrystalPrint ran neck and neck with the LaserJet and ahead of the Crystal Jet. The LaserJet was slower in some tests because of its 512K bytes of memory, but it was faster in one of the tests because it was connected to an AT. By and large, however, the times are comparable.

Spotty Emulation

In addition to the standard LaserJet emulation, we also tested the optional Epson

FX emulation. While the LaserJet emulation worked flawlessly, the Epson emulation didn't.

The CrystalPrint failed when we attempted to print some sample pages from Ventura Publisher configured for an Epson printer. This test is a particularly severe one because Ventura Publisher tells an Epson printer to make three passes per line to get a higher resolution (about 216 dpi). On the CrystalPrint, this produced three superimposed partial copies of each line. However, a WordPerfect test document that puts out the entire character set and samples of the various fonts, pitches, and other printer characteristics worked perfectly in Epson mode.

Technical support for Data Technology said that the company was not aware of a problem, but that it would try to repeat the problem we had.

The CrystalPrint's documentation is adequate. The installation manual, Getting Started, is complete, accurate, and illustrated; the Reference Manual, however, is not as good. The last half of the Reference Manual is a listing of the LaserJet control codes in hexadecimal. This is perhaps useful for programmers, and Data Technology's listing is better formatted than LaserJet's, but it is not something the average user needs. The manuals with the review printer were preliminary versions; final versions are now included with the printer.

Data Technology estimates the life of a toner cartridge at 5000 pages, and the life of the drum at 8000 pages. The duty cycle is 5000 pages per month. The toner cartridges and drum are considerably more expensive than Taxan's—\$119 and \$159, respectively.

The CrystalPrinter comes with either a one-year warranty with walk-in service or a 90-day warranty with service on-site. Service is provided through Momentum Service Corp., which has 140 offices throughout the U.S. Extended service contracts are available.

No Major Advantages

The Taxan Crystal Jet and the Data Technology CrystalPrint are good, solid page printers. While LCS print engines do not yet offer any major advantages over a laser printer, we found no serious drawbacks either. Taken simply as page printers, they are worthy competitors of the LaserJet. They provide reasonable speed (assuming the Crystal Jet is connected to at least an 8-MHz AT), solid performance, and good, but not great, print quality at decent prices.

Of the two, we consider the Crystal Jet to be the better value. The PS2.0 interface board, the CrystalControl program,

continued

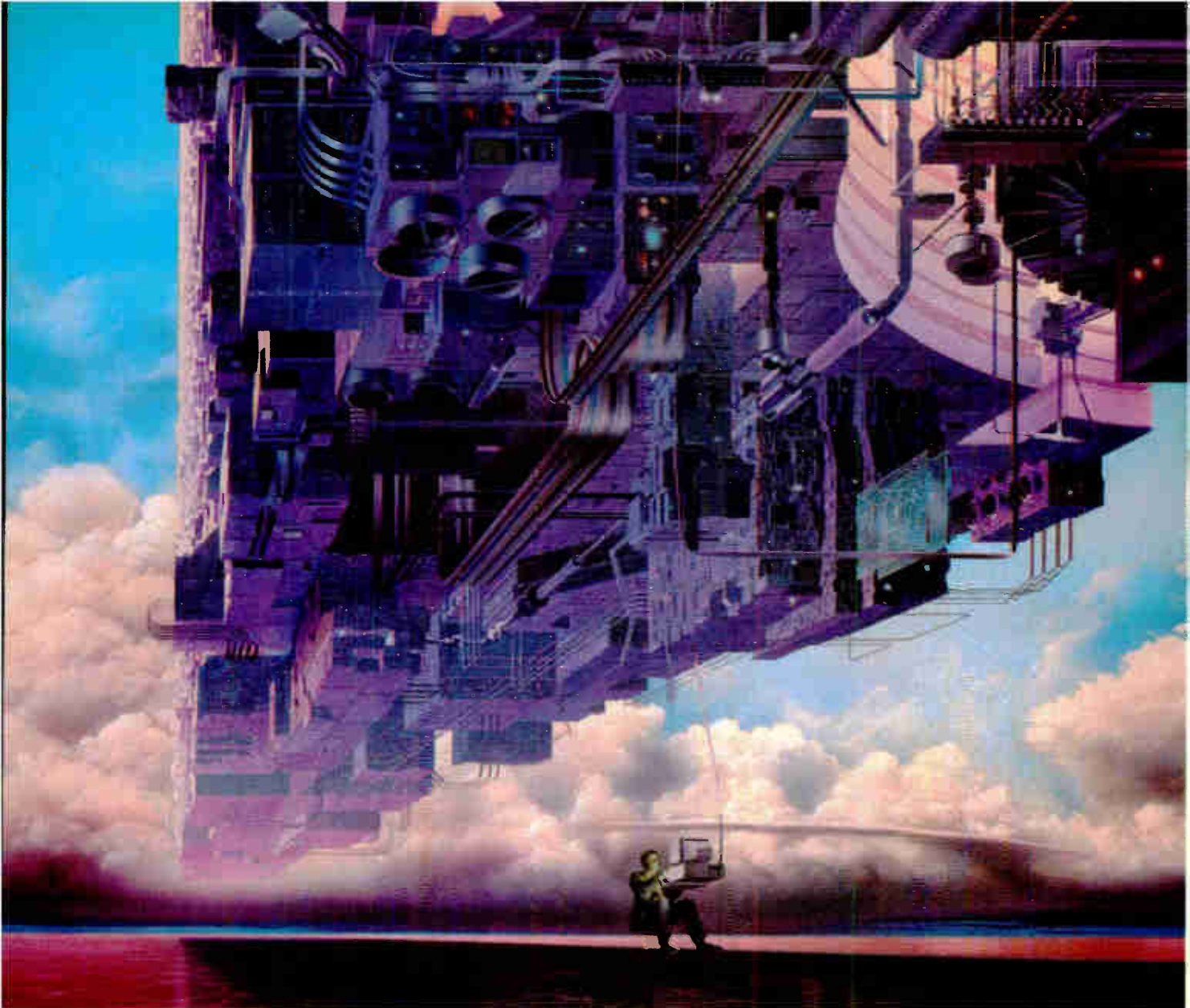

CONNECT YOUR COMPUTER TO A HIGHER INTELLIGENCE.

CompuServe's reference databases make you more productive, competitive, and better informed.

Remember the last time you tried to get your hands on hard-to-find facts? In a magazine article you read a year ago. In a news report you never saw. Or in a table of data you didn't know existed.

Imagine those facts just a few keystrokes away on your personal computer. Through CompuServe.

Your personal research center.

Save hours of research by going

straight to the reference information you need in seconds.

Access thousands of sources of information in the areas of business, finance, medicine, education, demographics, science, law, news, popular entertainment, and sports.

What you know can help you.

Research an industry or company through articles, financial statements, and other sources. Analyze an investment. Assist in a job search. Follow market competition. Investigate a business opportunity.

Check characteristics such as age,

income, and occupation in any U.S. community. For a geography report, a business plan, or a family move.

All you need to access CompuServe's unlimited world of information is a modem and just about any personal computer. Visit your computer dealer today. To order direct, or for more information, call or write:

CompuServe®

Information Services, P.O. Box 20212
5000 Arlington Centre Blvd., Columbus, OH 43220
800-848-8199
In Ohio and Canada, call 614 457-4802
An H&R Stock Company

and the Fontware software provide flexibility; and both the board and the software can be replaced with improved versions without scrapping the printer. The CrystalPrint has the advantage of being \$1000 cheaper, easier to set up, and somewhat easier to use, thanks to the font and emulation cartridges. Both printers share the disadvantages of producing output that is not quite as good as the Laser-

Jet's and of using supplies that are not as widely available as those for the LaserJet.

Someday, LCS printers may be smaller and cost less; in fact, Data Technology has already announced the CrystalPrint Series II (\$1995), which the company says has the smallest footprint of any available xerographic page printer. For the time being, however, the LCS printers aren't any cheaper, faster, or smaller

than laser printers. Still, if you need a non-PostScript page printer, the Crystal Jet and the CrystalPrint VIII are both worth a look. ■

Rick Cook is a freelance writer from Phoenix, Arizona, specializing in computers and high technology. Paul Schauble is a computer consultant doing business as The Second Ring in Glendale, Arizona.

Getting the Bugs Out

Ross M. Greenberg

*Two debugging tools:
Is AT Probe worth \$1500
more than Periscope III?*

Your project is due in a week. All beta test sites have been calling dutifully, indicating no major problems. Suddenly, one site after another calls with the same problem. It seems their hard disk dissolved, and your program was the only one running when it occurred. Time to start debugging.

Either of two hardware-assisted debugging systems, AT Probe (\$2495) from Atron and Periscope III (\$995) from The Periscope Company, may be able to help. Both provide a means of isolating their respective debugging programs from "normal" code space. They offer some unique features as well, including the ability to stop your code in the middle of *anything*, debug it, and then continue processing; real-time tracing, which only ICEs (in-circuit emulators) could do until now; the ability to breakpoint in real time, based on access to any component within the machine; and displaying and experimenting with the prefetch buffer. (For a discussion of debugging, see "Finding the Culprit" on page 154.)

During the review process, I used the boards to solve a variety of bugs: a write access by a terminate-and-stay-resident (TSR) program outside its data space; problems with the initialization routines in two different device drivers; timing problems between incoming characters in an interrupt-driven TSR concurrent serial-communications program; spe-lunking through the innards of MS-DOS to determine real-time DOS usage of the PSP (Program Segment Prefix) and FCB (File Control Block) records; and using

breakout switches to enter the debugger on an apparent total-system lockup. I might have been able to solve some of these problems without a hardware-assisted debugging board, but it would have taken significantly longer.

I tested the boards on a variety of high-speed AT clones with and without EGA displays. The EGA causes a problem with AT Probe because the debugger's 128K-byte RAM footprint conflicts with the memory space normally allocated for the EGA BIOS. (This problem is documented in the manual.) You can select another area, but the 128K-byte footprint is pretty large. At 64K bytes, Periscope III's DOS footprint is smaller than AT Probe's, so it ran on my EGA system without any modifications.

AT Probe

AT Probe 2.0 is a full-height, full-length, IBM PC AT card with 1 megabyte of write-protected on-board memory and the ability to be used in protected mode. It comes with a cable that plugs into the 80287 socket on the AT motherboard. Your 80287 plugs into the cable's piggyback socket. The debugger has both hardware and software components. Most of the software loads directly into AT Probe's own memory, but 128K bytes of system RAM is also required. Installation is easy; it takes only moments. (An XT version of the board is also available.)

A switchbox comes with AT Probe and is an intrinsic part of the package. It contains a Stop button, which you can use to break out to the debugger, and a Reset button, which you can optionally install to let you reset the computer. To install the Reset button, you crimp a connector (which is provided) to the power-supply reset wire (not available on all AT clones). This is a permanent change, and I'm surprised Atron didn't use a less in-

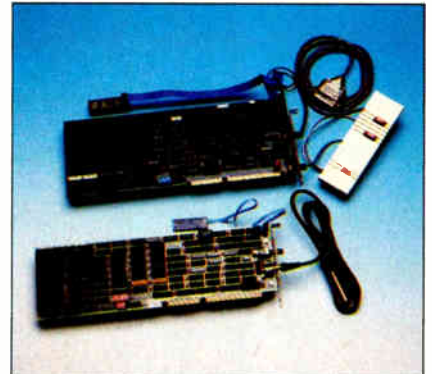

Hardware-assisted debuggers like AT Probe (top) and Periscope III (bottom) can significantly reduce debugging time—for a price.

trusive method. However, if you need to remove AT Probe from your system, you simply pull its reset wire out of the connector, which then remains attached to the power-supply wire.

Various add-ons to AT Probe are available: AT Source Probe (\$395) lets you debug at the source code level in addition to the symbolic level; AT Software Performance and Timing Analyzer (\$395) adds timing and performance measurement tools to the debugger; and Winprobe (\$495) enables you to debug software designed to run under Microsoft Windows 2.0.

Three options are also available to optimize AT Probe for specific applications. The /ISO option (\$395) lets you run the entire debugging process in the 80286's protected mode using no system memory. There are certain relatively obscure disadvantages to running the /ISO version (most having to do with the keyboard), but the beauty of running in protected space, where the debugger is almost invisible to your own code, is worth it.

The /PL option (\$125) supports Plink86 Plus, a linker from Phoenix Technologies that resembles the standard Microsoft Linker but lets you use overlays in a more powerful way. The /PL option lets you set breakpoints in overlays

continued



DOS system running Lotus 1-2-3



SCO XENIX system running SCO Professional

THIS IS AN IBM PS/2 MODEL 80 RUNNING DOS

Under DOS, this PS/2™ is a powerful 80386-based single-tasking, single-user computer that can run thousands of DOS applications. In 16-bit, 8086 mode.

One at a time.

When OS/2™ becomes available, the PS/2 can become a multitasking, single-user computer running in 16-bit, 286 mode that can utilize DOS applications under OS/2.

One at a time.

With DOS or OS/2, the PS/2 will support one user.

	1 user (DOS)	1 user (OS/2)
Cost per system**:	\$12,389	\$12,594
Cost per user:	\$12,389	\$12,594

THIS IS AN IBM PS/2 MODEL 80 RUNNING SCO XENIX

Under SCO XENIX®, this PS/2 becomes a powerful 80386-based multitasking, multiuser computer that can run thousands of XENIX applications. In full-tilt, 32-bit, 386 mode.

Many at a time.

And using SCO VP/ix™, the PS/2 can multitask DOS applications under SCO XENIX.

Many at a time.

With SCO XENIX, the PS/2 will support one user. Or 9 users. Or even 33 users.

And it can do all that today because you can get SCO XENIX for the PS/2—*now!*

	1 user	9 users	33 users
Cost per system**:	\$14,559	\$19,726	\$40,402
Cost per user:	\$14,559	\$2,192	\$1,224

SCO XENIX System V and the SCO XENIX family of software solutions are available for all industry-standard 8086-, 80286-, and 80386-based computers, and the IBM® Personal System/2™ Models 50, 60, and 80.



(800) 626-UNIX (626-8649)
 (408) 425-7222
 FAX: (408) 458-4227
 TWX: 910-598-4510 SCO SACZ
 uucp: ...decvax!microsoft!sco!info

Circle 246 on Reader Service Card

*SCO VP/ix is available as separate product.

**Cost comparisons are based on most recently published U.S. domestic suggested list prices. Cost model: Base machine: IBM PS/2 Model 80, 70Mb disk, 1Mb RAM, IBM 8512 color monitor, 1Mb additional IBM RAM, IBM ProPrinter XL, 1-user DOS system, Base machine, plus DOS 3.3, WordPerfect+2, Lotus 1-2-3, dBASE III PLUS, 1-user OS/2 system, 1-user DOS system, substitute OS/2 for DOS, 1-user SCO XENIX system, Base machine plus SCO XENIX 086 for PS/2, SCO VP/ix, SCO VP/ix, SCO VP/ix (word processing), SCO FORBASE+™ (dBASE III PLUS work-alike), SCO Professional™ (1-2-3 work-alike), 9-user SCO XENIX system, 1-user SCO XENIX system, plus intelligent 8-user multiport card, 8 IBM 3151 SCO terminals, 33-user SCO XENIX system, 9-user SCO XENIX system, plus 3 more intelligent 8-user multiport cards, 24 more IBM 3151 ASCD terminals, 4 Mb additional RAM, additional 70Mb disk.

IBM and ProPrinter XL are registered trademarks and Personal System/2, PS/2 and OS/2 are trademarks of International Business Machines Corporation. Lotus and 1-2-3 are registered trademarks of Lotus Development Corporation. dBASE III PLUS is a registered trademark of Ashton-Tate. XENIX is a registered trademark of Microsoft Corporation. VP/ix is a trademark of INTERACTIVE Systems, Inc. VP/ix is a registered trademark and SCO Professional is a trademark of The Santa Cruz Operation, Inc. FORBASE+ is a trademark of Fox Software, Inc. ©1987 The Santa Cruz Operation, Inc., 400 Ermaul Street, P.O. Box 1400, Santa Cruz, CA 95061. The Santa Cruz Operation, Ltd., 18 Noel Street, P.O. Box 47N, London W1A 4YN, United Kingdom. +44 1 439 2911 (FAX) +44 1 637 9301. TELE: 917 572 5700.

AT Probe 2.0**Type**

Hardware-assisted debugger

Company

Atron
12950 Saratoga Ave.
Saratoga, CA 95070
(408) 253-5933

Features

2K bus-cycle traceback buffer; 4 hardware breakpoints with 1 megabyte of on-board memory; 660K-byte symbol-table space; multiple software tools; breakout switch Reset button; 12-inch 80287 cable (longer lengths available); 2-foot cable on breakout switch

Size

5 by 13½ inches

Hardware Needed

IBM PC AT or compatible with 8-MHz/10-MHz AT hardware-compatible bus structure (one 16-bit slot required); one wait state required; 128K bytes of available memory

Software Needed

DOS 2.0 or higher; DOS 3.0 or higher recommended

Documentation

220-page AT Probe/AT Source Probe Manual

Options

AT Source Probe: \$395
AT Software Performance and Timing Analyzer: \$395
Winprobe: \$495
/PL (Plink86 Plus) extension: \$125
/ISO (protected-mode debugger): \$395
/ISO and /PL extension: \$495
/PRO (protected-mode operation): \$975
/PRO and /PL extension: \$1075

Price

\$2495
386 Probe: \$4195

Inquiry 887.**Periscope III 3.1****Type**

Hardware-assisted debugger

Company

The Periscope Company
1197 Peachtree St., Plaza Level
Atlanta, GA 30361
(404) 875-8080
(800) 722-7006

Features

8K bus-event traceback buffer; 64K bytes of on-board memory with 32 hardware breakpoints; ability to use alternate display device; multiple software tools; 15-inch 80x87 cable (longer lengths available on request); 5-foot cable on breakout switch

Size

4½ by 13¼ inches

Hardware Needed

IBM PC, XT, AT, or compatible (16-bit bus slot required on AT), operating with one wait state at up to 10 MHz; 64K bytes of available RAM

Software Needed

DOS 2.0 or higher; DOS 3.0 or higher recommended

Documentation

218-page Periscope Manual; Quick Reference card

Price

8-MHz version: \$995
10-MHz version: \$1095

Inquiry 888.

that you haven't yet loaded from disk. Another option, /PRO (\$975), lets you run in protected mode in memory above the first megabyte. Combinations of these options are also available: /ISO with /PL (\$495), and /PRO with /PL (\$1075). The particular software configuration I tested included the /ISO and /PL options and the AT Source Probe.

Probing for Bugs

Using AT Probe is straightforward. The command structure of the debugger requires a considerable learning curve be-

cause it is not similar to DOS DEBUG; however, the on-screen help facility in two command windows makes the process less painful than it would be if you had to turn to the manual all the time. The user interface, however, is simply a command-line interface.

When invoked, AT Probe looks for its configuration file, PROBE.CFG, which contains the base address at which to load the software, as well as the cursor- and screen-addressing information required to use a remote serial device as if it were a local console.

When you first load the debugger, it also looks for an INIT.MAC file, which can contain user-defined macros concerned with initialization. (An AT Probe macro contains a series of AT Probe commands.) As with any macro library, you eventually end up with your own set of specially designed tools, but AT Probe comes with a good set in PROBE.MAC to use for your initial debugging sessions. This set includes such macros as sector read, sector write, display program prefix segment, display registers, and display stack data.

Once within the debugger, you can specify the name of the file you want to debug and its associated symbol tables, as well as any additional macro files you wish to load. You can examine the code in its disassembled state, and symbol names are shown after their actual addresses to aid in your debugging. From past experience, I find that actually replacing the hexadecimal address with the symbol name is a bit more comfortable and closer to the original source code, but that's a matter of personal preference.

Debugging an application without a symbol table is more difficult, but since AT Probe lets you enter symbol names at specific addresses and thereafter displays those symbol names, exploring code fragments (even DOS itself) is easier than before. The board devotes 660K bytes to keeping your symbol table in its write-protected memory so that it won't be overwritten.

The heart of debugging, the setting of breakpoints, is an easy task with AT Probe. You can set them to occur when execution reaches a given location; when a particular range of memory is read, written, or fetched by the CPU; or when a specified I/O port (or a particular value for that port) is read from or written to.

The real power of AT Probe shows in its macros. The macro capability lets you execute an intelligent breakpoint request, such as: "Breakpoint when an area outside of this bounded area is written to, if and only if the code segment is within this range and the data value at this address is greater than a particular value and less than this value." You can make a macro just about any length you like, and it can call other macros (up to a nesting level of 5) with parameter passing.

The macro processing speed isn't as fast as I'd like. An intelligent breakpoint request runs at full speed on AT Probe, but once it reaches a breakpoint and starts executing in the CPU, processing slows down. When you know this, you will find yourself setting breakpoints a bit more sparsely.

You can have a total of only four hard-

continued



An Incredible Display Of Power And Versatility.

For just \$599,* the new 965 gives you ASCII, ANSI and IBM® PC compatibility in one terminal.

The new 965's versatility is unparalleled. It supports 23 terminal emulations, more than any other model in its class. You even get your choice of ASCII, ANSI or IBM Enhanced PC keyboard styles.

There's a 14" flat display in green or page-white with crisp, clear characters in a high-resolution 10x16 matrix. A 2-position keyboard with a true accounting keypad, 20 user-

programmable editing keys, and 128 programmable function keys.

The 965 can display up to 49 data lines, enough to show large spreadsheets or two normal display pages of text at the same time. No other terminal this affordable can do that.

The 965's state-of-the-art single board design uses a 16-bit CPU and sophisticated gate array to give you a high-performance, very reliable terminal with a full one-year end-user limited warranty.

The 965. A whole new look in terminals from TeleVideo. Call us toll-free or write today for more information.

TeleVideo Systems, Inc.,
1170 Morse Ave., Sunnyvale, CA
94088-3568.

Circle 276 on Reader Service Card

 **TeleVideo®**
THE VISION YOU NEED TO SUCCEED

Call 1-800-835-3228

Finding the Culprit

Fixing a bug, once found, usually takes only minutes; finding it, however, can take minutes or weeks. A great number of software-only debuggers are available, all of which let you examine, step-by-step, each instruction the CPU executes, and compare the actual results with the results you expected. But, for a variety of reasons, hardware-assisted debuggers can make the process go much more quickly than software-only debuggers can.

One of the most common software debuggers is DEBUG, included with MS-DOS up to version 3.3. DEBUG is very useful for examining small assembly language programs or for resolving simple problems. However, it's woefully inadequate for any but the most rudimentary debugging. To debug program code easily, you need to be able to examine it with a symbolic listing; for example, `INC [TIMER_TICK]` is inherently clearer than `INC [ODCA]`. The first conveys at least part of the meaning the original programmer intended. To debug easily, you need to see the source code, or at least the symbol map. Many symbolic debuggers contain options to enter these symbols as required.

Other capabilities also affect the debugging process. When single-stepping through your code, for instance, a debugger needs to be able to set the "single-step" bit in the processor flag word. This bit generates an interrupt after each instruction, which the debugging program then processes, and it usually results in a display of the next instruction to execute (or the previous one) and the current setting of each register. If this information is stored in a traceback buffer, then you can see how your code arrived at the current point of execution. The larger the traceback buffer, the more instructions you can see, and the easier debugging becomes.

Determining when to examine that traceback buffer is more of an art than a

science; being able to set breakpoints to stop execution of the current program and enter debug mode makes the process easier. The number of breakpoints a particular debugger allows is an important consideration, since the number and different types of breakpoints you use let you execute more of your code and less single-step tracing. The ability to issue breakpoints when your program reads or writes to a particular area of memory, when a register equals a certain value or range of values, or when your program accesses a particular I/O port is an important aid to debugging.

However, if the problem you're trying to find stems from the interaction of various hardware components over which you have no control (such as a timer tick occurring every 1/18 second or a conflict of serial-port interrupts), then even the niceties of Microsoft's CodeView (a full-screen symbolic debugger) may not suffice. It's not that software debuggers don't have the ability—most do; it's simply that tracing or single-stepping through your code can be terribly slow, because the CPU is executing perhaps hundreds of debugger instructions each time it executes one of your program's instructions. Trying to use the same CPU chip to process all these "intelligent" breakpoints, to manage a traceback buffer, and to protect your code and the debugger code from each other is a difficult, if not impossible, task.

Finally, sometimes the software debugger itself has an adverse effect on what you're debugging (since the position of your program in memory may depend on where the debugger is placed). Debugging may even be impossible, since the errant pointer causing your problem may actually modify a portion of the memory space occupied by the debugger—thus causing the debugger to crash mysteriously. In these situations, hardware-assisted debuggers like the ones reviewed here are your only choice.

ware breakpoints active at any given time. I found that this wasn't sufficient in many cases, especially when I was trying to trace carefully through the many different cases on a `C case/switch` statement. I don't like having to outsmart limitations a debugger places on me.

Fetch and Carry

For the CPU to be as fast as possible, it automatically reads the next few instruc-

tions into a small on-board buffer while it executes its current instruction. In most programs, after a given instruction has run, the instruction most likely to run next is the one that follows it; since that instruction is already in the prefetch queue, little access time is needed except to read or write the operands.

Since prefetch is used only for instruction execution, it might be useful to set a breakpoint on prefetch into any area of

memory that should never be executed but can be read or written to, such as your data-segment area or your low-memory interrupt table.

AT Probe's traceback buffer is 2K bus cycles, or events, in length. Atron calls this a *dequeued* buffer. You won't see instructions that have been fetched but not executed unless you specifically ask to see them. This is an important consideration when looking at the traceback buffer; it can be confusing to see instructions that were never executed.

A few features of note are AT Probe's ability to debug using Microsoft C's local stack referencing, its complete 80287 support, an on-line editor and notepad (in AT Source Probe), the ability to follow a nested calling convention backward on the stack, and the ability to re-enter data items by data type instead of hexadecimal, byte by byte.

One caveat, however, regarding AT Probe: One of the manual's appendixes contains a note about executing breakpoints while in a non-reentrant BIOS call, such as the keyboard- or monitor-service routines. Atron says that since AT Probe uses these routines, you could crash the system if you breakpoint within them.

Writing a Wrong

I used AT Probe to find a write access by a TSR outside of its data and code space. First, I defined a write-to-memory breakpoint for each of two memory-address ranges: one before the initial TSR code segment, and one after the last TSR segment. Both DOS and foreground programs, such as `COMMAND.COM`, normally access these areas of memory. Therefore, the debugger had to filter out all such valid write accesses.

Using a macro to set the breakpoints, I checked the code segment after each breakpoint to see if it fell within the TSR range. If it didn't, I resumed program execution; if it did, I knew I had found the culprit and could use the real-time traceback buffer to determine how I had gotten to the instruction causing the problem. Again, the macro didn't execute as fast as I'd like, but with some fine-tuning of its logic, I managed to speed it up.

Periscope III

Periscope III 3.1 is a full-length hardware-assisted debugging card with 64K bytes of write-protected RAM, an 8K-bus-event real-time traceback buffer, 32 hardware breakpoints, and a remote breakout switch. It requires an IBM PC XT, AT, or compatible with 64K bytes of available RAM. (Since the board is not a full-height card, it runs in the XT as well as the AT.) Periscope III comes in two

continued

MODEL 24

high performance

DATA EXCHANGE SYSTEM

UP
TO
4½MB
BUFFER

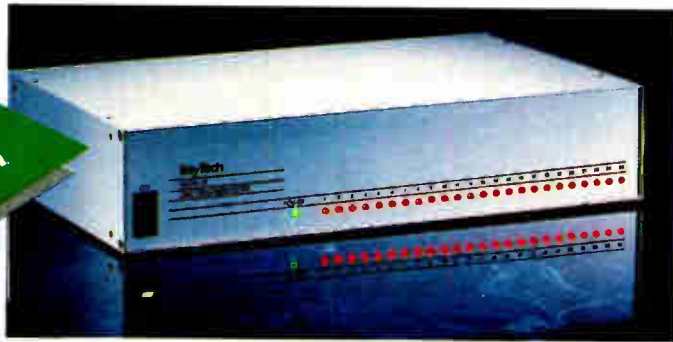

Engineered for speed, flexibility and expandability

BayTech

Bay Technical Associates, Inc., Data Communications Products Division
200 N. Second St., Bay Saint Louis, MS 39520 USA
Telex 910-333-1618 BAYTECH, Telephone 601-467-8231 or toll-free
800-523-2702

CHECK THE SPECS

- The Data Exchange System, Model 24, allows high speed exchange of data between computers, printers and other peripherals.
- Powerful 16-bit CPU plus multiple high performance I/O processors allow super high speed transfer of data demanded by new faster computers and software.
- Optimum flexibility: Select the right combination of serial and parallel ports, and set *any* of these ports as a peripheral port or as a computer port.
- Basic unit expandable to 24 ports by 4-port modules offered in serial/parallel combinations.
- Standard 512KB buffer expandable to 4½ megabytes, to handle big print/plot jobs and many small ones.
- Buffer memory dynamically allocated to maximize buffer utilization.
- Simultaneous data input and output on *all* ports, so no devices are kept waiting.
- Computer-to-computer communication concurrent with all other operations.
- Full duplex communication allows file transfer capability with many communications software packages.
- Compatible with virtually all computers, printers, plotters, modems and other peripherals.
- Pop-up RAM resident PC support software allows peripheral selection via hot key.
- Super fast throughput allows data to pass through with no apparent processing delays.
- Many user-definable parameters including separate baud rates, flow control and parity for each port.
- Internal serial-to-parallel and parallel-to-serial conversion.
- Cascading capability to increase available number of ports.
- Unlimited hotline tech support.
- Designed and manufactured in the U.S.A.

Circle 35 on Reader Service Card

models: an 8-MHz version (\$995) and a 10-MHz version (\$1095). It requires DOS 2.0 or higher, but DOS 3.0 or higher is recommended because DOS 2.0 and 2.1 contain some bugs involving improper changes to the stack; The Periscope Company warns that if your breakpoint happens to occur at just the right—or wrong—moment, you may have trouble. Note that this is true for AT Probe, too.

Like AT Probe, Periscope III has a cable that plugs into the 80287 socket on the motherboard, and an existing 80287 plugs into the cable's piggyback socket. A plug socket at the end of the card attaches to a breakout button that immediately enables the debugger.

Once you install the hardware (which takes about 5 minutes), you must install the software—also a rapid and straightforward process. You can run the software portion of the debugger without the hardware. After you install the software, you're ready to run a TSR called PS.COM, which takes command-line or indirect file switches. One switch lets you specify which area of memory the board is to use. Other switches let you specify the size of the symbol table, various window sizes, and other setup parameters.

No software extensions are available at

this time, including those that allow for protected-mode operation; thus, most of the symbol table is visible in system memory. Although the debugger program itself is write-protected and is therefore safe from typical programming mistakes, the symbol table and other important tables are not protected. And since these tables are stored in system memory, you may not have enough memory to debug a large program with a large symbol table. This was not a problem in my testing, however.

Up Periscope

Once you load PS.COM, it sits quietly in the background until you call it. You can access it in either of two ways: through the breakout switch, or through RUN.COM, which automatically loads your program and its symbol table. Once your program is loaded, you are in the debugger, ready to debug your code.

Part of Periscope III's power is, surprisingly enough, in its user interface. You can choose from a variety of screen windows. I found that having two data windows, one stack window, a register window, and a disassembly window usually sufficed for my needs. Changing window sizes is an easy operation; for ex-

ample, if you want two data windows with lengths of 4 lines and 6 lines, respectively, you enter /W D:4 D:6.

There is a not-so-subtle difference between Periscope III and AT Probe: AT Probe feels as if it were designed for programmers, while Periscope III feels as if it were designed by programmers. This shows through not just in the display of the various windows, but also in the command set and options, designed for programmers who want ultimate control over their debugging environment. For example, to issue a breakpoint when the byte, COUNT, equals 08, you would enter BB COUNT EQ 08. For AT Probe, the command would be BP 1=.COUNT W DATA 08.

Periscope III provides breakpoints on byte, code, interrupt, line, memory, port, register, user test, word, and exit. AT Probe has many of these abilities, but its interface uses a less intuitive format.

The myriad breakpoints that Periscope III allows also reflect this philosophy: You can set up to 16 hardware breakpoints, allowing read, write, execute, and fetch breaks, and including breakpoints above the first megabyte of memory for AT-class machines. You can also set breakpoints when the data on the bus meets a particular value, or when input or

Solutions You Can See.

Color display monitors for personal computers.



output to a port occurs (you can specify up to 16 different ports). These breakpoints can be set directly on Periscope III's board. Finally, you can set a *pass count*, which breaks out only after the breakpoint has been executed a certain number of times; for example, "break on the fifth write to this screen location."

You can also set software breakpoints. Aside from those breakpoints that are put in Periscope III hardware for speed, you can set additional interrupts when a particular byte, word, or register meets certain tests (less than, equal to, or greater than a specified value), as well as when a particular interrupt executes, when a particular line of source code runs, when returning from the currently executing routine, or when a user-supplied (and previously loaded) assembly language routine returns a certain value.

With Periscope III's "go using monitor" mode (GM command), some of these software breakpoints can work in combination with the hardware breakpoints. Thus, the program can run at full speed until it reaches a breakpoint on the board. Control then transfers to the board to determine if the specific condition exists, such as "break on register value" (BR breakpoint). If not, the code resumes exe-

cution immediately. If the conditions are met, the breakpoint executes, and you can start debugging.

One real disappointment is that "break on register value" allows only one breakpoint test for each register. Thus, testing for a write access to a range of memory with a double range check on the CS register isn't as easy to accomplish on Periscope III as on AT Probe. (AT Probe's macro capability can handle this.)

Periscope III lacks macro capability, but, with its USEREXIT capability, you can make tests as arbitrarily complex as you wish. A USEREXIT is user-written assembly language code (USEREXIT.ASM) with which Periscope III can interface. It is loaded as a memory-resident program, called USEREXIT.COM, that uses an available interrupt. Of course, you'll have to debug the assembly language routines that make up the USEREXIT routine itself.

Like AT Probe, Periscope III has traceback-buffer capabilities. However, Periscope III's traceback buffer is 8K bus events long (a bus-event record is 48 bits wide), so it can hold substantially more information than AT Probe's 2K-bus-cycle buffer. You can set up the buffer to capture 8K events before the breakpoint, 4K events before and 4K events after the

breakpoint, or 8K events after the breakpoint. However, much of Periscope III's traceback information consists of prefetch instructions. As such, except for the obvious ones, like *jmp*, *call*, *ret*, and *int*, the trace buffer contains instructions that may not have been executed but were only in the prefetch buffer. This makes debugging more difficult.

Periscope III comes with a number of auxiliary programs, including one to let you use the map-file output from Plink86 Plus, and another to run through assembly language source code and make each symbol public. Since the more symbols you have, the easier the debugging becomes, the PUBLIC program should be a welcome addition to any library.

Driving Devices Crazy

Debugging a device driver can be difficult, especially since the device driver is loaded before you can load your debugger. Periscope III's distribution disk contains a program, SYSLOAD, that lets you load the important parts of Periscope III as device drivers so you can debug the device-driver initialization routine. When I combined this with Periscope III's ability to perform a "short boot" (which usually

continued

Mitsubishi Electronics can support all your monitor requirements with *solutions you can see*. Mitsubishi® brand name monitors continue to set the standards in quality, reliability and value. For IBM® PC, XT, AT, PS/2, Apple® Macintosh™ II or AT&T compatibility, Mitsubishi can provide the right monitor at an affordable price.

Sharper, Brighter Images On A 13V"/14" Screen.

Each Mitsubishi brand name monitor combines advanced, proven technology to produce an image that's uniformly bright along with clear, vibrant colors—all without annoying flicker.

Commitment To Customer Satisfaction.

Mitsubishi Electronics is the experienced and proven

vendor of high quality monitors for a wide range of applications, including presentation graphics, CAD/CAM, desktop publishing, or image processing.

For product information or authorized Mitsubishi Electronics representatives, please call 1-800-556-1234 Ext. 54. In California, call 1-800-441-2345 Ext. 54. Mitsubishi Electronics America, Inc., Computer Peripherals Division, 991 Knox Street, Torrance, CA 90502 (213) 515-3993.

Visit us at NCGA Booth #1154



Circle 177 on Reader Service Card (DEALERS: 178)



AUM1371A—
Diamond Scan
Auto-Tracking



NC1429C
IBM® PS/2™
VGA Compatible

leaves the interrupt vectors loaded), debugging a device driver became as easy as debugging any other program.

The problem I had was that the serial-communications device driver was crashing the system somewhere in the initialization routine—sometimes. At other times, and at high data transfer rates, characters were being dropped. The worst kind of bug is the kind that isn't always repeatable.

By setting breakpoints on input or output instructions to ranges of ports, I found that the device-driver initialization

routine was turning interrupts on too soon. By using Periscope III's user-exit capability, I found that the time used to return after a polling loop and before generating the End-of-Interrupt instruction was sufficient for a character to arrive when receiving at 115K bytes per second. Without a hardware-assisted debugging board, either condition would have been difficult, if not impossible, to discover.

The Competitive Edge

Determining which debugger is better is a difficult task. There is no clear and sim-

ple benchmark that you can base a judgment on. Once you find a bug with one debugger, it's gone, and it's impossible to replicate the problem. (But, sadly, another bug always lurks around the corner; there's never a shortage of them.)

If you're developing Microsoft Windows programs; if you're using the overlay capability of Plink86 Plus substantially; if your code is very large (greater than 400K bytes); if you have a huge number of symbols; or if you're writing a protected-mode application (and with OS/2 on the horizon, protected-mode operations are going to become increasingly important), then you need the support offered as options for AT Probe 2.0.

However, the interface on Periscope III is easier to work with than AT Probe 2.0's; the capabilities, such as the number and type of breakpoints, are substantially better; and the command summary is, to my way of thinking, closer to the debugging needs of a programmer. And if you're a small developer with limited funds, Periscope III's lower price becomes paramount.

But all this is changing. New releases on both products are forthcoming. The features in the new releases clearly indicate how acutely each company is aware of the competitive edge the other has to offer.

The Periscope Company says that Periscope III 4.0 (due out this month) will support Microsoft Windows, Plink86 Plus's overlays, and Microsoft C's local symbols. Periscope IV, due out this spring, is planned to support the 80386 as well as the 80286. Atron says that the next release of AT Probe, also due out this month, will contain a user interface similar to that of Microsoft CodeView. Atron's 386 Probe for 80386 systems has recently been released. It's an interesting race to watch.

Both AT Probe and Periscope III serve admirably as debuggers. Each does quite a bit more than its advertising represents, and each also has major enhancements in the works. But does AT Probe make up the \$1500 difference in price (almost \$2000 if you include AT Source Probe) with added programmer productivity?

The answer isn't as clear-cut as I'd wish. If you don't need the special capabilities AT Probe has that Periscope III doesn't have, then, no, AT Probe isn't worth the difference in price. If, however, you do need them, and you need them badly, then the price doesn't matter as much. ■

Ross M. Greenberg, owner and chief executive officer of Software Concepts Design in New York, is a computer consultant and software designer.

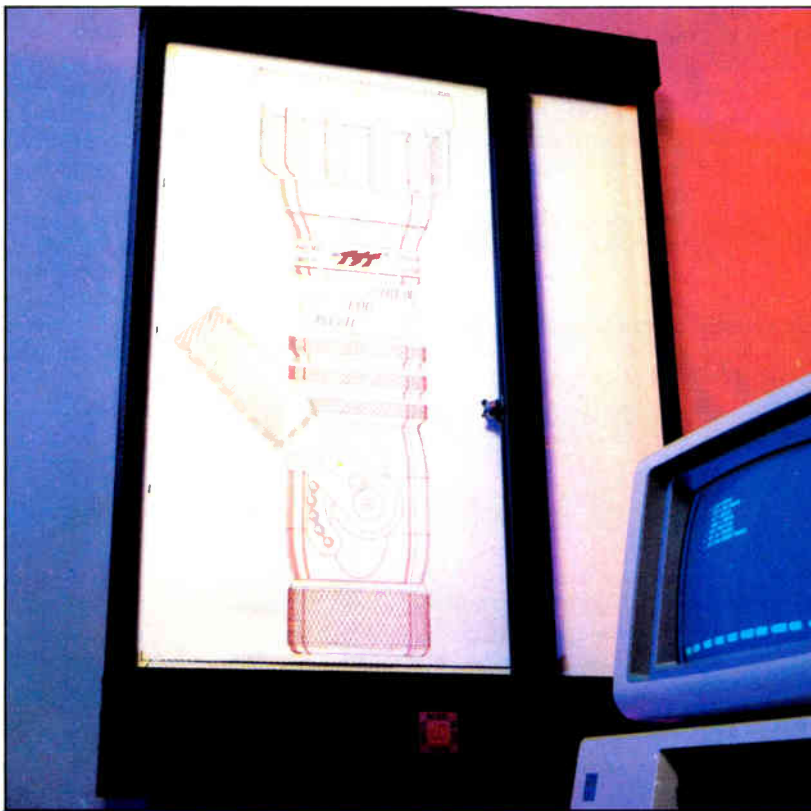

THE MURAL PLOTTER D SIZE PLUS. FLATBED TECHNOLOGY.

\$2495.

We're not going to razzle-dazzle you with a lot of hype about the Mural Plotter. We'll let the facts speak for themselves.

- Plot area 25" x 34"
- Compatible with leading software programs

- Emulates Hewlett-Packard 7475 Plotter
- Compatible with IBM/PC/XT/AT, T.L., NEC, AT&T and more using RS-232-C serial interface
- Desk top or wall mount
- Excellent repeatability • 5 ips

Call for the name of your local CAD Dealer!

UI United Innovations • Crossroads Ind. Park • Holyoke MA 01040 • 413-534-4400



Good News For People Who've Always Wanted A TARGA 16...

Now less gets you more.

**The NEW Improved
TARGA 16 is only
\$1995!**

It's 100% redesigned, 100% compatible, 100% reliable, but costs 33% less than the original TARGA 16. Oh, and it's 100% TRUEVISION, of course.

When we set out to redesign the industry-standard for high color resolution videographics, we wanted to incorporate the latest technological advances. The result is a TARGA 16 with improved video quality, built-in overscan, simultaneous RGB and composite video output, and more. So contact your nearest Authorized Truevision Reseller, or call **800/858-TRUE** and see how less can become more.



TRUEVISION®
INC.

7351 Shadeland Station, Suite 100 Indianapolis, IN 46256 800/858-TRUE

INTERNATIONAL: Canada 416/479-1102 France 33-13-952-6253 Italy 39-2-301-0051
Switzerland 41-1-825-0949 U.K. 44-1-991-0121 West Germany 49-89-612-0010 Other 617/229-6900

Prices quoted are US Domestic suggested retail prices.

Circle 280 on Reader Service Card



RECENT PRICE REDUCTION ON OUR SYSTEM 300

Since the printing of the latest catalog, the price of our 386-based MS[®] OS/2 compatible system has been reduced substantially. Call toll-free 800-426-5150 for the new list price.

11ED8 MS-DOS and OS are registered trademarks of Microsoft Corporation. ©1987 DELL COMPUTER CORPORATION



We've been Dell Computer Corporation since day one. The systems we make have always gone by the name PC's Limited.

WE'RE MAKING A NAME FOR OURSELVES.

And that's how things are going to stay for some time to come.

Because, in just three years, we've become one of the seven largest personal

computer companies in the US.

So we're going to keep on designing, developing and building fast, high performance computers right here in Austin, Texas. And we'll keep on selling them directly to users like you. Because the only good way to keep prices down is to cut out the middleman. No computer dealer means no dealer mark up.

And what could be simpler than picking up the phone, placing an order and having PC's Limited MS-DOS® and MS®OS/2 personal computers delivered right to you?

You can also call for our free catalog.

Keep in mind that our low, systems prices include something other manufacturers can't match. A one year, on-site service contract from Honeywell Bull, along with access to our technical support people over toll free phone lines.

And remember too that everything we make goes out the door with something you'll be able to count on for a long time to come. Our good name.

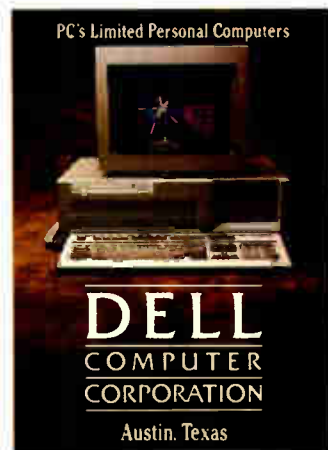

8 0 0 • 4 2 6 • 5 1 5 0

Circle 79 on Reader Service Card

APRIL 1988 • B Y T E 161



How To Easily Start A Feeding Frenzy.

We realize if you're looking for a fast, letter-quality printer, there's a few out there to choose from. We should know, we've developed some of the very best.

But if you're looking for a printer that's not only fast, but can easily devour any job you throw at it, you'd best look at the new Toshiba P351SX 24-pin dot matrix printer.

Take envelopes, for example. The P351SX comes with an optional automatic envelope feeder. That way your envelope is printed with the same speed and ease as your document.

We even replaced the hassle of dip switches with our new front panel. So you can make all your choices at the touch of a button.

But we wanted to make your printing jobs even easier still, so we added a few more convenient features.

Like the unique ability to print six-part forms with each part as legible as the first. Plus a built-in

tractor and tear bar. A fanfold bypass. An autoloader lever. A multistrike film ribbon. IBM Proprinter and Graphics Printer,¹ Qume Sprint 11,² Toshiba and other popular printer emulations. And a 64K buffer.



But rest assured, none of these features were added at the expense of speed. Because the P351SX zips merrily along at an amazing 360 cps for draft and 120 cps for letter quality.

All of which means the P351SX printer will quickly polish off any printing job. From letters and envelopes to graphics and full-sized spreadsheets.

And that's an appetizing thought for any busy office.

For the name of your nearest Toshiba printer and computer dealer, call 1-800-457-7777.

¹IBM and Proprinter are registered trademarks of International Business Machines Corporation. ²Qume Sprint 11 is a registered trademark of Qume Corp.



In Touch with Tomorrow
TOSHIBA

Toshiba America, Inc., Information Systems Division

Circle 307 on Reader Service Card (DEALERS: 308)

World Radio History



Two Fast C Compilers for PCs

Namir Clement Shammam

First, Microsoft improved its C compiler, MS-C version 5.0, by adding powerful optimizing capabilities and support for the ANSI C standard. Then, it threw in an integrated package for C language development called QuickC. In a nutshell, QuickC is to traditional C compilers what Borland's Turbo Pascal is to Pascal implementations: a convenient, integrated environment for rapid software development. Now C programmers can buy one package that provides a friendly environment for front-end prototyping and professional workhorse language tools.

Microsoft sells the MS-C compiler bundled with QuickC 1.0 for \$450. It also sells QuickC separately for \$99. Both compilers run on an IBM PC or compatible with 448K bytes of RAM. QuickC requires a system with two floppy disk drives or a 5¼-inch floppy disk drive and a hard disk drive. MS-C 5.0 requires a hard disk drive.

You install both MS-C and QuickC using the SETUP.EXE utility. It automates the installation process and lets you customize the configuration of both compilers. It does this by prompting you to insert various disks from the package into drive A and copying only the files required for your particular installation. Moreover, SETUP.EXE uses the librarian utility, LIB.EXE, to combine one or more of these files into libraries built to fit the various configurations you request. This operation reduces the amount of disk space required and speeds the linking process.

The configuration options include the destination drive, the names of the QuickC subdirectory and auxiliary subdirectories, the memory model, the type of floating-point math support, and the graphics library support.

QuickC 1.0

QuickC parallels the QuickBASIC environment and includes an editor, filing system, compiler, linker, and debugger.

Microsoft introduces an improved version of its C compiler and QuickC, a front-end development tool

You can invoke the QuickC environment by typing `qc`, and you can specify options related to the type of video card (e.g., CGA, EGA, and MA) in the system and the presence of a color monitor. The environment displays the main pull-down menu bar, the editor window, the error window, and the program-status line. Vertical and horizontal scroll bars are visible at the right and bottom edges of the editor window. QuickC lets you enter commands by pressing keys or by using an optional mouse.

You invoke the pull-down menus in the main menu bars by using the Alt key with other key combinations or by clicking on a choice with a mouse. You can select items in a pull-down menu in several ways. First, you can use the cursor-control keys to highlight a choice and then press Return. Second, you can press the key that corresponds to highlighted characters in the menu. Finally, you can point to and click on an item with the mouse. These various selection methods allow you to pick the style you're most comfortable with.

QuickC has two types of on-line help, and both are available by pressing the F1 key. The first is a series of eight help screens that present information on editing commands, characters in a regular (string-based) expression pattern search, C operator precedence, standard ASCII table, extended ASCII table, escape sequences, printf formatting, and C data types (with value ranges).

The second type of help documents the C keywords and various library functions. In this case, a window displays the different topics, and you make a selection by using the cursor-control keys or by typing the first letter in an option and then pressing Return. Once you've made a se-

lection, the Topics window displays the names of the functions in the chosen category. You select functions in this window the same way you select topics. QuickC redisplay the editor window, with a brief description of the chosen function above it.

The QuickC editor is similar to WordStar in nondocument mode, except in how you select and manipulate a block of text. The commands are easy to learn and lend themselves more naturally to the use of a mouse. The editor uses a clipboard to save deleted text that you can paste back into the source code. The editor also has an interesting feature that lets you put it in read-only mode, protecting source code files from accidental changes during browsing.

While the QuickC editor supports the Find and Replace features present in any text editor, it also supports a Regular Expression option. This enables you to seek more complex and flexible text patterns. The Regular Expression feature is a subset of the Unix `grep` (global regular expression processing).

The QuickC editor does not handle multiple files. Professional programmers will still use their sophisticated multifile text editors to write the source code and resort to the editor in QuickC for fast corrections.

The QuickC environment incorporates a filer that is responsible for various tasks related to source code file management. Among these tasks is a reminder for you to save the currently edited file when you exit or load another. The filer permits you to load an entire file and merge an include file with the currently edited file. The filer also offers you two mechanisms to select a source code file. The first involves picking a file at large from a directory display; you can specify the subdirectory path and wild cards used to display the filenames. The second method is to select a .MAK file from a program list. A program list groups a related set of source

continued

QuickC 1.0**Type**
C compiler**Company**
Microsoft Corp.
16011 Northeast 36th Way
P.O. Box 97017
Redmond, WA 98073
(206) 882-8080**Format**
One double-sided, double-density
5¼-inch floppy disk**Language**
Machine language**Hardware Needed**
IBM PC or compatible with 448K bytes
of RAM and two floppy disk drives, or one
5¼-inch floppy disk drive and a hard
disk drive**Software Needed**
MS-/PC-DOS 2.1 or higher**Documentation**
417-page Programmer's Manual; on-
line help; Quick Reference card**Price**
\$99**Inquiry 902.****MS-C 5.0 (including QuickC 1.0)****Type**
C compiler**Company**
Microsoft Corp.
16011 Northeast 36th Way
P.O. Box 97017
Redmond, WA 98073
(206) 882-8080**Format**
Eight double-sided, double-density
5¼-inch floppy disks**Language**
Machine language**Hardware Needed**
IBM PC or compatible with 448K bytes
of RAM and a hard disk drive**Software Needed**
MS-/PC-DOS 2.1 or higher**Documentation**
Three manuals and a spiral-bound
Quick Reference Guide**Price**
\$450**Inquiry 903.**

files for a software project and is similar to a make facility.

Compiling with QuickC invokes a special dialog box that permits you to select various compilation options, such as warning levels, output objects (e.g., object files, stand-alone executable files, or an in-memory executable image), Microsoft language extensions, speed optimizations, stack checking, pointer checking, and debugging. Other options let you control the extent of compilation: a single file, altered files, or all project files. The QuickC environment allows only the medium memory model, which imposes restrictions on the amount of data a program can handle. Its run-time library incorporates code that supports the automatic use of the 8087 and 80287 chips. QuickC contains its own debugger in its environment and cannot use the Code-View debugger.

The QuickC package also includes a command-line version of the QuickC compiler, QCL.EXE. This program lets you compile and link in one step, or compile your source code into object files that you link later. The QCL compiler employs many switches that parallel the menu options of the QuickC environment. Its advantage over the QuickC environment is

its ability to generate code for different memory models: It supports the small, medium, compact, and large models. (If you use the code within the QuickC environment, you can use only the medium memory model.) Since QCL's options resemble those of the full-fledged MS-C compiler, I will concentrate on the latter in this review.

Microsoft C 5.0

Unlike QuickC, the MS-C 5.0 compiler is strictly command line-oriented. However, its operation closely resembles QCL in that it quickly compiles source code and automatically links the object code files. MS-C 5.0 comes with several enhancements and changes from its predecessor, version 4.0. Two of the most significant changes are its improved code optimization and support of the ANSI C standard. Although it was not available for this review, Microsoft's newly released MS-C version 5.10 adds OS/2 support.

ANSI-standard support includes function prototyping and the implementation of the const and volatile types. MS-C 5.0 also lets you use enumerated types, treating them as integer values. The compiler no longer supports the long float

type (its replacement is the type double). MS-C 5.0 now supports the long double type to provide enhanced data precision. You can use the signed keyword to explicitly indicate signed data.

The MS-C compiler is rich with numerous directives that let you fine-tune the resulting output code. These switches fall into a number of categories, such as memory-model selection, type of processor instructions, type of floating-point support, types of code optimization, and object-code generation for a debugger, to name a few.

The MS-C compiler supports five memory models: small, medium, compact, large, and huge. The floating-point switches enable you to generate code for the 80x87 coprocessor and use emulation routines, generate in-line code, or call for an alternate floating-point math package. You can also instruct the compiler to generate instructions for the 8088/8086, the 80186/80188, or the 80286 processors, but MS-C 5.0 does not generate native code for the 80386.

MS-C 5.0 can optimize programs for execution speed, code size, and loop execution. Other directives let you perform a wide variety of tasks, such as control checking for null and out-of-range far pointers, enforcing ANSI standards, specifying output filenames for .OBJ, .EXE, .LST, .ASM, and .MAP files, and generating code for Windows applications. You can also specify the generation of an object file for use with either Code-View or SYMDEB debuggers.

MS-C comes with many function libraries that let you perform a wide variety of tasks. The low-level libraries provide routines for buffer manipulation, memory allocation, process control, time management, and routines to access the BIOS and MS-DOS interface. The common C function libraries provide support for character classification, data conversion, searching, sorting, and string manipulation.

The file manipulation and I/O libraries provide directory control, file handling, stream I/O, low-level I/O, console I/O, and port I/O. The math function libraries encompass logarithmic, trigonometric, hyperbolic, power, and other transcendental functions. Finally, the graphics library contains routines to select the proper display mode, set coordinates, set the palette, set display attributes, output images and text, and transfer images. The graphics library supports EGA, CGA, MA, 2- and 16-color high-resolution VGA, and 256-color medium-resolution VGA modes.

Included in the package are the linker (LINK.EXE) file utilities and the Code-

continued

Some of the world's biggest problems are being solved with a touch of Smalltalk.



On the ground floor of high-tech environmental control. Climate, energy, fire and security are all critical aspects of environmental control in large office buildings. The challenge for Johnson Controls, a leader in this industry, is to provide a control system that is both technologically advanced and simple to operate. Using Smalltalk/V, Research Scientists Gene Korienek and Tom Wrensch have created a workspace environment that allows rapid prototyping and modeling of future systems. At Johnson Controls this system is used to explore relationships between cognitive models of building operators and corresponding iconic representations of building components. Each system can then be tested by simply clicking a mouse and viewing the results in sophisticated color graphics on a PC.

Abroad and involved in foreign affairs. The French Ministry of Foreign Affairs is responsible for keeping track of every French citizen living abroad and every foreigner living in France. Each day, they process thousands of requests for documents or information, each one of which takes at least fifteen minutes. Arthur Andersen, the world's largest accounting firm, has developed a natural language processing application with Smalltalk/V that enables clerks without computer training to extract the necessary data much faster. Thanks to Smalltalk and system developers Bart Schutte and Pascal Wattiaux, what once took fifteen minutes now takes 30 seconds. Vive la Smalltalk!



The world is made of objects. So naturally, the world is turning to Object-Oriented Programming (OOPS). And the fastest, easiest OOPS language and environment is Smalltalk/V.

With OOPS you program by defining objects, their inter-relationships and their behavior. Objects can represent both real-world entities — people, things — as well as useful abstractions such as stacks, sets and rectangles. Smalltalk/V provides everything you need to solve problems big and small, including a comprehensive tutorial to get you started.

Who needs Smalltalk?

Because Smalltalk models the way people really think, it is perfect for scientists, engineers and professionals who have to solve tough problems in a

short amount of time. Perfect for programmers who are looking for a fast, efficient prototyping environment. And anyone who wants to quickly and easily learn OOPS.

Introducing Smalltalk/V286.

Our newest version of Smalltalk offers faster and more powerful OOPS capabilities. We've gone from 16 to 32-bit architecture. From 640K to 16 MB capacity for 25 times the memory. And designed it to run

on the next generation OS/2 operating system as well as DOS.

Get Smalltalk for a small price.

Smalltalk/V sells for just \$99.95. Smalltalk/V286 is \$199.95. The following optional applications packs are available for \$49.95 each: Communications; EGA/VGA Color; Goodies #1, Goodies #2, Carleton Tools and Goodies #3, Carleton Projects.

And everything comes with a 60-day, money-back guarantee.

So visit your nearest dealer. Or call toll-free, 800-922-8255 and order direct with MasterCard or Visa. Or write to Digitalt, Inc., 9841 Airport Blvd., Los Angeles, CA 90045.

And let us help you put Smalltalk into action.



Teaching students to think economically.

With Smalltalk, even non-programmers can create exciting applications. Economics Professor Arnold Katz of the University of Pittsburgh developed Economics PC Discovery World, an intelligent tutoring system for beginning microeconomics students. Using a mouse to access windows and manipulate data, a student can call up a set of markets and commodities for an imaginary community. By changing the scenario, the student can not only study a variety of market behaviors, but also test the validity of his or her own reasoning. A process that provides a lot of food for thought.

Smalltalk/V
digitalk inc.



Circle 81 on Reader Service Card (DEALERS: 82)

Smalltalk/V requires DOS and 512K RAM on IBM PC/AT/PS or compatibles and a CGA, MCGA, EGA, VGA, Toshiba T3100, Hercules, or AT&T 6300 graphic controller. A Microsoft or compatible mouse is recommended. Smalltalk/V286 requires a 286 or 386, DOS or OS/2 and 1 MB of memory and one of the graphic controllers listed above. Not cdp® protected.

Table 1: MS-C 4.0, 5.0, and QuickC 1.0, compared using the BYTE benchmark programs. The compilers were directed to generate code that would resemble QuickC's code as closely as possible. You can see that optimized MS-C 5.0 code is faster than either MS-C 4.0 or QuickC code and that QuickC is faster than MS-C 4.0.

Test	Sieve	Sort	Float coprocessor	Float emulation	Dhrystone
Compile/link					
QuickC 1.0	00:10	00:13	00:12	'	00:17
MS-C 5.0 ²	00:12	00:13	00:12	'	00:18
MS-C 5.0 ³	00:11	00:12	00:12	'	00:15
MS-C 4.0 ²	00:16	00:18	00:19	'	00:24
MS-C 4.0 ³	00:15	00:18	00:19	'	00:23
Execution					
QuickC 1.0	00:08	00:24	00:13	6:37	2382*
MS-C 5.0 ²	00:07	00:23	00:10	3:35	2777*
MS-C 5.0 ³	00:16	00:30	N/A	N/A	2173*
MS-C 4.0 ²	00:13	00:27	00:10	3:52	2272*
MS-C 4.0 ³	00:18	00:31	N/A	N/A	2000*

* Higher numbers indicate better performance.

¹ Benchmark compiled once using the /FP1 directive.

² Optimized code.

³ Unoptimized code.

Note: The QuickC environment supports only the medium memory model. I set QuickC to disable stack checking and to generate 80286-specific code. Since MS-C 5.0 loop optimization produced invalid times, I disabled this feature for the Float benchmark. Also for the Float benchmark, I used the /FP1 option to allow the program to run with or without a coprocessor present. Compile/link and execution times are in minutes:seconds; Dhrystone execution is in Dhrystones per second. The Dhrystone version is 1.1, using no registers and performing 50,000 iterations.

View debugger. LINK is a command line-oriented linker that complements the features of the compiler with many directives to tailor the final properties of the executable file. Among these directives are ones to create special-format .EXE files for use with the CodeView debugger, pack adjacent code into one 64K-byte segment, and create libraries for use with QuickC.

You use a librarian utility (LIB.EXE) to manage object code libraries by adding, deleting, replacing, copying, and extracting sublibraries from larger ones. You use the MAKE.EXE utility to maintain or automate software projects. It works by checking the dates of a program's source files. If some of the dates have changed, MAKE invokes the compiler or linker to bring all the program's components up to date.

The CodeView debugger is perhaps the most important programming tool accompanying the MS-C compiler. This sophisticated and versatile debugger comes with its own environment. It lets you view the C source code along with the compiled machine code, single-step through the code, display registers, and set breakpoints.

See How They Run

I compiled and ran four benchmark programs: BYTE's Float, Sieve, and Sort benchmarks and the Dhrystone. I used an 8-MHz IBM AT equipped with Intel's Inboard AT/386 that had an 80386 CPU and an 80387 coprocessor running at 16 MHz, 640K bytes of base memory, 2 megabytes of extended memory (used for a RAM disk), a 20-megabyte hard disk drive, and a 30-megabyte HardCard. The system ran under PC-DOS 3.1.

I installed the C compilers on the HardCard. I then used the QuickC compiler to compile the benchmark programs into stand-alone executable files, which I ran from DOS. I set the compile options for speed optimization; this setting generates 80286-specific code and disables stack-checking. I ran the Float benchmark twice, once to utilize the math coprocessor and once with the coprocessor disabled to evaluate the speed of the emulation libraries. I suppressed the 80387 chip by setting the NO87 environment using the command SET NO87=true.

I also compiled these programs using MS-C 4.0 and 5.0. To get a reliable idea of how QuickC's results compared to MS-C's, I set the compiler switches to

match QuickC's optimizations as much as possible. To do this, I used the medium memory model, disabled stack-checking, and requested 80286-specific code. I invoked the /FP1 directive when I compiled the floating-point test program, allowing it to run with or without the coprocessor chip.

With the exception of the Float test, I compiled the programs twice: once with maximum code optimization, and once with optimizations disabled. MS-C 5.0's loop optimization capability eliminated the for loop within this program entirely, yielding an elapsed time of 0. Therefore, I used a combination of compiler directives that matched all but loop optimizations when compiling the Float program.

The benchmark results, shown in table 1, favor the MS-C compiler over QuickC. The executable files emitted by MS-C 5.0 have faster run times than those produced by QuickC or MS-C 4.0. The speed optimization made a significant impact on the Sieve benchmark, nearly doubling the speed of the program. You can see improvements of roughly 20 to 50 percent in execution speed between the optimized executables of MS-C 5.0 versus MS-C 4.0. The compilation and linking speeds for both MS-C 5.0 and QuickC are better than those for MS-C 4.0 and are indicative of their good overall speed. (Keep in mind that I used a 386 system running IBM PC AT hard disks.)

Two Good Choices

QuickC offers the novice C programmer a comfortable environment in which to learn C. The WordStar-like editor, flexible filer system, rich on-line help, in-memory compilation feature, and fast, convenient compilation are factors that appeal to the student of C language or to the software designer who wants to prototype code rapidly. The optimized code is faster than MS-C 4.0's and comes close to the speeds of optimized MS-C 5.0 code. However, the QuickC environment supports only the medium memory model, which limits its usefulness in developing large programs and even its use as a front-end development tool.

The Microsoft C 5.0 compiler is a workhorse language tool. It incorporates many optimization features, supports the new ANSI standard, and automates the linking process. The extensive compiler and linker directives, the librarian, and the CodeView debugger provide you with a robust development package. ■

Namir Clement Shammis, of Glen Allen, Virginia, is a freelance writer and a columnist for several microcomputing magazines.

continued

INTRODUCING FUJITSU'S
DL3000 SERIES PRINTERS.

If you have to ask how much it costs, this is the printer for you.

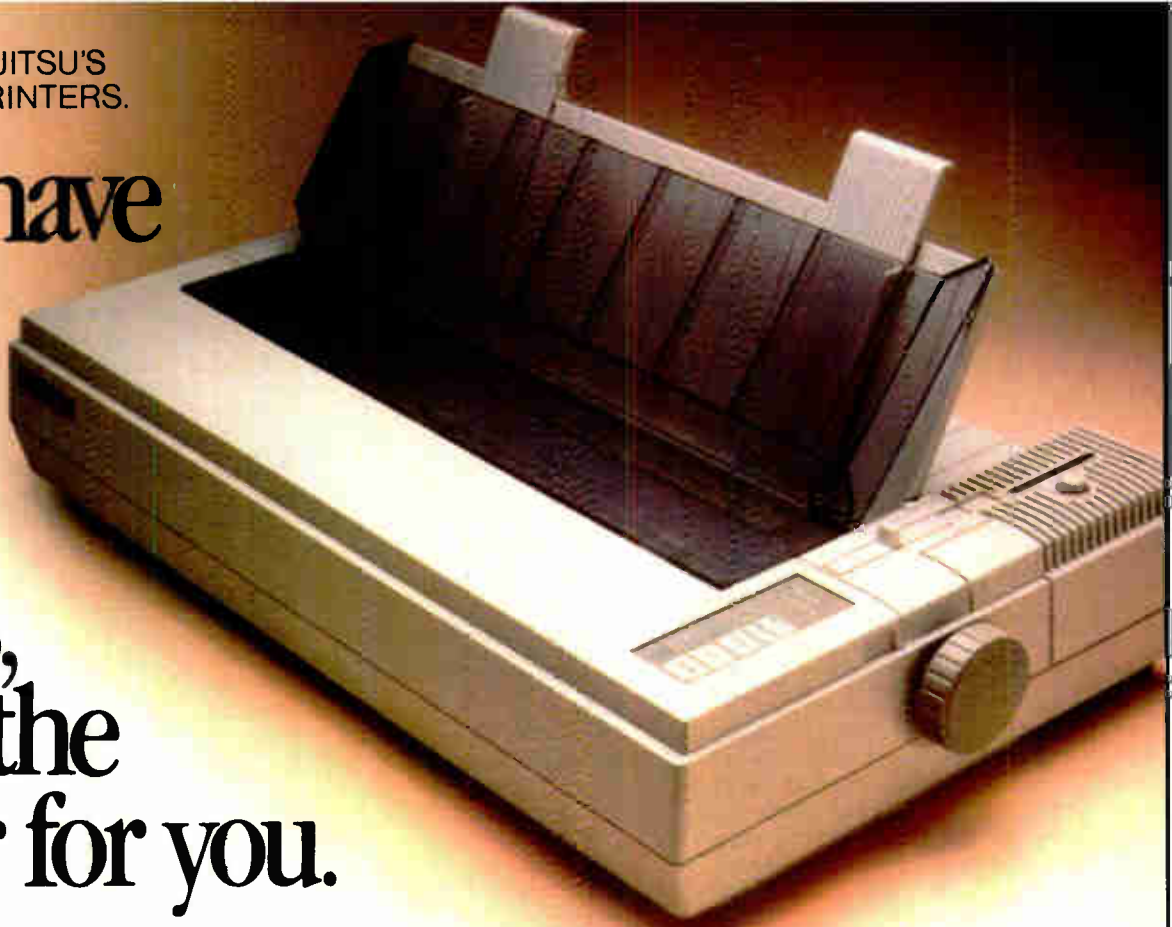

Meet Fujitsu's new DL3000 series printers. All you ever wanted from a 24-wire dot matrix printer at a surprisingly affordable price.

Superb Paper Handling, Speed, and Quiet Operation.

First, with just a push of a button you can switch between letterhead and computer paper. The built-in tractor with paper parking does all the work.

Next, print fast. 288 characters per second, or one-page memos in 10 seconds.

Finally, print quiet. Quiet enough to let you comfortably carry on a conversation.

Easier, faster and quieter than the competition. Ask to see one. We'll prove it.

Comes Fully Loaded, Ready To Go To Work.

The DL3000 printers give you crisp graphics and exceptional letter quality printing.

They give you an easy-to-use programmable operator panel with memory for two different menus. And you'll be compatible with today's popular business systems and software.

You even get an industry leading reliability rating of

8,000 hours MTBF. For years of trouble-free performance.

Call 800-626-4686 today for more information on this or any of our world famous family of printers, including daisywheel, dot matrix, laser and band.

Because the more you ask, the more we can do for you.

DL3300 (Narrow Carriage), DL3400 (Wide Carriage)		
Speed	High Speed Draft	288 cps at 12 cpi
	Draft Quality	216 cps at 12 cpi
	Letter Quality	72 cps at 12 cpi
Fonts	Courier 10	
	Prestige Elite	
	Compressed	
	Optional Font Card with 2 Fonts per Card	
Paper Handling	Standard Push Tractors with Automatic Sheetloading and Paper Parking; Optional Single and Double Bin Cut Sheet Feeders	
	Acoustic Noise	55 dBA
Interfaces	Centronics Parallel or RS232C Serial	
Emulations	IBM® Proprinter XL® IBM Graphic Printer, Diablo 630® API, Epson JX80® (with Color Option)	
Color Option	User Installable Kit	

A COMPANY WITH CHARACTER AND DRIVE



FUJITSU AMERICA
Computer Products Group

FOR MORE INFORMATION ON THE DL3000 SERIES PRINTERS, CALL 800-626-4686

© 1987, Fujitsu America, Inc. IBM, Proprinter XL and Graphics Printer are registered trademarks of International Business Machines Corporation. Epson JX80 is a registered trademark of Seiko Epson Corporation. Diablo 630 is a registered trademark of Xerox Corporation.

Circle 108 on Reader Service Card (DEALERS: 109)

World Radio History

New Power for FORTRAN

Carl Byington

Two new compilers take advantage of the 80386 and its coprocessors

FORTRAN has been around for over 30 years, but when it comes to number crunching, FORTRAN is still the best tool. Now, it is even better. Two new compilers use the 32-bit registers of the Intel 80386 to allow more efficient code when accessing arrays larger than 64K bytes and when using 32-bit integers. Both SVS FORTRAN 386 version 2.7 (\$895) from Science Applications International Corp. (SAIC) and NDP FORTRAN 386 version 1.3a (\$595) from MicroWay generate code for the 80386 32-bit native mode and support the 80287, 80387, and Weitek 1167 floating-point coprocessors.

These compilers require more than minimum hardware configurations. NDP FORTRAN 386 requires an 80386-based computer with a 1.2-megabyte floppy disk drive, a hard disk drive with at least 2 megabytes free, at least 640K bytes on the motherboard, and 2 megabytes of extended memory. It also requires that you have MS-DOS 3.2 (or higher) and Phar Lap's 386|ASM, 386|LINK, and RUN386. The Phar Lap programs are available in the 386|ASM/LINK package for \$495. SVS FORTRAN 386 requires an 80386-based computer with a 1.2-megabyte floppy disk drive and a hard disk drive with 2 megabytes free. SVS FORTRAN needs 640K bytes, but does not require extended memory to run. You will need MS-DOS version 2.0 or higher and Phar Lap 386|LINK. Both compilers produce executable code that requires a floating-point coprocessor, but only the SVS compiler requires a floating-point coprocessor for the compiler itself.

Power at a Price

Both compilers depend on a DOS-extension package that interfaces their 32-bit code to the IBM PC's 16-bit operating system. The SVS FORTRAN system uses a modified version of the X-AM package from Intelligent Graphics Corp. NDP FORTRAN uses Phar Lap's RUN386 version 1.1v or higher. In a normal 16-bit

compiler, there are three components that may contain bugs (the compiler, the run-time libraries, and the operating system). With these 32-bit compilers, you also have to worry about the DOS-extension package.

Both compilers generate object modules that you must link with the run-time libraries to create an almost executable module. To run that module, you must first invoke the DOS-extension package. Neither the compilers nor their generated object programs will run if the 80386 processor is in the virtual 86 mode. The run-time libraries do not include any routines for screen I/O, cursor control, color control, graphics, or database management.

Both compilers, their generated object programs, and the Phar Lap tools all work correctly with Personal REXX from Mansfield Software Group. Personal REXX is a powerful command processor to which I am addicted.

SVS FORTRAN 2.7

When you purchase the SVS system, you receive the compiler and the run-time libraries. Also included is a copy of the required DOS-extension package, but you must purchase the required linker separately from Phar Lap. The software is on two 1.2-megabyte floppy disks: one for use on 80287/80387 systems and the other for use on Weitek 1167 systems. SAIC supplies a user's guide, a FORTRAN reference manual, and a debugger reference manual. None of the manuals include an index. The license for the compiler provides an unlimited license to distribute the DOS-extension package with your linked modules to your clients.

The SVS compiler runs on Motorola 68000 and National Semiconductor 32000 Unix environments, in addition to MS-DOS on an 80386-based system. The manual covers all systems generically, with an appendix giving the specific details for each system.

The SVS FORTRAN compiler requires a floating-point coprocessor. You must choose a numeric processor (e.g., 80287, 80387, or Weitek 1167) when you install the compiler. If you want to compile a program on a machine with one numeric processor and execute that pro-

gram on a machine with a different numeric processor, you must modify the compile-and-link batch files. You need to copy the target coprocessor support library to the proper subdirectory on your hard disk and change the numeric coprocessor switch in the compiler command line before you can begin cross development. The documentation for this process is sketchy.

The compiler recognizes over 20 switches to control the input and output files, debug status, FORTRAN-66 compatibility, numeric processor selection, and parameter passing model. You can also specify most of these as metacommands of the form \$xxx in the source file.

A Complex Path to Execution

The SVS FORTRAN compiler is really three separate programs (FORTRAN, TCODE, and JLINKER) that you must run with different parameters. These three programs read your FORTRAN program and produce a linkable object module. There is no option to generate an assembly language source or listing file.

SAIC supplies a small batch file to compile and link a single FORTRAN program. Compiling FOO.FOR will produce FOO.OBJ, FOO.REX, and FOO.EXE. The .OBJ file is the linkable object module. The linker produces the relocatable executable file called the .REX file. The .EXE file is a copy of XAMENV, the X-AM equivalent of Phar Lap's RUN386. When you run FOO from the DOS command line, you are really running a copy of XAMENV with a different name. That program determines the name (FOO) from DOS and loads FOO.REX as a protected native-mode 80386 program.

You can modify two pieces of information in the FOO.EXE file. The STACKSZ utility can modify the stack size value in the FOO.EXE file. If you are running under DOS 2.x, the program name (FOO) is not available for execution. The SVSNAME utility can modify the program name value inside the FOO.EXE file so that it can locate FOO.REX even under DOS 2.x.

Every FORTRAN object program creates another copy of XAMENV on your disk. All these copies differ only in name, in the few bytes that store the FORTRAN object program name (you cannot even reference that field unless you run it under DOS 2.x), and in the stack size for the program. The problem is that each FORTRAN program on your disk uses 116K bytes of disk space to store just 20 bytes of information. The alternative is to create a batch file that runs your programs and makes a temporary copy of

continued

If you can see the difference,
you must be looking at the price.

Hewlett-Packard Company
18110 S.E. 34th Street
Camas, WA 98607

Dear Reader:

This letter was printed on two of the finest printers available today. One half on a laser printer, the other on the new HP DeskJet Printer. But which one printed which half? Hard to tell, isn't it?

Small and quiet enough for your own desk, our HP DeskJet Printer gives you clean, crisp text and graphics. Just like a laser. You get perfect printing from A to Z. Look for yourself.

AaBbCcDdEeFf JjKkLlMm NnOoPpQq RrSsTtUuVvWwXxYyZz

So which half is from the laser printer and which from the HP DeskJet Printer for under \$1,000? Not sure? That's the point. To see the difference you've got to look at the price. So call for the name of your local dealer and a free brochure on the new HP DeskJet Printer at 1 800 752-0900 Ext. 908A.

Sincerely,

HEWLETT-PACKARD COMPANY

Greg Wallace
Greg Wallace

Laser Printer

HP DeskJet Printer

The New HP DeskJet Printer. Laser-Quality Output for Under \$1000.

 **HEWLETT
PACKARD**

© Hewlett-Packard Co 1987

Circle 121 on Reader Service Card

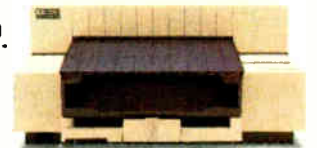

Table 1: Results of FORTRAN benchmarks show that SVS FORTRAN produces considerably smaller executable code than that produced by NDP FORTRAN.

	Time (in seconds)			Size (in bytes)		
	Compile	Link	Execute	.OBJ	.EXE	
Floating-point arithmetic (calculations) (10,000 iterations)						
NDP	11	8	.32	923	54332	
SVS	18	7	.25	687	20084	
Eratosthenes Sieve (15,000 iterations)						
NDP	11	9	.11	888	84312	
SVS	18	7	.11	730	20160	
Write 1024 128-byte records of character data						
NDP	10	8	4.97	1034	54508	
SVS ¹	18	8	5.49	939	30248	
SVS ²	18	8	8.94	939	30248	
Read 1024 128-byte records of character data						
NDP	10	9	8.42	812	54328	
SVS	18	8	8.68	784	30368	
Write 1024 126-byte records of formatted numeric data						
NDP	10	8	9.06	850	54236	
SVS ¹	19	8	7.07	830	28252	
SVS ²	19	8	12.89	830	28252	
Read 1024 126-byte records of formatted numeric data						
NDP	11	8	9.03	821	54244	
SVS	20	8	9.01	773	31628	
Write 1024 36-byte records of unformatted numeric data						
NDP	11	9	1.81	846	54928	
SVS ¹	19	8	1.69	825	24824	
SVS ²	19	8	2.60	825	24824	
Read 1024 36-byte records of unformatted numeric data						
NDP	11	9	1.65	813	54932	
SVS	20	7	1.43	764	24800	
	Time (in seconds)			Size (in bytes)		
	Compile	Link	Whetstones	.OBJ	.EXE	
Single-precision Whetstones						
NDP	23	8	1923	5209	56972	
SVS	21	7	2000	3285	28488	
Double-precision Whetstones						
NDP	24	8	1666	5698	57252	
SVS	22	8	1666	3629	28740	
	Time (in seconds)			MFLOPS	Size (in bytes)	
	Compile	Link	Execute		.OBJ	.EXE
Single-precision LINPACK						
NDP	55	12	83.87	.242	14935	388776
SVS	25	9	76.73	.265	9138	40972
Double-precision LINPACK						
NDP	57	16	102.38	.195	15344	711720
SVS	26	9	97.93	.204	9543	44200

¹Create new file.
²Overwrite old file.

Note: Timings for the Whetstone benchmarks are given in thousands of Whetstones per second. Timings for the LINPACK benchmarks are given in both seconds and MFLOPS (millions of floating-point operations per second). The object-file sizes are given for the .EXP form for the NDP system, and the .REX form for the SVS system.

XAMENV, sets its stack size to the current program's required size, runs it, and then deletes it.

Tools for Debugging

The SVS debugger is a symbolic debugger that uses a line-oriented display. Instead of the multiple-window, user-screen-saving debuggers found with many MS-DOS packages, SVS FORTRAN uses a glass-teletype display with simple scrolling lines of information. The debugger can display variables by name or by specific value as long as the variable is not in a register. You set breakpoints and tracepoints by the subroutine name and the statement number (not line number) within that subroutine. This debugger does not know about watchpoints, so you will have to single-step the program and display the variable of interest at each step.

The debugger can also display array elements, but there is no command to display every element (or a collection of elements) of an array. You can display the value of $x(1)$, $x(i)$, or $x(x(1))$, but you cannot display $i+j$ or $x(i+1)$ since the debugger has no arithmetic operations.

Gotchas

The SVS system does not associate units 5 and 6 with standard I/O. Although the ANSI standard does not require this, there are a lot of programs that assume these unit numbers are special. The SVS system uses unit 0 for standard I/O and unit 1 for standard error. New FORTRAN programs should use READ(*, ...) and WRITE(*, ...) rather than any specific unit number.

SVS FORTRAN 386 can create a new file about twice as fast as it can overwrite an existing file. For this reason, I performed file-manipulation benchmarks twice for the SVS compiler (see table 1). The NDP system does not display this anomaly.

The SVS system does not tolerate device drivers that use extended memory. If you try to run an SVS FORTRAN program while SMARTDRV is active, the system will reboot itself with no error message. Your program will also hang if it tries to write an unformatted file that is larger than the available disk space. If that happens, you just press Control-C to terminate the program without rebooting the machine. Finally, the DOS-extension package takes over interrupt vectors 78 to 7F and does not restore them when the FORTRAN program terminates.

SVS Code Generation

The SVS compiler generates code that contains some interesting features. The

continued

SVS FORTRAN 386 2.7

Type
80386 native-mode FORTRAN compiler

Company
Science Applications
International Corp.
5150 El Camino Real
Suite C-31
Los Altos, CA 94022
(415) 960-3322

Format
Two 1.2-megabyte 5¼-inch floppy disks (one for 80287/80387 systems and one for Weitek 1167 systems); one 3½-inch floppy disk for PS/2 Model 80

Language
Pascal

Hardware Needed
80386-based system with one 1.2-megabyte 5¼-inch floppy disk drive; 640K bytes of RAM; hard disk drive with at least 2 megabytes free; 80287, 80387, or Weitek 1167 floating-point coprocessor

Software Needed
Phar Lap 386|ASM/LINK: \$495

Documentation
45-page user's guide; 200-page FORTRAN reference manual; 55-page debugger reference manual

Price
\$895

Inquiry 904.

NDP FORTRAN 386 1.3a

Type
80386 native-mode FORTRAN compiler

Company
MicroWay
P.O. Box 79
Kingston, MA 02364
(617) 746-7341

Format
One 1.2-megabyte 5¼-inch floppy disk

Language
FORTRAN

Hardware Needed
80386-based system with one 1.2-megabyte 5¼-inch floppy disk drive; 640K bytes of RAM; hard disk drive with at least 2 megabytes free; 2 megabytes of extended memory; 80287, 80387, or Weitek 1167 floating-point coprocessor

Software Needed
Phar Lap RUN386 and 386|ASM/LINK: \$495 (needed only if running under DOS)

Documentation
90-page user's manual; 100-page reference manual

Price
\$595

Inquiry 905.

loop only as an array subscript, SVS could improve this code by changing to the loop style that NDP FORTRAN uses.

NDP FORTRAN 1.3a

When you purchase the NDP system, you receive the compiler and the run-time libraries. You must still purchase the required assembler, linker, and DOS-extension package separately from either Phar Lap or MicroWay. You can sell your linked modules to your clients, but the modules will be of no value to them unless you also buy an unlimited license to distribute the DOS-extension package, your client buys a copy of the DOS-extension package for each machine that will run your application, or your client runs Unix.

This compiler is available only for the 80386 under either Microport's Unix or MS-DOS with Phar Lap's 386|DOS-Extender (see table 2). The package includes the NDP FORTRAN compiler, a compiler driver (f77), a make utility (mm), and the run-time libraries. The run-time libraries do not include any procedures for screen I/O—for example, cursor control, color control, windows, or graphics.

NDP FORTRAN comes on a single 1.2-megabyte floppy disk. To install NDP FORTRAN, you simply copy the entire contents of the floppy disk to any subdirectory listed in your PATH command. You must also add SET NDP=path to your AUTOEXEC.BAT file to tell the compiler its location. If the Phar Lap tools are not in the NDP directory, you need to add SET TOOLS=path to your AUTOEXEC.BAT file.

MicroWay supplies a user's manual and a reference manual. Both manuals include an index.

The NDP FORTRAN compiler does not require any numeric processor. The object programs that it generates require a numeric processor (e.g., 80287, 80387, or Weitek 1167) based on the switches that you specify when the program compiles.

There are three ways to run this compiler. You can run the compiler driver (f77) with a variety of switches. The driver will then run the compiler, assembler, and linker with the appropriate switches. You can run the minimake program (mm), and it will build your program according to the values that it has saved in a small database, or you can directly run the compiler, assembler, and linker yourself (from a batch file) with the correct switches. This last approach is the only way to get the assembler to produce the assembly language listing file that you will need to use the debug-

continued

compiler aligns the code for a loop on a 4-byte boundary. When the jump transfers control from the bottom of the loop back to the top, the 80386 processor needs to access memory to fill the prefetch queue with the first instruction. This alignment ensures that all the bytes fetched with that first instruction are part of the current loop.

The compiler typically optimizes for execution speed, generating the three-instruction sequence

```
mov  eax,temp20
lea  ecx,[eax+eax*8]
lea  eax,[ecx+eax*2]
```

rather than the much shorter single instruction

```
imul eax,temp20,11
```

because the three-instruction sequence actually executes about 12 percent faster.

You should not consider the SVS compiler as a perfect optimizing compiler,

however. A peephole optimizer would clean up these instruction pairs that the SVS compiler generated in some of my test cases.

```
mov  temp10,eax
mov  eax,temp10 ; remove
```

```
mov  temp10,eax
mov  ecx,temp10 ; replace with
      mov ecx,eax
```

```
mov  edi,temp10 ; remove
mov  edi,1
```

For a DO loop of the form "DO 10 I = 1,N", SVS generates the following loop-control instructions at the bottom of the loop:

```
inc temp10
mov  esi,temp10
cmp  esi,temp14
jle top
```

If you use the index variable inside the

Every presenter wants to make a compelling, persuasive case. And color, you'll agree, makes all the difference.

It's more eye-catching. More readily understood. More

memorable. In short, color makes any desktop presentation more effective. And research proves it.

All you need is a Hewlett-Packard ColorPro Plotter like we used here, or the HP PaintJet Color Graphics Printer. Together with a PC—IBM compatible or Apple Macintosh—you can use all the popular graphics software like Lotus Freelance Plus, Cricket Presents, HP's Graphics Gallery (used below), Microsoft Chart and Harvard Graphics.

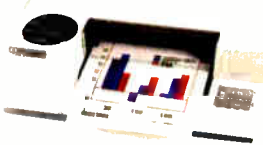

At under \$1,300, the HP ColorPro Plotter may be just where you want to start. It will turn your ideas into colorful, easy-to-grasp visuals. Or, if you need to combine near-letter quality text with color graphics, you can rely on the HP PaintJet Color Graphics Printer for under \$1,400. Whichever you choose, you'll create desktop presentations with startling color and greater impact.

For a colorful sample overhead and the name of your nearest dealer, call 1 800 752-0900, Ext. 903A.

Freelance Plus* and Lotus* are U.S. registered trademarks of Lotus Development Corporation. Microsoft* is a U.S. registered trademark of Microsoft Corporation.
© Hewlett-Packard 1988



Circle 123 on Reader Service Card

Guess which presentation made the sale.

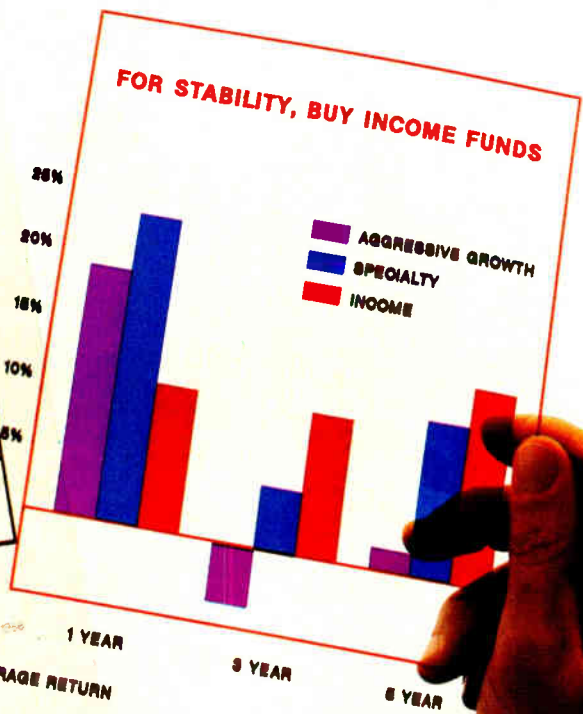
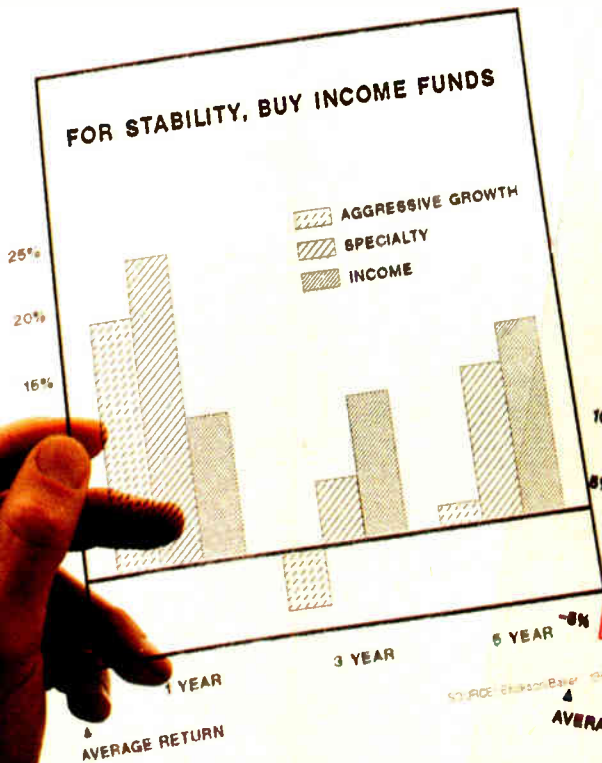

Table 2: A comparison of features.

Basic facilities		
Product version	SVS FORTRAN 386 version 2.7	NDP FORTRAN 386 version 1.3a
Hardware support	80386, 68000, 32000, 80287, 80387, Weitek 1167	80386, 80287, 80387, Weitek 1167
Operating system	Unix (68000 and 32000); MS-DOS (80386)	Microport Unix V.3; MS-DOS
MS-DOS extension	X-AM from IGC	Phar Lap RUN386
Copy-protected	No	No
Memory required	2 megabytes	2 megabytes
Disk space required	2 megabytes	2 megabytes
Assembler required	None	Phar Lap 386 ASM 1.1v
Linker required	Phar Lap 386 LINK	Phar Lap 386 LINK 1.1v
Development		
Debugger	Symbolic	DOS-type Debug supplied with Phar Lap software
Generates symbolic assembly code	No	Yes
Data Types		
Logical	*1, *2, *4	*1, *2, *4
Integer	*1, *2, *4	*1, *2, *4
Real	*4, *8	*4, *8
Complex	*8	*8, *16
File I/O		
Unit 5 or 6 for standard I/O	No	Yes
Interfaces		
Call other languages	Pascal, C	Pascal, C
DOS I/O	No	No
Compatibility		
VDISK	No	Yes
SMARTDRV	No	Yes
REXX	Yes	Yes

ger. The compiler recognizes over 50 switches to control the optimization level, I/O file directories, FORTRAN-66 compatibility, and numeric-processor selection. Although the FORTRAN language is not case-sensitive, these compiler switches are.

Limited Debugging Capabilities

The NDP FORTRAN system does not include a debugger, but the Phar Lap tools include two debuggers. The MINIBUG debugger is very similar to the DOS Debug. The 386DEBUG is something of a symbolic debugger, which probably works nicely for assembly language programmers, but has serious limitations for FORTRAN programmers. The only

symbols that this debugger knows are global (external) symbols, and NDP FORTRAN generates global symbols only for named common blocks and subroutines. This means that you can dump the contents of a named common block, or set a breakpoint at the entry to a subroutine, without the listing files. If you want to do anything else, you still need the listing files and the ability to read 80386 code.

Like MINIBUG, 386DEBUG cannot display any file on the screen, so you still need hard copy listings. 386DEBUG can use a second ASCII terminal connected to COM1 or COM2 for debugging. In this mode, the debug commands do not overwrite your FORTRAN program output

on the main monitor, but you need a second monitor and keyboard on your desk.

Into Extended Memory

Both the compiler and the object programs that the compiler generates recognize the existence of the VDISK and SMARTDRV device drivers. You could place your source code and the run-time libraries on a large VDISK, letting you compile, link, and execute programs without touching the hard disk. If you gave that same memory to SMARTDRV, you would achieve almost the same performance level, but the hard disk would always have a current copy of your code.

Gotchas

The NDP system has problems detecting the end of available disk space. If your program tries to write a file (formatted or unformatted) that is larger than the available disk space, it will not receive any error indication. The write statement will complete, and control will pass to the next statement, even though the data was not actually written.

Data size has a dramatic effect on program size in the NDP environment. Consider a program that declares a 4-megabyte array. The object program that the NDP compiler generates is much smaller than 4 megabytes, but the executable program that the Phar Lap linker generates is larger than 4 megabytes. The executable file contains an image of the array, even if the array is not initialized. If you locate the array in a common block, this problem does not occur.

The -n2 compiler switch for 80387 code works correctly, but the compiler driver still asks for the 80287 library during the link phase.

NDP Code Generation

The main weakness of the NDP compiler's code generator is in the array-addressing computations in DO loops. The compiler generated a total of 68 instructions for a simple array multiply routine. Of these, the compiler could remove 15 (22 percent) without changing any of the other instructions.

Another weak spot is the code generated for real-to-integer conversions. This compiler generates the following code for the statement i=x:

```

fnstew word ptr temp16
mov ax,temp16
or ax,3072
mov temp14,ax
fldcw word ptr temp14
fld dword ptr x
fstp dword ptr i
fldcw word ptr temp16
    
```

continued

This compiler needs only two control words to run the 80387 for most operations. One control word specifies round nearest (used for normal operations) and the other specifies chop (for real-to-integer conversions). In the above example, the first four instructions store the normal control word and convert it to the conversion control word. The compiler could remove those instructions if it generated two constants for the appropriate control words and loaded them as necessary.

A peephole optimizer should be added to clean up these instruction pairs that

were generated in some of my test cases:

```

mov ecx,1 ; remove
imul ecx,ecx,10 ; replace with
; mov ecx,10

mov temp24,edx
cmp temp24,0 ; replace with
; or
; edx,edx

jle label

lea ecx,[edx] ; replace with
; mov ecx,edx
    
```

```

fst [ebx] ; replace with
; fstp [ebx]
fstp st(0) ; remove
    
```

For a DO loop of the form "DO 10 I = 1,N", this compiler generates the following loop-control instructions at the bottom of the loop:

```

dec temp10
jne top
    
```

Note that this code is much faster than the code that the SVS compiler generates.

Trade-offs of Speed and Convenience

I tested both compilers on a Compaq 386/20 with an 80387, 6 megabytes of Compaq 32-bit memory, and a 60-mega-byte hard disk drive.

The SVS system creates executable files about 25K bytes smaller than those that the NDP system produces. This mainly reflects the size of the base set of run-time routines that link into any FORTRAN program. The NDP compiler generates object code sequences that are about 25 percent larger (in terms of object code bytes) than those that the SVS compiler generates, but the code executes only about 5 percent slower.

The SVS compiler takes almost 50 percent longer than the NDP compiler on small test cases like the Sieve and File I/O benchmarks, but it becomes almost twice as fast as the NDP compiler on large or complicated programs such as the LINPACK.

The SVS system comes complete with almost everything you need to write, debug, and sell your FORTRAN application object module. The only other equipment you need is the Phar Lap linker. The NDP system does not include a debugger, although it does include one with the required package from Phar Lap.

While the SVS compiler has much better debugging facilities than NDP, with SVS you'll have multiple copies of XAMENV.EXE taking up hard disk space.

If you need a compiler that is compatible with extended-memory utilities, such as VDISK and SMARTDRV, NDP FORTRAN is the only choice.

In short, while both compilers are powerful, neither is perfect. Indeed, the major disadvantages of both compilers are that they are neither as mature nor as stable as the 16-bit compilers from Ryan-McFarland or Microsoft. ■

Carl Byington is the founder of 510 Software Group, Rancho Palos Verdes, California. The company specializes in language-run-time support systems and database applications.

REPROGRAM THE ORIGINAL COMPUTER

Access a new, hands-on experience in OS/2 and C Programming.

Lattice, the consensus leader in C compilers, introduces a new way for program designers, users and managers to learn everything there is to know about OS/2 and C. Our seminars and workshops are taught by expert programmers with real world experience. With less theory, more hands-on. In fact, each course is so intense, it's the equivalent of college level, packed into a 4-day session.

Demand is intense too, so make your reservations now. And come prepared to open your mind.

Call 1-800-533-3577

CALENDAR OF COURSES

OS/2 for Managers	OS/2 Programming
April 28 - June 30	April 19-21 June 14-16
May 19 - July 21	May 10-12 July 5-7

C-Programming

May 3-6	July 12-15
May 24-27	July 26-29
June 21-24	

All courses taught in the Lattice Training Center, Lombard, Illinois, near Chicago's O'Hare Airport. Special room rates are available in nearby hotels. Ask for information.



Lattice

Subsidiary of SAS Institute Inc.
Lattice, Incorporated
2500 S. Highland Avenue
Lombard, IL 60148
Phone: 800/533-3577
In Illinois 312/916-1600

Lattice is a registered trademark of Lattice, Incorporated.

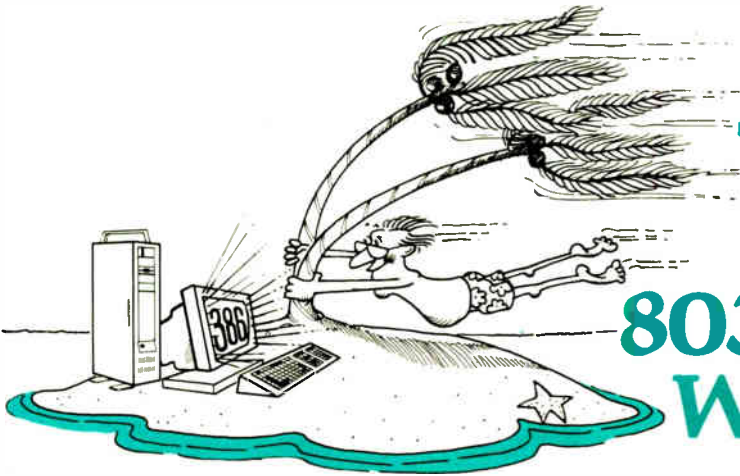

UNLEASH THE POWER OF YOUR 80386 COMPUTER WITH VM/386...

The 80386 control program that brings you true DOS multitasking.

IGC and Programmer's Paradise offer you the best value on the Software you need.

VM/386 uses the virtual 8086 mode, built into the 80386 processor, to create individual virtual machines. You can load a different application in each virtual machine. A 386 PC with VM/386 is like having a desktop full of PC's all working for you at the same time, giving you the power and flexibility to get all your jobs done at once. TRUE MULTITASKING with VM/386 from

IGC

Increased Productivity

With VM/386, your 386 PC becomes more than just a fast AT. VM/386 dramatically increases your productivity by allowing you to run several programs simultaneously and not have to wait for one application to finish before you start-up or work with another. *And unlike other control programs, VM/386 is easy-to-install, easy-to-learn and easy-to-use.*

More Compatibility, No Retraining

VM/386 runs all industry standard MS-DOS and PC-DOS software. It supports LIM expanded memory specifications and runs EGA applications in the background perfectly. VM/386 supports the monitors, hard disks, printers, mice and modems you are currently using or plan to use.

Interact with VM/386 in exactly the same way as you interact with your PC, using the familiar DOS commands. No need to learn a new interface or be retrained.

Circle 218 on Reader Service Card

Complete Control over the Environment

Each virtual machine (VM) can be customized to make full use of the power of your 386 PC. Each VM has its own DOS, AUTOEXEC file and CONFIG file. You can specify the size and type of RAM in each VM and can set the processing power and priority of each VM. And VMs are protected from one another.

Superior Performance

VM/386 takes full advantage of the power of the 80386 because it was designed specifically for 386 PCs. VM/386 provides superior performance compared to other 386 control programs by utilizing buffered I/O to reduce disk access and allowing VMs to share a RAM disk.

PC Magazine called VM/386, "An exciting, new program..." Try it yourself and get the performance you bought your 386 PC for.

Call PROGRAMMER'S PARADISE today to order VM/386
List Price: \$245 Our Special Price: \$179

Get all the power your 386 has to offer and true multitasking with VM/386 from IGC.

1-800-445-7899
In NY: 914-332-4548

Programmer's
Paradise™

A Division of Hudson Technologies, Inc.
42 River Street, Tarrytown, NY 10591



APRIL 1988 • BYTE 177

	LIST OURS
TURBO PASCAL ADD-ONS	
ASCII TURBO GHOST WRITER	
STARTER	NEW 89
COMPLETE	NEW 289 259
AZATAR DOS TOOLKIT	NEW 95 85
DOS/BIOS & MOUSE TOOLS	75 69
FLASH-UP	89 79
FLASH-UP TOOLBOX	49 45
INSIDE TRACK	65 55
MACH 2	75 59
METRABYTE DATA ACQ. TOOLS	100 89
SCIENCE AND ENGIN. TOOLS	125 95
SCREEN EDITOR	150 129
SYSTEM BUILDER	100 89
IMPEX	130 115
REPORT BUILDER	100 89
T-DEBUG PLUS V. 4.0	SPECIAL 45 39
W/SOURCE	NEW 90 79
TURBO ADVANTAGE	50 45
TURBO ADVANTAGE COMPLEX	90 79
TURBO ADVANTAGE DISPLAY	70 65
TURBO ASM	99 69
TURBO ASYNCH PLUS	129 99
TURBO GEOMETRY LIBRARY	NEW 100 89
TURBO HALO	99 85
TURBO MAGIC	99 89
TURBO PASCAL TOOLBOXES	
DATABASE	100 69
EDITOR	100 69
GAMEWORKS	100 69
GRAPHIX	100 69
NUMERICAL METHODS	100 69
TUTOR	70 45
TURBO POWER TOOLS PLUS	129 99
TURBO POWER UTILITIES	95 79
TURBO PROFESSIONAL 4.0	99 79
TURBO WINDOW/PASCAL	95 79
UNIVERSAL GRAPHICS LIBRARY	150 119
SCREENS/WINDOWS	
C-SCAPE	279 265
CURSES W/SOURCE CODE	250 169
GREENLEAF DATA WINDOWS	225 155
W/SOURCE	395 259
JVACC FORMAKER	495 449
JVACC JAM	750 679
MICROSOFT WINDOWS	95 79
MS WINDOWS DEVELOPMENT KIT	500 319
PANEL	295 199
PANEL PLUS	SPECIAL 495 389
PANEL/PC (QUICK C)	129 99
PANEL/T (TURBO C)	129 99
QUICKSCREEN	195 175
SCREENSTAR W/SOURCE	198 169
SOFTCODE	NEW SPECIAL 129 109
VIEW MANAGER	275 199
VITAMIN C	SPECIAL 225 149
VC SCREEN	99 79

	LIST OURS
WINDOWS FOR C	195 CALL
WINDOWS FOR DATA	295 CALL
W/SOURCE	590 CALL
SOURCE CODE MAINTENANCE	
ADVANTAGE MAKE	125 99
ADVANTAGE VCMs	379 329
XENIX/UNIX SOFTWARE	
MICROPORT & SCO PRODUCTS	CALL CALL
ADVANTAGE C++	695 625
BTRIEVE/N	300 455
DIRECTORY SHELL (286 or 386)	CALL CALL
EPSILON	195 149
FOXBASE+	795 649
FOXBASE+ /386	895 729
INFORMIX PRODUCTS	CALL CALL
JVACC FORMAKER	895 809
JVACC JAM	1350 1219
KORN SHELL	145 115
MICROSOFT LANGUAGES	CALL CALL
PANEL PLUS	795 675
RM/COBOL	1250 949
RM/FORTRAN	750 549
WINDOWS FOR DATA	795 CALL
LMK	NEW 195 139
LUGARU MAKE	NEW 69 CALL
MKS RCS	NEW SPECIAL 189 169
PVCS CORPORATE	395 329
PVCS-NETWORK	CALL CALL
PVCS-PERSONAL	149 129
POLY LIBRARIAN	99 89
POLYMAKE	149 129
SEIDL VERSION MANAGER	NEW 300 CALL
NETWORK VERSION	NEW 1000 CALL
SEIDL MAKE UTILITY	NEW 100 90
SMK GEN	NEW 50 45
SOURCE TOOLS	NEW 595 535
TLIB	100 89
TRANSLATORS	
BAS_C OR BAS_PAS	CALL CALL
BASTOC	495 399
DB2C	299 CALL
DBX TRANSLATOR	350 299
RTC PLUS	325 299
ADDITIONAL LANGUAGES	
HS/FORTH	395 359
LATTICE RPG II DEV. SYS.	1400 1119
RPG II COMPILER	750 629
RPG II SEU	250 199
RPG II SORT MERGE	250 199
RPG II SCREEN DESIGN AID	350 309
MASTER FORTH	125 115

	LIST OURS
PC FORTH	150 109
PERSONAL REXX	125 99
PLL_86	750 675
VP EXPERT	100 89
ADDITIONAL PRODUCTS	
CROSS REFERENCE GENERATOR	50 39
DAN BRICKLIN'S DEMO PROGRAM	75 59
DAN BRICKLIN'S DEMO PROG. II	195 155
DAN BRICKLIN'S DEMO TUTORIAL	50 45
FLOW CHARTING II	229 205
MKS AWK	75 69
MKS-SQPS	NEW 495 469
POLYBOOST	80 69
POLYDESK III	99 75
SAPIENS V8	300 269
SOFTSCREEN HELP	195 149
SOURCE PRINT	95 75
TEXT MANAGEMENT UTILITIES	120 89
TREE DIAGRAMMER	77 69
BLAISE	
ASYNCH MANAGER (C/PASCAL)	175 135
C TOOLS PLUS/5.0	129 99
EXEC	95 79
PASCAL TOOLS/TOOLS 2	175 135
TURBO ASYNCH PLUS	129 99
TURBO C TOOLS	129 99
TURBO POWER TOOLS PLUS	129 99
VIEW MANAGER (C/PASCAL)	275 199

	LIST OURS
ESSENTIAL GRAPHICS	250 189
RESIDENT_C*/	99 85
W/SOURCE	198 169
SCREENSTAR	99 85
W/SOURCE	198 169
GREENLEAF	
GREENLEAF C SAMPLER	95 69
GREENLEAF COMM LIBRARY	185 125
GREENLEAF DATA WINDOWS	225 155
W/SOURCE	395 259
GREENLEAF FUNCTIONS	185 125
MICROSOFT	
MS BASIC COMPILER (XENIX)	695 449
MS BASIC INTERPRETER (XENIX)	350 229
MS C COMPILER	450 285
MS COBOL COMPILER	700 449
FOR XENIX	995 649
MS EXCEL	NEW 495 329
MS FORTRAN	450 285
FOR XENIX	695 449
MS LEARNING DS	50 39
MS MACRO ASSEMBLER	150 99
MS MOUSE SERIAL OR BUS	150 99
W/MS WINDOWS	200 139
W/EASY CAD	175 119
MS NUMATH	300 185

MOUSE PRODUCTS

LOGITECH SERIAL OR BUS MOUSE	
W/PLUS, SOFTWARE	119 99
W/PLUS, LOGICPAINT	149 119
W/PLUS, LOGICADD	189 149
W/PLUS, PUBLISHER MOUSE	179 145
W/PLUS, PAINT, CADD	199 159
W/PLUS, CADD, PUBL. MOUSE	239 189
W/PLUS, PAINT, PUBL. MOUSE	199 159
W/PLUS, PAINT, CADD, PUBL.	253 205
LOGITECH SERIES 2 W/PLUS	99 79
MICROSOFT SER OR BUS MOUSE	150 99
W/EASY CAD	175 119
W/MS WINDOWS	200 139
PC MOUSE SER W/PNT & POPUPS	179 129
PC MOUSE SER W/PNT & POPUPS	159 115
SUMMAMOUSE	119 99
MS PASCAL COMPILER	300 189
FOR XENIX	695 449
MS QUICK BASIC	99 65
MS QUICK C	SPECIAL 99 65
MS SORT	195 129
MS WINDOWS	99 65
MS WINDOWS DEVELOPMENT KIT	500 319
MS WINDOWS/386	SPECIAL 195 125
MS WORD	NEW 450 285
MS WORKS	NEW 195 129

Special Savings from Paradise

Flash-Up

Flash-Up enhances every program... without writing a single line of code. Just use the RAM resident window editor to "draw" menus and help windows into any program. Think of Flash-Up as a full keyboard macro utility, a help note annotator and a menu maker rolled into one to help you do things that could never be done before. Like making smart menus that send keyboard macros. Automatically attaching them to your program with "electronic glue" and even adding mouse support to all your programs.



THE SOFTWARE BOTTLING COMPANY

List: \$89 Special Price: \$75

Microsoft Windows/386

Windows/386 gives you the look and feel of OS/2, by IBM and Microsoft — the standard for tomorrow. Turns your personal computer into a multitasking, virtual machine, where any number of DOS and Microsoft Windows applications can run at the same time. Each DOS application runs in its own 640K — even memory resident programs. Copying and passing of selected data between DOS and Windows application is supported. Features greatly enhanced support for DOS applications, they can run in a window or use the full screen.

Microsoft®

List: \$195 Special Price: \$125

QuickC

QuickC gives you the features that you need to learn C quickly. It's the best for easy compilation and prototyping, compiling programs at 10,000 lines per minute. Features a built-in editor with selectable insert or overwrite mode, automatic MAKE file creation, context-sensitive help for easy learning and an integrated debugger that lets you set breakpoints, animate through your program and add watch variables. QuickC is completely source code and object compatible with Microsoft C 5.0.

Microsoft®

List: \$99 Special Price: \$65

TimeSlicer

Enhance your C programs with TimeSlicer, a multitasking library that gives you the ability to create multitasking and real-time programs at the application level rather than interfacing with the operating system. New version 5.0 includes multiple, user defined critical classes, math coprocessor support, terminate and stay resident functionality, improved event counters and timers and ability to terminate other tasks from the current one.

LIFEBOAT®

List: \$295

Special Price: \$269

Pfix86plus

Pfix 86plus, an easy-to-use, menu driven, multi-windowed symbolic debugger. Includes: in-line assembler for temporary patches, temporary and permanent breakpoint settings, full speed or trace modes, user-assignable variables, dual-monitor support, up to 100 step trace-back, debug log to disk or printer, synchronized source file disassembly to disk, configurable menus, multiple code and data windows, and key-stroke macros.

Phoenix

List: \$395

Special Price: \$199

Vitamin C

Fast, flexible, versatile, reliable. Just some of the reasons why serious programmers use Vitamin C in their most important projects. They know that using Vitamin C means lightning fast displays, responsive user interfaces, professionally crafted C code and a commitment to tech support. Features include: multiple bullet-proof overlapping windows, easy single-field of full-screen data entry, unlimited data validation, context sensitive help manager, menus like Lotus and Mac, programmable keyboard handler and much more. No royalties and library source included free. Optional VCScreen package generates source code.

creative PROGRAMMING

List: \$225

Special Price: \$149

Terms and Policies
 • We honor MC, VISA, AMERICAN EXPRESS
 No surcharge on credit card or C.O.D. Payment by check. New York State residents add applicable sales tax. Shipping and handling \$3.95 per item, sent UPS ground. Rush service available, prevailing rates.
 Programmer's Paradise will match any current nationally advertised price for the products listed in this ad.
 • Prices and Policies subject to change without notice.
 • Hours 9AM EST - 7PM EST
 • We'll Match any Nationally Advertised Price
 • Mail Orders include your phone number
 *Ask for details. Some manufacturers will not allow returns once that seals are broken.
 Dealers and Corporate Buyers — Call for special discounts and benefits!

1-800-445-7899
 In NY: 914-332-4548
 Customer Service:
 914-332-0869
 International Orders:
 914-332-4548
 Telex: 510-601-7602

Programmer's Paradise™

A Division of Hudson Technologies, Inc.
 42 River Street, Tarrytown, NY 10591



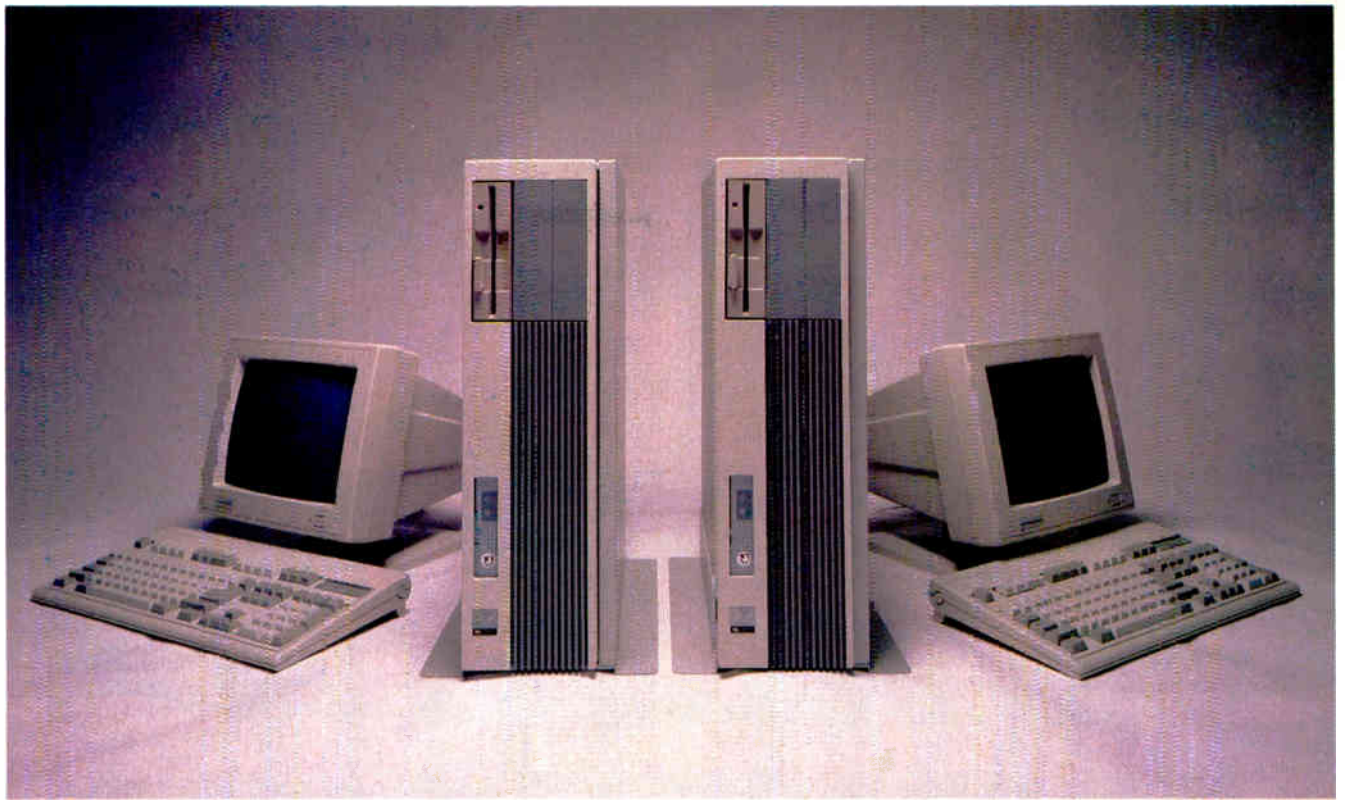

What an ALR 386 20MHz looks like at Compaq's price.

You could buy two ALR 386/220 systems for what Compaq is asking for just one DeskPro 386/20*. The ALR 386/220 model R66 cost \$3990. That's all! That's all for the PC performance that is now the standard for professional applications, industry-wide. But don't take our word for it.

Meet the press.



PC Magazine lists the ALR 386/220 among "The Best of 1987" - "...ALR has come out of nowhere over the last two years to earn a

place in the sun among important PC-compatible makers."

- PC Magazine - January 12, 1988.



Info World gave ALR 386/220 a very high overall grade of 8.8 - "...one of the fastest desk-top machines we've tested ...Low price; simple design; very fast sequential access for hard disk..."
-Info World - October 5, 1987.

PC Week says: **PC WEEK**
"High Standards ...The performance is excellent; construction quality is very good; and ALR backs the machine with a 1 year limited warranty and good telephone support..."
-PC Week - November 10, 1987.

At ALR we believe that even the most advanced technology is useless if no one can afford it. So, nearly two years ago, when we

released the first 80386 based PC, we made a commitment to high performance that the rest of us could afford. And we did it without sacrificing service or technical support.

But that's not all; with any order of a 386/220 model R66 placed with your authorized ALR dealer through June 30, 1988, you will receive an additional 1 year extended factory warranty at no charge. To find the ALR dealer nearest you call us at:

1-800-366-2574



Advanced Logic Research, Inc.

10 Chrysler, Irvine, CA 92718
714-581-6770
FAX: 714-581-9240
Telex: 5106014525,
Answer back Advanced Logic

* As compared to Compaq's DeskPro 386/20 model 60 with an additional 1 year extended service agreement. DeskPro is a registered trademark of Compaq Computer Corporation.



Interleaf Publisher for the Macintosh II

Paul Kahn

Combined features from both the personal-computer and workstation worlds yield mixed results

As Interleaf moves its publishing software downstream from the engineering workstation world of Sun and Apollo into the desktop-publishing world of the Macintosh II, it becomes clear that both worlds have a lot to learn from each other. Interleaf Publisher is a heavy-duty publishing system that includes good and bad features from its original workstation implementation and the popular Macintosh user interface.

Interleaf Publisher 3.00 is a complete translation of Interleaf's Technical Publishing System 3.0. No part of the basic system has been left out, but the equation editor, an added cost option on the other implementations, is not available for the Mac II. Interleaf has adapted its product from previous multitasking, multiuser, virtual-memory-using versions to the single-tasking, single-user, no-virtual-memory Macintosh operating system. Currently, Interleaf does not work under MultiFinder. It costs \$2495 and requires a Mac II with 5 megabytes of memory and at least 14 megabytes of hard disk storage.

To fit it into the Macintosh user interface, Interleaf has made some modifications to its user interface but has retained some non-Macintosh ways of doing things. Veteran Interleaf users will still find the desktop/pop-up menu/window system they have used before, but for the Macintosh version they will also find a pull-down menu bar, windows with a close box, scrolling bars, and resizing boxes, all controlled from a one-button mouse (previous implementations used two- or three-button mice). Veteran Macintosh users will find a desktop that resembles the Finder desktop in some ways, but that requires them to access menus and manipulate icons in ways that are unique to the Interleaf product.

The overall result is mixed. On the up side, Interleaf Publisher sets new standards for many things: editing tools for structured documents; production control for large publications; integration of

text, vector graphics, and image editing within one application; and portability of document results across multiple implementations on different machines. On the down side, when you look at Interleaf Publisher next to the current crop of Macintosh desktop-publishing applications, you can see that it has user-interface conventions that differ radically from other Macintosh applications; it is expensive both in price and configuration requirements; it is not well suited for publications with more than one story per page; and it does not provide a high level of typographic controls (e.g., no kerning).

Considerable Features

Interleaf Publisher's major features set it apart from other document preparation systems on any machine:

Document, component, and frame property sheets. An Interleaf document consists of things that have properties. The notion that you could describe the formatting of text in terms of property sheets first appeared on the Xerox Star. The concept has been notably absent from the world of Macintosh text processing until quite recently, when it appeared as "style sheets" in Microsoft Word 3.0.

In Interleaf, a document's page format is described in a *document* property sheet. The text is structured in components (e.g., a paragraph, a title, and a subhead), and each component has a name and a set of *component* property sheets that describe it. Frames that contain any mixture of text and graphics have a *frame* property sheet.

Hyphenation control and spelling checker. Interleaf uses the same Houghton Mifflin hyphenation dictionary (an 80,000-word dictionary that has up to 4000 user-defined words) that is fa-

miliar to Macintosh users of Aldus PageMaker and Microsoft Word.

Auto-number streams and auto-reference marks. Interleaf lets you automatically generate tokens, called auto-number streams, to produce numbers for such purposes as outline headings, paragraph numbers, and table or figure captions. From this, you can produce auto-reference marks that the program automatically updates as needed.

Index and table of contents. At any time, you can mark words or passages to be collected in an index, or headings to be included in a table of contents; both are created after editing rather than interactively.

Multiple columns. Interleaf handles multiple columns on a document rather than a page level. Sophisticated vertical balancing controls allow the document property sheet to distribute white space between letters, words, and components to balance out columns on a page.

Book directory. Interleaf provides a special directory, called a book, for organizing documents within a single publication. Page numbers, auto-number streams, auto-references, and even word searching and page scrolling for all documents placed in a book directory are linked together.

Graphics frames and micro-documents. You can create one or more frames in any component. A frame, which can contain graphics or text, can be as small as a single period or as large as the current page. Frames are anchored to some point in the component and move from page to page as needed. Interleaf provides a diagramming editor for creating graphics in these frames.

Text typed into a frame from the keyboard is organized in "micro-documents." You can cut, copy, paste, or edit the micro-documents just like any other text. You can resize the rectangle in which they appear or break it up into

continued

Interleaf Publisher 3.00**Type**

Document preparation and management/desktop-publishing software

Company

Interleaf Inc.
Ten Canal Park
Cambridge, MA 02141
(617) 577-9800

Format

16 800K-byte 3½-inch floppy disks

Hardware Needed

Mac II with 5 megabytes of RAM and 14 megabytes of available hard disk space

Software Needed

System 4.2; Finder 6.0 or higher (does not work under MultiFinder)

Documentation

120-page Getting Started; 326-page Tutorials; 424-page Reference Manual; 6 megabytes of on-line help, tutorials, and example documents

Price

\$2495 (academic discount available)

Inquiry 900.

multiple columns like a regular page.

Diagramming editor. The full-featured vector graphics editor provides tools for creating lines, circles, ovals, rectangles, polygons, and splines. You can fill any closed object with a pattern; group, lock, or arrange objects in layers; and move, size, or rotate objects by moving the mouse in relation to the size of the frame or by numeric increments.

Data-driven charts. The system provides a range of common chart formats (including a bar, pie, or line chart and a scatter plot) that you can paste into any frame. Data entered into a property sheet generates the chart. These charts are well suited for business graphics but do not support the number of data points needed for scientific work.

Image editing. You can copy and paste raster files created by scanners or paint programs into graphics frames, which the Interleaf image editor can manipulate.

Portability. All versions of Interleaf's publishing software can save a document as a simple ASCII text file. Interleaf uses a markup scheme for describing both text and graphics that looks like a cross be-

tween a Pascal program and SGML (Standard Generalized Markup Language, a proposed ISO standard for completely describing a document). Such files are upwardly compatible (i.e., later versions of Interleaf can read files saved by simpler or older versions on any machine). This means that any group using a mixture of Suns, Apollos, VAXes, IBM RT PCs, and Mac IIs can run Interleaf software and share documents.

These features have proven to suit applications where people produce large publications (20 to 200 pages, though the software does not limit the size of the document) that require some mix of text and graphics and benefit from writers and editors sharing documents on a network. The primary application that fits this description is technical publishing: documentation and technical reports that are long, complex, and include a mix of text and graphics on the page.

Grafting Interleaf onto the Mac II

Although any innovative Macintosh application will bring *some* new conventions that you must learn, Interleaf brings to the Mac II implementation some workstation-based features that run contrary to what you would normally expect to find.

The Interleaf desktop. Interleaf publishing software first appeared on Apollo and Sun workstations in 1983, before either had a sufficiently powerful window environment to support Interleaf's software. So Interleaf developed its own graphic interface (operated by a three-button mouse) as part of the publishing program itself. The idea of providing a graphic desktop interface to shield the user from the command shell made a great deal of sense in a Unix environment. However, what was a great idea in 1983 now seems to be a bad habit that the company can't do without.

To start Interleaf Publisher, you must choose a workspace, called a "desktop," where Interleaf keeps all working documents. Interleaf can maintain as many of these desktops as disk space will allow. You can use desktops to separate projects or users, but there is no password protection (because the Mac is a single-user system), and you can actually get to anyone else's desktop by simply opening a series of folders from the Macintosh Finder.

Links. To provide a functional bridge between your (Interleaf) desktop and the documents on the Macintosh desktop, Interleaf lets you create links between icons on your desktop and icons elsewhere in the Macintosh file system. The icon representing a link simply contains the path down which Interleaf expects to locate the original document or direc-

tory. The original document reflects changes made to this link copy and vice versa. This provides an interesting way to distribute the parts of a publication across various writers' desktops, while an editor maintains linked copies organized in a single book directory.

Special icons. Interleaf also maintains its own set of icons. Just as the Finder manages icon shape, view, and location without making you see all the resources it needs to maintain this graphic information, Interleaf similarly shows you its interpretation of what is actually on a disk.

When viewed from the Finder, Interleaf folders are filled with documents having names ending in three-character dot extensions (e.g., .doc, .boo, and .fdr), along with backup and auto-save versions with added numerical extensions (.doc,1, or .doc,9). **Attribute files** are control files that store icon location and window-size information. These files have the same name as the document or folder but begin with a special prefix (e.g., .@report.doc). Obviously, if you move or rename these files from the Macintosh Finder, Interleaf will not find the files and will not work properly.

Jumbled User Interface

Those who know Interleaf Publisher and the Macintosh have been gritting their teeth about the mix of user-interface conventions that this program contains. The designers of Interleaf Publisher have added some Macintosh features (a close box, elevator scroll bars, and a resizing box, for example) as optional controls to their "native" windowing system. They have added a minimal Macintosh pull-down menu bar at the top of the screen to provide access to desk accessories from the Apple menu, and they have adapted their software to work with a one-button mouse. But they also expect you to adapt to all the other non-Macintosh things that the program does.

Interleaf Publisher relies on pop-up, rather than pull-down, menus. The Interleaf pop-up menu is context- and state-sensitive so that different menus appear depending on what you select and on the cursor position. The menus can have slide-off extensions (secondary menu choices that appear to the right of a menu item), a feature appearing in some new Macintosh applications. Once you get the hang of using pop-up menus and slide-off extensions, you can see all your choices more easily and avoid many dialog boxes (for making secondary choices) that would otherwise be necessary.

Interleaf is very awkward to use with a one-button mouse. The Sun workstation, where Interleaf was born, has a three-

continued

Sysgen brings you the best buys in backup.

\$795

60Mb QIC-File™

- Compatibility with all PCs and PS/2s™ (New QIC-File Plus available for PS/2 Models 50, 60 and 80 at \$995)
- Streaming tape technology with superior 90 IPS speeds
- Dual read/write heads for simultaneous backup and verification
- QIC-File and QIC-File Plus tapes are fully interchangeable between PCs and PS/2s

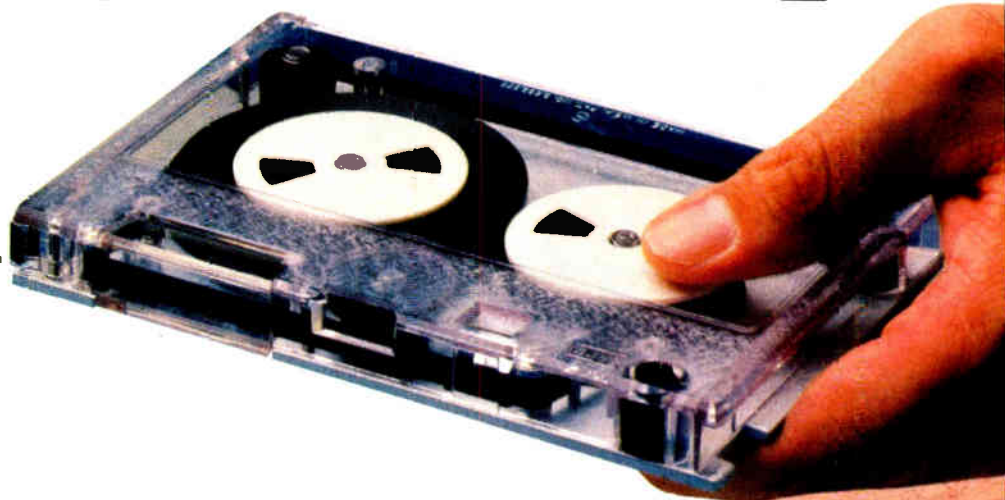

\$595

60Mb Smart Image™

- Compatibility with all PCs and PS/2s (New Smart Image Plus for PS/2 Models 50, 60 and 80 at \$795)
- Streaming tape technology with superior 90 IPS speeds
- Dual read/write heads for simultaneous backup and verification
- Smart Image and Smart Image Plus tapes are fully interchangeable between PCs and PS/2s



Sysgen™ gives you a lot more backup for a lot less.

Choose a Sysgen ¼" tape cartridge system or a Sysgen cassette tape system for all your PC and PS/2 backup needs.

Or choose other leading backup products from the complete Sysgen family, including the 120Mb Net-File™ for backing up entire Novell® networks and

the 40Mb Bridge-Tape™ subsystem that's PC and PS/2 compatible, for total backup and data transfer flexibility.

Sysgen backup systems offer you the highest performance at the lowest prices in the marketplace. With the proven reliability of 100,000 installed backup systems. And a #1 rating by industry experts.

Ask your dealer for a Sysgen backup system or call the Sysgen hotline for more information.

1-800-821-2151

SYSGEN
INCORPORATED

Circle 267 on Reader Service Card

button mouse. The left button selects, the middle button pops up the menu, and the right button extends the selection. On the Macintosh version, you click the mouse to select, command-click to pop the menu, and shift-click to extend the selection. You use pop-up menus for *everything*, so the hand not on the mouse more or less devotes itself to the command key, which makes the program more awkward to use on the Mac II than on any other workstation.

While Interleaf did not choose the one-button mouse, it did choose to retain other features of its user interface that could have been left behind. The company could have chosen to do something about a few of these differences.

On the Macintosh desktop, you can select an object by pointing and clicking, then you can manipulate it by dragging it with the mouse or by pulling a command down from a menu bar. On the Interleaf desktop, you still must select an icon by clicking on it, but before you can manipulate it, you must choose an action (e.g., move, cut, copy, or open) from a pop-up menu.

The ability to interchange data among Macintosh applications is based on their shared use of the Macintosh Clipboard.

Interleaf has its own clipboard, of incompatible format, that serves the function of both the Macintosh Clipboard and Trashcan, without the simple elegance of either. When you cut or copy an icon (a whole document) in Interleaf, it stays on the clipboard until you select and paste it somewhere else, or until you delete it. The clipboard can also contain a maximum of one text selection and one graphics selection from each document. Pasting actually moves the text or graphics out of the clipboard into a document. This means that to copy an item several times, you must copy, paste, and recopy it. Any number of pieces of text, graphics, or documents can be on this clipboard. To paste anything but the most recent item, you must open the clipboard, select the desired item, and then do the paste operation.

Interleaf handles the replacement of highlighted text differently from other Macintosh applications: You must explicitly cut or delete highlighted text, whereas if you type from the keyboard, you will add new text to the old text instead of replace it.

Fonts and Formats

With regard to fonts and formats, historical precedents are, again, very influen-

tial. Interleaf continues to use its own hand-tuned screen fonts, which take up over 6 megabytes of hard disk storage. The product supplies 9 of the 11 Adobe PostScript fonts used on Apple's LaserWriter Plus—all but Adobe Symbol and Zapf Dingbats (it provides its own math and Greek symbols fonts, which contain similar characters). It also supplies its own screen bit maps for 13 major sizes, from 6 to 72 points. Those are the only sizes available for use—it cannot generate intermediate point sizes or use any other PostScript fonts downloaded into the LaserWriter.

Interleaf's implementation of the nine Adobe fonts does not include support for the Macintosh keyboard layout or for the entire character set, however. All the European accented vowels and dead-key support for accents are gone (a feature that has been available since the original 128K-byte Macintosh).

All this special font handling maintains Interleaf's speed and compatibility with versions on other machines. In general, the screen fonts are clearer than their scaled approximations as displayed by many other Macintosh applications—except when used to display 6-, 8-, and

continued

April Specials

- BROTHER M1109 DOT PRINTER**
100 cps friction/tractor **\$189⁹⁵**
- BROTHER M1409 DOT PRINTER**
180 cps. friction/tractor **\$299⁹⁵**
- BROTHER TWINWRITER-6 PRINTER**
Dual head, tractor included **\$999⁹⁵**
- DATAVUE SPARK LAP TOP**
640K, IBM compatible, 2-3.5" drives **\$999⁹⁵**
- EPSON LQ500 DOT PRINTER**
24-pin head, 180 cps, tractor **\$369⁹⁵**
- FUJI DOUBLE SIDED DISKS**
3.5" 10-pack 19.95, 525" **10-Pack \$9⁹⁵**
- KRAFT PREMIUM 3 JOYSTICK**
For IBM and compatibles **Each \$29⁹⁵**
- OKIDATA 180 DOT PRINTER**
Cammadare/parallel interfaces **\$239⁹⁵**
- OKIDATA 183 DOT PRINTER**
136-column, 120 cps, tractor **\$289⁹⁵**
- SEIKOSHA SK3000AI PRINTER**
By Seiko, 300 cps, parallel/serial **\$369⁹⁵**
- SHARP PC4501 LAP TOP**
720K expanded RAM, IBM compatible **\$749⁹⁵**
- TOSHIBA T1000 LAP TOP**
IBM compatible, 512K, rechargeable **\$799⁹⁵**
- TOSHIBA T1100+ LAP TOP**
IBM compatible, built-in drive **\$1499⁹⁵**
- TOSHIBA T1200 LAP TOP**
Includes 20MB hard drive **\$2449⁹⁵**
- ACCOLADE HARDBALL**
For IBM and Mac **\$29⁹⁵**
- SOFTWARE TOOLWORKS**
CHESSMASTER 2000 For IBM and Mac **\$29⁹⁵**
- XOR CORP. NFL CHALLENGE**
For IBM and Mac **\$69⁹⁵**



Amstrad PC-1512
XT Compatible Computer System
•512K RAM •Mouse •2.360K floppy drives
•Display card •Serial/parallel ports •GEM
desktop & paint •DOS 3.2 •Basic 2

Sale Price **\$499⁹⁵** List \$899
Monochrome monitor with stand...\$199.95
Color Monitor with stand...\$399.95



Blue Chip "286"
IBM AT Compatible Computer
•640K RAM •1.2 MB floppy drive •Enhanced
AT keyboard •EGA/CGA/color/mono card
•DOS •GW-BASIC •Monitor not included

Sale Price **\$999⁹⁵** List \$1799

Monitor Specials

- EPSON APIO20A RGB COLOR**
For IBM and compatibles **\$279⁹⁵**
- MAGNAVOX 053 EGA MONITOR**
14-inch screen, IBM compatible **\$399⁹⁵**
- MAGNAVOX 515 DUAL MODE**
RGB & composite inputs, 12-inch **\$279⁹⁵**
- MAGNAVOX 873 MULTI-SCAN**
14-inch screen, IBM compatible **\$539⁹⁵**

IBM Compatibles

- BLUE CHIP 2-DRIVE PC**
512K, mono card, DOS, no monitor **\$499⁹⁵**
- EPSON APEX COMPUTER**
512K turbo!st Choice s/w, no monitor **\$699⁹⁵**
- VENDEX HEADSTART SYSTEMS**
512K, 2-drives, software, monitor **From \$999⁹⁵**
- SEAGATE 40MB HARD DISK**
For IBM AT and compatibles **\$449⁹⁵**

April Specials

- ASHTON-TATE DBASE**
For IBM...\$389.95. For Mac **\$289⁹⁵**
- BORLAND TURBO PASCAL**
Version 4.0 for IBM and Mac **\$69⁹⁵**
- BRODERBUND JAM SESSION**
For Mac **\$34⁹⁵**
- BRODERBUND MEMORY MATE**
For IBM **\$44⁹⁵**
- BRODERBUND THE PRINT SHOP**
For IBM and Macintosh **\$39⁹⁵**
- COVOX SPEECH THING**
For IBM and compatibles **\$64⁹⁵**
- DESIGN SOFTWARE DS BACKUP+**
For IBM and Macintosh **\$54⁹⁵**
- ELECT. ARTS PATTON VS. ROMMEL**
For IBM and Macintosh **\$27⁹⁵**
- INFOCOM BEYOND ZORK**
For IBM and Macintosh **\$34⁹⁵**
- INTELLISOFT BOOKMARK**
For IBM and Macintosh **\$69⁹⁵**
- LEISURE GENIUS SCRABBLE**
For IBM and Macintosh **\$27⁹⁵**
- LETRASET READY SET GO!**
Version 4.0 for Macintosh **\$279⁹⁵**
- MICRO PROSE PIRATES**
For IBM **\$27⁹⁵**
- MICROSOFT WORKS**
For Macintosh...\$179.95. For IBM **\$139⁹⁵**
- NORTON EDITOR**
For IBM and compatibles **\$49⁹⁵**
- PALANTIK IN TALK**
Version 3.0 for Macintosh **\$29⁹⁵**
- SIERRA LEISURE SUIT LARRY**
For IBM and Macintosh **\$27⁹⁵**

To Order Toll Free **800-221-8180** In New York, Alaska & Canada Call: (718) 417-3737

Dealer Inquiries Invited — Prices Effective Through April 30, 1988

HOW TO ORDER BY MAIL: SEND MONEY ORDER, CERTIFIED OR CASHIER'S CHECK, MASTERCARD, VISA or AMEX (include card number, Interbank No., expiration date and signature.) TO: J&R MUSIC WORLD, 59-50 QUEENS-MIDTOWN EXPRESSWAY, DEPARTMENT BMO488, MASPETH, NY 11378 DO NOT SEND CASH. Personal and business checks must clear our Authorization Center before processing. \$25 MINIMUM ORDER. Shipping, Handling & Insurance Charge is 5% of total Order with a \$3.95 minimum. (Canadian Orders Add 15% Shipping, with a \$9.95 minimum charge). For shipments by air, please double these charges. SORRY, NO C.O.D.'s. NEW YORK RESIDENTS PLEASE ADD SALES TAX. ALL MERCHANDISE SHIPPED BRAND NEW, FACTORY FRESH, AND 100% GUARANTEED. WE ARE NOT RESPONSIBLE FOR ANY TYPOGRAPHICAL ERRORS.

59-50 Queens-Midtown Expressway, Maspeth, NY 11378

NEW: The Trident VGA

The only single-chip VGA *guaranteed* compatible with IBM to the register level in all video modes.

If you're building MS-DOS or OS/2 systems, video displays or VGA boards, you'll want to see the TVGA in action.

It's a single-chip VGA. It needs only five other chips to make your basic VGA card.

It offers resolution of 800 x 600 with 256 colors from a palette of 256K.

It even supports 1024 x 768 double page mode in 16 colors out of the same 256K palette.

Trident's turbo design gives it at least 50% more bandwidth which means you can

write to the screen four to six times faster!

And it has the only on-board RAM font capabilities in the VGA world. 16Kbytes of software-loadable RAM fonts let you speed up word processing, pack more data on the screen, or easily generate foreign alphabets. Great for Asian languages.

Best of all, the price is right. Check out the chart to see if we've got what you need. If you need chips or OEM proprietary board-level products, give us a call and get all the glorious details.

One TVGA, five outboard chips and you've got a working VGA card. Add memory and your special magic and you've got something a lot of people will want.

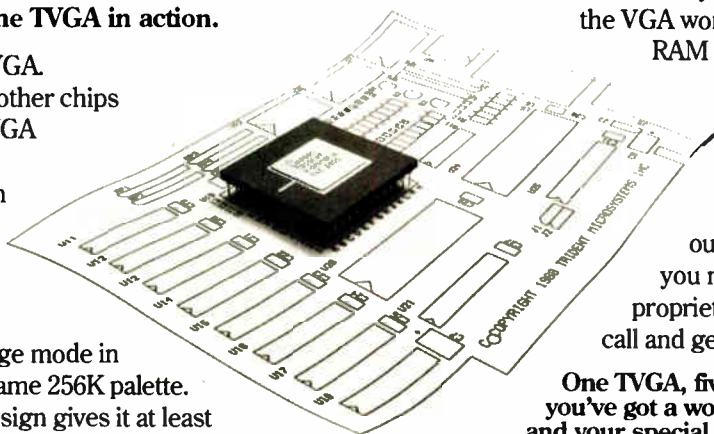

The TVGA and theirs:

Features	Trident VGA	IBM VGA	Paradise PVGA1	Chip & Tech CS8245	Cirrus Logic L-DG510/520	Tseng Lab ET3000
Compatibility:						
VGA	Register	Register	Register	BIOS	Partial Register	?
EGA	Register	BIOS	BIOS	BIOS	Partial Register	?
CGA	Register	BIOS	Register	BIOS	Register	?
MOA	Register	BIOS	Register	BIOS	Register	?
Hercules	Register	None	Register	BIOS	Register	?
Bus Interface:						
16-bit	Yes	No	Yes	No	No	?
8-bit	Yes	Yes	Yes	Yes	Yes	Yes
Support Micro Channel protocol:	Yes	No	Partially	No	No	No
RAM Font Size (16x16 char. box):	16K	N/A	N/A	N/A	N/A	?
Speed Enhancement: ²	400%-600%	100%	?	?	?	?
Graphics Mode:						
1024 x 768/16	Yes	No	No	No	No	Yes
800 x 600/256	Yes	No	No	No	No	Yes
640 x 480/256	Yes	No	Yes	No	No	Yes
Chip Set Count:	1	1	1	2	2	1
Min. Chip Count ³	6	25	11	14	18	?
Max. Clock Rate:	50 MHz	28 MHz	44.5 MHz	38 MHz	33.5 MHz	65 MHz
BIOS Included:	Yes	Yes	Yes	No	No	Yes

¹ Failed to run MS Windows/386 virtual mode operation. ² Peak Drawing Speed. ³ PC/AT 8-bit bus graphic board implementation, excluding memory chips

This information was, to the best of our knowledge, current and accurate on February 2, 1988. Things change however, so we urge you to ask any company listed about their current products before making up your mind.

TRIDENT
MICROSYSTEMS, INCORPORATED

Phone, FAX, or write us for the data sheet and pricing.

Phone: 408-727-3494, FAX: 408-727-3498, 4701 Patrick Henry Drive, Suite 2201, Santa Clara, CA 95054

TVGA is a trademark of Trident Microsystems, Inc. IBM, VGA, EGA, CGA, MOA, PC/AT, Micro Channel, Hercules, OS/2, MS-DOS, MS Windows/386, PVGA1, Chip & Tech CS8245, Cirrus Logic L-DG510/520, Tseng Lab ET3000 are trademarks or registered trademarks of their respective companies

Circle 279 on Reader Service Card

APRIL 1988 • B Y T E 185

9-point fonts, which are innately hard to read. Unfortunately, in contrast to some other desktop-publishing packages, the program has no zoom option to help ease the precise placement of small text characters (but it does allow zooming in graphics frames).

Interleaf Publisher can read five file formats: bit-mapped images saved in MacPaint or TIFF (Tag Image File Format) files, vector graphics saved as PICT files, graphics saved in EPSF (encapsulated PostScript format) files, text saved in Microsoft's RTF (rich text format)

files, and simple ASCII text files.

Interleaf retains some or all of the formatting information created by the source applications, though certain kinds of graphics or text do not translate well. You can import, but you cannot view or edit EPSF format, which Adobe Illustrator uses to export drawings to other desktop-publishing applications.

Mixed Results

When you compare Interleaf Publisher to current Macintosh desktop-publishing leaders like Aldus PageMaker and Quark

XPress, you'll find mixed results: In some cases, Interleaf does bring some new capabilities to the Macintosh world, but it also falls short of doing many of the things these smaller, less expensive programs do well.

Interleaf does provide a unified application for creating, editing, and paginating a rich mixture of text and graphics. The Interleaf text editor is full-functioned and fast, as good for writing as it is for complex formatting. This is in contrast to the modular approach taken by PageMaker or XPress, where the system assumes that other programs will edit and revise text and graphics.

But in page layout, Interleaf is more like a word processor than a desktop-publishing program. It basically understands one story per document. It does not provide good tools for mixing several stories across multiple pages, nor does it provide for complex page layout and the fluid combination of text and graphics, things that both PageMaker and XPress do easily. The drawing editor doesn't provide a ruler, a basic tool in any Macintosh graphics application. It is not as simple to use as MacDraw, nor as sophisticated as Adobe Illustrator.

While Interleaf produces good-looking documents, it does not provide the kind of typographic controls found in other desktop-publishing applications. There is no kerning or other controls for tightening or loosening intercharacter spacing. For flexible and full typographic support, PageMaker and XPress win hands down.

By the previous standard of the Macintosh world, the configuration requirements and cost of Interleaf Publisher for the Mac II are both expensive. The program needs 5 times the memory and 10 times the hard disk space of any of the competition; it costs several times as much, and it really needs a full-page monitor since it cannot scale a page to fit a small screen. However, it is by far the least expensive version of the full Interleaf product ever offered, and that's not bad. Interleaf has shown a remarkable ability to improve its product. I hope that future Macintosh versions will include full support for Macintosh fonts and closer adherence to the Macintosh interface. Meanwhile, for creating long, single-story documents, Interleaf Publisher for the Mac II is tough to beat. ■

Paul Kahn is the project coordinator for the Institute for Research in Information and Scholarship at Brown University, Providence, Rhode Island. He has used the Sun and IBM RT PC implementations of the Interleaf Technical Publishing System for over 2 years.

MIRROR II™

MIRROR II™

Crosstalk XVI®
Users Call 1-800-634-8670
For A Unique Upgrade Offer



The Closer You Look... The More You Find!

Like this Russian Doll, a careful inspection of MIRROR II will reveal layer upon layer of carefully crafted features designed to provide you with the best solution to today's and tomorrow's data communication problems.

MIRROR II (the Crosstalk® SuperKlone) provides a superior reflection of the best in Crosstalk XVI®, at a fraction of the cost. MIRROR II comes complete with a superset of the Crosstalk XVI® Script language. This Scripting capability and MIRROR II's background communications mode gives you the power to fully automate your PC communications, and the freedom to use your PC for other tasks while sending or receiving data.

- Background communications mode (call or answer)
- File transfer protocols including Xmodem (Batch, CRC or Checksum), Crosstalk®, Hayes®, Ymodem and Kermit
- Terminal emulations for DEC VT-100 / 52, IBM 3101 (character or block mode), Televideo 910 / 920 / 925 (character or block mode), Adds Viewpoint, ADM-3A, Data General D210, ANSI and Honeywell VIP7200
- Learn mode for the automatic creation of auto-logon Scripts
- Full screen Wordstar-like text editor
- Site License (the cost effective way to standardize)
- 60-Day, No Questions Asked Money-Back Guarantee

MIRROR II

A Better Reflection

SOFTKLONE™

\$69.95 To order, call Toll-Free:
1-800-634-8670

(In Florida call 904-878-8564). Visa / MasterCard / COD. \$5.00 for Shipping and Handling (\$8.00 for COD orders) Florida residents please add 5% sales tax.

MIRROR II and SoftKlone are trademarks of SoftKlone Distributing Corp. / IBM is a registered trademark of International Business Machines Corp. / WordStar is a registered trademark of MicroPro International / Crosstalk and Crosstalk XVI are registered trademarks of Digital Communications Associates Inc. / Hayes is a registered trademark of Hayes Microcomputer Products Inc.

336 Office Plaza Drive
Tallahassee, Florida 32301
Telephone: (904) 878-8564
Telex: 6714280 KLON

MIRROR II is designed for use on IBM and 100% compatible microcomputers (including the IBM PS/2 line) running MS-DOS / PC-DOS 2.0 or higher and is not copy protected.

95% of the Top U.S. Companies Solve Their Complex Numeric Problems with APL ... Shouldn't You?

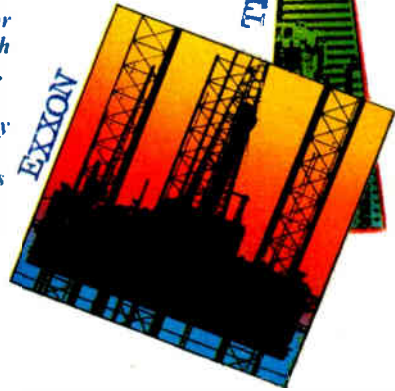

In businesses where complex numeric problems are a daily challenge, professionals from all walks of life rely on the APL★PLUS® System.

The APL★PLUS System

Thousands of professionals in a wide range of fields—investment research, insurance, corporate finance, engineering, and science—find the APL★PLUS System the perfect software for complex problem solving. That's because its natural mathematical orientation and conciseness of code provide the ideal environment for model building, array handling, system prototyping, and matrix manipulation. And for your connectivity needs, the APL★PLUS System runs on a

wide range of machines and operating environments.

Why not give yourself the analytical edge, for only \$695* Call 800-592-0050 and we'll show you how to put the APL★PLUS System to work in *your* specific application.

STSC

STSC, Inc.
2115 East Jefferson Street
Rockville, Maryland 20852
800-592-0050
301-984-5123 in Maryland or Canada
Telex 898085

A PLUS★WARE® PRODUCT

The APL★PLUS System is available for the mainframe, IBM PC and compatibles, Macintosh, and machines running UNIX and VAX. VMS. The APL★PLUS System may be purchased through dealers and distributors worldwide.

APL★PLUS and PLUS★WARE are registered trademarks of STSC, Inc. UNIX, Macintosh, and IBM are registered trademarks of AT&T Bell Laboratories, Apple Computer, and International Business Machines Corporation, respectively.

Top companies according to the April 17, 1987 issue of *Business Week*.

*U.S. suggested retail for DOS version. International prices slightly higher.

Circle 265 on Reader Service Card

APL is indispensable in developing mathematical models for pricing financial securities such as options, futures, and bonds. Complex mathematical algorithms are programmed quickly and concisely. And, empirical research is facilitated by APL's unmatched capabilities in manipulating and analyzing arrays of data.

Mark Schroder
Option Research Specialist
Prudential Bache

When you need to consider three classes of service, numerous fare types, and multiple connections, fare pricing analysis without APL is a Herculean task. APL's ability to manipulate tables of data with a single command enables us to explore a wider range of scenarios as fast as we can think of them.

Mike Fisher
Manager, Systems
Development
Pan American World Airways



Each quarter we consolidate and analyze historical data, current data, and forecasts from over 800 entities within GE and then quickly compile it into a comprehensive series of reports. With APL we get it done in a third of the time it would take us using other methods.

Eric Baelen
Manager, Business Systems
Development
General Electric Company



PERISCOPE™ POWER

...Keeps you going full steam ahead when other debuggers let you down! With four models to pick from, you'll find a Periscope that has just the power you need.

Start with the model that fits your current needs. If you need more horsepower, upgrade for the difference in price plus \$10!

When you move to another Periscope model, don't worry about having a lot to learn... Even when you move to the most powerful model, Periscope III, an extra dozen commands are all that's involved.

A Periscope I user who recently began using Periscope III writes, "I like the fact that within the first half hour of use I was debugging my program instead of learning to use the debugger."

■ **Periscope's software is solid, comprehensive, and flexible.** It helps you debug just about any kind of program you can write... thoroughly and efficiently.

Periscope's the answer for debugging device-drivers, memory-resident, non-DOS, and interrupt-driven programs. Periscope works with any language, and provides source and/or symbol support for programs written in high-level languages and assembler.

■ **Periscope's hardware adds the power to solve the really tough debugging problems.** The break-out switch lets you break into the system any time. You can track down a bug instantly, or just check what's going on, without having to reboot or power down and back up. That's really useful when your system hangs! The switch is included with Periscope I, Periscope II, and Periscope III.



Periscope Break-Out Switch

Periscope I has a board with 56K of write-protected RAM.

The Periscope software resides in this memory, safe from run-away programs. DOS memory, where debugger software would normally reside, is

thus freed up for your program.

Periscope III has a board with 64K of write-protected RAM, which performs the same function as the Periscope I protected memory. AND...

The Periscope III board adds another powerful dimension to your debugging. Its hardware breakpoints and real-time trace buffer let you track down bugs that a software-oriented debugger would take too long to find, or can't find at all!

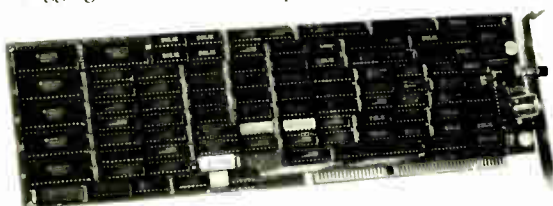

Periscope III Board

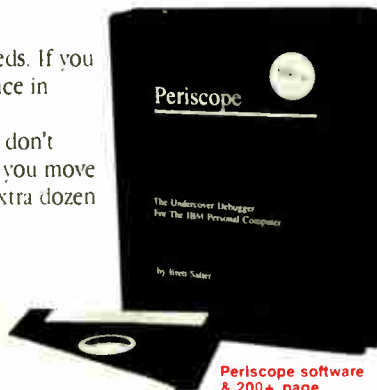

Periscope software & 200+ page manual

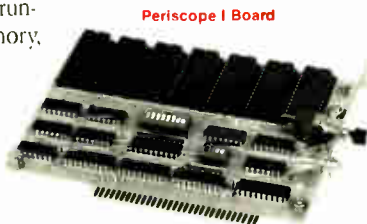

Periscope I Board

What Periscope Users Like Best:

"I like the clean, solid design and the crash recovery!"

Periscope I user

"I like the ability to break out of (a) locked up system!"

Periscope II user

"I am very impressed with Periscope II-X... it has become my 'heavy duty' debugger of choice, especially if I need to work on a memory resident utility or a device driver."

Periscope II-X user

"... Periscope III is the perfect answer to the debugging needs of anyone involved in real-time programming for the PC... The real time trace feature has saved me many hours of heartache already!"

Periscope III user

- **Periscope I** includes a half-length board with 56K of write-protected RAM; break-out switch; software and manual for \$345.
- **Periscope II** includes break-out switch; software and manual for \$175.
- **Periscope II-X** includes software and manual (no hardware) for \$145.
- **Periscope III** includes a full-length board with 64K of write-protected RAM, hardware breakpoints and real-time trace buffer; break-out switch; software and manual. Periscope III for machines running up to 8 MHz is \$995; for machines running up to 10 MHz, \$1095.

REQUIREMENTS: IBM PC, XT, AT, or close compatible (Periscope III requires hardware as well as software compatibility); DOS 2.0 or later; 64K available memory; one disk drive; an 80-column monitor.

Call us with your questions. We'll be happy to send you free information or help you decide on the model that best fits your needs.

Order Your Periscope, Toll-Free, Today!
800-722-7006

MAJOR CREDIT CARDS ACCEPTED

The
PERISCOPE
Company, Inc.

1197 PEACHTREE ST.
PLAZA LEVEL
ATLANTA, GA 30361
404/875-8080

REVIEW UPDATE

Datavue's Snap Gets a Hard Disk

When Alex Lane reviewed the Datavue Snap 1+1 (February BYTE), he came to the conclusion that the machine was based on good ideas that were poorly executed. After spending some time working with the new hard disk version of the Snap 1+1, I'm amazed at what a hard disk drive can do for the perceived value of a computer.

In addition to the 20-megabyte hard disk drive, there's a 9.54-MHz V20 processor, a very readable fluorescent backlit LCD screen, a keyboard with superb tactile response, and a 720K-byte 3½-inch floppy disk drive. All told, it's a package that has considerably more potential than its dual-floppy disk drive relative, Spark.

Unfortunately, adding a hard disk drive does not eliminate all the problems with the basic Snap 1+1 design. The system has an internal nickel-cadmium battery that promises to allow operation free from the restraint of an AC power cord. I like the freedom of computing without being plugged in, so I eagerly charged the battery, unplugged the cord, and flipped on the power. Nothing happened.

I looked in the manual, and, sure enough, the battery will not power the unit with the hard disk drive installed. I disabled the hard disk drive through the power-on setup program, but the machine still refused to work from the battery. If you get the hard disk drive, the battery becomes just so much dead weight. Of course, you can ditch the extra weight by "snapping" the machine into two parts and using the front half as a RAM disk-based laptop, but then you give up the hard disk drive, too.

If you're looking for a very portable computer with a hard disk drive, the Snap 1+1 (\$3695) stacks up pretty well against the competition. It's about the same size as the NEC MultiSpeed HD and the Zenith Z-183: 13½ by 12¾ by 3½ inches. Running at 9.54 MHz, it's faster than the Z-183 in both processing and disk access benchmarks, and it's

slower than the MultiSpeed in processing. For example, BYTE's BASIC File Write benchmark took 15 seconds on the Snap 1+1 versus 43 seconds on the Z-183. The Sieve benchmark took 138 seconds on the Z-183, 90 seconds on the Snap 1+1, and 68 seconds on the MultiSpeed.

I still think that the Snap 1+1 falls short of the potential of its design. In spite of that, adding a hard disk drive brings the machine into the middle of a pack of computers offering fully functional computing on the go.

—Curt Franklin

GCC Beefs Up Its Mac Laser Printer Line

In his review of General Computer Corp.'s Personal Laserprinter (PLP) for the Macintosh (January BYTE), Donald Evan Crabb commended the printer for its affordable price but faulted it on several points: its slow speed, its lack of AppleTalk support, and its lack of PostScript support. The company has since taken steps to address all these gripes.

A new version (2.0) of the software, GCC says, offers up to 50 percent faster performance and better compatibility

with Macintosh applications. Also new is PLP Share, a \$499 network adapter slated to ship this month. The adapter connects to AppleTalk and the PLP, letting multiple users access the printer. GCC also dropped the price of the Personal Laserprinter from \$2599 to \$1999, which means that you can get the printer-network combo for less than \$2500—a very competitive price.

If you really want PostScript support for the printer, you can get that, too. The company now sells an upgrade board, priced at \$1999, that authorized dealers can install in the PLP. This board gives the PLP all the features of the company's new printer, the Business Personal Laserprinter Plus. Besides PostScript, the Business Personal Laserprinter Plus has a 12.5-MHz 68000 processor, 2 megabytes of RAM (expandable to 3 megabytes), an AppleTalk interface, and serial and parallel ports for connecting IBM PC compatibles. The printer's font library includes the 35 resident fonts in Apple's standard LaserWriter Plus. At this writing, the Business Personal Laserprinter Plus was scheduled to ship in March for \$3999.

—Cathryn Baskin

And Miscellany . . .

. . . Claiming that it's the first company to do so, Zenith has started shipping its version of Microsoft OS/2 for the Zenith Z-386 (March BYTE). The company has also bumped the standard 1 megabyte of 32-bit RAM in the system to 2 megabytes to provide plenty of memory for OS/2. The system with the extra RAM will sell for the same price as the original machine. Zenith's MS OS/2 sells for \$299.

. . . Compaq is second out of the gate with OS/2. Compaq's MS OS/2 Standard Version 1.0 for the Deskpro 286 and 386 lines sells for \$325.

. . . Our February review of WORM

drives by Wayne Rash Jr. included Optotech's 5984 drive and Maximum Storage's APX-3200. Maximum Storage tells us that it—not Information Storage Inc.—designs and manufactures the APX-3200 drives. Also, Optotech informs us that in February it released a single-board controller for the 5984 drive that avoids the problems caused by the bulkiness of the drive's former dual-board controller. The company says that the new controller improves performance by 50 percent, and new software accompanying the controller can now make use of Expanded Memory Specification memory.

The American Success Story Continues..



CLUB 286 (12MHz Zero Wait State) (16MHz Throughput) Mono System **\$1695**

- 12MHz, Zero Wait State 80286 /• 16MHz Throughput /• Small Footprint Chassis /• Secured Hardware Reset /• 12" Monochrome Monitor (800x350) /• Hercules Compatible 132 Column Video Card
- Speaker On/Off /• Standard 1MB Memory /• Norton SI:15.3
- Keyboard Selectable Between 8/12 and Zero/1 Wait State
- Plus Basic System Features /• Made In U.S.A.

12MHz EGA System **\$2065** **New**

Basic System Features:

- 80286 16-bit CPU /• 512K Motherboard Expandable to 1MB
- Clock Calendar with Battery Backup /• 195 Watt Power Supply 220/110V (UL, CSA) /• Fully Compatible AMI BIOS (Written in USA)
- 200 Page Documentation and User's Guide /• Limited One Year Warranty
- Optional Add Ons: 360KB Floppy Drives/ Enhanced Keyboard/ 720KB Floppy Drives 3 1/2"

ORDER BY MAIL: Check and Money Order. California add 7% Sales Tax

ORDER BY PHONE: COD, Cashier Check, VISA (4%), American Express (4%), or Approved Company P.O.'s
Policy and Terms: All prices are subject to changes and quantities may be limited and we reserve the right to substitute equivalent items. Unauthorized returns are subject to a 15% restocking fee. RMA numbers must be attached to all returned items and must be sent shipping prepaid by customer. The limited warranty is 1 year on parts and 6 months on labor.



CLUB 286 (10MHz Zero Wait State) (12MHz Throughput) Mono System **\$1529**

- 80286 10MHz Zero Wait State /• 8/10 Keyboard Switch
- 12" Monochrome Monitor (800x350) /• Hercules Compatible 132 Column Video Card /• Wait State Insertable Slots
- 12MHz Throughput /• 2 Serials, 1 Parallel Port Built In
- Norton SI:V(3.0) 11.5 /• Plus Basic System Features /• Made in U.S.A.

10MHz EGA System **\$1895**

286 System Options

20MB 65ms Half Height	\$280	80287-8	\$235
30MB 39ms Full Height	\$500	80287-10	\$310
44MB 28ms Full Height	\$575	Optical Mouse	\$99
72MB 23ms Full Height	\$920	Mechanical Mouse	\$69
71MB 28ms Full Height	\$870	14" Flatscreen Eversion Mono Monitor	CALL
130MB 18ms Full Height	\$1800		
NEC Multisync	CALL		

All 14" Eversion monitors shown above are optional
NEC Hercules Eversion OS/2 OS/3 Xenix Unix DBase III+ Lotus Framework Sidekick Symphony PC Limited Compaq and Premium 286 are trademarks or registered trademarks of their respective companies.

And now, the most powerful line up of machines from the leading manufacturing, design and engineering company in America....

Introducing the 12MHz Pulse

The CLUB 286 Series of computers is ready for OS/2™ and OS/3™. The CLUB 286 Series will run Xenix, Unix, DBase III+, Lotus Framework, Sidekick, Symphony and a host of all the popular software you can think of.

Call for our 386 Machine



CLUB 286 (8MHz 1 Wait State) 8MHz Monochrome System

- Includes Basic System /• 12" Monochrome Monitor (800x350) /• Hercules Compatible 132 Column Video Card /• Made in U.S.A.

Special Only
\$995

8MHz EGA System **\$1399**

Model	Pulse-286	IBM	PC Limited	COMPAQ	Premium 286
Processor	80286-12	80286-10	80286-12	80286-12	80286-10
Clock speed					
Wait States	0	1	0	1	0
Horizon SI (3.0)	15.3	10.1	13.3	11.5	11.5

Mon - Fri	7:30 - 6:30 (West Coast)
Mon - Fri	10:30 - 9:30 (East Coast)
Saturday	10:30 - 3:00 (West Coast)
Saturday	1:30 - 6:00 (East Coast)

International sales desk now open
Corporate Buyer call for Corporate Desk
University P.O.'s are welcome
Dealers and Quantity Discounts are available

CLUB Turbo 4.77/8.0MHz Monochrome System

\$699

- 8088-2 Keyboard Selectable /• 256K Standard /• 12" Monochrome Monitor (800x350) /• Hercules Compatible 132 Column Video Card
- 135 Watt Power Supply

4.77/8MHz EGA System **\$1150** 20MB System Add **\$300**

CLUB

American Technologies, Inc.

3401 W. Warren Ave., Fremont, CA 94539
FAX (415) 490-2687 (24 hrs.)

(415) 490-2201 Tech Support (415) 683-6580

Circle 54 on Reader Service Card

APRIL 1988 • BYTE 191

Train Your PC to Read...

...the Same Things You Read!

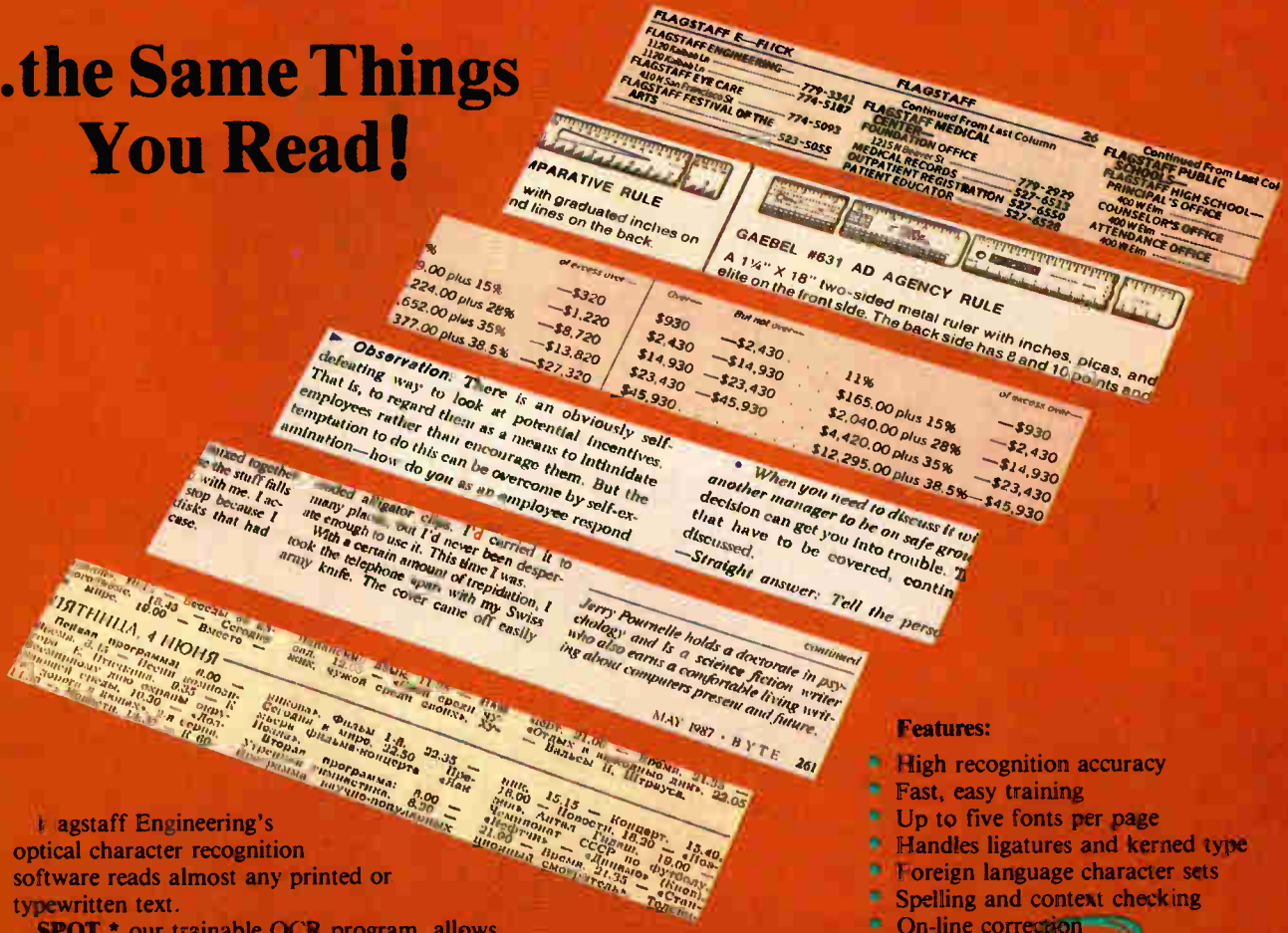

Flagstaff Engineering's optical character recognition software reads almost any printed or typewritten text.

SPOT,* our trainable OCR program, allows you to compile information from books, magazines, typewritten records, genealogical data, directories, catalogs, and public documents, including foreign-language material. The data captured by SPOT can be used by database, word processing, desktop publishing and typesetting applications.

SPOT's flexible output options allow you to preserve the original page format, including columns and margins. Reformatting options include the choice of DCA or ASCII output files, with options to generate single-column output from multiple-column text.

Features:

- High recognition accuracy
- Fast, easy training
- Up to five fonts per page
- Handles ligatures and kerned type
- Foreign language character sets
- Spelling and context checking
- On-line correction
- Affordable at \$995.00

Flagstaff Engineering leads the PC industry in desktop conversion systems for 9-track tape and 8-inch diskette data files. We have already supplied thousands of customers worldwide with our OCR systems. Call for the best prices on Panasonic, Hewlett-Packard, and Canon scanners. Dealer and volume discounts are available.

Flagstaff Engineering can modify the software code to meet your custom applications. For details, call us at (602)779-3341.

*Syntactic Pattern Optical Translator

"JOIN" FLAGENG for vendor support on BIX!



1120 Kaibab Lane • Flagstaff, AZ 86001
(602)779-3341 • Telex 705609 • FAX (602)779-5998

Circle 304 on World Radio History (DEALERS: 305)



Memories, Memories

Jerry Pournelle

New ways to speed up, clean up, beef up, and back up all kinds of memory

This column is late, mostly because there's so much good stuff here that I don't know where to begin. Every time I sit down to work, something new comes that I just have to play with. This has happened before, but I don't think things have ever been this bad; only of course I don't really mean "bad," since I'd be in a much worse pickle if I had nothing to write about.

The upshot, though, is that some items are going to get fairly short shrift even though they deserve better.

Fastback Plus

I became a Fastback fan one day at an Atlanta COMDEX when I saw one of its developers back up a hard disk, put a staple through one of the floppies, remove the staple, and restore the files. That was impressive.

I've been using Fastback ever since, and while I've heard rumors of problems with very long files, I've got some very long files indeed and have never had the smallest difficulty. Fastback is fast and reliable; and because it's so fast, it gets used, something I can't say for a lot of other backup programs.

Well, Fifth Generation went and improved it with Fastback Plus. I'd complained about the documents. They not only fixed them, they put in help files that make the documents nearly superfluous. They added data compression to save disk space. They added a utility that estimates how many floppies the job will take—it always overestimates for me—and how long it will take (generally an underestimate, but I'm slow and careful about not putting in a new disk until I have labeled the one I took out).

I'm about to change over from the Kaypro 386 to a new Zenith Z-386, so this afternoon I copied 38 megabytes of data from the Kaypro; it took 28 minutes. It required 27 high-density floppies to accomplish the job; and beyond reading the section on installation (Fastback Plus

isn't copy-protected, but Fifth Generation likes to handle things with their install batch file), I never opened the manual until the job was done. I then took those files and put them into the Z-386 in considerably less time than it took to copy them.

Fastback Plus is a genuine improvement (in ease of use and user options) over the old Fastback. It will also read backup disks made with older versions, using an option that is called Old Restore Program.

If you have a hard disk drive, you need this program. Highly recommended.

The Golden Bow

If I ever run out of things to write about, I can rate my Christmas presents. (After all, one of my colleagues used to rate the parties at COMDEX.) I won't do that here, but I should mention that Golden Bow sent me a very nice gift: two coffee mugs of a shape I like a lot (straight sides, large handle, and fairly thin china), both marked in gold with the Golden Bow logo plus my name on one and Roberta's on the other.

Packed in the box was a pound of Jamaica Blue Mountain coffee beans, and each mug had liqueur-filled chocolates in it. Since I'm not about to send those mugs back—and I've already consumed the comestibles—I figure I better warn you I've been bribed.

When you use Fastback Plus to back up your files, the program shows you which directory it's working on and flashes the filenames as it copies them; it goes almost too fast to read them, but if you're like me you'll see all kinds of stuff you didn't really want to keep. So, one invariable result of a backup is that I invoke PC Sweep and roam about erasing files I no longer want.

PC Sweep is a shareware program available from Sandi and Shane Strump (P.O. Box 13719, College Station, TX 77841) for \$30. Commercial versions are also available, but the original PC Sweep is at least as good as any of those. You can also get a copy, registration paid, from Workman and Associates.

Once you've erased a bunch of files, you'll have empty spaces scattered all over your hard disk. That fragmentation can slow things down, from a little to quite a lot (I've noticed up to a 25 percent increase in the time it takes to copy a large file). The remedy for that is Golden Bow's Vopt, which repacks the disk by moving the files into compact and continuous blocks. There's a new version that shows, in animation, just what it's doing; very pretty, very fast, and quite effective.

I've been using Vopt for nearly a year now, and I've never had the slightest problem with it. In fact, it was Vopt that told me I'd somehow managed to get one of those horrible unmovable Prolock copy-protected programs onto my hard disk; I think one of the kids put in a game when I wasn't here. I got rid of it, of course. But if it weren't for Vopt, I wouldn't have known it was there.

Most books will tell you that disk read/write operations are often the limiting factor in systems operations throughput, which is a fancy way of saying that most disk systems are too slow. This is especially true if you have only floppies.

Repacking the disk with Vopt will help, but the best remedy for slow disk operations is a caching system: a way to put and keep the frequently used disk stuff into memory. Golden Bow's Vcache does that quite nicely. The neat part is that it can make use of either the Lotus/Intel/Microsoft Expanded Memory Specification (LIM/EMS) or the extended memory that works on the IBM PC AT and compatibles. It has been my experience that extended memory isn't

continued

very useful except as a means to heat your house; but used with Vcache, it can speed up some operations (ones that have to go to the disk a lot) something wonderful.

There are limits to what cache systems can do, and if you have a hard disk and use DESQview, they can be more trouble than they're worth; but if you use floppies, you need it bad. If you've got an IBM PC or XT that has an expanded-memory board (like an AST RAMpage), or an AT with extended memory, and don't use DESQview, caching is a simple and effective way to make things go faster. Note too that some copy-protection schemes require you to use floppy disks; caching can help there, too.

Golden Bow's final product, Vfeature Deluxe, competes with SpeedStor, which I've written about in previous columns. Vfeature Deluxe lets you partition your hard disk so that instead of chopping it up into several "logical drives" of 32 megabytes or less, you get one humongous drive of 80, 100, or 300 megabytes—or whatever you have. You can also use Vfeature Deluxe to partition the hard disk into smaller chunks and write-protect any one. You can also password-protect selected volumes.

We got SpeedStor early on, and on the

"it ain't broke" theory, I haven't tried Vfeature Deluxe. I make no doubt that it works.

In fact, though, I've little desire to have an enormous hard disk partition. Partly that's superstition, I guess, but there's this as well: if you have a partition larger than 32 megabytes, you *must* boot up the system either from the hard disk or from a specially ginned-up working boot floppy; if you use the original DOS disk to boot up, you can lose some of the data on the hard disk.

I've more than once had some kind of problem that required me to boot up with the original DOS disk; and since that usually happens when we're desperately trying to meet deadlines—and I have a lousy memory as well—I'm a bit afraid to add that kind of complication. You probably don't have that kind of problem.

I've just been told that Priam is sending me one of their 330-megabyte internal hard disks. When it comes, I'll use Vfeature Deluxe to manage it. More on that another time. Meanwhile, Golden Bow makes good stuff.

Memories

I'd guess from my mail that more people are confused about extended and ex-

panded memory than anything else in the microcomputer world. I know I am: every time I write on the subject, I get a flood of mail telling me I got it wrong again.

This time for sure.

I got interested in this when the Z-386 arrived. It came with a 70-megabyte hard disk drive, a Z-449 card to drive the Zenith Flat Technology Monitor (FTM), and 640K bytes of memory on the motherboard. The Z-386 is, hands down, the fastest machine I have; my benchmarks put it as just faster than the 16-MHz Compaq Deskpro 386.

Pure speed isn't everything; in fact, it's not even the main thing. Neither is disk size. What I want is speed in changing from one program to another. Here's an example. Just now the phone rang, and it was Microsoft inviting me to a conference about OS/2. I needed to get at my calendar and my notebook, then send a message to my assistant, all without dumping this article, which I'm writing with Q&A Write. In theory, I can do that with SideKick, DeskLink, and a few other terminate-and-stay-resident (TSR or memory-resident) programs, but in fact the TSRs eat up so much memory

continued

LOOK!
It's Flow Charting™ II+!

The ultimate fast track tool—for internal auditors, public auditors, secretaries, engineers, managers and line leads. Performance power WITH A PLUS, for even faster and easier construction, editing and printing of flowcharts and org charts.

- Text auto centering
- Smart line mode
- Internal mouse driver
- 10 text fonts
- Ega support
- Comprehensive, friendly manual

Give your charts the PLUS for only \$229.* Contact your local software dealer—or call us.

PATTON & PATTON
Software Corporation
81 Great Oaks Blvd., San Jose, CA 95119
1-800/672-3470, ext. 897 California
1-800/538-8157, ext. 897 Outside California
408/629-5044 International
*plus shipping. In California add tax.

Excellence in charting the flow of ideas

THE PROGRAMMER'S SHOP

helps save time, money, and cut frustrations. Compare, evaluate, and find products.

FREE Catalogs and Guarantee

Whether you're searching for an obscure product no one seems to know about, or you just want to know which of 5 competitors makes the most well-regarded product, our catalogs make finding software easier.

- Comprehensive Product Listing, filled with over 1,000 products.
- Popular Programmer's Tools, containing the most-requested titles (over 300 in all) from each category.
- Dbase Programmer's Catalog with over 60 development tools.

We'll also help you select products with free advice or literature. Plus full guarantee on any recommended product. Mention "BY488".

Call to request a catalog or information today.

Our Services:

- International Sales Desk
- Compare Products
- Help find a Publisher
- Evaluation Literature FREE
- Programmer's Update
- Dealers Inquiry
- Newsletter
- Rush Order
- Over 700 products
- National Accounts Center

RECENT DISCOVERY

Automated Programmer by KGK - Math notation and technical English input produces FORTRAN code. Link to libraries, output in 'IMAGE' format, structured reports, pictures. PC \$949

C Language-Compilers

AZTEC C86 - Commercial	PC	\$499
C86 PLUS - by CI	MS	\$359
Datalight Optimum - C	MS	\$ 99
High C Optimizing Compiler	PC	Call
Instant-C/16M	PC	Call
Lattice C - from Lattice	MS	\$259
Microsoft C 5.0 - Codeview		Special*
Microsoft Quick C		Special*
Turbo C by Borland	PC	\$ 67

C-Screens, Windows, Graphics

C-Worthy Interface Library	PC	\$249
Curses by Aspen Scientific	PC	\$109
dBASE Graphics for C	PC	\$ 69
ESSENTIAL GRAPHICS - fast	PC	\$185
FontWINDOW PLUS	PC	\$229
GraphiC - new color version	PC	\$279
Greenleaf Data Windows	PC	\$155
w/source	PC	\$259
Terminal Mapping System	PC	\$279
TurboWINDOW/C - for Turbo C	PC	\$ 75
View Manager by Blaise	PC	\$199
Vitamin C - screen I/O	PC	\$159
VC Screen	PC	\$ 79
Windows for C - fast	PC	Call
Windows for Data - validation	PC	Call

DBASE Language

Clipper compiler	PC	\$399
dBASE III Plus	PC	\$399
dBASE III LANPack	PC	\$649
DBXL Interpreter by WordTech	PC	\$ 99
FoxBASE + Dev. - V2.0	MS	\$259
Quicksilver Diamond	PC	\$369

Note: All prices subject to change without notice. Mention this ad. Some prices are specials. Ask about COD and PDS. Formats: 3. Laptop now available, plus 200 others. UPS surface shipping add \$3 item.

Call for a catalog, literature, and solid value

800-421-8006

THE PROGRAMMER'S SHOP
Your complete source for software, services and answers

5-B Pond Park Road, Hingham, MA 02043
Mass: 800-442-8070 or 617-740-2510 2/88

Circle 216 on Reader Service Card

Your Source for Debuggers

Order before 4/30/88 and mention "BY488" for these Special Prices:

Embedded code, C, Asm. Whatever you write, chances are it doesn't run right the first time.

For clear windows on your code, consider these professional tools. Recover from even frozen machines, debug at high level, and keep interactivity in the debugging process. Mention "BY488" for the special prices at right.
Call one of our Tech Reps for help choosing TODAY.

	List	Normal	SPECIAL
C Sprite by Lattice	\$ 175	\$119	\$ 99
DBUG III - for dBASE	\$ 195	\$179	\$159
Periscope I-incl. board	\$ 345	\$275	\$255
Periscope II-incl. switch	\$ 175	\$139	\$119
Periscope III-10			
MHZ version	\$1095	\$795	\$749
SoftProbe II/TX-Rom	\$ 750	\$695	\$599
TURBOsmith-Turbo Pas	\$ 99	\$ 79	\$ 59

DBASE Support

dAnalyst	PC	\$ 219
dBASE Tools for C	PC	\$ 65
dBRIEF with BRIEF	PC	Call
DBC III by Lattice	MS	\$ 169
Documentor - dFlow superset	MS	\$ 229
Genifer by Bytel-code generator	MS	\$ 279
QuickCode III Plus	MS	\$ 189
R&R Report Writer	MS	\$ 139
Seek-It - Query-by-example	PC	\$ 79
Silver Comm Library	MS	\$ 139
Tom Rettig's Library	PC	\$ 79
UI Programmer-user interfaces	PC	\$ 249

Editors for Programming

BRIEF Programmer's Editor	PC	Call
de - EMACS-style	PC	\$ 65
EMACS by UniPress Source:	\$895	\$ 265
Epsilon - like EMACS	PC	\$ 149
ME Macro Editor - Source	PC	\$ 79
MKS VI	MS	\$ 65
PC/EDT - macros	PC	\$ 229
SPE/PC - Version 2.0	PC	\$ 179
Vedit PLUS	MS	\$ 129

*Mention "Special BY488" and get both a good price and FREE Software!

Even More Power & Flexibility BRIEF 2.0

BRIEF easily conforms to your editing preferences and style, ensuring you are truly comfortable and productive.

Straight from the box, BRIEF is as much editor as most people will ever need — thanks to features like the real Undo, flexible windowing, and unlimited file size.

But BRIEF's hidden power is in its exclusive macro language. Customize BRIEF to include the commands and features YOU desire. It's fast and easy.

Users and industry press alike unanimously praise BRIEF. "Recommended." — Jerry Pournelle, Byte 12/86.

Now BRIEF 2.0 adds:

- | | |
|--|--|
| <p>Basic Features</p> <ul style="list-style-type: none"> - Windows - Multi-level Undo - Edit many files at once. - File size limited only by disk space. - Automatic language sensitive indentation. - EGA and Hercules Plus 43-line support - Compile & find errors within BRIEF. | <ul style="list-style-type: none"> • Setup Program for easy installation and configuration. (Requires no macro knowledge). • Increased speed for sophisticated operations like Undo and Regular Expression Search. • All new documentation WITH tutorial on the Macro Language. • Command line editing (move cursor, add & delete characters, specify parameters). • Expanded Regular Expressions, with matching over line boundaries. • More block types, with marking by character, line or column. • Reconfigurable indenting for C files (supports most indenting styles). • Enhanced large display support, including wider displays. • Optional borderless windows. |
|--|--|

Try BRIEF (\$195) for 30 days — if not satisfied get a full refund.

If you already own BRIEF, call for update info.

CALL 800-821-2492

in MA 617-337-6963

Circle 261

on Reader Service Card

Requires an IBM PC, AT or compatible with 192K.

And much, much more!



Solution Systems

541 Main Street, Suite 410B
So. Weymouth, MA 02190

than it would be to a hard disk. In addition, DESQview has a trick whereby it can get 64K bytes of itself into extended memory. Running DESQview with extended memory is a heck of a lot better than running without it; but extended memory is still less useful than EEMS (or LIM/EMS 4.0).

To further confuse the issue, programs like Above Disc try to use software methods to fool your machine into thinking that extended memory is really expanded memory. None of these programs can do more than turn a block of extended mem-

ory into the early version of LIM/EMS; making the machine think extended memory is EEMS is impossible. To get EEMS capability, you have to use some hardware.

These programs don't always work; indeed, those that do work don't work all the time. As an example, I used Above Disc for a while before I converted to DESQview.

One program that is supposed to know how to use the early version of LIM/EMS (as well as EEMS) is Living Videotext's Ready!; about half the time, though,

Ready! would load itself into the extended memory that Above Disc was trying to turn into LIM/EMS—and about half the time it wouldn't. I never could see any reason for this; maybe I didn't hold my mouth right. Eventually I gave up on Above Disc.

The LIM/EMS 4.0 standard explicitly states that it cannot be emulated in software. That doesn't mean some hacker out there won't be able to do it. It does mean the big boys won't support it. If you want to expand your system's memory, you need LIM/EMS 4.0 boards. AST boards work fine.

Enter the 386

All the above applies only to PC, XT, and AT machines. It's all different if you have a 386. The 386 machines have memory management and know how to address a lot more than the simple 640K bytes that the PC, XT, and AT can find.

In practice this means that if you have a 386 machine, there doesn't have to be any practical difference between extended memory and expanded memory; the 386 is perfectly capable of operating with either, or both. DESQview on the 386, for instance, can not only swap programs into extended memory, but can also run them from there. (You'll need a 386 memory management program such as Quarterdeck's Expanded Memory Manager 386 [QEMM], but that's a detail.)

Unfortunately, this isn't quite the whole story. The 386 is a 32-bit machine that can also do 16-bit operations; and it has both a 16-bit bus and a 32-bit bus. So far as I know, everyone who makes 386 computers makes the 16-bit bus conform to the IBM PC AT bus standard (except, of course, machines that use the new IBM Micro Channel bus; but let's confine ourselves only to AT compatibles for the moment).

On the other hand, no two manufacturers seem to use the same 32-bit bus structure. We have one bus by Compaq, another by Cheetah, a third by Zenith, yet another by Intel, still another by AST, and there are probably more.

The result is that if you want to add 32-bit memory to your 386, you will probably have to buy it from the company that made your computer. There are exceptions; some machines can use two Cheetah 16-bit memory boards chained to make them 32-bit. Certainly the new Cheetah 386 motherboard can do that. In general, though, to get 32-bit memory you should go to the manufacturer of your 386.

The good news is that you don't really *have* to use 32-bit memory. The 386 chip is smart enough to know what kind of

continued

CAN YOU REACH YOUR FULL POTENTIAL WITH ONLY HALF THE VIEW?

Let CPT give you the total view — today. Upgrade your PC, XT, or AT-compatible computer with CPT's full-page displays, at a price far lower than you might expect. For more information on how CPT can expand your display-horizons, call 1-800-447-4700.



More Than Office Automation...Office Productivity

PC, XT and AT are trademarks of International Business Machines, Inc.

Compact, Low Power, Cost Effective Single Board Computers for Embedded Applications

World's smallest PC — and CMOS too!

**A Motherboard and 4 Expansion Cards in the
Space of a Half-Height 5-1/4" Disk Drive!**

from **\$359**
Qty 1

Little Board™/PC

3 WATTS!
5 VOLT ONLY OPERATION
± 12 V GENERATED ON BOARD

SCSI BUS OPTION
(HARD DISK, ETC)

256 K RAM
(512 K, 768 K
OPTIONS)

POWERFUL
V40 CPU

FLOPPY DISK CONTROLLER
(3.5"/5.25",
360 K/720 K, 1.2 MB)

UP TO 128 K
EPROM/RAM/NOVRAM
BATTERY BACKED RT CLOCK



PC COMPATIBLE
ROM-BIOS

MOUNTS ON A
5.25" DRIVE
(5.75"x8"x1")

2 RS232C
SERIAL PORTS

SPEAKER PORT

KEYBOARD PORT

PARALLEL
PRINTER PORT

PC BUS

4 MODE VIDEO
CONTROLLER
OPTION
FITS ENTIRELY
WITHIN BOARD
DIMENSIONS

The CMOS Little Board/PC represents a significant breakthrough in microcomputer technology, providing system designers with a highly compact, self-contained, low power, "PC-compatible" system module in the space of a half height 5-1/4-inch disk drive. Everything but the keyboard, monitor, disk drive, and power supply is included!

The CMOS Little Board/PC is ideally suited for embedded microcomputer applications where IBM PC software and bus compatibility are required and where low power consumption, small size, and high reliability are critical. Its low power requirements, compactness, and solid state disk drive support make the Little Board/PC especially useful in rugged or harsh operating environments.

Typical applications for the Little Board/PC include:

- Data acquisition and control
- Portable instruments
- Protocol conversion
- Telecommunications
- Security systems
- Intelligent terminals
- Diskless workstations
- Remote data logging
- Point-of-sale terminals
- Network servers
- Distributed processing
- SCSI device control

Development Chassis / PC™

The Little Board/PC Development Chassis offers a low cost, "known good" development environment for projects and products based on the Little Board/PC single board computer.

The Little Board/PC Development Chassis includes a two slot PC Expansion Bus, a 360K byte (DSD) floppy disk drive, a power supply, and all I/O and power cables required for immediate operation with the Little Board/PC.

All I/O connections are conveniently available. Included on the Development Chassis rear panel are standard connectors for keyboard, parallel printer, both serial ports, optional video monitor interface, and the AC power outlet and power switch.

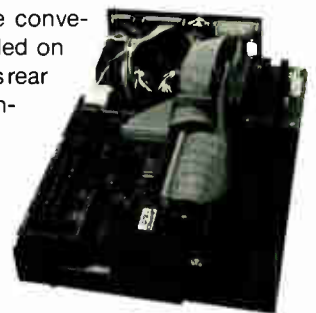

Distributors • Australia: Current Solutions (613) 720-3298 • Canada: Tri-M (604) 438-0028 • Denmark: Danbit (03) 66 20 20 • Italy: Microcom (6) 811-9406 • Finland: Symmetric OY 358-0-585-322 • France: Egal Plus (1) 4502-1600 • Germany, West: IST-Elektronik Vertriebs GmbH 089-611 6151 • Israel: Alpha Terminals, Ltd. (03) 49-16-95 • Sweden: AB Akta (08) 54-20-20 • Switzerland: Thau Computer AG 41 1740-41-05 • UK: Ambar Systems Ltd. 0296 4355*1 • USA: Contact Ampro Computers Inc.

AMPRO
COMPUTERS, INCORPORATED

1130 Mountain View/Alviso Road
Sunnyvale, California 94089
(408) 734-2800
TLX 4940302 FAX (408) 734-2939

memory it's dealing with, and when it needs 32 bits of data from a 16-bit memory board, it automatically does two reads. Of course, that takes longer, so it's much better to have 32-bit memory, especially if you happen to be doing computation-intensive work like CAD.

You can also mix both 32-bit and 16-bit memory; I have 2 megabytes of Kaypro 32-bit memory in my Kaypro 386 and another 2 megabytes of Cheetah 16-bit memory addressed above that. I don't often fill the machine with enough programs that it needs that extra memory, but once or twice I have; and while the speed difference was noticeable, there weren't any glitches.

What I was doing at the time was using Crosstalk (under DESQview) to communicate on BIX; keeping SideKick in its own DESQview window; reading a Q&A database in another window; and doing some writing with Q&A Write in yet one more window. Then I got a sudden urge to look in on a game I'd been playing. If I hadn't had those extra 2 megabytes, I wouldn't have been able to do that.

Generally, though, the Kaypro 386 with 2 megabytes of 32-bit extended memory is more than good enough to let me communicate, write, keep my calen-

dar, get at my memory-resident unit-conversion programs, and do my writing. What I've been using to manage this is the combination of DESQview and QEMM. Doubtless other combinations would work, but I don't guarantee them.

For instance, I've had Microsoft Windows/386 for a couple of weeks now, and I understand it's pretty good; but DESQview certainly ain't broke, better is the enemy of good enough, and I don't have any real reason to expect Windows/386 is all that much better than DESQview anyway. I'll get to Windows/386 when I get a chance, but I'm in no great hurry.

Logitech Does It Again

I like mice. As is the case with most touch-typists, I don't like them for writing, but when it comes to editing they're very handy. I've also got accustomed to using the mouse to control Microsoft QuickBASIC 4.0 and in a number of other contexts, including DESQview, which adapts very nicely to a mouse.

I've always preferred the Logitech three-button LogiMouse. I suppose that's because my first exposure to computer rodentia was on Niklaus Wirth's Lilith (I miss that machine a lot). In the Lilith scheme, the middle button of the mouse

calls a menu, the left button does some kind of action, and the right button generally cancels the action or changes modes. This seems intuitive to me.

Of course, you can get the effect of three buttons on the Microsoft two-button mouse (i.e., by pushing both buttons at once), and a lot of people prefer the shape, heft, and feel of the Microsoft Mouse to Logitech's. There are even some people who like the Macintosh scheme of using a one-button mouse with double clicks, shift clicks, splat-key double clicks, and so forth. I suppose it's all a matter of preference. In any event, I've always been fond of the LogiMouse.

Lately, though, I've had better reasons than mere preference.

First, there's Logitech's Point editor, which is a terrific utility. For people who just need an editor to manage their system—to change AUTOEXEC.BAT and CONFIG.SYS, make batch files, and suchlike—it's a near-perfect replacement for EDLIN, because it's full-screen, very intuitive, and also has an extensive help menu.

The only nonintuitive feature of Point is that Replace is found under the Edit menu, rather than Search. Most U.S. edi-

continued

The Complete 68000 C Compiler

The UniWare™ 68000 C Cross Compiler generates fully optimized code for your ROMable applications. It supports:

- * 68000
- * 68010
- * 68020
- * 68008
- * 68012
- * 68881

You won't find a more complete package — the UniWare 68000 C Compiler comes with a relocating macro assembler, type-checking linker, librarian, and all the utilities you need to put your program into ROM. And it's just \$995 under MS-DOS. Also available under UNIX.

CALL TODAY

(312) 971-8170

SOFTWARE DEVELOPMENT SYSTEMS, INC.
3110 Woodcreek Drive
Downers Grove, IL 60515

The Complete Z80 C Compiler

The UniWare™ Z80 C Cross Compiler generates fully optimized code for your ROMable applications. It supports:

- * Zilog Z80
- * Zilog Z180
- * Hitachi HD64180

You won't find a more complete package — the UniWare Z80 C Compiler comes with a relocating macro assembler, type-checking linker, librarian, and all the utilities you need to put your program into ROM. And it's just \$995 under MS-DOS. Also available under UNIX.

CALL TODAY

(312) 971-8170

SOFTWARE DEVELOPMENT SYSTEMS, INC.
3110 Woodcreek Drive
Downers Grove, IL 60515



THE IMPROVED VGA

Extending across barriers of graphics incompatibilities, ATI introduces a VGA improved performance card - VIP. VIP delivers the IBM PS/2 VGA standard to IBM PC/XT/AT and Model/30 users, providing an upgrade path to the outstanding world of VGA graphics.

Totally compatible with the ATI EGA WONDER, users have the unique ability to display EGA, Color/Graphics and Hercules software on monochrome, RGB and EGA monitors.

- Compatible to IBM Video Graphics Array (VGA). All 17 modes.
- Runs EGA/CGA/Hercules & 132 column software on IBM PS/2 Analog¹, Multisync, EGA, RGB, TTL monochrome, PC Portable, Compaq Portable² monitors.
- Softsense automatic mode switching.
- Automatic analog monitor detection.
- High resolution 800 x 560 graphics for Multisync monitors with drivers supplied for Windows, Gem, Ventura, Autocad.



Call today at (416) 756-0711 for more information.

¹ 132 Columns not available on IBM PS/2 Analog Monitors
² Compaq via optional Compaq Expansion Module

Trademarks: IBM, PS/2, Model 30, VIDEO GRAPHICS ARRAY, VGA, EGA, CGA, MDA - International Business Machines Corp.; HERCULES - Hercules Computer Technologies Inc.; Multisync - NEC Home Electronics Corp.; COMPAQ - Compaq Computer Corp.; WINDOWS - Microsoft Inc.; GEM - Digital Research Inc.; VENTURA - Xerox Corp.; AUTOCAD - Autodesk Inc.



Technology you can Trust

ATI Technologies Inc. 3761 Victoria Park Ave. Scarborough, Ontario, Canada M1W 3S2 Tel: (416) 756-0711 Telex: 06 960640 Fax: (416) 756-0720

Circle 24 on Reader Service Card

tor programs make Search and Replace part of the same operation, but since Replace changes text, while Search doesn't, you can also argue for the Point organization. Besides, if you remember that anomaly, you'll probably never need to use the Point manual.

Point doesn't have all the features of VEdit or Brief, but it has most of them; and since I never remember how to use all the features of those other (excellent) editors, it hardly matters. People who do a lot of programming might want to look further, but Logitech's Point is darned near perfect for the rest of us, and I know some very experienced programmers who prefer it to any of the others. Point is a great bargain, since it comes as a bonus in the Logitech Mouse with Plus Software-package.

I'm also fond of Logitech's Publisher Mouse package; it's still the easiest introduction to desktop publishing I've seen.

Now Logitech has taken the next step: they make a half-slot board that supports both EGA and their mouse. It's called, unsurprisingly, the EGA&Mouse board, and it also has a light-pen connector. The package comes with the Plus Software (including Point); EGA support software, including a program that deter-

mines the date of your system's BIOS ROM (any ROM manufactured before October 27, 1982, can't support EGA, and you'll need new ROMs to use theirs or any other EGA board); and the PaintShow program.

PaintShow is an EGA color paint program with several fonts, including math and engineering symbols. I haven't had a chance to compare it with, say, EGA-Paint 2005 from RIX SoftWorks; but certainly PaintShow is capable of some really nice graphics. I'm very fond of the RIX paint programs, but, realistically, PaintShow is good enough for any color graphics I'm ever likely to do. The code isn't provided, but there are ways to glue PaintShow pictures into Modula-2 programs. Printer support is provided.

To top it all off, Logitech offers the Autosync Monitor, which can switch between TTL and analog inputs. In EGA mode it has sharp resolution and a nice crisp picture. There are full controls—horizontal and vertical position, and hold, brightness, and contrast—and they're set at the right side of the monitor, where it's easy to get at them while looking at the screen. Alas, many monitors have those controls at the back where you can't reach them, or on top where

they neatly put your arm in the way of your vision when you try to make adjustments.

It's a bit hard to "rate" monitors; at least it is for me, since I don't know much about them. All I can say is that this Logitech monitor is as good as any I've seen in its size. It's a bit small for me, given my eye problems; I still prefer my 19-inch Electrohome and Intecolor monitors. The fact is, though, I could live with the Logitech monitor, and I suspect most people won't ever need anything much better. The only odd thing about the monitor is that it looks rectangular.

Now, all EGA monitors *are* rectangular; at least all of them in this house are. I confess that I hadn't noticed that before; but when I uncrated the Logitech monitor, it was so visibly wider than it was tall that I measured it: 8½ inches tall by 11 inches wide. Then I measured the others. The NEC MultiSync and the Zenith EGA are both 8¼ by 10¾ inches, while the Zenith FTM monitor is 8 by 10¾ inches. My Electrohome 19-inch monitor is actually 11½ inches high by 15 inches wide.

Of the smaller monitors, the Zenith FTM has by far the crispest images, and

continued

The Word Is Out: Send Protected Data Over Any Modem.



Data Sentinel™
The Word Is Out.

Now you can secure your PC data files and keep modem transmissions completely private. With the Data Sentinel hardware key from Rainbow Technologies. And without passwords or modem-matching.

Simply plug the Data Sentinel into your PC's parallel port. Then follow the easy step-by-step menu to encrypt and compress your data files. Which can be opened only with a duplicate of your own personalized Data Sentinel key.

Up to now, it hasn't been easy to send secured files. You see, 'old' modems don't encrypt or compress data. And while 'new' ones can, they can't send the secured data to an 'old' one.

But to the Data Sentinel, that's a piece of the past. Because as long as your old-old, old-new, new-old or new-new modems at each end are compatible,

Data Sentinel-secured data can be transmitted. You can even send secured data to electronic bulletin boards and mail services like CompuServe and GEnie for a 'pickup' the next morning. And if you're not transmitting, you can use your Data Sentinel to protect your own personal files.

All of which ties up a lot of very loose ends. Very quickly.

The word is out in data security. And the word is Data Sentinel.

Data Sentinel—How It Works.

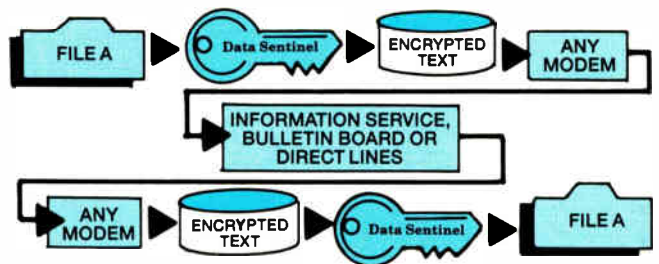

- For IBM PCs and Compatibles • Saves Transmission Time & Cost
- Proprietary Encryption & Compression • No Password • Easy Menu Prompts
- Plugs Into Parallel Port • Modem & Printer Transparent • DES System Compatible



RAINBOW TECHNOLOGIES

18011-A Mitchell South, Irvine, CA 92714 • (714) 261-0228
TELEX: 386078 • FAX: (714) 261-0260

©1987 Rainbow Technologies, Inc. Data Sentinel is a trademark of Rainbow Technologies.
IBM is a registered trademark of International Business Machines. CompuServe is a registered trademark of H&R Block.
GEnie is a trademark of General Electric Information Services Company.

Circle 239 on Reader Service Card (DEALERS: 240)

Great Selection + Superior Service + Competitive Prices = Top Value

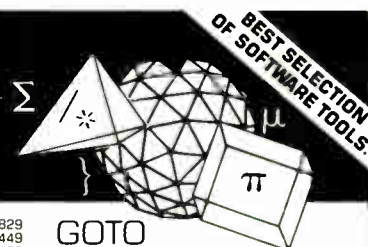

**BEST SELECTION
OF SOFTWARE TOOLS**

We have the technical expertise to fulfill your specialized needs in software development, circuit design, data analysis, CAD and much more. Call today!

- No one offers you more variety.
- 30-day Money-Back Guarantee*
- Latest versions
- Over 500 name-brand products in stock, if you don't see it — call!

Software Development Tools

ASSEMBLERS

ADVANTAGE Disassembler, Lifeboat.....	\$ 279
Microsoft MASM.....	99
OPTASM, SLR Systems.....	169
Pasm86, Phoenix.....	115

BASIC

Flash-up, Software Bottling Co.....	\$ 79
MS QuickBASIC.....	65
QuickPak, Crescent Software.....	59
T BASIC, TransEra Corp.....	445
Turbo Basic, Borland.....	69
Turbo Basic Toolboxes, Borland.....	69

C

AZTEC C-Commercial, Manx.....	CALL
C-terp, Gimpel.....	\$ 229
Lattice C.....	269
w/source.....	499
Microsoft C.....	285
QuickC, Microsoft.....	65
Turbo C, Borland.....	65

COMPILERS

C TOOLS PLUS 5.0, Blaise.....	\$ 99
C Utility Library, Essential.....	125
Essential Communications.....	125
Greenleaf C Sampler.....	69
Greenleaf Comm Library.....	125
Greenleaf Functions.....	125
PforCa, Phoenix.....	215
TimeSlider, Lifeboat.....	79
Turbo C TOOLS, Blaise.....	99

COBOL

Micro Focus Products.....	\$ CALL
MS COBOL, Microsoft.....	449
Realia COBOL.....	785
RM/COBOL, Austec.....	759

PASCAL

MS Pascal, Microsoft.....	\$ 189
Pascal-2, Oregon Software.....	CALL
Turbo Pascal, Borland.....	69
Professional Pascal, Metaware.....	545

PASCAL LIBRARIES (TURBO)

Turbo Pascal Dev. Lib., Borland.....	\$ 289
Metabyte Data Acq. TOOLS, Quinn-Curtis.....	89
Turbo Pascal 5 & E Tools, Quinn-Curtis.....	69
Turbo HALO, Media Cybernetics.....	69
Turbo MAGIC, Sophisticated Software.....	89
Turbo ASYNCH PLUS, Blaise.....	99
Turbo Power Tools Plus, Blaise.....	99

MODULA-2

LOGITECH Modula-2 Compiler Kit.....	\$ 79
Development System Toolkit.....	139
SOLID B+ Toolkit, Advanced Sys. Consultants.....	89
StonyBrook Modula-2 w/Utilities.....	169
	299

386 DEVELOPMENT TOOLS

386-Max, Qualitas.....	\$ 65
------------------------	-------

ADVANTAGE 386 C, Lifeboat.....	829
FoxBASE/386+.....	449
High C Metaware.....	835
NDP FORTRAN, Microway.....	545
Pharlap 386ASM/LINK.....	419

386 SOFTWARE

DESOview, Quarterdeck.....	\$ 109
Microport — Complete.....	679
MS Windows/386, Microsoft.....	129
VM/386, IGC.....	185
SCO XENIX-Complete.....	1195

DEBUGGERS

Periscope II.....	\$ 139
OTHER Periscope Products.....	CALL
Advanced Trace-86, Morgan Computing.....	119
Breakout, Essential.....	89
TDebug PLUS V4.0, Turbo Power Software.....	39
w/SOURCE.....	79
Prix86plus, Phoenix.....	209

EDITORS

BRIEF, Solution Systems.....	\$ CALL
w/DRIF.....	CALL
EDIK, Emerging Technology.....	165
EMACS, Unipress.....	265
Epsilon, Lugaru.....	149
KEDIT, Mansfield.....	99
LSE, Lattice.....	89
MULTI-EDIT, American Cybernetics.....	89
PC/EDIT, Boston Business Computing.....	229
Pmate, Phoenix.....	115
SPF/PC, Command Technology.....	185
VEDIT PLUS, CompuView.....	129
XTC, Wendin.....	79

FILE MANAGERS

Brieve, Softcraft.....	\$ 185
Xtrieve.....	189
Report Option.....	109
CBTREE, Peacock System.....	139
c-tree, Faircom.....	315
r-tree.....	239
4BC III, Lattice.....	169
4BC III w/source.....	359
4BC III PLUS.....	595
db_VISTA OR db_QUERY, Rama.....	CALL
XOL, Softcraft.....	599

GRAPHICS

ADVANTAGE Graphics, Lifeboat.....	\$ 229
-----------------------------------	--------

GOTO

Drawbridge, Courseware Applic.....	109
Essential Graphics.....	189
Graphic, Software Endeavors.....	319
GSS Graphics Dev. Toolkit, Software Endeavors.....	375
HALO, Media Cybernetics.....	209
HOOPS, Ithaca Software.....	319
MetaWINDOW, Metagraphics.....	159
MetaWINDOW PLUS.....	229
Turbo WINDOW/C.....	79
Turbo HALO (Turbo CI, Media Cybernetics.....	79

OBJECT-ORIENTED

ACTOR, White Water Group.....	\$ 419
ADVANTAGE C++, Lifeboat.....	479
PforCa++, Phoenix.....	215
Smalltalk/V, Digital.....	85
Smalltalk/V285.....	169

OPERATING SYSTEMS

Microport Sys W/AT.....	\$ 469
SCO XENIX System V.....	995
Wendin-DOS.....	79
Other Microport, SCO, Wendin Products.....	CALL

SCREENS/WINDOWS

Greenleaf Data Windows.....	\$ 155
MS Windows, Microsoft.....	65
MS Windows Dev. Kit, Microsoft.....	319
PANEL Plus, Lifeboat.....	395
PANEL/IG or ITC.....	89
Vitamin C, Creative Programming.....	155
Windows for Data, Vermont Creative.....	CALL
ScreenStar w/source, Essential.....	169
SoftCode, Software Bottling Co.....	109

OTHER PRODUCTS

Pink86Plus, Phoenix.....	\$ 279
Pre-C, Phoenix.....	159
PC Int, Gimpel.....	159
MKS Toolkit.....	115
Dan Bricklin's Demo Program, Software Garden.....	59
Source Print, Aldebaran Labs.....	75
Tree Diagrammer, Aldebaran Labs.....	69
Polygon, PVCS CORPORATE.....	329
SEIDL Version Manager.....	CALL

Science & Engineering Software

CIRCUIT DESIGN/SCHEMATIC CAPTURE

HiWIRE, Wintek Corp.....	\$ 849
MICRO-CAP II, Spectrum Software.....	759
PADS Drill, CAD Software.....	1411
PADS PCB.....	1411
PADS Route.....	1411
PSpic, MicroSim.....	309
Device Equations Source.....	309
Probe graphics post-processor.....	399
Parts parameter estimator.....	399
Monte Carlo Analysis.....	309
Digital Files.....	449
Schema II, Dmaton.....	449
smARTWORK, Wintek Corp.....	449
Tango PCB, ACCEL Tech.....	495
Tango Route, ACCEL Tech.....	495

DATA ACQUISITION/SIGNAL ANALYSIS

Asyst 2.5.....	\$ 179
Asyst Modules 1,2,3.....	1,989
Asyst Modules 1,2,4.....	1,989
Asyst Modules 1,2.....	1,609
Asystant Plus +, Macmillan.....	849
Asystant, Macmillan.....	469
DADISP, DSP Systems.....	749
DADISP-488, DSP Systems.....	175
Fourier PERSPECTIVE II, Alligator Trans.....	309
HYPERSIGNAL, Hyperception.....	439
LABTECH Acquire, Lab Tech, Corp.....	1411
LABTECH CHROM.....	709
LABTECH Notebook.....	759
LABTECH Real Time Access.....	269
Lotus Measure.....	445
O.E.D. A. and Control, Hart Scientific.....	709
SNAP-CALC, HEM Data Corp.....	295
SNAP-FIT, HEM Data Corp.....	495
SNAPSHOT STORAGE SCOPE.....	109
UnkelScope Junior, Unkel Software.....	315
UnkelScope Level 1.....	499
UnkelScope Level 2+.....	499

PLOTTING AND GRAPHING

ChartBuster PC, Interchart Software.....	\$ 369
Datapat Graph, Mihalsin Assoc. SPECIAL.....	259
Omniplot, Scientific Endeavors.....	269
PLOTZ, Curtis Technical Soft.....	319
TECH*GRAPH*PAD, binary engineering.....	259

EQUATION SOLVERS

Eureka: The Solver, Borland.....	\$ 109
MathCAD 2.0, MathSoft.....	279

muMATH, Soft Warehouse.....	185
SolverIT, Structured Scientific Software.....	79
Solver-Q, SDDC.....	79
TKISolver-Plus, Universal Tech Sys.....	395

CAD

AutoCAD, by Autodesk.....	\$ CALL
Autodesk, by Autodesk.....	65
Speed Enhanced Version.....	79
Design CAD, American Small Bus. Comp.....	219
Defax 1 Plus, Foresight.....	239
Defax 3-D Modeler, Foresight.....	169
EAS/CAD, Evolution Computing.....	139
ECAD, Pitton Engineering.....	439
FASTCAD, Evolution Computing.....	1,849
Generic CAD.....	69
Generic 3-D Solid Modeling.....	159
3-D Rendering Module.....	119
In'A'Vision, Micrografix.....	459
Windows Draw w/Clip Art.....	239
Windows Graph.....	319
LaserCAD, DISL Link.....	89
PRO-3D/PC, Enabling Technologies.....	355
TurboCAD, MSA Group.....	79

AUTOCAD ADD-ONS

AutoESL, Systems Unlimited of CA.....	\$ 279
AutoSHAPE.....	189
FSIMPLEX.....	89
Turbo View, Sublogic Corp.....	449

MOUSE PRODUCTS

LOGITECH SERIAL OR BUS MOUSE.....	\$ 99
LOGITECH OTHERS.....	CALL
LOGITECH SERIES 2 W/PLUS.....	79
MICROSOFT SER OR BUS MOUSE.....	99
W/EASY CAD.....	119
W/MS WINDOWS.....	139
SUMMAW/MS, Summagraphics.....	99

APL LANGUAGE

APL+PLUS/PC, STSC.....	\$ 439
APL+PLUS PC TOOLS.....	209
Pocket APL.....	79

SCIENTIFIC TEXT PROCESSING

CHEM-TEXT, Molecular Design Ltd.....	\$1,500
EMACT, Technical Support Software.....	419
EXP, Brooks/Cole Publishing.....	129
For Math, Shantha Software.....	379
Lotus Manuscript.....	445
PC TEX, Personal TEX.....	229

T ³ Sci. Word Proc., TCI Software Res.....	499
---	-----

STATISTICS

ABstat, Anderson Bell.....	\$ 315
CSS, StatSoft.....	469
Microstat, Ecosoft.....	319
NW-STATPAK, Northwest.....	749
P-STAT.....	659
The Scientific Wheel, Dalin Inc.....	699
SPSS/PC.....	749
StatPac Gold, Walonick Associates.....	539
STATS-2, StatSoft.....	135
THE SYSTAT.....	499

ADDITIONAL S&E PRODUCTS

ATLAS*GRAPHICS, STSC.....	\$ 339
Atoms, Curtis Technical Soft.....	25
Engineer's Aide, Eng Prog Concepts.....	649
LASCAUX 1000 Calculator.....	659
PC-Matlab, The Math Works.....	659
Control System Toolbox.....	375
System ID Toolbox.....	375
POINT FIVE, Pacific Crest.....	279

The Professional Wheel, Dalin Inc.....	199
Units, Curtis Technical Soft.....	25

FORTRAN LANGUAGE

DIFF-E-O, Microcomputables.....	\$ 449
Extend, Design Decisions.....	119
GRAFmatic or PLotmatic, Microcomputables.....	119
Lahy FORTRAN.....	CALL
Lahy Personal FORTRAN.....	89
MathPac, Systolic Systems.....	445
Microsoft FORTRAN w/CodeView.....	289
Numerical Analysis, Magus.....	249
RM/FORTRAN, Ryan-McFarland.....	479
Spindrit Library, Laboratory LTD.....	SPECIAL
SSP/PC, Lattice.....	279

GAUSS

GAUSS Prog. Lang., Aptech Sys.....	\$ 189
GAUSS Math & Stat System.....	339

X-ASMS/SIMULATORS

Microtec, Reims, Uniware, Quelo.....	CALL
--------------------------------------	------

Ordering Information

We accept AMERICAN EXPRESS, MC, VISA and PERSONAL CHECKS. There is no surcharge on credit card or C.O.D. orders. New York State residents must add sales tax. Shipping and handling \$3.95 per item. Rush service is available.
• Dealers & Corporate buyers — Call for Special Discounts and Benefits
• International orders add \$10 for export. No preparation.
• Prices and policies may change without notice.
• Mail orders must include phone number.
*Ask for details before you buy, some manufacturers won't take returns if disk seals are broken.

Call for your FREE catalog today!

In the U.S. call

1-800-333-3141

International Orders: 914-332-0756

Science & Engineering SOFTWARE CO.

55 South Broadway, Tarrytown, NY 10591

■ COPY PROTECTION

RUN YOUR PROGRAM ON ANY HARD DISK

UNlock MasterKey Removes Copy Protection from 140 PC Programs

The new UNlock MasterKey "copying" disk by TranSec and best selling UNlock Albums A+ and D+ allow you to quickly and easily make unprotected DOS backup copies of more than 140 popular original PC programs.

Your original disk is unchanged and the unprotected backup copies perform exactly the same as the original, as do copies of these copies.

UNlock copies run on any hard disk, including Bernoulli Boxes. No original key disk is required in Drive A. You can also run on a RAM disk and conveniently copy DOS 5 1/4" programs to 3 1/2" diskettes.

Take protection off programs not listed by using generic routines.

New UNlock MasterKey is TranSec's most comprehensive copy protection removal program. It unlocks all the programs in TranSec's Albums A+,

B+ and D+...and more than an additional 100 programs. It is intended for the user who wants the best and most comprehensive copy-busting program available.

MasterKey has the ability to break more than 140 specific menu listed programs. In addition you can take protection off programs not listed in the menus by using generic routines for the PROlok, SUPERlok and EVERlock protected programs.

With UNlock MasterKey an analyser will tell you if the disk is protected by either PROlok or SUPERlok, so that you can simply apply the proper UNlock liberating routine. Even many programs using hardware protection schemes can be unlocked.

While other copiers will make copies of some programs, *only UNlock removes copy protection.* Backups don't require tedious uninstalls, and reorganizing your hard disk doesn't result in your software calling you a thief! To order call 1-800-423-0772.

UNLOCK™ MasterKey™ \$159.95

Add \$5.00 ship/handling. Foreign orders \$10.00

MasterKey unlocks the programs in Albums "A" Plus and "D" Plus and those below:

Aldergat (2.2) • Autocad Etn & Win (2.5x) • Bancstar • Basic-2C Runtime Package (2.00.04 & 12/12/86) • Balance of Power '85 • Cadkey (2.11.01, 3.01) • Cadvance (1.10, 1.20, 1.30) • Computer Aided Planning (CAP) 12/15/86 • Cadvance DXF Translator • CAP (3.00) • Chessmaster 2000 ('86) • Courtracting System (2'2) • CP2A (5.8) • DAM Busters ('86) • Data Highway Diagnostics (1.3) • Database Manager II (2.0, 2.02) • Diagram Master (5.1) • Diagraph (3.3, 3.4.1, 3.5) • Discovery Litigation Support (2.3, 2.3e, 3.0) • Disk Optimizer (1.4, 1.5) • Erunacad (1'10B) • Escriben (2, 2.0A) • Financial Analysis for Farmers (6.0) • Financial Profiles (1.5, 2.2, 2.3) • Fund Master-TC (3.5) • GSS Arab World (1.36A) • Harmony (2.35, 3.00) • IBM Drawing Assistant (1.0) • IBM Graphing Assistant (1.0, 2.0) • IBM Planning Assistant (1.0) • ICSI Interactive IQ Program (1.11) • Insearch (1.02) • Insmark (4.03E) • Interceptor IV (1.0A, 1.0B) • Intercom 102 (2.30S, 4.14) • Kampfgruppe ('85) • Maintenance Analysis System (4.00) • Magnatype (1.4) • Mapmaster (6.0) • Mean 18 Golf ('86) • Minitab (5.1.1) • Multilingual Scholar (2.9) • Multilingual Scribe (2.9) • Paradox (1.0) • PBS (1.0) • PC Emulator (1.03) • Petrocalc (85) • PCATE (3.3n-4) • PC FOCUS (1.5, 2.0, 4.5) • PC Information System (9.21) • PCLINK (1.0) • Pfs:Access ('84, C) • Pfs:File (Tandy B, C) • Pfs:Graph (Tandy, B) • Pfs:Plan (Tandy, B, C, 2.00) • Pfs:Report (Tandy, 1.00, 1.00.00, B, C) • Pfs:Write (Tandy, 1.00, 1.01, C, 2.00) • Picture Perfect (3.3, 3.5) • PLC-2 Ladder Logistics (2/11/87) • Pluto ('84) • Print Master (1.1P) • Print Shop (Early '85, Late '85, '86) • Pro-Cite (1.2) • Quicken ('84) • Real CICS (1.10) • Real Estate Appraisal System ('87) • Redboard • Residential Appraisal Processor (R8C) • Screenio for Cobol (2.0) • Sidekick (1.56B) • Sketch Processor (SSK) • SmARTWORK (1.0 r.8-10, 1.1, 1.2 r.3..7) • Softbol II Runtime System (2.11) (11) • Softbridge Financial Planner (2.1) • Spectra Business Systems (3.01) • Spotlight (1.0) • SPSS Statistics for the IBM PC (1.1) • Star Trek: The Kobayashi Alternative • Superpage • Sstat (2) • Tango PCB Layout System (3.03, 3.04) • Tango Route (1.10) • Techsonix Digitizer (2.6M) • Taylor Allen Bradley Programmer (6.19) • T-Bond Trading System ('84) • Tencore Authoring System (3.00 Beta) • Toatex (1.5) • Type 1 (Broderbund) ('87) • Universal Life Pers. Prop. System (6.4N) • Versatile Report System (2.31) • Video Store Manager ('86) • What's Best (1.1) • Westinghouse Numa Logic (2.1, 3.0) • GENERIC PROLOK Unlocker • GENERIC PROLOK Classic • GENERIC SUPERLOK

THE BEST OF 1987

JANUARY 12, 1988 • PC MAGAZINE
BEST OF 1987 AWARD

UNlock MasterKey

For 1987 PC Magazine's authors and editors chose the most significant contributions and most favored products of the year. They called UNlock MasterKey unlocking tools the ultimate equalizer for removing copy protection.



Guaranteed to work only with listed programs:

UNLOCK™ Album "A" Plus \$49.95*

Lotus 1-2-3 (1.A, 1A', 2.0, 2.01)
IBM Writing Assistant (1.0, 2.0)
IBM Filing Assistant (1.0, 2.0)
IBM Reporting Assistant (1.0, 2.0)
Graphwriter (4.3, 4.3.1)
Relia Cobol (1.2, 2.0)
MultiLink Advanced (3.02, 3.03)
dBASE III & dBASE III PLUS (1.0)
Framework I and II (1.0)
Chartmaster (6.1, 6.2)
Signmaster (5.03, 5.05, 5.1)
Fastback (5.3)
Harvard Total Project Mgr (1.10)
ThinkTank (2.0, 2.1)
Dollars & Sense (2.0)

*Add \$4.00 ship/handling. Foreign orders \$10.00

CHOICE OF THE CRITICS!

PERSONAL COMPUTING

"UNlock has two particularly endearing characteristics. It works, and works simply. I was able to quickly produce unprotected copies... These copies performed flawlessly, as did copies of these copies."
Christopher O'Malley

BYTE "UNlock... It's menu-driven and works fine on the program its supposed to work on: Lotus 1-2-3, dBASE III, Framework, Symphony, Paradox and several others."
Jerry Pournelle

PC "Because copy protection can interfere with the ability to back up a hard disk, business oriented users may prefer programs like TranSec's UNlock series"

Winn L. Rosch

UNLOCK™ Album "D" Plus \$79.95*

dBASE III & dBASE III Plus (1.0)
Framework I & II (1.0)
Clipper (thru winter '85)
Fastback (5.3)
Chartmaster (6.1, 6.2)
Signmaster (5.1)
Dollars & Sense (2.0)
Microsoft Word (1.15, 2.0, 2.01)
Lotus 1-2-3 (1.A, 1A', 2.0, 2.01)
Symphony (1.1, 1.2)
Lotus 1-2-3 Report Writer (1.0)
DoubleDOS (All)
Harvard Total Project Mgr (1.10)
MngYour Money (All)
ThinkTank (2.0, 2.1)

More than 40,000 Copies Sold!

TRANSEC UNLOCK™

ORDER TODAY TOLL FREE:
1-800-423-0772
IN FLORIDA 305-276-1500



UNlock is available for IBM PC, XT, AT and compatibles with at least 256K and DOS 2.1.

All software product names and trademarks are the sole property of their respective owners.

Circle 322 on Reader Service Card
World Radio History

APRIL 1988 • B Y T E 205

haven't been much of a fan of NASA since Apollo days—how can it take longer to design an O-ring than it did to design and build fleets of bombers in World War II?—but JPL has always been the exception, the showpiece shop NASA points to when they want to look superb.

I never miss a chance to get to a JPL spacecraft encounter, and I've always wanted a way to get at the planetary data they've gathered. Now I have one: they're putting it on CD-ROMs. So far there are two CD-ROM disks in the Planetary Data System Space Science Sampler series. Both play fine on the Amdek Laserdrive; and they're gorgeous.

One contains images of *Voyager 2's* encounter with Uranus: on an EGA system, they're terrific; on a full PGA system (Orchid's TurboPGA board and Electrohome's 19-inch multisync color monitor), they're nothing short of glorious. They ain't too shabby with plain old CGA, either.

The other disk is a collection of data files from all over the solar system: images of Los Angeles from space; a weather movie of Jupiter; Callisto and Io; Mars maps; Saturn's rings; Titan and Tethys; and just a lot more.

The whole thing is incredible. If you weren't planning on buying a CD-ROM reader for Microsoft Bookshelf or the Micro Medex medical library, get one just to look at these. Check with Tom Renfrow at JPL on availability; JPL's address is in the Items Discussed box on page 208.

Short Shrift

This is embarrassing: I have all these tons of things to write about, and I can't even get started.

Example: the Atari Mega ST, with hard disk drive and Antic's Spectrum and CAD three-dimensional software. This package is nothing short of amazing, and half the ad agencies in Hollywood are

using Atari Mega STs as visual workstations to block out their ad campaigns.

The problem is, the package is so good it deserves a whole column. There's absolutely no way I can cover all that in the space I have left.

Then there's DeskLink from Traveling Software. They've taken LapLink to its logical conclusion and have come up with a 1-to-1 computer-linkage system that uses normal 4-wire telephone cord to connect the machines, works like a dream with totally intuitive menus, and even has a "talk" feature that lets, for instance, a secretary send an unobtrusive on-screen note to the boss, or vice versa.

I can use this to link machines that are themselves linked into the CompuPro ARCNET PC network, thus completing the integration of Chaos Manor. I've yet to see a Traveling Software product I didn't like, and this is certainly no exception; more next month.

There's the new edition of the Mace Utilities, which do an amazing job of resurrecting data from dead hard disks. If one day your hard disk reports Invalid Drive Specification or General Failure Reading Drive C:, my advice is, don't touch it. Leave the machine running, pick up the phone, and call Mace. If you don't have their utilities, buy them; your chances are much better if you have them installed before things crash.

Since crashes are inevitable, you have to be braver than I am to be without the Mace Utilities.

Mace also makes programs that fix problems with dBASE files; once again, if you find you've lost valuable dBASE data, *don't do anything* until you've called Mace.

Incidentally, if you're scared to try recovering data yourself, Workman and Associates have made quite a reputation by getting data off supposedly dead hard disks. My son Alex has become a Mace fan. He also has other tricks he won't tell

me about. They sure can find data everyone thought was lost.

TurboTax

This column will be out just when everyone has to face their taxes.

My bookkeeping system runs under Concurrent 286 on the Golem, my big CompuPro machine. I wrote the software a long time ago to conform to what I learned from Accounting 101 textbooks; it seems to be flexible enough to take care of my *business* tax accounting.

Filling out the personal tax forms is something else again.

In years past I've relied on MacInTax, partly because that program will print everything, forms and all. ChipSoft's TurboTax, on the other hand, required you to use a normal IRS Form 1040 in your printer, and I have *never* had much luck at getting any printer in the world lined up well enough to put its output into little boxes and squared; certainly, I don't think I can do it with a 1040.

This year, TurboTax will print the 1040, provided you have an Epson- or IBM Graphics-compatible dot-matrix printer. I don't have one of those, but they aren't hard to come by for a few hours, and that's greatly preferable to trying to get things properly aligned.

I haven't used TurboTax before, but I've heard good things about it. The manual looks complete and, given the subject matter, relatively easy to use—although, face it, even with a computer things are going to be *complicated* this year. It's also available as I write this, which MacInTax is not.

I can't strongly recommend a program I haven't actually used, but TurboTax looks like the one I *will* use.

Winding Down

I'm completely out of space, and I still haven't touched all the good stuff.

continued

Custom Imprinted Keys, Keytop Shells, Snap-on KeyCaps™, and Keytop™ Labels

Available in a rainbow of colors for IBM and most other keyboards. Produced to your exact specifications by our competent engineering staff and precision imprinted for wear-resistance and compatibility to your present keys. Hooleon keyboard enhancements also include keytop kits, keyboard protectors, individual key lockouts, vinyl templates, keytop expanders, plus much, much, more. Call or write for our free 1988 Catalog today. (602) 634-7515

...FROM THE LEADER IN
KEYTOP INNOVATIONS

Hooleon
CORPORATION

P. O. BOX 201, DEPT. BYTE
CORNVILLE, AZ 86325

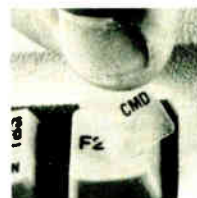



NEW AVOCET C™ FOR MICROCONTROLLERS— A BREAKTHROUGH IN SPEED AND QUALITY.

Introducing Avocet C.™ Fast, *optimizing* cross-compilers that can cut microcontroller development time in half—without sacrificing code quality.

From concept to code in a fraction of the time.

Programming in C lets you concentrate on end results, not annoying details—so you get more done, faster. And rapid compilation takes the frustration out. But for microcontrollers, you need more than speed. You need tight, high-quality code.

That's why we spent two years field-testing and perfecting Avocet C for both speed and quality. We built in three separate phases of optimization—for object code tight enough for real applications. And we integrated Avocet C with an assembler package that's mature in its own right—not an afterthought. So you can still work magic at the bits-and-bytes level.

Avocet C saves you time in all phases of development. Our run-time library is extensive—no need to write the routines yourself. You'll arrive at bug-free code faster, thanks to LINT-like type checking. And your program's useful life is extended, because you can recompile for other target chips.

Testing is easier, too. Avocet C is ANSI-standard—so you can test generic parts of your program with host-resident systems like Microsoft Quick-C™ and Codeview.™ And when you're ready for hardware-specific testing, Avocet's AVSIM Simulator/Debugger tests microcontroller code right on your PC.

An excellent value.

Just \$895 buys Avocet C for your favorite chip: Intel 8051 or 8096, Hitachi 64180, or Zilog Z80—with more to follow. And Avocet C includes the latest version of AVMAC—Avocet's super-fast, professional assembly-language development package. (*If you're already a registered AVMAC owner, you can upgrade to Avocet C for only \$595.*)



AVOCET

SYSTEMS, INC.®

THE SOURCE FOR QUALITY PERSONAL μ P DEVELOPMENT TOOLS.

Circle 28 on Reader Service Card

World Radio History

Free Catalog



Call Toll-Free
800-448-8500*

For your free Avocet catalog—to order—or for more information about Avocet C and other Avocet products.

The best technology— responsive, personal service.

Avocet offers a powerful, comprehensive approach to microcontroller development.

Avocet development tools put the most advanced technology at your fingertips. The Avocet staff stands ready to give you complete support—including technical assistance—on a moment's notice. And we'll ship your order in 48 hours or less.

Call 800-448-8500. Discover how Avocet can speed up your next project.

Avocet Systems, Inc., 120 Union Street
P.O. Box 490AP, Rockport, Maine 04856

*In Maine, or outside U.S., call (207) 236-9055
TLX: 467210 Avocet CI, FAX: (207) 236-6713

© 1988 Avocet Systems, Inc. All rights reserved. Quick-C and Codeview are trademarks of Microsoft Corp. Logo and name Avocet are registered trademarks of Avocet Systems, Inc.

Items Discussed

Amdek Laserdrive\$995	PC Sweep\$5
Amdek Corp. 1901 Zanker Rd. San Jose, CA 95112 (408) 436-8570 Inquiry 934.	Workman and Associates 1925 East Mountain Pasadena, CA 91104 (818) 791-7979 Inquiry 942.
DeskLink\$169.95	Planetary Data System Space Science Sampler
Traveling Software 19310 North Creek Parkway Bothell, WA 98011 (206) 483-8088 Inquiry 935.	NASA JPL 4800 Oak Grove Dr. Pasadena, CA 91109 (818) 354-6347 Inquiry 943.
DESQview 2.0\$129.95	RAMpage/2\$345
Quarterdeck Office Systems 150 Pico Blvd. Santa Monica, CA 90405 (213) 392-9851 Inquiry 936.	RAMpage/286\$545
Empire\$49.95	AST Research Inc. 2121 Alton Ave. Irvine, CA 92714 (714) 756-4942 Inquiry 944.
Interstel P.O. Box 57825 Webster, TX 77598 (713) 486-4163 Inquiry 937.	Reach for the Stars\$40
Fastback Plus\$189	Strategic Studies Group 1747 Orleans Ct. Walnut Creek, CA 94598 (415) 932-3019 Inquiry 945.
Fifth Generation Systems Inc. 1322 Bell Ave. Suite 1A Tustin, CA 92680 (800) 225-2775 Inquiry 938.	TurboTax\$75
Mace Utilities 4.10\$99	ChipSoft 5045 Shoreham Place, #100 San Diego, CA 92122 (619) 453-8722 Inquiry 946.
Paul Mace Software 400 Williamson Way Ashland, OR 97520 (503) 488-0224 Inquiry 939.	Vopt\$49.95
Microsoft Bookshelf\$295	Vcache\$49.95
Microsoft Corp. 16011 Northeast 36th Way P.O. Box 97017 Redmond, WA 98073 (203) 882-8080 (800) 426-9400 Inquiry 940.	Vfeature Deluxe\$120
PaintShow\$79	Golden Bow Systems 2870 Fifth Ave. Suite 201 San Diego, CA 92103 (619) 298-9349 Inquiry 947.
Plus Software\$29	Zenith Z-386
EGA&Mouse\$399	Model 40.....\$6499
Autosync Monitor\$699	Model 80.....\$7499
Logitech Inc. 6505 Kaiser Dr. Fremont, CA 94555 (415) 795-8500 Inquiry 941.	Zenith Data Systems 1000 Milwaukee Ave. Glenview, IL 60025 (312) 391-7000 Inquiry 948.

There's the Complete PC Answering Machine, which is so good it might be worth buying a Blue Chip XT clone just to dedicate for use as a telephone device. There's Borland's Quattro, which in my judgment is the spreadsheet for the rest of us: not copy-protected, plenty of features, and the simplest installation and tutorial I've ever seen for a spreadsheet. There's Concurrent DOS 386. Here's AutoDimensioning for Generic Software's CADD 3.0 (PC). TK!Solver. MathCAD. The list goes on, and what am I supposed to do?

The book of the month is *David's Sling* by Marc Steigler (Baen Books, 1988), a novel of how information-age technology might be used to defeat bureaucracy; a really good read. While you're in the bookstore, you might pick up *Imperial Stars, Volume Two: Republic and Empire*, edited by J. E. Pournelle, also from Baen Books.

The computer books of the month are Timothy Budd's *A Little Smalltalk* (Addison-Wesley, 1986) and Chris DeVoney's newest edition of *Using PC DOS* (Que Corp., 1986). One's a great intro, the other's the best DOS handbook I have.

The games of the month are *Reach for the Stars* (Macintosh only) and *Empire* (Atari ST; PC version upcoming). Both are revisions of classics. *Reach for the Stars* is a computerized version of the old board game *Stellar Conquest*, with new features added. It's totally strategic level; combat is automatic and is based on the Lanchester equations in which the squares of the forces involved are the key numbers. You control economics as well as military production, and the darned game is fascinating, as well as a good example of using the Mac interface to control something really complex.

Empire is a microcomputer version of a classic originally written for a VAX. It has some bugs, which the designer promises to take care of in a revision; but bugs and all, the darned thing turns out to be fascinating enough that the other night I sat down at 9:30 and didn't look up until 4:30 the next morning.

Maybe next month things will slow down, but I doubt it. ■

Jerry Pournelle holds a doctorate in psychology and is a science fiction writer who also earns a comfortable living writing about computers present and future. Jerry welcomes readers' comments and opinions. Send a self-addressed, stamped envelope to Jerry Pournelle, c/o BYTE, One Phoenix Mill Lane, Peterborough, NH 03458. Please put your address on the letter as well as on the envelope. Due to the high volume of letters, Jerry cannot guarantee a personal reply.



This 386 Hauls.

We realize putting an 80386 microprocessor in a PC isn't a new concept. But to put an 80386 microprocessor, running at 16 MHz, in a portable PC that weighs in at only 15 pounds, certainly is.

And you'll find just that in the new Toshiba T5100.

Thanks to the T5100's 29 msec 40MB hard disk and 144MB 3 1/2" PS/2-compatible diskette drive, you can run complex graphics and CAD/CAM programs faster than you can re-design your latest brainstorm.

We even gave it a built-in EGA system with a gas plasma display and an EGA monitor port. An 82-key full-function

keyboard. A multitude of built-in ports. Plus MS-DOS® and Lotus® Metro.™

And if your good ideas need extra room to become great ones, the T5100 can be quite accommodating. With its 2MB of RAM that's expandable to a hefty 4MB.

Of course, if you'd like to see just how fast the T5100 really is, we suggest you call 1-800-457-7777 for your nearest Toshiba dealer. And we also suggest you call soon.

At the rate they're going, they'll be hauled off in no time.

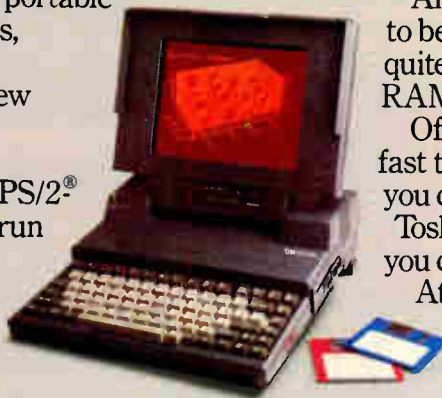

The T5100 has a built-in EGA system and a 40MB hard disk.

The T5100 is backed by the Exceptional Care program. No cost enrollment required. See your dealer for details. MS-DOS is a registered trademark of Microsoft Corp. Lotus and Metro are trademarks of Lotus Development Corp. PS/2 is a registered trademark of International Business Machines Corporation.

In Touch with Tomorrow
TOSHIBA

Toshiba America, Inc., Information Systems Division

Now you can grab, store, and process 16 images in Real Time on the PC AT.



The many faces of Fred Molinari, President.

The DT2861 Arithmetic Frame Grabber can process 4 times as many images as any other frame grabber built for the PC AT.

With a built-in processor, the DT2861 also lets you process 4 images in parallel, or switch display instantaneously from as many as 16 images. The DT2861 grabs images off virtually any video source,



including CAT scanners, scanning electron microscopes, line-scan cameras, as well as ordinary video cameras and VCRs. It even ships with IRISutor™ software— for free!

For more information about the Frame Grabber

that's 4 times better than anything else made for PCs, give us a call today.

(617) 481-3700.

◀ **DT-Connect™** is an open interface specification which permits the direct connection of stand-alone data acquisition and frame grabber boards to processor boards for greatly accelerated signal (DSP) and image processing.



Image Processing Board	Computer	Resolution	Gray Levels	RS-170, NTSC, RS-330, CCIR, PAL Compatible	VCR Compatible	Slow Scan	Number of Video Inputs	Real-Time Frame Grab	On Board 8-bit ALU	Memory-Mapped Frame-Store Memory	Zoom, Pan, Scroll	Software Support	Price
DT2861 Frame Grabber	IBM PC AT	512x512	256	Yes	Yes	0-12 MHz	8*	Yes	Yes	16 buffers 512x512x8 each (4 Mbytes)	Yes	DT-IRIS IRISutor	\$4995

*With DT2859 1/2 size multiplexer board (\$395).

DATA TRANSLATION®

World Headquarters: Data Translation, Inc., 100 Locke Drive, Marlboro, MA 01752-1192, (617) 481-3700 Tlx 951646
 United Kingdom Headquarters: Data Translation Ltd., The Mulberry Business Park, Wokingham, Berkshire RG11 2QJ, U.K. (0734) 793838 Tlx 94011914
 West Germany Headquarters: Data Translation GmbH, Stuttgarter Strasse 66, 7120 Bietigheim-Bissingen, West Germany 07142-54025
 International Sales Offices: Australia (2) 662-4255; Belgium (2) 735-2135; Canada (416) 625-1907; Chile (2) 25-3689; China (408) 727-8222, (8) 721-4017; Denmark (2) 274511; Finland (90) 372-144; France (1) 69077802; Greece 951-4944, 527-039; Hong Kong (3) 771-8585; India (22) 23-1040; Israel (3) 32-4298; Italy (2) 82470.1; Japan (3) 502-5550, (3) 375-1551, (3) 355-1111; Korea (82) 756-9954; Netherlands (70) 99-6360; New Zealand (9) 504-759; Norway (02) 55 90 50; Portugal 545313; Singapore 7797621; South Africa (12) 46-9221; Spain (1) 455-8112; Sweden (8) 761-7820; Switzerland (1) 723-1410; Taiwan (2) 709-1394; United Kingdom (0734) 793838; West Germany 07142-54025.
 IBM PC AT is a registered trademark of IBM. Data Translation is a registered trademark of Data Translation, Inc.

Circle 316 on Reader Service Card

World Radio History



Two Big Winners

Ezra Shapiro

It's April, time for pranks and all sorts of tomfoolery. Unfortunately, I received my April Fools' surprise early, courtesy of Jasmine Technologies, manufacturer of hard disk drives for the Macintosh. I've had a Jasmine Direct Drive 160 for about 3 weeks now, and it has performed splendidly; that's not the problem. Jasmine sells its drives loaded with roughly 10 megabytes of shareware and public domain software. On the surface, it's a nice idea; sure beats collecting the stuff on your own.

However, not all of this assortment has been tested by Jasmine. A number of the programs can bring your Mac to a grinding, ugly halt, and some can even do serious damage to your system files. Many programs are experimental versions, and a few date back as far as 1984. Some are grossly incompatible with current system software, and some never worked well even when they were new.

It took me about 3 days to plow through the disk. It's not all bad—you get the latest version of ResEdit, a couple of interesting utilities, some fonts, and suchlike. Only a small percentage of the programs are seriously problematic, but weeding them out requires painstaking effort.

What's particularly irritating is that Jasmine is in a position to perform a real service to customers and starving shareware authors by providing a selection of tested software. But instead of checking the programs, Jasmine posted a message disclaiming any responsibility for mishaps arising from use of these programs. If I read my dictionary right, the opposite of "responsible" is "irresponsible." And Jasmine's policy is certainly irresponsible.

This is no public service; it's a menace. Be warned. A loud boo to Jasmine for this one.

Almost Artificial Intelligence

Decision Pad (Apian Software, \$195) is an MS-DOS package that falls into the nebulous category of "decision support

Decision Pad helps clarify tough choices; QuicKeys enhances a Mac keyboard

software." I've always hated that label; it's an imprecise term, and I'm never sure what the companies that use it want it to mean. Many of the programs I've seen billed as such are mostly hot air.

But Decision Pad is a top-notch piece of software, and it has been growing on me in the 5 weeks I've been working with it. The program is a useful tool for examining the strengths and weaknesses of alternative solutions to any given problem, from choosing the right restaurant for a business lunch to selecting the best candidate for a job opening. Essentially, Decision Pad uses simple quantitative techniques to provide qualitative analyses of your data.

The metaphor is much like that of a spreadsheet or a database table. Each row shows one alternative; columns are used to break that alternative into its component parts. Using the lunch example, the rows would be individual restaurants, and the columns would be attributes like price, speed, quality, and atmosphere.

Decision Pad lets you develop a ranking scale for each attribute in verbal units that seem to be appropriate, like "excellent/good/average/fair/poor" for quality or "expensive/reasonable/bargain" for price. You then assign number values to these ranking scales. Finally, you give weight to the different attributes; let's say price is twice as important to you as atmosphere. Decision Pad then computes the results and tells you which restaurant would be your best bet.

Unfortunately, examples like this tend to trivialize the utility of the program. I wouldn't recommend using Decision Pad to choose a restaurant any more than I'd suggest that you need an expert system to tell you when your car is out of gas. Decision Pad is much more appropriate for

issues that require selecting from among a quantity of very similar alternatives.

Ten years ago, I ran a want ad in the *New York Times* for an assistant and received over 200 resumes; almost all of them were in line with the basic requirements. It took me weeks to whittle down the list to a manageable group of applicants. Decision Pad would have been extremely helpful.

Other examples leap to mind: Which combination of nutrients grows the healthiest culture in a petri dish? What midsize car, from which rental agency, should you try to get for freeway driving in Los Angeles? Where should you build a new manufacturing facility, from among a selection of 200 suburban sites in six states? Decision Pad looks better and better as the quantity of data grows and the differentiating characteristics get less and less obvious.

The program is easy to learn, and it comes with examples at different levels of complexity. The basic interface is rather a cross between a spreadsheet and a utility program like SideKick; you can enter commands as Alt-key mnemonics, use a mouse or cursor keys to select from a menu, or enter the traditional slash followed by a letter à la Lotus 1-2-3 or SuperCalc.

The documentation is clear, if a little overlaid with hyperbole. It's missing a decent spec sheet, but it does give you a thorough tutorial. I had no trouble getting going. Once you've grasped the basic principles of Decision Pad (in an hour or less), you should be able to start using it immediately.

The worksheet holds a maximum of 150 alternatives (rows) and 60 attributes (columns). Decision Pad has no internal computational ability except what I've described; that is, you cannot modify numerical data or make comparisons employing any method other than the ranking system. However, the program can

continued

import and export files in Lotus .WKS format, so if you need heavy-duty number crunching, you can pop your file into (or out of) your favorite spreadsheet or analytical database. Reports can be generated as standard text documents, or you can see them depicted as bar graphs.

Perhaps the nicest feature lets several users get at the same data and develop their own ratings. Decision Pad will track the variations in the standings and report on how each member of the group has evaluated the data.

You can play "what if" to your heart's content, changing the data or reworking the scales. It's possible, of course, to alter the weights so that the results turn out exactly the way you want them; using this program effectively requires self-discipline. Even if you cheat, though, my hunch is that the process of preparing your information for Decision Pad will focus your attention on meaningful details you might otherwise overlook. At the very least, a session with this program will give you insight into the criteria you're applying to a decision.

At the start of my testing, I was prepared to dislike Decision Pad. I thought it was going to be a way to use a computer to perform tasks better handled by scrawling notes on a legal pad. Instead, I was delightfully surprised. Even if you get nothing from Decision Pad but a better understanding of your decision-making strategy, it's worth the price.

Highly recommended.

The Jury's in on QuicKeys

Last month, I mentioned that I hadn't had enough time to decide whether I liked QuicKeys (CE Software, \$99.95), a keyboard programming utility for the Macintosh. The jury is now in, and the verdict is favorable. QuicKeys is right up there with sliced bread, the Great Pyramid of Cheops, and other wonders.

It's what is known as a keyboard enhancer; you use it to assign commands, mouse operations, and text strings to keys of your choosing. Anyone coming in from another operating system (MS-DOS or CP/M, say) already understands the concept; I'm amazed that it has taken this long for a good product like this to appear on the Mac. Nevertheless, here it is, and it's as invaluable as products like SmartKey, ProKey, and SuperKey are in the IBM PC universe.

Running the program is no big deal. You can define keyboard substitutes either by using a stand-alone application or by calling up a device-configuration screen from the Mac's Control Panel. QuicKeys can also be brought to life by hitting a hot key that avoids the Control Panel step. Once you're looking at the

Items Discussed

Decision Pad\$195
Apian Software
P.O. Box 1224
Menlo Park, CA 94026
(415) 851-8496
Inquiry 949.

QuicKeys \$99.95
CE Software
801 73rd St.
Des Moines, IA 50312
(515) 224-1995
Inquiry 950.

QuicKeys panel, you select the type of operation (e.g., choosing a menu item, inserting text, defining a command alias, and clicking and dragging the mouse), then press the key or key combination that will ever after invoke your definition. Every type of Mac action has a QuicKeys equivalent.

Sets of QuicKeys can be saved to or loaded from disk at any time. This is a very smart program; it has both a universal set of keys available wherever you are and the intelligence to let you create sets specific to the application you're running at the moment. To my delight, I discovered that the application-oriented stuff is not sacrificed under MultiFinder. Since QuicKeys intercepts your keystrokes before passing them along to the operating system, your new keyboard shortcuts supersede the command-key equivalents on the Mac menus so you can effectively redefine anything to suit your taste.

This override process caused the only problem I had while getting adjusted to QuicKeys. The universal key set that comes with the program defines Command-Q as an automatic, absolute "quit." While using MicroPhone, a telecommunications program that uses Command-Q as an alias for Control-Q, I found myself aborting the program every time I tried to stop screen scrolling. This was easily fixed by redefining the quit maneuver to Option-Command-Q.

Bear in mind that QuicKeys is not a macro recording program like Tempo; the product is a bit of a pain if you need to build complex macros. You're allowed to assign only one action to any particular key, so you can't simply log a series of operations and attach it to a single keystroke. To work around this, QuicKeys does let you chain reassigned keystrokes into sequences, so you can build macros

step by step. Think of each key as a variable and its related operation as a value, and you've got the basic idea.

There are certainly enough key combinations to go around. QuicKeys recognizes the Shift, command, and option keys as unique modifiers, so every key represents eight different characters. On keyboards for the Mac SE and II, which have a separate Control key, the total jumps to 16.

On an extended keyboard, you'd theoretically have 1488 combinations to work with. To get some of the more obscure possibilities on my new DataDesk keyboard, I figure I'd need both hands and my nose to hold down the correct keys at the same time.

The number of keys on these extended keyboards does legislate a healthy amount of organization. As I get deeper into the product, I find myself regularly rethinking which keys do what. I certainly don't have the mental fortitude to master function keys mapped to a depth of 16 levels. My personal maximum is about three per key.

Also, it would be a big help to have similar actions located in the same region of the keyboard no matter what program I'm using.

I'm also a little concerned that as I become addicted to QuicKeys, I'm losing touch with the Mac as a lowest-common-denominator machine. To explain: I've known many MS-DOS users who have become so dependent on a selection of utilities and keyboard enhancements that they become paralyzed when they're forced to work on other people's computers. Will my customization of the Mac interface with QuicKeys ruin me for other Macs?

But philosophical mutterings aside, QuicKeys is first-class software. It's never crashed on me, no matter how hard I've pounded on it. The documentation is excellent. QuicKeys is an absolute requirement if you have an extended keyboard (particularly since no Mac programs understand or use the function keys yet); if you're stuck with a standard keyboard, it's merely wonderful.

There's an implicit irony in all this. Back in 1984, I heard an awful lot of sneering from rabid Macaholics who couldn't understand why anyone would want to use a keyboard instead of a mouse. Function keys and Control-key sequences? Phooey!

My, how times have changed! ■

Ezra Shapiro is a consulting editor for BYTE. Contact him c/o BYTE, One Phoenix Mill Lane, Peterborough, NH 03458. Because of the volume of mail he receives, Ezra, regretfully, cannot respond to each inquiry.

Order Status,
Technical & Other
Info. (602) 246-2222
FAX # (602) 246-7805

Call for programs not listed



SPECIAL
MICROSOFT WORD 4.0
\$195



No Charge for MasterCard or Visa

TOLL-FREE ORDER LINE 1-800-421-3135

FREE SOFTWARE!

Purchase over \$100 and receive one of these disks absolutely FREE! Purchases over \$250 get two free disks, over \$400 get three, or get all four disks when your purchase is over \$500! 1) **MIXED BAG**—A great assortment of utilities and games all packed on one disk. 2) **PC-WRITE**—Try this famous feature packed word processor. It's a winner! 3) **FONT-SET**—Lets you set popular fonts like bold, underline, etc. on most late model printers from Citizen, Epson, NEC, Okidata, Panasonic, Star, Toshiba, etc. You can even use your printer like a typewriter! 4) **ABC-LIST**—Great mailing list program! Sort on any field, do qualified searches, print reports and mailing labels, and more!

— SOFTWARE —

Accounting

Cyma	Call
Dac Easy Acct.	\$54
Dac Easy Payroll	39
Dollars & Sense	94
In House Acct.	112
Managing Your Money 3.0	117

Communication Programs

Carbon Copy Plus	\$108
Crosstalk XVI	89
Crosstalk MK4	110
Remote	89
Smartcom II	79

Data Base Managers

Clipper	\$375
Condor 3	325
DBase III Plus	Call
DB-XL	80
Fox Base Plus	195
Genifer	189
Paradox 2.0 Premium	435
PFS Pro File	Call
Powerbase	169
Q&A	189
Quicksilver Diamond	329
Revelation	464
R Base System V	Call
Reflex	81
Relate & Report	112
VP Info	65

Desktop Publishing

Pagemaker	\$479
PFS First Publisher	59
Ventura Publisher	Call

Graphics

Chartmaster	\$199
Design Cad 2	148
Diagram Master	Call
Easy Cad	109
Energraphics 2.01	294
Generic Cad	49
In-A-Vision	270
Microsoft Chart 3.0	Call
Newsroom Pro	65
Printshop	33

Integrated

Ability	\$56
Ability Plus	Call
Enable	Call
Framework II	Call
Smart System	429
Symphony	Call

Languages

Lattice C Compiler	\$220
Microsoft C Compiler	275
Microsoft Fortran	Call
Microsoft Macro Assembler	92

Languages

Microsoft Pascal	Call
Microsoft Quick Basic	59
Microsoft Quick C	59
Ryan McFarlan Fortran	342
Ryan McFarlan Cobol	549
Turbo Basic	59
Turbo C	59
Turbo Pascal	59
Turbo Prolog	59

Multi-User Software

Fox Base	\$299
Word Perfect	310
Word Perfect Modules	ea 75
Microsoft Word	Call

Project Manager

Microsoft Project	Call
Super Project Plus	Call
Timeline 2.0	\$270
Total Havard Man. 2	Call

Spreadsheet

Lotus 1-2-3	Call
Microsoft PC Excel	Call
Spreadsheet Auditor	\$82
Supercalc 4	Call
Surpass	329
VP Planner Plus	88

Utilities

Copy II PC	\$19
Copywrite	39
Cubit	39
Deskview 2.0	72
Direct Access	49
Eureka	49
Fastback Plus	92
Formtools	56
Graph in the Box 2	55
Mace	55
Microsoft Windows	59
Norton Advanced	75
Norton Utilities	48
PC Tools Deluxe	37
Prokey 4.0	70
Q DOS II	49
Rightwriter	75
Sidekick	55
Sideways	39
Soz	Call
Superkey	55
Turbo Lightning	55
XTree	35

Word Processing

Microsoft Word 4.0	\$195
Multimate Advantage II	Call
Volkswriter 3	139
Webster Spellcheck	37
Word Perfect	195
Word Perfect Executive	106
Word Perfect Library	59
Wordstar Pro	233
Wordstar 2000+	194

— HARDWARE —

Accessories

Brooklyn Bridge	\$72
Copy II PC Bd.	75
Curtis Ruby	59
Mach III Joystick	36
Masterpiece	88
Masterpiece+	99
150 Watt Power Supply	69

Boards

AST	
Advantage Premium	\$285
Sixpac Premium	Call
Sixpac Plus	129
HERCULES	
Color Card	145
In Color Card	302
Graphics Plus	182
INTEL	
Above PC 64K	225
Above 286	319
Orchid Tiny Turbo	289
TALLTREE	
J Ram 3 ATP	Call

COMPUTERS

AZ 386

80386-16 Micro Processor, 1 MB of Ram, Teac 1.2 MB disk drive, 220 watt power supply, 6 layer mother board, RT keyboard **\$2595**

AZ Turbo AT

512K, 6 & 10 MHZ, keyboard, 200 watt power supply, one 1.2 teac drive, Phoenix Bios **\$975**

AZ Turbo XT

135 watt power supply, One 360K drive, 640K, keyboard **\$519**

AZ 10

150 watt power supply, dual 360K drive, 10 MHZ mother board, 640K, keyboard **\$670**

AST 286

Premium Computer

512K, expandable to 2MB on the system board, RT enhanced style keyboard, parallel, serial and clock, 1.2 MB floppy disk drive, 7 expansion slots, two 32 bit fastram slots, DOS 3.1 & Basic 1 year warranty **Call**

EGA Boards

ATI Ega Wonders	\$195
NEC GBI	Call
Paradise Auto 480	155
Quad EGA Plus	165
Vega Deluxe	229

TERMS: Shipping on most software is \$5.00. AZ order +6.7% sales tax. Personal check/company check—allow fourteen (14) days to clear. We accept purchase orders from authorized institutions for 3.5% more than cash price. All returns are subject to our approval. There will be a 20% restock fee. Minimum phone order \$50. All prices are subject to change. Due to copyright laws we cannot take back any open software.

EGA Monitors

AMDEK 722	\$455
Casper	410
Mitsubishi Diamond Scan	486
NEC	
Multisync Plus	Call

Hard Cards

Plus 20 MB	Call
Plus 40 MB	Call

Hard Drives

Seagate 20 MB	\$269
Seagate 30 MB	299
Seagate 30 MB AT	Call

Modems

AZ 300/1200	\$75
Everex 300/1200	89
Hayes 1200	Call
Hayes 1200B	Call
Hayes 2400	Call
U.S. Robotics 2400	335

Mice

Genius	\$59
Logitech	Call
Microsoft Bus w/Paintbrush	92
Microsoft Serial	92
Optimouse w/Dr Halo	89
Optimouse w/DPE	185

Monitors

AMDEK	
410 Amber	\$145
Magnavox RGB	Call
PRINCETON	
Max 12	138
HX 12E	460
SAMSUNG	
TTL Amber w/tilt	75
Color w/tilt	249

Printers

CITIZEN	
MSP 10	\$249
MSP 15	315
MSP 20	285
120 D	142
Premiere 35	471
Tribute 224	639
EPSON—Call on all models	
NEC	
P5XLP	815
P7 Parallel	595
8850	1059
P6 Parallel	419
P960XL	1005
P2200	335
OKIDATA—Call on all models	
PANASONIC—Call on all models	
STAR MICRONICS	
NB24-10	456
NB24-15	610
ND10	275
NX1000	179
TOSHIBA—Call on all models	

Ram

64K 150NS	\$16.50
256K 150NS	33

TOLL-FREE ORDER LINE 1-800-421-3135

WAREHOUSE DATA PRODUCTS

2701 West Glendale Ave. • Phoenix, AZ 85051
We do not guarantee compatibility

Servicing our PC buyers with low pricing and technical experience since 1979.

Phone Hours: Monday, Wednesday & Thursday 7 am-90am; Tuesday & Friday 7am-5 pm; Saturday 9am-5pm MST.

ABOVE BOARD 2 LEAVES THE COM

Above® Board 2 is the first memory board for the PS/2™ that comes with the new expanded memory specification — LIM 4.0.

Because only Above Board 2 comes from Intel. The company that developed LIM 4.0.

So now your users can access more memory. And run the very latest DOS application software well beyond 640K. Which will give everyone powerful, new capabilities they never thought possible.

Above Board 2 also promises 100% compatibility with OS/2™ application software.

Along with guaranteeing compatibility with the PS/2's microchannel technology.

Add to that Intel's technical support, award-winning documentation and five-year warranty, and Above Board 2 is clearly your one and only choice.

Of course you could always wait for the competition to catch up. But, where would that leave you?

The Intel logo, consisting of the word "intel" in a lowercase, sans-serif font with a registered trademark symbol (®) to the upper right.

For more information, call 800-538-3373. Trademarks/owner: Above, Intel/Intel Corporation, PS/2, OS/2/International Business Machines Corporation. © 1988 Intel Corporation.

Circle 129 on Reader Service Card



PETITION OUT ON A LIM.

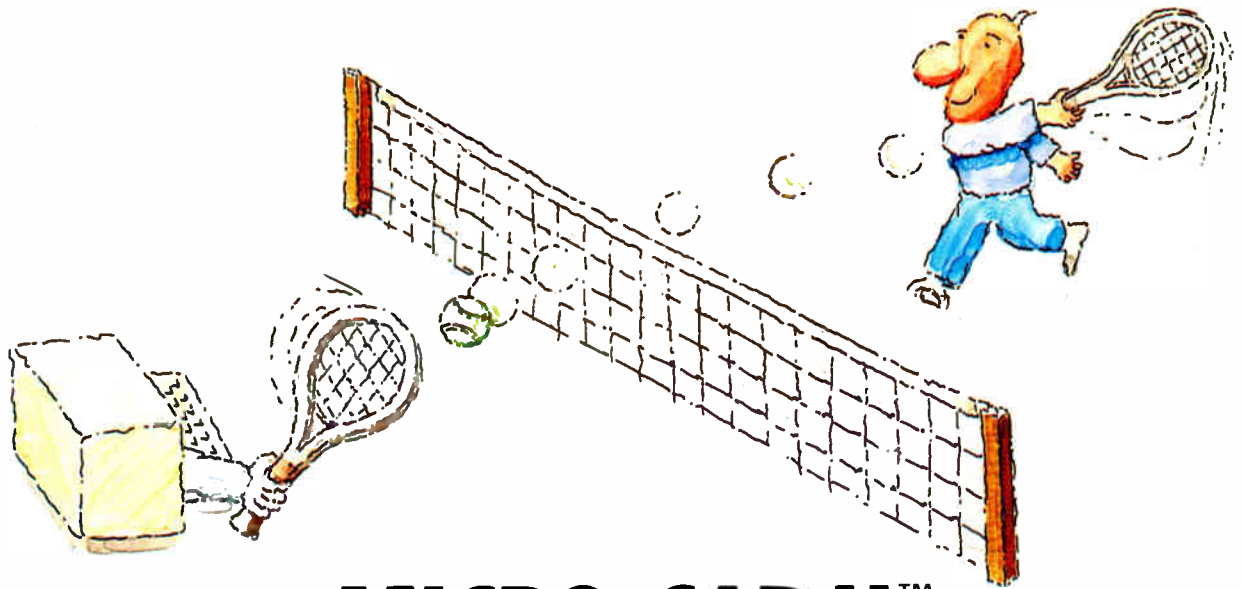

MICRO-CAP II.™

The CAE tool with fully interactive analog simulation for your PC.

Spectrum Software's MICRO-CAP II® is fast, powerful, and feature rich. This fully interactive, advanced electronic circuit analysis program helps engineers speed through analog problems right at their own PCs.

MICRO-CAP II, which is based on our original MICRO-CAP software, is a field-proven, second-generation program. But it's dramatically improved.

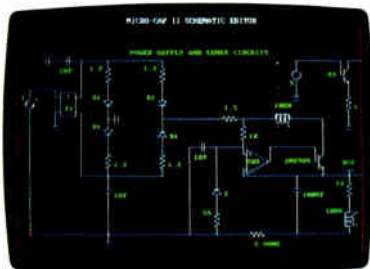

Schematic Editor

MICRO-CAP II has faster analysis routines. Better resolution and color. Larger libraries. All add up to a powerful, cost-effective CAE tool for your PC.

The program has a sophisticated integrated schematic editor with a pan capability. Just sketch and analyze. You can step

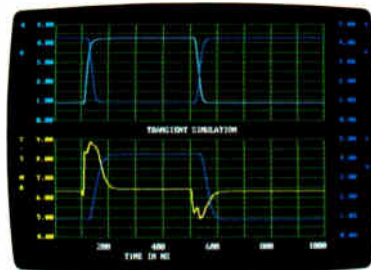

Transient Analysis

component values, and run worst-case scenarios—all interactively. And a 500-type* library of standard parts is at your fingertips for added flexibility.

MICRO-CAP II is available for IBM® PCs and Macintosh.™ The IBM version is CGA, EGA, and Hercules® compatible and costs only \$895 complete. An evaluation version is available for \$100. Call or write today for our free brochure and demo disk. We'd like to tell you more about analog solutions in the fast lane.

- Integrated schematic editor
- Fast analysis routines
- High-resolution graphic output
- Standard parts library of 500* types

*IBM versions only.

- Transient, AC, DC, and FFT routines
- Op-amp and switch models
- Spec-sheet-to model converter*
- Printer and plotter* hard copy



AC Analysis

Spectrum

1021 S. Wolfe Road, Dept. E
Sunnyvale, CA 94087
(408) 738-4387

MICRO-CAP II is a registered trademark of Spectrum Software.

Macintosh is a trademark of McIntosh Laboratory, Inc. and is being used with express permission of its owner.

Hercules is a registered trademark of Hercules Computer Technology.

IBM is a registered trademark of International Business Machines, Inc.

Memory Management

- 219 **Overview of Memory Management**
by Randall L. Hyde
- 227 **OS/2 Virtual Memory Management**
by Vic Heller
- 237 **Marrying Unix and the 80386**
by Carl Hensler and Ken Sarno
- 249 **Macintosh Memory Management**
by Alan Anderson
- 256 **Resource Guide**

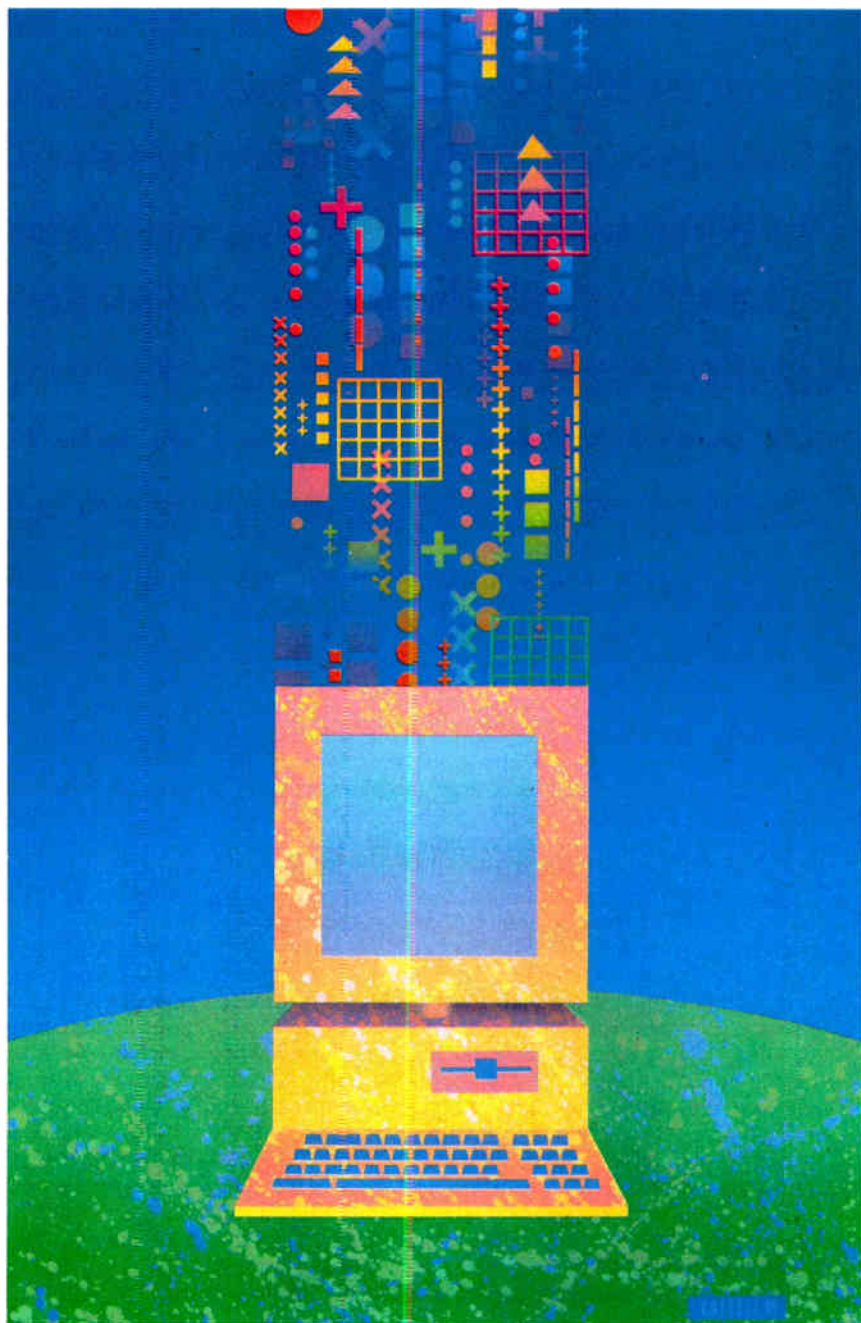

Introduction

Memory Management



Life with computers has evolved in funny ways. First, we learned to manage stacks of punch cards, then piles of floppy disks, then our virtual desktops. Next, they'll be asking us to learn to manage memory.

Maybe not. Some things are still best left to the machines themselves, and managing memory may be one of them. But understanding the dynamics of memory management helps us choose the right technology for a given task.

The trend in microcomputer technology has always been toward more powerful hardware. Today, it is not uncommon to find personal computers with a megabyte or more of memory and the capability to expand to 8 or 16 megabytes. Many microcomputers now come with sophisticated 32-bit processors that either provide hardware support for memory management on-chip (e.g., the CPU in a Compaq Deskpro 386) or have a socket for adding a memory management unit (the Mac II, with a socket for Motorola's 68851 MMU).

As usual, hardware technology outpaces software technology, and today's currently available operating systems use only a fraction of the potential of these machines. For MS-DOS, interim available solutions to the memory management problem include bank switching and multitasking shells that sit on top of DOS. Apple introduced MultiFinder in October 1987 to provide limited concurrent processing and background printing capability. However, these options are clearly short-term solutions.

Meanwhile, software engineers are devising new operating-system designs that can take advantage of the large address spaces provided by these sophisticated CPUs. These operating systems will be complex. They will be capable of running multiple applications that are protected from each other, yet allow these same applications to communicate information among one another. The same complexity that gives these multitasking systems such power also requires much training and experience to tap their full capabilities. After the initial time investment, however, they will be safer and more interesting environments under which to program.

This month, we chose to look at techniques that these operating systems use to manage the computer's main memory.

In addition to a general introduction to the subject, we present three examples of how these techniques are applied in three operating systems: OS/2, Unix, and the Macintosh operating system.

In his "Overview of Memory Management," Randall L. Hyde discusses memory management techniques for personal computers—past, present, and future. He covers the wide array of memory management techniques, from those implemented only in software to those that require hardware support for their proper operation. He discusses the relative merits of segmented and paged virtual memory.

Vic Heller gives us an inside look at how OS/2 uses the 80286 to implement segmented virtual memory. In his article "OS/2 Virtual Memory Management," we see how OS/2's software data structures work with the 80286's hardware data structures to provide not only virtual memory but also dynamic linking and sharing of code segments.

Unix is an alternative to OS/2. Unix has been running on 680x0s for many years due to that processor's flat address space, but as Carl Hensler and Ken Sarno explain in their article "Marrying Unix and the 80386," porting Unix to the 80386 is quite easy. In addition, the 80386 offers modes that make it easy to run existing DOS applications.

Finally, Alan Anderson, in "Macintosh Memory Management," gives us a look at the Mac's memory management system, which was present in the first 128K-byte RAM Macs and is still with us today in the Mac II. He explains how this memory management software works, along with its advantages for the end user and its pitfalls for the unwary programmer. He concludes with a look at MultiFinder and how it was carefully crafted to provide compatibility with existing Mac software and concurrency among several applications.

These articles show that microcomputer environments are evolving toward solutions that will allow us to harness the true potential locked within the new generation of 32-bit microcomputers, without jeopardizing our huge investment in existing software.

—Eva White, Technical Editor
Tom Thompson, Senior Technical Editor at Large

Overview of Memory Management

Powerful hardware and plentiful memory make techniques for managing microcomputer memory more interesting—and necessary

Randall L. Hyde

UNTIL RECENTLY, it has been too expensive to provide hardware support for memory management on microcomputers, or even enough memory to make it worthwhile to manage. But with the advent of microprocessors with on-chip memory management and cheap memory, many of the memory management techniques for mainframes are migrating to the world of microcomputers.

More sophisticated memory management means faster and more reliable multitasking. With the emergence of multitasking systems on microcomputers, it's time to dust off those college textbooks and look at some of the classic issues in memory management. I'll discuss the memory management techniques that have become prevalent on microcomputers and look at some others migrating to this realm—techniques such as paging, segmentation, or a combination of both. Other articles in this issue will look at specific examples of these techniques.

A memory manager is a process, typically within an operating system, that provides memory-related services to other processes. Its job is to allocate and deallocate memory, swap code and data between main memory and secondary memory, protect one process from another, and coordinate access to shared data between processes.

Although many of the memory manager's tasks are easily done in software, performance considerations often dictate the use of special memory management hardware. Some functions (like protection) require assistance from a hardware memory management unit (MMU).

Because of the high costs of hardware support and memory, memory management on personal computers has typically been done in software. When memory prices fell, bank-switching techniques were developed to extend the addressing range of machines while allowing people to use existing hardware and software. But bank switching is only an interim measure. Tomorrow's applications will run on new, sophisticated hardware that will let operating system designers make memory management practically transparent to the application developer and user alike.

Software Memory Management

Software-based memory managers provide at least two functions: memory allocation and deallocation. To allocate memory, the requesting process specifies a block size. The memory manager returns the address of the block allocated to the process. When deallocating memory, the process provides the block address (and sometimes the length of the block as well), and the memory manager returns the memory to the free memory pool.

After several allocation and deallocation requests, free memory can divide into many small pieces spread throughout the address space. This memory fragmentation reduces the largest block of memory available to a requesting process. If there isn't a block big enough to handle the request, the memory manager may attempt to rearrange the blocks in memory so that the free blocks are joined together in a single, large free block of memory. This technique, called garbage

collection, is a convenient way to maximize memory use. However, there are three problems with garbage collection: performance, contents, and pointers.

The performance issue stems from the fact that to build a large free block of memory, large blocks of (currently used) memory might be moved (which takes a considerable amount of time). The performance problem, however burdensome, pales in comparison to the content and pointer problems. The content problem arises if the memory manager moves a block of memory containing machine instructions that are referenced by other code (via calls and jumps). Those instructions using this code will fail unless the garbage collector fixes the references.

Whenever the memory manager allocates a block of memory to a process, it gives the process a pointer to the allocated block. Then the process uses that pointer to access the block of memory. But if the memory manager moves that block of memory via a garbage collection operation, that pointer will no longer point to its original data.

A simple way to solve the pointer problem is to make the memory manager aware of pointers that point into movable data blocks. Whenever the memory manager needs to move the block, it simply adjusts all pointers that point to the block so that they point into the block at its new location. The only problem with this approach is that the user process might make several copies of the pointer, all of which the memory manager must know and adjust when it moves the block. The

continued

overhead for such a situation can quickly overwhelm the system.

A memory manager can use *handles* to overcome the problem of keeping track of multiple pointers. A handle is a double indirect pointer—that is, a pointer to a pointer to the data. To access a data block, a process loads a temporary pointer variable with the value to which the handle points. The process then uses this temporary pointer to access the desired

data. Now when the memory manager wants to move a block of data around, it changes only the master pointer to the data. The handle that points to the pointer is still valid, as are any copies of the handle (see figure 1). (For a discussion of the Macintosh's handle-based memory manager, see "Macintosh Memory Management" by Alan Anderson on page 249.)

However, handles are not without their own problems. They aren't particularly

efficient. After all, it takes much more time to access a block of data using a handle than it does using a straight pointer. Furthermore, address arithmetic isn't as convenient when using handles as it is when using straight pointers. You can't (safely) copy the pointer into a register and continually increment that pointer to access successive items in an array. A system call may result in a garbage collection operation that may cause the mas-

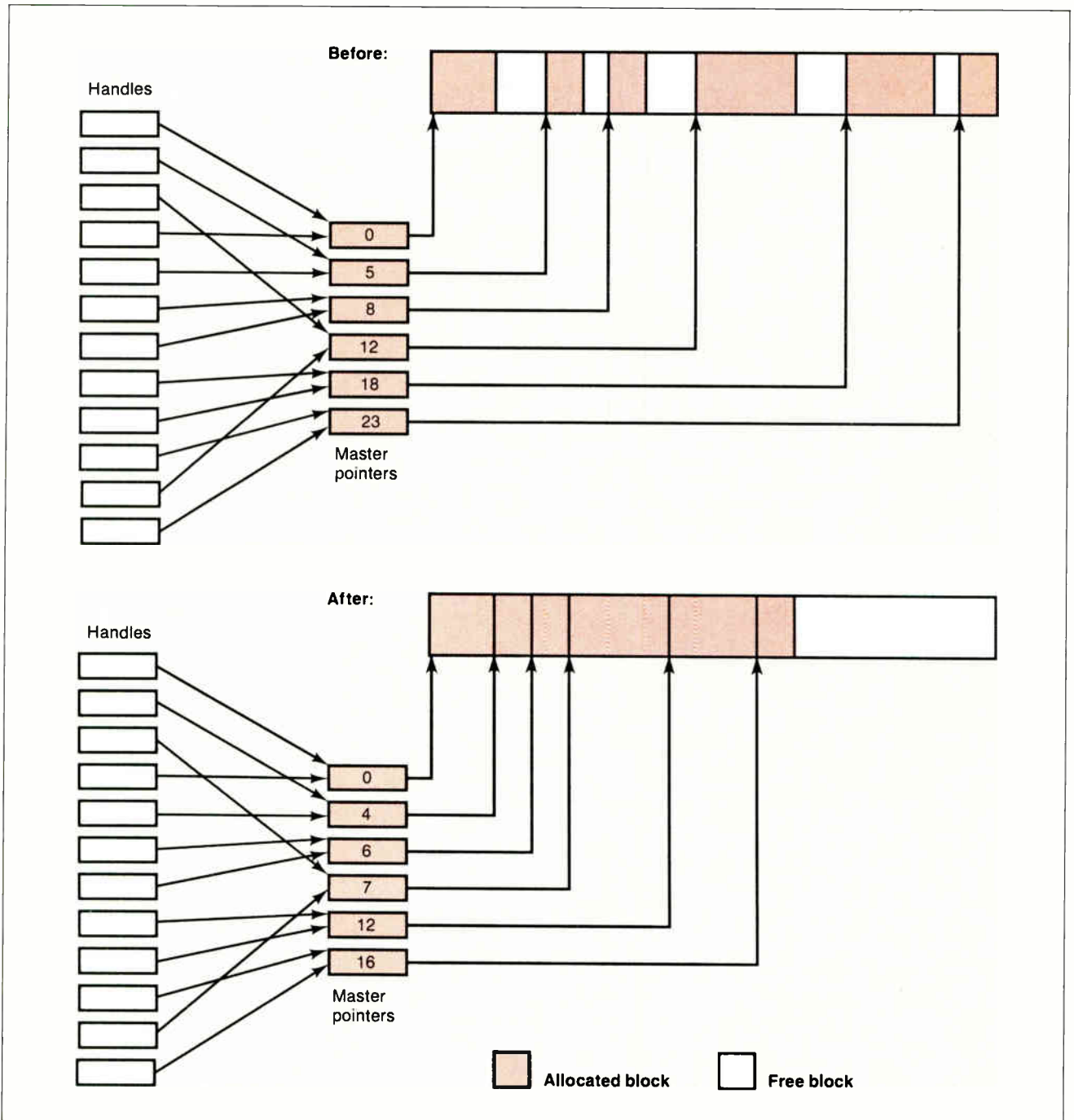

Figure 1: Handles can ease the memory manager's job of moving blocks to free space for allocation requests. The system can change the value of the master pointers without having to change the value of the handle embedded in the user programs.

OVERVIEW

ter pointer (but not your register) to point to a different location. Continuing to use the now invalid register value to access the array may produce unexpected results.

Another disadvantage of handle-based memory managers is their complexity. There's a lot more work involved in using handles than making calls to ALLOC and FREE. On systems like the Atari, Amiga, and IBM PC (under DOS), the memory manager routines may not provide sophisticated garbage collection routines and other amenities, but these systems are easy to use. In fact, most of the memory management routines provided on these systems correspond to those routines provided by high-level languages like C or Pascal.

Finally, it is very difficult to safely implement handles in a true multitasking environment. One process might dereference a handle, but before accessing the specified memory location, a timer interrupt could come along and transfer control to another process. That process might ask for some additional RAM that could force a garbage collection operation. The garbage collection operation could move the data pointed to by the dereferenced handle, rendering the dereferenced handle invalid. When control is returned to the original process, it will reference the incorrect memory location.

The benefits gained by a handle-based system's complexity are easily lost as more and more memory is added to the system. Whereas garbage collection can be quite useful on a system with 1 megabyte or less, as you approach 4, 8, or 16 megabytes of system memory its usefulness declines. With 8 megabytes of system RAM, most processes will be able to allocate all the memory they need. An incredible amount of activity, or a large number of concurrent processes, would be necessary before memory fragmentation would cause a problem.

Bank Switching: A Stoppap Measure

Bank switching is an all-but-obsolete memory management technique used mainly to expand the capabilities of a machine with a limited address space. It is present in systems like the Apple IIe and the IBM PC (via LIM/EMS systems). Bank switching extends the memory space of a processor by assigning several blocks of memory to the same memory address in the processor's address space. Whenever an access to the address range containing these blocks of memory is performed, only one of the blocks responds. The choice of which block responds to the access request is controlled by a bank selection register. By changing this register's content, a program can access different banks of RAM, thereby

providing access to more memory than the processor can directly address.

Bank switching suffers from two major drawbacks. First, controlling the bank selection register(s) is an exercise left to the application programmer. This complicates the program's design and introduces several problems related to program maintenance. Second, accessing the bank registers requires a certain amount of time—time taken away from the program. This results in a performance penalty for programs using bank switching techniques. The penalty can range from mild, for programs that rarely switch banks of memory, to extreme, for those that may have to switch banks between each data access.

Of course, bank switching is preferable to its alternatives: either living with the address space limitations of the processor (impractical for today's high-powered applications) or swapping the data to and from the disk drive (as cumbersome as bank switching and far slower).

Virtual Memory

The best solution in a multiprogramming/multitasking environment is a virtual memory manager. With a virtual memory manager, the process can assume that the entire logical address space is available; the process need not make explicit memory manager calls.

Paging and **segmentation** are the two main virtual memory techniques in use. Paging uses a fixed-size allocation scheme; segmentation uses variable-size blocks. In paging systems, the entire address space is partitioned into equal-size blocks, which are given to a process upon request. Internal fragmentation results when the process does not use the entire block. With segmentation systems, because the programmer can specify the size of the block, there is little waste due to internal fragmentation; but external fragmentation occurs when blocks of available memory, scattered throughout memory, accumulate because they are too small to fill an allocation request.

Whenever the process accesses a memory location not currently in memory, the hardware signals that a fault has occurred, and the memory manager maps in a free page (or segment) for use by the process and returns control. If there aren't any free pages or segments of memory available, the memory manager attempts to free up some memory by writing used blocks of data to disk and allocating that memory to the process. It then swaps these blocks back in if the process that owns them needs to access them.

Generally, the programmer need not be concerned with the details of memory

continued

The best Modula-2 compilers for PCs and compatibles

Taylor Modula-2

The professional high-performance compiler for PCs: the fastest compiler in the world!

- **unrivalled speed of compilation**
7,000–10,000 lines per minute (80286, 8 MHz).
- **excellent code**
Mini-computer standard global optimisation. Code performs 1580 Dhrystone tests per second! (80286, 8 MHz)
- **ultra-compact**
high code density and a library of unrivalled compactness (23 modules in a total of 13K!)
- **completely standard implementation**
Follows N. Wirth's standard for Modula-2. BIOS independent – uses MS/PC DOS exclusively.
- **easy to use**
Straightforward user interface. Comprehensive documentation for system programmers.
- **Guarantee and support**
One year guarantee. Maintenance contracts available. Swiss quality product.

**TaylorModula-2
Demo disk**

**\$ 900
\$ 10**

M2SDS

\$ 99

The professional Modula-2 software development system M2SDS comprises the following features in an easy-to-use window environment:

- modern, syntax-driven editor
- fast compiler
- linker producing EXE programs
- unique library manager
- comprehensive standard library

There are a vast number of tools, toolboxes, demo disks, public domain programs and books for M2SDS – probably more than for any other development system! M2SDS was used for the writing of the Farsight integrated business software package!

Demo disks

\$ 10

JPI-Modula-2

\$ 149

A reasonably-priced Modula-2 compiler with a configurable environment, integrated Make function and highly optimising code generator.

We have Modula-2 compilers for the Amiga, HP9000/300, IBM/370, OS-9 and Sun. The list is constantly growing!

Texas residents add 8% sales tax. International Orders add \$ 20 shipping.

The Modula-2 people:

**INTERFACE
TECHNOLOGIES**

3336 Richmond, Suite 323
Houston, TX 77098-9990 (713) 523 8422

Dealer inquiries welcome

International

Austria: 0222/4545010

Belgium: 071/366133

France: 20822662

Italy: 02/405174

Scandinavia: +45/3/512014

Switzerland: 01/9455432

United Kingdom: 01/6567333

Germany: 02983/8337;

0731/26932;

0821/85737;

04106/3998;

0531/347121



A. + L. Meier-Vogt
Im Späten 23
CH-8906 Bonstetten/ZH
Switzerland
Tel. (41)(1) 700 30 37

management; there are, however, certain data structure considerations that will affect performance in paging systems. For example, languages such as Pascal and C store elements of an array in row major order. Other languages, such as FORTRAN and certain dialects of BASIC, store array elements in column major order. By knowing the orientation, the programmer can reduce page faults tremendously by using array indexes that follow the storage order.

A simple paged memory management system is easy to implement in hardware. A set of page registers intercepts certain address bits from the CPU and translates these bits to a different value via a lookup table. This lets the system remap memory as desired. Figure 2 illustrates this remapping function. In this example, the

CPU supports 16 address lines. The lower 13 address lines are passed, unchanged, to the memory modules. The upper 3 bits are used as an index to select the appropriate page register. The 13 address lines, passed directly to the memory module, determine the page size—in this case, 8K bytes.

Operating systems can use paging schemes to extend the addressing range of a CPU in addition to remapping the address space. A CPU with a 16-bit address bus can be expanded to a 24-bit address bus with 256 16-bit page registers. The upper 8 bits of the logical address are fed into the page register array. Each page register is 16 bits long, and the 16-bit output is combined with the 8-bit offset (the lower 8 bits of the logical address) to yield a 24-bit physical address. This

scheme uses a page size of 256 bytes. The page size is determined by the number of bits passed directly from the CPU to the memory module.

Paging systems, however, suffer from a few drawbacks. Manipulating page registers can be time consuming. The examples presented thus far use a 16-bit logical address. To use a 24-bit address bus with a 256-byte page size, the page registers will consume 128K bytes. Since the operating system must save and reload the page register values every time it transfers CPU control to a different process, a considerable amount of time will be required just to save and load the page registers. Furthermore, those 128K bytes have to be fast, and that means expensive.

For larger systems, most paging schemes use page table pointers, which point to page register values in main memory. These pointers usually take the form of a small associative cache memory that keeps the most recently used page register values. Main memory access to the page table adds 5 percent to 10 percent overhead, depending on the size of the page register's on-board cache. For example, the National Semiconductor 32082 MMU maintains a 32-entry associative cache on-board and refers to main memory when a memory access cannot be translated with on-chip data. The 32532 CPU with MMU provides a 64-entry cache. The Motorola 68851 operates similarly, providing 64 entries in the associative cache.

To reduce the amount of fast storage required for page tables, the operating system can use larger page sizes. For a 64K-byte page size, for example, it would need only 256 page registers to remap up to 16 megabytes of memory. Unfortunately, memory must be allocated in integral page sizes. A process requesting 32

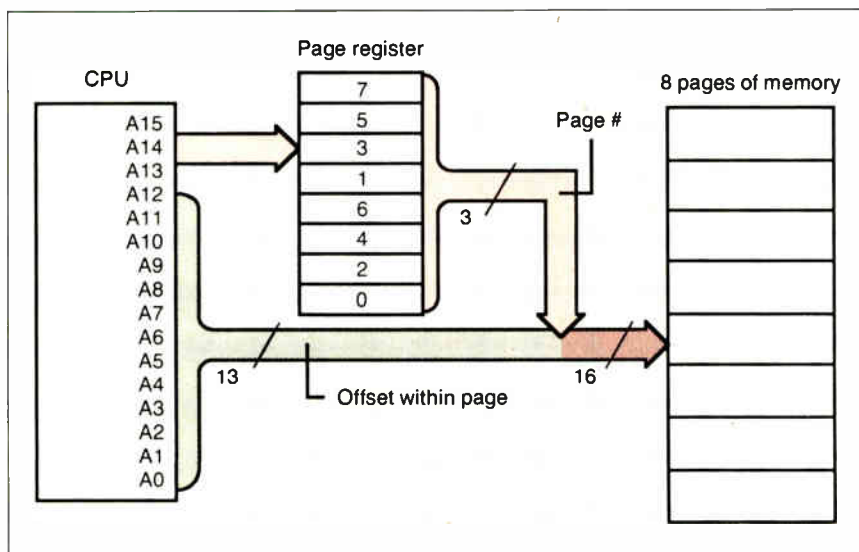

Figure 2: Example of a paging system that uses 3 bits of the CPU's 16 address lines as an index into the eight 8K-byte memory pages.

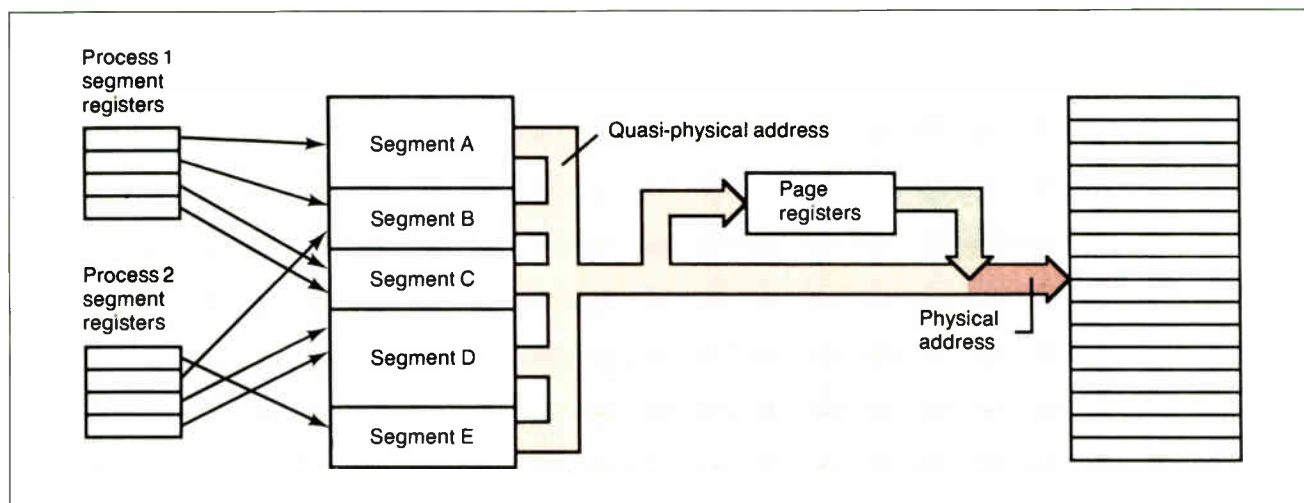

Figure 3: A hybrid segmentation/paging system tends to reduce both internal and external fragmentation.

OVERVIEW

additional bytes would be allocated a 64K-byte page. Increasing the page size decreases the number of page registers required; however, it also increases the amount of waste due to internal fragmentation.

The National Semiconductor 32082 MMU chip allocates memory in 512-byte pages. The National 32532 CPU chip, which includes an on-chip MMU, uses 4K-byte pages. The Motorola 68851 chip lets the system designer select from various page sizes (e.g., 512, 1024, 2048, on up to 32K-byte), although you can employ only one page size at any given time. This lets you decide about compromises between internal fragmentation problems and large page table sizes.

Segmentation

Segmentation eliminates the need for an expensive bank of page registers. Intel's 80x86 and Zilog's Z8000 families use segmentation techniques. Segmentation is unique in the sense that its effects are visible in both the logical and physical address spaces. Segmented addresses consist of a segment component and an offset component, usually specified by segment:address. "Segment" represents the name of some block of storage, and "address" specifies an offset into that block. (For a discussion of a segmented memory manager, see "OS/2 Virtual Memory Management" by Vic Heller on page 227.)

The advantage of segmentation over paging lies in the way programs are organized. Most programs deal with only two distinct items: code and data. Data can be further divided into categories (e.g., static data, dynamic data, stack data, shared data, and constants). Segmentation works on the principle that a program will need to access only a limited number of items at one time. Even in the extreme example above, only six different items (the code segment and the five data segments) need be accessed at once.

In a segmentation system, you need a segment register for each concurrently referenced data segment. For the six items listed above, only six segment registers are required to provide complete access. Compare this to the 65,536 page registers required in a system with a 24-bit logical address and a 256-byte page size. Segmentation, therefore, is not only more sophisticated than paging mechanisms (by adding two component logical addresses), but more economical as well.

Segmentation is actually a powerful concept that has been given a bad name by Intel's earlier processors (pre-80386). Due to Intel's implementations, most people associate segmentation with a 64K-byte addressing limit. This is a limi-

tation of certain Intel processors because they allow only a 16-bit offset as part of the segmented address. The 80386 corrects this problem by allowing a 32-bit offset associated with each segment value. (For an example of an operating system that uses the memory management facilities of the 80386, see "Marrying Unix and the 80386" by Carl Hensler and Ken Sarno on page 237.)

Sharing Memory

Besides supplying all the memory a process requests, memory management coordinates access to shared data between two or more processes. This could be something as simple as two users sharing the same copy of a compiler or editor in memory, or as complex as shared data structures for communication between multiple processes (e.g., cutting and pasting between two applications). Data sharing presents many challenges to the memory manager designer, as well as to the application designers exploiting these features.

In a paging system, if two processes need to share a page of memory, a page register for each process points to the page they need to share. The major problem with data sharing in paged-memory systems concerns the use of pointers. A pointer stored in a shared data structure may not point to the same item in the address spaces of both processes sharing that pointer. The only solution is to ensure that the data which a shared pointer references is also shared and lies at the same logical address in both processes.

Segmented systems don't have a problem with pointers. Since a segmented address consists of two components, a segment and an offset within that segment, a pointer containing these two elements provides all the information needed to access data anywhere in memory.

Paging schemes have two major drawbacks: the large size of the page table required for each process (which must be stored in main memory, further degrading performance) and the problem with shared data structures. Segmentation systems suffer from external fragmentation. Using a hybrid segmentation/paging scheme can solve these three problems.

This system appears as a segmented system to the software. Once the segmentation hardware generates a "quasi-physical" address, it then passes this address through a set of page registers to produce the true physical address (see figure 3). To the software, this system looks like a pure segmentation system, so all the advantages of segmentation apply. The paging hardware eliminates segmentation's big problem: external fragmentation. The

continued

Tools and Toolboxes

Modula-2

Applications Generator

Amadeus \$ 395
Generate Modula-2 programs directly from your own input, and save yourself hours of coding!

Graphics

M2Graph* \$ 65
Controls Hercules cards in Modula-2.

M2EGA* \$ 65
Controls EGA cards in Modula-2.

Modula Graphics Toolbox I* \$ 112
A collection of extremely fast graphics routines for CGA cards written in Modula-2.

Modula Graphics Toolbox II* \$ 188
Comprehensive package of Modula-2 procedures for all currently available graphics cards. Includes graphics window system, font generator, sprite handler, mouse driver, maths routines, as well as pie chart, histogram and line graph functions etc.

Input/Output

LCR-Window Manager* \$ 133
Fast, compact window system.

M2Windows* \$ 188
Fast, professional window system. Small, high-performance library with integrated menu system and simple mask generator.

Modula Mask & Menu Generator* \$ 360
Development system for creating masks and menus in Modula-2 source code. Mask, menu and frame editor. Supports all colours and attributes.

Other Tools

M2 Prolib \$ 495
The professional library

B-Tree ISAM \$ 290
Ultra fast database

Pascal-Modula Converter \$ 59
Converts Turbo-Pascal to Modula-2.

RTA-Utility Disk \$ 30
2-10x faster I/O, extended MathLib.

EMS-Utilities* \$ 188
Make full use of your Megabytes of memory expansion.

M2IEEE-Interface* \$ 144
Modula-2 interface to National Instruments IEEE Interface.

This is only a small selection from our comprehensive list of tools for Modula-2. Demo disks are available for products marked with an asterisk. Send \$ 10 for three demo disks, \$ 20 for seven. There is also a wide choice of books and literature on Modula-2.

We have Modula-2 compilers for the Amiga, HP-DX, IBM-PC, PCs, Taylor, M2SBS, HP-11, OS-9 and Sun. The list is continually growing.

The Modula-2 people:

INTERFACE TECHNOLOGIES

3336 Richmond, Suite 323
Houston, TX 77098-9990 (713) 523 8422

Dealer inquiries welcome

International	
Austria: 0222/4545010	United Kingdom: 01/6567333
Belgium: 071/366133	Germany: 02983/8337;
France: 20822662	0731/26932;
Italy: 02/405174	0821/85737;
Scandinavia: +45/3/512014	04106/3998;
Switzerland: 01/9455432	0531/347121

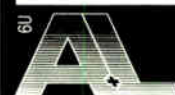

A. + L. Meier-Vogt
Im Späten 23
CH-8906 Bonstetten/ZH
Switzerland
Tel. (41)(1) 700 30 37

paging hardware remaps unused segments to a contiguous memory pool for use by other processes. Even though paging is used, there aren't any problems with data sharing since pointer addresses refer to the segmented addresses rather than physical addresses.

Placement and Replacement

Regardless of how a process requests memory, the virtual memory manager's job is to provide the memory. The memory manager usually keeps track of free memory with a bit map or a linked list. With the fixed-size allocation blocks of a paged system, placement and replacement algorithms are very easy. Any block in memory can be remapped to any address. However, for segmentation and software-only schemes, the requested block of memory can be placed only in an area of memory currently unoccupied. If two or more such areas are free, then the memory manager must choose (using some algorithm) which free block to allocate for the request.

A placement algorithm selects a free block in memory for a given request. Some well-known placement algorithms are first-fit, best-fit, and next-fit. First-fit allocates the first available block large enough to satisfy the request, best-fit allocates the block closest in size to the request, and next-fit allocates the next available block large enough to satisfy the request.

The diagram in figure 4 shows a list of free and allocated memory blocks. The last block allocated was 14K bytes from a 22K-byte block, which left an 8K-byte

fragment. If a process needs to allocate a 16K-byte block, then the first-fit algorithm selects the first available block that satisfies the request, starting at the beginning of the memory pool. The best-fit algorithm also starts its search at the beginning of the list and selects the block closest in size to 16K bytes. The next-fit, however, will start its search at the point where the last block was allocated and select the next available block of sufficient size.

As it turns out, the first-fit algorithm is not only the simplest but usually the best and fastest as well. The next-fit algorithm produces slightly worse results than the first-fit. The next-fit algorithm produces more external fragmentation than the first-fit because it always starts at the last block allocated and seeks the first available block (of sufficient size) beyond that point. The result is that the largest block of free memory, which usually appears at the end of the memory space, is quickly broken up into small fragments.

The best-fit algorithm produces results inferior to the next-fit. Because the best-fit always searches for the smallest possible block to satisfy the current request, this algorithm also guarantees that the amount of memory left over after the allocation occurs is as small as possible. Each memory request always wastes the smallest amount of memory; main memory is quickly littered by blocks too small to satisfy memory allocation requests.

In a virtual memory system, the memory manager often encounters a situation where one process is requesting a block too large to fit into memory. Since there

is insufficient storage for the request, the memory manager must make room for the request by writing certain blocks of data to disk, thereby freeing those blocks to satisfy the current request. Replacement algorithms decide which blocks of memory can be swapped out.

A poor choice for the replacement algorithm may cause *thrashing*, a situation where the system may spend more time swapping blocks in and out of memory instead of operating on the data therein. To reduce this possibility, the replacement algorithm should select a block that won't be accessed for a considerable amount of time. The optimal-replacement algorithm holds that the best block to choose is the one that will be accessed the farthest in the future. Unfortunately, in most systems the order in which the blocks will be allocated is not known.

The least recently used (LRU) algorithm is a good approximation of optimal replacement. It is based on the assumption that the likelihood that a process will access a block is usually inversely proportional to the amount of time that has passed since the last access. Temporal locality is where blocks (or groups of blocks) tend to be accessed in widely spaced bursts rather than in evenly spaced intervals. Therefore, if a block hasn't been accessed in a while, it is a good tip-off that it won't be used for quite some time.

Unfortunately, the LRU is too expensive to implement (in hardware or software) because each memory access requires a "time tag" to be written to a descriptor for that block. Whenever a block must be replaced in memory, the system must locate the oldest time tag and replace that block. Such operations involve considerable hardware and software overhead, so the LRU replacement algorithm is rarely used.

A slight modification of LRU is the not recently used (NRU) replacement algorithm. This algorithm classifies blocks into four categories based on memory references (R) and modifications (M). A memory reference is any access (read or write) to a memory location. A memory modification occurs when that location is written to. Based on these two operations, the following table rates them according to their "replaceability":

- 0: not referenced, not modified (___)
- 1: not referenced, modified (___M)
- 2: referenced, not modified (R__)
- 3: referenced, modified (RM)

(Class 1 occurs when a time-out operation resets the referenced bit).

The NRU algorithm picks a block of memory, at random, from the lowest-

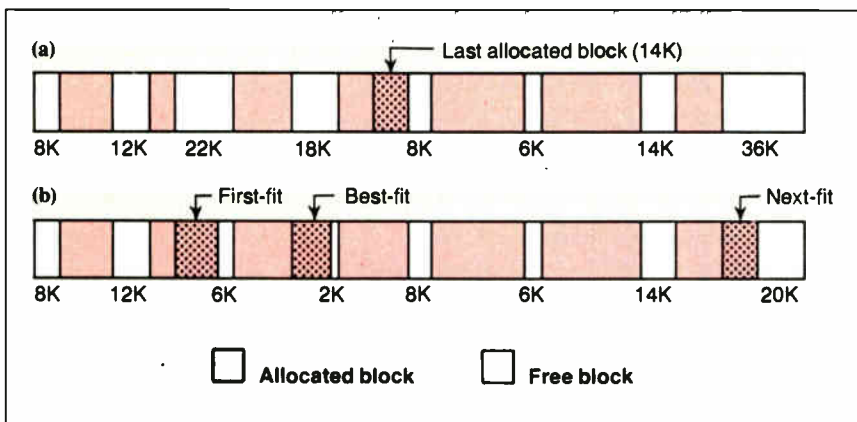

Figure 4: (a) A typical memory configuration after several allocation and deallocation operations. The last allocated block was a 14K-byte block from a 22K-byte free block. (b) The difference between the first-, best-, and next-fit placement algorithms in satisfying a 16K-byte allocation request. First-fit will allocate 16K bytes from the 22K-byte block, leaving a 6K-byte block free. The best-fit will search the entire list looking for the closest fit; it will leave a 2K-byte block free, which is too small for most processes to use. The next-fit will start looking from the last allocated block. Often, it will break up the large blocks of memory that tend to be found at the end of memory.

OVERVIEW

numbered class and swaps that block to disk. The algorithm offers reasonable performance with very little hardware overhead. It is best if hardware maintains the M and R bits; otherwise, the memory manager would have to execute many instructions for each user instruction that accessed memory. The National Semiconductor MMU chips, for example, provide hardware to support the NRU algorithm. The NRU algorithm is relatively easy to implement in hardware (it need handle only two additional bits) and doesn't place as much of a demand on the software as the LRU algorithm.

Other popular replacement algorithms include FIFO and first-in/not-used/first-out (FINUFO). The FIFO algorithm keeps all the blocks in the system in a queue. Whenever a block must be replaced, the FIFO algorithm replaces the block at the front of the queue and then moves that block to the tail of the queue. The FINUFO algorithm is similar, except that every time a block is accessed, it is moved to the end of the queue. Replacement blocks are still taken from the front of the list and added to the end once they are swapped. The FINUFO algorithm tends to congregate often-accessed blocks at the end of the queue so that they are rarely swapped out of memory.

In the simplest virtual memory system that uses paging, a process begins without any of its pages in memory. As soon as the CPU attempts to execute the first instruction, it will access a memory location not present in real (as opposed to virtual) memory. This will cause a page fault, requiring the memory manager to load the page containing the first page of the program. With each memory access outside this first page, or when the program "falls" into the next page, the memory manager loads the appropriate page of memory. This is called "demand paging" because pages are swapped in and out on demand.

Demand Paging

Usually, processes do not access many different pages in memory. Rather, most programs exhibit a locality of reference. During any point in the execution of the program, it will access only a small number of pages. The set of pages in use by a program at any given time is called its *working set*. In a demand-paged model, it may take 20 or more page faults before a process's working set is present in memory. Since the overhead associated with a page fault is rather high, the performance of the entire system is degraded. Many high-performance memory managers attempt to keep track of a process's working set. Whenever a process is swapped into memory, the memory manager at-

tempts to load the entire working set. This working set model (also called pre-paging) reduces the system overhead considerably.

In a virtual memory system employing segmentation, entire segments (rather than pages) are usually swapped in and out of memory. The principle of locality applies to segments as well. At any time, a process will access only a couple of segments. Since a code segment typically contains many more instructions than a page, and a data segment usually contains much more data than a page, thrashing is not as much of a problem with segmentation. In fact, swapping in an entire segment is a form of pre-paging.

Nevertheless, the working set model applies to segmentation systems as well as to paging systems. At any given time, the process accesses a certain set of segments. These segments form the working set for that process at that particular time. The virtual memory manager, to ensure the highest performance, should attempt to load the working set of segments for a process when it is being swapped into memory. Segmentation's benefits work against it as well. Although loading a segment is a form of pre-paging, segmentation suffers from the fact that segments are usually much larger than pages and hence take more time to swap to and from the disk.

Trend Toward Virtual Memory

Most microcomputer systems rely on software solutions to the memory management problem. They coordinate the use of allocated and deallocated blocks of memory, but most leave protection constraints to the individual programs.

Within 5 years, most (new) computer systems will routinely incorporate memory management hardware. Operating system designers will be able to provide virtual memory easily. The choice will be between segmentation, paging, or a hybrid segmentation scheme.

The trend in hardware is toward powerful on-chip hardware MMUs. Currently the 80386, 32532, Fairchild Clipper, and 68030 CPUs all provide sophisticated hardware memory management. In a few years, most personal computers (since they will be using chips such as these) will support hardware memory management and virtual memory. Today's complex software memory allocation and deallocation schemes will give way to systems in which memory management is totally transparent to the programmer. ■

Randall L. Hyde (Genest Technologies, Santa Ana, California) received his MS and BS in computer science from the University of California, Riverside.

A new concept in managing

Megabytes

of memory

IX-BoX*

Have you ever spent hours

- searching for a letter which you know exists, but can't seem to find?
- looking for an address which you can only remember half of?
- tracking down a variable which was initialised somewhere in your programs, and which is now causing them to crash?
- rummaging through your ultra-modern database, simply because you omitted to define a simple key field when setting it up?
- searching your literature index for an urgently needed article?
- looking and looking, but without success?

Then we can help! IX-BoX will instantly find all your correspondence, addresses, programs, entries, summaries - in fact, anything and everything stored on your computer. IX-BoX delivers the document you require in seconds, and you can carry out any necessary changes to it using the built-in editor. What more could you possibly need?

IX-BoX is much more than a simple **information retrieval system**, yet it only costs **\$ 275**

Demo disk costs

\$ 10

* IX-BoX is a trade mark of Snark AG, Zürich.

Farsight

Once you've used the Farsight integrated software package, you'll know the fun of working with and exploiting Megabytes of memory.

Window manager, word processor and spreadsheet together cost only **\$ 99**

Graphics **\$ 29**

Texas residents add 8% sales tax. International Orders add \$ 20 shipping.

The Modula-2 people:



INTERFACE TECHNOLOGIES

3336 Richmond, Suite 323
Houston, TX 77098-9990 (713) 523 8422

Dealer inquiries welcome

International

Austria: 0222/4545010

Belgium: 071/366133

France: 20822662

Italy: 02/405174

Scandinavia: +45/3/512014

Switzerland: 01/9455432

United Kingdom: 01/6567333

Germany: 02983/8337;

0731/26932;

0821/85737;

04106/3998;

0531/347121



A. + L. Meier-Vogt
Im Späten 23
CH-8906 Bonstetten/ZH
Switzerland
Tel. (41)1 700 30 37

Silicon Specialties

1-800-634-0402

\$435



FEDERAL EXPRESS
FREE
AIR EXPRESS SHIPPING
You Pay the Ground
We Pay the Air



256K on Mother Board, 300K Brand Name Floppy Drive, 135 Watt Power Supply, Slide Case, AT Style Keyboard, 4-10 MHz Clock Speed, (Keyboard Selectable), 8 Expansion Slots.

Hardware

DISK DRIVES

Bernoulli Box	
10 Meg	\$ 865
20 Meg	1260
40 Meg	1605
Seagate	
20 MG w/WD Controller	290
251-1	469

COMPUTERS

AST	
Model 80	\$ 1509
Model 120	2130
Model 340	4185
Model 390	5695
NEC	
Multispeed	1375
Multispeed EL	1609
Toshiba	
T-1000	785
T-1100 Supertwist	1370
T-3100	2799
T-3120	3068
T-3200	3714
AT & T New	Call
Sharp New	Call
4501	698
4502	1250

Alps

All models	Call
AST	
Turbo Lazer	\$2829
Brother Printers	Call
Citizen Printers	Call
120D	169
180D	160
MSP 40	260
MSP 45	415
MSP 50	355
MSP 55	450
Other Models	Call
Diconics	
150	299
300	480
Epson Printers	Call
Hewlett-Packard	
Laser Jet Series II	1775

MONITORS

Amdek Monitors	Call
NEC	
Multisync II	\$ 549
Multisync Plus	Call
Other Models	Call
Princeton Graphics Monitors	Call
Princeton Ultrasync	489
Sony Multiscan	\$-065
Mitsubishi Diamond Scan	\$ 489
Zenith 1490	615

PRINTERS

NEC	
Scientwriter	850
P-6	425
P-7	615
P-9	1035
Okidata Printers	Call
Panasonic	
1080I Model II	169
1091I Model II	190
1524	535
1595	460
Lazer P4450	1635
Other Models	Call
Star Micronics	Call
Toshiba	
321 SL	499
341 SL	465
351 SX	979

HARD CARDS

Plus 20 MEG	\$ 539
Plus 40 MEG	775
Mountain	Call
Everex Tape Back-up	Call

MODEMS

Hayes	
All Modules	Call
Prometheus	
1200B	90
2400 B New	129
Other Models	Call
US Robotics	
Password 1200	149
Courier 2400	299

BOARDS

AST	
Hot Spot	\$ 330
Six Pack Plus	109
Other Models	Call
ATI	
EGA Wonder	175
VGA	265
VIP VGA	265
Hercules	
Color Card	145
Graphics Card Plus	175
Intel	
In Board 386	719
PC 1010	115
4020	299
Inboard 386 w/cable	1005
Intel 386	719
Orchid	
Turbo EGA	449
Jet 386 Accelerator AT	829
Tiny Turbo 286	399
Paradise	
5 Pack	99
Autoswitch	Call
VGA - New	239
VGA Professional New	355
Video-7	
VGA	288
Vega Deluxe	195

Software

SPREADSHEETS

Cambridge Analyst	\$ 55
HAL	89
Lotus 1-2-3 Ver 2.01	295
MS Excell	285
Multiplan 3.0	Call
Quotation	Call
PFS Pro Plan	52
Supercalc 4	269
Twin Classic	32
VP Planner Plus	82

LANGUAGES

C Compiler (Microsoft)	Call
Fortran Compiler (Microsoft)	Call
Macro Assembler (Microsoft)	Call
Ryan McFarlan Fortran	\$339
Ryan McFarlan Cobol	539
Pascal Compiler (Microsoft)	Call
Quick Basic 4.0	Call
Turbo C	58
Turbo Jumbo Pack 3.0	159
Turbo Pascal 4.0	58

PROJECT MANAGEMENT

Harvard Total Project Manager II	\$ 309
Microsoft Project 4.0	Call
Super Project Plus	269
Timeline 2.0	259

INTEGRATIVE SOFTWARE

Ability Plus	Call
Enable 2.0	352
Framework II	309
MS Works	Call
PFS 1st Choice	72
Smart Software System	Best Price
Symphony	439

GRAPHICS/MICE

Chartmaster	\$199
Diagram Master	185
Generic CAD w/Dot Plot 3.0	72
Harvard Graphics 2.1	239
IMSI Mouse w/Dr. Halo III	88
In-A-Vision	259
Logimouse	65
Logimouse w/paint	89
Microsoft Buss Mouse 1.0	Call
Microsoft Chart 3.0	Call
Microsoft Serial Mouse 1.0	Call
News Room	30
News Room Professional	65
PC Buss Plus Mouse (New Ver.) w/paint	83
PC Mouse (New Ver.) w/paint	83
Printmaster	29
Print Shop	32
Signmaster	132
Turbo Graphix Tool Box	38
Windows Draw!! w/c/p art	159

DATA BASE MANAGEMENT

Clipper	\$ 368
dBase III Plus	374
DB-XL	79
Eureka	88
Fox Base Plus 2.0	185
Genifer	188
Nulshell	75
Paradox 2.0	Call
PFS: Professional File	111
Q & A	185
Quickcode Plus	138
QuickReport	138
Revelation	459
R-Base System V	399
Reflex	78
VP Expert	Call
VP Info	Call

ACCESSORIES

Copy II Option Board	\$ 72
Masterpiece	84
Masterpiece Plus	93
Masterpiece Remote	107
MousePad by MouseTrac	9
Summasketch 12x12 Plus	369

ACCOUNTING

BPI-G/L A/R, A/P, Payroll	\$165 ea.
Computer Associates	Call
DAC Easy Accounting	Call
One Write Plus 2.0	Call
Time Slips	69

TRAINING

Flight Simulator	Call
MS Learning DOS	Call
PC Logo	\$ 79
Turbo Tutor II	23
Typing Instructor	27
Typing Tutor IV	27

WORD PROCESSORS

Microsoft Word 4.0	\$185
Multimate Advantage II	249
PFS: Professional Write	102
Volkswriter 3	132
Volkswriter Deluxe Plus	59
Webster New World Write	55
Webster Spell Checker	32
Webster Thesaurus	39
Word Perfect	Call
Word Perfect Executive	Call
Word Perfect Library	Call
Wordstar Pro Pack 4.0	205
Wordstar 2000 Plus 3.0	189

DESKTOP PUBLISHING

Newsmaster	\$ 48
Pagemaker	442
PFS: First Publisher	52
Ventura Publishing	Call

MONEY MANAGEMENT

Tobias Managing Your Money 4.0	\$114
Dollars & Sense w/Forecast	92



No Charge for VISA and MasterCard
We Do Not Charge Your Card Until Your Order is Shipped
You Pay the Ground Shipping - We Pay the Air
Ground Shipping & Handling \$6.00
Free Air applies ONLY to orders up to 10 lbs. & Over 550
All product carries a manufacturer's warranty. All
Guarantee, rebates, trial period privileges & promotional
programs are handled by the manufacturer only.

No APO, FPO or international orders, please
Call before submitting P.O.'s Ask for National Accounts
Personal and Company Checks Will Delay Shipping 3 weeks
Prices, Terms & Availability Subject to Change Without Notice
Add 5% for C.O.D. Orders
We Do Not Guarantee Machine Compatibility

Mailing Address:
8804 N. 23rd Avenue, Phoenix, Arizona 85021
To place an Order 1-800-634-0402
To follow up on an Order (602) 944-2552
Order Line Hours: Mon-Fri 7a.m.-6p.m.
Saturday 9a.m.-1p.m.
Order Processing Hours (602) 944-1037
10a.m.-3p.m. Mon-Fri

Circle 251 on Reader Service Card for MS DOS Products. (All others: 252)

OS/2 Virtual Memory Management

How OS/2's hardware and software data structures work together to provide virtual memory, dynamic linking, and sharing of code

Vic Heller

MICROSOFT OS/2 MEMORY management takes advantage of the 80286's fault-handling capability to support segment-based virtual memory. Programs link dynamically at load time or run time or both to library modules for system services; independent software packages can use dynamic-link library (DLL) modules to share code and data used by multiple related applications. I'll give an inside look at the design of OS/2's memory manager version 1.1 as an example of segmented virtual memory management.

Providing the virtual memory, as well as the dynamic linking and sharing of code between tasks, requires some carefully thought out data structures. The 80286 supplies hardware support for protecting tasks from each other, but we also need to keep track of allocated and unallocated memory and the status of a task's segments (e.g., present, swapped, discarded, or allocate on demand (AOD)). We need to be able to find a segment that is not present. If there isn't enough physical memory for an allocation request, the memory compactor must be able to determine whether it can move segments around to make room, or if it will have to discard or swap some segments out of memory. Providing the ability to share data among tasks adds another dimension to the complexity of the system. I'll look at the data structures OS/2 uses and explain how they work together.

Figure 1 shows OS/2's hardware and software data structures. Each task has a per task data area (PTDA) created by OS/2. Every executable or DLL file has a module table entry (MTE) as part of its

header. The operating system reads the MTE into memory when it loads a program or library module. The PTDA contains data global to the task (local descriptor table (LDT) information, thread count, and so on) and some data specific to each thread of execution within the task (current register contents and so forth); the MTE contains each segment's size, location in the file, and other type information. The system uses the PTDA to locate a single descriptor that maps a segment so it can be edited when the state changes. The system uses the MTE to find the executable or DLL file information so it can find and read the segment contents into memory.

The 80286 hardware provides each task with an array of segment "descriptor" structures (LDT) to restrict each task's access to those segments the operating system allows. A valid descriptor entry contains a user segment's physical address, size, and access rights (read/write/execute). The operation of placing a selector into a segment register causes the 80286 hardware to use the selector to index the LDT, fetch the corresponding LDT descriptor, and allow access and limit checking during each subsequent memory reference. Figure 2 shows an LDT entry (descriptor), along with the format for a selector and the segment registers with their hidden descriptor cache.

The LDT descriptors work closely with two software data structures: the physical arena and the handle table. In fact, starting with any one of these structures, the system can find either one of the others.

The physical arena is a list of headers that keeps track of all available physical memory by linking free and allocated blocks of memory. A header holds a segment's handle, owner, and last detected access time (time stamp). The handle table holds more permanent information that the system must have when a segment is not present in the physical arena—information such as the segment's selector, owner, swap ID, and state.

The 80286 provides an accessed bit in each descriptor that assists the operating system in choosing which segments can be swapped out or discarded. The hardware sets this bit whenever it accesses the corresponding segment. On the order of once per second, OS/2 examines and clears these bits, and updates the physical arena time stamps for each accessed segment. When physical memory becomes scarce, OS/2 builds a simple ordered list of the segments, with the oldest time stamps first. This list is rebuilt when it is exhausted (all its entries are discarded or swapped) or when significant physical arena changes take place.

The compactor uses the handle table and owner to modify the descriptor and handle states of segments that it moves, swaps, or discards. When a segment is not present, the handle state tells whether the segment is swapped, discarded, AOD, or in transition (being swapped or moved), and part of the handle table's address field is used to identify the owner. If the segment is swapped out, the address field also contains the swap ID. A swap ID indexes the swap control table

continued

(SCT), which tells where the segment is located in the swap file. When the state of a segment is discarded or AOD, the system uses the owner ID to locate the MTE, which contains information about where to find the segment contents.

When the system swaps out or discards a segment, it moves the segment's owner into the handle table, and the handle is stored in the LDT descriptor's address field. If a descriptor's access is marked "not present," the hardware does not depend on the contents of the address field, which lets OS/2 overlay the address field with the segment's handle.

Dynamic Linking and Sharing

Executable and DLL files have relocation records that encode internal and external references that OS/2 must resolve when it loads the files. Because the system allocates selectors for each segment defined by an executable or library module when a module is loaded, internal segment or far pointer references are not resolved at link time; they must be resolved at load time. Because DLL modules can be individually replaced, all external references to library modules must also be resolved at load time.

Segments can share their virtual addresses, their contents, or both. Each LDT has separate shared and private selector regions. Selectors that map to descriptors in the private region are called private selectors; those that map to descriptors in the shared region are called shared selectors. Figure 3 graphically depicts the difference between the two.

Private and shared selectors are interleaved to allow for the smallest possible LDT size (see figure 1). The selector type is independent of whether the segment contents are shared; table 1 shows the four possible combinations of shared and private memory.

Figure 1: The hardware and software data structures that OS/2 uses. This example shows the state of three segments in the task EXE1. Segment A is an example of an EXE file code segment that is currently discarded. Notice it uses a private selector, and the handle table entry shows that segment A's owner is EXE1's MTE. Segment B is currently swapped to disk and has a shared selector. The owner of segment B is EXE1's PTDA. Segment C is present in memory and has a private selector. Since it is present in memory, its physical arena header points to its owner, EXE1's PTDA. Notice the shared and private segment descriptors are interleaved in a 3-to-1 ratio.

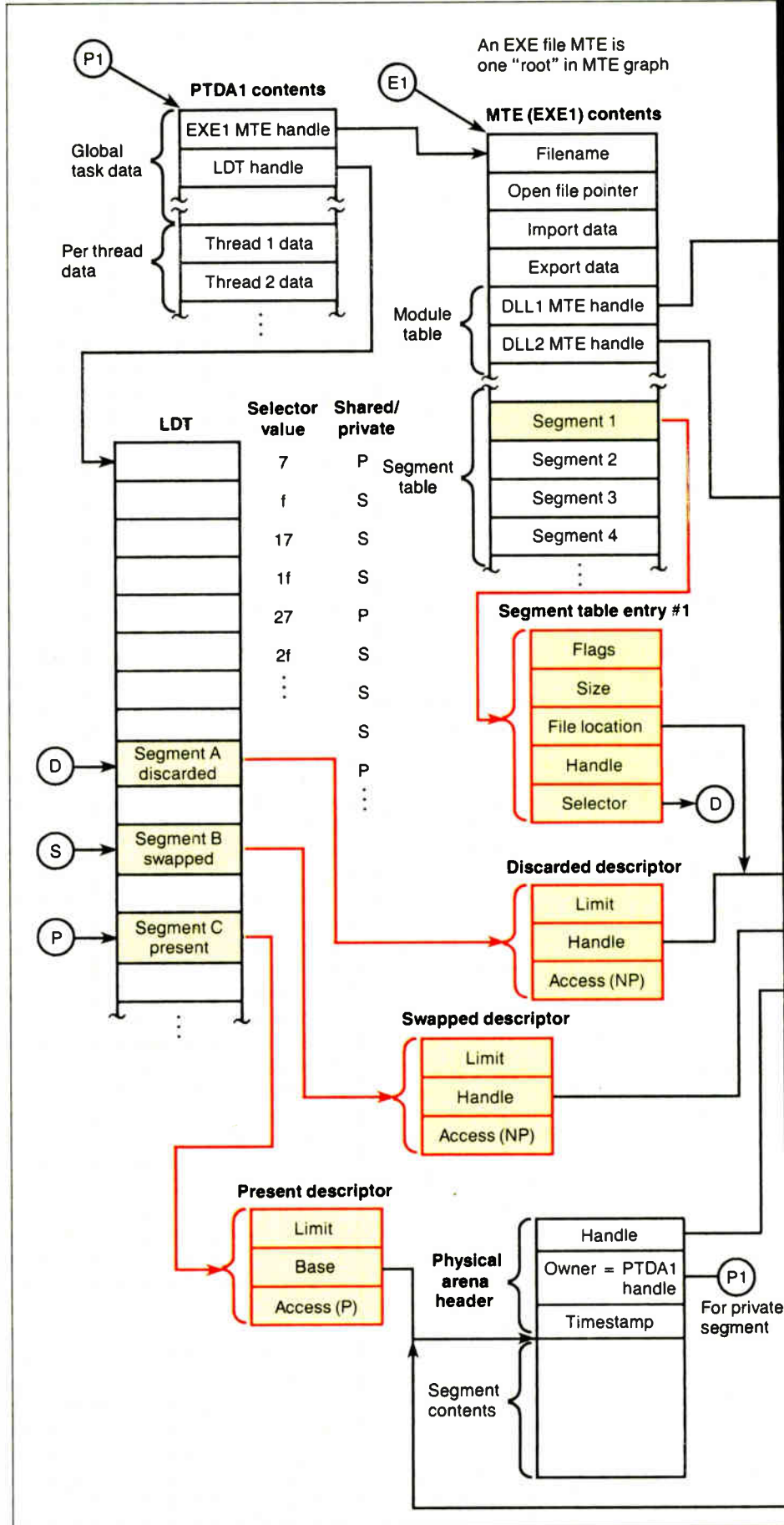

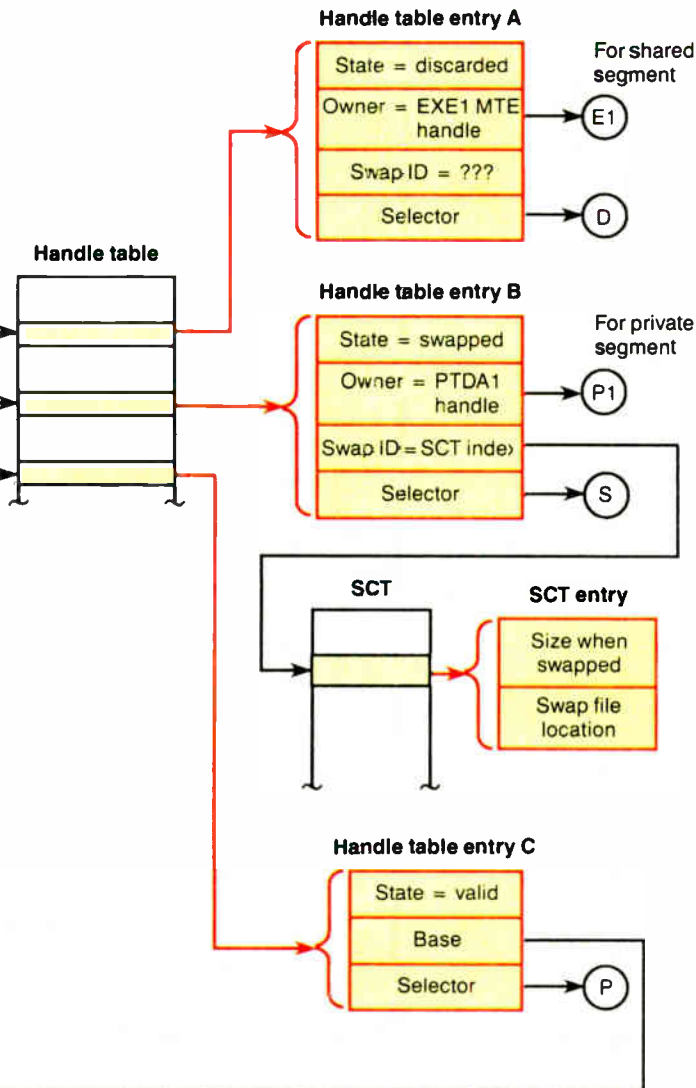
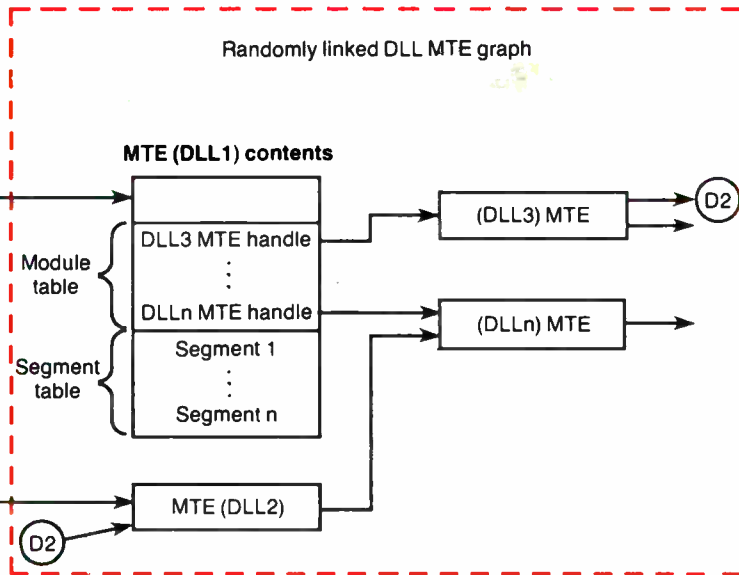

Private, dynamically allocated data segments also use private selectors and private memory. Shared, dynamically allocated data segments (both named shared and unnamed shared) use shared selectors and shared memory to let an application dynamically attach to shared segments.

When the system allocates a shared selector, the corresponding descriptor is reserved in all tasks for the purpose of mapping a single segment. Shared selectors are always used for library module segments, because an application can dynamically attach to any library module. If the library module is in memory, its selectors have already been allocated, and they must be available in the caller's context to map the library's segments.

OS/2 uses private selectors for all of an executable module's segments. If shared selectors were used, large numbers of shared selectors would be reserved. Since a task can attach only to an executable module while the task is being created, OS/2 can guarantee allocation of specific private selectors, because the LDT starts out empty.

To show why an executable file must use private selectors, consider an executable file that contains 100 segments and uses shared selectors: When this executable file is active, 100 shared selectors would be reserved in every task's context, including tasks that do not (and cannot ever) reference the executable file. When new segments that require shared selectors are created (i.e., another executable file is added to the system), numerically greater selectors must be allocated, which results in the growth of every LDT that contains a reference to the new segments. LDT memory waste would increase with each executable file in use.

Executable and library module code segments always share their contents. You can declare data segments at link time as private or shared. If a segment is shared between tasks, the system duplicates the LDT descriptor contents among all tasks that reference the segment, and only one handle and physical memory segment exist for the segment. If a segment's contents are private, the system loads a new copy of the segment for each referencing task. The segment's contents may vary from one task to another over time, but each task's copy is referenced using the same selector value and has the same initial contents and size.

The owner ID of a private segment is the handle of the task's PTDA, so that when a segment's state changes, the single appropriate descriptor can be easily found and updated. The example in figure 1 shows that the owner field for the

continued

Program your way to the top with Gold Hill.

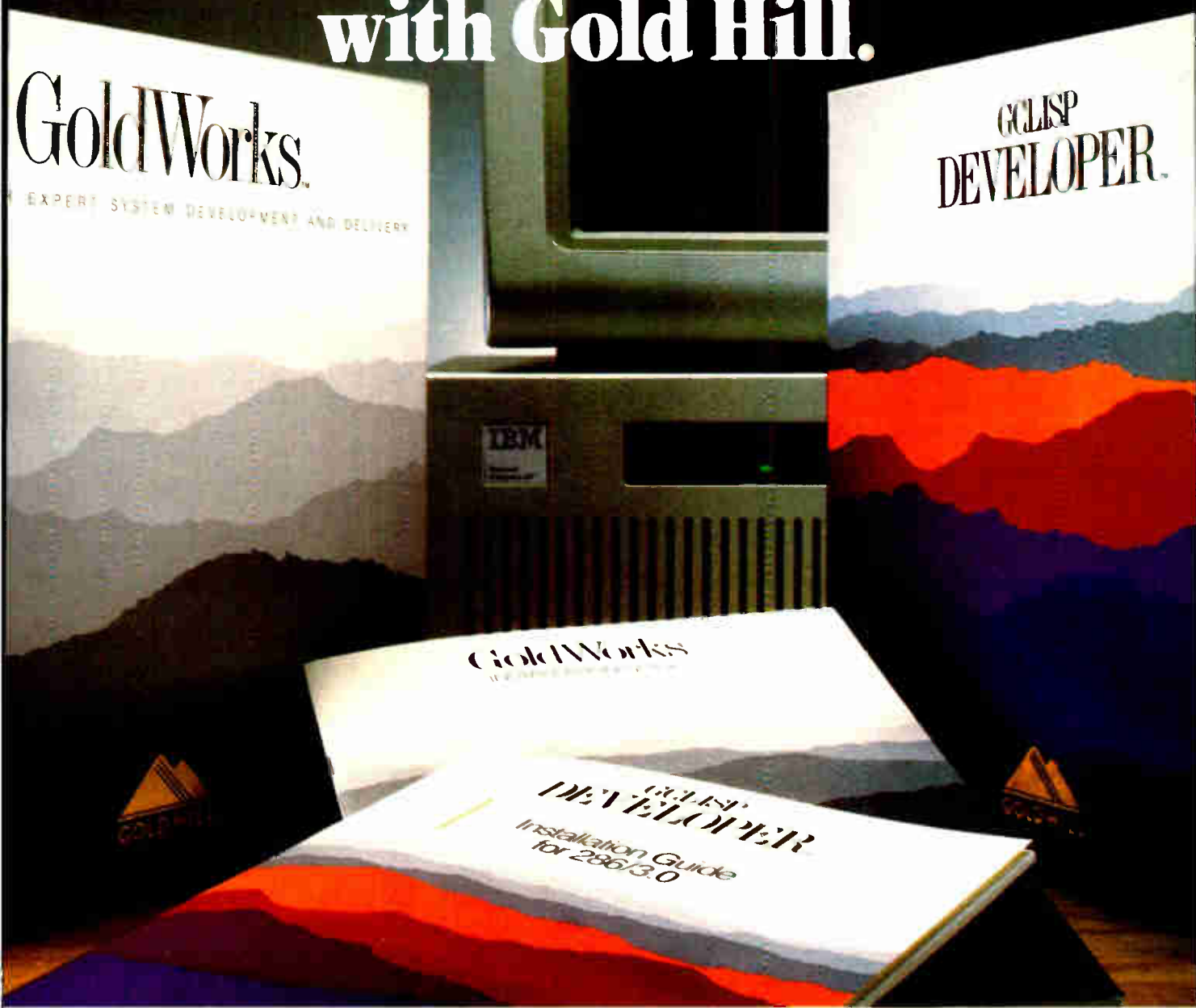

Your challenge is to develop the best expert system applications and deliver them to many users. Or to break new ground in AI development.

To succeed, you have to use the best development tools. They should be power tools that are technologically superior, cost-effective and proven. Tools that are fully supported with a comprehensive program of service, education and consulting.

Gold Hill's success depends on *your* success. That's why we're helping developers like you get to the top in AI—with **GoldWorks**, the PC-based expert system development/delivery tool, and **Golden Common LISP Developer 3.0**, the first *full* implementation of Common LISP on the PC under DOS. Products like these, plus an uncompromising commitment to excellence in service and support, make Gold Hill the number one provider of AI power tools for PCs.

If you're a programmer and you haven't taken a serious look at Gold Hill's power tools, write or call today.

Gold Hill. The expert in AI on PCs.

Circle 113 on Reader Service Card

Gold Hill, GoldWorks and Golden Common LISP Developer are trademarks of Gold Hill Computers, Inc. Copyright 1988, Gold Hill Computers, Inc.



Gold Hill Computers, Inc.
26 Landsdowne Street
Cambridge, MA 02139

Toll-free: 1-800-242-LISP
In Mass.: (617) 621-3300

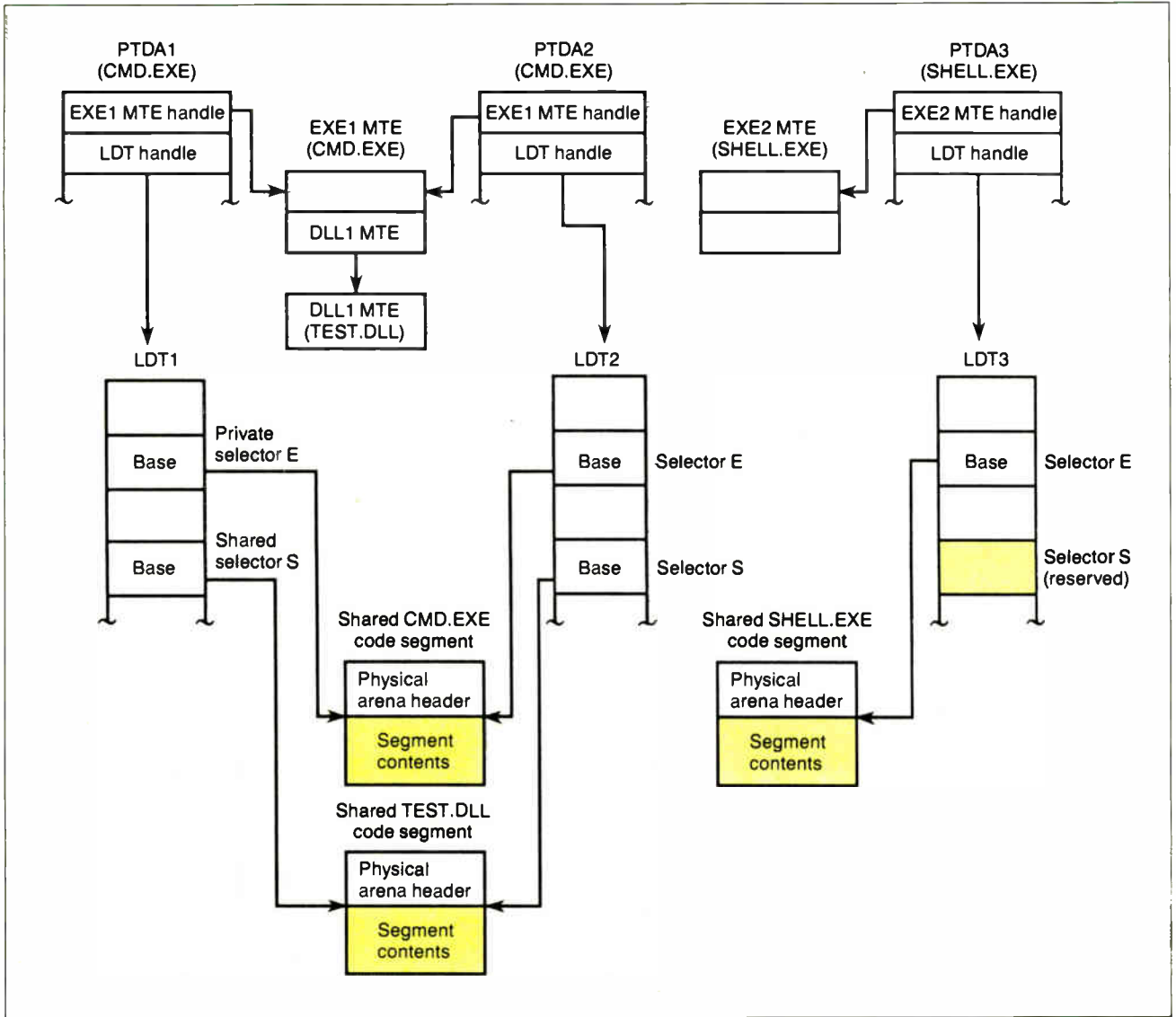

Figure 3: The difference between private and shared selectors. Private selector E maps the same shared (code) segment for all invocations of an executable file. Other tasks may use selector E for other purposes. Shared selector S maps the same shared (code) segment for all tasks attached to the TEST.DLL dynalink library. Shared selector S is reserved for the TEST.DLL segment; other tasks cannot use selector S for any other purpose.

Table 1: Four combinations of shared and private selectors and shared and private memory are possible.

Selector	Memory	Origin
Private	Private	EXE file private data segment
Private	Shared	EXE file code or shared data segment
Shared	Private	DLL file private data segment
Shared	Shared	DLL file code or shared data segment

temporarily overwritten and restored. If the system discards the display data due to low-memory conditions, you can always recreate it. If the video data is still available when needed, you can easily and quickly update the display.

Since many data structures are much larger than the 64K-byte segment size supported by the 80286, OS/2 provides

for "huge" segment allocation. This is made up of an array of individual segments; all but the last in the array are exactly 64K bytes in length, and consecutive segments are addressable by adding a constant increment multiple to the selector of the first segment.

The constant to be added to the base selector is available to an application

through a special dynamic-link reference. High-level language support for huge pointer manipulation is available that makes use of this constant; the value of the constant can change, so it should never be embedded in an application. This is the only case where an application can perform arithmetic on selector values.

Consecutive full-size data segments with consistent attributes that appear in a program or library module will be treated as adjacent huge subsegments. You can also allocate private and unnamed shared memory as huge segments.

When loaded from nonremovable media (e.g., a hard disk), the system always makes program and library module code segments discardable. Since these segments cannot be modified, you can restore their contents at any time by reading the program or library module file and performing any necessary relocation fix-ups. Program and library module writable segments and most run-time allocated segments are made swappable, since their contents may have changed from when they were initially loaded.

Some dynamic allocation requests result in allocating segments not present in physical memory. When the application first accesses the segment, the system allocates the memory. This is done when huge segments are allocated, to avoid unnecessary swapping when allocating enough memory to completely satisfy the huge allocation request.

The total of free, discardable, and swappable memory must always be large enough to let at least one task at a time reload enough segments to execute. Fixed and locked segments can reduce this total. The system performs overcommit accounting to ensure that a demand load request can be satisfied at any time. (Overcommit accounting is the allocation of more virtual memory than can be stored at once in the available physical memory.) Fixed allocation and long-term lock requests will fail if the resulting total of free, discardable, and swappable memory would be too small to reload one task's currently referenced segment.

The system swaps segments to a data file, which cannot always be grown at the time of a swap-out request; the disk space may not be available. The system must keep the swap file large enough to handle swapping out a predictable amount of memory, in advance of the need. To accomplish this, the system grows the swap file whenever it allocates new swappable segments. If a growth attempt fails, it refuses the new segment allocation request.

Some Tips on Usage

All system services are referenced via dynamic links to library modules. OS/2

OS/2 kernel code supports some services directly, while other services are part of bona fide library modules.

kernel code supports some services directly, while others are part of bona fide library modules. A programmer references a system service as if it were a normal far procedure call with the Pascal calling convention (the callee cleans parameters off the stack). Having a consistent procedure-call interface makes system services directly available to assembly language programs and several high-level languages, including Pascal, FORTRAN, and C, assuming a small amount of compiler support for the latter. The linker recognizes a dynamic-link definition in a provided library, and it turns the reference into a relocation record processed at program load time to resolve the final virtual address.

It is best to minimize the number of individual code and data segments. This is because segment allocation requests are rounded up to the granularity of the physical memory manager (32-byte multiples), and because additional memory is consumed for LDT descriptors, handles, and physical arena headers. You must separate program and library module shared and private data, so one type of data should be eliminated if it can be done without compromising the rest of the module. Reducing or eliminating library module private data is particularly useful because the effect is multiplied by the number of processes attached to the library module.

It is also helpful to put nontrivial initialization code and data into segments separate from the main code and data. Explicitly freeing these segments after initialization will release valuable memory or swap-file space if swapping is disabled or if the module is loaded from removable media. Also, rarely used code should be put into separate segments. This will reduce overall memory requirements because only the most frequently used portions of the program will be in memory. ■

Vic Heller is the lead technical system software engineer for OS/2's virtual memory manager at Microsoft Corp., Redmond, WA.

LABELING SOFTWARE



For DOT MATRIX and Laser Printers

(Epson/IBM/Okidata/LaserJet)

- Labels for shelves, bins, inventory
- 13 text sizes readable up to 50 ft.
- Bar Codes: 2 of 5, UPC/EAN, 128, MIL-STD, AIAG, MSI, Code 39
- Any size label • Flexible format
- Color options • Reversals • Fast
- File input • Menu driven • \$279
- Other bar code programs from \$49.
- Font Cartridges NOT required
- Fast • Easy • Not Copy Protected!

30 Day Money Back Guarantee!

Bar Code Readers for PC, XT, AT, PS/2



- Reads 2 of 5, UPC/EAN, Code 39
- Attaches as 2nd Keyboard
- No software changes to add bar codes to any program
- Rugged stainless steel wand
- Optional Magnetic Stripe Reader only \$100 additional
- External attach to all PS/2 models
- External OR Internal to PC, XT, AT
- Upgrade from PC to PS/2-only \$30

PC, XT, AT model-complete \$385

ALL PS/2 models-complete \$399

RS-232 & Kimtron-complete \$399

30 Day Money Back Guarantee!

WORTHINGTON
DATA SOLUTIONS

417-A Ingalls Street,
Santa Cruz, California 95060
408/458-9938

When you want to talk computers..

ATARI COMPUTERS

65XE 64K Computer	99.99
130XE 132K Computer	139.00
520ST-FM Monochrome System	Call
520ST-FM Color System	789.00
SF124 Monochrome Monitor	149.00
SF1224 Color Monitor	329.00



Atari 1040 Color System **\$939**

Includes: 1040ST, 1MB RAM with 3 1/2" Drive Built-In, 192K ROM with TOS, Basic, ST Language and Color Monitor.

ATARI ST SOFTWARE

Access	
Leaderboard Golf	24.99
Antic	
Stereo CAD 30 Flash	24.99
Avant Garde	
PC Ditto (IBM Emulation)	69.99
Batteries Included	
Degas Elite	44.99
DAC	
Easy Accounting	64.99
Timeworks	
Swiftcalc/Wordwriter	49.99
VIP	
Professional Gem	144.00

AMIGA SOFTWARE

Absoft	
AC Basic	139.00
Aegis Development	
Animator/Images	89.99
Draw Plus	149.00
Sonix	49.99
Discovery Software	
Marander II	31.99
Electronic Arts	
Deluxe Video 1.2	89.99
Gold Disk Software	
Pagesetter w/Text ed	89.99
Micro Illusions	
Dynamic Cad	349.00
Micro Systems Software	
Scribble	69.99

AMIGA SOFTWARE

New Tek Inc.	
Digi-View 2.0	149.00
Digi-Paint	44.99
Sub-Logic Corp.	
Flight Simulator II	39.99
Word Perfect Corp.	
Word Perfect	199.00

MACINTOSH PRODUCTS

HARD DRIVES	
CMS	
MacStack 20	599.00
Everex	
40 MB SCSI	999.00
Mountain	
20 MB SCSI	849.00

FLOPPY DRIVES	
Cutting Edge by Ehman	
Book External	189.00
Mirror Technologies	
Magnum Book	199.00

MONITORS

Sigma Designs	
Laser View Display Syst.	1,899.00



Network Specialities Big Top 20" Desk Top Publishing **\$1499**

MEMORY UPGRADES	
Dove Computer	
Mac Snap 524S	199.00
Mac Memory	
Max Plus Mega	329.00
Turbo SE 16 MHz	369.00
SCANNERS	
AST	
Turboscan	1,299.00
Datacopy	
720 Flatbed Scanner	1,199.00

MS/DOS SYSTEMS

AST Prem. 140 Desktop	2,499.00
Compaq Deskpro and Portables	Call

MS/DOS SYSTEMS

IBM PS/2 model 30 and 50	Call
IBM PS/2 model 60 and 80	Call
Leading Edge	899.00



NEC Multispeed Floppy Laptop **\$1,199**

NEC APC-IV Powermate	2,399.00
PC-TOO 80286 1.2MB, 512K	999.00
Toshiba T-1000 Laptop	799.00

MULTIFUNCTION CARDS

AST	
Hot Shot 286 Accelerator	349.00
Hercules	
Color Card	139.00
Graphics Card Plus	159.00
5th Generation	
Logical Connection 256K	299.00
Quadram	
Quad386XT 80386 PC-Upgrade	799.00
Video 7	
Vega V.G.A. Adapter	319.00
Zuckerboard	
Color Card w/Parallel Port	89.99

MS/DOS SOFTWARE

Ashton-Tate	
d-Base III +	389.00
Borland	
Quattro	129.00
5th Generation	
Fastback Plus	89.99
IMS!	
Optimouse w/dr. Halo	89.99
Logitech	
C7 Mouse w/Software	79.99
Lotus	
Lotus 1.2.3	309.00
Micropro	
Professional 4.0 w/GL	239.00
Word Perfect Corp.	
Word Perfect 4.2	209.00



COMPUTER MAIL ORDER

.....When you want to talk price.

MONITORS	MODEMS	PRINTERS
<p>Amdek Video 310A 12" Amber 119.00 Video 410 12" A/G/W (ea.) 159.00</p> <p>Magnavox 7BM623 12" TTL Amber 99.00</p>  <p>Magnavox CM8502 13" Composite Color \$159</p> <p>CM8515 14" RGB/Composite . 269.00 CM8762 14" RGB/Composite .. New</p> <p>NEC GS-1400 14" Monochr. TTL... 219.00 JC-1402 Multisync-II 599.00</p> <p>Packard Bell PB-1418F 14" Flat TTL A/G/W (ea.) 119.00 PB-1420CG 14" Mid-Res CGA 269.00 PB-1422EG 14" Hi-Res EGA . 369.00 PB-8526-MJ Uniscan Monitor . 399.00</p> <p>Princeton Graphics Max-12 12" TTL Amber 149.00</p> <p>Thomson 450 15" 132 col. TTL Amber .. 119.00 4120 14" RGB/Composite 239.00</p>	<p>Anchor 6480 C64/128 1200 Baud 99.99 Vu-520 ST520/1040 1200 Baud 129.00 1200E 1200 Baud External ... 129.00</p> <p>Atari SX-212 ST Modem 94.99</p> <p>Avatex 1200 HC External 99.99 2400 External 209.00</p> <p>Best Products 1200 Baud 1/2 Card w/software . 89.99</p> <p>Everex Evercom 2400 Baud External . 239.00</p> <p>Hayes Smartmodem 300 149.00 Smartmodem 1200 259.00</p> <p>Packard Bell 1200 External 89.99 2400 External 169.00</p>  <p>Practical Peripherals Complete Telecom Package \$89.99</p> <p>2400 Baud Stand-Alone 199.00</p> <p>Supra MPP-1064 AD/AA C64 69.99 2400AT 2400 Baud Atari 169.00</p> <p>U.S. Robotics Direct 1200 Baud External ... 89.99 Direct 2400 Baud External ... 199.00</p>	<p>Atari 1020 XL/XE Plotter 31.99 XDM-121 Letter Quality XL-XE 159.00 XM-M801 XL-XE Dot Matrix ... 199.00 XM-M804 ST Dot Matrix 189.00</p> <p>Brother M-1109 100 cps Dot Matrix ... 199.00 M-1409 180 cps Dot Matrix ... 309.00</p> <p>Citizen 120D 120 cps Dot Matrix 149.00 Premier-35 35 cps Daisywhl. . . 479.00</p> <p>C.Itoh 315-XP Epson/IBM 132 col. . . . 549.00</p>  <p>Epson FX-86E 80 Column 240 CPS \$279</p> <p>Epson LX-800 150 cps, 80 col. 179.00 FX-286E 240 cps, 132 col. Call LQ-500 180 cps, 24-wire Call LQ-850 330 cps, 80 col. Call LQ-1050 330 cps, 24-wire Call EX-800 300 cps, 80 col. Call</p> <p>Hewlett-Packard HP-2225 Thinkjet 369.00</p> <p>NEC P2200 Pinwriter 24-wire 379.00 P660 Pinwriter 24-wire 459.00 P760 Pinwriter 132 col. 679.00</p> <p>Okidata Okimate 20 color printer 129.00 ML-182 120 cps 80 col. 229.00 ML-192 + 200 cps, 80 col. 359.00 ML-193 + 200 cps, 132 col. . . 469.00</p> <p>Panasonic KX-P1080i 144 cps, 80 col. ... 189.00 KX-P1091i 194 cps, 80 col. ... 199.00</p> <p>Star Micronics NX-1000 140 cps, 80 col. 169.00 NX-1000C C64/128 Interface . 189.00 NX-15 120 cps, 132 col. 319.00</p> <p>Toshiba P321-SL 216 cps, 24-wire ... 539.00 P351-SX 300 cps, 24-wire ... 999.00</p>
<h2>DRIVES</h2>	<h2>DISKETTES</h2>	
<p>Atari AA354 SS/DD ST Disk 129.00 AA314 DS/DD ST Disk 199.00 SHD204 20MB ST Hard Drive . 569.00</p> <p>C.LTD (For Amiga) C.LTD 20MB 899.00 C.LTD 33MB 999.00 C.LTD A500 SCSI Controller . 179.00</p> <p>Indus GT Disk Drive Atari XL/XE ... 179.00</p> <p>Racore Jr. Expansion Chassis 299.00</p> <p>Seagate Technologies ST-225 20MB Drive 249.00</p> <p>Supra Atari ST 20MB Hard Drive ... 559.00 Amiga 2000 20MB Hard Drive . 649.00</p> <p>Xebec Amiga 20MB Hard Drive 799.00</p>	<p>MD1-M SS/DD 5 1/4" 8.49 MD2-DM DS/DD 5 1/4" 9.49 MF1-DDM SS/DD 3 1/2" 12.49 MF2-DDM DS/DD 3 1/2" 18.49 MC-6000 DC-600 Tape 23.99</p> <p>Sony MD1D SS/DD 5 1/2" 6.99 MD2D DS/DD 5 1/2" 7.99 MFD-1DD SS/DD 3 1/2" 11.99 MFD-2DD DS/DD 3 1/2" 16.99</p>	

In the U.S.A. and in Canada

Call toll-free: 1-800-233-8950

Outside the U.S.A. call 717-327-9575, Fax 717-327-1217

Educational, Governmental and Corporate Organizations call toll-free 1-800-221-4283

CMO. 477 East Third Street, Dept. A1, Williamsport, PA 17701

ALL MAJOR CREDIT CARDS ACCEPTED

POLICY: Add 3% (minimum \$7.00) shipping and handling. Larger shipments may require additional charges. Personal and company checks require 3 weeks to clear. For faster delivery, use your credit card or send cashier's check or bank money order. Credit cards are not charged until we ship. Pennsylvania residents add 6% sales tax. All prices are U.S.A. prices and are subject to change, and all items are subject to availability. Defective software will be replaced with the same item only. Hardware will be replaced or repaired at our discretion within the terms and limits of the manufacturer's warranty. We cannot guarantee compatibility. All sales are final and returned shipments are subject to a restocking fee.

POWER USER'S GUIDE SERIES

The Best Source of Unique Features and Expert Techniques for Sophisticated Users

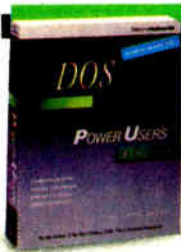

DOS: Power User's Guide

by Kris Jamsa

Learn to wield DOS in powerful ways. Compares advanced DOS and OS/2™ features.

\$22.95 Paperback,
ISBN: 0-07-881310-7, 921 pp.,
Available Now

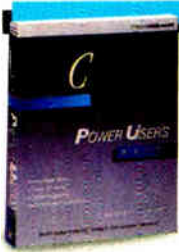

C: Power User's Guide

by Herbert Schildt

Make C programs sizzle! All the slick tricks used in commercial software are unveiled to serious programmers.

\$22.95 Paperback,
ISBN: 0-07-881307-7, 382 pp.,
Available Now

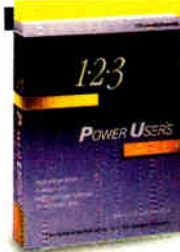

1-2-3®: Power User's Guide

by Mary Campbell

Extend 1-2-3® productivity to the limit with masterful techniques that are unavailable elsewhere.

\$22.95 Paperback,
ISBN: 0-07-881298-4, 861 pp.,
Available Now

dBASE III PLUS™: Power User's Guide

by Edward Jones

dBASE III PLUS limitations disappear with sophisticated analyses of dBASE III PLUS techniques.

\$22.95 Paperback,
ISBN: 0-07-881317-4, 444 pp.,
Available Now



Microsoft® Word: Power User's Guide

by John V. Hedtke

Reach a new level of Word Version 4 operations, from desktop publishing to specialized legal and medical applications.

\$22.95 Paperback,
ISBN: 0-07-881357-3, 500 pp.,
Available 5/88

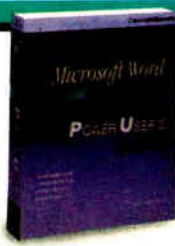

WordPerfect®: Power User's Guide

by Ruth Halpern

These advanced tools make WordPerfect pros. Jump into macros, desktop publishing, scientific equations, and more.

\$22.95 Paperback,
ISBN: 0-07-881364-6, 650 pp.,
Available 6/88

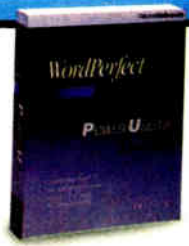

Quattro™: Power User's Guide

by Stephen Cobb

Refine Quattro skills and unlock the full speed and power of Borland's professional spreadsheet program.

Borland-Osborne/McGraw-Hill Business Series

\$22.95 Paperback,
ISBN: 0-07-881367-0, 600 pp.,
Available 6/88

Available at Fine Book Stores and Computer Stores Everywhere
Or Call Our TOLL-FREE Number 800-227-0900

We accept Visa, MasterCard, and American Express.

Available in Canada through McGraw-Hill Ryerson, Ltd. Phone 416-293-1911



Osborne/McGraw-Hill
2600 Tenth Street
Berkeley, California 94710

dBASE III PLUS is a trademark of Ashton-Tate. Microsoft is a registered trademark of Microsoft Corp. OS/2 is a trademark of International Business Machines, Corp. 1-2-3 is a registered trademark of Lotus Development Corp. Quattro is a trademark of Borland International, Inc. WordPerfect is a registered trademark of WordPerfect Corp. Copyright © 1988 McGraw-Hill, Inc.

Marrying Unix and the 80386

*How a Unix kernel design takes advantage
of the 80386's memory management hardware*

Carl Hensler and Ken Sarno

A CRITICAL ISSUE in designing a multitasking operating system such as Unix is how to protect the programs that are sharing system memory. This is called memory management. The Unix executive program, called the *kernel*, solves the memory protection problem by giving each program its own virtual address space. The memory management hardware and software must map the virtual address space seen by a program into the physical memory that has been allocated to the program, and must prevent access to memory that has not been allocated to it.

The Intel 80386 processor provides powerful, flexible, and extremely fast memory management hardware that makes implementing Unix relatively easy. It provides paged virtual memory with all the segment translation and protection architecture of the 80286 and can execute in a 16-bit mode to maintain backward compatibility with 80286 versions of Unix.

In virtual 8086 mode, the 80386 emulates the 8086, making it possible to run MS-DOS programs under Unix. In the standard 32-bit mode, segments can be made so large that only one segment is needed, simplifying programming and eliminating cycle-wasting segment register loading.

How can the 80386's memory management hardware be best used in a Unix kernel? We will discuss a series of design issues and the alternatives. The design we describe is not identical to any existing implementation of the Unix kernel on the 80386, but it is quite similar to the ones

with which we are familiar.

However, before leaping into kernel design, let's briefly review the multistep process through which an 80386 translates a program's virtual address into the corresponding physical memory address.

Address Translation

A virtual address generated by instruction fetching or execution is translated by segmentation hardware into a 32-bit, intermediate *linear address*, which is in turn translated by paging hardware into a 32-bit physical memory address, as shown in figure 1.

In the 80386, a virtual address has two components: a segment register specification and an offset in the memory segment described by the segment register. A virtual address is translated into a linear address by adding the offset component to the segment base value in the specified segment register.

Pages are 4096-byte memory units, and *page frames* are pages of physical memory. The processor's page directory base register (PDBR) points to the *page directory*, entries in the page directory point to *page tables*, and entries in the page tables point to pages of physical memory. The page directory and the page tables are each one page in size, and each contains 1024 4-byte page table entries (PTE). A PTE contains a page frame address and some page attribute bits.

The processor translates a linear address by breaking it into directory, page, and offset fields. The 10-bit directory field is used as an index into the page directory to select a PTE that points to a

page table. The 10-bit page field is used as an index into the page table to select a PTE that points to the page that contains the linear address. The 12-bit offset field is combined with the address of the page to form the physical address.

Thus, each entry in the page directory maps a 4-megabyte (1024×4096 bytes) section of the linear address space to a page table, and each entry in a page table maps a 4096-byte section to a memory page, as shown in figure 2. Note that the mapping between virtual and physical addresses can be changed incrementally by changing a PTE, or it can be changed completely by loading the address of a new page directory into the PDBR.

Page Faults

Each PTE has a *present bit* that indicates whether the entry can be used for address translation. If the present bit is not set in a PTE when it is used for translation, execution of the instruction that caused the translation is terminated as if it had not begun; the address that was being translated is put in a register where it is accessible to operating system software; and a page fault exception is generated.

The software that handles the page fault exception can correct the fault by allocating a page frame, loading the appropriate data into the page frame, putting the page frame address into the PTE, setting the present bit, and returning from the exception to the instruction that caused the fault. This time, the present bit is set and the translation succeeds. The ability to correct page faults by

continued

allocating a page that was not present and then restarting the instruction is essential for implementing demand paging.

Memory Protection

The 80386 provides memory protection during segment and page translation. The processor runs at a *current privilege level* that is compared to the privilege levels of segments and pages during address translation. The processor completes a segment or page address translation only if it is running at a current privilege level as high as that of the segment or page. Unix

runs at two privilege levels: a lower level when running user programs, and a higher level when running the kernel.

In addition to privilege restrictions, the 80386 checks segment offsets against a segment limit in the segment register to verify that the virtual address is within the segment's boundaries. Segments and pages can be marked read-only, so that they are protected from writing. Unfortunately, read-only protection for pages works only when the processor is running at user level. Read-only protection for pages is ignored at kernel level.

Segmented versus Nonsegmented Addressing

There are two addressing models, segmented and nonsegmented, that can be used on the 80286 and 80386. The segmented model allows a program to use many segments. Before a program can access a variable, it must load a segment register, unless it knows that a register already specifies the segment that contains the variable. This means that a C language pointer variable must include both a segment selector and an offset. Dereferencing a segmented pointer is very slow on the 80286 and 80386 because the selector must be loaded into a segment register, and loading a segment register takes 8 times longer than loading a data register.

The alternative is the nonsegmented model, in which a program uses only one segment, and virtual addresses are simply offsets in that segment. All the segment registers have the same segment base and limit and are never reloaded while the program is running. This limits the program size to the maximum segment size, but the maximum segment size on the 80386 is 4 gigabytes, the full 32-bit linear address range.

Thus, we can use the faster nonsegmented addressing model and still have an address space much larger than the amount of memory that could be installed in any contemporary computer. This is the simplest and most efficient way to use the 80386, and our design will assume it.

A special case of the nonsegmented model on the 80386 is the *flat* model, which uses segments that have a segment base value of 0. Since offsets are added to 0 to produce linear addresses, virtual and linear addresses are identical in the flat model, and segmentation becomes invisible unless we use segment limits for protection. This simplifies some things, and both 80386 Unix kernels with which we are familiar use the flat model.

Separate or Combined User and Kernel Address Spaces

A Unix process is the environment in which a user program runs under control of the kernel. A process runs in either *user mode* or *kernel mode*. When user program instructions are being executed, the process is in user mode and can access only the memory allocated to the user program. It cannot access memory allocated to another process or to the kernel.

When kernel program instructions are being executed to provide a service for the user program, the process is in kernel mode, and it has access to both the user program's data and the kernel program's data. A process switches from user mode

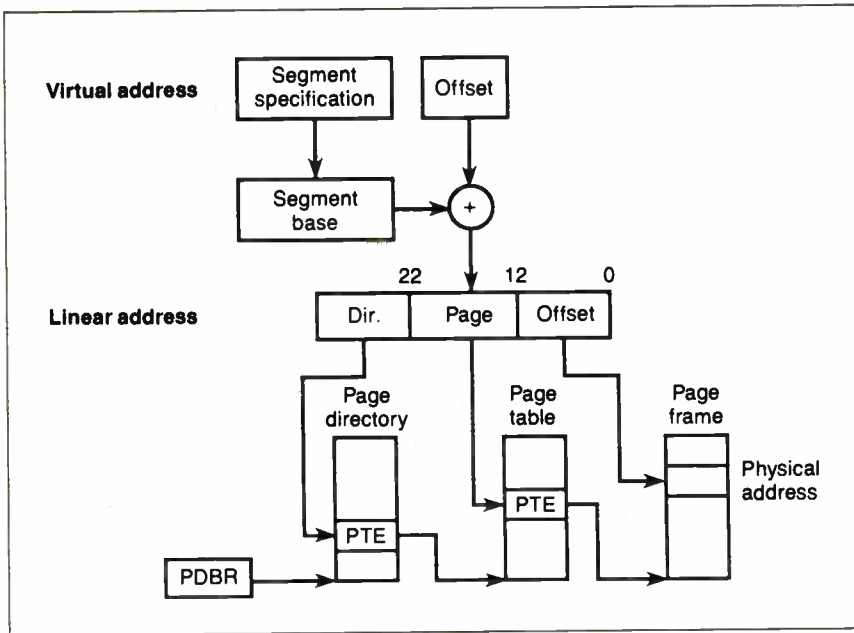

Figure 1: The 80386 uses segmentation and paging to translate a virtual address into a physical memory location.

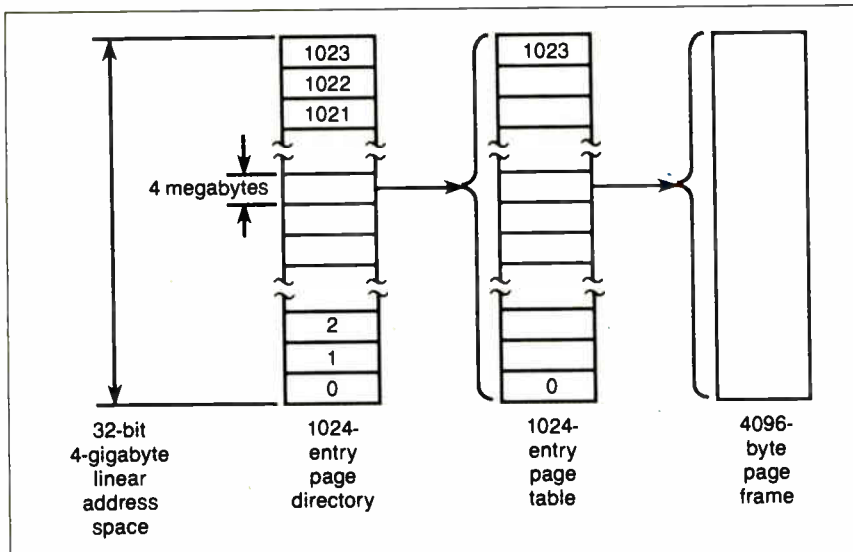

Figure 2: The 80386's page translation uses page directories, page tables, and page frames.

UNIX AND THE 80386

to kernel mode when it requests an operating system service, and it switches back to user mode when the service has been performed.

Our first design issue is whether to separate the user and kernel mode linear address spaces. It is possible to run the user program and the kernel in entirely different linear address spaces, so that the user program could not possibly access the kernel's memory. This would require having two different page directories for user and kernel modes, and making the transition from user to kernel mode through a *task gate*, because that is the only way to get a new page directory base pointer loaded automatically.

The simpler and more efficient solution is to have a single linear address space that is shared by both the user process and the kernel. Most of the linear address range is reserved for the user program, and only a small part is used by the kernel. Thus, a process can use the same page directory in user mode and kernel mode, and it can switch from user to kernel mode without reloading the PDBR. When you have 4 gigabytes to play with, taking a small fraction of it away from the user program is a small price to pay for simplicity.

Who's on Top?

The next issue is how to divide up the linear address space. The kernel could be at the lower end or the higher end of the linear address space. This issue is decided for you if you wish to be able to use the 80386's *virtual 8086 mode*, which lets you run 8086 programs in protected mode, and thus run MS-DOS programs under Unix. In this mode, the 8086's 1-megabyte address range is translated to the low end of the linear address space, bypassing the usual protected-mode segment translation. If we want to be able to use virtual 8086 mode, we must therefore put the user program at the low end.

If we do not care about virtual 8086 mode, we might choose to put the kernel at the low end of the linear address space because then we could run the kernel without page translation enabled during start-up. However, the implementations with which we are familiar both place the kernel at the high end, and we will assume the same arrangement here.

User and Kernel Segment Layout

Now we must decide how to lay out the user and kernel segments. Since the user program is at the lower end of the linear address space, we base the user segments at linear address 0, and we set their limits so that they do not extend into the kernel's part of the linear address space.

continued

It copies 5¼ and 3½ inch diskettes all by itself.

Just load your diskettes, press one button, and walk away. The Victory Auto-loader automatically copies diskettes operating stand-alone or attached to an IBM/PC* or Mountair® compatible system.

Bulk cannisters allow fast, easy loading and unloading. Switching drives takes less than five minutes.

Copy Different Formats, Flawlessly.

Our Auto-Format-Analysis™ feature lets you copy different formats, including PS/2*. The system tests for quality and accuracy, sorting disks into one of two output cannisters.

No User-Required Adjustments.

The Autoloader's self-calibration and simple diagnostics for checking drive alignment allow you to maintain the system without outside service.

Call 1-800-421-0103.

And ask about the Victory family of affordable duplication systems—with serialization, copy protection and custom label printing.



VICTORY ENTERPRISES

Technology, Inc.

8910 Research Blvd., B2
Austin, Texas 78758
512-450-0801

In Europe call BFI: Paris (33-1) 4530137,
Frankfurt (49-6074) 27051, London (44-1)
941-4066, Milan (39-2) 316716.

*IBM PC and PS/2 are trademarks of International Business Machines Corporation. Mountair is a registered trademark of Mountair Computer, Inc.

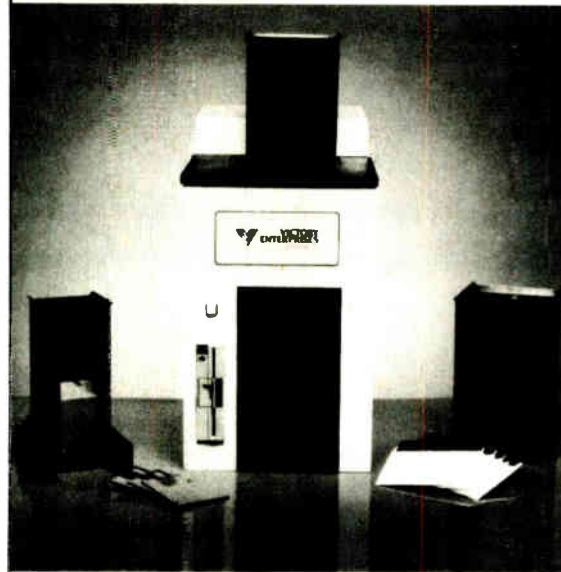

LAHEY SETS NEW FORTRAN STANDARDS

LAHEY PERSONAL FORTRAN 77 **\$95**
Low cost, Full 77 Standard, Debugger, Fast Compilation

F77L FORTRAN LANGUAGE SYSTEM **\$477**

For porting or developing, this is the critics' choice.

"Editor's Choice"

PC Magazine

"... the most robust compiler tested."

Micro/Systems

"... the most efficient and productive FORTRAN

development tool for the DOS environment"

BYTE

F77L-EM/32-bit **\$895** **F77L-EM/16-bit** **\$695**

Break through the DOS 640K barrier. The most powerful PC Fortran Language Systems for downloading or writing large programs.

PRODUCTIVITY TOOLS

Profiler, ULI Mathematical Functions Library, Overlay Linker, Toolkit, Utility Libraries, Windows, Memory Boards, 80386 HummingBoard.

IF YOU DEMAND THE VERY BEST, THEN YOU SHOULD BE USING LAHEY. CALL US TO DISCUSS YOUR PC FORTRAN NEEDS.

CALL FOR NEW FEATURES INCLUDING MATH COPROCESSOR EMULATION

30 DAY MONEY-BACK GUARANTEE

FOR INFORMATION OR TO ORDER:
1-800-548-4778

Lahey Computer Systems, Inc.
P.O. Box 6091, Incline Village, NV 89450
TEL: 702-831-2500 TLX: 9102401256

Lahey
Computer Systems Inc.

This protects the kernel from user programs without using page protection.

We can base the kernel segments at 0 so that they overlap the user segments, or we can base them at the linear address at which the kernel starts so that the segments do not overlap. If the segments overlap, we run the risk that a bug in the kernel code will accidentally access a location in the user program without causing a protection exception.

Thus, from a protection standpoint, it is better to keep the segments separate, but it is simpler and more efficient to base them all at 0, so that a piece of data in the user program is at a kernel virtual address that is the same as the user virtual address. Then, when a user program passes an address in a system call to the kernel, the kernel can access that address without loading the user data segment selector into a segment register.

Kernel Sections

How is the kernel's part of the linear address space to be mapped to physical memory? The kernel has three sections that use fundamentally different page mappings:

- Statically mapped physical memory.
- Dynamically allocated kernel memory.
- The U area.

The kernel text and static data are loaded from the kernel executable file during Unix start-up. They are typically loaded as contiguously as possible into low physical memory by the boot loader, though the hole between 640K bytes and 1 megabyte on AT clones presents an obstacle. Thus, the lower end of physical memory contains the kernel code and static data.

It is convenient if all physical memory is mapped into the kernel virtual address space so that the kernel can get to any of it without changing page tables. One or more page directory entries and page tables can map the low end of the kernel's section of the linear address space to all physical memory. This maps the virtual address range of the kernel's code and static data into the physical memory address range in which they are loaded, and also gives the kernel easy access to all physical memory. The virtual address of a byte of physical memory is its physical address plus the base linear address of the kernel.

Usually, most of the memory needed by the kernel for its own internal use is statically allocated at the time the kernel is linked. In addition, the kernel must be able to dynamically allocate pieces of memory for its own use. Since the page frames of physical memory that are free for allocation at any point are unlikely to

be adjacent in memory, the kernel must be able to map a contiguous section of its virtual address space, of the size needed, into randomly located pages. This means that the kernel must have one or more page directory entries and page tables it can use for mapping dynamically allocated memory.

The U area, which contains the kernel stack and process information that is needed only when a process is running, is mapped into the kernel address space at a fixed location. When the kernel switches from one process to another, it changes the mapping of the virtual U area to the physical memory that contains the U area of the new process. We can dedicate a page directory entry and a page table to the U area, but this wastes most of the page table, because the U area is probably only one or two pages in size. It is more efficient to map the U area through the first few pages of the dynamically allocated kernel memory section. Then the virtual address of the U area is the base address of the dynamically allocated memory section.

So how big a piece of the linear address space should we reserve for the kernel? The biggest potential requirement is for

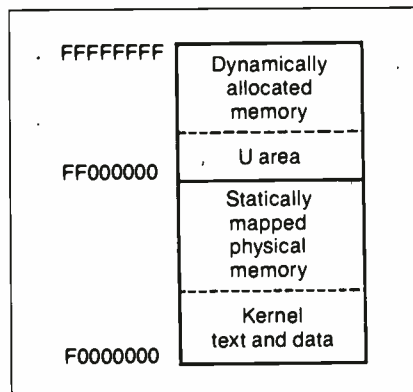

Figure 3: The kernel's virtual address space.

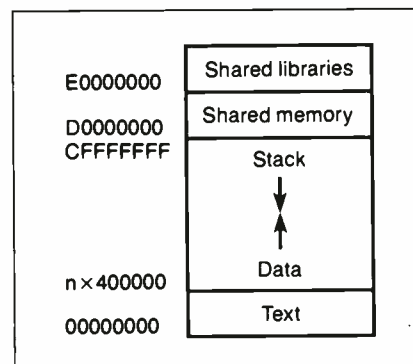

Figure 4: The user program's virtual address space.

mapping physical memory. Even if we reserve 256 megabytes for the kernel, that is still only 1/16 the linear address space.

Figure 3 shows our layout of the kernel part of the virtual address space. All addresses are in hexadecimal. The kernel occupies addresses F0000000 through FFFFFFFF. The statically mapped physical memory section takes up most of that, from addresses F0000000 through FEFFFFFF. The dynamically allocated memory area occupies FF000000 through FFFFFFFF, and the U area is at FF000000.

The page table overhead for a typical kernel is minimal. For a machine with 4 megabytes of physical memory, we need one page table each for the statically mapped physical memory and dynamically allocated memory sections. This is less than the page table overhead for a single process.

User Program Sections

A Unix process must have three distinct sections of memory:

- A text section that contains the program instructions and can be shared with other processes running the same program.
- A data section containing static and dynamically allocated data.
- A stack section containing function call linkage and automatically allocated local variables.

In addition, a process can also have an arbitrary number of shared memory and shared library sections. How should these be laid out in the user virtual address space?

A fundamental consideration is that both the data and stack sections can grow in size, and we want to leave room for them to grow. Most applications will use only a small fraction of the 32-bit address space, and most use a lot more data than stack. Yet we want to avoid layout decisions that will interfere with the efficient execution of future applications whose needs we can only guess.

Unix assumes that the data section grows upward toward higher addresses. The 80386 stack must grow downward, because the PUSH instruction decrements the stack pointer. Only the text section is fixed in size. Our layout, shown in figure 4, has the text section starting at virtual address 0, and the data section starting at the next multiple of 4 megabytes above the top of the text.

The gap between text and data is necessary because the two sections are mapped by different page tables, and each page table must be mapped by a different page

continued

New Prices

OS/2

WINDOWS FOR DATA®

MULTI-LEVEL MENU SYSTEM

NESTED POP-UP FORMS

SCROLLABLE REGION

CHOICE LIST

CLOCK

POP-UP WINDOW

RUNNING TOTALS

MESSAGE WINDOW

Invoice: Create Review Print Exit

INVOICE

Invoice No.: 888284 Date: 12/03/87 Time: 16:43:15

-Customer-

William Jones
Innovative Software
351 Bulletin Avenue
Needham, MA 02194
(617) 394-5512

Search for customer record? (Y/N): N
Enter customer information? (Y/N): N
Enter billing address? (Y/N): N
Enter marketing information? (Y/N): N

No.	PFODCT	DESCRIPTION	QUANTITY	PRICE	AMOUNT
5	WMS	Windows for Data Microsoft	10	295.00	2950.00
6	WDLF	Windows for Data Lattice	5	295.00	1475.00
7	WDTL	Windows for Data Turbo C	5	295.00	1475.00
8	WDXE	Windows for Data XENIX	2	795.00	1590.00
9				0.00	0.00

Subtotal: 11325.00
Shipping: 0.00
TOTAL: 11325.00
Payment: 0.00

Choice List:

- WDXE Windows for Data - XENIX
- WDBZ Windows for Data - 3B2 Unix
- WDSU2 Windows for Data - Sun Unix
- WDM3 Windows for Data - MicroVax
- WDM4 Windows for Data - Vax 780

Cursor keys scroll, ENTER selects and ESC exits choice menu

If you program in C, take a few moments to learn how Windows for Data can help you build a state-of-the-art user interface.

- ✓ Create and manage menus, data-entry forms, context-sensitive help, and text displays — all within windows.
- ✓ Develop window-based OS/2 programs right now, without the headaches of learning OS/2 screen management. Run the same source code in PC DOS and OS/2 protected mode.
- ✓ Build a better front end for any DBMS that has a C-language interface (most popular ones do).

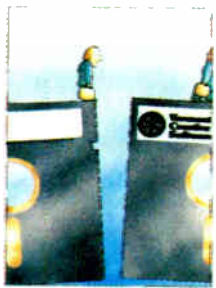

FROM END TO BEGINNING
Windows for Data begins where other screen packages end, with special features like nested pop-up forms and menus, field entry from lists of choices, scrollable regions for the entry of variable numbers of line items, and an exclusive built-in debugging system.

NO WALLS

If you've been frustrated by the limitations of other screen utilities, don't be discouraged. You won't run into walls with Windows for Data. Our customers repeatedly tell us how they've used our system in ways we never imagined — but which we anticipated by designing Windows for Data for unprecedented adaptability. You will be amazed at what you can do with Windows for Data.

YOU ARE ALWAYS IN CHARGE

Control functions that you write and attach to fields and/or keys can read, compare, validate, and change the data values in all fields of the form. Upon entry or exit from any field, control functions can call up subsidiary forms and menus, change the active field, exit or abort the form, perform almost any task you can imagine.



OUR WINDOWS WILL OPEN DOORS

Our windows will open doors to new markets for your software. High-performance, source-code-compatible versions of Windows for Data are now available for PC DOS, OS/2, XENIX, UNIX, and VMS. PC DOS

versions are fully compatible with Microsoft Windows. **No royalties.**

MONEY BACK GUARANTEE

You owe it to yourself and your programs to try Windows for Data. If not satisfied, you can return it for a full refund.

Prices: PC DOS \$295, Source \$295. OS/2 \$495. XENIX \$795. UNIX, VMS, please call.

Call: (802) 848-7731

ext. 51

Telex: 510-601-4160 VCISOFT

FAX 802-848-3502



Vermont Creative Software

21 Elm Ave.
Richford,
VT 05476

directory entry. The stack is near the high end of the user address space, so that there is plenty of room for the data section to grow upward and the stack to grow downward.

Exactly where we put the stack depends on where we put shared memory and shared library sections. We can put them between the data and the stack, or we can put them above the stack. There are things to be said for and against both arrangements, and with such a big address space, it is not clear that it makes much difference. In figure 4, we show shared libraries at E0000000, shared memory at D0000000, and the stack starting down from CFFFFFFF.

Memory Management Data Structures

Thus far our design has focused on abstract issues of address space layout. Now it is time to turn to the more concrete task

of deciding how to organize the part of the kernel program that manages memory. We have already discussed the basic building blocks: processes, sections, page directories, page tables, and page frames. Figure 5 shows how we put them together.

Processes and Sections

Shared text, shared memory, and shared library sections can all be attached to more than one process. Since a section can exist independently of any single process, information about sections must be kept separate from the process information in the process table and the U area. Thus, we assume that there is a section table with an entry for each section that currently exists.

An entry contains information about the type and state of the section, the number of processes to which it is attached, its size, and a way to find its page tables.

Note that page tables are associated with sections, not processes, because the page tables that map a section to physical memory are the same for every process that shares that section, and it would be silly to duplicate them. Since there is only one page directory per process, it is associated with the process.

How do we associate a process with its sections? We must keep in mind that a shared memory section can appear at different virtual addresses in the processes to which it is attached, and it can be attached as either read/write or read-only. Thus, we need to distinguish between information about a section that is the same for all processes that share it, and information that differs among those processes. The former information goes in the section table, and the latter is kept in the process's *process section table*.

This table could be located in the pro-
continued

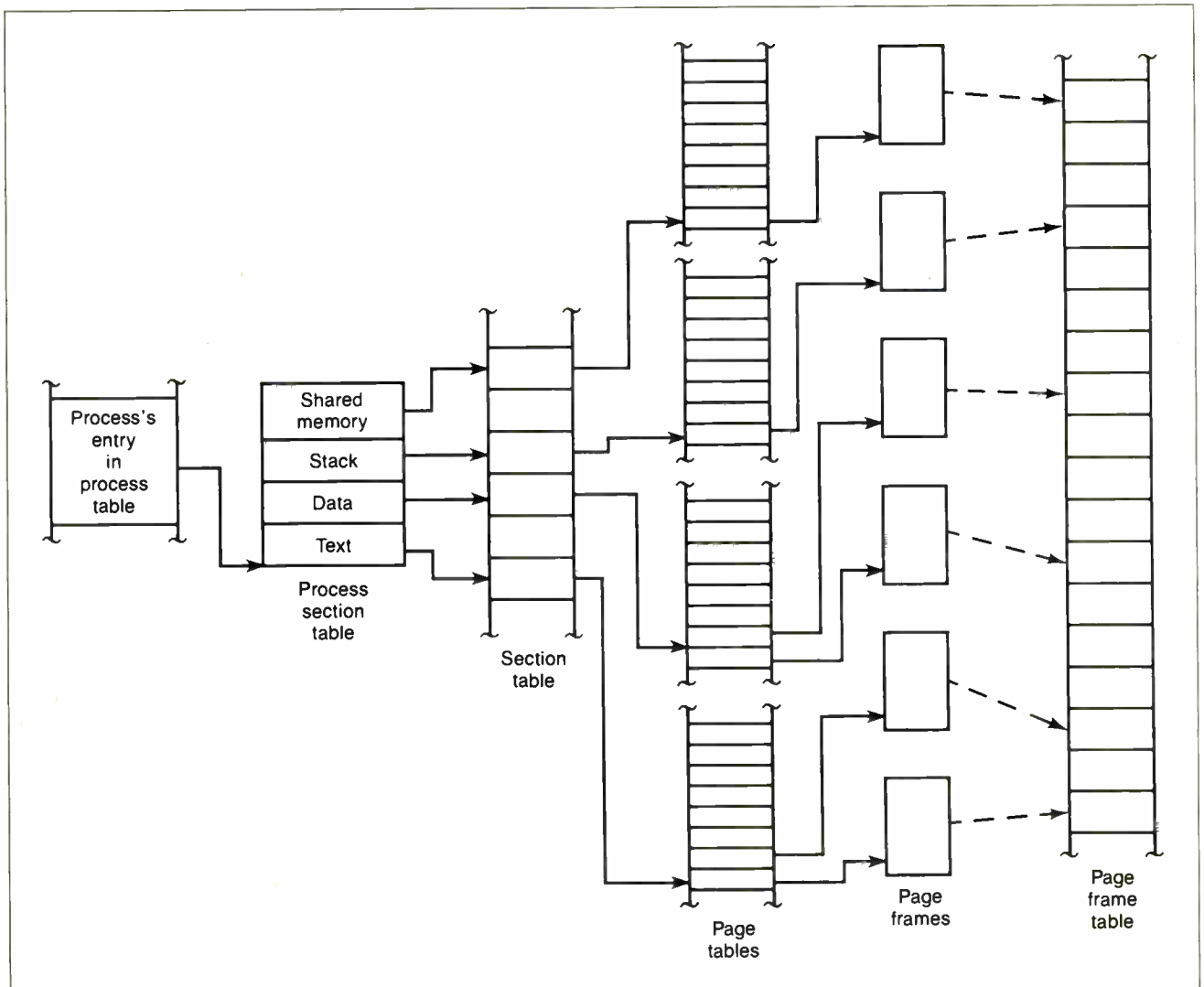
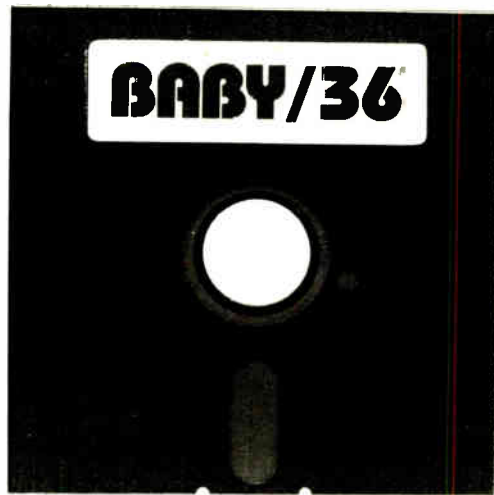

Figure 5: The entire memory management organizational hierarchy.

This Software Won't Run.



Without This.

And that's the way California Software Products, Inc. wants it. And a host of other big and not-so-big software developers who use our Software Sentinel. To make sure their successful software is protected. So it stays successful.

We've become used to being seen with top-notch software. A lot of the reason is how our engineers designed the Software Sentinel family. For the developer and the user. To make it the most technologically foolproof yet easiest to use software protection key you or CSPI can get.

For users of BABY/36 and the thousands of other programs we're protecting, it's a cinch to get up and running. They simply plug the Software Sentinel into the PC's parallel printer port. That's it. How much easier can it get? Users can even make unlimited backup copies. And run them wherever and whenever they need to—as long as they have the Software Sentinel key.



As long as we're talking success, there's something else you should know. Right now, our engineers are putting the finishing touches on a new microprocessor that we'll use in a whole new generation of software and data protection products. With the same high-performance and high-reliability of our past successes but with many new features. Which no doubt is going to make life even easier for you and CSPI.

The Software Sentinel. Making sure software developers stay successful with the successful software they've developed.

For more information on the Software Sentinel family, contact Rainbow Technologies, 18011-A Mitchell South, Irvine, California 92714; or call (714) 261-0228.

Software Sentinel Features:

- Runs under DOS and Xenix
 - Uses algorithm technique, never a fixed response
 - Minimal implementation
 - Higher level language interfaces included
 - Transparent operation
-



RAINBOW TECHNOLOGIES

18011-A Mitchell South, Irvine, CA 92714 • (714) 261-0228 • TELEX: 386078 • FAX: (714) 261-0260

©1987 Rainbow Technologies, Inc. Software Sentinel is a trademark of Rainbow Technologies, Inc.
BABY/36 is a trademark of California Software Products, Inc.

A process has at least three sections, and unless we engage in some trickery, each has its own page table.

cess's entry in the process table or in the U area, or it could be allocated separately and linked to the process table entry or U area. Each entry in the process section table points to a section table entry.

Page Table and Page Frame Management

It must be possible for a section to map a large virtual address area so that we can run those few applications that use a large amount of memory. Thus, we must be able to attach an arbitrary number of page tables to a section.

However, because a single page table can map 4 megabytes of virtual address space, most sections have only one page table, and that is the case we wish to handle most efficiently. Each section table entry contains the first (and usually only) element of a list of pointers to page tables. Pages for page tables are dynamically allocated as needed.

The page frames at the low end of physical memory are dedicated to kernel code and static data when the kernel is loaded. Page frames above these can be allocated as needed.

Information about these allocatable page frames is kept in a *page frame table* established by the kernel at start-up after it has determined how much memory it has. Page frames available for allocation have their table entries linked on a *free list* so that it is easy to find the next one to be allocated.

Pages in Memory and on Disk

A page of a user program's virtual address space can be in memory, where it is accessible to the program, or it can be on disk, in either an executable file or the page swapping area. If a page is not in memory when it is referenced by the program, the page fault handler allocates a page frame and reads in the page from disk. Both the memory and disk forms of a page can coexist. For example, a text page always has an image in the executable file, even if it is in memory, because text pages are read-only.

Because a page can reside both in memory and on disk at the same time, we must be able to keep track of both of them. The straightforward solution to this problem

is to use arrays of *disk page descriptors* that parallel the page tables. Each PTE has a corresponding descriptor that tells whether the page is on swap, is in a file, or is a demand 0 page. If the page is on swap or in a file, the descriptor specifies where it is on disk. A demand 0 page is cleared to 0s when it is allocated, and it has no image on disk. Demand 0 pages are used for uninitialized data, the stack, and dynamically allocated memory.

The trouble with the disk page descriptor solution is that it increases the page table overhead. A process has at least three sections—text, data, and stack—and unless we engage in some complex trickery, each has its own page table. On a processor with 512-byte pages, this would be only 1.5K bytes of page tables per process. But the 80386 has very large 4096-byte pages, requiring 12K bytes of page tables per process. If we allocate a page of disk page descriptors for each page table, which is the straightforward thing to do, we double this already large memory overhead.

The alternative is to put the disk information in the PTE when the page is not in memory, and put it in the page frame table entry when the page is in memory. Using the PTE for both memory and disk information is a bit more complex than the disk page descriptors but uses much less memory.

Page Caching

When a page frame contains data that is also on disk, its entry in the page frame data table shows where its image is on disk. When a page frame is put on the free list, it retains its disk identity until it is reallocated for a different use. If the page with that identity is needed again before the page is reallocated, it can be reused without reading from disk, because it already contains the needed data. Being able to locate a page frame with a particular disk identity is called *page caching*. It improves system performance by avoiding unnecessary disk reading.

Page frames that do not have a disk identity, such as the modified data and stack pages of a defunct process, are placed at the head of the free list when they are freed, and those that do have a disk identity are placed at the tail. That way, page frames that cannot be reused are reallocated first, and those that can be reused are reallocated in least-recently used order.

How It All Works

Now that we have presented our memory management design for Unix on the 80386, let's briefly discuss how it works. When the kernel executes a program, it creates text, data, and stack sections and

allocates page tables for them. The PTEs in the text section and in the initialized part of the data section are set up to point to the corresponding pages in the program executable file. The PTEs in the uninitialized part of the data section and in the stack section are marked demand 0.

When the process first starts to run, it immediately accesses the text page containing its entry point, causing a page fault. The page fault handler corrects the fault by bringing in the page of text from the executable file. The first instruction accesses the stack, causing another fault. Stack pages are demand 0, so the page fault handler simply allocates a page frame and clears it to 0s. Another instruction accesses an initialized static variable, causing a fault on a page in the data section, and the page fault handler brings in the data page from the executable file. This process continues until all the pages accessed by the program have been faulted in.

As long as there is enough physical memory so that the pages needed by all the processes can be in memory at the same time, the kernel can run without paging out. But when the kernel runs out of free page frames, it must free some for reallocation. This is sometimes called page stealing.

The prime candidates for stealing are pages belonging to processes that are waiting for events that may not occur for a while, such as a keystroke at a keyboard. If a process is waiting for a "slow" event, it is swapped out entirely. Otherwise, the kernel frees the pages least likely to be accessed again soon.

Text pages, and initialized data pages that have not been modified, can be freed without writing, because their images are in an executable file. Stack and modified data pages must be written out to the swap area on the disk before they can be freed. The PTEs for the stolen pages are changed to point to the pages on disk.

If a page frame is stolen away from a process and reallocated, the page must be read in from disk when it is accessed again. But if the process accesses the page before it is reallocated, the page frame is found in the page cache, and no I/O is necessary.

A Happy Marriage

Unix and the 80386 are a happy marriage. The processor is fast, has a large address space, and provides on-chip memory management that supports demand paging. Everything you need to implement Unix efficiently is there. ■

Carl Hensler and Ken Sarno are software engineers at Interactive Systems Corp., Santa Monica, California.



**LOTS OF ONLINE
NEWS SERVICES
GIVE YOU NEWS.**

**SERVICE IS
ANOTHER STORY.**

Introducing the business news service that serves you better. McGraw-Hill News. It's up-to-the-minute business news. *Online* and in time for you to do something about it.

It's news about specific companies and industries. Government, stock market, economic, political news. It gives you the whole story—plus its *implications* for your business.

And it's easy to get to McGraw-Hill News because it's available on a variety of

online services, including CompuServe, DIALOG, DRI, BIX and Executive One.

Best of all it's from McGraw-Hill, the people who bring you Business Week, and *online* services such as S & P MarketScope and DRI.

Our business is getting business news to you. With service you won't find anywhere else.

Find out more. For a FREE brochure call 1-800-426-0647. And get the news.



**McGraw-Hill
NEWS**

THE BUSINESS NEWS SERVICE THAT SERVES YOU BETTER.

© 1988 McGraw-Hill, Inc. All rights reserved.

The Big Ban



World Pacific History

g Theory.



In the beginning, there was power. When Wyse engineers set out to create a new PC family, their objective was not merely to design a new system, but a new *design*. Criterion one was power with total compatibility: higher performance for industry standard software. Today's *and* tomorrow's.

The results are four uniquely upgradeable Modular Systems Architecture™ Wyse PCs that make up the most powerful PC family in the business.

At the top, the new WYSEpc 386 has one of the highest benchmark ratings yet for a personal computer. Our unique design achieves exceptional memory speed as well as processing speed for zero wait state performance on multiple operating systems. Such as MS-DOS®, OS/2™, and Xenix®. For CAD/CAE, heavy duty spreadsheets, or multi-user applications, it delivers power to satisfy the insatiable.

And it's *only* the beginning. Our 8MHz AT compatible, 12.5 MHz professional desktop 286, and 12.5 MHz zero wait state 286 provide more power for every level of user.

Introducing SystemWyse™. Our PCs form the core of a comprehensive system for creating solutions. They link effortlessly with our terminals, monitors, and expansion modules in solutions of exceptional quality and value. And SystemWyse is backed by the company that makes more terminals than anyone but IBM.

SystemWyse. It's a power structure you can build on. Call for more information. **1-800-GET-WYSE**

WYSEpc 386 driving our VGA color monitor. Actual screen image.

Wyse® is a registered trademark of Wyse Technology. SystemWyse, WYSEpc 386, and Modular Systems Architecture are trademarks of Wyse Technology. Other trademarks/owners: MS-DOS, Xenix/Microsoft; OS/2, IBM/International Business Machines.

WYSE

We make it better, or we just don't make it.

Circle 298 on Reader Service Card

World Radio History

HypertExpert Systems

...something totally new from Knowledge Garden

HYPertext

Hypertext lets you link related concepts, logic or procedures. It adds a whole new dimension to written material like training manuals, help systems and reference works. Hypertext allows users to access information in a non-linear fashion by following a train of thought. Hypertext lets the reader control the level of detail and the type of information displayed. But that's just one side of the coin.

EXPERT SYSTEMS

The other key ingredient to real exchange of knowledge via the computer is control by the author. That's why integration of hypertext and expert systems is such a breakthrough — it lets communication take place between teacher and pupil, author and reader, expert and novice. It lets each side REACT to what the other says.

Announcing KnowledgePro™, a new development environment, from Knowledge Garden. It integrates **hypertext** with **expert systems** to create the world's first **knowledge processor**. KnowledgePro is unlike anything you have seen before.

KNOWLEDGE PROCESSOR

The age of packaged knowledge is upon us. PC's now have the power to manipulate, store and retrieve knowledge using KnowledgePro, **a language for experts**, and **a tool for beginners**. KnowledgePro is the first system to provide an effective, simple and aesthetic medium for the communication of knowledge on disk.

Big corporations can now construct expert systems for internal use quickly and without expensive AI training. Individuals can author knowledge bases for commercial or educational use.

KNOWLEDGEPRO

KnowledgePro is a totally new development environment created by Bev and Bill Thompson. It costs \$495 plus \$5 shipping and handling and runs on IBM PC, XT, AT or PS/2 with 512k memory. KnowledgePro is not copy-protected and there are no run-time fees. A working demonstration disk is available for \$30 with full credit towards purchase of KnowledgePro. Call today **to order** your copy.

A LANGUAGE FOR EXPERTS

KnowledgePro is for experts because it provides a wide variety of structures to work with. It has many advanced features, like inference, list processing, topics, procedural control and inheritance. You can write new procedures in other languages and interface to other programs. You can read DBASE III and LOTUS 123 data directly into the knowledge base.

A TOOL FOR BEGINNERS

KnowledgePro let's you communicate knowledge, easily and without spending weeks on the details. KnowledgePro handles the details for you. It provides easy access to colors, windows and mouse control. It's been called the BASIC of the 80's because anyone can get results quickly — and then grow into more sophisticated features at their own pace.

TO ORDER

Call 518-766-3000 (American Express, Visa, M/C accepted) or mail your **check** today. *check*

Knowledge Garden Inc.
473A Malden Bridge Rd.
Nassau, NY 12123

The run-time version of KnowledgePro is free on the electronic networks or \$15 from Knowledge Garden complete with useful example applications.



Another intelligent tool in the Knowledge Garden family of products.

Published by



IBM is a registered trademark of International Business Machines Inc. KnowledgePro is a trademark of Knowledge Garden Inc. DBASE III is a trademark of Ashton Tate. LOTUS 123 is a registered trademark of Lotus Development Corp. Photo Tcherevkoff ©

Macintosh Memory Management

With the Mac's generalized design, you can use the same software on a Mac 512KE or on a Mac II

Alan Anderson

MOST NEW INVENTIONS in the computer industry are evolutions. When a computer company decides to develop a new machine, the design is usually done within the constraints of the company's existing products, making it harder to come up with something innovative. Why is this? Because the company isn't likely to create a product that can't be used by past customers, who have made a tremendous investment in the older computers with the purchase of software and peripherals. The most recent example of this phenomenon is OS/2, which includes the ability to run MS-DOS applications that were created long before OS/2 was conceived.

Once in a while, though, engineers are allowed to invent a system without having to worry about compatibility. Obviously this is a pretty risky thing to do, but it can produce major leaps in the state of the art. This is what Apple Computer did with the Macintosh in the years before its introduction in 1984. The Macintosh didn't have to run existing software. Of course there were constraints, but they involved the computer's physical size and cost.

Unhampered by software compatibility requirements, the Macintosh designers were free to invent and borrow whatever they wanted to reach the goal of a powerful, easy-to-learn computer. Two parts of the design were improved significantly. The first was the now-familiar Mac user interface of mouse, windows, and icons. The second improvement was internal and involved a generalized system design. An important part of this

generalized system is the Macintosh Memory Manager.

Memory Manager Background

Currently, there are seven different Macintosh models (the Mac 128K, the Mac 512K, the Mac XL, the Mac 512KE, the Mac Plus, the Mac SE, and the Mac II), using 68000 and 68020 microprocessors and perhaps having one or more slots. However, thanks to the generalized system design, the programmer's view of all of them is very much the same. Each machine contains a large part of the user-interface routines (called the Toolbox) and operating system in ROM, with additional routines loaded into RAM from a system disk.

The requirements of the Macintosh made it clear that it had to have good control of RAM use. The Macintosh was to be a very busy system: At any time, the screen contains a menu bar, windows, controls like push buttons and check boxes, and other miscellaneous graphic objects. Each object is controlled by a part of the Toolbox—the Menu Manager for menus, the Window Manager for windows, and so on. Each of these managers has to allocate memory for its objects without stepping on the application or its storage. The Memory Manager was created to act as a clearinghouse for memory allocation requests and to keep its clients from overwriting each other.

The Memory Manager also has to handle a large amount of traffic, with new objects being allocated and old ones being deallocated constantly as an application executes. Ideally, the Memory

Manager needed a way of ensuring that the free memory opened up between allocated objects as other objects were released didn't go to waste. This was especially true for the Mac 128K, where objects had to be shoehorned into a cramped memory space. To fulfill these design goals, the Memory Manager was given the ability to allocate memory blocks that can be moved around, or relocated, in memory and to deallocate memory blocks as necessary.

The Memory Manager allocates these objects from an area in RAM called a *heap*. Most operating environments use a stack for various purposes: variables, return addresses, and stack frames, among other things. The Macintosh also has a stack, a separate structure from the heap, which it uses for these conventional things. Register A7, the stack pointer, contains the address of the top of the stack. In a typical Macintosh application, the stack contains the program's declared variables, while the heap holds its dynamically allocated objects.

Of course, without any hardware memory management support, there is no way to physically prevent a program from writing anywhere in RAM, but the Memory Manager at least implements an honor-system rule: *Don't use memory unless you get it from the Memory Manager.*

If you get memory through the Memory Manager, it at least knows what part of memory you're using, and this ensures that future memory requests made to the Memory Manager won't affect your

continued

One benefit of the Memory Manager is that programs take advantage of extra RAM automatically.

block of memory. This system works as long as every program obtains its memory through the Memory Manager.

One benefit of using the Memory Manager to allocate memory is that applications can take advantage of machines with more RAM without requiring special code. The result is that many applications originally written for Macintoshes with 512K bytes of RAM automatically can make use of the 8 megabytes of RAM available in a fully loaded Mac II.

Since the Macintosh Memory Manager presents all available RAM as simply a series of blocks allocated through a procedural interface, seeing a memory map of the system isn't vital for most programmers, although it's useful for debugging. So, before I present a memory map, I'll take a closer look at how the Memory Manager operates.

Purgeable and Relocatable Blocks

The Memory Manager employs some elaborate software techniques to make the most of RAM. Memory blocks can be made *purgeable* if desired. The Memory Manager can return purgeable memory blocks to the free-memory pool when space is needed. How is this feature put to work in the Macintosh?

The answer lies in looking at how Macintosh applications are put together. A Macintosh application is a very granular collection of diverse items: pieces of code, text strings, templates for windows and controls, pictures, menus, icons, color information, and much more. Most Macintosh applications are split into many different code segments, each of which can be loaded separately. All these items are called *resources*.

Each resource can be loaded from disk individually. This characteristic is crucial, because it makes resources perfect candidates for purgeable memory blocks. Since each resource is available on disk, it's still accessible if the in-memory copy is purged. The Macintosh operating system also provides a facility for updating a resource on disk if it's altered in memory. Of course, there are some complications: Some resources are so vital that they should never be purged (more on this later). Since the programmer can make

any resource purgeable or nonpurgeable, this normally isn't a problem. In practice, only memory blocks that contain resources are made purgeable.

Another Memory Manager feature that makes good use of available RAM is the ability to manage *relocatable* blocks, which are created with the system call `NewHandle` and are deallocated using `DisposHandle`. To get reasonable system performance, all memory blocks that the Memory Manager allocates must be made up of contiguous bytes.

In a system that constantly loads new objects and deallocates old ones, this can cause lots of free-space "holes" to develop in the heap. To alleviate this problem, memory blocks marked as relocatable can be moved, allowing the free blocks to be fused together into a single, larger free space. The Memory Manager moves relocatable blocks only at well-defined times—specifically, only when a request requires a memory block that can't be allocated using the current free space.

This technique also adds some complications. The Memory Manager must make sure that relocatable blocks aren't moved "out from under" an application. That is, if the Memory Manager moves a block of memory that an application is using, it must provide some means for the application to access the block at its new location.

When a program requests a relocatable block, the Memory Manager allocates it, then stores its address (i.e., a pointer to the block) into a private data structure called a *master pointer*, whose address never changes. Rather than returning that pointer to the caller, the Memory Manager returns the address of the master pointer. This value, called a *handle*, is a double-indirect pointer to the memory block. The handle is used with a double dereference to refer to the block wherever a pointer and a single dereference would normally be used.

What happens when the Memory Manager has to relocate the block? After moving the block to its new location, the Memory Manager stores its new address into the master pointer. Remember that the application knows about the block by its handle, which is the address of the master pointer. The address of the master pointer never changes, so the handle to the block remains valid even if the master pointer's value changes. Note that, for this scheme to work, the master pointers must be nonrelocatable. Nonrelocatable memory blocks are created with the system call `NewPtr` and deallocated with `DisposPtr`.

As with purgeable blocks, there are objects that must not be moved. The best instance of this is a memory block that

contains active code. For example, the 68000's RTS (return from subroutine) instruction relies on an absolute return address that's kept on the stack. Now suppose a routine inside a relocatable block calls another routine with a JSR (jump to subroutine). Next, the block containing the calling routine is relocated while the other routine is running. The RTS from the running routine will be disastrous since the address on the stack no longer points to the intended block.

To prevent this problem, the Memory Manager can temporarily prevent relocatable blocks from being moved, or *lock* them. The system call `HLock` locks a memory block's position in memory, and `HUnlock` unlocks it. Code that's not part of the current chain of return addresses can be relocated, or even purged, if necessary.

The Perils of Relocation

This scheme of relocatable objects works very well in general, but there are a few problem situations. One scenario to watch out for is calling a routine that expects a pointer and providing a pointer to a relocatable object. The pointer will be valid only as long as a request to the Memory Manager does not trigger memory relocation. For example, let's assume that `myRecord` is a handle to a record:

```
FarawayProc (myRecord);
```

This call passes a pointer to the record. Since the record is a relocatable object, it might be moved. If `FarawayProc` contains a statement that allocates memory, either directly or indirectly, it may cause the block containing `myRecord` to move, causing the pointer to become invalid. A reasonable way to avoid this problem would be to use an assignment statement to make a copy of `myRecord` into a global variable, then pass a pointer to that variable to `FarawayProc`. This works because global variables are not kept in relocatable blocks. Another solution would be to lock the block that `myRecord` points to before calling `FarawayProc`.

You may be wondering why I pass a handle to a global variable rather than simply a pointer (i.e., `myRecord`), since I'll use a pointer to reference the global variable and thus create a handle to `myRecord`. The answer is that some Pascal compilers may create implicit dereferences (i.e., convert a handle to a pointer) as they optimize the object code. The only defense against problems like this is a thorough understanding of the Memory Manager and your development system.

Let's look at a more subtle—but just as dangerous—situation. In order to optimize an inner loop and prevent unne-

continued

Intelligent statistics. Consider the alternatives.

Today there are numerous micro-computer statistics software packages to consider.

But, in the considered opinion of many experts, there is one that is clearly better.

Highest rated.

In its recent review of the five leading microcomputer statistics programs, *InfoWorld* concludes that Systat™ Version 3.0 is "unrivaled in performance", "tops in number crunching power" and "unfailingly accurate."

And *InfoWorld* doesn't stop here, but goes on to rank Systat as the Number One statistics package of the group.

In doing so, they aren't alone. Every published independent comparative review rates Systat at the top of the list.

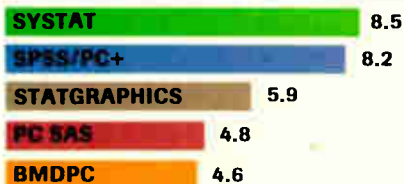

Of the statistics packages reviewed by InfoWorld, Systat rated highest, as it has in every published competitive review.

Some practical benefits.

Such ratings are important because they relate directly to the quality of your work, not just to glitzy features. For example:

Are capabilities important to

you? Systat gives you more statistical capabilities than any microcomputer statistical package, including three major procedures that PC SAS® and SPSS/PC+® programs simply don't offer.

Is accuracy important? Systat gives you more accuracy. In fact,

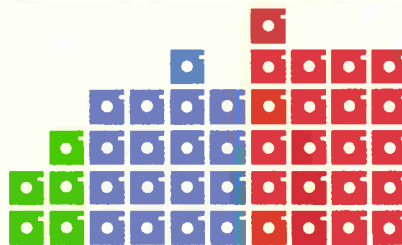

Although more comprehensive, Systat requires less than 1/2 the commands and has 1/2 the bulk of competitive programs. Compare its 5 disks to 17 for SPSS/PC+ and 21 for PC SAS!

numerous reviews and technical conference proceedings consistently prove Systat to be the most accurate statistical package available.

Is ease of operation important? Systat operates on less than 1/2 the commands of its two largest competitors, with less than 1/2 the bulk. According to *InfoWorld*, "Systat's commands are terse, and a few keystrokes will do amazing things."

Is cost important? Systat costs less than any other major package: less than 1/2 the price of the comparably equipped PC SAS or SPSS/PC+.

Truly interactive.

Unlike its major competitors, Systat has *not* ported some 20-year-old code from a mainframe program. Written specifically for microcomputers, Systat Version 3.0 uses an incredibly small amount of disk space: only 1.4 megabytes versus their 5 to 10 megabytes.

What's more, the package is genuinely interactive, freeing you from rigid command protocols. In doing so, Systat allows you to approach statistical problems more intelligently: letting you work the way you think instead of forcing you to think the way it works.

Next to this, the alternatives to Systat don't look very bright.

For more information and a complete copy of the *InfoWorld* review, call 312 864.5670, or write Systat Inc., 1800 Sherman Avenue, Evanston, Illinois 60201.

Systat operates on IBM PCs® and compatibles, MS-DOS® and CP/M® machines, several UNIX® minicomputers and mainframes, and the VAX/Microvax®. Menu/windowed Macintosh® version also available. Single copy price \$595 USA and Canada, \$695 Foreign. Site licenses and quantity prices available.

The following are registered trademarks: BMDPC of BMDP Inc., CP/M of Digital Research, Inc., IBM PC of IBM, Inc., MS-DOS of Microsoft, Inc., PC SAS of SAS Institute Inc., SPSS/PC+ of SPSS Inc., STATGRAPHICS of STSC Inc., UNIX of AT&T and VAX of Digital Equipment Corporation.

Systat. Intelligent statistics.

IMAGING CARD



DV-01 GRAY SCALE FRAME GRABBER

Composite video in/out
256 x 240 resolution
Digitize/display at frame speed
256 gray levels in
16 Meg. color palette out
PC/XT/AT compatible

\$849.00 Complete with software

Control Vision

P.O. Box 596, Pittsburg, KS 66762
(316) 231-6647

Circle 71 on Reader Service Card

IBM/PC DOCUMENT CONVERSIONS

WORDFORWORD

The Industry Standard in
document conversion.

- Two way conversions
- Preserves all formatting
- Fast and menu-driven
- Special "Smart" ASCII retains page formatting

\$149.00

Supports conversions between:

WordStar	WordPerfect	MultiMate
PFS: WRITE	PFS: First Choice	PFS: Pro Write
OfficeWriter	IBM Writing Asst.	Microsoft Word
Volkswriter	DCA/RFT	ASCII
XyWrite	EBCDIC	"Smart" ASCII
DisplayWrite		

LAN Version \$299

Call (800) 624-6107, Dept. B

MASTERSOFT, INC.
4621 N. 16th ST.
PHOENIX, AZ 85016
(602) 277-0900

Circle 157 on Reader Service Card

FAX/Scanner/OCR

For IBM
XT / AT / 386
& Compatibles



Three Powerful
Computer Products in One.

- All the features of CCITT Group III Facsimile Machine + the ability to send direct from ASCII files & 9600 bps data modem w/CRC checking.
- Sends multiple FAX's to multiple destinations instantly, or when you choose + receives while you use your computer for other programs.
- Scanner reads line art, photos, and FAX & OCR documents up to 300 dpi w/32 dither shades + editing.
- OCR translates to ASCII files typewritten, letter-quality, & dot matrix print + proportional spacing.

Complete System Price **\$2495.**
(Including all Interfaces & Software)

Call (408) 748-8611

Spectron Systems - Mastercard & Visa Accepted
2405 De La Cruz Blvd. Santa Clara, CA 95050

Circle 311 on Reader Service Card
(DEALERS: 312)

MAC MEMORY MANAGEMENT

sary double dereferencing, programmers sometimes perform one dereference before entering the loop. In this example, I'll assume that `matHdl` is a handle to an array of 500 integers, and I want to initialize each of them to its index value:

```
matPtr := matHdl^; {dereference
matHdl}
for index := 1 to 500 do
    matPtr^.theArray[index] :=
index;
```

In this example, the handle is dereferenced and the master pointer is copied into `matPtr`. If the block is relocated while the loop is executing, I'm in trouble, since in that case `matPtr` will no longer point to the block. However, blocks are never relocated unless the Memory Manager is trying to allocate a new block. By examining the source code, you can see that no new memory is being allocated within the loop—it's simply storing values. So, this technique is safe to use.

What if the loop contains a statement that can cause memory to be allocated, as in the next example?

```
matPtr := matHdl^;
for index := 1 to 500 do
    begin
matPtr^.theArray[index] := index;
DrawText('Another'); {Trouble!
See below}
    end;
```

This time, the Macintosh ROM routine `DrawText` is called each time through the loop. Although it's not obvious, `DrawText` can trigger memory allocation. If the Memory Manager does allocate a new memory object for `DrawText`, `matPtr` can become invalid. To prevent problems like this, be sure not to rely on pointers to relocatable objects after using Toolbox calls that can cause memory allocation. *Inside Macintosh* has a list of the ROM routines of this type. The safest technique is to always use the handle and double dereference, like this:

```
for index := 1 to 500 do
    begin
matPtr^^.theArray[index]
:= index; {Safe technique...}
DrawText('Another'); {...since
handle is always valid}

    end;
```

Memory Organization

I've already said that there's a heap and a stack in RAM, so I'll discuss the other important areas of memory (see figure 1). Notice that there are actually two separate heaps, called the system heap and the application heap. The system heap is created as the Macintosh starts up and is never reinitialized. It holds objects that are used exclusively by the system, such as device drivers. By contrast, the application heap is created when an application starts up and is destroyed when the application quits.

Note that the application heap starts just above the system heap. This obviously prevents the system heap from growing further, so it's a fixed size. The application heap, however, has room to grow upward in memory, and the stack can grow downward. The operating system uses a couple of schemes to keep the application heap and the stack from colliding. To avoid collisions from the bottom (the heap growing into the stack), the Memory Manager prevents the heap from growing past a predetermined limit, called `ApplLimit`.

Restraining the stack is a little trickier, since it grows as a direct result of 68000 instructions, without giving the operating

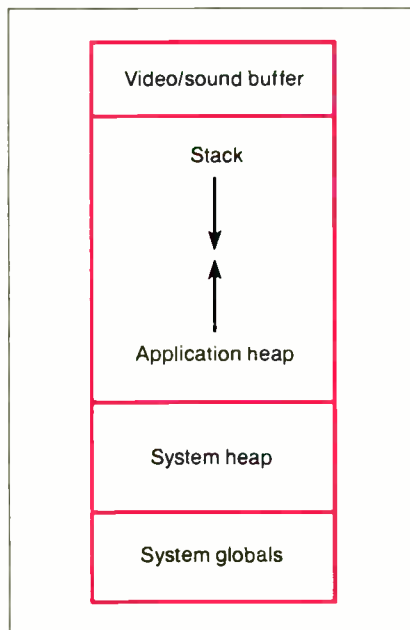

Figure 1: Memory organization in the Macintosh family. The Macintosh II memory layout is essentially the same, except that the video buffer is located in the NuBus slot space. The application heap is allocated just above the system heap and grows upward in memory, while the stack grows down. The application heap is destroyed each time a new application is loaded, while the system heap and system globals remain intact throughout the operation of the computer. This memory model is valid for any Macintosh running under the Finder.

MAC MEMORY MANAGEMENT

system a chance to intervene. Instead, the operating system frequently checks the stack pointer to see if it has gone below the highest heap address. The routine that performs this check is called the "stack sniffer."

There are two ways to exhaust memory in the Macintosh with this memory model. The first condition occurs when the Memory Manager is unable to find enough memory to satisfy a request by NewHandle or NewPtr. In this case, the Memory Manager passes an error code to the calling routine and allows the application to respond to the problem in a reasonable manner.

The other out-of-memory condition occurs if the stack sniffer finds that the stack has overflowed into the application heap. Since the damage has already been done in this situation, the Macintosh reports a system error 28 (the infamous "bomb box").

There are two other areas of RAM shown in figure 1. The lowest part of memory, called the system globals area, contains crucial information for the microprocessor, the operating system, and the Toolbox. This area includes the 68000 exception vectors—a table of system routine addresses—and global variables used by all parts of the operating system and Toolbox.

The highest part of RAM on the Mac Plus and the Mac SE is a memory-mapped buffer for video and sound. For the Mac II, the video buffer is physically located on the video card that's mapped to a NuBus slot address range, and the sound buffer is contained in the Apple custom ASC chip, which is also mapped into a different address range. [Editor's note: *For a look at the memory map of the Mac II, see BYTE's Inside the IBM PCs, Fall 1987, page 90.*]

The most important rule for using the Macintosh Memory Manager is to try to use relocatable blocks for all heap objects, and to avoid locking them. This allows the Memory Manager to consolidate the free space in the application heap. If you must lock relocatables, be sure you don't allocate any new blocks while another block is locked. If you do, this can fragment the heap temporarily, and the Memory Manager might not be able to find enough free space to fulfill your next request.

Even if you're careful about your relocatable objects, you may still run into some problems. As discussed earlier, code segments have to be locked while they're executing so that the return addresses stay correct. Depending on how your program is segmented, this can lead to a fragmented heap.

There is a two-part strategy for avoid-

ing this problem. First, use the operating system call UnloadSeg to make unused code segments purgeable; second, try to allocate all new heap objects from the program's main loop. The main loop is always loaded and is firmly entrenched as one of the first objects in the heap. This will leave most of the heap free of locked segments when new objects are created. Following this strategy will help ensure that new objects have their pick of a heap that's as unobstructed as possible.

For serious Macintosh debugging, you'll get to be pretty friendly with an object code debugger, such as Apple's MacsBug or Icom Simulations's TMON. These programs let you examine memory, display your program's code, and show you what your heap looks like. There are also several books available on the subject to supplement the excellent foundation of knowledge provided by Apple's *Inside Macintosh*.

MultiFinder

The Macintosh world got a lot more interesting last October when Apple released MultiFinder, the first "multitasking" version of the Macintosh operating system. This package of routines gives the Macintosh the ability to open multiple applications at once, with all of them displaying their windows on the screen at the same time. Switching between applications is accomplished simply by clicking on an application's window.

Although MultiFinder can manage up to a maximum of 30 applications, practical use of MultiFinder is limited by the amount of RAM. A Macintosh with 1 megabyte of memory has barely enough memory to manage two typical applications. If you have 4 megabytes of RAM—the maximum RAM available in a Macintosh Plus or SE—you'll probably have enough memory to last you for some time.

One of MultiFinder's most impressive features is that it amounts to no more than a midcourse correction in the Macintosh memory model, and most applications work with MultiFinder without modification. This was no accident, but the result of a lot of work by the MultiFinder team at Apple.

MultiFinder works by creating a separate heap for each application, as well as allocating its own storage space for each application's system global space, microprocessor registers, and other state information. When an application is started under MultiFinder, a predetermined amount of RAM is set aside for the application heap. This amount is read from a SIZE resource stored within the application. If there is no SIZE resource present,

continued

Eco-C88 C Compiler with Cmore Debugger

Professionals prefer the Eco-C88 C compiler for ease of use and its powerful debugging features. Our "picky flag" gives you nine levels of lint-like error checking and makes debugging easy:

"I'm very impressed with the compiler, editor, and debugger. I've tried quite a few different compilers for the PC and have given up on all of the others in favor of yours... I've gotten to the point where I download C code from a DEC VAX/VMS system just to be able to compile it with the picky flag set at 9. It finds lots of things VMS totally ignores..."

JS, Oak Ridge, TN

The Eco-C88 compiler includes:

- A full-featured C compiler with 4 memory models (up to 1 meg of code and data) plus most ANSI enhancements.
- Without a doubt, the best error checking you can get. We catch bugs the others miss, making you much more productive.
- Cmore is a full-featured source code debugger, not some stripped-down version.
- Robust standard library with over 230 useful (no "fluff") functions, many of which are System V and ANSI compatible. Full source is available for only \$25.00 at time of order.
- CED, a fast, full screen, multiple-window program editor with on-line function help. You can compile, edit, and link from within CED.
- cc and mini-make utilities included that simplifies the most complex compiles.
- Users manual with over 150 program examples (not fragments) to illustrate how to use the library functions.
- Fast compiles producing fast code.

Our Guarantee: Try the Eco-C88 compiler for \$99.95. Use it for 30 days and if you are not completely satisfied, simply return it for a full refund. We are confident that once you've tried Eco-C88, you'll never use anything else. Call or write today!

Orders: 1-800-952-0472

Info: 1-317-255-6476



Ecosoft Inc.
6413 N. College Avenue
Indianapolis, IN 46220

ECOSOFT

DYNAMIC RAMS

1 MBIT	100ns	\$42.00
51258	100ns	\$ 7.50
41464	150ns	\$ 6.25
41256	100ns	SCALL
41256	120ns	SCALL
41256	150ns	SCALL
41264	150ns	\$ 7.95
4164	150ns	SCALL

* For high-speed, Zip, Picc, Semm Please Call!

PROCESSORS		S. RAMS	
80287-18	18MHz	27C101	250ns \$ 29.00
80287-10	10MHz	27C512	200ns \$ 15.00
80287-8	8MHz	27512	250ns \$ 10.95
80287-6	6MHz	27C258	250ns \$ 5.50
8087-1	10MHz	27256	250ns \$ 4.95
8087-2	8MHz	27128A	250ns \$ 4.75
8087	5MHz	27C84A	200ns \$ 4.50
V-30	8MHz	2784	250ns \$ 4.25
V-20	10MHz	43256	120ns \$ 13.95
V-20	8MHz	4364	150ns \$ 4.25

I.C. EXPRESS

15358 Valley Blvd. City of Industry, CA 91746 Tel: 818-369-2688
 ORDER TOLL FREE (Mon-Fri 8-5 PST)
(800) 892-8889 • (800) 882-8181
Outside California
 CALL FOR CURRENT PRICES & VOLUME DISCOUNTS
 Price Shown for cash. MasterCard/VISA add 3%. Prices are subject to change.
 Minimum order \$10.00. Shipping & handling. L&H required \$5.00. Air \$7.00 (T.F.)
 ALL MERCHANDISE IS 100% GUARANTEED WITH PROMPT DELIVERY

Circle 127 on Reader Service Card

**2400 Baud Performance
 Incredible \$149 Price!!**



- 2400, 1200, 300 Baud Async Modem
- Hayes "AT" Command Set
- CCITT V.22 bis, V.22 & Bell 212A/103 Compatible
- Auto Answer/Auto Dial
- Compact Size
- Programmable non-volatile phone number memory, user configuration & speaker volume
- One year warranty

**Order Now
 Toll Free**

USA: 800-533-8049
 CA: 800-624-5628
 MC/VISA/AMEX Accepted
 (805) 524-4189



330 Central Avenue
 Fillmore, CA 93015

Serving Computer Users Since 1982

Circle 52 on Reader Service Card

DUMP YOUR MENU

DUMP your manual and start using **MENU DRIVEN** utility program **DOS MANAGER** for your system's operation. Press a key—Zap! and your command is executed immediately.

- DOS Tutorial
- Format
- Copy
- Mode settings
- Display file contents
- Transmit files

AND many more. All at a Press of a key!!

For IBM PC, XT, AT, . . .

Only **\$39.95** + \$3.50 shipping, send order to:

SOFTWAREL

P.O. Box 1874, Lowell, MA 01853
 (617) 452-2189

Circle 260 on Reader Service Card

MultiFinder allocates, by default, 384K bytes of memory to the application.

This multiple-application world changes the memory map, as you can see in figure 2. The most obvious change is that there is now an application heap for each open application. Also, note that the system heap is not necessarily adjacent to the application heap, as it is in the old memory model, since application heaps are now created from the top of RAM

down. This created a problem with some existing applications that assumed the application heap was located immediately above the system heap, which was always true under the old memory model. This usually isn't the case under MultiFinder, and an application that makes this assumption breaks under the new memory model.

Another phenomenon of life under MultiFinder is that there is often a pool of memory that's not allocated to any application—it's just waiting for possible use by applications that may be started in the future. To avoid wasting this valuable RAM real estate, MultiFinder implements the notion of *temporary memory allocation*.

With this scheme, an application can request memory from this free memory pool. Typically, this is done for a modal situation like a file-copy operation, where the extra memory for buffers helps the job go much faster. MultiFinder provides a procedural interface to manage this memory. There are calls named MFTempNewHandle, MFTempDisposHandle, MFTempHLock, and MFTempHUnlock. Each of these calls performs the same function as its Memory Manager counterpart, except that the space that's managed is in this free memory pool.

Obviously, the temporary memory idea works only through cooperation and good behavior among applications. There's nothing to stop a single program from grabbing the entire temporary space and not letting go. However, most Macintosh users won't appreciate a single application gobbling up all the remaining RAM in their machines, so it's generally a bad idea to do so.

What's Next?

In the future, Apple will continue down the path started by MultiFinder. This first effort opens the door for more features and stronger services that will complete the transition from a single-task system to a true multitasking environment. However, Apple, its developers, and its customers have a tremendous investment in software. For MultiFinder, its engineers had to be concerned with an installed base of well over a million computers.

The Macintosh has come full circle: Now, it must carefully evolve to its new MultiFinder environment, while still providing compatibility for established users. ■

Alan Anderson has written numerous articles about the Macintosh, Lisa, and Apple III computers for various publications. He is currently a writer/engineer living in Cupertino, California.

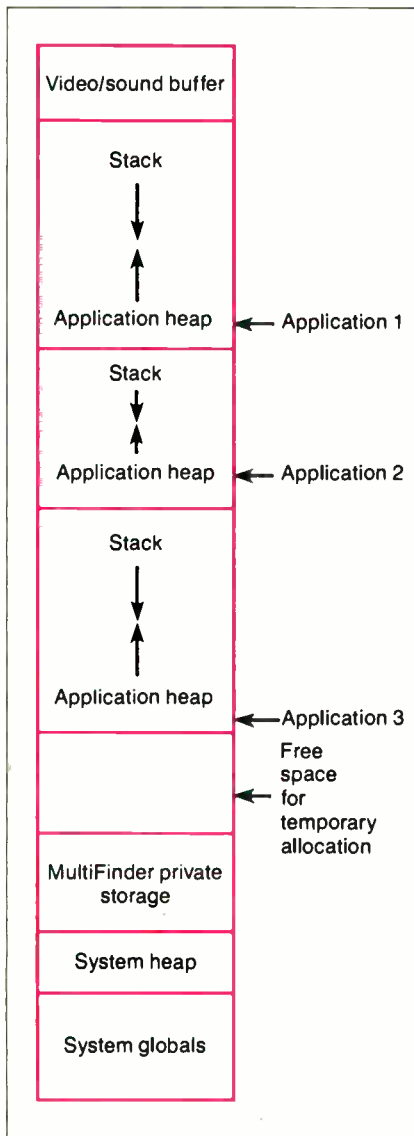
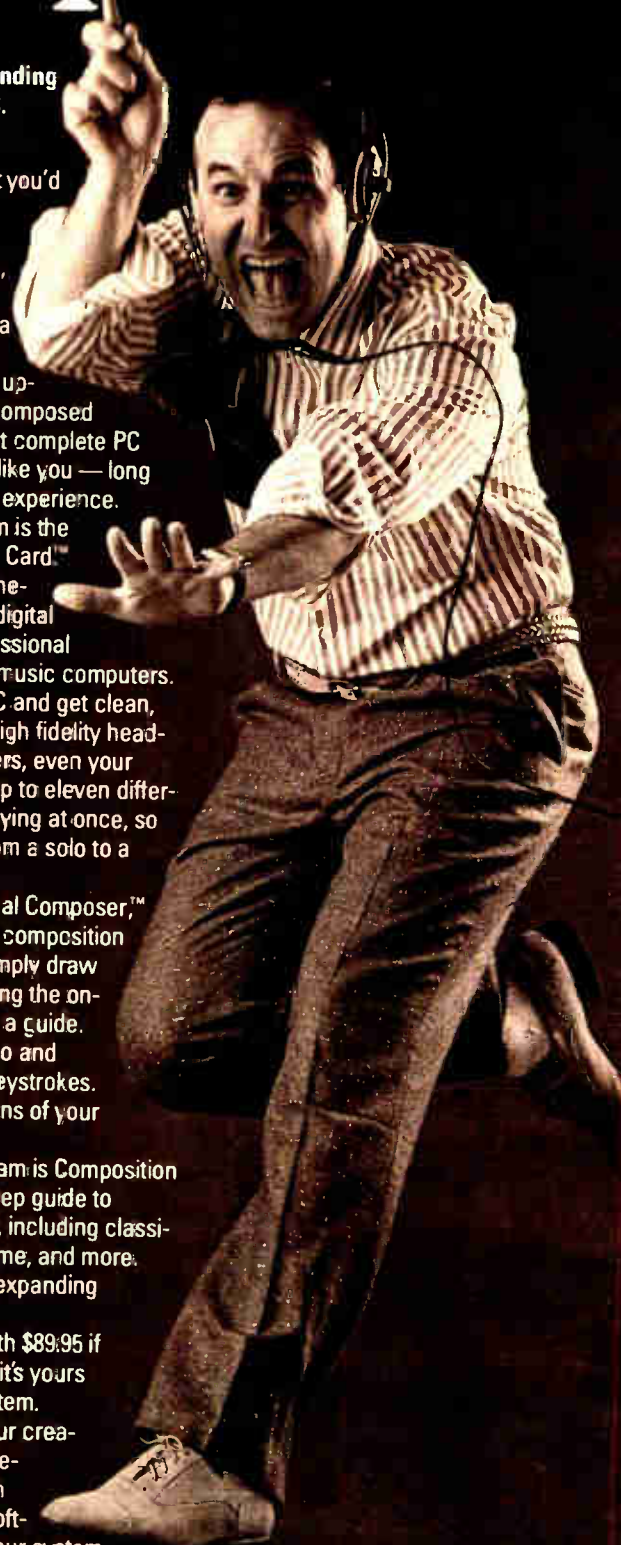

Figure 2: Memory organization for a Macintosh running MultiFinder. Notice that in this memory model each application is allocated its own stack and heap. The size of each heap is determined from information stored in the application. Application heaps are allocated starting from the top of memory. The MultiFinder private storage area contains the state information for each application.

Compose Yourself!



Now create superb sounding music on your IBM® PC. Ad Lib™ makes it easy.

Just when you thought you'd heard it all, along comes Ad Lib.

And with it comes rich, room-filling music like you've never heard from a PC before. With rumbling bass, crystal clear highs, up-front mid-range. All of it composed and performed on the first complete PC music system for people like you — long on desire, a little short on experience.

The heart of the system is the Ad Lib Music Synthesizer Card.™ An electronic sound synthesizer based on the same digital technology found in professional keyboards and the finest music computers.

Just plug it into your PC and get clean, powerful music through high fidelity headphones, bookshelf speakers, even your home stereo. It'll handle up to eleven different instrument sounds playing at once, so it's perfect for anything from a solo to a symphony.

There's also Ad Lib Visual Composer,™ about the most instinctive composition software ever devised. Simply draw lines to indicate notes, using the on-screen piano keyboard as a guide. Change instruments, tempo and volume with a couple of keystrokes. Cut, copy and paste portions of your music in a snap.

Included with the program is Composition Projects™ #1, a step-by-step guide to creating all kinds of music, including classical, jazz, bossa nova, ragtime, and more. Just the thing for an ever-expanding repertoire.

Visual Composer is worth \$89.95 if purchased separately, but it's yours free when you buy the system.

Then play back all of your creations, as well as several pre-programmed selections, on the Juke Box™ playback software, also included with your system.

Look for the Ad Lib Personal Computer Music System™ at selected computer and music stores, or order direct from Ad Lib with your check, Visa or MasterCard.

The Ad Lib Personal Computer Music System. At last, you have what it takes to make great-sounding music.

The Ad Lib Personal Computer Music System. Includes the Ad Lib Music Synthesizer Card, Juke Box playback software, free Visual Composer software with 50 pre-set instrument sounds and Composition Projects #1 \$245.00

Enhance your system further with this additional Ad Lib software:

Music Championship™ #1 — Basic Concepts. Learn to identify basic musical concepts, including tempo, mode, rhythm and key. Perfect for all ages. The first in a series of music training programs combining syn-

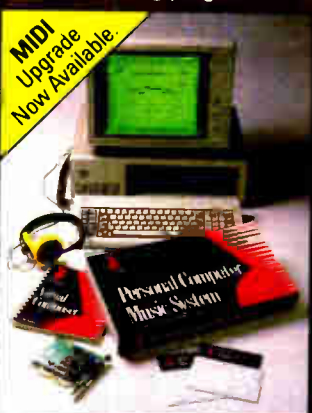

thesized music with exciting computer game competition . . . \$39.95

Instrument Maker software. Lets you create and save new instrument

sounds for use with Visual Composer. After 23 sound characteristics like attack, sustain and decay. Modeled after professional music synthesizer software . . . \$49.95

Look for more Ad Lib music software titles coming soon.

Requires IBM PC, XT, AT or compatible, 256K RAM, CGA, EGA, or VGA.

For the name of your nearest dealer and a free demonstration recording, or to place an order, call us toll free today from either the US or Canada.



Ad Lib Inc.
50 Staniford Street
Suite 800
Boston, MA 02114

AdLib™
Personal Computer
Music System

1-800-463-2686

Circle 8 on Reader Service Card

MEMORY MANAGEMENT RESOURCE GUIDE

MEMORY MANAGEMENT HARDWARE

Intel Corp.
Literature Distribution
Mail Stop SC6-714
3065 Bowers Ave.
Santa Clara, CA 95051

Motorola Inc.
6501 William Cannon Dr. W
Austin, TX 78735

National Semiconductor
P.O. Box 58090
Santa Clara, CA 95052

Fairchild Semiconductor
Corp.
Advanced Processor Div.
4001 Miranda Ave.
Palo Alto, CA 94304

Signetics Corp.
Mail Stop 27A
P.O. Box 3409
Sunnyvale, CA 94088

LOTUS/INTEL/MICROSOFT EXPANDED MEMORY SPECIFICATION

Lotus Development Corp.
55 Cambridge Pkwy.
Cambridge, MA 02142

Intel Corp.
5200 Northeast Elam
Young Pkwy.
Hillsboro, OR 97124

Microsoft Corp.
16011 Northeast 36th Way
P.O. Box 97017
Redmond, WA 98073

SELECTED READING LIST

These operating system books have sections devoted to memory management issues.

Coffman, Edward G., and Peter J. Denning. *Operating Systems Theory*. Englewood Cliffs, NJ: Prentice-Hall, 1973.

Tanenbaum, Andrew S. *Operating Systems: Design and Implementation*. Englewood Cliffs, NJ: Prentice-Hall, 1987.

Bic, Lubomir, and Alan C. Shaw. *The Logical Design of Operating Systems*. 2nd ed. Englewood Cliffs, NJ: Prentice-Hall, 1988.

Two books that describe the Macintosh's handle-based memory manager:

Knaster, Scott. *How to Write Macintosh Software*. Hasbrouck, NJ: Hayden, 1986.

West, Joel W. *Programming with Macintosh Programmer's Workshop*. New York: Bantam Books, 1987.

PERSTOR ADVANCES HARD DISK STORAGE

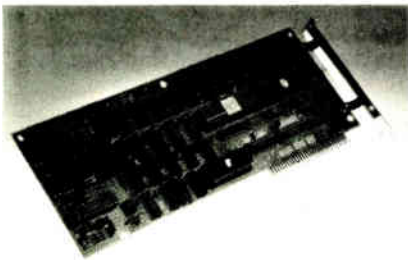

Other RLL controllers require drives approved for RLL encoding. The PERSTOR 200 Series Advanced RLL Controllers are compatible with standard MFM drives and RLL approved drives, whether oxide or plated media.

Our competitors offer only a 50% increase in capacity with their controllers. The PERSTOR 200 Series Controllers allow a 90% or 100% increase in capacity.

If speed is critical to you, the PERSTOR 200 Series Controllers are the answer. They deliver up to a 110% increase in data transfer rate, and a general decrease in system average access time.

FEATURES:

- **ADVANCED CAPACITY** — 90% or 100% increase in capacity.
- **ADVANCED PERFORMANCE** — As much as a 110% increase in speed in your IBM compatible microcomputer.
- **ADVANCED COMPATIBILITY** — Compatible with either MFM or RLL approved drives with oxide or plated media, including Maxtor, Miniscribe, Seagate, Newbury Data, CDC, and more.*
- **ADVANCED VERSATILITY** — Compatible with most PC, XT, AT, or 386 based systems in a single design.

The bottom line is that you can upgrade current systems or design new systems with higher capacity, performance, and quality.

*CDC is a trademark of Control Data Corporation. Maxtor is a trademark of Maxtor Corporation. Miniscribe is a trademark of Miniscribe Corporation. Newbury Data is a trademark of Newbury Data, Inc. Seagate is a trademark of Seagate Technology.

PERSTOR®
PERSTOR SYSTEMS INC.

7631 E. Greenway Rd.
Scottsdale, AZ 85260
(602) 991-5451

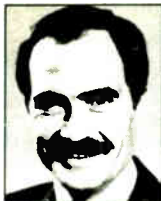

Tech Talk

By Steve Gibson

FEBRUARY 8, 1988

Finding the Ideal Keyboard: One That Won't Throw Spitwads With Its Recoil

You might think that the best keyboard would be the last thing I'd worry about as I was assembling my "dream machine," but it was almost my first concern.

Have you ever stopped to really think about the "feel" of your keyboard? I've long believed that the feel of a computer's keyboard might almost be the single most important aspect of the machine. After all, except for occasional mouse and modem usage, the keyboard is the sole entry point for all of a machine's data. I care tremendously about the feel of the keyboard I'm typing with. I want it to feel just right under my fingers. I want to know from mechanical feedback, without looking, when I've pressed a key successfully. Yet I don't want my biceps enlarged as a consequence.

It's been my experience that most keyboards are utterly horrible, seeming to come only at the far extremes of the scale. Either they just lie there like dead sponges, unresponsive and unreacting, or they fight back tooth and nail, daring you to press the next key. To either extreme I say, "No thanks."

The original IBM keyboard must have been tough to engineer. I can't imagine the mechanical contrivance that was used to induce such a ridiculous snap action underneath such small keys. A keyboard should not be able to launch spitwads across the room with its recoil. Bruised fingertips are not my idea of a typing reward, and it's no fun having to close the windows on a hot summer night for fear of keeping the neighbors awake with the clack-clacking din.

At the other end of the scale we have the ubiquitous sponge-press keyboard. This keyboard dares you to determine whether the computer has sensed your data entry — which is not easy when you sure couldn't sense it yourself. I'm always worried that the keys are just lying there still depressed after I've removed my fingers.

So imagine my joy about a year ago when I stumbled upon a keyboard that knocked me flat (and not from its key recoil). Feeling a bit like Goldilocks, I ran my fingers over its keys. Here was a masterpiece that was neither too stiff nor too mushy — it was just right. It had a marvelous snap action.

Since the company selling this goodly was one of those "here today, gone tomorrow" generic Taiwan clone outfits, I purchased seven keyboards on the spot! I was determined never to be caught without one of these beauties underneath me again.

As I proudly carried my collection home, I reasoned that I'd be adding machines over the years, and I needed them all to be outfitted not only with the best feeling keyboard I'd ever had the joy of touching but also with identical keyboards. There's nothing worse than moving to another machine after really getting used to one keyboard only to find that the Esc key has jumped to the other side of the room. Better to have plenty of spares in the garage.

Shortly afterward, the Taiwan-based company from which I'd purchased my keyboards stopped carrying the one I

loved, and then it stopped carrying anything.

Well about two months ago I received a call out of the blue from a crazy-sounding guy identifying himself as the president of Northgate Computer Systems. Art asked if I was aware of his ads in the back of *InfoWorld*, and he was a bit peeved when I said, "No, not really." So he made me turn to the back of *InfoWorld* to take a look.

"Oh yeah, that's the ad with the tactile snap action diagram," I said. Art said this

was the most incredible keyboard on earth and that he was going to send me one because he could tell from reading my column that I was a "touchy feely" kind of guy.

I warned him about me and keyboards. I told him about my inventory of spare keyboards in the garage, and I said that *nothing* would move me away from these beauties since there was no way to improve upon what I already had. Art was not swayed. He told me about celebrities who were using his keyboard

and said he had lots of congratulatory letters, and it was simply the best keyboard anywhere. "Boy, this guy is a pain," I thought. I shrugged and told him to send it out but that I couldn't promise anything.

When it arrived, my curiosity took over. Imagine my surprise and delight when I found myself facing my dream keyboard, exactly like the four I still had in my garage! If you want the best keyboard I've ever had my hands on, check out Northgate's snap action keyboard.

Critics, Corporations, Individuals Around the World Agree with Steve Gibson,
Northgate's "C/T" is the Best Keyboard

★ 10-Day
Money Back
Satisfaction
Guaranteed!

★ 3-Year
Unlimited
Warranty!



"C/T" 101
NOW COMPATIBLE
WITH ALL
IBM PS MODELS

The Touch and Feel of An Electric Typewriter

The sensation of the computer world, Northgate's Click/Tactile keyboards are setting the new standard for the touch of typing.

Not only Steve Gibson, but computer experts everywhere agree, Northgate has come up with what's been missing in keyboards—positive entry.

Some day all keyboards will use the same keyswitches and quality components Northgate incorporates in its 84-key and 101-key boards.

But for now, Northgate leads the way. Order yours today. If you are not 100% satisfied in every way, return it within 10 days for full refund.

"C/T" 101 KEYBOARD \$99.00

"C/T" 84 KEYBOARD \$79.00

FOR IBM PS MODELS ADD \$15.00

FOR QUANTITY ORDERS CALL 612-553-0111

TOLL FREE 800 453-1400 ANSWERED 24 HOURS

COMPATIBLE WITH MOST CURRENT MODEL XT AND AT TYPE SYSTEMS WITH STANDARD 5-PIN DIN CONNECTOR. SOME COMPUTERS ARE NOT COMPATIBLE WITH STANDARD IBM CONNECTORS—THESE MAY INCLUDE SOME MODELS OF ZENITH, TANDY, AT&T, EPSON EQUITY, PC LIMITED 286.

Phone Your Order Toll Free



2905 NORTHWEST BLVD., SUITE 250
PLYMOUTH, MINNESOTA 55441

IBM, PS and AT are registered trademarks of IBM Corp.



NORTHGATE COMPUTER SYSTEMS
2905 NORTHWEST BLVD., PLYMOUTH, MN 55441

SHIP (QUANTITY) "C/T" 101 @ \$99.00
(QUANTITY) "C/T" 84 @ \$79.00
FOR IBM PS MODELS ADD \$15.00

NAME _____

COMPANY _____

ADDRESS _____

CITY _____ STATE _____ ZIP _____

VISA/MC NO. _____ EXP. DATE _____

SIGNATURE _____

NOTE: ORDER PROCESSING TAKES 3-4 DAYS. WE SHIP UPS.
FOR GROUND SHIPPING ADD \$7.00 EA. FOR SECOND DAY
AFTER PROCESSING TIME ADD \$12.00 EA. FOR OVERNIGHT
AFTER PROCESSING TIME ADD \$22.00 EA.

Steve Gibson is the developer and publisher of *Flicker Free* and president of *Gibson Research Corp.* of Irvine, California. The views expressed are his own.

Circle 187 on Reader Service Card

APRIL 1988 • B Y T E 257

Now, with Northgate Super 286

Turbo Throughput

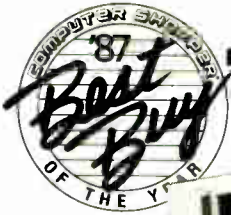

800,000 Bytes Per Second Data
 • Turbo Speed Hard Drive Controller

**TRULY A COMPLETE, READY TO USE SYSTEM
 YOU GET ALL THESE QUALITY FEATURES:**

65MB Miniscribe Hard Drive, Formatted and Partitioned 32.5MB in C and D Partitions • Turbo Throughput 16-Bit Hard Drive RLL and 1:1 Interleave Controller • 12MHz Intel Processor • 2 16-Bit, 6 8-Bit Expansion Slots • 1.2MB (Reads & Writes 360K Disks AND 1.44MB Drive (Reads & Writes 720K) • 200 Watt Power Supply • 2 Parallel, 1 Serial Port • Full Size (Not Baby Size) Case with Keylock, Turbo On/Off, Indicator Lights • 14 Inch Tilt/Swivel Flat Screen Amber Graphics Monitor with 1000 Line Resolution Capability for CAD • Hercules Compatible Graphics Card • Latest Version MS-DOS 3.3 with GWBasic including hardbound manuals for both (Northgate is a Microsoft OEM Licensee).

**AND NOW, TO GIVE YOU EVEN
 GREATER PERFORMANCE...**

**DRIVE CACHING AND VOPT™
 OPTIMIZER ARE INCLUDED!**

Installed on your hard drive is Northgate's exclusive Insta-Cache™ Hard Disk Caching program. Once a file is read it's in cache. Retrieving it again is 0-wait. No hard drive access is needed. This is an \$80.00 value, yours at no extra cost. AND...WE ALSO GIVE YOU THE BEST DISK OPTIMIZER PROGRAM EVER—VOPT™ BY GOLDEN BOW SYSTEMS. CLEANS UP FRAGMENTED SECTORS AUTOMATICALLY EVERY TIME YOU START YOUR SYSTEM. A \$50.00 VALUE. AGAIN YOURS FREE WITH THE NORTHGATE 286.

The Bottom Line

**400% Faster Performing
 WORLD CLASS QUALITY
 Features Unmatched Anywhere**

\$2149⁰⁰

**complete
 as shown**

WAS THE FASTEST...

65MB Hard Drive System you get:

Computing Power

Transfer Rate • RLL Encoded Hard Drives • 1:1 Interleaving
 • World's Highest Performance AT Class Computer System!

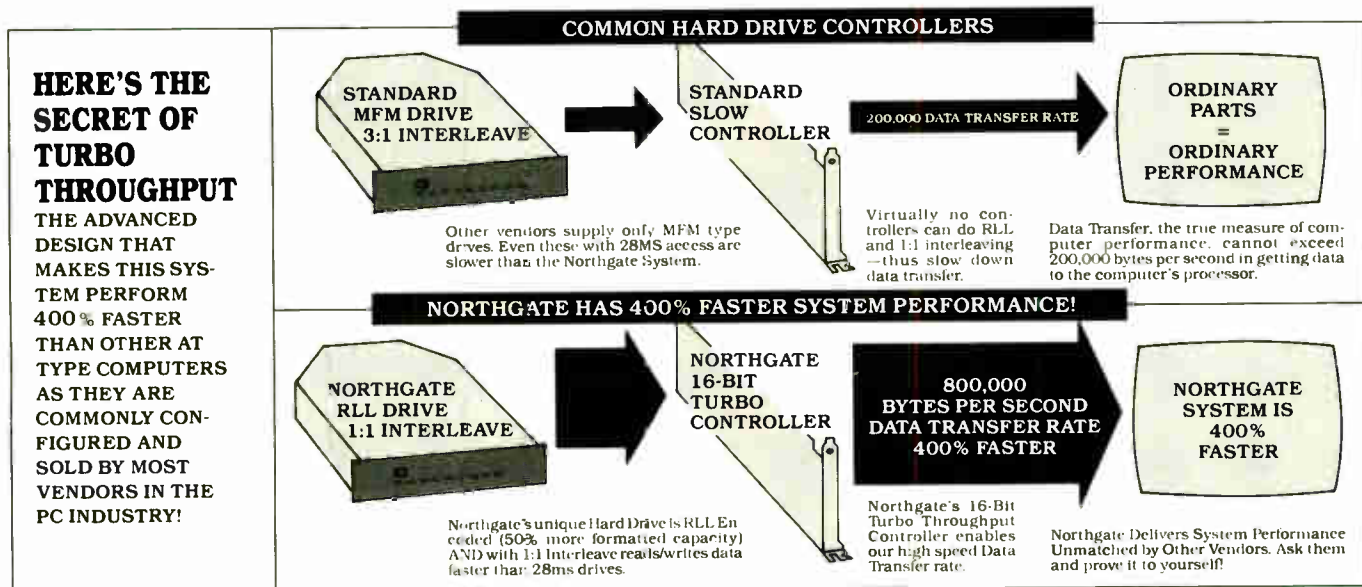

HERE'S THE SECRET OF TURBO THROUGHPUT
 THE ADVANCED DESIGN THAT MAKES THIS SYSTEM PERFORM 400% FASTER THAN OTHER AT TYPE COMPUTERS AS THEY ARE COMMONLY CONFIGURED AND SOLD BY MOST VENDORS IN THE PC INDUSTRY!

Most computers look similar. Most vendors advertise processor speed and 28MS hard drive access. There is little to distinguish one from another. Thus everyone tends to assume all computers are alike.

NOT SO. Northgate is truly a different System. And because it is, the computer buyer gets far greater computer value for his money. That's why Northgate has soared in popularity. Those who know choose Northgate.

They know they get value through performance that's demonstrated every time they turn on the system. They know all parts are World Class, not the ordinary "off the shelf" items others use to keep costs down.

Northgate pioneered RLL Hard Drive and 1:1 interleaving in its 286 systems. To our knowledge, no competitor even offers these vital performance features. Call them. We did. Only Northgate gives you this

unique throughput-enhancement.
 If Northgate pricing seems higher, don't be deceived by Bare Bones Prices you see in others' ads. Northgate's System is complete —IT'S THE 286 SYSTEM YOU WON'T OUT-GROW! We encourage you—Shop Around, Call all the Others and Compare.

ALL THIS PLUS...The Computer Industry's Most Meaningful Service and Warranty Policy...

- 30-Day Compatibility Warranty:**
 Northgate guarantees its systems will operate any standard, commercially available DOS programs written for use on IBM Compatible Computers. If, on consultation with Northgate, a program cannot be made to operate satisfactorily, owner may return the system, complete and unaltered for a prompt and full refund including all freight costs.
- One-Year Overnight AT NORTHGATE EXPENSE Parts Replacement Warranty:**
 Northgate Computer Systems warrants that all systems sold by Northgate will be free of defects in workmanship and materials for one year from date of shipment.

- In the event of failure of a part that disables the system, Northgate will ship, the same day if notified by 12 Noon Central Time, a new replacement part. Customer must phone Northgate Customer Service for diagnosis of the failure.
- Shipment of the replacement part will be by overnight-express service—AT NORTHGATE'S EXPENSE—for next day delivery depending on the carrier's ability to provide such service in owner's geographic area.
- Owner must return any replaced part, complete and unaltered, and pay return shipping costs, to be received at Northgate within two weeks after receiving the replacement part.
- Northgate's Customer Service department will provide full

- instructions on making the repair or replacement and will consult with customer on the phone to assure repair is properly completed and the system is again operating.
- In the case of a complete system returned for repair under warranty, customer pays freight to Northgate and Northgate pays return freight by whatever service the system is sent to Northgate.
- In the event of a part replaced under warranty, the new part carries a NEW ONE-YEAR GUARANTEE FROM SHIP DATE!
 NOTE: Many computer vendors extend only the parts manufacturer's warranty which may be as little as 30-days. All products sold by NORTHGATE are fully guaranteed by Northgate for one year from date of shipment.

Circle 188 on Reader Service Card



USE OUR TOLL FREE ORDER LINE

800-548-1993

2905 NORTHWEST BOULEVARD SUITE 250
 PLYMOUTH, MINNESOTA 55441

VISA MC COD TERMS: Credit Card, Pre-Payment (allow 2 weeks for personal checks to clear) Wire Transfer and Purchase Orders for Rated Accounts. We also ship to APO and FPO. All shipments are FOB Minneapolis, MN

ALL CORPORATION AND BRAND NAMES IN THIS AD ARE THE PROPERTY OF THEIR RESPECTIVE OWNERS. NORTHGATE IS NOT RESPONSIBLE FOR ERRORS OR OMISSIONS IN THIS ADVERTISEMENT. • PRICES ARE SUBJECT TO CHANGE WITHOUT NOTICE. • TURBO THROUGHPUT, INSTA-CACHE AND NORTHGATE ARE TRADENAMES OF NORTHGATE COMPUTER SYSTEMS. COPYRIGHT 1988, NORTHGATE

Get Your RS232C On Speaking Terms. In A Snap.

RS232 was developed to simplify communications between computers, peripherals and other electronic equipment. But what started out simple has become more complex, with different manufacturers using different cable configurations. All of which made isolating and fixing problems more time-consuming.

Beckman Industrial answers the problem with a complete line of breakout boxes that not only make locating and changing signals quick and easy, but also keeps the system communicating while you test.

Monitor 15 Lines For Less Than \$100.

The line-powered Model 725 lets you monitor the most common 15 lines including most modem communications. Red or green LEDs make identifying positive and negative voltages easy. Dual-gender connectors make hook-up a snap. And any additional line can be monitored via jumpers to a spare set of LED monitors. Plus, its tough ABS, snap-tight case features a removable cover for added convenience. There's even an optional zippered vinyl case available.

A Breakout Box And Cable Tester In One.

Beckman Industrial makes your job twice as easy with a feature no one else offers. The Model 785 is a combination breakout box and cable tester. Its battery-powered operation allows you extra mobility and freedom while 100 LEDs allow you to fully monitor 25 lines.



Model 725 \$99.00 Breakout Box

Monitors 15 primary data communications lines
Red and green LEDs identify +/- voltages.
Includes spare Red/Green LED set.
Jumpers included.
Optional vinyl case available.

And, of course, it's also a full-function cable tester. With support for parallel interfaces and automatic or manual scanning of all lines. Easy-to-use faceplate voltage jacks, pulse trapping, and separate DIP switches to perform modem loopback settings are only a few of the features.

Presenting A Whole New Way To Patch.

To keep your RS232C and RS449 communications on speaking terms and make signal emulation easy, Beckman Industrial has devised a system that lets you custom-build patch boxes right in the field. Another first from Beckman Industrial to make your job easier. Try the Model 701 Quadverter to solve printer interface problems, or the Model 702 Quad II to make patching RS232C to RS449 simple and quick.

Better yet, build your own patch system with the Model 703 Easy PATCH™ Patching



Model 785 \$345.00 Breakout Box & Cable Tester

100 battery-powered LEDs.
Full-function RS232C cable tester scans all lines.
Signal emulation via faceplate voltage jumpering.
Pin 2 to pin 3 crossover switching.
2 μsec signal pulse trap.

System. Just pick any combination of 15 different connector modules included in the kit, install it in the 703 case and snap on the cover. It's that simple.

With such versatility, you can leave an Easy PATCH in the line to keep vital data communications going while you repair a bad connector or cable.

Visit your local distributor today for Beckman Industrial's data communications test equipment. Or write for a free eight-page brochure.

And keep your lines of communication open.

Beckman Industrial™

Beckman Industrial Corporation
Instrumentation Products Division
A Subsidiary of Emerson Electric Company
3883 Ruffin Road, San Diego, CA 92123-1898
(619) 495-3200 • FAX (619) 268-0172 • TLX 249031

In Service Instruments, We're The One.

Features

- 263 Ciarcia's Circuit Cellar:
The SmartSpooler
Part 1: The Spooler Hardware**
by Steve Ciarcia
- 273 Dynamic Linking in OS/2**
*by Gordon Letwin, Chief
Architect, Systems Software,
Microsoft Corp.*
- 285 When Facts Get Fuzzy**
by Bradley L. Richards
- 293 Faster Than Fast Fourier**
by Mark A. O'Neill



UNLEASH YOUR 80386!

Your 80386-based PC should run two to three times as fast as your old AT. This speed-up is primarily due to the doubling of the clock speed from 8 to 16 MHz. The new MicroWay products discussed below take advantage of the real power of your 80386, which is actually 4 to 16 times that of the old AT! These new products take advantage of the 32 bit registers and data bus of the 80386 and the Weitek 1167 numeric coprocessor chip set. They include a family of MicroWay

80386 compilers that run in protected mode and numeric coprocessor cards that utilize the Weitek technology.

The benefits of our new technologies include:

- An increase in addressable memory from 640K to 4 gigabytes using MS-DOS or Unix.
- A 12 fold increase in the speed of 32 bit integer arithmetic.
- A 4 to 16 fold increase in floating point

speed over the 80387/80287 numeric coprocessors.

Equally important, whichever MicroWay product you choose, you can be assured of the same excellent pre- and post-sales support that has made MicroWay the world leader in PC numerics and high performance PC upgrades. For more information, please call the Technical Support Department at

617-746-7341

After July 1988 call 508-746-7341

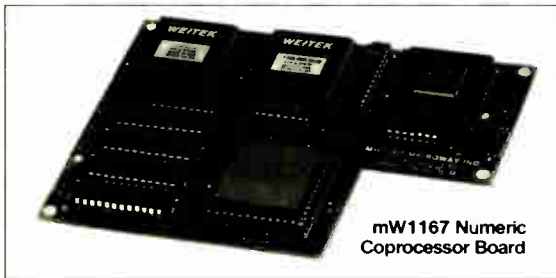

mW1167 Numeric Coprocessor Board

MicroWay® 80386 Support

MicroWay 80386 Compilers

NDP Fortran-386 and **NDP C-386** are globally optimizing 80386 native code compilers that support a number of Numeric Data Processors, including the 80287, 80387 and mW1167. They generate mainframe quality optimized code and are syntactically and operationally compatible to the Berkeley 4.2 Unix f77 and PCC compilers. MS-DOS specific extensions have been added where necessary to make it easy to port programs written with Microsoft C or Fortran and R/M Fortran.

The compilers are presently available in two formats: Microport Unix 5.3 or MS-DOS as extended by the Phar Lap Tools. MicroWay will port them to other 80386 operating systems such as OS/2 as the need arises and as 80386 versions become available.

The key to addressing more than 640 kbytes is the use of 32-bit integers to address arrays. **NDP Fortran-386** generates 32-bit code which executes 3 to 8 times faster than the current generation of 16-bit compilers. There are three elements each of which contributes a factor of 2 to this speed increase: very efficient use of 80386 registers to store 32-bit entities, the use of inline 32-bit arithmetic instead of library calls, and a doubling in the effective utilization of the system data bus.

An example of the benefit of excellent code is a 32-bit matrix multiply. In this benchmark an **NDP Fortran-386** program is run against the same program compiled with a 16-bit Fortran. Both programs were run on the same 80386 system. However, the 32-bit code ran 7.5 times faster than the 16-bit code, and 58.5 times faster than the 16-bit code executing on an IBM PC.

NDP FORTRAN-386™ \$595
NDP C-386™ \$595

MicroWay Numerics

The **mW1167™** is a MicroWay designed high speed numeric coprocessor that works with the 80386. It plugs into a 121 pin "Weitek" socket that is actually a super set of the 80387. This socket is available on a number of motherboards and accelerators including the AT&T 6386, Tandy 4000, Compaq 386/20, Hewlett Packard RS/20 and MicroWay Number Smasher 386. It combines the 64-bit Weitek 1163/64 floating point multiplier/adder with a Weitek/Intel designed "glue chip". The mW1167™ runs at 3.6 MegaWhetstones (compiled with **NDP Fortran-386**) which is a factor of 16 faster than an AT and 2 to 4 times faster than an 80387.

mW1167 16 MHz \$1495
mW1167 20 MHz \$1995

Monoputer™ - The INMOS T800-20 Transputer is a 32-bit computer on a chip that features a built-in floating point coprocessor. The T800 can be used to build arbitrarily large parallel processing machines. The Monoputer comes with either the 20 MHz T800 or the T414 (a T800 without the NDP) and includes 2 megabytes of processor memory. Transputer language support from MicroWay includes Occam, C, Fortran, Pascal and Prolog.

Monoputer T414-20 with 2 meg¹ ... \$1495
Monoputer T800-20 with 2 meg¹ ... \$1995

Quadputer™ can be purchased with 2, 3 or 4 transputers each of which has 1 or 4 megabytes of memory. Quadputers can be cabled together to build arbitrarily fast parallel processing systems that are as fast or faster than today's mainframes. A single T800 is as fast as an 80386/mW1167 combination!

Biputer™ T800/T414 with 2 meg¹ ... \$3495
Quadputer 4 T414-20 with 4 meg¹ ... \$6000

¹Includes Occam

80386 Multi-User Solutions

AT8™ - This intelligent serial controller series is designed to handle 4 to 16 users in a Xenix or Unix environment with as little as 3% degradation in speed. It has been tested and approved by Compaq, Intel, NCR, Zenith, and the Department of Defense for use in high performance 80286 and 80386 Xenix or Unix based multi-user systems.

AT4 - 4 users \$795
AT8 - 8 users \$995
AT16 - 16 users \$1295

Phar Lap™ created the first tools that make it possible to develop 80386 applications which run under MS-DOS yet take advantage of the full power of the 80386. These include an 80386 monitor/loader that runs the 80386 in protected linear address mode, an assembler, linker and debugger. These tools are required for the MS-DOS version of the MicroWay NDP Compilers. **Phar Lap Tools** \$495

PC/AT ACCELERATORS

287Turbo-10 10 MHz \$450
287Turbo-12 12 MHz \$550
287TurboPlus-12 12 MHz \$629
FASTCACHE-286 9 MHz \$299
FASTCACHE-286 12 MHz \$399
SUPERCACHE-286 \$499

MATH COPROCESSORS

80387-20 20 MHz \$895
80387-16 16 MHz \$495
80287-10 10 MHz \$349
80287-8 8 MHz \$259
80287-6 6 MHz \$179
8087-2 8 MHz \$154
8087 5 MHz \$99

MicroWay

The World Leader in PC Numerics

P.O. Box 79, Kingston, Mass. 02364 USA (617) 746-7341
32 High St., Kingston-Upon-Thames, U.K., 01-541-5466
St. Leonards, NSW, Australia 02-439-8400

The SmartSpooler

Part 1: The Spooler Hardware

Steve clears your printer's throughput bottleneck and comes up with more than a buffer



The discrepancy in speed between fast CPUs and slow printers has existed since the early days of computing, and the magnitude of the speed difference is becoming ever larger. When you upgrade and add performance to a computer system, you generally add processing power rather than printing power. The net result is that many 20-MHz 80386 "million-instructions-per-second-class" machines out there are waiting for 100-character-per-second printers.

Admittedly, many computer users have light printing requirements, and they don't mind waiting 5 to 10 minutes for an occasional printout. Some, I'm sure, welcome this downtime as a mandatory coffee break. However, those who rely on their computers as a tool for making a living know that time is money.

Spooling to the Rescue

This problem is not new, and one solution has always been spooling. *Spool* stands for "simultaneous peripheral operations on-line." Pioneered on mainframes and minicomputers, spooling solves the CPU/printer speed gap by temporarily buffering printer output on intermediate storage (typically a disk drive) at high speed. Then, you move the stored data from storage to the printer at the latter's low speed. In the meantime, the CPU also runs foreground applications.

Traditional spooling has been tried on personal computers with limited success. One problem is that spooling requires an operating system with either multitasking capabilities or special software patches that effect the appearance of simultaneous operation. Even with a multitasking operating system or a patch, however, spooling often taxes the computer's processing power and affects system performance.

Spooling also creates problems in disk priority and data conflicts. If not properly coordinated through the operating system, a computer's disk can get "trashed" if it has to handle print data and application data at the same time. Given the declining cost of processing power and mem-

ory, it finally became obvious that a separate computer should handle the printing task, which led to the dedicated printer buffer.

I have received many letters over the years asking when I would present a printer buffer as a project. Generally, I would avoid answering the question or jokingly say "never." Of course, it really wasn't a joking matter. It troubled me greatly that I couldn't do justice to such an important subject and had to live with such an embarrassing answer until I could invest the time and effort to present a Circuit Cellar-quality design. Let me explain.

Most printer buffer projects are cumbersome and simplistic. The ones I remember seeing offer only rudimentary functions and use 40 or 50 chips for a 64K-byte buffer.

Commercial units, on the other hand, have narrowly defined capabilities enhanced by software-implemented system functions and tricky hardware designs intended to reduce manufacturing cost and complexity.

I recall seeing one rather unique printer buffer design that used an 8051 single-chip microcomputer connected to dynamic RAMs (DRAMs) that operated *serially*. The 8051 would constantly cycle through the DRAM addresses at a rate that precluded any need for DRAM refresh. The system stored text serially in the individual 64K- by 1-bit DRAMs rather than in a parallel bank of them, as you'd usually expect. An 8K-byte text buffer therefore consisted of a single 64K-bit DRAM chip, while a 32K-byte buffer used four, and so on.

While I am not totally opposed to off-the-wall hardware designs, fancy technique has its price. Most computer-based technical designs are a trade-off between hardware and software. Anytime a company expects to be manufacturing something in a high-volume quantity, it tries to minimize recurring hardware costs by doing as much as possible in the one-time nonrecurring software development phase.

In a magazine article, however, there aren't any recurring expenses (beyond a few prototypes), therefore all costs associated with the one-time presentation are essentially nonrecurring. Since most magazine authors don't have infinite software resources (and deep pockets), published print spooler designs have usually ended up as a far cry from commercial units, both in technique and capability.

I could hardly criticize mediocre designs if I presented a piece of hardware that merely

continued

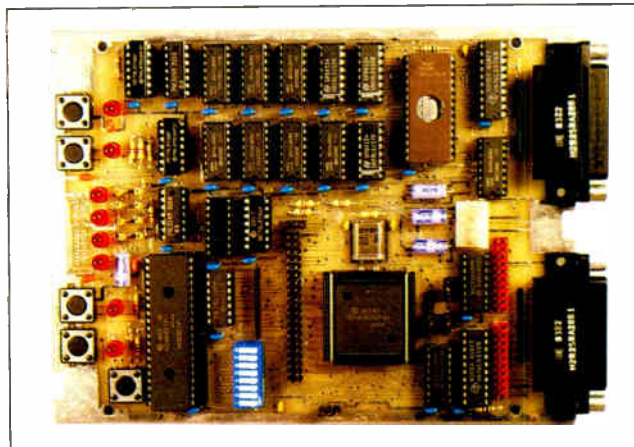

While I've presented SmartSpooler primarily as a printer buffer, it can function as a complete remote data-processing computer.

met the objective with little regard for the hardware costs and complexity. At the same time, it would be insane to custom-mask an 8051 and present a three-chip printer buffer project that demonstrates nothing to readers who want to learn something about the architecture of printer buffers.

Fast Computers, Slow Printers

With the Circuit Cellar SmartSpooler, I have achieved my goal. This is an efficient integration of commercial and educational objectives. I've complemented its hardware design with interrupt-driven software that does not compromise performance to maintain cost-effectiveness. Designated as a spooler rather than as a simple printer buffer, SmartSpooler vastly improves computing throughput with slow peripherals.

SmartSpooler has 256K bytes of memory, serial and parallel I/O ports, and features that improve versatility and ease of use.

These include "switchbox" capability for routing serial or parallel computer input to serial or parallel printer output, the ability to print multiple copies, single-sheet feeding mode, and buffer capacity indicators. Also, you can daisy-chain multiple SmartSpoolers to control a whole network of peripherals.

More important, SmartSpooler is intelligent. While I've presented it primarily as a printer buffer, a host computer can completely control its operation. You can even download executable code to SmartSpooler. It can function as a complete remote data-processing computer that analyzes and interprets the data flowing through it.

After a summary of SmartSpooler's features, I'll cover some printer buffer basics and then describe SmartSpooler's hardware and software specifics.

SmartSpooler has the following features:

- 256K-byte buffer capacity = 100 pages (typically)
- Switchable serial (RS-232C) or parallel (Centronics) inputs and outputs
- Serial port data rates: 300, 600, 1200, 2400, 4800, 9600, 19,200, and 38,400 bits per second (bps)
- Serial port handshaking: hardware (RTS, CTS, and so on) and software (XON-XOFF)
- Multiple copy capability: 0 to 4 copies plus original
- Pause mode for single-sheet feeding

continued

Figure 1: (a) The SmartSpooler combines the function of a 256K-byte printer buffer and a serial/parallel converter switch. **(b)** Its HD64180 CPU—with built-in serial ports, extensive interrupt handling, address range beyond 64K bytes using direct memory access, and easy DRAM interface—is ideal for this application.

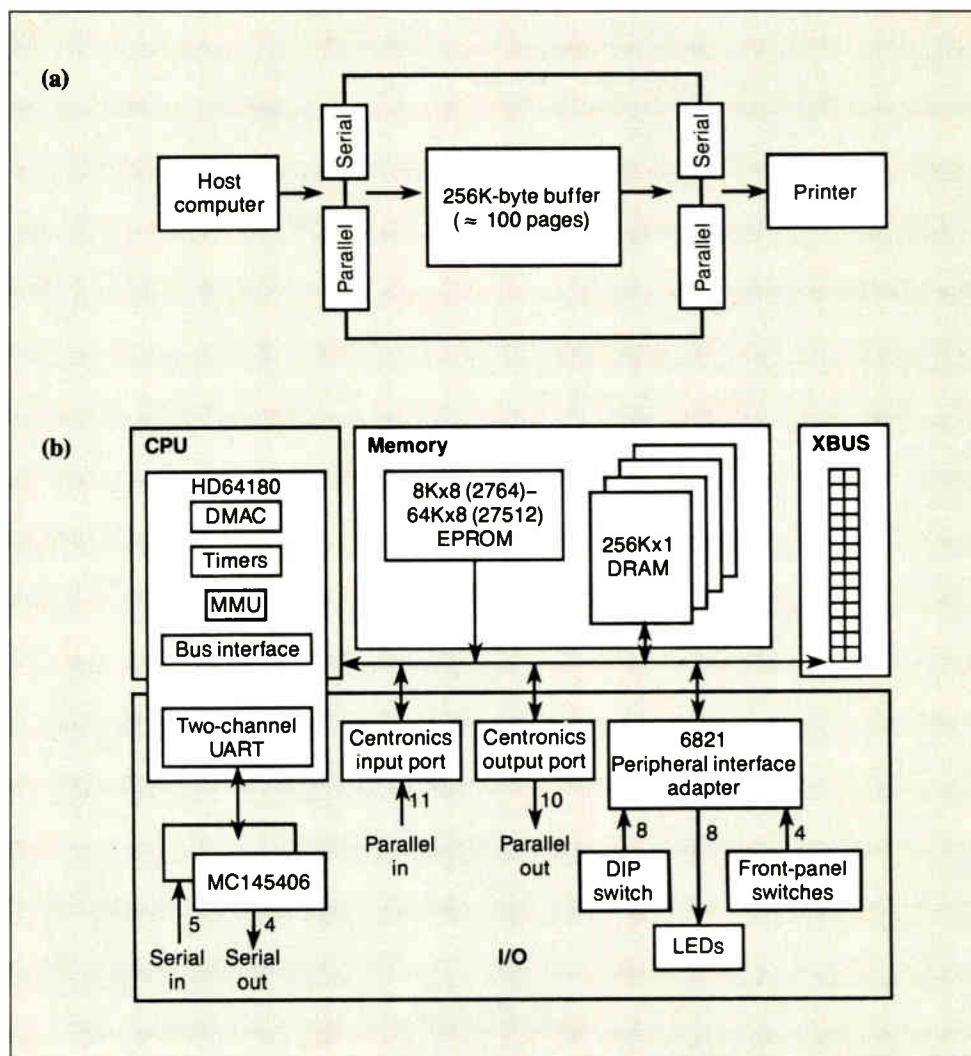

NEW!

TOOLKITS FOR TURBO C & QUICK C from ZORTECH INC.

HOTKEY

A complete set of *Terminate Stay Resident (TSR)* functions that help you to write reliable 'pop-up' programs.

Now you can make your programs 'Sidekickable'. Two example programs are included, a 'pop-up Calculator' and a pop-up 'Critical Error Handler'.

The Hotkey toolkit handles all floating point functions in resident mode.

The 32 page manual includes an interesting discussion of the origin and history of undocumented MS-DOS function calls, together with a full explanation of the theory and practical use of TSR's.

Only \$49.95! (State Turbo C or Quick C version.)

COMMS

Do you need to incorporate serial communications into your applications? Yes! Then get this inexpensive but highly professional COMMS toolkit from Zortech Inc.

Look at the list of features: Xmodem, Kermit and ASCII file transfer, Hayes modem control, VT52, VT100 and ANSI terminal emulation, supports up to 8 serial ports, speeds up to 19.2k baud rate and higher.

Two demonstration programs are included, MINICOM and MAXICOM (like Procomm) together with the 120 page manual and full source code FREE!

Only \$49.95! (State Turbo C or Quick C version.)

GAMES

Have you ever wondered how to write a chess program? Now we reveal the secret algorithms and techniques of the masters with this dynamic Games toolkit.

The package comes complete with the full source code to three ready to play games of strategy - Chess, Backgammon and Wari (an ancient African game).

A comprehensive 150 page manual is provided giving an in depth look at the history, structure and program design of such 'Strategy Games'.

Only \$49.95!

(State Turbo C or Quick C version.)

SUPERTEXT

This is not simply an 'Editor' toolkit, but a full-blown, 'WordStar' compatible wordprocessor with the full source code.

As well as all the normal editing functions, you will also find 'do' commands and full printer control. The SuperText toolkit handles files of any size and allows full on-screen configuration.

Do you need to incorporate a wordprocessor into your application? Yes! Then get the SuperText toolkit complete with full source code and 150 page manual now!

Only \$49.95! (State Turbo C or Quick C version.)

PROSCREEN

Generate high quality data entry screens with the Pro-Screen - Screen Designer and Code Generator.

You can draw the data entry screen, define the input fields, define the input criteria, set screen colors and attributes, draw single or double lines, make boxes - press a few buttons and 'hey presto' Pro-Screen generates the C source code for your application!

Professional applications programmers will find this versatile utility and it's associated functions invaluable.

Comes complete with a substantial 78 page manual and demo programs.

Only \$49.95! (State Turbo C or Quick C version.)

**ONLY
\$49.95
EACH**

WINDOWS

Add super-fast text screen handling to your applications with the WINDOWS library from Zortech Inc.

Give your applications the professional look - with instant zooming and exploding windows. Incorporate drop-down menus and Lotus style menus with our easy to use functions.

Automatically handles memory saving and buffering of window text. Use any number of overlapping windows in your applications. Write to any window, read from any window, close any window, pull any window to the top.

Over 55 functions together with a big 85 page manual and remember, you get the full source code.

Only \$49.95! (State Turbo C or Quick C version.)



Turbo C is the trademark of Borland Inc. Quick C is the trademark of Microsoft Inc.

NEW! C VIDEO

- Now learn C the easy way!
- Get the 'Complete C Video Course' from Zortech Inc. together with our big 365 page workbook.
- Ten 1 hour tapes - 36 lessons!
- Easy to follow course, you get an excellent introduction to the C language.
- Takes you step-by-step up to the intermediate and advanced levels.
- Teach yourself at home or the office - at your own speed.

only ~~\$295.00~~ **\$199.95**

Yes!
Rush me
these items!

HOTKEY
 COMMS
 PRO-SCREEN

WINDOWS GAMES
 SUPERTEXT C VIDEO

FREE SHIPPING - VISA/MC/COD/CHECK

Name

Address

Phone

VISA or MC#

Exp. Date

ZORTECH Inc. 361 Massachusetts Ave, Arlington, MA 02174
Orders & Enquiries Tel: (617) 646 6703

ORDER HOTLINE 800-848-8408

ZORTECH

- Real-time clock (power required)
- Front-panel buffer capacity gauge
- Host programmed configuration and operation mode
- Built-in interactive diagnostic monitor program
- Low power (5 volts [V] at 0.5 ampere [A], ± 12 V at 0.1 A typical)

Generic printer buffers come with a variety of functions. SmartSpooler combines the best features of these other printer buffers and adds a few of its own. SmartSpooler sits between a computer printer port and the printer. Since it provides both parallel and serial I/O ports, it adapts between computers and printers of each type.

When the computer prints, SmartSpooler accepts the data at high speed, buffers it, and outputs it to the low-speed printer. From the computer's point of view, printing a document takes only seconds. During the printout, SmartSpooler can make copies, temporarily suspend printing (pause button), and handle embedded formfeeds for single-sheet printing.

Hardware—Keep It Simple

The hardware requirements for SmartSpooler are simple: a CPU, buffer memory, and host/printer ports (serial and parallel). We also need some parallel I/O ports to handle switches and LEDs for SmartSpooler's front-panel operation.

I used the complementary-metal-oxide-semiconductor

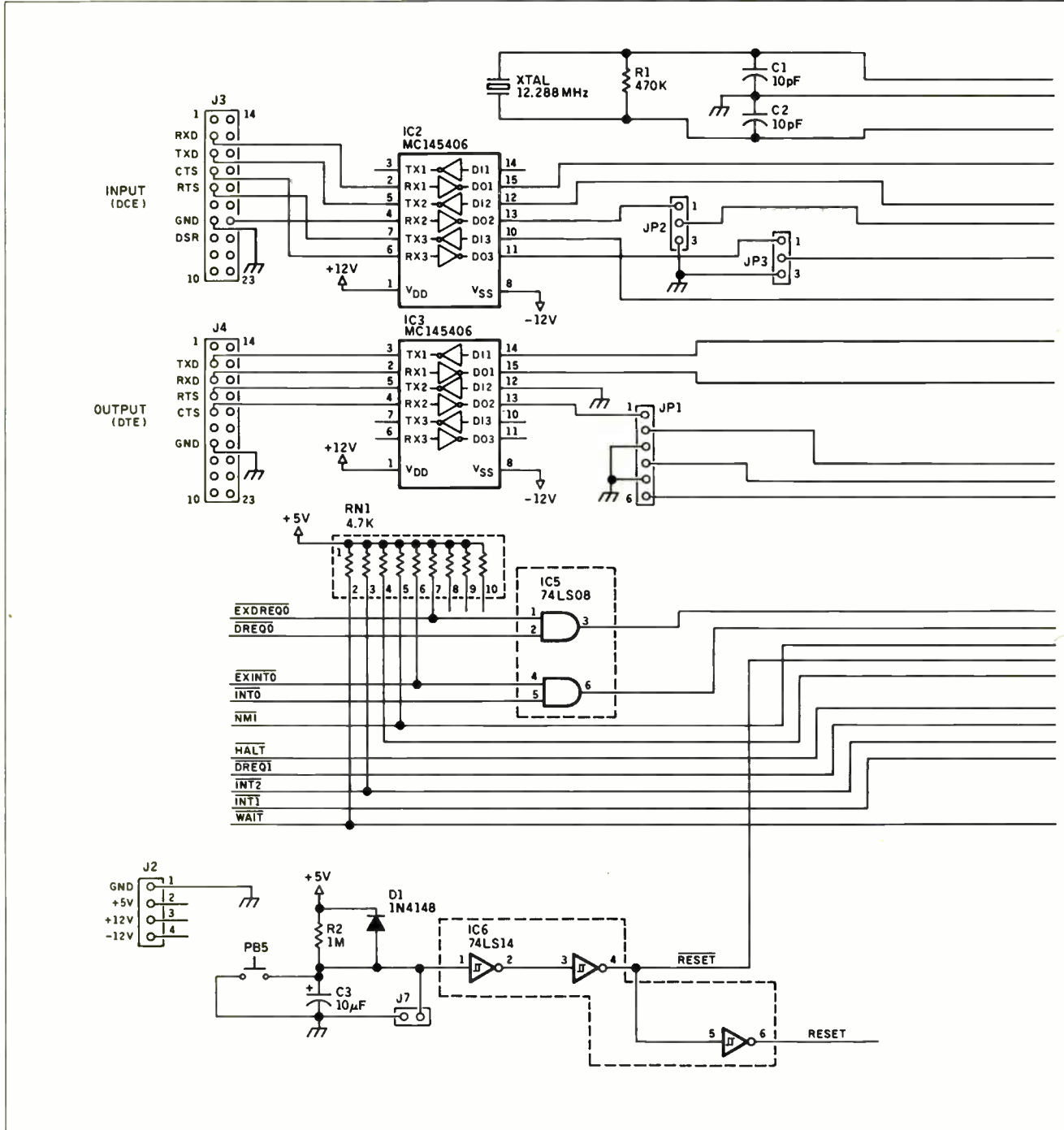

HD64180 CPU because it is ideally suited to the task and significantly reduces the hardware complexity. First, it includes two RS-232C serial ports on-chip, eliminating an external dual-UNIT (universal asynchronous receiver/transmitter) chip.

Second, the need for a large, low-cost buffer demands dynamic memory chips. The HD64180, with its built-in refresh, easily accommodates DRAMs and offers a performance level that can meet today's high-speed communications requirements. (Though the task seems simple, many computers choke when running terminal emulator programs at 19,200 or 38,400 bps.)

The SmartSpooler block diagram in figure 1 shows the three basic components: CPU (i.e., HD64180), memory (i.e.,

DRAM and SmartSpooler EPROM), and I/O (i.e., host, printer, switches, and LEDs) interface. The SmartSpooler also provides an SB180 XBUS I/O expansion connector for additional I/O (more on that later). See figure 2 for the complete SmartSpooler schematic (less the section covering the DIP-switch settings and LEDs, which I will cover next month).

The EPROM socket (IC7) accepts 8K-byte (2764) to 64K-byte (27512) EPROMs, though the SmartSpooler code presently requires only 16K bytes (27128). Because of the on-chip DRAM refresh controller, connecting 256K bytes of DRAM is relatively easy. All the HD64180 needs are three 74LS157 row/column address multiplexers (IC8 through IC10) and a CAS\

continued

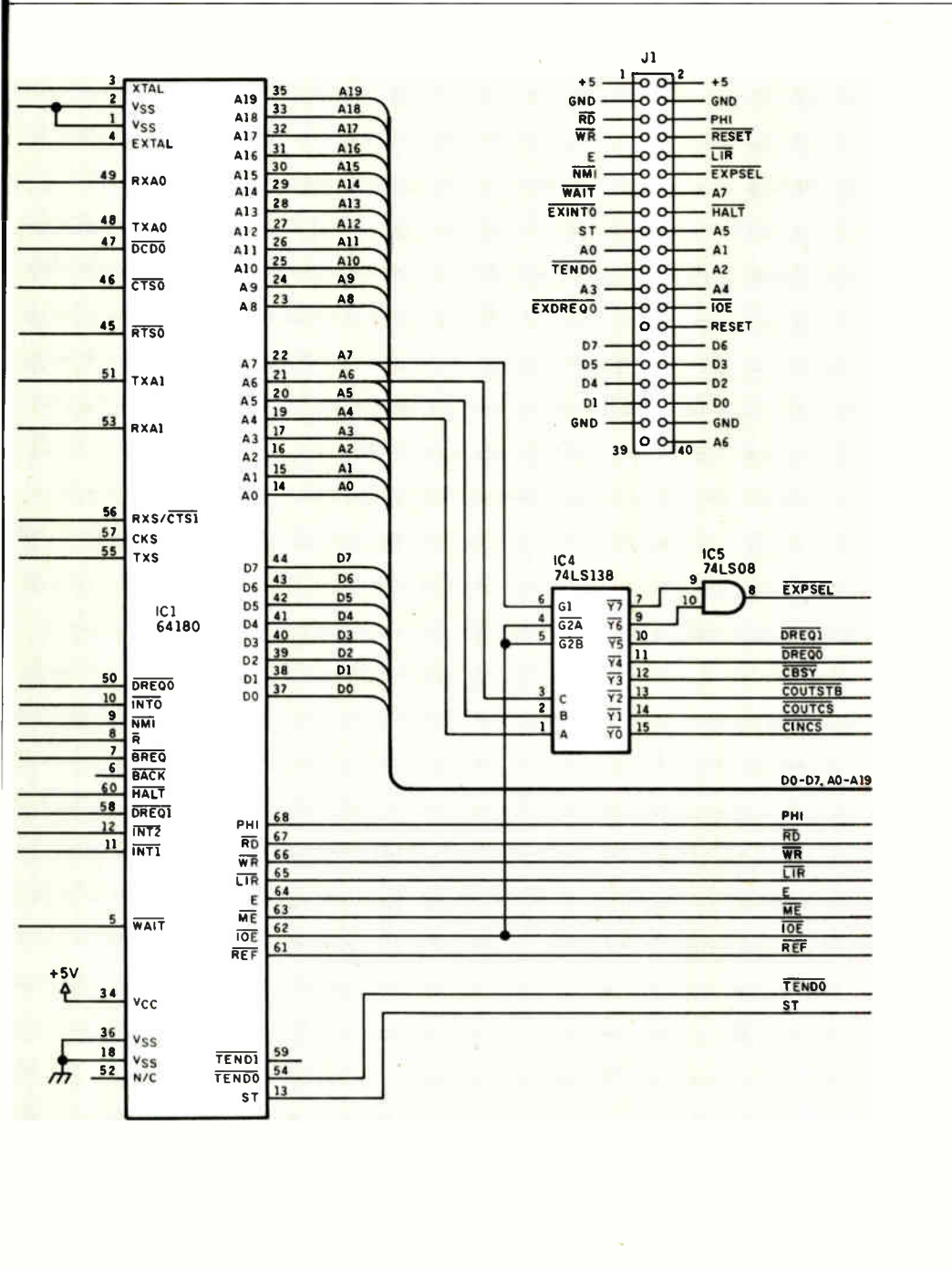

Figure 2a: Schematic for the SmartSpooler's CPU and serial I/O section. (Not shown this month are the 6821 peripheral interface adapter and other circuitry associated with the switches, push buttons, and LEDs; that portion will appear next month.)

generator consisting of a flip-flop and a couple of gates (IC5, IC6, and IC19). The plastic-leaded-chip-carrier version of the HD64180 can address 1 megabyte, but I feel that 256K bytes is more than adequate for typical printing applications, and it keeps power consumption low.

If you examine the SmartSpooler's architecture closely, you will note some similarities with the SB180 single-board computer (see the September 1985 Circuit Cellar). Considering the performance and popularity of the SB180, any similarities are purely intentional. The SmartSpooler's core architecture lets it be more or less software-compatible with the BCC180 multi-tasking controller (presented the last three months) and the SB180. Remember that you can download executable code to the SmartSpooler using its host programmed mode. This code could be a compiled BASIC program generated on a BCC180 just as easily as any HD64180 assembly code produced on an IBM PC cross assembler or the SB180.

SmartSpooler's I/O

SmartSpooler has two serial ports and two parallel printer ports. Since the HD64180 has two on-chip serial ports, the only extra hardware needed for the RS-232C ports are a pair of MC145406 RS-232C level shifters (IC2 and IC3). The rest of the I/O hardware consists of the Centronics I/O ports and the front-panel switch/LED interface.

A 74LS138 (IC4) I/O address decoder generates eight chip selects. Two outputs are reserved for XBUS addressing: I/O addresses E0 to FF hexadecimal. Two chip selects are connected to the HD64180 direct-memory-access request inputs, and the remaining four are associated with the Centronics I/O ports.

The Centronics output port consists of a 74LS374 (IC22), which latches the output data, plus both halves of a 74LS74 (IC23) for controlling the handshaking. To send a character to the device connected to the port, the control software first

continued

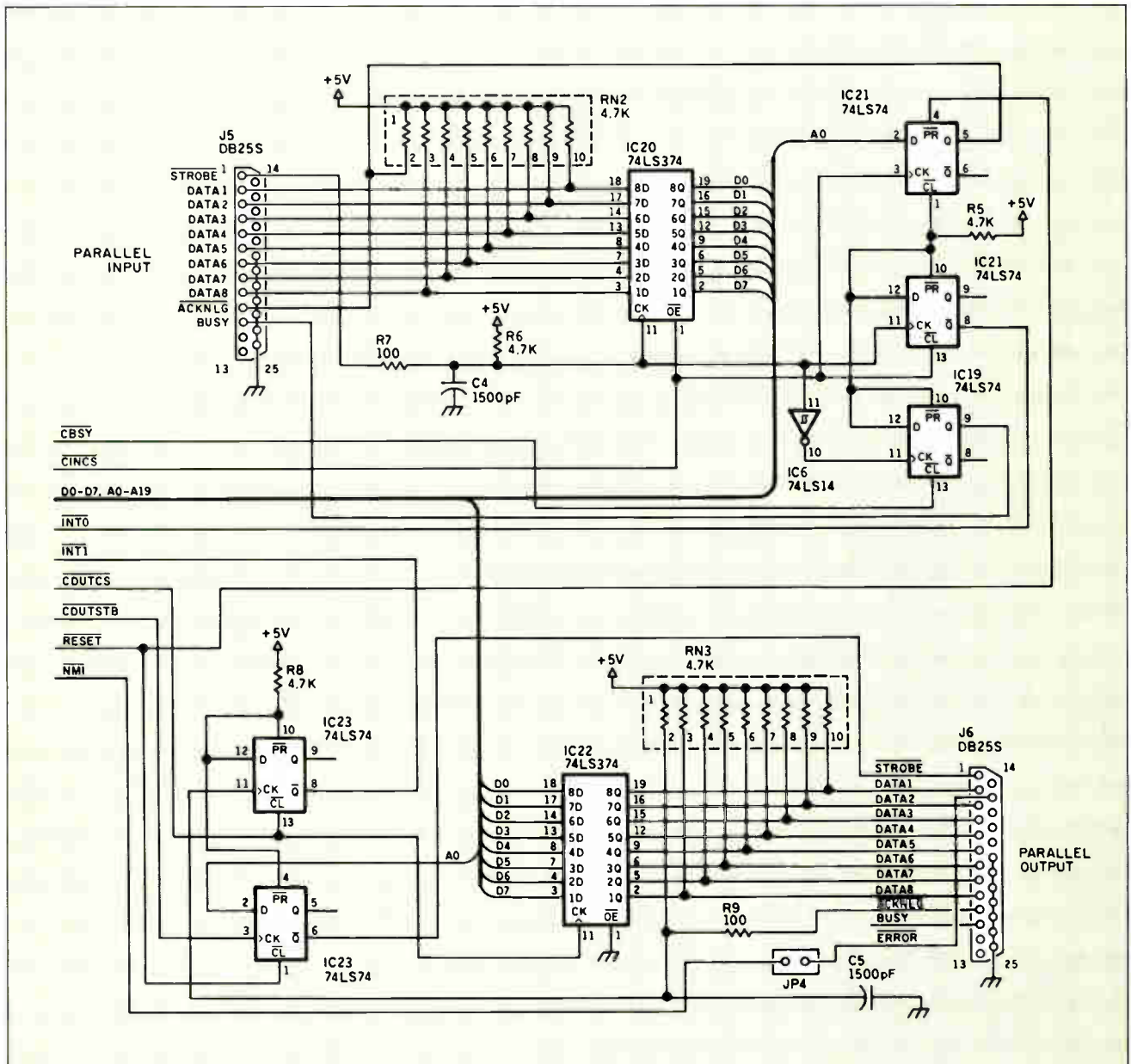

Figure 2b: The SmartSpooler's parallel I/O section.

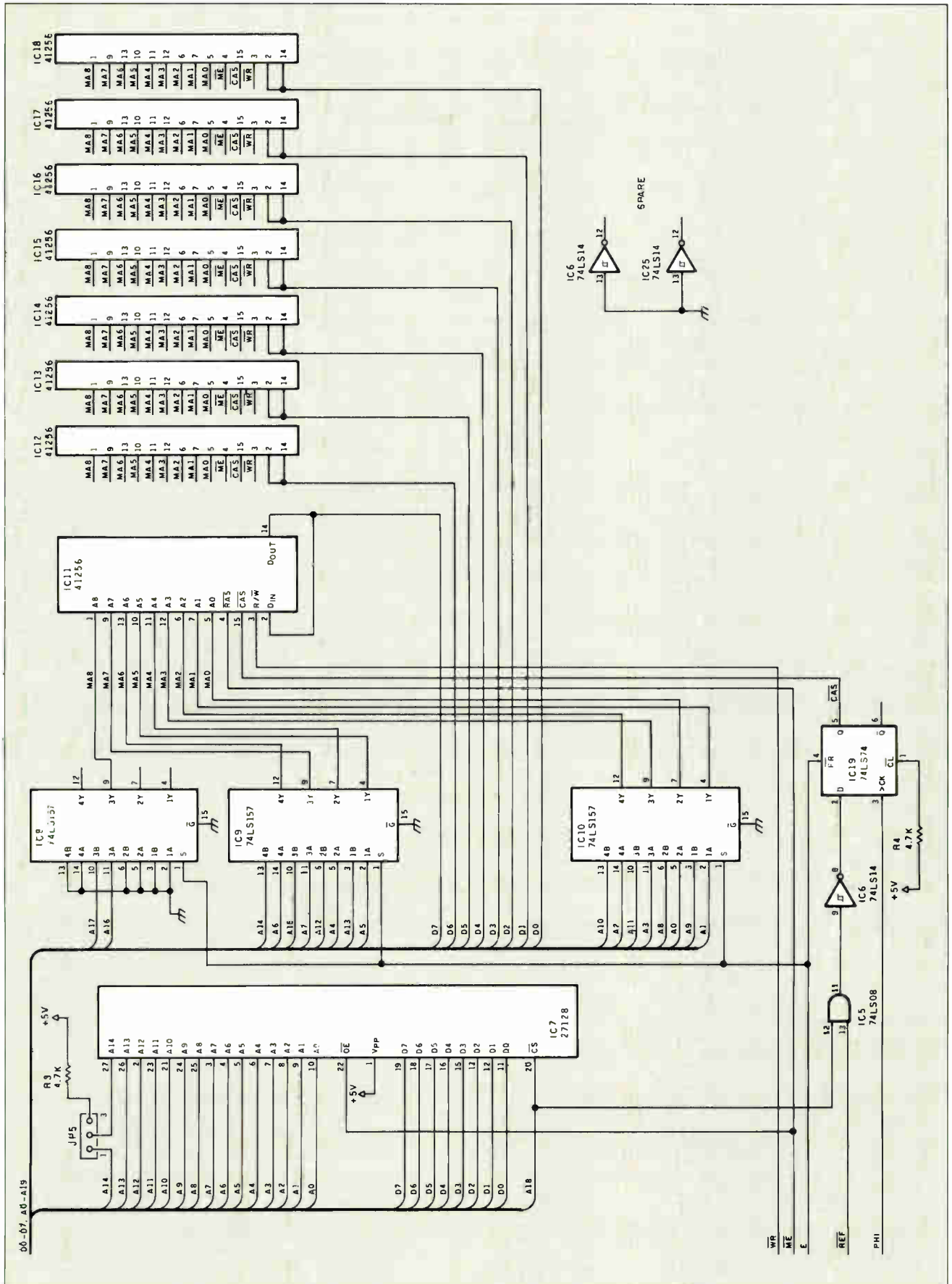

Figure 2c: The EPROM and DRAM circuitry for the SmartSpooler.

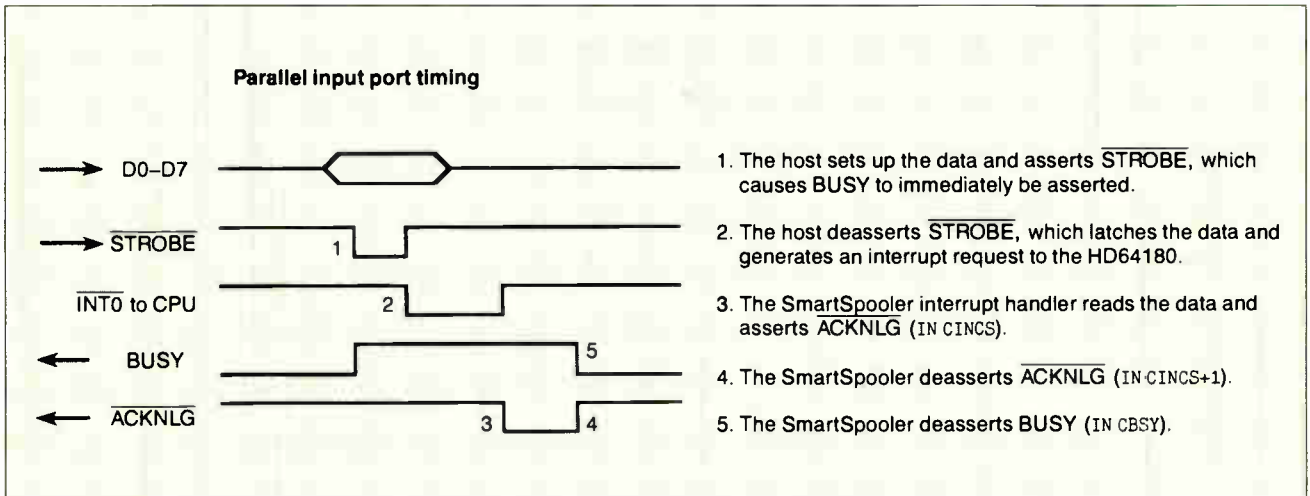

Figure 3a: Timing diagram for SmartSpooler's parallel input port.

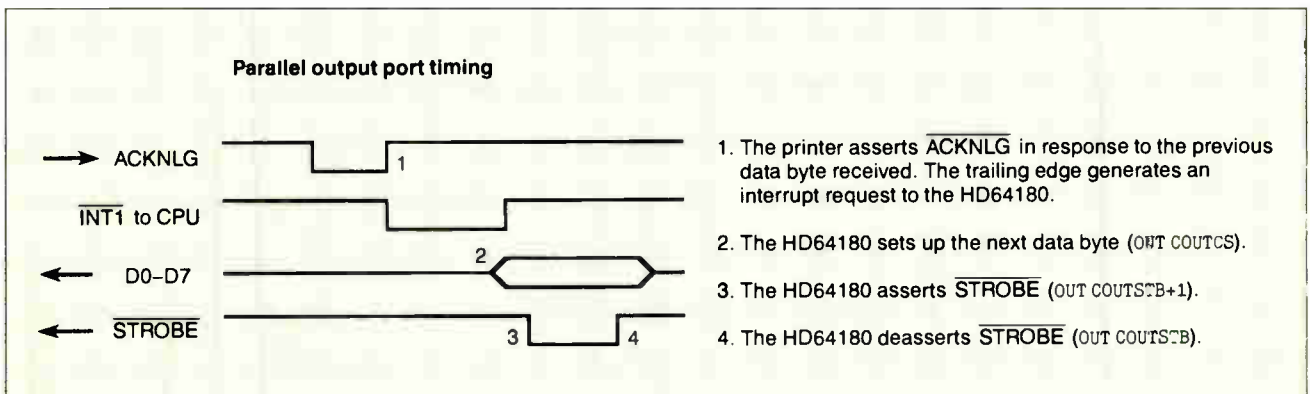

Figure 3b: Timing diagram for the parallel output port.

writes the byte out to port 90h. This latches the byte into the 74LS374 and also clears $\text{INT1} \setminus$ high. ($\text{INT1} \setminus$ is used during the acknowledge sequence that I'll describe next.)

Next, the program accesses (either reads or writes) port A1h to assert $\text{STROBE} \setminus$ on J6 low. Finally, the software accesses port A0h to cause $\text{STROBE} \setminus$ to go high, signaling the target device that a byte is ready.

Once the target printer device has retrieved the byte and wants to tell the spooler that it is ready for another byte, the device asserts the $\text{ACKNLG} \setminus$ line on J6 low, then sets it high again. The rising edge clocks the 74LS74 and forces $\text{INT1} \setminus$ low, generating an interrupt. Writing the next byte out to the Centronics port (usually part of the interrupt service routine) clears the interrupt.

The Centronics input port is similar to the output port, but it works in reverse. When the device connected to J5 sends the spooler a character, the device simultaneously generates a low-to-high signal on the $\text{STROBE} \setminus$ input. This latches the data into a 74LS374 (IC20) and sets $\text{INT0} \setminus$ low, generating an interrupt to the HD64180 processor. It also clocks another flip-flop, sending the BUSY line to the input device into a high state.

As part of the interrupt service routine, the processor first reads port 80h to get the character being sent to it by the input device. The port access also clears the interrupt and causes the $\text{ACKNLG} \setminus$ output to go low as the first part of the acknowledge sequence. Next, an access to port 81h sets $\text{ACKNLG} \setminus$ high again, signaling the input device that the character has been read

and the spooler is ready for another. Finally, it accesses I/O port B0h, causing the BUSY output to go low. This signals those devices that rely on the BUSY signal that SmartSpooler is ready for another character. Figure 3 shows the timing details of the parallel I/O ports.

Purists may argue that SmartSpooler does not support the full Centronics interface, which, technically, includes additional signals like Paper Error, Error, and Init. However, these signals (and other vendor-unique signals) are inconsistent for different computers, printers, and software. Just in case, SmartSpooler's output port does provide an option for handling a Printer Error input signal. You can jumper it to $\text{NMI} \setminus$.

Experimenters

While printed circuit board kits for the SmartSpooler are available, I encourage you to build your own. If you don't mind doing a little work, I will support your efforts as usual. You can download a hexadecimal file of the executable code for SmartSpooler's system EPROM (27128) from my bulletin board at (203) 871-1988. Alternatively, you can send me a preformatted IBM PC disk with return postage, and I'll put all the files on it for you (add \$6 for the SmartSpooler User's Manual). Of course, this free software is for noncommercial personal use.

Next Month

I'll finish the hardware by explaining the switch and LED configuration and describe SmartSpooler's software. ■

I'd like to personally thank Tom Cantrell for his extensive work on this project. Without his software expertise, I'd be hopelessly mired in an ocean of bits forever.

Editor's Note: Steve often refers to previous Circuit Cellar articles. Most of these past articles are available in book form from BYTE Books, McGraw-Hill Book Co., P.O. Box 400, Hightstown, NJ 08250.

Ciarcia's Circuit Cellar, Volume I covers articles in BYTE from September 1977 through November 1978. *Volume II* covers December 1978 through June 1980. *Volume III* covers July 1980 through December 1981. *Volume IV* covers January 1982 through June 1983. *Volume V* covers July 1983 through December 1984. *Volume VI* covers January 1985 through June 1986.

It's virtually impossible to provide all the pertinent details of a project or cover all the designs I'd like to in the pages of BYTE. For that reason, I have started a bimonthly supplemental publication called Circuit Cellar Ink, which presents additional information on projects published in BYTE, new projects, and supplemental applications-oriented materials. For a one-year subscription (6 issues), send \$14.95 to Circuit Cellar Ink, P.O. Box 3378, Wallingford, CT 06494. Credit card orders can call (203) 875-2199.

The following items are available from

CCI
P.O. Box 428
Tolland, CT 06084
(203) 875-2751
Inquiry 951.

1. SmartSpooler RAMless full printed circuit board kit for parallel-to-parallel operation. Comes complete with printed circuit board and all printed-circuit-board-mounted components, including HD64180, IC sockets, SmartSpooler software on EPROM, and User's Manual. Less DRAM chips. SS01-KIT \$119
2. SmartSpooler experimenter's kit for parallel-to-parallel operation. Comes with printed circuit board, crystal, HD64180 and plastic-leaded-chip-carrier socket, software on EPROM, and User's Manual. Available only through September 30, 1988. SS02-EXP \$89

Optional serial port ribbon cables are available. Call for pricing.

The SmartSpooler design is available for licensing to qualified manufacturers. Call for information.

All payments should be made in U.S. dollars by check, money order, MasterCard, or Visa. Surface delivery (U.S. and Canada only): add \$5 for U.S., \$8 for Canada. For delivery to Europe via U.S. airmail, add \$14. Three-day air freight delivery: add \$10 for U.S. (UPS Blue), \$25 for Canada (Purolator overnight), \$45 for Europe (Federal Express), or \$60 for Asia and elsewhere in the world (Federal Express).

There is a multiline Circuit Cellar bulletin board system (running TBBS 2.0M) that supports past and present projects in BYTE and Ink. You are invited to call and exchange ideas and comments with other Circuit Cellar supporters. The 300/1200/2400-bps BBS is on-line 24 hours a day at (203) 871-1988.

To receive information about the Circuit Cellar Ink publication for hardware designers and developers, please circle 100 on the Reader Service inquiry card at the back of the magazine.

Steve Ciarcia (pronounced "see-ARE-see-ah") is an electronics engineer and computer consultant with experience in process control, digital design, nuclear instrumentation, and product development. The author of several books on electronics, he can be reached at P.O. Box 582, Glastonbury, CT 06033.

Want to save Time, Money,
& Headaches?

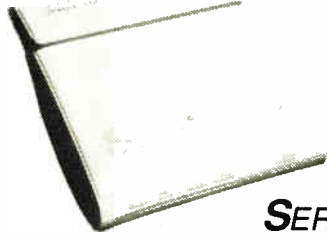

GET SUPERSOFT'S
SERVICE DIAGNOSTICS

All the software, alignment diskettes, parallel/serial wrap-around plugs, ROM POSTs and extensive, professional documentation to provide the most comprehensive testing available for IBM PCs, XTs, ATs and all compatibles under DOS or Stand Alone. No other diagnostics offers such in-depth testing on as many different types of equipment by isolating problems to the board and chip level.

NEW: SuperSoft's ROM POST performs the most advanced Power-on-Self-Test available for system boards that are compatible with the IBM ROM BIOS. It works even in circumstances when the Service Diagnostics diskette cannot be loaded.

NEW: 386 diagnostics for hybrids and PS/2s!

For over nine years, major manufacturers have been relying on SuperSoft's diagnostics software to help them and their customers repair microcomputers. End users have been relying on SuperSoft's Diagnostics II for the most thorough hardware error isolation available. Now versions of Service Diagnostics are available to save everyone (including every serious repair technician) time, money, and headaches in fixing their computers, even non-IBM equipment.

- | | |
|--|--|
| All CPUs & Numeric Co-processors | All Color Graphics & Monochrome Monitors |
| System Expansion & Extended Memory | Parallel & Serial Ports |
| Floppy, Fixed & Non-standard Disk Drives | Mono, CGA, Hercules & EGA Adapters |
| Standard & Non-standard Printers | All Keyboards & the 8042 Controller |
| System Board: DMA, Timers, Interrupt, Real-time Clock & CMOS config. RAM | |

Join the ranks of XEROX, NCR, CDC, SONY, PRIME, ... who have bundled SuperSoft's diagnostics with their microcomputers at no risk because of our 30 day money back guarantee.

Service Diagnostics for PC, PC/XT, and compatibles only	\$169
Alignment Diskette for PC, PC/XT and compatibles (48 tpi drives)	\$ 50
Wrap-around Plug for PC, PC/XT and compatibles (parallel and serial)	\$ 30
Service Diagnostics for AT and compatibles only	\$169
Alignment Diskette for AT and compatibles (96 tpi drives)	\$ 50
Wrap-around Plug for AT (serial)	\$ 15
ROM POST for PC, PC/XT, and compatibles only	\$245
ROM POST for AT and compatibles only	\$245
Service Diagnostics: The KIT (includes all of the above—save \$502)	\$495
Service Diagnostics for all other CPUs (386, V20, V30, Harris, etc.)	\$195
Diagnostics II is the solution to the service problems of users of all CP/M-80, CP/M-86 and MS-DOS computers	\$125
ROM POST for PS/2 and compatibles only	\$245
Alignment Diskette for PS/2 and compatibles (3.5 inch)	\$ 50

To order, call 800-678-3600 or 217-359-2112, FAX 217-398-5923, or write SuperSoft.

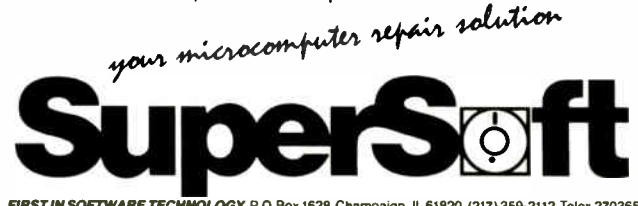

SUPERSOFT is a registered trademark of SuperSoft, Inc.; CDC of Control Data Corp.; IBM PC, AT & XT of International Business Machines Corp.; MS-DOS of MicroSoft Corp.; NEC of NEC Information Systems, Inc.; PRIME of PRIME INC.; Sony of Sony Corp.

New From Osborne/McGraw-Hill

The OS/2™ Books by The OS/2™ Experts

According to Bill Gates "Ed Iacobucci was a key architect. . . and made very important contributions. Ed is one of the few individuals who can explain the foundation that OS/2 will provide for the industry. . . what you will read here represents the real ideas behind the operating system and what can be done with it."

From the Foreword of
OS/2™ Programmer's Guide

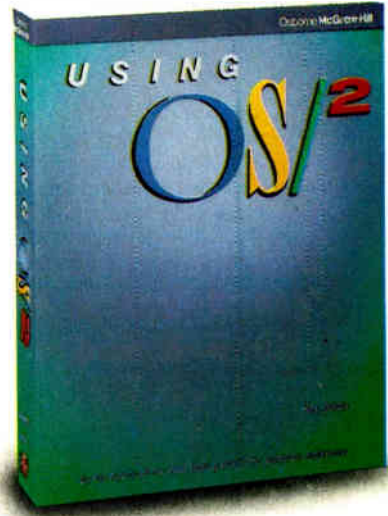
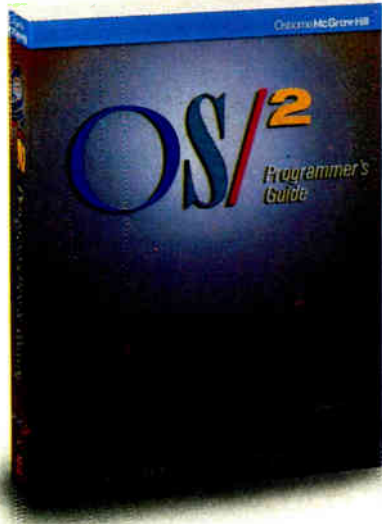

OS/2™ Programmer's Guide

by Ed Iacobucci,
Leader of the IBM® OS/2 Design Team

Foreword by Bill Gates

Here are the techniques and insights on OS/2 version 1.0 that serious programmers need. Learn how and why the system works. Iacobucci discusses

- Dynamic linking and the system API
- Memory management in a protected environment
- OS/2 multi-tasking
- Advanced inter-process communications facilities
- The system I/O capabilities
- Session management, user interface, utilities, and more.

\$24.95, ISBN: 0-07-881300-X, 650 pages

Using OS/2™

by Kris Jamsa,
Author of the Bestseller
DOS: The Complete Reference

You'll get up to speed on OS/2 with Jamsa's expertise. This quick-paced guide covers fundamental to advanced concepts, illustrated with numerous examples and screen displays. You'll find details on

- Redirection of I/O
- System configuration
- Multi-tasking
- Similarities between DOS and OS/2
- A *complete* command reference with syntax charts that are unavailable elsewhere
- Tips for system configuration with analyses of configuration file entries

\$19.95, ISBN: 0-07-881306-9, 600 pages

Available at Fine Book Stores and Computer Stores Everywhere

Or Call Our Toll-Free Number **800-227-0900** (Outside California) **800-772-2531** (Inside California)
(Use Your Visa or MasterCard)

Available in Canada through McGraw-Hill Ryerson, Ltd. Phone 416-293-1911



Osborne/McGraw-Hill
2600 Tenth Street
Berkeley, California 94710

Circle 199 on Reader Service Card

Dynamic Linking in OS/2

Dynlinks make OS/2 programs smaller, more efficient, and easier to upgrade—here's how they work



Most operating systems let you create programs piecemeal. You can compile one piece at a time and have it refer to the other pieces as externals. A linker combines these pieces into one final executable image, fixing up the external references (i.e., references between one piece and another) that those pieces contain.

The primary advantage of linking to external code is that you can use it to refer to a standard set of subroutines—a subroutine library—without compiling or even possessing the source code for those subroutines. Nearly all high-level language packages come with one or more standard run-time libraries that contain various useful subroutines that the compiler can call implicitly and that the programmer can call explicitly.

In this process, called *static linking*, the static code (i.e., the external subroutine) is built into the final executable module. Naturally, this makes the executable file larger, but more importantly, the target code can't be changed or upgraded without relinking to the main program's object files. Because the personal computer field is built on commercial software whose authors don't release source or object files, this relinking is out of the question for the typical end user.

Finally, the target code can't be shared in memory among several different applications that use the same library routines, for two reasons. First, the target code was relocated differently by the linker for each client; so although the code remains logically the same for each application, the address components of the binary instructions are different in each executable file. Second, the operating system has no way of knowing that these applications are using the same library, and it has no way of knowing where that library is in each executable file. Therefore, it can't avoid having duplicate copies of the library in memory.

To do away with these problems, OS/2 uses *dynamic linking*, in which a program's external references to subroutines are resolved either when the program is loaded, or later at run time, as the subroutines are needed by the program. Subroutines are kept in special dynlink libraries, application programs can share subroutines, and programmers can make changes to frequently used procedures (such as user-interface routines) without changing the applications that use them.

Load-Time Dynlinks

On the surface, the process of load-time dynamic linking looks the same as that of static linking. The programmer makes an external reference to a subroutine, and at link time specifies a

library file (or an object file) that defines the reference. The linker produces an executable file that OS/2 then loads and executes. Behind the scenes, however, things are very different.

In static linking, the linker finds the actual externally referenced subroutine in the library file. In dynamic linking, the linker finds a special record that defines a module name string and an entry-point name string. For example, in a hypothetical routine called `Foo`, the library file contains only these two name strings, not the code for `Foo` itself. (The entry-point name string doesn't have to be the name by which programs called the routine.) The resultant executable file doesn't contain the code for `Foo`; it contains a special dynlink record that specifies these module and entry-point names for `Foo`.

When this executable file is run, OS/2 loads the code in the .EXE file into memory and discovers the dynlink record(s). For each dynlink module that is named, OS/2 locates the code in the system's dynlink library directory and loads it into memory (unless the module is already in use; more about this later). The system then links the external references in the application to the addresses of the called entry points (see figure 1).

Although this is just postponing the linkage until load time, the technique has several important ramifications. First, the target code is not in the executable file but in a separate dynlink library (.DLL) file. Thus, the executable file is smaller because it contains only the name of the target code, not the code itself. You can change or upgrade the target code at any time simply by replacing this .DLL file. The next time a referencing application is loaded (with some restrictions, as I'll discuss later), it is linked to the new version of the target code. Having the target code in a dynlink file paves the way for automatic code sharing. OS/2 can easily understand that two applications are using the same dynlink code because it loaded and linked that code, and it can use this knowledge to share the pure segments of that dynlink package rather than loading duplicate copies.

Although you need to understand dynamic linking to create a dynlink module, you can use one without even knowing that it's not an ordinary static link. Dynamically linked programs sometimes take longer to load into memory than do statically linked programs. The performance ramifications depend on the kind of dynlink module that is referenced and whether this executable file is the first to reference the module.

Although I have concentrated on processes that call dynlink routines, these routines can also be called by other dynlink routines. When OS/2 loads a routine in response to a process's request, it examines it to see if it has any dynlink references of its own. Any such referenced dynlink routines are also loaded until no unsatisfied dynlink references remain.

Run-Time Dynamic Linking

Not all dynlink names need to appear in the executable file at load time; a process can link itself to a dynlink package at run

continued

time as well. Run-time dynamic linking works exactly like load-time dynamic linking, except that the process creates the dynlink module and entry-point names at run time and then passes them to OS/2 so that OS/2 can locate and load the specified dynlink code.

Run-time linking takes place in four steps:

1. The process issues a `DosLoadModule` call to tell OS/2 to locate and load the dynlink code into memory.
2. The `DosGetProcAddress` call is used to obtain the addresses of the routines that the process wants to call.
3. The process calls the dynlink library entry points by an indirect call through the address returned by `DosGetProcAddress`.
4. When the process has no further use for the dynlink code, it can call `DosFreeModule` to release the dynlink code. After this call, the process will still have the addresses returned by `DosGetProcAddress`, but they will be illegal addresses; referencing them will cause a GP (general protection) fault.

Run-time dynlinks are useful when a program knows it will want to call some dynlink routines but doesn't know which

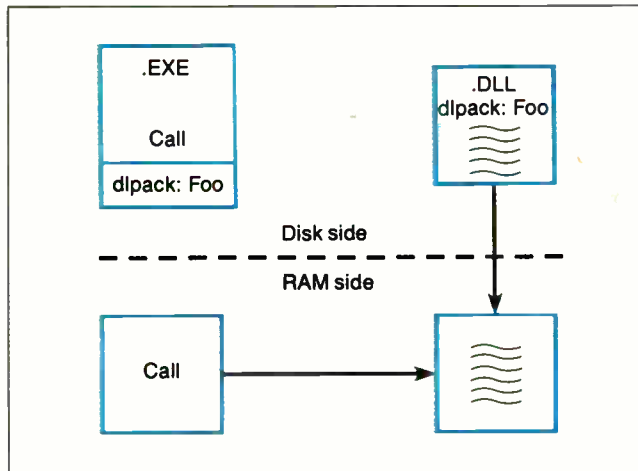

Figure 1: In load-time dynamic linking, the executable file contains an entry that tells OS/2 where to find the dynlink module, `Foo`. When OS/2 loads the executable file into memory, it also loads `Foo` and fixes all references to `Foo` from the executable file.

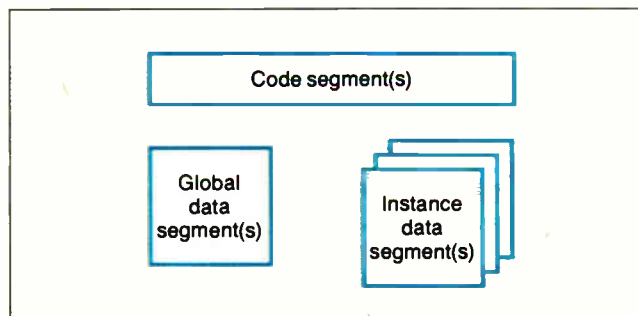

Figure 2: A dynlink routine can have three kinds of segments. Each process using the dynlink module will get its own copy of the instance data segments while sharing the same copy of the global data segments with the other processes attached to the dynlink module. OS/2 performs an optimization so that code segments are shared transparently among all processes.

ones. For example, a charting program may support four plotters, and it might want to use dynlink plotter-driver packages. It doesn't make sense for the application to contain load-time dynlinks to all four plotters, because only one will be used and the others will take up memory and swap space. Instead, the charting program can wait until it learns which plotter is installed and then use the run-time dynlink facility to load the appropriate package. The application can even wait until the user issues a plot command before it calls `DosLoadModule`, thereby reducing memory demands on the system.

The application need not even be able to enumerate all the modules or entry points that may be called. The application can learn the names of the dynlink modules from another process or by looking in a configuration file. This allows the user of the charting program, for example, to install additional plotter drivers that didn't even exist at the time the application was written. Of course, in this example the calling sequences of the dynlink plotter driver must be standardized, or you must devise a way for the application to figure out the proper way to call these newly found routines.

Naturally, a process is not limited to one run-time dynlink module; you can use multiple calls to `DosLoadModule` to link to several dynlink modules simultaneously. Regardless of the number of modules in use, you should use `DosFreeModule` if the dynlink module is no longer needed and the process intends to continue executing. But issuing `DosFreeModule` is unnecessary if the process is about to terminate; OS/2 releases all dynlink modules at process-termination time.

Dynlinks, Processes, and Threads

Simply put, OS/2 views dynlinks as a fancy subroutine package. Dynlinks aren't processes, and they don't own any resources. A dynlink executes only because a thread belonging to a client process has called the dynlink code. The dynlink code is executing as the client thread and process because, in the eyes of the system, the dynlink is merely a subroutine that the process has called. Before the client process can call a dynlink package, OS/2 ensures that the dynlink's segments are in the client's address space. No ring transition or context-switching overhead occurs when a client calls a dynlink routine; the far call to a dynlink entry point is just that—an ordinary far call to a subroutine in the process's address space.

One side effect is that dynlink calls are very fast; little CPU time is spent getting to the dynlink package. Another side effect is that there is no separation between a client's segments and a dynlink package's segments, because segments belong to processes and only one process is running both the client and the dynlink code.

Handling Dynlink Data

You might have noticed something missing in this discussion of dynamic linking: I've said nothing about how to handle a dynlink routine's data. OS/2 supports two types of data segments for dynlink routines—instance and global (see figure 2). Instance data segments hold data specific to each instance of the dynlink routine. In other words, a dynlink routine has a separate set of instance data segments for each process using the routine. The dynlink code has no difficulty addressing its data; the code can reference the data segment selectors as immediate values.

A global data segment, as the name implies, is not duplicated for each client process. There is only one copy of each dynlink module's global data segment; each client process is given shared access to that segment. The segment is loaded only once—when the dynlink package is first brought into memory to be linked with its first client process. Global data segments allow a dynlink routine to be explicitly aware of its multiple clients, because changes to a global segment made by calls from

one client process are visible to the dynlink code when called from another client process. Global data segments support subsystems, which I'll discuss later.

Because a dynlink routine's data requirements are not known at link time, the technique of fixing up the references that the client code makes to the dynlink routine's data is more complicated than that for statically linked routines. In statically linked subroutines, when the linker binds the external code with the main code, it sees how much static data the external code needs and allocates the necessary space in the proper data segments. References that the external code makes to its data are then fixed up to point to the proper location. Because the linker is combining all the object files into an executable file, it can easily divide the static data segments among the various compilands.

This technique doesn't work for dynlink routines, because their code (and therefore their data requirements) aren't present at link time. It's possible to extend the special .OBJ file to describe the amount of static data that the dynlink package will need, but it won't work. (And even if it did work, it would be a poor design because it would restrict our ability to upgrade the dynlink code in the field.) Because the main code in each application uses different amounts of static data, the data area reserved for the dynlink package would end up at a different offset in each executable file that was built. When these .EXE files were executed, one set of shared dynlink code segments would need to reference the data that resides at different addresses for each different client. Relocating the static references in all dynlink code modules at each occurrence of a context switch is clearly out of the question.

An alternative to letting dynlink routines have their own static data is to require that their callers allocate the necessary data areas and pass pointers to them upon every call. We easily rejected this scheme: It's cumbersome; call statements must be written differently if they're for a dynlink routine; and, finally, this hack wouldn't support subsystems, which I'll discuss later.

Instead, OS/2 takes advantage of the segmented architecture of the 80286 to solve the static addressability problem. Each dynlink routine can use one or more data segments to hold its static data. Each client process has a separate set of these segments. Because these segments hold only the dynlink routine's data and none of the calling process's data, the offsets of the data items within that segment will be the same no matter which client process is calling the dynlink code. All you need to do to solve the static-data addressability problem is ensure that the segment selectors of the dynlink routine's static data segments are the same for each client process.

OS/2 does this by means of a technique called the *disjoint LDT space*. I won't attempt a general introduction to the segmented architecture of the 80286, but a brief summary is in order. Each process in 80286 protected mode can have a maximum of 16,383 segments. These segments are described in two tables: the LDT (local descriptor table) and the GDT (global descriptor table). An application can't read from or write to these tables. OS/2 manages them, and the 80286 microprocessor uses their contents when a process loads selectors into its segment registers.

In practice, the GDT is not used for application segments, which leaves the LDT 8192 segments—or, more precisely, 8192 segment selectors, which OS/2 can set up to point to memory segments. The 80286 does not support efficient position-independent code, so 80286 programs contain within them, as part of the instruction stream, the particular segment selector needed to access a particular memory location, as well as an offset within that segment. This applies to both code and data references.

When OS/2 loads a program into memory, the executable file describes the number, type, and size of the program's seg-

ments. OS/2 creates these segments and allocates a selector for each from the 8192 possible LDT selectors. There isn't any conflict with other processes in the system at this point, because each process has its own LDT and its own private set of 8192 LDT selectors. After OS/2 chooses a selector for each segment, both code and data, it uses a table of addresses provided in the executable file to relocate each segment reference in the program, changing the place-holder value put there by the linker into the proper segment-selector value. OS/2 never combines or splits segments, so it never has to relocate the offset part of addresses—only the segment parts. Address offsets are more common than segment references. Because the segment references are relatively few, this relocation process is not very time-consuming.

If OS/2 discovers that the process it is loading references a dynlink routine, the situation is more complex. For example, suppose the process isn't the first caller of Foo; Foo is already in memory and already relocated to some particular LDT slots in the LDT of the earlier client of Foo. OS/2 has to fill in those same slots in the new process's LDT with pointers to Foo; it can't assign different LDT slots because Foo's code and data have already been relocated to the earlier process's slots. If the new process is already using Foo's slot numbers for something else, then you're in trouble. This is a problem with all Foo's segments, both data segments and code segments.

This is where the disjoint LDT space comes in. OS/2 reserves many of each process's LDT slots for the disjoint space. The same slot numbers are reserved in every process's LDT. When OS/2 allocates an LDT selector for a memory segment that may be shared between processes, it allocates an entry from the disjoint LDT space. After a selector is allocated, that same slot is reserved in all other LDTs in the system. The slot either remains empty (i.e., invalid) or points to this shared segment; it can have no other use. This guarantees that a process that has been running for hours and that has created dozens of segments can still call `DosLoadModule` to get access to a dynlink routine; OS/2 will find that the proper slots in this process's LDT are ready and waiting.

The disjoint LDT space is used for all shared memory objects, not just dynlink routines. Shared memory data segments are also allocated from the disjoint LDT space. A process's code segments are not allocated in the disjoint LDT space, yet they can still be shared. [Editor's note: *For more discussion of the disjoint LDT space, see "OS/2 Virtual Memory Management" by Vic Heller on page 227.*]

Uses of Dynamic Linking

Dynlink libraries can serve as simple subroutine libraries or as subsystems. They can form the interface to other processes, the interface to OS/2 itself, and even the interface to a device without the device driver's overhead.

As I discussed earlier, a dynlink subroutine is written and executes in much the same way as a statically linked subroutine. The only difference is in the preparation of the dynlink library file, which contains the actual subroutines, and in the preparation of the special object file, to which client programs can link. During execution, both the dynlink routines and the client routines can use their own static data freely, and they can pass pointers to their data areas back and forth to each other. The only difference between static linking and dynamic linking in this model is that the dynlink routine cannot reference any external symbols that the client code defines, nor can the client externally reference any dynlink package symbols other than the module entry points. The execution environment is nearly identical to that of a traditional statically linked subroutine; the client and the subroutine each reference their own static data areas, all

continued

of which are contained in the process's address space. Note that a dynlink package can reference the application's data and the application can reference the dynlink package's data, but only if they pass pointers to their data to one another.

The term *dynlink subsystems* is merely a descriptive term that refers to the design and intended function of a particular style of dynlink package. A dynlink subsystem is a module that provides a set of services built around a resource. For example, OS/2's video I/O (VIO) dynlink entry points are considered a dynlink subsystem because they provide a set of services to manage the display screen. A subsystem usually has to manage a limited resource for an effectively unlimited number of clients. VIO does this, managing a single physical display controller and a small number of screen groups for an indefinite number of clients.

Because subsystems generally manage a limited resource, they have one or more global data segments that they use to keep information about the state of the resource they're controlling; they also have buffers, flags, semaphores, and so on. Per-client work areas are generally kept in instance data segments; it's best to reserve the global data segments for global information. Figure 3 illustrates a dynlink routine being used as a subsystem. A dynlink subsystem differs from a dynlink being used as a subroutine only by the addition of a static data segment.

Special Subsystem Support

Two OS/2 features are particularly valuable to subsystems: global data segments (which I've already discussed) and special client-initialization and client-termination support. Clearly, if a subsystem is going to manage a resource, keeping track of its clients in a global data segment, it needs to know when new clients arrive and when old clients terminate. The simple dynlink subroutine model doesn't provide this information reliably. A subsystem undoubtedly has initialize and terminate entry points, but client programs may terminate without having called a subsystem's terminate entry point. Such a failure may be an error on the part of the client, but the system architecture decrees that errors should be localized; it's not acceptable for a bug in a client process to be able to hang up a subsystem, and thus all its clients as well.

The two forms of subsystem initialization are *global* and *instance*. If a subsystem specifies global initialization, the initialization entry point is called only once per activation of the subsystem. When the subsystem dynlink package is first referenced, OS/2 allocates the subsystem's global data segments, taking their initial values from the .DLL file. OS/2 then calls the subsystem's global initialization entry point so that the module can do its one-time initialization. The thread that is used to

call the initialization entry point belongs to that first client process, so the first client's instance data segments are also set up and can be used by the global initialization process. This means that although the dynlink subsystem is free to open files, read and write their contents, and close them again, it cannot open a handle to a file, store the handle number in a global data segment, and expect to use that handle in the future.

Remember, subsystems don't own resources; processes own resources. When a dynlink package opens a file, that file is open only for that one client process. That handle has meaning only when that particular client is calling the subsystem code. If a dynlink package were to store process A's handle number in a global data segment and then attempt to do a read from that handle when running as process B, at best the read would fail with invalid handle; at worst some unrelated file of B's would be molested. And, of course, when client process A eventually terminates, the handle becomes invalid for all clients.

The second form of initialization is instance initialization. The instance initialization entry point is called in the same way as the global initialization entry point, except that it is called for every new client when that client first attaches to the dynlink package. Any instance data segments that exist will already be allocated and will have been given their initial values from the .DLL file. The initialization entry point for a load-time dynlink is called before the client's code begins executing. The initialization entry point for a run-time dynlink is called when the client calls the `DosLoadModule` function. A dynlink package cannot specify both global and instance initialization; if it desires both, it should specify instance initialization and use a counter in one of its global data segments to detect the first instance initialization.

Even more important than initialization control is termination control. In its global data area, a subsystem may have records, buffers, or semaphores on behalf of a client process. It may have queued-up requests from that client that it needs to purge when the client terminates. The dynlink package need not release instance data segments; because these belong to the client process, they are destroyed when the client terminates. The global data segments themselves are released if this is the dynlink module's last client, so the module might want to take this last chance to update a log file, release a system semaphore, and so on.

Using the `DosExitList` service allows a process to specify one or more subroutine addresses that will be called when the process terminates. Addresses can be added or removed from the list. There can be many such addresses, which are called under all termination conditions. Both the client process and the

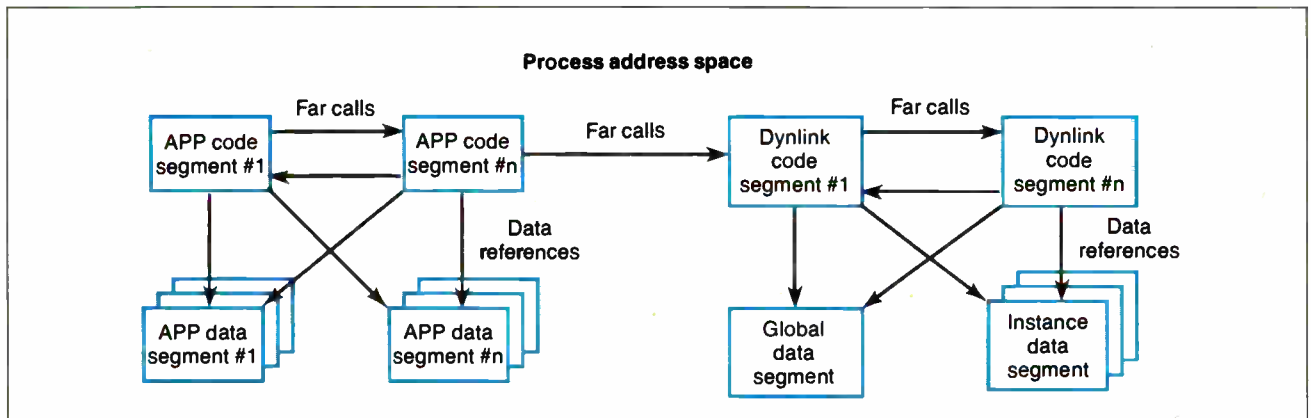

Figure 3: A dynlink routine used as a subsystem. The main difference between a dynlink subsystem and a subroutine is the presence of the global data segment(s).

subsystem dynlinks that it calls can have their own termination routines.

Interfaces to Other Processes

Earlier, I mentioned that dynlink subsystems have difficulty dealing with resources—other than global memory—because resource ownership and access are on a per-process basis. Life as a dynlink subsystem can be schizophrenic. Which files are open, which semaphores are owned, and so on, depends on which client is running your code at the moment. Global memory is different; it's the one resource that all clients own jointly. The global memory remains as long as the client count doesn't go to zero.

One way to deal with resource issues is for a dynlink package to act as a front end for a server process. During module initialization, the dynlink module can check a system semaphore to see whether the server process is already running and, if not, start it up. It needs to do this with the detach form of `DosExecPgm` so that the server process doesn't appear to the system as a child of the subsystem's first client. Such a mistake could mean that the client's parent thinks that the command subtree it founded by running the client never terminates because the server process appears to be part of the command subtree.

When the server process is running, the dynlink subsystem can forward some or all requests to it by one of the many inter-process communication (IPC) facilities. For example, a database subsystem might want to use a dedicated server process to hold open the database file and do reads and writes to it. It might keep buffers and ISAM (indexed sequential-access memory) directories in a shared-memory segment to which the dynlink subsystem requests access for each of its clients. Then requests that can be satisfied by data from these buffers won't require the IPC to the server process.

The only function of some dynlink packages is to act as a procedural interface to another process. For example, a spreadsheet program might provide an interface through which other applications can retrieve data values from a spreadsheet. The best way to do this is for the spreadsheet package to contain a dynlink library that provides clients with a procedural interface to the spreadsheet process. The library routine itself will invoke a noninteractive copy (perhaps a special subset .EXE) of the spreadsheet to recover the information, passing it back to the client via IPC. Alternatively, the retrieval code that understands the spreadsheet data formats could be in the dynlink package itself because that package ships with the spreadsheet and will be upgraded when the spreadsheet is updated. In this case, the spreadsheet itself could use the package instead of duplicating the functionality in its own executable file. In any case, the implementation details are hidden from the client process; the client process simply makes a procedure call that returns the desired data.

Viewed from the highest level, this arrangement is simple: A client process uses IPC to get service from a server process via a subroutine library. From the programmer's point of view, though, the entire mechanism is encapsulated in the dynlink subsystem's interface. A future upgrade to the dynlink package may use an improved server process and different forms of IPC to talk to it but retain full binary compatibility with the existing client base.

Interface to OS/2 Itself

All OS/2 interface calls are dynlink calls. We implemented some OS/2 calls as simple library routines. For example, in OS/2 version 1.0, `DosErrClass` takes an error code and locates, in a table, an explanatory text string, an error classification, and a recommended action. Services such as these have traditionally been part of the kernel of operating systems, not

In OS/2, system calls are indistinguishable from ordinary dynlink calls. This gives us the freedom to, in future releases, move functions between dynlink and call-gate entries.

because they need to use privileged instructions, but because their error tables must be changed each time an upgrade to the operating system is released. If the service is provided as a statically linked subroutine, older applications running on newer releases will receive new error codes that will not be in the library code's tables.

Although OS/2 implements `DosErrClass` as a library routine, it's a dynlink library routine, and the .DLL file is bundled with the operating system itself. Any later release of the system will contain an upgraded version of the `DosErrClass` routine, one that knows about new error codes. Consequently, the dynlink facility provides OS/2 with a great deal of flexibility in packaging its functions.

Some functions, such as "open file" or "allocate memory," can't be implemented as ordinary subroutines. They need access to key internal data structures, and these structures are, of course, protected so they can't be changed by unprivileged code. To get these services, the processor must make a system call, entering the kernel code in a very controlled fashion and there running with sufficient privilege to do its work. This privilege transition is via a call gate—a feature of the 80286/80386 hardware. A program calls a call gate exactly as it performs an ordinary far call; special flags in the GDT and LDT tell the processor that this is a call gate rather than a regular call.

In OS/2, system calls are indistinguishable from ordinary dynlink calls. All OS/2 system calls are defined in a dynlink module called `DosCalls`. When OS/2 fixes up dynlink references to this module, it consults a special table, built into OS/2, of resident functions. If the function is not listed in this table, then an ordinary dynlink is set up. If the function is in the table, OS/2 sets up a call-gate call in place of the ordinary dynlink call. The transparency between library and call-gate functions explains why passing an invalid address to an OS/2 system call causes the calling process to trigger a GP fault. Because the OS/2 kernel code controls and manages the GP fault mechanism, OS/2 calls that are call gates could easily return an error code if an invalid address causes the fault. If this were done, however, the behavior of OS/2 calls would differ depending on their implementation: Invalid addresses for dynlink entry points would cause a GP fault; call-gate entries would return an error code. OS/2 prevents this dichotomy and preserves its freedom to, in future releases, move functions between dynlink and call-gate entries. Because non-call-gate dynlink routines must generate GP faults, call-gate routines produce them as well.

Device Drivers

Dynlinks do much more than act as system calls. They provide an interface that is as device-independent as a device driver, but without the overhead. Using dynlinks, applications can make high-speed calls to a subroutine package that can directly manipulate the device. The call itself is fast, and the package can specify an arbitrarily wide set of parameters. No privilege or ring transition is needed, and the dynlink package can directly access its client's data areas. Finally, the dynlink package can

continued

With an open system architecture, you can add system services simply by plugging in dynlink modules, just as hardware cards plug into an open hardware system.

use subsystem support features to virtualize the device or to referee its use among multiple clients. Device independence is provided because a new version of the dynlink interface can be installed whenever new hardware is installed. VIO and the Presentation Manager are examples of this kind of dynlink use. Dynlink packages have an important drawback when they are being used as device-driver replacements: They cannot receive hardware interrupts. Some devices, such as video displays, do not generate interrupts. Interrupt-driven devices, though, require a true device driver. That driver can contain all the device interface function, or the work can be split between a device driver and a dynlink package that acts as a front end for that device driver.

Dynlink routines can also act as nonkernel service packages—as an open system architecture for software. Most operating systems are like the early versions of the Apple Macintosh computer: They are closed systems; only their creators can add features to them. Because of OS/2's open system architecture, third parties and end users can add system services simply by plugging in dynlink modules, just as hardware cards plug into an open hardware system. The analogy extends further: Some hardware cards like the Hayes modem and the Hercules Graphics Card become so popular that their interface defines a standard. Third-party dynlink packages will, over time, establish similar standards. Vendors will offer, for example, improved database dynlink routines that are advertised as plug-compatible with the standard database dynlink interface, but better, cheaper, and faster.

Dynlinks allow third parties to add interfaces to OS/2; they also allow OS/2's developers to add future interfaces. The dynlink interface model allows additional functionality to be implemented as subroutines or processes, or even to be distributed across a network environment.

Special Considerations

Although dynlink routines often act very much like traditional static subroutines, a programmer must be aware of some special considerations. I have discussed how a dynlink package runs as a subroutine of the client process and that the client process has access to the dynlink package's instance and global data segments. This use of the dynlink interface is efficient and thus advantageous, but it's also disadvantageous because aberrant client processes can damage the dynlink package's global data segments. The measures a programmer takes to deal with the security issue depend on the nature and sensitivity of the dynlink package. Dynlink packages that don't have global data segments are at no risk; an aberrant program can damage its instance data segments and thereby fail to run correctly, but that's the expected outcome of a program bug. A dynlink package with global data segments can minimize the risk by never giving its callers pointers into the dynlink package's global data segment. If the amount of global data is small and merely detecting damage is sufficient, the global data segments could be checksummed.

If accidental damage to the global data segments would be

grave, a dynlink package can work in conjunction with another dynlink package acting as a server. The server process can protect the sensitive data and provide it on a per-client basis to the dynlink package in response to an IPC request. Because the server process is a separate process, its segments are fully protected from the client process as well as from all others.

Dynlink Life, Death, and Sharing

Throughout this discussion, I have referred to sharing pure segments, which are segments that are never modified during their lifetime. The ability to share pure segments is an optimization that OS/2 makes for all memory segments whether they are dynlink segments or an application's executable file segments. All code segments (except for those created by `DosCreateCSAlias`) are pure; read-only data segments are also pure. When OS/2 notices that it's going to load two copies of the same pure segment, it performs a behind-the-scenes optimization and gives the second client access to the earlier copy of the segment instead of wasting memory with a duplicate version.

For example, if two copies of a program are run, all code segments are pure; at most, only one copy of each code segment will be in memory. OS/2 flags these segments as *internally shared* and doesn't release them until the last user has finished with the segment. This is not the same as shared memory as it is generally defined in OS/2. Because pure segments can only be read, never written, no process can tell that pure segments are being shared or being affected by that sharing. Although threads from two or more processes may execute the same shared code segment at the same time, this is not the same as a multithreaded process. Each copy of a program has its own data areas, its own stack, its own file handles, and so on. They are totally independent of one another even if OS/2 is quietly sharing their pure code segments among them.

Because the pure segments of a dynlink package are shared, the second and subsequent clients of a dynlink package can load much more quickly (because these pure segments don't have to be loaded from the .DLL disk file). This doesn't mean that OS/2 doesn't have to hit the disk at all: Many dynlink packages use instance data segments, and OS/2 loads a fresh copy of the initial values for these segments from the .DLL file.

When the last client process of a dynlink object dies or otherwise releases the object, OS/2 destroys the object and frees up the memory. This mechanism has the potential to cause a problem only in the management of the dynlink package's global data segment. For example, when the first client (since boot-up) of a dynlink package references it, OS/2 loads the package's code and data segments. Then OS/2 calls the package's initialization routine—if the package has one. OS/2 records in an internal data structure that this dynlink package has one client. If additional clients come along while the first is still using the dynlink package, OS/2 increments the package's user count appropriately. Each time a client disconnects or dies, the user count is decremented.

As long as the user count remains nonzero, the package remains in existence, with each client sharing the original global data segments. When the client count goes to zero, OS/2 discards the dynlink package's code and global data segments and in effect forgets all about the package. When another client comes along, OS/2 reloads the package and reloads its global data segment as if the earlier use had never occurred.

If discarding the global data segment is a problem for a dynlink package, an associated dummy process (which the dynlink package could start during its load-time initialization) can reference the dynlink package. As long as this process stays alive, the dynlink package and its global data segments stay alive.

An alternative is for the dynlink package to keep track of the

continued

You Never Regret A WYSE Decision



WYSEpc 286 SYSTEM

Intel 80286 Running AT 8 and 12.5 MHz
 Phoenix Bios • 1.2 Meg Floppy Drive
 102 - Key Enhanced PC - Style Key Board
 1 Meg of Parity Checked RAM
 Clock/Calendar with Battery Backup
 WYSEwindow system status display
 190 W Power Supply • GW Basic 3.21
 1 Serial and 1 Parallel Port
 MS-DOS 3.21 and Users Guide
 20 Meg 65ms Hard Disk Drive

\$1,795

\$2,295



WYSEpc 386 SYSTEM

Intel 80386 Running AT 8 and 16 MHz
 Phoenix Bios • 1.2 Meg Floppy
 102-Key Enhanced PC - Style Keyboard
 1 Meg of 0 wait state static ram
 Clock/Calendar with Battery Backup
 WYSEwindow system status display
 1 Serial and 1 Parallel Port
 GW - Basic 3.21 • 220 W Power Supply
 MS-DOS 3.21 • FREE C-MOS-286
 41 Meg 28ms Hard Disk Drive

\$3,750

\$4,250



HERCULES COMPATIBLE MONO SYSTEM
 With WY-530 14inch Hi Res Amber Monitor

EGA COLOR SYSTEM
 With WY-640 Hi Res EGA MONITOR

OPTIONS

- 2nd Floppy Drive 5 1/4" 360K \$99
- 2nd Floppy Drive 3 1/2" 720K \$155
- 41Meg 28ms Hard Disk Drive \$210
- 1200 Baud Internal Modem w/Software \$89
- 2400 Baud Internal Modem w/Software \$199
- 12.5 MHz Speed Option \$450

- NEC MultiSync EGA Monitor \$99
- 71 Meg 23 ms Hard Disk Drive \$450
- Math Co-Processor
- Extended Service Contract Available
- Other Options Available

THIRTY-DAY MONEY BACK GUARANTEE

You can return any B & W SYSTEMS, INC. computer system within thirty days of the date of shipment. Return the items like new with complete documentation, warranty cards and packing material. Return product cards and packing material. Return product must be labeled with a Return Merchandise Authorization (RMA) number and shipped prepaid and insured.

ONE YEAR LIMITED WARRANTY

We warranty our products to be free of defects in material and workmanship for a period of one year from the date of shipment. The Warranty covers the cost of all materials and labor.

- WORLDWIDE SERVICE AND SUPPORT
- QUANTITY DISCOUNTS AVAILABLE
- No Extra Charge for Visa or Mastercard

TO ORDER TOLL FREE

1-800-638-9628

For Information Call — (301) 963-5800

Visa • Master Card



7877 Cessna Ave
 Gaithersburg, MD
 20879

B & W SYSTEMS, INC.

Trademarks: WYSE — trademark of WYSE Technology • MS-DOS & OS 2 — trademark of Microsoft Corporation • Hercules — trademark of Hercules Computer Technology • NEC — trademark of NEC Corporation • PC-MOS 386 — trade mark of Software Link. Specifications, configurations, and prices subject to change without notice. Copyright 1987 B & W SYSTEMS, INC.

Circle 323 on Reader Service Card

APRIL 1988 • BYTE 279

count of its clients and save the contents of its global data segments to a disk file when the last client terminates, but this is tricky. Because a process may fail to call a dynlink package's "I'm finished" entry point (presumably part of the dynlink package's interface) before it terminates, the dynlink package must get control to write its segment via `DosExitList`. If the client process is connected to the dynlink package via `DosLoadModule` (i.e., via run-time dynamic linking), it cannot disconnect from the package via `DosFreeModule` as long as a `DosExitList` address points into the dynlink package. An attempt to do so returns an error code. Typically, you might expect the application to ignore this error code, but because the dynlink package is still attached to the client process, it will receive `DosExitList` service when the client eventually terminates. It's important that dynlink packages that maintain client-state information and therefore need `DosExitList` also offer an "I'm finished" function. When a client calls this function, the package should close it out and then remove its processing address from `DosExitList` so that `DosFreeModule` can take effect if the client wishes.

Note that OS/2's habit of sharing in-use dynlink libraries has implications for the replacement of dynlink packages. Specifically, OS/2 holds the .DLL file open for as long as that library has any clients. To replace a dynlink library with an upgraded version, you must first ensure that all clients of the old package have terminated.

Dynlink segments, like executable file segments, can be marked (by the linker) as *preload* or *load on demand*. When a dynlink module or an executable file is loaded, OS/2 immediately loads all segments marked *preload* but usually does not load any segments marked *load on demand*. These segments are loaded only if and when they are referenced. (Segments that are loaded from removable media will be fully loaded, regardless of the load-on-demand bit.) This mechanism speeds process and library loading and reduces swapping by leaving infrequently used segments out of memory until they are needed. Once a segment is loaded, its *preload* or *load-on-demand* status has no further bearing; the segment will be swapped or discarded without consideration for these bits.

Finally, special OS/2 code keeps track of dynlink *circular references*. Because dynlink packages can call other dynlink packages, package A can call package B, and package B can call package A. Even if the client process C terminates, packages A and B might appear to be in use by each other, and they would both stay in memory. OS/2 keeps a graph of dynlink clients—both processes and other dynlink packages. When a process can no longer reach a dynlink package over this graph, the dynlink package is released.

Avoiding Side Effects

A well-written dynlink library should have no side effects. It should export to the client process only its functional interface and not accidentally export side effects that might interfere with the consistent execution of the client.

Some possible side effects are obvious: A dynlink routine shouldn't close any file handles that it didn't open itself. The same applies to other system resources that the client process may be accessing, and it applies in the inverse as well: A dynlink routine that obtains resources for itself, in the guise of the client process, should do so in a way that doesn't affect the client code.

For example, consuming many of the available file handles would be a side effect because the client would then be unexpectedly short of available file handles. A dynlink package with a healthy file-handle appetite should be sure to call OS/2 to raise the maximum number of file handles so that the client process isn't constrained. Finally, a dynlink package must not exhaust the available stack space. A dynlink routine should minimize its

stack needs, and an upgrade to an existing dynlink package must not consume much more stack space than did the earlier version, lest the upgrade cause existing clients to fail in the field.

Dynlink routines can also cause side effects by issuing system calls that affect the client process. For example, each signal event can have only one handler address; if a dynlink routine establishes a signal handler, then that signal handler preempts any handler set up by the client application. Likewise, if a dynlink routine changes the priority of the thread with which it was called, the dynlink routine must be sure to restore that priority before it returns to its caller. Several other system functions such as `DosError` and `DosSetVerify` also cause side effects that can affect the client process.

Enumerating all forms of side effects is not possible; it's up to the programmer to take the care needed to ensure that a dynlink module is properly house-trained.

Naming Dynlinks

Each dynlink entry point has three names associated with it: an *external name*, a *module name*, and an *entry-point name*. The name the client program calls as an external reference is the external name. The programmer works with this name, and its syntax and form must be compatible with the assembler or compiler being used. The name should be simple and explanatory yet unlikely to collide with another external name in the client code or in another library. A name such as `READ` or `RESET` is a poor choice because of the collision possibilities; a name such as `XR23P11` is obviously hard to work with.

The linker replaces the external name with a module name and an entry-point name, which are embedded in the resultant executable file. OS/2 uses the module name to locate the dynlink .DLL file; the code for module `modname` is in file `MOD-NAME.DLL`. The entry-point name specifies the entry point in the module; the entry-point name need not be the same as the external name. For modules with a lot of entry points, the client executable file size can be minimized and the loading speed maximized by using entry ordinals in place of entry-point names. Run-time dynlinks are established by using the module name and the entry-point name; the external name is not used.

Flexibility, Efficiency, Consistency

Dynamic linking provides not only a uniform interface to OS/2 that is consistent across system calls and most device interfaces, but it also builds in enough flexibility to allow OS/2 to adapt to developments in technology through the use of nonkernel service packages.

Dynamic linking allows you to keep the target code separate from the executable code, which lets you change or upgrade the code simply by replacing the dynlink code. Because the system links in the dynlink routines itself, it knows it can save more space by sharing segments where possible, thus avoiding duplicate copies of code in memory. With run-time dynamic linking, a process can use OS/2 system calls to determine which dynlink modules it wants to run and then load them. Being able to determine the necessary modules at run time can save space by allowing a process to load only what it needs.

Finally, dynlink routines can serve as a subsystem, a set of services built around a resource such as VIO. Dynlinks can also form the interface between processes, which can add a level of control and protection to the processes involved. Devices that do not need to intercept interrupts can be controlled with dynlinks. And finally, dynlinks form the interface to the OS/2 kernel itself, thus providing a truly consistent interface for the programmer. ■

Gordon Letwin is chief architect of systems software at Microsoft Corp., Redmond, Washington.

Harris/3M copiers come with a unique paper supply.



It's something no other copier company in the world can offer. We call it the Harris/3M promise. And it guarantees, in writing, that your copier will be up and running when you need it. But that's only part of what we offer you.

Trade in now for up to \$1000!

Give us a call or send in this coupon and we'll tell you how, for a limited time, you can save up to \$1000 on a new Harris/3M copier. We'll also send you two free booklets to help you evaluate your copier needs.

Get all the facts on the Harris/3M promise and our valuable trade-in offer soon. You'll be convinced

that your next copier should be a Harris/3M. We guarantee it.

Call 1-800-TLC-COPY

Or send in this coupon to receive information on our trade-in offer plus two FREE booklets to help you evaluate your copier needs.

I'd also like information on your full line of fax machines.

Name _____

Company Name _____

Address _____

City _____ State _____

Zip _____ Telephone _____

Mail to Harris/3M Document Products, Inc.,
P.O. Box 785, Dayton, OH 45401. MH388FP

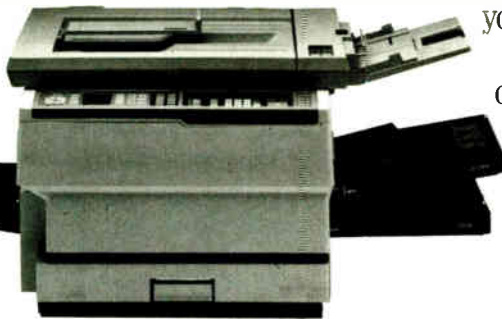

HARRIS/3M

Get more than a copier. Get a commitment.

Offer is valid at participating U.S. dealers for a limited time and other restrictions and limitations apply; see your Harris/3M sales representative for details. Free loaner offer is valid if copier is installed within 50 miles of an authorized Harris/3M service facility. ©1988 Harris/3M Document Products, Inc. Harris is a trademark of the Harris Corporation. 3M is a trademark of the 3M Company.

Circle 118 on Reader Service Card

APRIL 1988 • BYTE 281

World Radio History

PICK BIX BRAINS

... With a 10 Day Trial Membership

If you've thought about joining **BIX** before but weren't sure it was what you needed, now is the time to try it. Because now for a limited time, we're inviting you to try **BIX** for 10 days. If at any time during this 10 day trial period you don't feel **BIX** has made you a more knowledgeable microcomputer user, we'll refund your entire registration fee. You pay only for time spent on the system.* (See log-on instructions for hourly rates).

Explore **BIX** in your home or office. Put its power to work for you and unleash your full microcomputer potential — programming, designing, specifying, researching — and more.

Try **BIX** for 10 full days and see what it can do for you. Explore more than 160 conferences. Access vendor support. Speak to expert consultants. Research new products and systems, and download public domain software.

Prepare yourself for success

It takes a sharp mind and hard work to stay ahead, and having the right tools helps.

Today, you can put one of the most powerful instruments for career advancement to work for you: **BIX**.

- Learn about new products before they hit the market.
- Get quality marketplace feedback on the products you're thinking of purchasing before you invest.
- Research problems and find the solutions that no one else has been able to render.
- Access some of the most advanced public domain software available in the industry.
- Increase your working knowledge of micros to make more confident purchasing decisions and recommendations.

Join **BIX** and arm yourself with the latest in microcomputer-related information

BIX's exclusive *Microbytes* newswire gives you complete, daily, up-to-date computer industry information. You'll gain insight from **BYTE** editors and writers who analyze new products and their potential impact, inform you of the latest mergers and acquisitions, and report late-breaking news from important seminars and conferences.

Talk to colleagues worldwide

You'll stay on top of your company's

business with **BIX's** electronic mail service.

"Talk" to your east coast, west coast — even European — contacts all in the same day.

Or, simply communicate with other **BIX** users worldwide. Share information and ideas privately, or in conference.

Choose any option for online access with a one time \$39 membership fee

- Use MasterCard, VISA or American Express and begin your 10 day trial use of **BIX** right now.
- The 10 day trial also applies if you open an individual pre-paid account on **BIX**. Trial commences once we open your account and notify you.
- Other billing options including qualified corporate accounts are available. (Sorry, our 10 day trial is not available for these accounts.) Call or write **BIX** for details.

Use credit cards for immediate access or call the **BIX** Helpline for information on any other payment option at, 1-800-227-2983 (from U.S. and Canada) 603-924-7681 (in New Hampshire and elsewhere).

Act now! Our 10 day trial offer is subject to cancellation at any time.

* To notify **BIX** that you wish to discontinue service at any time during the trial period, call the **BIX** Helpline, and your entire membership fee will be refunded.

****BIX** can be accessed via Tymnet throughout the U.S. and Canada. For the Tymnet number nearest you, call the **BIX** Helpline or Tymnet at 1-800-336-0149.

† If your local Tymnet number is a toll call you will receive additional charges from your local phone company at their prevailing rate.

†† Continental U.S. Tymnet rates. Rates from other areas are available from **BIX**.

BIX is easy to join

To log-on to **BIX**, simply:

Set your computer's telecommunications program for full-duplex, 8-bit characters, no parity, 1 stop bit OR 7-bit characters, even parity, 1 stop bit. Use 300 or 1200 baud.

Call your Tymnet number ** and respond as follows:

Tymnet Prompt	You Enter
Garble or request for "terminal identifier"	a
login:	bix<CR>
BIX logo/name:	bix.038 <CR>

Callers outside the U.S. who have a communicating computer or terminal and a packet switching account with their host country phone system

can reach **BIX** by entering 310690157800. To commence registration, enter the code listed at the **BIX** logo/name: prompt.

After you register, you'll automatically be taken to the **BIX** Learn Conference, an online tutorial that will show you how to begin using the system immediately. Time spent in the Learn Conference is FREE. Complete system documentation will be sent to you within a few days.

Access time will be billed at the following hourly rates.†

Off-Peak Time \$11/hr. (\$9 **BIX**, \$2 Tymnet)††
(7 PM - 6 AM weekdays, all day weekends and holidays)

Peak Time \$20/hr. (\$12 **BIX**, \$8 Tymnet)††
(6 AM - 7 PM weekdays)

BIX

BYTE INFORMATION EXCHANGE

One Phoenix Mill Lane
Peterborough, NH 03458

BYTE's Subscriber Benefits Program

Your BYTE subscription brings you a complete menu of the latest in microcomputer technology every 30 days. The kind of broad-based objective coverage you read in every issue. *In addition*, your subscription carries a wealth of other benefits. Check the check list:

BONUSES

- ✓ **Annual Separate Issues:** In addition to BYTE's 12 monthly issues, subscribers also receive our annual IBM PC issue free of charge, as well as any other annual issues BYTE may produce.
- ✓ **BYTE Deck:** Subscribers receive five BYTE postcard deck mailings each year—a direct response system for you to obtain information on advertised products through return mail.
- ✓ **Reader Service:** For information on products advertised in BYTE, circle the numbers on the Reader Service card enclosed in each issue that correspond to the numbers for the advertisers you select. Drop the post-paid card in the mail and we'll get your inquiries to the advertisers.
- ✓ **TIPS:** BYTE's Telephone Inquiry System is available to subscribers who need *fast response* from advertisers. After obtaining your Subscriber I.D. Card, dial TIPS and enter your inquiries. You'll save as much as ten days over the response to Reader Service cards.
- ✓ **Free Programs Via BYTENet:** You get access to the BYTENet Bulletin Board Service, which allows you to download, via



modem, valuable program listings. There is no connect charge for this service.

- ✓ **Subscription Service:** If you have a problem with, or a question about your subscription, you may call our service department toll-free at 800-423-8272 (in New Jersey call 800-367-0218) during regular business hours (Eastern Time). You can also use Subscription Service to obtain back issues. Should you care to correspond, use the following address: P.O. Box 6821, Piscataway, N.J. 08855.
- ✓ **Editorial Indices:** Available through our customer service department P.O. Box 328, Hancock, New Hampshire 03449.

PAID SERVICES

- ✓ **BIX:** BYTE's Information Exchange puts you on-line 24 hours a day with your peers via computer conferencing and electronic mail. All you need to

sign up is a microcomputer, a modem, and telecomm software. For further information and cost, call 1-800-227-BYTE.

- ✓ **Program Listings:** Listings of programs that accompany BYTE articles are now available on BIX, on disks or in quarterly printed supplements (see reply cards in this issue for cost information), or call 1-800-258-5485.
- ✓ **Microform:** BYTE is available in microform from University Microfilm International in the U.S. and Europe. See Contents page for cost information.

DISCOUNTS

- ✓ One-year subscription at \$22.95
- ✓ Two-year subscription at \$39.95
- ✓ Three-year subscription at \$55.95
- ✓ One-year group subscription for ten or more at \$18.95 each. (Call or write for details.)

TOLL-FREE NUMBERS FOR YOUR CONVENIENCE:

Subscriptions & Back Issues:
1-800-423-8272
(in N.J., 1-800-367-0218)
BIX: 1-800-227-BYTE
Program Listings Orders:
1-800-258-5485

BYTE



It's indispensable.

When Facts Get Fuzzy

Add fuzzy logic to your Turbo Prolog programs and they'll be able to cope with the uncertainties of real-world situations

Most of us like to reason in absolutes. For example, we might say, "If the sky is blue, then it isn't raining." This simple approach works well for reasoning in artificial domains such as formula-proving. But as soon as the meteorologist says "partly cloudy," we are thrown back into the real world, where facts are often ambiguous. If artificial intelligence (AI) is to succeed at modeling human reasoning, it must be able to deal with information that might be uncertain, or even inaccurate.

Fuzzy logic lets us do just that. Programs using fuzzy logic are a series of fuzzy-logic statements, just as ordinary Prolog programs are a series of predicate (i.e., two-valued) logic statements.

Reasoning with Uncertainty

In traditional set theory, an element either belongs to a set or it doesn't. Elements in a fuzzy set may belong only partially to the set. The classic example is the set of "young" people. At what age is someone no longer young? There is no established dividing line, so a fuzzy-set definition might show a person 20 years old as "90 percent young," while someone 60 years old would be only "30 percent young." The degree of membership in a fuzzy set ranges from 0 to 1.

This ability to deal with a continuous range of values, rather than just true and false, is exactly what we need to reason in the real world. However, applications that try to model human reasoning also need additional operations derived from probability theory, since we often think in terms of probabilities. To date, the sets of operations that different applications use to deal with uncertainty have had little in common.

Fuzzy logic defines the minimum set of operations needed by most applications that deal with uncertainty, and is therefore a good candidate to use as a standard. Applications with unusual requirements can define further fuzzy-logic operations by building on this basic set. Fuzzy logic is a superset of predicate logic, which means that nonfuzzy information is handled normally, using the same operators that you would use to handle fuzzy information.

Fuzzy-logic operators are defined on fuzzy truth values, which range from 0 (false) to 1 (true). There are four binary operations: fuzzy AND, fuzzy OR, probability AND, and probability OR (which are written as f-AND, f-OR, p-AND,

and p-OR). One unary operation is defined: NOT. We can describe these operations by ordinary arithmetic functions:

$$\begin{aligned} a \text{ f-AND } b &= \min(a, b) \\ a \text{ f-OR } b &= \max(a, b) \\ a \text{ p-AND } b &= a \times b \\ a \text{ p-OR } b &= a + b - (a \times b) \\ \text{NOT } a &= 1 - a \end{aligned}$$

The three operations f-AND, f-OR, and NOT correspond directly to the predicate-logic operations AND, OR, and NOT. They produce the same results on nonfuzzy values (i.e., 0 and 1), and they obey the same mathematical properties.

Operations from Fuzzy-Set Theory

Fuzzy-set theory, like ordinary set theory, has the three basic set operations: *intersection*, *union*, and *complement*. From these operations we can derive the f-AND, f-OR, and NOT operations, as I'll explain.

- *Fuzzy intersection.* If an element has differing degrees of membership in two fuzzy sets, the *lesser* degree dictates its degree of membership in an intersection of the two sets. For example, if a man is 80 percent young and 40 percent good-looking, he is only 40 percent young *and* good-looking. With the nonfuzzy values 0 and 1, this operation produces the same results as an AND in predicate logic. From this operation we derive the f-AND.

- *Fuzzy union.* Conversely, if an element has differing degrees of membership in two fuzzy sets, the *greater* of the two indicates its degree of membership in a union of two fuzzy sets. Using the previous example, our subject would then be 80 percent young *or* good-looking.

With nonfuzzy values, this operation is equivalent to the predicate logic OR. This becomes the f-OR operation. It is the only significant incompatibility between Prolog and Fuzzy Prolog; the Prolog OR operator is a decision point rather than a true predicate logic OR.

- *Fuzzy complement.* An element's degree of membership in the complement of a fuzzy set is 1 minus its degree of membership in the set itself. Someone who is 80 percent young is, therefore, only 20 percent old. With nonfuzzy values, this operation is equivalent to the NOT in predicate logic and is the basis for the NOT in fuzzy logic. It is not called the f-NOT, since there is no difference between the complement operation we derive from fuzzy-set theory and the one we will derive from probability theory.

Fuzzy-set operations are important, since they essentially extend predicate logic into the realm of fuzzy information without altering the way we think about logic. Past enhancements to Lisp

continued

and Prolog that added fuzzy reasoning abilities have used some or all of these fuzzy-set operations. Unfortunately, fuzzy-set operators are not, by themselves, sufficient to model human reasoning. Most applications require additional operations derived from probability theory.

Operations from Probability Theory

The need for reasoning in probabilities comes up in everyday experience. When you make a decision based on uncertain information, you intuitively weight the data according to their importance and certainty. You then select the course of action which, based on all the evidence, seems most likely to yield a desired result.

Consider, for example, the process of diagnosing a disease. Several symptoms may be characteristic of the disease, and the more symptoms we observe, the more certain we are that the disease is present. Symptoms may not have equal importance—a headache could indicate any number of ailments, but blurred vision is more specific and more indicative of a particular disease.

Fuzzy-set operators provide no good means of combining weightings of symptoms. The best we can do is use the f-OR. If symptom A indicates a 70 percent chance of the disease and symptom B indicates a 40 percent chance, the likelihood of the disease would be calculated as

$$0.4 \text{ f-OR } 0.7 = \max(0.4, 0.7) = 0.7.$$

This totally disregards the accumulation of evidence; it only considers the single most significant symptom.

Now, let's consider a probability function. Given two independent events A and B, the probability of either occurring is

$$p(A \text{ or } B) = p(A) + p(B) - (p(A) \times p(B)).$$

If we apply this function to the diagnosis above, we find that the likelihood of the disease is

$$0.4 \text{ p-OR } 0.7 = 0.4 + 0.7 - (0.4 \times 0.7) = 0.82,$$

which does show an accumulation of evidence. This is the *probability-OR* (p-OR) in fuzzy logic.

Up to this point, we've assumed that symptoms are either present or absent. This two-valued logic is exactly what fuzzy logic is supposed to avoid. Suppose, for example, that one of the symptoms is an elevated white-blood-cell count. There is no specific value above which the cell count suddenly becomes "elevated." The cell count covers a continuous range; higher counts yield more certainty that something is wrong. So, the proper way to handle this is to map the range of cell counts onto the range of fuzzy values and include this certainty factor in the calculations.

The way to include the certainty factor is to use another probability function. Given two independent events, A and B, the probability of both occurring is

$$p(A \text{ and } B) = p(A) \times p(B).$$

In the example above, the probabilities are: The chance that a symptom is present (the certainty factor) and the relative importance of that symptom to the diagnosis (the weighting factor). This is the *probability-AND* (p-AND) function in fuzzy logic.

Finally, we can derive a complement operation from probability theory. If we know the probability of event A, then the probability that the event will not occur is

$$p(\text{not } A) = 1 - p(A).$$

Since this is identical to the complement function derived from fuzzy-set theory, no distinction need be drawn between the two.

Using Fuzzy Logic

The most common method of adding fuzzy-logic capabilities to existing AI languages is to write a shell that runs on top of the existing language. For example, we can add fuzzy-logic operations to Turbo Prolog with the file FUZZY.PRO (see listing 1). This file is referenced as an include file by Turbo Prolog programs in which you wish to use fuzzy logic.

Since Turbo Prolog does not allow the definition of new operators, the fuzzy-logic operators are used as predicates, and fuzzy-logic statements are expressed in Reverse Polish Notation. We use the symbols below to represent the five operators in fuzzy logic.

NOT	f_NOT
p-AND	p_AND
p-OR	p_OR
f-AND	f_AND
f-OR	f_OR

In addition, we define and use the two predicates *fuzzy* and *threshold*. Listing 1, FUZZY.PRO, uses *fuzzy* to set and retrieve fuzzy-truth values, and it uses *threshold* to tell the program the lowest acceptable truth value, below which Prolog should backtrack and search for another solution.

In Prolog, the statement (*or rule*)

```
grandparent(X, Z) :- parent(X, Y), parent(Y, Z).
```

means "X is the grandparent of Z if X is the parent of Y and Y is the parent of Z." Similarly, simple facts are represented as

```
parent(betty, tammy).
arent(anna, betty).
```

Given these two facts, and the rule above, if you ask

```
grandparent(anna, tammy).
```

Prolog will respond

True.

With fuzzy logic, Prolog will also accept facts like

```
scary(king_kong) :- fuzzy(0.5).
funny(king_kong) :- fuzzy(0.1).
```

```
scary(american_werewolf) :- fuzzy(0.5).
funny(american_werewolf) :- fuzzy(0.5).
```

and rules like

```
good_movie(X) :- scary(X), funny(X), p_OR,
                threshold(0.6).
```

The values in the facts are fuzzy-truth values. *King Kong* is moderately scary, but not particularly funny. *An American Werewolf in London* is both moderately scary and moderately funny.

The rule says, in effect, that a movie is good if it is sufficiently scary or sufficiently funny; the threshold of "good" is defined as any truth value 0.6 or higher. You use the p-OR operator in cases like this where evidence is to be accumulated. *American Werewolf* wouldn't be "good" based on either factor

continued

Listing 1: This file, *FUZZY.PRO*, adds fuzzy-logic operations to Turbo Prolog when referenced as an include file in Turbo Prolog programs.

```

database
  truth(real)
  thresh(real)

predicates
  init_fuzzy fuzzy(real) threshold(real)
  f_OR f_AND p_OR p_AND f_NOT

  fuzzy_max(real, real, real)
  fuzzy_min(real, real, real)

clauses

/* Init_fuzzy must be called before any
   fuzzy operators or predicates are used.
   It sets the initial search threshold to
   which fuzzy truth values are compared.*/

init_fuzzy :- asserta(thresh(0.01)).

/* Fuzzy is used to specify a particular
   fuzzy truth value, or to retrieve the
   current truth value. */

fuzzy(Truth) :- bound(Truth),
  asserta(truth(Truth)),
  retract(thresh(Thresh)),
  asserta(thresh(Thresh)), !,
  Truth >= Thresh.

fuzzy(Truth) :- retract(truth(Truth)),
  asserta(truth(Truth)), !.

/* Threshold sets or retrieves the search
   threshold used by the Fuzzy Logic
   operations. If a call to FUZZY or the
   result of a Fuzzy Logic operator results
   in a truth value less than the threshold,
   the predicate or operator will fail. */

threshold(Truth) :- bound(Truth),
  retract(thresh(_)),
  asserta(thresh(Truth)),
  retract(truth(Current)),
  asserta(truth(Current)),
  !, Current >= Truth.

threshold(Truth) :- retract(thresh(Truth)),
  asserta(thresh(Truth)),
  !.

/* Fuzzy logic contains five basic
   operators: fuzzy-AND, fuzzy-OR,
   probability-AND, probability-OR, and
   NOT. In this Turbo Prolog implementation,
   these are represented by f-AND, f-OR,
   p-AND, p-OR, and f-NOT respectively.
   "f-NOT" is used to avoid conflicting
   with the Turbo Prolog predicate "NOT."

```

continued

A MESSAGE TO OUR SUBSCRIBERS

FROM TIME TO TIME WE MAKE THE BYTE subscriber list available to other companies who wish to send our subscribers material about their products. We take great care to screen these companies, choosing only those who are reputable, and whose products, services, or information we feel would be of interest to you. Direct mail is an efficient medium for presenting the latest personal computer goods and services to our subscribers.

Many BYTE subscribers appreciate this controlled use of our mailing list, and look forward to finding information of interest to them in the mail. Used are our subscribers' names and addresses only (no other information we may have is ever given).

While we believe the distribution of this information is of benefit to our subscribers, we firmly respect the wishes of any subscriber who does not want to receive such promotional literature. Should you wish to restrict the use of your name, simply send your request to the following address.

BYTE MAGAZINE
ATTN: SUBSCRIBER SERVICE
P.O. Box 7643
TEANECK, NJ 07666-9866



MAXIT increases your DOS addressable conventional memory beyond 640K

- Add up to 256K above 640K for programs like FOXBASE+ and PC/FOCUS.
- Top off a 512K AT's memory to 640K and add another 128K beyond that.
- Compatible with EGA, Network, and other memory cards.
- Short card works in the IBM PC, XT, AT, and compatibles.
- Run resident programs like Sidekick above 640K.
- Add up to 96K above 640K to all programs.

Break through the 640 barrier. MAXIT increases your PC's available memory by making use of the vacant unused address space between 640K and 1 megabyte. (See illustrations)

Extend the productive life of your, IBM PC, XT, AT or compatible. The MAXIT 256K memory card and software works automatically. If you have questions, our customer support people will answer them, fast.

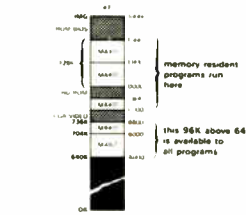

XT class machine (8088 8086) w/ 640K and a CGA Color Monitor or a Compaq Type Dual Mode Display

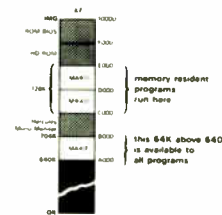

AT class machine (80286) w/ 640K and a Mono HERC Monitor

Order toll free 1-800-227-0900. MAXIT is just \$245 plus \$4 shipping, and applicable state sales tax. Buy MAXIT today and solve your PC's memory crisis. Outside the U.S.A. call 1-415-548-2085. We accept VISA, MC, American Express

MAXIT is a trademark of Osborne McGraw-Hill. IBM is a registered trademark of International Business Machines Corporation. Sidekick is a registered trademark of Borland International, Inc. FOXBASE+ is a trademark of Fox Software, Hercules is a trademark of Hercules Computer Technology, Inc. XT and AT are registered trademarks of International Business Machines Corporation. Compaq is a registered trademark of Compaq Computer Corporation.

Since Turbo Prolog does not support true operator definition, the Fuzzy Logic operators are used syntactically as predicates, in the order specified by Reverse Polish Notation (RPN). For example, the clause

```
woof :- fuzzy(0.6), fuzzy(0.7),
      p-AND, fuzzy(0.4), p-OR.
```

represents the Fuzzy Logic expression

```
(0.6 p-AND 0.7) p-OR 0.4
```

Note that only predicates which use Fuzzy Logic will generate fuzzy truth value operands. Other predicates, including those built in to Turbo Prolog, do not generate fuzzy truth values. Hence, the clause

```
woof(X, Y) :- fuzzy(0.6), X > Y,
             f-AND.
```

is incorrect since f-AND requires two operands, but only one (from the FUZZY predicate) has been generated. */

```
f_OR :- retract(truth(X)),
        retract(truth(Y)),!,
        fuzzy_max(X, Y, Z), fuzzy(Z), !.
f_AND :- retract(truth(X)),
        retract(truth(Y)),!,
        fuzzy_min(X, Y, Z), fuzzy(Z), !.
p_OR :- retract(truth(X)),
        retract(truth(Y)),!,
        Z = X + Y - (X * Y), fuzzy(Z), !.
p_AND :- retract(truth(X)),
        retract(truth(Y)),!,
        Z = X * Y, fuzzy(Z), !.
f_NOT :- retract(truth(X)), !,
        Z = 1 - X, fuzzy(Z), !.
```

```
/* Local predicates used by the
   fuzzy operators */
```

```
fuzzy_max(X, Y, Z) :- X >= Y, !, Z = X.
fuzzy_max(_, Y, Z) :- Z = Y.
```

```
fuzzy_min(X, Y, Z) :- X <= Y, !, Z = X.
fuzzy_min(_, Y, Z) :- Z = Y.
```

alone, but the p-OR will calculate the combined value

$$0.5 \text{ p-OR } 0.5 = 0.5 + 0.5 - (0.5 \times 0.5) = 0.75,$$

which is high enough to pass the threshold test and to be accepted. For *King Kong*, on the other hand, the value calculated would be

$$0.5 \text{ p-OR } 0.1 = 0.5 + 0.1 - (0.5 \times 0.1) = 0.55,$$

which would not pass the test. So, if we asked

```
good_movie(X).
```

the program would respond with

```
X=american_werewolf
1 Solution
```

indicating that *American Werewolf* is the only good movie it knows of, based on the program's criteria.

As another example of how you can use fuzzy logic, look at listing 2, CITY.PRO. This program evaluates the quality of life in different cities, based on a few factors that reflect one view of what is important. It uses a database of facts that describe the characteristics of various cities: how warm and dry the climate is, the approximate population, and the relative cost of living. All values but the population are rated on a scale from 0 to 1.

The program breaks these criteria into two categories, location and characteristics, and it treats these categories as evidence to be accumulated using the probability operators. It assigns a weight, or importance, of 0.5 to location using the p-AND operator, and similarly assigns a weight of 0.9 to characteristics. The main rule reads

```
nice_city(X) :-
    init_fuzzy, location(X), fuzzy(0.5), p_AND,
    characteristics(X), fuzzy(0.9), p_AND, p_OR,
    fuzzy(Rating),
    write(X, "has a rating of", Rating), nl.
```

The first predicate, `init_fuzzy`, initializes the fuzzy-logic operations. `location` generates the fuzzy-truth value for the city's location. `fuzzy` sets a fuzzy-truth value of 0.5, which is then combined with the value from `location` using the `p_AND` operator. This sequence is repeated with `characteristics`, and then the weighted results of `location` and `characteristics` are combined with the `p_OR`. Finally, the program calls `fuzzy` with the variable `Rating` (which has no value yet) to retrieve the current fuzzy-truth value, and prints this as the rating of the city.

Not all predicates generate fuzzy-truth values—only user-defined ones that themselves use fuzzy logic, and the predicate `fuzzy` called with an instantiated value, generate fuzzy-truth values, which can be combined using the fuzzy operators.

In `nice_city`, the first predicate resolved is `location`, which contains two predicates and a fuzzy-logic operator

```
location(X) :- city(X), climate(X), f_AND.
```

These provide the name of the city and an evaluation of climate. So long as the database contains a city that hasn't been looked at, predicate `city` will set `X` to a city name and return a fuzzy-truth value of 1. This value is combined with the results of `climate` by an `f_AND` (which selects the lowest value); hence, `location` will return the truth value from `climate`.

Climate evaluates the two climatic factors by using the `f_AND`

```
climate(X) :- warm(X), dry(X), f_AND.
```

Since the `f_AND` selects the lower of the two values, this reflects the idea that a climate is only as nice as its worst factor; in order to be pleasant, a city must be both warm and dry.

The `characteristics` rule evaluates the population and the cost of living:

```
characteristics(X) :-
    population(X, Pop), Val = Pop/2500.0,
    fuzzy(Val), fuzzy(0.9), p_AND,
    expensive(X), f_NOT, fuzzy(0.5), p_AND,
    p_OR, f_AND.
```

MASTER THE "NEW ELECTRONICS" WITH MCGRAW-HILL'S Contemporary Electronics Series

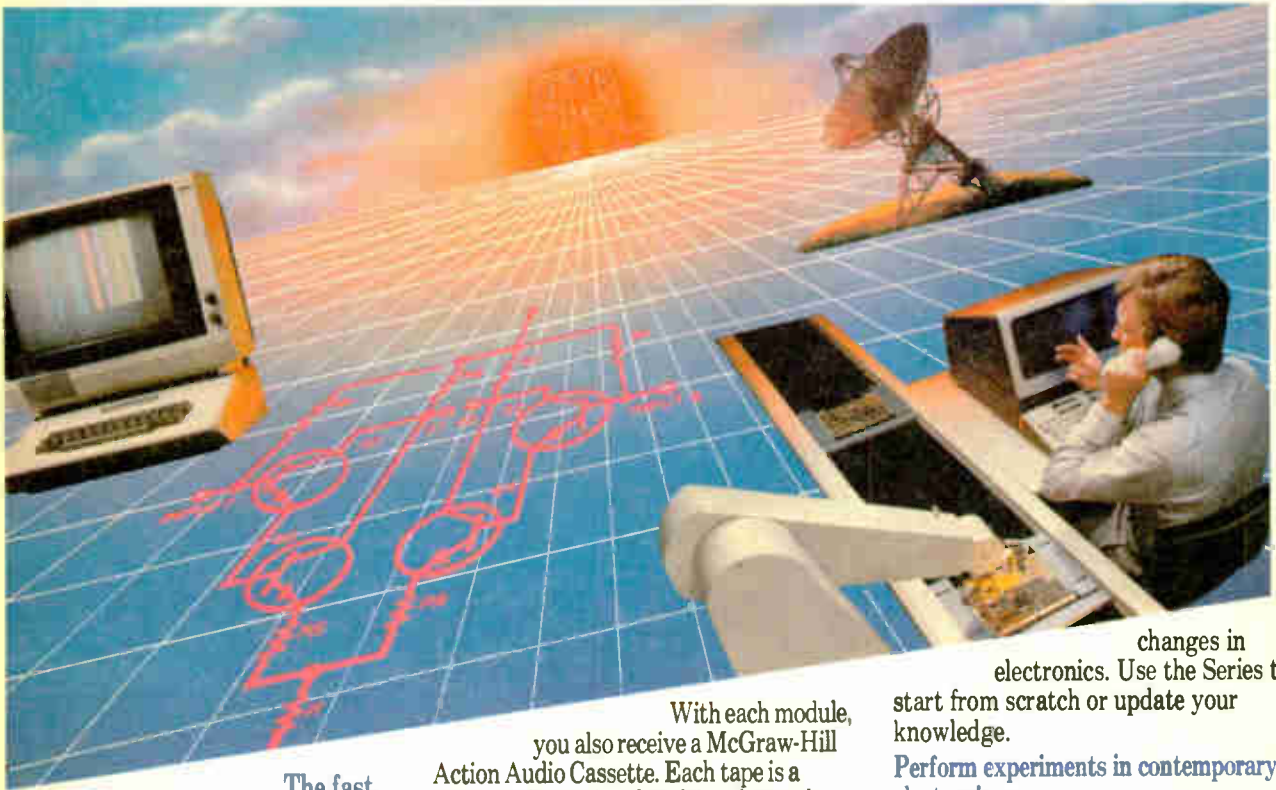

The fast, easy and low cost way to meet the challenges of today's electronic innovations. A unique learning series that's as innovative as the circuitry it explains, as fascinating as the experiments you build and explore!

From digital logic to the latest 32-bit microprocessor, you master one subject at a time with the McGraw-Hill Contemporary Electronics Series. Fifteen unique *Concept Modules*, sent to you one every 4-6 weeks, give you a handle on subjects like optoelectronics, transistors, integrated circuits, logic circuits, and more.

Each *Concept Module* goes right to the heart of the matter. You waste no time on extraneous material or outdated history. It's a fast, efficient, and lively learning experience... a non-traditional approach to the most modern of subject matter.

Unique Interactive Instruction

Your learning experience is reinforced through the integration of vividly illustrated text with actual electronic experiments.

With each module, you also receive a McGraw-Hill Action Audio Cassette. Each tape is a dynamic discussion that drives home the key facts about the subject. Indexed binders preserve backup material, notes and tapes for convenient referral.

Understand digital logic... microprocessors... and more.

McGraw-Hill's Contemporary Electronics Series is an extraordinary opportunity to update your understanding of today's most important technological

changes in electronics. Use the Series to start from scratch or update your knowledge.

Perform experiments in contemporary electronics.

Throughout your series, laboratory experiments reinforce every significant point. This essential experience... dynamic, hands-on demonstrations of theory in practice... will help you master principles that apply all the way up to tomorrow's latest VLSI (very large scale integrated) circuitry.

See other side for more details →

SEND THIS CARD TODAY!

YES! I'm interested in learning contemporary electronics and would like to examine the first module in the series. If I decide to keep it, I will pay just \$19.95 plus \$2.25 shipping and handling. I will then receive future modules automatically, one every 4 to 6 weeks. Each of the 15 modules in the series is \$19.95 plus \$2.25 shipping and handling, and comes on the same 15-day Free Examination basis. There is no minimum number of modules that I must buy, and I may cancel at any time simply by notifying you.

If I do not choose to keep the first module, I will return all materials in good condition and pay nothing. Future modules will be canceled, and I will be under no further obligation.

Name _____
(Please Print)

Address _____

City _____ State _____ Zip _____

Phone No. (_____) _____

All orders subject to approval and payable in U.S. funds only. Available in U.S. and Canada only.

2080-048

Your adventure begins with Module 1

With your first module, you'll use the latest digital integrated circuits to build an oscillator circuit that demonstrates digital signals—verified visually by the flash of light emitting diodes (LEDs).

You'll learn concepts applicable to all electronic circuits. With the first module, you will be able to identify the major passive components like resistors, capacitors, inductors, diodes and transformers, and active components such as transistors and integrated circuits.

Each module adds more to your expanding knowledge of the new electronics. You'll cover every important subject in contemporary electronics:

- Digital logic
- Digital gates (TTL, CMOS, ECL, NMOS)
- Flip-flops, counters, and registers
- Op-amps and applications
- Power supplies (plus IC and switching regulations)



Working with actual electronic components, you discover first-hand the operation of the circuitry found in contemporary electronic devices.



With your first module, you get easy-to-follow text and interactive audio instruction. Plus you build this solderless breadboarding system, which you'll use throughout the Series to construct electronic circuits and bring concepts to life.

- Combinational logic circuits (ROMs, PLAs, decoders, etc.)
- Circuit analysis, AC theory, LCR networks
- Transistors (bipolar and FETs, diodes, thyristors)
- Integrated circuits (linear and digital)
- Oscillators and function generators
- Modulation and demodulation
- Optoelectronics
- Digital multimeters and scopes
- Microprocessors
- Electronic troubleshooting
- Data communications
- Robotics and industrial controls
- and more!

For anyone interested in electronics

The Contemporary Electronic Series is designed for anyone from hobbyist to professional. It's for you if you're looking for new fields of interest . . . if you're a teacher who wants an update in contemporary circuits . . . an industrial manager

or supervisor . . . a doctor, an engineer, a chemist, or anyone who finds electronics playing an increasingly important role in their work. It's even for electronics engineers, technicians and scientists who feel their training needs freshening up. It's the quickest, most convenient, and probably the least expensive way to do it. And the only one that gives you hands-on experience.

15 day no-risk trial

We invite you to prove to yourself that the Contemporary Electronics Series is all we say it is . . . without risk and without committing yourself in any way. Return the reply card and we'll send you the first module for a free, 15-day examination. If you're not absolutely certain that this is an enjoyable as well as highly effective way to learn, simply return the module to us.

If you want to continue, we'll ship the remaining modules automatically, about once a month, for only \$19.95 plus \$2.25 for shipping and handling.

Return the postage-paid reply card today! And let McGraw-Hill guide you into the fascinating world of Contemporary Electronics. If the card has been used, write us for ordering information.

SEND CARD TODAY FOR YOUR FIRST MODULE!



BUSINESS REPLY MAIL

FIRST CLASS MAIL PERMIT NO. 10008 WASHINGTON, D.C.

POSTAGE WILL BE PAID BY ADDRESSEE

**McGraw-Hill Continuing
Education Center**
3939 Wisconsin Avenue
Washington, D.C. 20077-9265

NO POSTAGE
NECESSARY
IF MAILED
IN THE
UNITED STATES



McGraw-Hill
Continuing Education Center
3939 Wisconsin Avenue
Washington, D.C. 20016

**Send card today for your
first module!**



World Radio History

The first task of this rule is to map population (given in thousands) onto the range 0 to 1. In this case, the population is simply divided by 2500 and the answer stored in Val. The fuzzy predicate turns this into a fuzzy-truth value.

The factor for cost of living is higher for cities where the cost of living is higher. To determine the desirability of a city, the program uses f-NOT to invert the truth value of the expensive predicate so that less expensive cities receive higher ratings. The population and expense factors are combined using the same method of accumulating evidence discussed above. The final f-AND considers this value and the truth value (1.0) returned by population and chooses the lesser of the two, and so does not change the calculated value. The f-AND is required, however, to remove the population truth value from the evaluation stack.

To see how all this works, let's trace the execution of the program. If you ask

```
nice_city(Where).
```

the program will enter the nice_city rule and begin by evaluating location, which, in turn, first evaluates city. The city predicate searches the database and returns with X set to albuquerque, the first city appearing in the database; its truth value is 1.0.

Location continues by evaluating climate. The climate predicate gets the values for warm(albuquerque) and dry(albuquerque), which are both 0.9, combines them with the f-AND operator, and returns the result of 0.9. Location takes this value, f-ANDs it with the truth value returned by city (1.0, since it found a city), and hence returns with its own truth value set to 0.9. Predicate nice_city weights this with the value 0.5, resulting in an intermediate value of 0.45.

The program must then resolve characteristics. In characteristics, the program retrieves the population of albuquerque, divides it by 2500, and stores the result of 0.2 in Val. The evidence accumulation

```
fuzzy(Val), fuzzy(0.9), p_AND,
expensive(X), f_NOT, fuzzy(0.5), p_AND,
p_OR
```

takes the value of Val, 0.2, and p-ANDs it with the weighting 0.9, resulting in a value of 0.18. The second half of the expression retrieves the expensive value of 0.6, uses f-NOT to invert it to 0.4, and weights it with the value 0.5 for a result of 0.2. The two halves are combined with the p-OR, which yields a value of 0.344.

This value is f-ANDed with the truth value 1.0 returned when the population was retrieved. This results in no change, so the program returns value 0.344 as the truth value of characteristics.

Finally, the program can evaluate the nice_city clause. The value from characteristics is p-ANDed with 0.9, producing a value of 0.3096, and this is p-ORed with the truth value from the first half, which was 0.45. This yields a final rating for Albuquerque of 0.62028. Based on this, the program will respond to our query about where nice cities are located with

```
albuquerque has a rating of 0.62028
Where=albuquerque
```

The program also provides the answers:

```
boston has a rating of 0.74545
Where=boston
```

Listing 2: *The program CITY.PRO uses the fuzzy-logic operations in listing 1 to evaluate the quality of life in different cities.*

```
/*
  City -- This is a simple program which
  uses fuzzy logic to determine how "nice"
  various cities are. */

include "fuzzy.pro" /* Include the fuzzy
                    logic module */

predicates
  nice_city(symbol) location(symbol)
  city(symbol)      climate(symbol)
  warm(symbol)      dry(symbol)
  characteristics(symbol)
  population(symbol, integer)
  expensive(symbol)

clauses

  nice_city(X) :- init_fuzzy, location(X),
                  fuzzy(0.5), p_AND,
                  characteristics(X),
                  fuzzy(0.9), p_AND, p_OR,
                  fuzzy(Rating),
                  write(X,
                    " has a rating of ",
                    Rating),
                  nl.

  location(X) :- city(X), climate(X), f_AND.

  climate(X) :- warm(X), dry(X), f_AND.

  characteristics(X) :- population(X,Pop),
                        Val = Pop/2500.0,
                        fuzzy(Val),
                        fuzzy(0.9), p_AND,
                        expensive(X), f_NOT,
                        fuzzy(0.5), p_AND,
                        p_OR, f_AND.

/* Data on various cities */

city(albuquerque) :- fuzzy(1.0).
city(boston)     :- fuzzy(1.0).
city(ft_worth)  :- fuzzy(1.0).

warm(albuquerque) :- fuzzy(0.9).
warm(boston)      :- fuzzy(0.5).
warm(ft_worth)    :- fuzzy(0.9).

dry(albuquerque)  :- fuzzy(0.9).
dry(boston)      :- fuzzy(0.6).
dry(ft_worth)    :- fuzzy(0.7).

population(albuquerque, 500) :- fuzzy(1.0).
population(boston, 2000)  :- fuzzy(1.0).
population(ft_worth, 1500) :- fuzzy(1.0).

expensive(albuquerque) :- fuzzy(0.6).
expensive(boston)     :- fuzzy(0.9).
expensive(ft_worth)   :- fuzzy(0.8).
```

continued

ft_worth has a rating of 0.69281
Where=ft_worth

3 Solutions

From this, we can see that the program continued searching the database for more cities. It evaluated the cities in the order it found them, and printed out the results for each nice city it found.

Creating Fuzzy Prolog From the Ground Up

While you can add fuzzy logic to an existing dialect of Prolog, applications pay a significant penalty in efficiency, since the shell adds another layer of software between the application and the machine. Also, the result is often awkward to use. This is true of my Turbo Prolog implementation in two regards: Using Reverse Polish Notation for fuzzy-logic operators, and remembering which predicates produce fuzzy-truth values can be confusing. In addition, backtracking will not properly undo the results of fuzzy operations, since they are not an implicit part of the language.

The best solution to these difficulties is to build fuzzy logic into a dialect of Prolog from the ground up. I have written a dialect of Prolog called Fuzzy Prolog, which implements fuzzy logic.

Since fuzzy-logic operations are an implicit part of the language, the difficulties mentioned above do not exist. Also, since fuzzy logic is a superset of predicate logic, Fuzzy Prolog remains compatible with Prolog and will run all ordinary Prolog programs. For information on obtaining the source code to Fuzzy Prolog, see the Editor's note at right.

A Fuzzy Standard

Problems are rarely black and white, and answers almost never true or false. Current applications that try to simulate human reasoning must deal with uncertainty before they can begin to address their real objectives.

To date, however, the different approaches that have been developed for dealing with uncertainty have shown little consistency with one another. Fuzzy logic provides a common core of operations and, thereby, a basis for standardization. Making fuzzy logic an implicit feature of a language such as Fuzzy Prolog relieves applications of much of the burden of dealing with uncertainty. Consequently, software development will take less time, and the resulting software will be less complex. Of that, we can be fairly certain. ■

Editor's note: *The Turbo Prolog programs FUZZY.PRO and CITY.PRO and the source code for the Fuzzy Prolog interpreter are available on BIX, on BYTEnet, on disk, and in the Quarterly Listings Supplement. See page 3. The Fuzzy Prolog interpreter is written in Ada, and the source code is public domain. The user's manual, source code listings, and complete documentation for Fuzzy Prolog are also included in the author's master's thesis, "Programming in Fuzzy Logic: Fuzzy Prolog," Air Force Institute of Technology, December 1986, available for \$30.95 from the National Technical Information Service, (703) 487-4650. Request document #ADA177940.*

Bradley L. Richards is a captain in the Air Force assigned to the Defense Logistics Agency in Boston, Massachusetts. He is also a faculty member in the department of computer science at Merrimack College.

IN-HOUSE DATA TRANSMISSION MARATHON

Out of breath at 50 feet? Now go the distance.

Are your RS-232 data lines out of breath before they cross the finish line? Are you restricted from placing your computers and peripherals where you need them due to the 50 foot limit imposed by the RS-232 standard? Now you can extend your serial data communication lines up to 5000 feet without even

breathing hard. Using standard, inexpensive twisted pair telephone wiring and our easy-connect LD series long line drivers, you can achieve data rates in excess of 56 kilobits per second. Contact us today and we'll rush to get you more information... FAST.

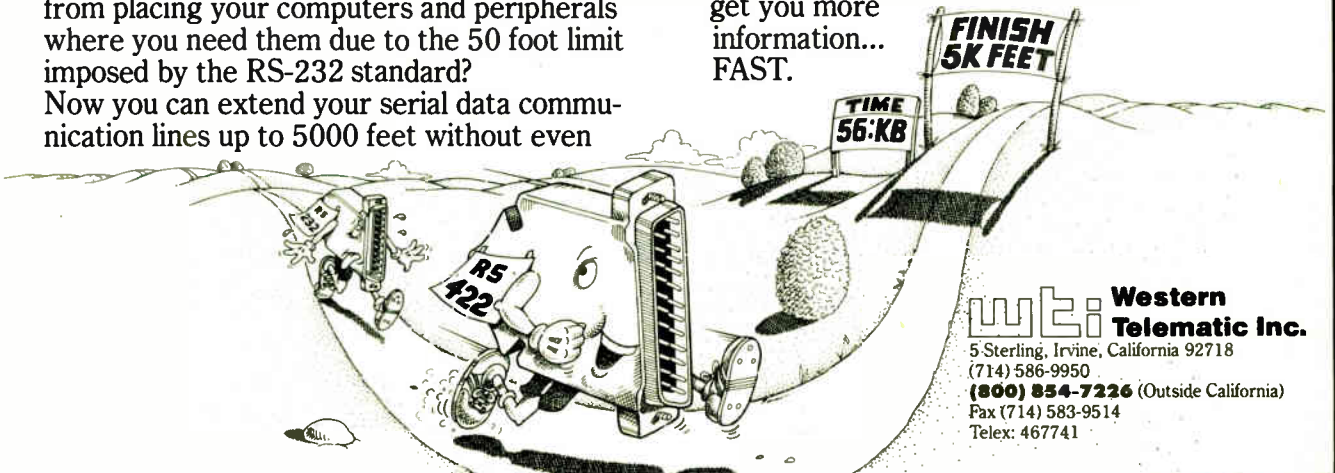

wte: Western Telematic Inc.
5 Sterling, Irvine, California 92718
(714) 586-9950
(800) 854-7226 (Outside California)
Fax (714) 583-9514
Telex: 467741

LOWEST CPM.
LEAST
DUPLICATED READERS.
SMALLEST
RATE INCREASE.

Other computer magazines have been raising their rates way out of proportion to their circulation growth (costs up 30 or 40 percent). We've raised ours a modest 7%.

While other magazines are breaking the \$30, \$40, \$50, and even \$100 B&W CPM barriers, ours remains an attractive \$25.28.

While other PC books are scrambling to figure out how to juggle the PC and Mac, we're already delivering. With a combined 95% PC, and 38% Mac penetration.

While other magazines fight head to head for the same readership, *45% of our paid readers do not read any other major PC-specific books.*

And, when they're not reading BYTE, they're busy buying product. In fact, 90% of our subscribers directly influence their company's microcomputer purchasing decisions.

You'd like to find a way to keep your media budget in line. We're it. Call Dennis Riley at (603) 924-9281 for more facts.

Sources: Fall 1987 MRI Study; 1987 Subscriber Profile Study.

BYTE
IT'S INDISPENSABLE.

BYTE *Limited Editions*

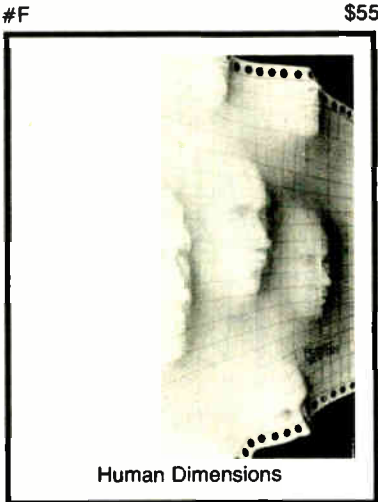
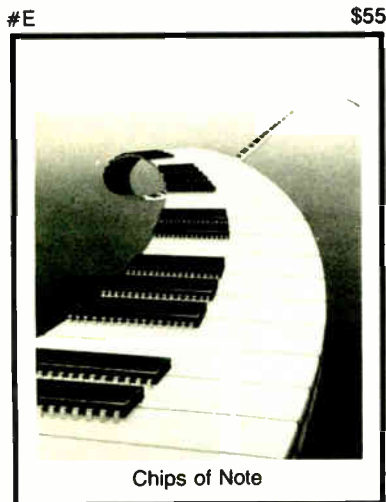

Striking 16" x 20" Limited Edition Prints from the pages of Byte. Each print is signed and numbered by the artist, Robert Tinney.

Limited Edition Classics

You've seen them on the cover of Byte — now enjoy these delightful images as stunning limited edition prints! Each print pictured here is published in an edition strictly limited to only 1000 signed and numbered prints, and each is accompanied by its own Certificate of Authenticity.

These gorgeous reproductions are printed on select 100% cotton fiber stock; this is a museum grade acid-free paper, highly resistant to yellowing and cracking. You will be assured of a print which will retain its color and beauty for generations.

Price and Shipping

The price of Byte Limited Editions, which depends on the number of unsold prints in each edition, is shown above each print pictured here. In addition, a 15% discount is available if you order two or more prints.

Your prints will be shipped flat, usually within a week of our receipt of the order. Shipping is via UPS Blue Label.

Guarantee

Ship your prints back to us within 30 days of your order, and you will be given a complete, no-questions-asked refund.

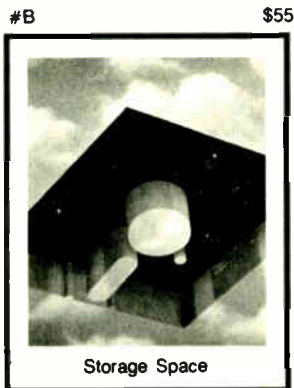

Yes! Send me the following Byte Limited Editions.

QTY.	#	TITLE	AMOUNT
			\$
			\$
			\$
			\$
			\$
			\$
Deduct 15% if ordering two or more prints.			\$
Shipping: \$4 (\$20 overseas).			\$
TOTAL			\$

Please send your COLOR brochure

- I have enclosed U.S. check or money order.
 C.O.D. (via UPS—stateside orders only)
 VISA MasterCard American Express

Card #: _____

Expires: _____ Signature: _____

Ship my Print(s) to:

Name: _____

(Business): _____

Address: _____

City: _____

State: _____ Zip: _____

mail this coupon to:

**Robert Tinney
Graphics**

1864 North Pamela Dr.
Baton Rouge, Louisiana
70815

For VISA, MasterCard or
American Express orders,
or for more information

Call 1-504-272-7266



Faster Than Fast Fourier

The fast Hartley transform is twice as fast as the fast Fourier and uses only half the computer resources

Joseph Fourier left to mathematics a rich legacy: The transform that bears his name processes many of today's audio and electromagnetic signals. Image processing and digital filtering of signals use the Fourier transform or its faster descendant.

However, the fast Fourier transform (FFT) requires a large amount of computer resources. The fast Hartley transform (FHT) can accomplish the same results faster, using fewer resources. First described by Ronald Bracewell (see reference 1), the FHT handles many of the jobs now done by the Fourier transform.

Both the FHT and the FFT let you map a continuous signal over time onto a frequency function. The Fourier transform maps a real function of time $X(t)$ to a complex function of frequency, $F(f)$.

The Hartley transform maps a real function of time $X(t)$ onto a real function of frequency $H(f)$. Since the Hartley frequency function is real, you need only single arithmetic operations to compute it.

Compare this to the many arithmetic operations required of the complex Fourier frequency function (four operations for a complex multiply or divide, and two for complex addition or subtraction).

Furthermore, real data arrays require only half the memory storage of complex data arrays. This means that the Hartley transform will require considerably less memory for a given data set than the Fourier transform. Therefore, the Hartley transform will be distinctly faster and use less memory than the conventional Fourier transform in digital filtering and image enhancement applications where you have to process large amounts of data.

A Definition of the Hartley Transform

Equation (1) shows the analytical form of the Hartley transform, and (2) shows its inverse transform, used to map the frequency function back into the time domain:

$$H(f) = \frac{1}{2\pi} \int_{-\infty}^{\infty} x(t) \text{cas}(2\pi ft) dt, \tag{1}$$

$$X(t) = \int_{-\infty}^{\infty} H(f) \text{cas}(2\pi ft) df, \tag{2}$$

where $\text{cas}(2\pi ft) = \cos(2\pi ft) + \sin(2\pi ft)$.

The function $\text{cas}(2\pi ft)$ was introduced by R.V.L Hartley (see reference 2), who first proposed the Hartley transform in 1942.

You can see that these equations are very similar to those of the Fourier transform and its inverse:

$$F(f) = \frac{1}{2\pi} \int_{-\infty}^{\infty} X(t) e^{-j2\pi ft} dt, \tag{3}$$

$$X(t) = \int_{-\infty}^{\infty} F(f) e^{j2\pi ft} df, \tag{4}$$

where $e^{j2\pi ft} = \cos(2\pi ft) + j \sin(2\pi ft)$, and $e^{-j2\pi ft} = \cos(2\pi ft) - j \sin(2\pi ft)$. (These are known as Euler's formulas.)

Note that I'm using the electrical engineering convention of labeling the imaginary unit i as j . The principal difference between the two functions is that the real function $\text{cas}(2\pi ft)$ in the Hartley transform replaces the complex exponential term $e^{\pm j2\pi ft}$ in the Fourier transform pair.

The Hartley and Fourier transform functions in (1) through (4) deal only with continuous variables. As is often the case with computer data in the real world, signals are sampled at discrete intervals of time or for a specific interval. Fortunately, you can define a discrete transform that can represent a quantized continuous signal, or a signal of limited duration. The discrete forms of the Hartley transform pairs are

$$H(f) = \frac{1}{N} \sum_{t=0}^{N-1} F(t) \text{cas}(2\pi ft/N) \tag{5}$$

and

$$X(t) = \sum_{f=0}^{N-1} H(f) \text{cas}(2\pi ft/N). \tag{6}$$

Again, note the similarities to the Fourier transform pairs:

$$F(f) = \frac{1}{N} \sum_{t=0}^{N-1} X(t) e^{(-j2\pi ft/N)}, \tag{7}$$

$$X(t) = \sum_{f=0}^{N-1} F(f) e^{(j2\pi ft/N)}. \tag{8}$$

The Fast Algorithm

As it stands in (5) and (6), computation of the discrete Hartley transform presents an analogous problem to the computation of the discrete Fourier transform. That is, you have to perform N^2 arithmetic operations to compute the discrete Hartley transform of an N -element data set.

A classic paper by Cooley and Tukey (see reference 3) in 1965 led to the development of a fast algorithm for the machine computation of a complex Fourier series.

Essentially, the FFT uses a permutation process to bisect the data until data pairs are reached. Calculating the Fourier trans-

continued

form of such data pairs is trivial (i.e., rapid).

The idea behind the permutation process is that it's faster to split the data into pairs, compute the transform of the pairs, and recombine these to make the entire transform rather than to compute the transform for the complete data set.

Permutation is particularly fast when the amount of data is large. If you superimpose all such two-element pairs using a process sometimes referred to as the "butterfly" (due to the appearance of the diagram of the data flow; see figure 1), you can compute the Fourier transform of the input data set. It takes approximately $N \log(N)$ seconds to compute the transform of an N -point data set.

Bracewell (see reference 4) has shown that you can employ a similar methodology in the case of the Hartley transform. Again, you use the permutation process to bisect the data until you get data pairs.

The Hartley transform of a data pair (a, b) is $\frac{1}{2}(a + b, a - b)$, and the computation of such pairs is trivial. You can also superimpose these two-element sequences to calculate the Hartley transform of the input data set. However, to do so requires a formula that expresses a complete discrete Hartley transform (DHT) in terms of its half-length subsequences.

Bracewell has shown by application of the Shift and the Similarity theorems that (9) expresses the general decomposition formula for the DHT. This general decomposition formula generates the desired DHT by bisecting the data.

Put another way, it's the rule used to generate the elements to be used in the butterfly computation of the transform. You can apply similar methodology to the Fourier transform to yield the decomposition formula given in (10):

$$H(f) = H_1(f) + H_2(f) \cos(2\pi f/N_s) + H_2(N_s - f) \sin(2\pi f/N_s), \quad (9)$$

$$F(f) = F_1(f) + F_2(f)e^{j2\pi f/N_s}, \quad (10)$$

where N_s is the number of elements in the half-length sequence, and thus $N_s = N/2$ for a data set of N elements. Figure 1 shows a complete butterfly diagram for computing the FHT for an eight-element data set.

The decomposition formula for the FHT differs from the FFT in one important respect: The elements multiplied by the trigonometric terms are not symmetric. In the FFT decomposition formula of (10), terms multiplied by the trigonometric coefficients involve terms only in $F(f)$. In the FHT decomposition formula of (9), both $H(f)$ and $H(N_s - f)$ have sine coefficients. This asymmetry becomes apparent when you express the discrete transforms as matrix operations: FFT matrix terms are symmetric about the matrices' leading diagonal, while corresponding terms for the FHT are asymmetric.

This introduces some computation problems, because asymmetric matrix processing is difficult to implement. You can deal

Figure 1: The butterfly diagram for the fast Hartley transform for an eight-element data set. In the first column of cells, the indexes show the effects of permutation on the data elements. The next three columns represent the data elements as superimposed by the decomposition formula for the butterfly computation. These cells show the three indexes of the elements. You can see the effects of retrograde indexing for an eight-element data set in indexes for the third and fourth iteration of the butterfly. Radians at the bottom of the diagram give the angular spacing between trigonometric coefficients.

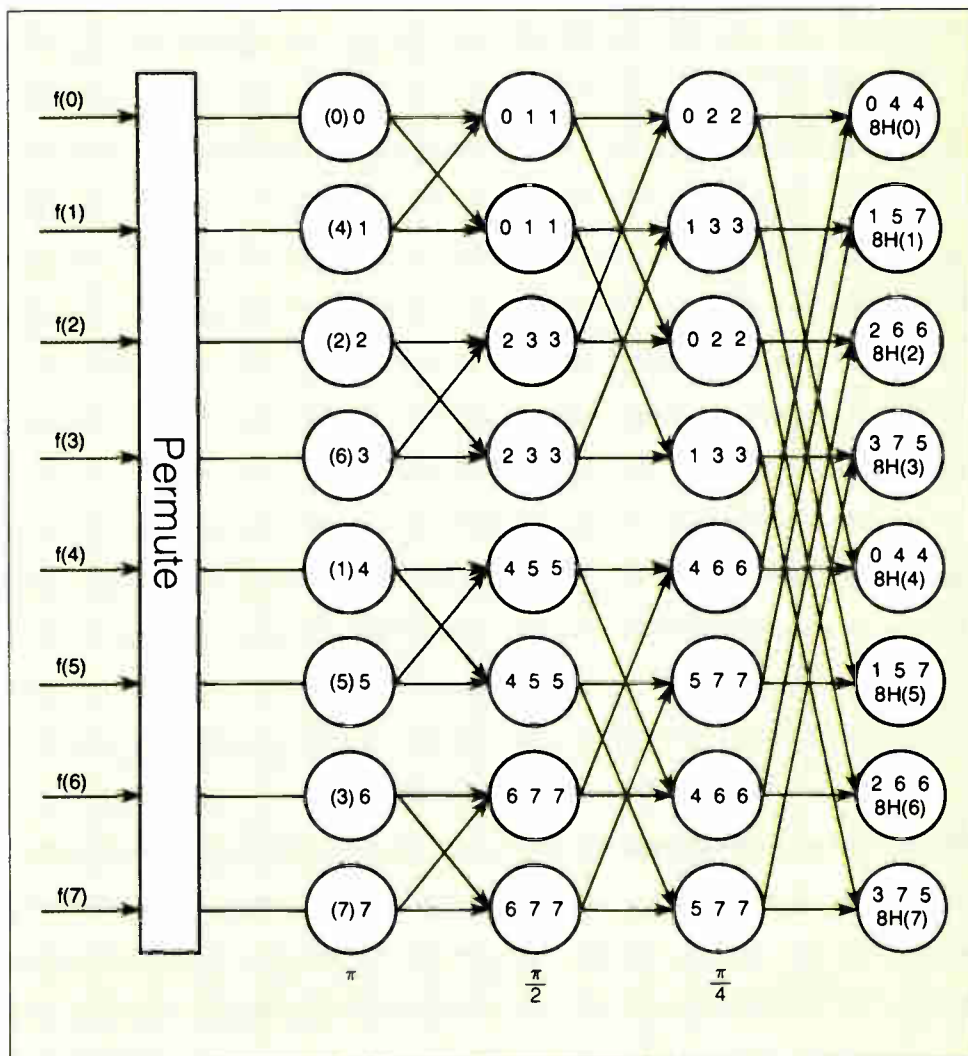

with this asymmetry by using an independent variable as an index for the elements multiplied by the sine coefficients. This index decreases while the other indexes increase; this behavior is called retrograde indexing. Bracewell gives descriptions of the FHT and FFT algorithms using matrix formalism (see reference 5).

You can obtain the inverse Hartley transform by applying the FHT algorithm again to its own output, thus regenerating the input data. This means that you can use the same program code to compute the transform and its inverse. However, there is a slight asymmetry between the FHT and its inverse. In the case of the time-to-frequency transform, you need to scale the result of the butterfly computation. That is, for an input data set of N elements, you must divide the output of the butterfly by N to obtain the discrete Hartley transform.

You don't need to do this for frequency-to-time transform; consequently, the butterfly computation itself constitutes the inverse transform. It is not difficult to add a small amount of code to control whether scaling should be applied during a conversion.

Comparing the FFT and FHT Algorithms

You can use the FHT algorithm for many of the applications for which you would now use the FFT algorithm. These include convolution and deconvolution (used to remove artifacts introduced into data by imperfections in the sensors), and the generation of power spectra for filtering. You can also obtain the Fourier transform itself from the Hartley transform. In fact, it is often faster to generate the Fourier transform and power spectrum with the FHT than with the FFT, because computing the butterfly using real rather than complex quantities requires fewer floating-point operations. You assemble the real and imaginary parts of the FFT at the end of the calculation using the equations

$$F_r = H(f) + H(N-f)$$

and

$$F_{im} = H(f) - H(N-f),$$

where F_r is the real portion of the complex Fourier transform, F_{im} is the imaginary portion, and N is the number of elements in the data set.

You can calculate the power spectrum directly from the Hartley transform using the equation

$$P_x(f) = [H(f)^2 + H(N-f)^2]/2,$$

where P_x is the power spectrum.

The theorem for convolving a pair of functions is almost identical, whether you are considering the Hartley transform or the Fourier transform. Again, the FHT should prove superior to the FFT in terms of speed for any given implementation. Equation (11) summarizes the theorem for the convolution for the Hartley transform, (12) for the Fourier transforms.

$$f_1(t) \otimes f_2(t) = H_1(f)H_{2e}(f) + H_1(-f)H_{2o}(f) \quad (11)$$

and

$$f_1(t) \otimes f_2(t) = F_1(f)F_2(f). \quad (12)$$

The \otimes symbol denotes the convolution operation.

The subscripts e and o in (11) denote the even and odd parts of the Hartley transform. Note that if one of the functions being convoluted is either even or odd, then the form of the convolution theorem for the Hartley transform reduces to the particularly simple form indicated in (13):

$$f_1(t) \otimes f_2(t) = H_1(f)H_2(f). \quad (13)$$

In practical applications, many of the convolution functions are even. For example, the Gaussian function, used in image-enhancement work, is an even function. We can take advantage of the nature of these functions to use the computational shortcut provided by (13).

Spectral Leakage

As with the FFT algorithm, the FHT algorithm will produce an erroneous frequency function if the data set to be transformed does not smoothly approach 0 at both ends of its range. Such spectral leakage is undesirable in many cases. You can reduce it

continued

Listing 1: The code fragment from *hartley.pas* that shows the complete Hartley transform as implemented in TML Pascal.

```

{-----}
Fast Hartley transform routine ...
version 1.00, Dated 22nd November 1986,

transform:= forward; Forward transform from
time frequency domain. transform := reverse;
Reverse transform from frequency to time
domain.

power_index: Index to which 2 must be raised
to generate a transform containing 'syze'
elements:
    if syze = 8 then power_index = 3;
    if syze = 16 then power_index = 4; etc
...

syze: Number of element in the input data
array.
-----}

const
    datasize = 512;
type
    direction_type = (forward,reverse);
    data_array_type = array[1..datasize] of
real;
var
    dir, test_option: char;
    i, j, syze, iter, demo: integer;
    data_array: data_array_type;
    transform_direction: direction_type;

procedure fht(var data_array: data_array_type;
power_index,
syze: integer;
transform:direction_type);

var
    i,
    j,
    k,
    trg_ind,
    trg_inc,
    power,
    t_a,
    f_a,
    i_temp,
    section,
    s_start,
    s_end: integer;
    sne,csn: array[1..datasize] of real;
    accu: array[1..2,1..datasize] of real;

```

continued

```

(-----)
Permutation routine. This routine
reorders the data before the butterfly
transform routine is called ...
(-----)

function permute(index: integer): integer;
var
  i, j, s: integer;
begin
  j := 0;
  index := index - 1;
  for i := 1 to power_index do
  begin
    s := index div 2;
    j := j + j + index - s - s;
    index := s;
  end;
  permute := j + 1;
end;

(-----)
Calculate the trigonometric functions
required by the FHT and store values.
For a N point transform, the trigono-
metric functions will be calculated
at intervals of Nths of a turn ...
(-----)

procedure trig_table(npts: integer);
const
  pi = 3.14159265;
var
  i: integer;
  angle, omega: real;
begin
  angle := 0;
  omega := 2 * pi / npts;
  for i := 1 to npts do
  begin
    sne[i] := sin(angle);
    csn[i] := cos(angle);
    angle := angle + omega;
  end;
end;

(-----)
Calculate the address of the retrograde
index for the sine term for the dual
place algorithm, if it is required ...
(-----)

function modify(power, s_start, s_end, index:
integer): integer;
begin
  if (s_start = index) or (power < 3) then
    modify := index
  else
    modify := s_start + s_end - index + 1;
end;
(-----)
Butterfly transform an index pair ...
(-----)

procedure butterfly(trig_ind, i_1, i_2, i_3:
integer);
begin
  accu[t_a, i_1] := accu[f_a, i_1] +
    accu[f_a, i_2] * csn[trig_ind] +
    accu[f_a, i_3] * sne[trig_ind];

```

continued

by multiplying the data set to be transformed by a suitable win-
dow function before computing the transform.

All these window functions cause the data to smoothly ap-
proach 0 at the limits of its range. Stigall, Ziemer, and Hudec
have reviewed the effects of these window functions on the
power spectrum (see reference 6).

If you're interested in some experimentation, I've provided a
number of these window functions below. The triangular win-
dow is a low-quality window function whose primary advantage
is its speed. An example of its use is to filter noise from telem-
etry signals in real time.

Triangular window:
 $W(n) = 2(n+0.5)/N$,
 $W(N-n-1) = W(n)$,

where $n = 0, 1, \dots, N/2$.

The Hanning and Hamming windows feature better reduction
in spectral leakage, but at the expense of speed. I've used these
window functions to preprocess satellite image data before using
the Hartley transform to correct the images for defects in the
camera optics.

Hanning window: $W(n) = 0.5(1 - \cos(2\pi(n+0.5)/N))$,

where $n = 0, 1, \dots, N-1$.

Hamming window: $W(n) = 0.54 - 0.46(\cos(2\pi(n+0.5)/N))$,

where $n = 0, 1, \dots, N-1$.

The Blackman window is for data sets where the Hamming/
Hanning windows would not be suitable.

Blackman window: $W(n) = 0.42 - 0.5\cos(2\pi(n+0.5)/$
 $(N-1))$,

where $n = 0, 1, \dots, N-1$.

You can find additional information about spectral window
functions in the papers by Harris (see reference 7) and Nutall
(see reference 8).

The FHT program

The demonstrator program `hartley.pas` described below com-
putes the Hartley transform and inverse Hartley transform of an
 N -element data set. The program was originally written in
Acornsoft ISO Pascal for the BBC Microcomputer, but few ma-
chine-dependent Pascal extensions are used.

The routine has also been successfully ported to a Prime 9975
minicomputer, running Sheffield Pascal, and a Sun-3/160
workstation running International Standard Organization level 0
Pascal.

As an example of just how easy it is to port the fast Hartley
routine to other machines, I have included the code for `hart-`
`ley.pas` as written in TML Pascal for the Macintosh.

The `hartley.pas` program simply generates a suitable func-
tion to be transformed and then calls the `fht` procedure twice.
Thus, the program calculates both the Hartley transform and its
inverse transform. The procedure `fht` is the major routine in the
program. Listing 1 is a code fragment of `hartley.pas` that con-
tains the `fht` procedure.

The code within procedure `fht` complies with the ISO level 1
standard for Pascal, except that the program uses the underscore
character in variable names. Consequently, you can lift the pro-

continued

MICROMINT'S Gold Standard in Single Board Computers & Controllers

Announcing

BCC180 — \$395.00 MULTITASKING CONTROLLER



The **BCC180**, only 4.5" x 8.5" uses the same 64180 CMOS 2.80 instruction compatible processor as Micromint's SB180 and SB180FX single board computers. Configured primarily for process control or work of memory, 6 parallel I/O ports, console serial port, RS-232C/422/485 selectable auxiliary serial ports, and an interrupt (direct ROM resident) multitasking BASIC-180 compiler. The **BCC180** uses the same 44 pin I/O expansion bus as Micromint's BC-59 controller board.

PROCESSOR
• CMOS HD64180 4.2MHz 8-bit CPU, 68-pin PLCC package

MEMORY
• Up to 34K bytes static memory on board
• Mask of either static RAM (EPROM 07250) or 256K dynamic RAM (DRAM)
• Full function 8K RAM monitor included

INPUT/OUTPUT
• Console RS-232C serial port with auto baud rate select to 19,200 baud
• Peripheral serial port, 150 or 300 baud, selectable RS-232C, RS-422 or RS-485
• 48 bit bi-directional parallel I/O
• Ask I/O available through the BCC bus edge connector

DIAGNOSIS AND CONNECTIONS
• Dual 96-pin 0.156" edge connector
• Compatible with all Micromint BCC series I/O expansion boards
• Two 96-pin headers for via backdoor (normal parallel port)
• 25 pin DB-25 for RS-232C console I/O
• 20 pin header for RS-232C auxiliary serial port
• 4 screw terminals for RS-232C/485 connection

BCC180-1-20 1MHz assembled and fully socketed BCC180 Computer/Controller with 32K bytes of static RAM, ROM Monitor, BASIC-180 development software and user's manual. For additional 256K DRAM add \$100.00 \$395.00

BCC180-1 100 Quantity w/32K RAM, w/o Monitor ROM \$209.00

SB180FX — \$409.00 Single Board Computer



SB180FX TECHNICAL SPECIFICATIONS

PROCESSOR
• Hitachi HD64180 4.2MHz CPU in a 68-pin PLCC package
• Support of 2.80 instruction set, including hardware multiply
• Integrated Memory Management (User and 318K bytes address space)
• Dynamic RAM refresh
• User write generator
• Clocked serial I/O port
• Channel Direct Memory Access Controller
• Channel Asynchronous Serial Communications Interface
• Channel 16-bit Programmable Bit/Shift Timer
• 4K interrupt
• Dual bus interface to allow real time support chips
• 4MHz to 9.1MHz and 16.9MHz system operation

MEMORY
• 31.8K bytes dynamic RAM on board
• Memory externally expandable to 4 Mbytes RAM
• Fetch an 8K 976K 16K 9719K or 36K 9756 EPROM usable
• Full function 8K ROM resident monitor

INPUT/OUTPUT
• Console RS-232C serial port with auto baud rate select to 19,200 baud
• Peripheral RS-232C serial port full hand wiring, 150 or 300 baud
• Line printer parallel I/O port
• 48 bits bi-directional parallel I/O
• 48 bit address decoding I/O port direct and dual bus interface brought out to expansion bus connector
• Can be direct attached to GT180 and 480 color graphics adapter
• Fully implemented SCSI hard disk and communications bus interface

FLOPPY/TAPE/DISK INTERFACE
• Uses Standard Microcomputers one disk controller
• Compatible with NEC TERA controller
• On-chip digital data separator
• Can control 5 1/4" and 5 1/8" floppy disk drives — up to 4 in any combination
• Handles both FM encoded single density and MFM encoded double density data
• MC 53C80 SCSI bus controller for hard disk or network communication
• SCSI Z80DS Z80MS Compatible

SB180FX-1 SB180FX 0.64 MHz computer board populated with 256K bytes RAM, 8K byte ROM monitor, without SCSI chip Add \$50.00 for 4 MHz \$409.00

SB180FX-1.30 SB180FX 1.3MHz computer board as described above with 2 system software including Z80DS Z80MS color adapters, JAS assembler, and Z80 debugger BIOS and ROM resident sources, and BIOS for SCSI hard disk supplied on two 5 1/4" 5B180 format floppy disks \$499.00

GT180 — \$395.00 Graphics Display System

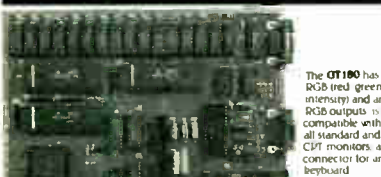

The **GT180** offers these features:
• Advanced graphics controller provides intelligent link between computer and user
• Only 9.75" x 8" — plugs back in either an SB180 or SB180FX computer
• High resolution at 1/2 inch CSI — 480 x 480 with 16 color colors
• Hardware drawing commands: LINE, RECTANGLE, POLYLINE, POLYGON, CIRCLE, ELLIPSE, ARC, FILLED, DIAGONAL, PAINT, PATTERN, WINDOW, and COPY to name: but a few
• Automatic translation of logic X, Y coordinates to physical frame buffer addresses
• Fast drawing speed of 9 million pixels per second
• Provides fully programmable horizontal split screens and window screen
• Fully supported by **GT180** Graphics ToolBox written in Modula 2

GT180-1 Graphics Display Expansion Board (TTL RGB only) \$395.00

GT180-2 Graphics Display Expansion Board (TTL RGB and Analog RGB) \$499.00

ImageWise™ Serial Digital Imaging System

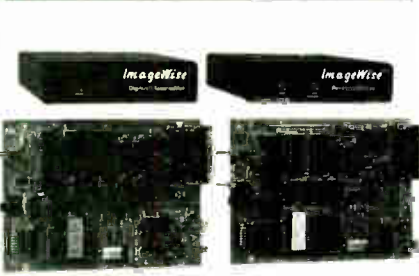

MICROMINT INTRODUCES A STAND-ALONE SERIAL DIGITAL IMAGING SYSTEM. The MICROMINT ImageWise™ Serial Digital Imaging System is the most cost effective and versatile high performance, graphics video digitizing system on the market today. The ImageWise system has been designed to function as a standalone digitizer or as an integral component of a complete tele imaging system. ImageWise™ is serially bit mapped digitizers provides great image resolution compatibility with any computer capable of attaching to a modern or terminal. It is ideally suited for CAD/CAM, Desktop Publishing, automatic inspection, and security applications. Critical System functions such as image resolution and picture update can be controlled and commanded remotely. Images are transmitted and received serially, either compressed or uncompressed, and can be displayed, transmitted, stored, edited, or processed for use in a variety of industry standard application software.

IMAGEWISE SYSTEM SPECIFICATIONS

- NOT bus dependent — can function stand-alone
- Use frame grabber — uses a high speed flash A/D converter and 64K bytes of static RAM to capture an image in 1/10th second
- Accepts any DVI or other NTSC video signal
- Source pictures as stills or up to 256 pictures, full screen, sequential
- Resolution of transmitted image is software selectable; all images are compressed in real time at 4:1 scale
- Selectable resolutions:
 Low: 320x240
 Med: 640x480
 High: 640x480
- Video Input: 1 volt peak-to-peak B/W or color 75 ohm termination
- Video Output: 75 Ohm 1.5 V peak-to-peak NTSC composite video
- Serial I/O: Output RS-232C 4 bit one stop bit, no parity, 300 bps — 19,200 bps, selectable data rate. Xon/Xoff Handshaking Switch select cable data compression control
- Modern compatible: Easy functions as a smart telephone to send video images anywhere
- Video processing, still, upload/download, and display utilities provided for PC DOS and MS DOS machines

Optional PC Interfaces Disk converts ImageWise™ files for use with popular Desktop and Paint Programs

DT01 ImageWise Digitizer + Transmitter \$349.00

DIR01 ImageWise Receiver + Display \$349.00



NEW LOW PRICE CEM-286 — \$620.00 complete PC/AT CPU



Low Power
Expansion Card Form Factor!
100% AT Compatible!

MICROMINT'S **CEM-286** is a complete PC/AT CPU and more. The **CEM-286** is the first low power 100% AT compatible which has been specifically designed for OEM use within the industrial and business sectors. The **CEM-286** features the Zymos CMOS PDMCH™ and 100% compatible Award BIOS. The development of the PDMCH chipset has allowed the 100% AT on a standard AT to be reduced to 20 IC's and two SIMMs. What this means for you is:

- 1) The overall size of a standard AT/PCPU has been condensed into the expansion card form factor (13 1/2" x 7 1/4")
- 2) Fewer requirements and less than 1 A @ 5 volts.
- 3) **CEM-286** plugs into a passive backplane for easy connection to other expansion peripherals.

The **CEM-286** is available in both 8 and 10 MHz versions and comes with the Award BIOS.

CEM-286 FEATURES

- 100% AT compatible
- 2098 Microprocessor at 8 or 10 MHz
- 50287 Co-Processor optional
- 64 Kbytes of ROM, can accommodate 128 Kbytes
- 512 Kbytes of RAM
- Keyboard controller
- Expansion card size factor
- Standard interface to the System/Expansion Bus
- Battery backed real time clock
- Award BIOS included

OEM-286/10 10MHz AT/PCU \$680.00
OEM-286/8 8MHz AT/PCU \$615.00
OEM-286/NI 100 QUANTITY PRICE \$562.00

BCC52 — \$199.00 BASIC 52 Computer/Controller

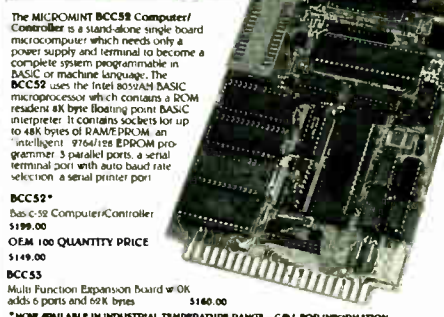

The **MICROMINT BCC52 Computer/Controller** is a stand-alone single board microcomputer which needs only a power supply and terminal to become a complete system programmable in BASIC or machine language. The **BCC52** uses the Intel 8052A1 BASIC microprocessor which contains a ROM resident 8K byte floating point BASIC interpreter. It contains sockets for up to 48K bytes of RAM/EPROM, an intelligent 9764198 EPROM programmer, 3 parallel ports, a serial terminal port with auto baud rate selection, a serial printer port.

BCC52* Basic 52 Computer/Controller \$199.00

OEM 100 QUANTITY PRICE \$149.00

BCC53 Multi Function Expansion Board w/OK adds 6 ports and 64K bytes \$160.00

* NOW AVAILABLE IN INDUSTRIAL TEMPERATURE RANGE — CALL FOR INFORMATION

BCC11 — \$139.00 Basic Controller

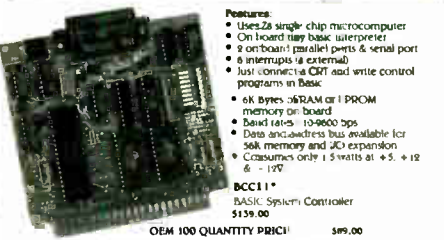

Features:
• Uses 28 single chip microcomputer
• On board 8K byte basic interpreter
• 2 on board parallel ports & serial port
• 3 interrupts (4 external)
• Just connect a CRT and write control programs in Basic
• 6K Bytes 16K RAM or 1 PROAM memory on board
• Baud rates 10-9600 bps
• Data and address bus available for 36K memory and I/O expansion
• Consumes only 1.5 watts at 5, 12 & 10V

BCC11* BASIC System Controller \$139.00

OEM 100 QUANTITY PRICE \$95.00

* NOW AVAILABLE IN INDUSTRIAL TEMPERATURE RANGE — CALL FOR INFORMATION

BCC22 — \$249.00 Term-Mite Smart Terminal

Why pay \$500 or more for a smart terminal? The **TERM-MITE ST** offers you all of the following on a single board for less than 1/4 the price:

- Dimensions 4" x 6 1/2"
- 198 displayable characters
- 24 lines x 80 characters
- Separate transmit & receiver baud rates (10-19,200bps)
- CRT refresh at 50-60 Hz
- Supports scanned and encoded keyboards
- 11 Graphic characters
- 25th line reverse video status display
- 31 escape functions
- 14 control functions
- Directly drives composite video or separated semi-monitors
- All functions are firmware controlled — source code available

EDITING FEATURES: Clear to screen to space or null — erase to end of page, erase to end of line, absolute cursor addressing
VISIO ATTRIBUTES: reverse video, half intensity, double height, double width, underlined, blinking, and other characters
BUS CONFIGURATION: MICROMINT BCC compatible — no bus connection necessary for stand-alone operation with parallel keyboard

BCC22 TERM-MITE Smart Terminal Keyboard \$249.00
BCC22K PARALLEL Encoded ASCII KEYBOARD plugs directly into TERM-MITE \$ 79.00

European Distributor:

J.B. Designs
Cirencester, Glos. England
Tel: 0285-68122

Manufacturer Representatives:

Access Technology
Placentia, CA 92670
Tel: (714) 996-3917
Microfuture
Fremont, CA 94538
Tel: (415) 657-0264

To order call

1-800-635-3355

for technical information 1-(203)-871-6170

TELEX: 643331 FAX (203) 872-2204

Micromint, Inc.

4 Park Street
Vernon, CT 06066



```

    trig_ind := trig_ind + syze div 2;
    accu[t_a,i_2] := accu[f_a,i_1] +
        accu[f_a,i_2] * csn[trig_ind] +
        accu[f_a,i_3] * sne[trig_ind];
end;

{-----}
Main program for the fast Hartley
transform.
{-----}

begin
    power := 1;
    f_a := 1;
    t_a := 2;
    trig_table(syze);
    for i := 1 to syze do accu[f_a,permute(i)]
:=
        data_array[i];

{-----}
Start of the Hartley butterfly
transform ...
{-----}

    for i := 1 to power_index do
begin
    j := 1;
    section := 1;
    trg_inc := syze div (power + power);
    repeat
        trg_ind := 1;
        s_start := section * power + 1;
        s_end := (section + 1) * power;
        for k := 1 to power do
begin
            butterfly(trg_ind,j,j + power,
                modify(power,s_start,s_end,j
                    + power));
            trg_ind := trg_ind + trg_inc;
            j := j + 1;
        end;
        j := j + power;
        section := section + 2;
    until j > syze;
    power := power + power;
    i_temp := t_a;
    t_a := f_a;
    f_a := i_temp;
end;

{-----}
End of Hartley butterfly. The results are
scaled if necessary, and then placed in
back into the array data ...
{-----}

    case transform_direction of
        forward: for i := 1 to syze do
            data_array[i] :=
accu[f_a,i] / syze;
        reverse: for i := 1 to syze do
            data_array[i] :=
accu[f_a,i];
    end;
end;

```

cedure from the demonstration program and use it freely in your own applications.

However, a brief description of fht and its embedded sub-procedures may be useful if you'd like to experiment with the program.

The procedure trig_table precalculates the trigonometric functions required by fht. For an input data set containing N elements, adjacent entries in this table are $2\pi/N$ radians apart. This precalculation of the trigonometric terms avoids redundant computations of these values if they are needed frequently during processing.

The procedure permute bisects the input data set progressively until data pairs are reached. The algorithm given is adapted from one described by Bracewell, who has also described faster permutation routines (see reference 5) that you can substitute if you want.

The procedure butterfly calculates the butterfly of a single index pair. This procedure requires three indexes to use as entry parameters. This takes into account the possibility of retrograde indexing for the data element multiplied by the sine factor. Where retrograde indexing is necessary, the procedure modify calculates the retrograde indexes used by the procedure butterfly.

The main program of the fht procedure first precalculates the trigonometric function tables and permutes the input data. The program then enters an iterative loop that computes the butterfly for the whole of the N -element input data set. You then scale the resulting output by a factor of N if you are computing the time-to-frequency transform.

When you have to deal with the complex form of the frequency transform, you can obtain Fourier transform from the FHT algorithm by operating on the output data of the procedure fht using the Pascal procedure get_FFT.pas, shown in listing 2. By the time you exit from this procedure, the real and imaginary parts of the Fourier transform will be in the arrays. They are passed via the dummy conformant array variables r_pt and i_pt, respectively.

A similar procedure in get_pwr.pas called get_power_spectrum (shown in listing 3) allows you to obtain the power spectrum from the Hartley transform. At exit from this procedure, the power spectrum will be in the array passed to the procedure via the dummy conformant array variable p_sp. You can use both of the above procedures in applications programs without any modification. These procedures conform to the ISO level 1 standard of the Pascal language, and should be usable directly on any computer that supports an ISO level 1 Pascal compiler.

The modifications required to compile these procedures with an ISO level 0 compiler are trivial. Basically, it is just a case of replacing all the conformant array parameters' procedure headers of get_fft and get_power_spectrum, with array parameters of fixed size.

Performance

The BBC Microcomputer implementation of the FHT program has proved to be fast and is currently running on a 6502A-based BBC Microcomputer with a second add-on 3-MHz 6502 processor, which executes the program. This hardware can compute a 256-point transform in about 32 seconds. This compares favorably with the 2 minutes it took Bracewell's original implementation of the FHT algorithm to accomplish a 256-point transform on an HP-85 system. You can expect even better performance from 16-bit microcomputers.

Table 1 shows the timings for running the FHT program on the Macintosh Plus and Mac II using TML Pascal and the Sun-3/160 workstation using ISO Pascal.

continued

MICROCOM
9600+

MNP. ERROR CORR.
FROM \$699
 ONLY
 Both new & refurb. Full warranty. Special quantity and term commitment arrangements available.

U.S. Robotics
2400 BAUD MODEMS
 • Hayes compatible
 • 300, 1200, 2400 Baud
 • Auto dial/answer
 • US made, 2 yr. warr.
LOWEST PRICES AVAILABLE
\$149

FAX ON-A-CARD
 Fully automated FAX now to any Group III FAX machine. Unattended background operation. Send scanned, ASCII, or word processed files. Use any laser or dot matrix printer for output.
\$289
 NOW, VOICE-MAIL FOR YOUR PC ALSO

LAN STARTER PACKAGE \$599
SAVE OVER 50% NOW*
 • NOVELL COMPATIBLE
 • SOFTWARE INCLUDED
 • TWISTED PAIR/COAX/RJ11
 • IBM NETBIOS COMPAT.
 • COMM PORT SHARING
 • UP TO 255 NODES MAX
 • FULLY EXPANDABLE

 * LIMITED TO FIRST 150 SETS SOLD

BEST PRICES ANYWHERE!
30 MB HARD DISK 286

 • Intel 80286 Processor
 • 80287 Co-Processor Slot
 • 30 MB Seagate H/D
 • VGA/EGA Graphics Card
 • Novell, IBM, & OS/2 Compatible System
NOW ONLY \$995
 Your Choice of Optional Monitors

QUADRAM

Quad 386 XT
 Upgrades XT to 386 performance. 80386-16MHz processor. Easy to install.
\$699
286 Upgrade \$399

THIS MONTH'S SPECIALS
 • 2400 BAUD LAPTOP MODEMS NOW \$279
 • EXTERNAL TAPE BACKUP UNIT \$389
 • TOSHIBA 2 MB 3 1/2 IN. FLOPPY \$139
 • 130 MB/28 MS HARD DISK & CONT. \$999
 • GENOA PLUS EGA & GEM SOFTWARE \$199
 HUNDREDS OF OTHER TOP NAME PRODUCTS AVAILABLE ON OUR 24-HR BBS DATA LINE (805) 650-0193 (8/1/1N)

ONLINE STORE BRAND NAMES FOR MUCH LESS!
(805) 650-0188
  
 Ask About BBS Software

How a software engineer got to captain the lunar landing module.

The Computer Museum is everything you'd expect, and a lot of things you wouldn't.

Of course, the museum contains a collection of the most significant accomplishments in the history of information processing. But it's not just a great place to see things, it's also a great place to do things.

There are over twenty interactive exhibits at The Computer Museum. You can design a car, create your own fractal landscape, or even captain the lunar landing



module on the Apollo flight simulator.

So, the next time you're in Boston, stop by The Computer Museum. You'll discover it's more than a lot of machines, it's also a lot of fun.

For more information, or to become a Museum Member, write The Computer Museum, or call (617) 423-6758.

The Computer Museum

B O S T O N
 There's something in it for everyone.

300 Congress Street, Boston, MA 02210

Table 1: Timings for the hartley.pas demonstrator program on several machines. For the Macintosh computers, TML Pascal version 2.50 was used, and times are to the nearest second. No 68881 coprocessor code was generated for the test, so the Mac II's 68881 was not used. You can expect better times if you use the 68881. For comparison, the results of the same code compiled on a Sun-3/160 workstation using ISO Pascal are shown. Times are in seconds.

Number of points	Mac Plus FPU not used	Mac II FPU not used	Sun-3/160 FPU not used	Sun-3/160 68881 FPU used
2	0.00	0.00	0.00	0.00
4	0.00	0.00	0.02	0.00
8	0.00	0.00	0.04	0.00
16	1.00	0.00	0.08	0.02
32	1.00	1.00	0.18	0.04
64	2.00	1.00	0.34	0.06
128	6.00	2.00	0.70	0.08
256	12.00	3.00	1.48	0.18
512	27.00	6.00	3.60	0.40

Listing 2: Pascal code to compute the Fourier transform from the FHT algorithm.

```

Procedure get_FFT(var data:
array[10..h0:s_int] of real;
var r_pt: array[11..h1:s_int] of real;
var i_pt: array[12..h2:s_int] of real;
size: s_int);
var i: s_int;
begin
i := 1;
while i < size do
begin
r_pt[i] := data[i] + data[size - i + 1];
i_pt[i] := data[i] - data[size - i + 1];
i := i + 2;
end;
end;
    
```

Listing 3: Pascal code to compute the power spectrum from the FHT algorithm.

```

procedure get_power_spectrum
(var data: array[10..h0:s_int] of real;
var p_sp: array[11..h1:s_int] of real;
size: s_int);
var i: s_int;
begin
i := 1;
while i < size do
begin
p_sp[i] := (data[i] * data[i] +
data[size - i + 1] *
data[size - i]) / 2;
i := i + 1;
end;
end;
    
```

Note that you can attain very high speeds with the Sun workstation, with its combination of a 20-MHz 68020 processor, 68881 floating-point coprocessor, and optimizing Pascal compiler.

New Limits to Explore

I hope this article has given you enough information to seriously consider using the Hartley transform for your signal processing needs. Since the transform uses only real functions, you don't need computationally expensive complex math to digitally filter or enhance a signal.

The elimination of complex numbers also reduces the amount of memory required to process a signal. Finally, since the Hartley transform uses fewer operations to process a signal, you will have fewer roundoff errors.

The FFT made a lot of what we call image processing possible by manipulating large amounts of data in a reasonable amount of time. The FHT offers better performance using less computational resources. With the same code you use to compute the transform, you can compute its inverse when necessary. It will be interesting to see what new uses will result from the expanded limits of processing that the Hartley transform provides. ■

Editor's note: Source code listings that accompany this article, hartley.pas, get_FFT.pas, and getpwr.pas, are available on BIX, on BYTEnet, on disk, and in the Quarterly Listings Supplement. See page 3.

REFERENCES

1. Bracewell, Ronald N. "The Fast Hartley Transform." *Proceedings of the IEEE*, vol. 72, no. 8, p. 1010, 1984.
2. Hartley, R. V. L. "A More Symmetrical Fourier Analysis Applied to Transmission Problems." *Proceedings of the IRE*, vol. 30, p. 144, 1942.
3. Cooley, J. W., and J. W. Tukey. "An Algorithm for the Machine Computation of Complex Fourier Series." *Mathematical Computing*, vol. 19, p. 297, 1965.
4. Bracewell, Ronald N. "The Discrete Hartley Transform." *Journal of the Optical Society of America*, vol. 73, p. 1832, 1983.
5. Bracewell, Ronald N. *The Fast Hartley Transform*. New York: Oxford University Press, 1986.
6. Stigall, P., R. E. Ziemer, and L. Hudc. "A Performance Study of 16-bit Microcomputer-Implemented FFT Algorithms." *IEEE Micro*, p. 61, November 1982.
7. Harris, F. J. "On The Use of Windows for Harmonic Analysis with Discrete Fourier Transforms." *Proceedings of the IEEE*, vol. 66, no. 1, p. 51, 1978.
8. Nutall, H. H. "Some Windows with Very Good Sidelobe Behaviour." *IEEE transcripts of Acoustics Speech and Signal Processing*, vol. ASSP-29, no. 1, p. 84, 1980.

Mark A. O'Neill is a member of a research team working on the automated production of topographical maps from satellite (SPOT) images. He is also a member of the department of photogrammetry and surveying at University College in London, U. K.

THE BUYER'S MART

A Directory of Products and Services

THE BUYER'S MART is a monthly advertising section which enables readers to easily locate suppliers by product category. As a unique feature, each BUYER'S MART ad includes a Reader Service number to assist interested readers in requesting information from participating advertisers.

RATES: 1x—\$475 3x—\$450 6x—\$425 12x—\$375
Prepayment must accompany each insertion. VISA/MC Accepted.

AD FORMAT: Each ad will be designed and typeset by BYTE. Advertisers must

furnish typewritten copy. Ads can include headline (23 characters maximum), descriptive text (250 characters maximum), plus company name, address and telephone number. Do not send logos or camera-ready artwork.

DEADLINE: Ad copy is due approximately 2 months prior to issue date. For example: March issue closes on January 7. Send your copy and payment to THE BUYER'S MART, BYTE magazine, 1 Phoenix Mill Lane, Peterborough, NH 03458. For more information call Mark Stone at BYTE 603-924-3754.

ACCESSORIES

PROTECT YOURSELF!!!

Ergo-Vision™ Plus 2 Radiation Filter with patented nickel mesh protects you from radiation, static, and glare. Reduces electromagnetic radiation by 90% +, electrostatic charge to 0 and eliminates glare. Anti/Rad/Stat/GI filter \$99. Anti/Stat/GI \$39. s/h \$3. Check/COD. Specify monitor manufacturer & model #. Free catalog.

Abelson Communications

Dept. B, POB 1031, Rockville Centre, NY 11570
516-766-7782

Inquiry 551.

ACCESSORIES

SELF-INKING PRINTER RIBBON

Awarded United States Patent #4701062
Lasts 10-15 times longer than the conventional ribbon
For printers using 1/2" width open spool ribbon

Olivetti 82A-83A-84-92-93	Dec LA 180120
Teletype 33, 35	Dec LA 3018M 1443
Star Gemini 10X	Teletype Model 40
Extel	TI 800/810, 820, 880

Contact us by mail, phone or telex and we will forward you a brochure

CONTROLLED PRINTOUT DEVICES, INC.

POB 869, Baldwin Rd., Arden, NC 28704
(704) 684-9044 • TELEX: (FILMON-AREN) 577454

Inquiry 556.

ACCESSORIES

GENIUS MOUSE W/DR. HALO III

Complete package includes:

- Serial mouse
- Dr. Halo III software
- Menu maker & menu library
- Mouse pocket
- Mouse pad & cutting board in one
- Dealer inquiries welcome.

\$79

WELLEX CORP.

44141 So. Grimmer Blvd., Fremont, CA 94538
(415) 490-3263 FAX: (415) 651-5047

Inquiry 561.

FREE CATALOG

Thousands of parts and new surplus electronic parts at ANDER LOW prices. FAST ORDER PROCESSING AND SHIPPING (95% of all orders shipped within 48 hours).

CALL OR WRITE FOR A FREE CATALOG.

ALL ELECTRONICS CORPORATION

P.O. Box 567, Van Nuys, CA 91408-0567

1-800-826-5432

Inquiry 552.

CUSTOM CABLE ASSEMBLIES

COMPETITIVE PRICING — 100% COMPUTER TESTED OEM'S & DEALERS WELCOME
RS232, ETHERNET, COAX, TWINAX, V.35, OCTOPUS, RIBBON, MODULAR ADAPTERS, AND BULK CABLE ALSO STOCKING: SWITCHBOXES, COMPUTER ACCESS., CONNECTORS, SURGE PRODUCTS, UPS SYSTEMS

PRODUCT RESOURCES INC.

P.O. BOX 30497, HOUSTON, TX 77249-0497
US: 1-800-222-1537 FAX: 1-713-659-7140
THEN DIAL "990638" LOCAL: 713-659-4416

Inquiry 557.

ARTIFICIAL INTELLIGENCE

Neural Net + Compiler

Netzwerkz demos neural net finding nearest match of input word to list of words. PL/D compiles Netzwerk and itself for retarget to new CPUs. Three manuals total 150 pages. All source. Need PC/XT/AT w 256KB. See 10/87, BYTE, pg.46 & 2/88, pg.11 for more info.

Netzwerkz: 79.95 PL/D: 124.95 Both: \$154.95

DAIR Computer Systems

3440 Kenneth Dr., Palo Alto, CA 94303
(415) 494-7081

Inquiry 562.

SOFTWARE PACKAGING, DISKS

Cloth binders & slips like IBMs. Vinyl binders, boxes, and folders—many sizes. Disk pages, envelopes & labels. Low qty. imprinting. Bulk & branded disks. Much More! Low prices. Fast service. Call or write for FREE CATALOG.

Anthropomorphic Systems Limited

376-B East St. Charles Road
Lombard, IL 60148

1-800-DEAL-NOW (312) 629-5160

Inquiry 553.

500

Letter size, 20#, continuous paper computer forms, invoices, statements, letterheads, etc. OFFSET PRINTING, AS LOW AS .08¢ EA. Send/Fax: (516-293-0113) the drafts/samples, or direct feed to our computer. (516-293-0153), WE SET THE PAGE FREE. Free UPS shipment in 6 days. Matching envelopes same low price. For 2nd color, add .02¢ EA. NY residents add sales tax. MC/VISA, # & Exp. date.

SPTC

40 SARAH DR • E FARMINGDALE • NY • 11735-1210
516-293-0110

Inquiry 558.

FamilyCare™ Software

This comprehensive medical diagnostic expert system spares expensive, unnecessary trips to a physician by guiding you quickly through possible symptoms and giving you specific directions for medical care, home treatment, and medications. Includes hundreds of symptoms, injuries, and diseases of newborns through teenagers.

FamilyCare™ Software

Lundin Laboratories, Inc.
29451 Greenfield Dr., Suite #216, Southfield, MI 48076
800/426-8426 or 313/559-4561

Inquiry 563.

JOB PROTECTION

If your job depends on your computer, you should have our FREE catalog. Call (800) 356-5794 Ext. 8986 for a FREE catalog from the world's largest manufacturer of single phase uninterruptible power supplies. Call or write today!

BEST POWER TECHNOLOGY, INC.

P.O. Box 280, Necedah, WI 54646
In WIs. (608) 565-7200 Ext. 8986
(800) 356-5794 Ext. 8986

Inquiry 554.

PC CABLES & ACCESSORIES!

Our FREE Catalog includes hundreds of Switches, Cables (Standard & Custom), Buffers, Data Converters, Signal Boosters, Surge Protectors & More for your PC. LOW Direct Prices, SAME DAY Shipping & Satisfaction GUARANTEED!

Write or Call for a FREE CATALOG Today!

Tipz Computer Accessories

P.O. Box 690, San Francisco, CA 94101-0690
800-367-8479 or 415-626-4333

Inquiry 559.

muLISP™-87 for MS-DOS

Fast, compact, efficient LISP programming environment. muLISP programs run 2 to 3 times faster & take 1/2 to 1/3 the space of other LISPs. 450 Common LISP functions, multi-window editing & debugging, flavors, graphics primitives, lessons & help, demo programs, comprehensive manual.

Soft Warehouse, Inc.

3615 Harding Ave., Suite 505, Honolulu, HI 96816
(808) 734-5801

Inquiry 564.

RE-INK FABRIC RIBBONS

Cut ribbon cost by using Borg Ribbon Inkers. Do all cartridge ribbons with just one ink. Choose from 3 models. Manual E-Zee Inker — \$39.50
Electric E-Zee Inker — \$89.50
Ink Master (Electric) — \$159.00

1000's of satisfied users in 5 years. Moneyback guarantee.

BORG INDUSTRIES

525 MAIN ST., JANESVILLE, IA 50647
1-800-553-2404

Inquiry 555.

POLAR FILTER

- Prevent the glare, flicker and shake caused by the reflection of outside light which are common causes of eye fatigue
 - Prevent the aggravated nearsightedness (proved by test) and weakening of eye nerves
 - Blocks out 100% of Ultraviolet rays
- COMES IN VARIOUS SIZES EVEN FOR TV'S 12", 14", 19", 26"
(\$21, \$27, \$37, \$49) respectively. Cashier's check, money order, or COD, wholesalers welcome

UNLIMITED Computer Systems

11175 Mt. View Ave., #K, Loma Linda, CA 92354
Ph # (714) 796-7974 Fax # (714) 796-3931

Inquiry 560.

AUTHORS

AUTHORS WANTED BY NEW YORK PUBLISHER

Leading subsidy book publisher seeks manuscripts of all types: fiction, non-fiction, poetry, scholarly and juvenile works, etc. New authors welcomed. Send for free, illustrated 40-page brochure H-1.

Vantage Press

516 W. 34 St., New York, N.Y. 10001

THE BUYER'S MART

BAR CODE

BAR CODE READERS

For PC/XT/AT, and ALL PS/2 models—attaches as 2nd keyboard, reads as keyed data. External mounting via velcro to side of monitor, OR in short slot of PC, XT, AT. PC—\$385. PS/2, Kimtron, & RS-232 models—\$399. UPC/EAN, 2 of 5, Code 39, MagStripe +\$100. Badge Readers—Lasers too! 30 day \$ back.

Worthington Data Solutions

417A Ingalls St., Santa Cruz, CA 95060
(800) 345-4220 In CA: (408) 458-9938
Please see our ad on page 233

PRINT BAR CODES/BIG TEXT FROM YOUR PROGRAM

Add bar codes and big graphics text to your program. Print from inside of dBASE, BASIC, C, etc. Bar codes UPC, EAN, 2 of 5, Code 39, Epson/OKI/IBM dot matrix text up to 1/2". LaserJet fonts up to 2" (158 pts), tall. \$159-\$239. 30 day \$\$ back guarantee.

Worthington Data Solutions

417A Ingalls St., Santa Cruz, CA 95060
(800) 345-4220 In CA: (408) 458-9938
Please see our ad on page 233

PRINT BAR CODES AND BIG TEXT

On your EPSON/IBM/OKI/LaserJet printers. 1" tall text-readable at 50 ft. Code 39, 2 of 5, 128, MSI, UPC/EAN, MIL-STD, AIAG. Menu-Driven. Any format/size. File input. One screen to design label—\$279. Drives LaserJet at 8 ppm. Other simple programs for bar codes from \$49. 30 day \$ back.

Worthington Data Solutions

417A Ingalls St., Santa Cruz, CA 95060
(800) 345-4220 In CA: (408) 458-9938
Please see our ad on page 233

BARCODE BARGAINS

Buy direct and save. We'll beat any written quotes for competing equivalent bar code readers or bar code label generation software. Call or write for brochures. Quantity discounts, warranty, same day shipping. Bar codes are all we do at ITS.

International Technologies & Systems Corp.
1950 White Star Dr., Diamond Bar, CA 91765
(714) 861-7977 Telex 285716 ITSCO UR

Inquiry 565.

BAR CODE MADE EASY

PERCON® E-Z READER® keyboard interfaces and multiuser RS-232 models make it easy to add bar code to virtually any computer/terminal WITHOUT SOFTWARE MODIFICATION. Immediate shipping. Two year warranty. Bar code printing software available. Call for details on fast, accurate, easy data entry. Substantial reseller discounts.

PERCON®

2190 W. 11th St., Eugene, OR 97402
(503) 344-1189

Inquiry 566.

READ & PRINT BAR CODES

Fast, reliable data entry into your programs as if from your keyboard. Internal unit for PC, XT, AT, PS/2-M30. RS-232 unit for DOS & Non-DOS systems (incl. all PS/2). Stainless steel wand and LASER interfaces. Powerful Bar Code and Text printing software.

Seagull Scientific Systems

601 University Ave., Suite 150, Sacramento, CA 95825
(916) 386-1776

BAR CODE

BAR CODE READERS

Among the industries best and most widely used barcode reader, reads all major barcode formats (code 39, 2 of 5, UPC/EAN, codabar), connects between keyboard & system, advanced CMOS uses keyboard power supply, connects to all IBM compatibles and DIN terminals, completely OS independent, software independent. Same day ship, 1 year warranty, 30 day satisfaction guarantee. CALL for prices too low to advertise.

Solutions Engineering Sales

8653 Georgia Ave., Silver Spring, MD 20910
800-635-6533

Inquiry 567.

DATA INPUT DEVICES

Bar Code & Magnetic Stripe Readers for microcomputers & terminals, including IBM PS/2 & others, DEC, AT&T, CT, Wyse, Wang. All readers connect on the keyboard cable & are transparent to all software. Low cost bar code print programs & magnetic encoders are also available. GSA approved.

TPS Electronics

4047 Transport, Palo Alto, CA 94303
415-856-6833 Telex 371-9097 TPS PLA

Inquiry 568.

BAR CODE SCANNER/READER

For PC/XT/AT and compatibles, and APPLE II. Keyboard emulating model with wand for only \$249. Reads 2 of 5, UPC/EAN/JAN/UPC E, Code 39, CODABAR with 1 yr. warranty.

Also RS-232C and CENTRONICS models with choice of wands, hand-held, and auto scanners.
Call or write for free catalog.

TRADE MATRIX of Silicon Valley

3639 Sattinwood Dr., San Jose, CA 95148
(800) 222-4229 Ext. 39, (408) 238-1784

Inquiry 569.

CAD/CAM

UNTANGLE TANGO

UnTangle Tango allows you to use Tango printed circuit design tools without the hardware locks! Eliminate the wire mess, operate without a printer, installs in minutes on current versions. \$ 49 + \$2 S/H. Plotter drivers also available — Calcomp, Apple, etc. \$25 + \$2 S/H. Ca add 7% sales tax.

Challenge Computer Consulting

P O Box 53299, San Jose, CA 95153
(408) 226-4214

Inquiry 570.

CADKEY 3-D CADD Software

CADKEY 3 Reg: \$3,195 HLB:\$2,695
CADKEY 1 Reg: \$495 HLB:\$425

Call or write today for free catalog.
VISA/MC/COD/POs accepted

703-977-6520 HLB Technology

PO Box 527, Blue Ridge, VA 24064

Inquiry 571.

COMMUNICATIONS

MULTI-USER BBS (FOR IBM PC AT)

TEAMate — a mainframe quality BBS. A mini CompuServe. Full screen cursor-controlled interface, topic outline structure, public and private topics, audit trails, xmodem, integrated mail, content retrieval and more. MS-DOS, XENIX and UNIX versions.

MMB Development Corporation

1021 No. Sepulveda Blvd., Suite K, Manhattan Beach, CA 90266
1-800-832-6022, In CA (213) 545-1455

Inquiry 572.

COMPUTER INSURANCE

COMPUTERS + INSURANCE = SAFEWARE

Call toll free for information

- HOME COMPUTERS
- OVERSEAS COMPUTERS
- COMPUTERS LEASED TO OTHERS
- COMPUTERS TAKEN TO SHOWS
- COMPUTERS HELD FOR SALE
- OTHERS COMPUTERS IN YOUR CARE
- BUSINESS COMPUTERS
- LEASED COMPUTERS

SAFEWARE,

The Insurance Agency Inc.

CALL TOLL FREE 1-800-848-3469

Inquiry 573.

CROSS ASSEMBLERS

FASTER TMS32020/C25

Macro Assembler
only \$49.95

Ariel Corporation

212-925-4155

110 Greene Street, Suite 404
New York, New York 10012

Inquiry 574.

CROSS ASSEMBLERS

Universal Linker, Librarian

Targets for 36 Microprocessors

Hosts: PC/MS DOS, micro VAX, VAX 8000

Developed and supported at:

ENERTEC, INC.

BOX 1312, Lansdale, PA 19446

215-362-0966

MC/VISA

Inquiry 575.

8051 SIMULATOR

Superb full function debugger simulator supports all 8051 modes of interrupt, just like the real thing! Full disassembler and many unique features.
ONLY \$150.00

CROSS ASSEMBLERS

For Z80, 8080/8085, 8048, 8051, and 8096
still \$75.00 each!

LEAR COM COMPANY

2440 Kipling St., Suite 206, Lakewood, CO 80215
(303) 232-2226

Inquiry 576.

CROSS ASSEMBLERS

Macros, PC Compatible, Relocatable, Conditionals, Fast, Reliable from \$150

also: Disassemblers

EPROM Programmer Board

MICROCOMPUTER TOOLS CO.

Phone (800) 443-0779

In CA (415) 825-4200

912 Hastings Dr., Concord, CA 94518

Inquiry 577.

680X0 Cross Assemblers

Now, inexpensive quality 680X0 Cross Assemblers that use your IBM PC or compatible. All versions include extensive listing facilities, up to 32 char labels, sorted symbol tables. INCLUDE files, PATH names, ORG, DC, DS, EQU, many other directives (except MACROS), printed manuals. Basic versions create S-reports. Linking versions create either S-reports or relocatable modules, and include a linker which creates S-reports or binary output files. Not copy protected. Minimum requirements are 320K, DOS 2.0K, & 1.5M* DSDD.
Basic: 68000/68010—\$48.95 Linking: 68000/68010—\$89.95
Basic: 68020/68881—\$149.95

Checks: VISA, MC accepted. MW residents +6% sales tax. No PO's or COD's, please

RAVEN Computer Systems

Box 12116, St. Paul, MN 55112 (612) 836-0365

Inquiry 578.

THE BUYER'S MART

CROSS ASSEMBLERS

ASSEMBLERS & TRANSLATORS

Over 20 high quality, full function, fast relocatable and absolute macro assemblers are available immediately. Source language translators help you change microcomputers. Call for info about MS/DOS, CPM80, ISIS versions.

RELMS™

P.O. Box 6719
San Jose, California 95150
(408) 356-1210
TWX 910-379-0014

Inquiry 579.

DATA CONVERSION

MEDIA CONVERSION/DATA TRANSLATION

More than just a straight dump or ASCII transfer!

Word Processing, DBMS, and Spreadsheet data on Olsaks or Tapes transferred directly into applications running on Mainframes, Minis, Micros. Dedicated Word Processors, Typesetters, and Electronic Publishing systems. IBM PS/2 & Macintosh supported. #1 in the translation industry!

CompuData Translators, Inc.

3325 Wilshire Blvd., Suite 1202, Los Angeles, CA 90010
(213) 387-4477

Inquiry 580.

DATA/DISK CONVERSIONS

Get the Expertise You Need!

Disk/Disk • Tape/Disk • OCR

Over 1,000 formats! 3 1/2", 5 1/4", or 8 inch disks; 9 track mag tape; 10 MB Bernoulli cartridge. Data base and word processor translation. Specialists in Government Security Data. Call for free consultation.

Computer Conversions, Inc.

9580 Black Mtn Rd., Ste J, San Diego, CA 92126
(619) 693-1697

Inquiry 581.

DISK CONVERSIONS

Media transfer to or from: IBM, Xerox, DEC, Wang, Lanier, CPT, Micom, NBI, CT, also WP, WS, MS/WRD, DW3, MM, Samna, DEC DX, MAS 11, Xerox-Writer, ASCII.

FREE TEST CONVERSION CONVERSION SPECIALISTS

531 Main St., Ste. 835, El Segundo, CA 90245
(213) 545-6551 (213) 322-6319

Inquiry 582.

DISK & TAPE CONVERSIONS AUTOMATICALLY SAVE TIME AND MONEY

Over 1000 formats from Mini, Micro Mainframe, Word Processors, & Typesetters.

TAPE Conversions as low as \$23.00 MB

DISK Conversions as low as \$25.00 per Disk

Call or write TODAY for a cost saving quotation.

CREATIVE DATA SERVICES

1210 W. Latimer Ave., Campbell, CA 95008
(408) 866-6080

Inquiry 583.

IBM PC ↔ to → HP

FILE COPY

IBM PC to HP File Copy allows IBM PCs, PS/2, compatibles to read, write files written by Hewlett Packard Series 70, 80, 200, 300, 1000, 9000's. We offer custom work using our file copy utilities and program translators. Call for estimate, catalog, data sheet.

Oswego Software 312/554-3567
507 North Adams St. Fax 312/554-3573
Oswego, Illinois 60543 Telex 858-757

Inquiry 584.

DATA/DISK CONVERSIONS

CONVERSION SERVICES

Convert any 9 track magnetic tape to or from over 1000 formats including 3 1/2", 5 1/4", 8" disk formats & word processors. Disk to disk conversions also available. Call for more info. Introducing OCR Scanning Services.

Pivar Computing Services, Inc.

165 Arlington Hgts. Rd., Dept. #B
Buffalo Grove, IL 60089 (312) 459-6010

Inquiry 585.

DATABASE MGMT. SYSTEMS

FREE FORM DATABASE!

Full relational power; natural language 4GL interface; application generator; built-in text editor; spelling checker; form-doer. Store data without declarations or fixed structures. Handle simple commands to advanced programs with full data recovery security. (Price: MS DOS single-user \$595.)

Logirex Software, Corp.

20863 Stevens Creek Blvd., #330, Cupertino, CA 95014
(408) 257-5203

dBASE III COMPILERS

FREE dBASE III + COMPILER DEMO DISK

Don't buy Clipper™ until you see our FREE dBASE Compiler Evaluation Kit. Includes DEMO DISK with 8 PRG's and results of compiling with Clipper, Quicksilver & FoxBASE+. Also 15 benchmark tests, complete magazine reviews, and detailed brochures about all 3 compilers. FREE. No obligation. Call 24 hours, 7 days.

dataBASE Specialties (415) 652-2790

P.O. Box 2975, Oakland, CA 94618

FREE DEMO DISK

dBASE programmers give your programs a professional, polished look and feel. These modules provide you with a proven user interface at a sensible price. Modules include light bar menus, windows, calendars, + many more. Module prices from \$19.95. All code runs with all dBASE III+ dialects without modification.

Call today for your free demo disk—no obligation
Orders only: 800-433-1468 in CO 303-578-3220

Steve Schwartz Technical Services

1125 S. Oneida, Unit A, Denver, CO 80224
303-759-4843

Inquiry 586.

dBASE GRAPHICS

EASY dBASE GRAPHICS

Wary of complicated graphing programs?

Announcing dPICT.

dPICT is expressly designed to be easy to use. Type two words; in three minutes you see four presentations of your dBASE data.

Pick one. That's all. \$49.95

Requires IBM PC or compatible.

Paragon Tech

1581 Garland Ave., Tustin, CA 92680

Inquiry 587.

dBASE UTILITY

RECOVER DAMAGED dBASE FILES

We could give you all the technical data about QuickFix-2, but the bottom line is: it recovers all of the data in the DOS directory. Requires DOS 2.0. Works with Clipper, dBASE II/III/III+, dBase, and FoxBASE+ databases. Special developer's release available. \$29.00 plus \$1.74 tax in California.

HILCO Software

11266 Barnett Valley Rd., Sebastopol, CA 95472-9555

(707) 829-5011

Inquiry 588.

DEMOS/TUTORIALS

INSTANT REPLAY III

Build Demos, Tutorials, Prototypes, Presentations, Music, Timed Keyboard Macros, and Menu Systems. Includes Screen Maker, Keystroke/Time Editor, Program Memorizer, and Animator. Rec'd Great Reviews! Simply the BEST. Not copy protected. No royalties. 60 day satisfaction money back guar. IBM and Compatib \$149.95 U.S. Chk/Crd Demo Diskette \$5.00

NOSTRADAMUS, INC.

3191 South Valley Street (ste 252)
Salt Lake City, Utah 84109 (801) 487-9662

Inquiry 589.

DESKTOP PUBLISHING

New! Award Maker Plus

Macintosh®, IBM®, Tandy®, & MS-DOS® compatibles. Print professional quality awards, certificates, coupons, diplomas and more. Hundreds of predesigned styles for all occasions. Just enter text, select border, color and print. Includes special offer for Pin-feed parchment paper.

BAUVILLE • 616-698-0888 • \$49.95

5380 52nd Street SE, Grand Rapids, MI 49508

Inquiry 590.

DISK DRIVES

PS/2 DRIVES FOR PC's AT's

CompatiKit/PC \$329
CompatiKit/AT \$309

Built-in floppy controllers—no problem. Supports multiple drives and formats. Lets your computer use IBM PS/2 1.4M diskettes *plus more!* Call for further information or to place an order. VISA/MC/COD/CHECK

Micro Solutions Computer Products

132 W. Lincoln Hwy., DeKalb, IL 60115 815/756-3411

Inquiry 591.

DUPLICATION SERVICES

SOFTWARE DUPLICATION

- One Stop Shopping
- Custom Packaging
- Copy Protection
- Technical Support
- Drop Shipping
- Fast Turnaround
- Competitive Pricing

SATISFACTION GUARANTEED

800-222-0490 NJ 201-462-7628

MEGAsoft

P.O. Box 710, Freehold, NJ 07728 See our ad on page 314.

Inquiry 592.

SOFTWARE PRODUCTION

- Disk duplication
- All formats
- EVERLOCK copy protection
- Label/sleeve printing
- Full packaging services
- Warehousing
- Drop shipping
- Fulfillment
- 48-hour delivery
- Consultation & guidance

Star-Byte, Inc.

713 W. Main St., Lansdale, PA 19446

215-368-1200 800-243-1515

Inquiry 593.

ELECTRONIC PROJECT

BUILD TALKING ROBOT!

- Build B.E.R.T.™ the Basic Educational Robot Trainer
- Featured in BYTE April & May / 87
- Even a child can program this talking Robot, built from off-the-shelf components
- Minimum Kit \$43.00 U.S.
- Complete Kit \$165.00 U.S.
- For further information send \$1.00 for postage & handling to:

GoCod Dist.

Suite 806, 1146 Haxwood St
Vancouver, B.C. Canada V6E 3V1

Inquiry 594.

THE BUYER'S MART

FRAMEWORK II USERS

FRAMEWORK II FRED DICTIONARY

Automatic functions dictionary.
—immediate access to a full screen function reference.
Development tools, menus, FW tips, books info., more.
Built-in automatic database filtering/menu.
Programs disk + manual booklet \$39.95 inc. s/h.
3.5" add \$2.00, req. "FRAMEWORK II"
Not FW serial # copy protected. Send check or money order to:

M. FRANKEL

189 FRANKLIN St., NY, NY 10013

Inquiry 595.

FLOW CHARTS

FLOW CHARTING II+ HELPS YOU!

Precise flowcharting is fast and simple with Flow Charting II+. Draw, edit and print perfect charts: bold and normal fonts, 24 shapes — 95 sizes; fast entry of arrows, bypasses & connectors; Fast Insert Line; shrink screen displays 200-column chart; 40 column edit screen for detail work, much more!

PATTON & PATTON

81 Great Oaks Blvd., San Jose, CA 95119

1-800-672-3470, ext. 897 (CA residents)

1-800-538-8157, ext. 897 (Outside CA)

408/629-5044 (Outside the U.S.A.)

Inquiry 596.

STRUCTURED FLOW CHART

NSChart creates Nassi-Shneiderman (structured) flowcharts from a simple PDL. Keywords define structures & text strings appear in the chart. Easy to create, even easier to revise! Automatic chart sizing, text centering. Translators from many languages available. For Mac and IBM PC.

SILTRONIX, INC.

P.O. Box 82544, San Diego, CA 92138

1-800-637-4888

Inquiry 597.

HARDWARE

DISCOUNT CLONES

- XT Turbo — \$435.
- AT 8/10 MHz — \$995.
- Seagate ST225 20MB hard drive with controller — \$300.
- 386 25MHz — \$2,650.
- Hayes compatible 1200 baud modem — \$99.
- Everrexx EGA — \$150.
- HP Laser Jet Series II — \$1700.

Automated Business Solutions

516-379-3995

30 day money back guarantee • 1 yr parts & labor warrantee
Dealer Inquiries Invited. Please call for complete price list.

Inquiry 598.

CHIP CHECKER

- 74/54 TTL + CMOS • 8000 Nat. + Signetics
- 14/4000 CMOS • 9000 TTL
- 14-24 Pin Chips • 3" + 6" IC widths

Tests/identifies over 650 digital chips with ANY type of output in seconds. Also tests popular RAM chips. IBM compatible version \$259. C128 + C64 version \$159.

DUNE SYSTEMS

2603 Willa Dr., St. Joseph, MI 49085

(616) 983-2352

Inquiry 599.

New XT Turbo

- 640K RAM, Mono/Graphics • Multi I/O w/clock-cal Bat backup • 2 Parallel, 2 Serial & 1 Game ports •
- Monochrome Monitor & XTAT keyboard •

1 360K Floppy Drive and

1 20 Meg Seagate Hard Drive

One Year Factory Warranty—\$1225.00 DOS inc.

Texas residents add 6% sales tax • Plus \$35.00 s/h

Phone 214 449 3523

Ferris Computers

P.O. Box 22, Ferris, TX 75125 Chk. • M.O. • Cashier's Chk.

HARDWARE

87C51 PROG. \$125.00

The UPA 87C51 Programming Adapter lets you use your general purpose programmer to program the 87C51, 8751H, AMD8753H, 87C252, and 8752BH. Also lets you program the 87C51/8751H security bits and the 87C51 encryption array. It's very simple and VERY cost effective.

LOGICAL SYSTEMS CORPORATION

6184 Teall Station, Syracuse NY 13217

(315) 478-0722 Telex 6715617 LOGS

Inquiry 600.

EDUCATIONAL COMPUTER \$99

A 6802 based SBC for academic use. It includes 8K ROM, 2K RAM, two parallel ports, serial port, full-featured monitor, help screen, assembler and disassembler in ROM, expansion bus. Free PC compatible terminal program and xasm. +5 volt power. 3.2" x 4.6". Manual included.

MICRO BOARD DESIGNS

29 Belvoir Rd., Williamsville, NY 14221

716-633-8613

Inquiry 601.

NEW/USED APPLES & STUFF

MACINTOSH — Call

Apple Parts — Call

Mac accessories—hard drives Call

We buy, sell & horsetrade — Apple, IBM.

SHREVE SYSTEMS

2421 Malcom St., Shreveport, LA 71108

318-865-6743 4-9 p.m. • FAX-318-865-2006

International inquiries welcome C.ST.—VISA/MC

Inquiry 602.

HARDWARE/ADD-ONS

External 5 1/4 for the PS/2

5 1/4" External drive for the PS/2 Models 25, 30, 50, 60 & 80. Plugs into an existing slot in the PS/2 and runs off the computer's internal power supply. The 525 EXTRA allows the PS/2 to read, write and format standard 360KB disks as the computers "B" drive. Includes everything to begin working right away, no extra controllers to buy. Two year warranty, \$325.00. Dealer Inquiries welcome. Call for our Catalog.

Delkin Devises U.S.A.

4655 Cass St., Ste. 306, San Diego, CA 92109

(619) 273-8086

Inquiry 603.

PC RELAY CARD

8 FORM C RELAYS

8 Isolated relay outputs on a short slot configured IBM PC I/O card. Relays socketed. Contact rating 4VA @ 0.25 A.

Price: \$150 Delivery: Stock

ULTRALINK

P.O. Box 1809, Minden, NV 89423

1-800-852-6273 702-782-9758

Inquiry 604.

Z80* / HD64180/CP/M* CO-PROCESSORS

Plug-in co-processors for PC, PC/AT.

Blue Thunder Z80 co-processors

6 MHz \$249.95 10 MHz \$399.95

12.5 MHz \$599.95

HD64180 co-processors \$295 and up

All co-processors with CP/M emulator. Software only emulator ZS1M only \$99.95.

Z-WORLD 916-753-3722

1772A Picasso Ave., Davis, CA 95616

See our ads on page 316.

Inquiry 605.

HARDWARE COPROCESSOR

AT/FORCE RISC SYSTEM

Replace Bit-Slice Technology

5-MIPS IBM/AT coprocessor and software system with new Force Core from Harris Semiconductor. Forth Optimized RISC Engine Core Set comprises 5 HCMOS standard cell chips: Core, Interrupt Controller, 1-cycle Multiplier, and 2 Stack Controllers. Forth development language included. \$4995.

SILICON COMPOSERS (415) 322-8763

210 California Ave., Suite K, Palo Alto, CA 94306

Inquiry 606.

PC MINI-SUPERCOMPUTER

Up to 40 MIPS in Your PC!

Fill your PC/XT/AT with 1 to 6 PC4000 boards for a high speed PC-RISC system. The PC4000 uses the NC4016 RISC Engine which executes high level Forth in silicon. Each PC4000 is a general purpose parallel coprocessor that delivers speeds in the 5 to 7 MIPS range...over a 100 times faster than a PC, uses Forth, C or Assembler. From \$1295.

SILICON COMPOSERS (415) 322-8763

210 California Ave., Suite K, Palo Alto, CA 94306

Inquiry 607.

HYPertext

BLACK MAGIC

Hypertext Word Processor

Hypertext allows you to link pieces of information naturally. • BLACK MAGIC does this in a WYSIWYG environment, integrating graphics and text. • A Link Structure Map allows you to quickly navigate any document. • Distribute documents with Public Domain Runtime. • Only \$150.

NTERGAID (203) 368-0632

955 Connecticut Ave., Bridgeport, CT 06607

Inquiry 608.

INFORMATION

The Tables of ERP

The "Economic Report of the President" has concise tables of the major economic indicators (GNP, Employment, Inflation, Population and much more.) The Tables of the 1988 Report are now available on disk in (CAL, WKS, CSV, or TXT) formats for (PC or MAC or most CP/IM)—\$29.95

FAIRFACTS

Box 536 San Rafael, CA 94915

Tel. 415-485-1781

Inquiry 609.

LAPTOP COMPUTERS

LAPTOP SPECIALS

Zenith • Toshiba • NEC

• AFFORDABLE 5 1/4" or 3 1/2" DRIVE UNITS

FOR LAPTOPS & DESKTOPS • DICONIX

PRINTERS • 1200 & 2400 BAUD MODEMS (for

LAPTOPS) • Fast delivery & reliable friendly service

Call for low pricing...

COMPUTER OPTIONS UNLIMITED

201-469-7678 (7 Days, 9AM-9PM Eastern time)

Inquiry 610.

LAP-LINK

The ultimate solution for linking laptop computer with any IBM compatible desktop PC. 115, 200 baud transfer rate—faster than any other product available. No installation necessary, easy to use split screen design. Includes Incredible "universal cable" that connects any two computers. Transfer entire disks faster than a DOS copy command! Only \$129.95 including universal cable and both 3 1/2" and 5 1/4" disks. "Bridge" owners can trade in for only \$89.95 w/o cable.

Traveling Software, Inc.

19310 North Creek Parkway, Bothell WA 98011

1-800-343-8080 (206) 483-8088

Inquiry 611.

LEGAL

DESIGNED FOR LEGAL WORK
The SoftWars™ Substantive System. "This could save a law office 30% — 45% of the time to process pleadings." *Brief*, 9/87. Version 3.3 \$159. Free brochure.

TSC
The Software Company
P.O. Box 872687, Wasilla, AK 99687
(907) 745-6267

Inquiry 612.

MEMORY CHIPS

MEMORY CHIPS

41256-15-12-10	Call	51000 (1 Meg)	Call
4164-15	Call	51258 for Compaq 386	6.43
4164-12	Call	8087-3-2	96/143
41128 Piggy Back for AT	2.63	80287-6-8-10	155/233/293
41464-12 (64Kx4)	3.27	80387	Call
414256 (256Kx4)	Call	NEC-V-20-8	Call
2764,27128,27256,27512	Call	Mouse	\$49

Prices subject to change

ESSKAY 1-800-327-3237
718-353-3353

Inquiry 613.

MISCELLANEOUS

WHY PAY RETAIL PRICES?

Why spend your precious time searching the stores/catalogs for the computer/office equipment/supplies you want? Through our program you can save time and obtain name brand items at low prices. Free trial membership! For more information:

THE ULTIMATE BUYER'S SOURCE
308 Crocker #46941-A Mt. Clemens, MI 48046
1-800-327-4226

Inquiry 614.

OPTICAL SCANNING

STOP TYPING!

OCR SERVICE BUREAU — We Scan EVERYTHING

Previously Printed Material

- Invoices • Books • Documents • Phone Bills
- Output to • 3 1/4" • 5" • 8" • MAC • 1600 BPI • WORM • CD ROM

We Convert EVERYTHING.

All Word Processing and Data Bases Supported.

Kurzweil & Palantir Scanning

Phototypesetting & Printing • Day & Night Service

DATASCAN

1 World Trade Ctr., New York, NY 10048 (212) 938-5727

Inquiry 615.

PROGRAMMER'S TOOLS

FINITE STATE COMPILERS

Develop complex software programs in minutes instead of hours! The COMPEDITOR forms source Finite State programs in: ADA, BASIC, C, FORTRAN and PASCAL.

IBM PC, XT, AT, PS/2 175K RAM Dos 2.0+
Price: \$175.00 per compiler (With Primer)

AYECO 5025 Nassau Circle, Orlando
INCORPORATED FL 32808 (305) 295-0930

Inquiry 616.

Affordable CASE

A new concept in Computer Aided Engineering for developing PC/DOS applications! C Dispatcher generates fast, efficient C code for command and menu driven applications. Develop, document, and change easily. Many features. For many compilers.

Amaryllis Inc.

563 Wataquodoc Rd., Bolton, MA 01740
(617) 365-5456

Inquiry 617.

PROGRAMMER'S TOOLS

TLIB™ 4.0 Version Control

The best gets better! They loved TLIB 3.0: "packed with features... [does deltas] amazingly fast... excellent!"—PC Tech Journal Sept 87. "has my highest recommendation"—R. Richardson, Computer Shopper Aug 87. Now TLIB 4.0 has: branching, more keywords, wildcards & file lists, revision merge, LAN and WORM drive support, more. MS/PC-DOS 2.x & 3.x \$99.95 + \$3 s&h. Visa/MC.

BURTON SYSTEMS SOFTWARE
P.O. Box 4156, Cary, NC 27519 (919) 469-3068

Inquiry 618.

XACT-16C PROGRAMMER

Complete RAM-Resident emulation of the Hewlett-Packard 16C Programmer's Calculator. Binary, hex, decimal, octal and float modes. AND, OR, XOR, shift, mask and more. See BYTE "What's New", Jan. '88 pp. 88 for details. \$49.95 PC/XT/AT. 30 day money back guarantee. VISA/MC.

CALCTECH, INC.

13629 Bellevue-Redmond Rd. #202, Bellevue, WA 98005
(206) 643-1682

Inquiry 619.

TurboGeometry Library (Source & Manual)

Turbo Pascal, C, Mac, & Microsoft C. Over 150 2 & 3 dimensional routines including: Intersections, Transformations, Equations, Hidden Lines, Perspective, Curves, Areas, Volumes, Clipping, Planes, Matrices, Vectors, Distance, PolyDecomp. IBM PC (Comp.), MAC
VISA/MC \$99.95

Disk Software, Inc.

2116 E. Arapaho #487, Richardson, TX 75081
(214) 423-7288

Inquiry 620.

AMADEUS AND MODULA-2

For better programming in Modula-2

Amaedeus is a complete and powerful environment for developing applications in M2 (Logitech, SOS, Taylor, Vax) on PCs. Amaedeus includes an application editor with mask/code generator and a run-time support composed of 25 modules which supply windowing, ISAM database, improved interface for Btrieve, menus creation, full I/O procedures, special support of the HiNutra (touch screen) and much more... Developers: Amaedeus will increase your efficiency. With complete manual. Only \$395! Free demo disk available.

ID NOUVELLES SA

CP 877, 1001 LAUSANNE, SWITZERLAND

Inquiry 621.

Modula-2

EmStorage is an advanced memory manager for M2. Detects and uses LIM expanded memory if present, or regular DOS memory if not; your programs use EMS, but don't depend on it. Only \$49. For Logitech, Stony Brook, JPL, EST, FTL, ITC compilers. From the creators of Repertoire, Mod-Base, Macro2, Graphix, and the Repertoire/Btrieve Toolkit. MCVISA/AMEX/PO/COD.

PMI 4536 SE 50th, Portland, OR 97206
(503) 777-8844; TLX: 6502691013

Inquiry 622.

Disassemble MPU OBJECT CODE on your PC
Relocatable, symbolic disassemblers are now available for the Motorola, Intel, RCA, TI, Rockwell, & Zilog micros! Automatic label generation, assembly capability and much more. Call and ask for what you need.

RELMS™

P.O. Box 6719
San Jose, California 95150
(408) 356-1210

TXW 910-379-0014 (800) 448-4880

Inquiry 623.

PROGRAMMER'S TOOLS

Intelligent Front End

3 years in development, DataPlex revolutionizes data entry and file conversion. Captures raw data faster, easier, more accurately than any software. All techniques speed formatting and validation. No programming. DP can frontend your applications—cuts training & programming. Reads, writes, converts ASCII/IBASE/Lotus and more. \$149. PC/XT/AT.

Tools & Techniques, Inc.

1620 W. 12th St., Austin, TX 78703
(512) 482-0824 MCVISA/COD

Inquiry 624.

PUBLIC DOMAIN

\$3.00 SOFTWARE FOR IBM PC

Hundreds to choose from, word processors, databases, spreadsheets, games, x-rated, logic, communications, business, music, bible, art, education, language and useful utilities for making your computer easier to learn. Most programs have documentation on the disk.

Write for your FREE catalog today!

BEST BITS & BYTES

P.O. Box 8245, Dept B, Van Nuys, CA 91409
(818) 781-9975

Inquiry 625.

FINEST PUBLIC DOMAIN COLLECTION FROM AROUND THE WORLD

Only \$2.50/disk with many programs. "If you can't find it, you can use it." This is exactly why we created the disk catalogue with search program. It's much faster than going through a hard copy of over 400 pages. So, ORDER the catalogue NOW! It costs \$6.90 only. You will never run out of good software again. Send US \$6.90 for

EXECUTIVE MARKETING SERVICES

11, Collyer Quay, The Arcade #12-05
Singapore 0104, Republic of Singapore

Or Telex: RS43195EXESIN Fax: 65 2248905 Tel: 65 2221105

By VISA/MC, please give detailed address, name, card number & exp. date

Inquiry 626.

RENT SOFTWARE \$1/DISK

Rent Public Domain and User Supported Software for \$1 per disk/roll or we'll copy IBM (3 1/4" also), Apple, C-64, Sanyo 550 and Mac. Sampler \$3. VISA/MC 24 hr. Info/order line, (619) 941-3244 or send #10 SASE (specify computer) Money Back Guarantee!

FutureSystems

Box 3040 (T), Vista, CA 92083

office: 10-6 PST Mon-Sat. (619) 941-9761

Inquiry 627.

QUALITY SOFTWARE IBM/COMPATIBLES

Get a Word Processor, Spreadsheet, Database, Money Manager and 5 arcade games plus our 10,000 program catalog for ONLY \$10.00 (+s/h)

800-992-1992 (National)

800-992-1993 (Ca only)

619-942-9998 (Foreign)

VISA, MC, AMEX Accepted. (COD + 1.90)

The International Software Library

511-104 Encinitas Blvd., Encinitas, CA 92024

Inquiry 628.

FREE SOFTWARE

The PUBLIC DOMAIN USERS GROUP provides public domain software for IBM, CP/M, CPM, C64 & C-128 computers. PONG is one of the oldest (est. 1982) & largest (over 10,000 members worldwide) users groups.

SPECIAL OFFER—Send \$10 and receive not only our 1 year membership but also our new member disk free (contains 21 great programs). Or for more info, send a SASE (specify computer) to:

PUBLIC DOMAIN USERS GROUP

P.O. Box 1442-BM, Orangepark, FL 32067

904-264-3512 (ORDER LINE)

Inquiry 629.

THE BUYER'S MART

SECURITY

BIT-LOCK® SECURITY

Piracy SURVIVAL 5 YEARS proves effectiveness of powerful multilayered security. Rapid decryption algorithms. Reliable/small port transparent security device. PARALLEL or SERIAL port. Countdown and timeout options also available. KEY-LOK™ security at about 1/2 BIT-LOCK cost.

MICROCOMPUTER APPLICATIONS

7805 S. Windemere Circle, Littleton, CO 80120
(303) 922-6410 or 798-7683

Inquiry 630.

SOFTWARE/ACCOUNTING

dBASE BUSINESS TOOLS

- * General Ledger
- * Accounts Recvbl.
- * Order Entry
- * Sales Analysis
- * Purch Ord/Inventory
- * Accounts Payable
- * Job Costing
- * Job Estimating

\$99 EA. + s&h w/dBASE 2, 3 or 3+ SOURCE CODE

dATAMAR SYSTEMS™ Cr. Crd/Chk/COD

4876-B Santa Monica Ave.
San Diego, CA 92107 (619) 223-3344

Inquiry 631.

SOFTWARE/AI

Learn AI Fast

If/then™ is a book and a disk of Lotus spreadsheets. "A marvelous little AI training package... you'll find it an excellent tutorial... this product is a must!"

Ezra Shapiro,
BYTE, Aug. '87, p.263

If/then is only \$69.95

If/then Solutions

1 Mallorca Way, #301B SF, CA 94123 415-346-5886
Lotus 1-2-3 rel 2 required, \$3 for shipping N.A., \$8 elsewhere

Inquiry 632.

YOUR OWN EXPERT SYSTEM

MicroExpert, an affordable expert system shell, allows you (beginner or programmer) to see how a system works as you build it yourself. Software includes tutorial for design of knowledge base and creation of rules. Source code provided.

IBM PC: 852109-2 Apple II: 852110-6

\$49.95

McGraw-Hill Book Company

PO Box 400, Hightstown, NJ 08520
1-800-2-MCGRAW

Inquiry 633.

SOFTWARE/ARCHITECTURE

NATURAL 3-D NAVIGATION

3 Vanishing Points Navigator: Great help for artists & architects. Navigator provides rapid moving natural views and the capability for unusual slanted rotation. The perspective can also be suppressed or enhanced. \$449.95 + \$4.00 S&H (may change without notice.)

Require IBM PC or compatible (256K up).
Demo-disk \$7.00 + \$1.00 S&H (Version 2.0)

bp-Coding Systems, Inc.

2445 University Heights Ave., Boulder, CO 80302
telephone (303) 449-3640 • facsimile (303) 442-1967

Inquiry 634.

SOFTWARE/BASIC

XGRAF DRAWS IN BASIC!

FINALLY! XGRAF replaces QuickBASIC's poor drawing commands with assembly language calls that work on Hercules, EGA, VGA, CGA and EEGA screens. Only \$99.00 + \$4.00 S&H. Call us at 1-800-423-3400 (9:00 AM to 8:00 PM EST)

KOMPUTERWERK, INC.

851 Parkview Blvd., Pittsburgh, PA 15215
For info., call (412) 782-0384

Inquiry 635.

SOFTWARE/BUSINESS

DATA ENTRY SYSTEM

Heads-down data entry with two-pass verification for the PC/XT/AT & compatibles. Loaded with features like: Auto dup & skip, verify bypass, range checks, & table lookups. Fully menu driven only \$395. Call for free 30 day trial period.

COMPUTER KEYES

21929 Makah Rd., Woodway, WA 98020
(206) 776-6443

Inquiry 636.

LP88-SPREADSHEET LP

Our best-selling menu-driven linear programming system now solves problems with 1000 constraints and 5000 variables up to 30 times faster. New version reads/writes Lotus worksheets. Use 1-2-3/Symphony as a matrix generator or post processor. Many other features including interactive and batch operation, spreadsheet-style display, equation processor, problem/basis storage, file I/O, Simplex, restart, report generator, sensitivity analysis. IENews says "The flexibility and features of this program are a bargain at its low price" \$149 with 8087 support and 100 page manual \$29 for working demo and manual.

EASTERN SOFTWARE PRODUCTS, INC.
PO. Box 15328, Alexandria, VA 22309 (703) 360-7800

Inquiry 637.

dFELLER Inventory

Business inventory programs written in modifiable dBASE source code.

dFELLER Inventory \$150.00

Requires dBASE II or III, PC-DOS/CPM

dFELLER Plus \$200.00

with History and Purchase Orders

Requires dBASE III or dBASE III Plus (For Stockrooms)

Feller Associates

550 CR PPA, Route 3, Ishpeming, MI 49849
(906) 486-6024

Inquiry 638.

BATCH DATA ENTRY ON THE IBM PC

dePC emulates operational features of standard key-to-disk keypunches, and has many other features. Data is stored on diskette and uploaded to host using third-party file transfer software.

dePC is FAST!

Send cheque or company P.O.
Single Copy \$49
Site License \$190
Or write for free information

Numeros
Microsystems
69 Summerhill Ave.
Toronto, Canada
M4T 1A9

Inquiry 639.

SOFTWARE/CHURCH

PowerChurch Plus®

Fast, friendly, reliable church administration system. Full fund accounting, mailing lists, membership, contributions, attendance, word processing, accts. payable, payroll, multi-user support, and much more - all for \$695 complete. FREE demo version.

F1 SOFTWARE

PO. Box 3096, Beverly Hills, CA 90212
(213) 854-0865

Inquiry 640.

ROMAR CHURCH SYSTEMS™

Membership-61 fields plus alternate addresses; labels, letters, reports any field(s). Offering-256 funds, optional pledge; statements; post to 255x/yr. Finance gen ledger w/budget, up to 500 subtotals & 99 depts., month & YTD reports anytime for any month. Attendance—B service times, 250 events per service, 60 consecutive weeks. Available for floppy, 3½ & hard disk. Ad too short! Write for free 48 page guide.

Romar Church Systems, Attn: BJB
PO. Box 4211, Elkhart, IN 46514
(219) 262-2188

Inquiry 641.

SOFTWARE/DISK LABELING

SOFTWARE/DISK LABELING

"Diskette Labeler"

Makes professional labels for 5.25" disks on your printer with combination of 23 character Title, 120 File Names, 10 lines of 80 character Comments, and complete Stats. Includes software, manual, 240 color labels (60 ea. of 4 colors) with permanent adhesive. For IBM & compatibles with IBM/Epson compatible dot matrix printer.

WeedPatch Productions, Inc.

Box 716, Hockessin, DE 19707
(800) 451-0474 (302) 239-9266

Inquiry 642.

SOFTWARE/EDUCATION

PRIVATE LESSONS™

The combined tutor, game-maker & knowledge base that grows with you. Makes learning any subject fun. Gives time, grade & recommendations. Stresses difficult questions. Includes tester/editor, 2 games & sample Chemistry, DOS lessons. \$49.95 VISA-MASTERCARD

CORBIN Software

600 Industrial Circle, White City, OR 97503
503-826-6737

Inquiry 643.

SOFTWARE/ENGINEERING

Affordable Engineering Software

FREE APPLICATION GUIDE & CATALOG

Circuit Analysis • Root Locus • Thermal Analysis • Plotter Drivers • Engineering Graphics • Signal Processing • Active/Passive Filter Design • Transfer Function/FFT Analysis • Logic Simulation • Micro-strip Design • PC/MSDOS • Macintosh • VISA/MC Accepted.

BV Engineering • (714) 781-0252
2023 Chicago Ave., Unit B-13, Riverside, CA 93111

Inquiry 644.

PROFESSIONAL SOLUTIONS

FOR PCs and MS-DOS

DEFLECTION OF BEAMS OF UNIFORM OR VARIABLE CROSS SECTION (not an FE-program): Statistically determinate problems & continuous beams
SIMPLE OR MULTIPLE SHRINK-FITS: Shrinkage pressures, stresses, torsional holding ability etc.
HERTZ: Pressure between bodies

MICROMIN® — Software

Dan Steurer, P.O. Box 344, Mansfield, OK 74044
Recorded Message (800) 336-2072, ext. 5776

Inquiry 645.

STRUCTURAL ANALYSIS

MICROSAFE: Inexpensive, easy to learn and use Finite Element Analysis for IBM PCs and compatibles. Up to 400 nodes, 600 beams, 500 plates. Graphics. 2-D: \$75, 3-D: \$120, Both: \$160. Overseas add \$20. Evaluation copies. NOT COPY-PROTECTED. Ask for brochure.

MICROSTRESS Corp. (Dep. BM1)

10950 Forest Ave. S., Seattle, WA 98178-3205
(206) 772-0508

Inquiry 646.

SIMULATION WITH GPSS/PC™

GPSS/PC™ is an IBM personal computer implementation of the popular mainframe simulation language GPSS. Graphics, animation and an extremely interactive environment allow a totally new view of your simulations. Simulate complex real-world systems with the most interactive and visual yet economical simulation software.

MINUTEMAN Software

P.O. Box 1711Y, Stow, Massachusetts USA
(617) 897-5662 ext. 540 (800) 223-1430 ext. 540

Inquiry 647.

THE BUYER'S MART

SOFTWARE/ENGINEERING

Circuit Analysis — SPICE

Non-linear DC & Transient; Linear AC.
 * Version 3B1 with BSIM, GaAs, JFET, MOSFET, BJT, diode, etc. models, screen graphics, improved speed and convergence.
 * PC Version 2G6 available at \$95.
 Call, write, or check inquiry # for more info.

Northern Valley Software

28327 Rothrock Dr., Rancho Palos Verdes, CA 90274
 (213) 541-3677

Inquiry 648.

FREE ENGINEERING MAGAZINE

Personal Engineering is a monthly magazine sent free of charge (USA only) to scientists/engineers who use PCs for technical applications. Topics each month include **Instrumentation** • **Data Acq/Control** • **Design Automation**. To receive a free sample issue and qualification form either circle below or send request on letterhead to:

Personal Engineering Communications

Box 1821, Brookline, MA 02146

Inquiry 649.

EC-Ace ANALOG CIRCUIT ANALYSIS

You can afford to get started with EC-Ace, a subset of the powerful ECA-2 circuit simulator. Includes all the basics and built-in graphics.

- AC, DC, Temperature, Transient.
- A full 525 pg. ECA-2 manual.
- Interactive, twice as fast as SPICE.

EC-Ace 2.31 IBM PC/XT/AT \$145.

An upgrade to ECA-2 available.

Call 313-663-8810 for **FREE DEMO**.

Tatum Labs, Inc.

1478 Mark Twain Ct., Ann Arbor, MI 48103

Inquiry 650.

SOFTWARE/FINANCIAL

THE FINANCIAL PLANNER AS EASY AS "ATM"

Your Bank's Auto. Teller Machine & THE FINANCIAL PLANNER have a lot in common. NEW Menu driven program w/ easy to use Manual. • Balance Checkbook, Prepare Budget, Financial Statement, Loan Amortization Schedule & more • \$99.95 —OUR PRICE—\$59.95 + \$2 S/H. PA 6% TX. Apple IIc, Iie, Iigs, IBM PC or Compatible. CK/MC/VISA

SOFTTECH IND., INC. 717-584-5191

Box 117A, Dept. B456, Hughesville, PA 17737

Inquiry 651.

SOFTWARE/FORECAST

FORECAST PRO

An excellent forecasting package that uses *artificial intelligence* to help both the beginner and the experienced forecaster achieve top-notch results. Time series analysis techniques include exponential smoothing, Box-Jenkins, & dynamic regression.

CALL NOW FOR A FREE DEMO DISK!

Business Forecast Systems, Inc.
 68 Leonard Street, Belmont, MA 02178
 (617) 484-5050 TELEX #710-3201382

Inquiry 652.

SOFTWARE/FORTRAN

FORTRAN 77 Extension

EXTEND subroutines for MS, RM, IBM Pro compilers to control keyboard, monitor, text & graphics, DOS file & directory operations, parallel & serial I/O. Plus user graphics for CGA, EGA, VGA, HP475A, TEK 4010, AutoCAD DXF & db save files. Both 8087 & non 8087 libraries pkg'd for \$149. Royalty free. VISA/MC/PO/CHK.

Design Decisions, Inc.

P.O. Box 12884, Pittsburgh, PA 15241
 (412) 941-4525

Inquiry 653.

SOFTWARE/GAME

PLAY LIVE CHESS via MODEM!

on IBM™ or clone (Requires CGA, EGA, VGA or Hercules™ compat. grph., Hayes™ compat. modem)

- Auto Dial & Ans. • analog clocks • Kibitz mode • Selectable board view • mouse support • Archiving • Disks for you & your favorite opponent • Free member list (updates \$2 ea.) • E-mail feature • Numerous off-line study aids • Send Name, addr. & phone number • \$34.95 (Ck. or M.O.) To:

TELE-CHESS PRODUCTS Dept. C

PO Box 5356, Louisville, KY 40205

Specify graphics, modem, 3.5" or 5.25" disks

SOFTWARE/GENERAL

WOULD YOU LIKE TO KNOW?

Your I.Q.? Memory Level? Response Time? Coordination? Visual Perception?

Expand your mind with MENTOR™—software that lets you explore your hidden talents. 58 psychometric exercises, incl. 25 I.Q. tests. IBM PC/Compatibles • 256K

• CGA/EGA/VGA • \$49.95 • VISA/MC

No shipping charge to anywhere in the world

Heuristic Research, Inc.

3112-A West Culbert Ave., Midland, TX 79701

800-443-7380 (In TX, collect 915-694-5936)

Inquiry 654.

SOFTWARE/GEOLOGICAL

FREE CATALOG!

Geological and scientific software for all applications: log plotting, gridding/contouring, hydrology, digitizing, 3-D solid modelling, synthetic seismogram, fracture analysis, image processing, scout ticket manager, over 50 programs in catalog. Macintosh too!

RockWare, Inc.

7195 W. 30th Ave., Denver, CO 80215 USA

(303) 238-9113

Inquiry 655.

SOFTWARE/GRAPHICS

PC TECHNICAL GRAPHICS

TEKMAR is a graphics library for the EGA or Tecmar Graphics Master. Similar to PLOT-10, includes WINDOW, VIEWPORT, AXIS. Support for HP, HI plotters. Curve fitting, complete plotting program. Log, semi-log, multi-axis, 3-D, contours. Jerry Pournelle (Aug 86 Byte): "As good as any I have ever seen..." Demo disks, literature available.

Advanced Systems Consultants

2115 Devonshire St. #329, Chatsworth, CA 91311

(818) 407-1059

Inquiry 656.

FPLOT PEN PLOTTER EMULATOR

Use your dot matrix or laser printer as an HP pen plotter. Fast hi-res output. Vary line width. Includes FVLOT virtual plotter utility to capture plotting commands. Supports NEC P5/P6, IBM Proprinter, Epson LQ/MX/FX, HP Laserjet. Uses Hercules, CGA, EGA or VGA for screen preview. \$64 check or m.o.

HORIZON SOFTWARE

Suite 605, 24-16 Steinway St., Astoria, NY 11103

212-418-8469

Inquiry 657.

GRAPHICS PRINTER SUPPORT

AT LAST! Use the *PrintSc* key to make quality scaled B&W or color reproductions of your display on any dot matrix, inkjet, or laser printer. GRAFPLUS supports all versions of PC or MS-DOS with IBM (incl. EGA, VGA), Tecmar, and Hercules graphics boards. \$49.95.

Jewell Technologies, Inc.

4740 44th Ave. SW, Seattle, WA 98116

800-628-2828 x 527 (206) 937-1081

Inquiry 658.

SOFTWARE/GRAPHICS

FORTRAN PROGRAMMER?

Now you can call 2-D and 3-D graphics routines within your FORTRAN program.

GRAF/MATIC: screen routines \$135.

PLOT/MATIC: plotter driver 135.

PRINT/MATIC: printer driver 135.

For the IBM PC, XT, AT & compatibles. We support a variety of compilers, graphics bds., plotters and printers.

MICROCOMPATIBLES

301 Prelude Dr., Dept. B, Silver Spring, MD 20901 USA

(301) 593-0683

Inquiry 659.

MAPIT

Make your own MAPS!!

Simple to produce maps with your data. Includes most country and state outlines. Any printer or HP plotter.

Only \$95 for MS-DOS or PC-DOS

US County Outlines available for \$95.

QSC Box 778, East Lansing, MI 48826

(517) 641-4428

Inquiry 660.

CGA → Hercules™ Graphics

Mode-MGA™ allows you to use business graphics, games, BASIC graphics and other CGA specific software with your Hercules™ Monochrome Graphics adaptor and monochrome monitor. Works with all CGA programs. \$79.95 (+ \$5 s&h) for the 3k-TSR version. 30-day money back guarantee. Call or write:

T.B.S.P. Inc.

2265 Westwood Blvd., Suite 793, Los Angeles, CA 90064

(213) 312-0154

Inquiry 661.

SOFTWARE/INVESTMENT

MUTUAL FUND INVESTORS

The new Business Week Mutual Fund Scoreboard Diskettes use the enormous power of your IBM or compatible PC to select rate and compare virtually every equity and fixed income mutual fund on the market (\$49.95 each or \$239.90 for subscriptions to both).

Order now or receive more information by calling 1-800-553-3575 (In Illinois, call 1-312-250-9292).

Business Week Mutual Fund Scoreboard Diskettes

P.O. Box 621, Elk Grove, IL 60009

Inquiry 662.

SOFTWARE/LANGUAGES

SERIES 32000 MODULA-2 COMPILER

National Semiconductor's 32000 family of microprocessors and Modula-2 have common characteristics that make them the ideal combination for virtually any embedded microprocessor system. Both are well designed and easy to use. The Modula-2 compiler helps you develop and maintain your software in a fraction of the time spent writing programs in Assembler, C, or ADA. Includes EDITOR, COMPILER, LINKER, DECODER and MAKE UTILITY. The target run-time support module, supplied in source form, includes a floating point package which emulates the NS32001 chip, if necessary.

Low-cost compiler board for IBM PC/XT/AT bus \$750
 High performance compiler board for IBM PC/XT/AT bus \$1995
 High performance compiler board for Micro Channel bus \$1995

ALOIS SCHÖNBÄCHLER

Freischützgasse 14, CH-8004 Zürich, Switzerland
 41-1-241-0514

Inquiry 663.

THE PL/M CONNECTION

• Your link to the IBM PC from PL/M 86

Write programs—Create utilities

Build application systems

• Complete system interface libraries

• Dos 1, Dos 2, Dos 3, Bios, Graphics

• Large and compact memory modules

• 200 page Technical Reference Manual

• Complete source in PL/M 86 and Assembler

• Demonstration utilities with source

CompuFirm Corporation

7841 Balboa Ave., Ste 210, San Diego, CA

(619) 571-0228

Inquiry 664.

SOFTWARE/LANGUAGES

DRUMA FORTH-83

Strict '83 STANDARD. Developed for in house use. No 64K limitation. 64K speed & compactness to 320K.

- IBM PC/XT/AT & compatibles, DOS 2.0+
- ROM: Headerless code, separated variables
- Editor, assembler, file & DOS Interfaces
- On-line documentation & many other features
- Full Package \$79., S&H \$2, VISA/MC

DRUMA FORTH-83, DRUMA INC.

6448 Hwy. 290E, Suite E-103, Austin, TX 78723
Orders: 512-323-0403 BBoard: 512-323-2402

Inquiry 665.

Did you know that Prospero Software makes programming environments using GEM? Well, they do! We have both Pascal and Fortran using GEM for the Atari ST and MS-DOS machines. Both versions are ANSI and Internationally validated.

Pro Pascal with GEM is \$149.00 and
Pro Fortran with GEM is \$199.00

To order: call 1-800-327-6730 (VISA/MC) or mail your check \$149 or \$199, plus \$5.00 shipping to:

Prospero Software, Inc.

100 Commercial St., Suite 306, Portland, ME 04101

Inquiry 666.

MULTI-USER DEVELOPMENT PLATFORM

Gain the 80386 edge for your applications with THEOS C, an advanced compiler for the new THEOS 386 multi-user, multitasking operating system. Meets ANSI C standard, plus offers the power of 250 additional functions for VDI graphics, real-time processing and file access. Provides UNIX and DOS source code compatibility. Breaks 64K limitation. Two-volume manual set. BASIC Language package also available.

For complete multi-user solutions, call us today.

THEOS Software Corp.

1777 Bothello Dr., Suite 360, Walnut Creek, CA 94596

(415) 935-1118

FAX (415) 935-1177

Inquiry 667.

SOFTWARE/LASER FONTS

LaserJet Fonts

FASTfont downloads 4-10 times faster — EASY! MS-DOS program to select (by title) & group fonts. Download immediately or in groups. Any softfonts work. FASTfont — \$79. Also BIGfont — 8 fonts in sizes from 10 pts. to 158 pts. (2 inches) — print from any word processor — easy commands. 30 day \$5 back.

Worthington Data Solutions

417 A Ingalls St., Santa Cruz, CA 95060

(800) 345-4220 In CA: (408) 458-9938

See our ad on page 233.

SOFTWARE/LOANS

Execamort™ Amortizer+

Loan Amortization reports—simple or complex, extra payments, points/fees, APR's (per Regulation Z), balloons, solve for unknowns, yields/IRR, PV, FV, store/retrieve, PM/Esrow charges, more. IBM-PC/XT/AT/PS2 compatible. Simple yet complete—great for client services. Acclaimed nationwide by Banks/CPAs/CUs/Finance/Legal/R.E./S&Ls. \$14995 + \$400 ship. Visa/MC/AmEx. 60 day MBG.

Electrosonics

36380 Garfield #1, Fraser, MI 48026

800/858-8448, 313/791-0770.

Inquiry 668.

SOFTWARE/MAPS

PC MAPPING SOFTWARE

MapInfo software can:

- Display color maps from 52 ft. to 5,000 miles across the screen.
- Find addresses you type in
- Overlay data directly from dBASE III
- Color or shade boundaries
- Cost only \$750. Maps also available

MapInfo Corp.

200 Broadway, Troy, NY 12180

1-800-FASTMAP

In New York, (518) 274-8673

Inquiry 669.

SOFTWARE/MATHEMATICS

What? You've never seen a complex function?

Try f(z) - The Complex Variables Graphing Package for PC's with CGA/EGA

"Let our animated screens show you what the printed page cannot."

Lascaux Graphics

(212) 654-7429

Inquiry 670.

SOFTWARE/MUSIC

MUSIC SOFTWARE CATALOG!

Just published! Our new Musician's Music Software Catalog and it's better than ever! Over 80 pages of detailed information on the leading MIDI software programs, interfaces, and accessories—everything for the modern musician. Send \$3 for a 2-year catalog subscription including SALE! updates.

Digital Arts & Technologies

Dept. BT1, P.O. Box 11, Milford, CT 06460

203-874-9080

Inquiry 671.

SOFTWARE/PRINTER

PRINTER GENIUS

Powerful memory resident printer management — Control printer features from menus or within documents — Print spool to disk files — Background print — Directory & file browse — Edit small text — Redirect output — User friendly pop-up screens — 92 page manual — Preset for all printers — Completely flexible — PC MS-DOS — \$69 + \$4 S/H — VISA/MC

Nor Software Inc.

527 3rd Ave., Suite 150, New York, NY 10016

(212) 213-9118

Inquiry 672.

SOFTWARE/RESEARCH

REFBASE™—VERSION 2.0 REFERENCE MANAGEMENT SYSTEM

- Boolean search of all fields including abstracts
- Compatible with most popular word processors
- Up to 16,000 records; dBase™—compatible files
- Flexible bibliography formatting
- Append text files from on-line searching
- IBM™ PC and Macintosh™ versions
- Complete system \$150/Demo \$5—MC/VISA/PO

DataChp Corporation

(402) 553-4333

5624 Pierce Street, Omaha, NE 68106

Inquiry 673.

SOFTWARE/SCIENTIFIC

Data Acquisition & Analysis on PC's

- FOURIER PERSPECTIVE II Advanced Digital Signal Analysis
- PRIME FACTOR FFT subroutines library. Call from Turbo Pascal, C, Fortran, Basic. Up to 65,520 data points. 2D interface available. Rectangular FFT's now possible in a multitude of dimensions.
- 2 & 3D Scientific Graphic packages with plotter support from Golden Software.
- Data Acquisition & Control Boards from Metrabyte, Analog Devices, Burr-Brown, Strawberry Tree, National Instruments, Contec, & Tecmar.
- Data Acquisition & Analysis Software—Labtech Notebook, Axyt, UnixScope, Lotus Measure with 12.3/Symphony, & Quinn-Curtis

Call for FREE Application Assistance & Technical Literature

LOW PRICES—Satisfaction GUARANTEED

Alligator Technologies — (714) 850-9984

P.O. Box 11386 Costa Mesa, CA 92627

Inquiry 674.

NONLINEAR DYNAMICS

Tools for Studying Mathematical and Experimental Systems

- Ordinary and Delay Differential Equation Solvers * Bifurcation Diagrams * 2- and 3-D Plotting, Sequential Magnification, Poincaré Sections * Next Maximum, 1-D & Circle Maps
- * Phase Portraits with Multiple Initial Conditions * Spectral Analysis, Fractal Dimensions, Lyapunov Exponents

DS-I \$250.00 DS-II \$350.00

DYNAMICAL SYSTEMS, INC.

P.O. Box 35241, Tucson, AZ 85740, 602-825-1331

Inquiry 675.

SOFTWARE/SCIENTIFIC

ORDINARY/PARTIAL DIFFERENTIAL EQN SOLVER

FOR THE IBM PC & COMPATIBLES

MICROCOMPATIBLES INC.

301 Prelude Dr., Silver Spring, MD 20901

(301) 593-0683

Inquiry 676.

SCI-GRAF and SCI-DATA

SCI-GRAF produces huge hi-res graphs thru easy menus or linkable C libraries. Supports log scales, error bars, screen and printer output.

SCI-DATA performs least squares and normal curve fits, scaling and polar coordinate transformations.

Prices start at \$59.95.

Microcomputer Systems Consultants

Box 747, Santa Barbara, CA 93102

(805) 963-3412

Inquiry 677.

Scientific/Engineering/Graphics Libraries

Turbo & Lightspeed Pascal, Modula-2, C

Send for FREE catalogue of software tools for Scientists and Engineers. Includes: Scientific subroutine libraries, device independent graphics libraries (including EGA, HP plotter and Laserjet support), scientific charting libraries, 3-D plotting library, data acquisition libraries, menu-driven process control software. Versions available for a variety of popular languages.

Quinn-Curtis

49 Highland Ave., Needham, MA 02194

Inquiry 678.

SOFTWARE/SORT

OPT-TECH SORT/MERGE

Extremely fast Sort/Merge/Select utility. Run as an MS-DOS command or CALL as a subroutine. Supports most languages and filetypes including Btrieve and dBASE. Unlimited filesizes, multiple keys and much more! MS-DOS \$149. XENIX \$249.

(702) 588-3737

Opt-Tech Data Processing

P.O. Box 678 - Zephyr Cove, NV 89448

Inquiry 679.

SOFTWARE/TOOLS

DISK CACHE

Accelerate XT or AT PERFORMANCE with FLASHBACK Disk Cache. FLASHBACK automatically retains recently accessed disk data and neighboring data in memory for immediate access. Programs are instantly retrieved and run up to 10 times faster! \$19.95 + \$2 S/H, 60 day \$ back. Check/MO/Visa/MC.

aep designs, inc.

14810 N. Ninth St., Phoenix, AZ 85022

(602) 863-2861

Inquiry 680.

ADVERTISE YOUR COMPUTER PRODUCTS HERE

for as little as \$375 in
THE BUYER'S MART

For more information call

Mark Stone at BYTE

603-924-3754

Inquiry 681.

THE BUYER'S MART

STATISTICS

STATA

Statistics and graphics join to make STATA the most powerful package for the PC. No comparable program is as fast, friendly, and accurate. \$20 Demo. Quantity discount available. Call toll-free for more information. AX/VISA/MC.

1-800-STATAPC
Computing Resource Center
 10801 National Boulevard, Los Angeles, CA 90064
 (213) 470-4341

Inquiry 682.

UTILITIES

PERSONAL POP-UP

Create and access your own memory-resident reference and help files with the KeyNotes® Reference System. Open the KeyNotes "window" and return to the primary application with single keystrokes. Compatible with all popular programs. For IBM PC and compatibles. \$99.95 + \$5.00 shipping.

To order, call or write:
Digital Learning Systems
 4 Century Dr., Parsippany, NJ 07054
 800-992-0264 (in NJ 201-538-6640)

Inquiry 688.

UTILITIES

HANDS OFF THE PROGRAM®

- Locks Hard Disk. - Restricts Floppy Use
- Protects Subdirectories.
- Normal Use of DOS Commands and Application Software.
- IBM PC, XT, AT and True Compatibles.
- DOS V2.0 and Higher. Hard Disk System.
- Keep Other People's HANDS OFF Your System - \$89.95

SYSTEM CONSULTING, INC.
 314 Canterbury Dr., Pittsburgh, PA 15238
 (412) 963-1624

Inquiry 692.

THE SURVEY SYSTEM

An easy-to-use package designed specifically for questionnaire data. Produces banner format, cross tabs & related tables, statistics (inc. regression) & bar charts. Codes and reports answers to open-end questions. All reports are camera-ready for professional presentations. CRT interviewing option.

CREATIVE RESEARCH SYSTEMS
 15 Lone Oak Ctr., Dept. B, Petaluma, CA 94952
 707-765-1001

Inquiry 683.

Enhanced DOS Commands

Get directory listings of all files that don't match a template. Search all directories for files matching a template. New commands and new versions of existing commands, all with lots of variable options. Plus all commands accept special codes to reduce repetitive entries. Get the most from DOS with these time-saving routines. For MS-DOS/PCDOS 2.0 and higher. \$29.95

Driscoll Graphics
 135 E. Church, P.O. Box 625
 Clinton, MI 49236

Inquiry 689.

WORD PROCESSING

FARSI / GREEK / ARABIC / RUSSIAN

Hebrew, all European, Scandinavian, plus either Hindi, Punjabi, Bengali, Gujarati, Tamil, Thai, Korean, Viet, or IPA. Full-featured multi-language word processor supports on-screen foreign characters and NLO printing with no hardware modifications. Includes Font Editor. \$355 dot matrix; \$150 add'l for laser; \$19 demo. S/H in U.S. Incl'd. Req. PC, 640K, graphics. 30 day Guarantee. MC/VISA/AMEX

GAMMA PRODUCTIONS, INC.
 710 Wilshire Blvd., Suite 609, Santa Monica, CA 90401
 213/394-8622 Tlx: 5106008273 Gamma Pro SNM

Inquiry 693.

NUMBER CRUNCHER STAT SYS

Menu-driven. Multiple & stepwise regression, ANOVA, time series, discriminant cluster and factor analysis, principal components, scatter plots, histograms, t-tests, contingency tables, non-parametrics. Import export data. Spreadsheet, sort, join, merge. \$99. MS-DOS. Graphics program, \$59.

NCSS-B
 865 East 400 North, Kaysville, UT 84037
 801-546-0445

Inquiry 684.

MATCH PRINTERS TO PC

Match-A-Printer adapts most printers to PC/PS2 and compatibles. With this resident driver, get the full extended IBM ASCII character set on most printers. French, Spanish, German, Italian, Swedish, Greek, etc. and logic symbols. Works great with Apple ImageWriter and D.M.P., Epson and most daisy wheel printers. Solve character compatibility now, great for academic and engineering application. Introductory Price: \$59.95 & \$2 S&H. California residents add 6 1/2% sales tax. MO/Checks.

MATCH SOFTWARE
 6426 Coldwater Canyon, North Hollywood, CA 91606-1113
 Toll free # 1 (800) FLOPPYO

Inquiry 690.

CompareRite™

CompareRite saves editing time by comparing two documents and generating a third that shows the differences in an average of two seconds per page. CompareRite highlights changes the way you want to see them. Works with all major word processing programs. Price — \$129.95 + shipping/handling

JURISoft, Inc.

763 Massachusetts Ave., Dept. 11, Cambridge, MA 02139
 1-800-262-5656 ext. 11
 In MA — 617-864-6151 ext. 11

Inquiry 694.

STATISTIX™ II

Comprehensive, powerful and incredibly easy-to-use. Full screen editor, transformations, linear models (ANOVA, regression, logit, PCA, etc), ARIMA, most standard stat procedures. Clear, well organized documentation. Satisfaction guaranteed. \$169 PC DOS, \$99 Apple II.

NH ANALYTICAL SOFTWARE
 P.O. Box 13204, Roseville, MN 55113
 (612) 631-2852

Inquiry 685.

COPY AT TO PC

The 1.2mB drive has long been known to READ but NOT reliably WRITE on 360KB floppies. With "CPYAT2PC"™ 1.2mB drives CAN reliably WRITE 360KB floppies saving a slot for a second hard disk or backup tape. "CPYAT2PC"™ (Not Copy Protected) offers "the preferable SOFTWARE SOLUTION! ONLY \$79+\$4 S/H VISA/MC/COD UPS B/R

MICROBRIDGE COMPUTERS
 655 Skyway, San Carlos, CA 94070
 Order toll free 1-800-523-8777
 415-593-8777 (CA) 212-334-1858 (NY)
 TELEX EZLNK 62873089 Dealer inquiries invited

Inquiry 691.

DuangJan 1.3

Bilingual word processor for English and one of these: Armenian, Bengali, Euro/Latin, Greek, Hindi, Khmer, Lao, Russian, Tamil, Telugu, Thai, Viet, . . . or create your own language with font editor. \$69+\$4 s/h (+\$10 for.) LaserJet +\$49. Demo \$5. IBM compatibles.

MegaChomp Company

3524 Cotman Avenue, Philadelphia, PA 19145-1605
 (215) 331-2748/8138

Inquiry 695.

TAXES

TAXES—RECEIPTS SUMMARIES

Enter business or personal tax receipts • Get listings/summaries/archived files • Enter your own deduction sets (up to 40) • Enter your own account names for deduction set (up to 9) • Create Tax Receipt files. Update/edit any existing file. Archive files to floppy. List & Summarize data by account/data/deduction, (expdate, amount, datept). MS/DOS IBM or compatible. \$49.95. Call or write: (805) 985-4615

J. McCollum Inc.
 5310 Seabreeze Way, Oxnard, CA 93035

Inquiry 686.

Recover deleted files fast!

Disk Explorer now includes automatic file recovery. You type in the deleted file's name. Disk Explorer finds and restores it. Disk Explorer also shows what's really on disk; view, change or create formats, change a file's status, change data in any sector. MS-DOS \$75 U.S. Check/Credit card welcome.

QUAID SOFTWARE LIMITED
 45 Charles St. E. 3rd Fl.
 Toronto, Ontario, Canada M4Y 1S2
 (416) 961-8243

PC-Write™ Shareware Ver. 2.71

Fast, full featured word processor/text editor for IBM PC. With spell check, screen clip, mailmerge, split screen, ASCII files, macros. Easy to use. Supports 400 printers - LaserJet+ and PostScript. Software, User Guide, and Tutorial on 2 disks for \$16. Try it, then register with us for only \$89 and get User Manual, 1 year tele-support, newsletter and 2 upgrades. 90-day guarantee. VISA/MC.

Quicksoft 1-800-888-8088 CALL TODAY!
 219 First N., #224-BYTC, Seattle, WA 98109

Inquiry 696.

Advertise your computer products for
 as little as **\$375** in THE BUYER'S MART
 For more information call
 Mark Stone at BYTE **603-924-3754**

Inquiry 687.

NEC V20 & V30 CHIPS

Replace the 8086 or 8088 in Your IBM-PC and Increase Its Speed by up to 40%! Price

Part No.	Price
UPD70108-5 (5MHz) V20 Chip	\$ 7.49
UPD70108-8 (8MHz) V20 Chip	\$ 8.95
UPD70108-10 (10MHz) V20 Chip	\$21.95
UPD70116-8 (8MHz) V30 Chip	\$11.95
UPD70116-10 (10MHz) V30 Chip	\$24.95

7400

Part No.	1-9	10+	Part No.	1-9	10+
7400.	29	19	7485.	65	55
7402.	29	19	7486.	45	35
7404.	29	19	7489.	2.05	1.95
7405.	35	25	7490.	49	39
7406.	39	29	7493.	45	35
7407.	39	29	7421.	45	35
7408.	35	25	74123.	55	45
7410.	29	19	74125.	55	45
7414.	49	39	74126.	69	59
7416.	39	29	74143.	3.95	3.85
7417.	29	19	74150.	1.35	1.25
7420.	35	25	74154.	1.35	1.25
7430.	35	25	74158.	1.59	1.49
7432.	39	29	74173.	.85	.75
7438.	39	29	74174.	.59	.49
7442.	55	45	74175.	.59	.49
7445.	79	69	74176.	.99	.89
7446.	89	79	74181.	1.95	1.85
7447.	89	79	74189.	1.95	1.85
7448.	2.05	1.95	74193.	.79	.69
7472.	89	79	74198.	1.85	1.75
7473.	39	29	74221.	.99	.89
7474.	29	19	74273.	1.95	1.85
7475.	49	39	74365.	.65	.55
7476.	45	35	74367.	.65	.55

74LS

74LS00.	29	19	74LS165.	.75	.65
74LS02.	29	19	74LS166.	.99	.89
74LS04.	35	25	74LS173.	.59	.49
74LS05.	35	25	74LS174.	.49	.39
74LS06.	1.09	.99	74LS175.	.49	.39
74LS07.	1.09	.99	74LS189.	4.59	4.49
74LS08.	29	19	74LS191.	.59	.49
74LS10.	29	19	74LS193.	.79	.69
74LS14.	49	39	74LS221.	.69	.59
74LS27.	35	25	74LS240.	.69	.59
74LS30.	29	19	74LS243.	.69	.59
74LS32.	35	25	74LS244.	.69	.59
74LS42.	49	39	74LS245.	.89	.79
74LS47.	99	89	74LS259.	.99	.89
74LS73.	39	29	74LS273.	.89	.79
74LS74.	35	25	74LS279.	.49	.39
74LS75.	39	29	74LS322.	4.05	3.95
74LS76.	55	45	74LS365.	.49	.39
74LS85.	59	49	74LS366.	.49	.39
74LS86.	35	25	74LS367.	.49	.39
74LS90.	49	39	74LS368.	.49	.39
74LS92.	49	39	74LS373.	.79	.69
74LS123.	59	49	74LS374.	.79	.69
74LS125.	49	39	74LS393.	.89	.79
74LS138.	49	39	74LS590.	6.05	5.95
74LS139.	49	39	74LS624.	2.05	1.95
74LS154.	1.09	.99	74LS625.	2.95	2.85
74LS157.	1.09	.99	74LS640.	1.09	.99
74LS158.	45	35	74LS645.	1.09	.99
74LS163.	59	49	74LS670.	1.09	.99
74LS164.	59	49	74LS688.	2.39	2.29

74S/PROMS*

74S00.	29	19	74S188*	1.49
74S04.	29	19	74S189.	1.49
74S08.	35	25	74S196.	2.49
74S10.	29	19	74S240.	1.49
74S32.	35	25	74S244.	1.49
74S74.	45	35	74S253.	.79
74S85.	1.79	1.49	74S287*	1.49
74S86.	49	39	74S288*	1.49
74S124.	2.79	2.49	74S373.	1.49
74S174.	1.09	.79	74S374.	1.49
74S175.	.79	.49	74S472*	2.95

74F

74F00.	29	19	74F139.	.69
74F04.	29	19	74F157.	.69
74F08.	29	19	74F193.	2.95
74F10.	29	19	74F240.	.69
74F27.	29	19	74F244.	.39
74F74.	39	29	74F253.	.69
74F86.	39	29	74F373.	.99
74F138.	69	59	74F374.	.99

CD-CMOS

CD4001.	19	CD4076.	.59
CD4008.	69	CD4081.	.25
CD4011.	19	CD4082.	.25
CD4013.	29	CD4093.	.35
CD4016.	29	CD4094.	.89
CD4017.	49	CD40103.	2.49
CD4018.	59	CD40107.	.49
CD4020.	59	CD40109.	.79
CD4024.	49	CD4510.	.69
CD4027.	35	CD4511.	.69
CD4030.	29	CD4520.	.75
CD4040.	65	CD4522.	.79
CD4049.	29	CD4538.	.89
CD4050.	29	CD4541.	.89
CD4051.	59	CD4543.	1.79
CD4052.	59	CD4553.	4.95
CD4053.	59	CD4555.	7.95
CD4063.	1.49	CD4559.	7.95
CD4066.	29	CD4566.	2.49
CD4067.	1.29	CD4583.	.89
CD4069.	25	CD4584.	.39
CD4070.	25	CD4585.	.89
CD4071.	25	MC14411P.	8.95
CD4072.	25	MC14490P.	4.49

MICROPROCESSOR COMPONENTS

MISCELLANEOUS CHIPS		6500/6800/68000 Cont.		8000 SERIES Cont.	
Part No.	Price	Part No.	Price	Part No.	Price
D765AC.	4.95 3.95	6845.	9.95 2.95	8228.	2.95
WD9216.	6.95	6850.	1.95	8237-5.	4.95 4.49
95H90.	9.95 5.95	6852.	1.49	8243.	2.25 1.95
Z80, Z80A, Z80B SERIES					
Z80.	1.25 .99	MC68000L8.	11.95	8250A.	6.49
Z80-CTC.	1.79 .99	MC68000L10.	13.95	8250B (For IBM).	6.95
Z80-DART.	4.95	MC68010L10.	49.95	8251-5.	1.89
Z80-PIO.	1.79 .99	MC68020RC12B.	169.95	8252A.	1.95
Z80A.	1.69	MC68881RC12A.	149.95	8254-5.	1.89
Z80A-CTC.	1.79	8000 SERIES			
Z80A-PART.	4.95	80C1.	3.95	8257-5.	1.95
Z80A-PIO.	1.69	80C31.	9.95	8259.	2.25
Z80A-SIO/0.	5.75	80C35.	1.95	8272.	4.95 3.95
Z80B.	3.49	80C73.	9.95	8279-5.	2.95
Z80B-CTC.	3.95	80C8A.	2.49	8741.	4.95
Z80B-PIO.	4.99 3.95	80C8E.	5.95	8742.	29.95 22.95
6500/6800/68000 SER.					
6502.	2.55	8086 2.	6.95	8748 (25V).	7.95
65C02 (CMOS).	8.95 7.75	8087 (5MHz).	129.95	8748H (HMOS) (21V).	9.95
6520.	1.95	8087-1 (10MHz).	229.95	8751.	39.95
6522.	3.95	8087-2 (8MHz).	159.95	8755.	14.95
6532.	6.49 5.49	8088.	6.49 5.75	DATA ACQUISITION	
6551.	4.49 3.95	8088-2.	6.95 7.75	ADC0804LCN.	9.49 7.79
65C802 (CMOS).	17.95	8116.	4.95	ADC0808CCN.	5.95
6900.	1.95	8115-2.	2.49	ADC0816CCN.	8.95 3.69
6902.	3.95	8155-2.	3.49	ADC1205CCU-1.	19.95
6910.	1.25	8156.	3.95	DAC0808LCN.	1.95
6917.	1.75	8202.	5.95	DAC1008LCN.	4.95
6940.	3.95	8203.	9.95	AY-3-1015D.	4.95
		8212.	2.25	AY-5-1013A.	2.95
		8224.	2.25		

MICROPROCESSOR SALE!

Part No.	Description	Price
8052AHBASIC	CPU w/BASIC Interpreter	\$ 29.95
MC68008L8	32-Bit MPU (8-Bit Data Bus)	49.95 \$ 16.95
MC68701	8-Bit EPROM Microcomputer	\$ 14.95
MC68705P3S	8-Bit EPROM Microcomputer	\$ 14.95
MC68705U3L	8-Bit EPROM Microcomputer	\$ 10.95
80286-10	16-Bit Hi Performance MPU	\$ 99.95
80287-8	Math Co-processor (8MHz)	\$259.95
80287-10	Math Co-processor (10MHz)	\$309.95
80387-16	Math Co-processor (16MHz)	\$494.95
80387-20	Math Co-processor (20MHz)	\$895.95

DYNAMIC RAMS

Part No.	Description	Price
*4116-15	16,384 x 1 (150ns)	1.09
*4128-20	131,072 x 1 (200ns) (Piggyback)	9.25 2.75
*4164-100	25,536 x 1 (100ns)	3.49
*4164-120	65,536 x 1 (120ns)	2.75
*4164-150	65,536 x 1 (150ns)	2.49
*4164-200	65,536 x 1 (200ns)	1.95
*TMS4416-12	16,384 x 4 (120ns)	4.95
*41256-80	262,144 x 1 (80ns)	8.95
*41256-100	262,144 x 1 (100ns)	8.49
*41256-120	262,144 x 1 (120ns)	7.95
*41256-150	262,144 x 1 (150ns)	7.75
*50464-15	65,536 x 4 (150ns) (4464)	5.95
*511000P-10	1,048,576 x 1 (100ns) 1 Meg	49.95
*514256P-10	262,144 x 4 (100ns) 1 Meg	89.95

STATIC RAMS

2016-12	2048 x 8 (120ns)	1.69
2016-145	2048 x 8 (45ns)	6.95 1.69
2102-2L	1024 x 1 (250ns) Low Power	1.95
2114N	1024 x 4 (450ns)	.99
2114N-2L	1024 x 4 (200ns) Low Power	1.49
21C14	1024 x 4 (200ns) (CMOS)	.49
5101	256 x 4 (450ns) (CMOS)	1.95
616R-3	2048 x 8 (150ns) CMOS	2.49
6116LP-3	2048 x 8 (150ns) LP CMOS	2.59
6264LP-12	8192 x 8 (120ns) LP CMOS	4.25 3.95
6264P-15	8192 x 8 (150ns) CMOS	3.49
6264LP-15	8192 x 8 (150ns) LP CMOS	9.75 3.49
6514	1024 x 4 (350ns) CMOS	3.49
43256-15L	32,768 x 8 (150ns) Low Power	11.95

PROMS

TMS2516	2048 x 8 (450ns) 25V	6.95
TMS2532	4096 x 8 (450ns) 25V	6.95
TMS2532A	4096 x 8 (450ns) 21V	5.95
TMS2564	8192 x 8 (450ns) 25V	9.95
TMS2716	2048 x 8 (450ns) 3 Voltage	9.95 6.95
1702A	256 x 8 (1µs)	6.95 4.95
2708	1024 x 8 (450ns)	4.95
2716	2048 x 8 (450ns) 25V	3.75
2716-1	2048 x 8 (350ns) 25V	4.25
27C16	2048 x 8 (450ns) 25V (CMOS)	3.95
4032	4096 x 25 (450ns) 25V	3.95
2732A-20	4096 x 8 (200ns) 21V	4.25
2732A-25	4096 x 8 (250ns) 21V	3.95
27C32	4096 x 8 (450ns) 25V (CMOS)	5.95
2764-20	8192 x 8 (200ns) 21V	4.25
2764-25	8192 x 8 (250ns) 21V	3.75
2764A-25	8192 x 8 (250ns) 12.5V	3.95
2764-45	8192 x 8 (450ns) 21V	2.95
27C64-15	8192 x 8 (150ns) 21V (CMOS)	6.49
27128-20	16,384 x 8 (200ns) 21V	6.95
27128-25	16,384 x 8 (250ns) 21V	5.25
27128-25	16,384 x 8 (250ns) 12.5V	5.25
27C128-25	16,384 x 8 (250ns) 21V (CMOS)	6.95
27256-20	32,768 x 8 (200ns) 12.5V	6.95
27256-25	32,768 x 8 (250ns) 12.5V	5.95
27C256-25	32,768 x 8 (250ns) 12.5V (CMOS)	7.95
27512-20	65,536 x 8 (200ns) 12.5V	13.49
27512-25	65,536 x 8 (250ns) 12.5V	11.95
6876A	8192 x 8 (450ns) 25V	13.95

EPROMS

2816A	2048 x 8 (350ns) 5V Read/Write	5.95
2817A	2048 x 8 (350ns) 5V Read/Write	7.95
2865A	8192 x 8 (250ns) 5V Read/Write	9.95
52B13 (21V)	2048 x 8 (350ns) 5V Read Only	1.49

COMMODORE CHIPS

LAG570	40.95 9.95
WD1770	11.95
S13052P	2.49
65002	2.65
6504A	1.95
65047	4.39

6510

Now Available...Jameco's NEW Winter/Spring Flyer #136 with 48 pages of Computer Peripherals, Components & More!

PROTOTYPING PRODUCTS

Jameco Solderless Breadboard Sockets

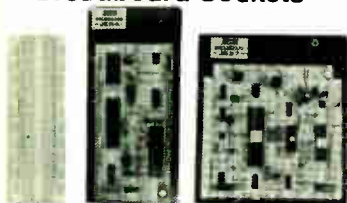

Part No.	Dim. L x W	Contact Points	Binding Posts	Price
JE20	6 1/2 x 3 1/4	200	0	\$ 2.29
JE21	3 1/4 x 2 1/8	300	0	\$ 4.49
JE22	6 1/2 x 1 3/8	630	0	\$ 5.95
JE23	6 1/2 x 2 1/8	930	0	\$ 7.49
JE24	6 1/2 x 3 1/8	1,360	2	\$14.95
JE25	6 1/2 x 4 1/8	1,560	3	\$22.95
JE26	6 7/8 x 5 3/4	2,390	4	\$27.95
JE27	7 1/4 x 7 1/2	3,220	4	\$37.95

Jameco's IBM PC/XT/AT Compatible Motherboards



- Award BIOS ROMs included
- JE1000 4.77MHz (PC/XT) \$ 84.95
- JE1001 4.77/8MHz (PC/XT) \$ 99.95
- JE1002 4.77/10MHz (PC/XT) \$119.95
- JE1007 6.8/10/12MHz (AT) \$349.95

Jameco Computer Power Protection



- JE1190 Power Base \$29.95
- JE1191 6-Outlet Power Strip \$11.95
- JE1192 300 Watt Back-Up \$269.95
- JE1193 500 Watt Back-Up \$349.95



Zuckersboard TANDY 1000 Expansion Memory Half Card

Expand the memory of your Tandy 1000 (128K Version) to as much as 544K. Also includes DMA controller chip.

- TE512 Includes 512K RAM \$199.95
- TANC Plug-in Clock option chip (only) \$39.95
- 30Meg Hard Disk Drive Board for Tandy 1000, 1000A, 1000SX, 1200, 3000 and 3000HL
- T30MB 30MB Hard Disk Drive Board \$599.95

DATA BOOKS

- 400041 NSC Linear Data Book-Vol. I (87) \$14.95
- 400042 NSC Linear Data Book-Vol. II (87) \$ 9.95
- 400043 NSC Linear Data Book-Vol. III (87) \$ 9.95
- 210830 Intel Memory Handbook (87) \$17.95
- 230843 Intel Microsystem Hdbk. Set (87) \$24.95

MUFFIN/SPRITE-STYLE FANS

- TA450S \$11.95
Torin Industries (4 68" sq, 50 cfm)
- SU2A1 \$11.95
EG&G Rotron (3 125" square, 34 cfm)

NEW! Turbo 10MHz PC/XT Compatible Kit! FREE! Word Processing Software! New! Compact Case

JE1059 . . . \$499.95 (EGA Monitor and Card not included)



Jameco's 4.77/10MHz Turbo IBM PC/XT Compatible Kit

- JE1002 4.77/10MHz Turbo Motherboard (Zero-K RAM - Includes Award BIOS ROMs) \$119.95
- JE1014 Mini Turbo PC/XT Compatible Case \$69.95
- JE1015 XT/AT Comp Keyboard \$59.95
- JE1021 5 1/4" DSDD Disk Drive (Beige Bezel) \$89.95
- JE1031 Mini 150W Turbo PC/XT Comp. Power Supply \$69.95
- JE1043 360K/720K/1.2M Floppy Controller Card \$49.95
- 4164-150 16K RAM (65,536x1) (2 Chips, 150ns) \$4.98
- 41256-150 512K RAM (262,144x1) (18 Chips, 150ns) \$139.50
- 50464-15 112K RAM (65,536x4) (4 Chips, 150ns) \$23.80

Regular List \$627.98 SAVE \$128.03!

JE1006 IBM PC/XT Comp. 10MHz Turbo Kit . . \$499.95

IBM COMPATIBLE DISPLAY MONITORS

12" Amber Monochrome - TTL Input, High Resolution (PC/XT/AT) AMBER . . . \$109.95 \$99.95

14" RGB Color - CGA Compatible Amber/Green/Color Switchable, 640 x 200 Resolution (PC/XT/AT) TTX1410 \$279.95



14" EGA Color - EGA/CGA Compat., 720 x 350 (max.) resolution (PC/XT/AT) TE5154 \$399.95

14" Ultrascor Color - CGA/EGA/PGC/VGA Compatible, 800 x 560 (max.) Resolution (PC/XT/AT) 4375M \$579.95 \$549.95

IBM PC/XT/AT COMPATIBLE CARDS

Graphic Display Cards



- JE1050 Mono Graphics Card w/Printer Port (PC/XT/AT) \$59.95
- JE1052 Color Graphics Card w/Printer Port (PC/XT/AT) \$49.95
- JE1055 EGA Card with 256K Video RAM and Printer Port (PC/XT/AT) \$149.95
- JE1071 Multi I/O with Drive Controller and Mono Graphics (PC/XT) \$119.95

Multifunction, I/O and Expansion Cards

- JE1060 I/O Card with Serial, Game, Parallel Printer Port and Real Time Clock (PC/XT) \$59.95
- JE1061 RS242 Serial Half Card (PC/XT/AT) \$29.95
- JE1065 I/O Card with Serial, Game and Parallel Printer Port (AT) \$59.95
- JE1078 Expand to 384K (incl. zero-K) Multifunction w/Serial, Game, Parallel Printer Port & Real Time Clock (PC/XT) . . \$79.95

Floppy and Hard Disk Controller Cards

- JE1040 360KB Floppy Disk Drive Controller Card (PC/XT) \$29.95
- JE1041 20/40MB Hard Disk Controller Card (PC/XT) \$79.95
- JE1043 360K/720K/1.2MB Floppy Disk Cont. Card (PC/XT/AT) \$49.95
- JE1045 360K/720K/1.2MB Floppy/Hard Disk Controller Card (AT) \$159.95

Additional Add-Ons Available!

COMPUTER PERIPHERALS

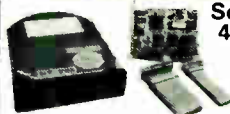

Seagate 20,30, 40 and 60MB Half Height Hard Disk Drives

- ST225K (Pictured) ST225K \$259.95
- ST225K 20MB Drive only (PC/XT/AT) \$289.95
- ST238 30MB Drive only (PC/XT/AT) \$299.95
- ST238K 30MB w/Cont. (PC/XT/AT) \$329.95
- ST251 40MB Drive only (PC/XT/AT) \$439.95
- ST251XT 40MB w/Cont. Card (AT) \$499.95
- ST251AT 40MB w/Cont. Card (AT) \$539.95
- ST277 60MB Drive only (PC/XT/AT) \$549.95
- ST277K 60MB w/Cont. Card (AT) \$659.95



Jameco PC/XT & AT Compatible Disk Drives

- JE1020 360K Black Bzl. (PC/XT/AT) . . . \$ 89.95
- JE1021 360K Beige Bzl. (PC/XT/AT) . . . \$ 89.95
- JE1022 1.2MB Beige Bzl. (AT) \$109.95

Datronics

2400/1200/300 Modems



• Hayes command compatible • Bell 103/212A compatible • Auto-dial/auto-answer • FCC approved • 1-year warranty • Includes MaxiMite Communication Software

- 1200H 1200/300 Baud Internal Modem . . . \$ 79.95
- 2400S 2400/1200/300 Internal Modem . . . \$174.95
- 1200C 1200/300 Baud External Modem . . . \$119.95
- 2400E 2400/1200/300 External Modem . . . \$219.95

Prometheus 1200B Internal Modem PM1200B-2S (Software incl.) \$149.95 \$119.95

Jameco Extended 80-Column Card for Apple IIe



• 80 Col / 64K RAM • Doubles amount of data your Apple IIe can display as well as its memory capacity • Ideal for word processing • Complete with instructions

JE864 \$39.95

ADD12 (Disk Drive II, II+, IIe) \$99.95

TEST EQUIPMENT

Kingdom and Metex Digital Multimeters



- KD302:**
 - Pocket Size in handy carry case
 - 3 1/2 Digit LCD
 - Auto or manual ranging
 - Audible continuity tester
 - Tests AC/DC Voltage, Resistance and Continuity
 - One Year Warranty
 - Size 4 1/4" x 2 1/4" x 1 1/2" H

KD302 . . \$27.95



- M4650:**
 - Handheld, high accuracy
 - 4 1/2 Digit LCD
 - Manual ranging with Overload Protection
 - Audible continuity tester
 - Tests AC/DC Voltage, Resistance, Continuity Capacitance and Frequency
 - One Year Warranty
 - Size 7" L x 3 1/2" W x 1 1/2" H

M4650 . . \$79.95

U.S. Funds Only
Shipping: Add 5% plus \$1.50 Insurance
(May vary according to weight)

\$20 Minimum Order

IBM is a registered trademark of International Business Machines

California Residents:
Add 6%, 6 1/2% or 7%
Sales Tax
FAX 415-592-2503
4/88



Data Sheets - 50¢ each
Prices Subject to Change

Send \$1.00 Postage for a FREE 1988 CATALOG

Telex: 176043

©1988 Jameco Electronics

1355 SHOREWAY RD., BELMONT, CA 94002 • FOR ORDERS ONLY 415-592-8097 • ALL OTHER INQUIRIES 415-592-8121

Terrific! Fast BUS Computer Systems, Inc.

**30-DAY MONEY BACK
OPEN 7 DAYS**

**Money
Order**

**Wire
Transfer**

VISA

Boston
59 Prince St.
Brookline, MA 02116
1-800-451-5279

Atlanta
591 Memorial Drive, Suite 206
Stone Mountain, GA 30083
1-800-451-5279

New York
135 W. 26th St., 8th Fl.
New York, NY 10001
1-800-451-5279

Los Angeles
6951 Warner St., Suite 291
Huntington Beach, CA 92647
1-800-451-5279

Taipei
432, Kesheng Rd., Sec. 1, Suite 410
Taipei, Taiwan
886 2 766-4244 (FAX)
12061 LHICAL (TLX)

Wire Transfer
Chemical Bank
305 Seventh Ave., N.Y. 10001
For the Acct. of BUS Computer Systems, Inc.
Acct. #021 030138

IBM and PC are registered trademarks of International Business Machines Corp. (IBM). MS-DOS is a registered trademark of Microsoft Corp. (Microsoft).

FAX: (212) 627-9884 TLX: 3712634 BUS TECH HELP: (212) 627-9872

BUS 88

640K 8 MHz
10 MHz Optional

Fully IBM Compatible
Phoenix BIOS

\$650

- 100% IBM AT Compatible w/ 640K RAM on Board
- Phoenix or Award BIOS Installed
- One 12" High-Res. Amber Monitor (720 x 318)
- Hercules Graphics Emulation Card w/ Printer Port
- Intel 16-Bit 8088-2 Running at 1.7/7.6/0MHz
- Two 5 1/4" HD 360K Half-Height Drive Bays
- 8 Fully IBM Compatible Expansion Slots Accept All IBM Parts
- Runs All MS-DOS Programs Including 1-2-3, Flight Simulator, dBase III Plus, Autocad, WordStar, WordPerfect, etc.
- Operates MS-DOS, PC-DOS, GW Basic, Novell, Xenix
- Keyboard Replaceable 1.77 and 8.0MHz
- 130 Watt 110/220 VAC Power Supply w/ Fuse Cables
- Enhanced Keyboard w/ LEDs, Enlarged Return/Shift Keys and 81 Keys
- Multi I/O Card (Controls Two Floppy Drives w/ Printer Port) Game Port and an Optional 2nd Serial Port (Light Pen Port) Battery Backed Real-Time A/B Circular
- 8087 Math Co-Processor Socket Installed on Board
- MS EPROM Sockets Also Installed on Board
- Powerful Self-Testing of System Components
- Nickel-Plated, Enamel Coating, Heavy-Duty Metal Case w/ Four Drive Slots and Speaker
- 8x Slots Still Available after System Configuration
- Ready for 10/20/30/10/65 MB Hard Disk Installations
- Ready for Network/Multiuser Installations
- Ready for Mouse/Joystick Interface
- Fully Set-Up and Diagnostically Tested in America
- Operating Manual for Monitor, Keyboard, Motherboard, W/P Card, Multi I/O Card and the Operator
- 30-Day Money Back Guarantee
- Our Year Fully Warranted Labor and Parts
- 72-Hour Burn-In Period
- Ready for Immediate Delivery
- Ship Worldwide via Federal Express, DHL, UPS or Air Cargo
- Accept Overseas Telephone Orders w/ VISA/Master/AmEx Card or Wire Transfer

**BUS 88 w/20MB & 1 Floppy
Seagate ST-225, 65MS . . . \$900**

- OPTIONAL FEATURES**
- 1.0 MHz System w/ Intel 8088-1 Microprocessor
 - NEC V20 Microprocessor
 - VGA System w/ Auto-Switch VGA Card (800x600)
 - EGA System w/ Auto-Switch EGA Card (640x350)
 - Color System w/ Color Card (640x200)
 - Excess Memory Expansion Board of 2 MB RAM
 - Excess VGA VGA Card
 - 10/20/30/40/65 MB Hard Disk
 - TEAC 5 1/4" 360K and 3 1/2" 720K or 1.44MB Floppy
 - Talgaras 20/40/60 Tape Backup System
 - Hercules or Smart 1200 or 2400 Baud Internal or External Modem
 - Epson, Toshiba, Citizen, NEC and Star Printers
 - Microsoft or Genius Mouse and Joystick
 - Intel 8087-2 or 8087-3 Math Co-Processor
 - 2nd Serial Port Upgrade

BUS LCDs

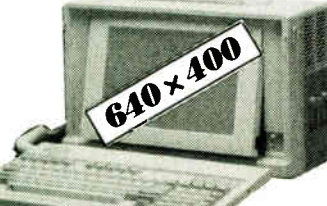

- 100% IBM XT/AT, Compaq 386 Compatible
- 640 x 400 Pixels for Hercules Graphics Mode
- New Superintend/Contrast/FL Backlite
- 80 Characters x 25 Lines
- Dot Size 0.33mm (H) x 0.33mm (V) w/ 0.03mm Spacing
- Crystal-Blue Dots on White Background Reverse Mode
- 6 Bits Not Available
- 84 Keys w/ Clicking Feel and Enlarged Return/Shift Keys
- 180 Watt 110/220 VAC Auto Switching
- Built-In Line Filter and Cooling Fan
- Over-Voltage, Over-Current and Short-Circuit Protection
- Operates MS-DOS, PC-DOS, OS/2 and Unix
- 15% (W) x 10% (H) x 7% (D) or 308mm x 253mm x 190mm
- 2.5kg (16.5 lbs) in CKD Form
- Real-Time Clock w/ Battery Backup; Built-In Speaker
- Can Be Connected to Color/EGA Monitor, Network, etc.
- Two 3 1/2" Drive Slots Available

BUS 88 LCD	\$1100
Configured Same as BUS 88 w/ Two 360K w/20MB Seagate ST-225, 65MS, One 360K	1700
BUS 286 LCD	2000
Configured Same as BUS 286 w/ One 1.2MB w/20MB Seagate ST-225, 65MS, One 1.2MB	3430
BUS 386 LCD	3950
Configured Same as BUS 386 w/ One 1.2MB w/13MB Seagate ST-251, 39MS, One 1.2MB	3950

HARD DISKS

20MB, Seagate ST-225 w/Controller/Cable	260
30MB, Seagate, ST-238 w/Controller/Cable	300
40MB, Miniscribe 3650 w/Controller/Cable	350
13MB, Seagate ST-251	550
65MB, Seagate ST-277	575
72MB, Miniscribe 6085	790
84MB, Seagate ST-4096	850
103MB, Prim 1D-100RC w/Controller/Cable	1300

Quantity Prices

Network/Multi-User Installations

BUS 286

One MEGabyte
10 MHz "0" Wait
12 MHz/16 MHz Optional

BEST BUY
Fully IBM Compatible
Phoenix BIOS

\$1100

- 100% IBM AT Compatible, Accepts All IBM Parts
- Fully Compatible Phoenix BIOS Installed
- Intel 80286-10 Running 6 and 10MHz "0" Wait
- One Megabyte of RAM on Board
- Memory Expandable to 16MB w/ Add-On Memory Card
- One 12" High-Res. Super-VGA Board Amber Monitor (720 x 318)
- Hercules Graphics Emulation Card w/ Printer Port
- Runs All MS-DOS Programs Including 1-2-3, Flight Simulator, dBase III Plus, Autocad, WordStar, etc.
- Operates MS-DOS, PC-DOS, GW Basic, Novell, Xenix, Unix
- D Expansion Slot: Six 16-Bit Two 8-Bit
- One Western Digital WD1003-WA2 Combined Hard-Disk/Floppy-Disk Controller Controls Two Hard Disks and Two Floppies
- Enhanced Keyboard w/ LEDs, Enlarged Return/Shift, 101 Keys
- 200 Watt 110/220 VAC Power Supply w/ Fuse Cables
- Hardware Reset/Turbo Button Installed
- One Fujitsu 1.2MB Half-Height High-Density, FD (M2533K)
- Real-Time Clock w/ Battery-Backed CMOS Memory for System Configuration Data
- One RN-232 Serial Card w/ 2nd Port Optional
- Power-On Self-Testing of System Components
- 80287 Math Co-Processor Socket Installed on Board
- Nickel-Plated, Enamel Coating, Heavy-Duty, Lockable Case
- Five Drive Slots Available w/ Speaker Installed
- Five Slots Available After System Configuration
- Power/Hard Disk Turbo Indicator Light Installed
- Ready for OS/2 Systems Operation
- Ready for 20/30/40/72/84/103/120/140MB Hard-Disk
- Ready for 20/40/60MB Tape Backup Installation
- Ready for Network/Multiuser/Multitasking Interface
- Ready for Mouse/Joystick Interface
- Fully Set-Up and Diagnostically Tested in America
- Operating Manual for Monitor, Keyboard, Motherboard, MGP Card, Serial Card and the Operator
- 30-Day Money Back Guarantee
- 20-Month Fully Warranted Labor and Parts
- 72-Hour Burn-In Period
- Ready for Immediate Delivery
- Ship Worldwide via Federal Express, DHL, UPS or Air Cargo
- Accept Overseas Telephone Orders w/ VISA/Master/AmEx Card or Wire Transfer

**BUS 286 Systems . . . \$1700
w/43MB Seagate ST-251, 39MS**

- OPTIONAL FEATURES**
- 12 MHz "0" Wait System w/ 1000 Nanosecond RAM, S1 = 13.3
 - 16 MHz "0" Wait System w/ 800 Nanosecond RAM, S1 = 17.1
 - VGA System w/ Auto-Switch VGA Card (800x600)
 - EGA System w/ Auto-Switch EGA Card (640x350)
 - Color System w/ Color Card (640x200)
 - Hercules Graphics Plus Card and In-Color Card
 - Intel All Above-Boards
 - Quadram Quad EGA Plus
 - ATI VGA Card and EGA Wonder Card
 - Excess Memory Expansion Board RAM 3000 Delux
 - Excess EGA VGA Card
 - Genoa Super EGA
 - Video-7 EGA Deluxe EGA
 - Paradise AutoSwitch 180 EGA
 - NT Rampage, Advantage Premium, Sinsar Premium
 - NEC 13" Multisync II (800 x 360)
 - 20/30/40/65/72/84/103/120/140MB Hard Disk
 - 11" Dual-Frequency Amber Monitor
 - TEAC 5 1/4" 360K and 3 1/2" 720K Floppy
 - Talgaras 20/40/60MB Tape Backup System
 - Hercules or Smart 1200 or 2400 Baud Internal or External Modem
 - Epson, Toshiba, Citizen, NEC and Star Printers
 - Microsoft or Genius Mouse and Joystick
 - Intel 80287-2 or 80287-3 Math Co-Processor
 - 2nd Serial Port Upgrade
 - Multisync or Networking Installations

BUSTOP 286

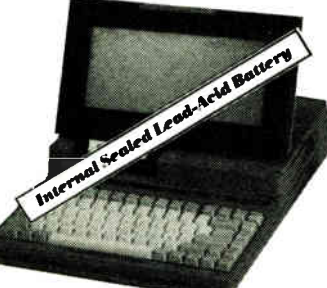

- 100% IBM AT Compatible • 80286-10 10MHz**
- 640K on Board Expansion to 2MB • Operates MS-DOS, PC-DOS, Unix, Dual 3 1/2" 720K Floppies, Parallel and Serial Ports
- One XT Compatible Slot • 12V/2A Internal Sealed Lead-Acid Battery • External AC or DC Adapter
- Superintend LCD w/ Contrast Adjustment • Graphics 640 x 480, Numeric, Low Battery, Modem Hook On/Off, Drive A/B x 14 1/4" x 12 1/4" x 3 1/4" or 380 x 310 x 70 (mm) • Weight: 13.5 lbs. or 5.9 kg • Optional 1200 baud Internal Modem, 2MB RAM Card, External HDD 20/40MB
- Minicenter/2nd floppy not included.
Price subject to change without notice.

BUS 386

One MEGabyte 80NS Static Col. Ram
16 MHz "0" Wait
20 MHz "0" Wait Optional

BEST BUY
Fully Compaq Compatible
Phoenix BIOS

\$2300

- 100% Compaq Compatible
- Phoenix 386 or Award 386 BIOS w/ Setup Software
- One MB Parity-Checked Static Lullam RAM of 80 Nanoseconds on Memory Card, 2 x 8-MB Pogo-Back Expansion Board (Option, Allows Memory Expansion to 10MB Using 80-Nanosecond RAM Chips) Fully Compaq-Compatible Memory Bus
- One 14" Super-VGA Board (720 x 318) Pogo-Back Expansion Board (Option, Allows Memory Expansion to 10MB Using 80-Nanosecond RAM Chips) Fully Compaq-Compatible Memory Bus
- Enhanced Keyboard w/ LEDs, 101 Keys and Enlarged Return/Shift Keys
- Hercules Graphics Emulation Card w/ Parallel Port
- Intel 32-Bit 80386-16 Microprocessor
- Operating at 16MHz "0" Wait
- Software-Selectable of Four Speeds: 4.776/8/16
- Performance Rating: MIPS = 2.03, S1 = 18.7, Landmark = 20.5
- 80287/80387 Math Co-Processor Socket Installed
- 80387 is Bootable to DOS/MS-DOS Xenix System V/386/2/PC/MS-DOS/386
- 80387 Runs with Turbo Power/Advanced Version 2.0/Full CAD/Am Support
- Eight Expansion Slots: 2 8-Bit, 5 16-Bit, 1 32-Bit
- Operates OS/2, MS-DOS, PC-DOS, Unix V, Xenix & Windows/386
- Runs All MS-DOS Software Including Lotus 1-2-3, WordStar, Autocad, Flight Simulator, dBase III Plus, Symphony, etc.
- Software Utilities Including:
 - Relocatable EGA and System BIOS from ROM to RAM
 - Emulating the Lotus/Intel/MS-DOS Memory Specification (LIM/MS)
 - User Downloadable BIOS/Software-Selectable Speeds
- Fullly Compatible w/ AT Mechanical Mounting Locations
- Real-Time Clock w/ Battery-Backed CMOS Memory for System Configuration Data
- Three Address Modes:
 - 8086-Compatible Real-Address Mode
 - Protected 80286/80386 Virtual-Address Mode
- Seven Interrupts
- 18-Level Direct-Memory-Access (DMA) Channels
- 64 Translates of Virtual Address, System and I/O
- 32-Bit Internal Address Bus and Memory Interface/BIOS
- Hardware Five-Digit Multiplier and Divider
- AT-Compatible I/O Channel Timing
- High-Speed Instruction Execution
- 8742 Keyboard Controller Interface an AT Keyboard
- 200 Watt 110/220 VAC Power Supply with Four Cables
- One Fujitsu 1.2MB Half-Height High-Density, FD (M2533K)
- One Hercules Magic 101 (EV-170) w/ One Parallel and One Serial Port, 2nd Serial Port Optional
- One Western Digital WD1003-WA2 Combined Hard-Disk/Floppy-Disk Controller Controls Two Hard Disks and Two Floppies
- Turbo-Speed of Hard-Disk/Power Indicator Lights Installed
- Hardware Reset and Turbo Buttons Installed
- Nickel-Plated, Enamel Coating, Heavy-Duty Lockable Case
- Five Drive Slots Available w/ Speaker Interface
- Power-On Self-Testing of System Components
- Five Slots Still Left Open after System Configuration
- Ready for OS/2 Systems Operation
- Ready for 20/40/65/72/84/103/140/230/337MB Hard Disk
- Ready for 20/40/60MB Tape Backup Installation
- Ready for Network/Multiuser/Multitasking Systems
- Operating Manual for Monitor, Keyboard, Motherboard, W/P Card and W/P Card
- 30-Day Money Back Guarantee
- 20-Month Fully Warranted Labor and Parts
- 72-Hour Burn-In Period
- Fully Set-Up and Diagnostically Tested in America
- Ready for Immediate Delivery
- Ship Worldwide via Federal Express, DHL, UPS or Air Cargo
- Accept Overseas Telephone Orders w/ VISA/Master/AmEx Card or Wire Transfer

**BUS 386 Systems . . . \$2,800
w/43MB Seagate ST-251, 39MS**

- OPTIONAL FEATURES**
- 20MHz System w/ Intel 80386-20 Microprocessor w/ MIPS = 2.83, S1 = 23.0, Landmark = 25.5
 - 25MHz System w/ Intel 80386-25 Available
 - RAM Expansion Board of 2MB, 4MB, 8MB
 - Two 80NS Phoenix 386/Award 386 on Motherboard
 - Magnum w/ Auto-Switch VGA Card (800 x 600)
 - EGA System w/ Auto-Switch EGA Card (640 x 350)
 - Color System w/ Color Card 640 x 200
 - Magnum w/ MSB52 13" RGB Color Monitor
 - All Intel Above-Boards
 - ATI VGA Card and EGA Wonder Card
 - Excess EGA VGA Card
 - Quadram Quad EGA Plus
 - Genoa Super EGA
 - Video-7 EGA Deluxe EGA
 - Paradise AutoSwitch 180 EGA
 - NT Rampage, Advantage Premium, Sinsar Premium
 - NEC 13" Multisync II (800 x 360)
 - 20/30/40/65/72/84/103/120/140/230/337MB Hard Disk
 - 11" Dual-Frequency Amber Monitor
 - TEAC 5 1/4" 360K and 3 1/2" 720K Floppy
 - Talgaras 20/40/60MB Tape Backup System
 - Hercules or Smart 1200 or 2400 Baud Internal or External Modem
 - Epson, Toshiba, Citizen, NEC and Star Printers
 - Microsoft or Genius Mouse and Joystick
 - Three Serial Ports (and Two Parallel Ports)
 - Intel 80387 Math Co-Processor
 - Mini Case w/ Three Drive Slots
 - Minicenter or Tower Case
 - 2nd Serial Port Upgrade
 - Software of All Kinds
 - 20/30/40/65/72/84/103/120/140/230/337MB Hard Disk Options
 - Multisync or Networking Installations

BUS PORTABLES

Terrribly Fast

88/286/386

8/10/16 MHz

10/12/20 MHz Optional

**30-Day Money-Back
One Year Labor & Parts**

SPECIFICATIONS

- 9" High Res. (750x348) Dual Frequency Amber CRT Monitor Accepts Both Mono and Color Card
- Three Half Height Drive Slots
- Reinforced Aluminum Frame
- 200 Watts 110/220 VAC Power Supply
- 7 Expansion Slots Available
- 81 Keys w/LEDs for CAP, Num and Scroll Lock
- Enlarged Return and Shift Keys
- Mechanical Keyswitch of Clicking Feel w/ A Positive Tactile Feedback
- Power Lock Key Installed
- Contrast Adjusting Knob Installed
- Brightness Adjusting Knob Installed
- Turbo Speed Light Indicator Installed
- Hardware Reset Button Installed
- Dimensions: 17.3"(W) x 8.2"(H) x 16.9"(D)
- Weight 22 lbs in CKD Form
- EGA Portables Available Now:
 - 9" EGA Monitor w/ 640x350 (EGA) or 640x200 (CGA)
 - 230 Watts 110/220 VAC Power Supply
 - Dot Pitch: 0.28

Best Buy

OPTIONAL FEATURES

- TEAC 5 1/4" 360K Floppy Disk
- TEAC 3 1/2" 720K Floppy Disk
- TEAC 3 1/2" 1.44MB Floppy Disk
- Seagate 3 1/2" Hard Disk of 20/30/40 MB
- Hercules Graphics Plus Card or In-Color Card
- Intel All Above Boards
- Quadrant Quad EGA Plus
- Everex EY 657 Antistatic EGA
- Paradise Antistatic 180 EGA
- ATI EGA Wonder
- Genoa Super EGA
- Video-7 Vega Deluxe EGA
- AST Advantage Premium, Sixpac Premium, Rampage
- Everex Ram Expansion Boards
- Hayes or Smart 1200 Baud Internal or External Modem
- Hayes or Smart 2400 Baud Internal or External Modem
- Microsoft or Genius Mouse
- Winner Joystick
- Intel Math Coprocessor
- 2nd Serial Port Upgrade
- Epson, Toshiba, Citizen, NEC, and Star Printers
- Tallgrass Tape Backup of 20/30/40 MB
- Portable Carrying Bag

CONFIGURATIONS

VT200PX BI 888 Portable		\$1,050
Configured Same as BI 888 w/Two 360K		
VT120PX w/20MB Seagate ST-225, 65 MS, One 360 K	1,350	
VT130PX w/30MB Seagate ST-238, 65 MS, One 360K	1,100	
VT140PX w/40MB Miniscribe 3650, 60 MS, One 360K	1,150	
VT165PX w/65MB Seagate ST-277, 39 MS, One 360K	1,750	
AT100PX BI 286 Portable		1,650
Configured Same as BI 286 w/One 1.2MB		
AT200PX w/One 1.2MB and One 360K	1,700	
AT120PX w/20MB Seagate ST-225, 65 MS, One 1.2MB	1,900	
AT130PX w/30MB Seagate ST-238, 65 MS, One 1.2MB	1,950	
AT140PX w/40MB Miniscribe 3650, 60 MS, One 1.2MB	2,000	
AT143PX w/43MB Seagate ST-251, 39 MS, One 1.2MB	2,200	
AT144PX w/43MB Seagate ST-251-1, 28 MS, One 1.2MB	2,300	
AT142PX w/42MB Miniscribe 6053, 28 MS, One 1.2MB	2,400	
AT165PX w/65MB Seagate ST-277, 39 MS, One 1.2MB	2,150	
AT172PX w/72MB Miniscribe 6085, 28 MS, One 1.2MB	2,600	
AT181PX w/84MB Seagate ST-4096, 28 MS, One 1.2MB	2,650	
AT1103PX w/103MB Prim ID-100, 25 MS, One 1.2MB	2,800	
AT1120PX w/120MB Miniscribe 6128, 28 MS, One 1.2MB	2,900	
TT100PX BI 386 Portable		3,100
Configured Same as BI 386 w/One 1.2MB		
TT200PX w/One 1.2MB and One 360K	3,150	
TT120PX w/20MB Seagate ST-225, 65 MS, One 1.2MB	3,350	
TT130PX w/30MB Seagate ST-238, 65 MS, One 1.2MB	3,100	
TT110PX w/40MB Miniscribe 3650, 60 MS, One 1.2MB	3,150	
TT143PX w/43MB Seagate ST-251, 39 MS, One 1.2MB	3,600	
TT144PX w/43MB Seagate ST-251-1, 28 MS, One 1.2MB	3,700	
TT142PX w/42MB Miniscribe 6053, 28 MS, One 1.2MB	3,800	
TT165PX w/65MB Seagate ST-277, 39 MS, One 1.2MB	3,850	
TT172PX w/72MB Miniscribe 6085, 28 MS, One 1.2MB	4,000	
TT181PX w/84MB Seagate ST-4096, 28 MS, One 1.2MB	4,050	
TT1103PX w/103MB Prim ID-100, 16 MS, One 1.2MB	4,200	
TT1120PX w/120MB Miniscribe 6128, 28 MS, One 1.2MB	4,300	
TT1140PX w/140MB Microplus 1355, 23 MS, One 1.2MB	5,200	
TT1230PX w/230MB Prim ID-230, 12 MS, One 1.2MB	5,600	
TT1333PX w/333MB Prim ID-337, 15 MS, One 1.2MB	7,000	

All BUS Computer Systems Feature:

- Operating Manual for Monitor, Keyboard, Motherboard
- MGP, Multi I/O, Serial Cards
- Fully Set-Up and Diagnostically Tested in America
- 72 Hours Burn-In Period
- 30-Day Money Back Guaranty
- One Year Fully Warranted Labor & Parts
- Ready for Immediate Delivery
- Ship Worldwide via Federal Express, DHL, UPS or Air Cargo
- Accept Overseas Telephone Orders w/NTA/Master/AE Card or Wire Transfers



Reinforced Aluminum Frame

Three Half-Height Drive Slots

7 Expansion Slots Available

Price subject to change without notice.

Circle 204 on Reader Service Card

APRIL 1988 • BYTE 313

MUST SELL SAVE OVER 60%

Factory New!

First Quality!



IBM COMPATIBLE SOFTWARE

13 High Quality Programs!

Balance Your Checkbook, keep files, organize your finances, transfer data, get DOS assistance, and do easy or advanced word processing. This set of 13 IBM compatible Software Programs let you do all this and more! Our special arrangement with the manufacturer makes this **LOW price** possible. Act now. Order today and save!

- Programs Use MS or PC-DOS Systems 2.0 or Later.
- For Use with IBM PC/XT/AT Series and Compatibles.
- Instructions Are in Each Program to Read On-Screen or Print Out.

13 Disks Include: Credit Card Accounting, Document File, Auto Expenser, Network Builder, Video File, Business/Personal File, Recall, Budget and Income Forecaster, Multiple Checkbook Accounting, Personal Banking Reconciler, Connect, DOS Assistant and Word Processor.

Mfr. List **\$194.35**

**Liquidation
Price For Set**

\$69

Item H-3283-7347-982 S/H: \$5.00/set

IBM AND IBM/PC/XT/AT are registered trademarks of International Business Machines Corp.

Credit card customers can order by phone, 24 hours a day, 7 days a week.
Toll-Free: 1-800-328-0609

SEND TO:

COM Authorized Liquidator
1405 Xenium Lane N/Minneapolis, MN 55441-4494

Send Computer Software Set(s) Item H-3283-7347-982 at \$69 per set, plus \$5.00 per set for insured shipping and handling. (Minnesota residents add 6% sales tax. Sorry, no C.O.D. orders.)

My check or money order is enclosed. (No delays in processing orders paid by check.)

PLEASE CHECK: VISA   

Acct. No. _____ Exp. / _____

PLEASE PRINT CLEARLY

Name _____

Address _____ Apt. # _____

City _____

State _____ ZIP _____

Phone (____) _____

Sign Here _____

MAXELL

100% CERTIFIED 5 1/4" BULK DISKS

5 1/4" DS/DD **59¢**

5 1/4" DS/HD **1.59**

3 1/2" DS/DD **1.09**

Price based on quantity of 300 includes sleeves, labels and tabs.

800-222-0490

In NJ 201-462-7628

• 24 Hour Shipment •

MEGAsoft

P.O. Box 710, Freehold, NJ 07728

Circle 162 on Reader Service Card



E(P)ROM PROGRAMMER \$395

- No personality modules; Menu-driven device selection.
- Built-in Eraser/Timer option (\$50); Foam pad.
- User friendly software; Complete help menu.
- Direct technical support; Full 1 year warranty.
- Quick pulse algorithm (27256 under 60 sec).
- Programs 27xx to 1 Mbit; 25xx, 68xx; CMOS, EEPROMS.
- Micros: 8741, -2, -8, -9 OR 87(C)51 87(C)52, 8753, 9761
- IBM-PC, Apple, CPM or Unix driver; Autobaoud RS232.
- Offset/split Hex, Binary, Intel & Motorola 8,16,32 bit.
- Manual with complete schematics.

VISA MC AMEX Call today for datasheets!!

B&C MICROSYSTEMS

355 WEST OLIVE AVE. SUNNYVALE, CA 94086
PH: (408) 730-5511 FAX: (408) 730-5521 TELEX: 984185

Circle 30 on Reader Service Card

Dealers!

Network-OS LAN Systems - Includes Boards, Cabling, Terminators and Software. Two-user hardware and software for under \$1,000 list!

Close-Up Remote Communications - Support your customer without leaving your office. Authored by Cogitate for Norton-Lambert!

Context Sensitive Help for DataFlex, RM/COBOL, Clipper and dBase III - Puts your application's documentation "on line."

DataFlex Database Management - True Multi-User database for MS/PC-DOS, Unix and Xenix. Site licensing available.

Dump/Restore-XT - Seven utilities for the MS/PC-DOS user.

Call or write today for our catalog and pricing!

COGITATE, INCORPORATED

"A Higher Form of Software"
24000 Telegraph Road
Southfield, MI 48034
(313) 352-2345/Telex: 386581
Visa/MasterCard Accepted

Circle 57 on Reader Service Card

SHARE SERIAL PRINTER or MODEM between TWO COMPUTERS!

"Printer Data Splitter"
Model 232PDS **\$44.95**

"Modem Data Splitter"
Model 232MDS **\$44.95**



Now two computers can share one modem or one serial printer, and both can be connected at the same time. Self-powered from RS-232C port, may be left permanently installed.

SAME-DAY SHIPMENT! MONEY-BACK GUARANTEE!

Order Direct from Manufacturer TODAY and SAVE!



Request your **FREE B & B ELECTRONICS** Catalog of RS-232C interface and monitoring equipment.

* Terms: Visa, MC, cash orders postpaid, P.O.'s from qualified rated firms accepted. IL residents add 6% sales tax.

B & B electronics

ORDER TODAY!

15020 Boyce Memorial Drive • P.O. Box 1040 • Ottawa, IL 61360
Ottawa, IL 61350 • Phone: 815-434-0846

Circle 29 on Reader Service Card

Why waste your time formatting disks?

**Preformatted disks
save you time and money!**

Memorex • Nashua • 3M

5 1/4" (from 48c) • 5 1/4" HD • 3 1/2" • 3 1/2" HC

Call toll-free TODAY!

1-800-321-4668

In Colorado (303) 234-0871.
Open 8:00 to 5:30 Mountain Time,
Monday—Friday.

ALF

ALF Products, 1315F Nelson St.,
Denver, CO 80215

Circle 14 on Reader Service Card

LOCAL AND REMOTE I/O THE EASY WAY...

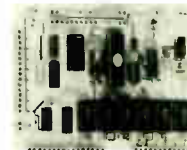

- 8 analog inputs
- 8 contact (status) inputs
- 8 relay driver outputs
- 6 optional pulse accumulators
- Base Price \$595.00

The MOJAVE LMX I/O processor communicates with any computer or terminal in ASCII over RS-232 or over built in Bell 103 or Bell 202 modems. Operates over virtually any distance over dial up or over multi-drop radio or cable. A small battery can power the LMX for up to 4 years. Larger capacity I/O processors are available.

mojave

"We're the I/O specialists!"
7100 Hayvenhurst Ave., Van Nuys, CA 91406
818-902-1611, FAX 818-902-1934

Circle 180 on Reader Service Card

Compu\$ave

Call Toll Free: 1-800-624-8949

BOARDS

Above Board 286	319	Artist 1	799
ATI EGA Wonder	172	ATI V.I.P.	269
AST Rampage XT	199	VMI IM 1024	2375
AST Rampage 286	299	BOCA RAM AT	142
AST 5251-11	559	NEC GB-1	195
Genoa EGA Plus	225	NEC MVA 1024	799
Orchids Tiny Turbo	259	Paradise Auto	132
Paradise VGA Pro	359	Paradise 480	149
Talltree J-Laser AT	419	AST 6 Pack	109
Hercules InColor	215	Zenith 449	245
Video 7 Vega VGA	269	Vega Deluxe	195
ADC Alloy BNW Everex Number 9 Orchid			CALL
Computone STB Tseng Verticom Intel			CALL

MONITORS

Samsung TTL	85	Amdek 410A	139
Mitsubishi 1371A	479	Amdek 4280	658
Mitsubishi 6905	2095	Thomson 450-A	149
NEC Multisync II	SAVE	Thomson Ultra	465
NEC Multisync	889	PGS LM300	539
NEC Multisync XL	1999	PGS Ultra	525
Sigma Laser 19	1699	Zenith 1490	619
Verticom 2 Page	1795	Taxan Crystal	1499
AST Turbovision	1429	Wyse 700	678

SCANNERS

Datacopy Model 730	1125
PGS LS-300 With DCR Software & Adapter	975
Panasonic FX-RS 505	975
AST Hewlett-Packard Taxan Others	SAVE

COMPUTERS

NEC Multispeed	1299	AST Model 300	3349
NEC Multispeed EL	1549	AST Model 340	4049
NEC Multispeed HD	2399	AST Model 390	5449
Sharp 4521	2195	AST Model 3150	6349
Sharp 4501	629	AST 286	SAVE
Sharp PC-7100	2049	AT&T 6386	SAVE
Toshiba 3100 20	2999	Toshiba 1000	765
Toshiba 1100	1419	Toshiba 3200	3695
Toshiba 1200	2329	Zenith Z-181	1599
Toshiba 5100	4695	Zenith Z-183	2095
Acer 80386: 16MHz 0 Wait 40M Drive			3065
Acer 80386: 16MHz 0 Wait 80M Drive			3595
NEC Powermate Portable 286 640K 20M			2675
Televideo 386 16 MHz 2M 1 2M Drive			2495
NEC Powermate Desktop 386 16MHz 1 2M			2675
Wyse 2108: 8 MHz 512K 1.2M Drive			1129
Wyse 2112 12.5 MHz 1M 1 2M Drive			1545
Wyse 2214 12.5 MHz 0 Wait 1 2M Drive			1945
Wyse 386: 16 MHz 1M 1.2M Drive			2575
Altos ITS Mitsubishi Samsun Tandon			CALL

TERMINALS

Link MC 1	325	Altos V	469
Link 125	369	Wyse 30	289
Kimtron KT 70 PC	359	Wyse 50	359
Televideo 965	SAVE	Wyse 60	395
Televideo 905	289	Wyse 85G	429
Televideo 955	365	Wyse 99GT	472
Visual Falco CIE Adds IBM			CALL

PLOTTERS

Calcomp 1041 GT	4395	Houston 41 42	2095
Calcomp 1043GT	6395	Ioline 3700	3099
Calcomp 1042GT	7595	Ioline 4000	4065
Calcomp 1044	10695	Houston 56A	3895
Houston OMP 52	2795	Houston 61	3295
Hewlett-P 7595	9395	Houston 62	4495
Roland 980	1199	Enter SP 1000	2665
Hewlett-P 7595	7795	Roland 880	939
Numonics Taxan Versatec Other Models			CALL

DIGITIZERS

Summa 24x36	3095	Calcomp 12 - 12	385
Calcomp 44 - 60	4695	GTCO 24 - 36	2099
Kurta IS 8.5 x 11	259	GTCO 36 - 48	2495
Kurta IS 12 x 12	322	Hitachi 11 - 11	449
Kurta IS 12 x 17	545	Summa 42 - 60	4195
Calcomp 36 48	4295	Summa 12 x 12 +	365
Numonics 20 - 20	1245	Summa 12 x 18	598

MODEMS

Multitec 224EH	388	Anchor 1200-i	78
Multitec 224EC	329	AST 9600	795
Packard Bell 1200	98	Ven-Tel 2400-I	285
Anchor 2400 E	145	Hayes 1200	275
Prometheus 2400 B 2	119	Hayes 1200B	252
Prometheus 2400G	155	Hayes 2400	409
Racal-Vadic 2400VP	395	Zoom 2400 PC	149
USR Courier 2400	319	Novation Parrot	89
USR Courier 2400E	362	USR HST 9600	649
Ven-Tel 2400 MNP	462	Ven-Tel 18000	949
Avatec Case Everex UDS Migent			CALL

PRINTERS

Citizen 120D	139	Alps 224	465
Citizen MSP40	282	Epson FX 86E	322
Citizen MSP50	379	NEC P660	422
Epson FX286E	475	Epson EX 1000	519
Diconix D150	295	NEC P760	592
Citizen 180 D	158	Epson LQ 500	358
Okidata 2410	1739	NEC PSXL	835
Panasonic 1080iM2	169	NEC P9XL	1018
Panasonic 1091iM2	189	NEC P2200	335
Panasonic 1524	549	Toshiba 321SL	489
Panasonic 1595	459	Toshiba 341SL	648
Star NX1000	174	HP Deskjet	739
DataSouth CIE Fujitsu OTC Brother TI			CALL
C Itoh Diablo Data Products Genicom			SAVE

LOW PRICES FOR LASER PRINTERS

AST Turbo P S	3045	AST Turbo EL	1765
HP Laser Jet II	SAVE	Canon 8-II	1545
Ok Laserline 6	1365	NEC 890	3199
Taxan Crystal Jet	2445	Panasonic 4450	SAVE
Toshiba Page 12	2545	Quadlaser	2399

DISK DRIVES

Miniscribe 6053	585	Bernoulli-II	SAVE
Miniscribe 30M Card	398	Miniscribe 40M	325
Miniscribe 6085	799	Plus Card 20M	559
Seagate 20M Kit	268	Plus Card 40M	765
Miniscribe 30M Kit	285	Seagate 40M	389
Toshiba 3 5" Kit	105	Seagate 4096	829
AST Alloy Everex Genoa Maynard Maxtor			CALL
Mountain Priam Tallgrass CDC Tecmar			CALL

**HOURS: MON-FRI 7AM-6PM/SAT 9AM-2PM
IN ARIZONA CALL (602) 437-4855**

CompuSave: 4207 S. 37th St., Phoenix, AZ 85040/Prices Reflect Cash Discounts And Are Subject To Change Without Notice. Major Credit Cards And Selected PO's Are Accepted. We Cannot Guarantee Compatibility. CompuSave Is A Division Of Adlanko Corporation.

Great Quality Low Low Price



PACIFIC 286-12

- 80286-12
- Zero/1 Wait
- (Zero Wait \$150 Option)
- 640K RAM
- Speed 6/8/10/12 MHz
- 200 W Power Supply
- 101 Key Enhanced Keyboard
- WA2 HD & FD Controller
- 1.2MB Floppy Drive
- SI=13.3
- OWAIT SI=15.3

MONO SYSTEM

- * W/Mono Monitor
 - * 20MB Hard Disk
- \$1,199**

CGA SYSTEM

- * W/CGA Monitor
 - * 20MB Hard Disk
- \$1,380**

EGA SYSTEM

- * W/EGA Monitor
 - * EGA Card
 - * 20MB Hard Drive
- \$1,580**

LCD-286 PORTABLE

\$1,595

- 10 MHz
- 20 MB Hard Disk
- 1.2MB Floppy Disk
- 80286-10
- 200W Power Supply
- LCD Screen
- RGB Connector
- Size 16"x9"x7"
- Weight 20 Lbs.
- 640K RAM
- Supertwist & Lighting Back

80286-10 PORTABLE

\$1,399

- * TTL Amber Screen
- * 200W Power Supply
- * 1.2MB Floppy Drive
- * 20MB Hard Disk
- * AT Keyboard
- * 640K RAM



8088-10 XT

\$780

- * 8088-10
- * 2 Floppy Drive
- * TTL Mono Display
- * AT Type Keyboard
- * 640K RAM



PACIFIC COMPUTER (818) 571-5548
120 E. Valley Blvd., #H, San Gabriel, CA 91776



(800) 346-7207 ORDER ONLY

DiskMASTER®
The Ultimate Diskette Value ...



Discover the Difference ...
2 FOR 1 LIFETIME WARRANTY

- ✓ Pkg'd in 6 different colors, bulk or boxed
- ✓ Backed by 2 for 1 Lifetime Warranty
- ✓ 100% tested and certified
- ✓ Made to exceed A.N.S.I. specs by 62.5% with a guaranteed clipping level of 65% or above
- ✓ Includes tyvek envelopes (not paper), write protect tabs and user labels
- ✓ Brand-name quality at affordable prices

5-1/4" - 48 TPI DS-HD 96 TPI
DS-DD IBM-AT Compatible

.49 BULK COLOR OR GRAY **.90**
.59 BOXED COLOR **.99**

NOW IN COLOR

ICENTECH® Premium Quality Color Diskettes

- ✓ TIMELESS WARRANTY
- ✓ 75%+ clipping level guaranteed
- ✓ Performance exceeds A.N.S.I. spec. by 88%
- ✓ Each disk 100% tested and certified
- ✓ 15 COLORS for data organization
- ✓ Pkgs include tyvek sleeves, w/p tabs, & ID labels

5-1/4" - 48 TPI DS-HD 96 TPI
DS-DD IBM-AT Compatible

.84 PLASTIC STORAGE BOX COLOR **1.39**
.63 BULK COLOR **1.15**

3-1/2" - 135 TPI DS-DD COLOR 3-1/2" - 135 TPI BLACK DS-HD

1.75 PLASTIC STORAGE BOX **4.90**

3M Call for best prices!



BASF

5-1/4" DS-HD 96 TPI
48 TPI DS-DD IBM-AT Compatible

.75 **1.25**

Nashua

5-1/4" - 48 TPI DS-HD 96 TPI
DS-DD IBM-AT Compatible

.50 ***1.00***

BOXED

BULK

32¢ 5-1/4" DS/DD 48 TPI
Exceeds ANSI specifications
+ 6¢ FOR TYVEK

ORDERING INFORMATION

TERMS: P.O. orders accepted, government and schools on net 30. SHIPPING: U.S. orders add \$3.00 per 100 diskettes or fraction thereof, add \$3.00 for COD orders.
PRICE PROMISE: We will better any lower delivered price on the same products and quantities advertised nationally.



Toll Free Order Line: **1-800-233-2477** Information Line: **1-801-561-0092**

DISC INTERNATIONAL
SUPPLY COMPANY
1376 W. 8040 S. / WEST JORDAN, UT 84088
HRS: 8 AM TO 5 PM (MTN. TIME)

HD64180 Single Board Prototyping / Control Computer

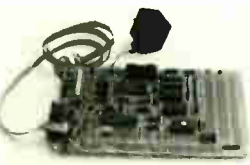

The SBC1100 is a complete computer powered by a wall transformer. Assembler, linker and debugger run on a PC. Has battery-backed RAM, battery-backed clock, power fail interrupt, SBX bus connectors, serial and parallel I/O, prototype area for up to 20 IC's. Only \$695 including serial cable, power supply, 32k of battery backed RAM, software and schematics. \$395 less software.

Z-World
1772A Picasso Avenue
Davis, CA 95616
(916) 753-3722 "Z80 Family Specialists"
In Germany: iSystem 08131/1687

Circle 302 on Reader Service Card

IBM PC/VT220

EM220 • VT220, VT102 emulation
• File Transfer
• 132 Column modes
• Color Support
• Hot Keys
\$169

TEK 4010/4014

EM4010 • Tektronix 4010 emulation
• VT220, VT102 emulation
• Picture files
• High resolution hardcopy
• Supports IBM, IBM Enhanced, Hercules, Tecmar and AT&T.
\$249

DCS
3775 Iris Ave., Suite 1B
Boulder, CO 80301
(303) 447-9251

In trademarks: VT100 - Digital Equipment IBM PC, XT - IBM Corp.

Circle 87 on Reader Service Card

EPROM/PAL Programmer



- * PAL MODULE **\$295**
 - Programs 20 & 24 pin MMI (A,B), NS TI PALS
 - Read JEDEC file format
 - Security, DIR, LOAD, SAVE, EDIT, READ, WRITE, VERIFY, User friendly menu driven SAW
- * EPROM MODULE (1, 4, 8 socket) **\$145**
 - 16K to 1024K EPROM, CMOS EEPROM.
 - Read Intel, Motorola, TEK HEX file
 - Very fast (Quick pulse), reliable, easy to use
- * BIPOLAR ROM MODULE **\$295**
 - MMI, NS, TI & Signetics parts
 - Read Intel, Motorola, TEK HEX file
- * 8741/42/48/49/50 Module **\$195**
 - 1, 4, 8 socket module available
 - 8748 Disassembler included
 - Read Intel, Motorola, TEK HEX file
- * 8751/52/252/44 Module **\$245**
 - Normal, intelligent programming algorithm
 - Read Intel, Motorola, TEK HEX file
- * TTL & MEMORY IC TESTER MODULE **\$195**
 - Test almost TTL, CMOS, Dynamic, Static IC's
 - Auto search for unknown IC part No.
 - User can make his own test pattern
- * INTERFACE CARD & CABLE **\$50**
 - This card is common to all above modules
 - Fits in any PC/XT/AT or compatibles
 - Space saving half size.

XELTEK
473 Sapena Ct., #24 Santa Clara, CA 95054 (408) 727-6995 CA residents add 6.5% tax. Add \$5 for SH

Circle 299 on Reader Service Card

C See how well you can program for

Z80 or HD64180

This professional, IBM-PC based, compiler is a complete implementation of the "C" language for the Z80 or HD64180 microprocessor. Includes features such as: function prototyping, 31-character names, single precision floating point, full library source, M80-L80 and SLR Systems compatibility, etc. Hi-Tech™ "C" has been established for years in Australia. Pricing from \$295.00. We also have Z80/HD64180 co-processor cards for IBM-PC and PC/AT. Call for a full catalog of Microprocessor development tools.

Z-World
1772A Picasso Ave.
Davis, CA 95616
(916) 753-3722 "Z80 Specialists"
In Germany: iSystem Tel: 08131/1687

Circle 303 on Reader Service Card

MOTION CONTROL DREAM



\$75 per axis

4 AXIS VERY SMART STEPPER CONTROLLER

- 49 high level commands in plain English.
- Macros. Battery backup for memory.
- Learn mode with optional "Teach Pendant"
- 4 axis simultaneous control. You select the ramps units, speeds, drive types...
- Input for Limit Switches, Panic button, etc.
- On board multitasking compiler.
- Works with any computer with a Centronics port or with the Alpha Products A-BUS system

See page 327 for details of the SC-149

ALPHA Products

Circle 15 on Reader Service Card

Temple Datatap™ Graph 3.1 for IBM and HP9000, SUN3

A NEW STANDARD FOR SCIENTIFIC GRAPH SOFTWARE

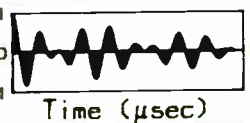

Unparalleled power, interactivity & ease of use

USERS, DEALERS, VARS & MANUFACTURERS

Developed at Temple University
Mihalitsin Assoc. (215) 646-3814
600 Honey Run Rd, Ambler, PA 19002

Circle 175 on Reader Service Card

LETTER QUALITY PRINTER

Why pay \$1149 for a C.Itoh
STARWRITER™ F-10

DAISYWHEEL PRINTER MANUFACTURED BY C.ITOH

When our 40 cps letter quality daisywheel printer from the same mfg. is only

\$299⁰⁰ ea.

These printers were originally priced to sell at over \$1100. Through a special arrangement MEAD has purchased these units from a major computer manufacturer and is offering these printers at a fraction of their original cost.

LIMITED QUANTITY ONLY 665 LEFT!



3 MONTH WARRANTY

OPTIONS

- 6 ft. Serial Cable \$ 19⁰⁰
- AT or XT RS232/Serial Interface 29⁰⁰
- Bidirectional Tractor 149⁰⁰
- Cut Sheet Feeder 199⁰⁰

STANDARD FEATURES

- 40 CPS • Accepts Paper to 15 inches
- Form Length and Pitch Set from Control Panel
- Industry compat. ribbon, printwheels and control commands
- RS232 Serial Interface

TECHNICAL DATA

Printing Speed: 40 CPS; 38 CPS Shannon
Printing Method: Full character
Number of char/wheel: 96
Pitches: 10, 12, proportional
Fonts: DIABLO/QUIME compatible printwheels
Characters/line: 136/110 pitch
Vertical / Horizontal increment: 1/48 in. / 1/120 in.
Printing Modes: Serial-unidirectional; Line-bidirectional
Input buffer: 2K standard

Carriage return time: 900 ms (15 IPS)
Noise: 65 dBA
Ribbon Type: Cartridge DIABLO compatible
Ribbon Quality: Multi strike film, fabric
Ribbon Color: Black
Pape Feed: Friction Platen
Optional: Bidirectional Forms Tractor; Cut Sheet Feeder
Number of Copies: 1+ 2
Paper Speed: 4.2 IPS

Max. paper width: 406mm (16 in.)
Operator controls/indicators
Switches: ON/OFF Line; Form feed/Line feed
TOF/Reset; Pitch selector; Format selector
Indicators: Power On; On line; Error
Communication
Interface: RS-232C/CCITTV.24
Protocols: Data terminal Ready/Busy; XON/XOFF; ETX/ACK
Baud Rates: 300-2400

HARD DRIVES



COMPLETE KITS

- ST225 20Meg w/cont. & Cables 279⁰⁰
- ST238 30Meg w/cont. & Cables 299⁰⁰
- ST251 40Meg 1/2 HT 40 Mil w/software 429⁰⁰
- ST4051 40Meg Full HT w/software 459⁰⁰
- ST4026 20Meg Full HT 40 Mil 279⁰⁰
- ST4096 80Meg Full HT w/software 799⁰⁰

1 Yr. Warranty
Bitcom Software

MODEMS



ALL HAYES
COMPATIBLE

- EV-920 EverCom 12 300/1200 bps 84⁰⁰
- EV-940 Internal 300/1200/2400 179⁰⁰
- EV-945 External 300/1200/2400 239⁰⁰
- EV Pocket Modem 139⁰⁰

US ROBOTICS — COMPLUS — ADDA

- 1200 Baud w/Bitcom 1 yr. Warranty 69⁰⁰
- 1200 Baud External, 1 yr. Warranty 119⁰⁰
- 2400 Baud Internal, 1 yr. Warranty 149⁰⁰

COPROCESSORS

- Intel 8087 5Mhz 102⁰⁰
- Intel 8087 8Mhz 149⁰⁰
- Intel 80287 6Mhz 179⁰⁰
- Intel 80287 8Mhz 249⁰⁰
- Intel 80287 10Mhz 289⁰⁰
- Intel 80387 16Mhz 498⁰⁰
- Intel 80387 20Mhz 787⁰⁰

MEMORY UPGRADES

- 41128 160NS 1⁹⁵ ea
- 256k 100NS 9⁹⁵ ea
- 256k 120NS 8⁹⁵ ea
- 256k 150NS 8⁴⁵ ea

CAT™ 8MHZ

BASE SYSTEM

- 256K (Opt. 640K) • 150 Watt Power Supply • AT Style Keyboard
- 4.77 or 8 MHZ Keyboard Selectable
- FDC Controls 4 Disk Drives
- 8087 Socket • 350K Floppy Drive



1 Year Warranty



\$369⁰⁰

CAT™ 286-10

BASE SYSTEM

- 512K (120 NS) • 200 Watt Power Supply • AT Style Keyboard
- Western Digital Controller • 1.2 Meg Floppy • Legal Bios w/manuals • Systems Documentation • 1 yr war. • Clock/Calc



11.3 Nortons SI

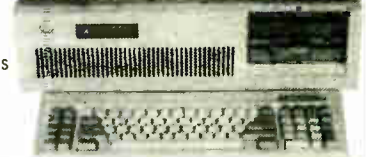

\$898⁰⁰

CLOSEOUT SALE 50%-100% OFF LIST PRICE ON ALL ITEMS LISTED BELOW

MITSUBISHI

1.2 meg Disk Drive

- 5 1/4" Black Face Drive • Half HT Floppy • New — 90 Day Warranty
- List 199⁰⁰ Mead 79⁰⁰

SEAGATE 10MEG HARD DRIVE

- Half Height/Factory Fresh
- 65 Mil. Sec. • 3 Month Warranty
- List 299⁰⁰ Mead 129⁰⁰
- 5 Meg. full HT 79⁰⁰

LQ1500 EPSON TRACTORS

- Epson discontinued these thus Mead has acquired last 450 units • Only 1100 left
- List 99⁰⁰ Mead 49⁰⁰
- Epson 3 1/2" Disk Drive 99⁰⁰

3M EQUIVALENT DATA CARTRIDGES

- DC 300 XLP • 45 Meg (450 ft)
- Individually Wrapped
- 5 Year Warranty
- List 39⁰⁰ Mead 14⁰⁰ ea

INTEL ABOVE BOARD

- 2010 — 128K Exp. to 2Meg • PC AT Compatibles • Provides Conventional-Expanded and Extended
- List 545⁰⁰ Mead 199⁰⁰

TANDON TM100-2A

- This was the original drive used by IBM
- Full Height
- 360K
- List 249⁰⁰ Mead 89⁰⁰

PRINTER STAND

- Manufactured by Epson
- List 25⁰⁰ Mead 9⁰⁰

NEC COMPOSITE MONITOR

- 12" Green Screen • JB1201 New 90 Day Warranty • Works w/IBM (off color adaptor) SANYO / APPLE
- List 199⁰⁰ Mead 59⁰⁰

800-654-7762

SALES: 7 a.m.-6 p.m. PST

702-294-0204

CUSTOMER SERVICE / ORDER STATUS:
9 a.m.-4 p.m. PST

FAX 702-294-1168

Trademarks are Registered with their respective Co.'s.



1000 Nevada Hwy. • Unit 101 • Boulder City, NV 89005

NO SURCHARGE FOR MC/VISA

TERMS:

- MC • VISA • COO • CASH
- Purchase Orders from Qualified Firms
- Personal Checks • AE add 4%



SHIPPING: (min. 6²⁵) UPS • Fed Express

DISKS ToGo

100% certified and tested. Error free life time warranty. All disks include generic white box, Tyvek sleeves, labels, write protect tabs, shrink wrapped.

- 5.25 Black Disks, DS/DD36 ea.
- 5.25 Color Disks, 8 Colors Available, DS/DD46 ea.
- 5.25 Black Disks, DS/HD82 ea.
- 5.25 Color Disks, 8 Colors Available, DS/HD94 ea.
- 3.5 Blue or Gray Disks, DS/DD98 ea.
- 3.5 Color Disks, 5 Colors Available, DS/DD 1.17 ea.

BULK MEDIA AVAILABLE

- 5.25 DS/DD32 ea.
- 5.25 DS/DD Colors42 ea.
- 5.25 DS/HD78 ea.
- 5.25 DS/HD Colors90 ea.
- 3.5 DS/DD Blue or Gray95 ea.
- 3.5 DS/DD Colors 1.07 ea.
- 5.25 Tyvek Sleeves03 ea.
- 5.25 Paper Sleeves02 ea.
- 5.25 Label Sheet08 ea.
- 3.5 Label Sheet20 ea.
- 5.25 White Box15 ea.
- 3.5 White Box14 ea.

LABELS ToGo

CONTINUOUS FORM LABELS

Size	Across	Box Qty.	Price Per/1000
2 3/4 x 7/16	1 across	10,000	\$1.95
2 3/4 x 7/16	4 across	20,000	\$1.95
2 1/2 x 15/16	1 across	5,000	\$2.18
2 1/2 x 15/16	3 across	15,000	\$1.98
3 x 15/16	4 across	20,000	\$2.00
3 x 15/16	4 across	20,000	\$2.05
3 1/2 x 15/16	1 across	5,000	\$1.90
3 1/2 x 15/16	2 across	10,000	\$1.90
3 1/2 x 15/16	3 across	15,000	\$1.90
3 1/2 x 15/16	4 across	20,000	\$1.90
4 x 15/16	1 across	5,000	\$3.21
4 x 15/16	3 across	15,000	\$3.21
4 x 1-7/16	1 across	5,000	\$3.25
4 x 1-7/16	3 across	15,000	\$3.25

Prices subject to change without notice.

1040 Broadway
Westville, NJ 08093

609-456-6996

FAX# 609-456-7172

All orders F.O.B. Westville, NJ.
COD orders add \$2.20. Visa & MC accepted.
All orders shipped same day.

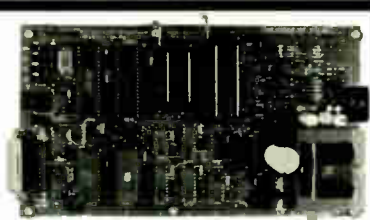

UNIVERSAL E(E)PROM PROGRAMMER KITS FROM \$95

- No personality modules; Menu-driven device selection.
- On board power supply (110/220V AC).
- Direct technical support: Full 1 year warranty.
- User friendly software; Complete help menu.
- Quick pulse algorithm (27256 under 60 sec).
- Programs: 27xx to 1 Mbit: 25xx, 68xx, CMOS; EEPROMS.
- Micros: 8741, 8742, 8748, 8748H, 8749, 8749H & more.
- IBM-PC, Apple CPM or Unix driver; Autobaud RS232.
- Off/On/plit Hex, Binary, Intel & Motorola 8,16,32 bit.
- Manual with complete schematics.

VISA MC AMEX Call today for datasheets!!
B&C MICROSYSTEMS
355 WEST OLIVE AVE. SUNNYVALE, CA 94086
PH: (408) 730-5511 FAX: (408) 730-5521 TELEX: 984185

Circle 32 on Reader Service Card

AMX 86

KADAK's engineers bring years of practical real-time experience to this mature

MULTI-TASKING SYSTEM (version 2.0)

for the IBM® PC, PC/XT and PC/AT

- No royalties
- IBM PC DOS® support
- C language support
- Preemptive scheduler
- Time slicing available
- Source code of the C interface and device drivers is included

- Intertask message passing
- Dynamic operations - task create/delete - task priorities - memory allocation
- Event Manager
- Semaphore Manager

AMX86™ operates on any 8086/88, 80186/88, 80286 system

Demo package \$25 US	KADAK Systems Ltd.
Manual only \$75 US	206-1847 W Broadway
AMX 86 system \$2195 US	Vancouver B.C. Canada
(shipping handling extra)	V6J 1Y5
	Telephone (604) 734-2796
	Telex 04-55670

Also available for \$400. 750 80000

Circle 141 on Reader Service Card

One memory plugs into two computers!

Dual Port RAM

Plugs into existing 28 pin Static RAM sockets allowing both computers access to the same memory simultaneously

HiTech Equipment Corp
9560 Black Mountain Road
San Diego, CA 92126
(619) 566-1892

Circle 124 on Reader Service Card

World Radio History

Industrial — PC Cards made in Germany

- Multiplex - card, 32 channel to 1 channel \$167.
- Bus-extender - card for PC/XT \$58.
- Slot - expansion card for 4 slots \$148.
- Printer-buffer-card with 64 KB on board \$153.
- EGA BAS Adapter, set RGB to BW/Video \$69.
- IEEE - 488 card \$448.
- RS 422 serial card \$195.
- 35 MHz AD/DA - converter with 1 channel 8 bit \$317.
- AD/DA 12 bit 16 A/D and 1 D/A channel 60 us \$143.
- AD - converter with 8 bit resolution 1 channel \$75.
- Prototype card with 24 TTL-I/O (8255 PIO) \$114.
- Relais - card with 8255 and 8 TTL I/O's \$144.
- Stepmotor - card for 2 motors & software \$172.
- Frequencycounter card 300 HZ - 1300 Mhz for PC/AT \$172.
- Video-digiter with 256 shades and 1024 pix. \$574.
- SSTV-card for sending picture on air or phone \$190.
- 48 I/O's with 3 x 16 bit-counter \$143.
- Opto coupler-card with 16 in / 8 out channel \$213.
- Eprommer 2716. . . 27512 with textool ext. \$230.
- PAL - programmer for PC/XT/AT & Software \$462.
- 3. 5 MB ram expansion board for AT without ram's \$196.
- SC-NET 1000 networkcard for Novell Software \$263.
- Modem card for phone PC/XT 300/1200 bd. & softw. \$196.
- Game I/O card with 2 inputs, short card \$45.
- Joy-Stick for PC \$20.
- CCD - industrial camera 500 x 500 pixel, 3 lux \$1038.
- RS 232 to RS 422 converter for long wire \$288.
- Multi-serial card with 4 ser. RS 232 ports \$135.
- Bar-code-pen with interface \$458.
- Fax - card, group 3, max. 9600 bpd. \$1682.

Please ask for INFO. Distributors required.
Payment per lift to our Dresdner Bank,
bankno. 395 800 41 account no. 156 164 900

COMPUTER-RING
Heinrich Koller Electronic Phone 02235-76707
Steinstr. 22, P.O. Box 1127 Fax 02235-70248
D-5042 Erfstadt W.GERMANY Telex 888 2134

Circle 315 on Reader Service Card

FREE!

Turn-key PC Systems Handbook

NEW 1988
Supplement Edition

Save Time and Money
Over 1000 Hard-to-find Hardware and Software Items of Special Interest to Technical PC Users

- RS 232/IEEE 488 Networks
- Stopping & Servo Motor Controls
- Ruggedized PCs
- Rack Mtg 80286 & 80386
- Laboratory Automation
- 1 MHz A/D
- Digital Scopes to 200 MHz
- High Speed Bus Adapters
- Waveform Synthesizers
- Data Loggers
- PC Bus Expansion Chassis
- And Much More

A How-to-Handbook that enables you to configure the BEST products from the world's leading PC hardware and software vendors into task free turn-key system solutions that meet your needs.

Toll Free Hotline for application assistance and convenient one stop shopping at competitive prices. 100% Satisfaction Guaranteed.

144 Pages Available Now

Call or write for a FREE handbook today!
203-786-5151
Outside USA include \$15 postage

CyberResearch Inc.
P O Box 9565 New Haven, CT 06536
Fax: 203-786-5023 Telex: 9102501037

Circle 74 on Reader Service Card

ZSTEM VT240 Smart Terminal Emulator and Communications Program for the IBM XT, AT, PS/2 and compatibles

- Comprehensive VT240 & VT241 emulation at 2-4 times the speed.
- Complete VT240 ANSI emulation including true double-high double-wide characters, true smooth scrolling, national/multinational support, and downloadable fonts.
- At least 128 columns displayable in 132-column mode on the CGA, EGA, VGA, and Hercules adapters.
- Full Tektronix 4010-4014, sixel and ReGIS graphics support.
- KERMIT and XMODEM transfers.
- Ungermann Bass Net One and VMS Services for MS-DOS support.

VT241

\$295*

*plus your PC or compatible

Also available VT220, VT100, D400, 4014 emulators and the PowerStation™ VT200 style keyboard.

KEA SYSTEMS LTD.
Suite 412, 2150 West Broadway, Vancouver, B.C. Canada V6K 4L9
Telephone (604) 732-7411 Telex: 04-352848 VCR Fax: (604) 732-0715
Order Toll Free 800-663-8702
30 day money back guarantee

AMEX/MC/VISA

Circle 143 on Reader Service Card

COMPLETE 12 MHz ZERO-WAIT 286 SYSTEM WITH 32MB HARD DRIVE!

Can you believe it? *Yes you can!*

32 MB hard drive. 12 MHz ZERO Wait State. Fully AT compatible. Our *complete* 286 system ready to plug in and fly right out of the box! At the amazing price of only \$1,295!

How is it possible? By buying direct from the manufacturer that's how. ZEOS International offers you the finest, best-backed fully AT compatible systems available . . . at *factory direct* prices.

We think you'll agree, this is the very best value you'll find anywhere.

And every ZEOS® system is fully assembled, burned-in and tested in our own laboratories. We would like to build one for you. Give us a call today!

OTHER ZEOS OPTIONS:

- Basic System Only: Everything except a hard drive. \$995
- Complete 60+ MB hard drive system! Only \$1,595
- EGA Upgrade. 14" EGA color monitor with ZEOS EGA card. Fully tested. Add \$495
- Many other drives and options available. Call Toll Free for details, 800-423-5891.

ZEOS® Customer Assurance Program

Compare not only our features but the ZEOS® Customer Assurance Program as well: 1. Full refund within 30 days of shipment if you are not absolutely satisfied. 2. One full year limited warranty on parts and labor. 3. Federal Express replacement of any failed parts for your first year of ownership.

ONLY
\$1,295⁰⁰

NEW! ZEOS® 386 Motherboards!

ZEOS® 80386 motherboards, 16 or 20 MHz, Zero-Wait state. Up to 16MB of 32-bit memory *on board*. Plus *on board* options include Weitek 1167 Math Co-processor, 80387, 80287, FDC and SCSI HDC. Ideal for upgrades and OEM systems. Only \$1395.00

STANDARD FEATURES INCLUDE:

- 12" High Resolution Amber Screen TTL Monitor with Tilt & Swivel base. Easy on the eyes!
- 80286 CPU Zero-Wait State Motherboard with 8 I/O slots and socket for 80287 Math Co-processor.
- 6/12 MHz Dual Speed, Keyboard Selectable, Zero Wait-State. Phoenix BIOS!
- Deluxe AT-style Case, Security Keylock, Reset Button, LEDs.
- Full 101 key AT-style Keyboard, Mechanical Tactile with Pleasant "Click" Feel.

- Heavy Duty 200W Power Supply.
- Real Time Clock/Calendar with Battery Backup.
- 512K, 80ns Memory expandable to 1MB on the Motherboard.
- Hard and Floppy Drive Controller.
- Serial and Parallel/Printer Ports.
- 1.2 MB High Capacity Floppy Drive.
- 32MB hard drive.
- High Resolution Monochrome Graphic Card.
- FCC approved.

And More!

AT is a registered trademark of IBM Corporation.

Due to currency fluctuations and other factors beyond our control, prices are subject to change without notice.

Call for complete warranty details.

In Minnesota Call: 612-633-4591
FAX Orders Dial: 612-633-2310



Circle 300 on Reader Service Card

**ORDER NOW TOLL FREE
800-423-5891**

ZEOS

INTERNATIONAL, LTD.

530 5th Avenue NW, Suite 1000
St. Paul, MN 55112

APRIL 1988 • B Y T E 319

MONTGOMERY GRANT

Bye 4/88

IN N.Y.S. (& outside Continental U.S.)
(212) 594-7140

FOR ORDERS AND INFORMATION CALL TOLL FREE
1-800-345-7059
1-800-345-7058

OR WRITE:
MONTGOMERY GRANT
MAIL ORDER DEPT.
P.O. BOX 58
BROOKLYN, N.Y., 11230

FOR CUSTOMER SERVICE
CALL MON-FRI/9 AM-4 PM
(718)965-8686
FAX NO. 2125641497
TELEX NO. 422132HMOLLER

OPEN 7 DAYS A WEEK FOR ORDERS: MONDAY-
FRIDAY:9AM-7PM / SATURDAY & SUNDAY: 9:30AM-6PM EDT

Circle 181 on Reader Service Card

EPSON EQUITY 1+

IBM PC/XT COMPATIBLE PACKAGE

- 640K RAM w/Clock Calendar • 360K Drive
- Keyboard
- Serial/Parallel Ports • Box of 10 Diskettes
- 12" High Resolution Monitor

\$769

Same Pkg. w/One Floppy **\$1049**
& 20 MB Hard Drive

Same Pkg. w/Two 360K Floppy Drives **\$849**

IBM XT

HARD DRIVE PACKAGE

IBM XT Computer-IBM Keyboard-256K RAM Expandable to 640K • 360K Disk Drive • 20MB Hard Drive • Package of 10 Diskettes (Monitor Optional)

\$1499

IBM XT PKG W/2 360K FLOPPY DRIVES...\$1279

IBM PC PACKAGE

IBM PC Computer - IBM Keyboard - 256K RAM Expandable to 640K • One floppy 360K Drive - 12" Monitor - Serial/Parallel Ports

\$899

IBM PERSONAL SYSTEM 2 MODEL 50

w/720K Floppy Drive & 20MB IBM Hard Drive

\$2599

Personal System II Model 25.....\$1049
PS II Model 25 w/Color Monitor.....\$1299
PS II Model 60 w/44MB Hard Drive & 1720 k Floppy Drive.....\$3599

IBM Personal System II Monitors

8503 Mono.....\$249
8512 Color.....\$479
8513 Color.....\$529

IBM PERSONAL SYSTEM 2

MODEL 30 PACKAGE

- IBM Computer • Two 720K Drives
- 640K RAM • Built-in Graphics
- Serial/Parallel Ports • Optional 12" Monitor

\$1199

PS/2 Model 30 w/720 Floppy Drive & 20MB IBM Hard Drive **\$1599**

NEC POWERMATE I PACKAGE

IBM PC/XT/AT COMPATIBLE

• 800286 8 MHz Processor • 640K RAM • 1.2 MB Floppy • 12" Monitor

\$1349

w/20MB Hard Drive.....\$1579

POWERMATE II with monitor **\$1879**

HARD DRIVES

HARD DRIVES & CARDS

SEAGATE
20MB 1/2 Ht. w/Controller.....\$279
30MB 1/2 Ht. w/Controller.....\$319
40 MB 1/2 Ht. w/Controller.....\$449

MINISCRIBE
40MB 1/2 Ht. w/Controller.....\$369
CMS 20MB Card.....\$339
CMS 30MB Card.....\$379

SANYO PR-3000

L.Q. Daisy Wheel Printer

\$99.50

PRINTERS

EPSON	STAR
FX-86E.....\$319.95	NX-1000.....\$169.95
FX-285E.....\$429.95	NX-15.....\$289.95
FX-800.....\$429.95	NB-2410.....\$399.95
LQ-800.....\$389.95	NB-2415.....\$559.95
LQ-850.....\$489.95	IBM Pro-Printer II.....\$369.95
LQ-500.....\$329.95	OKIDATA
LQ-1050.....\$659.95	OKI-120.....\$189.95
EX-800.....\$419.95	OKIMATE20.....\$139.95
EX-1000.....\$459.95	OKIDATA180.....\$219.95

PANASONIC
1080-II.....\$159.95
1082.....\$279.95
1091-II.....\$199.95

TOSHIBA
321-SL.....\$479.95
341-SL.....\$649.95
351-II.....\$799.95

Laserjet Series II

\$1649

IBM PC/XT COMPATIBLE PACKAGE

Keyboard 640KRAM Power TurboSpeed 4.7/88 MHz Two 360K Floppy Drives MS-DOS • Mono-Graphics Card High Resolution Mono Monitor • FREE Word Processing Software

\$679

BLUE CHIP IBM PC/XT COMPAT. PKG. W/MONITOR

512K RAM Expandable to 640K • 360K Floppy Disk Drive • 12" Monitor • Box of 10 Diskettes • Game Disk

\$499

W/20 MB HARD DRIVE...\$769

Commodore PC10-1

IBM PC/XT COMPATIBLE PACKAGE

- PC10-1 Computer
- 512K Expandable to 1M
- 360K Disk Drive
- Enhanced Keyboard
- Serial & Parallel Ports • 12" Monitor & Adapters • Package of 10 Diskettes
- All Hook-up Cables

\$529

Same Package with 20MB Hard Drive **\$789**

VENDEX HEADSTART

PC/XT COMPATIBLE

4.7 MHz • Dual Floppy Drives • 7 Expansion Slots • 512K Expandable to 768K • Parallel & Serial Ports • Mouse • Available in Color or Monochrome System • Over 1000 Worth of Software • NO CHARGE!

Mono System **\$899** Color System **\$1049**

MODEL D PACKAGE

- 512K RAM Computer • Keyboard
- 360K Floppy Disk • 4.7-7.16 MHz
- 12" Monitor • 8088-2 Processor

\$799

Same Package with 20 MB Hard Drive.....\$1049

Apple PACKAGES

- Apple IIC or IIE
- Keyboard • 5.25" Disk Drive • 12" Monitor • All Hook-up Cables and Adaptors • Package of 10 Diskettes

APPLE IIC **\$579** APPLE IIE **\$799**

Apple IIGS Computer • 3.5" Drive • Apple RGB Color Monitor • Pkg. of 10 Diskettes • All Cables & Adapters • Apple Software

Apple IIGS Computer Package.....\$1579
IMAGEWRITER II Printer.....\$459
MAC SE Computer w/Dual Drive.....\$1949
MAC SE Computer w/20MB APPLE Hard Drive.....\$2599
APPLE MAC II.....CALL

LAPTOPS MONITORS

TOSHIBA

TOSHIBA 1000
720K Floppy Drive • 512K RAM • 4.77 MHz • Super Twist LCD Screen

\$778

NEC MULTISPEED H.D.....	\$2199
NEC MULTISPEED EL.....	\$1399
NEC MULTISPEED.....	\$1099
TOSHIBA 1200.....	\$2299
TOSHIBA 1100/20.....	\$3050
TOSHIBA 1200.....	\$2295
ZENITH 181.....	\$1449
ZENITH 183.....	\$1999
SPARK by DATAVUE.....	\$1099
640K w/2720K DRIVES.....	\$1199
SPARK EL.....	\$1199

COMMODORE 1080 RGB Color Monitor.....	\$259
THOMPSON 14" CGA Monitor.....	\$289
THOMPSON ULTRA SCAN.....	\$469
MAGNAVOX EGA Monitor.....	\$339
with EGA Card.....	\$459

Commodore **AMIGA 500** NOW IN STOCK!

Commodore **AMIGA 2000** LOW PRICE!

AMIGA 1010 DISK DRIVE
AMIGA 1020 DISK DRIVE
AMIGA 501 • 512K EXPANSION

1084 RGB COLOR MONITOR
BRIDGE CARD - RF MODULATOR
THESE & ALL OTHER PERIPHERALS IN STOCK

Commodore 128 PACKAGE

Commodore 128 Computer • Commodore 1571 Disk Drive • Commodore 1902 Color Monitor • Commodore 1515 80 Column Printer

\$729

Commodore 64/c PACKAGE

Commodore 64/C Computer • Commodore 1541 Disk Drive • Computer Printer • 12" Computer Monitor

\$399

AMIGA 500 w/1080 **\$769**

AMIGA 500 w/1080/1010 **\$979**



Credit checks, bank checks, Mastercard, Visa, AMEX, Diner's Club, Carte Blanche, Discover Card and C.O.D.'s accepted. No additional surcharge for credit card orders. Non-certified checks must wait 1-4 weeks clearance. Money orders are non-certified checks. Please add \$3. for shipping and handling. Minimum shipping charge is \$10. APO/FPO and PO Box addresses—please call for shipping charges. N.Y. residents add applicable sales tax. Prices and availability subject to change without notice. Not responsible for typographical errors. Return of defective merchandise must have prior authorization number, or returns will not be accepted. IBM PC/XT are registered trademarks of International Business Machines Corp. All orders can be shipped Air Express—call for details. For your protection, we check for credit card theft.

World Radio History

NO ADDITIONAL SURCHARGE FOR CREDIT CARD ORDERS

WE INVITE EDUCATIONAL ACCOUNTS

WE INVITE CORPORATE ACCOUNTS

Okidata ML 82A and ML 83A Printers:

IBM EMULATION "PLUS"
Epson Compatibility/Letter Quality

PC-WRITER

ONLY
\$99.00

plus shipping & sales tax (Calif addresses)
Money back guarantee

- FULL EMULATION OF THE IBM PC GRAPHICS PRINTER
- LETTER QUALITY PRINTING
- ELITE CHARACTER PITCH
- SUBSCRIPTS/SUPERSSCRIPTS
- DOT ADDRESSABLE GRAPHICS
- FRONT PANEL FEATURE SELECTION

To Order: (714) 261-0228
Dealer Information Available

RAINBOW TECHNOLOGIES, INC.

18011-A Mitchell So., Irvine, CA 92714
(714) 261-0228 Telex: 386078

Circle 241 on Reader Service Card

JKL's APRIL BARGAINS

JKL AT 40-25: 25 MHz 80386, 40 Meg HD \$9100.00

JKL AT 80: 80386 (16 MHz) case, 200W P.S., Keybd, 80 Meg HD, 1.2 Meg Floppy, VGA, EGA, ULTRASYN Monitor, 2.5 Meg Byte Ram \$5369.00

JKL AT 30-10: 80286 (10 MHz), 30 Meg HD, Cir. Monitor, EGA, CGA, 200 P.S., Keybd., Floppy \$1500.00

JKL XT 30-10: 8088 (10 MHz), Case, 150W P.S., Keybd, Parallel, Serial, Clock, Floppy, 30 Meg HD, EGA, Mono Monitor \$1050.00

Price & availability subject to change without notice



Jack Krochmal, Ltd.
Computers,
Peripherals & Supplies
717 Ellsworth Drive
Silver Spring, MD 20910
(301) 565-2910 / 587-3232

Toll Free: 1-800-JK3-0386

Circle 136 on Reader Service Card

REAL WORLD I/O
For PC/XT/ATs

AD200 - 4 channel, 12-bit A/D board, 10 kHz sampling rate, Instrumentation amp front end \$239



AD500

ADA300 - 8 channel, 8-bit A/D, single D/A; 24 programmable digital I/O lines \$239

AD500 - 8 channel, 12-bit A/D board, Software programmable gains of 1, 10, and 100. Highly accurate integrating converter \$239

AD100 - Single channel version of AD500. 10 digital I/O lines. Same accuracy and programmable gains \$149

DA600 - Fast settling 12-bit dual D/A converter \$169

DG24 - Digital I/O board with 24 TTL lines, configurable in software \$95

XB40 - Easy connect extender prototype board with terminal strips \$49

DEM discounts available

Real Time Devices, Inc.

1930 PARK FOREST AVENUE
P.O. BOX 908
STATE COLLEGE, PENNSYLVANIA 16804

(814) 234-8087

Circle 243 on Reader Service Card

9-Track Tape Subsystem
for the IBM PC/XT/AT



Now you can exchange data files between your IBM PC and any mainframe or mini-computer using IBM compatible 1600 BPI 9-Track tape. Unit can also be used for disk backup. Transfer rate is up to 4 megabytes per minute on PCs and compatibles. Subsystems include 7" or 10 1/2" streaming tape drive, tape coupler card and DOS or XENIX compatible software.
Prices start at \$2,995.

QUALSTAR

9621 Irondale Ave., Chatsworth, CA 91311
Telephone: (818) 882-5822

Circle 231 on Reader Service Card



Everex AT 1800
Basic System \$899
(MADE IN U.S.A. with quality)

- Fully compatible with IBM AT
- 6/8 MHz selectable 8 slots
- 512K on IM mother board
- 195 watt power supply 100/220
- Clock/Gate: Everex HD510 core
- FCC class B approved
- 48 Hour factory high temp dynamic burn-in
- 1.2 MEG Teac Dr. Max. speed AT keyboard
- Rams: Autocad, Lotus, Kern, Novell, et al. prog. Software
- 200 pages of documentation (written in U.S.A.)
- 80287 CD-Processor socket
- 40,000 units instaled with customer report on file
- Made in U.S.A. by Everex with 1 year warranty

Mini System (Basic Sys. + Monographics card w/soft port) Hi-Res monitor w/stand \$989
Upgrade Options: (Call for options not listed)
A: Everex 20M/40M/70M Harddisk \$800/\$1500/\$2400 B: 80MHz \$100

System 800 XT	\$595	Schwab AT 10MHz, 0' wait	\$799
	\$799 w/20M		\$899 complete system
• Fully IBM XT Compatible		• 80286-10 108"	
• 8288 & 778 MHz, 360K Dr		• AMI BIOS 512K 1.2 meg Test	
• 640K on Motherboard		• 200 w. P.S. Max/switch KB	
• Max. Switch Keyboard		• Hi-Res Mon. Graphics card w/ibo	
• Hi-Res Mini w/Stand		• 8 slots clock/calendar	
• Free set-up utility support 1.44 meg dr		• Free set-up utility support 1.44 meg dr	
• Video: Crystal Graphics Card w/ibo		• USA made motherboard	

Schwab Computer Center
"The Everex Store" - Authorized Everex Dealer
3282 El Camino Real, Santa Clara, CA 95051
408 241 1210
Daily UPS M-F 10:30 A.M. - 5:00 P.M. VISAC/MC
Dealer/Consultant Inquiries Welcome

Circle 247 on Reader Service Card



... at your command
Master Switch is sophisticated yet flexible. Several computers can access one another or share printers and modems. Use serial or parallel interfaces, up to nine ports. The buffer is expandable up to one megabyte. Access a job control menu from each computer to view the queue or cancel, hold, and release jobs. Many other features.

MasterNet software allows computer networking and electronic mail capabilities for PCs.

Other solutions from ROSE

- Printer Sharing
- Protocol Conversion
- Buffering
- Micro to mainframe
- Multiplexers
- Modems
- Manual Switches
- Cables

We design a variety of quality products for computer networking and data communication solutions guaranteed to work.

Dealer and OEM Inquiries are welcome.

ROSE ELECTRONICS
P.O. BOX 742571 HOUSTON, TX 77274
CALL FOR CATALOG 713 933 7673

Circle 313 on Reader Service Card

(DEALERS: 314) World Radio History

WITH TYVEK SLEEVES
1000+ **29** ea.

BULK 5 1/4" DISKS
Double Side-Double Den.

100% Tested & Certified Error Free, at "Minimum 55% Clipping Level or Higher." "Lifetime Warranty" With Tyvek Sleeves & Write on Labels

100	200	600
.38¢ each	.35¢ each	.32¢ each

DEALERS WELCOME

Telex #4933362 • Fax #405-495-4598
Shipping Charges Vary With Quantity Call

Delaware 1-800-451-1849
PO BOX 10247 WILMINGTON DE 19800
Oklahoma 1-800-654-4058
PO BOX 1074 BE THANY OK 73008
Nevada 1-800-621-6221
PO BOX 12300 LAS VEGAS NV 89112
Minimum Order 2500 - Visa/MasterCard accepted. COD add 3% UPS delivery U.S. Mail for APO, FPO AK, HI, PR add 5% additional for PAL



5 1/4"	5 Box	10 Box
D-Side D-Den.	950	850
HIGH Den.	1750	1650
	1600	1600

"Worldwide" Orders Accepted

3.5 S-Side 1195	DATA CARTRIDGES	8" S-Side 1540
3.5 D-Side 1650	DC 1000 - 12.95	8" S-Den. 1895
3.5 H-Den. 4795	DC 2000 - 17.50	8" D-Side 2095
	DC 300XLP 19.75	
	DC 600A - 21.95	

Authorized Distributor
Magnetic Media Division
3M
Delaware 1-800-451-1849
PO BOX 10247 WILMINGTON DE 19800
Oklahoma 1-800-654-4058
PO BOX 1074 BE THANY OK 73008
Nevada 1-800-621-6221
PO BOX 12300 LAS VEGAS NV 89112
Minimum Order 12500. Visa/MasterCard accepted. C.O.D. orders add 5% fee. Surface Shipping on 3.5 and 5.25" add \$3.00 per 100 disks. 8" add \$4.00 per 100 disks. UPS delivery only. U.S. Mail for APO, FPO, HI, PR add an additional 5% fee. Prices subject to change without notice!

Telex #4933362 • Fax #405-495-4598

Verbatim
A Kodak Company

5 1/4" DISKS	5 BOX	10 BOX
D-Side D-Den.	950	850
High Den.	1750	1650
	1595	

3 1/2" Diskettes
S-Side 1195 D-Side 1650 H-Den. 3995

8" Diskettes
S-Side 1540 S-Side 1795 D-Side 2095
S-Den. D-Den.

International Orders Accepted

Delaware 1-800-451-1849
PO BOX 10247 WILMINGTON DE 19800
Oklahoma 1-800-654-4058
PO BOX 1074 BE THANY OK 73008
Nevada 1-800-621-6221
PO BOX 12300 LAS VEGAS NV 89112
Minimum Order 12500. Visa/MasterCard accepted. C.O.D. orders add 5% fee. Surface Shipping on 3.5 and 5.25" add \$3.00 per 100 disks. 8" add \$4.00 per 100 disks. UPS delivery only. U.S. Mail for APO, FPO, HI, PR add an additional 5% fee. Prices subject to change without notice!

Telex #4933362 • Fax #405-495-4598

RS-422 FOR PS/2



MODELS 50, 60, 80

- Two Channel
- Transfers to 256 K baud
- Address Selectable
- Interrupt Selectable

1-800-553-1170



478 E. Exchange St., Akron, OH 44304
TEL: (216) 434-3154 FAX: (216) 434-1409
TLX: 5101012726

Circle 222 on Reader Service Card

MODULAR DATA ACQUISITION



- FOR IBM & Compatibles
- Flexible and Inexpensive
- Money Back Guarantee
- Free Technical Support

Fast Delivery
1-800-553-1170



Leaders in Communication Technology
478 E. Exchange St., Akron, OH 44304
(216) 434-3154 TLX: 5101012726

Circle 223 on Reader Service Card

CURRENT LOOP Communications Board



- Dual Channel
- Address Selectable
- Supports 20, 30, 60mA
- Configurable as Active & Passive
- Selectable & Shareable Interrupts

1-800-553-1170



478 E. Exchange St., Akron, OH 44304
TEL: (216) 434-3154 FAX: (216) 434-1409
TLX: 5101012726

Circle 224 on Reader Service Card

RS-422/232 CURRENT LOOP



DS-225

- Single channel async communication board for IBM PC/XT/AT
- Software selectable to be RS/422/485, 232 or Current Loop
- Selectable Address & Interrupt

1-800-553-1170



478 E. Exchange St., Akron, OH 44304
(216) 434-3154 TLX: 5101012726

Circle 225 on Reader Service Card

72 DIGITAL I/O FOR PS/2

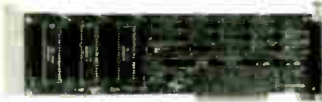

MODELS 50, 60, 80

- Parallel Expansion
- 72 I/O Lines
- Address Selectable

1-800-553-1170



478 E. Exchange St., Akron, OH 44304
TEL: (216) 434-3154 FAX: (216) 434-1409
TLX: 5101012726

Circle 226 on Reader Service Card

WAVEFORM SYNTHESIZER

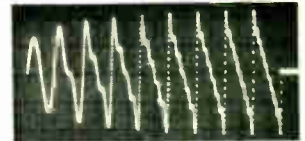

- For IBM PC/XT/AT and compatibles
- Generates user-definable signal
- Up to 200C points per envelope

\$795.00

1-800-553-1170



478 E. Exchange St., Akron, OH 44304
(216) 434-3154 TLX: 5101012726

Circle 227 on Reader Service Card

SERIAL/PARALLEL Communications Board



- Two Parallel Printer Ports
- Two 8-Bit Digital I/O Ports
- Two Serial Ports, RS-232, RS-422 or RS-485
- Address Selectable
- Selectable & Shareable Interrupts

1-800-553-1170



478 E. Exchange St., Akron, OH 44304
TEL: (216) 434-3154 FAX: (216) 434-1409
TLX: 5101012726

Circle 228 on Reader Service Card

IEEE-488 CONTROLLER FOR PS/2

MODELS 50, 60, 80

- GPIB Compatibility
- Control Up to 14 Devices
- Selectable Addressing
- Software Included

1-800-553-1170



478 E. Exchange St., Akron, OH 44304
TEL: (216) 434-3154 FAX: (216) 434-1409
TLX: 5101012726

Circle 229 on Reader Service Card

24 DIGITAL I/O

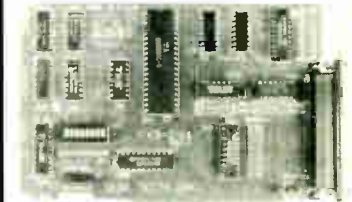

- 24 Bit Digital I/O
- Buffered Output
- Selectable Address

1-800-553-1170



478 E. Exchange St., Akron, OH 44304
TEL: (216) 434-3154 FAX: (216) 434-1409
TLX: 5101012726

Circle 230 on Reader Service Card

SPECIAL EPROM PROGRAMMER



APROTEK 1000
ONLY
\$225.00

COMPLETE WITH
PERSONALITY
MODULE

117 AC POWER-RS-232 CONNECT
-6 BAUD RATES - HANDSHAKE TO HOST
ALLOWS READ, WRITE, VERIFY & COPY

Comes complete with IBM-PC, Apple IIe, or CPM
(Specify Computer) Driver Program on Disc.

Programs the following 5 Volt 24 or 28 pin
devices: 2716 series through 27512, 25xx series,
68764 plus others. Please Specify Personality
Module desired with order. Additional Personality
Modules only \$15.00 ea. Full 1 year warranty.

TO ORDER CALL 1-800/962-5800 OR WRITE
APROTEK

1071 A AVENIDA ACASO Addl
CAMARILLO, CA 93010 \$4.00 Shipping-USA
Info (805) 987 2454 VISA or MC Addl 3%
We Accept Govt., School & Large Corp. P.O.s

Circle 22 on Reader Service Card

ICs PROMPT DELIVERY!!!

SAME DAY SHIPPING (USUALLY)
QUANTITY ONE PRICES SHOWN for FEB. 9, 1988

OUTSIDE OKLAHOMA: NO SALES TAX

DYNAMIC RAM		RAM	PRICE
1Mbit	1048Kx1	100 ns	\$36.00
51258	* 256Kx1	100 ns	7.25
4464	64Kx4	120 ns	6.75
41256	256Kx1	80 ns	7.10
41256	256Kx1	100 ns	6.95
41256	256Kx1	120 ns	6.85
41256	256Kx1	150 ns	6.60
41264	+ 64Kx4	120 ns	9.25
EPROM		PRICE	
27C1024	64Kx16	150 ns	\$37.95
27C1000	128Kx8	200 ns	37.50
27C512	64Kx8	200 ns	15.50
27256	32Kx8	250 ns	6.75
27128	16Kx8	250 ns	6.50
STATIC RAM		PRICE	
43256L-12	32Kx8	120 ns	\$10.95
5864LP-12	8Kx8	120 ns	4.50

OPEN 6 1/2 DAYS, 7:30 AM-10 PM: SHIP VIA FED-EX ON SAT.

SUNDAYS & HOLIDAYS: SHIPMENT OR DELIVERY VIA U.S. EXPRESS MAIL

SAT DELIVERY INCLUDED ON
FED-EX ORDERS RECEIVED BY
TH. FR. 11:58 AM (EST)
* Minimum order: \$10.00 plus shipping. Orders received by
9 PM CST can usually be delivered the next morning via Federal Express Standard
A.T. = \$4.00 or guaranteed next day Priority One = \$10.50*

Circle 168 on Reader Service Card

9-TRACK MAG. TAPE SUBSYSTEM* FOR THE IBM PC/XT/AT AND...



For information interchange, backup and archival storage,
AK Systems offers a 9-track, IBM format-compatible
magnetic tape subsystem for the IBM PC featuring

- IBM format 1600 3200 and 800 cpi.
- Software for PC-DOS, MS-DOS, XENIX.
- Also for AT&T, DEC, VAX,
VME, S-100, RS-232,
IEEE 488.

AKSystems

20741 Millville
Channahon, IL 61011
(815) 798-8888
TWX 910 49-2071

Write phone or TWX for information

Circle 12 on Reader Service Card



data systems with Monitor and Software

IBM
PC/XT
Compatible
System.



First-Quality,
Factory New!

For Home, School,
Or Office!

Includes MS-DOS Operating System, Two Program Disks,
User's Guide, Quick-Reference Guide, and Owner's Manual.

- 512K Random Access Memory.
- Two 5 1/4" 360K Drives.
- 12" Monochrome Monitor.
- IBM Style 84-Key Keyboard.
- MS-DOS 3.2 Operating System with User's Guide and 2 Disks.
- Parallel Interface.
- 4 Expansion Slots.
- Hercules Graphics Compatible.
- Color Card Included.



Zenith—The Quality Goes In Before the Name Goes On. For decades, Zenith has been making fine electronics for home and business. Products built to perform and to last. They have put their experience to work to develop the 157-2 Personal Computer. Now you can order this IBM compatible computer at a price that's

almost 50% less than what you could pay for a comparable system. Why buy a no-name clone when you can own a Zenith? This kind of quality, at such a LOW price, makes this a computer deal you can't afford to pass up!

Zenith Data Systems are made by skilled engineers to exacting specifications. The Zenith Model 157-2 Computer is expandable to 540K RAM. A hard disk drive can be added with addition of controller card. The MS-DOS Disk operating System is the most widely used system available. Order one or more Zenith Computers for your home or business today!

90-Day Limited
Manufacturer's Warranty.

IBM and IBM PC/XT are registered trademarks of International Business Machines Corp.

List: **\$1499.00**
Value
Priced At

\$799

Item H-3440-7344-054
S/H: \$49.50 ea.

To Order Toll-Free: 1-800-328-0609

Credit Card customers can order by phone, 24 hours a day, 7 days a week.

COMB Authorized Liquidator

1405 Xenium Lane N/Minneapolis, MN 55441-4494
Send Zenith Computer(s) Item H-3440-7344-054 at \$799 each, plus \$49.50 each for insured shipping, handling. (Minnesota residents add 6% sales tax. Sorry, no C.O.D. orders)

PLEASE CHECK: VISA M/C DISCOVER AMERICAN EXPRESS
 My check or money order is enclosed. (No delays in processing orders paid by check.)

Acct. No. _____ Exp. / _____

Name _____

Address _____ Apt # _____

City _____

State _____ ZIP _____

Phone _____

Sign Here _____

Circle 76 on Reader Service Card

APRIL 1988 • B Y T E 323

ATTENTION p*cad USERS

Now you can increase the productivity of your software by using the new...

RAPICAD buffer/decoder.

Two buffers in one unit with parallel and serial in/out. Up to 1 Meg total memory.

NO EXTERNAL DECODER

needed any more... because RAPICAD is fully p*cad box compatible and software transparent, allowing the use of p*cad and any other software with any printer, plotter, laser, etc.

Prices as low as **\$995.00**



INECTRA Inc.
2629 Terminal Blvd.
Mtn. View, CA 94043
(415) 964-5018



UNIVERSAL E(E)PROM PROGRAMMER \$495 (Kits from \$165)

- No personality modules: Menu driven device selection.
- Built-in Eraser/Timer option (\$50); Conductive foam pad.
- Direct technical support; Full 1 year warranty.
- Stand alone duplication & verify (27XX parts).
- Quick pulse algorithm (27256 under 60 sec).
- 27xx to 1 Mbit; 25xx; 68xx; CMOS; EEPROMS.
- 8741, -2, -4, -8, -8H, -9, 911, -51, -C51, -52, -55, 9761 & more.
- IBM-PC, Apple, CPM or Unix driver; Autobaud RS232
- Offset/split Hex, Binary, Intel & Motorola 8,16,32 bit.
- Manual with complete schematics.

VISA MC AMEX Call today for datasheets!*

B&C MICROSYSTEMS

355 WEST OLIVE AVE. SUNNYVALE, CA 94086
PH: (408) 730-5511 FAX: (408) 730-5521 TELEX: 984185

DATA FLEX™

- Multi-user Database!
 - Powerful!
 - Multiple Operating System Compatibility!
 - Attractive Dealer Pricing!
 - Full Dealer Support!
- Dataflex is a trademark of Data Access
Dealer Inquiries Invited

COGITATE

24000 Telegraph Road
Southfield, Michigan 48034 USA
(313) 352-2345

Circle 33 on Reader Service Card

Circle 58 on Reader Service Card

new! SPEECH THING™

For all PCs, compatibles, laptops



\$69.95 CLEAR, CLEAN, DIGITIZED SPEECH & MUSIC, UNLIMITED TEXT-TO-SPEECH
Attaches outside the computer.

Now get popular speech technologies in ONE product! Speech Thing is a full-featured 8 bit D/A sound converter. Easily attaches outside the computer—no slots required. Software includes prerecorded speech vocabularies, synthetic text to speech (speaks any ASCII text), demo programs, and complete editing features. Price only \$69.95. Also available: Voice Master PC plug in board for digital recording, editing, and VOICE RECOGNITION. (Requires Speech Thing for sound output.) Only \$79.95. Patented price-performance breakthrough!

TO ORDER BY MAIL include \$4 shipping & handling (\$6 Canada, \$12 overseas) per order. Visa, MasterCard phone orders accepted. 30 day money back guarantee, one year warranty. Other voice I/O systems available for Apple, Commodore, and Atari computers.



Call or write today for FREE Product Catalog

COVOX INC. (503) 342-1271
675 Canger St., Eugene, Oregon 97402

Circle 72 on Reader Service Card



Sure it's insured?

SAFEWARE® Insurance provides full replacement of hardware, media and purchased software. As little as \$39/yr. covers:

- Fire • Theft • Power Surges
- Earthquake • Water Damage • Auto Accident

For information or immediate coverage call:

1-800-848-3469

In Ohio call 1-614-262-0559



SAFEWARE, The Insurance Agency Inc.

Circle 245 on Reader Service Card



Presto!
A Link to Mainframe Graphics

Find out how our whole family of EMU-TEK graphics terminal emulation software makes good sense for the work you do. Call today for more information.

FTG DATA SYSTEMS

(714) 995-3900
(800) 962-3900 (800) 972-3900 (Calif.)
10801 Dale St., Suite M-2
Stanton, CA 90680

Circle 107 on Reader Service Card

HARD DISK CONTROLLERS

ADAPTEC	
PC-XT Controller ST506/412	\$45
2072 PC/XT RLL	\$98
3530 SCSI to Tape QIC 36	\$78
4000 SCSI to ST506/415	\$89
4070 SCSI to ST506/412 RLL	\$98
4520 SCSI to ESDI	\$98
5500 SCSI to ST506/412	\$125
5580 SCSI to SMD	\$175
XEBEC	
S1410 SASI Controller	\$109
S1420 SASI to 5 1/4" Floppy & Hard Disk Controller	\$99
Apple II, II+, IIE Host Adapter	\$29
Toshiba PC to SASI/SCSI Host Adapter	\$29
9205 Multibus Hard Disk Controller	\$199
9305D IEEE 488 (HPIB) to ST506/412 Controller	\$89
1490 SASI to SMD Controller	\$149
OTHERS	
OMTI 20C, L SASI Controller	\$99
DTC 510A SASI Controller	\$99
Shugart 1610-13 or 4 SASI/SCSI Controller	\$79
WD 1002-SHD Xebec Compatible SASI Controller	\$109

* Call for cable prices
• Controller manuals \$8 each.



Computer Surplus Store "WE BUY AND SELL"
Phone 408-434-1060
FAX 408-434-0931
Telex 1561447

MC/VISA/Discover/COD's

Circle 67 on Reader Service Card

PDK51

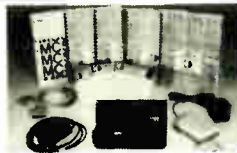

The \$595 Solution to 8051 Product Development

The PDK51 is a powerful and economical choice for the development of 8051-based systems. The PDK51 is used with an IBM-PC or equivalent and includes:

- SIBEC-II 8052 Basic Microcontroller
- SXA51 Cross Assembler
- ROM-Based Monitor/Debugger
- PROM Programmer
- Power Supplies
- Documentation, Tutorial and More

Call Now! (603) 469-3232



Binary Technology, Inc.

Main St., P.O. Box 67, Meriden, NH 03770

Circle 89 on Reader Service Card

Dynamic Electronics CO.

Where the CUSTOMER Comes First!

8087 - 5, 8, 10 MEG

80287 - 6, 8, 10 MEG

80387 - 16, 20 MEG

64K • 256K • 128K

V20 • V30

No refund, only exchange
Exchange good for 30 days, unless manufacturer warranties merchandise longer.

Phone: (714) 582-1224

FAX: (714) 582-3780

27402 Camino Capistrano, Suite 112
Laguna Niguel, California 92677



FCC APPROVED!

Sub-Mini AT!
The Space Saver
3-DR. Capability
8-Expansion Slots!

Basic System:

- 8/10MHz Speed, 0 Wait
- 3-LEDs, Reset & Turbo Switch
- 0-1MB on Board With 0K
- 200-Watt Power Supply
- AT Style Keyboard
- 1ea 1.2M Floppy Disk Drive
- 1ea Floppy/H.D. Controller
- 1ea Mono Graphics Card W/Printer
- 1ea 12" TTL Amber Monitor W/Swivel Base
- Assembled & Tested

\$963.00

10MHz XT Turbo Basic System:

- Baby AT Case W/Keyboard
- 4.77/10MHz Hardware Selectable
- 8 Expansion Slots
- 0-640K on Board With 0K
- 150-Watt Power Supply
- XT Style Keyboard
- 1ea 360K Floppy Disk Drive
- 1ea Floppy Disk Controller
- 1ea Mono Graphics Card W/Printer
- 1ea 12" TTL Amber Monitor W/Swivel Base
- Assembled & Tested

\$493.00

10MHz or 12MHz AT-286 Basic System:

- 6/10 or 6/12 MHz Speed, 0 Wait
- 8 Expansion Slots
- 0-1MB on Board With 0K
- Regular AT Slide Case or Digital Display Case
- 200-Watt Power Supply
- AT Style Keyboard
- 1ea 1.2MB Floppy Disk Drive
- 1ea Floppy & H.D. Controller
- 1ea Mono Graphics Card W/Printer
- 1ea 12" TTL Amber Monitor W/Swivel Base
- Assembled & Tested

Regular Case	938.00	1001.00
Digital Case	959.00	1022.00

PERIPHERALS AT/XT
For XT

- | | |
|--------------------------------------|----------|
| 1 Floppy Disk Controller With Cable | \$22.50 |
| 2 Hard Disk Controller With Cable | \$72.20 |
| 3 0-384K Multifunction Card, 0K | \$86.30 |
| 4 Monochrome Graphics Printer Card | \$43.80 |
| 5 Color Graphics Card | \$46.30 |
| 6 Color Graphics Printer Card | \$50.00 |
| 7 Enhanced Graphics Adaptor (EGA) | \$131.10 |
| 8 Color/Monochrome Display Card | \$61.30 |
| 9 Parallel Printer Card | \$18.80 |
| 10 Dual Game I/O Card | \$18.80 |
| 11 Serial I/O Card | \$25.00 |
| 12 Dual Serial I/O Card | \$43.80 |
| 13 Mouse For AT/XT W/Driver Software | \$61.30 |
| 14 Multi I/O W/Controller | \$68.80 |
| 15 Multi I/O | \$56.30 |
| 16 No-Slot Clock | \$28.80 |
| 17 576K RAM Card, 0K | \$35.00 |
| 18 4.77/8MHz XT Turbo Motherboard | \$93.80 |
| 19 4.77/10MHz XT Turbo Motherboard | \$100.00 |
| 20 XT Slide Case | \$35.30 |
| 21 XT Flip Top Case | \$32.90 |
| 22 Baby AT Case, XT | \$47.10 |
| 23 150 Watt Power Supply | \$48.80 |
| 24 150 Watt Power Supply (UL) | \$68.80 |

For AT

- | | |
|--|----------|
| 25 Floppy/H.D. Controller W/Cables | \$156.30 |
| 26 128K RAM Card, 0K | \$68.80 |
| 27 2MB EMS RAM Card, 0K | \$123.80 |
| 28 Serial/Parallel Card | \$46.30 |
| 29 6/10MHz AT Motherboard, 0 Wait | \$331.30 |
| 30 6/12MHz AT Motherboard, 0 Wait | \$393.80 |
| 31 8/10MHz Mini AT Motherboard, 0 Wait | \$362.50 |
| 32 AT Slide Case | \$64.70 |
| 33 AT Slide Case W/Digital Display | 85.90 |
| 34 Mini AT Slide Case | 61.20 |
| 35 200 Watt Power Supply | 81.30 |
| 36 200 Watt Power Supply (UL) | 95.00 |
| 37 200-Watt Power Supply For Mini AT | 78.80 |

ORDER HOT LINE 1-800-543-5107

Technical Information (714) 990-2097

Hours: Mon. - Fri. 9:00 am - 6:00 pm PST
 Please write for our complete price list.

JAWIN COMPUTER PRODUCTS

565 W. Lambert Rd., #C
 Brea, CA 92621

Terms: Please add 5% (or \$2.00 whichever is higher) plus .25% for each \$100.00 CA residents please add 6% sales tax. We accept VISA/MC/Cash. Personal checks please allow 2 weeks to clear. All merchandise is warranted for 1 year unless otherwise stated.

Industrial PC/AT Computer



- Intel 80286 Processor
- 10 MHz Clock Speed
- 640 K RAM
- Two Disk Drives
- RGB Monitor
- Parallel and Serial Port
- Operating Temperature 0 to 55 C
- Double Air Filter
- Surge Protection
- Weight 50 lbs
- Dimension 28 high 19 wide 20 deep
- Detachable Keyboard

OPTIONS

- RS 422
- Factory Data Collection
- Bar Code Input
- Process Control Monitoring
- Real Time Control Software

Quintel Technology Corp.
 2446 Cawthra Rd B4 U5 Mississauga, Ont.
 (416) 897-8455 FAX (416)897-8457

Circle 235 on Reader Service Card

the **LOGIC LAB** *\$599.00*

the **LOGIC LAB** is a complete logic development system

- * Complete System Including Programmer, Sample GAL Devices, Software and all Cabling.
- * Programs GAL Devices Including 16V8, 16Z8, 20V8, & 39V18.
- * Allows Prototyping of 42 different standard PLD's.
- * Includes Updated Equation Assembler Software.
- * Accepts All Standard JEDEC Download Files.
- * Software Updatable.
- * 30 Day Money Back Guarantee.

* Visa and Master Card Accepted*

CALL FOR FREE DEMO DISK

Programmable Logic Technologies, Inc.
 P.O. Box 1567
 Longmont, CO 80501
 Ph. [303] 772-9059

GAL is a registered trademark of Lattice Semiconductor Corporation

Circle 215 on Reader Service Card

Get the whole story on graphics terminal emulation.

To find out more about software that lets your PC emulate TEKTRONIX™ 4105/6/7/9 and DEC VT100™ terminals, call or write:

GRAFPOINT
 4340 Stevens Creeks Blvd., Suite 280,
 San Jose, CA 95129 (408) 249-7951

Circle 115 on Reader Service Card

SAVE ON 9 TRACK TAPE SYSTEM
FOR IBM PC XT/AT

- Mainframe to PC Data Transfer
- High Speed Backup
- All Software, Complete System
- Service and Support, easy Installation

call (818) 343-6505 or write to:
CONTECH Computer Corp.
 P.O. Box 153 Tarzana, Calif. 91356

CONTECH

Circle 70 on Reader Service Card

Motion Control & Data Acquisition
 on your IBM PC or Apple II and all compatibles

Smart 2 Axis Motion Controller: For many types of motors & encoders. New I.C. (from HP) allows changes & monitoring on the fly. Optically isolated. W/SOFTWARE \$450 in U.S.

Four Axis Stepper Driver: With SOFTWARE & motor for instant automation. \$95.

Fast A/D Board: With programmed gain, 650 KHz, 4 inputs, \$220. Complete Scope hardware & SOFTWARE \$525. Also: 12 Bit A/D, Relay Driver, Real Time Clock. Circuit developers Project Book \$25.

How do you do it? Use our Local Applications Bus, LAB 40. One host adapter (\$150) supports up to 8 boards, like those above, on a 50 ft. ribbon cable.

Please call (415) 755-1978 for free literature.

Computer Continuum
 75 Southgate Ave., Suite 6
 Daly City, CA 94015

Circle 324 on Reader Service Card

Advertise your computer products through **BYTE BITS** (2" x 3" ads)

For more information call Dan Harper at 603-924-6830

BYTE
 70 Main St.
 Peterborough, NH 03458

Circle 324 on Reader Service Card

The Amazing A-BUS

NEW

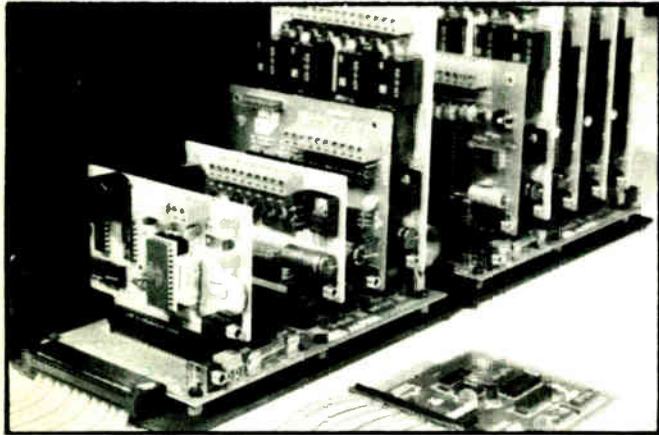

An A-BUS system with two Motherboards
A-BUS adapter (BM) in foreground

Plug into the future

With the A-BUS you can plug your PC (IBM, Apple, TRS-80) into a future of exciting new applications in the fields of control, monitoring, automation, sensing, robotics, etc.

Alpha's modular A-BUS offers a proven method to build your "custom" system today. Tomorrow, when you are ready to take another step, you will be able to add more functions. This is ideal for first time experimenting and teaching.

A-BUS control can be entirely done in simple BASIC or Pascal, and no knowledge of electronics is required!

An A-BUS system consists of the A-BUS adapter plugged into your computer and a cable to connect the Adapter to 1 or 2 A-BUS cards. The same cable will also fit an A-BUS Motherboard for expansion up to 25 cards in any combination.

The A-BUS is backed by Alpha's continuing support (our 11th year, 50000 customers in over 60 countries).

The complete set of A-BUS User's Manuals is available for \$10.

About the A-BUS:

- All the A-BUS cards are very easy to use with any language that can read or write to a Port or Memory. In BASIC, use INP and OUT (or PEEK and POKE with Apples and Tandy Color Computers)
- They are all compatible with each other. You can mix and match up to 25 cards to fit your application. Card addresses are easily set with jumpers.
- A-BUS cards are shipped with power supplies (except PD-123) and detailed manuals (including schematics and programming examples).

Relay Card

RE-140: \$129

Includes eight industrial relays. (3 amp contacts, SPST) individually controlled and latched. 8 LED's show status. Easy to use (OUT or POKE in BASIC). Card address is jumper selectable.

Reed Relay Card

RE-156: \$99

Same features as above, but uses 8 Reed Relays to switch low level signals (20mA max). Use as a channel selector, solid state relay driver, etc.

Analog Input Card

AD-142: \$129

Eight analog inputs 0 to +5V range can be expanded to +00V by adding a resistor. 8 bit resolution (20mV). Converts on time 120us. Perfect to measure voltage, temperature, light levels, pressure, etc. Very easy to use.

12 Bit A/D Converter

AN-146: \$139

This analog to digital converter is accurate to ±0.25%. Input ranges -4V to +4V. Resolution: 1 millivolt. The on board amplifier boosts signals up to 50 times to read microvolts. Conversion time is 130ms. Ideal for thermocouple, strain gauge, etc. 1 channel. (Expand to 8 channels using the RE-156 card).

Digital Input Card

IN-141: \$59

The eight inputs are optically isolated, so it's safe and easy to connect any "on/off" devices, such as switches, thermostats, alarm loops, etc. to your computer. To read the eight inputs, simply use BASIC INP (or PEEK).

24 Line TTL I/O

DG-148: \$65

Connect 24 input or output signals (switches or any TTL device) to your computer. The card can be set for: input, latched output, strobed output, strobed input, and/or bidirectional strobed I/O. Uses the 8255A chip.

Clock with Alarm

CL-144: \$89

Powerful clock/calendar with: battery backup for Time, Date and Alarm setting (time and date); built in alarm relay, led and buzzer, timing to 1/100 second. Easy to use decimal format. Lithium battery included.

Touch Tone® Decoder

PH-145: \$79

Each tone is converted into a number which is stored on the board. Simply read the number with INP or POKE. Use for remote control projects, etc.

A-BUS Prototyping Card

PR-152: \$15

3½ by 4½ in. with power and ground bus. Fits up to 13 I.C.s

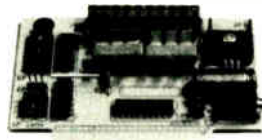

ST-143

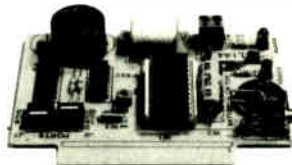

CL-144

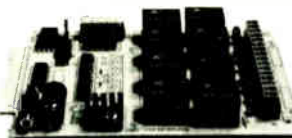

RE-140



IN-141

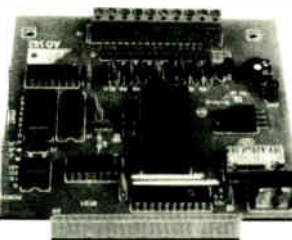

AD-142

Smart Stepper Controller SC-149: \$299

World's finest stepper controller. On board microprocessor controls 4 motors simultaneously. Incredibly, it accepts plain English commands like "Move arm 10.2 inches left". Many complex sequences can be defined as "macros" and stored in the on board memory. For each axis, you can control: coordinate (relative or absolute), ramping, speed, step type (half, full, wave), scale factor, units, holding power, etc. Many inputs: 8 limit & "wait until" switches, panic button, etc. On the fly reporting of position, speed, etc. On board drivers (350mA) for small steppers (MO-103). Send for SC-149 flyer.

Remote Control Keypad Option RC-121: \$49

To control the 4 motors directly, and "teach" sequences of motions.

Power Driver Board Option PD-123: \$89

Boost controller drive to 5 amps per phase. For two motors (eight drivers).

Breakout Board Option BB-122: \$19

For easy connection of 2 motors. 3 ft. cable ends with screw terminal board.

Stepper Motor Driver ST-143: \$79

Stepper motors are the ultimate in motion control. The special package (below) includes everything you need to get familiar with them. Each card drives two stepper motors (12V, bidirectional, 4 phase, 350mA per phase).

Special Package: 2 motors (MO-103) + ST-143 PA-181: \$99

Stepper Motors MO-103: \$15 or 4 for \$39

Pancake type, 2¼" dia, ¼" shaft, 7.5"/step, 4 phase bidirectional, 300 step/sec, 12V, 36 ohm, bipolar, 5 oz-in torque, same as Airpax K82701-P2.

Current Developments

Intelligent Voice Synthesizer, 14 Bit Analog to Digital converter, 4 Channel Digital to Analog converter, Counter Timer, Voice Recognition.

A-BUS Adapters for:

IBM PC, XT, AT and compatibles. Uses one short slot.	AR-133	\$69
Tandy 1000, 1000 EX & SX, 1200, 3000. Uses one short slot	AR-133	\$69
Apple II, II+, IIe. Uses any slot	AR-134	\$49
TRS-80 Model 102, 200. Plugs into 40 pin "system bus"	AR-136	\$69
Model 100. Uses 40 pin socket (Socket is duplicated on adapter)	AR-135	\$69
TRS-80 Mod 3, 4, 4 D. Fits 50 pin bus (With hard disk, use Y-cable)	AR-132	\$49
TRS-80 Model 4 P. Includes extra cable. (50 pin bus is recessed)	AR-137	\$62
TRS-80 Model I. Plugs into 40 pin I/O bus on KB or E/I	AR-131	\$39
Color Computers (Tandy). Fits 80M slot. Multipak, or Y-cable	AR-138	\$49

A-BUS Cable (3 ft, 50 cond.) CA-163: \$24

Connects the A-BUS adapter to one A-BUS card or to first Motherboard.

Special cable for two A-BUS cards: CA-162: \$34

A-BUS Motherboard MB-120: \$99

Each Motherboard holds five A-BUS cards. A sixth connector allows a second Motherboard to be added to the first (with connecting cable CA-161: \$12). Up to five Motherboards can be joined this way to a single A-BUS adapter. Sturdy aluminum frame and card guides included.

Add \$3.00 per order for shipping.
Visa, MC, checks, M.O. welcome.
CT & NY residents add sales tax.
C.O.D. add \$3.00 extra.
Canada: shipping is \$5
Overseas add 10%



ALPHA Products

242-B West Avenue, Darien, CT 06820

Technical info: (203) 656-1806
Orders only 800 221-0916
Except in CT
Connecticut orders: (203) 348-9436
All lines open weekdays 9 to 5 Eastern time

IEEE-2

Easiest IEEE 488(GPIB/HPIB) Interfaces for your PC, PS/2, Macintosh, HP and more!

- Controllers
- Converters
- Extenders
- Buffers
- Boards



Please see our ad on page 139.

Call or send for your **FREE** Technical Guide

Lotech (216) 439-4091

25971 Cannon Road • Cleveland, Ohio 44146
Telex 6502820864 • Fax (216) 439-4093

Circle 131 on Reader Service Card

NEW! VERS. 2.0

BIG MOUTH™

REAL VOICE Digital Recording for your PC, XT, AT or Compatible

- ◆ VOICE MAIL SYSTEM
- ◆ TELEMARKETING - Inbound & Outbound
- ◆ SMARTEST ANSWERING MACHINE
- ◆ AUTODIALER—DATABASE
- ◆ VOICEPAD™ - Voice for your Programs
- ◆ PROGRAMMER'S TOOLKIT (optional 79")

1/2 card, software, cables, and speaker



\$239⁰⁰ + 5 s/h



(415) 652-9600

Talking Technology, Inc.
4383 Piedmont Ave. Suite B
Oakland, CA 94611

Circle 273 on Reader Service Card

"D" SIZE PLOTTER

\$2295⁰⁰
RETAIL

\$1695⁰⁰
INTRODUCTORY
OFFER



- Model PC 3600
- Repeatability .001"
- Speed at 7" Per Second
- Vacuum Paper Hold Down
- High Resolution Circles: Suitable for PCB Artwork

(415) 490-8380 **ZERICON**
STEVENSON BUSINESS PARK
BOX 1669, FREMONT, CA 94538

Circle 301 on Reader Service Card

RS-422

- RS-422/485
- Selectable Address/IRQ
- Two/Four Wire Operation
- One/Two/Four Port Versions
- Delivery From Stock

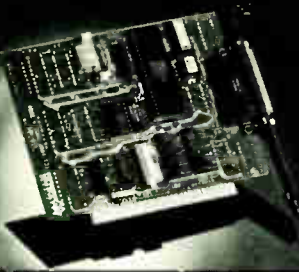

SEALEVEL SYSTEMS INC
PO BOX 1808
EASLEY, SC 29641
(803) 855-1581

Circle 249 on Reader Service Card

Serial ← ||||| → Parallel



Convert What You Have
To What You Want!

- * RS232 Serial
- * 8 Baud Rates
- * Latched Outputs
- * Centronics Parallel
- * Handshake Signals
- * Compact 3/4 x 4 1/4 x 1 1/2

No longer will your peripheral choices be limited by the type of port you have available! Our new High Performance 700 Series Converters provide the missing link. Based on the latest in CMOS technology, these units feature full baud rate selection to 19.2K with handshake signals to maximize transfer efficiency. Detailed documentation allows simplified installation. Order the Model 770 (Ser/Par) or Model 775 (Par/Ser) Today!

WE'VE
MOVED!!

Tigertronics
SERIAL-TO-PARALLEL
CONVERTERS

only \$89.⁹⁵

Connector Option \$10.00
CA Residents 6% Tax
UPS Shipping \$3.00

400 Daily Lane
P.O. Box 5210
Grants Pass, OR 97527
Call (503) 474-6700 or 474-6701
For FAST Delivery

Circle 278 on Reader Service Card

SDC

SOFTWARE DEVELOPMENT
DISTRIBUTION CENTER

Solver-Q

A Numerical Analysis &
Equation Handling Program
"... This is a wonderful program."
Mathematics Instructor:
"... it was a life saver..."
Statistics Professor.

- Enter equations easily, edit, and solve. It's that simple.
- Equations readable from any ASCII text file.
- Symbolic manipulation.
- Up to 1000 non-linear equations.
- Requires IBM PC, 256k or more.
- \$40 academic, \$90 commercial.

See Nov. '87 **EVIE**
"WHAT'S NEW" page 94

University of Wisconsin-Madison
1025 West Johnson Street
Madison, WI 53706
800/262-6243, WI 800/362-3020

Circle 257 on Reader Service Card



! not only a
printer buffer !

THIS IS THE MOST SOPHISTICATED
PRINTER BUFFER - MULTIPLEXOR - SWITCH

WITH TWO SEPARATE INPUTS (SERIAL AND PARALLEL) AND TWO SEPARATE OUTPUTS (SERIAL AND PARALLEL) CAN BE USED LIKE STANDARD BUFFER WITH ANY INPUT TO ANY OUTPUT BUT ALSO YOU CAN CONNECT 2 COMPUTERS TO 1 PRINTER OR 1 COMPUTER TO 2 PRINTERS OR 2 COMPUTERS AND 2 PRINTERS AND MORE - 1 COMPUTER TO 3 PRINTERS OR 3 COMPUTERS TO 1 PRINTER
HIGH CAPACITY 64 KB TO 256 KB AND - 256 KB TO 1 MB (MODELS A AND B) PAUSE, COPY AND RESET FUNCTIONS SERIAL PORTS WITH 7 OR 8 BITS WORD LENGTH, 1 OR 2 STOP BIT, PARITY, XON/XOFF, DTR RTS

DCB A 64K \$ 195 DCB B 256K \$ 255 (**)

(**) Power supply and parallel cables are included

ALSO, WE HAVE THE MOST COMPLETE DATA CONVERTER UNIT CONVERTS RS232 SERIAL TO CENTRONICS PARALLEL OR VICE VERSA, JUST BY MOVING JUMPERS, BAUD RATES AND PROTOCOL FULLY PROGRAMMABLE FROM 160 TO 19200 BAUDS INCLUDES DTR, RTS, XON/XOFF, PARITY, etc

DCU \$ 80 (**)

(**) Power supply and cables NOT included



serial ↔ parallel
bi-directional converter



INTECTRA Int - Dept 232

2029 TERMINAL BLVD
MOUNTAIN VIEW, CA 94043

(415) 967-8818 TX 345545

NEW!

INSTANT TERMINAL

"EXACT TERMINAL EMULATION
AND COMMUNICATIONS SOFTWARE"

- PRECISE EMULATION OF THE DEC VT52, VT100, VT102, VT220
- EXPANSION MODULES FOR OVER 40 EXACT EMULATIONS
- 9 FILE TRANSFER PROTOCOLS.
- EASY TO USE, QUICK TO INSTALL, AND MUCH MORE
- IBM PC, XT, AT, PS/2

FOR INFORMATION
800/548-9777

ONLY

\$97⁵⁰

SOFTRONICS
303/593-9540
TELEX 450236

Circle 255 on Reader Service Card

World Radio History

PAL®/EPLD PROGRAMMER

From
\$689.00



Stand Alone/RS-232 Programs and Verifies
20/24 pin P.I.Ds from MMI, TI, National
Cypress, Lattice, AMD, Altera
PAL is a registered trademark of MMI.

From A Name You Can Trust

LOGICAL DEVICES INC.
1201 N.W. 65th Place
Ft. Lauderdale, FL 33309

1-800-331-7766 (305) 974-0967
Telex 383142 Fax (305) 974-8531

Circle 148 on Reader Service Card

(DEALERS: 149)

FEDERAL EXPRESS
FREE WHEN YOU PAY
GROUND RATES!

NO SURCHARGE!

SEI100™

"THE PC PEOPLE"

SINCE 1977

Circle 271 on Reader Service Card (DEALERS: 272)

PC COMPATIBLE SYSTEMS



FastData Mini-AT - 80286-10/0 runs 11.5 Norton SI, 512K-1Mb RAM, Award Bios, only 16" wide, 8 slots, room for 3 half-hi drives. Speed, drive & power LED's, key, reset & turbo switch on front panel. AT-Style Keyboard, 200W 110/220V P/S, FCC, 1 year warranty. \$725

ARC

ARC 386i Desktop - 6/16 MHz 1 Wait, 512K RAM, 1.2 Mb, 5.25 Floppy Drive, MS-DOS 3.21..... CALL
ARC Turbo 12 - 1.5 MHz 80286-1 Wait, 1Mb RAM, 1.2 Mb Flpy, MS-DOS 3.21..... CALL
ARC Model 10 XT - 8088-10 MHz, 640K RAM, 360K Floppy, MS-DOS 3.21..... CALL
ARC Options
 AT-Style Maxiswitch Keyboard..... \$ 59
 RT-Style 101 Maxiswitch Keyboard..... \$ 79
 Add-In Boards..... See Modems & Boards
 Monitors..... See Monitors
 Drives..... See Drives

Ask about 1 & 2 year on-site service.

AST Premium/286™ \$ 59./mo.*

Model 140 with 44Mb Dr, 1Mb RAM, S&P Ports, Clk/Cal, RT-Style Keyboard, 3-G Plus Card with EGA, CGA, HGC, MS-DOS 3.3, GW-Basic
AST Premium Workstation..... CALL
AST Premium/386 - 20 MHz, 0 Wait..... CALL

* 1 to 5 year leases available to qualified businesses.

FORTRON

80386-16/1 MHz Tower Server 2Mb RAM, 1 para, 2 ser. ports on Mb, 8 AT, 4 XT slots, 230W, max-switch enhanced keyboard, up to 6HH drive, 80287/80387 socket, WD-WA2 controller, 1.2Mb floppy drive. On-site warranty service included...... \$2,595

DRIVES

PRIAM

ID 130 133Mb, 20mSEC w/ Installation Hardware/ Software (Maxtor XT-1140 Compatible).....\$2,169
ID100 103Mb 20mSEC w/AT RLL Ctrl.....\$1,179
ID230 233Mb 20mSEC w/software, RLL Ctrl.....\$2,549
V150 43Mb 30mSEC.....\$699

EVEREX

Everex 40 Mb Tape Internal.....\$525
Everex 60i 60 Mb Internal Tape.....\$739
CDC 300 Mb SCSI - runs with NetWare 2.1..\$2,699
Fujitsu 360K floppy dr ..\$ 79 / 1.2 Mb\$125

MICROPOLIS

Micropolis 53 Mb 28mSEC.....\$709
Micropolis 85Mb 28mSEC.....\$ 848
Micropolis 1333A 53 Mb.....\$699
Mitsubishi MF501.....\$ 95 / MF504 1.2Mb\$125
Mitsubishi 3.5" 1.4 Mb Floppy.....\$139
Mitsubishi 3.5" 720K.....\$115
Seagate 20 Mb PC Subsystem ..\$ 275
Seagate 30 Mb PC Subsystem, ST-238&Ctrl..\$329
Teac FD-55-BV 48ipl ..\$ 95 / FD55GV 1.2 ..\$125

POWER ACCESSORIES

American Power Conversion Corp
 450AT.....\$ 450
 520 ES.....\$ 525
 1200VX.....\$ 1,049

Some Novell U.P.S. Monitor Board Compatible!

CONNECTIVITY

4-User Network Special

NOVELL

Server/Work Station:

INDTECH 6/10 MHz AT-Fileserver - 12 slots, 238W Power Supply, Serial & 2 Parallel Ports, Monitor, 1.2 Mb Floppy, 2Mb RAM, 71Mb Hard Drive, 60Mb Tape & (5) 60 Mb Tapes.
AMERICAN POWER CONV. 450 Watt U.P.S.
NOVELL ELS NetWare 286 Level I (4-users) Network set-up is Menu Driven!
4 ArcNet Cards, Cables & 1 Passive Hub
3 ARC™ Model M10 - Each Incl: 640K, 4.77/10MHz, 8088-1 CPU, AT-Style Keyboard, & Amber Tilt 'n' Swivel Monitor. MS-DOS 3.21.
**** A COMPLETE NETWORK ****

Retail.....\$14,237 **NOW ONLY. \$ 7,469**
Lease this system for ONLY \$191. per month!

MONITORS & TERMINALS

SAMSUNG

Samsung EGA Tilt 'n' Swivel, 14" Monitor..... \$359
Samsung 14" Tilt 'n' Swivel Color Hi-Res.....\$249
Samsung 12" TTL Tilt 'n' Swivel Amber..... \$ 79

TATUNG

CM-1495 OmniScan 14"PGA, EGA, HGC, CGA with OmniCard 900 controller.....\$679
NIM-1422 Dual Freq, T 'n' S 14" Grm/Amb.....\$119

MONITERM

MoniTerm Viking dual page 19" or 24" paper white or color monitors up to 1280 x 960 resolution..CALL
MONDS Genius full page for PC, PS/2 & MAC...CALL

WYSE

WYSE 50.....\$379
WYSE 60.....\$419
WYSE WY700 1280 x 800...\$759

MODEMS & BOARDS

ANCHOR

1200 External.....\$119 / **1200 Internal** \$ 79
2400 External.....\$149 / **2400 Internal** \$129

EVEREX

Everex EverCom II Internal 1200.....\$ 85
Everex EverCom 2400 Internal 2400.....\$ 175
Everex EverCom 2400E External 2400.....\$ 219
MultiTech..... CALL
U.S. Robotics Personal Modems..... CALL

AST RESEARCH INC.

RAMPAGE XT-256K.....\$ 256
Hot Shot 286-10XT Accel. Bd. \$ 359
ADVANTAGE-AT-512K.....\$ 278
ADVANTAGE PS/2 - 512K.....\$ 278
I/O PAK/T for PS/2 - S & P.....\$ 98

EVEREX

Deluxe Hi-Res EGA ..\$119 / **VGA**.....\$275
Magic I/O 1-3 S,P,G.....\$ 58 / **Deluxe PGA**..\$ 88
Floppy I/O Serial, Parallel, Game, Clock.....\$ 79
UltraGraphics 1664x1200 resolution for Everex 19" landscape.....CALL
Intel Above Board/286-512K 4020.....\$339

LASER PRINTERS

AST TurboLaser/PS Ricoh, postscript, AppleMac/PC I/F, 3Mb, 35 fonts, 300dpi. Fast Graphics!..\$3,249



Brother HL-8 1Mb, 20fonts, full pg graphics CALL
H.P. LaserJet Series II.....CALL
NEC Model 890 PS.....CALL
QUME Script 10 3Mb, PostScript.....\$ 3,999

PRINTERS, PLOTTERS & FAX

brother Twin-6 \$ 899 **FREE!** (Tractor Feeder) with Twin-6
M-1709 with tractor.....\$439 / **M-1724**.....\$599
HR-40 w/sheet & tract..\$569 / **FAX 100**.....CALL
500 CPS Dual Voltage.....CALL

CITIZEN

120D.....\$145 **MSP 40**.....\$285
180D.....\$160 **MSP 45**.....\$415
Premiere 35.....\$465 **MSP 50**.....\$355
Tribute 224.....\$655 **MSP 55**.....\$450

houston instrument CALL

Ask about Nationwide Service!

Panasonic

1080 Model 2.....CALL **1091 Model 2**..CALL
1092 I.....CALL **1592**.....CALL
1524.....\$545 **1595**.....\$455
3131.....\$288 **3151**.....CALL
XEROX 635 - 4045 Laser & 7010 FAX.....CALL

PC COMPATIBLE SOFTWARE*

Data Base Management

Ashton-Tate dBase III Plus.....\$378
Knowledgeman 2.01.....\$285
PFS: Professional File.....\$139
R:Base 5000 System V.....\$415
WordTech DBXL (dBASE 3).....CALL

Communications

Carbon Copy Plus (Meridian).....\$118
Crosstalk XVI (Microstuf).....\$ 99
Microsoft Access.....\$137

Word Processors

NewWord (Wordstar 4.0 clone).....\$178
WordStar 4.0.....\$334
MultiMate Advantage II.....\$268
PFS: Professional Write.....\$109
Word Perfect.....\$212

Integrated / Spreadsheets

Enable 2.0 (software group).....\$375
MicroSoft Excel.....\$339
Framework II (Ashton-Tate).....\$375
Lotus 1-2-3.....\$298
Multiplan 1.11.....\$138
PFS: First Choice.....\$ 81
PFS: ProPlan.....\$ 54
Borland Quattro.....\$129
Symphony (Lotus).....\$438

Desktop Publishing

PFS: First Publisher.....\$ 54
Xerox Ventura 1.1.....\$519

Graphics & Mice

Harvard Graphics.....\$269
IMSI OptiMouse Serial.....\$ 88
IMSI Genius Mouse Serial.....\$ 59
Microsoft Bus Mouse.....\$ 98
SummaMouse-Optical.....\$ 78

Project Management

Harvard Total Project Manager.....\$325

* Compatibility with PC/XT/AT Clones not guaranteed.

800-528-3138 Orders Only 602-991-7870 Customer Service

S-100 Div./696 Corp. • 14151 N. 76th St. • Scottsdale, AZ 85260 • TELEX 9103806778 SNSCORP FAX 602-483-0920

Advertised prices are cash, prepaid, VISA or M/C Only! Customers qualifying for terms calculate addl charges in the following way: AMEX,C.O.D. & P.O.'s - .95. Credit card charged on day of shipment. Special order items require prepayment with other than credit card and they are not cancellable/returnable. Shipping first 6 lbs. min. \$6.00. *Free FedEx only applies to orders from 1-9 lbs & over \$50. Sales tax AZ res. only. All returns subject to a restocking fee or full credit towards a future purchase. All prices subject to change without notice

ACP's Break thru Prices!!

Since 1976...The Nation's TOP Computer Supplier

CALL FOR 80386!!

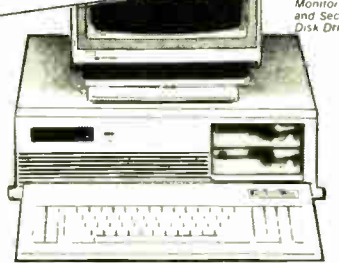

Advanced 286 \$899

ACP IBM COMPATIBLE VIDEO & I/O CARDS

Diamond Card w/2s.p.p.c	140
Monographics Printer/HGA/half	49
Monographics Printer/132 col	59
SuperEGA Genoa LSI/half	149
XT Multi I/O w/floppy	69
XT Dual floppy controller	29
XT/AT game port adapter	29
XT/AT parallel port adapter	29
XT/AT serial port adapter	29
Stxap compatible I/OK	69
AT floppy/hard controller	179

NEW! PS/2 AT CARDS	
1Mb LaserJet II ram card	\$239
PS/2 Multi I/O	99
PS/2 floppy controller 14Mb	59
XT/AT EPROM Programmer	129
AT 3.5Mb ram w/4 serial	179
AT Multi I/O w/4 serial	109
Accelerator 286/half	249

MOTHERBOARDS	
XT Turbo w/4.77MHz	599
XT Turbo w/4.77MHz	129
AT Motherboard 6/10MHz	369

AST	
Rampage 286/512K	\$335
Rampage/2 PS/2	208
Advantage Premium/512K	297
Advantage/2 PS/2	CALL
Stxapplus/64K	129
Xtormer XT to AT motherboard	699

ATI	
EGA Wonder	\$169

GENOA	
Super EGA (800x600)	\$289
Genoa VGA	319

GULFSTREAM	
EZ-FAX Board w/software	\$1188

HERCULES	
Color card/CGA	\$149
Graphics card plus	174
Incolor card New!	298

INTEL	
Inboard 386/PC New!	\$649
Inboard 386/AT reduced	229
Aboveboard PS/2/86, 512K	345
Aboveboard 286/512K	315

INTEL PROCESSORS	
8087 (5MHz)	\$102
8087-1 (PS/2)	229
8087-2 (8MHz)	168
80287-8	185
80287-9	285
80287-10	449
80387-16	499

ORCHID TECHNOLOGY	
Tiny Turbo 286 reduced	\$269
RAMQUEST 50/2MB PS/2	699
Designer VGA board SPECIAL	

PARADISE	
Autoswitch 480 EGA sale!	\$167
Paradise VGA plus	288

QUADRAM	
QuadEGA	\$299
QuadEGA Prosync w/mouse	249
Microfazer II printer/64K	269

VIDEO 7	
Vega Deluxe EGA (540x480)	\$192
Vega VGA (800x600)	299

INPUT DEVICES	
AC KEYBOARDS	
5160 Bakkey XT/AT switchable	\$59
5161 10key XT/AT switchable	75

KEYBOARDS	
KB101 101 key AT keyboard	\$88
KB515 deluxe 84 keys	119
KB515 101 w/pad	155

KRAFT	
IBM joystick	\$32

MICROSOFT	
Bus mouse w/paintbrush	\$106
Serial/PS/2 w-Windows	133
Serial/PS/2 w/paint	109

MSC Technologies	
PC Mouse (serial)	\$98
PC Mouse (bus)	118
PS/2 Mouse	118

HARD DRIVES

MINISCRIBE	
3650 40Mb (88ms)	\$399
6053 40Mb (28ms)	CALL
6085 70Mb (28ms)	819

PLUS DEVELOPMENT	
Hardcard 20 w/20 Mb	\$549
Hardcard 40 w/40 Mb	839

SEAGATE	
ST238 20Mb w/W/O cont	\$329
ST238 30Mb w/W/O cont RLL	419
ST251 40Mb w/cont (40ms)	479
ST251 40Mb (28ms)	498
ST4038 40ms	549
ST4038 80Mb (28ms) sale!	799

WESTERN DIGITAL	
Filecard 20 (20Mb add-in crd)	\$369
Filecard 30 (30Mb add-in crd)	CALL
PS30 Filecard for PS/2	CALL
1003-RAH RLL cont for AT	199
1003-WA2 AT floppy/hard	169
1002 WX1 ST506 for XT	75
1002 Z7X RLL cont for XT	95

BACK-UP DEVICES

ALPHA MICRO	
VCR tape backup card	\$333

IONEGA	
Bernoulli 10Mb	\$888
Bernoulli 20Mb	1288
Bernoulli 40Mb	1648
Beta (ext)	1639
IRWIN	925

1100 XT/AT 10Mb tape (int)	\$199
120XT 20Mb (int) for XT	345
120XT 20Mb (int) for AT	555

TALL GRASS TECHNOLOGIES	
1020-AT 20Mb tape drive (int)	\$349
1020-XT 20Mb tape drive (int)	349
1040-AT/XT 40Mb tape (int)	CALL

BARE BONES - 8 MHz XT KIT

• 4 77MHz Components	
• 0K expansion to 640K	
• XT/AT Deluxe Keyboard	
• Runs all Major software	
• Inc. Intel FDC Case	
• 150W Power Supply	
• Phoenix BIOS written for IBM	

Price Break Thru! **\$288.**

Amber Mono System w/360K FDD, Mono, FDC 256K **\$599.**

COMPUTERS

AST COMPUTERS	
QuadEGA	CALL
QuadEGA Prosync w/mouse	CALL
Microfazer II printer/64K	CALL

COMPAG	
Portable III Mod 20	CALL
Desktop 386 Mod 20	CALL
Desktop 386 Mod 40	CALL
Desktop 386 20 w/VGA	CALL

HYUNDAI	
Diskless Workstation Novell	CALL
Hyundai XT w/20Mb	CALL
Hyundai 286 New!	CALL

NEC	
Multispeed EL backhd LCD	CALL
Powermate Portable 20 New!	CALL
Powermate 1 Model 20	CALL
Powermate 386 Model 40	CALL

SHARP LAPTOPS	
4501 laptop sale!	\$699
4502 laptop I/1	1229
4521 w/20Mb	CALL

TOSHIBA LAPTOPS	
T1000/1100	\$799/1395
T1200/T1300	2395/2995
T1300/1500	CALL

MICROSOFT MACH 10 \$199.

2-3 times speed-up for your XT. Increase your CPU to 10 MHz. P104 bundled with Microsoft Mouse + Microsoft Windows v1.04. Note: upgrade to Windows v2.0 available from factory for \$25. SAVE 75% now only \$199. You get the Mach 10 board, PC mouse and Windows all for \$199.

NEW PRODUCT OF THE MONTH! ORCHID TECHNOLOGY DESIGNER VGA BOARD

Yes, the dust has settled and this card truly does work with OS/2 and Windows 386. So take advantage of the 16 color hi-res world of 1024x768 resolution. **\$319.**

BEST BUY LAPTOPS

Compaq Portable III/20Mb	3995	Sharp 4501 Portable	699
Compaq Portable III/40Mb	4795	Sharp 4502 F/F	1298
Toshiba 13100/15100	2990/4590	Sharp 4501 w/20Mb	CALL
Toshiba 11000/1000	769/1450	Laptop Options	Big Selection
Toshiba 11200/1100	1499/2090	1300/2400 Baud Modems	CALL
NEC Multi-speed EL	1599	Slot & Memory Expansion	CALL
NEC Multi-speed/20Mb	2550	12VDC Battery Adaptors	CALL
Sharp 7100 Portable	CALL		

CLOSEOUTS

Aboveboard PU/64K	\$215	PS/1 Model20 300 cps graphics	799
5160/84 key XT standard	16.48	Trace Printer Sound Enclosure	29
Panasonic JU455-2 360K XT drv	79	Omniport 1200 Baud	CALL
10Mb Hard disk drive	149	Modem/Multicard	149

FLIP N FILE SALE

Price BreakThru! SAVE 60%		Univ. Printer Stand	9.88
FNF Minn XT (100 5 1/4")	\$14.95	5 1/4" Disk Storage Box	1.88
FNF Max (100 5 1/4")	16.48	FNF Minn XT (holds 50 5 1/4")	8.88
Trace Sound Cove	48.88	5 1/4" Disk Box (set of colors)	8.85
FNF II (holds 40 3 1/2")	14.95	Flip Sort (holds 50 3 1/2")	11.88

NETWORKS

3COM	
EtherNet card	\$399
EtherNet II card	399

WESTERN DIGITAL	
Network for less than \$400 each	
Starlan/Novell Starter Kit	1077
StarHub	329
Star Card	175
EtherCardPlus	SPECIAL

MODEMS

ACP MODEMS	
1200 (int) w/software sale!	\$88
1200 (ext) w/software	99
2400 (int) w/software	149
2400 (ext) w/software	169

HAYES	
Smartmodem 2400B (int)	\$439
Smartmodem 2400B (ext)	447

MINENT	
Packet Modem 1200	\$159

PROMETHEUS	
2400G ProModem (ext) sale!	\$188

US ROBOTICS	
Courier 2400B (ext) w/MNP	CALL
Courier 9600 HST (ext)	799
Sporkster 1200 (ext)	129

EGA Best Buy \$499.

14" EGA Monitor w/10" n swivel plus Genoa Compatible Super EGA Card

MONITORS

AMDEK	
Video 310A amber mono 12"	\$129
410A amber grn. white 12"	149
1280 mono graphics (1280x800) 799	
Laser Drive I CD ROM drive	CALL

IBM MONITORS	
8503 12" mono (540x480)	\$228
8512 14" color analog	527
8513 12" EGA (540x480)	575
8514 16" HiRes (1024x768)	1395

MAGNAVOX	
Multimode (Multisync comp)	\$499
EGA monitor, non glare	399
CGA monitor, non glare	289
12" TTL amber, non glare	89

NEC	
Multisync II	CALL
Multisync Plus 15" (960x720)	899
Multisync XL 20" (1024x768)	CALL
Graphics Board G-1	315

SAMSUNG/LTI MONITOR	
12" Flat TTL amber T/S	\$119
12" non-glare amber T/S	88
14" non-glare color CGA T/S	275
14" non-glare color EGA T/S	389

SONY	
1311 CGA color w/TV	\$419
1302 Multisync (1024x768)	679
1303 Multisync (INEC comp)	519

WYSE	
WY700 (1280x800) graphics	\$799
WY350 Terminal	319
WY550 60, 75, 85	CALL

AT 'No Slot' Clock with Battery 2995

Ray-O-Vac 5 Yr. AT Repl. Battery 11.95

Plastic Box Box of 10 DS/DD 895 (5 colors) BOX

3M DATA CARTRIDGES

DC100A	\$14.95
DC500A	24.95
DC1000	22.95
DC1000	16.95

PRINTERS

DICONICS/KODAK	
150P portable printer	\$299
300P file carriage	CALL

EPSON	
FX-80 New! (80 col 180 cps)	\$166.00
FX-800 (80 col 300 cps)	CALL
FX-100 (24 pin 180 cps)	175
FX-286 (136 col 200 cps)	CALL
FX-86 (24 pin 200 cps)	CALL
LD-800 (24 pin 180 cps)	429.00
LD-1000 (24 pin 180 cps)	515.00
LD-2500 (24 pin 400 cps)	CALL

HEWLETT PACKARD	
LaserJet II	CALL
ScanJet/DeskJet	149

IBM PRINTERS	
Printer II 240cps	\$435
Printer XL24 240cps 24 pin	635
Printer XL24 24 pin 132 col	835

NEC	
P2200 24 pin 80 col New!	\$377
3550 35cps Letter Duality	749
PS-P6 P7 P9 Pinwriters	CALL

OKIDATA	
ML39324 pin 450 cps 132 col	\$1099
ML19324 pin 450 cps 132 col	799
193/293/292/294 Microline	CALL

PANASONIC	
KX-P1080 I/M/2 144 cps	\$169
KX-P4050 I/M/2 144 cps	302
KX-P1080 I/M/2 182 cps	195
1592 1595 3131 3151	CALL

TOSHIBA	
P3215L 24 pin 80 col	\$499
KX-P4050 I/M/2 144 cps	668
3131SX New! Super Hi-res	995
PageLaser 12 Hi volume/laser	CALL

PLOTTERS

HOUSTON INSTRUMENT	
DM/1500	\$2299.00
PS1 51 or 52	3099.00
SCANCAD	2499.00
MDP 56A	4399.00

ROLAND	
DXY 980 B/A/B size	\$1068
DXY 980	1488

ACCESSORIES

COMPUTER ACCESSORIES	
PS power director	\$89
PS2 4 outlet stand alone	52
A200 PC Data protection module	899

KENSINGTON	
Masterpiece power ctr	\$98
MasterpiecePlus	108
Printer Master (80 col)	319

MICRO ACCESSORIES	
5-1/4" Rolltop Diskette	\$29
5-1/4" Rolltop Diskette	22
PC Vacuum Cleaner	39
CRT Vajet (12" x 12")	119
Underdesk KB drawer	49
Flip-Sort (to 75 disks)	\$14.00
PS-5-1/4" Disk Holder	9.00
AC 3-1/2" Disk Holder	12.00
Head Cleaner 5-1/4" or 8"	9.00
PERFECT COMPUTER/EMC kit	19.95

PRINT BUFFERS

IC's IC's, Parts, Components... Shipped Fast!

West Coast's Largest Selection... Call for More

RAM Upgrades!

- ...priced in sets of 9
- 64K/120ns \$18.95
 - 64K/150ns 16.95
 - 256K/100ns 48.95
 - 256K/120ns 39.95
 - 256K/150ns 34.95

DYNAMIC RAMS

4116/200ns	\$1.29	4464/150ns	\$5.49
MK4332/200ns	5.95	41256/100ns	3.45
4164/200ns	.95	41256/120ns	4.49
4164/150ns	1.95	41256/150ns	3.95
4164/120ns	2.15	41264/150ns	11.95
4164/PIN ONE	2.75	4128/150ns	4.19
4416/200ns	3.75	8118/4517-150ns	1.19
4416/150ns	4.19	1 MEG/100ns	32.95
4464/120ns	6.49	TMS 4161/150ns	6.95

STATIC RAMS

2102LP/450ns	\$.99	6116/120ns	\$2.95
2101/450ns	1.79	6116LP/150ns	2.45
2112/450ns	2.69	6264LP/120ns	4.95
2114/450ns	89	6264LP/150ns	4.45
21142	1.19	6264/150ns	4.25
2114L/2	1.99	62256/120ns	12.85
6116/150ns	2.45	62256/100ns	19.95

74 HCT SERIES

74HC100	\$2.25	74HC1161	\$6.65	74HC540S1	\$9.99
74HC102	2.5	74HC1163	6.5	74HC541	1.99
74HC104	2.5	74HC1164	6.5	74HC563	2.99
74HC108	2.5	74HC1175	6.5	74HC564	2.99
74HC110	2.5	74HC1240	1.29	74HC573	1.99
74HC127	3.0	74HC1241	1.29	74HC574	.99
74HC134	4.9	74HC1244	1.29	74HC640	1.99
74HC138	5.0	74HC1245	1.29	74HC646	2.99
74HC1157	6.5	74HC1257	6.5	74HC563	2.99
74HC1160	6.5	74HC1259	1.10	74HC564	2.99

LINEAR

CA3086	\$1.19	LM566	\$1.10	LM3900	45
CA3089	1.19	LM567	7.15	LM3909	1.25
CA3403	1.19	LM723	30	LM3911	1.35
LF347N	1.49	LM733	30	LM3914	2.75
LF348N	1.49	LM741	30	LM3915	2.75
LF356H	1.99	LM747	60	LM3916	2.75
LF441	1.69	LM748	65	LM4024	3.95
LM301	3.0	LM1414	1.49	LM4044	3.95
LM309K	1.00	LM1886	3.29	LM4136	1.50
LM317K	2.95	LM1330	1.95	LM4558	.75
LM317T	1.75	LM1350	1.25	LM7555	2.50
LM318	1.15	LM1358	1.95	LM7556	2.50
LM319	95	LM1372	2.25	LM7660	2.95
LM320T-XX	60	LM1408L8	2.50	LM7663	2.95
LM320K-XX	1.35	LM1458	40	LM7805	6.95
LM323K	4.25	LM1488	60	LM78H12	6.95
LM324	3.5	LM1489	60	LM8038	3.5
LM335-02	1.19	LM1889	2.50	MC3423	1.99
LM336-02	1.19	LM2003	7.5	MC3459	2.99
LM337H	2.49	LM2206	3.75	MC3470	2.99
LM337K	4.95	LM2211	1.19	MC3480	6.95
LM338K	6.95	LM2211	1.19	MC3486	1.99
LM340T-XX	60	LM2240	1.75	MC3487	1.99
LM340K-XX	1.35	LM2900	1.19	LM3524	1.99
LM358	4.5	LM2901	1.19	TOA1170	5.99
LM376	1.69	LM2917	1.29	TOA1180	5.99
LM380	95	LM3045	1.19	TL074	1.65
LM386	95	LM3054	1.99	TL081	.75
LM393	65	LM3079	1.49	TL082	.65
LM497	2.50	LM3130	95	TL084	1.25
LM565	30	LM3140	95	ULN2003	1.99
LM566	45	LM3160	1.95	ULN2064	1.79
LM568	85	LM3161	1.95	ULN2074	1.99
LM564	2.75	LM3162	1.95	ULN2081	1.49
LM565	1.50	LM3852	1.49	ULN2981	1.99

74HC SERIES

74HC00	\$2.25	74HC125	\$5.50	74HC174	\$6.65
74HC02	2.5	74HC132	50	74HC175	.65
74HC04	2.5	74HC133	50	74HC240	1.29
74HC08	2.5	74HC138	55	74HC244	1.29
74HC09	2.5	74HC139	55	74HC245	1.29
74HC10	2.5	74HC148	.75	74HC368	.65
74HC11	2.5	74HC151	.65	74HC373	1.29
74HC14	2.5	74HC153	.65	74HC374	1.29
74HC20	2.5	74HC154	3.75	74HC4020	9.99
74HC32	2.5	74HC157	.65	74HC4060	9.99
74HC74	.35	74HC161	.65	74HC4066	9.99
74HC85	.65	74HC166	1.15	74HC4075	.80
74HC112	.65	74HC173	.65	74HC4078	1.49

7400 SERIES

7400	\$1.18	7474	\$3.35	74157	\$6.65
7402	.18	7475	.35	74158	.65
7404	.18	7476	.35	74173	.65
7405	.18	7488	.35	74174	.65
7406	.35	7489	.35	74175	.65
7407	.35	7499	.35	74176	.65
7408	.25	7494	.35	74181	1.75
7410	.25	7499	.35	74189	2.95
7414	.35	7411	.35	74193	.65
7420	.25	7413	.45	74195	.65
7426	.25	74135	.45	74198	1.65
7427	.25	74136	.45	74221	.75
7430	.25	74148	.65	74273	1.75
7432	.25	74150	1.20	74365	.50
7438	.25	74151	.65	74366	.50
7442	.30	74153	.65	74367	.50
7446	.85	74154	1.20	74368	.50
7447	.95				

74C CHIPS

74C00	\$2.25	74C154	\$2.85	74C374	\$1.69
74C02	2.5	74C173	99	74C903	1.19
74C04	2.5	74C174	99	74C906	1.19
74C08	3.5	74C175	99	74C912	6.95
74C10	3.5	74C21	1.25	74C922	3.95
74C14	4.9	74C240	1.69	74C933	3.95
74C32	3.5	74C244	1.69	74C929	4.89
74C90	1.19	74C313	1.69	74C932	14.89

Partial Listing Only!!!
Call us for components...

74LS SERIES

74LS00	\$1.19	74LS125	\$4.45	74LS241	\$9.99
74LS02	.19	74LS126	.49	74LS242	.99
74LS03	.19	74LS138	.45	74LS243	.99
74LS04	.19	74LS139	.45	74LS244	.99
74LS05	.19	74LS153	.59	74LS245	.99
74LS06	.19	74LS154	1.29	74LS257	.69
74LS09	.19	74LS157	.40	74LS258	.69
74LS10	.19	74LS158	.40	74LS259	.99
74LS14	.35	74LS161	.49	74LS273	.99
74LS27	.28	74LS163	.49	74LS322	1.79
74LS30	2.5	74LS164	.49	74LS323	1.79
74LS32	.28	74LS165	.49	74LS365	.59
74LS47	.99	74LS166	.99	74LS366	.59
74LS73	.35	74LS173	.49	74LS367	.59
74LS74	.35	74LS174	.49	74LS368	.99
74LS75	.35	74LS175	.49	74LS373	.99
74LS76	.35	74LS179	3.95	74LS374	.99
74LS85	.49	74LS180	.49	74LS393	.99
74LS86	.28	74LS181	.49	74LS394	1.89
74LS90	.45	74LS182	.49	74LS629	1.89
74LS92	.45	74LS183	.49	74LS640	1.89
74LS107	.45	74LS185	.49	74LS641	1.89
74LS109	.45	74LS221	.65	74LS670	.99
74LS123	.49	74LS240	.99	74LS688	1.89

74F SERIES

74F00	\$3.35	74F153	\$5.59	74F243	\$1.29
74F02	.35	74F157	.59	74F244	1.29
74F04	.35	74F158	.59	74F245	1.29
74F08	.35	74F160	.59	74F251	.79
74F10	.35	74F161	.59	74F258	.79
74F11	.35	74F163	.59	74F290	2.89
74F20	.35	74F174	.69	74F374	1.49
74F32	.35	74F175	.69	74F379	1.99
74F46	.49	74F181	.99	74F399	2.99
74F74	.49	74F189	2.99	74F521	2.99
74F86	.49	74F219	4.99	74F523	2.99
74F109	.49	74F240	1.29	74F533	2.99
74F139	.49	74F241	1.29	74F534	2.99
74F151	.59				

IC SOCKETS

SOLDER TAIL	HR16S/T	59	22PIN/W/W	1.29	
8PIN/LP	HR18S/T	69	24PIN/W/W	1.29	
14PIN/LP	HR20S/T	79	28PIN/W/W	1.59	
16PIN/LP	HR22S/T	89	40PIN/W/W	1.99	
18PIN/LP	HR24S/T	99	HR RES/W	5.79	
20PIN/LP	HR28S/T	1.19	HR14W/W	1.19	
22PIN/LP	HR40S/T	1.49	HR16W/W	1.29	
24PIN/LP	HR64S/T	4.99	HR18W/W	1.39	
28PIN/LP	WIREWRAP		HR20W/W	1.69	
40PIN/LP	29	8PIN/W/W	5.59	HR22W/W	1.79
48PIN/LP	99	14PIN/W/W	5.99	HR24W/W	1.99
64PIN/LP	2.49	16PIN/W/W	6.99	HR28W/W	2.29
HR RES	18PIN/W/W	99	HR28W/W	2.49	
HR8S/T	39	20PIN/W/W	1.19	HR40W/W	3.49
HR14S/T	49				

SPECIAL FUNCTION

VOICE RECOGNITION	16450 - 16 BIT	
CHIP SET	USART	\$16.95
YAMAHA DXY	8250 - 8 BIT	
CHIP SET	USART	6.95
TMS 6100	5832 - CLODK	3.95
SPEECH CHIP	58167 - CLODK	8.95
TMS 5200 SPEECH CHIP		7.95

CMOS

CD4001	\$1.18	CD4017	\$5.59	CD4047	\$6.65	CD4069	\$2.99	CD4510	\$6.99	CD4543	\$8.99
CD4002	.18	CD4018	.59	CD4048	.75	CD4070	.29	CD4511	.69	CD4555	.99
CD4007	.59	CD4020	.59	CD4049	.29	CD4071	.29	CD4512	.69	CD4556	.99
CD4008	.59	CD4024	.49	CD4050	.39	CD4072	.29	CD4518	.79	CD4584	.69
CD4009	.59	CD4025	.59	CD4051	.39	CD4073	.79	CD4519	.79	CD14409	6.95
CD4010	.29	CD4027	.35	CD4052	.59	CD4076	.65	CD4520	.79</		

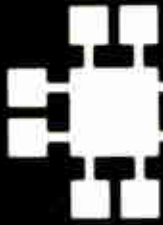

JDR Microdevices®

Complete customer satisfaction...superior service...friendly, knowledgeable personnel
quality merchandise...providing the best values in leading edge technology.

**EASYDATA
2400 BAUD
\$149⁹⁵
NEW LOW PRICE!**

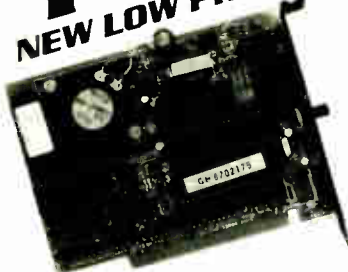

IT'S TIME TO TRADE UP NOW THAT JDR BREAKS THE PRICE BARRIER ON 2400 BAUD MODEMS

- AUTO DIAL ANSWER
- SELF TEST ON POWER-UP
- TOUCHTONE OR PULSE DIALING
- HAYES & BELL SYSTEMS COMPATIBLE
- FULL OR HALF DUPLEX
- PC TALK III INCLUDED WITH INTERNAL MODEMS

12H 1200 BAUD 1/2 CARD \$69.95
EXTERNAL MODEMS
12D 1200 BAUD \$119.95
24D 2400 BAUD \$219.95

COMPUTER CASES

ATTRACTIVE, STURDY STEEL CASES FIT THE POPULAR SIZED MOTHERBOARDS AND INCLUDE SPEAKERS, FACEPLATES, EXPANSION SLOTS, FRONT PANEL KEYLOCKS, LED INDICATORS AND ALL NECESSARY HARDWARE.



XT STYLE FLIP-TOP \$34.95
XT STYLE SLIDE-TOP \$39.95
AT STYLE SLIDE-TOP \$89.95
JR. AT STYLE FLIP-TOP \$149.95
 • INCLUDES 150 WATT POWER SUPPLY

POWER SUPPLIES

FOR IBM XT COMPATIBLE \$59.95

- UL APP. 135 WATTS
- +5V 15A, +12V 4 2A
- -5V 5A, -12V 5A

PS-135

PS-150 150W MODEL \$69.95



FOR IBM AT COMPATIBLE \$89.95

- 200 WATTS
- +5V 22A, +12V 8A
- -5V 5A, -12V 5A

PS-200



**DIABLO
PRINTER
\$279⁹⁵**

- LETTER QUALITY AT 20 CPS, 132 COLS
- 10, 12, 15 PITCH & PROPORTIONAL SPACING
- SERIAL & PARALLEL INTERFACE
- AUTO PAPER LOAD, FRICTION FEED
- FULL XEROX WARRANTY



**CENTRONICS
LASER \$1195
PRINTER**

**NEAR TYPESET QUALITY
AFFORDABLE AT LAST**

- 8 PAGES PER MINUTE • 300 DPI RESOLUTION¹
- 1 YEAR WARRANTY • CHOICE OF EMULATION BOARDS

MULTI-PRINTER EMULATION BOARD:

EPSON FX-80 EMULATION—NOTHING ELSE REQUIRED
IBM PC GRAPHICS PROPRINTER & DIABLO 630
EMULATION REQUIRES ADDITIONAL FONT CARD

HP LJ+ EMULATION BOARD:

HP LASERJET EMULATION—3 RESIDENT FONTS &
2 PITCHES ADDITIONAL FONT CARD AVAILABLE

1.5MB RAM CARD \$139.95
EXTRA FONT CARDS \$199.95
TONER CARTRIDGES \$59.95
PFS FIRST PUBLISHER \$99.95



**IBM
COMPATIBLE
KEYBOARDS
FULL ONE YEAR WARRANTY**

IBM ENHANCED STYLE LAYOUT \$79.95

- AUTOSENSE FOR XT OR AT COMPATIBLES
- LED INDICATORS • AUTO REPEAT FEATURE
- SEPARATE CURSOR PAD

MCT-5339

IBM AT STYLE LAYOUT \$59.95

- SOFTWARE AUTOSENSE FOR XT OR AT COMPATIBLES
- LED INDICATORS • AUTO REPEAT FEATURE

MCT-5060

MAXI-SWITCH KEYBOARDS

ENHANCED STYLE LAYOUT \$84.95

- STANDARD ENHANCED KEYBOARD LAYOUT
- TACTILE FEEDBACK
- LIGHTED NUM. CAPS. AND SCROLL LOCK
- NUMERIC & CURSOR KEYPADS, 12" F. KEYS

MAX-5339

MAX-5060 MAXI-SWITCH, AT STYLE \$64.95

**SAMSUNG
MONOCHROME
MONITOR
\$129⁹⁵**

- IBM COMPATIBLE TTL INPUT
- 12" NON-GLARE, LOW DISTORTION AMBER SCREEN
- 720 X 350 RESOLUTION
- SWIVEL BASE



NEC MULTISYNC \$599.95

- ORIGINAL CGA EGA VGA COMPATIBLE MONITOR
- AUTO FREQUENCY ADJUSTMENT
- RESOLUTION AS HIGH AS 800 X 560

CASPER E6A \$399.95

- 15 75 21 85 KHZ SCANNING FREQUENCIES
- 640 X 200/350 RESOLUTION • 31 MM DOT PITCH
- 14" BLACK MATRIX SCREEN • 16 COLORS

CASPER R6B \$279.95

- COLOR GREEN AMBER SWITCH • 39MM DOT PITCH
- 640 X 240 RESOLUTION • 14" NON-GLARE SCREEN
- RGB IBM COMPATIBLE • CABLE INCLUDED

**SAKATA
MONOCHROME \$69.95**

- IBM COMPATIBLE TTL INPUT
- 12" NON-GLARE SCREEN
- CABLE FOR IBM PC INCLUDED

MONITOR STANDS

MODEL MS-100 \$12.95

- TILTS AND SWIVELS
- STURDY PLASTIC CONSTRUCTION

MODEL MS-200 \$39.95

- TILTS AND SWIVELS • BUILT-IN SURGE SUPPRESSOR
- INDEPENDENTLY CONTROLS UP TO 5 AC OUTLETS

**LOGITECH
MOUSE
\$79⁹⁵**



PC MAGAZINE'S EDITORS CHOICE
ALL MODELS HAVE SERIAL SUPPORT (COM1/COM2) 200
DPI RESOLUTION, LOTUS 1-2-3 SHELL, SELF-INSTALLING
SOFTWARE AND "POINT EDITOR"

SERIAL MOUSE W/PC PAINTBRUSH \$99.95

BUS MOUSE W/PC PAINTBRUSH \$99.95

BUS MOUSE W/PC PAINTBRUSH/CAD \$149.95

**3.5" FLOPPY
DISK DRIVE
\$129⁹⁵**



- IBM COMPATIBLE DRIVE • AT AND XT VERSIONS AVAILABLE
- FORMATS TO 720K, DS QD UNDER DOS 3.2
- MEDIA COMPATIBLE WITH PS-2 & LAPTOP MACHINES
- INCLUDES HARDWARE FOR MOUNTING IN 5 1/4" SLOT
- QUIET OPERATION

FDD-3.5X (FOR XT)

FDD-3.5A (FOR AT)



1/2 HEIGHT HARD DISK SYSTEMS

20 MB **\$269**
 30 MB **\$299**

SYSTEMS INCLUDE SEAGATE 1/2 HEIGHT HARD DRIVE, DRIVE CONTROLLER, CABLES & INSTRUCTIONS. ALL DRIVES ARE PRE-TESTED & WARRANTED FOR 1 YEAR.

1/2 HEIGHT HARD DISK DRIVES

40 MB **\$429**
 60 MB **\$649**

DRIVES ARE SEAGATE MODELS ST-251 (40 MB) & ST-277 (60 MB RLL) 5 1/4" HALF HEIGHTS FAST 40MS ACCESS TIME!

INTERFACE CARDS FROM MODULAR CIRCUIT TECHNOLOGY DISPLAY ADAPTORS

MONOCHROME GRAPHICS CARD \$59.95
 TRUE HERCULES COMPATIBILITY. SUPPORTS LOTUS 123
 ■ DRIVER ALLOWS COLOR GRAPHICS SOFTWARE TO RUN ON A MONOCHROME MONITOR ■ PARALLEL PRINTER PORT
 MCT-MGP

ENHANCED GRAPHICS ADAPTOR \$149.95
 100% IBM COMPATIBLE PASSES IBM EGA DIAGNOSTICS
 ■ 256K OF VIDEO RAM ALLOWS 640 X 350 IN 16 OF 64 COLORS ■ COMPATIBLE WITH COLOR AND MONOCHROME ADAPTORS
 MCT-EGA

COLOR GRAPHICS ADAPTOR \$49.95
 COMPATIBLE WITH IBM GRAPHICS STANDARDS
 ■ SUPPORTS RGB, COLOR & COMPOSITE MONOCHROME
 ■ 640 320 X 200 RESOLUTION. LIGHT PEN INTERFACE
 MCT-CG

MULTIFUNCTION CARDS

MONOGRAPHICS MULTI I/O \$119.75
 TOTAL SYSTEM CONTROL FROM A SINGLE SLOT!
 ■ CTRL 2 FLOPPY S, SERIAL, PARALLEL, GAME PORT
 CLOCK CAL ■ RUN COLOR GRAPHICS SOFTWARE ON A MONOCHROME MONITOR
 MCT-MGMI0

MULTI I/O FLOPPY CONTROLLER \$79.95
 A PERFECT COMPLEMENT FOR OUR MOTHERBOARDS
 ■ SUPPORTS UP TO 2 360K FLOPPIES, 720K WITH DOS 3.2
 ■ SERIAL, PARALLEL, GAME PORT, C.CLOCK CALENDAR
 MCT-MIO
 MIO-SERIAL—2ND SERIAL PORT \$15.95

MULTI I/O CARD \$59.95
 USE WITH MCT-FH FOR A MINIMUM OF SLOTS USED
 ■ SERIAL PORT, CLOCK CALENDAR WITH BATTERY BACK UP
 ■ PARALLEL PRINTER PORT ADDRESSABLE AS LPT1 OR LPT2
 MCT-IO

AT MULTIFUNCTION CARD \$139.95
 ADDS UP TO 3 MEGABYTES OF RAM TO THE AT
 ■ USER EXPANDABLE TO 1 5MB (ZERO K INSTALLED)
 ■ INCLUDES SERIAL PORT AND PARALLEL PORT
 MCT-ATMF
 ATMF SERIAL—2ND SERIAL PORT \$24.95
 MCT-ATMF-MC—PIGGYBACK BOARD (NO MEMORY) \$29.95

AT MULTI I/O CARD \$59.95
 USE WITH MCT-ATFH FOR MINIMUM OF SLOTS USED
 ■ SERIAL, PARALLEL AND GAME PORTS ■ USES 16450 SERIAL SUPPORT CHIPS FOR HIGH SPEED OPS
 MCT-ATIO
 ATIO-SERIAL—2ND SERIAL PORT \$24.95

MEMORY CARDS
576K RAM CARD \$59.95
 A CONTIGUOUS MEMORY SOLUTION IN A SHORT SLOT
 ■ USER SELECTABLE CONFIGURATION UP TO 576K
 ■ USES 64K & 256K RAM CHIPS (ZERO K INSTALLED)
 MCT-RAM

EXPANDED MEMORY CARD \$129.95
 2 MB OF LOTUS INTEL MICROSOFT COMPATIBLE MEMORY FOR AN XT ■ CONFORMS TO LOTUS INTEL EMS ■ USER EXPANDABLE TO 2 MB ■ CAN BE USED AS EXPANDED OR CONVENTIONAL MEMORY, RAMDISK AND SPOOLER
 MCT-ATEMS
 MCT-ATEMS-AT VERSION \$139.95

DRIVE CONTROLLERS

FLOPPY DISK CONTROLLER \$29.95
 QUALITY DESIGN FOR SINGLE SLOT CONTROL OF 4 FLOPPY'S ■ INTERFACES UP TO 4 FDD'S TO AN IBM PC OR COMPATIBLE ■ SUPPORTS BOTH DS/DD AND DS/OD WITH DOS 3.2
 MCT-FDC

1.2 MB FLOPPY CONTROLLER \$69.95
 ADD VERSATILITY AND CAPACITY TO YOUR XT
 ■ SUPPORTS 2 DRIVES, BOTH MAY BE 360K OR 1.2 MB
 ■ ALLOWS DATA TO FLOW FREELY FROM XT'S TO AT'S
 MCT-FDC-1.2

FLOPPY/HARD CONTROLLER \$139.95
 XT SYSTEM STARVED FOR SLOTS? THIS CARD FEEDS ONE UP ■ INTERFACES UP TO 2 FDD'S & 2 HDD'S, CABLING FOR 2 FDD 1 HDD ■ SUPPORTS BOTH DS DD & DS OD WITH DOS 3.2
 MCT-FH

ATFH CONTROLLER \$149.95
 FLOPPY HARD DISK CONTROL IN A TRUE AT DESIGN
 ■ SUPPORTS UP TO 2 360K 720K 1.2MB FDD'S AS WELL AS 2 HDD'S USING STANDARD CONTROL TABLES
 MCT-ATFH

RLL DISK CONTROLLER \$199.95
 IMPROVE SPEED AND STORAGE OF YOUR AT COMPATIBLE ■ SUPPORTS UP TO 2 RLL HARD DISCS AND 2 FLOPPY DRIVES ■ SUPPORTS 360 720 1.2 MB FLOPPIES IN 5.25" & 3.5"
 MCT-ATFH-RLL



INBOARD 386/PC \$895.00

UPGRADE YOUR XT TO A 386 FOR LESS THAN \$1000
 ■ 16 MHZ PROCESSOR REPLACES 8088 ■ 1 MB INSTALLED ■ EXPAND TO 3MB WITH PIGGYBACK CARD
 ■ 5 YR WARRANTY

INBOARD 386 AT \$1199.95
 ABOVE BOARD PS 286 \$399.95
 ABOVE BOARD 286 \$369.95

DISK DRIVES

5 1/4" SEAGATE HARD DISK DRIVES
 ST-225 HALF HEIGHT 20MB 65MS \$255.00
 ST-238 HALF HEIGHT 30MB 65MS (RLL) \$249.00
 ST-4038 FULL HEIGHT 30MB 40 MS \$559.00
 ST-4096 FULL HEIGHT 80MB 28MS \$895.00

1/2 HEIGHT FLOPPY DISK DRIVES
 5 1/4" TEAC FD-55B DS/DD 360K \$99.95
 5 1/4" TEAC FD-55G DS/HD 1.2M \$129.95
 5 1/4" FUJITSU M2551A DS/DD 360K \$89.95
 5 1/4" FUJITSU M2553K DS/HD 1.2M \$119.95
 5 1/4" DS/DD 360K \$69.95
 5 1/4" DS/HD-1.2M \$109.95
 3 1/2" MITSUBISHI DS/DD (AT OR XT) \$129.95

ARCHIVE XL TAPE BACK-UP \$369.95

BACK UP 40 MB IN 40 MINUTES!
 ■ EASY-TO-USE MENU DRIVEN SOFTWARE
 ■ USES STANDARD QIC DATA FORMAT
 ■ FULL & INCREMENTAL BACK-UP

■ PARTIAL & FULL RESTORE
 AR 5240 XT —FOR XT S & AT S
 AR 5540 AT —AT S ONLY 2X FASTER TAPE NOT INCLUDED
 TAPE CARTRIDGE—40 MB \$24.95



20MB HARD DISK ON A CARD \$349

■ SAVES SPACE AND REDUCES POWER CONSUMPTION
 ■ IDEAL FOR PC S WITH FULL HEIGHT FLOPPIES
 ■ LEAVES ROOM FOR A HALF LENGTH CARD IN ADJACENT SLOT



“ I'M WRITING TO EXPRESS MY PLEASURE WITH THE PC-XT TYPE COMPUTERS BUILT FROM MCT COMPONENTS THAT WE HAVE OBTAINED FROM YOUR COMPANY. AFTER 3 YEARS OF DAILY USAGE I AM EXTREMELY PLEASED WITH THE LEVEL OF COMPATIBILITY AND PERFORMANCE. WITH A RECENT PURCHASE, I WAS ELATED WITH THE PROMPT MANNER IN WHICH OUR ORDER WAS HANDLED. AFTER DEALING WITH OTHER MAIL ORDER FIRMS, I HAVE FOUND ONLY JDR AND 2 OTHER SOFTWARE VENDORS HELPFUL AND RELIABLE. KEEP UP THE EXCELLENT WORK. ”

J.R.D.
 OMAHA, NE.

BARGAIN HUNTER'S CORNER MACINTOSH FLOPPY DRIVE

■ 100% MACINTOSH COMPATIBLE 3.5" ADD-ON DRIVE
 ■ HIGH RELIABILITY DRIVE WITH AUTO-EJECT MECHANISM
 ■ DOUBLE SIDED—800K

ONLY **\$169.95**

WE HAVE JUST 48 DRIVES LEFT SO HURRY TO GET THIS UNBELIEVABLE PRICE!
 SPECIAL ENDS 4/30 88



JDR MICRODEVICES, 110 KNOWLES DRIVE, LOS GATOS, CA 95030
 LOCAL (408) 866-6200 FAX (408) 378-8927 TELEX 171-110

ORDER TOLL FREE 800-538-5000

COPYRIGHT 1988 JDR MICRODEVICES

CONTINENTAL U.S. AND CANADA

BUILD YOUR OWN SYSTEM

OVER 20,000 JDR SYSTEMS HAVE ALREADY BEEN BUILT. EASY TO ASSEMBLE IN JUST 2 HOURS WITH A SCREWDRIVER. SAVE MONEY AND LEARN ABOUT YOUR COMPUTER AT THE SAME TIME.

12 MHZ AT COMPATIBLE
\$1034²⁰

- 12 MHZ BABY AT MOTHERBOARD
- 256K RAM MEMORY
- MINI-AT CASE W/POWER SUPPLY
- AT STYLE KEYBOARD
- 1 2 MB FLOPPY DRIVE
- FLOPPY HARD DRIVE CONTROLLER
- MONOCHROME MONITOR
- GRAPHICS ADAPTOR

10 MHZ XT COMPATIBLE
\$589⁰⁰

- INCLUDES SERIAL PORT 2 PARALLEL PORTS. CLOCK CALENDAR AND GAME ADAPTOR. RUNS COLOR GRAPHICS ON A MONOCHROME MONITOR
- MOTHERBOARD
- 256K RAM MEMORY
- 135 WATT POWER SUPPLY
- FLIP-TOP CASE
- AT STYLE KEYBOARD
- 360K FLOPPY DRIVE
- MONOGRAPHS I/O CARD
- MONOCHROME MONITOR

16 MHZ 1 MB 386
\$2298⁶⁵

- MYLEX 386 MOTHERBOARD
- 1 MB RAM ON BOARD
- 200 WATT POWER SUPPLY
- AT STYLE CASE
- ENHANCED AT STYLE KEYBOARD
- 1 2 MB FLOPPY DRIVE
- AT FLOPPY HARD CONTROLLER
- MONOCHROME MONITOR
- MONOGRAPHS CARD

VIDEO INSTRUCTIONS
\$4.95
WITH KIT PURCHASE
IT'S A JDR EXCLUSIVE!
EASY TO FOLLOW
20 MINUTE VHS TAPE SHOWS YOU STEP-BY-STEP HOW TO BUILD AN XT COMPATIBLE SYSTEM.
WITHOUT KIT \$19.95



MOTHERBOARDS

TURBO 4.77/8 MHZ \$99.95 **12 MHZ MINI 80286 \$399.95**

- 4.77 OR 8 MHZ OPERATION WITH 8088-2 & OPTIONAL 8087-2 CO-PROCESSOR
- FRONT PANEL LED SPEED INDICATOR AND RESET SWITCH SET SUPPORTED
- CHOICE OF NORMAL TURBO MODE OR SOFTWARE SELECT PROCESSOR SPEED

MCT-TURBO
MCT-XTMB STANDARD MOTHERBOARD \$87.95

- 6 MHZ, 10 MHZ (0/1 WAIT STATE), 12 MHZ (1 WAIT STATE)
- USES ZYMOS ASIC'S FOR LESS CHIPS. GREATER RELIABILITY
- SUPPORTS 256K-1024K MEMORY
- RE-CHARGEABLE HIGH CAPACITY NI-CAD BATTERY
- 6 16-BIT SLOTS, 2 8-BIT SLOTS
- MOUNTS IN STANDARD XT CASE

MCT-BATMB-12
MCT-BATMB 6/10 MHZ MINI 80286 BOARD \$389.95

80286 6/8 MHZ \$379.95 **16 MHZ MYLEX 386 \$1649.00**

- 8 SLOT (2 EIGHT BIT, 6 SIXTEEN BIT) AT MOTHERBOARD
- HARDWARE SELECTION OF 6 OR 8 MHZ
- 1 WAIT STATE
- KEYLOCK SUPPORTED. RESET SWITCH. FRONT PANEL LED INDICATOR
- SOCKETS FOR 1 MB OF RAM AND 80287
- BATTERY BACKED CLOCK

MCT-ATMB

- 1 MB RAM ON BOARD
- 8 SLOTS, 2 8-BIT, 6 16-BIT
- SUPPORTS 80287 MATH CO-PROCESSOR
- SUPPORTS 80387 W ADAPTOR
- 64 KB CACHE FOR NEAR 0 WAIT STATE
- USES AMI BIOS

MCT-386 MB
MCT-386 MB-4 4 MB MEMORY INSTALLED \$2649.00
MCT-386 MB-MCB MATH CO-PROCESSOR ADAPTOR BOARD \$149.00

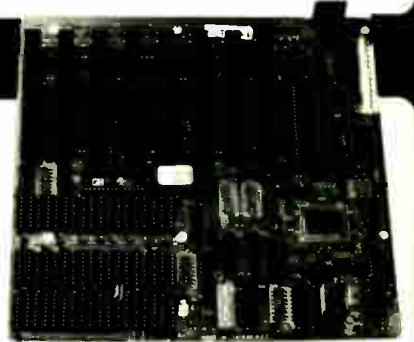

10 MHZ SINGLE CHIP XT
\$129⁹⁵

- SINGLE CHIP USES LESS POWER. IMPROVES RELIABILITY
- KEY SELECTABLE SPEED. 4.77 MHZ OR 10 MHZ
- 2 3 TIMES FASTER THAN A STANDARD
- RESET SWITCH, KEYLOCK AND SPEED POWER INDICATORS SUPPORTED

MCT-TURBO-10

DEVELOPMENT TOOLS

EPROM PROGRAMMER
\$129⁹⁵

- PROGRAMS 27XX & 27XXX EPROMS UP TO 27512
- SUPPORTS VARIOUS PROGRAMMING FORMATS AND VOLTAGES
- SPLIT OR COMBINE CONTENTS OF SEVERAL EPROMS OF DIFFERENT SIZES
- READ, WRITE, COPY, ERASE CHECK AND VERIFY
- SOFTWARE FOR HEX AND INTEL HEX FORMATS

MCT-EPROM
MCT-EPROM-4 4 GANG PROGRAMMER \$189.00
MCT-EPROM-10 10 GANG PROGRAMMER \$299.95
MCT-PAL PAL PROGRAMMER \$269.95
MCT-MP PROCESSOR PROG. \$199.95

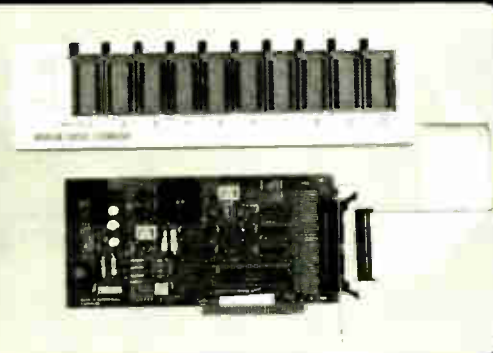

- 1 YEAR WARRANTY ON MCT PRODUCTS
- 30 DAY MONEY BACK GUARANTEE
- TOLL-FREE TECHNICAL SUPPORT
- NEXT DAY AIR SHIP AVAILABLE

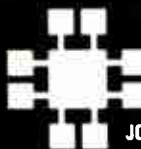

JDR Microdevices®

JDR MICRODEVICES, 110 KNOWLES DRIVE, LOS GATOS, CA 95030
LOCAL (408) 866-6200 FAX (408) 378-8927 TELEX 171-110



ORDER TOLL FREE 800-538-5000

COPYRIGHT 1988 JDR MICRODEVICES

CONTINENTAL U.S. AND CANADA

IT'S NOT 29¢ PLUS THIS AND THAT, IT'S

29¢

2 for 1 replacement guarantee on bulk 5 1/4" if found initially defective within six months
With sleeves, tabs, labels

EACH

5 1/4" DS/DD (Min. 100)	29¢
DS/DD (Min. 50)	39¢
Color 5 1/4" DS/DD (Min. 50)	49¢
5 1/4" IBM-AT HD (Min. 50)	79¢
Box of 10 5 1/4" DS/DD (Min. 10)	\$4.29
Box of 10 Color 5 1/4" DS/DD	
Free Plastic Case (Min. 5)	\$5.99

3 1/2" SS/DD (Min. 25)	99¢
DS/DD (Min. 25)	\$1.09

Data 205 40 MB Mini Cartridge

3m DEI Compatible (Min. 5)	\$15.90
600 120 MB Data Cartridge (Min. 5)	\$19.20

Immediate shipping—Guaranteed satisfaction

Call for greater discounts on larger orders. *Subject to availability

100% Lifetime Warranty

Shipping \$3.50 per min. order \$1.50 each addl. Int'l MCA/VISA accepted

1-800-537-1600
Operator No. 227

MEP

Dept. No. 1523 P.O. Box 61000, San Francisco, CA 94161

Circle 164 on Reader Service Card

EPROM PROGRAMMER \$349



THE EP-1's A GREAT VALUE & HERE'S WHY:

- READS, PROGRAMS, COPIES OVER 300 EPROMS AND EEPROMS FROM 29 MANUFACTURERS INCLUDING 2716 27513, 2804 28256, 27011
- READS & WRITES INTEL, MOTOROLA, STRAIGHT HEX AND BINARY
- OPTIONAL HEADS PROGRAM INTEL 804X, 8751, 87C51, 8755
- MENU-DRIVEN CHIP SELECTION BY MFG & PIN, NO MODULES
- FAST, SLOW, QUICK PULSE PROGRAMMING ALGORITHMS
- SPLITS FILES BY BASE ADDRESS AND ODD/EVEN (16 & 32 BIT)
- ALL INTELLIGENCE IN UNIT, 280 MICROPROCESSOR BASED
- 5, 12.5, 21, 25 VOLT PROGRAMMING FOR CMOS AND -A SUFFIX PARTS
- FREE PC DOS SOFTWARE
- GOLD TEXT/DL ZIF SOCKET
- SAME DAY SHIPMENT
- NINE YEAR WARRANTY
- MONEYBACK GUARANTEE
- RS232 TO ANY COMPUTER
- 8 BAUD RATES TO 38400
- GENERATES, CHECKS CHECKSUMS
- TWO FREE FIRMWARE UPDATES
- UV ERASERS FROM \$34.95

CALL TODAY FOR MORE INFORMATION

BP MICROSYSTEMS

800/225-2102 713/461-9430 TELEX 1561477
10681 HAODDINGTON #190 HOUSTON, TX 77043

Circle 45 on Reader Service Card

ALDE PUBLISHING

presents the...
\$ 99.00
CDROM

A CDROM containing over 2000 programs for the 8088/286/386 based pc.

• *Public Domain Shareware*
• *High Sierra Compatible*

call or write:

ALDE Publishing
P.O. Box 35326
Mpls, MN 55435
(612) 835-6240

Circle 13 on Reader Service Card

**DATA ACQUISITION TO GO
INTERFACE FOR ANY COMPUTER
FREE IBM SOFTWARE**



Connects via RS-232. Fully IBM compatible. Built-in BASIC. Stand alone capability. Expandable. Battery Option. Basic system: 16 ch. 12 bit A/D, 2 ch. D/A, 32 bit Digital I/O. Expansion boards available. Direct Bus units for many computers.

(201) 299-1615

P.O. Box 246, Morris Plains, NJ 07950

ELEXOR

Circle 92 on Reader Service Card

Why waste time?
ACCELERATE with VCACHE™

HARD DISK ACCELERATOR

- Caching eliminates repetitive disk accesses
- Use up to 15 Mb of extended/expanded or 500 Kb of standard memory

DISKETTE ACCELERATOR

SCREEN ACCELERATOR

FAST — FRIENDLY — SAFE

VCACHE

GOLDEN BOW SYSTEMS

\$49.95

Add \$3 for shipping/handling
California residents add 6% sales tax

2870 Fifth Avenue Suite 201
San Diego, CA-92103
619/298-9349

Circle 114 on Reader Service Card

6805/6305 SINGLE CHIP MICROCOMPUTER DEVELOPMENT SYSTEMS

Two systems allow the IBM PC/XT/AT to be used as a complete development system for the MOTOROLA 6805 series single chip microcomputers. Model MCPM-1 supports the MC68705P3, P5, U3, U5, R3, & R5 chips. Model MCPM-2 supports the MC1468705F2 & G2 cross versions. Both systems are priced at \$495 and include a cross assembler program, a Simulator/Debugger program and a programming circuit board with driver software. A system is also avail. for the HITACHI 63705 ZTAT micro.

THE ENGINEERS COLLABORATIVE
P.O. Box 53, West Glover, VT 05875
(802) 525-3458

Circle 94 on Reader Service Card

**16-BIT RESOLUTION
ANALOG-TO-DIGITAL
CONVERTER
12,000 SAMPLES/SEC
for IBM PC, XT & AT
SINGLE PIECE PRICE
\$475**

We manufacture a broad line of data acquisition and control hardware and software for Apple and IBM computers.

Call for quotes on custom hardware or complete systems.

LAWSON LABS, INC.

5700 RAIBE ROAD
COLUMBIA FALLS, MT 59912
406-387-5355

Circle 146 on Reader Service Card

AS FEATURED IN BYTE, AUG. '87

\$69.95 ONLY

PC-BANDIT™
(A STEAL!)

Affordable accelerator for IBM®-PC and compatibles

- PC-BANDIT speed is user selectable at 7.4, 6.7 or 6.2 MHz
- Software selectable at 4.7 or BANDIT speed
- No expansion slot required
- Includes 3 software programs, including T8R Speed Select Software
- Maintains correct system clock speed
- Fully compatible with virtually all PC-based software
- Quick and easy to install
- Increases speed as much as 280% (Norton™)
- 8 MHz NEC V20 CPU option only \$16.95* (Plus shipping)

PRISM ELECTRONICS, INC.
14682 NE 95th St., Redmond, WA 98052
(806) 881-1088
(Dealer inquiries invited)

Circle 214 on Reader Service Card

MIDI!

The MIDI Starter System™
for your IBM PC or compatible

MIDI Co-Processor Card
Easy-8 Sequencer
Editor/Librarian Software
\$199

ask about our Programmer's ToolKit

Music Quest, Inc.
1700 Alma Dr., Suite 260
Plano, Texas 75075 (214) 881-7408

Circle 182 on Reader Service Card

EDITORIAL INDEX BY COMPANY

Index of companies covered in articles, columns, or news stories in this issue
Each reference is to the first page of the article or section in which the company name appears

INQUIRY #	COMPANY	PAGE	INQUIRY #	COMPANY	PAGE	INQUIRY #	COMPANY	PAGE
	ADOBE SYSTEMS	11, 181		HARRIS	11	923	OKIDATA	118
	ALDUS	181		HAYDEN	256	771	OLDUVAI	67
907	ALPS AMERICA	118	788	HEM DATA	67	770	ONSET COMPUTER	67
934	AMDEK	193	852	HEWLETT-PACKARD	11, 89, 118, 144		OPTOTECH	189
	AMERICAN HOME BUSINESS ASSOCIATION	11	917			924	PANASONIC	118
	ANZA RESEARCH	11	762	HONEYWELL BULL ITALIA	67	772	PATTON ELECTRONICS	67
768	AOX	67		HOUGHTON-MIFFLIN	181	939	PAUL MACE SOFTWARE	193
949	APIAN SOFTWARE	211	753	HYUNDAI ELECTRONICS AMERICA	67	785	PHAR LAP	163
755	APPLE COMPUTER	11, 67, 181, 219, 249	918	IBM	11, 118, 131, 144, 219	757	PHASE THREE LOGIC	67
	ASHTON-TATE	113		ICON SIMULATIONS	249		PHOENIX ASSOCIATES	144
944	AST RESEARCH	193	787	INDUSTRIAL COMPUTER SOURCE	67		POWER R	67
908	AT&T	118		INFORITE	67		PRENTICE-HALL	256
887	ATRON SYSTEMS	144	760	INNER MEDIA	67	925	PRIAM	193
	BANTAM BOOKS	256	794	INNOVATIVE SOFTWARE	67		PRINTRONIX	118
	BELLCORE	11	791	INTEL	193, 219, 237, 256	856	QUADRAM	89
780	BERKELEY SOFTWORKS	67		INTELLIGENT GRAPHICS	163	936	QUARK	181
	BITSTREAM	144	789	INTERACTIVE MICROWARE	67		QUARTERDECK OFFICE SYSTEMS	193
	BLUE CHIP TECHNOLOGIES	11	900	INTERLEAF	181	781	QUE	51
	BOEING COMPUTER SERVICES	11	937	INTERSTEL	193		QUINN-CURTIS	67
858	BORLAND INTERNATIONAL	89		JAPAN DIGITAL LABORATORY	118	926	QUME	144
	BRADY BOOKS	51	919	JASMINE TECHNOLOGIES	67, 211	767	RADIO SHACK	118
909	BROTHER INTERNATIONAL	118	758	KARTECH DATA SERVICES	67	759	RADIUS	67
910	C. ITOH DIGITAL PRODUCTS	118	786	KENTEK INFORMATION SYSTEMS	67		RELAX TECHNOLOGY	67
	CALCOMP	11	761	LANGUAGE SYSTEMS	67		RESEARCH CORPORATION TECHNOLOGIES	11
951	CCI	263	779	LOGITECH	11, 193		ROCKWELL INTERNATIONAL	11
950	CE SOFTWARE	211	790	LOTUS DEVELOPMENT	67, 256	927	SANDI AND SHANE STRUMP	193
	CHEETAH INTERNATIONAL	193	784	MACNEAL-SCHWENDLER	67	774	SANYO BUSINESS SYSTEMS	118
946	CHIPS & TECHNOLOGIES	11	920	MANNESMANN TALLY	118		SCIENCE APPLICATIONS INTERNATIONAL	67, 163
911	CHIPSOFT	193		MANSFIELD SOFTWARE GROUP	163	928	SEIKOSHA AMERICA	118
911	CITIZEN AMERICA	118		MCGRAW-HILL BOOKS	263	859	SHARP ELECTRONICS	89
795	CODA MUSIC SOFTWARE	67	764	MEAD IMAGING	11		SIGNETICS	256
884	COMMODORE INTERNATIONAL	137	756	MEMTECH	67	796	SILICON BEACH SOFTWARE	67
	COMPAQ	131, 189, 193		MICRO DISPLAY SYSTEMS	67	776	SILVER STATE SOFTWARE	67
782	COMPUNEERING	67		MICROELECTRONICS AND COMPUTER TECHNOLOGY	11	929	STAR MICRONICS	118
	CONTROL DATA	11	855	MICROPRO INTERNATIONAL	89	945	STRATEGIC STUDIES GROUP	193
912	COPAL (USA)	118	752	MICROPROJECT	67	783	STRUCTURAL MEASUREMENT SYSTEMS	67
886	DATA TECHNOLOGY	144		MICROSOFT	11, 89, 103, 113, 163, 193, 227		SUN MICROSYSTEMS	181
913	DATAPRODUCTS	118	905	MICROWAY	163	754	SUPRA	67
	DATAVUE	189		MIGENT SOFTWARE	11		SYBASE	113
	DIABLO SYSTEMS	144		MINOLTA	11		SYBEX	51
765	DIGIBOARD	67		MOTOROLA	11, 219, 256	763	TACTRON SCIENTIFIC	67
	E. I. DU PONT	11		NASA JPL	193		TANDY	11
	EASTMAN KODAK	11	943	NATIONAL SEMICONDUCTOR	219, 256	766	TANDY/RADIO SHACK	67
	ENGINEER'S ISLE	11		NCR	11	769	TASCO	67
914	EPSON AMERICA	118, 144		NEC HOME ELECTRONICS	11, 144, 189	885	TAXAN USA	144
793	ESP SOFTWARE SYSTEMS	67		NEC INFORMATION SYSTEMS	118	777	TECKNOWLEDGE	67
915	FACIT	118	921	NISSHO INFORMATION SYSTEMS	118	888	THE PERISCOPE COMPANY	144
	FAIRCHILD SEMICONDUCTOR	219, 256	922	NUDATA	67		3M	11
938	FIFTH GENERATION SYSTEMS	193					THREE-SIXTY	11
916	FUJITSU AMERICA	118				930	TOSHIBA AMERICA	11, 118
	GENERAL COMPUTER	189				935	TRAVELING SOFTWARE	193
	GENERAL ELECTRIC	11					UNIVERSITY OF CALIFORNIA	11
947	GOLDEN BOW SYSTEMS	193	751			775	UNIVERSITY OF NEW HAMPSHIRE	67

INQUIRY #	COMPANY	PAGE	INQUIRY #	COMPANY	PAGE
778	VIRTUAL SOFTWARE	67	883	WYSE TECHNOLOGY	131
	WESTINGHOUSE ELECTRIC	11	853	ZENITH DATA	
792	WORDPERFECT	67		SYSTEMS.....	89, 189, 193
942	WORKMAN AND ASSOCIATES ...	193		ZILOG	219

COMING UP IN BYTE

PRODUCTS IN PERSPECTIVE:

Short Takes for May include Sysgen's BridgeFile; high- and double-density 3½- and 5¼-inch add-on floppy disk drives for IBM's PS/2; Fujitsu's finite-element-analysis package, Elm; WordPerfect for the Macintosh; a fast assembler from SLR, Optasm; a Macintosh desk-accessory scheduler from Mainstay called Think 'N Time; and more.

Ten word processors for the IBM PC family are reviewed in the **Product Focus** for May: new releases of DisplayWrite, MASS-11, Microsoft Word, MultiMate, OfficeWriter, Samna Word IV, Smart Word, WordPerfect, WordStar, and XyWrite.

System reviews consider Amdek's offering in the 80386 competition and the laptop Macintosh from Dynamac.

In the **hardware reviews** section, we look at the Apple LaserWriter II. This printer with interchangeable memory modules is at least two printers right now, with the potential to be more as time goes by.

There are many uncomfortable ways to get Macintosh data to an IBM PC—and vice versa; we'll look at three that are painless.

Software reviews: Windows/386 and Windows 2.0 are programs to enhance your interface. Command Plus replaces your DOS command processor and enhances the basic commands.

Products up for discussion in **application reviews** are Silverado and @Base, two spreadsheet add-ins; Q-Calc, a spreadsheet that runs under Unix; and Nexview, a relational spreadsheet.

Jerry Pournelle's **Computing at Chaos Manor** and Ezra Shapiro's **Applications Only** look at products from unique perspectives.

IN DEPTH:

May is devoted to the subject of **CPU architectures**—everything from the growth and development of CPUs, to parallelism, to RISC, to what's wrong with the ones we've seen so far.

FEATURES:

In the **Circuit Cellar**, Steve Ciarcia concludes his SmartSpooler construction project; Dick Pountain talks about **Pop-11**, a powerful artificial intelligence programming language for the Macintosh.

Subscription Problems?



We want to help!

*If you have a problem with your **BYTE** subscription, write us with the details. We'll do our best to set it right. But we must have the name, address, and zip of the subscription (new and old address, if it's a change of address). If the problem involves a payment, be sure to include copies of the credit card statement, or front and back of cancelled checks. Include a "business hours" phone number if possible.*

BYTE

Subscriber Service
P.O. Box 7643
Teaneck, NJ 07666-9866



Important TIPS* for BYTE Subscribers: Receive Product Information 10 Days Earlier!



All you need is a touch-tone telephone and your subscriber I.D. number.
See instructions facing the Reader Service Index in the back
of this issue for outrageous time-saving opportunities!

*BYTE's Telephone Inquiry Processing Service

BYTE ADVERTISING SALES STAFF:

Dennis J. Riley, Advertising Sales Manager, One Phoenix Mill Lane, Peterborough, NH 03458, tel. (603) 924-9281

NEW ENGLAND
ME, NH, VT, MA, RI, ONTARIO
CANADA & EASTERN CANADA
(617) 262-1160
McGraw-Hill Publications
575 Boylston Street
Boston, MA 02116

ATLANTIC
NY, NYC, CT, NJ (NORTH)
Leah G. Rabinowitz (212) 512-2096
McGraw-Hill Publications
1221 Avenue of the Americas—
39th Floor
New York, NY 10020

Dick McGurk (203) 968-7111
McGraw-Hill Publications
Building A—3rd Floor
777 Long Ridge Road
Stamford, CT 06902

EAST
PA, NJ (SOUTH),
MD, VA, W. VA, DE, D.C.
Daniel Ferro (215) 496-3833
McGraw-Hill Publications
Three Parkway
Philadelphia, PA 19102

SOUTHEAST
NC, SC, GA, FL, AL, TN
Carolyn F. Lovett (404) 252-0626
McGraw-Hill Publications
4170 Ashford-Dunwoody Road
Suite 420
Atlanta, GA 30319

MIDWEST
IL, MO, KS, IA, ND, SD, MN,
KY, OH, WI, NB, IN, MI, MS
Bob Denmead (312) 751-3740
McGraw-Hill Publications
Blair Building
645 North Michigan Ave.
Chicago, IL 60611

**SOUTHWEST,
ROCKY MOUNTAIN**
CO, WY, OK, TX, AR, LA
Karl Heinrich (713) 462-0757
McGraw-Hill Publications
7600 W. Tidwell Rd.—Suite 500
Houston, TX 77040

SOUTH PACIFIC
SOUTHERN CA, AZ, NM,
LAS VEGAS
Jack Anderson (714) 557-6292
McGraw-Hill Publications
3001 Red Hill Ave.
Building #1—Suite 222
Costa Mesa, CA 92626

Tom Harvey (213) 480-5243
McGraw-Hill Publications
3333 Wilshire Boulevard #407
Los Angeles, CA 90010

NORTH PACIFIC
HI, WA, OR, ID, MT,
NORTHERN CA,
NV (except LAS VEGAS), UT,
W. CANADA
Mike Kisseberth (415) 362-4600
McGraw-Hill Publications
425 Battery Street
San Francisco, CA 94111

Bill McAfee (415) 349-4100
McGraw-Hill Publications
951 Mariner's Island Blvd.—
3rd Floor
San Mateo, CA 94404

BYTE BITS (2x3)
Dan Harper (603) 924-6830
BYTE Publications
One Phoenix Mill Lane
Peterborough, NH 03458

The Buyer's Mart (1x2)
Mark Stone (603) 924-3754
BYTE Publications
One Phoenix Mill Lane
Peterborough, NH 03458

Regional Advertising
(So. CA, Mid-Atlantic, Southeast,
New York/New England)
Elisa Lister (603) 924-6830
BYTE Publications
One Phoenix Mill Lane
Peterborough, NH 03458

Regional Advertising
(Pacific NW, Midwest, Southwest,
New York/New England)
Scott Gagnon (603) 924-9281
BYTE Publications
One Phoenix Mill Lane
Peterborough, NH 03458

BYTE Deck Mailings
National
Ed Ware (603) 924-6166
BYTE Publications
One Phoenix Mill Lane
Peterborough, NH 03458

A/E/C Computing Deck
Computing for Engineers
Mary Ann Goulding
(603) 924-9281
BYTE Publications
One Phoenix Mill Lane
Peterborough, NH 03458

International Advertising Sales Staff:

Mr. Hans Csokor
Publimedia
Reinsestrasse 61
A-1037 Vienna, Austria
222 75 76 84

Mrs. Gurit Gepner
McGraw-Hill Publishing Co.
PO Box 2156
Bat Yam, 59121 Israel
3 866 561 321 39

Ros Weyman
McGraw-Hill Publishing Co.
Liebigstrasse 19
D-6000 Frankfurt/Main 1
West Germany
69 72 01 81

Mrs. Maria Sarmiento
Pedro Teixeira 8, Off. 320
Iberia Mart 1
Madrid 4, Spain
1 45 52 891

Michael Karnig
Andrew Karnig & Associates
Finnbodavagen
S-131 31 Nacka, Sweden
8-44 0005

Mr. Alain Faure
McGraw-Hill Publishing Co.
128 Faubourg Saint Honore
75008 Paris
France
(1) 42-89-03-81

Karen Lennie
Ros Weyman
McGraw-Hill Publishing Co.
34 Dover St.
London W1X 4BR
England 01 493 1451

Emilio Zerboni
McGraw-Hill Publishing Co.
Via Flavio Baracchini 1
20123 Milan, Italy
(2) 89010103

Seavex Ltd.
400 Orchard Road, #10-01
Singapore 0923
Republic of Singapore
Tel: 734-9790
Telex: RS35539 SEAVEX

Sevex Ltd.
503 Wilson House
19-27 Wyndham St.
Central, Hong Kong
Tel: 5-260149
Telex: 60904 SEVEX HX

Hiro Morita
McGraw-Hill Publishing Co.
Overseas Corp.
Room 1528
Kasumigaseki Bldg.
3-2-5 Kasumigaseki,
Tokyo-Ku
Tokyo 100, Japan
3 581 9811

Mr. Ernest McCrary
Empresa Internacional de
Comunicacoes Ltda.
Rua da Consolacao, 222
Conjunto 103
01302 Sao Paulo, S.P., Brasil
Tel: (11) 259-3811
Telex: (100) 32122 EMBN

READER SERVICE

To get further information on the products advertised in BYTE, fill out the reader service card by circling the numbers on the card that correspond to the inquiry number listed with the advertiser. This index is provided as an additional service by the publisher, who assumes no liability for errors or omissions.

* Correspond directly with company

Alphabetical Index to Advertisers

Inquiry No.	Page No.	Inquiry No.	Page No.	Inquiry No.	Page No.	Inquiry No.	Page No.	
220	1ST CLASS EXPERT SYS	28	72	COVOX	324	155	MAP INFO	16
3	2500 AD SOFTWARE	45	73	CPT CORP	198	156	MARK WILLIAMS	30
4	A + L MEIER VOGT	221	74	CYBER RESEARCH	318	157	MASTERSOFT	252
5	A + L MEIER VOGT	223	75	C.O.M.B.	314	158	MATHSOFT	69
6	A + L MEIER VOGT	225	76	C.O.M.B.	323		MAXELL DATA PRODUCTS	7
7	ACM SIGGRAPH '88	93	77	DATA TRANSLATION	58		MCGRW-HILL CEC	288A-B
8	AD LIB, INC.	255	316	DATA TRANSLATION	210		MCGRW-HILL NEWS	245
9	ADVANCED COMP. PRODS.	330,331	78	DB FAST	52		MCGRW-HILL NRI	272A-B
10	ADV. LOGIC RESEARCH	180	87	DCS	316	159	MEAD COMPUTER	317
11	ADV. LOGIC RESEARCH	180		DELL COMPUTER CORP.	160A-H	160	MEDIA CYBERNETICS	50
12	AK SYSTEMS	323	79	DELL COMPUTER CORP.	160,161	161	MEDIA CYBERNETICS	50
13	ALDE PUBLISHING	337	80	DICONIX	8,9	162	MEGASOFT	314
14	ALF	314	81	DIGITALK	185	183	MERRITT COMP. PRODS.	96
15	ALPHA PRODUCTS	318	82	DIGITALK	165	164	MICRO ELEC. PROD. (MEP)	337
16	ALPHA PRODUCTS CO.	327	85	DISC INT'L	316	185	MICROCOM SYSTEMS	28
17	ALPS AMERICA	100,101	83	DISKOTEC	325		MICROMINT	297
18	ALPS AMERICA	100,101	84	DISKETTE CONNECTION	321	188	MICROPORT	175
19	AMER. SMALL BUS. COMP.	99	86	DISKS TO GO	318	187	MICROPORT	175
	* AMPRO	199	88	DRESSELHAUS	46	188	MICROPROCESSORS UNLTD.	323
20	ANTHRO CORP	13	89	DYNAMIC ELECTRONICS	324	169	MICROSIM	112
21	APPLIED ENGINEERING	82,83	90	ECOSOFT	253	170	MICROSIM	112
22	APROTEK	323	91	ELECTRONE	94	171	MICROSOFT	142,143
23	ASHTON-TATE	109	92	ELEXOR, INC.	337	172	MICROSOFT	142,143
	* AT&T INFO. SYS.	48,49	93	ELLIS COMPUTING	24	309	MICROSOFT	73
	* AT&T INFO. SYS.	116,117	94	ENGINEERS COLLABORATIVE	337	310	MICROSOFT	73
24	ATI TECHNOLOGIES INC.	201	95	EVEREX	27	174	MICROWAY	130
25	ATRON	66	96	EVEREX	27		* MICROWAY	282
28	AVOCET SYSTEMS INC	207	97	EVEREX	29	175	MIHALISIN ASSOC.	316
29	B&B ELECTRONICS	314	98	EVEREX	29	177	MITSUBISHI	156,157
30	B&C MICRO	314	102	EVEREX	31	178	MITSUBISHI	156,157
31	B&C MICRO	325	103	EVEREX	31	179	MIX SOFTWARE	55
32	B&C MICRO	318	104	EVEREX	33	180	MOJAVE SCADA	314
33	B&C MICRO	324	105	EVEREX	33	181	MONTGOMERY GRANT	320
323	B&W SYSTEMS INC.	279	304	FLAGSTAFF ENG.	192	182	MUSIC QUEST	337
34	BASF	115	305	FLAGSTAFF ENG.	192	183	M.H.I.	97
35	BAY TECHNICAL ASSOC.	155	106	FOX SOFTWARE	23	184	NATIONAL COMP. RIBBONS	204
317	BECKMAN INDUSTRIES	260	107	FTG DATA SYSTEMS	324	185	NATIONAL INSTRUMENTS	110
318	BECKMAN INDUSTRIES	260	108	FUJITSU AMERICA	167	188	NEC INFO. SYSTEMS	CIII
	* BEST WESTERN	24	109	FUJITSU AMERICA	167	187	NORTHGATE COMP. SYS.	257
	* BINARY TECH	324	111	GENOA	79	188	NORTHGATE COMP. SYS.	258,259
450	BIX	282,283	112	GLORIOUS UNION	98	192	OLYMPIA U.S.A. INC.	47
36	BLAISE	32	113	GOLD HILL COMPUTERS	231	194	ONLINE STORE	299
37	BOCA RESEARCH	35	114	GOLDEN BOW SYSTEMS	337		* ORACLE	77
38	BOCA RESEARCH	35	115	GRAFPPOINT	326	197	ORION	64
39	BORLAND INT'L	CII	118	GTEK INC.	114	198	OSBORNE/MCGRW-HILL	236
40	BORLAND INT'L	CII	117	GTEK INC.	114	199	OSBORNE/MCGRW-HILL	272
41	BORLAND INT'L	1		HARMONY COMPUTERS	18	200	OSBORNE/MCGRW-HILL	287
42	BORLAND INT'L	1	118	HARRIS/3M COPIERS	281	319	PACIFIC COMPUTER	315
43	BORLAND INT'L	71	119	HEWLETT PACKARD	127	320	PACIFIC COMPUTER	315
44	BORLAND INT'L	71	120	HEWLETT PACKARD	129	201	PANASONIC OA	140,141
45	BP MICROSYSYSTEMS	337	121	HEWLETT PACKARD	169	202	PARA SYSTEMS	111
46	BRODERBUND	147	122	HEWLETT PACKARD	171	203	PATTON & PATTON	194
204	BUS COMPUTER SYS.	312,313	123	HEWLETT PACKARD	173	205	PEACHTREE SOFTWARE	135
	* BUYER'S MART	301-309	124	HITECH EQUIPMENT	318	206	PERISCOPE CO.	188
324	BYTE BITS	328	125	HOOLEON	206	50	PERFOT	87
	* BYTE CIRCULATION	284	126	HOOLEON	206	208	PERSTOR	256
	* BYTE MARKETING	291	127	IC EXPRESS	254	209	PERSTOR	256
	* BYTE SUB. MESSAGE	287		* INECTRA	324	210	PETER NORTON	20,21
	* BYTE SUB. SERVICE	339		* INECTRA	328	211	PETER NORTON	20,21
47	BYTEK CORP.	34	128	INTEGRAND	42	212	PRINCETON GRAPHIC SYS.	40,41
48	CADAM	95	129	INTEL CORP.	214,215	213	PRINTERS PLUS INC.	38
49	CADAM	95	130	IO TECH	134	214	PRISM ELECTRONICS	337
	* CALIFORNIA DIGITAL	37	131	IO TECH	328	215	PROGRAMMABLE LOGIC	328
51	CAPITAL EQUIPMENT	46	132	J&R MUSIC WORLD	184	216	PROGRAMMERS SHOP	195
52	CENTRAL COMP. PRODS.	254	133	JAMECO	310,311	217	PROGRAMMER'S CONNECTION	19
53	CITIZEN AMERICA	15	134	JAWIN	326	218	PROGRAMMER'S PARADISE	177
	* CLEO SOFTWARE	136	135	JAWIN	326	219	PROGRAMMER'S PARADISE	178,179
54	CLUB AMERICAN TECH.	190,191	136	JKL	321	221	PROTEUS TECHNOLOGY	74,75
55	CNS INC	60	137	J.D.R. INSTRUMENTS	85	222	QUA TECH	322
56	CNS INC	80	138	J.D.R. MICRODEVICES	332,333	223	QUA TECH	322
57	COGITATE	314	139	J.D.R. MICRODEVICES	334,335	224	QUA TECH	322
58	COGITATE	324	140	J.D.R. MICRODEVICES	336	225	QUA TECH	322
60	COMPACT DISC PRODS. INC.	92	141	KADAK PRODUCTS	318	228	QUA TECH	322
	* COMPAQ	56,57	142	KEA SYSTEMS	44	227	QUA TECH	322
62	COMPUSAVE	315	143	KEA SYSTEMS	318	228	QUA TECH	322
63	COMPUSERVE	149	144	KNOWLEDGE GARDEN, INC.	248	229	QUA TECH	322
	* COMPUTER CONTINUUM	328	321	LAHEY COMPUTER SYSTEM	239	230	QUA TECH	322
59	COMP. DISC. WAREHOUSE	197	145	LATTICE, INC.	176	231	QUANTSTAR	321
65	COMPUTER EXPO	61	146	LAWSON LABS	337	235	QUINLET TECH	326
66	COMPUTER FRIENDS	96	147	LINK COMP. GRAPHICS	325	236	RADIO SHACK	CIV
64	COMPUTER MAIL ORDER	234,235	148	LOGICAL DEVICES	328		* RAIMA	107
315	COMPUTER-RING	318	149	LOGICAL DEVICES	328	237	RAINBOW TECH	243
67	COMP. SURPLUS STORE	324	150	LOGITECH	81	238	RAINBOW TECH	243
68	COMPUTER WAREHOUSE	102	151	LOGITECH	81	239	RAINBOW TECH	202
69	COMPUTER WAREHOUSE	102	152	LOGITECH	82,83	240	RAINBOW TECH	202
70	CONTECH	328	153	LOGITECH	82,83	241	RAINBOW TECH	321
71	CONTROL VISION	252	154	MANX SOFTWARE SYSTEMS	39	242	RAMBENDERS	92
						243	REAL TIME DEVICES	321
						313	ROSE ELECTRONICS	321
						314	ROSE ELECTRONICS	321
						245	SAFEWARE	324
						246	SANTA CRUZ OPERATION	151
						247	SCHWAB COMP. CTR.	321
						248	SCIENCE & ENG. SW	203
						249	SEALEVEL	328
						250	SHAMROCK COMPUTER	53
						251	SILICON SPECIALTIES	228
						252	SILICON SPECIALTIES	226
						253	SOFTKONE	188
						254	SOFTRONICS	54
						255	SOFTRONICS	328
						256	SOFTWARE DEV. SYS.	200
						257	SOFTWARE DEV. DISTRIB. CTR.	328
						258	SOFTWARE LINK	25
						259	SOFTWARE LINK	25
						260	SOFTWORLD	254
						281	SOLUTION SYSTEMS	195
						311	SPECTRON SYSTEMS	252
						312	SPECTRON SYSTEMS	252
						283	SPECTRUM	216
						284	STANFORD SYSTEMS	43
						265	STSC, INC.	187
						266	SUPERSOFT	271
						287	SYSGEN	183
						266	SYSTAT, INC.	251
						269	SYSTAT, INC.	251
						270	S'N'W ELECTRONICS	44
						271	S-100	329
						272	S-100	329
						273	TALKING TECH.	328
						275	TELEBYTE TECHNOLOGY	54
						276	TELEVIDEO	153
						277	TIGERTRONICS	60
						278	TIGERTRONICS	328
							* TINNEY, ROBT. GRAPHICS	292
						307	TOSHIBA	162
						308	TOSHIBA	162
							* TOSHIBA	209
						322	TRANSEC SYSTEMS	205
						279	TRIDENT	185
						280	TRUEVISION	159
						281	TXM, INC.	108
						282	TYSTAR MANUFACTURING	325
						284	UNITED INNOVATIONS	158
						285	UNIVERSAL CROSS ASSEMB.	325
						283	UNIVERSAL DATA SYSTEMS	59
							* VERMONT CREATIVE SW	241
						286	VICTORY ENTERPRISE	239
						287	VOYETRA TECH.	325
						288	WAREHOUSE DATA PRODS.	213
						289	WATCOM C	10
						290	WELLS AMERICAN	91
						292	WESTERN TELEMATIC	290
						293	WESTERN TELEMATIC	290
						294	WESTERN UNION TELEGRAPH CO.	17
						295	WHITE CRANE SYSTEMS	196
						296	WINTEK CORP.	5
						297	WINTEK CORP.	325
							* WORTHINGTON DATA SOLNS.	233
						298	WYSE TECH	246,247
						299	XELTEK	316
						300	ZEOS INT'L	319

READER SERVICE

To get further information on the products advertised in BYTE, fill out the reader service card by circling the numbers on the card that correspond to the inquiry number listed with the advertiser. This index is provided as an additional service by the publisher, who assumes no liability for errors or omissions.

* Correspond directly with company

Index to Advertisers by Product Category

Inquiry No.	Page No.	Inquiry No.	Page No.	Inquiry No.	Page No.	Inquiry No.	Page No.
HARDWARE		518 HARDWARE PROGRAMMERS		238 RAINBOW TECH 243		301 ZERICON 328	
516 ADD INS		22 APROTEK 323		275 TELEBYTE TECHNOLOGY 54		546 PRINTER RIBBONS	
8 AD LIB, INC. 255		30 B&C MICRO 314		286 VICTORY ENTERPRISE 239		184 NATIONAL COMP. RIBBONS 97	
15 ALPHA PRODUCTS 316		32 B&C MICRO 318		521 MODEMS/MULTIPLEXORS		525 SCANNERS/DIGITIZERS	
16 ALPHA PRODUCTS COMPANY 327		33 B&C MICRO 324		* AT&T INFO SYSTEMS 116,117		316 DATA TRANSLATION 210	
21 APPLIED ENGINEERING 62,63		45 BP MICROSYSTEMS 337		52 CENTRAL COMP. PRODS 254		304 FLAGSTAFF ENGINEERING 192	
24 ATI TECHNOLOGIES INC 201		47 BYTEK CORP. 34		* CLEO SOFTWARE 136		305 FLAGSTAFF ENGINEERING 192	
25 ATRON 66		116 GTEK INC. 114		95 EVEREX 27		112 GLORIOUS UNION 96	
31 B&C MICRO 325		117 GTEK INC. 114		96 EVEREX 27		311 SPECTRON SYSTEMS 252	
* BINARY TECH 324		147 LINK COMP. GRAPHICS 325		283 UNIVERSAL DATA SYSTEMS 59		312 SPECTRON SYSTEMS 252	
37 BOCA RESEARCH 35		148 LOGICAL DEVICES 328		522 MONITORS		526 KEYBOARDS/MICE	
38 BOCA RESEARCH 35		149 LOGICAL DEVICES 328		73 CPT CORP. 198		72 COVOX 324	
315 COMPUTER-RING 318		215 PROGRAMMABLE LOGIC 326		87 DCS 316		91 ELECTRONE 94	
71 CONTROL VISION 252		299 XELTEK 316		177 MITSUBISHI 156,157		142 KEA SYSTEMS 44	
316 DATA TRANSLATION 210		519 INSTRUMENTATION		178 MITSUBISHI 156,157		150 LOGITECH 81	
97 EVEREX 29		317 BECKMAN INDUSTRIES 260		212 PRINCETON GRAPHIC SYS. 40,41		151 LOGITECH 81	
98 EVEREX 29		318 BECKMAN INDUSTRIES 260		523 NETWORK HARDWARE		152 LOGITECH 82,83	
111 GENOA 79		51 CAPITAL EQUIPMENT 46		* AT&T INFO SYSTEMS 48,49		153 LOGITECH 82,83	
116 GTEK INC. 114		92 ELEXOR, INC. 337		57 COGITATE 314		187 NORTHGATE COMPUTER SYS. 257	
117 GTEK INC. 114		137 J.D.R. INSTRUMENTS 85		222 QUA TECH 322		223 QUA TECH 322	
124 HITECH EQUIPMENT 318		146 LAWSON LABS 337		224 QUA TECH 322		527 SYSTEMS	
129 INTEL CORP. 214,215		180 MOJAVE SCADA 314		225 QUA TECH 322		10 ADVANCED LOGIC RESEARCH 180	
130 IO TECH 134		197 ORION 64		228 QUA TECH 322		11 ADVANCED LOGIC RESEARCH 180	
131 IO TECH 328		223 QUA TECH 322		313 ROSE ELECTRONICS 321		* AMPRO 199	
* MICROMINT 297		227 QUA TECH 322		314 ROSE ELECTRONICS 321		* AT&T INFO SYSTEMS 116,117	
174 MICROWAY 130		229 QUA TECH 322		292 WESTERN TELEMATIC 290		54 CLUB AMERICAN TECH. 190,191	
* MICROWAY 262		243 REAL TIME DEVICES 321		293 WESTERN TELEMATIC 290		* COMPAQ 56,57	
182 MUSIC QUEST 337		520 MASS STORAGE		524 PRINTERS/PLOTTERS		79 DELL COMPUTER CORP. 160,161	
185 NATIONAL INSTRUMENTS 110		12 AK SYSTEMS 323		17 ALPS AMERICA 100,101		94 ENGINEERS COLLABORATIVE 337	
200 OSBORNE/MCGRAW-HILL 287		34 BASF 115		18 ALPS AMERICA 100,101		104 EVEREX 33	
206 PERISCOPE CO. 188		60 COMPACT DISC PRODS. INC. 92		53 CITIZEN AMERICA 15		105 EVEREX 33	
208 PERSTOR 256		70 CONTECH 326		80 DICONIX 8,9		188 NORTHGATE COMP. SYS. 256,259	
209 PERSTOR 256		102 EVEREX 31		108 FUJITSU AMERICA 167		319 PACIFIC COMPUTER 315	
214 PRISM ELECTRONICS 337		103 EVEREX 31		109 FUJITSU AMERICA 167		320 PACIFIC COMPUTER 315	
222 QUA TECH 322		* MAXELL DATA PRODUCTS 7		119 HEWLETT-PACKARD 127		221 PROTEUS TECHNOLOGY 74,75	
224 QUA TECH 322		231 QUALSTAR 321		120 HEWLETT-PACKARD 129		235 QUINTEL TECH 326	
225 QUA TECH 322		287 SYSGEN 183		121 HEWLETT-PACKARD 169		236 RADIO SHACK CIV	
226 QUA TECH 322		* MISCELLANEOUS		122 HEWLETT-PACKARD 171		264 STANFORD SYSTEMS 43	
227 QUA TECH 322		29 B&B ELECTRONICS 314		123 HEWLETT-PACKARD 173		* TOSHIBA 209	
228 QUA TECH 322		35 BAY TECHNICAL ASSOC 155		* INTECTRA 324		282 TYSTAR MANUFACTURING 325	
229 QUA TECH 322		* COMPUTER CONTINUUM 326		186 NEC INFO SYSTEMS CIV		290 WELLS AMERICAN 91	
230 QUA TECH 322		88 DRESSSELHAUS 46		192 OLYMPIA U.S.A. INC. 47		297 WINTEK CORP. 325	
239 QUA TECH 328		125 HOOLEON 206		201 PANASONIC OA 140,141		296 WYSE TECH 246,247	
273 TALKING TECH 326		126 HOOLEON 206		241 RAINBOW TECH 321		300 ZEOS INT'L 319	
279 TRIDENT 165		* INTECTRA 328		313 ROSE ELECTRONICS 321		302 Z-WORLD 316	
280 TRUEVISION 159		128 INTEGRAND 42		314 ROSE ELECTRONICS 321		528 TERMINALS	
517 DRIVES		202 PARA SYSTEMS 111		307 TOSHIBA 162		276 TELEVIDEO 153	
21 APPLIED ENGINEERING 62,63		239 RAINBOW TECH 202		308 TOSHIBA 162			
60 COMPACT DISC PRODS. INC. 92		240 RAINBOW TECH 202		284 UNITED INNOVATIONS 158			
277 TIGERTRONICS 60		237 RAINBOW TECH 243					

READER SERVICE

Advertising Supplement included with this issue:
Jade Computer (U.S. Subscribers)

Inquiry No.	Page No.	Inquiry No.	Page No.	Inquiry No.	Page No.	Inquiry No.	Page No.
SOFTWARE							
529 APPLE2/MAC LANGUAGES							
256	SOFTWARE DEV. SYS.	200					
530 IBM/MSDOS APPLICATIONS—Business/Office							
220	1ST CLASS EXPERT SYSTEMS	28					
6	A&L MEIER VOGT	225					
23	ASHTON-TATE	109					
46	BRODERBUND	147					
58	COGITATE	324					
78	DB FAST	52					
106	FOX SOFTWARE	23					
107	FTG DATA SYSTEMS	324					
171	MICROSOFT	142,143					
172	MICROSOFT	142,143					
*	ORACLE	77					
203	PATTON&PATTON	194					
205	PEACHTREE SOFTWARE	135					
*	RAIMA	107					
278	TIGERTRONICS	328					
531 IBM/MSDOS APPLICATIONS—Miscellaneous							
90	ECOSOFT	253					
155	MAP INFO	16					
157	MASTERSOFT	252					
322	TRANSEC SYSTEMS	205					
*	WORTHINGTON DATA SOLNS.	233					
532 IBM/MSDOS APPLICATIONS—Scientific/Technical							
144	KNOWLEDGE GARDEN, INC.	248					
158	MATHSOFT	69					
169	MICROSIM	112					
170	MICROSIM	112					
175	MIHALISIN ASSOC.	316					
257	SOFTWARE DEV. DISTRIB. CTR.	328					
283	SPECTRUM	216					
288	SYSTAT, INC.	251					
289	SYSTAT, INC.	251					
533 IBM/MSDOS—CAD							
19	AMER. SMALL BUS. COMP.	99					
48	CADAM	95					
49	CADAM	95					
296	WINTEK	5					
534 IBM/MSDOS COMMUNICATIONS							
143	KEA SYSTEMS	318					
50	PERSOFT	87					
253	SOFTKLONE	186					
254	SOFTRONICS	54					
255	SOFTRONICS	328					
295	WHITE CRANE SYSTEMS	196					
535 IBM/MSDOS—LAN							
313	ROSE ELECTRONICS	321					
314	ROSE ELECTRONICS	321					
258	SOFTWARE LINK	25					
259	SOFTWARE LINK	25					
536 IBM/MSDOS—LANGUAGES							
3	2500 AD SOFTWARE	45					
4	A&L MEIER VOGT	221					
28	AVOCET SYSTEMS INC.	207					
39	BORLAND INT'L	CII					
40	BORLAND INT'L	CII					
41	BORLAND INT'L	1					
42	BORLAND INT'L	1					
43	BORLAND INT'L	71					
44	BORLAND INT'L	71					
90	ECOSOFT	253					
93	ELLIS COMPUTING	24					
113	GOLD HILL COMPUTERS	231					
321	LAHEY COMPUTER SYSTEM	239					
145	LATTICE, INC.	176					
154	MANX SOFTWARE SYSTEMS	39					
156	MARK WILLIAMS	30					
166	MICROPORT	175					
167	MICROPORT	175					
309	MICROSOFT	73					
310	MICROSOFT	73					
179	MIX SOFTWARE	55					
285	STSC, INC.	187					
289	WATCOM C	10					
303	Z-WORLD	316					
537 IBM/MSDOS—UTILITIES							
5	A&L MEIER VOGT	223					
25	ATRON	66					
36	BLAISE	32					
55	CNS INC.	60					
56	CNS INC.	60					
81	DIGITALK	165					
82	DIGITALK	165					
114	GOLDEN BOW SYS.	337					
115	GRAFPPOINT	326					
180	MEDIA CYBERNETICS	50					
161	MEDIA CYBERNETICS	50					
206	PERISCOPE CO.	188					
210	PETER NORTON	20,21					
211	PETER NORTON	20,21					
280	SOFTWORLD	254					
281	SOLUTION SYSTEMS	195					
286	SUPERSOFT	271					
281	TXM, INC.	108					
*	VERMONT CREATIVE S/W	241					
306	ZORTECH	285					
538	OTHER APPLICATIONS—Miscellaneous						
287	VOYETRA TECH.	325					
539 OTHER—LANGUAGES							
256	SOFTWARE DEV. SYS.	200					
540 OTHER—UTILITIES							
285	UNIVERSAL CROSS ASSEMB.	325					
541 MAIL ORDER/RETAIL							
9	ADVANCED COMP. PRODS.	330,331					
14	ALF	314					
323	B&W SYSTEMS INC.	279					
204	BUS COMPUTER SYS.	312,313					
*	BUYER'S MART	301-309					
*	CALIFORNIA DIGITAL	37					
62	COMPUSAVE	315					
59	COMP. DISC. WAREHOUSE	197					
65	COMPUTER EXPO	61					
66	COMPUTER FRIENDS	96					
64	COMPUTER MAIL ORDER	234,235					
67	COMPUTER SURPLUS STORE	324					
68	COMPUTER WAREHOUSE	102					
69	COMPUTER WAREHOUSE	102					
75	C.O.M.B.	314					
76	C.O.M.B.	323					
85	DISC INT'L	316					
83	DISK COTECH	325					
84	DISKETTE CONNECTION	321					
86	DISKS TO GO	318					
89	DYNAMIC ELECTRONICS	324					
*	HARMONY COMPUTERS	18					
127	IC EXPRESS	254					
132	J&R MUSIC WORLD	184					
133	JAMECO	310,311					
134	JAWIN	326					
135	JAWIN	326					
136	JKL	321					
138	J.D.R. MICRODEVICES	332,333					
139	J.D.R. MICRODEVICES	334,335					
140	J.D.R. MICRODEVICES	336					
159	MEAD COMPUTER	317					
182	MEGASOFT	314					
164	MICRO ELEC. PROD. (MEP)	337					
185	MICROCOM SYSTEMS	26					
188	MICROPROCESSORS UNLTD.	323					
181	MONTGOMERY GRANT	320					
183	M.H.I.	204					
194	ON-LINE STORE	299					
213	PRINTERS PLUS INC.	38					
216	PROGRAMMERS SHOP	195					
217	PROGRAMMER'S CONNECTION	19					
218	PROGRAMMER'S PARADISE	177					
219	PROGRAMMER'S PARADISE	178,179					
247	SCHWAB COMP. CENTER	321					
248	SCIENCE & ENG. S/W	203					
250	SHAMROCK COMPUTER	53					
251	SILICON SPECIALTIES	226					
252	SILICON SPECIALTIES	226					
270	S'NW ELECTRONICS	44					
271	S-100	329					
272	S-100	329					
288	WAREHOUSE DATA PRODS.	213					
543 OPERATING SYSTEMS							
141	KADAK PRODUCTS	318					
246	SANTA CRUZ OPERATION	151					
544 ON-LINE SERVICES							
450	BIX	282,283					
63	COMPUSERVE	149					
*	MCGRAW-HILL NEWS	245					
294	WEST. UNION TELEGRAPH CO.	17					
545 EDUCATIONAL/INSTRUCTIONAL							
7	ACM SIGGRAPH '88	93					
13	ALDE PUBLISHING	337					
324	BYTE BITS	326					
*	BYTE CIRCULATION	284					
*	BYTE MARKETING	291					
*	BYTE SUB. MESSAGE	287					
*	BYTE SUB. SERVICE	339					
74	CYBER RESEARCH	318					
77	DATA TRANSLATION	58					
*	MCGRAW-HILL CEC	288A-B					
*	MCGRAW-HILL NRI	272A-B					
198	OSBORNE/MCGRAW-HILL	236					
199	OSBORNE/MCGRAW-HILL	272					
* MISCELLANEOUS							
20	ANTHRO CORP.	13					
*	BEST WESTERN	24					
163	MERRITT COMPUTER PRODS.	96					
242	RAM-BENDERS	92					
245	SAFEWARE	324					
*	TINNEY, ROBERT GRAPHICS	292					
118	HARRIS/3M COPIERS	281					

* Correspond directly with company.

IF THE REASON YOU HAVEN'T BOUGHT A 24-PIN PRINTER IS PRICE, YOU'VE LOST YOUR REASON.

You've also lost your last reason for buying a 9-pin printer. Our new Pinwriter® P2200 dot matrix printer is the first 24-pin printer that is priced lower than many of today's 9-pin printers.

However, we didn't strip the price by doing the same thing to features.

In fact, we gave the P2200 a few features you won't find on any other printers at any price.

Like more software support than any other 24-wire printer and unrivaled paper-handling capabilities. It feeds from both the rear and the front. And you can print a single sheet without removing your continuous paper. You can also produce up to 128 type variations within a single document.

We also didn't get the price down at the expense of speed. The P2200 prints 55 cps in LQ mode – that's faster than any other printer in its price range. And in draft mode, it speeds along at 170 cps.

So see your NEC dealer today. Anything else would be thoroughly unreasonable.

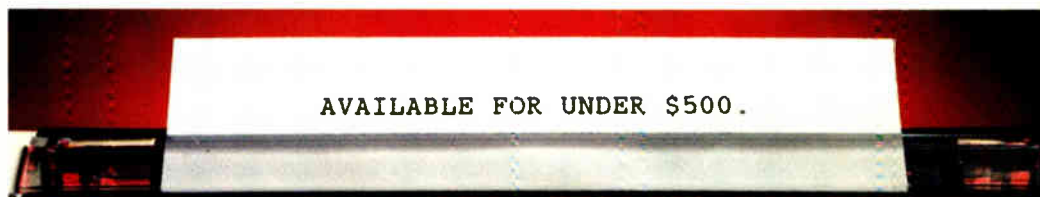

**NEC PRINTERS. THEY ONLY STOP
WHEN YOU WANT THEM TO.**

NEC

NEC Information Systems, Inc.

For more information, and the name of the NECIS dealer nearest you, call 1-800-343-4418 (in MA 617-264-8635).
Or write: NEC Information Systems, Dept. 1610, 1414 Massachusetts Ave., Boxborough, MA 01719.

World Record **Circle 136** on Reader Service Card

Tandy Computers:
Because there is
no better value.TM

The Tandy[®] 4000



A price breakthrough
in high-performance
80386 technology.

Put a Tandy 4000 personal computer on your desk and unleash the remarkable power of the 80386 microprocessor.

With the Tandy 4000's 16-megahertz clock speed, IBM PC and AT[®] compatible software comes alive with incredible speed. And new operating systems such as Microsoft[®] OS/2 will deliver the full potential of the 80386.

The 4000 is just one of a complete line of Tandy computers—the best-selling IBM PC compatibles in America. We have the system solutions your business can depend on . . . for years to come.

Workgroup Solutions. Our 3Com[®] workgroup lets people and PCs work together, so your entire office can share information and route messages—electronically. And with IRMA-LAN[™], up to 20 people in your workgroup can access your company's IBM mainframe.

Multuser Solutions. With the XENIX[®] multiuser operating system you can share the power of the Tandy 4000 with others in your office. The fact is, we have more experience with XENIX[®] multiuser systems than anyone. And we offer SCO[™] business productivity software that's designed expressly for maximum multiuser efficiency.

Total Support. Radio Shack Computer Centers offer the most comprehensive range of support services in the industry. The bottom line? We work hard for your business! Come in and find out for yourself—ask for a demonstration of the Tandy 4000 today.

See Tandy's Complete Line of IBM[®] PC Compatible Computers



Tandy 4000

Tandy 3000

Tandy 3000 HL



Tandy 1000 TX

Tandy 1000 SX

Tandy 1000 HX

Tandy 1400 LT

Radio Shack[®]
COMPUTER CENTERS
A DIVISION OF TANDY CORPORATION

XENIX Reg. TM Microsoft Corp. 3Com/Reg. TM 3Com Corp. IBM and AT/Reg. TM IBM Corp. IRMALAN/TM Digital Communications Associates, Inc. SCO/Reg. TM The Santa Cruz Operation.