

BYTE

THE SMALL SYSTEMS JOURNAL

MAY 1985 VOL. 10, NO. 5

\$3.50 IN UNITED STATES
\$4.25 IN CANADA / £2.10 IN U.K.
A MCGRAW-HILL PUBLICATION
0360-5280

MULTIPROCESSING

THE AT&T
UNIX PC



These are some of in The Mac

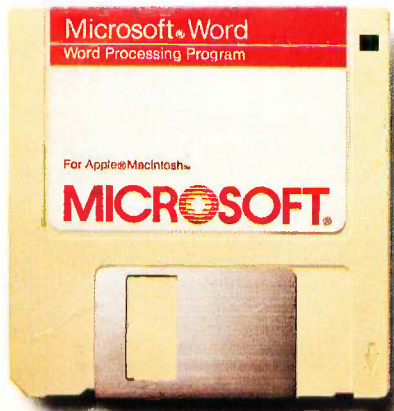

Microsoft® Word. Full feature word processor for memos, personalized form letters, sales reports or any professional document.



Back to Basics™ Manage your books with a full feature general ledger system for small business.



pfs: Report. Prepare inventory reports, price lists, salary and payroll analyses and sales reports.



ThinkTank™ 512. An idea processor to organize projects, manage details, outline ideas and support decisions.



MacProject™ Create complex "critical path" flow charts for production schedules, timelines and managing projects.



Microsoft® Multiplan®. Electronic spreadsheet for budget forecasting, business planning and "what if" analysis.

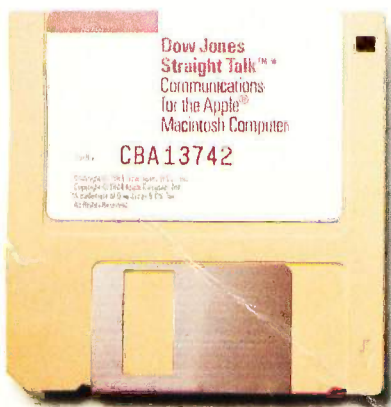

Dow Jones Straight Talk™ Get up-to-the-minute information for informed business decisions on stocks, bonds and commodities.

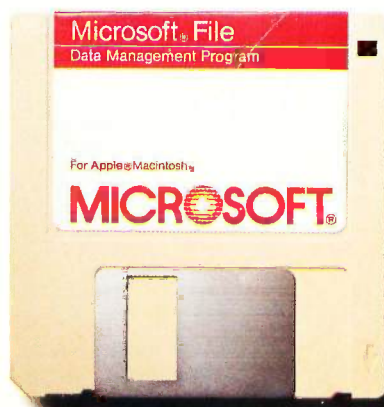

Microsoft® File. Filing systems for mailing lists, payroll records, inventory and customer lists.



OverVUE™ Analyze sales, track inventory, update customer lists and monitor accounts receivable.

The hardest workers in the Macintosh Office.



MacTerminal™ Talk to mainframes via 3270 emulation, as well as information services and other computers.



Lotus® Jazz™ Integrated word processing, business graphics, database management, data communications and worksheet.



PFS® File Store and retrieve mailing lists, client records, collections, schedules and inventories.



Microsoft® Chart. 42 different charts and graphs for presentations, sales reports and transparencies.

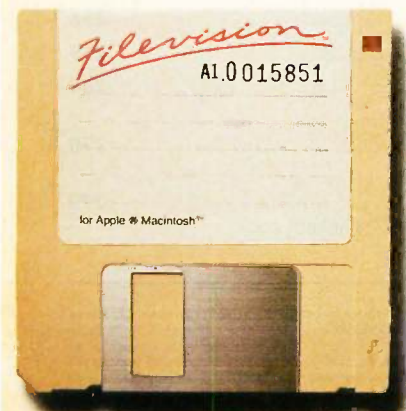

Filevision™ Visualize market trends, organize and track sales and present data in pictures.



Odesta Helix™ A relational database and decision support system for tracking information, resources and ideas.

They're fast. They're dependable. And they seldom, if ever, complain.

We're talking, of course, about all the powerful business software that works in The Macintosh™ Office. Our family of integrated office products that, we believe, will revolutionize the way business does business.

And apparently, more than a few people agree with us.

Leading software developers have already written more than 350 programs for The Macintosh Office. And there are hundreds of others on the way.

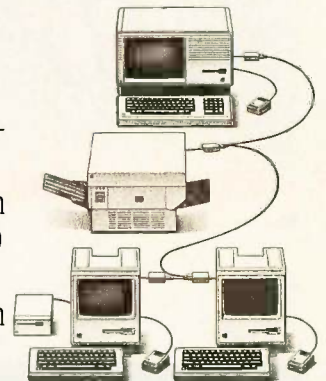

Just as Macintosh makes individuals more productive, The Macintosh Office increases productivity for workgroups of 5 to 25.

But more impressive than the sheer number of programs for The Macintosh Office, is the sheer ease with which you can use them.

Thanks to Macintosh's windows, icons, pull-down menus and mouse technology, every Macintosh program works the same way. Learn one, and you've learned them all.

Which means you'll have a lot more time to do the one thing you've probably been too busy to do:

Your job.



* Available Spring 1985. © 1985 Apple Computer, Inc. Apple, the Apple logo, MacProject and MacTerminal are trademarks of Apple Computer, Inc. Macintosh is a trademark licensed to Apple Computer, Inc. For an authorized Apple dealer nearest you call (800) 538-9696. In Canada, call (800) 268-7796 or (800) 268-7637.

C·O·N·T·E·N·T·S

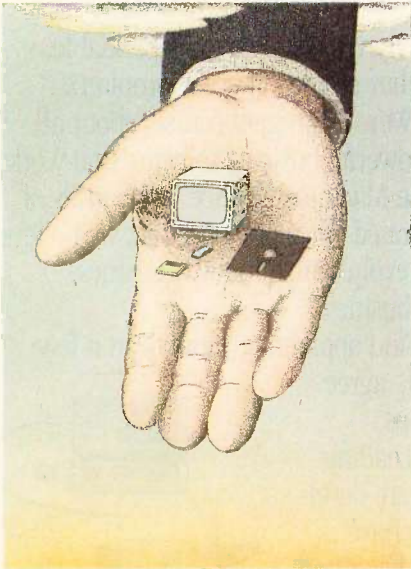

96

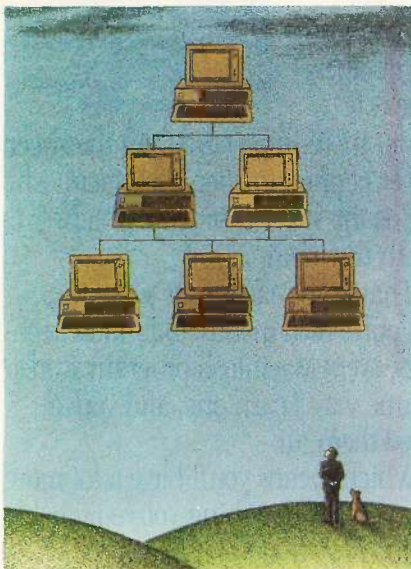

168

FEATURES

INTRODUCTION	96
THE AT&T UNIX PC by Gregg Williams	98
AT&T integrates computer and telephone and civilizes UNIX for under \$6000.	
CIARCIA'S CIRCUIT CELLAR: BUILD THE HOME RUN CONTROL SYSTEM, PART 2: THE HARDWARE by Steve Ciarcia	108
Steve gets into the nuts and bolts of his new control system.	
SET EXTENSIONS WITH APPLE PASCAL by Alfred L. Schumer	128
Expand your set capabilities with the SuperSets program.	
BUILD A TALKING CLOCK SPEECH SYNTHESIZER by Ernest H. Piette	143
Have your Commodore 64, VIC-20, or TRS-80 audibly announce the time.	
SMALLTALK COMES TO THE MICROCOMPUTER WORLD by Bruce Webster	151
Three articles focus on this object-oriented language.	
METHODS: A PRELIMINARY LOOK by Bruce Webster and Tom Yonkman	152
Methods attempts to recreate the Smalltalk development environment on the IBM PC and compatibles.	
SMALLTALK-PC by Christopher Macie	155
You can run Smalltalk on such systems as the Apple II and the IBM PC.	
THE SMALLTALK PROGRAMMING LANGUAGE by Jim Anderson and Barry Fishman	160
This article presents a brief introduction to object-oriented programming.	

THEMES

INTRODUCTION	168
MULTIPROCESSING: AN OVERVIEW by Rich Krajewski	171
One word covers a variety of techniques for increasing computing speed.	
EXTENDING MICROPROCESSOR ARCHITECTURES by Gary D. Beals	185
Extended-processing units can significantly broaden instruction sets.	
APPLYING DATA FLOW IN THE REAL WORLD by William Gerhard Paseman	201
This model for parallel processing is finding its way into commercial applications.	
THE TRANSPUTER by Paul Walker	219
A small computer can serve as a building block for parallel processing.	
DATA-MOVEMENT PRIMITIVES by J. Eric Roskos and Ching-Dong Hsieh	239
The authors describe a low-cost, innovative technique for sharing memory.	

REVIEWS

INTRODUCTION	256
REVIEWER'S NOTEBOOK by Glenn Hartwig	259
THE COMPAQ DESKPRO by Jerry Grady	260
Four models offer "99.9 percent" IBM PC compatibility.	
IBM PC AT by Alan Finger	270
This PC is geared toward business applications.	
TRUE BASIC by G. Michael Vose	279
BASIC's originators try to bring structure to the realm of "spaghetti code."	

BYTE (ISSN 0360-5280) is published monthly with one extra issue per year by McGraw-Hill Inc. Founder: James H. McGraw (1860-1948); Executive, editorial, circulation, and advertising offices: 70 Main St., Peterborough, NH 03458, phone (603) 924-9281. Office hours: Mon-Thur 8:30 AM - 4:30 PM, Friday 8:30 AM - 1:00 PM, Eastern Time. Address subscriptions to BYTE Subscriptions, POB 590, Martinsville, NJ 08836. Postmaster: send address changes USPS Form 3579, undeliverable copies and fulfillment questions to BYTE Subscriptions, POB 596, Martinsville, NJ 08836. Second-class postage paid at Peterborough, NH 03458 and additional mailing offices. Postage paid at Winnipeg, Manitoba. Registration number 9321. Subscriptions are \$21 for one year, \$38 for two years, and \$55 for three years in the USA and its possessions. In Canada and Mexico, \$23 for one year, \$42 for two years, \$61 for three years, \$69 for one year air delivery to Europe, 17,100 yen for one year surface delivery to Japan, \$37 surface delivery elsewhere. Air delivery to selected areas at additional rates upon request. Single copy price is \$3.50 in the USA and its possessions, \$3.95 in Canada and Mexico, \$4.50 in Europe, and \$5 elsewhere. Foreign subscriptions and sales should be remitted in United States funds drawn on a U.S. bank. Please allow six to eight weeks for delivery of first issue. Printed in the United States of America.

BYTE May

VOLUME 10, NUMBER 5, 1985

THE GTX-100 MODEM *by Mark Haas* 291
Security functions are built into this smart device.

REVIEW FEEDBACK 299
Readers respond to previous reviews.

KERNEL

INTRODUCTION 305

COMPUTING AT CHAOS MANOR: IN SEARCH OF THE PERFECT PRODUCT
by Jerry Pournelle 307
Chaos Manor awards are handed out, and Jerry discusses a new type of micro.

CHAOS MANOR MAIL *conducted by Jerry Pournelle* 347
Jerry's readers write, and he replies.

BYTE JAPAN: MEGABITS AND GIGAFLOPS *by William M. Raike* 355
This month Bill looks at IBM Japan's 1-megabit RAM chips and new personal computers from NEC and Fujitsu.

BYTE WEST COAST: HOMEBREW CHIPS
by John Markoff, Phillip Robinson, and Donna Osgood 363
Our West Coast editors describe MOSIS and much more.

BYTE U.K.: PARALLEL PROCESSING *by Dick Pountain* 385
From London, Dick introduces a machine called ALICE that uses parallel processors and executes a higher-order applicative language called Hope.

COMPUTERS AND LAW: THE SALE OF COMPUTER PRODUCTS
by Robert Greene Sterne and Perry J. Saidman 399
Two attorneys look at the legal aspects of buying and selling computers.

MATHEMATICAL RECREATIONS: AN EXERCISE IN BASIC BITWISE LOGIC OPERATION
by Robert T. Kurosaka 417
The ancient game of Nim helps teach the use of logical operators.

CIRCUIT CELLAR FEEDBACK *conducted by Steve Ciarcia* 424
Steve answers project-related queries from readers.

PROGRAMMING INSIGHT: $0.8660254 \approx \sqrt{3}/2$ *by Dan Sandberg* 429
This program lets you easily find the fractional equivalent of a decimal.

PROGRAMMING INSIGHT: COMPUTING PI *by David J. Crawford* 433
Approximate the decimal value of irrational numbers.

EDITORIAL: BYTE'S READER POLL	6	BOOK REVIEWS	65
MICROBYTES	9	EVENT QUEUE	83
LETTERS	14	BOOKS RECEIVED	442
FIXES AND UPDATES	33	UNCLASSIFIED ADS	525
WHAT'S NEW	39, 464	BYTE'S ONGOING MONITOR BOX.	
ASK BYTE	48	BOMB RESULTS	526
CLUBS & NEWSLETTERS	58	READER SERVICE	527

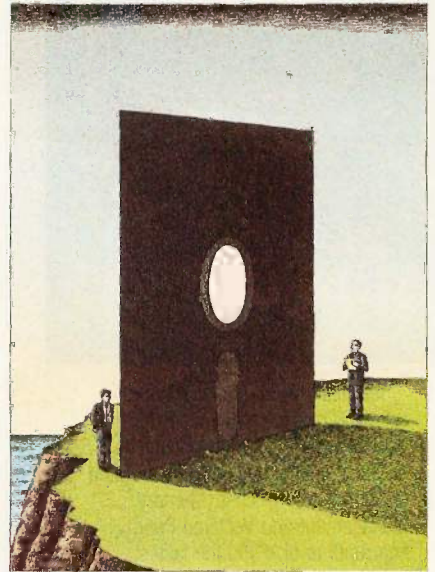

256

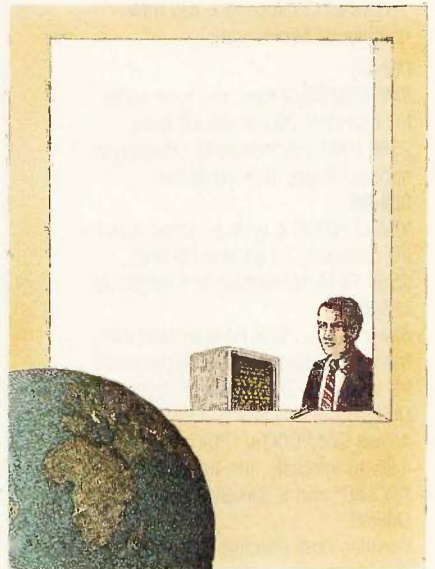

305

Address all editorial correspondence to the Editor, BYTE, POB 372, Hancock, NH 03449. Unacceptable manuscripts will be returned if accompanied by sufficient first-class postage. Not responsible for lost manuscripts or photos. Opinions expressed by the authors are not necessarily those of BYTE. Copyright © 1985 by McGraw-Hill Inc. All rights reserved. Trademark registered in the United States Patent and Trademark Office. Where necessary, permission is granted by the copyright owner for libraries and others registered with the Copyright Clearance Center (CCC) to photocopy any article herein for the flat fee of \$1.50 per copy of the article or any part thereof. Correspondence and payment should be sent directly to the CCC, 29 Congress St., Salem, MA 01970. Specify ISSN 0360-5280/83 \$1.50. Copying done for other than personal or internal reference use without the permission of McGraw-Hill Inc. is prohibited. Requests for special permission or bulk orders should be addressed to the publisher, BYTE is available in microform from University Microfilms International, 300 North Zeeb Rd., Dept. PR, Ann Arbor, MI 48106 or 18 Bedford Row, Dept. PR, London WC1R 4EJ, England. Subscription questions or problems should be addressed to: BYTE Subscriber Service, POB 328, Hancock, NH 03449.



16-Bit Networks To Go



Intercontinental Micro is shipping solutions today for all your S-100 BUS 16-bit and PC network needs.

Our products have always featured Direct Memory Access, Memory Management and Vectored Priority Interrupts to give you the fastest networks possible, bar none.

Of course, we also offer a complete line of 8-bit and interface/controller products as well as the sophisticated TurboDOS™ multiuser operating system.

For complete networking solutions and years of experience call Intercontinental Micro today.

CPZ-186-

8MHZ 80186, 2 sync or async serial I/O channels 20 parallel I/O lines, 256K RAM expandable to 1 megabyte, onboard floppy disk controller.

CPS-186-

10MHZ 80186, 4 sync or async serial I/O channels, 20 parallel I/O lines, 256K RAM expandable to 1 megabyte.

CPS-16X-

8MHZ 8086, 256K RAM expandable to 1 megabyte, 2 sync or async serial I/O channels, 20 parallel I/O lines.

LANPC-

Allows IBM PC/XTs™ PCs or compatibles to integrate into TurboLAN, ARCnet™ and S-100 BUS networks.

LANjr™

Provides cost effective true multiuser PCjr™ networks with simple installation.



4015 Leaverton Ct., Anaheim, Ca 92807,
(714) 630-0964, TELEX: 821375 SUPPORT UD

TurboDOS is a Trademark of Software 2,000 Inc.
IBM PC, XT & PCjr are Trademarks of International Business Machines.

TurboLAN is a Trademark of Intercontinental Micro Systems. ARCnet is a Trademark of Datapoint.

BYTE

EDITOR IN CHIEF

PHILIP LEMMONS
MANAGING EDITOR
GENE SMARTE

CONSULTING EDITORS

STEVE CIARCIA
JERRY POURNELLE

SENIOR TECHNICAL EDITORS

G. MICHAEL VOSE, *Themes*
GREGG WILLIAMS
TECHNICAL EDITORS
THOMAS R. CLUNE
JON R. EDWARDS
RICHARD GREHAN
GLENN HARTWIG, *Review*
RICHARD KRAJEWSKI
KEN SHELDON
RICHARD S. SHUFORD
JANE MORRILL TAZELAAR
EVA WHITE
STANLEY WSZOLA
MARGARET COOK GURNEY, *Associate*
ALAN EASTON, *Drafting*

WEST COAST EDITORS

EZRA SHAPIRO, *Bureau Chief, San Francisco*
JOHN MARKOFF, *Senior Technical Editor, Palo Alto*
PHILIP ROBINSON, *Senior Technical Editor, Palo Alto*
DONNA OSGOOD, *Associate Editor, San Francisco*
BRENDA McLAUGHLIN, *Editorial Assistant, San Francisco*

NEW YORK EDITOR

RICHARD MALLOY, *Senior Technical Editor*

MANAGING EDITOR

ELECTRONIC PUBLISHING AND COMMUNICATIONS

GEORGE BOND

USER NEWS EDITOR, EAST COAST

ANTHONY J. LOCKWOOD, *What's New*

USER NEWS EDITOR, WEST COAST

MARK WELCH, *Microbytes*

CONTRIBUTING EDITORS

DENNIS ALLISON, *at large*
MARK DAHMKE, *video, operating systems*
MARK HAAS, *at large*
RIK JADRNICEK, *CAD, graphics, spreadsheets*
MARK KLEIN, *communications*
ALAN MILLER, *languages and engineering*
JOHN C. NASH, *scientific computing*
DICK POUNTAIN, *U.K.*

WILLIAM M. RAIKE, *Japan*

PERRY SAIDMAN, *computers and law*

ROBERT STERNE, *computers and law*

BRUCE WEBSTER, *software*

COPY EDITORS

BUD SADLER, *Chief*
DENNIS BARKER
ELIZABETH COOPER
ANNE L. FISCHER
NANCY HAYES
LYNNE M. NADEAU
PAULA NOONAN
JOAN VIGNEAU ROY
WARREN WILLIAMSON

ASSISTANTS

PEGGY DUNHAM
MARTHA HICKS
BEVERLY JACKSON
LISA JO STEINER

ART

ROSSLYN A. FRICK, *Art Director*
NANCY RICE, *Assistant Art Director*

PRODUCTION

DAVID R. ANDERSON, *Production Director*
DENISE CHARTRAND
MICHAEL J. LONSKY
JAN MULLER

SENIOR VICE PRESIDENT PUBLISHER

HARRY L. BROWN
PUBLISHER'S ASSISTANT
DORIS R. GAMBLE

PERSONNEL

CHERYL HURD, *Office Manager*
PATRICIA BURKE, *Personnel Coordinator*

ADVERTISING SALES (603-924-6137)

J. PETER HUESTIS, *Sales Manager*
SANDRA FOSTER, *Administrative Assistant*
ADVERTISING/PRODUCTION (603-924-6448)
LISA WOZMAK, *Supervisor*
ROBERT D. HANNINGS, *Senior Account Manager*
MARION CARLSON
KAREN CILLEY
LYDA CLARK
MICHELE GILMORE
DENISE PROCTOR
WAI CHIU LI, *Quality Control Director*
JULIE NELSON, *Advertising/Production Coordinator*

CIRCULATION (800-258-5485)

GREGORY SPITZFADEN, *Director*
ANDREW JACKSON, *Subscriptions Manager*
CATHY A. R. DREW, *Assistant Manager*
LAURIE SEAMANS, *Assistant Manager*
SUSAN BOYD
PHIL DECHERT
MARY EMERSON
LOUISE MENEGUS
AGNES E. PERRY
JENNIFER PRICE
JAMES BINGHAM, *Single-Copy Sales Manager*
LINDA RUTH, *Assistant Manager*
CAROL AHO
CLAUDETTE CARSWELL
KAREN DESROCHES

MARKETING COMMUNICATIONS

HORACE T. HOWLAND, *Director (603-924-3424)*
VICKI REYNOLDS, *Marketing Production Manager*
PRISCILLA ARNOLD, *Marketing Assistant*
STEPHANIE WARNESEY, *Marketing Art Director*
SHARON PRICE, *Assistant Art Director*
DOUG WEBSTER, *Director of Public Relations (603-924-9027)*
WILBUR S. WATSON, *Operations Manager, Exhibits*

PLANNING AND DEVELOPMENT

MICHELE P. VERVILLE, *Manager*
PATRICIA AKERLEY, *Research Manager*
CYNTHIA DAMATO SANDS, *Reader Service Coordinator*
FAITH KLUNTZ, *Copyrights Coordinator*

MANUFACTURING/FINANCE/SERVICES

DANIEL RODRIGUES, *Director*

ACCOUNTING

KENNETH A. KING, *Assistant Controller*
VICKI WESTON, *Accounting Manager*
LINDA SHORT, *D/P Manager*
EDSON WARE, *Credit*
MARIE CAGGIANI
MARILYN HAIGH
DIANE HENRY
VERN ROCKWELL
JOANN WALTER

TYPOGRAPHY

SHERRY MCCARTHY, *Chief Typographer*
NAN FORNAL
LEN LORETTE

KATHY QUIST

DONNA SWEENEY

BUILDING SERVICES/TRAFFIC

ANTHONY BENNETT, *Building Services Manager*

BRIAN HIGGINS

MARK MONKTON

RECEPTIONISTS

L. RYAN MCCOMBS
CHERYL CASTRO, *Assistant*

Editorial and Business Office: 70 Main Street, Peterborough, New Hampshire 03458, (603) 924-9281.

West Coast Offices: McGraw-Hill, 425 Battery St., San Francisco, CA 94111, (415) 362-4600.

McGraw-Hill, 1000 Elwell Court, Palo Alto, CA 94303, (415) 964-0624.

New York Office: 1221 Avenue of the Americas, New York, NY 10020, (212) 512-2000.

Officers of McGraw-Hill Information Systems Company: President: Richard B. Miller. Executive Vice Presidents: Frederick P. Jannott. Construction Information Group: Russell C. White. Computers and Communications Information Group: J. Thomas Ryan. Marketing and International. Senior Vice Presidents: Francis A. Shinal. Controller: Robert C. Violette. Manufacturing and Technology. Senior Vice Presidents and Publishers: Harry L. Brown. Computers and Communications: David J. McGrath. Construction Group Vice President: Peter B. McCuen. Communications. Vice Presidents: Fred O. Jensen. Planning and Development: Margaret L. Dagner. Human Resources.

Officers of McGraw-Hill, Inc.: Harold W. McGraw, Jr., Chairman; Joseph L. Dionne, President and Chief Executive Officer; Robert N. Landes, Executive Vice President and Secretary; Ralph I. Webb, Vice President and Treasurer; Donald L. Fruehling, Executive Vice President, Publishing Operations Group; Ralph R. Schulz, Senior Vice President, Editorial; Walter D. Serwatka, Senior Vice President, Manufacturing and Circulation Services. Vice Presidents: Shel F. Asen, Manufacturing; George R. Elsing, Circulation.

CROMEMCO COMPUTERS: DESIGNED TO MAKE UNIX SYSTEM V EVEN BETTER...

UNIX System V, the new standard in multi-user microcomputer operating systems, gives you high performance features along with the portability and flexibility of a standard.

Cromemco computers can make UNIX System V even better. Because our systems are designed with UNIX in mind. First of all, we offer UNIX System V with Berkeley enhancements. Then, our hardware uses advanced features like 64K of on-board cache memory and our high speed STDC controller to speed up disk operations—very important with UNIX.

More capability and expandability

We have a high-speed, 68000-based CPU that runs at 10 MHz, coupled with a memory manager that uses demand-paging and scatter loading to work *with* UNIX, not for it.

We provide room for expanding RAM to 16 megabytes—with error detection and correction—for running even the most sophisticated and advanced microcomputer programs. And the power to accommodate up to 16 users—all with plenty of memory.

But we give you even more.

A complete solution

We give you a choice in systems: the System 100 series, expandable up to 4 megabytes of RAM, and the System 300 series, expandable to 16 megabytes. A high speed 50 megabyte hard disk drive is standard on the systems. And you can expand the hard disk capacity up to 1200 megabytes using standard SMD drives. You can add floating point processing. High resolution graphics. Video digitizing and imaging. Communications through

standard protocols. Mainframe interface.

And software support is here to meet your needs. We offer major programming languages, database management systems, communications software, including SNA architecture, X.25 protocol, and Ethernet; even a program to interface to an IBM PC if you need to. And, of course, access to the broad range of standard UNIX applications programs that is growing dramatically every day.

Easy to use.

We also make our systems easier to use, because we install the operating system before we ship your computer. No complicated installation procedures. And the Berkeley enhancements give you the standard UNIX System V operating system, but with the added convenience of these widely acclaimed improvements.

Cromemco's System 100 and System 300 computers: designed to be the highest performance UNIX systems available anywhere.

Just call or visit one of our UNIX System V Official System Centers to see for yourself. They'll also give you a copy of our new publication, "What you should know before you buy a UNIX system." Or contact us directly.

We'll be glad to show you how to get a better UNIX system.

Corporate Headquarters: Cromemco, Inc., 280 Bernardo Avenue, P.O. Box 7400, Mountain View, CA 94039. (415) 969-4710. In Europe:

Cromemco
GmbH, 6236
Eschborn 1,
Frankfurter Str.
33-35, P.O. 5267,
Frankfurt Main,
Germany.

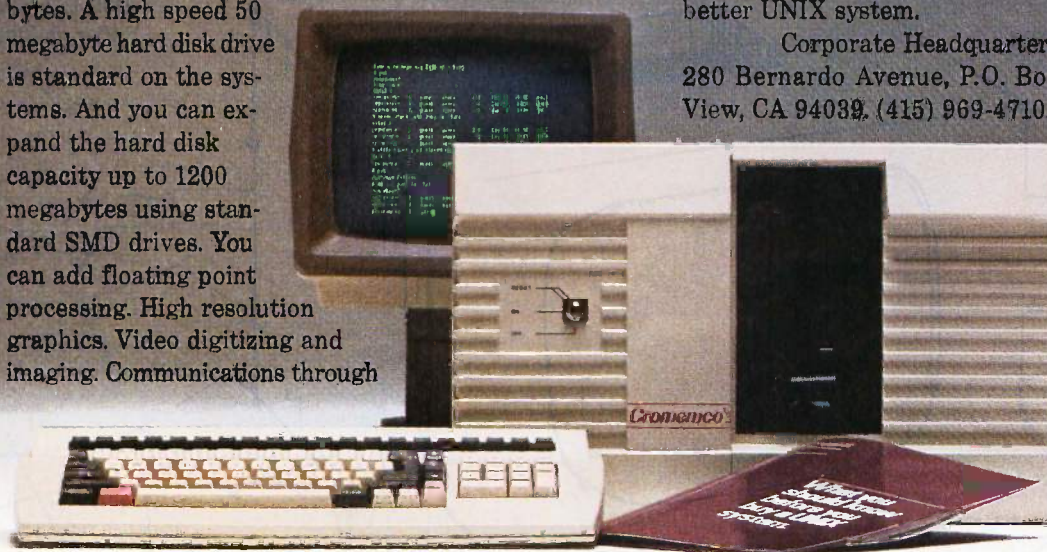

UNIX is a trademark of Bell Laboratories.
IBM is a trademark of International Business Machines Corp.

Cromemco®

BYTE'S READER POLL

Each month, several hundred BYTE readers vote in the reader poll called the BOMB (BYTE's Ongoing Monitor Box). We've done little to call attention to the poll but wish to do so now to urge increased participation. We take the BOMB results seriously. Besides awarding modest prizes to the writers whose articles win the most votes, we try to interpret the BOMB results in a way that will help us develop and choose articles that win the applause of BYTE readers.

Admittedly, several hundred votes from a circulation of 400,000 are neither a random sample nor a large one. We want to encourage you to vote on this month's articles to increase both the size and the significance of the BOMB results and to help us keep BYTE attuned to your needs.

The great majority of you have never voted in the BOMB and probably have never noticed the numbered list of articles published at the back of the magazine

between the Unclassified Ads and the Reader Service index. The numbers on the list identify the articles for voting purposes. The ballot itself is one page further along, on the Reader Service card. Beneath the area where you circle Reader Service numbers to obtain information about advertised products, a smaller set of numbers lets you circle numbers to rate this month's articles. The ballot asks you to rate each article as excellent, good, fair, or poor. We assign weights to all these ratings to identify the best-liked articles.

Steve Ciarcia and Jerry Pournelle are, of course, frequent winners of the BOMB, as are articles about major new personal computers. We do sometimes have surprises. A survey of statistical software scored very well, as did two articles examining the state of Soviet computers and electronics—Ruth Heuertz's look at Soviet microprocessors (April 1984) and Leo

Bores's account of the Soviet Apple clone, AGAT (November 1984). We didn't realize how broad the appeal of statistics would be or how powerful people's curiosity about Soviet products, topics which lack the most important criterion of interest turned up in our reader research—emphasis on new technology.

Results that surprise us might not surprise you. Voting in the BOMB is the best way to keep us abreast of your interests and needs. We urge you to take a minute each month to make your opinion heard. We'll be listening when you do.

THE LONG-AWAITED BYTE INDEX

Finally. An index to the 1983 and 1984 issues of BYTE is now available. For a hard copy of this 48-page document, please send us \$1 and we'll send you a copy postpaid. The index will also be available electronically. We'll release the details as soon as possible.

—Phil Lemmons
Editor in Chief

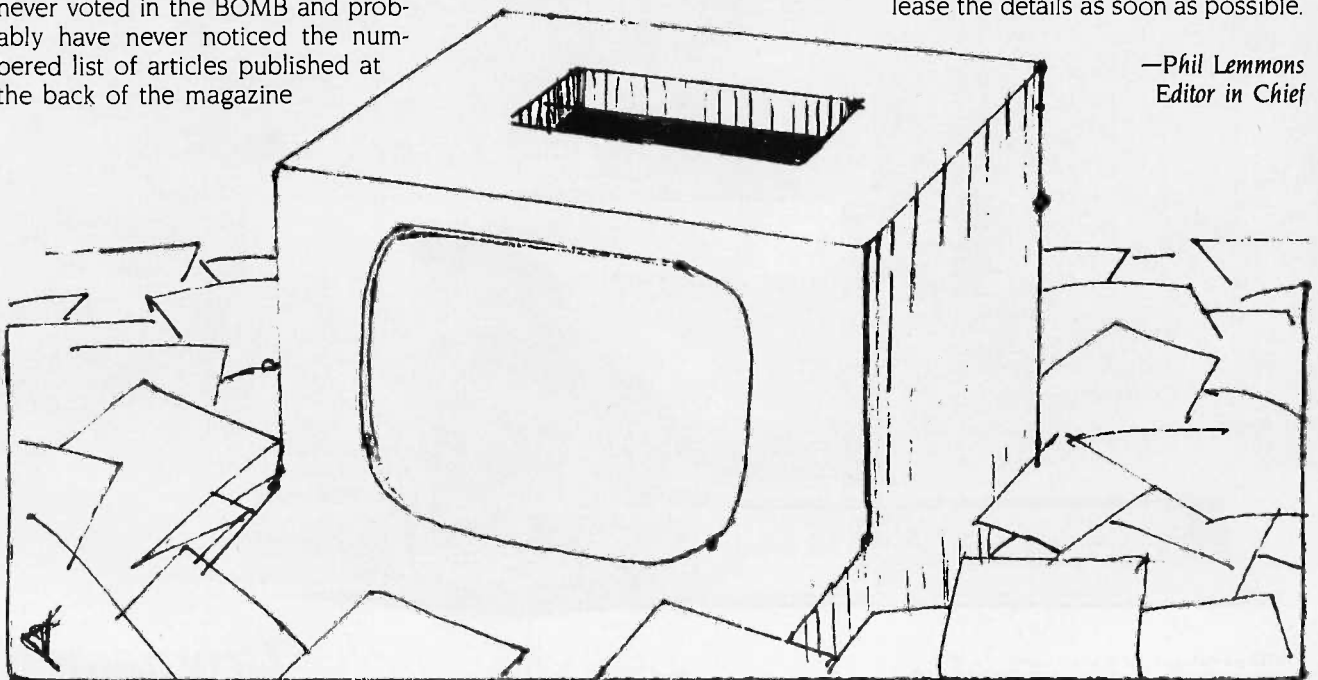



Maxell Gold.

The floppy disk that
lets PC ATTM speed ahead,
makes PC/XTTM
X-traordinary,
and helps IBM[®] PCTM
capitalize
on its powers.

For your Big Blue, only the Gold Standard will do. Maxell. The floppy disk chosen by many disk drive manufacturers to test their new equipment. Each Gold Standard is backed by a lifetime warranty. And each is a perfect match for your IBM. In fact, there's a Gold Standard for virtually any computer made. Even if it's the new IBM PC AT!

maxell[®]
IT'S WORTH IT.

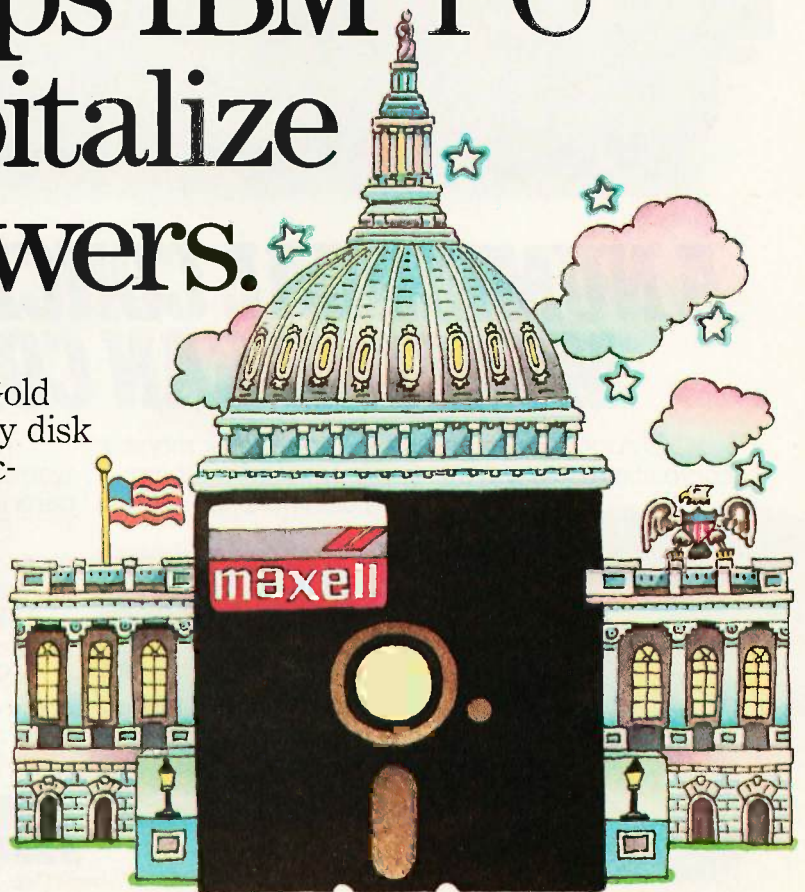

PC AT, PC/XT and PC are trademarks of IBM Corp.



A NUMERICAL CONCEPT NO OTHER MONITOR CAN COMPREHEND.

As sophisticated as they are, you'd think monitor companies could solve a simple problem: keeping customers happy.

Fortunately, Amdek can. With the longest warranty in the industry. Namely, two years on all parts and labor. And three years on the CRT.

Even simpler, our warranty applies to every monitor we make, from our new Color Series to our amazingly popular Video Series.

And Amdek's own trained technicians make repairs quick and professional.

So when you're shopping for a monitor, look at the quality Amdek guarantees you, years after you leave the store.

According to our figures, it really adds up.

AMDEK® MONITORS

Amdek Corp., 2201 Lively Blvd., Elk Grove Village, IL 60007, 312/595-6890, Telex 280803



New Laser Printers May Outperform Canon's Engine

Two new printers from Konica and NEC may offer some advantages over the Canon LBP-CX engine used in Apple's and Hewlett-Packard's laser printers. The TMC Co., Wayne, PA, the U.S. distributor for Konica's LP-3010, says the newer laser printer is faster, will cost less to operate, and lasts longer than Canon's LBP-CX, but it is priced the same and offers the same 300-dot-per-inch (dpi) resolution.

While Canon suggests that the LBP-CX be used to print up to 3000 pages per month at a speed of 8 pages per minute, TMC says the LP-3010 can handle 10,000 copies per month at 10 pages per minute. The LP-3010 uses a \$200 drum/toner cartridge the company says will last for 15,000 pages, while the LBP-CX's \$99 cartridge must be replaced after 3000 copies. And while Canon suggests that the LBP-CX be "overhauled" at 100,000 pages, TMC says the LP-3010 will last for 600,000 pages.

TMC says that several OEMs have placed orders for the LP-3010 and will announce products early this summer; pricing for a low-end printer based on Konica's engine should start at about \$3500. With more advanced capabilities, including full-page bit-mapped graphics, a Konica-based laser printer would be priced competitively with Apple's \$6995 LaserWriter, TMC claims.

NEC Information Systems plans to begin shipping its own 8-page-per-minute, 300-dpi laser-class printer in late summer. NEC's printer uses an LED array rather than a laser. Because it is not based on copier technology, NEC claims the printer will last longer and require less service than laser printers. NEC's offering will feature three built-in fonts; two cartridges can add up to eight more fonts. NEC's 55-pound printer occupies only half the footprint of the heavier Canon-based printers. With a 64K-byte printer buffer and both serial and parallel ports, NEC's LED-array printer will sell for less than \$3000. NEC is also considering unveiling one or more laser printers in the fall or winter.

A 300-dpi laser printer from Fujitsu is the basis of an even more advanced combination printer/scanner/copier that Corporate Data Sciences planned to unveil in April. Eight pages per minute can be digitized at 300 dpi. The image can then be stored or manipulated by a personal computer and printed. The unit will also work as a standard copying machine. The printer/scanner/copier will be priced at about \$24,000; the 16-page-per-minute laser printer alone will sell for about \$15,000. CDS says its laser-printer controller can also address higher-resolution laser printers, up to 1000 dpi, and it plans to offer a printer engine using a 480-dpi laser printer expected next year from Fujitsu.

DEC Revamps Rainbow to Match New PC Strategy

Stating that "stand-alone personal computing in the office is a thing of the past," Digital Equipment Corp. announced the Rainbow 190, designed to operate as a workstation for other DEC computers. With a 10-megabyte hard-disk drive, 640K bytes of memory, MS-DOS, and Rainbow Office Workstation software, the Rainbow 190 costs \$6495. Also newly available for the Rainbow is the \$595 WPS-PLUS word-processing program, already available on the VAX and ALL-IN-1 systems. DEC also announced a \$295 DECnet interface for the Rainbow.

Fairchild Unveils First Single-Chip 212A 1200-bps Modem

Fairchild announced a single-chip 1200-bps modem that supports the Bell 212A standard. The Fairchild uA212A modem includes all signal-processing functions on a single chip, unlike previous applications that required several chips. To build a working modem, however, several other devices are required: A general-purpose microprocessor must handle dialing, handshaking protocols, and control functions, while other circuitry must handle RS-232C and telephone interfaces and ring detection. The chip should be available by June for \$82.67 in quantities of 100.

(continued)

Firms Show Chinese-Language Word Processors

Two companies are developing Chinese-language word processors for the 512K-byte IBM PC using a standard American keyboard. Chinese Computer Communications, Lansing, MI, is showing PC 2001, which uses the company's own Pinxxiee input method; the company hasn't yet set a shipping date but hopes to price the software at about \$795.

Asiagraphics Corp., Port Jefferson, NY, expected to begin shipping its Asiagraphics System in April for \$995. This product employs a "descriptor" input method, using one of three Chinese phonetic systems (pinyin, Wade-Giles, or Bopomofo). Asiagraphics also plans Korean and Japanese versions and hopes to allow use of the IBM graphics adapter as well as the Hercules graphics card now supported.

IBM Puts Series/1 on a Chip, in an IBM PC Box

IBM has put its Series/1 computer architecture onto a single proprietary 16-bit microprocessor and announced versions of the IBM PC XT and AT that include the Series/1 chip and related circuits on two IBM PC expansion cards. The Series/1 5170 Model 495 is an IBM PC AT with the Series/1 expansion cards, a monochrome adapter and monitor, a 20-megabyte hard disk, and a 1.2-megabyte floppy-disk drive. It is priced at \$9420. The Model 4950, based on the IBM PC XT, includes a 10-megabyte hard disk and one 320K-byte floppy-disk drive for \$8130. IBM will stress the new system's usefulness as a file server in a network environment.

Morrow Upgrades Pivot: Fully IBM-Compatible

Morrow Designs has redesigned its Pivot portable computer to add a 25-line display and to make it more compatible with the IBM PC. The new Pivot, which Morrow hoped to begin shipping this month, will feature a backlit 25-line by 80-character liquid-crystal display, serial and parallel ports, two 5¼-inch disk drives, 256K bytes of RAM (expandable to 640K), rechargeable batteries, MS-DOS, and NewWord. Optional internal expansions will include an RGB/composite video output adapter and a 300/1200-bps modem. An optional expansion chassis is also planned. Morrow plans to price the two-drive machine at about \$2995; it had already dropped the price of the 16-line Pivot to \$1995 in March.

NANOBYTES

Optionware Inc. introduced OptionWord+, a \$100 word-processing template for Lotus 1-2-3. . . . **AT&T** introduced its long-expected UNIX personal computer. For details, see page 98. . . . **Intel** has sued **NEC**, charging that NEC's V20 and V30 microprocessors violate Intel's copyright for the microcode used in the 8088 and 8086. . . . **Apple** has developed a version of Smalltalk that runs on the Macintosh XL. Because it doesn't run on a standard Macintosh, Apple is selling it only on a limited basis, mostly to universities. . . . **Microsoft** has released a new version of Multiplan for the IBM PC. Multiplan 2.0 supports keyboard macros and has faster recalculation and a larger virtual spreadsheet (256- by 4096-cell). . . . For the Macintosh, **Microsoft** announced a run-time Microsoft BASIC interpreter, which software developers can distribute with programs they sell. . . . **Microsoft** also announced Excel, a sophisticated spreadsheet for the Macintosh (see page 44). . . . **Summa Technologies** announced a site license-fee program under which buyers can make unlimited copies of a program for use by company employees—including personal use—for as little as \$9800. . . . **Prometheus**, Fremont, CA, now offers a version of its ProModem 300/1200-bps modem for the Macintosh. With ProCom-M telecommunications software and a cable, it's \$549. . . . **Prometheus** also planned to introduce a compact 300-bps modem for the Apple IIc for less than \$200. The modem will provide an extra serial port and uses the IIc's power signal. . . . **Manzana**, Isla Vista, CA, is selling a double-sided 3½-inch disk drive for the IBM PC. The external 720K-byte drive is \$625. . . . **Advanced Micro Devices** expected to begin shipping samples of the 20-MHz 29PL141 microcode-programmable controller this month. . . . **Nestar Systems Inc.** announced a six-port HUB for its baseband LAN system that allows it to interface to a broadband network. . . . **Roger Wagner Publishing**, San Diego, CA, is developing a MacWrite-like word processor for the Apple IIc and IIe. MouseWrite takes advantage of the MouseText ROM included in the IIc and newer IIe models. . . . **Intel** announced OpenNET, a local-area-network (LAN) product line that incorporates Microsoft's Networks (MS-NET) software.

Both letter-quality and draft hard copy

Fastest document throughput in its class

Both friction and tractor paper feed

Industry standard serial and parallel interfaces.

Better, more versatile operator controls

TI reliability

Compatibility with third-party and proprietary software

Better, more durable easy-access font modules

The TI 855 microprinter. No other printer says better so many ways.

Feature for feature, no other microprinter can match the versatility, compatibility, reliability and productivity of the OMNI 800* Model 855 microprinter.

Here's why.
Two Printers In One. With the TI 855 you get the speed of dot matrix draft copy. Plus the precise clarity of the most advanced matrix technology for letter-quality print. It's two printers in one — at one low price.

A Great Family Name. Texas Instruments is known for providing the world with the industry standard for printers — the TI 810. TI builds the same reliability into every 800 series microprinter. Both the 855 and the data processing Model 850 are part of the expanding TI line of high-performance, low-cost microprinters.

Hardware Compatible. The TI 855 microprinter is compatible with all major PC hardware. And it provides both serial RS232C subset and "Centronics-type" parallel as standard interfaces.

Software Compatible. The TI 855 uses industry standard escape sequences for compatibility with virtually all third-party software. And for those with proprietary software needs, a model is available with ANSI standard escape sequences.

Tough Font Modules For Quick Character Change. Three font modules can be inserted into the front of the printer at one time, and are accessed individually. Each contains both draft- and letter-quality character sets. They're easier to use, more reliable and more durable than traditional metal or plastic daisy wheels.

More Productivity Than Any Other Microprinter. The 855 offers both friction and tractor paper feed, to handle all types of word and data processing applications. A quick-change snap-in cartridge ribbon. Raster and mosaic graphics. And intelligent printing which maximizes document throughput — regardless of format.

Get the printer that makes for better information systems. For more information visit your nearest TI authorized dealer or write Texas Instruments Incorporated, P.O. Box 402430, Dept. DPF-082BY, Dallas, TX 75380-9063. Or call toll-free: 1-800-527-3500.



TEXAS INSTRUMENTS
Creating useful products
and services for you.



We're about to change business views the co

A computer revolution of enormous magnitude is about to take place.

Because Europe's most successful business computer company is now doing business in America. Introducing Apricot. A full line of computers specifically designed for business.

Not adapted to it.

In fact, the facts speak for themselves.

Apricots are elegant and compact 16-bit computers. They employ the MS-DOS operating system, and a minimum of 256K memory. One of our models, the Apricot Xi, boasts an incredible

one Megabyte of memory, and features a Winchester hard disk with 20 Megabytes of storage. We also have models that feature speech recognition, full-size LCD, and icon driven menus.

In addition, you also have a choice between 9" or 12" b/w or 10" color monitors. All of which



change how American computer industry.

have a higher screen resolution than Apple.

And as if that weren't enough, all of our models can be networked from the moment you take them out of the box. They're also capable of running thousands of business software programs specially written for Apricot on 3½ inch disks.

So, if you still think that Apple is a better business computer, look at it from a different perspective.

It's not.

Apricot, Inc., 3375 Scott Boulevard, Santa Clara, CA 95054. Call 800-227-6703, or in California 800-632-7979.



The Apricot Xi. 1Mb RAM. 20Mb hard disk. 720K floppy diskette. MS-DOS. \$4495 (excluding monitor).

apricotTM
We're changing how
American business does business.

CRYPTOGRAPHIC MESSAGE SENDING

Thank you for Charles Kluepfel's article, "Implementing Cryptographic Algorithms on Microcomputers" (October 1984, page 126). This is an area in which I have an interest and would like to see more articles in the future, especially on the practical aspects of making and using a large-scale (widely used) public-key cryptography (PKC) system.

An assumption that some people make is that the telephone system is a perfect "channel," that is, that all information put into one end will reach its destination and come out the other end. This is not necessarily true. It is definitely not true when a store-and-forward system such as an electronic-mail or electronic bulletin-board system is used. Since many messages sent in a PKC system will be longer than the maximum number of digits that can be encoded, the message will have to be broken into segments, each segment being encoded and sent separately. This raises the possibility of a third party (with or without the telephone company's approval) intercepting and preventing one or more segments from reaching the intended recipient, while letting other segments pass through. Even without the ability to decode the intercepted segments, a third party could do great damage to both the sender and recipient due to the recipient's assuming that the entire message was received, when in fact it was not. Under some conditions, damage could also be done by rearranging the order of the segments, if the recipient was to assume that they were sent in the same order as received. (Admittedly, such situations would be rare.)

The telephone company should not be thought of as a "channel," but rather as a third party that can usually be trusted to deliver *some* of the segments of the message. It is up to the sender and recipient to ensure that all segments arrive and are put into their proper order before taking action on the basis of a message received.

A possible method of achieving this would be to include in each segment a four- or five-character (or more) code, ran-

domly chosen and different for each segment within a message. These random characters would be inserted into the plain text before the segment was encoded with the recipient's public key. Then the last segment sent would contain a repetition of all of these codes in their correct order. The recipient could check to make sure each segment had arrived and was in its proper order. Any segments containing codes not repeated in the final segment would be discarded.

Briefly covered in the article was the topic of a sender using his own private key to provide a "signature" to a message. For ordinary messages, only the last segment (containing the repeated random codes from all the other segments) need be signed. However, if an electronic contract is desired, all segments of the message should be encoded with both the sender's private key and the recipient's public one. This is to prevent the recipient from altering a segment (while keeping the same random code) and then claiming his copy to be the true contract. This means that in order to prove a contract, the recipient would have to provide a copy of each segment exactly as it was received from the modem and a copy of each segment after it was completely decoded into plain text. The arbitrator of a contract dispute need only encode the plain-text segment with the recipient's public key and "decode" the "segment as received" with the sender's public key. Comparing the two resulting segments should show them to be exactly alike, thus proving that the segment came from the sender that the recipient claims sent it. The recipient need not disclose his private key to the arbitrator.

Actually, the first segment of every message, ordinary or contract, should be encoded only with the recipient's public key and should contain information of who the sender is, so that the recipient can apply the right key to decode any signed segments. Otherwise, that information would have to be sent in plain text (horror!). Also, in order to prevent the recipient from reusing the sender's signed last segment (containing the repeated random codes) to send a falsely signed message to someone else, the sender should include identification of the intended recip-

ient in the plain text of all signed segments. It wouldn't hurt to include the date and time as well.

PAUL S. BURNEY
Portland, OR

Charles Kluepfel replies:

To protect against nonreception of segments of the message, the scheme need not be as complex as Mr. Burney suggests. The sequence code that he suggests at the beginning of each segment can be merely 00001, 00002, etc., without the need for a key as the last segment. This insertion is, as he states, before encryption, and the nature of this code prevents the presence of these or any known message contents from making the code breakable. Indeed, as the code used for message sending (as opposed to signature forming) is public, anyone trying to intercept code can himself encode 00001, etc. It does not aid the interceptor and thus can be safely used by the legitimate parties.

As for the portion regarding electronic signatures, encoding by the sender's private key is sufficient so that the recipient cannot alter the message. The use of the recipient's public key would not be of any further benefit. The recipient cannot produce a new message that is encoded by the sender's private key, that is, one that is decodable by the sender's public key. What must be guarded against, rather, is that the sender might claim to have sent further segments, modifying the intent of the message. The only way to guard against any disagreement is to have the entire document signed by both parties. Since signing is

(continued)

.....
LETTERS POLICY: To be considered for publication, a letter must be typed double-spaced on one side of the paper and must include your name and address. Comments and ideas should be expressed as clearly and concisely as possible. Listings and tables may be printed along with a letter if they are short and legible.
.....

Because BYTE receives hundreds of letters each month, not all of them can be published. Letters will not be returned to authors. Generally, it takes four months from the time BYTE receives a letter until it is published.
.....

LEAVE THE COMPUTER... TAKE THE DRIVE!



With Maynard's Transport™— the Original Portable Hard Drive!

Now you can leave that heavy "portable" computer on the desk where it belongs and carry up to 20MB of data between home and office. Transport™ comes with easy-release cable and convenient carrying handle. Call or write today for product specifics.

Your Assurance of Quality:

- plated media, double shock-mounted drive
- extensively tested against rigorous performance standards
- backed by industry-leading 1-year warranty

Available in 10MB or 20MB.

Purchase your Transport™ and receive a carrying case at no cost (limited time offer).

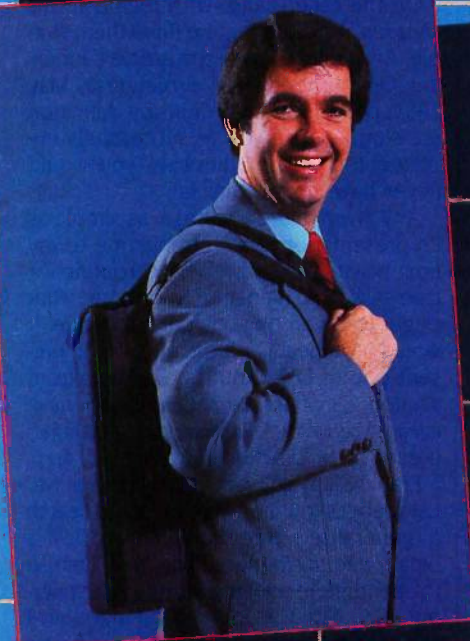

TRANSPORT
PORTABLE HARD DRIVES BY MAYNARD ELECTRONICS

 **Maynard Electronics**

Shaping Tomorrow's Technology

430 E. SEMORAN BLVD., CASSELBERRY, FL 32707

305/331-6402

Inquiry 257

**ACT NOW!
\$9.95 VALUE**

FREE OPUS DISKETTE HEAD CLEANER

With Purchase of OPUS "Unfloppable" Floppies

OPUS has a money saving offer to get you to try our floppies, the most reliable on the market today. Purchase 20 OPUS 5-1/4" diskettes and you can receive a Free UNIVERSAL HEAD CLEANER (\$9.95 value), for use on single or dual-side drives.

Purchase OPUS diskettes at your local computer store, send two box tops, a dated sales receipt, and coupon and we will send your Free Head Cleaner.

Or - order by mail and receive Head Cleaner with your shipment.

Or - Call, Toll Free:
1-800-692-6905, Dept. "M,"
to charge on your VISA or
MasterCard.

Now you have a
money saving reason
to try OPUS diskettes.
You will have "NO
BAD MEMORIES!"



OPUS[®]
NO BAD MEMORIES

SEND TO: OPUS Computer Products
'85 HEAD CLEANER OFFER
Dept. BYT 585, 150 Chicago Street
Cary, IL 60013

Name _____
Address _____
City _____ State _____ Zip _____
Phone () _____

Proof of Purchase Enclosed OR SHIP ME _____ Boxes of OPUS 5-1/4" Diskettes:
CHECK ONE: \$19.95 Single-Side 10-pack \$29.95 Dual-Side 10-pack
Add \$1.50 for shipping & handling (Illinois residents add 6% sales tax.)
TOTAL ENCLOSED: \$ _____ (Check or Money Order Only)

Charge to my: VISA MasterCard

Account Number:

Expiration Date:

Signature: _____

OFFER EXPIRES AUGUST 31, 1985.

LETTERS

encoding by the private key, each party must do encoding by private key of all segments. It can be by each separately encoding the plain text, or by the plain text being encoded by one, and the resulting text further encoded by the recipient's private code. Of course the sender must then get a copy of this further-encoded text to later prove the recipient agreed to it. The sender's private and recipient's public encoding does not assure a contract, only that the sender sent it.

To assure any segment came from the sender, it would have to be encoded in the sender's private key. Including the recipient's name in the one (or few) signed segment(s) in no way prevents forgery of unsigned segments.

MORE ON BINARY TREES

I quite agree with John Snyder's remark, in his response to Lawrence Leinweber's letter ("Binary Trees Explained," September 1984, page 22), that there is no "proper solution" in software to a given problem.

On the other hand, with regard to his "A-trees," I'm sure that he finds them simple. After all, he wrote the article ("Indexing Open-Ended Tree Structures," May 1984, page 406). Algorithms by definition are simple, once you've successfully implemented them. Otherwise, you would never have gotten that far.

Any given data structure is as simple as its presentation, which brings me to my next point. Mr. Leinweber's C routine for tree searching managed to obscure what ought to be an obvious data structure. It would have been far more effective to present one of D. E. Knuth's diagrams from section 2.3 of *The Art of Computer Programming, Volume 1: Fundamental Algorithms* (Reading, MA: Addison-Wesley, 1974).

Frankly, I'm still not sure whether Mr. Leinweber's routines were meant to search a generalized tree implemented as a binary tree or simply a binary tree. I refuse to spend more than five minutes deciphering a five-line text in any language that I supposedly understand.

Finally, Dr. Snyder, since when are binary trees sometimes called B-trees? Binary-tree nodes have at most two children (and possibly none) and by no means fulfill the well-defined properties of a B-tree (see the section on trees in Niklaus Wirth's *Algorithms Plus Data Structures Equals Programs*; Englewood Cliffs, NJ: Prentice-Hall, 1976). I've always assumed that the "B" stands

(continued)

ProModem 1200...

HOT-LINE

Our ProModem 1200 Makes Smart Modems Look Dumb



ProModem 1200 (RS-232)



ProModem 1200M (Macintosh)

Send Or Receive 50 Pages Of Text Without Tying Up Your Computer

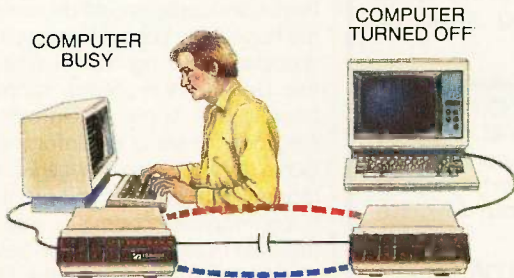

No wonder Smart Modems, Cats, and Maxwells cringe when compared to our \$495 ProModem 1200, an expandable 1200/300 baud modem for use with all personal computers. It costs less, but is smarter than the rest.

And when you add our \$99 Communications Buffer and Alphanumeric Display options, ProModem 1200 becomes a veritable genius!

Imagine, you unplug your computer, take it home for the weekend, and while you're gone, ProModem 1200 answers the phone, collects messages up to 50 pages long, sends out electronic mail, and displays all events with the exact time of each. Thanks to ProModem 1200, expensive, hard-to-use communications software isn't needed. The communications is in the modem, and electronic mail becomes a background function, where it belongs.

Simple To Install And Use

Our Communications Buffer is a 4 by 6 card that plugs into the ProModem 1200 motherboard. It comes with 2K of CMOS battery backed-up memory, expandable to 64K. Part of the memory is used as a dialing directory with the balance reserved for storage. For \$99 more, a front panel Alphanumeric Display can be added to show time, date, and 24 status and help messages. These two powerful options can be included at time of purchase, or can be added later.

Hayes Compatible

ProModem 1200 is Hayes compatible but that's where the resemblance ends. Our standard \$495 modem includes a real-time clock/calendar. Hayes charges hundreds more for a Smart Modem with a time-base. Nor do they have electronic mail capability at any price.

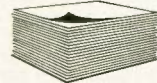

ProModem 1200 contains a battery backed-up real-time clock/calendar, a large dialing directory and can send or receive messages up to 50 pages long without tying up the computer.

Send for complete details and the name of the Prometheus dealer nearest you.

See us at Comdex, Booth #5046 West Hall



The Hot Line

PROMETHEUS PRODUCTS INCORPORATED

4545 Cushing Pkwy. • Fremont CA 94538

Call Now For Complete Info...
415/490-2370

RUN/C:TM The C Interpreter

Only \$149.95!

For both the beginner and the C professional, **RUN/C: The C Interpreter** makes program development easier and faster. With **RUN/C** all those C programs you've been writing — or have been wanting to write — can be up and running in a fraction of the time.

The beauty of **RUN/C** is that it provides a BASIC-like user interface for C; it allows the user to edit and debug code immediately and interactively.

RUN/C is the first program to make C a user-friendly language.

Although C is structured, compact and FAST, the writing and testing of C programs is often a tedious process. **RUN/C** helps bring up to speed both your programs and your C programming skills. C programming has never been so fast and enjoyable!

When running under **RUN/C** your C program performs exactly as it would if it were compiled (although slower since **RUN/C** is a *true* interpreter). If your program does have an error, **RUN/C** finds it, gives you a comprehensive error message and allows you to correct the error on the spot. Once you are completely satisfied with your C program it can be **SAVEd**, then compiled and linked using your favorite C compiler.

RUN/C offers easy and familiar commands such as **LOAD**, **LIST**, **SAVE**, **RUN**, etc. A powerful line editor is built right in. **RUN/C**'s **SHELL** command will also allow you to use your own editor for extensive full-screen editing, and then return your newly edited program to **RUN/C** — all within a single, unified environment.

RUN/C offers:

- A robust implementation of standard Kernighan and Ritchie C.
- Full floating point, 8087 math chip support, **structures**, **unions**, **initializers**, casts and more than 100 built-in standard C library functions.
- An easy-to-read 475-page manual filled with useful examples to help you master the C language.
- **TRON**, **TRACE** and **DUMP** diagnostics PLUS a program profiler.
- Printer and asynchronous communications support.
- A full set of buffered and unbuffered file I/O functions.
- Nearly 100 sample C programs on disk illustrating the most important C functions and concepts.
- System Requirements: IBM® PC or compatible with PC-DOS 2.0 or MS™-DOS 2.0

CALL for information on non-IBM compatible MS-DOS systems.

For immediate delivery or more information:

Call
1-800-847-7078
In NY, **1-212-860-0300**

Lifeboat™ Associates 1651 Third Ave. New York, NY 10128

RUN/C is a trademark of Age of Reason Co.



LETTERS

for "balanced;" which is what makes them so popular. They never degenerate into a linear linked list, which is what a binary tree is prone to do under certain input conditions (keys arriving in a well-ordered sequence).

C is a horrible language for clarifying ideas. What's wrong with English or, better still, pictures?

I. CARON
Kibbutz Ga'ash
Israel 60950

THE MACINTOSH DEBATE GOES ON

For years I have wanted a computer of my own; the type of work I do literally demands one. What had kept me from buying one had been a growing awareness of the fact that, while I was previously a slave to the thousands of bits of data I was entering into my file cabinet manually, none of the personal computers I had been considering would do more than put me hopelessly behind because I would be spending all of my time learning how to use the machine. Seven months ago I bought the Apple Macintosh, and my methods for using the information I collect in my work have changed dramatically. Indeed, for the past few months I have been imagining countless ways of using this data in ways I could have never hoped to use it if I did not have the Macintosh.

Which brings me to the essence of this letter. So much has been written about the Macintosh in various parts of your January issue that I find it difficult to address just one of the points that have been made. The three letters appearing on pages 26 to 32 seem befitting testimonials to the positivism most Macintosh owners express; Bill Benzon's article on MacPaint as a thought-process tool is, clearly, the most provocative piece I have seen written on any computer/application; and Steve Wozniak's description of his experiences at the University of California at Berkeley, coupled with the naive comments of Jerry Pournelle, serve to solidify my disdain for the conventional wisdom of the computer world. What is even more amusing is that I work for a company that perpetuates this conventional wisdom by choosing to ignore completely the existence of the technology embodied in the Macintosh and deciding to introduce a line of software only for IBM PCs.

I am not saying here that the Macintosh is the perfect machine. Surely, what we have in it is only a promise of what could

(continued)

4 Out Of 5 PC-AT™ Expansion Board Buyers Own Advantage!™

The overwhelming choice of IBM® PC-AT users, Advantage! from AST sets the standard in high-powered multifunction enhancement. Advantage! was the first multifunction board for the PC-AT. And it remains the leader by providing millions of characters of memory capacity, two serial ports, a parallel port and a game port. All in a single expansion slot.

First In Memory. All it takes is Advantage! There's no need to add other cards or hard-to-find chips on your system board. Whether you have an 256K, 512K or 640K AT, our unique memory addressing technique lets you add up to 3 Megabytes of parity checked user memory efficiently and economically. For flexibility, Advantage! can use either 64K or 256K memory chips. And of course, it supports your AT's high performance 16-bit bus and faster program processing speed.

Now you can have the extra memory to run integrated business software such as Symphony™ and

Framework™. To make full use of new concept windowing software such as DESQ™. To utilize multitasking programs such as IBM's TopView™ or multiuser operating systems such as XENIX™. To handle larger amounts of data, faster. Or for RAM disks.

First In I/O. Here's all the I/O capability you need now, even if you're starting with a base model AT. Every Advantage! card includes an AT compatible serial port and a parallel port so you can connect printers, plotters, mice and modems. Or with the appropriate software, you can connect other terminals to create multiuser environments.

With our optional second serial port you can attach even more peripherals, while our optional game port lets you plug in joysticks and other cursor-control devices for business or just for fun.

First In Quality. AST's reputation is built on quality products, quality support and quality service. Our complete documentation means Advantage! is exceptionally easy

to install and use, but if it's not enough we're always here to help.

Four out of five buyers agree, the choice is Advantage!—only from AST. Ask your dealer, or call our Customer Information Center (714) 863-1333 for more information. AST Research, Inc., 2121 Alton Avenue, Irvine, CA 92714 TWX: 753699ASTR UR

FEATURES

Memory Expansion

- 128Kb to 3.0Mb in a single slot
- User Upgradeable with either 64K or 256K memory chips
- Split Memory Addressing rounds out AT's system memory to 640K and continues memory expansion at 1Mb

I/O Expansion

- Up to 2 Serial Ports (1 optional)
- Parallel Printer Port
- Optional Game Port

Advantage!
Supports AT's Full Program Processing Speed

Advantage! trademark of AST Research, Inc. IBM PC-AT and TopView trademarks of International Business Machines Corp. Framework trademark of Ashton-Tate. Symphony trademark of Lotus Development Corp. DESQ trademark of Quarterdeck Office Systems. XENIX trademark of Microsoft Corp.

AST
RESEARCH INC.

Inquiry 4 for Dealers.
Inquiry 5 for End-Users.



Discover what 50,000

QUBIE' delivers the finest peripheral available in terms of features, reliability and price/performance. That's why corporations like IBM, GM and Exxon buy peripheral equipment from Qubie', and have for years. Check some of your old back issues of PC — we've been satisfying PC owners since 1982.



Select products at low prices, with service and support unparalleled in the microcomputer industry. Our 30 day No Risk Guarantee and 48 Hour Repair Service during the 12 month warranty period is proof our products are first rate. We stand behind what we sell. No "call the manufacturer" responses when you have a question. We also offer our exclusive **Preferred Customer Plan***1 with 24 hour repairs and 24 months of coverage.

Our low, money-saving prices are the total prices. No small print telling you to add up for credit card charges or shipping and handling. Our prices include surface UPS charges and insurance. In a hurry? 2-day air UPS service is available.*2



At Qubie', customer satisfaction is one of the cornerstones of our philosophy. Ask your friends, business associates and colleagues about Qubie'. Chances are they are one of our fifty thousand satisfied customers.



INTERNAL MODEM

PC212A/1200 \$299

Auto-dial, Auto-Answer • 300/1200 Baud Operation • Runs Hayes Compatible Software Like Crosstalk, Smartcom II, and Sidekick • Two Phone Jacks Allow You To Hook Up Desk Phone • Includes PC-

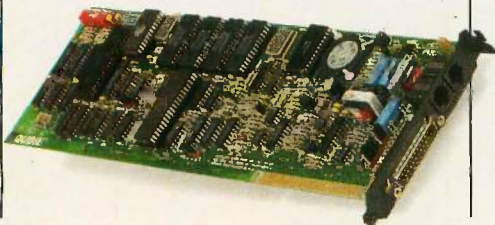

TALK III Software (Complete Communications Package), Modular Phone Cord, User's Manual / Installation Instructions • Optional Serial Port (\$40) Allows You To Use Port For Other Peripherals When Modem Is Not Being Used.

STANDBY POWER SUPPLY

SB200 \$329
XT300 \$429

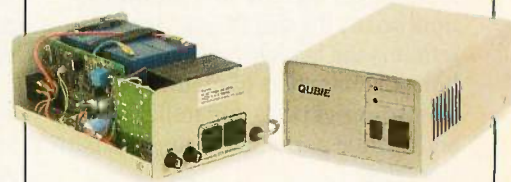

Noise Filtering/Surge Suppression • Powers Your Computer For Up To 30 Minutes In The Event Of A Blackout Or Brown-out • SB200 (200 Watt) For Floppy-Based Systems, XT300 (300 Watt) For Hard Disk Based Systems

HIGH RESOLUTION MONOCHROME MONITORS

HR 39 \$149
HR 134 \$159

Plugs Into The IBM Monochrome or Compatible Adapter Card • 720 x 350 Resolution • 12" Diagonal Screen • Super Crisp Text Capability • High Resolution TTL • Includes Tilt/Swivel Base and Interface Cable • HR 134 (Amber) HR 39 (Green)

MULTIFUNCTION CARD

BT6Plus (OK) \$195

Memory Sockets For Adding Up To 384K • Parallel Printer Port • Asynchronous Serial Communications Port • Battery-powered Clock/Calendar • BTPak Software — BT-Drive (Electronic Disk Emulation)



and BTSpool (Print Spooling Software) • Optional Game Port — Chips,

PC owners now know.

Dual Mounting Bracket and Cable (\$20) • 64K Memory – Installed and Tested (\$25) • Includes Cable, Single Slot Mounting Bracket, Installation Instructions/User's Manual



HIGH RESOLUTION COLOR MONITOR HR31 200 \$439

14" Diagonal Screen • Black Matrix Picture Tube Reduces Glare And Enhances RGB Color • Plugs Into IBM Color/Graphics Or Compatible Adapter Card • 640 x 200 Resolution • Includes Interface Cable And Tilt/Swivel Base

INTERNAL HARD DISK SUBSYSTEMS

PC10 \$699
PC20 \$1088

Boot From The Hard Disk – No Software Patches or Drivers To Install • Runs All The Popular Software •

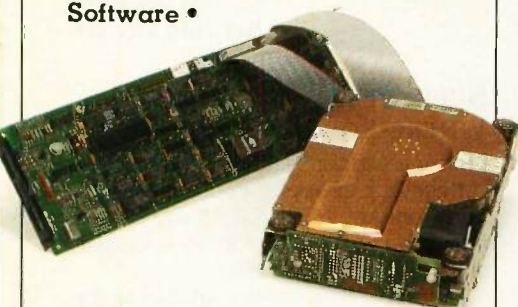

Adjustment • Keys In Standard Typewriter Positions • Separate Cursor Control and Numeric Keypads • Easy-To-Read Key Legends • LED Indicators On All Lock Keys • Extra-Wide Left-Hand Control Key Adjacent To "A" • Control/Reset Replaces Awkward Control/Alt/Delete • Plugs Into IBM PC, PC/XT and Compaq Deskpro



EXTERNAL MODEM 212A/1200E \$329

Auto-dial, Auto-Answer • 300/1200 Baud Operation • Runs Hayes Compatible Software Like Crosstalk, Smartcom II, And Sidekick • Two Phone Jacks Allow You To Hook Up Desk Phone • RS-232C Compatible • Includes 8' Shielded Cable (Specify Male Or Female) • Eight Status Indicator Lamps • External Volume Control Knob

Low Power Consumption • High Reliability And Durability – Specially Plated Drives • Faster Access Time Than XT • Includes Idir "Visual Shell" Software, Cables, Mounting Hardware, Installation Instructions/User's Manual, Full-Height Bezel – Optional Half-Height Bezel (\$15) • Auxiliary Power Supply And External Models Are Also Available.



KEYBOARD #f5151 \$159

Solid State Capacitive Key Switches • 3-Position Height

	*1 PREFERRED CUSTOMER PLAN	*2 UPS BLUE LABEL
--	-------------------------------------	----------------------------

Hard Disks	\$150.00	\$12.00
Modems	50.00	5.00
#f5151	35.00	7.50
BT6Plus	50.00	5.00
HR 39 and HR 134	50.00	NA
HR31 200	95.00	NA

No Risk Guarantee

If you are not completely satisfied with your purchase, you may return it within 30 days for a full refund, including the cost to send it back.

The Acid Test

If you can get any dealer or competitor to give you the same No Risk Guarantee, buy both products and return the one you don't like.

For fastest delivery, send cashier's check, money order, or order by Mastercard/Visa. Personal checks, allow 18 days to clear. Company purchase orders accepted, call for prior authorization. California residents, add 6% sales tax.

Hours: M-F 8 am - 6 pm PTZ
Sat 9 am - 1 pm PTZ
London (01) 223-4569
Paris (01) 321-5316
Sydney (02) 579-3322



Outside California

1-800-821-4479

Inside California

1-805-987-9741

4809 Calle Alto
Camarillo, California 93010

QUBIE'

Order Today,
Shipped Tomorrow!™

be done with the computer if only all of those "me, too" marketers who want a financial ride on IBM's coattails could understand that the merry-go-round has to stop some time. It is, furthermore, an indictment of American business at large of its failure to identify and satisfy its customers' changing needs—a phenomenon that is known in marketing as "Harley-Davidson Syndrome." There isn't a month that goes by that someone somewhere doesn't introduce another word processor for the IBM machine, while over here in the Macintosh world, Microsoft is about to introduce the *only* alternative to MacWrite.

History has shown us many times what happens to those "madmen" who introduce new concepts. Invariably they were either burned at the stake as heretics or at least exiled to some uncivilized land where their unconventional wisdom could do no detriment. Strangely enough, their tenets have, somehow, managed to pervade our everyday lives. In some senses I often wonder why we don't continue to think of the world as flat.

STEVEN G. BAIRD
Baton Rouge, LA

Both detractors and defenders of the Macintosh have been surprisingly un-discerning regarding the performance of the Sony microfloppies. Clearly one spends considerable time listening to the Sony play tunes. So Jerry Pournelle concludes the drives are "painfully slow" (August 1984 BYTE, page 316). A guy confesses anonymously to John Dvorak (*Info-World*, November 26, 1984) that he has changed his mind about the Mac: "The big flaw is clearly the slow, small Sonys and the big overhead on starting and ending use of any serious programs." A Mac defender in your Letters section, Selden Deemer, concedes that the Mac is not without its faults: "Among the worst of these is the perpetuation of a disk-drive controller that lacks direct memory access. . . . The drives are maddeningly slow" (November 1984, page 18). Indeed, the Mac would be fatally crippled if this were true.

In fact, it ain't so. From MBASIC, the standard BYTE disk benchmark shows the Mac writing the standard 64K-byte sequential file in 25.2 seconds, reading same in 23. In both cases this is twice as quickly as the IBM PC under MS-DOS. By using the FIELD statement to PUT and GET four 16K-byte strings to a relative file, reducing BASIC overhead, one gets even closer to the hardware potential of the Mac/

Sonys: 64K bytes of data are written in 6 seconds, read in 5 seconds. That is faster than the IBM PC XT runs the standard benchmark using the fixed drive (about 8 seconds each way). Finally, using the DiskCopy utility included with the Finder update, one reads 100K bytes in 4 to 5 seconds, writes 100K bytes in 7 to 8 seconds. That is not slow. Hasn't anyone noticed?

Clearly, it is software overhead, not hardware limitations, that accounts for the long waits while the Mac sings.

WILLIAM MILLER
Cleveland Hts., OH

The many arguments in the Macintosh debate, which has become a leitmotiv on your pages, seem to focus not on the niftiness of the Macintosh's special features but rather on their significance. Bill Benzon's article, "The Visual Mind and the Macintosh" (January, page 113), eloquently related the importance of the Macintosh to the role of visual images in creative thinking and persuasive communication.

But why should visual thinking and visual communication suddenly seem so important in the first place? Another perspective on the significance of the Mac is to see it in relation to the increasingly visual nature of all communication in recent history.

A middle-class burgher in, say, 17th-century Amsterdam probably saw three or four hundred artificial images (paintings, drawings, engravings, and so on) in a lifetime. In this world of television, advertising, and personalized T-shirts, we process that many images in a day! The phrase "Age of Information" usually connotes the invention and spread of the computer since World War II, but this period also witnessed the emergence of today's huge graphics and advertising industries. In 1971 (when Alan Kay was designing Smalltalk), there were 697,000 artists in the U.S., according to the Bureau of Labor Statistics. Ten years later, there were 1,055,000 artists, including 223,000 designers and 106,000 photographers. Today even the smallest company has a graphic logo and a "corporate identification" program—a practice almost unheard of 30 years ago.

Articles and books whose subject is the "information age" often make the point that the ever-increasing volume of information generated in the world is inevitable; the real issue, though, is how to give it useful shape and dimension. Visual communications does precisely that: It shapes information, gives it character, and

streamlines it for faster travel to its target audience. Design is the art of taking a message and giving it impact through typography, composition, and both abstract as well as representational drawing and coloring.

As the information environment becomes ever fuller and noisier, the stakes are continually raised for those who want their message to carry above the din, which means new tools and techniques are needed to communicate effectively. In treating all information as visual information and greatly simplifying methods of combining verbal and visual information, the Macintosh is in harmony with the broad lines of evolution in human communication. (I've had mine for two weeks, and already my mouse finger is getting stronger.)

JIM HOEKEMA
Salt Lake City, UT

SUPPORT IS WHERE YOU FIND IT

I would like to comment on the letters concerning lack of Apple support ("No Support from Apple," February, page 18) and how I dealt with this problem since purchasing a IIc in June 1984.

The Apple IIc is being marketed as the somewhat portable version of the IIe with over 95 percent of IIe software running on the IIc. Therefore, any manual covering Applesoft as implemented on the IIe should be about 95 percent applicable to the IIc. This I quickly found to be true. For assembly-language programming, advanced BASIC programming, and a description of the Apple II family firmware (up to the IIe), Paul Irwin's *Apple Programmer's Handbook* (Indianapolis, IN: Howard W. Sams & Co., 1984) is exceptional. Major computer publications have described Apple's ProDOS, summarizing its many DOS 3.3 similarities and new features such as its UNIX-like nested hierarchical directory structure, RAM-disk support for the extra 64K bytes of memory, etc. The best summaries (nearly 100 percent coverage of features and commands) have appeared in BYTE ("ProDOS" by Rob Moore, February 1984, page 252) and *Apple Orchard* ("Introducing ProDOS" by Morgan P. Caffrey, January 1984, page 12). The former mentions all ProDOS-related publications by Apple. A thorough non-Apple description of ProDOS, combining the best segments of *BASIC Programming with ProDOS* and the *ProDOS Technical Reference Manual*, is given in John Campbell's *Inside Apple's ProDOS* (Reston, VA: Reston Pub-

lishing Co., 1984). Although the text is informative, the book has several typographical errors. A small paperback entitled *An Introduction to the Apple IIc* documents the serial-port and mouse-port pin outputs, among others, in its appendixes.

All the substitute texts mentioned above served very well until late October 1984, when several New York dealers received the entire complement of Apple documentation. A one-stop source for documentation has been the McGraw-Hill Bookstore, 1221 Avenue of the Americas, New York, NY 10020. Here I purchased the *Apple IIc Reference Manual*, *ProDOS Technical Reference Manual*, and *BASIC Programming with ProDOS*. Note that the *ProDOS Technical Reference Manual* is part of the "WorkBench" series of documents in loose-leaf format that can only be purchased separately and whose unusual page size fits best in Apple's "WorkBench" binder (\$8). All the substitute texts purchased originally continue to be useful except Mr. Campbell's book, now completely redundant.

Thus, it would seem that the availability of Apple documentation continues to be a problem, but however late, the documentation did appear. The *IIc Reference* and the *ProDOS Technical* manuals have a few typographical errors that must not be considered lightly, since the text deals mostly with system software. I have programmed in BASIC quite extensively on an IBM PC XT, using PC-DOS 2.1 quite frequently. Although IBM manuals have been much more available, they have been consistently difficult to read, and as a physician-in-training with severe time constraints, I find that the clarity of Apple's presentation and the structure of ProDOS still puts Apple on top on my list. Its difficulties have mainly been eased by the availability of excellent documentation by third parties, a condition which has always been part of Apple's continued success.

MARVIN E. GOZUM, M.D.
Brooklyn, NY

After reading of some problems encountered by your readers in obtaining Apple technical manuals, I thought my own experience might be of interest.

After purchasing my IIc I wanted to purchase the technical reference manual but was surprised to learn that it was not available from my dealer. I checked around and learned that most dealers in this area did not stock the manual. After some digging, I learned that the dealers do not stock the manuals because they

(continued)

More terminals without more computer



The advantages are clear. A BayTech port contender adds more users to your computer and does it at a price that's far less than expensive hardware or software modifications. A Model 5218B, for example, doubles your users by allowing 12 terminals to contend for 6 ports. Simple to set up and use, with easy-to-understand messages, the port contenders' feature protocol conversion; user queue; disconnect by operator, computer or time-out; hardware or X-ON/X-OFF handshaking; and more.

Seven models, \$629 to \$1,750. **(800) 523-2702**



BayTech®

DATA COMMUNICATIONS PRODUCTS

Bay Technical Associates, Hwy. 603, P.O. Box 387, Bay Saint Louis, Mississippi 39520
(601) 467-8231 Telex: 9103331618 (BAY TECH)

Share printers easily and automatically



Instead of adding more printers, get maximum use of the printers you have by adding a BayTech multiport controller. A versatile D-series multiport allows several RS-232C devices to share printers or plotters. No cable-switching, knobs to turn, or software to add. These printer sharers work automatically; just hook them up and they're ready to use. Features include custom power-up default configuration, protocol conversion, buffer, and your choice of hardware or X-ON/X-OFF handshaking.

Seven models, \$319 to \$629. **(800) 523-2702**



BayTech®

DATA COMMUNICATIONS PRODUCTS

Bay Technical Associates, Hwy. 603, P.O. Box 387, Bay Saint Louis, Mississippi 39520
(601) 467-8231 Telex: 9103331618 (BAY TECH)

are considered very low dollar items that are "not worth the bother." Apple understandably requires dealers to purchase the manuals in lots of five. Evidently, the prevalent feeling among dealers is that the manuals will not be hot-selling items, and they do not want to deal with them. Two dealers told me this directly.

Fortunately, I was able to locate a store that regularly stocks all manuals but oc-

asionally runs out due to demand. According to them, they have had no problems or unusual delays in getting the manuals from Apple. I now have *BASIC Programming with ProDOS*, *ProDOS Users Kit*, and the *Apple IIe Reference Manual*, all supposedly rare books but obtained with very little effort. Right after I purchased *BASIC Programming with ProDOS*, two dealers told me it was not yet available from Apple,

and one dealer told me it was too much trouble to order.

I have found the manuals to be excellent—among the best I have seen. It may not be the same in all areas, but I believe that the problem lies more in the failure of dealers to provide for customer needs rather than insufficient support from Apple.

STEVE A. MUNCY
Dallas, TX

If you can't share files on PC Network, you're using the wrong file manager.

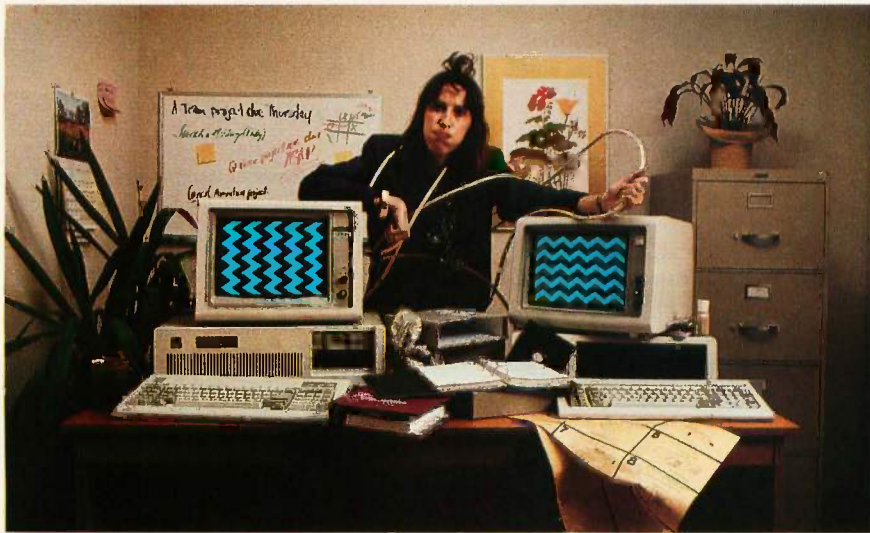

Be connected. Btrieve™

Networks can solve problems. But running a single-user file manager can create new ones: Lost updates. Garbled data. Trashed files.

Btrieve™/N offers *safe* multi-user file management that protects your data when sharing files. And eliminates the need to rewrite your application for LANs. Btrieve/N set the file management standard for the industry's most popular networks: Netware, Davong MultiLink, Omninet, PC Net, EtherSeries, Nestar, and NetOne. And now IBM's PC Network.

Fast. Btrieve/N is fast, too. It's written in assembly language especially for the IBM PC. And based on b-tree file indexing, for access speed that won't degrade as your database grows.

Automatic file recovery. Btrieve/N provides automatic file recovery after

a system crash. Your Btrieve data always comes back intact.

Fully-relational data management. SoftCraft's entire family of products gives you a complete, fully-relational database management system. Btrieve™/N adds report writing capabilities. Xtrieve™/N speeds users through database queries with interactive menus.

For professional programmers. Btrieve/N is the fast, reliable answer for all your application development in BASIC, Pascal, COBOL, C, FORTRAN, and APL. With Btrieve/N, you can develop better network applications. And solve problems, not create new ones.

 **SoftCraft Inc.**

P. O. Box #917 Austin, Texas 78766
(512) 346-8380 Telex 358 200

Suggested retail prices: Btrieve, \$245; Btrieve/N, \$595; Xtrieve, \$195; Xtrieve/N, \$395; Rtrieve, \$85; Rtrieve/N, \$175. Requires PC-DOS or MS-DOS 1.X, 2.X, or 3.X.

I read with interest the three letters under the heading "No Support from Apple" in your February Letters section. Although I missed the letter to which they referred, I felt I had to tell my experience with getting manuals.

The manuals named in the three letters are all manuals that I've wanted, with the exception of the *Apple IIc Reference Manual* because I have a IIe. Anyway, I no more than asked if my local dealer could get these for me and I had them. I waited one week for both the *ProDOS Users Kit* and the Applesoft manuals, both volumes. I had to wait three weeks for the *ProDOS Technical Reference Manual*, and it didn't bother me a bit. I'm sure that when the time comes that I want another manual I'll have it in short order.

I have had no problem at all with getting information on the Apple. In fact, when I found out that there was an update for ProDOS, I asked my dealer if he had it. He said he didn't even know there was one, but two days later he called and said he had it. I stopped by and picked up a copy and was on my way in a total time expenditure of 10 minutes. Maybe I'm lucky to have this dealer, but I wanted your readers to know that not everyone has problems getting the information they want.

BRAD W. HANSEN
Apple Valley, MN

A RAM DISK FOR THE MAC

In his letter (under the heading "Take Back Your Mac," February, page 22), Don Slaughter pleads for RAM-disk software for the 512K-byte Macintosh and hopes for a "reasonable price (\$50 or less)."

A public-domain RAM disk is available and can be downloaded from CompuServe's MAUG area (you need to be knowledgeable in the use of "BinHex.Hex" to download it and "Rmover" to install it).

Assimilation Process (20833 Stevens Creek Blvd., Suite 101, Cupertino, CA 95014) has been advertising the

(continued)

If you don't have a Hercules Graphics Card, you could end up looking like this:

"I know, because one day it happened to me . . .

"I was running some routine tests on a non-Hercules monochrome graphics card when I was struck by a severe case of *low resolutionitis*. I'm the president of Hercules and that's me exhibiting the symptoms of the disease in its advanced stages. Not a pretty sight, is it?

"What causes *low resolutionitis*? Experts point to ordinary monochrome graphics cards with coarse, hard-to-read graphics. A bad case of eyestrain may develop if action is not taken immediately.

"Fortunately for me, a Hercules Graphics Card was nearby. A quick change brought soothing 720 x 348 graphics. That's twice the resolution of ordinary 640 x 200 graphics cards.

"Which means better graphics for Lotus[®] 1-2-3[™], Symphony[™], Framework[™], pfs:Graph[®], Microsoft[®] Chart and Word, SuperCalc3[®], AutoCad[™], and dozens of other programs.

"Including Microsoft Flight Simulator, now Hercules compatible!

"Oh, and don't forget that a parallel printer port is standard on the Hercules Graphics Card, not an extra cost option.

"Now, if you're worried about buying a new product that hasn't had all the bugs

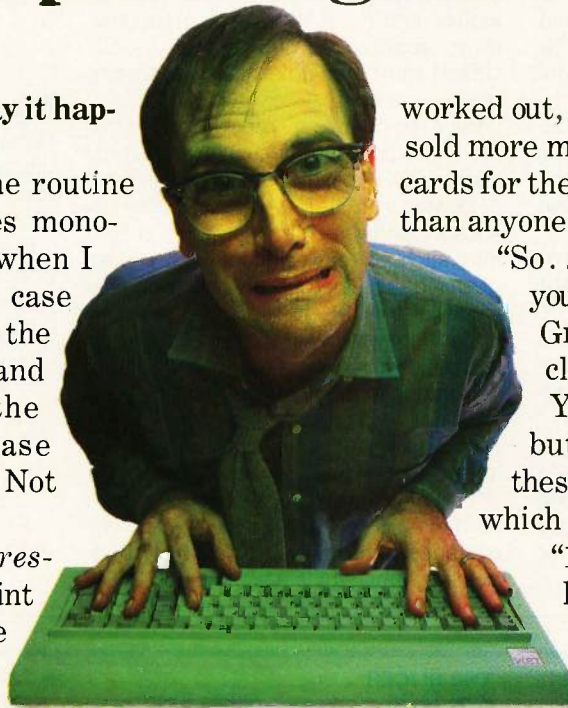

worked out, relax. Hercules has sold more monochrome graphics cards for the IBM[®] PC, XT[™] and AT[™] than anyone else in the world.

"So . . . you're convinced that you should buy a Hercules Graphics Card. Now, steer clear of cheap imitations. You may save a few bucks, but you won't get all of these five essential features which only Hercules has:

"1) A safety switch that helps prevent damage to your monitor, 2) the ability to keep a Hercules Color Card in your

system, 3) the ability to use the PC's BASIC to do graphics, 4) a Hercules designed chip that eliminates 30% of the parts that can go wrong, and 5) a two year warranty, because we think reliability is something you should deliver and not just talk about."

"Call 1-800-532-0600 Ext 408 for the name of the Hercules dealer nearest you and we'll rush you our free info kit.

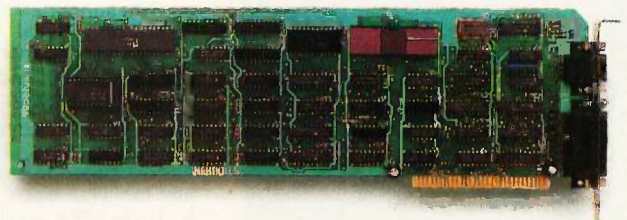

Hercules. We're strong on graphics.

Mac•Memory•Disk for several months in both *MacWorld* and *A+*. This product sells for \$29. I had no trouble getting copies through a local dealer, and it does everything Mr. Slaughter wants and more. The RAM disk can be set anywhere from about 30K to 300K, and any set of files can be automatically copied into it as part of the boot process.

Network Consulting Inc. (110-3700 Gilmore Way, Burnaby, BC V5G 4M1, Canada) has a \$29.95 RAM-disk product in the beta-test stage that does a bit more than Mac•Memory•Disk.

DANIEL P. B. SMITH
Norwood, MA

Shortly after mailing my letter I learned that Assimilation Process of Cupertino, California, was planning to release RAM-disk software.

The Mac•Memory•Disk (as it is called) will only open a maximum of a 315K RAM disk on a 512K Mac, though it will open a RAM disk in excess of 700K on a Lisa running MacWorks with 1 megabyte of memory.

My experience in testing the speed of operation quickly showed that to obtain substantial speed gains in loading and exiting applications software on the Mac, the operating system of the Mac must be loaded into the RAM disk. It seems that most applications, on being double-clicked, must then do extensive accessing of the operating system to load.

But if the operating system is loaded into the RAM disk, this effectively leaves only about 100K left in the RAM disk (using the 512K Mac with 316K RAM disk) for the application software. MacPaint, when copied into such an environment, won't even open a disk file because there isn't enough room left on the disk for one.

MacWrite will create very small data files in that environment. Clearly, such an environment is adequate neither for business nor for software development. But Apple will not offer 1-megabyte caches for its products from now on except in the \$4000-plus Macintosh XL (Lisa 2/10 with hard disk) or the \$6995 laser printer. The evidence suggests that a relatively inexpensive 1-megabyte Mac (below \$3500)

will not be offered before January of 1986 (perhaps in the guise of using 1-megabit chips on a new main circuit board), if ever. My summary of these facts is that I am disappointed, and I think Apple has goofed.

DON SLAUGHTER
Seattle, WA

MODULA-2 REVISITED

I would like to correct some readers' misunderstandings and possibly add some fuel to the fire of the Pascal versus Modula-2 debate.

In my article on Modula-2 ("An Introduction to Modula-2," August 1984, *BYTE* page 195), I use the following example:

```
IF (oregano IN recipe[1])
  THEN
    IF (thyme IN recipe[1])
      THEN
        WriteString('Use oregano
          and thyme')
      END
    ELSE WriteString('No oregano');
  END
```

(continued)

SLICER—THE SYSTEM THAT GROWS TO FIT YOUR NEEDS

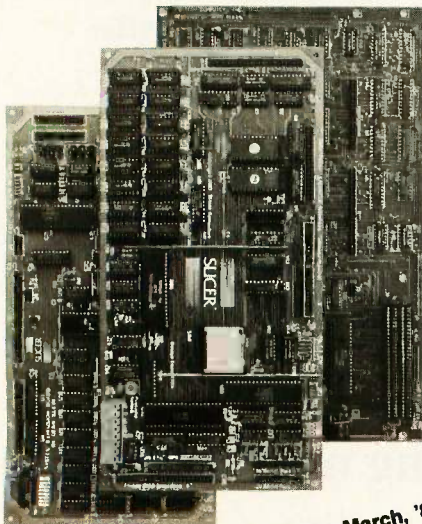

see *BYTE*, March, '85
page 193

THE SLICER Real 16 Bit Power on a Single Board— Featuring the Intel 80186

- Complete 8 MHz 16-bit micro-processor on a 6" x 12" board
- 256K RAM, plus up to 64K EPROM
- SASI port for hard disk controller
- Two full function RS232C serial ports with individually programmed transmission rates—50 to 38.4K baud
- Software compatibility with the 8086 and 8088.
- 8K of EPROM contains drivers for peripherals, commands for hardware checkout and software testing
- Software supports most types and sizes of disk drives
- Source for monitor included on disk
- Bios supports Xebec 1410 and Western Digital WD 1002 SHD controller for hard disks

Fully assembled and tested only \$995
Also available in several kit forms

THE SLICER SYSTEM EXPANSION BOARD For expanded memory, additional ports, and real time clock

- Up to 256K additional dynamic RAM
- 2 RS232C asynchronous ports with baud rates to 38.4K for serial communication

- 2 additional serial ports for asynchronous RS232C or synchronous communication (Zilog 8530 SCC)
 - Real Time Clock with battery backup for continuous timekeeping
 - Centronics type parallel printer port
- Fully assembled and tested only \$750
Available in several kit forms also

THE SLICER PC EXPANSION BOARD Gives your Slicer high performance video capability

- IBM compatible monochrome video
 - Video memory provides 8 pages of text or special graphics capability
 - 2 IBM type card slots for color video, I/O expansion, etc.
 - IBM type keyboard port
- Fully assembled and tested only \$600
Available in several kit forms also

Also available: The μ SLICER 188 \$700; 8087 Math Co-Processor Bd. (call); 10 MB Hard Disk \$700; W.D. 1002-SHD H.D.C. Bd. \$200; Enclosures, Power Supply, and Support Hardware.

Operating systems are CP/M 86 by Digital Research, Inc. (\$85), and MS DOS by Microsoft Corporation (\$175).

MasterCard, Visa, Check, Money Order, or C.O.D. Allow four weeks for delivery. Prices subject to change without notice.

The SLICER Bulletin Board at 300/1200 Baud 612/788-5909



Slicer Computers, Inc.
2543 Marshall St. N.E., Minneapolis, MN 55418
612/788-9481 • Telex 501357 SLICER UD

A few smart reasons to buy our smart modem:

Features

1200 and 300 baud, auto-dial, auto-answer
 Compatible with "AT" command set
 Can be used with CROSSTALK-XVI or Smartcom II software
 Regulated DC power pack for cool, reliable operation
 Eight indicator lights to display modem status
 Speaker to monitor call progress
 Attractive, compact aluminum case
 Two built-in phone connectors
 Compatible with The Source and Dow Jones News Retrieval
 Unattended remote test capability
 Phone cable included
 Availability

Ven-Tel 1200 PLUS

Hayes

Yes	Yes
Yes	Yes
Yes	Yes
Yes	No
Yes	Yes
Yes	Yes
Yes	Yes
Yes	No
Yes	Yes
Yes	No
Yes	Yes
Now	

Price

\$499

\$699

The Ven-Tel 1200 PLUS offers high speed, reliable telecommunications for your personal computer or terminal. Whether you use information services or transfer data from computer to computer, the Ven-Tel 1200 PLUS is the best product around. Available at leading computer dealers and distributors nationwide.

Also from Ven-Tel: internal modems for the IBM and HP-150 Personal Computers with all of the features of the 1200 PLUS.

You choose. The Ven-Tel 1200 PLUS—the smartest choice in modems.

Ven-Tel Inc.

2342 Walsh Avenue
 Santa Clara, CA 95051
 (408) 727-5721

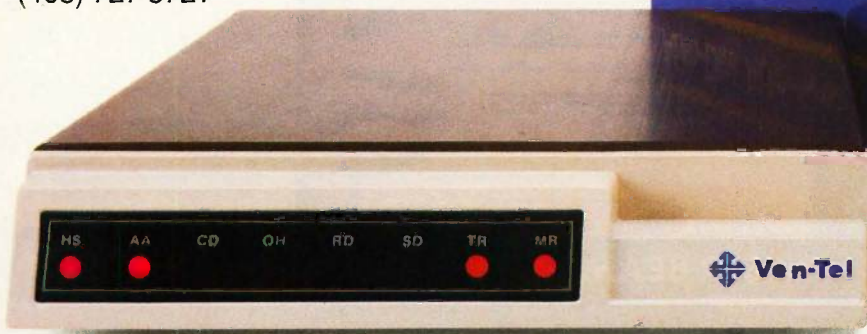
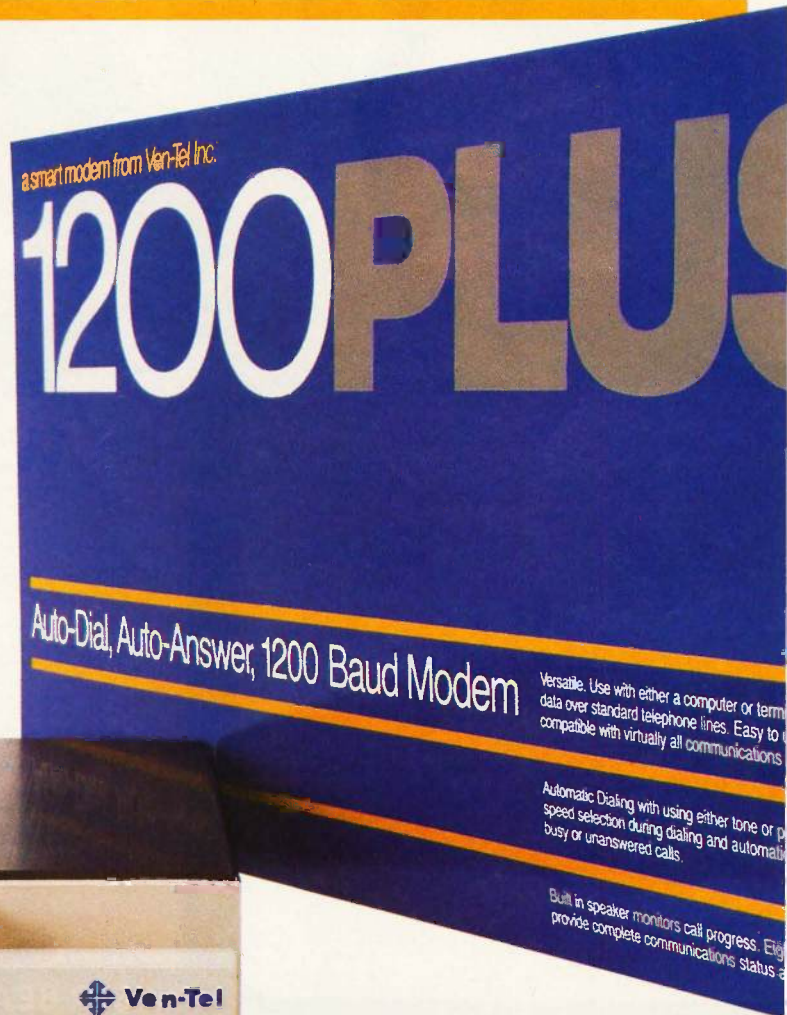

Crosstalk is a trademark of Microstuff, Hayes and Smartcom II are trademarks of Hayes Microcomputer Products.

PRINTOUTS TH

Take a close look at Canon's line of printers. The first thing you'll notice is how good they make you look. That's because Canon's experience in high-tech optics really shows. For instance, Canon was among the first to make a desktop Laser Beam Printer. At a price that's within any business's reach, the Canon Laser Printer can produce eight pages a minute with a quality that's more in common with a professional print shop than a personal computer.

Canon also developed the ingenious Bubble-Jet Printer technology, finally making it possible for a printer to not only work extremely quickly but also incredibly quietly.

Our Ink-Jet Printer can produce exceptionally sharp, high-resolution graphics in seven colors, even on transparencies. While the Thermal Transfer Printer has three kinds of print modes, including letter quality, at a very competitive price.

And the Canon Impact Matrix Series, for regular and extra-wide column paper, makes printing very fast, very economical.

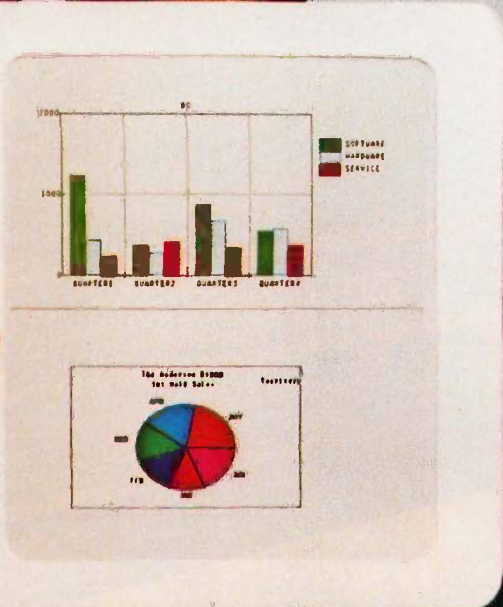

Welcome to Westchester

The Visitors Guide to Westchester County

THE MARKET

A conservative estimate places the number of annual visitors to Westchester County at 400,000 - more than 23,000 per month. This estimate is based on the following assumptions and calculations:

- Number of hotel hotel rooms: 4,300
- Number of nights per year: 365
- Average occupancy rate: 70%
- Average number of nights per stay: 2.6
- Number of visitors: 400,000

This computation assumes, of course, only one visitor per hotel room and does not include visitors who stay with relatives or one-day visitors.

- It is composed mostly of adults, the majority of whom are in the County for business.
- The group is, therefore, well-above average in income.
- The group has the leisure time and the access to transportation needed to travel about the County - day or night.

Published by Westchester Travel Guides, Inc.
P.O. Box 244, White Plains, N.Y. 10607 (914) 944-6700

Description	Quantity	Price	Ship	Subtotal
10 - Colson TV	25	470.00	0	11750.00
12 - Impact TV Stand	25	220.00	0	5500.00
TV Stand	25	220.00	0	5500.00
Deluxe TV Stand	25	80.00	0	2000.00
TV Bellows (1)	9	4.00	0	36.00
18 - Component TV	1	1500.00	0	1500.00
18 - Component TV	1	1500.00	0	1500.00
Deluxe Turntable	1	150.00	0	150.00
18 - Component TV	1	150.00	0	150.00
Component Video Player	1	200.00	0	200.00
Component Video Player	1	200.00	0	200.00
Component Cass	1	20.00	0	20.00
Deluxe Cassette Case	1	10.00	0	10.00
TOTALS				2400.00

INK-JET

LASER BEAM

IMPACT MATRIX

AT STAND OUT.

Visit your local computer store and judge the complete line of Canon printers firsthand.

You'll find the print quality is absolutely crisp. The graphics are remarkably clean. And the reasons for buying one are perfectly clear.

For more information, call 1-800-323-1717, ext. 300 (in Illinois, 1-800-942-8881, ext. 300). Or write Canon U.S.A., Inc., Printer Division, P.O. Box CN 11250, Trenton, NJ 08650.

Canon
PRINTERS

Inquiry 63

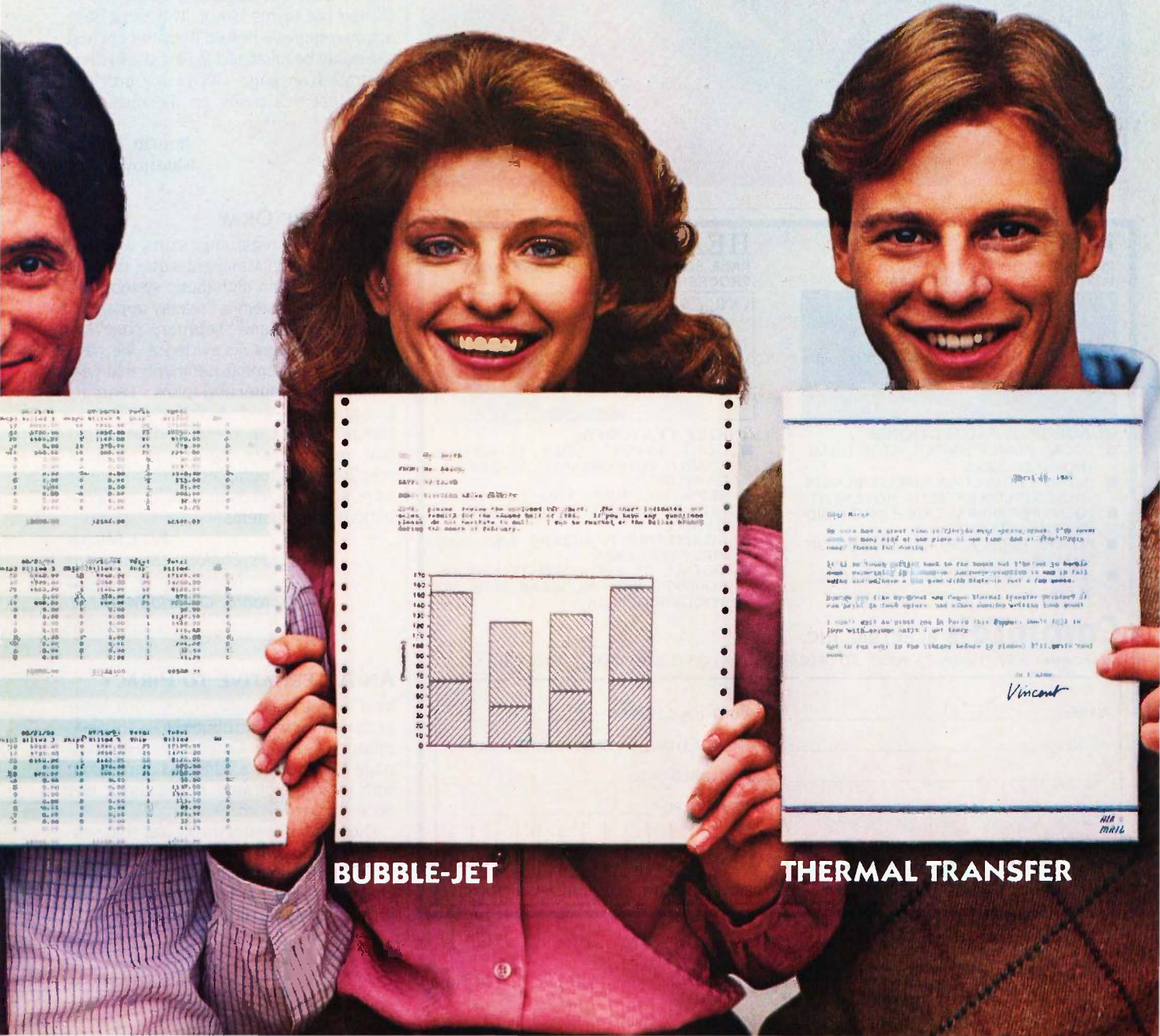

DATE	DESCRIPTION	DEBIT	CREDIT	BALANCE
01/01/88	OPENING DEPOSIT		1000.00	1000.00
01/15/88	PAYROLL	500.00		500.00
01/31/88	RENT	200.00		300.00
02/15/88	SALES		150.00	450.00
02/28/88	UTILITIES	75.00		375.00
03/15/88	SALES		200.00	575.00
03/31/88	RENT	200.00		375.00
04/15/88	SALES		180.00	555.00
04/30/88	RENT	200.00		355.00
05/15/88	SALES		220.00	575.00
05/31/88	RENT	200.00		375.00
06/15/88	SALES		190.00	565.00
06/30/88	RENT	200.00		365.00
07/15/88	SALES		210.00	575.00
07/31/88	RENT	200.00		375.00
08/15/88	SALES		230.00	605.00
08/31/88	RENT	200.00		405.00
09/15/88	SALES		200.00	605.00
09/30/88	RENT	200.00		405.00
10/15/88	SALES		220.00	625.00
10/31/88	RENT	200.00		425.00
11/15/88	SALES		240.00	665.00
11/30/88	RENT	200.00		465.00
12/15/88	SALES		260.00	725.00
12/31/88	RENT	200.00		525.00
	TOTAL			525.00

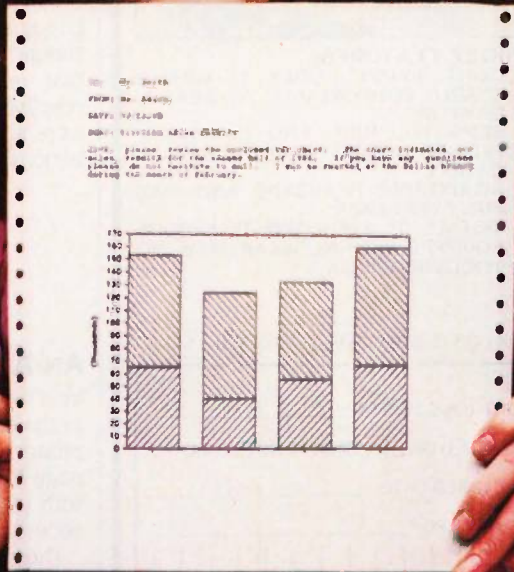

Dear Mr. Smith:

We have had a great time working with you. Please let us know if you have any questions. We will be happy to help you. We will be happy to help you. We will be happy to help you.

Yours truly,
 Vincent

BUBBLE-JET

THERMAL TRANSFER

HOW TO CONTROL THE RISE AND FALL OF POWER.

Your small business computer can give you the power to raise your productivity. But first you have to control the power you give it. Because even the slightest dip or surge of electricity can result in a shocking surprise. An instant loss of important data or misinformation. Even worse, a total power line failure can create department devastation... a total system crash. You can't afford errors, delays and other problems. After all, you've invested in a computer to increase efficiency. But now there's a solution you can afford. The Sola SPS. This economical, UL listed Standby Power System is designed to protect personal, micro and mini computers from AC line disturb-

ances and failures. Sola SPS provides clean, regulated AC power to your computer when your power line experiences irregular voltage. Line dips or line surges are immediately converted to proper voltage. When the AC line is present, the SPS filters power to eliminate electrical noise. And when the AC line fails, the SPS goes into full action, providing precise AC power to the load from its internal battery. So the only noise you'll hear is the sound of performance. There's no maintenance. No installation. No kidding. Just plug it in and turn it on. Why let your productivity rise and fall with your power? The solution is as simple as SPS. The standby system that Sola stands behind.



Write for free literature. 1717 Busse Hwy., Elk Grove Village, IL 60007 (312) 439-2800



a particular hardware configuration.

The pirate then stated that no software vendors offered a guarantee that allowed return of software simply because the customer was dissatisfied. Therefore, such piracy is necessary.

We at T.N.T. Software sell all our software with a 30-day, money-back guarantee. We have done this for nearly two years. Customers can freely open our packaging,

run our programs (not just demo versions), test all functions, and determine if our programs are suitable for their intended use. If the customer is dissatisfied for any reason—even if the program performs as advertised—the entire package may be returned within 30 days for a full refund of the purchase price.

Moreover, our dealers must give anyone who buys one of T.N.T. Software's pro-

grams the same or a better guarantee. That's part of our contract for all our dealers and distributors.

We find it hard to believe the pirate's statement that there are no other software companies or distributors with a policy equivalent to ours.

Yes, we do get some returns. Some types of programs are more prone to returns than others. Overall, our return rate is far less than 1 percent of sales.

We think our customers are far better served with our liberal return and non-restrictive licensing policy than by services such as a toll-free phone number. We hope that the pirate and others will buy our software in the future.

Further, our prices are uncommonly low. Our company's success in the software market amply proves that copy protection, restrictive licensing arrangements, and other barbed-wire tactics are both unnecessary and counterproductive. We'd rather give the customer a break and treat the customer like a presumably honest person. Frankly, we wish other companies would adopt our stand, instead of wasting the customer's money by developing ever more tricky and "foolproof" protection schemes.

BRUCE W. TONKIN
PRESIDENT
T.N.T. SOFTWARE INC.
Round Lake, IL

Since 1918 we've been quietly designing, manufacturing, and distributing a broad range of products for industry, business, and consumers all over the world. And so we've quietly grown to be a multi-national company with almost a billion in sales from the world's toughest markets. Markets that demand quality, performance, and reliability. Which is why Tatung terminals and monitors have become the choice of important systems designers.

Tatung monitors are compatible with virtually all popular computer systems. Each model offers superior resolution and CRT color imagery, along with controls for precise picture "tuning". Tatung terminals offer operational flexibility, compatibility with all popular systems, and day-in-day-out reliability. But, no matter which model you choose, no other terminal or monitor offers as much...for so little.



U.C.M. COMPUTER PRODUCTS
CANADA LIMITED
7225 Woodbine Ave., Unit 119
Markham, Ontario L3R 1A3
(Canada only) 1-800-387-9678/
1-416-475-1209 Telex: 06-986222

TATUNG

WESTERN MICRO SYSTEMS
A Quality Distributor
Serving the 13 Western States
Western States 1-800-544-0020
In California 1-800-338-1600

For complete information call toll free: 1-800-421-2929. In California, call (213) 979-7055.
TATUNG COMPANY OF AMERICA, INC., 2850 El Presidio, Long Beach, California 90810.

WHAT MAKES SOFTWARE EXPENSIVE

I'm writing on a topic of deep interest to me and many of your readers: software prices.

One thing we've seen in the last year is a tremendous explosion of good software. We've also seen a number of companies go belly-up. Is the market so bad? No, it's never been better. Why are all these outfits in trouble? It's easy to blame it on piracy, interest rates, or investor confidence. It's appropriate to blame it on greed, poor planning, and an inadequate understanding of free-market theory.

When the first application programs for personal computers hit the streets, what were the projected sales? Five thousand? Ten thousand? Who would have expected them to be 2000 percent higher? The original pricing was set with development and promotion costs to be spread over a much smaller number of units than in fact were being sold. Did we see prices being slashed to account for the new economies of production? Or did we see them at-

(continued on page 458)

F·I·X·E·S A·N·D U·P·D·A·T·E·S

UPDATES

Busy, Busy BYTEnet Listings

The popularity of BYTEnet Listings has exceeded our wildest expectations. It has been busy virtually all day, every day, with calls to download listings of programs mentioned in BYTE.

We have added two more telephone

lines to BYTEnet Listings to ease the congestion. The new number to call is (617) 861-9774. You should find it easier to get through to BYTEnet Listings.

If you find that BYTEnet Listings is busy, please don't call us at the BYTE offices to

find out if the line is bad or if the system is down. It isn't bad or down, it's just busy. (Incidentally, BYTEnet Listings is closed to the public from 4 to 5 a.m. east-coast time every day; it is doing private network business and will reject your calls.)

Sola Makes Uninterruptible Power Supplies

In our January survey of uninterruptible power supplies, we inadvertently neglected to mention the many products available from Sola Electric. (See "Uninterruptible Power Supplies" by William Rynone, page 183.)

Sola Electric offers a full line of uninter-

ruptible power supplies and power-conditioning equipment for microcomputers and minicomputers. A 20-page illustrated brochure details the electrical and performance specifications of the products. It describes the systems offered, contrasts power-protection alternatives, and ex-

plains the operation, design, and selection of uninterruptible power supplies. Request catalog number 696 from Sola Electric, 1717 Busse Rd., Elk Grove Village, IL 60007, (312) 439-2800 (marketing), (312) 228-1393 (technical services), or (312) 228-1250 (customer service).

Modifications to Printer Buffer

A few modifications to John Bono's printer-buffer project recently arrived from Dr. H. A. Tasman of Karlsruhe, West Germany. (See "Build a Printer Buffer," June 1984 BYTE, page 142.)

In figure 3b (page 452), the input BUSY flip-flop, IC10a, is set on the leading edge of the input STB, but the input byte is not clocked into the input register until the trailing edge of the input STB. However, in line 60 of listing 1 (page 453), OKAY:IN A,(STATUS) places BUSY in bit 0 of the A register and proceeds to IN A,(BYTEIN) if not 0.

"This procedure may work satisfactorily," writes Tasman, "if the host computer's parallel-port driver always produces an

STB pulse that is shorter than the time needed for the instructions AND 01H and JP Z,NOCHAR, which, for a 1-MHz clock frequency, amounts to 17 microseconds."

Dr. Tasman found this condition to be unsatisfactory when he tried to use the printer buffer with a software parallel-port driver on his 4-MHz Z80 computer. In particular, he found that the STB pulse could surpass the clock-frequency limit when an interrupt occurs. If, for example, a character is read in before the STB is terminated, the input register will still be holding the previous character. If the STB extends beyond the input ACK pulse, the BUSY flip-flop will not reset and the character can be read in repeatedly.

Dr. Tasman suggests that you check the input STB before processing the character. Also, since the tri-state buffer, IC14, can put two more lines on the data bus with the STATUS command, you can connect the input STB (IC9 pin 11 through IC10 pin 1) to IC14 pin 10 and hook IC14 pin 9 to D3. To eliminate the STB problem, modify the software around line 60 to

```
OKAY:IN      A,(STATUS)
            BIT    0,A
            JR     Z,NOCHAR
            BIT    3,A
            JR     Z,OKAY
; GET CHARACTER
            IN     A,(BYTEIN)
```

BYTE'S BUGS

FreeSoft Address

Additional information about some products mentioned in "Public-Domain Gems" by John Markoff and Ezra Shapiro has come to light. (See the March BYTE, page 207.)

In the discussion about Red Ryder 3.0, a communications program for the Macintosh, the name and address of the author/distributor was inadvertently omitted. Earlier in the article, during the presentation on the Ultra utilities, the author was

duly credited, but the address was incorrect. Both Red Ryder 3.0 and the Ultra utility programs are available from The FreeSoft Co., 10828 Lacklink, St. Louis, MO 63114.

Also mentioned in the article was Newkey, a program that lets you redefine the IBM PC keyboard. Newkey can be obtained for \$39 from FAB Software, POB 12363, Birmingham, MI 48012.

We regret these errors.

A Bit Too Wide

An editing error in the February BYTE U.K. resulted in our creating a dream product rather than describing the real McCoy. (See "Realizing a Dream" by Dick Pountain, page 379.)

In the first and second columns on page 382, we say that "... a 32K-bit processor is necessary to efficiently manipulate objects ..." and that "by employing some tricky design techniques, including a 64K-

(continued)

MidWest Micro-Peripherals

Gigantic Sale!
Epson • Brother • Sanyo

PRICE GUARANTEE

We at MidWest Micro guarantee that we can save you up to 49% or more on your purchase of new fully warranted equipment and supplies. And we will still give you friendly, courteous service. Call today and Save With Confidence!

Don't spend a fortune to own the world's most popular printer . . .

NEW!

EPSON LIST \$349
LX-80 YOUR PRICE **\$269**



The new EPSON LX-80 prints smoothly and quietly at a speed of 100 cps. With the superb near letter quality mode and full graphic capabilities as standard, your correspondence will be letter perfect. The LX-80 comes complete with a parallel interface to quickly connect it to virtually all computers. There are 160 typescripts that are switch selectable and the LX-80 comes with EPSON's full 1 year warranty. Friction feed is standard and an optional tractor feed is available. Let the EPSON LX-80 print your next business letter or report.

Complete EPSON Line . . .	List	Your Price
Homewriter 10 (100 cps, NLQ Mode, 80 Col.) . . .	\$288	SCALLS
LX-80 (100 cps, NLQ Mode, 80 Col.) . . .	349	269
RX-100 (100 cps, 136 Col.) . . .	895	399
FX-80+(160 cps, 80 Col., 2k Buffer) . . .	699	389
FX-100+(160 cps, 136 Col., 2k Buffer) . . .	999	589
LQ-1500 (200 cps, NLQ Mode, 136 Col.) . . .	1395	SCALLS



brother
printer's give you all the features of a letter quality and more with . . .

NEW HR-15XL ONLY \$379

The HR-15 gives you Daisywheel printing and added attractions such as text reprinting, red printing, attachable cut sheet feeder and the exclusive Brother keyboard attachment.

Complete BROTHER Line . . .	List	Your Price
HR-15XL (17 cps, 13.5" carriage, 3k Buffer) . . .	\$598	\$379
HR-15 & HR-15XL Keyboard Attachment . . .	200	169
HR-25 (23 cps, 16.5" carriage, 3k Buffer) . . .	895	649
HR-35 (32 cps, 16.5" carriage, 7k Buffer) . . .	1245	899
Brother 2024 (160 cps, 24 pin head, NLQ Mode) . . .	1495	999

SANYO

Complete 1.8 Mb SUPER SYSTEM

JUST \$1399

Includes:

- *Sanyo Computer with 2-800k quad-density floppy disk drives
- *1.8 Megabytes of storage
- *256k Random Access Memory
- *Green or Amber Monitor (Your Choice)
- *Fast, efficient 16 bit 8088 processor
- *Convenient, full function, detachable keyboard
- *Centronics parallel printer port
- *High quality color graphics capabilities
- *Flexible MS-DOS Operating System
- *Flexible MW QuadDOS 4 Operating System for SS/DD, DS/DD, DS/ID
- *Business Management Software
- *Both Wordstar and Easywriter word processing software packages
- *Calcutat Software for spreadsheets
- *Filebase database software
- *And others!
- *Completely set-up and run tested



SAVE 49%

FREE BONUS

- 6-Plug surge protected power strip
- 2 Boxes of 10 brand name Quad-Density Diskettes

Prices subject to change and type errors

FREE CARD USE

Call Today!

Information - Ordering

1-800-423-8215

In Ohio 1-800-321-7731

CUSTOMER SERVICE (513) 663-4992

CASH PRICES: Cert. Check, Money Orders, VISA or MC
CODs (Add \$5) AMEX (Add 4%) P.O.s (Add 5%)

MidWest Micro-Peripherals
(Division of Intelnet, Inc.)
135 South Springfield St.
St. Paris, Ohio 43072

FIXES AND UPDATES

bit-wide memory bus . . ." We ask you to ignore the capital Ks as you read those sentences.

Mathematics Mistake

A pair of bugs appeared in listing 1 of Peter Rice's article "Arithmetic on Your PC" (See March, page 119.) The superscript ones (1s) in lines 13370 and 13380 on page 124 should have been minus signs.

We apologize for this error.

Caption in Error

A photo caption appearing in Jon Edwards's review, "Atari 800XL," misidentifies the screen display. (See March, page 268.) The photo actually shows a scene from Electronic Arts' Seven Cities of Gold.

Corrections for EPROM Programmer

In figure 2 (page 107) of the February Circuit Cellar, four corrections are necessary. (See "Build a Serial EPROM Programmer," page 104.)

Make a connection between the RESET line (pin 4) of IC8 and the line between pin 11 of IC7 and pin 2 of IC9.

On the lower right-hand corner, IC12 is a 74LS04, not a 74LS02.

The input to IC7, inverter b, should be labeled pin 3, not pin 13 as it was presented.

Finally, Q3 should be a 2N2905 and not a 2N905.

Also, when using 24-pin EPROMs, insert them into the ZIF socket so that the socket's pins 1 and 2 are empty.

BYTE'S BITS

Poke the II's Drive Delays in the Sixth Slot

Owen Sargent from Chicago, Illinois, has come up with a programming solution to the Apple II's drive shutoff and start-up delay. For the drive controller in slot 6:

- POKE 49386.0 assigns drive 1
- POKE 49387.0 assigns drive 2
- POKE 48385.0 turns assigned motor on
- POKE 49384.0 turns assigned motor off

Please note that any DOS command that causes the motor to switch on will

shut it down after execution. If you wish to keep your motor running, insert POKE 49385 immediately after the DOS command.

Mr. Sargent came across this solution in Don Worth and Pieter Lechner's *Beneath Apple DOS* (Quality Software, Chatsworth, CA: 1981, page 6-2) and Apple's *Reference Manual for the IIe Only* (Cupertino, CA: 1982, page 128).

"I have tested this in a read-print loop," says Sargent, "and keeping the motor on increases speeds by 25 percent."

Computer Art Contest for Kids

West Publishing seeks entries for its First Annual Computer Art Contest for Kids. The theme is "Computers and the Imagination." It is hoped that children will use computers both as subjects and tools.

Both computer graphics and traditional art forms are acceptable. Computer graphics can be programmed by a child or created with a graphics tablet. The contest is open to students in kindergarten through high school. Winners will be announced at the World Conference on Computers for Education, July 29 through August 2, in Norfolk, Virginia. Winners will receive prizes from \$50 to \$300. The Grand and First Prize winners' schools will receive prizes of \$300 and \$100. The first 500 entrants and the winners will receive a commemorative T-shirt.

Contest entries must be post-marked no later than June 1, 1985, and mailed to Ann

Kellogg, West Publishing Co., 4th floor, 201 Castro St., Mountain View, CA 94041. For further information, complete rules, and an official entry blank, call (800) 532-9378; in California, (415) 969-1283.

Alternative Address

In the November 1984 Fixes and Updates, we mentioned the services offered by Video Vision Associates, makers of laserdisc software. (See "Laserdiscs Here Today and With Us Tomorrow," page 33.) We supplied a Huntington Beach, California, address for the firm. While this address is correct, interested readers have had some difficulty reaching the office.

If you have encountered such problems, try contacting Video Vision Associates at its home office: 7 Waverly Place, Madison, NJ 07940, (201) 377-0302. ■

GIVE US 3 MONTHS, AND WE'LL CHANGE YOUR COMPANY'S WAY OF DOING BUSINESS FOREVER.

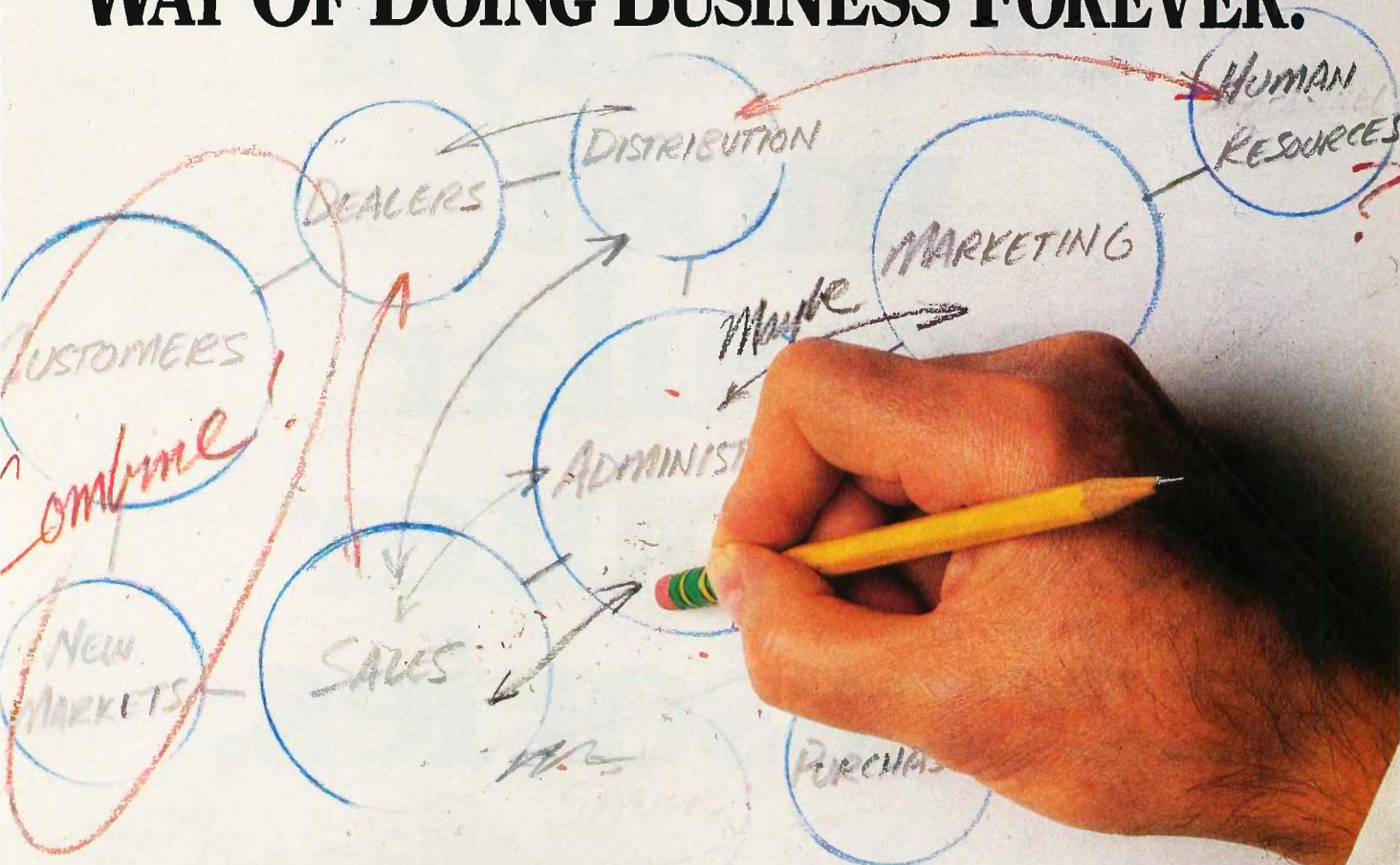

Presenting a superior communications and information delivery system, CompuServe Interchange.

Finally, there's a way for all those computers out there to really increase your company's productivity.

The breakthrough is Interchange, a superior electronic communications and information delivery system from CompuServe—the premier supplier of business information, electronic mail and network services to major financial institutions, government agencies and FORTUNE 500 companies.

Interchange lets you build and maintain your company's information sources and then disseminate this information to any audience: office staff, sales representatives, customers, distributors, suppliers, purchasing agents—in any combination that is right for your business.

Many corporations and associations in a wide range of industries are already

profiting from Interchange and our electronic mail system, InfoPlex.[®] Borg-Warner Chemicals has increased sales significantly with an Interchange system that (1) supplies technical information, (2) updates changing trade news, and (3) allows customers to run interactive, industry-oriented programs.

Heinz U.S.A. uses CompuServe's electronic mail to communicate sales and promotional information to the company's sales personnel. The speed and accuracy of InfoPlex have resulted in improved customer service and effectiveness.

CompuServe Interchange also allows access to a variety of useful information including stock quotes, the AP newswires, USA TODAY Update, and market research databases.

You can organize and disseminate information, provide electronic mail and much more. And we can help you put it together quickly and efficiently.

And in just 3 months, that can change your company's way of doing business forever.

For more information, call us or send this coupon today.



CompuServe Interchange

- Please send me additional information.
 Please have a CompuServe representative call me.

Name _____
Title _____
Company _____
City _____
State _____ Zip _____
Business Phone _____

CompuServe

CompuServe Interchange
P.O. 20212
5000 Arlington Centre Blvd.
Columbus, Ohio 43220
800-848-8199
In Ohio call 614-457-0802

705

An H&R Block Company

Three of today's most popular computer accessories.



Tylenol® is a registered trademark of McNEILAB, INC. Visine® and Ben-Gay® are registered trademarks of Lemming Division, Pfizer Inc.

Do you ever get the feeling that computers are treated with more respect than people?

Everyone talks about technology.

But what about the people who have to use it?

Quite clearly, they're having problems.

Industry publications like PC Magazine have written about those problems.

And now, more than twenty states are currently preparing special computer legislation to force some changes.

You are not a machine.

Computers are designed by engineers.

They usually know a lot about technology but very little about people.

Which is why so many computers often are technically impressive yet strangely unnatural to use.

Computer-induced problems (%)	
Eye strain	55%
Back pain	43%
Headaches	30%
Shoulder	25%
Hand/wrist	18%
Neck pain	15%

(Source: "Ergonomic Principles in Office Automation" Pub. 1983 by E.I.S. AB, Sweden.)

The result has been a whole range of computer-induced problems ranging from stress and fatigue to blurred vision.

In Sweden, they have an attitude the

world is just catching up with.

It's this:

That the machine is the servant of man.

Not the other way around.

That excellent ergonomic design isn't a privilege.

It's a right.

That ergonomics isn't just a noble gesture.

It's good business.

Because computers are only as fast and as accurate as the people who operate them.

If they suffer, so does business.

This attitude has made Ericsson No. 1 in Europe twice over:

First, as the giant of European telecommunications.

Then again as Europe's biggest workstation company by far.

(You couldn't ask for a better marriage of technology for the future.)

Here is one example of how Ericsson got there.

It's the first of a range of computers being introduced in the U.S.A.

The Ericsson P.C. It's Ergo-Intelligent.™

Ericsson has spent \$300 million finding ways to make people and computers work better together.

Here are some of the results.

Ergo-Screen.™

Aspirin gets rid of a headache. Ergonomics gets rid of the cause.

The Ericsson PC has a non-glare screen with restful amber characters on a specially developed, low-fatigue background color.

Even the shape of the characters was specially developed to allow easier recognition of difficult letters like O and Q.

On the monochrome monitor, the resolution is double that of IBM's, so clarity is remarkable.

You can even have text and graphics on the same screen.

Ergo-Arm.™

Thousands of people get neck and back pain from inadequate screen height and angle adjustment.

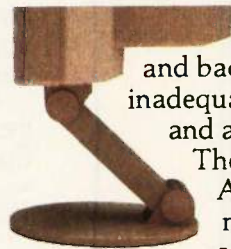

The Ericsson Ergo-Arm lets you move your screen exactly where you want it.

Ergo-Touch.™

Ericsson keys are full-size, and the layout is ergonomically planned for greater speed and accuracy.

Yet the keyboard is 20% more compact and less than half the weight of IBM's.

Even the cord is adjustable to suit left- or right-handers.

Ergo-Color.™

Even the color of the case is ergonomically selected to be restful on the eye over many hours.



Ergo-Space.™

The system unit is one-third smaller than IBM's.

It even fits under your desk in a special vertical rack.

So your desktop is your own again.

IBM Compatible.

Many companies claim to be compatible.

Some are. Some are stretching the truth.

The Ericsson PC boasts the highest compatibility rating there is.

It's operationally compatible.

You can take advantage of thousands of PC-compatible programs already available.

In fact, with the best-selling software, program and data disks are interchangeable with those of the IBM PC.

Service. Not excuses.

Ericsson wouldn't give you anything less than on-site or carry-in service. The choice is yours.

3 Free Offers.

Ericsson will send you revealing literature on ergonomics.

Also a detailed brochure on the Ericsson PC.

And arrange a hands-on test if you ask for it.

Call toll-free 1-800-FOR-ERGO.



ERICSSON

INTRODUCING NEAR LETTER QUALITY AND THROUGHPUT SPEEDS OTHER PRINTERS CAN'T COME NEAR.

The new C. Itoh ProWriter™ 8510S-LQ Near Letter Quality printer is a whole new field of one.

It's priced at just \$549. But it gives you near letter quality printing for beautifully sharp characters like printers costing hundreds of dollars more.

And in a text and graphics speed test against its closest competition, namely the Epson® FX-80 and the Okidata Microline 92, the new and faster C. Itoh 8510S-LQ out printed them all.

The stopwatch proved that the 8510S-LQ, at throughput speeds of 100 full lines per minute, printed text up to 35% faster than the competition. And it created bar graphs and pie charts up to 54% faster.

Of course, speed in itself does not keep a printer in a class by itself. Reliability does. That's something no C. Itoh printer has ever lacked. No other printers are more thoroughly tested or proven on the job. Which is why C. Itoh printers continue to be the world's best sellers, with 1.7 million sold last year alone.

For more information on the new and faster C. Itoh 8510S-LQ or wider carriage 1550S-LQ Near Letter Quality printers just see your C. Itoh dealer. Or call us toll free at 1-800-423-0300.

Or write C. Itoh Digital Products, Inc., 19750 South Vermont Avenue, Suite 220, Torrance, CA 90502.

™ ProWriter is a Trademark of C. Itoh Digital Products, Inc.
® Epson is a Registered Trademark of Epson, America, Inc.
© 1985 C. Itoh Digital Products, Inc.

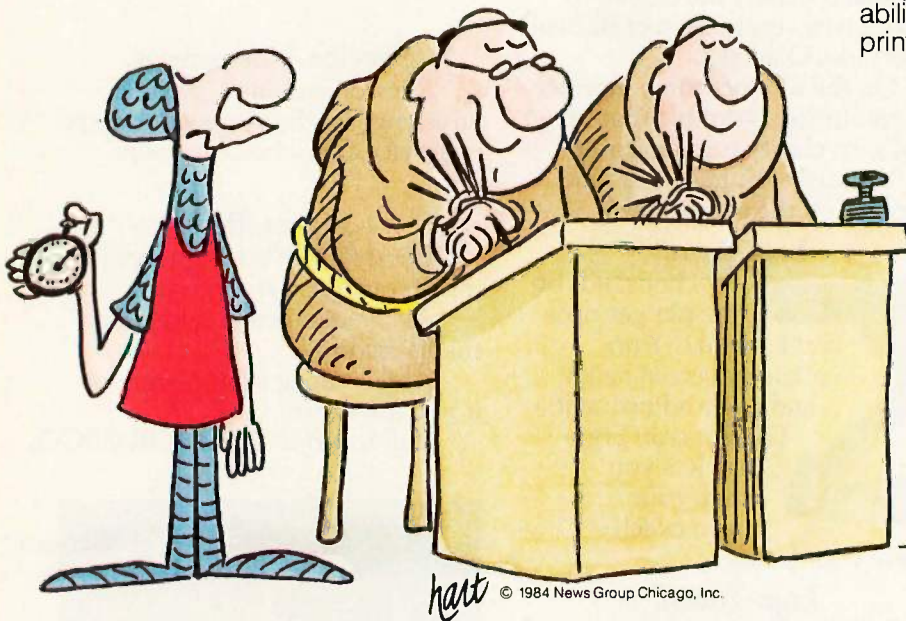

C. ITOH

Printers

Kaypro 2000 Features Detachable Keyboard

The Kaypro 2000 is an 11-pound battery-powered portable computer with a detachable 75-key keyboard. Standard are a single 720K-byte floppy-disk drive, one RS-232C serial port, a real-time clock/calendar, an 80-character by 25-line liquid-crystal display (LCD), bundled software, and 256K bytes of memory (expandable to 640K bytes using standard NMOS chips). Optionally, you can add an 8087 chip on the main board. An internal 300/1200-bps modem is also available.

Kaypro says that the unit's batteries will last approximately four hours in normal use. To conserve power, the unit automatically powers down when no activity occurs in one minute or when the cover is closed (without losing data or programs in RAM), and the disk drives are turned off when not actually reading or writing data. The Kaypro 2000 uses Phoenix's IBM PC-compatible ROM BIOS and can run virtually any program for the IBM Personal Computer. Graphics images are displayed with a resolution of 640 by 200 pixels.

The Kaypro 2000 measures about 12½ by 2½ by 11 inches when closed. An optional "base unit" for the Kaypro 2000 is planned. The base unit will allow use of additional floppy- and/or hard-disk drives, an external monitor, a parallel printer,



The Kaypro 2000's keyboard is detachable.

and other IBM-compatible peripherals.

The Kaypro 2000 should be available in June for \$1995. Contact Kaypro Corp., POB N, Del Mar, CA 92014, (619) 481-4300. Inquiry **600**.

Mac COBOL Has ANSI 74, Allows Access to Mac ROM

Micro Focus's Mac COBOL is the first version of COBOL for Apple's Macintosh. Mac COBOL includes an editor, a full ANSI 74 compiler, a 68000 object-code generator, and access to 386 of the Macintosh

ROM routines. Any COBOL program written for Micro Focus's IBM PC compiler will run on the Macintosh without modification, although programmers can add features to take advantage of the Macintosh's user interface.

Micro Focus also plans to give Mac COBOL a debugging tool, a forms generator, a help facility, and access to all 512 of the Macintosh ROM routines. Buyers of Mac COBOL version 1.0 will receive an upgrade to the next version free of charge.

Mac COBOL is priced at \$2000. Contact Micro Focus Inc., 2465 East Bayshore Rd., Palo Alto, CA 94303, (415) 856-4161. Inquiry **601**.

Graphics Software for HP Touchscreen and IBM PC

Hewlett-Packard has announced two families of software: one for its Touchscreen Personal Computer (formerly the HP 150) and the other for the IBM PC.

A majority of the programs for the Touchscreen Personal Computer are centered around business graphics and are designed to work with HP's line of plotters, and the InkJet and the LaserJet printers.

The Charting Gallery (\$265) lets you make various charts. The Drawing Gallery (\$345) is a MacDraw-type drawing program that can use the HP Mouse (\$210). The Executive MemoMaker (\$245) is supplied with a spelling checker, and it lets you incorporate graphics from the Charting and Drawing Galleries into text documents.

Most of the programs unveiled for the IBM PC are versions of programs already available for the Touchscreen PC. Among the releases are the MemoMaker word processor (\$160) and the Personal Card File database (\$160). Also offered is TextCharts (\$200), which lets you create presentation-quality signs and transparencies on HP's plotters and printers.

For further information, contact your local Hewlett-Packard sales office. Inquiry **602**.

(continued)

Business-Pro Runs AT Software

Texas Instruments' Business-Pro can be configured to run IBM PC AT and TI's Professional Computer software. This 80286-based tool has 512K bytes of RAM expandable to 3.5 megabytes without consuming any of its eight full- or six half-size card slots or to 15 megabytes using card slots. Memory speed is 150 nanoseconds.

Storage options are 360K-byte or 1.2-megabyte floppy drives, a 60-megabyte tape backup, or 21-, 40-, or 72-megabyte hard disks.

The DOS is MS-DOS 3.0 for one person or XENIX for up to eight users. Languages supported are MS-BASIC, MS-Pascal, MS-FORTRAN, MS- and RM/COBOL, LISP, C, and assembly.

Networking is provided by EtherLink hardware, supported by NetWare/E-TI software. As a workstation, it'll serve up to 50 micros sharing 144 megabytes of storage, a tape backup, and three printers.

An 80287 coprocessor, a mouse, speech technology, and communications hardware and software are optional.

With a serial/parallel interface and a 1.2-megabyte floppy-disk drive, the base unit is \$3995. A 21-megabyte Winchester drive increases the price to \$5795. Other configurations will range from \$4440 to \$10,785. Network servers will be offered. Contact Texas Instruments Inc., Data Systems Group, POB 809063, Dallas, TX 75380-9063, (800) 527-3500. Inquiry **603**.

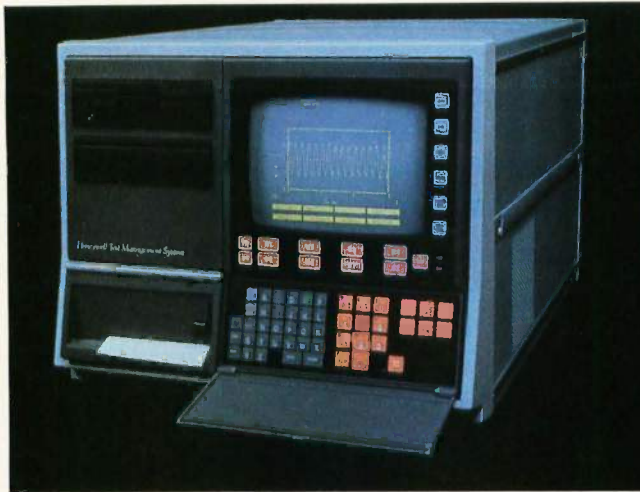

The HOTMS 3000 series is a system solution for test engineers.

Systems Solution for Test, Measurement, Analysis

Honeywell's HOTMS 3000 Series, a systems solution for the test and measurement environment, is said to be easy to operate, capable of a wide variety of measurements, and able to produce on-site test results with its high-performance architecture and powerful data-analysis software. With an HOTMS 3000, a test engineer works with a complete data-acquisition system designed to manage all aspects of testing, such as the initial design, measurement, data analysis, and communications. The price for a fully configured HOTMS 3000 begins at \$20,000; cost varies depending upon your application.

HOTMS 3000 is a modular series built around a multi-processor-based microcomputer. The computer has a distributed bus architecture that uses four Motorola MC68000 microprocessors. It runs under Regulus, a UNIX-like operating system with real-time extensions. Regulus supports BASIC, Pascal, FORTRAN, and C.

The six system cards com-

municate across a VME bus in a multitasking environment. Three card slots are available for a communications card or for up to 8 megabytes of RAM.

Each HOTMS has a so-called mechanical support structure with a rack-mountable, tabletop enclosure and a 17-slot card cage. The card cage has a 9-slot computer card rack and an 8-slot signal-conditioning card rack. The signal-conditioning front end can handle a continuous system throughput of up to 160,000 samples per second. A series of analog and digital signal-conditioning cards offering a range of input and output options complements the data-collection bus.

Other features of the main housing are a 9-inch amber monitor and a built-in multi-function keypad. Each comes standard with a 5¼-inch floppy-disk drive and a choice of a second floppy drive and a 36- or 86-megabyte hard-disk drive. The power for all devices in the main unit is supplied by a 640-watt power supply

that comes in a variety of voltages and frequencies. An external VT-200-style keyboard and a 13-inch external color monitor are optional.

Major system functionality is provided by Operator Interface Devices, which are supported by several user-interface programs. These programs provide a consistent set of menu interfaces to the system and a plug-in structure for software modules. The modules are offered as either integral parts of each HOTMS or as upgrade options.

For information on hardware and software options and system configurations, contact Honeywell Inc., Test Instruments Division, POB 5227, Denver, CO 80217-5227. Inquiry **604**.

GRiDCase Family of Portables

GRiD Systems has introduced three IBM PC-compatible portables: the GRiDCase I, II, and III. Members of this family are nearly identical, differing mainly in display-screen apparatus. The GRiDCase III, for example, has a high-clarity gas-plasma display, while the low-end GRiDCase I uses an LCD. The GRiDCase II features an enhanced LCD screen, according to the manufacturer.

GRiD claims that, unlike the Compass, the new GRiDCase models are highly compatible with the IBM PC. The company cites the new line's ability to run Lotus 1-2-3 and Microsoft's Flight Simulator as proof of compatibility.

Each GRiDCase comes with a 720K-byte floppy-disk drive, an interface for an RGB monitor, and a standard-size typewriter keyboard. Options include

(continued)

MOST SIGNIFICANT PRODUCT OF THE YEAR - PC WEEK

They said it couldn't be done. Borland Did It. Turbo Pascal 3.0

The industry standard

With more than 250,000 users worldwide Turbo Pascal is the industry's de facto standard. Turbo Pascal is praised by more engineers, hobbyists, students and professional programmers than any other development environment in the history of microcomputing. And yet, Turbo Pascal is simple and fun to use!

	TURBO 3.0	TURBO 2.0	MS PASCAL
COMPILATION SPEED	8.1	16	206
EXECUTION SPEED	9 ^{min}	13 ^{sec}	20 ^{sec}
CODE SIZE	12 K	12 K	35 K
BUILT-IN INTERACTIVE EDITOR	YES	YES	NO
ONE STEP COMPILE (NO LINKING NECESSARY)	YES	YES	NO
COMPILER SIZE	39K		NO
TURTLE GRAPHICS	YES		YES
BCD OPTION	YES	\$54 ⁹⁵	\$295 ⁰⁰
PRICE	\$69 ⁹⁵		

The best just got better: Introducing Turbo Pascal 3.0

We just added a whole range of exciting new features to Turbo Pascal:

- First, the world's fastest Pascal compiler just got faster. Turbo Pascal 3.0 (16 bit version) compiles twice as fast as Turbo Pascal 2.0! No kidding.
- Then, we totally rewrote the file I/O system, and we also now support I/O redirection.
- For the IBM PC versions, we've even added "turtle graphics" and full tree directory support.
- For all 16 Bit versions, we now offer two additional options: 8087 math coprocessor support for intensive calculations and Binary Coded Decimals (BCD) for business applications.
- And much much more.

The Critics' Choice.

Jeff Duntemann, PC Magazine: "Language deal of the century . . . Turbo Pascal: It introduces a new programming environment and runs like magic."

Dave Garland, Popular Computing: "Most Pascal compilers barely fit on a disk, but Turbo Pascal packs an editor, compiler, linker, and run-time library into just 39K bytes of random-access memory."

Jerry Pournelle, BYTE: "What I think the computer industry is headed for: well documented, standard, plenty of good features, and a reasonable price."

Portability.

Turbo Pascal is available today for most computers running PC DOS, MS DOS, CP/M 80 or CP/M 86. A XENIX version of Turbo Pascal will soon be announced, and before the end of the year, Turbo Pascal will be running on most 68000 based microcomputers.

(* Benchmark run on an IBM PC using MS Pascal version 3.2 and the DOS linker version 2.6. The 179 line program used is the "Gauss-Seidel" program out of Alan R. Miller's book: *Pascal programs for scientists and engineers* (Sybex, page 128) with a 3 dimensional non-singular matrix and a relaxation coefficient of 1.0.

An Offer You Can't Refuse.

Until June 1st, 1985, you can get Turbo Pascal 3.0 for only \$69.95. Turbo Pascal 3.0, equipped with either the BCD or 8087 options, is available for an additional \$39.95 or Turbo Pascal 3.0 with both options for only \$124.95. As a matter of fact, if you own a 16-Bit computer and are serious about programming, you might as well get both options right away and save almost \$25.

Update policy.

As always, our first commitment is to our customers. You built Borland and we will always honor your support.

So, to make your upgrade to the exciting new version of Turbo Pascal 3.0 easy, we will accept your original Turbo Pascal disk (in a bend-proof container) for a trade-in credit of \$39.95 and your Turbo87 original disk for \$59.95. This trade-in credit may only be applied toward the purchase of Turbo Pascal 3.0 and its additional BCD and 8087 options (trade-in offer is only valid directly through Borland and until June 1st, 1985).

TURBO PASCAL

NOT COPY-PROTECTED

Available at better dealers nationwide. Call (800) 556-2283 for the dealer nearest you. To order by Credit Card call (800) 255-8008, CA (800) 742-1133

Carefully Describe your Computer System!

Mine is: 8 bit 16 bit MS-DOS
 I Use: PC DOS CP/M 80 CP/M 86
 My computer's name/model is: _____

The disk size I use is:

3 1/2" 5 1/4" 8"

Name: _____

Shipping Address: _____

City: _____ Zip: _____

State: _____ Telephone: _____

For update: original Turbo disk must accompany order

YES! I want the Best! Please send: _____

Please send:	Quantity
Pascal 3.0	\$ 69.95
Pascal w/8087	\$109.90
Pascal w/BCD	\$109.90
Pascal w/8087 & BCD	\$124.95 (SAVE \$24.90)

* These prices include shipping to all U.S. cities. All foreign orders add \$10 per product ordered.

Subtotal (CA 6% tax): _____

Trade-in Credit Claimed: _____

Amount Enclosed: _____

Payment: VISA MC BankDraft Check

Credit Card Expir. Date: _____

Card #: _____

COD's and Purchase Orders WILL NOT be accepted by Borland. California residents: add 6% sales tax. Outside USA: add \$10 and make payment by bank draft, payable in US dollars drawn on a US bank.

BORLAND INTERNATIONAL Software's Newest Direction
 4585 Scotts Valley Drive
 Scotts Valley, CA 95066
 TELEX 172373

Turbo Pascal is a registered trademark of Borland International, Inc.
 PC Week is a trademark of Ziff-Davis Pub. Co.
 Inquiry 455 for Dealers. Inquiry 456 for End-Users.

an external 5¼-inch floppy-disk drive, an internal 1200-bps modem, and a battery pack that lasts from one to five hours, depending on which model is being used.

Prices range from approximately \$3000 for the GRiD-Case I to about \$4500 for the GRiDCase III. Contact GRiD Systems Corp., 2535 Garcia Ave., Mountain View, CA 94043, (415) 961-4800. Inquiry **605**.

Integrated CAD System for IBM

CADKey, a two- and three-dimensional design and drafting tool for 512K-byte IBM PCs, PC XTs, and PC ATs, is said to be the only IBM PC-based system with true three-dimensional capabilities fully integrated with two-dimensional drafting abilities.

You can use CADKey to draw in three dimensions and to convert those images into two-dimensional drawings that conform to ANSI and ISO standards. Once you create a three-dimensional image, you can automatically view it from any angle. If you modify a design, CADKey automatically updates all views.

CADKey drawings appear as wireframe representations. For a solid appearance, hidden lines can be trimmed. All parts, families of parts, and drawings can be stored, automatically scaled to size, and retrieved from disk within the program. All entities making up an image can be manipulated individually or as a group, and any entity or group of entities can be altered at will. Entities to be transformed may be

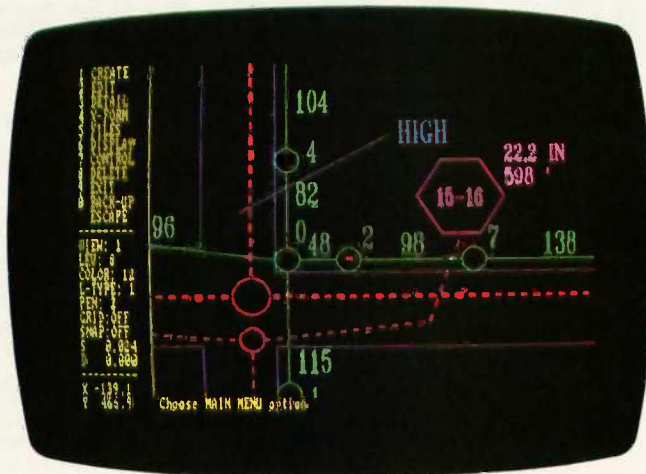

Sample screen produced by CADKey.

selected by cursor position, last created, type, level, and windowing, and you can use geometric relationships between entities for selection, construction, transformation, editing, and dimensioning.

Any part, section of a part, or group of parts can be rotated, scaled, or moved along any of three coordinate axes by user-selected angle, distance, or factor. Both numerical and interactive methods are supported, and zoom and pan features are provided.

CADKey uses English-language menus. Commands can be tailored to suit your needs. The program supports 640- by 420-dot resolution, 256 levels, and 16 colors and accepts input from a digitizer, mouse, function keys, and keyboard. Among its other features are quick selection and repaint, the ability to use disk space as virtual memory, and the ability to accommodate parts exceeding 10,000 entities.

CADKey is \$1895. Contact Micro Control Systems Inc., 27 Hartford Turnpike, Vernon, CT 06066, (203) 647-0220. Inquiry **606**.

Laser Printer Produces Full-Page, High-Resolution Graphics

Corporate Data Sciences' CDS 2300, a \$5695 laser printer, can store and print a full 8½- by 11-inch image with a resolution of 90,000 dots per square inch. It uses Canon's LBP-CX standard laser-printer engine, augmented with an 8-MHz 80186 processor, 1.28 megabytes of bit-mapped RAM for images, 128K bytes of system RAM, and 128K bytes of ROM.

In addition to several CDS fonts provided for use in the bit-mapped image mode, the CDS 2300 can emulate a Diablo 630 daisy-wheel printer, a Tektronix 4014 graphics terminal, and the ANSI X3.64 protocol. Once a bit-mapped image is loaded into the printer, copies can be produced at

a rate of eight per minute. Both RS-232C serial and Centronics parallel interfaces are supplied.

CDS also sells a Graphics Display/Processor (GD/P), an intelligent graphics terminal for the IBM PC. The GD/P workstation costs \$4995.

Also newly available from CDS is a graphics terminal called Whizzie (an abbreviated form of "what you see is what you get"). This \$1995 terminal has a 17-inch display and an interface card for the IBM PC XT or AT, but it does not have the intelligence or the advanced capabilities of the GD/P. Like the GD/P, Whizzie displays a 1024- by 1024- pixel image exactly as the laser printer will produce it.

Contact Corporate Data Sciences Inc., Suite 102, 2560 Mission College Blvd., Santa Clara, CA 95054, (408) 980-9747. Inquiry **607**.

Cermetek Unveils 3-line, 1200-bps Multiplexer

Cermetek Microelectronics' 3X1200 Multiplexer lets three users communicate at 1200 bps over a single telephone line, reducing phone bills by as much as two-thirds. This statistical multiplexer uses the Hayes AT command set and can serve as a single-user 1200-bps modem. When two 3X1200s are connected by a phone line, users at any of the six RS-232C serial ports can communicate with any other port and share peripherals.

The 3X1200 supports switched multiplexing. Users can opt to communicate with any port at any time instead of being tied to a

(continued)

Borland's SideKick Software Product of the Year*

SideKick is InfoWorld Software Product of the Year. It won over Symphony. Over Framework. Over ALL the programs advertised in this magazine. Including, of course, all the "fly-by-night" SideKick imitations. **SideKick Simply the best.**



Here's SideKick running over Lotus 1-2-3. In the SideKick Notepad you'll notice data that's been imported directly from the Lotus screen. In the upper right you can see the SideKick Calculator.

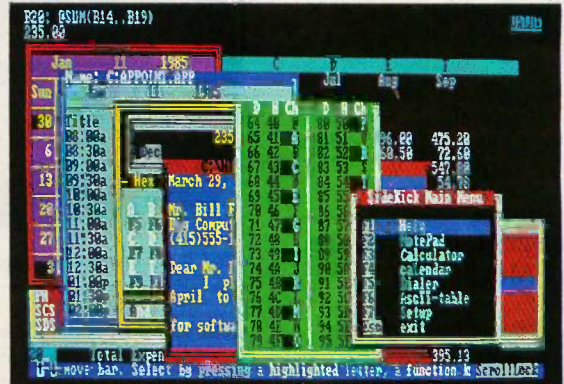

All the SideKick windows stacked up over Lotus 1-2-3. From bottom to top: SideKick's "Menu Window", ASCII table, Notepad, Calculator, Appointment Scheduler/Calendar, and Phone Dialer. Whether you're running WordStar, Lotus, dBase, or any other program, SideKick puts all these desktop accessories instantly at your fingertips.



InfoWorld Report Card 1984 by Popular Computing, Inc., a subsidiary of CW Communications Inc. Reprinted from InfoWorld, 1060 Marsh Road, Menlo Park, CA 94025.

Jerry Pournelle, BYTE: "If you use a PC, get SideKick. You'll soon become dependent on it."

Garry Ray, PC Week: "SideKick deserves a place in every PC."

Charles Petzold, PC Magazine: "In a simple, beautiful implementation of WordStar's block copy commands, SideKick can transport all or any part of the display screen (even an area overlaid by the notepad display) to the notepad."

Dan Robinson, InfoWorld: "SideKick is a time-saving, frustration-saving bargain"

BORLAND INTERNATIONAL Software's Newest Direction
4585 Scotts Valley Drive
Scotts Valley, CA 95066
TELEX 172373

SIDEKICK

NOT COPY-PROTECTED

Available at better dealers nationwide. Call (800) 556-2283 for the dealer nearest you. To order by Credit Card call (800) 255-8008, CA (800) 742-1133

Yes, I want the Best.
Please send me SideKick!

SideKick Copy Protected
Quantity: _____ at \$54.95
(CA res. add \$3.30 tax per copy)

SideKick Not Copy-Protected
Quantity: _____ at \$84.95
(CA res. add \$5.10 tax per copy)

These prices include shipping to all U.S. cities. All foreign orders add \$10 per product ordered.

PCjr requires not copy-protected version

Name: _____

Shipping Address: _____

City: _____ State: _____ Zip: _____

Telephone: _____

Amount: (CA 6% tax) _____

Payment: VISA MC BankDraft Check

Credit Card Expir. Date: _____

Card #: _____

COD's and Purchase Orders WILL NOT be accepted by Borland. California residents: add 6% sales tax. Outside USA: add \$10 and make payment by bank draft, payable in US dollars drawn on a US bank.

\$15

Symphony, Lotus & Lotus 1-2-3 are trademarks of Lotus Development Corp. dBase & Framework are trademarks of Ashton-Tate. WordStar is a trademark of Micropro International Corp. SideKick is a trademark of Borland International.

*Selected by InfoWorld as the most significant software product of the year.

Inquiry 457 for Dealers. Inquiry 458 for End-Users.

single channel. Its system software provides error checking and retransmission of garbled data. System parameters can be reset remotely, even though they are password-protected. The 3X1200 also keeps activity statistics on all ports.

The Cermetek 3X1200 is priced at \$1395. Contact Cermetek Microelectronics Inc., 1308 Borregas Ave., POB 3565, Sunnyvale, CA 94088-3565, (408) 752-5000. Inquiry 608.

Integrated Software for Macintosh

Microsoft's first integrated package, Excel for the Macintosh, has spreadsheet and graphics capabilities, a spreadsheet-oriented database, and a macro facility for storing and recalling commonly used keystrokes. It supports the AppleTalk network and provides two-way file compatibility with Multiplan and Chart for the Macintosh, Lotus 1-2-3 for the IBM PC, and applications that support Microsoft's SYLK format.

The Excel spreadsheet provides you with a 256-column by 16,384-row work area. You can view and reference multiple spreadsheets, consolidate worksheets, enter multiple-variable problems or situations, and vary the borders, number formats, and font styles and size. You can assign names to cell references, numbers, and mathematical expressions and call four windows into a worksheet.

You can produce instant "what if" graphics with Excel's charting abilities, which are functionally iden-

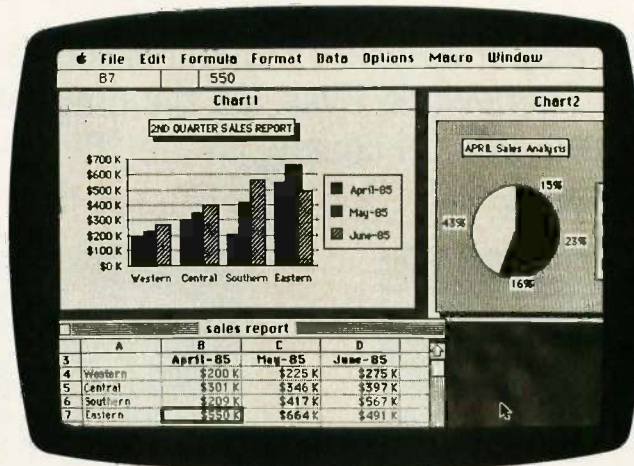

Excel is Microsoft's first integrated package.

tical to Microsoft's Chart for the Mac. Excel files can be read directly into Chart, and Excel can read Chart files. When you alter numbers in a spreadsheet window, charts in separate windows are instantly updated. For data comparisons, you can open more than one chart window for the same or different data. The charting facility also has 42 pre-designed charts, the ability to relocate objects on screen, and your choice of font, range, scale, and patterns.

The database is an ancillary function of Excel's spreadsheet. With it, you can sort, extract, and display information in a variety of ways. The database lacks form- and report-design capabilities; however, Excel's formatting capabilities let you create reports. It does let you remove data for analysis in a different section of your work area.

Excel's suggested retail price is \$395. It requires 512K bytes of memory and will work with the Macintosh XL. Contact Microsoft, 10700 Northrup Way, Bellevue, WA 98009, (206) 828-8080. Inquiry 609.

Test, Measurement Tools

Hewlett-Packard's PC Instruments are peripheral devices that give you the ability to run test or measurement applications from the same computer you use to write reports. Modular tools that work with the HP Touchscreen and IBM's PC, PC XT, and PC AT computers, the PC Instruments line consists of eight units, several software packages, and accessories. A typical micro can support up to eight modules, and additional modules can be engaged with more interface cards.

Current members of the line are a digitizing oscilloscope, a digital multimeter, a function generator, a universal counter, a 16-channel digital I/O, a relay multiplexer, a dual-voltage D/A converter, and a relay actuator. Each is housed in a stackable plastic box with its own external power supply.

Key to PC Instruments, says Hewlett-Packard, is its

system software. The software operates with a single HP PCIB interface card inside the computer, provides the user interface and instrument I/O drivers, and gives you control over instrument modules. It has data-conversion utilities and supports three data-conversion formats (BASIC, DIF, and stripped ASCII) that order acquired data for use with such programs as Lotus 1-2-3 and Statpak.

In its manual mode, the software displays an instrument's control panel on screen along with multiple windows. The windows let you monitor the status of several instruments, fiddle with instrument settings, and oversee the entire operation. The software supports the Touchscreen, an IBM PC mouse, and cursor keys. Instrument initialization parameters can be stored and recalled.

The program mode lets you exercise control over each instrument through calls to the BASIC subroutine library. A pair of generic commands, Output and Measure, are used to program all the instruments.

Optional data-acquisition software lets you start logging and plotting data immediately. This menu-driven BASIC package has an engineering-graphics utility. Software libraries that permit the Touchscreen and IBMs to control up to 15 PC Instruments in a BASIC environment are available.

PC Instruments are priced between \$650 and \$1500. The PCIB interface and system software are \$500. The optional I/O library is \$300 for the Touchscreen and \$400 for the IBM PC. Contact your local Hewlett-Packard dealer.

Inquiry 610.

(continued on page 464)

Speed, Power, Price.

Borland's Turbo Pascal Family.

The industry standard. With more than 250,000 users worldwide Turbo Pascal is the industry's de facto standard. Turbo Pascal is praised by more engineers, hobbyists, students and professional programmers than any other development environment in the history of microcomputing. And yet, Turbo Pascal is simple and fun to use!

Jeff Duntemann, PC Magazine: "Language deal of the century . . . Turbo Pascal: It introduces a new programming environment and runs like magic."

Dave Garland, Popular Computing: "Most Pascal compilers barely fit on a disk, but Turbo Pascal packs an editor, compiler, linker, and run-time library into just 29K bytes of random-access memory."

Jerry Pournelle, BYTE: "What I think the computer industry is headed for: well documented, standard, plenty of good features, and a reasonable price."

Portability. Turbo Pascal is available today for most computers running PC DOS, MS DOS, CP/M 80 or CP/M 86. A XENIX version of Turbo Pascal will soon be announced, and before the end of the year, Turbo Pascal will be running on most 68000 based microcomputers.

\$69.95

High resolution monochrome graphics for the IBM PC and the Zenith 100 computers

Dazzling graphics and painless windows. The Turbo Graphix Toolbox will give even a beginning programmer the expert's edge. It's a complete library of Pascal procedures that include:

- Full graphics window management.
- Tools that will allow you to draw and hatch pie charts, bar charts, circles, rectangles and a full range of geometric shapes.
- Procedures that will save and restore graphic images to and from disk.
- Functions that will allow you to precisely plot curves.
- Tools that will allow you to create animation or solve those difficult curve fitting problems and much, much more

No sweat and no royalties. You may incorporate part, or all of these tools in your programs, and yet, we won't charge you any royalties. Best of all, these functions and procedures come complete with commented source code on disk ready to compile!

\$54.95
NEW

Searching and sorting made simple

The perfect complement to Turbo Pascal. It contains: *Turbo-Access*, a powerful implementation of the state-of-the-art B+ tree ISAM technique; *Turbo-Sort*, a super efficient implementation of the fastest data sorting algorithm, "Quicksort on disk". And much more.

Jerry Pournelle, BYTE: "The tools include a B+ tree search and a sorting system; I've seen stuff like this, but not as well thought out, sell for hundreds of dollars."

Get started right away: free database! Included on every Toolbox disk is the source code to a working data base which demonstrates how powerful and easy to use the Turbo-Access system really is. Modify it to suit your individual needs or just compile it and run.

Remember, no royalties!

\$54.95

From Start to Finish in 300 pages. Turbo Tutor is for everyone, from novice to expert. Even if you've never programmed before, Turbo Tutor will get you started right away. If you already have some experience with Pascal or another programming language, Turbo Tutor will take you step by step through topics like data structures and pointers. If you're an expert, you'll love the sections detailing subjects such as "how to use assembly language routines with your Turbo Pascal programs."

A must. You'll find the source code for all the examples in the book on the accompanying disk ready to compile. Turbo Tutor might be the only reference on Pascal and programming you'll ever need.

\$34.95

TURBO PASCAL FAMILY

Available at better dealers nationwide. Call (800) 556-2283 for the dealer nearest you. To order by Credit Card call (800) 255-8008, CA (800) 742-1133

Carefully Describe your Computer System!

Mine is: 8 bit 16 bit
I Use: PC-DOS MS-DOS
 CP/M 80 CP/M 86
My computer's name/model is: _____

The disk size I use is:
 3 1/2" 5 1/4" 8"

Name: _____

Shipping Address: _____

City: _____

State: _____

Zip: _____

Telephone: _____

Amount: (CA 6% tax) _____

Payment: VISA MC BankDraft Check

Credit Card Expir. Date: _____

Card #: _____

Pascal 3.0 \$ 69.95
Pascal w/8087 \$109.90
Pascal w/BCD \$109.90
Pascal w/8087 & BCD \$124.95
Turbo Toolbox \$ 54.95
Turbo Graphix \$ 54.95
Turbo Tutor \$ 34.95
*These prices include shipping to all U.S. cities. All foreign orders add \$10 per product ordered.

BORLAND INTERNATIONAL

Software's Newest Direction
4585 Scotts Valley Drive
Scotts Valley, CA 95066
TELEX 172373

Inquiry 459 for Dealers. Inquiry 460 for End-Users.

Turbo Pascal is a registered trademark of Borland International, Inc.

F15
COD's and Purchase Orders WILL NOT be accepted by Borland. California residents: add 6% sales tax. Outside USA: add \$10 and make payment by bank draft, payable in US dollars drawn on a US bank.



SuperKey

TERMINATOR

ROBERT
GUNNEY

Borland Does It Again: SuperKey \$69.95

Sure, ProKey™ is a nice little program. But when the people who brought you Turbo Pascal and SideKick get serious about keyboard enhancers, you can expect the impossible . . . and we deliver.

SuperKey		
ProKey		YES
ALL FEATURES RESIDENT IN RAM AT ALL TIMES	NO	YES
RESIDENT PULL-DOWN MACRO EDITOR	NO	YES
RESIDENT FILE ENCRYPTION	NO	YES
PROKEY COMPATIBILITY	YES	YES
DISPLAY PROTECTION	NO	YES
ABILITY TO IMPORT DATA FROM SCREEN	NO	YES
PULL-DOWN MENU USER INTERFACE	NO	YES
CONTEXT-SENSITIVE ON-LINE HELP SYSTEM	NO	YES
DISPLAY-ONLY MACRO CREATION	NO	YES
ENTRY AND FORMAT CONTROL IN DATA FIELDS	NO	YES
COMMAND KEYS REDEFINABLE "ON THE FLY"	NO	69 ⁹⁵
PRICE	129 ⁹⁵	

Total ProKey compatibility. Every Prokey Macro file may be used by SuperKey *without change* so that you may capitalize on all the precious time you've invested.

Now your PC can keep a secret! SuperKey includes a resident file encryption system that uses your password to encrypt and decrypt files, even while running other programs. Two different encryption modes are offered:

1. Direct overwrite encryption (which leaves the file size unchanged) for complete protection. At no point is a second file that could be reconstructed by an intruder generated. Without your secret password, no one will ever be able to type out your confidential letters again!

2. COM or EXE file encryption which allows you to encrypt a binary file into an ASCII file, transmit it through a phone line as a text file and turn it back again into an executable file on the target machine (only of course if your correspondent knows the secret password!). Now, you will even be able to secretly exchange programs through Public Bulletin Board Systems or services such as CompuServe.

Totally memory resident at all times, gives SuperKey the ability to create, edit, save and even recall new or existing macro files anytime, even while running another program.

Pull down macro editor. Finally, a sensible way to create, edit, change and alter existing macro definitions. Even while using another application, a simple keystroke instantly opens a wordprocessor-like window where you're allowed to see, edit, delete, save and even attach names to an individual macro or file of macros, and much more.

Sorry ProKey !

Superb software at reasonable prices!

There is much more to SuperKey. Maybe the best reason to buy SuperKey is that it is a Borland International Product. Each one of our products is the best in its category. We only believe in absolutely superb software at reasonable prices!

An offer you can't refuse.

Whether you are a ProKey user or you've never used a keyboard enhancer before, your boat has come in. You can get your copy of SuperKey at this irresistible price.

Get your PC a SuperKey today!

SuperKey is available now for your IBM PC, XT, AT, jr. and truly compatible microcomputers.



Software's Newest Direction
4585 Scotts Valley Drive
Scotts Valley, CA 95066
TELEX 172373

IBM is a registered trademark of International Business Machine Corporation. ProKey is a trademark of RoseSoft. SuperKey and SideKick are trademarks of Borland International, Inc. CompuServe is a trademark of CompuServe Corp.

Inquiry 461 for Dealers. Inquiry 462 for End-Users.



NOT COPY-PROTECTED

Available at better dealers nationwide. Call (800) 556-2283 for the dealer nearest you. To order by Credit Card call (800) 255-8008, CA (800) 742-1133

\$69.95



YES! Please rush SuperKey to me. Send me _____ copies.

This price includes shipping to all U.S. cities. All foreign orders add \$10 per product ordered.

Name: _____

Shipping Address: _____

City: _____

State: _____ Zip: _____

Telephone: _____

Subtotal: _____
(CA res. add 4.20 tax per copy)

Amount Enclosed: _____

Payment: VISA MC BankDraft Check

Credit Card Exp. Date: _____

Card # _____

COD's and Purchase Orders WILL NOT be accepted by Borland. California residents: add 6% sales tax. Outside USA: add \$10 and make payment by bank draft, payable in US dollars drawn on a US bank.

Conducted by Steve Ciarcia

INTELLIGENT DISK DRIVE

Dear Steve,

How about an intelligent disk drive that will interface through an RS-232C port? It might be useful in solving format incompatibilities.

RUSS SHALL
Key West, FL

An intelligent disk drive with an RS-232C serial port is a good idea, and I will consider it for a future article.

Such products are already on the market. One such device, the SEEDI from Mariachi Oy (Puutarhakatu 17, SF-20100 Turku 10, Finland), interfaces an RS-232C serial port with an Apple II disk drive. It allows data to be taken or transferred without the need for the computer itself. The disk can then be put into an Apple II system and booted to retrieve the data.

Another unit is the FDS-200 Minifile from Greco Systems (372 Coogan Way, El Cajon, CA 92020). It, too, can be interfaced to an RS-232C port and will store data directly on a 5¼-inch floppy disk. It is an intelligent minifloppy-disk system that can store up to 179K bytes per disk.—Steve

COMPUTERS AND THE DISABLED

Dear Steve,

I am a student at the University of South Alabama who is working on a project to help a quadriplegic communicate. Here is the nature of the problem. We are hoping to translate jaw pressures to menu-selection responses. The menu could consist of words that could be sent to a speech synthesizer. I am using an IBM PC clone (a Columbia) and need suggestions as to what interface and other peripheral devices to acquire for a speech synthesizer. Your help in this matter is greatly appreciated.

RON LINDQUIST
Mobile, AL

Helping the disabled is one of the most rewarding areas for microcomputer experimenters. I wish you success.

You can acquire two basic types of speech synthesizers for the Columbia; a plug-in board or one that is connected through a serial or parallel port. The plug-in type ties up a slot, so this may be a consideration in your choice. Tecmar makes a speech board for PCs, as does MSI. Add-on types include two models from Votrax. Identical units are available assembled from Intex and in kit form from Micromint. Some of these units have speakers built in; others would require you to add your own.

Although you did not mention it specifically in your letter, I assume that your input device will be interfaced through the game adapter port. This would probably be the simplest and cheapest way to go. Simple micro-switches could be used to initiate the selection process.

I hope that this is of some help. A lot of planning beforehand is much better than a lot of kludges later! I have listed the addresses of the referenced manufacturers for your convenience.

Micromint Inc.
561 Willow Ave.
Cedarhurst, NY 11516
(800) 645-3479

Street Electronics
1140 Mark Ave.
Carpinteria, CA 93013
(805) 684-4593

Tecmar
6225 Cochran Rd.,
Solon, OH 44139
(216) 349-0600

—Steve

STEREOSCOPIC GRAPHICS

Dear Steve,

Can you refer me to a source of mathematical formulas for generating true-perspective proportions from elevations and for reducing right-eye images to left-eye offsets for three-dimensional imagery? I have never seen a discussion of the mathematical relationships.

I can take a lead pencil and produce drawings that merge beautifully into three-dimensional images, even without a

viewer, but I can't explain to my computer how to do it without the mathematical base, and it is crucial to a project I'm working on. Unfortunately, I'm more of an artist than I am a theoretical mathematician.

B. R. POGUE
Thatcher, AZ

Creative Computing magazine ran a two-part article, "Stereo Graphics," by John D. Fowler in the January and February 1983 issues. It seems to be exactly what you are looking for. The article describes the math briefly and gives a program in TRS-80 Color Computer BASIC to produce some stereo pictures.

Another article, which gets into the math of perspective drawing and rotation, is "Three Dimensional Apple Graphics" by Mark Pelczarski, in the February 1982 issue of Creative Computing.—Steve

TRANSORBS BETTER

Dear Steve,

In your article on power-line conditioning (December 1983), you recommended the use of MOVs (metal-oxide varistors) for transient voltage suppression. I believe I have located a better device for this—the Transorb by General Semiconductor.

I learned about this device while designing a burglar alarm, which my company sells. I tried zeners, then MOVs, to eliminate power glitches caused by the cycling of refrigerator motors, incandescent lamps, and the like. The zeners were useless because they didn't clamp with the high-voltage values. The MOVs were a little better, but the clamping voltage for a 15-V-rated device might still rise to 30 or 40 V under actual clamping currents.

I tried the Transorbs, and they worked perfectly. I now use them exclusively in all my products. They cost about 50 cents apiece, so they're less expensive than MOVs.

LOGAN CRESAP

SQUARE ROOTS

Dear Steve,

Recently, one of your readers complained that his computer could not deter-

(continued)

Four score and seven years ago our fathers brought forth, upon this continent, a new nation, conceived in liberty, and dedicated to the proposition that "all men are created equal."

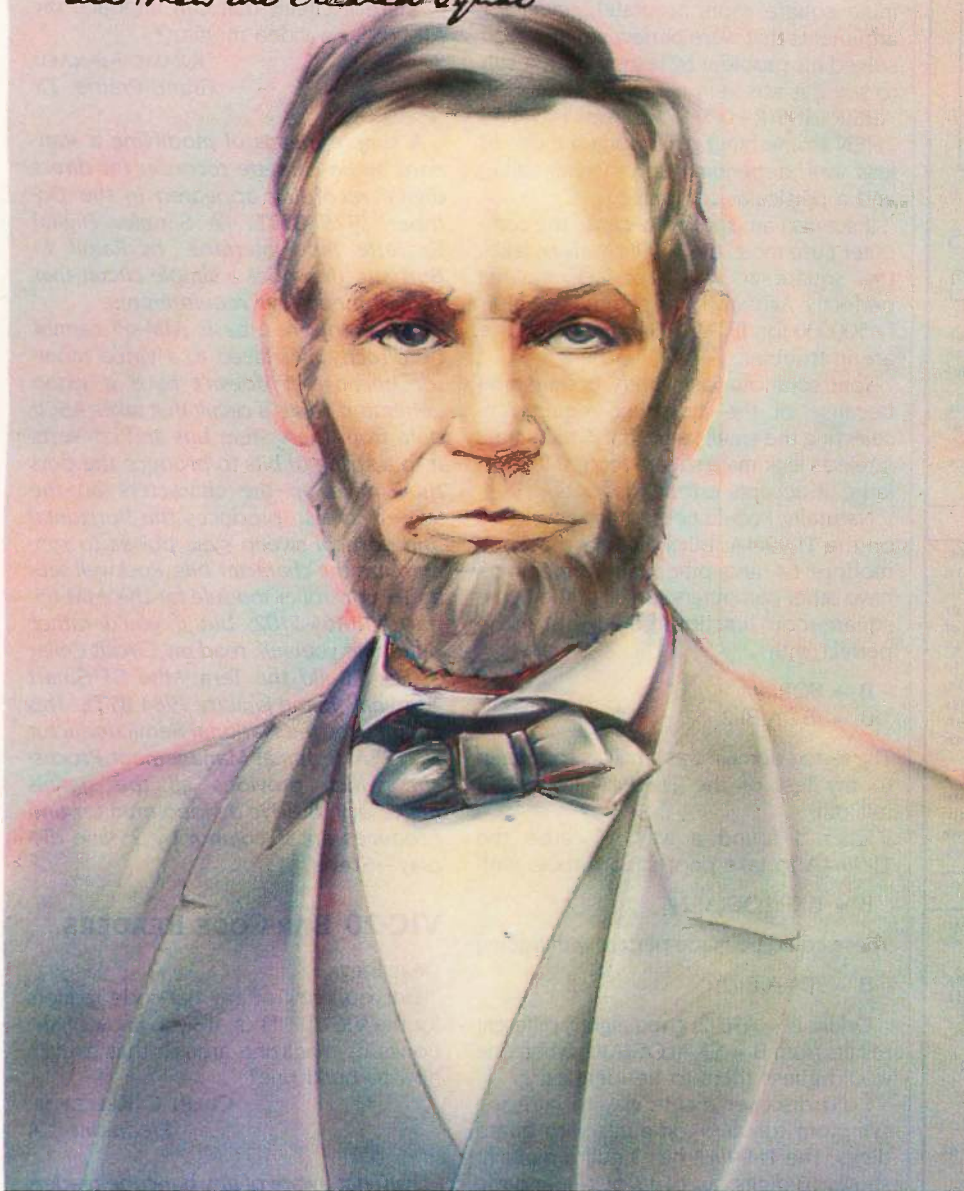

The picture in this ad is actually an 18" by 24" collector's item—an originally commissioned museum-quality print. This month, the Gettysburg print is yours, absolutely free, at most computer stores that carry Leading Edge Word Processing.

For the name of the dealer nearest you, give us a call.

800-343-6833,
(617) 828-8150.



LEADING EDGE

Leading Edge Products, Inc.
Systems and Software Division
225 Turnpike Street, Canton, MA 02021

WORD PROCESSORS AT THE LEADING EDGE

Ah, the great ones . . .

They organized their ideas, their intuitions, their idioms. They set them down, sorted them out, arranged them and re-arranged them till they came out right.

They used small scraps of paper to record huge hunks of Truth; primitive tools to produce profound prose. But when the words finally went forth, they

made indelible marks on all who read them.

The amazing thing is that these monumental processors of words, did it without the benefit of monumental help.

Like Leading Edge Word Processing: the easiest to use, yet most potent piece of software ever created to take full advantage of all the power inherent, but until now un-tapped, in today's

most sophisticated personal computer. (Like the IBM® PC and the even faster and more powerful Leading Edge™ PC.)

The heart and soul of it is a 5 1/4" floppy disk, elegantly logical instruction manual and documentation . . . everything. And what you end up with is word processing at the leading edge.

LEADING EDGE™ WORD PROCESSING FROM \$100

IBM IS A REGISTERED TRADEMARK OF INTERNATIONAL BUSINESS MACHINES CORPORATION.
LEADING EDGE IS A TRADEMARK OF LEADING EDGE PRODUCTS, INCORPORATED.



The Silver Fox™ Trots through Lotuslike 1,2,3

The Silver Fox is not IBM-PC DOS compatible yet it runs hundreds of MS-DOS programs including Lotus 1,2,3, dBASE II, Multiplan, and even Flight Simulator.

The Silver Fox does not have IBM compatible expansion slots but you can add printers, serial ports, modems, 10-40 Mb. hard disks, clock/calendar cards, RAM, joysticks, an 8087 co-processor, and more.

MORE HARDWARE

What makes the Silver Fox unique, however, isn't what you can add to it, but what comes with it. Each Silver Fox comes with an 8088 CPU, 256K of RAM, four video ports, and a printer port. Plus you get more than twice the storage of a standard PC. 1.6 Megabytes on a dual 5 1/4" floppies, and the Fox will read and write to standard 160K, 320K, and 360K IBM-PC formats.

Standard equipment also includes a better keyboard, and a 12" high-resolution, green monochrome monitor, with a full 25x80 column display.

Because the Silver Fox is born on Sanyo's totally automated line in Japan it is simply more reliable than PC's that are assembled by hand. So we back each Silver Fox with a one year limited warranty, four times the industry standard.

FREE SILVERWARE

Were this not enough, each Fox comes with the best free software bundle in the business including:

- | | | |
|-------------|------------------|-------------|
| MS-DOS 2.11 | Wordstar 3.3 | FILEBASE |
| HAGEN-DOS | Easy Writer | PC File III |
| Color BASIC | Mail Track | PD Disk |
| GW BASIC | Spell | Datamate |
| OS Tutor | Games & Graphics | CalcStar |

If you didn't think your

\$1397

could buy this much computer, call our machine at

1-800-FORAFox

leave your name and address, at the beep, and we'll rush you a booklet that will tell you how it can.

To order call

Scottsdale Systems, Ltd.
617 N. Scottsdale Rd. #B, Scottsdale, Az 85257

(602) 941-5856

ColorFox **\$1647**

The Silver Fox is sold exclusively by Scottsdale Systems Ltd., 617 N. Scottsdale Road #B, Scottsdale, AZ 85257. Trademarks: Silver Fox, HAGEN-DOS, and Datamate, Scottsdale Systems Ltd., WordStar and CalcStar, Micropro International; MS-DOS, and Multiplan, Microsoft Corporation; FILEBASE, EWDP Software, Inc.; dBASE II, Ashton-Tate; IBM-PC, and IBM-PC DOS; International Business Machines Corporation. Ordering: Telemarketing only, Silver Fox price is for cash, F.O.B. Scottsdale, prices subject to change, product subject to limited supply. We accept purchase orders from Fortune 1000 companies and major universities with good credit - add 2% Visa, Mastercard add 3%, AZ residents add 6%. Returned merchandise subject to a 20% restocking fee. Personal or company checks take up to 3 weeks to clear. No COD's or APO's.

mine square roots accurately, even for arguments that were perfect squares. You solved his problem by testing each result to see if it was very nearly an integer: IF ABS(R-INT(R+0.5)) < (small value) THEN (something). This worked more or less well, depending upon (small value) and a particular computer.

It seems I am spoiled because the computer I use most, the TI-99/4A, always takes the square roots of perfect squares perfectly. Actually I stopped the test after I=500000 for: IF SQR(I*1) < > I THEN (we are in trouble).

Your solution was slightly bothersome because of the judgment required in selecting the small value. If it is too small, it rejects legitimate square roots; if it is too large, it accepts erroneous roots.

Naturally, I could not test any new ideas on the TI-99/4A, but I also have a Commodore 64 and other family members have other computers. On all of them, the square-root function could be made perfect with

$$B = \text{SQR}(A)$$

$$B = (B + A/B)/2$$

The tested domain was small as compared to my test of the TI-99/4A (to a half million).

Later, I found a way to cause the TI-99/4A to take poor square roots with

$$B = \text{EXP}(\text{LOG}(A)/2)$$

These could be made perfect with adding

$$B = (B + A/B)/2$$

Oddly, $B = A^{1/2}$ gives slightly different results from $B = \text{EXP}(\text{LOG}(A)/2)$ when one would guess them to be identical.

I did discover a cute way to cure the symptom for any computer with guard digits. The TI-99/4A has 3 guard digits (it shows 10 digits out of 13 or 14), and the C64 has a single guard digit (it shows 9 digits out of 10):

$$B = \text{SQR}(A)$$

$$B = \text{VAL}(\text{STRS}(B))$$

This scheme is nice because it adjusts itself for a particular computer and for the relative magnitude of A and B.

WEBB SIMMONS
San Diego, CA

AIM-65 PERIPHERALS

Dear Steve,

To avoid the expense of a disk drive, I wish to connect a cassette recorder to my AIM-65 computer. Is there a BYTE article that shows how to accomplish this? Also,

is there a circuit that can interface my AIM-65 to a video monitor?

KWAME AJANAKU
Grand Prairie, TX

A simple means of modifying a standard audio cassette recorder for direct digital recording appeared in the October 1978 BYTE. "A Simpler Digital Cassette Tape Interface," by Ralph W. Burhans, describes a simple circuit that should meet your requirements.

The output of a basic AIM-65 cannot be directly interfaced to a video monitor because it doesn't have a video generator. This is a circuit that takes ASCII data from the system bus and converts it to a string of bits to produce the dots that make up the characters on the screen. It also produces the horizontal and vertical sweep sync pulses to synchronize the character bits. Rockwell sells a CRT controller module for the AIM-65, part #RM65-5102, but if you'd rather build one yourself, read my Circuit Cellar article "Build the Term-Mite ST Smart Terminal" in the January 1984 BYTE. This circuit uses the National Semiconductor NS455A Terminal Management Processor, which provides all the signals necessary to drive a video monitor and produces an 80-column by 25-line display.—Steve

VIC-20 BAR-CODE READERS

Dear Steve,

Do you know of any bar-code readers for the VIC-20? If not, do you know of any books or magazine articles that explain how to build one?

COLIN C. KELLEY JR.
Piedmont, CA

I am not aware of any bar-code readers specifically designed for the VIC-20, but several readers on the market interface with an RS-232C serial port. Such a port can be added to the VIC-20, either through a commercial accessory or via an article in the May 1983 BYTE, "The Enhanced VIC-20, Part 4: Connecting Serial RS-232C Peripherals to the VIC's TTL Port" by Joel Swank.

Two bar-code readers that interface to an RS-232C serial port are

The D2 Series Mini Bar Code Reader
Skan-a-Matic Corp.
POB 5, Route 5 West
Elbridge, NY 13060
(315) 689-3961

(continued)

**YOU'VE GOT THE BEST PASCAL COMPILER!
NOW — GET THE BEST UTILITY!**

TURBO SCREEN™

\$49.95

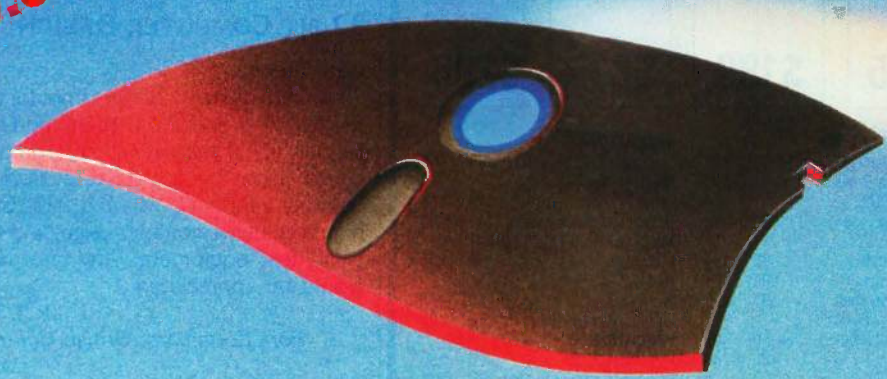

NEVER AGAIN WRITE SOURCE CODE FOR SCREEN DISPLAYS!

If you LIKE Turbo Pascal, you'll LOVE TURBO SCREEN™!*

Tired of writing line after line of source code just to create effective screen displays and error-proof data handling? Then use TURBO SCREEN's Editor to create the screens, the Collator to define a list of screens... and then relax for a few seconds while the Generator writes the code!

TURBO SCREEN™

- 100 Fields per screen, and up to 80 screens in your application.
- One screen or eighty, the size of your program doesn't change.
- I/O field types of: Real, Integer, String, Character, Boolean.
- "Bullet-proof" data entry.
- Create Window-Style overlays or Full-screen pictures in CP/M*, MS-DOS*, or PC-DOS.
- Supports video attributes for your terminal. And YES, if you have an RGB monitor, you can create screens in COLOR on your IBM PC or true compatible.
- A SINGLE LINE of source code invoking TURBO SCREEN'S "display" procedure controls:
 - picture selection
 - output to screen, printer, or disk
 - I/O field update
- TURBO SCREEN™ is completely menu-driven and includes a built-in Screen Editor, Collator, and Generator, each called up with a single keystroke!
- ADVANCED EDITOR:
 - Turbo Pascal*-like commands include:
 - Block commands for copy, fill, exchange, erase.
 - Draw lines in any direction with any character.
 - Supports IBM color monitor and graphics characters.
- FAST—Generates code for 20 screens in about 60 seconds!
- DISK UTILITIES built-in:
 - directories
 - erase files
- REQUIRES:
 - Turbo Pascal any version
 - 80x24 or larger video screen
- AVOID software "bottlenecks!"

PASCOM COMPUTING

23611 Chagrin Blvd., Suite 101
Cleveland, Ohio 44122

Check _____	TURBO SCREEN™	
Money Order _____	package	\$49.95
Visa _____	Plus Ship.	
Master Card _____	(UPS)	5.00
Card # _____	Total	\$54.95
Exp. Date: _____		

Start letting TURBO SCREEN™ write your I/O source code today!



ONLY — Call TOLL-FREE: 1-800-243-1849

Inside Ohio call 1-216-292-8745 (Lines Open 24 hours, 7 days)

Computer System: _____ 8-bit _____ 16-bit

Operating System: _____ CP/M80 _____ PC-DOS

_____ CP/M86 _____ MS-DOS

Computer Model: _____ Disk Format: _____

Name: _____

Address: _____

City: _____ State _____ Zip _____

Telephone: _____

Ohio residents add 6½% sales tax. Outside U.S.A. add \$20.00 U.S. Dealer Inquiries Welcome.

*Turbo Pascal is a trademark of Borland International. IBM is a trademark of International Business Machines. MS-DOS is a trademark of Microsoft. CP/M is a trademark of Digital Research.

FINALLY! MAIL ORDER SERVICE YOU CAN DEPEND ON!

EXPRESS

BUSINESS SOFTWARE

PROFESSIONAL SUPPORT PLUS RELIABLE PERSONALIZED SERVICE
AND WE'LL STILL BEAT MOST PRICES IN THIS MAGAZINE!

WORDSTAR PROPAC	SYMPHONY	SIDEKICK (C.P.)	SUPERCALC 3	WORD PERFECT	LOTUS 1-2-3
\$243	\$409	\$35	\$189	\$235	\$295

AID Typequick ALPHA SOFTWARE Data Base Manager 2 ANDERSON-BELL Abstat ASHTON-TATE D Base II D Base III Framework Friday ATI Training Word Star Training dBase III BPI General Ledger General Accounting BORLAND INTERNATIONAL Toolbox Turbo Pascal CDEX Advanced Lotus 1-2-3 CHANG LABS Rags to Riches Ledger CONDOR Condor 3 CONTINENTAL SOFTWARE Home Accountant Plus DIGITAL MARKETING Writers Pak Milestone (PC) Datebook II Proofreader DIGITAL RESEARCH Concurrent PC DOS ENERTRONICS Energraphics Plotter Option FOX & GELLER DGraph dUtil Quickcode II or III FUNK Sideways	85 295 169 395 267 495 CALL 695 CALL 695 CALL 295 CALL 75 45 75 45 595 399 595 399 54 35 54 35 70 45 99 78 650 239 150 89 250 165 250 165 150 98 50 38 295 239 350 259 100 55 295 145 99 58 295 145 60 39	HARVARD SOFTWARE Harvard Project Mgr Harvard Total Project Mgr HUMAN EDGE Mind Prober IUS Easy System II General Ledger Accounts Payable KOALA Touch Tablet (PC) MacVision LEXISOFT Spellbinder LIFETREE Volkswriter Deluxe LIVING VIDEO TEXT INC. Think Tank (IBM) Think Tank (Mac) MDBS Knowledgeman K Paint K Graph MECA Managing Your Money MICROGRAFX PC Draw MICROPRO WordStar SpellStar CorrectStar MailMerge InfoStar WordStar 2000 WordStar 2000 Plus MICROROM R Base 4000 Extended Report Writer Clout MICROSOFT Multiplan Charl (MAC) Project	395 229 495 299 50 35 395 184 595 295 595 295 150 95 400 249 495 239 295 158 195 109 150 99 500 275 100 65 225 145 199 119 395 289 350 179 99 55 145 99 99 55 250 199 CALL CALL 495 259 150 109 250 135 195 139 125 99 250 179	MICROSTUFF Crosstalk MONOGRAM Dollars and Sense (IBM) Dollars and Sense (Mac) MULTIMATE INTERNATIONAL Multimate Word Plus Punctuation and Style PEACHTREE Peachtext 5000 Business Graphics System Peachpak 4 PETER NORTON Norton Utilities (Vers. 3.0) PRENTICE-HALL Execuision PRO TEM SOFTWARE Notebook II Footnote ROSESOFT Prokey SAMNA Word III SORCIM SuperCalc 2 Super Project SOFTWARE PRODUCTS INT'L Open Access SOFTWARE PUBLISHING PFS File or Write SSI Word Perfect TELOS Filevision (Mac) TYLOG dBase Window WARNER SOFTWARE INC. The Desk Organizer WOLFF SYSTEMS Move It	195 98 179 110 149 99 495 253 150 105 150 95 425 185 295 219 395 199 100 65 395 299 189 123 99 84 130 79 550 295 295 154 395 219 695 349 140 85 495 249 195 125 249 155 195 129 150 85
--	--	---	---	---	---

Free UPS shipping on orders over \$1,000.00

CALL FOR PRODUCTS YOU DON'T SEE HERE!

CALL FOR OUR FREE CATALOG

TO ORDER CALL TOLL-FREE:

(800) 235-3020 (USA)

(800) 235-3021 (CA)

(415) 382-9085

TERMS:

- Call for shipping charges and support policies
 - Full guarantee against manufacturers defects
 - Allow 3 weeks for checks to clear
 - Prices may change
 - Call for availability
 - No cash refunds!
- Due to our low prices, all sales final.



448 IGNACIO BLVD., STE. 332
NOVATO, CA 94947

- SAME DAY SHIPMENT ON MOST ORDERS
- Prompt UPS service
- Authorized purchase orders accepted
- Dealer, institutional and quantity discounts available
- No surcharge for credit card purchases
- VISA & Mastercard accepted
- COD

ASK BYTE

SRD Corporation Model BCR-170
SRD USA Liaison Office
999 North Sepulveda Blvd.
Suite 314
El Segundo, CA 90245
(213) 417-5114
—Steve

32-BIT COMPUTER DESIGN

Dear Steve,

I want to design a 32-bit computer using the 32032 processor. I am in need of information on high-resolution graphics-board design, bit-slice and array microprocessors, interfacing 32- and 8-bit buses, high-resolution monitor design, and some good test equipment. Any information would be appreciated.

R. J. ILING
Port Coquitlam, British Columbia,
Canada

Data on the 32032 can be obtained from National Semiconductor Corporation, POB 70818, Sunnyvale, CA 94086. This processor is quite new, but the company probably has application notes that will help in designing your system.

Texas Instruments Inc. (POB 401560, Dallas, TX 75240) features a line of bit-slice processors, and it also publishes the book Fundamentals of Microcomputer Design. Contact TI at the above address for information on data sheets and application notes.

Two Motorola application notes, AN-843: "Using the MC68000 and the MC6845 for a Color Graphics System" and AN-851: "Motorola MC6845 CRTS Simplifies Video Display Controllers" (available from Motorola Semiconductor Products Inc., POB 20912, Phoenix, AZ 85036), provide design details for a graphics-display system. Other video-display-controller chips are made by Texas Instruments and several other semiconductor manufacturers. (See my article "High-Resolution Sprite-Oriented Color Graphics" in the August 1982 BYTE.)

Test equipment can be obtained from a number of advertisers in BYTE. You will need at least a digital multimeter, a digital-signal generator, and a good oscilloscope to start.—Steve

WHAT MEANS COMPATIBLE?

Dear Steve,

Would you please explain the term "IBM-compatible"? IBM clones are sprout-

(continued)



The Most Powerful C

for the IBM AT • MACINTOSH • MS DOS • CP/M-80 • ROM APPLICATIONS
IBM PC/XT • APPLE II • CP/M-86 • TRSDOS • CROSS DEVELOPMENT

Why Professionals Choose Aztec C

AZTEC C compilers generate fast, compact code. AZTEC C is a sophisticated development system with assemblers, debuggers, linkers, editors, utilities and extensive run time libraries. AZTEC C is documented in detail. AZTEC C is the most accurate and portable implementation of C for microcomputers. AZTEC C supports specialized professional needs such as cross development and ROM code development. MANX provides qualified technical support.

AZTEC C86/PRO

— for the IBM AT and PC/XT

AZTEC C86/PRO provides the power, portability, and professional features you need to develop sophisticated software for PC DOS, MS DOS AND CP/M-86 based microsystems. The system also supports the generation of ROM based software for 8088/8086, 80186, and 80286 processors. Options exist to cross develop ROM code for 65xx, 8080, 8085, and Z80 processors. Cross development systems are also available that target most micro computers. Call for information on AZTEC C86/PRO support for XENIX and TOPVIEW.

POWERFUL — AZTEC C86/PRO 3.2 outperforms Lattice 2.1 on the DHRYSTONE benchmark 2 to 1 for speed (17.8 secs vs 37.1) while using 65% less memory (5.8K vs 14K). The AZTEC C86/PRO system also compiles in 10% to 60% less time and supports fast, high volume I/O.

PORTABLE — MANX Software Systems provides real portability with a family of compatible AZTEC C software development systems for PC DOS, MS DOS, CP/M-86, Macintosh, CP/M-80, APPLE II+, IIe, and IIc (NIBBLE - 4 apple rating), TRSDOS (80-MICRO - 5 star rating), and Commodore C64 (the C64 system is only available as a cross compiler - call for details). AZTEC C86/PRO is compatible with UNIX and XENIX.

PROFESSIONAL — For professional features AZTEC C86/PRO is unparalleled.

- Full C Compiler (8088/8086 - 80186 - 80286)
- Macro Assembler for 8088/8086/80186/80286
- Linkage Editor with ROM support and overlays
- Run Time Libraries - object libraries + source DOS 1.x; DOS 2.x; DOS 3.x; screen I/O; Graphics; UNIX I/O; STRING; simulated float; 8087 support; MATH; ROM; CP/M-86
- Selection of 8088/8086, 80186, or 80286 code generation to guarantee best choice for performance and compatibility

- Utility to convert AZTEC object code or libraries to Microsoft format. (Assembly + conversion takes less than half the time as Microsoft's MASM to produce MS object)
- Large memory models and sophisticated memory management
- Support products for graphics, DB, Screen, & ...
- ROMable code + ROM support + separate code and data + INTEL Hex Converter
- Symbolic Debugger & Other Utilities
- Full Screen Editor (like Vi)
- CROSS Compilers are available to APPLE II, Macintosh, CP/M-80, TRSDOS, COMMODORE C64, and ROM based 65xx, and 8080/8085/Z80
- Detailed Documentation

AZTEC C86/PRO-AT\$500
(configured for IBM AT - options for 8088/8086)

AZTEC C86/PRO-PC/XT\$500
(configured for IBM PC/XT - options for 80186/80286)

AZTEC C86/BAS includes C compiler (small model only), 8086 MACRO assembler, overlay linker, UNIX, MATH, SCREEN, and GRAPHICS libraries, debugger, and editor.

AZTEC C86/BAS\$199
 AZTEC C86/BAS (CP/M-86)\$199
 AZTEC C86/BAS (DOS + CP/M-86)\$299
 UPGRADE to AZTEC C86/PRO\$310
 C-TREE Database with source\$399
 C-TREE Database (object)\$149

CROSS COMPILERS

Cross Compilers for ROM, MS DOS, PC DOS, or CP/M-86 applications.

VAX -> 8086/80xxx cross\$5000
 PDP-11 -> 8086/80xxx cross\$2000

Cross Compilers with PC DOS or CP/M-86 hosts are \$750 for the first target and \$500 for each additional target. Targets: 65xx; CP/M-80; C64; 8080/8085/Z80; Macintosh; TRSDOS; 8086/8088/80186/80286; APPLE II.

AZTEC C68K

— for the Macintosh

For power, portability, and professional features AZTEC C68K-c is the finest C software development system available for the Macintosh.

The AZTEC C68K-c system includes a 68000 macro assembler, a linkage editor, a source editor, a mouse based editor, a SHELL development environment, a library of UNIX I/O and utility routines, full access and support of the Macintosh TOOLBOX routines, debugging aides, utilities, make, diff, grep, TTY simulator with upload & download (source supplied), a RAM disk (for 512K Mac), a resource maker, and a no royalty license agreement. Programming examples are included. (Over 600 pages of documentation).

AZTEC C68K-c requires a 128K Macintosh, and two disk drives (frugal developers can make do with one drive). AZTEC C68K supports the 512K Macintosh and hard disks.

AZTEC C68K-c (commercial system)\$500
 AZTEC C68K-p (personal system)\$199
 AZTEC C68K-p to AZTEC C68K-c upgrade\$310

Mac C-tree database\$149
 Mac C-tree database with source\$399
 Lisa Kit (Pascal to AZTEC C68K object converter) . . \$ 99

AZTEC C65

— for the APPLE II

"...The AZTEC C-system is one of the finest software packages I have seen..." NIBBLE review, July 1984.

The only commercial C development system available that runs native on the APPLE II+, IIc, and IIe, the AZTEC C65 development system includes a full floating point C compiler compatible with UNIX C and other MANX AZTEC C compilers, a 6502 relocating assembler, a linkage editor, a library utility, a SHELL development environment, a full screen editor, UNIX I/O and utility subroutines, simple graphics, and screen functions.

AZTEC C65 (Apple DOS 3.3)\$199
 AZTEC C65/PRO (Apple DOS + ProDos)\$350
 (call for availability)

AZTEC C II/PRO

— for CP/M-80

The first member of the AZTEC C family was the CP/M-80 AZTEC C compiler. It is "the standard" compiler for development on CP/M-80. The system includes the AZTEC C II C compiler, an 8080 assembler, a linkage editor, an object librarian, a full library of UNIX I/O and utility routines, CP/M-80 run time routines, the SMALL library (creates modules less than 3K in size), the fast linker for reduced development times, the ROM library, RMAC and M80 support, library source, support for DRI's SIDZSID symbolic debugger, and more.

AZTEC C II/PRO\$349
 AZTEC C II/BAS\$199
 C-TREE Database with source\$399
 C-TREE Database in AZTEC object form\$149

AZTEC C80

— for TRSDOS (Radio Shack Model III & 4)

"I've had a lot of experience with different C compilers, but the Aztec C80 Compiler and Professional Development System is the best I've seen." 80-Micro, December, 1984, John B. Harrell III

This system has most of the features of AZTEC C II for CP/M. It is perhaps the best software development system for the Radio Shack Model III and IV.

AZTEC C80 model 3 (no floating point)\$149
 AZTEC C80 model 4 (full)\$199
 AZTEC C80/PRO (full for model 3 and 4)\$299

To order or for information call:

800-221-0440

(201) 530-7997 (NJ and outside U.S.A.). Or write: MANX SOFTWARE SYSTEMS, P.O. Box 55, Shrewsbury, N.J. 07701.



TRS 80 RADIO SHACK TRS DOS is a trademark of TANDY.
APPLE DOS MACINTOSH is a trademark of APPLE.

For Technical Support
(Bug Busters) call: 201-530-6557

SHIPPING INFORMATION - Standard U.S. shipment is UPS ground (no fee). In the U.S. one day shipment is \$20, two days is \$10. Canadian shipment is \$10. Two days shipment outside the U.S. is by courier and is freight collect.

A FULL C COMPILER FOR \$4995

The Ecosoft Eco-C88 compiler for the 8088 and MSDOS is going to set a new standard for price and performance. Consider the evidence:

Compiler	Eco-C88	Lotus (1)	CB6 (1)
Seive	13	11	13
Fib	44	58	46
Deref	13	13	-
Matrix	21	29	27
Price	\$49.95	\$500.00	\$395.00

(1) *Computer Language*, Feb., 1985, pp.73-102. Reprinted by permission.

The Eco-C88 compiler is a full K&R C compiler that supports all data types and operators (except bit fields). Now look at the other features we offer:

- ★ 8087 co-processor support using a single library. If you install an 8087 later, the software will use it without having to recompile.
- ★ A robust standard library with over 150 functions, including transcendentials, color, and others.
- ★ OBJ output for linking with the MSDOS linker (LINK).
- ★ Error messages in English - no cryptic numbers to look up. A real plus especially if you're just getting started with C.
- ★ Easy-to-read and complete user's manual.
- ★ Works with all IBM and compatibles running MSDOS 2.0 (or later).
- ★ Plus many other features.

For \$10.00 more, we will include the source code for the C library functions (excluding transcendentials). For an additional \$15.00, we will include our ISAM file handler in OBJ format (as published in the **C Programmer's Library**, Que Publishing). The discount prices for the library source and ISAM only apply at the time the compiler is purchased. Please add \$4.00 to cover postage and handling. To order, call or write:

Ecosoft Inc.
6413 N. College Avenue
Indianapolis, IN 46220
(317) 255-6476



Eco-C (Ecosoft), MSDOS (Microsoft), UNIX (Bell Labs), CP/M (Digital Research), Z80 (Zilog), 8086, 8087, 8088 (Intel).



YOU WIN!



ing up like weeds, and every manufacturer claims that his product is IBM-compatible. Some, though, qualify this statement and state that it does not run all the IBM software. Even you designed a 16-bit machine, and you also claim that it is IBM-compatible.

There is a considerable price difference between the real IBM and the clones, and I am contemplating whether I should go IBM or compatible.

HARRY RIESBECK
Nepean, Ontario, Canada

IBM compatibility is indeed an often misused term. In a general sense, any computer that can run Lotus 1-2-3 and Microsoft's Flight Simulator is said to be "IBM-compatible," since these programs make extensive use of keyboard, memory, and graphics features. Any machine capable of running MS-DOS is considered compatible, since MS-DOS and PC-DOS are compatible. However, to be 100 percent compatible, the ROM BIOS (read-only memory basic input/output system) routines must be identical. Since these routines, which oversee the operation of the hardware, are copyrighted by IBM, the only legal way to get them is to license them or develop them independently.

Many computers are bus-compatible with the IBM PC and will handle most of the accessory boards now on the market. Others have some minor quirks in the graphics routines, keyboard control functions, and use of interrupts.

Some PC clones on the market are 100 percent compatible with the IBM PC, and they do represent a better value. Check product reviews in the major computer magazines.—Steve ■

* With T³, save complex expressions by name, and you never have to type them again.

* With T³, use up to 25 levels of subscripting and superscripting.

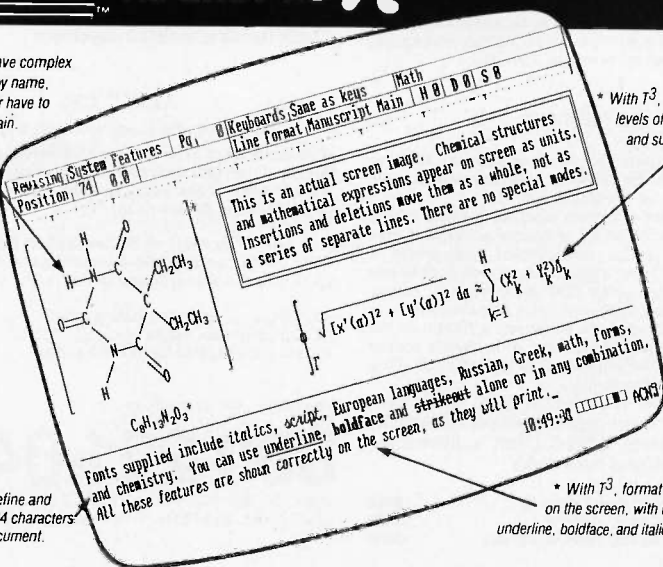

* With T³, define and use up to 1024 characters in a single document.

* With T³, format text directly on the screen, with line spacing, underline, boldface, and italics all visible.

With T³ complex expressions appear on the screen as they will be printed. You enter them in a simple, direct manner which won't interfere with your train of thought. You can compose scientific manuscripts directly at the keyboard.

THE SCIENTIFIC WORD PROCESSING SYSTEM THAT'S EASY TO USE!



TCI SOFTWARE RESEARCH, INC.
1190-B FOSTER ROAD · LAS CRUCES, NEW MEXICO 88001

FOR THE IBM PC, XT, AT AND MANY COMPATIBLES. SUPPORTS: DOT MATRIX, DAISY WHEEL AND LASER PRINTERS, SUPPORTS HERCULES GRAPHICS CARD

CALL US FOR MORE INFORMATION
1-800-874-2383
IN NEW MEXICO (505)522-4600
TELEX: 317629

IN ASK BYTE, Steve Ciarcia answers questions on any area of microcomputing. The most representative questions received each month will be answered and published. Do you have a nagging problem? Send your inquiry to

Ask BYTE
c/o Steve Ciarcia
POB 582
Glastonbury, CT 06033

Due to the high volume of inquiries, personal replies cannot be given. All letters and photographs become the property of Steve Ciarcia and cannot be returned. Be sure to include "Ask BYTE" in the address.

The Ask BYTE staff includes manager Harv Weiner and researchers Bill Curlew, Larry Bregoli, Dick Sawyer, Robert Stek, and Jeanette Dojan.

EVERYTHING ABOUT YOU IS UNIQUE.

283-3340
FREDERICK BRINS
Vice President
Concepts

You need nothing less than a custom news service

From your fingerprint to your monogram, you are unique. You wear a business suit tailored just for you; now you can get business news tailored just for you. With NewsNet you get vital, in-depth business news. You get expert information on your industry or profession. Through your computer and telephone, you get news on a vast range of subjects from the world's largest retrieval service of business newsletter information.

3,000 New Articles Screened Each Day

You'll get access to more than 250 business newsletters, plus wire services like UPI and PR Newswire. There's news on everything from computers to investments, from taxes to telecommunications. 3000 new articles are added every day and each one is screened specially for you.

Fast, Versatile, Simple

You enter key words, names or phrases. NewsNet stores them and saves every article containing those words. Check in daily, even hourly; scan the headlines or read entire articles, and print out what you want to keep. Change key words when you like. You're free from the worry that you've missed something important—and your topics may turn up in publications you'd never have time to read. If you're onto a new topic, the entire NewsNet database is available for your search. Get special reports on your competition, the inside story on an industry, or press coverage of a company's new product.

Start Saving Now

The average newsletter carried by NewsNet costs \$200 per year in print form. That's \$50,000 worth of newsletters. Yet with NewsNet you pay as little as \$15 per month for access. And NewsNet has no initiation fee. It's a tremendous value. So call today. We'll send everything you need to start saving now.



800-345-1301

(In PA 215-527-8030)

945 Haverford Rd. Bryn Mawr, PA 19010

Inquiry 293

Alloy. We b



And AT&T, Columbia, Compaq, Corona, Eagle, TI Professional, and
QICSTOR-PLUS, PC-DISC, PC-BACKUP, PC-CARD, and PC-9 TRACK

Alloy Computer Products, Inc., 100 Pennsylvania Ave., Framingham, Mass. 01701 (617) 875-6100, TWX: 710-346-0394 Europ

Backup IBM.



Zenith. With PC-QICTAPE, PC-STOR, PC-SLAVE/16, PC-QICSTOR,
See Alloy's full line of innovative products in action at your local dealer. Inquiry 21

Alloy Computer Products (Europe) Ltd., Cirencester, Gloucestershire, England. Tel: 0285-68709, Tlx: 43340

ALLOY
Computer Products, Inc.

CLUBS & NEWSLETTERS

● BBS FOR MEMBERS

Uploading and downloading are features of the 300-bps BBS called ABACUS-COM, operating 24 hours, 7 days a week at (805) 871-2725. It is for members of A Bakersfield Area Commodore User Society (ABACUS). The group meets on the second Wednesday of every month in Bakersfield, California. Contact Gene Smith, ABACUS, 2316 Sandy Lane, Bakersfield, CA 93306.

● FARMER'S CHOICE

Descriptions of agricultural software packages, electronic information services, and university contact information for farmers is available in a capsule form in the newsletter *Agricultural Computing*. Contact Doane Publishing, 11701 Borman Dr., St. Louis, MO 63146, (314) 569-2700.

● TECHNICAL SCHOLASTICS

An independent newsletter from a nonprofit organization about educational computing, *Academically Speaking*... is produced bi-monthly for the benefit of computerists, teachers, and manufacturers. Contributions concerning hardware and software developments that affect curriculum and administration in postsecondary education are welcome. Contact William Buchholz, *Academically Speaking*... Scholastech Inc., POB 1545, Cambridge, MA 02238.

● A HUNDREDFOLD

A newsletter for the TRS-80 Model 100, *Century*, contains hardware and software news and reviews, programs, and information that is also ap-

plicable to the NEC and Olivetti computers. It is published eight times a year; a subscription is \$35. Contact *Century*, Peregrine International, Suite P-225, 323 South Franklin, Chicago, IL 60606-7095.

● ENGINEERS REVIEW

Engineering Software Exchange (ESE) is a monthly newsletter that promotes high standards in engineering-applications software. Reviewers critique programs based on the quality of documentation, degree of user-friendliness, interactive features, and the completeness of the software. A subscription is \$60 annually. Contact Lidia LoPinto, CAE Consultants Inc., 41 Travers Ave., Yonkers, NY 10705.

● A WELCOMING

ASSEMBLY—The Milwaukee Area IBM Personal Computer Users Group meets at 7 p.m. twice a month. Members who use IBM PC and compatible computers can benefit from product demonstrations, instructional sessions, a monthly newsletter, and access to a library of public-domain software. Contact the IBM PC Users Group, POB 2121, Milwaukee, WI 53203-2121, (414) 679-9075.

● COMPUTERS FOR

HOOSIERS—The BBS of the Hoosier Users Group (HUG) is on line 24 hours a day at (317) 631-994A to serve

users of the Texas Instruments 99/4A computer. The monthly newsletter, which is exchanged with other users groups, supplements monthly meetings. The group sponsors classes in BASIC and Extended BASIC. Special-interest groups and a library of public-domain software meet members' specific needs. Contact HUG, POB 2222, Indianapolis, IN 46206-2222.

● TELEWORKS

The *TeleCommunting Report*, a monthly newsletter published by Electronic Services Unlimited, tracks developments in the field of location-independent work. Because corporations are presently running pilot programs and researching the use of computers in homes or at satellite offices, reports of their results can aid small businesses as well as manufacturers. A subscription is \$145. Contact Electronic Services Unlimited, 142 West 24th St., New York, NY 10011, (212) 206-8272.

● MAC STREET JOURNAL

The newsmagazine of the New York MacUsers' Group, *The Mac Street Journal*, is published monthly by and for the benefit of Mac users. Articles, reviews, and graphics are included as well as an order form for public-domain software and members' evaluations of software. Monthly meetings feature lectures, demonstra-

tions, and special-interest group discussions. A bulletin board is maintained. Annual dues are \$32. Contact New York MacUsers' Group, POB 6686, Yorkville Station, New York, NY 10128.

● BUG PREMIERS

The First Basis Users Group (1st BUG) meets on line and in New York City every month. Members maintain a BBS and produce a monthly newsletter and a semiannual directory of users of Basis 108, a 6502/Z80-based microcomputer. Contact John Flory, 1st BUG, 4 Tower Lane, Morristown, NJ 07960.

● FOR AGRICULTURALISTS

Farmers and agri-business-people who use computers in their operations can share ideas and public-domain software via a monthly newsletter called *The Computer Farmer*. Contact Kelly Klaas, Route 1, Box 4133, Twin Falls, ID 83301, (208) 733-4251.

● INDEPENDENT

EXPANSION—The Phoenix Chapter of the Independent Computer Consultants Association (ICCA) meets the second Tuesday of the month at 6 p.m. in Phoenix, Arizona. A newsletter is produced monthly; annual subscriptions are \$10. ICCA is a nonprofit club for computer consultants and contract programmers. Contact Mike Diross, ICCA, Phoenix Chapter, POB 32115, Phoenix, AZ 85064, (602) 892-3270.

● THE PUBLIC'S DOMAIN

A newsletter covering public-domain and user-supported

.....
CLUBS & NEWSLETTERS is a forum for letting BYTE readers know what is happening in the microcomputing community. Emphasis is given to electronic bulletin-board services, club-sponsored classes, community-help projects, and other activities. We will continue to list new clubs and newsletters. Allow at least four months for your club's mention to appear. Send information to BYTE, *Clubs & Newsletters*, POB 372, Hancock, NH 03449.

(continued)

PERSONALITY PROBLEM?

UNIX™ and DOS™ At the Same Time!

Looking at an IBM PC/AT? Happy with DOS but want UNIX? Happy with UNIX but want DOS? Want them working together?

Get The Connector!™

The Connector is a revolutionary product that allows DOS applications to run on the IBM PC/AT or XT under VENIX/86 (the first licensed AT&T UNIX operating system for the IBM PCs) or PC/IX. That means you can add one or more terminals to your AT which run programs using multi-user VENIX/86 to share the disk and printer. Switch between UNIX and DOS at the console with a single command. And run more than one task simultaneously. Like running a spelling check in the background while you print a report and run Lotus 1-2-3™ or dBaseII™.

Get yourself an AT and load it with VENIX. Collect your DOS and/or UNIX applications. We'll supply The Connector. The right solution to your software personality problems.

Call for complete details.

Unisource Software Corp., Department 4109,
71 Bent Street, Cambridge, MA 02141.
Telex 92-1401/COMPUMART CAM.
617-491-1264

Also
available
on the
PC/XT and
compatibles.



Getting UNIX Software
Down to Business

* UNIX is a trademark of AT&T Technologies, Inc. DOS is a trademark of Microsoft, Inc. PC/AT and PC/XT are trademarks of IBM. The Connector is a trademark of Unisource Software Systems, Inc. VENIX/86 implementation by VenturCom, Inc. 1-2-3 and LOTUS are trademarks of Lotus Development Corp. dBaseII is a trademark of Ashton-Tate.



data systems

THE QUALITY GOES IN BEFORE THE NAME GOES ON

PROFIT FROM ZENITH DATA SYSTEMS Z-150 PC DESKTOP OR Z-160 PC PORTABLE IBM COMPATIBLES!

OWN TOTAL PERFORMANCE
USE ZENITH'S PERSONAL COMPUTER SYSTEMS!

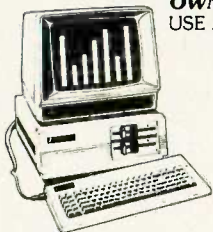

ZENITH DATA SYSTEMS Z-150 PC DESKTOP SYSTEM

W/ 2 DRVS, 320K RAM, 2P, S, CCB, RAM-DISK & PRT SPOOLER, MS-DOS, MS-WORD*, MS-MULTIPLAN* S/W \$1,929
SAME AS ABOVE W/ 576K RAM \$2,058
WITH 320K, 1 FLPY, 10.6Mb H.D. \$2,669
WITH 576K, 1 FLPY, 10.6Mb H.D. \$2,798

*WHILE SPECIAL OFFER LASTS!

S=100™
(800) 528-3138

- 4 Open Expansion Slots ■ Full Color*, Green*, or Amber Video ■ Clearly Labeled, Easy-to-Use Keyboard ■ Excellent Price/Performance Ratio ■ Zenith Total Service, Technical and Training Support

*Z-150 PC ONLY - MONITOR NOT INCLUDED



ZENITH DATA SYSTEMS Z-160 PC PORTABLE SYSTEM

SAME AS Z150PC W/ 2 DRVS, 320K RAM, S, P, MS-DOS, WORD* AND MULTI-PLAN* SOFTWARE \$2,239
SAME AS ABOVE W/ 10.6Mb H.D. \$2,849

*WHILE SPECIAL OFFER LASTS!

SEE PAGE 501
FOR OTHER PRODUCTS

BLANK DISKS

Major Brands • Low Prices

Call ALF first
1-800-321-4668

If you need 50 or more top quality disks, bulk-packed (without expensive labels or fancy packaging), call the toll-free number above for the latest price on your favorite brand. ALF copies thousands of disks each day—so we know which disks will perform best with your system! Inside Colorado call 234-0871.

ALF ALF Products • Denver, CO

CLUBS & NEWSLETTERS

software for the IBM PC is devoted entirely to new disks, their reviews, and questions and answers concerning their exchange. *PC-SIG News* is produced by the PC Software Interest Group, which has also published *Directory of Public Domain (and User-Supported) Software for the IBM Personal Computer*. Contact the PC Software Interest Group, Suite 130, 1556 Halford Ave., Santa Clara, CA 95051.

● **LOGO FOR THE TEACHER**—*Microquests*, a monthly publication available from September through May for teachers of Logo, contains mathematical, scientific, and linguistic problems for children to solve. A subscription is \$25 a year. Contact Martin-Bearden Inc., POB 337, Grapevine, TX 76051.

● **MEDICS ON LINE**
The Atlanta Medical Forum is available at (404) 351-9757 every hour of the day at 300 and 1200 bps. It is a user-supported private BBS for people interested in areas of health care that involve computers. The Bread Board System software allows message exchange and file transfer. A \$15 annual donation is requested. Contact Dr. Floyd Garrett, Suite 424, 315 Boulevard NE, Atlanta, GA 30312.

● **LONE TEXAN EAGLE**
The East Texas Eagle Users meet the second Thursday of every month. Interested persons can contact R. J. Dodson, 1809 Bell, Longview, TX 75602, (214) 758-2994.

● **A NEW ADDITION**
The Adam Users Group (AUG), though independent, benefits from Coleco's input on new products in the bi-monthly newsletter, *AUGment*. The international group has scheduled an AUG BBS

for telecommunications linkups using the Adam. A public-domain library is available to members. Annual dues are \$12. Contact AUG, POB P, Lynbrook, NY 11563.

● **GROUP FOR THE VALLEY**—The Los Angeles area Valley PC Users Group meets on the second Thursday of each month in North Hollywood. It is a forum for sharing information among users of IBM PCs and compatible computers and provides a public-domain software library. Contact Carlo di Giovanni, 6161 Whitsett, North Hollywood, CA 91606, (818) 762-7566, or Robin Kaplan, The Information Group, 3414 Troy Dr., Los Angeles, CA 90068, (213) 851-2480.

● **MINDSETTERS**
The First Mindset Users Group welcomes members across the nation who share an interest in this MS-DOS micro with advanced graphics capabilities. Send an SASE to receive a sample newsletter. An annual subscription costs \$15. Local members meet in the Bay Area on the second Monday of each month. Contact David Duberman, 355 15th Ave. #5, San Francisco, CA 94118, (415) 668-8352.

● **ATTENTION CANADIANS**
RAM (Regroupement des Amateurs de Microordinateurs) contains five user subgroups for the IBM, Apple, TRS-80 Color Computer, Commodore 64, and CP/M-based computers. General and subgroup meetings are held each month. A BBS is maintained, and a newsletter written in French, *Organigramme*, is produced bimonthly. A public-domain and freeware library exists for each subgroup. Contact Ronald Léger, RAM, POB 21, St. Jean, Quebec J3B 6Z1, Canada. ■

YOUR DAYS OF BUYING TERMINALS ARE OVER!

Now there's SmarTerm terminal emulation software for your IBM* PC, XT, AT or compatible system. All SmarTerm products offer comprehensive and exact terminal emulation, powerful ASCII and binary file transfer facilities, and include TTY mode to link you to The Source, CompuServe, Dow Jones, Easylink, Tymnet or other popular services. We've included features such as multiple setup configurations, XMODEM and

PDIP* protocol support, "smart" soft-keys, plus European DOS support.

NEW SmarTerm 220 supports A-to-Z and other software requiring DEC* VT220 terminals. It includes the full capabilities of **SmarTerm 100**: DEC VT102, VT100, and VT52 emulation. If you need VT125 ReGIS graphics support, choose **SmarTerm 125**. For Data General Dasher* D100, D200, or D400 emulation you need **SmarTerm 400**.

Don't "scurry" around buying more obsolete terminals. Join the 20,000 users that have chosen SmarTerm. Try it for 30 days, with full refund privileges.

Persoft, Inc. - Madison, WI
(608) 273-6000 - TELEX 759491



AFTER SMARTERM,™ WHAT DO YOU DO WITH YOUR OBSOLETE TERMINAL?



IDEA CREDIT: Anne Hillebrand of Ada, Oklahoma. See your name in print! The best ideas for uses of obsolete terminals replaced by SmarTerm will be used in future ads. Write Persoft, Dept. GERBIL., 2740 Ski Lane, Madison, WI 53713.

*SMARTERM and PDIP are trademarks of Persoft, Inc. * IBM is a registered trademark of International Business Machines Corp. * DEC, VT and ReGIS are trademarks of Digital Equipment Corp. * DASHER is a registered trademark of Data General Corp.

persoft

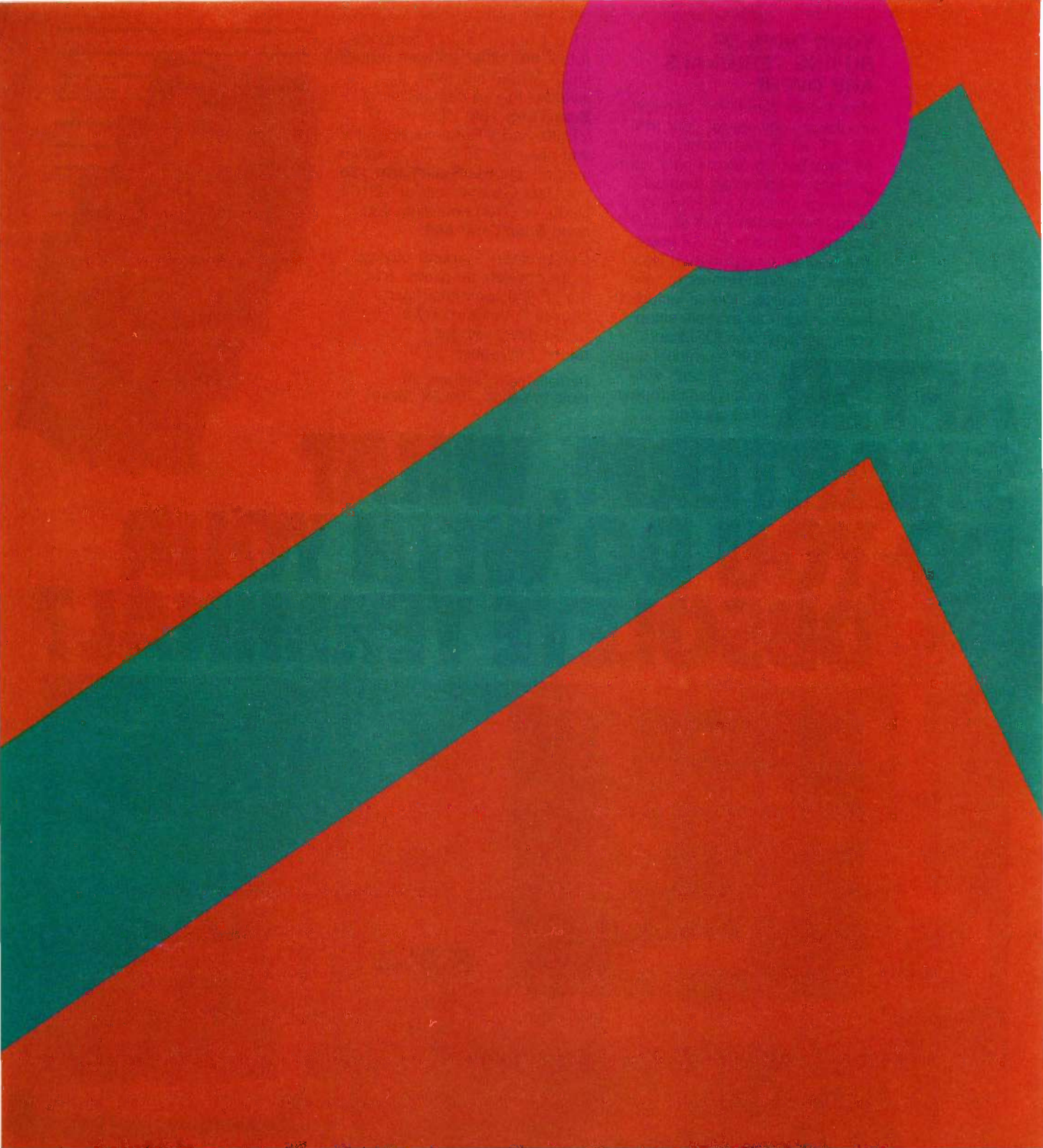

SPEAK SOFTLY AND CARRY A BIG SHTICK.

To lead an audience to your conclusions, you need more than strong words. You've got to show them your line of reasoning, and help them follow it.

You do that with strong, clear graphics. The kind you get from just one graphics package, Graphwriter. It's built to allow you to speak softly, while you hammer your message home.

Point by point.

It's got more easy-to-use, easy-to-customize charts than Lotus 1-2-3[®] or any other software on the market. And with Graphwriter, you can turn out your first chart in 15 minutes.

So, before your next presentation, get your hands on Graphwriter. Speak softly to the people at your local computer store. Or call 617-890-8778.

FORMATS

text/word
vertical column
stacked column
clustered column
horizontal bar
stacked bar
clustered bar
pies (1-4)
proportional pies
line
scatter plots
bar-line combination
Gantt
organization
bubble
table
pie-bar combination
surface line
stacked line
line-table
double stacked bars
range
paired bars
3D horizontal bar

FLEXIBILITY

text justification
variable font sizes
variable font colors
22 font styles
adjustable bar widths
pie rotation/placement
unequal line lengths
8 line types
5 frame options
8 fill patterns
axes labels (\$, %, x)
log/semilog scaling
multiple curve fits
floating comments
vertical page plotting
multiple plots per page

EASY-TO-USE

pre-designed formats
chartbook
input forms
1-2-3[®] DIF[®] access
Multiplan[®] file access
on-screen help messages
chart preview
'built-in artist'
batch processing
chart/template storage[®]

OUTPUT OPTIONS

paper
transparency
35mm slides
Polaroid Palette[™]
Matrix PCR[™]

COMPUTERS

IBM PC, XT and AT[®]
DEC Rainbow[®]
Tandy 2000[®]
HP 150[®]
NEC APC[®]
Burroughs ET2000[®]
Fortune Systems[®]
Wang Office Assistant[®]

Graphwriter with the Polaroid Palette
gives you slides in minutes. Even last minutes.

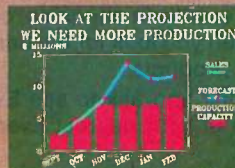

Graphwriter[®]

THE ART OF PERSUASION[™]

Inquiry 179

Graphic Communications Inc.
Waltham, Massachusetts 02254
(617) 890-8778

EVEREX EVER FOR EXCELLENCE



LOTUS 1-2-3 132 COLUMNS



PC PAINT



PC PAINTBRUSH 720x348

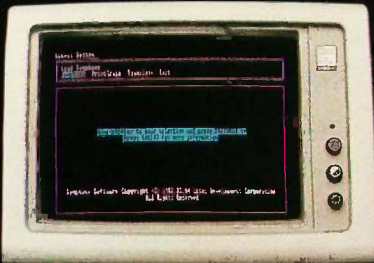

SYMPHONY HIGH RESOLUTION



PC PAINT

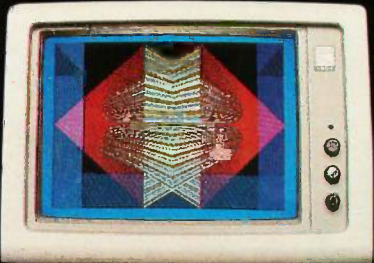

16 COLORS, 320x200

The Edge



The Plain Facts:

EVEREX THE EDGE	Everex The Edge	Paradise Modular Graphics	Tecmar Graphics Master	Tseng Lab Ultra Pak	Persyst Bob	Hercules Graphics Card
• IBM Monochrome Compatible, 720x348, High Resolution	✓		✓	✓		✓
• Runs Lotus 1-2-3™ and Symphony™ in high resolution monochrome:	✓		✓			✓
– 132 columnsx25 rows	✓			✓		
– 132 columnsx44 rows	✓			✓		
• PC Paintbrush in monochrome	✓		✓	✓		✓
• 16 shades of green on the IBM monochrome monitor	✓	✓				
• Runs color software on the IBM monochrome monitor, full screen:	✓	✓				
– Flight Simulator	✓	✓				
– PC Paintbrush	✓	✓				
– PC Paint	✓	✓				
– PC Tutor	✓	✓				
– Pinball	✓					
– Without software patch needed	✓					
• Automatic Boot-up without software patch needed	✓		✓	✓	✓	✓
• Runs Lotus 1-2-3™ and Symphony™ in high resolution color:	✓		✓			
– 16 colors, 320x200	✓		✓			
– 4 colors, 640x200	✓		✓			
• Printer port (standard)	✓		✓	✓	✓	✓
• Software switchable among color, monochrome and 132 columns mode	✓					
• Price	\$399	\$395	\$695	\$680	\$595	\$499

Excellence is the standard at Everex—it's in our name, our products, in everything we do. When you look for the best for your computer—you'll find Everex products.

Visit your local Everex dealer today and ask to see Everex products in action. For the name of your nearest Everex dealer, please call (415) 498-1111.

Dealer Hotline: (800) 821-0806. In CA (800) 821-0807.

Imaging Engineering Ultimo, Australia TLX: 74349 IMAGIN AA

Microage Distribution Ltd. London, England TLX: 881 3241 WONGS G

Feeder Paris, France TLX: 4413241 FEEDER

Automated Office Systems Hout Bay, South Africa 2721-70-8091

Survex, 1027 Speers Road, Oakville, Ontario Canada L6L-2X5, 416-842-6093

Pride Computers, 102-8167 Main Street, Vancouver,

British Columbia, V5X 3L2, 604-321-5690

Registered Trademarks: Paradise Modular Graphics Card—Paradise Systems, Inc.; Hercules Graphics Card—Hercules Computer Technology; Lotus 1-2-3—Lotus Development Corporation; PC Paint—Mouse Systems Corporation; Tecmar Graphics Master—Tecmar Inc.; Persyst Bob—Persyst Products; Ultra Pak—Tseng Lab.; The Edge—Everex Systems Inc.; IBM, PC Tutorial—International Business Machines Corporation; Flight Simulator—Microsoft Corporation.

EVEREX
EVER for Excellence

Address: 47777 Warm Springs Blvd., Fremont, CA 94539 (415) 498-1111.

B·O·O·K R·E·V·I·E·W·S

**THE APPLE
MACINTOSH BOOK**
Cary Lu
Microsoft Press
Bellevue, WA: 1984
383 pages, \$18.95

**FIRE IN THE VALLEY:
THE MAKING OF THE
PERSONAL COMPUTER**
Paul Freiberger and
Michael Swaine
Osborne/McGraw-Hill
Berkeley, CA: 1984
288 pages, \$9.95

**BENEATH
APPLE PRODOS**
Don Worth and
Pieter Lechner
Quality Software
Chatsworth, CA: 1984
295 pages, \$19.95

**PRODUCTIVE SOFTWARE
TEST MANAGEMENT**
Michael W. Evans
John Wiley & Sons
New York: 1984
232 pages, \$32.95

**THE APPLE
MACINTOSH BOOK**
Reviewed by Scott L. Norman

Cary Lu, in writing *The Apple Macintosh Book*, did not fall into the trap of creating an extended version of the Macintosh manuals. Instead, he produced a book that should be of broad interest to present and prospective owners of the Mac. To a lesser extent, it may also appeal to people who are generally interested in the improvement of the personal computer. Although the depth of coverage is occasionally shallow, the book lives up to the author's intention: to anticipate major questions and to furnish the tools for finding solutions rather than attempting to provide up-to-the-minute information on all relevant topics.

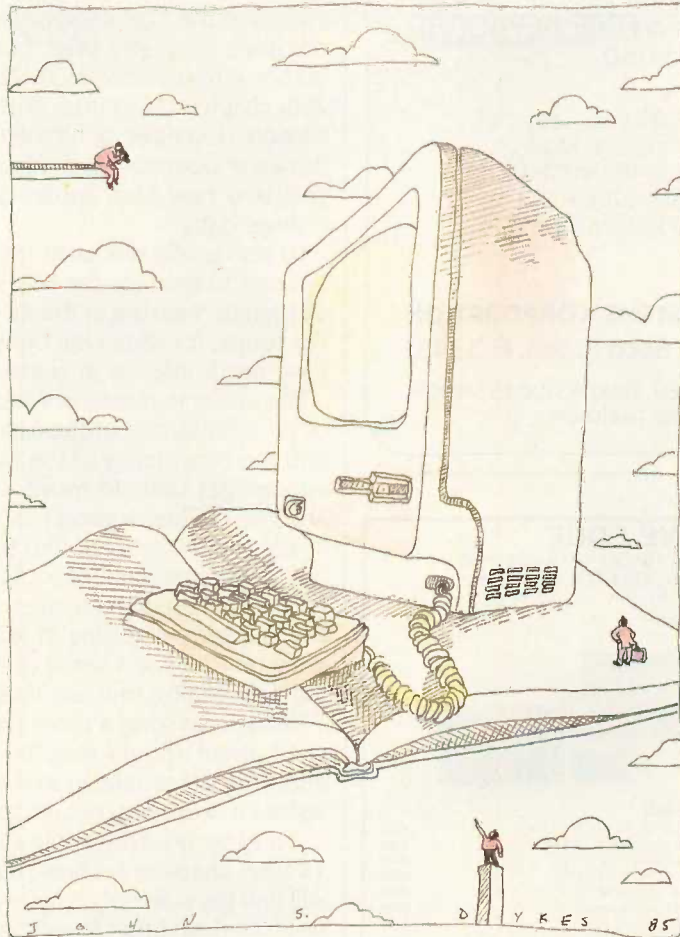

Because Lu's book was one of several commissioned by Microsoft Press while the Macintosh was still under development, it emphasizes the initial Microsoft programs: MacWrite, MacPaint, Multiplan, and Chart.

The book shares another, and more pleasing, characteristic with its competitors: the heavy use of graphics, in keeping with the computer's own style. The text is confined to half the width of a page, leaving plenty of room for screen printouts, sketches, and other marginalia. These are generally helpful, especially to people with little exposure to the Mac.

The Apple Macintosh Book is divided into four sections. Two chapters cover the philosophy of the visual interface, some of the strong points and limitations of the Mac, and the process of setting up the machine. Nine chapters emphasize basic machine operations.

The chapter "Fundamental Operations" is where Lu introduces the Mac desktop and the use of the mouse to manipulate windows and icons. It's well done, with plenty of illustrations of screens and menus and a liberal use of color to distinguish instructions to the user from a running commentary on what is happening.

DEALING WITH DISKS

In the 11th chapter, Lu describes the details of dealing with disks: initializing and erasing, copying, moving, renaming files, and so on. Although he is careful to describe how to go about things with a single-drive system, Lu emphasizes that two drives are almost mandatory for serious work. I think he's right, and prospective purchasers of the

(continued)

When Your Chips Are Down,

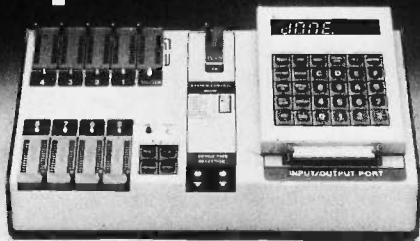

Bank on BYTEK'S
(E)PROM MultiProgrammer System S15-G
With Less Restrictions & a FREE KEYBOARD
For Only \$1150.

Stand Alone or Hook Up to your Terminal,
3 Voltage Devices, Simulation Module,
Supports Bipolar, PALs, 40 Pin Chips.
Also Available: S5 Basic (E)PROM
Programmer, \$690. UV Erasers from \$67.

BYTEK® COMPUTER SYSTEMS CORPORATION
1021 South Rogers Circle, Boca Raton, FL 33431
CALL TO ORDER (305) 994-3520, Telex 4310073 MEVBTC
Distributor Inquiries Welcome

COMPETITIVE EDGE

P.O. Box 556 — Plymouth, MI 48170 — 313-451-0665
CompuPro®, LOMAS, EARTH, TELETEK, Macrotech



SYSTEMS

CompuPro 286, SS1, I/O 4, Disk 1A, Disk 3, 20MB HD, 512K, 15 Slot 5" CCPM	4995.
Lomas 286, Hazitall, LDP 72, 1024K, 20MB, 1-5" Flop, 4 port, 15 Slot, CCPM	4995.
Lomas Thunder 186, 512K, 4 Slot, 10 MB HD, 4 Serial, CCPM, 1-5" Floppy	3995.
CompuPro 8085/88, I/O 4, Disk 1A, Ram 23, 10 Slot, 2-8" Drives CPM 2.2	2895.
CompuPro CPU Z, I/O 4, Disk 1A, Ram 23, 10 Slot, 2-8" Drs, CPM 2.2	2795.
Teletek Systemmaster II, 8MHz Z80, 128K, 10 Slot 2-8" Single Turbodos	2695.
Teletek Systemmaster, 4MHz Z80, 64K, 10 Slot, 2-8" CPM 2.2	2095.
Systemmaster II, 10MB HD, 1-8", 10 Slot, 4 Hi Speed 128K Slaves	4995.

S-100 CIRCUIT BOARDS

CompuPro 286 CPU**	\$695	Lomas 286	\$821	Macrotech 286/Z80H	\$995
CompuPro SPUZ** 8MHZ	261	Lomas 8086	420	Lomas 10MHz 8086	520
CompuPro 8085/88**	327	Lomas Oclaport**	320	Lomas 4 serial	200
CompuPro Disk 1A**	459	Lomas LDP**	206	Macrotech 256K Dram	499
CompuPro Disk 3**	525	Lomas 256K Dram	446	Macrotech 512K Dram	799
CompuPro Ram 22**	995	Lomas 512K Dram	821	Macrotech 512K static	1699
CompuPro Ram 23**	308	Lomas Ram 67**	725	Macrotech 256K static	995
CompuPro Ram 23 128	555	Lomas Hazitall**	244	Lomas Color Magic** 16K	476
CompuPro CPU Z**	215	Thunder 186**	1095	Lomas MSDOS** 2.11	225
CompuPro CPU/M**816*	250	Lomas CCP/M**86*	280	CompuPro MDrive H*512K	495
System Support One**	297	CompuPro I/O 4	297	CompuPro I/O 3 B port	459
Teletek HD/CTC	525	Teletek SBC 1	525	Teletek SBC 1 6MHz 128	699
Teletek Systemmaster*	557	Systemmaster II*	899	Turbodos® for Teletek	650

Earth Computer TURBO SLAVE I 8MHz 128K \$395.

Turbo Slave I runs with Teletek, North Star Horizon, Advanced Digital and Others.

CABINETS

Para Dynamics 20 Slot Pronto	\$1195.	Para Dynamics 2300D Floppy HD CAB	\$395.
Para Dynamics Mini Pronto	795.	Para Dynamics 2200 Rack Drive CAB	495.
CompuPro Enclosure 2 Desk Cab	611.	CompuPro Enclosure 2 Rack	645.

ALL PRICES SUBJECT TO CHANGE AND STOCK ON HAND

CompuPro is a Registered Trademark of Viasyn. CPU Z, Disk 1A, Disk 3, Interface 3, Interface 4, CPU 286, CPU 8085/88, System Support 1, MDRIVE-H, Ram 22, Ram 23 are trademarks or registered trademarks of Viasyn. CPM 2.2, CCPM, are registered trademarks of Digital Research Inc. MSDOS is a registered trademark of Microsoft. Systemmaster & Systemmaster II are registered trademarks of Teletek Enterprises. Turbodos is a registered trademark of Microsoft.

BOOK REVIEWS

Mac would do well to keep this in mind.

Lu dispenses reasonable advice on how to distribute system files, application programs, and data files among disks. The goal, as all Mac users soon learn, is to maximize usable storage space while minimizing the amount of time spent preparing disks for use. The trick is in learning which files must go where.

The chapter on disk handling closes with a discussion of how information can be moved between programs by means of the Mac's Clipboard and Scrapbook files. This discussion is pretty brief, however; at its conclusion the author advises interested readers to jump ahead to the 20th chapter, "Macintosh Software Issues." This interesting section describes a bit of the philosophy behind the design of operating systems and user interfaces and then gets into how Mac application programs store and exchange data.

Lu also briefly discusses the use of alternative operating systems to alleviate the Mac software shortage—a rather desperate measure at the moment. It seems unlikely that the people for whom the book is primarily intended would have much interest in pursuing this topic right away.

The ability to direct files with the mouse, Clipboard, and other tools is one of the Mac's most appealing features, and the consistency of the machine's operation certainly encourages users to move data from one application to another. Lu does a good job of describing the three forms in which the Clipboard and Scrapbook can store information: formatted data files, ASCII (American Standard Code for Information Interchange) text files, and picture files for the QuickDraw routine in ROM (read-only memory). He goes on to discuss some of the limitations on data sharing and editing that are likely to arise.

Readers seeking a more general idea of what the Mac is all about should read the chapter on MacPaint. The author devotes subsequent chapters to specific types of software: word processors, spreadsheets, business graphics, and so on. This applications material is followed by 14 brief chapters on how things work. This is where you will find the material on software issues that I have already described. Lu provides some details about the video display, keyboard, mouse, and I/O (input/output) ports, and he offers advice about printers and modems.

In three rather philosophical chapters, Lu speculates about future Mac products and the future development of microcomputers. He provides a comparison of the Mac and the IBM Personal Computer that will make few converts. This section is uneven. The chapters on the screen, keyboard, and mouse contain little material that most readers would care to refer to more than once. The chapter on disks and drives has more substance, and the one on printers contains at least a suggestion of what is needed to use printers other than the Imagewriter.

The final section consists of five chapters, containing material that didn't fit anywhere else. They are as much fun to read as anything in the book; the potpourri includes

(continued)

BIT FOR BIT THE BEST MODEM ON THE MARKET.

Other people make modems for telecommunications. But our new Courier 2400™ modem is made for business. This modern modem transmits, over the phone, 240 characters a second, enabling you to upload or download data at twice the speed of a 1200 bps modem. You'll cut phone costs, save precious hours and increase productivity.

BEING FASTER IS IMPORTANT BUT BEING BETTER WAS OUR GOAL.

The Courier 2400 features auto-dial and auto-answer ... and is fully CCITT and Bell compatible. It responds to the full AT command set, allowing you to use any of the popular telecom software packages, including Telpac™ by U.S. Robotics, Crosstalk™, PC Talk™,

Smartcom™ and many others. And the entire AT command set and S-register functions are displayed on "help screens" and again summarized for you on the underside of the unit.

Courier 2400 is accommodating in other ways too.

It lets you know the length of each call, tells you (on screen) the status of a call in progress, and even features an adjustable speaker to provide audio phone



Help Screens

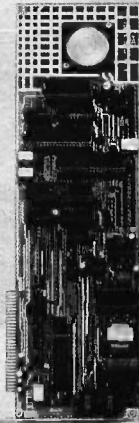

Microlink 2400™

line monitoring. Courier can test itself in both answer and originate modes, and automatically adjusts from 2400 bps to 1200 or 300 bps. And a powerful automatic equalizer assures nearly perfect performance on every call.

BEST OF ALL COURIER IS COMPATIBLE WITH YOUR BUDGET.

At \$699, you'll not find more modem for the money. If you prefer an internal slot modem for IBM-PC and compatible computers, our new Microlink 2400™

will deliver the same superior performance at the same affordable price.

And to get the most out of either Courier or Microlink, ask for new, improved Telpac telecommunications software with easy to use windows.

We set out to build the best modem on the market. Now, it's ready. Once you try Courier or Microlink, we think you'll agree — we're not exaggerating one bit.

Inquiry 402

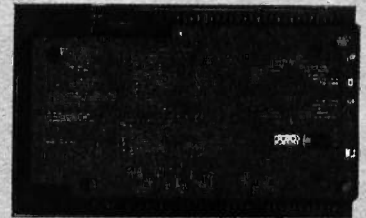

Bottom of Courier

courier 2400

by U.S. Robotics, Inc.

8100 McCormick Blvd.
Skokie, IL 60076
Phone: (312) 733-0497
Telex: 650-186-3130
Outside Illinois: 1-800-Dial USA



100% FLAWLESS COPIES . . .

. . . **FAST!**

No need to tie up your valuable computer to duplicate diskettes . . . when VICTORY can provide you with a duplicator that will do the job flawlessly, and much faster. One button operation automatically formats, duplicates and verifies up to 8 diskette copies at the same time.

VICTORY can supply you with literally dozens of standardized formats to match the protocol of virtually any current computer. In addition, built-in utilities enable you to read or devise any format you may require. If that's not enough, VICTORY can help you with unusual or unique formatting, serializing or copy-protecting problems.

VICTORY duplicators are designed to be reliable. Each of the copy drives has a separate controller to increase copying throughput and ensure maximum uptime. VICTORY Duplicators use industry proven drives combined with 100% digital technology . . . there are no analog circuits to slowly drift out of tolerance.

Let us help free you from your disk-duplicating bottleneck at a surprisingly attractive price. Write or call: VICTORY ENTERPRISES TECHNOLOGY, INC., 8910 Research Blvd., Suite B2, Austin, Texas 78758—(512) 450-0801.

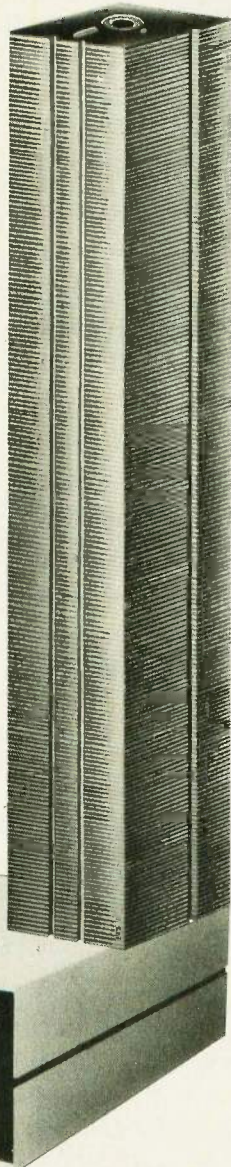

**VICTORY
ENTERPRISES**
Technology, Inc.

BOOK REVIEWS

thoughts on graphics, illustrations of the basic Macintosh fonts along with the names of their closest standard equivalents, and hints on moving specific types of files back and forth to popular application programs running on other machines. A 15-page glossary wraps things up.

Cary Lu, currently an editor at *High Technology* magazine, customarily takes a critical, level-headed approach to computers in his magazine writings; he maintains that approach in this book. It must have been difficult. The Macintosh is one of those high-tech objects that inspires high passions in its devotees and detractors, but Lu manages to keep things in perspective.

Scott L. Norman (8 Doris Rd., Framingham, MA 01701) is department manager of solid-state science at GTE Laboratories in Waltham, Massachusetts.

FIRE IN THE VALLEY: THE MAKING OF THE PERSONAL COMPUTER Reviewed by Joel Pitt

It's easy to forget that in the not-too-distant past the concept of a personal computer seemed fantastic. *Fire in the Valley*, by Paul Freiberger and Michael Swaine, is a history of the brief revolutionary period during which personal computers became a reality.

Changes in the direction of the computer revolution and in the image of the computer—from remote behemoth to tool of humanity—have been shaped by the personalities and motivations of the people who first dreamed of, and then built, personal computers. "The newborn industry," the authors write, was a movement of "hobbyists fully conscious that they were bringing on a social, not just a technological, revolution."

Freiberger and Swaine have lived in the valley south of San Francisco and watched the industry grow from that vantage point. Both men served as editors at *InfoWorld*; Freiberger is now West Coast editor of *Popular Computing*; Swaine is editor in chief of *Dr. Dobbs' Journal*. They don't ignore the contributions of hobbyists and professionals from other parts of the country, however, so their picture of the origin and development of the industry seems balanced and fair.

The chapter entitled "Tinder for the Fire" is a brief, general history of the computer and the transistor technology that permitted its miniaturization. The obligatory recitation of the evolution of the idea of the computer, starting with Charles Babbage's analytical engine, includes much that is old hat; however, the authors also discuss Intel's development of the first CPU (central processing unit) chip, the 4004, which is less well known. A brief account of David Ahl's failed attempt to interest Digital Equipment Corporation in selling computers for personal use underlines the conflict between the individual vision that drove the personal computer movement and the corporate computer world that "passed up the chance to

BOOK REVIEWS

bring computers into the home and onto the desk."

The birth and development of the MITS Altair computer is described in "The Voyage to Altair." We learn that the flashy cover photo on the January 1975 issue of *Popular Electronics*, which served to announce this first successful hobbyist computer kit to the world, was just a "photo of an empty metal box masquerading as a computer." The frantic race to bring the Altair into reality was a cliff-hanger. (What has come to be known as "vaporware"—products announced well before they're available—has an ancient and honorable role in the history of the microcomputer movement.) Fortunately, MITS was able to fill those metal boxes quickly enough so that the revolution was not brought to a halt just as it was getting off the ground.

But "The Voyage to Altair" is not only the story of the Altair computer. Many of the people who worked with the Altair went on to play major roles in the future of the personal computer. Freiburger and Swaine let us learn about them as we follow the history of MITS.

The next four chapters focus on the people, personalities, and est-inspired vision that drove IMSAI, the second major microcomputer manufacturer; the hobbyists and visionaries who flocked to and formed the Homebrew and other microcomputer clubs; the software developers who helped to make the microcomputer a usable tool; and the entrepreneurs who brought microcomputers and software to us in retail stores, computer shows, and magazines. We learn about the social vision that drove some people, the marketing vision that drove others, and the sense of discovery, play, and adventure that pervaded the movement. (The book is illustrated with 32 pages of photographs that help to put flesh on the players mentioned.)

The penultimate chapter, "American Pie," is devoted to Apple Computer and its founders, Steve Wozniak and Steve Jobs. And though the first six chapters of *Fire in the Valley* help refute Apple's occasional claim to have invented the personal computer, this chapter documents Apple's legitimate claim to a unique and critical role in bringing it to the people. The last chapter of the book, "Big Companies," covers the significant, though belated, entry of the major computer companies (which had passed up the opportunity to invent the personal computer) into the microcomputer business.

The story that Freiburger and Swaine have attempted to recount is rich with the excitement of discovery, serendipity, accidental association, businesses made and lost, and remarkable people. Because it is contemporary history, the authors were able to draw much of their information from interviews with many of the people involved. They have relied to a lesser degree on written sources. In the preface there's a long list of acknowledgments of the people they interviewed, but there is no bibliography.

Freiburger and Swaine's reliance on oral sources helps give their book a personal vitality; however, because of their dependence on interviews, the accuracy of their

(continued)

NEW!

THE UPS THAT TALKS TO YOUR COMPUTER.

MICRO-FERRUPS™

TOTALLY EFFECTIVE POWER PROTECTION
Protects against blackouts, brownouts, spikes, surges, glitches, noise and frequency shifts. Provides computer grade sine wave power.

TRUE NO-BREAK UNINTERRUPTIBLE POWER
MICRO-FERRUPS provides true no-break uninterruptible power. (Many UPS on market are really standby systems that break power from 2-10 milliseconds when transferring to battery backup. That's an eternity to your computer and disk drive.)

BATTERY INCLUDED
Sealed no-maintenance, long life battery included. An auxiliary 12 volt battery can be added for longer backup time.



250VA \$945
500VA \$1345

TALKS TO COMPUTERS
The on-board microprocessor and RS232 port allows MICRO-FERRUPS to interface with computers. Your power can be monitored by the computer so you know what is happening and an orderly shutdown can be made. AC input and output voltages, output current, load VA, line frequency, battery voltage and backup time remaining can be displayed on terminal. 300 or 1200 selectable baud rate. ASC II.

BEST BEST POWER TECHNOLOGY, INC. 800-356-5794
Wis. 608-565-7200

P.O. BOX 280, NECEDAHA, WISCONSIN 54646

NEW FOR '85
DATA CABLE
PRODUCTS

AUGAT

PACKAGED PRODUCTS

Visit us at
EDS
Booth Nos.
A47, A49

The Single Source for Sockets, Alcoswitches, Knobs, Ribbon Cable Products, RDI Terminal Blocks, D-Subs, Edge Cards, Telecon, RS-232 & Co-Axial Cables, Gender Changers, UHF & BNC, Flat Cable, Accessories

1985 Catalogs Available



1985 Catalog features Sockets, Switches, Knobs, Ribbon Cable Products

Data Cable Products Catalog features D-Subs, Edge Cards, Telecon, RS-232 Cables, UHF & BNC, Flat Cable, Accessories

1985 Supplement features RDI Terminal Blocks

GUARANTEED SALE

AUGAT

PACKAGED PRODUCTS

PREPAID*
FREIGHT

Call these TOLL FREE numbers for the name of the distributor or sales rep nearest you.

Nationwide (800) 336-3613 / In Mass. (800) 428-5700

P.O. Box 659, 40 Perry Avenue, Attleboro, MA 02703

Service Is Our Business
No Order Too Small

100% GUARANTEE

Undeniable.

Deluxe Computer Forms means undeniable quality. Your order must match your requirements — or you won't pay! That's quality, undeniably. Guaranteed.

Unquestionable.

Our unquestionable guarantee means the forms you select are 100% compatible with your software. Forms Consultants can answer your questions and we'll pay for the call. Tough questions about forms or compatibility — easy answers.

Unbelievable.

Unbelievable 3-day turn around means . . . fast service. You save money and time. Most custom forms orders 5-10 day turn around. Believe us, that's service. Fast.

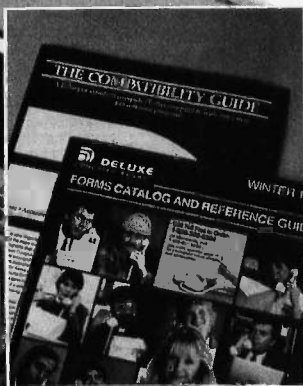

FREE CATALOG!

Call Toll Free to receive your FREE 32 page, color catalog.
1-800-328-5727 Ext. 513
In Minnesota 1-800-742-5685

 **DELUXE**
COMPUTER FORMS

7760

A DIVISION OF DELUXE CHECK PRINTERS, INC.

historical material may be open to question. It's not surprising to find that the intensely creative people who shaped the personal computer movement often had their own ideas about how things should be done and about their own rights and responsibilities. There were, of course, many disputes and, not surprisingly, differing accounts of what happened and why. It seems that the authors have made every attempt to be fair. It's not at all unlikely, however, that some of the many volatile personalities involved in the making of the microcomputer will take exception to a statement here or a date there.

Freiberger and Swaine have pulled together considerable information for *Fire in the Valley* and given it a sense of human vitality.

Joel Pitt (28 Cedar Ridge Rd., New Paltz, NY 12561) is a senior consultant with Woodbury Computer Associates and writes about microcomputer applications.

BENEATH APPLE PRODOS

Reviewed by Martin Kalman

From June 1978 to early 1984, the primary disk operating system (DOS) for the Apple II family was Apple DOS. Although early documentation was meager, this operating system was used to create the large body of software that has been an important factor in the popularity of these computers. Early in 1984, Apple Computer Inc. introduced a new operating system called ProDOS (Professional Disk Operating System) to rectify Apple DOS's shortcomings.

As with their earlier book, *Beneath Apple DOS*, Don Worth and Pieter Lechner attempt to document an operating system, with a particular emphasis on those topics that have been omitted or covered superficially in the Apple manuals. In the beginning, the authors state that *Beneath Apple ProDOS* is intended to serve as a companion to the manuals provided by Apple. They go on to enumerate the deficiencies of Apple DOS and point out how ProDOS has addressed these and made improvements.

The technical portion of the book begins with a chapter describing how data is stored on a floppy disk using the Apple II drive (or equivalent). The authors point out that this chapter should not be considered a prerequisite for understanding succeeding chapters. For this reason, I think it may have been more appropriate to place this chapter at the end of the book, perhaps as an appendix. The material, much of which is applicable to other Apple operating systems (DOS, Pascal, CP/M), would be of interest only to the advanced programmer who wants to access the disk at the lowest levels.

HIERARCHY

One of the most significant improvements provided by ProDOS is its hierarchically organized disk volume. In ad-

(continued)

IT'S ALL IN THE NAME



THE
LEADING EDGE™
PERSONAL
COMPUTER

THE BEST PRODUCT:

The Leading Edge™ PC is the only personal computer in the world that can run all the big name software packages 50% faster than an IBM® PC, while maintaining the highest level of reliability in the entire industry. And nobody can beat the list of standard features, or the twelve month warranty on all parts and labor.

THE BEST PRICE:

\$2095.
Complete with
Leading Edge™ Word Processing
with Spelling Correction

SUPPORTED BY THE BEST PEOPLE:

For as long as you own your Leading Edge PC, there will be a Technical Support Hotline—a staff of highly skilled, very friendly, hardware and software specialists, available toll free, at the other end of your telephone. No charge, no limits, no kidding.



LEADING EDGE®

Leading Edge Products, Inc.
Systems and Software Division
225 Turnpike Street, Canton, MA 02021
800-343-6833, (617) 828-8150

Leading Edge is a trademark of Leading Edge Products, Inc.
IBM is a registered trademark of International Business Machines, Corp.

THE MAINFRAME

When one of twenty Micro Mart Sales Pros answers a call, he's ready at his PC.

Micro Mart's Ten Million Dollar Inventory is on-line with our IBM Mainframe, so answers are fast and accurate.

With PC to Mainframe Inventory, this Micro Mart Salesman verifies his stock, quotes his best price and makes the sale.

HELLO. THIS IS MICRO MART MAY I HELP YOU?

YESSIR! YOU WANT 85 OF THEM? I'M CHECKING OUR INVENTORY. ONE MOMENT, PLEASE...

THEY'RE IN STOCK! CAN I LOCK THEM IN FOR YOU? THANK YOU, SIR! WOULD YOU LIKE THEM TOMORROW?

Computers

CANON Athena PC, Color or Monochrome Systems. AT INTRODUCTORY LOW PRICES LEADING EDGE Complete systems. FROM \$1495
THE COMPUTER SPECIAL OF THE MONTH! CALL FOR DETAILS!

Networking / Protocol Conversion

SNA & BISYNC 3270, 5251 Mod 12 & Mod 11, 3274, 3278.
PC TURBO 186 by ORCHID, 80186 coprocessor board. \$799
IRMA Complete line FROM \$799
FORTEGRAPH for IRMA, upgrades IRMA to 3279 S3G graphics.
IRMAPRINT Enhances IRMA graphics.
PC Net ORCHID's, new complete line. FROM \$299
TECHLAND SYSTEMS Blue Lynx 5251 Mod 12 & 3276 Emulators and 3270 Keyboards.
SANTA CLARA PC Partner & PC Terminal. CALL

Printers & Plotters

We have thousands in stock.
THE PRINTER SPECIAL OF THE MONTH! CALL FOR DETAILS!

HOUSTON INSTRUMENTS Plotters & Digitizers. Dot Matrix

EPSON FX80 Plus / 100 Plus.
EPSON LX80 / 100.
EPSON LQ1800.
EPSON JX80, color printer.
COMREX 420, 400 cps. Epson compatible. \$1795
OKIDATA 92 & 93, ML84, (200 cps.), w/opt. IBM PROMS, Pacemark 2410 (350 cps.)
OKIDATA Color printers. Complete line.
CANON Color printers. Complete line.
TOSHIBA P-1351, 1340 & P-351. \$1295 / \$799 / CALL
DATAPRODUCTS P. Series 8050 Color & 8070.
STAR MICRONICS Complete line.
TEXAS INSTRUMENTS 865, 866 & 850XL. FROM \$729

Letter Quality

NEC Spinwriters 2050, 3550, 8850.
JUKI 6100/6300. \$419 / \$749
C-ITOH Starwriter (40 cps), Printmaster, (55 cps). \$899 / \$1299
COMREX CR II E, CR III & CR IV.

We carry a full range of form handling options. Call for our unadvertised LQ Printers!!

Floppy Disk Drives

TANDON TM 100-2, DD/DS, 360K. \$149
1/2 HEIGHT DISK DRIVES: SHUGART, MITSUBISHI, TEAC. PC, XT & AT comp. FROM \$119
SPECIAL! Two 1/2 H. DD. "Y" cables & brackets. \$229



Hard Discs

Micro Mart carries all the major brands. If you don't see it—ask for it.
PEACHTREE PERIPHERALS P-10, 20, 30 & 50, internal & external. For your PC, XT, AT, AT&T, COMPAQ or others. FROM \$695
SYSGEN 10 & 20 Meg w/ streamer tape.
NEW MODELS—CALL!
SYSGEN Image & Quickfile, streamer tape back-up for your IBM XT & AT. CALL
BERNOULLI TECHNOLOGY Hard Disc Subsystems. FROM \$2595
DAVONG New line of hard discs. 21 & 32Mb w/ tape. Start @ \$2495

Chips

We guarantee the lowest price for chips!! Call us!!
INTEL 8087, 80287 High speed coproc. FROM \$129
64K RAMCHIPS. CALL FOR MARKET PRICE
256K RAMCHIPS. CALL FOR MARKET PRICE
128K PIGGY-BACK Chips for your AT. CALL FOR MARKET PRICE

Multifunction Boards

We have a complete line of multifunction boards compatible with the Portable, AT, XT, & Jr.
THE BOARD SPECIAL OF THE MONTH! CALL FOR DETAILS
SIX PACK 64-384K, multifunc.
MEGAPLUS 64-512K, max. 8 func.
MPII RAMboards, for PC & PC compatibles. CALL
I/O MINNIE, I/O shortboard for Portable & AT.

ADVANTAGE 128K-3Mb, expansion for AT. CALL
QUADRAM QUADBOARD, 64-384K. \$259
QUAD Jr. Expansion for PCjr.
TECMAR CAPTAIN, 0-384K multifunc. \$199
TECMAR CAPTAIN Jr., Multifunction for Jr.
TALLTREE J-RAM II, 0-512K, w/software.
TALLTREE J-RAM IIX, 0-512K, w/software. \$129
STB RIO GRANDE & GRANDE BYTE, Expansion for AT, 128K. FROM \$259
LEGACY Complete line of expansion products for Jr.

Graphic Cards

PREVIEW Monochrome graphics. Hercules look-alike for less. CALL
HERCULES Mono & color graphics cards.
PLANTRONICS ColorPlus + HiRes color board, par. port w/software. New low price!
TECMAR Graphics Master, HiRes color & mono supports Lotus. \$459
QUADRAM Quadcolor I & II, color cards.
PARADISE SYSTEM Multi-display or Mod. Graphics Cards, color & mono, par. port. FROM \$299

Software

ASK ABOUT THE SOFTWARE SPECIAL OF THE MONTH!
Accounting
SORCIM / IUS Complete line including windows. FROM \$279 / EA.
CYMA Complete business series.

MICRO MART HAS OVER 20 STORE LOCATIONS. CALL FOR THE ONE NEAREST YOU.

(404) 449-8089

Prices are subject to change without notice and are similar, but may vary at Micro Mart Retail Stores.

Service & Repairs

- On-Site—We have hundreds of service locations nationally.
- Depot—Our National Service Center is one of the fastest in the U.S.
- We Have—A wide variety of services available. Please call us.

EVENT. 1-800-241-8149.

orders only

As the order is processed, each product is thoroughly tested before shipping.

Micro to Mainframe Order Entry and Processing is fast... then we can ship by Federal Express for next day delivery.

The result? Some very satisfied Micro Mart Customers!



GREAT JOB GETTING THAT PC STUFF, DOCTOR!

Modems

- HAYES Smartmodem 300, 1200, 1200B & 2400.** The best stock in the U.S. **CALL PROMETHEUS Modems.**
- ANCHOR AUTOMATION Signalman Mk XII.** \$899
- VEN-TEL 1200 BAUD 1/2 Card** for IBM Port. & XT.
- POPCOM Popcom, int. & ext.** w/voice and data comm.

Miscellaneous

- DYSAN DISKETTES, PC, XT, & AT compatible.** GUARANTEED LOWEST PRICE IN THE U.S. **CALL!**
- MOUSE SYSTEMS PC Mouse, optical w/ software.**
- MICROSOFT MOUSE** Bus or serial mechanical mouse w/ mouse menu software.
- KEYTRONICS 5150 & 5151.** PC and Jr. Keyboards.
- KENSINGTON MICROWARE Master Piece.** \$119
- CURTIS Accessories.** Pedestals, cables, etc.
- EDP Best selling line of surge protectors.** FROM \$35

Spreadsheets & Integrated Packages

- Call for our unadvertised spreadsheets!
- ASHTON-TATE Framework.**
- MICROSOFT MultiPlan, w/ templates.**
- MDBS Knowledge Man.**
- SORCIM / IUS SuperCalc 3, vers. 2.0.**

NEW LOW PRICE!

Enhancements & Utilities

- FOX & GELLER** Complete line of enhancements for dBase II, III & Rbase 4000.
- NORTON Utilities 3.0.** \$69
- ROSEPOINT ProKey 3.0.** \$89
- CENTRAL POINT SOFTWARE Copy II PC.** \$35
- ATI Training.** \$55
- SOFTSTYLE Set/Fx + and Printworks.** Printer control pkgs.
- SIDEWAYS** Inverts printout. \$45
- BORLAND Sidekick.**
- LIVING VIDEO TEXT Think Tank.** \$125

Compilers & Language Tools

- LATTICE C-Compilers.** \$299
- MICROSOFT** Complete line.
- WORDTECH** The dBase compiler.
- DIGITAL RESEARCH** Complete line.
- BORLAND Turbo Pascal, Turbo Toolbox** and more. FROM \$38/EA.

Graphics & CAD

- Micro Mart carries all the major CAD packages. Call if you don't see it.
- Zsoft PC Paint Brush, mouse driven graphics.** \$95
- DECISION RESOURCES ChartMaster/Sign-Master pkgs.**
- MICROPRO ChartStar.**
- MICROSOFT Chart.**

Communications

- MICROSTUF CROSSTALK XVI.** Latest version. \$99
- HAYES SMARTCOM II.**

Word Processors

- MULTIMATE** w/ Spelling checker & tutorial. \$259
- SAMNA +** word processor.
- MICROSOFT Word.** New version.
- LIFETIME Volkswriter Deluxe.** \$169
- SSI WordPerfect.** New version.

Office & Project Planning

- HARVARD Total Project Manager.** \$299
- SORCIM / IUS Super Project.**
- MICROSOFT Project.**

Data Base Managers

- Call for our unadvertised Data Bases.
- MICROIM 4000 or 6000, Report Writer & Clout options.** New low price!
- WARNER SOFTWARE** The desk organizer. \$145
- ASHTON-TATE dBase II & III.** AT compatible.
- MICROSTUF Infoscope.**



Micro Mart has financing options available. Ask for a Micro Mart Blue Chip Credit Card application, today.

America's PC Specialist. MICRO MART

IBM is a registered trademark of International Business Machines Corporation.



COMPUTERBANC

BANC ON U\$

GET SERIOUS. STOP PAYING HIGH PRICES NOW!

THOUSANDS OF AVAILABLE ITEMS. CALL FOR COMPLETE PRICING.

SYSTEMS

IBM PC		
256K, Two 360KB Disk Drives, Color Graphics or Monochrome Graphics board, Parallel Printer Port, Monochrome Display (Amber/Green), DOS 2.1		
LIST PRICE \$2950.00 — ONLY \$2095.00		
SUPER XT 10 Meg Upgrade		\$2795.00
IBM AT		5% OFF

IBM SOFTWARE

LOTUS 1-2-3	\$289.00
LOTUS Symphony	425.00
MICROPRO Wordstar	249.00
ASCII Express For IBM	125.00
Wordstar Professional	359.00
Infostar	249.00
Multimate	269.00
MICROSOFT Word	229.00
PC Mouse W/Software	139.00
Multiplan	139.00
Project	159.00
ASHTON TATE Friday	179.00
dBASE II	280.00
dBASE III	369.00
Framework	359.00
LIFETREE SOFTWARE Volkswriter	119.00
Volkswriter Deluxe	169.00
FOX & GELLER Quickcode	139.00
dUtil	59.00
dGraph	149.00
MICRORIM Rbase: 400	295.00
PFS Write	89.00
File	89.00
Report	89.00
Proof	79.00
Access	79.00
ENERGRAPHICS	269.00

IBM HARDWARE

AST Six Pack Plus 64K	259.00
MegaPlus II	269.00
PC Net 1 Starter Kit	830.00
QUORAM Quadboard O-K	219.00
Quadcolor 1r or Microfazer 64K	205.00
Quad for PC Jr.	CALL
MICROSCIENCE	
10MB Winchester	679.00
FRANKLIN TELECOM	
10 Meg Harddisk	699.00
22 Meg Harddisk	CALL
Cartridge backup	CALL
HERCULES Mono Graphics	316.00
Color Card	159.00
ORCHIO Turbo	CALL
PC Net Starter Kit	CALL
PLANTRONICS Colorplus	399.00
STB Rio plus 64K	245.00
Super Rio	255.00
Graphix + II NEW	245.00
AT Hardware	CALL
TEAC 55B	119.00
55F	169.00
TANDON TM 100-2	179.00
IBM Floppy 1.2 Meg	CALL
TALL GRASS 12MB W/Tape	2395.00
IRWIN Tape Drive	539.00
MOUSE SYSTEMS Optical Mouse	169.00
ALSO — PERSYST, ORCHIO, TITAN AND OTHERS	

PRINTERS

BROTHER HR-15	369.00
HR-25	619.00
HR-35	859.00
2024L0	915.00
JUKI 6100	429.00

NEC 2030	659.00
2050	799.00
3530	1229.00
3550	1539.00
STAR MICRONICS Gemini 10X	259.00
Gemini 15X	389.00
EPSON RX-80 F/T	329.00
FX-80 +	389.00
FX-100 +	595.00
L01500	1299.00
OKI0ATA 92A	389.00
93A	649.00
PANASONIC 1091	CALL
TOSHIBA 1350-P	1299.00

MONITORS

AMOEX 300	129.00
300A	145.00
310 A	169.00
Color I+	269.00
Color II	459.00
TAXAN Composite Amber	119.00
121/122	149.00
420 (RGB)	439.00
415 (RGB)	489.00
PRINCETON GRAPHICS HX-12	469.00
SR-12	625.00
MAX-12	189.00
ZENITH ZVM-122 Amber	85.00
ZVM-123 Green	95.00
NEC 1201 Hi Res Green	115.00
1205 Hi Res Amber	115.00
1260 Green	79.00
JC1215 Composite Color w/audio	215.00
JC1216 Color RGB	329.00

MODEMS

HAYES 1200	395.00
1200B	349.00
300	195.00
Micromodem //e	219.00
ANCHOR Mark X	109.00
Mark XII	239.00
Volkmodem 1200	199.00
NOVATION Smart Cat Plus	CALL
Access 1-2-3	419.00
Apple Cat II	239.00
PROMETHEUS Promodem 1200	308.00

APPLE PRODUCTS

MICRO SCI A2 drives //e	179.00
//c Drive	199.00
TEAC drive	149.00
APPLE Compatible drive	145.00
WESPER Interface	69.00
BUFFERED 16K	139.00
SYSTEMS SAVER Fan	69.00
MICROSOFT Premium //e	279.00
Softcard CP/M	229.00
Multiplan	129.00
MAC Multiple (Macintosh)	129.00
Basic (Macintosh)	109.00
APRICORN Serial Card	69.00
TITAN Accelerator	239.00
ASCII Express Professional	89.00
OSKETTE S/S or D/S Box 10	12.00/19.00
KOALA Touch Tablet	79.00
HAYES Mach III JoyStick	39.00
MAC Software	CALL
APPLEMOUSE II	129.00
VIDEO Ultratram	179.00
80 COLUMN/64K Interface //e only	99.00
APPLEWORKS	215.00

WE SUPPORT THESE FINE SYSTEMS:
Apple, Compaq, IBM, and many more.

TELEX #550757 / ANSWER BACK — COMPUTERBANK UD



Orders Only

800/332-BANC

OUTSIDE CALIFORNIA



COMPUTERBANC

16783 Beach Blvd., Huntington Beach, CA 92647

714/841-6160

Cash prices indicated. All products are in factory sealed packages. No guarantee all items for 30 days. Within this period, original manufacturer's warranty shall be honored by Bank number. All other items will be subject to a 10% restocking fee. For special orders, there will be a 2% shipping charge, 5% to UPS. Rush orders, \$5.00 minimum, all orders outside U.S. \$1.00 shipping. California residents add 8% sales tax. Prices subject to change without notice.

Copyright 1984 COMPUTERBANC All Rights Reserved

BOOK REVIEWS

dition to the main directory on each volume, ProDOS allows subdirectories within the main directory. Each subdirectory can hold files of any type, including further subdirectories. In this manner, a nested structure is created that allows easy file organization and access through individual pathnames. The chapter that follows discusses how ProDOS organizes information on a disk to provide the directory structure just described. Although this discussion assumes the medium is a standard Apple 35-track floppy disk, all of the information presented is applicable to other disk sizes and even to a hard disk.

Worth and Lechner then embark on a detailed description of how individual blocks of data (512 bytes) are allocated on the disk, beginning with the initial formatting that creates the volume directory and volume bit-map blocks. They describe the internal layout of different types of files, complete with numerous examples and excellent diagrams that show data organization and storage. These include directory files as well as typical file types such as BASIC programs, binary files, and text files.

At this point we are introduced to the ProDOS assembly-language program itself, which is loaded into RAM (random-access read/write memory) when the disk is booted. It consists of two parts: the ProDOS kernel and the BASIC interpreter. The kernel is made up of subroutines that can be called by any assembly-language program to access the disk, either block by block or file by file. The BASIC interpreter acts as a translator between a BASIC program (or a user's immediate commands) and the kernel. A short chapter shows the memory usage of these two components and explains how they are loaded into the computer during the booting process.

The remaining three chapters, which occupy more than half the book, are intended to aid the assembly-language programmer who wants access to the routines within the ProDOS program. In contrast to Apple DOS, ProDOS provides a set of 20 externally callable subroutines in the kernel. These subroutines, referred to as the machine-language interface (MLI), provide a simple method for accessing the operating system's disk, time and date, and interrupt-handling functions. Entry points are well documented, with detailed descriptions of all the required input parameters. A list of MLI error messages includes explanations that would be valuable when debugging.

One of the most interesting and potentially useful aspects of ProDOS is the provision for adding extra user-written commands to the BASIC interpreter. The chapter entitled "Customizing ProDOS" examines this feature. The authors even include a program in the appendix that installs a "Type" command. You can use this command to display the contents of an input text file on the screen.

In the final chapter of the book, Worth and Lechner describe the ProDOS global pages. These two pages always occupy a fixed position in memory and contain system-status and device-configuration information. Addresses in these pages are of use to the programmer for

(continued)

Available
for IBM PC

What C did for Programming

Mark Williams has done for C Programming

The C Programming System from Mark Williams

MWC86 gets your C programs running faster and uses less memory space than any other compiler on the market. Then *csd*, Mark Williams' revolutionary C Source Debugger, helps you debug faster. That's The C Programming System from Mark Williams Company.

MWC86

MWC86 is the most highly optimized C compiler available anywhere for the DOS and 8086 environment. The benchmarks prove it! They show MWC86 is unmatched in speed and code density.

MWC86 supports large and small models of compilation, the 8087 math coprocessor and DOS 2.0 pathnames. The compiler features common code elimination, peephole optimization and register variables. It includes the most complete libraries. Unlike its competition, MWC86 supports the full C language including recent extensions such as the Berkeley structure rules, voids, enumerated data types, UNIX* I/O calls and structure assignments.

Quality is why Intel, DEC and Wang chose to distribute MWC86. These industry leaders looked and compared and found Mark Williams to be best.

User Friendly

MWC86 is the easiest to use of all compilers. One command runs all phases from pre-processor to assembler and linker. MWC86 eliminates the need to search for error messages in the back of a manual. All error messages appear on the screen in English.

A recent review of MWC86 in *PC World*, June, 1984, summed it up:

"Of all the compilers reviewed, MWC86 would be my first choice for product development. It compiles quickly, produces superior error messages, and generates quick, compact object code. The library is small and fast and closely follows the industry standard for C libraries."

csd C Source Debugger

Mark Williams was not content to write the best C compiler on the market. To advance the state of the art in software development, Mark Williams wrote *csd*.

csd C Source Debugger serves as a microscope on the program. Any C expression can be entered and evaluated. With *csd* a programmer can set tracepoints on variables and expressions with full history capability and can single step a program to find bugs. The debugger does not affect either code size or execution time. *csd* features online help instructions; the ability to walk through the stack; the debugging of graphics programs without disturb-

ing the program under test; and evaluation, source, program and history windows.

csd eases the most difficult part of development — debugging. Because *csd* debugs in C, not assembler, a programmer no longer has to rely on old-fashioned assembler tools, but can work as if using a C interpreter — in real time.

The C Programming System from Mark Williams now supports the following libraries:

Library	Company
Windows for C	Creative Solutions
Halo	Media Cybernetics
PHACT	PHACT Associates
The Greenleaf Functions	Greenleaf Software
Btrieve	SoftCraft

The C Programming System from Mark Williams

The C Programming System from Mark Williams delivers not only the best C compiler for the 8086 but also the only C source level debugger. That's why it does for C programming what C did for programming. The Mark Williams C Programming System gives the programmer the MWC86 C compiler and the *csd* C Source Debugger for only \$495. Order today by calling 1-800-MWC-1700. Major credit cards accepted.

Technical support for The Mark Williams C Programming System is provided free of charge by the team that developed it.

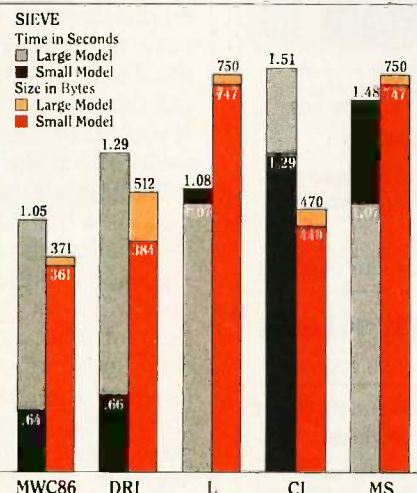

Mark Williams Company
1430 W. Wrightwood Ave.
Chicago, IL 60614

*Unix is a Trademark of Bell Laboratories.

64K S100 STATIC RAM

\$139⁰⁰
KIT

NEW!

LOW POWER!
150 NS ADD \$10

BLANK PC BOARD
WITH DOCUMENTATION
\$49.95

SUPPORT ICs + CAPS
\$17.50

FULL SOCKET SET
\$14.50

FULLY SUPPORTS THE
NEW IEEE 696 S100
STANDARD
(AS PROPOSED)

FOR 56K KIT \$125

ASSEMBLED AND
TESTED ADD \$50

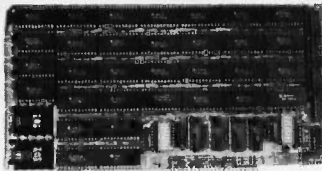

FEATURES: **PRICE CUT!**

- * Uses new 2K x 8 (TMM 2016 or HM 6116) RAMs.
- * Fully supports IEEE 696 24 BIT Extended Addressing.
- * 64K draws only approximately 500 MA.
- * 200 NS RAMs are standard. (TOSHIBA makes TMM 2016s as fast as 100 NS. FOR YOUR HIGH SPEED APPLICATIONS.)
- * SUPPORTS PHANTOM (BOTH LOWER 32K AND ENTIRE BOARD).
- * 2716 EPROMs may be installed in any of top 48K.
- * Any of the top 8K (E000 H AND ABOVE) may be disabled to provide windows to eliminate any possible conflicts with your system monitor, disk controller, etc.
- * Perfect for small systems since BOTH RAM and EPROM may co-exist on the same board.
- * BOARD may be partially populated as 56K.

256K S-100 SOLID STATE DISK SIMULATOR! WE CALL THIS BOARD THE "LIGHT-SPEED-100" BECAUSE IT OFFERS AN ASTOUNDING INCREASE IN YOUR COMPUTER'S PERFORMANCE WHEN COMPARED TO A MECHANICAL FLOPPY DISK DRIVE.

PRICE CUT!

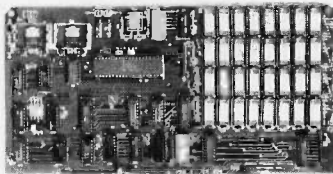

- FEATURES:
- * 256K on board, using + 5V 64K DRAMS.
 - * Uses new intel 8203-1 LSI Memory Controller.
 - * Requires only 4 Dip Switch Selectable I/O Ports.
 - * Runs on 8080 or Z80 S100 machines.
 - * Up to 8 LS-100 boards can be run together for 2 Meg. of On Line Solid State Disk Storage.
 - * Provisions for Battery back-up.
 - * Software to mate the LS-100 to your CP/M* 2.2 DOS is supplied.
 - * The LS-100 provides an increase in speed of up to 7 to 10 times on Disk Intensive Software.
 - * Compare our price! You could pay up to 3 times as much for similar boards.

BLANK PCB
(WITH CP/M* 2.2
PATCHES AND INSTALL
PROGRAM ON DISKETTE)
\$69.95
(8203-1 INTEL \$29.95)

\$199⁰⁰

#LS-100 (FULL 256K KIT)

THE NEW ZRT-80

CRT TERMINAL BOARD!

A LOW COST Z-80 BASED SINGLE BOARD THAT ONLY NEEDS AN ASCII KEYBOARD, POWER SUPPLY, AND VIDEO MONITOR TO MAKE A COMPLETE CRT TERMINAL. USE AS A COMPUTER CONSOLE, OR WITH A MODEM FOR USE WITH ANY OF THE PHONE-LINE COMPUTER SERVICES.

- FEATURES:
- * Uses a Z80A and 6845 CRT Controller for powerful video capabilities.
 - * RS232 at 16 BAUD Rates from 75 to 19,200.
 - * 24 x 80 standard format (60 Hz).
 - * Optional formats from 24 x 80 (50 Hz) to 64 lines x 96 characters (60 Hz).
 - * Higher density formats require up to 3 additional 2K x 8 6116 RAMS.
 - * Uses N.S. INS 8250 BAUD Rate Gen. and USART combo IC.
 - * 3 Terminal Emulation Modes which are Dip Switch selectable. These include the LSI-ADM3A, the Heath H-19, and the Beehive.
 - * Composite or Split Video.
 - * Any polarity of video or sync.
 - * Inverse Video Capability.
 - * Small Size: 6.5 x 9 Inches.
 - * Upper & lower case with descenders.
 - * 7 x 9 Character Matrix.
 - * Requires Par. ASCII keyboard.

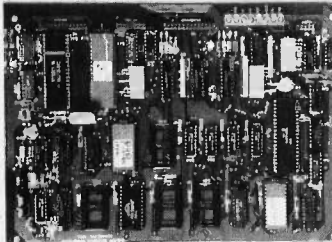

BLANK PCB WITH 2716
CHAR. ROM, 2732 MON. ROM
\$49.95
SOURCE DISKETTE - ADD \$10
SET OF 2 CRYSTALS - ADD \$7.50

WITH 8 IN.
SOURCE DISK!
(CP/M COMPATIBLE) **\$99.95** (COMPLETE KIT,
ZRT-80 2K VIDEO RAM)

Digital Research Computers

P.O. BOX 461565 • GARLAND, TEXAS 75046 • (214) 225-2309

Call or write for a free catalog on Z-80 or 6809 Single Board Computers, SS-50 Boards, and other S-100 products.

TERMS: Add \$3.00 postage. We pay balance. Orders under \$15 add 75¢ handling. No C.O.D. We accept Visa and MasterCard. Texas Res. add 5-1/8% Tax. Foreign orders (except Canada) add 20% P & H. Orders over \$50 add 85¢ for Insurance.

such tasks as calling the MLI via the BASIC interpreter or setting vectors to point to user-supplied command routines. The current ProDOS code occupies more than 22K bytes of memory. The authors expect that this code will change in the near future. Consequently, they have decided to describe only the BASIC-interpreter global page and the ProDOS global page. A special supplement is available from the publisher for those readers who wish to obtain a complete description of every piece of code and data within the ProDOS components.

Have the authors achieved their objective of improving upon the documentation provided by Apple? Yes, but I wish they had included even more information.

Martin Kalman (POB 243, Friday Harbor, WA 98250) has an M.S. from MIT and works as a freelance computer programmer and writer.

PRODUCTIVE SOFTWARE TEST MANAGEMENT

Reviewed by Douglas L. Freeman

Very little has been written about the testing of software. Since even the simplest program requires testing, clear-cut guidance is valuable to anyone who develops software. Michael W. Evans has missed the opportunity to provide this guidance because he has written a very complex book that will not appeal to a wide audience. He attempts to reduce most concepts to charts, some of which are fairly complicated, and he has a tendency to use acronyms excessively. Though *Productive Software Test Management* gets bogged down in details about organization, testing committees, definitions, and phases, some of the topics it raises are worth reviewing.

THE PLANNING PROCESS

Thorough software testing is often overlooked and undervalued. Testing can be easily overshadowed by the other complexities of software development. Evans correctly emphasizes the importance of planning. He begins his book with a story about a failed project and then tells how the disaster could have been avoided. The author points out that developers have a better chance of getting the resources needed for adequate testing if they've planned well for it at the beginning of a project.

Creating a detailed plan of how a system will be developed is a difficult task. In the early stages of a project, information and technical requirements are often vague. Precision is difficult to attain. The prudent systems manager will work hard to produce a strong software-development plan. According to Evans, planning should be done in a hierarchical fashion by first defining the top levels of development requirements (what is to be done) and structure (management and control). The development plan should contain a software test and integration segment. This segment describes the testing structure.

(continued)

ALL SALES SUBJECT TO THE TERMS OF OUR 90 DAY LIMITED WARRANTY. FREE COPY UPON REQUEST.

THE FORTH SOURCE™

MVP-FORTH

Stable - Transportable - Public Domain - Tools

You need two primary features in a software development package... a stable operating system and the ability to move programs easily and quickly to a variety of computers. MVP-FORTH gives you both these features and many extras. This public domain product includes an editor, FORTH assembler, tools, utilities and the vocabulary for the best selling book "Starting FORTH". The Programmer's Kit provides a complete FORTH for a variety of computers. Other MVP-FORTH products will simplify the development of your applications.

MVP Books - A Series

- Vol. 1, *All about FORTH* by Haydon. MVP-FORTH glossary with cross references to fig-FORTH, *Starting FORTH*, and FORTH-79 Standard. 2nd Ed. \$25
- Vol. 2, *MVP-FORTH Assembly Source Code*. Includes IBM-PC®, CP/M®, and APPLE® listing for kernel \$20
- Vol. 3, *Floating Point Glossary* by Springer \$10
- Vol. 4, *Expert System* with source code by Park \$15
- Vol. 5, *File Management System* with interrupt security by Moreton \$25
- Vol. 6, *Expert Tutorial for Volume 4* by M & L Derick \$15

MVP-FORTH Software - A Transportable FORTH

- MVP-FORTH Programmer's Kit** including disk, documentation, Volumes 1 & 2 of MVP-FORTH Series (*All About FORTH*, 2nd Ed. & *Assembly Source Code*), and *Starting FORTH*. CP/M, CP/M 86, Z100, APPLE, STM PC, IBM PC/XT/AT, PC/MS-DOS, Osborne, Kaypro, MicroDecisions, DEC Rainbow, TI-PC, NEC 8201, TRS-80/100 \$150
- MVP-FORTH Enhancement Package** for IBM-PC/XT/AT Programmer's Kit. Includes full screen editor, MS-DOS file interface, disk, display and assembler operators. \$110
- MVP-FORTH Floating Point & Matrix Math** for IBM PC/XT/AT with 8087 or Apple with Applesoft \$85
- MVP-FORTH Graphics Extension** for IBM PC/XT/AT or Apple \$65
- MVP-FORTH Programming Aids** for CP/M, IBM or APPLE Programmer's Kit. Extremely useful tool for decompiling, callfinding, translating, and debugging. \$200
- MVP-FORTH Cross Compiler** for CP/M Programmer's Kit. Generates headerless code for ROM or target CPU \$300
- MVP-FORTH Meta Compiler** for CP/M Programmer's kit. Use for applications on CP/M based computer. Includes public domain source. \$150
- MVP-FORTH PADS (Professional Application Development System)** for IBM PC/XT/AT or PCjr or Apple II, II+ or IIe. An integrated system for customizing your FORTH programs and applications. The editor includes a bi-directional string search and is a word processor specially designed for fast development. PADS has almost triple the compile speed of most FORTH's and provides fast debugging techniques. Minimum size target systems are easy with or without heads. Virtual overlays can be compiled in object code. PADS is a true professional development system. Specify Computer. \$500
- MVP-FORTH MS-DOS file interface** for IBM PC PADS \$80
- MVP-FORTH Floating Point & Matrix Math** see above \$85
- MVP-FORTH Graphics Extension** see above \$65
- MVP-FORTH EXPERT-2 System** for learning and developing knowledge based programs. Both IF-THEN procedures and analytical subroutines are available. Source code is provided. Specify Apple, IBM, or CP/M. Includes MVP Books, Vol. 4 & 6 \$100
- FORTH-Writer**, A Word Processor for the IBM PC/XT/AT with 256K. MVP-FORTH compatible kernel with Files, Edit and Print systems. Includes Disk and Calculator systems and ability to compile additional FORTH words. \$150
- MVP-FORTH Fast Floating Point** Includes 9511 math chip on board with disks, documentation and enhanced virtual MVP-FORTH for Apple II, II+, and IIe. \$450

Ordering Information: Check, Money Order (payable to MOUNTAIN VIEW PRESS, INC.), VISA, MasterCard, American Express. COD's \$5 extra. Minimum order \$15. No billing or unpaid PO's. California residents add sales tax. Shipping costs in US included in price. Foreign orders, pay in US funds on US bank, include for handling and shipping

FORTH DISKS

FORTH with editor, assembler, and manual.

- APPLE** by MM, 83 \$100
- MacIntosh** by MM, 83 \$125
- ATARI®** valFORTH \$60
- CP/M** by MM, 83 \$100
- HP-85** by Lange \$90
- HP-75** by Cassidy \$150
- IBM-PC** by LM, 83 \$100
- IBM-PC** by MM, 83 \$125
- Z80** by LM, 83 \$100
- 8086/88** by LM, 83 \$100
- 80000** by LM, 83 \$250
- VIC FORTH** by HES. VIC20 cartridge \$20
- C64** by HES Commodore 64 cartridge \$40
- Timex** by HW, cassette T/S 1000/ZX-81 \$25 2068 \$30

Enhanced FORTH with: F-Floating Point, G-Graphics, T-Tutorial, S-Stand Alone, M-Math Chip Support, MT-Multi-Tasking, X-Other Extras, 79-FORTH-79, 83-FORTH-83.

- APPLE** by MM, F, G, & 83 \$180
- ATARI** by PNS, F, G, & X. \$90
- CP/M** by MM, F & 83 \$140
- TRS-80/II or III** by MMS F, X, & 79 \$130
- C64** by PS MVP, F, G & X \$96
- C64** with EXPERT-2 by PS \$99
- Extensions** for LM Specify IBM, Z80, or 8086 Software Floating Point \$100 8087 Support (IBM-PC or 8086) \$100 9511 Support (Z80 or 8086) \$100 Color Graphics (IBM-PC) \$100 Data Base Management \$200

Key to vendors:

HW Hawk Wild Software
LM Laboratory Microsystems
MM MicroMotion
MMS Miller Microcomputer Services
PNS Pink Noise Studio
PS ParSec

FORTH MANUALS, GUIDES & DOCUMENTS

- Thinking FORTH** by Leo Brodie, author of best selling "Starting FORTH" \$16
- ALL ABOUT FORTH** by Haydon. MVP Glossary \$25
- FORTH Encyclopedia** by Derick & Baker \$25
- FYS FORTH from the Netherlands** User Manual \$25 Source Listing \$25
- FORTH Tools and Applic.** by Feierbach \$19
- The Complete FORTH** by Winfield \$16
- Learning FORTH** by Armstrong \$17
- Understanding FORTH** by Reymann \$3
- FORTH Fundamentals**, Vol. I by McCabe \$16 Vol. II Glossary \$14
- Mastering FORTH** by Anderson & Tracy \$18
- Beginning FORTH** by Chirlian \$17
- FORTH Encycl. Pocket Guide** \$7
- And So FORTH** by Huang. A college level text. \$25
- FORTH Programming** by Scanlon \$17
- Starting FORTH** by Brodie. Best instructional manual available. (soft cover) \$20
- 80000** fig-Forth with assembler \$25
- FORML Proceedings** 1980 1981 Vol 1 1981 Vol 2 1982 1983 1983 1984 each \$25
- 1981 Rochester Proceedings** 1981 1982 1983 1984 each \$25
- Bibliography of FORTH** \$17
- The Journal of FORTH Application & Research** Vol. 1/1 Vol. 1/2 Vol. 2/1 Vol. 2/2 Vol. 2/3 each \$17
- META-FORTH** by Cassidy \$30
- Threaded Interpretive Languages** \$25
- Systems Guide to fig-FORTH** by Ting \$25
- Inside F83 Manual** by Ting \$25
- FORTH Notebook** by Ting \$25
- Invitation to FORTH** \$20
- PDP-11 User Man.** \$20
- 6502 User's Manual** by Rockwell Intl. \$10
- FORTH-83 Standard** \$15
- FORTH-79 Standard** \$15
- Installation Manual for fig-FORTH** \$15
- Source Listings of fig-FORTH**, Specify CPU \$15

by Air: \$5 for each item under \$25, \$10 for each item between \$25 and \$99 and \$20 for each item over \$100. All prices and products subject to change or withdrawal without notice. Single system and/or single user license agreement required on some products.

MOUNTAIN VIEW PRESS, INC.

PO BOX 4656

MOUNTAIN VIEW, CA 94040

(415) 961-4103

COMPUPRO USERS

SMD Acceleration Options

now for Concurrent DOS

SMD SUBSYSTEMS

Controller—Drive—Power Supply—Cables

Desktop Cabinet / Concurrent DOS XIOS

600 MbMax	Concurrent DOS	XIOS
84 MBYTE	168 MBYTE	300 MBYTE
\$8,995.00	\$10,995.00	\$12,995.00

suggested list pricing

DATABANK ACCELERATED COMPUPROS

All systems with 5" & 8" floppy

Concurrent DOS XIOS

130 MBYTE Internal SMD Disk Drive & Controller

Standard Compupro System Specs and Enclosures

SUPER 816CH130 SMD	SUPER 816FH130 SMD
\$15,995.00	\$16,995.00

call for quote — any compupro system

WHY SMD?

1.2 MB/SEC x controller-disk transfer rate
20 MSEC average disk access time

****SPECIAL****
130 MYBTE = \$7,495.00
Internal retrofit on your lower enclosure
Prebooking Required
Only 48 hrs. at our site

WHY DATABANK?

Authorized Compupro System Center
Dunn & Bradstreet 05-204-9640

DATABANK 22B A WEST CARRILLO
SANTA BARBARA, CALIFORNIA 93101
(805) 962-8489

HARMONY VIDEO & COMPUTERS

2357 CONEY ISLAND AVE. BROOKLYN, NY 11223
800-VIDEO84 OR 800-441-1144 OR 718-627-1000



COMMODORE 64	APPLE 2C
\$149.95	\$889.95
APPLE 2E w/DRIVE	STAR SG 10
\$819.95	\$210.95

"PRINTER SPECIALS"

Brother HR15 XL	349	Juki 6100 Televideo	368	Panasonic KXP 1092	379
Brother HR 35	777	Juki 6300	629	Panasonic KXP 1093	562
Brother Keyboard	129	Mannesman Spirit 80	178	Panasonic KXP 3151	450
Citizen MSP 10	314	Mannesman 160L	458	PowerType	278
Citizen MSP 15	479	Mannesman 180L	829	QuadJet	720
Corona Laser	2468	NEC 2050	929	Riteman Blue +	195
Daisywriter	735	NEC 3550	1218	Star SG10	211
Diablo 620 API	659	NEC 7730	1629	Star SG15	352
Dynax DX 15 XL	342	NEC 8850	1679	Star SD10	352
Epson RX 80 FT +	285	Nec p3 or p2	839	Star SD15	431
Epson RX 80	219	Okidata 92	349	Star SR10	461
Epson RX 100	374	Okidata 93	564	Star SR15	571
Epson FX 80	369	Okimate 10	127	Star SB10	678
Epson J480	546	Olympal Compact 2	349	Silver Reed Exp 550	369
Epson FX 100 +	583	Olympal 10	304	Silver Reed Exp 500	263
Epson LQ 1500	908	Panasonic KXP 1091	252	Silver Reed Exp 770	659
HP Laser Jet	2678	Panasonic KXP 1090	168	Toshiba 1340	518
				Toshiba 1351	1113

WOW! WOW! WOW!

IBM	APPLE	MONITORS
PC w/Drive	2E w/Disk Drive	Amdek 300 Green
PC XT	Macintosh	Amdek 300 Amber
PC Portable w/Drive	Apple 2C	310 Amber
AST Six Pack	Imagewriter	Color 300
Tallgrass 20 Meg	Add. Drives	Color 200
Quad Board	Modem 12	Color 600
Keytronics		Color 700
Hercules Color	ATARI	Color 400
Hercules Monochrome	800 XL	Color 710
Paradise Graphics	1027 Printer	Taxan 210
Paradise Multi Display	1050 Drive	Princeton HX12
STB Graphics + 2	Intels. Drive	Taxan 122A
STB R10-2	1025 Printer	Taxan 420
Tecmar Graphics	Rana 1000	
Tecmar Captain	Koala Pad	SANYO
Persyst Color Card	Printer I/F	ESD D.S.
Persyst Monocard		505 D.S.
Bernoulli Box	MODEMS	CRT 70
10 Meg Drive	Hayes 1200	MBC 775
Joystick	Hayes 1200B	
Tandon 100-2	Hayes 300	COMMODORE
	Micromodem 2E	Commodore 64
ZENITH	Access 123	1541 Disk Drive
Zenith PC 2150	Novation J-cat	1702 Monitor
Zenith PC 15152		MPS 802
Zenith PC161-52		Indus. Drive

800-441-1144

Items reflect cash discount. For your protection we check for stolen credit cards.

BOOK REVIEWS

phases, levels, and organization. It lays the foundation for the entire software-testing process.

Test planning is the central theme throughout the first five chapters. Though Evans almost wears out the subject, he does make several good related points. He cautions the software manager against trading short-term project demands for long-term planning requirements. As a project proceeds, the demands on the manager increase. Time that was intended to be spent on planning disappears. The obvious result is a poorly developed software product and sometimes a failed project.

The author also observes that managers often try to apply techniques that worked for large projects to the development of small projects and vice versa. He advises that the software-development controls must be scaled to the technical and administrative requirements of the individual project. Readers should keep this point clear as they try to implement concepts from this book.

Evans devotes a chapter to the subject of motivating a software-test staff. This chapter is one of the best in the book. It gives the reader good advice about management direction and responsibility. The author counsels the software-test manager to "look and act like a leader" and "present a positive image to staff, customer, and management personnel." He also tells how to motivate three types of personnel: fast trackers, average performers, and poor performers. This advice is useful to managers of all disciplines.

THE REAL WORK OF TESTING

You have to read more than half of the book before you come to the two chapters that cover test specification and testing methodology. Evans warns that "personnel easily bog down in the morass of technical detail," but he does not follow his own warning. He proceeds to describe software testing in a style that is dense with terminology and definitions. In spite of this, a dedicated reader can still gain an insight into proper testing methods from these chapters.

A WORD OF CAUTION

Perhaps the most worthwhile part of the book's second half deals with satisfying the customer requirements of the project. Here Evans stresses the importance of customer participation throughout the software development. He states that customers will be more willing to accept a system if they have participated in the testing process.

Productive Software Test Management is not a book for every computer user. It would be of most interest to people involved in managing major software projects at very large development organizations. To other software developers the book would probably be fairly dull, and to casual users of microcomputers it would be close to useless. ■

Douglas L. Freeman (37819 Valley Rd., Oconomowoc, WI 53066), formerly a software-development consultant, is currently president of Color Corporation of America, Milwaukee.



sempé

Sperry introduces Usernet. Because PC's that talk only to themselves are a luxury few businesses can afford.

Stand alones shouldn't. Not in an office environment.

Alone, PC's are simply underutilized. But join them in the right kind of network, and their value as business tools increases exponentially. Your PC's can share fewer printers, share common data files, function independently or collectively. Just like people.

The question, then, is which system to choose.

Ours is not the only such system. But it may well be the most intelligently conceived.

It will accept any IBM-compatible PC's you already own. Eagle, Corona, Columbia, Compaq and so on. Even a Sperry.

Usernet begins with as few as four PC's, linked in a common bus with the industry-standard

"twisted pair" wiring. Simple and economical to install, service or expand. And expand you can, to as many as 64 PC's, merely by adding them on, without disrupting or replacing any part of the system.

As your Usernet grows, you'll appreciate a security system Stanford University rates as the best in the industry. It keeps your business yours.

But ultimately, any system such as Usernet stands or falls on speed. An information path, like a highway, can choke on its own traffic. So, the faster information moves, the less chance of developing a nasty form of gridlock.

It may surprise you to learn that Usernet speeds information along. In many cases, faster by a factor of 10 than our competition. Or yours.

For a demonstration at a Sperry Productivity Center near you, telephone 1-800-547-8362, or write: Sperry Corporation, P.O. Box 500, Blue Bell, PA 19424-0024.

© Sperry Corporation 1984



SPERRY

Lotus 1-2-3

dBase II

Wordstar

PFS: File

Crosstalk

Multi-Plan

Framework

Symphony

IBM

Personal Computer Color Display

How do you get your PC to wear many different hats at the same time?

E-Z-DOS-IT.™

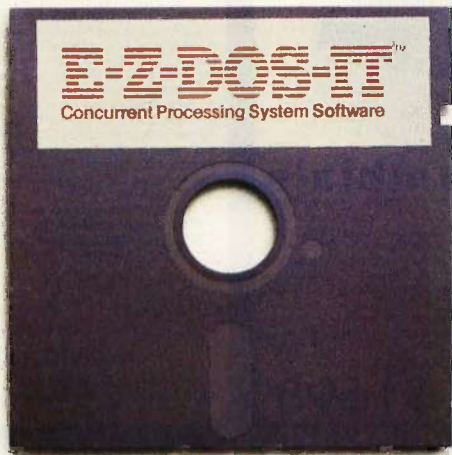

Introducing E-Z-DOS-IT™ Concurrent Processing — for IBM PCs and PC compatibles.

Before today, your IBM PC (or PC compatible) could wear only one processing hat at a time. Now, with E-Z-DOS-IT Concurrent Processing, your PC can be an editor, financial analyst, and artist all *at the same time*. And you can be a writer. Or a programmer. In fact, E-Z-DOS-IT is the only concurrent processing system that can run effectively on machines with 256K and up.

Switch from one program to another at the drop of a hat.

With your current system, each time you need to access information on a different disk, you have to save your files, unload and load a program. E-Z-DOS-IT enables you to switch con-

veniently from one application to another instantly. With this easy referencing capability, you can quickly respond to questions, and finish projects significantly faster.

E-Z to use, E-Z to afford.

You'll find it takes only ten minutes to master E-Z-DOS-IT Concurrent Processing. And the suggested retail price is only \$199.95 — improved productivity was never this affordable.

Improved personal productivity at your fingertips.

E-Z-DOS-IT is the one system software package you can't afford to be without. For more information and the name of the dealer nearest you, call toll-free: 800/228-9602 (in California, call 800/423-5592), ask for Operator 1.

 **HAMMER**
Redefining Your PC Productivity.

E-Z-DOS-IT is a trademark of Hammer Computer Systems, Inc., 700 Larkspur Landing Circle, Suite 285, Larkspur, CA 94939

The following registered trademarks are acknowledged: IBM and IBM PC, International Business Machines; Lotus 1-2-3 and Symphony, Lotus Development Corporation; dBase II and Framework, Ashton-Tate; Wordstar, MicroPro International; PFS:File, Software Publishing; Crosstalk, Microstuff, Inc.; Multi-Plan, Microsoft Corporation.

Compare with the Leading Edge PC



Super Sperry

Our new Super Sperry system is made by Mitsubishi, just like the Leading Edge PC. Like the Leading Edge it runs 50% faster than the IBM-PC, gives you 5 compatible slots for expansion, dual 5 1/4" drives, serial and parallel ports, MS-DOS 2.11, GW-BASIC, and an automatic clock/calendar card.

Unlike the Leading Edge our Super Sperry has a better keyboard with LED's on the lock keys and a tactile feedback, a more powerful power supply, a rat solid green phosphor display, and AT tutorials.

What makes our Super Sperry really super, however, is that they come with a massive 640K of RAM, installed and tested, as standard equipment. We urge you to buy the best, even if it's the less expensive Super Sperry for:

\$1949



Altos

High-performance, Xenix-based, multi-user systems from Altos-world leaders in multi-user systems and applications software.

As part of TRW's marketing support group we can have your Altos system installed on your site (additional charge).

Altos systems are easy to expand, and with shared printers and hard disks are cost competitive with multiple single user systems. Call for additional pricing and availability.

486-20	\$4539
586-40	\$7249
986-40	\$8829
Altos Acc't	\$2779

PRINTERS



Epson FX-80+	\$269 \$180 off
RX-80FT	\$369 \$100 off
Okidata 92	\$269 \$125 off
Okidata 93	\$299 \$210 off
Okidata 84	Call
Star 5G-10	\$239
Star SR-15	\$599
Panasonic 1091	\$298
Toshiba 1340	\$579

LETTER QUALITY

Powertype	\$299
Juki 6100	\$399
Juki 6300	\$719
Silver Reed 400	\$249
Silver Reed 500	\$299
Silver Reed 550	\$409
Silver Reed 770	\$724
Diablo	Call
NEC	Call
Daisywriter 2000	\$824

HOUSTON INSTRUMENTS

DMP-29	\$1795
DMP-40	\$745
DMP-41	\$2340
other models	Call

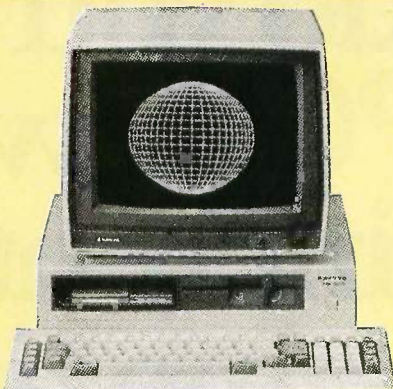

* More Free Software *

Along with all the free great software you get with a Sanyo MBC 550, Scotsdale Systems includes 3 extra disks with: (1) OS Tutor - Teaches you everything you need to know about the operating system right on your system. (2) 15 games for the Sanyo 550 - a \$29 (retail) value. (3) DateMate - an appointment keeper with a perpetual calendar. (4) IS Manager - Allows you to change the structure of existing InfoStar files. (5) PC File. (6) 10 public domain games. (7) diagnostics and utilities, and (8) Sketch - A graphics/drawing program written in Sanyo Color Graphics BASIC.

I went to look at the MBC-550... what I found made me an owner the next day!
Bill Sudbrink, Byte Magazine

Sanyo 555-2's

If you plan to purchase a Sanyo MBC 555-2, or a single drive MBC 550-2 you've made an excellent choice. The Sanyo MBC 550 series is the lowest priced 8088, MS-DOS system bar none. Plus with the single drive 550-2 systems you receive MS-DOS 2.11, Sanyo Color Graphics BASIC, WardStar 3.3, CalcStar, and Easy Writer I.

With the 555-2 systems you also receive your choice of DataStar, ReportStar, SpellStar, and MailMerge; or Easy Writer II, Easy Mailer, Easy Planner, and Easy Filer.

We have sold more Sanyo microcomputers than any other dealer in the United States. Our prices have also been the lowest or among the lowest in the country, and are presently too low to advertise.

But we wouldn't have become the largest Sanyo dealer in the country if all we offered was low prices. We include more free software than other dealers, we can install boards or extra memory for a modest charge, and we stock reference manuals for our customers.

Our sales staff knows the Sanyo system because they use Sanyo computers themselves, and unlike others who sell the Sanyo system we're an authorized Sanyo service center with techs on staff. If you plan to buy a Sanyo give us a call, we'll offer you a great price and a great deal more.



Columbia's

If you're looking for maximum compatibility, minimum prices, and nationwide service, you should consider buying a Columbia from Scotsdale Systems. Each system comes with a huge software bundle including MS-DOS 2.1, Basic, Perfect Writer, Perfect Calc, Perfect Filer, Perfect Speller, Fast Graphs, Home Accountant Plus, Space Commanders, AT Tutorials, and T.I.M. IV. We have the lowest prices on all Columbia computers including the new 4220 desktop with 256K 2220 portable with a built-in 9" monitor. Your choice

\$1698

The Silver Fox™ Trots Through Lotus Like 1,2,3

The Silver Fox is not IBM-PC DOS compatible yet it runs hundreds of MS-DOS programs including Lotus 1,2,3, dBASE II, Multiplan, and even Flight Simulator.

The Silver Fox does not have IBM compatible expansion slots but you can add printers, serial ports, modems, 10-40 Mb. hard disks, clock/calendar cards (RAM, joysticks, an 8087 co-processor, and more.

What makes the Silver Fox unique, however, isn't what you can add to it, but what comes with it. Each Silver Fox comes with an 8088 CPU, 256K of RAM, four video ports, and a printer port. Plus you get more than twice the storage of a standard PC, 1.6 Megabytes on dual 5 1/4" floppies, and the Fox will read and write to standard 160K, 320K, and 360K IBM-PC formats.

Standard equipment also includes a better keyboard, and a 12" high resolution, green monochrome monitor, with a full 25x80 display. Plus we back each Silver Fox with a one year limited warranty.

If you didn't think you:

\$1397

could buy you this much computer, call our machine of

1-800-FORAFox

leave your name and address at the beep, and we'll send you a booklet that will tell you how it can.

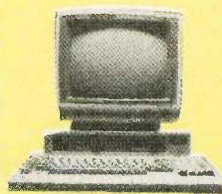

Free Silverware

MS-DOS 2.11	WordStar 3.3
HAGEN-DOS	Easy Writer
Color BASIC	Spell
GW BASIC	Mail Track
OS TUTOR	FILEBASE
15 Games	PC FILE III
CalcStar	PD Disk

Sanyo 1100's/1200's

Call

OLYMPIA

Scotsdale Systems Ltd.

617 N. Scotsdale Road, Suite B, Scotsdale, Arizona 85257

(602) 941-5856

Call 8-5 Mon.-Fri.



We participate in arbitration for business and customers through the Better Business Bureau of Maricopa County.

SINCE 1980

TELEMARKETING ONLY: If you plan to visit please call first for an appointment. Prices listed are for cash and include a 3% discount. We sell on a Net 30 basis to Fortune 1200 companies and universities. No C.O.D.'s or A.P.O.'s. P.O.'s add 2%. Visa, Mastercard add 3%. Az. residents add 6%. Prices subject to change, product subject to availability. Personal/company checks take 3 weeks to clear. All items listed are new with manufacturer's warranty, 0-20% restocking fee for returned merchandise. Shipping extra-products are F.O.B. point of shipment. Software is not warranted for suitability. Registered trademarks: Televideo-Televideo Systems, Inc.; Silver Fox™, HAGEN-DOS-Scotsdale Systems, Ltd.; Commuter-Visual Computer Incorporated.

WYSE

50's	\$499
75's	\$575



1200 BPS Modems

Volkmodem	\$199
Password	\$249
Prometheus	\$324
Hayes 300/1200	\$444



To LQ or NLQ

That is the Question

Whether it's nobler to zip along at 165 CPS in draft mode and use an incredible 17x17 NLQ mode for letters, or produce letter perfect output - Olympia gives you a choice.

Compare the Olympia NP to the popular Epson FX-80 or the Okidata 92. The NP is slightly faster, noticeably quieter, and includes push-type tractor (and friction feed) as standard equipment. But the NP's really big feature is its fine script mode which is much superior to the Okidata 92, and even better than an FX-80+ with a \$199 "NLQ" option.

To quote PC magazine, "The (NP) printer is a sure thing if it falls into your price range - and even if it doesn't, it may be worth considering."

If you're looking for the best buy in a true letter-quality printer (like the Silver Reed 550 or the Juki 6100) the Olympia RO is for you. The RO is a 14 CPS wide carriage, that comes with both friction and tractor feed, serial and parallel ports, and quality that has made Olympia a world leader in typewriters.

Before you spend \$100-\$200 too much for another brand, call us at Scotsdale Systems and ask for additional information on these exceptional values from Olympia. To LQ or NLQ is up to you, the price for either the Olympia NP or the RO with a 10' shielded cable to your computer is only

\$344

E·V·E·N·T Q·U·E·U·E

May 1985

● **BUSINESS RESEARCH Applications Seminars**, various sites throughout the U.S. and Montreal, Quebec, Canada. A seminar series for those researching business topics. Contact Data Courier, 620 South Fifth St., Louisville, KY 40202, (800) 626-2823; in Kentucky, (502) 582-4111; in Canada, (800) 626-0307. *May-June*

● **C STUDIED C-Language Workshops**, various sites throughout the U.S. Workshops and seminars on C programming and issues. Contact Plum Hall Inc., 1 Spruce Ave., Cardiff, NJ 08232, (609) 927-3770. *May-June*

● **CLASSES IN UNIX, C UNIX and C Classes**, City University, Bellevue, WA. Four-hour to five-day courses. Fees range from \$100 to \$750, depending upon course length. Contact Kathy Howard, Specialized Systems Consultants, POB 7, Northgate Station, Seattle, WA 98125, (206) 367-8649. *May-June*

● **CONFERENCES FOR MANUFACTURERS, USERS** Conferences for Manufacturers and Users, various sites throughout the U.S. Planned are "Document Processing in Tomorrow's Office" and "Document-based Optical Memories." Contact Richard D. Murray, Institute for Graphic Communication Inc., 375 Commonwealth Ave., Boston, MA 02115, (617) 267-9425. *May-June*

● **FIX-IT WORKSHOP** Computer Repair User Workshops, various sites throughout the U.S. A one-

day seminar on repairing computers. The fee ranges from \$140 to \$175, depending upon location. Contact Cascio School of Computer Technology, Suite B109-Q, 2580 San Ramon Valley Blvd., San Ramon, CA 94583, (415) 829-5140. *May-June*

● **HOME, OFFICE COMPUTING**—New Olden Spring and Summer Computer Workshops, New York City. Introductory and advanced workshops on personal, executive, and secretarial computing. Fees range from \$45 to \$400, depending upon duration. Contact The Olden Computer Workshops, 1265 Broadway, New York, NY 10001, (212) 685-1234. *May-June*

● **MICRO WORKSHOPS** Microcomputer Workshops, various sites throughout the U.S. and Canada. More than 20 workshops for all levels of expertise. Contact Rhonda Carney, Intel Corp., Customer Training, 27 Industrial Ave., Chelmsford, MA 01824-3688, (617) 256-1374. *May-June*

● **NETWORK PROTOCOLS** Network Communication Protocols, various sites throughout the U.S. Major topic areas include elements of data communications, data-link control concepts, and bit-oriented protocols. The fee is \$695. Contact Center for Advanced Professional Education, Suite 110,

1820 East Garry St., Santa Ana, CA 92705, (714) 261-0240. *May-June*

● **SEMINARS AND SYMPOSIA**—EDP Seminars and Symposia, various sites throughout the U.S. "Database Management Systems and Fourth Generation Languages for Personal Computers" and "Introduction to the UNIX System" are among the offerings. Fees range from \$395 to \$895. Calendar available. Contact Software Institute of America Inc., 8 Windsor St., Andover, MA 01810, (617) 470-3880. *May-June*

● **SUMMER SEMINARS** Summer Seminar Series, Rochester Institute of Technology, NY. A series of one-week seminars. Titles include "Introduction to Linear Systems and Digital Signal Processing," "Basic 6800/6809," and "Advanced Digital Logic." For details, contact Yvonne Fish, School of Engineering Technology, Rochester Institute of Technology, One Lomb Memorial Dr., POB 9887, Rochester, NY 14623, (716) 475-2915. *May-June*

● **AI, EXPERT SYSTEMS BRIEFING**—Artificial Intelligence and Expert Systems: What Users and Suppliers Must Know Today to Deploy These Technologies as Profitable Strategic Corporate Resources Tomorrow, Boston and Framingham, MA. A one-day executive briefing. The fee is \$790.

Contact Ms. Lee Burgess, Professional Development Programs, Rensselaer Polytechnic Institute, Troy Building, Troy, NY 12180-3590, (518) 266-6589. *May-July*

● **CONSULTANT TRAINING** Learn How to Be a Successful Independent Computer Consultant, various sites throughout the U.S. The risks and rewards of consulting, planning and marketing, legal considerations, and resources are covered. Contact Education Technology Center Inc., Suite 1042, 485 Fifth Ave., New York, NY 10017, (212) 505-6148. *May-July*

● **DATA SWITCHING** Distributed Data Switching Seminar, various sites throughout the U.S. A one-day seminar on the technology and application of distributed data switching in telecommunications. The fee is \$395. Contact Timeplex Seminars, 400 Chestnut Ridge Rd., Woodcliff Lake, NJ 07675, (201) 930-4600. *May-July*

● **SOFTWARE COURSES** Software Short Courses, various sites through out the U.S. Among the courses are "UNIX: A Hands-on Introduction," "Programming in C: A Hands-on Workshop," and "Software Requirements, Specifications, and Tests." Contact Integrated Computer Systems, 6305 Arizona Place, POB 45405, Los Angeles, CA 90045, (800) 421-8166; in California, (800) 352-8251 or (213) 417-8888; in Canada, (800) 228-6799. *May-August*

.....
IF YOU WANT *your organization's public activities listed in BYTE's Event Queue*, we need to know about them at least four months in advance. Send information about computer conferences, seminars, workshops, and courses to BYTE, Event Queue, POB 372, Hancock, NH 03449.

(continued)

QUALITY PARTS AT DISCOUNT PRICES!

<p>SUB-MINIATURE D TYPE CONNECTOR</p>  <p>SOLDER TYPE SUB-MINIATURE CONNECTORS USED FOR COMPUTER HOOK UPS.</p> <p>DB-15 PLUG \$2.75 DB-15 SOCKET \$4.00 DB-15 HOOD \$1.50 DB-25 PLUG \$2.75 DB-25 SOCKET \$3.50 DB-25 HOOD \$1.25</p> <p>"PARALLEL" PRINTER CONNECTOR</p>  <p>SOLDER STYLE 36 PIN MALE USED ON "PARALLEL" DATA CABLES.</p> <p>\$5.50 EACH</p>	<p>L.E.D.'S STANDARD JUMBO DIFFUSED</p> <p>RED 10 FOR \$1.50 GREEN 10 FOR \$2.00 YELLOW 10 FOR \$2.00</p> <p>FLASHER LED 5 VOLT OPERATION RED JUMBO SIZE \$1.00 EACH</p> <p>BI POLAR LED 2 FOR \$1.70</p> <p>CRYSTAL CASE STYLE HC33/U COLORBURST 3579.545 KC \$1.00 EACH</p> <p>2 MHZ \$3.50 EA</p>	<p>2 AMP SOLID STATE RELAY</p>  <p>SIZE: 1 1/2" x 1-7/16" x 3/8" HIGH</p> <p>CONTROL: 3.6-6 VDC TTL compatible LOAD: 120 Vac @ 2 amp</p> <p>\$2.50 each 10 for \$23.00</p> <p>13 VDC RELAY</p>  <p>CONTACT: S.P.N.C. 10 AMP @ 120 VAC ENERGIZE COIL TO OPEN CONTACT. COIL: 13 VDC 650 OHMS SPECIAL \$1.00 EACH</p>
<p align="center">SEND FOR NEW 1985 48 PAGE CATALOG FREE!</p>		
<p>MINIATURE TOGGLE SWITCHES</p> <p>ALL ARE RATED 5 AMPS @ 125 V</p> <p>S.P.D.T. (on-on)</p> <p>P.C. STYLE, NON-THREADED BUSHING. 75¢ EACH 10 FOR \$7.00</p> <p>S.P.D.T. (on-off)</p> <p>P.C. STYLE, THREADED BUSHING. 75¢ EACH 10 FOR \$7.00</p> <p>S.P.D.T. (on-on)</p> <p>P.C. LUGS, THREADED BUSHING. \$1.00 EACH 10 FOR \$9.00</p> <p>S.P.D.T. (on-off)</p> <p>P.C. LUGS, THREADED BUSHING. \$1.00 EACH 10 FOR \$9.00</p>	<p>SOLID STATE BUZZER</p> <p>STAR #SMB-06L 6 VDC. TTL COMPATIBLE \$1.00 EACH 10 FOR \$9.00</p> <p>120V INDICATOR</p> <p>NEON INDICATOR. RATED 120 V 1/3 W. MOUNTS IN 5/16" HOLE. 75¢ EACH - RED LENS 10 FOR \$7.00 100 FOR \$65.00</p>	<p>EDGE CONNECTORS</p> <p>22/44 22/44 GOLD PLATED CONTACTS .156 CONTACT SPACING. \$2.00 EACH 10 FOR \$18.00</p> <p>SWITCHING POWER SUPPLY</p>  <p>INPUT: 14 Vac-25.5 Vac OUTPUT: +12 Vdc @ 350 ma + 5 Vdc @ 1.2 amp - 5 Vdc @ 200 ma SIZE: 4 3/4" x 4 1/4" x 1 1/4" high</p> <p>\$5.00 each</p>
<p align="center">ALL ELECTRONICS CORP. 905 S. VERMONT • P.O. BOX 20406 • LOS ANGELES, CA 90006</p> <p align="center">TOLL FREE ORDERS • 1-800-826-5432 (IN CALIFORNIA: 1-800-258-6666)</p> <p align="center">AK, HI, OR INFORMATION • (213) 380-8000</p> <p>• QUANTITIES LIMITED • FOREIGN ORDERS INCLUDE SUFFICIENT SHIPPING • CALIF RES ADD 6.12</p> <p>• USA \$3.00 SHIPPING • NO COD</p>		

EVENT QUEUE

● **DEVELOPMENT SEMINARS**—Professional Development Seminars, various sites around Boston, MA. One- and two-day seminars on computer competence, management, sales, marketing, and finance. Contact Boston University Metropolitan College, 755 Commonwealth Ave., Boston, MA 02215. (800) 255-1080; in Massachusetts, (617) 738-5020. *May-September*

● **ENGINEERING, DRAFTING GRAPHICS**—Computer Graphics for Engineering/ Drafting Practice and Computer Graphics Workshop, University of Texas, Austin. Short courses stressing the principles of computer graphics and developing the ability to prescribe graphics equipment for engineering applications. Contact College of Engineering, University of Texas, Austin, TX 78712. (512) 471-3506. *May 13-17*

● **SME CONFERENCES, EXPOS**—Conferences and Expositions from the Society of Manufacturing Engineers, various sites throughout the U.S. For a calendar, contact the Society of Manufacturing Engineers, Public Relations Department, One SME Dr., POB 930, Dearborn, MI 48121. (313) 271-0777. *May-November*

● **MEDICAL GRAPHICS** Computer Graphics in Medicine and Surgery, Virginia Mason Medical Center, Seattle, WA. Contact Linda Orgel, Virginia Mason Medical Center, 1100 9th Ave., Seattle, WA 98111. (206) 223-6898. *May 10*

● **C CONVOCATION C85: The First International Conference on the C Programming Language.** Ramada Renaissance Hotel, San Francisco, CA. A forum for programmers and developers using or considering the use of the C language. Sessions on ANSI X3J11 standard, portability, programming tools, and applications. Contact Lifeboat Associates, 1651 Third Ave., New York, NY 10128. (800) 847-7078; in New York, (212) 860-0300. *May 13-15*

● **EDUCATION IN THE INFORMATION AGE** Delivering Education in the Information Age. Radisson-St. Paul, MN. A focus on the planning and use of alter-

native and information-age systems as an educational medium. Contact Conference Coordinator, Minnesota Curriculum Services Center, 3554 White Bear Ave., White Bear Lake, MN 55110, (800) 652-9024; in Minnesota, (612) 770-3943. *May 13-15*

● **ENGINEERING, DRAFTING GRAPHICS**—Computer Graphics for Engineering/ Drafting Practice and Computer Graphics Workshop, University of Texas, Austin. Short courses stressing the principles of computer graphics and developing the ability to prescribe graphics equipment for engineering applications. Contact College of Engineering, University of Texas, Austin, TX 78712. (512) 471-3506. *May 13-17*

● **PROFESSIONAL TUTORIALS**—Tutorials for Professional Development, Hyatt Hotel, Los Angeles, CA. A series of all-day seminars on software, logic programming, and communications. Contact Gerry Segal, Association for Computing Machinery, 11 West 42nd St., New York, NY 10036. (212) 869-7440. *May 13-17*

● **COMPUTERS IN GOLDEN STATE**—California Computer Show, Hyatt Hotel, Palo Alto, CA. Computers, software, engineering workstations, peripherals, and CAD/CAM systems. Contact Norm DeNardi Enterprises, Suite 204, 289 South San Antonio Rd., Los Altos, CA 94022. (415) 941-8440. *May 14-15*

● **TEST, MEASUREMENT EXPO**—The 1985 Test & Measurement World Expo, Convention Center, San Jose, CA. Conferences and technology exhibits. Contact Meg Bowen, Test & Measurement World Expo, 215 Brighton Ave., Boston, MA 02134. (617) 254-1445. *May 14-16*

9-TRACK 1/2" MAINFRAME TAPE SUBSYSTEM FOR THE IBM PC/XT/AT WITH FREE BACK-UP



MAG TAPE

- Worldwide data interchange
- Automatic tape loading
- High-speed hard disk back-up FREE
- Dual density at 800 or 1600 BPI
- Allows direct tape access under any language supported by DOS 2.0 (A Telebyte exclusive)



TELEBYTE TECHNOLOGY INC.
270 E. Pulaski Road A Public Company
Greenlawn, NY 11740

(800) 835-3298
(516) 423-3232
TWX 510-226-0449

EVENT QUEUE

● INTERACTIVE

VIDEODISCS—Interactive Videodisc-West, Airport Hilton, Los Angeles, CA. Contact Raymond G. Fox, Society for Applied Learning Technology, 50 Culpeper St., Warrenton, VA 22186, (703) 347-0055. May 15-17

● MODULA-2 ENGI-

NEERING—Software Engineering with Modula-2. Atlanta, GA. A course emphasizing methods for building large-scale software systems in Modula-2. Prerequisite: knowledge of Ada or Pascal. The fee is \$495. Contact Elaine Hadden Nicholas, Department of Continuing Education, Georgia Institute of Technology, Atlanta, GA 30332-0385, (404) 894-2547. May 15-17

● SOUTHERN CAL SHOW

The Southern California Computer Faire, Convention Center, Los Angeles, CA. Hardware, software, peripherals, and services for the home, office, and development site. Conference program. Contact Computer Faire Inc., 181 Wells Ave., Newton, MA 02159, (617) 965-8350. May 16-18

● OK SHOW

The Eighth Annual Show & Tell Microcomputer Conference, University of Oklahoma, Norman. Microcomputer fans of all ages and levels of expertise come together to share ideas and to demonstrate applications and hardware. Contact Richard V. Andree, Show & Tell Microcomputer Conference, Mathematics Department, University of Oklahoma, 601 Elm St., Norman, OK 73019. May 18

● TELECOMM

SYMPOSIUM—NTT International Symposium '85, Tokyo, Japan. Discussions on worldwide telecommunications policy, management,

and societal and technological changes. Contact Ms. Yuko Ishida, Nippon Telegraph & Telephone, 200 Park Ave., New York, NY 10166, (212) 867-1511, or Ms. Shizu Muneata, Nippon Telegraph & Telephone, Suite 230, 4962 El Camino Real, Los Altos, CA 94022, (415) 940-1414. May 20-21

● COMPUTERS AND

MEDICINE—AAMSI Congress 1985, Hilton Hotel, San Francisco, CA. Papers, sessions, and demonstrations. Contact American Association for Medical Systems and Informatics, Suite 402, 4405 East-West Highway, Bethesda, MD 20814, (301) 657-4142. May 20-22

● MANAGEMENT

CONGRESS—Update '85, Sheraton Hotel, Brussels, Belgium. A briefing covering technological developments for those in the information-management and micrographic industries. Contact Update '85, International Information Management Congress, POB 34404, Bethesda, MD 20817, (301) 983-0604. May 20-22

● MICROS FOR

ENGINEERS—Microcomputers for Engineers, Washington, DC. Two 2-day seminars on the use of microcomputers in engineering applications with a focus on hardware and software evaluation and selection. The fees are \$425 (government) and \$500 (industry). Contact Conference Manager, U.S. Professional Development Institute, 1620 Elton Rd., Silver Spring, MD 20903, (301) 445-4400. May 20-23

● GRAPHICS FOR

PRODUCTIVITY—The 1985 Trends and Applications Conference, Sheraton Northwest Washington, Silver

(continued)

High performance to cost ratio...

Programming Chips?

Projects develop profitably with development hardware/software from GTEK.



MODEL 7956
(with RS232 option) \$1099.
MODEL 7956 (stand alone) \$ 979.
GTEK's outstanding Gang Programmer with intelligent algorithm can copy 8 EPROMS at a time! This unit is used in a production environment when programming a large number of chips is required. It will program all popular chips on the market through the 27512 EPROMS. It also supports the Intel 2764A & 27128A chips. It will also program single chip processors.



MODEL 7228 - \$599

This model has all the features of Model 7128, plus *Intelligent Programming Algorithms*. It supports the newest devices available through 512Kbits; programs 6x as fast as standard algorithms. Programs the 2764 in one minute! Supports Intel 2764A & 27128A chips. Supports Tektronics, Intel, Motorola and other formats.

EPROM & PAL

PROGRAMMERS

—These features are standard from GTEK—

Compatible with all RS232 serial interface ports • Auto select baud rate • With or without hand-shaking • Bidirectional Xon/Xoff • CTS/DTR supported • Read pin compatible ROMS • No personality modules • Intel, Motorola, MCS86 Hex formats • Split facility for 16 bit data paths • Read, program, formatted list commands • Interrupt driven — program and verify real time while sending data • Program single byte, block, or whole EPROM • Intelligent diagnostics discern bad and/or erasable EPROM • Verify erasure and compare commands • Busy light • Complete with Textool zero insertion force socket and integral 120 VAC power (240 VAC/50Hz available) •



MODEL 7324 - \$1199

This unit has a built-in compiler. The Model 7324 programs all MMI, National and TI 20 and 24 pin PALs. Has non-volatile memory. It operates stand alone or via RS232.



MODEL 7128 - \$429

This model has the highest performance-to-price-ratio of any unit. This is GTEK's most popular unit! It supports the newest devices available through 256Kbits.

MODEL 7316 Pal Programmer \$ 599
Programs Series 20 PALs. Built-in PALASM compiler.

DEVICES SUPPORTED

by GTEK's EPROM Programmers

NMOS		NMOS		CMOS	EEPROM		MPU'S	
2758	2764A	2508	68764	27C16	5213	12816A	8748	8741H
2716	27128	2516	8755	27C16H	5213H	12817A	8748H	8744
2732	27128A	2532	5133	27C32H	52B13		8749H	8751
2732A	27256	2564	5143	27C64	X2816		8741	68705
2764	27512	68766		27C256	48016		8742H	

UTILITY PACKAGES

GTEK's PGX Utility Packages will allow you to specify a range of addresses to send to the programmer, verify erasure and/or set the EPROM type. The PGX Utility Package includes GHEX, a utility used to generate an Intel HEX file.

PALX Utility Package — for use with GTEK's Pal Programmers — allows transfer of PALASM® source file or ASCII HEX object code file.

Both utility packages are available for CPM,® MSDOS,® PCDOS,® ISIS,® and TRSDOS® operating systems. Call for pricing.

AVOCET CROSS ASSEMBLERS

These assemblers are available to handle the 8748, 8751, Z8, 6502, 68X and other microprocessors. They are available for CPM and MSDOS computers. When ordering, please specify processor and computer types.

ACCESSORIES

Model 7128-L1, L2, L2A	XASM (for MSDOS)	\$250.
(OEM Quantity)	\$259.	U/V Eraser DE-4	\$ 80.
Model 7128-24	RS232 Cables	\$ 30.
Cross Assemblers	8751 Adapter	\$174.
	\$200.	8755 Adapter	\$135.
PGX Utilities	48 Family Adapter	\$ 98.
PALX	68705 Programmer	\$299.
	Call for pricing			
	Call for pricing			



Development Hardware/Software
P.O. Box 289, Waveland, MS 39576
601/467-8048
, INC.

GTEK, PALASM, CPM, MSDOS, PCDOS, ISIS, and TRSDOS are all registered trademarks.



ONLY PUBLIC DOMAIN SOFTWARE

is uncopied, so no license fees to pay to anyone! Thousands of useful dbase, spreadsheet, word processors, games, utilities and business programs you can copy yourself from our User Group rental libraries. Join hundreds of companies and users enjoying a wealth of inexpensive software!

RENTAL LIBRARIES FOR CP/M

SIG/M UG (New Jersey Area Computer Club)	\$125.00
216 Disk Sides	
CP/M UG (New York Area Computer Club)	\$45.00
92 Disk Sides	
PICONET (Bay Area User Group)	\$25.00
34 Disk Sides	
KUG (Charlottesville Kaypro User Group)	\$25.00
25 Disk Sides	
NATIONAL EPSON UG	\$35.00
32 Disk Sides	
PD DIRECTORY CATALOG DISK	\$5.00 pp
SPECIAL SALE —includes CP/M, SIG/M UG & PNET	
RENTAL LIBRARIES FOR IBM PC DOS	
PC-BLUE (NYACC)	\$85.00
82 Disk Sides	
IBM-PC SIG (Santa Clara Group, others)	\$250.00
230 Disk Sides	
RENTAL LIBRARIES FOR COMMODORE 64	
28 Disk Sides	\$25.00
PD DIRECTORY BOOKLET	\$12.00 pp

Rental is for 7 days after receipt. 3 more days grace for return. Use your credit card — NO DISK DEPOSIT! Most formats available —even Apple! Specify. Software also available for sale; \$6.00 per disk full. 24 hr., 3 minute info. recording

(619) 727-1015

NATIONAL PUBLIC DOMAIN RENTAL CENTER



1533 Avohill Dr., Vista, CA 92083

(619) 941-0925 Orders



64K SBCs...\$99.

in OEM quantities



- Save development time and costs with Megatel Quark® single board computers
- Select only the features you require
- We deliver your first unit in two weeks or less

<ul style="list-style-type: none"> • 6MHz Z80B® • 8088 Co-Processor • 64K, 128K or 256K RAM • Alpha/Graphics Video Controller • Floppy Disk Control (8", 5 1/4" or 3 1/2") • Winchester Hard Disk Control • Up to 2 Full Duplex Serial Ports 	<ul style="list-style-type: none"> • Up to 128K EPROM • EPROM Support • Time of Day Clock • Up to 4 Parallel I/O Ports • Peripheral Expansion Interface • CP/M® 2.2 or CP/M® 3.0 Operating Systems • Fully configured board less than \$800.*
---	--

Special Packages:

Entry Level Quark 10 with Z80B®, 64K RAM, EPROM, Video, Serial and Parallel I/O..... only \$295.*

64K SBC Package with CP/M® 2.2 on disk... only \$375.*

Custom designs and layouts available

To order your first unit call our Toronto sales office today. (416) 745-7214

Or write us: Megatel
1051 Clinton St.,
Buffalo, N.Y. 14206

CP/M is a registered trademark of Digital Research. *Quantity one price Z80B is a registered trademark of Zilog Inc.

megatel

EVENT QUEUE

Spring, MD. Contact Trends and Applications '85, IEEE Computer Society, POB 639, Silver Spring, MD 20901. May 21-22

School of Business Administration, New York University, 7th Floor Merrill, 90 Trinity Place, New York, NY 10006. (212) 285-6120. May 22-24

● **PARISIAN CONGRESS** Intelligencia, Parc des Expositions, Porte de Versailles, France. An exhibition and congress on expert systems, simulation, graphics, courseware, and services. Contact Society for Computer Simulation, POB 2228, La Jolla, CA 92038-2228, (619) 459-3888; in France, AFIAS: Association Française d'Intelligence Artificielle et des Systèmes de Simulation, 211, Rue St-Honoré, 75001, Paris, France; tel: (1) 260 35 16; Telex: 214 456 F. May 21-24

● **DISK-STORAGE EXPO** The 1985 International Videodisc, Optical Disk, and CD-ROM Conference and Exhibition, London West Hotel, London, England. Workshops, presentations, and exhibitions. Contact Angela Suter, Meckler Communications, 11 Ferry Lane W, Westport, CT 06880, (203) 226-6967; in England, Alice Taylor, Meckler Communications, c/o Eurospan, 3 Henrietta St., London WC2E 8LU, England; tel: 01 240-0856. May 29-31

● **CAD TECHNOLOGY** CAD 2001: The Countdown, Dallas, TX. Presentations on the future of computer-aided design. The fee is \$900. Contact CAD Seminars Inc., Suite 400, 150 East Riverside, Austin, TX 78704, (512) 445-7342. May 22-24

● **MANAGE PROGRAMS** Configuration Management of Software Programs, Washington, DC. Methods for controlling the costs of development, maintenance, and operation of software. Contact Stod Cortelyou, Continuing Engineering Education, George Washington University, Washington, DC 20052, (800) 424-9773; in the District of Columbia, (202) 676-8520. May 29-31

● **SOFTWARE AND HUMAN DEVELOPMENT** Computer Software and Human Development Conference, Royal York Hotel, Toronto, Ontario, Canada. Held in conjunction with the Third Annual Software Panorama, this conference will examine the impact of software development on business, education, health, and agriculture. Contact Reuben Lando, The Software Developers Association, Suite 500, 185 Bloor St. E, Toronto, Ontario M4W 1C8, Canada, (416) 922-1153. May 22-24

● **READYING FOR THE AUTOMATED OFFICE**—Developing a Workable Plan for Office Automation, Washington, DC. Methods of planning for office automation and how to analyze technological developments. The fee is \$730. Contact Chip Blouin, Continuing Engineering Education, George Washington University, Washington DC 20052, (800) 424-9773; in the District of Columbia, (202) 676-8527. May 29-31

● **SYSTEM INTEGRATION FOR USERS**—Managers, Micros, and Mainframes: The 1985 NYU Symposium on Integrating Systems for End Users, New York University, New York City. Contact Matthias Jarke, Graduate

● **COMPUTER INTERFACING**—Personal Computer and STD Computer Interfacing for Scientific Instrument Automation, Virginia

(continued)

THE PROFESSIONAL'S CHOICE

Lotus 1-2-3 \$299	Lotus Symphony \$419	dBase III \$339	FrameWork \$339	MultiMate \$259	WordStar 2000+ \$309
----------------------------------	-------------------------------------	----------------------------	----------------------------	----------------------------	-------------------------------------

Software

Word Processing Editors

EASYWRITER II SYSTEM	\$199
FANCY FONT	\$139
FINAL WORD	\$189
MICROSOFT WORD	\$239
MICROSOFT WORD W/MOUSE	\$289
MULTIMATE	\$259
PFS: WRITE	\$ 95
SAMNA WORD III	\$289
VOLKSWRITER DELUXE	\$159
VOLKSWRITER SCIENTIFIC	\$279
THE WORD PLUS (OASIS)	\$105
WORD PERFECT	\$239
WORDSTAR	\$199
WORDSTAR 2000	\$269
WORDSTAR 2000+	\$309
WORDSTAR PRO	\$259
XYWRITER II+	\$229

Spreadsheets/

Integrated Packages	
ELECTRIC DESK	\$209
ENABLE	\$459
FRAMEWORK	\$339
LOTUS 1-2-3	\$299
MULTIPLAN	\$135
OPEN ACCESS	\$359
SMART SYSTEM SPREADSHEET	\$559
AUDITOR	\$ 79
SUPERCALC 3	\$199
SYMPHONY	\$619
TK! SOLVER	\$269

Communications/

Productivity Tools	
CROSSTALK	\$105
PROKEY	\$ 89
RELAY	\$ 99
SMARTCOM II	\$109

Project Management

HARVARD PROJECT MANAGER	\$219
HARVARD TOTAL PROJECT MANAGER	\$279
MICROSOFT PROJECT	\$159
SCITOR PROJECT 5000 W/GRAPHICS	\$289
SUPERPROJECT-NEW TIME LINE	\$269

Database Systems

ALPHA DATA BASE MANAGER II	\$179
CLIPPER	\$Call
CLOUT V 2.0	\$139
CONDOR III	\$299
CORNERSTONE	\$329
DBASE II	\$269
DBASE III	\$339
INFOSTAR+	\$319
KNOWLEDGEMAN	\$269
PFS: FILE/PFS: REPORT	\$169
POWERBASE	\$219
QUICKCODE III	\$169
QUICKREPORT	\$169
R BASE 4000	\$259

Languages/Utilities

CONCURRENT DOS	\$189
C86 C COMPILER	\$299
DIGITAL RESEARCH C COMPILER	\$219
DR FORTRAN 77	\$219
LATTICE C COMPILER	\$299
MICROSOFT C COMPILER	\$309
MS BASIC COMPILER	\$249
MS FORTRAN	\$239
NORTON UTILITIES	\$69
TURBO PASCAL	\$45

Accounting Modules

BPI	\$329
GREAT PLAINS	\$479
IUS EASYBUSINESS	\$279
MBA	\$369
OPEN SYSTEMS	\$399
PEACHTREE	\$299
REAL WORLD	\$469
STATE OF THE ART STAR ACCOUNTING PARTNER	\$389
STAR ACCOUNTING PARTNER II	\$249
STAR ACCOUNTING PARTNER II	\$549

Professional Development

MANAGEMENT EDGE	\$159
SALES EDGE	\$159
THINK TANK	\$119

Home/Personal

Finance	
DOLLARS AND SENSE	\$119
HOWARD TAX PREPARER 85	\$195
MICROTAX	\$Call
MANAGING YOUR MONEY	\$129

Graphics/Statistics

ABSTAT	\$279
AUTOCAD	\$1475
BPS BUSINESS GRAPHICS	\$229
CHARTMASTER	\$239
CHARTSTAR	\$209
DR DRAW	\$199
ENE3 GRAPHICS W/ PLOTTER	\$279
EXECUVISION	\$259
GRAPHWRITER	\$259
COMBO	\$389
MS CHART	\$159
OVERHEAD EXPRESS	\$139
PC DRAW	\$259
PC PAINTBRUSH	\$ 89
PFS: GRAPH	\$ 95
SIGNMASTER	\$179
STATPRO	\$499
STATPAK-NWA	\$329
STATPAC-WALONICK	\$349

Desktop Environments

DESK ORGANIZER	\$129
GET ORGANIZED	\$159
SIDEKICK	\$ 45
SPOTLIGHT	\$109

Hardware *

Display Boards

EVEREX GRAPHICS EDGE	\$359
HERCULES GRAPHICS CARD	\$329
HERCULES COLOR CARD	\$179
PARADISE MODULAR GRAPHICS	\$285
PARADISE MULTIDISPLAY CARD	\$295
PERSYST BOB	\$449
PLANTRONICS COLORPLUS	\$419
PRINCETON SCAN DOUBLER	\$Call
SIGMA COLOR 400	\$559
STB GRAPHICS PLUS II	\$309
TECMAR GRAPHICS MASTER	\$489
TSENG ULTRA PAK	\$429
TSENG ULTRA PAK - S	\$359

Multifunction Boards

AST ADVANTAGE	\$399
AST 6 PAK PLUS (64K)	\$259
AST 6 PAK PLUS (384K)	\$384
AST MEGAPLUS II (64K)	\$269
QUADBOARD EXP. (OK)	\$229
QUADBOARD EXP. (384K)	\$384
ORCHID BLOSSOM (64K)	\$289
ORCHID PC TURBO	\$739
PERSYST TIME SPECTRUM (64K)	\$259
STB SUPER RIO (64K)	\$299
TECMAR CAPTAIN (64K)	\$279
TECMAR JR CAPTAIN (128K)	\$329
TECMAR JR WAVE (64K)	\$259
TECMAR WAVE (64K)	\$209

Displays

AMDEK 310A	\$179
AMDEK COLOR II +	\$459
PRINCETON HX-12	\$469
PRINCETON MAX-12	\$179
PRINCETON SR-12	\$619
QUADRAM AMBERCHROME	\$179
TAXAN 122 AMBER	\$159
TAXAN 420/440	\$399/\$599
ZENITH 124 AMBER	\$145
ZENITH 135 COLOR	\$Call

Modems

AST REACH 1200	\$Call
HAYES 1200	\$429
HAYES 1200B	\$389
HAYES 2400	\$Call
VENTEL 1200 HALF CARD	\$399

Input Devices

KEYTRONIC 5151	\$189
KOALA	\$Call
MICROSOFT MOUSE	\$139
PC MOUSE W PAINT	\$159

Mass Storage

ALLOY PC-BACKUP 20MB	\$1649
ALLOY PC-DISC 20MB	\$1769
10MEGA 10+10 MB	\$2895
MAYNARD WS-1 10MB	\$Call
SIGMA	\$Call
SYSGEN IMAGE	\$Call
TALLGRASS	\$Call

Printers/Plotters

C. ITOH	\$Call
COMWRITER II/420	\$Call
DIABLO 620/630	\$Call
EPSON FX-100+	\$Call
EPSON LQ-1500	\$Call
EPSON JX-80	\$Call
HP 7475A PLOTTER	\$Call
JUKI 6100	\$479
NEC P3	\$899
NEC 2050	\$799
NEC 3550	\$1399
OKIDATA 84P/93P	\$729/\$619
PANASONIC	\$Call
QUME SPRINT 1155	\$1569
SWEET P 6 PEN PLOTTER	\$899
TOSHIBA P1340	\$779
TOSHIBA P1351	\$1279

Emulation Boards

ASTPCOX	\$949
AST 3780	\$609
AST SNA/BSC	\$689/\$529
BLUE LYNX	\$Call
CXI 3278/9	\$950
IRMA	\$869
IRMALINE	\$999
IRMAPRINT	\$Call
QUAD 3278	\$949

Networks

AST PC NET	\$Call
CORVUS NET	\$Call
ORCHID PC NET	\$Call
3 COM	\$Call
QUADNET IX	\$Call

Accessories

CURTIS SURGE PROTECTORS	\$Call
EPD SURGE PROTECTORS	\$Call
DATASHIELD BACKUP POWER	\$Call
GLTRONIX A/B SWITCH	\$Call
MICROBUFFER INLINE (64K)	\$264
MICROFAZER INLINE (64K)	\$219
64K RAM SET	\$25
256K RAM SET	\$Call
8087 MATH CHIP	\$150

*CALL FOR SHIPPING COSTS

Samna Word III \$289	Chart-Master \$239	AST 6 Pak Plus \$259	Tseng Ultra Pak \$429	Smartmodem 1200B \$389	Smartmodem 1200 \$429
-------------------------------------	-------------------------------	-------------------------------------	--------------------------------------	---------------------------------------	--------------------------------------



LOWEST PRICE GUARANTEE!!
We will match current nationally advertised prices on most products. Call and compare.



1-800-221-1260
In New York State call (718) 438-6057

TERMS:
Checks—allow 14 days to clear. Credit processing—add 3%. COD orders—cash, M.O or certified check—add \$3.00. Shipping and handling UPS surface—add \$3.00 per item (UPS Blue \$6.00 per item). NY State Residents—add applicable sales tax. All prices subject to change.

MasterCard VISA MON.-THURS. 9:00AM-8:00 PM
SUN. & FRI. 9:00AM-4:00 PM

Softline
Softline Corporation
P.O. Box 729, Brooklyn, N.Y. 11230
TELEX: 421047 ATLNUI



Hard to carry



Hard to read



Hard to expand



Hard to beat

Feature for feature, it's hard to beat the COMPAQ® Portable and COMPAQ PLUS™. For one simple reason. While others make compromises, COMPAQ makes portable personal computers that can do everything a desktop can. And more.

Compared to the IBM® PC, for instance, COMPAQ Portables run *all* the same popular business programs, all the same printers, and can expand to more than 30 times the storage. *Plus* they have a handle.

Compared to briefcase models, COMPAQ offers more again. More memory. More storage. A standard keyboard. Standard diskette drives so you can use industry-standard programs—as they are, without modification. And a brilliant, high-resolution screen that displays text *and* graphics at one time. Not one you have to play peekaboo with.

Compared to the Mac, COMPAQ lets you add a second diskette drive or even a 10-megabyte fixed disk drive. Inside, not out. Not to mention that we speak the Mother Tongue of Business Computers and Mac doesn't.

With a rugged, full-function COMPAQ, you don't have to compromise capability, compatibility or readability for portability.

COMPAQ®

It simply works better.

EVENT QUEUE

Polytechnic Institute and State University, Blacksburg. A hands-on workshop with participants wiring and testing interfaces. The fee is \$450. Contact Dr. Linda Leffel, C.E.C., Virginia Polytechnic Institute and State University, Blacksburg, VA 24061, (703) 961-4848. *May 30-June 1*

June 1985

- **ENGINEERING CONFERENCES**—Engineering Summer Conferences, Chrysler Center for Continuing Engineering Education, University of Michigan, Ann Arbor. Conferences in such areas as biomedical, chemical, civil, computer, electrical, and environmental engineering. Contact Engineering Summer Conferences, 200 Chrysler Center, North Campus, University of Michigan, Ann Arbor, MI 48109, (313) 764-8490. *June-August*
- **INFO MANAGEMENT SEMINARS**—NYU Seminars on Information Management, various sites throughout the U.S. On the agenda are "Legal Issues in Acquiring and Using Computers" and "Networking Personal Computers." Contact School of Continuing Education, Seminar Center, New York University, 575 Madison Ave., New York, NY 10022, (212) 580-5200. *June-October*
- **COMPUTER/HAMFEST** The Fifth Annual Columbus Computerfest/Hamfest, Columbus, OH. A flea market featuring computers and electronic and amateur radio equipment highlights this event. Admission is \$2 in advance or \$3 at the door. Send a self-addressed stamped envelope to Bill Welch, W8LLU, 396 Brevoort Rd., Columbus, OH 43214. *June 2*
- **LEARN TO BUILD PROGRAMS**—First North American Summer School on Program Construction, Newport, RI. Methods for the effective construction of software will be taught. Contact Teleprocessing Inc., 60 State St., Boston, MA 02109, (617) 367-6227. *June 3-12*
- **INTERFACES FOR SCHOOL LABS**—Interfacing for School Laboratories, Miami University, Oxford, OH. A workshop for secondary school and college teachers on the construction and use of interfaces for laboratory instrumentation. Contact Bill Rouse, 301 McGuffey Hall, Miami University, Oxford, OH 45056, (513) 529-2141. *June 3-14*
- **COMPUTER MAINTENANCE**—Independent Computer Maintenance, Halloran House, New York, NY. Contact Carol Every, Frost & Sullivan Inc., 106 Fulton St., New York, NY 10038, (212) 233-1080. *June 5-6*
- **OPTICAL STORAGE** First Annual Conference on Optical Storage for Small Systems, Biltmore Hotel, Los Angeles, CA. Contact Technology Opportunity Conference, POB 14817, San Francisco, CA 94114-0817, (415) 626-1133. *June 5-7*
- **COMPUTERS FOR SALE** Computer Supermarket Show and Sale, San Mateo County Fairgrounds, San Mateo, CA. Retailers, manufacturers, and distributors will be selling hardware and software. Admission is \$7; children, \$3. Contact Microshows, Suite 203, 1209 Donnelly Ave., Burlingame, CA 94010, (415) 340-9113. *June 8-9*
- **COMPUTER VISION** Computer Vision and Pattern Recognition Conference, Cathedral Hill Hotel, San Francisco, CA. Submitted
- and invited technical papers. Contact Computer Vision and Pattern Recognition, POB 639, Silver Spring, MD 20901, (301) 589-8142. *June 9-13*
- **MUMPS MEETING** The Fourteenth Annual Meeting of the MUMPS Users' Group, McCormick Center Hotel, Chicago, IL. Tutorials, workshops, site visits, discussions, and exhibits. Contact MUMPS Users' Group, Suite 510, 4321 Hartwick Rd., College Park, MD 20740, (301) 779-6555. *June 10-14*
- **UNIX, C CONFERENCE** USENIX Conference and Vendor Exhibition, Marriott Hotel, Portland, OR. USENIX is a nonprofit organization promoting UNIX, UNIX-like systems, and C-language programming. Contact USENIX Conference Office, POB 385, Sunset Beach, CA 90742, (213) 592-3243. *June 11-14*
- **NETWORK CONTROL AND MANAGEMENT**—Network Management/Technical Control, Santa Clara Marriott, Santa Clara, CA. Diagnostic and test instruments will be displayed. Contact Louise Myerow, CW Conference Management Group, 375 Cochituate Rd., POB 880, Framingham, MA 01701, (800) 225-4698; in Massachusetts, (617) 879-0700. *June 12-13*
- **CLINICAL COMPUTING** Computing in Clinical Laboratories: The Fifth International Conference, Stuttgart, Federal Republic of Germany. Topics include databases, data presentation, and expected developments. Demonstrations and exhibits. Contact PD Dr. Chr. Trendelenburg, Katharinenhospital KCl, Kriegsbergstrasse 60, D-7000 Stuttgart 1, Federal Republic of Germany; tel: (07 11) 20 34-4 82. *June 12-14*
- **COMPUTERS IN CLINICAL LABS**—Clinical Laboratory Computers: Symposium 1985, The Towsley Center, University of Michigan, Ann Arbor. Contact Dove Margenau, Office of Continuing Medical Education, The Towsley Center, Box 057, The University of Michigan Medical School, Ann Arbor, MI 48109-0010, (313) 763-1400. *June 12-14*
- **FORTH CONFERENCE** The 1985 Rochester FORTH Conference, University of Rochester, Rochester, NY. The focus will be on software engineering and management. Contact Ms. Maria Gress, Institute for Applied FORTH Research, 70 Elmwood Ave., Rochester, NY 14611, (716) 235-0168. *June 12-15*
- **LOGICAL MACHINES** The Second Annual Conference on Logic, Logic Machines, and Public Education, University of Houston—Clear Lake, Houston, TX. Formal and informal sessions, symposia, and workshops. Contact the Institute for Logic and Cognitive Studies, University of Houston—Clear Lake, Box 269, Houston, TX 77058, (713) 488-9274. *June 13-15*
- **INTERNATIONAL SHOW** The International Computer Show, Trade Fair Center, Cologne, West Germany. More than 350 manufacturers from more than 18 countries are expected to display their wares. Contact Messe- und Ausstellungs-Ges.m.b.H. Köln, Messeplatz, Postfach 210760, D-5000 Köln 21, West Germany; tel: (0221) 821-1; Telex: 8 873 426 mua d. *June 13-16*
- **BIO RESEARCH RESOURCE**—Introduction to

EVENT QUEUE

BIONET: A National Computer Resource for Molecular Biology, Rutgers University, Piscataway, NJ. Workshops on using computers for molecular biology research. Contact Selma Gitterman, Continuing Professional Education, Institute of Microbiology, Rutgers University, POB 759, Piscataway, NJ 08854-0759, (201) 932-4258. *June 17-19*

● **PC IN BIG APPLE**
PC Expo, Coliseum, New York, NY. Seminars and product displays. Contact PC Expo, 333 Sylvan Ave., Englewood Cliffs, NJ 07632, (800) 922-0324; in New Jersey, (201) 569-8542. *June 17-19*

● **ENGINEERING SOFTWARE**—Engineering Software: Engsoft 85, The Fourth International Conference and Exhibition, Kensington Exhibition Centre, London, England. Exhibits and sessions. Contact Elaine Taylor, Computational Mechanics Centre, Ashurst Lodge, Ashurst, Southampton SO4 2AA, England; tel: (042 129) 3223; Telex: 47388 Attn. COMPMECH. *June 18-20*

● **DATA COMMUNICATIONS UPDATE**—Data Communications: A Complete Overview and Update, Newport Beach, CA. The managerial, operational, and technical aspects of data communications and facilities are covered. Contact Data-Tech Institute, Lakeview Plaza, POB 2429, Clifton, NJ 07015, (201) 478-5400. *June 19-21*

● **TIPS FOR NET MANAGERS**—Network Management/Technical Control, Convention Center, San Jose, CA. A conference and exposition. Contact CW Conference Management Group, 375 Cochituate Rd., POB 880, Framingham, MA

01701, (800) 225-4698; in Massachusetts, (617) 879-0700. *June 24-27*

● **WORK WITH A COMPUTER**—Using a Personal Computer, Breckenridge Concourse Hotel, St. Louis, MO. A hands-on course for those who want to use integrated software packages. The fee is \$965. Contact The Center for Professional Advancement, POB H, East Brunswick, NJ 08816, (201) 238-1600. *June 24-27*

● **GRAPHICS IN SUNSHINE**
Computer Graphics '85 West, Los Angeles, CA. Contact National Computer Graphics Association, 8401 Arlington Blvd., Fairfax, VA 22031, (703) 698-9600. *June 25-27*

● **CAD TECHNOLOGY**
CAD 2001: The Countdown, Boston, MA. See May 22-24 for details. *June 26-28*

● **DATA COMMUNICATIONS UPDATE**—Data Communications: A Complete Overview and Update, Philadelphia, PA. See June 19-21 for details. *June 26-28*

July 1985

● **COMPUTER TRAINING**
Computer Training Programs, Wintergreen Learning Institute, Wintergreen, VA. Hands-on training in word processing, information management, spreadsheets, and graphics. Contact Dr. M. D. Corcoran, Wintergreen Learning Institute, POB 7, Wintergreen, VA 22958, (804) 325-1107. *July-September*

● **ADVANCED AUTOMATION**—Robot Manipulators, Computer Vision, and Automated Assembly, Cambridge, MA. Contact Director of the

(continued)

"Switch boxes are sold by many suppliers, but by far the two best values are from MFJ Enterprises."



"The MFJ RS-232 Transfer Switch. Buy it before the manufacturer comes to his senses!"

Joe Campbell, *The RS-232 Solution*
Sybex Computer Books

Now you can have *reliable and affordable* port expansion. Don't keep plugging and unplugging cables. You can easily switch your computer to your high-speed printer, letter-quality printer, modem, terminal — any RS-232 peripheral device. MFJ's range of Transfer Switches includes one to fit your needs at a price you can afford. Look at these choices; then look at these prices. Compare others at *any price!* Then ask them for *their reviews.* When they won't show you, call MFJ...



When you need to switch between two peripherals ... or you need to have two computers sharing the same peripheral ...

Model 1240/\$79.95

Never unplug a cable again. Now, with the push of a button you can go from dot matrix to letter-quality printing, or go from your printer to your modem. MFJ's Model 1240 Transfer Switch features a built-in transmit/receive switch allowing you two-way information flow. LEDs monitor important data lines while a built-in surge protector guards them. The 1240 also acts as a null modem. All this for just \$79.95. No wonder it's MFJ's No. 1 seller!

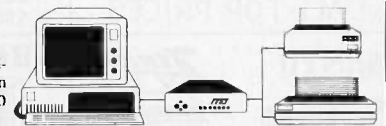

When you need 1-to-4 computers to share one peripheral or 1-to-4 peripherals to share a common computer ...

Model 1243/\$119.95

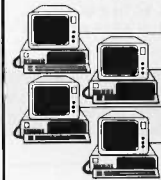

The perfect office Transfer Switch. Don't buy multiple printers or modems. Just buy MFJ's Model 1243. Then you can connect one or all your computers to a *single* printer or modem. Or let your one computer share up to *four* peripherals. Think of the money you'll save. LEDs monitor important data lines while a built-in surge protector guards them. Two-way communication is allowed with *no complicated software to learn: just push a button!*

Seven additional models to choose from. Each unit's casing is constructed from high-quality aluminum. Printed circuit boards assure maximum reliability by eliminating crosstalk, line interference and any need for wiring. *All MFJ switches have LEDs to monitor data lines and MOV surge protectors.* Enhance the investment you've already made in your computer by choosing from the finest line of Transfer Switches on the market, including MFJ's IBM & Centronics Parallel Switches.

You've got a lot of money tied up in your computer. Don't blow it!

Your valuable computer and peripheral equipment can be damaged by electrical surges *much smaller than you've been led to believe.* Far more likely to happen is having your important data wiped out. These disasters, and others, can be prevented with **MFJ's Power Centers**. *Relay latches* power off during power dropouts (Model 1108). *Multi-filters* isolate equipment, eliminate interaction, noise and hash. *MOV's* suppress spikes and surges. **MFJ's Power Centers** also have 3 isolated, switched socketpairs, with at least one unswitched socket (so you can add a clock, etc.), lighted power switch, fast-acting fuse, 3-wire, 6-foot cords; 15A, 125V, and 1875 watts. Although each model is attractively housed in a protective aluminum casing, *these are heavy-duty, commercial-quality power centers.*

Watch out for fancy names that cost twice as much, last half as long, and have half the features of **MFJ's Power Centers.**

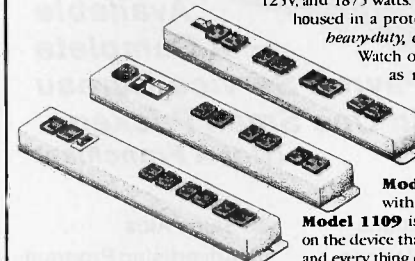

Model 1107 8 sockets,

2 unswitched; **\$79.95**

Model 1108 7 sockets, 1 unswitched, with dropout relay; **\$99.95**

Model 1109 is like 1107 but intelligent (switch on the device that's plugged into the control socket and every thing else comes on). **\$129.95**

There are other **RS-232 Switches, Power Centers, and Computer Peripheral Products** available from MFJ. Call and talk with us about all your computing needs, and when you do, ask for our latest catalog. **Both the call and the catalog are free.**

1-800-647-1800

For technical/repair information, or in Mississippi, or outside the Continental United States, please telephone...

1-(601)323-5869 or telex **53-4590 MFJSTKV**

All MFJ products come with a *double* guarantee we think is unmatched. Order from MFJ and try any product for 30 days. If it doesn't satisfy your needs, just return it for a *full refund*, less shipping. If you keep it you can be assured of continued service with our *One Year Unconditional Guarantee.*

Call toll-free 1-800-647-1800 and charge the products you need to your VISA or MasterCard, or send a check or money order, plus \$5.00 shipping, and our shipping department will promptly have your computer peripheral on its way to you.

MFJ MFJ Enterprises Inc.
921 Louisville Road
Starkville, MS 39759

EVENT QUEUE

MICROTIME

411 W. GRANT RD, TUCSON, AZ 05705



SANYO

\$1224

MSDOS 2.11 128K RAM (2)360K DRIVES
PARALLEL PORT ZENITH MONITOR
WORDSTAR EASYWRITER CALCSTAR
EPSON RX-80 WITH CABLE



ZENITH

\$2049

320K RAM (2)360K DRIVES
GRAPHICS CARD PARALLEL PORT
ZENITH MONITOR THE WORD MULTIPLAN
BROTHER HR-15 WITH CABLE

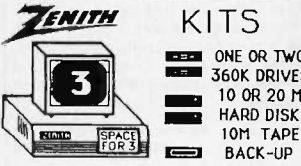

KITS

- ONE OR TWO 360K DRIVES
- 10 OR 20 M HARD DISK
- 10M TAPE BACK-UP

YOUR CHOICE: KIT OR ASSEMBLED
CALL FOR PRICES



ZENITH

\$5499

320K RAM 360K DRIVE GRAPHICS CARD
PARALLEL PORT Z133 COLOR MONITOR
MS DOS 2.11 THE WORD MULTIPLAN
20M BERNOULLI BROTHER 2024/CABLE

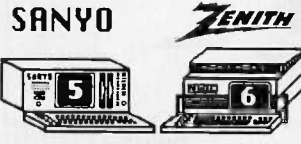

COLOR PORTABLE PORTABLE
OPTIONAL 10 MEGABYTE HARD DISK

CALL FOR PRICES

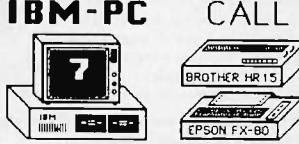

IBM-PC CALL

256K RAM (2) 360K DRIVES
AST SIX-PACK WITH 64K
HERCULES CARD ZENITH Z124 MONITOR
EPSON FX-80+ OR BROTHER HR-15



800-642-7684

ST. LOUIS 773-6951 TUCSON 791-9030



Summer Session, Room E19-356, MIT, Cambridge, MA 02139. July 8-12

● **COMPUTATIONAL LINGUISTICS**—The Twenty-Third Annual Meeting of the Association for Computational Linguistics, University of Chicago, IL. Papers, demonstrations, and tutorials. Contact Don Walker (ACL), Bell Communications Research, 445 South St., Morristown, NJ 07960, (201) 829-4312. July 8-12

● **AWC CONFERENCE**
The Fourth Annual National Conference of the Association for Women in Computing, Allerton Hotel, Chicago, IL. Workshops and sessions on technical and career-enhancement topics. Contact Joan Wallbaum, AWCC '85, 407 Hillmore Dr., Silver Spring, MD 20901. July 13-14

● **THE NCC**
The 1985 National Computer Conference—NCC '85, McCormick Place, Chicago, IL. Exhibits, technical sessions, and development seminars. This year's theme is "Technology's Expanding Horizons." Contact Helen Mugnier, AFIPS, 1899 Preston White Dr., Reston, VA 22091, (703) 620-8926. July 15-18

● **COMPUTER WORKSHOPS**—Personal Computer Workshops, Aspen and Colorado Springs, CO. Tutorials, including an introduction to personal computers, word processing, spreadsheets, and database management. Contact Rocky Mountain Institute of Software Engineering, 1670 Bear Mountain Dr., POB 3521, Boulder, CO 80303, (303) 499-4782. July 22-26

● **SIGGRAPH**
SIGGRAPH '85: The Twelfth

Annual Conference on Computer Graphics and Interactive Techniques, Moscone Center, San Francisco, CA. Contact SIGGRAPH '85, Conference Services Office, Smith, Bucklin and Associates Inc., 111 East Wacker Dr., Chicago, IL 60601, (312) 644-6610. July 22-26

● **SIMULATION**
The 1985 Summer Computer Simulation Conference—SCSC '85, Westin Hotel, Chicago, IL. Contact Charles Pratt, Society for Computer Simulation, POB 2228, La Jolla, CA 92038, (619) 459-3888. July 22-26

● **INTELLIGENT MACHINES**
Logic Programming & Expert Systems. The Turing Institute, Edinburgh, Scotland. Lectures, demonstrations, and sessions on programming techniques, system structure, and PROLOG. Contact The Turing Institute, 2 Hope Park Square, Edinburgh, EH8 9NW, Scotland; tel: 031-668-1737. July 24-25

● **PUBLIC COMPUTING**
The Twenty-Third Annual Conference of the Urban and Regional Information Systems Association, Westin Hotel, Ottawa, Ontario, Canada. The conference theme is "Computers in Public Agencies, Sharing Solutions." Contact URISA Secretariat, Suite 300, 1340 Old Chain Bridge Rd., McLean, VA 22101, (703) 790-1745. July 28-August 1

● **COMPUTERS AND EDUCATION**—The 1985 World Conference on Computers in Education, SCOPE Convention Center, Norfolk, VA. Exhibits, papers, panel sessions, tutorials, and preconference workshops. Contact WCCE/85, AFIPS, 1899 Preston White Dr., Reston, VA 22091, (800) 622-1985; in Virginia, (703) 620-8900. July 29-August 2

Buy A Business In A Box

Now Available — A Complete Payroll Service Bureau In One Small Package. (Not A Franchise)

- Banking Relations
- Customer Relations
- Complete Software Package for Your Equipment
- Sales Aids
- Advertising Program

Everything you need to start your independent payroll service bureau... software, manuals, a complete how to package. For more information write

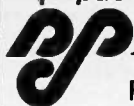

to: PACIFIC PAYROLL SYSTEMS, INC.
17280 Newhope Street, Suite 13
Fountain Valley, CA 92708

■ **DEALER INQUIRIES INVITED** ■

THE PANASONIC SR. PARTNER™ NO PERIPHERALS NEEDED

Because they're already built-in. The 80/132-column printer. The 9-inch, high-resolution display. There's even a built-in 360K disk drive. Which all make the Sr. Partner a complete computer as is.

The Sr. Partner is IBM hardware and software compatible so you can run popular business programs immediately. The software bundle currently offered with the Sr. Partner is WordStar, VisiCalc, pfs: Graph, File, Report, MS-DOS 2.11 and GW BASIC.*

And with its 256K internal memory expandable to 512K, the Sr. Partner can run the new integrated software.

Built-ins also include expansion slots and parallel and serial I/O ports. There's even a built-in RGB monitor port so you can take advantage of the Sr. Partner's color and graphics capability.

If you want 10 megabytes of storage, choose the new hard disk Sr. Partner.

Both the Sr. Partner and the hard disk Sr. Partner come with an exceptional Panasonic warranty.**

For the dealers nearest you, call: 1-800-PIC-8086. The Panasonic Sr. Partner. No peripherals needed. It makes the competition look like Jr. Executives.

Panasonic Industrial Company

Inquiry 314

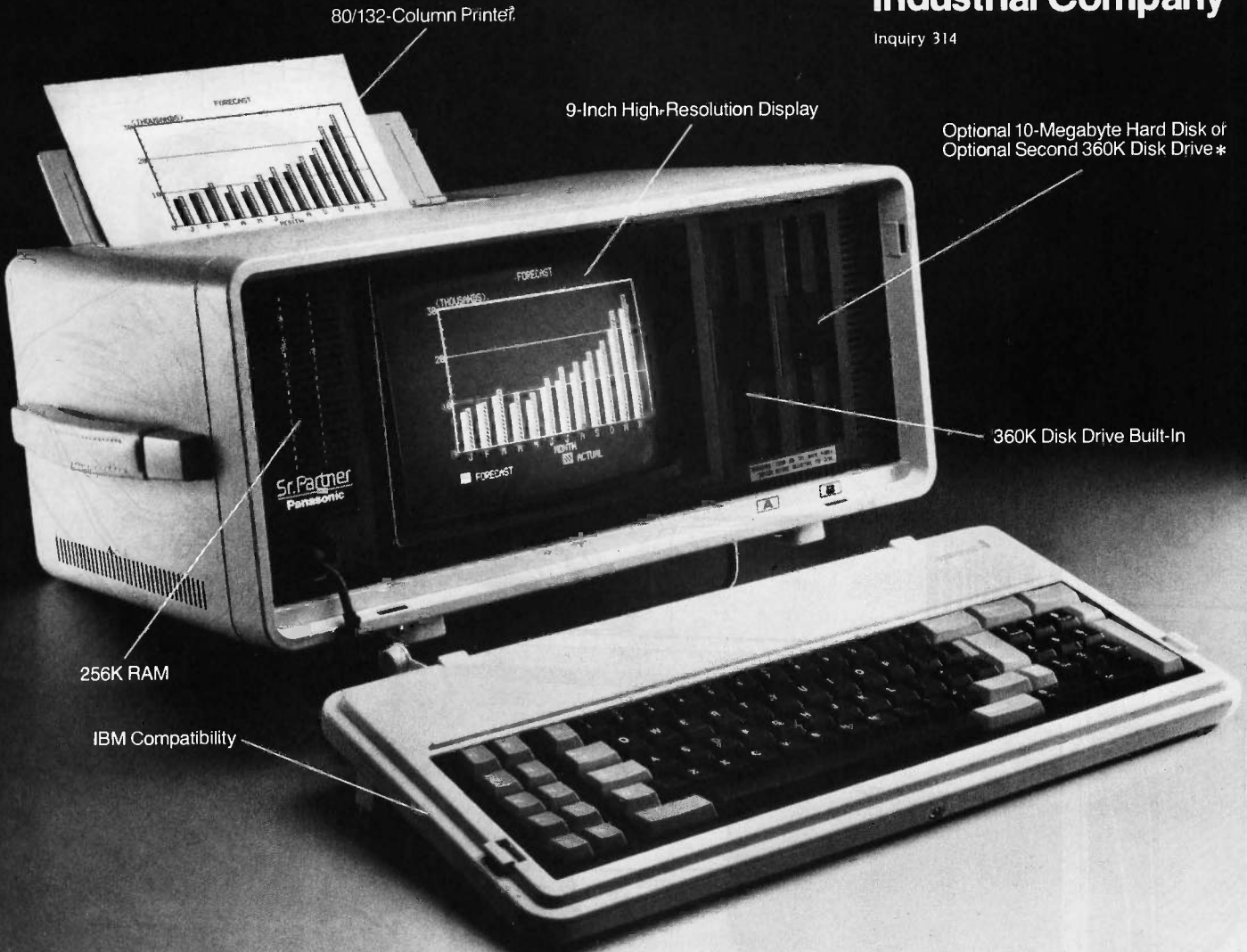

*Software bundle offer subject to change or withdrawal at any time without notice and is not available with Hard Disk Sr. Partner. **One-year limited warranty, 8 months on thermal printer head. Carry-in or mail-in service. Sr. Partner is a trademark of Matsushita Electric Industrial Company Ltd; WordStar is the trademark of MicroPro International Corporation; VisiCalc is the registered trademark of VisiCorp; pfs:Graph, File, Report are the registered trademarks of Software Publishing Corporation; GW BASIC, MS-DOS are the trademarks of Microsoft Corporation.

**FOR THE FIRST TIME IN
THE HISTORY OF THE UNIVERSE,
YOU CAN DEVELOP AN INTEGRATED
APPLICATION THAT REALLY SINGS.**



HERE'S HOW:

FRAMEWORK SOFTWARE

Framework™ is the only integrated software that contains a programming language. This means that you can use the language to create special applications which use all the features of Framework.

For the first time, you'll find it easy to design custom programs which let users outline, write, work with data and create graphs for their own special requirements, and use all Framework functions with a single set of easily-learned commands.

Let's say your customer is using a sales

analysis program you've written using Framework. He loves the ability to draw graphs and use all the other standard Framework features. To his surprise, when the Sales Analysis graph reveals the Southern region is leading, his PC starts playing "Dixie."

If you use the Framework programming language, you'll discover the @BEEP command, which lets you select both frequency and duration: @BEEP (440,300) plays a pure "A" for 3 seconds. Not quite long enough to tune an orches-

tra, but it's the start of a melody.

Ashton-Tate™ has created a whole industry of vertical-market applications with its dBASE II® and dBASE III™. It's doing the same with Framework.

Climb aboard the bandwagon. Make your programs take on the beauty of the varied capabilities of Framework.

For a dealer near you call (800) 437-4329, ext. 222. In Colorado (303) 799-4900, ext. 222.

Framework, dBASE-III, and Ashton-Tate are trademarks of Ashton-Tate. dBASE II is a registered trademark of Ashton-Tate. ©Ashton-Tate 1985. All rights reserved.

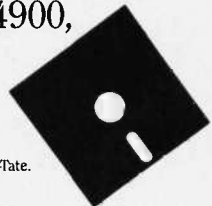

Software from

ASHTON-TATE™

We'll put you in control.

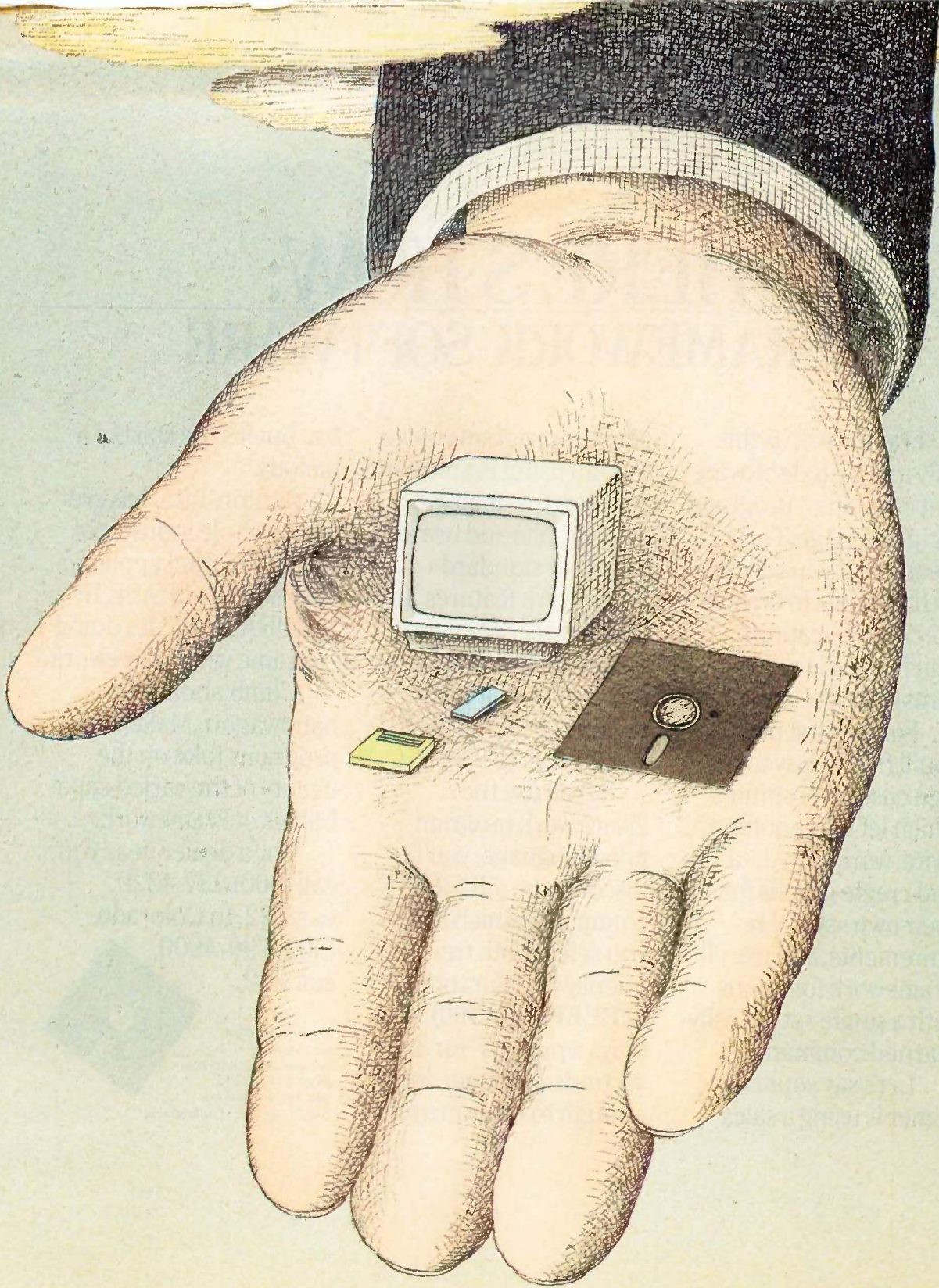

Features

THE AT&T UNIX PC <i>by Gregg Williams</i>	98
CIARCIA'S CIRCUIT CELLAR: BUILD THE HOME RUN CONTROL SYSTEM, PART 2: THE HARDWARE <i>by Steve Ciarcia</i>	108
SET EXTENSIONS WITH APPLE PASCAL <i>by Alfred L. Schumer</i>	128
BUILD A TALKING CLOCK SPEECH SYNTHESIZER <i>by Ernest H. Piette</i>	143
SMALLTALK COMES TO THE MICROCOMPUTER WORLD <i>by Bruce Webster</i>	151
METHODS: A PRELIMINARY LOOK <i>by Bruce Webster and Tom Yonkman</i>	152
SMALLTALK-PC <i>by Christopher Macie</i>	155
THE SMALLTALK PROGRAMMING LANGUAGE <i>by Jim Anderson and Barry Fishman</i>	160

THIS MONTH'S FEATURES lead off with a product description of the AT&T UNIX PC, a new machine from AT&T Information Systems. As Gregg Williams, senior technical editor, points out, with the UNIX PC, AT&T hopes to establish UNIX as a standard in the business world and challenge IBM. Gregg wasn't able to spend all the time he wanted with the machine, but he has some definite impressions of its pros and cons.

Steve Ciarcia continues with Part 2 of his Circuit Cellar Home Run Control System, explaining more of the details of his home and the system and how they come together.

Next, Al Schumer discusses "Set Extensions with Apple Pascal." He describes sets, operators, and logical machine equivalents and presents a fast extension program to Apple Pascal that increases the size of available sets and adds more set operations.

While "Build a Talking Clock Speech Synthesizer" might sound like a project that's been done before, this one adds the interesting capability of experimenting with unlimited-vocabulary speech processing. A couple of inexpensive chips, a few components, and your Commodore 64 or VIC-20 will keep time and also announce it.

People remember the August 1981 BYTE because of its Smalltalk theme. They also remember that Smalltalk wasn't available for microcomputers then and wondered when they would get a chance to experiment with this intriguing environment. This month we present a follow-up, what we call our Smalltalk trilogy.

First, contributing editor Bruce Webster and Tom Yonkman evaluate Methods, from Digitalk Inc., a Smalltalk version for the IBM PC and those machines that emulate it. Christopher Macie then describes his restricted version of Smalltalk, Smalltalk-PC, for the Apple II and others. And, finally, for those who would like a refresher on Smalltalk-80, Jim Anderson and Barry Fishman of Digitalk give us a brief review and an application that runs under Methods.

—Gene Smarte, Managing Editor

BY GREGG WILLIAMS

THE AT&T UNIX PC

Editor's note: The following is a BYTE product description. It is not a review. We provide an advance look at this new product because we feel it is significant.

THE UNIX OPERATING SYSTEM has been heralded as the answer to many of the problems that face computer users, especially those who need multiuser programs or who need to move a large software system from, say, a microcomputer to a mainframe. But, despite its good features, one fault of UNIX makes many people doubt that it can succeed in a commercial environment: UNIX contains many cryptic commands that must be mastered and remembered to make use of its power (for example, `mv` renames a file, `cat` prints it out, and `ls` gives a catalog of files in your current area).

The AT&T UNIX PC is AT&T Information Systems' attempt to establish UNIX as a standard for the business environment and to challenge IBM's dominance in the office. Its extensive use of windows and a menu-driven "front-end" program called the Office bring most of the power of UNIX to the unskilled user. Its Motorola 68010 processor gives the machine *virtual memory* capabilities—the system appears to software as if it has 4 megabytes of memory, even when it actually has as little as 512K bytes. Its telephone subsystem integrates the computer and the telephone, allowing such functions as computerized logging of phone calls, dialing from a customized directory, and saved, on-screen note taking during calls.

The UNIX PC comes with either a 10- or a 20-megabyte internal hard disk, can support up to two additional users (but without telephone services or multiple windows), and can read IBM PC-DOS data and source-code files. Although the machine has both good design features (it can be used equally well with or without its mouse, for example) and bad ones (windows respond sluggishly to mouse-initiated moves and change-size commands), its base price of \$5590 for the 10-megabyte model (and \$6590 for the 20-megabyte model) makes it a serious candidate for office use or UNIX program development. Buying the unit, however, forces you to cast your lot with the AT&T/UNIX world—AT&T says it has no plans to offer an add-on board that would allow the UNIX PC to run IBM PC programs.

SYSTEM DESCRIPTION

The UNIX PC was designed to AT&T specifications by Convergent Technologies of Santa Clara, California; its characteristics are summarized in the In Brief section on page 100. The AT&T mouse (see photo 1) has three buttons. These mimic the Enter, Cmd, and Mark keys on the keyboard (see photo 2); you can perform

(continued)

Gregg Williams is a senior technical editor at BYTE. He can be contacted at POB 372, Hancock, NH 03449.

Photo 1:

The AT&T

UNIX PC.

PRODUCT
DESCRIPTION



IN BRIEF

Name

AT&T UNIX PC

Price

\$5095 with 10-megabyte hard disk and 512K bytes of memory (UNIX \$495 extra, for a total of \$5590); \$6590 with UNIX, 20-megabyte hard disk, and 1 megabyte of memory (includes 512K-byte expansion card)

Microprocessor

Motorola 68010, a 32-/16-bit microprocessor (32-bit internal data path and registers, 16-bit external data bus), 24-bit address line (maximum address space of 16 megabytes), support for virtual memory

Clock Speed

10 MHz

Main Memory

512K bytes of dynamic RAM with parity bit on motherboard, currently expandable to 2 megabytes via expansion boards; machine's design allows for a maximum of 4 megabytes

Virtual Memory

Custom memory-management hardware and the Winchester disk allow a virtual memory space of 4 megabytes; page size is 4K bytes

ROM

16K bytes of EPROM used as initialization program when power or reset applied

Floppy Disk

Double-sided 5¼-inch floppy-disk drive using 48 tracks per inch; capable of reading IBM PC data and source-code disks; stores 320K bytes per disk AT&T format, 360K bytes per disk MS-DOS format

Hard Disk

10- or 20-megabyte Winchester disk

Mouse

Three-button optomechanical mouse (needs no special surface)

Video Display

12-inch green-on-black display; displays bit-mapped graphics at resolution of 348 by 720 pixels

Keyboard

Detachable 103-key keyboard

Serial Port

Standard RS-232C port configured as DTE (data terminal equipment); maximum transfer rate of 9600 bps (bits per second)

Parallel Port

Centronics-compatible

Telephone Subsystem

Built-in 300/1200-bps 212A-compatible modem, modular jacks for two incoming phone lines (one voice, one data), one outgoing line connects voice line to external telephone

Miscellaneous

Three expansion slots, battery-powered clock/calendar

Operating System

Custom version of UNIX System V, revision 2; extensions include demand-paging virtual memory, windows, shared function and source libraries, record locking at the character level; software provides for multiple users (up to three, with limitations) and multiple processes executing simultaneously for each user; only selected "core" functions provided with standard product; the rest of UNIX is available in optional AT&T UNIX Utilities package (\$495)

The UNIX PC Office Program

A window- and menu-driven software environment that allows the non-UNIX user access to computer-assisted telephone functions, UNIX functions, and optional application programs

Optional Hardware

512K-byte expansion card, \$1195

most operations with either the mouse or the keyboard. The video display is a bit-mapped display of 348 rows of 720 dots each—or 24 rows of 80 characters each (plus five lines of status information). The top line is a status line for the two phone lines, the time and date, and icons for window management and (if present) pending error messages and mail. The bottom two lines show the current functions of the eight function keys on the keyboard.

The UNIX PC is shipped with all its software already on the hard disk. The floppy-disk drive's odd placement (behind the ledge in which the keyboard fits) reflects the designers' UNIX orientation: Everything you need is on the hard disk. Still, you will use the floppy-disk drive to back up the contents of the hard disk, to install commercial software onto the hard disk, to format a floppy disk for later use, or to read data or source code from an IBM PC disk for use in the UNIX environment.

This system makes considerable use of windows but only occasional use of icons. Windows represent *folders* (which can contain files and other folders), but the UNIX PC represents an item inside a folder as a single line of text—its name, type, and optionally some other information.

THE OFFICE PROGRAM

The Office program is the mechanism through which most users will interact with the UNIX PC. It is a menu-driven "front-end" program that translates your selection to the proper UNIX commands and executes them. Once the Office window has been made active, you can execute an item by highlighting it with the cursor keys and hitting the Return key, by pointing to it with the mouse cursor (which highlights it) and pressing the left mouse button (or, equivalently, the Return key), or by typing enough of the item's name for the software to recognize it (this highlights the item) and hitting Return. When the software needs more information, it opens up another window that contains the additional choices.

The Administration item leads, through additional menus, to 24 operations that must be performed to keep the computer and the part of it you control in order. This includes everything from changing your password, to configuring the parallel and serial ports, to backing up the hard disk (see table 1 for a full list). Normally, you would need considerable knowledge about UNIX *and* the file structure of the machine to perform these functions; for example, it takes four pages of C code to implement the add/change/delete user log-on menu. The Administration item is at the heart of AT&T's attempt to make UNIX palatable to the average user.

The Clipboard item is rarely opened; it stores files and parts of files that are being trans-

ferred to a new location.

The Filecabinet item opens to a window that contains all your files and folders; the Filecabinet window is open in photo 1. The Filecabinet window can also contain modem data and RS-232C *profiles*. A profile contains the information needed to set up the internal modem or the serial port for a given use.

The Floppydisk item expands into a window that displays the contents of the disk currently in the floppy-disk drive. By copying files and folders into the Floppydisk window, you copy them onto the disk itself.

The Preferences item expands into several menus that allow you to change the order and manner of displaying items within windows, change the default window size, and turn on or off the availability of the UNIX window and certain Administration items.

The system automatically puts all material to be printed into a print queue and prints it as a background task. The Printer Queue item expands into a window that lists all items awaiting printing; you can examine the list and, optionally, cancel one or more items.

The UNIX System item expands to a window that acts like a standard UNIX terminal. This item defaults to the Bourne *shell* (this is a UNIX term that denotes the user interface between you and UNIX); you can access other shells (when they become available) by specifying a shell's name in the Office Preferences window.

When files and folders are deleted, they move to the Wastebasket. Only when they are removed from this window are the files and folders physically deleted from the hard disk.

WINDOWS

Windows in the AT&T UNIX PC behave differently from other windowing systems on personal computers. Different programs control their windows in different ways, and windows often adjust their dimensions to what they think best. The windowing system (called the *user agent* in the AT&T literature) automatically positions windows so that, if possible, all windows are at least partly visible from the screen. When that is not the case, you can cycle through all the windows by using "next window" and "previous window" function keys, or by opening and choosing from a window that lists all the windows currently open.

A window always has four icons (the ones in the corners) and may have pairs of arrows on the right edge (for up/down scrolling) and the bottom edge (for left/right scrolling); these arrows appear only if the window cannot display its complete contents. The corner icons are, clockwise from upper left, the move-window, help, grow-window, and close-window icons. The help icon, when clicked on, *always* gives a window—sometimes several—of explanatory information. The close-window icon,

when clicked, causes the window to vanish; if it represents a program, closing it exits the program.

The move-window and grow-window icons must be dragged—place pointer on icon, hold down the left button, move the mouse (which drags the icon with it), then release the button. When you press the left button, a "W" in a box appears with a ghost outline of the window; both follow the mouse movement until you release the left button. The UNIX PC displays inferior behavior to its competitors when moving or resizing a window; see the "Problems" section for details.

SYSTEM V UNIX

The UNIX PC contains a complete implementation of UNIX System V, revision 2. AT&T has added some enhancements including: demand-paging virtual memory, windows implemented as character devices, multiple processes in different windows executing simultaneously, Bass-style record locking at the character level (needed for multiuser business software), shared function libraries (saves space by using only one copy of a routine used by multiple processes), and shared source libraries (has a similar effect on simultaneous compilations). AT&T will not offer the source code for the enhancements to the standard release of System V UNIX.

To execute UNIX functions, you can either open a UNIX window (see photo 3) or, from any window, you can execute any single UNIX command by preceding it with the customary "!" sign.

Although the basic system contains the full UNIX operating system, it does not contain many of the utilities associated with a UNIX software developer's workstation. Instead, AT&T has divided the software into the Foundation Set (\$495), the UNIX Utilities package (\$495), and a UNIX Development Tools pack-

(continued)

Photo 2:
The UNIX PC keyboard.
Many of the dedicated keys allow the computer to be controlled without using the mouse.



Table 1: Functions handled through the menu-oriented Administration window.

- Change password
- Set date and time
- Run diagnostics from floppy disk
- View system configuration
- User log-ins (add, change, delete)
- Disk backup and restore (full, incremental, single user, by filename)
- Floppy-disk operations (copy disk, format, read MS-DOS disk)
- Hardware setup (RS-232C, serial printer, parallel printer, telephone, drivers)
- Software setup (install, remove, show installed software)
- Mail setup (name this machine, identify other machine)

Table 2: Software announced for the AT&T UNIX PC at the machine's introduction.

SOFTWARE FROM AT&T

- AT&T UNIX PC Word Processor
- AT&T UNIX PC Business Graphics
- AT&T UNIX PC Electronic Mail
- AT&T UNIX PC BASIC Interpreter
- AT&T UNIX PC BASIC Compiler
- AT&T UNIX PC UNIX Utilities (includes C and assembler)
- AT&T UNIX PC Development Tools
- AT&T UNIX PC Business Accounting System General Ledger, Accounts Payable, Accounts Receivable, Order Entry/Inventory, and Payroll (five packages)

SOFTWARE FROM THIRD-PARTY VENDORS

- Language Processors Inc. Debugger, COBOL, Pascal, C
- Silicon Valley Software Pascal and FORTRAN
- SUPERcomp 20 (spreadsheet)
- Graphic Software Systems Inc. Chart
- CDI Sound Presentations
- Microsoft Word, BASIC, and Multiplan
- Ashton-Tate dBASE III
- Ryan-McFarland Inc. RM/COBOL and RM/Run Time

Figure 1: Mapping logical addresses to physical addresses.

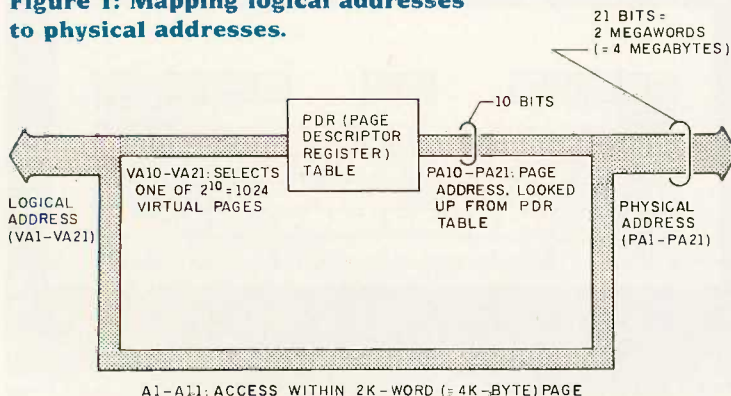

age (which includes ISAM-file and sort/merge routines, \$395). For example, the Foundation Set contains the standard ed line editor, but the Utilities package contains things like the vi screen editor, the nroff text formatter, and the yacc compiler tool.

TELEPHONE FUNCTIONS

Though AT&T's adaptation of UNIX is more important, the telephone functions (called *telephony* in the AT&T literature) most visibly distinguish the UNIX PC from other personal computers. These functions are available by opening the Telephone item in the Office window, which becomes a window of names and phone numbers titled Call Screen. Convenience features include dialing both people and computers by selecting a telephone directory entry, timing a call, redialing the last number, single-keystroke speed dialing, and putting a call on hold.

Other telephone functions go beyond simple convenience and will prove invaluable to people who use telephones a lot. The UNIX PC automatically maintains a log of all incoming and outgoing calls, including the time and duration of the call (plus name and number for outgoing calls). In addition, it gives you a chance to open a "Current Notes" window to take notes in; if you have taken notes during previous calls to the same person, the computer shows them to you (annotated with date, time, and number called) in a separate window. If you have installed the optional Electronic Mail program, you can also send UNIX-style electronic mail through either the Call Screen or the Electronic Mail windows.

INSIDE THE UNIX PC

The UNIX PC consists of removable modules that can be replaced by the user. Once the cover is off, you can see a pan assembly (which houses the floppy-disk drive, the hard disk, and the power supply) and, under it, the motherboard. (The three expansion boards each slide underneath the motherboard from the rear of the machine and connect to each other through a narrow backplane that runs along the front of the machine. The slots have a 21-bit address bus and a 16-bit data bus.)

Photo 4 shows details of the motherboard; photo 5 shows the pan assembly and the motherboard. The on-board memory area contains 512K bytes (with parity) in 4864 64K by 1-bit dynamic RAM (random-access read/write memory) chips; the chips have an access time of 150 nanoseconds and run with no wait states. These chips are pin-compatible with 256K by 1-bit dynamic RAM chips; at some later time, AT&T will start using them to get 2 megabytes of RAM on the motherboard. (The system can add up to 2 megabytes of memory via expansion cards, for a maximum of 4

megabytes of memory. AT&T plans to use one slot to connect to an external expansion-card box, but expansion memory must be in the internal slots.) The bit-mapped video display requires 32K bytes of the memory.

The system contains only 16K bytes of EPROM (erasable programmable read-only memory)—two 8K by 8-bit 2764s. These contain bootstrap and diagnostic code for power-up, as well as code executed on shutdown that ensures that the attached telephone works when the computer is off.

The 10- and 20-megabyte Winchester hard disks are built by MiniScribe. The 10-megabyte drive, which comes in the basic system, has an 85-millisecond access time and a transfer rate of 5 megabits per second. The UNIX PC uses a novel form of DMA (direct memory access) to move data from the hard disk to memory. Most computers transfer control of the address and data buses to specialized hardware that first moves data from the hard disk to a buffer area; the processor regains control of the buses and moves the data from the buffer to its final destination. The UNIX PC speeds this process by capturing the buses many times, each time only long enough to move a word of data *directly* to its final destination. By not holding the buses while the hard disk is forming the next word to be transferred, this method also decreases the time the DMA transfer prevents the 68010 processor from doing its work.

Finally, three custom gate arrays (see photo 4) perform complex functions in much less space than they would have taken using discrete logic chips.

MEMORY MANAGEMENT

One of the main differences between the 68010 processor, used here, and the 68000 processor, used in the Apple Macintosh and other computers, is the former's virtual-memory capability. In a virtual machine, dedicated hardware looks at the memory address being asked for by the processor (the *logical address*) and translates it to a *physical address* that the processor can access if the data is currently in physical memory. If it is not (meaning that it is stored instead on the hard disk), the hardware generates a *page fault* that eventually causes the needed data to be swapped into physical memory before allowing the memory to be accessed. In a 68010-based computer, the page fault is fed to the BERR* (Bus Error) pin on the 68010; the 68010, in turn, suspends the current instruction in midexecution, runs a routine that swaps the needed data into physical memory, performs related housekeeping tasks, and completes the suspended instruction.

Most computers use a dedicated integrated circuit called an MMU (memory-management



Photo 3:
A UNIX window.
This window is
running the
Bourne shell
and behaves like
a conventional
UNIX system.

unit) to translate logical addresses into physical ones and declare page faults. Instead, the designers of the UNIX PC use discrete logic and a table of high-speed static RAM called the PDR (page-descriptor register) table to do the translation (see figure 1). The lower 11 bits of the address are left alone; this gives a page size of 2K words or 4K bytes. (The 68010 does not have an address line A0 as such, but it uses the UDS [upper data strobe] and LDS [lower data strobe] lines to access byte-sized data.) The PDR table contains 1024 16-bit entries, one for each logical page. Six bits in each entry give status information about the page (including whether or not the page is in memory). If it is, the remaining 10 bits give its physical page number; if not, the logic generates a page fault and the 68010 interrupts itself to run a routine that puts the page into physical memory and updates the PDR table.

SOFTWARE

AT&T recognizes the need for as much application and system software as possible. Table 2 lists the software announced (at the time that this article was written) as immediately available. Included are several languages and popular application programs like Microsoft Multiplan, BASIC, Word, and Ashton-Tate's dBASE III. AT&T representatives said Lotus 1-2-3 will not be available; they also denied reports that they were developing an expansion card that would give their machine IBM PC compatibility.

PROBLEMS

Although the machine seemed to perform acceptably fast in the short time I had access to it (see "Caveats"), its behavior was definitely inferior to other 8086- and 68000-based windowing computers in its move-window and grow-window operations. In all cases, I measured a delay of between 1 and 1¾ seconds

(continued)

Telephone-on-a-chip hybrid IC

512K RAM

2764 EPROMs

Connector to backplane

Video gate array

Address gate array

68010 processor

Modem chip

Data gate array

WD1010 hard-disk controller

7201 UART (serial chip)

WD 2797 floppy-disk controller

Telephone line control

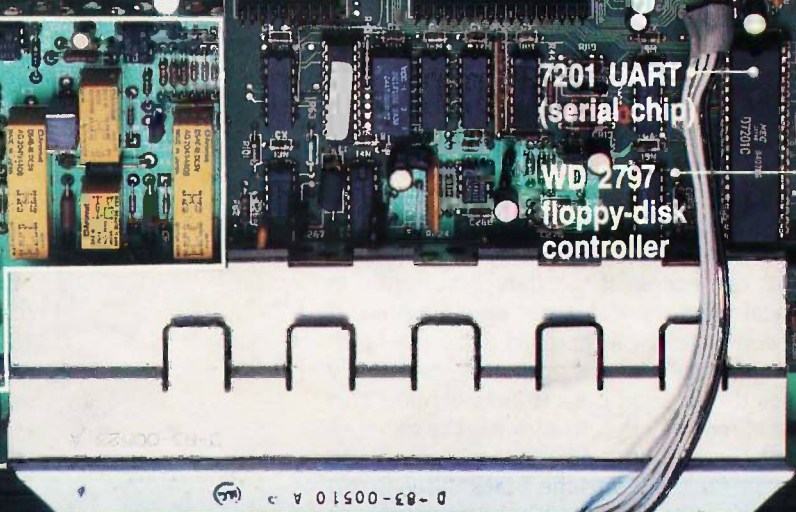

D-83-00510 A 3

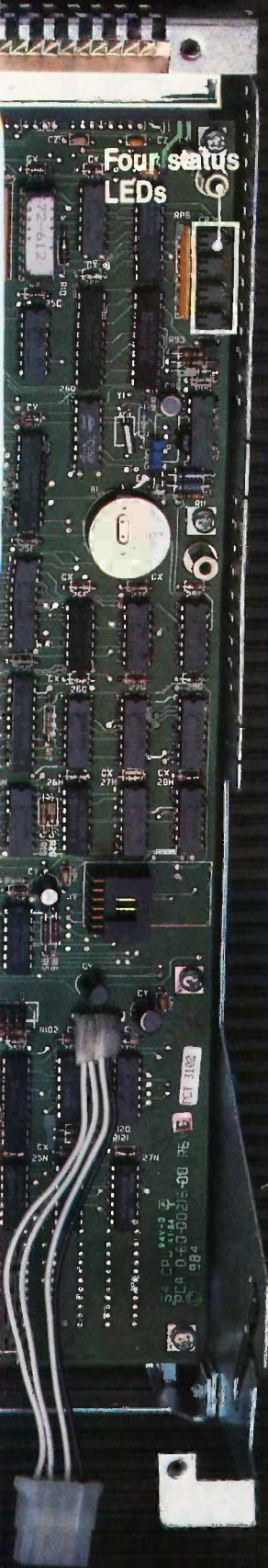
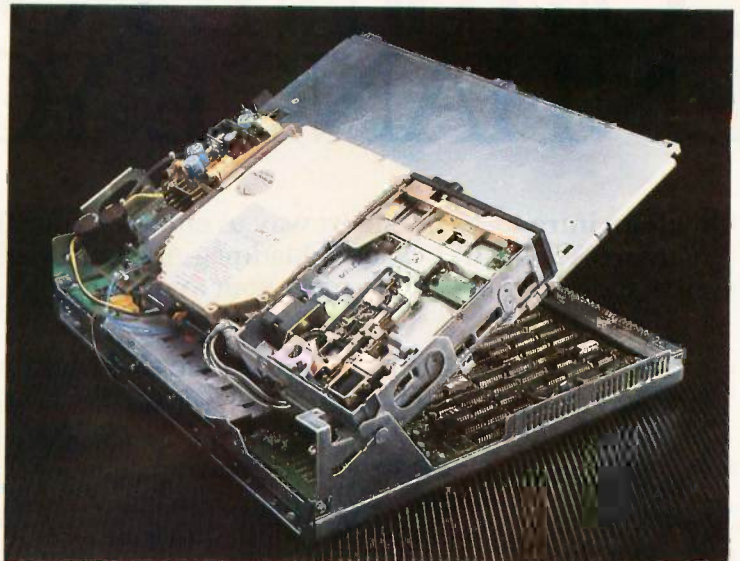

Photo 4:
The UNIX PC motherboard; the front of the board is at the bottom of this photograph.

Photo 5:
The pan assembly and motherboard. Here, the pan assembly (which holds, left to right, the floppy disk drive, the 10-megabyte hard disk, and the power supply) is hinged upward to allow access to the motherboard.



between the time the left mouse button was pressed and the move or grow operation (indicated by the "W" icon) started. The ghost outline of the window's new dimensions begins at the window's current outline when the "W" icon appears. If the mouse pointer has been dragged to a new location before the "W" appears, the ghost outline may lag the mouse pointer's position by over three-quarters the length and width of the screen, thus limiting the amount the window can change before the pointer reaches the edge of the screen. (The ghost outline of a Macintosh window, in contrast, always stays with the mouse pointer.) Though this does not prevent the use of the UNIX PC, it definitely interrupts the flow of work and mars one's perception of a machine that otherwise seems to be quite fast.

Another thing that disturbs me at first impression is the designers' positioning of the floppy-disk drive, which, given the necessity of periodically using it for hard-disk backups, seems awkward to me. However, the final vote on that should come from the first people who actually use the machine for several months.

CAVEATS

I wrote this report after two days of conferences with AT&T engineers and officials, a few hours of demonstrations and hands-on experience, and considerable study of six user- and repair-oriented manuals. The machine I used was a preproduction model that used discrete logic chips to emulate the three gate arrays. The machine had the 10-megabyte hard disk and ran the finished version of the software; I did not see the machine supporting more than one user.

COMMENTARY

Although I would have liked to have had more time to study the machine, I feel confident in describing it as "quietly impressive." No one feature—menu-driven UNIX, true multiprocessing in a windowed environment, telephone functions, virtual memory—really excites me, although each one is an important "first" in the micro-computer world. Its success as a UNIX software-development workstation is assured (although it really needs a megabyte of memory for this), but its fate in the business community is promising but uncertain. Further details will be available in the full product review of this machine, which will appear in a future issue of BYTE. ■

COMBINE POWER AND ENHANCE YOUR PC-AT

Quadram introduces the smart way to enhance your IBM PC-AT. Quadmeg-AT and Quadport-AT. Smart because Quadmeg-AT and Quadport-AT make the most of your AT system today and expand to meet your system's growing needs in the future.

Quadmeg-AT comes socketed for memory expansion from 128K to 2 Megabytes. Harness this power to create megabyte-sized RAM drives, access

QUADMEG-AT™

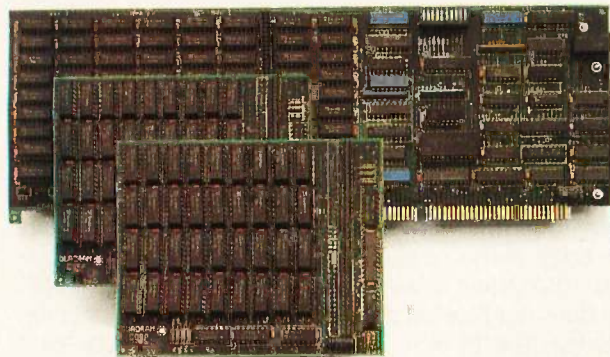

greater amounts of information, and process data faster and more efficiently than ever before. Plus, with "split memory mapping," Quadmeg-AT lets you expand the AT's base system memory to 640K without buying a space-wasting 128K card.

Advance to 4 Megabytes

When you need more than 2Mbytes, Quadmeg-AT adapts with two Quadmeg-AT Expansion Cards. Each packs 512K or 1Mbyte extra RAM.

Both cards filled give Quadmeg-AT a powerful 4Mbyte capacity. Quadmeg-AT delivers the power you need to take full advantage of the AT's capabilities.

Maximum Performance in Minimum Space

Quadmeg-AT and Quadport-AT fit snugly side by side to deliver a powerful 4Mb RAM and multiple I/O expansion in just two AT expansion slots.

Add a Second Quadport

Two Quadport-ATs give your AT system a total of 2 parallel ports and 10 serial ports. Add peripheral devices or workstations for the ultimate in PC-AT performance.

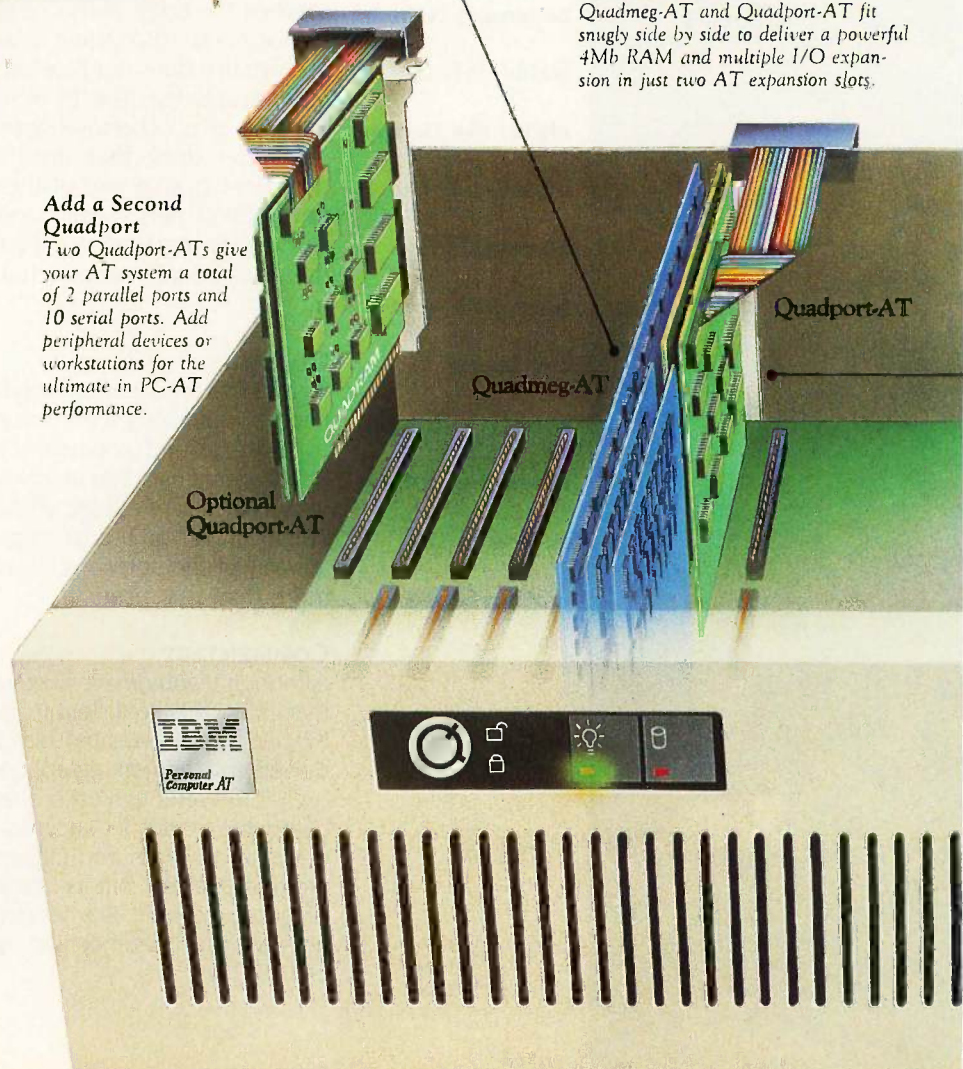

™ Look for this seal. It's the mark of dependability and performance from the leader in microcomputer enhancements.

IBM PC-AT is a registered trademark of International Business Machines Corporation.

EXPANDABILITY TO THE SMART WAY.

QUADPORT-AT™

Quadport-AT combines a parallel printer port and a serial port to give your AT the features found on IBM's Serial/Parallel Adapter. But at a lower cost and with

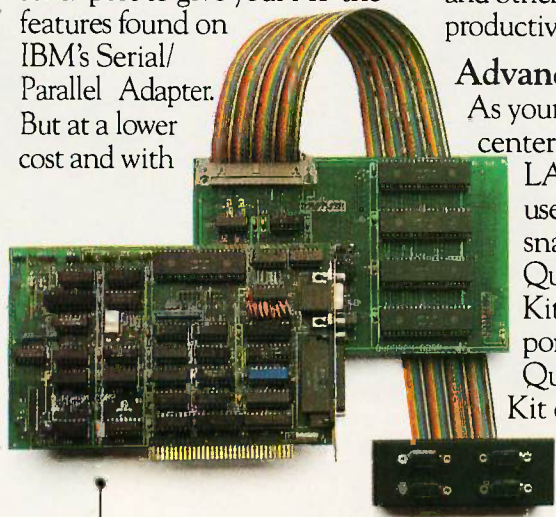

built-in expandability. Connect printers, plotters, modems, and other devices for increased productivity.

Advanced Port Expansion

As your AT becomes the center of a high-performance LAN or growing multi-user, multi-tasking system, snap on the optional Quadport-AT Expansion Kit and add 4 more serial ports to your system. The Quadport-AT Expansion Kit comes with software to access these ports, making it easy to add shared peripherals or workstations.

Enhance the smart way with Quadram.

For basic AT expansion, Quadmeg-AT and Quadport-AT work together to provide 128K memory expansion, a serial port, and a parallel port.

Then, as your system grows, Quadmeg-AT and Quadport-AT give you up to 4MB RAM, 1 parallel port, and up to 5 serial ports in just two PC AT expansion slots. Only Quadram combines so much power and expandability. That's PC AT enhancement the smart way.

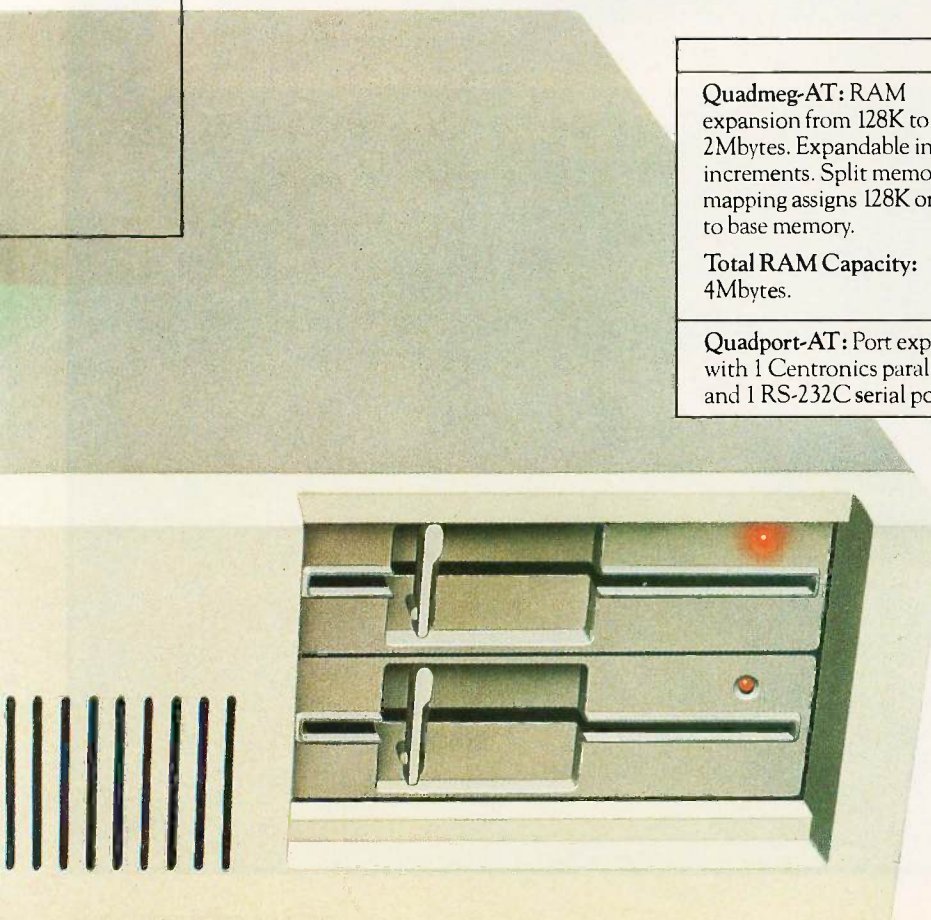

Features	
<p>Quadmeg-AT: RAM expansion from 128K to 2Mbytes. Expandable in 512K increments. Split memory mapping assigns 128K or 384K to base memory.</p> <p>Total RAM Capacity: 4Mbytes.</p>	<p>Expansion Cards: Two cards available. Each comes with 512K or 1Mbyte RAM installed.</p> <p>QuadMaster-AT Software: RAM Drives and Spooling for extended memory.</p>
<p>Quadport-AT: Port expansion with 1 Centronics parallel port and 1 RS-232C serial port.</p>	<p>Quadport-AT Expansion Kit: (optional) 4 RS-232C serial ports. Software to access ports.</p>

For a free demonstration visit the Quadram dealer nearest you. Or, for information, write us at 4355 International Blvd., Norcross, Georgia 30093 (404) 923-6666.



Inquiry 334



BUILD THE HOME RUN CONTROL SYSTEM

PART 2: THE HARDWARE

BY STEVE CIARCIA

*Energy management, convenience,
and security in one package*



I live in a large house with irregularly shaped rooms. The center section of the house is hexagonal, with a sunken living room in front of a fireplace. The kitchen is also hexagonally shaped and opens into a greenhouse. From the living room or the kitchen, you can descend to the "control center." The Circuit Cellar is also not your standard-shaped room. Defining a corner as the point at which two walls meet, you will find 13 corners in the Circuit Cellar.

My reason for describing this is not to elicit sympathy but instead to outline one of the reasons I designed the Home Run Control System (HCS). Visitors often comment on how wonderful it must be to live in a contemporary-styled home. Of course, they come from traditional houses with rectangular walls and light switches near the doors. There is no pattern of organization to the lighting in this house, and more than one light must be turned on in the Circuit Cellar and adjacent storage areas just to see around obstacles. If you try to walk around in the dark through some areas in this house, you can find yourself somersaulting over shin-high railings into pits, impaled on glass table corners, stunned on dark-painted Lally columns, or entangled forever in the masses of wires strung between groupings

of electronic equipment. Walking around this house in the dark can be hazardous to your health.

Over the years I've designed control systems that involved automatic lighting including the BSR. Unfortunately, the hand-held controller was always some place I wasn't, or the command console was pointed in another direction (and rooms with 13 corners have lots of directions).

While I could have bought out the local Radio Shack and put controllers and modules everywhere, the problem was one of greater dimension. I ultimately wanted a control system that followed prescribed security and environmental procedures when I wasn't there but that could redirect its control functions to provide simple, automatic convenient living when I was.

Bumping into things in the dark was merely an inconvenience. I solved it in the interim by just leaving lots of lights on at night. In the long run, however, I've been directing my efforts to building the true home-control system: one that senses presence in rooms and automatically turns lights on, raises the

(continued)

Steve Ciarcia (pronounced "see-ARE-see-ah") is an electronics engineer and computer consultant with experience in process control, digital design, nuclear instrumentation, and product development. He is the author of several books about electronics. You can write to him at POB 582, Glastonbury, CT 06033.

heat or lowers the air conditioning, and follows a variety of prescribed control sequences (as opposed to one) defined by the real-time assessment of the activities of the house's occupants. Finally, it is a reality, and photos 1-3 show some aspects of the system installation at my home.

The BSR by itself does not have the logical decision power to provide this capability. These functions require a computer and a program dedicated to analyzing and reacting to the environment. Home Run is such a dedicated home-control system. It uses BSR X-10 (Sears Home Control, Leviton, and Radio Shack Plug-N-Power, among others) remote-controlled receivers as many commercial timer/controllers do, but its concept and capabilities greatly exceed those systems. The Circuit Cellar HCS is a video-based closed-loop control sys-

tem. The text box on page 112 outlines Home Run's basic functions.

This month, I will continue the description of the HCS with an in-depth analysis of the hardware design. First, since much of the hardware function deals with the BSR remote controllers, I'll start by reviewing their function and the communication codes they use.

BSR X-10 SYSTEM COMPONENTS

When I first wrote about the X-10 in January 1980, the system consisted of five modules: command controller, cordless controller, lamp module, appliance module, and wall-switch module. The line has now been expanded to include a programmable timer, wall-receptacle modules, automatic setback thermostats, and a telephone auto-answer controller. The

HCS can use and control any BSR receivers.

The command controller (or any unit that functions as a command transmitter) is the central element in the system. It sends commands to the receiver modules by coded messages sent through the AC power lines. The cordless controller is a remote extension of the command controller and has a matching keyboard. When pointed at the command controller from up to 30 feet away, any command that is selected on it will be transmitted ultrasonically to the command controller and carried out.

Lamp and wall-switch modules are essentially the same. They are triac-controlled on/off switches, rated at 300 watts (W), that include dimmers. The lamp module is plugged into a wall outlet in series with the light to be controlled while the wall-switch

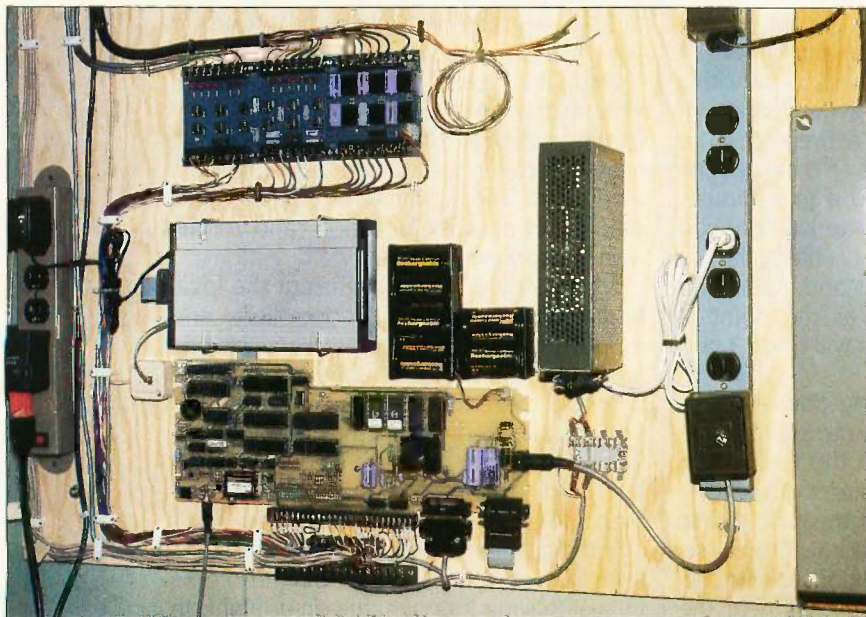

Photo 1: I'm getting very serious about using the HCS in my home. I installed a 3-by 4-foot piece of plywood next to the breaker box and started stringing wires everywhere for closed-loop input control. The HCS board is mounted in the bottom center. Directly above it in the silver box is a Hayes 300-bps auto-answer modem. To the right of that are the rechargeable battery backup and 12-V power supply for the motion detectors and interface boards. Directly above the modem is a custom optoisolated level shifter and AC-to-DC converter interface that connects the Touch Plate, a low-voltage relay system, and commercially installed alarm-system sensors to the HCS. By the time this series of articles is finished, the rest of the board should be filled.

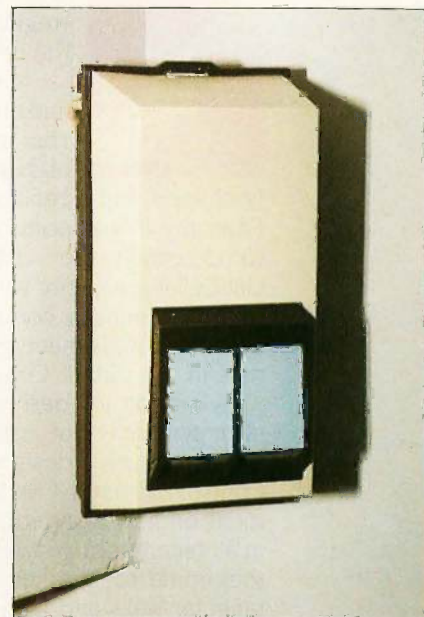

Photo 2: Much of my application for the HCS deals with its use for security and automatic lighting. Shown is the installation of a typical passive infrared motion detector. Costing in the neighborhood of \$140 each, these units detect the movement of objects (like people) that have a different temperature than the surroundings. The units require a 12-V power source. Output is a contact closure: closed is no motion and open is motion detected.

module replaces a conventional wall switch. For heavier or nonresistive loads, a contact-closure-output appliance module or wall-receptacle module is used. These are rated at 15 amperes (A) (about 1700 W).

At the heart of a BSR command module, as well as of the other system components, are custom LSI ICs (large-scale-integration integrated circuits) manufactured for BSR by General Instrument Corporation. Fully expanded, the BSR system can accommodate 256 independently addressable receivers. That is accomplished using 16 sets of addresses called *house codes* and 16 *device codes* for each house code. The separate house codes allow next-door neighbors to use X-10s without interfering with each other. A thumbwheel switch on the bottom of the command controller and the receiver modules sets the 4-bit house code.

In normal operation, the 22-button keypad, which is wired as a 3 by 8 matrix, is scanned at a rate of 3.8 kHz. When a button is pressed, its designated function and the house code (see tables 1 and 2) are combined into a single message. The digital message is directed to the transmitter section, where it generates 120-kHz signals that are used to modulate the AC line with pulse-width modulation.

To synchronize the digitally encoded serial output with the 60-Hz AC line, the circuit includes a zero-crossing detector. The transmitted message is clocked a bit at a time on zero crossing. A command message contains 9 bits of information, consisting of the 4-bit house code and the 5-bit matrix (keyboard function) code. Each message is transmitted in true and inverted format on successive half cycles of the AC waveform. This is illustrated in figures 1 and 2. A logic 1 bit consists of three 1-millisecond (ms) bursts of 120-kHz signal commencing approximately 200 microseconds (μ s) after the zero crossing of the AC line. A logic 0 bit is represented by no signal for that half cycle. To synchronize the receivers with the transmitter, a trigger code consisting of 3 successive logic 1 bits followed

by a logic 0 bit is used. The complete message takes 11 full AC cycles (183 ms) to complete.

Actual attachment to the AC line is accomplished by means of a transformer and capacitor coupler. That combination is necessary both for protection and economics. The effective range of this system is generally all the wiring from the controller to the nearest power company step-down transformer. Usually, five or six houses are on each transformer; some coordination with respect to the choice of house codes may be necessary. Also, since the version of the X-10 sold in the U.S. is a 117-volt (V) unit, and because most homes derive their 117-V power from both sides of a 220-V line, problems can sometimes occur in obtaining consistent operation when receiver modules are used on both 117-V lines and relatively few

220-V appliances are in operation to act as a communication bridge. Placement of the receivers could require some experimentation, or a capacitor jumper could be added between the sides of the 220-V line.

The receivers are quite sophisticated, considering that each one usually costs less than \$17. All receivers (lamp modules, appliance modules, wall-receptacle modules, and wall-switch modules) are essentially the same. Also incorporating a custom LSI IC, the receiver section monitors the AC line, waiting for a coded message corresponding to its unique house code (A through P) and unit device code (1 through 16). To turn on channel 10, you simply press 10 and ON, one after the other. When an appliance or wall-receptacle module activates, it energizes a relay.

(continued)

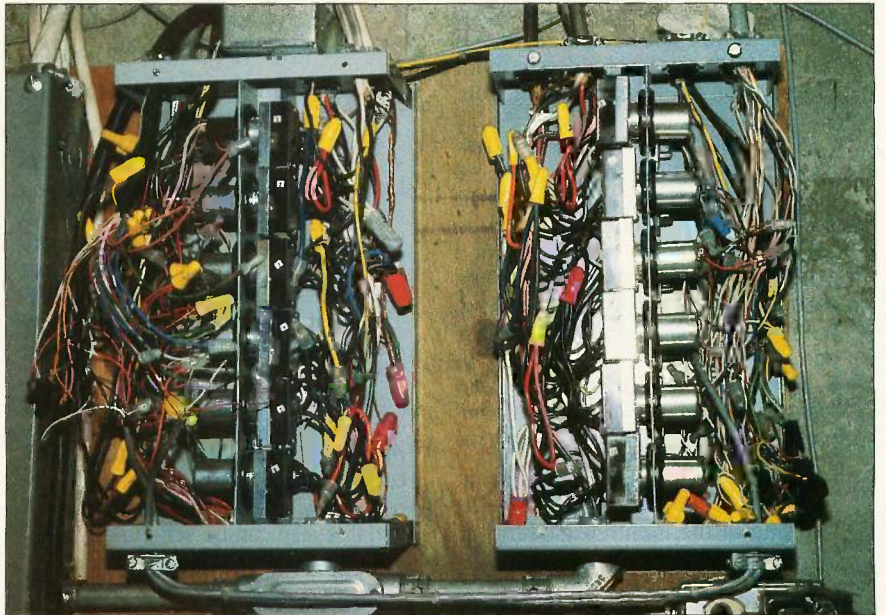

Photo 3: Much of the outside lighting and some of the outlets in my home are already remotely controlled through the Touch Plate. An absolute rat's nest of expensive electrician-installed wire controls 12 specific circuits. The highly reliable latching relays are controlled at various points in the house by illuminated push buttons. Their operation is push-on/push-off single-button control. When the circuit is on, the button is illuminated by a second low-voltage signal. Given the closed-loop nature of Touch Plate, I decided to connect some of the circuits to the HCS. The six relays wired in at present required a separate interface board to convert the low-voltage AC Touch Plate to TTL levels and an 18-conductor cable to route the signals. The HCS can now control as well as ascertain the present on/off state of the outside lighting.

HOME RUN CONTROL SYSTEM: OVERVIEW

The Home Run Control System is a single-board computer with the hardware and software needed to control lights and appliances in a home or a specific production process in a small business. The system uses BSR home-control modules that are activated by signals superimposed on the house wiring. The system can also directly control processes through hard-wired outputs. The following outline itemizes the features of the computer.

1. Versatility. The HCS can accommodate 48 BSR modules, 16 digital inputs, 8 TTL-compatible outputs, and 16 messages.

2. Self-containment. The HCS can use any terminal (or personal computer emulating a terminal) at 75-4800 bps. The HCS also incorporates an integral video-display generator to provide a 24-line by 40-character display either directly to a composite video monitor or television set. A keyboard encoder allows connection of either an Apple II-compatible parallel-encoded keyboard or an unencoded scanned-matrix keyboard. An additional serial port has been provided to which an auto-answer modem can be attached (such as the Hayes 300 or 1200). When the modem answers, the HCS allows the remote calling terminal to access and control the HCS.

3. Flexibility. The HCS can schedule to turn outputs on or off based on combinations of the following conditions:

- a. time of the week (e.g., Tuesday at 4:32)
- b. time of the month (e.g., 22nd at 11:20)

- c. input line going high
- d. input line going low
- e. turn off after time delay (e.g., remain on for 15 minutes)
- f. one-time action triggered by specific input or time

When you want to create an event, various combinations of inputs and time can be specified. They are as follows:

- 1 ON at specified time
OFF at specified time
- 2 ON at specified time
OFF when specified input occurs
- 3 ON when specified input occurs
OFF at specified time
- 4 ON when specified input occurs
OFF when specified input occurs
or
ON while specified input occurs
- 5 ON when specified input occurs
OFF after period of time

4. Superkeys. The HCS has 16 function-key inputs called superkeys, which cause a user-defined list of actions to be performed when the appropriate key is entered. This allows a complete sequence of events to be transmitted. The number of commands defined by a superkey is limited only by available RAM.

5. Light dimming. Lights can be dimmed to one of 16 levels. This allows mood control, a night light, or power-conservation operation.

6. Display messages. Text messages of variable size can be scheduled as announcements or reminders.

7. Low power. The HCS can be used to control energy consumption of a house, thus it is designed to be efficient. Power requirements are under 5 watts.

8. Battery backup. The processor and clock will continue to operate during a power failure; scheduled events will still be noted in memory. When AC power is restored, the HCS will restore all modules to the state they would be in if power weren't interrupted.

9. Sunset adjustment. The on time of desired modules, usually lights, will track the sunset. This alleviates having to adjust the schedule many times per year as the sunset changes. There is a command to compensate sunset times for daylight saving.

10. Automatic restore. The HCS can optionally restore the status of all modules every 4 minutes. This is useful in commercial applications where a module may be turned off by a transient or non-HCS-generated command. Restore can also be triggered by an input line. The HCS always restores all modules after a power loss.

11. Schedule bypass. Modules can be bypassed for a selected interval (up to 44 days). This can be used for vacations or holidays.

12. Hold on input. This allows an input occurrence to lock out specified modules.

13. Accurate clock. The clock accuracy can be adjusted by software to within 1 second per day.

14. List events. The entire event schedule can be listed to the serial port. The speed of the listing can be controlled to allow for printing of the schedule.

The lamp and wall-switch modules use a triac instead and have the capability to brighten or dim in response to control commands.

HOME RUN HARDWARE

The Home Run Control System is a complete microcomputer. Functionally block-diagramed in figure 3, it contains RAM (random-access read/write memory) and ROM (read-only mem-

ory), serial and parallel I/O (input/output) ports, a keyboard, and a video display. In its fully expanded form, it can communicate with an external terminal or a modem and display the events and status on its own display simultaneously. The HCS is based on the 6802 processor and runs entirely on interrupt. These interrupts update the real-time clock, scan the event tables, read the input lines, set the

outputs, refresh the video display, transmit the BSR codes, and service the communication ports.

Home Run was designed to work in a variety of home and industrial applications. As such, it accommodates both encoded and unencoded keyboards, terminal and integral video display, and BSR and direct I/O. Its software is flexible enough to work

(continued)

CIRCUIT CELLAR

Table 1: Security house codes.

STATE	H8	H4	H2	H1
A	0	1	1	0
B	1	1	1	0
C	0	0	1	0
D	1	0	1	0
E	0	0	0	1
F	1	0	0	1
G	0	1	0	1
H	1	1	0	1
I	0	1	1	1
J	1	1	1	1
K	0	0	1	1
L	1	0	1	1
M	0	0	0	0
N	1	0	0	0
O	0	1	0	0
P	1	1	0	0

Table 2: AC-line matrix key codes.

KEY	D8	D4	D2	D1	D16
1	0	1	1	0	0
2	1	1	1	0	0
3	0	0	1	0	0
4	1	0	1	0	0
5	0	0	0	1	0
6	1	0	0	1	0
7	0	1	0	1	0
8	1	1	0	1	0
9	0	1	1	1	0
10	1	1	1	1	0
11	0	0	1	1	0
12	1	0	1	1	0
13	0	0	0	0	0
14	1	0	0	0	0
15	0	1	0	0	0
16	1	1	0	0	0
CLEAR	0	0	0	0	1
ALL	0	0	0	1	1
ON	0	0	1	0	1
OFF	0	0	1	1	1
BR	0	1	0	0	1
DIM	0	1	0	1	1

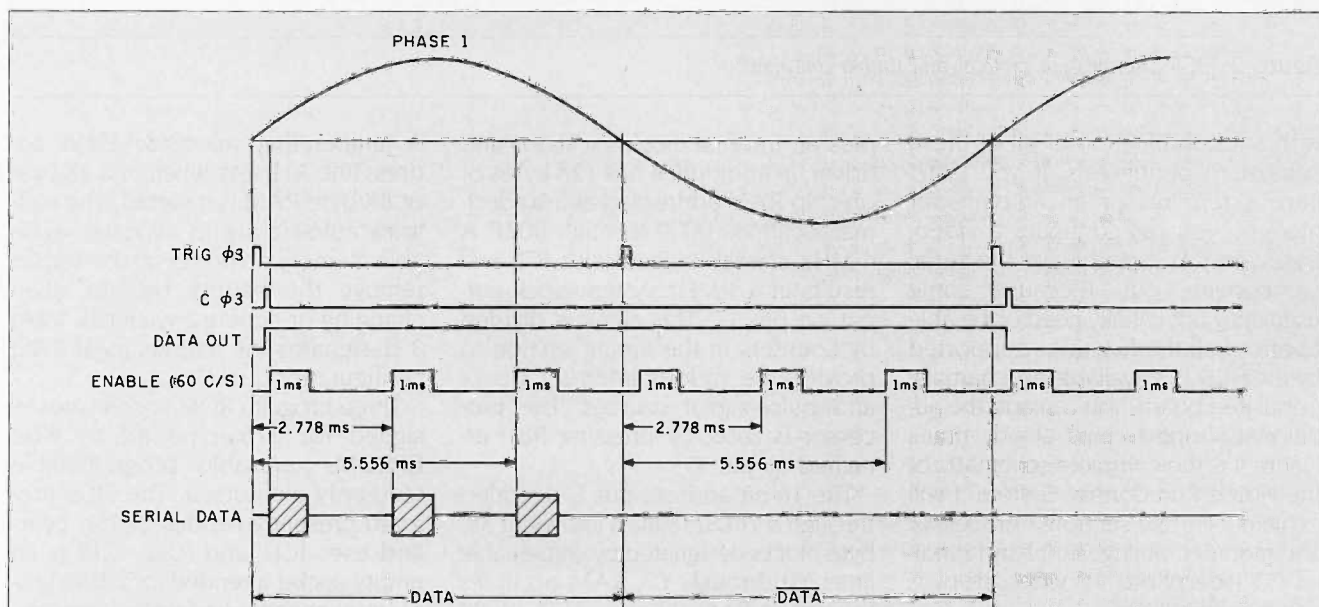

The transmitted message is synchronous with the AC line, and each bit is clocked on zero crossing. Each message contains 9 bits of information: 4 bits of security code and 5 bits of matrix code. Each message is transmitted in true and inverse form on successive half cycles of the AC-line signal.

A 1 bit is 3×1 -ms bursts of 120 kHz, commencing approximately $200 \mu\text{s}$ after the zero crossing of each phase. A 0 bit is no signal for that half cycle. To synchronize the receivers with the transmitter, a Start Code consisting of 3 successive 1 bits followed by a 0 bit is used. Thus, a complete message takes 11 full cycles of the AC line to complete.

Figure 1: BSR transmission protocol and timing.

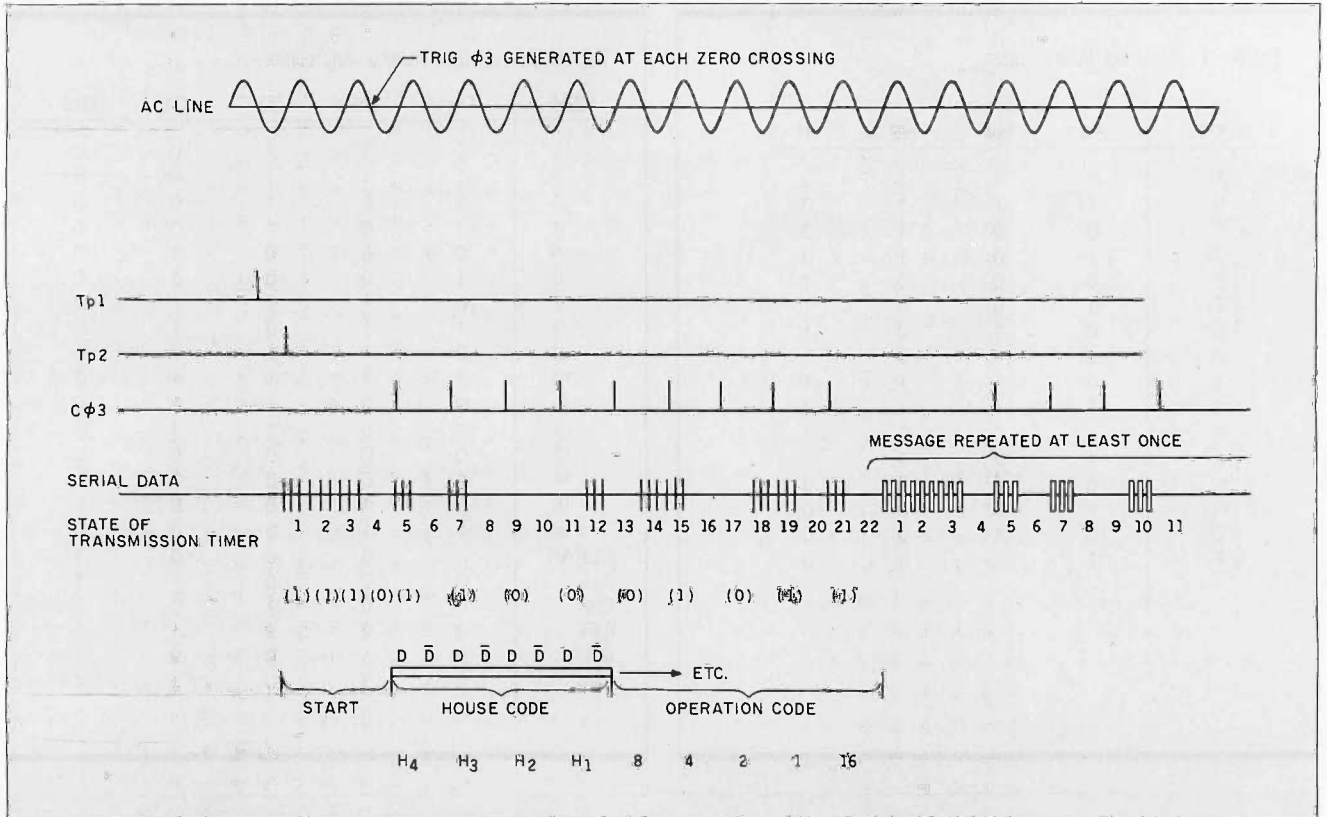

Figure 2: BSR transmission protocol and timing continued.

with any combination or all of these subsystem peripherals. If you don't have a terminal or an auto-answer modem, you can configure a video-based-only HCS and leave the serial components out. (Because some users may not initially need or be able to afford all the functions supported by the HCS, it is available as a partially populated board. You can add the additional support chips at any time.) Figure 4 is the complete schematic of the Home Run Control System. I will explain it in five sections: processor and memory, timing, serial and parallel I/O (see photo 4), video display, and power supply.

PROCESSOR AND MEMORY SECTION

At the center of the HCS is a Motorola 6802. IC1 (block-diagrammed in figure 5). The 6802 is an 8-bit processor that is software-compatible with the standard 6800. It contains the same registers and accumulators as the 6800

plus an internal clock oscillator and driver. In addition, it has 128 bytes of on-chip RAM addressed at hexadecimal locations 0000 through 007F. A 4-MHz crystal is used with IC1 and results in a 1-MHz system-clock output on pin 37. This clock is divided by counters in the timing section to provide the various interrupt clocks and pulse-signal sources. The processor is reset by pressing PBI, attached to pin 37.

The 16-bit address bus is decoded through a 74LS138 (IC5) into eight 8K-byte blocks designated by chip-enable lines Y0 through Y7. RAM occupies the space from 0000 to 3FFF. ROM occupies the range from A000 through FFFF.

The HCS has two 28-pin RAM sockets that can accommodate either 6116 (2K by 8-bit) or 6264 (8K by 8-bit) 350-nanosecond (ns) CMOS (complementary metal-oxide semiconductor) RAM chips. The HCS requires a minimum of 4K bytes of RAM to function.

A jumper that selects/deselects address line A11 sets, whether a 2K-byte or 8K-byte RAM is inserted. The software auto-sizes and allocates available memory on power-up (be sure to remove the battery backup when changing or adding any chips). Table 3 designates the various legal RAM configurations.

Three program ROM sockets are designed for 2764-type 8K by 8-bit EPROMs (erasable programmable read-only memories). The HCS program presently resides in 16K bytes and uses IC11 and IC12. IC19 is an empty socket intended for future program expansion and enhancements. (Eventually, I hope to design an analog I/O expansion board for the HCS, and I decided that it would be a good idea to put in the hooks now. Direct temperature monitoring and HVAC [heating, ventilating, and air conditioning] motor control are a possible consideration.) Portions of

(continued)

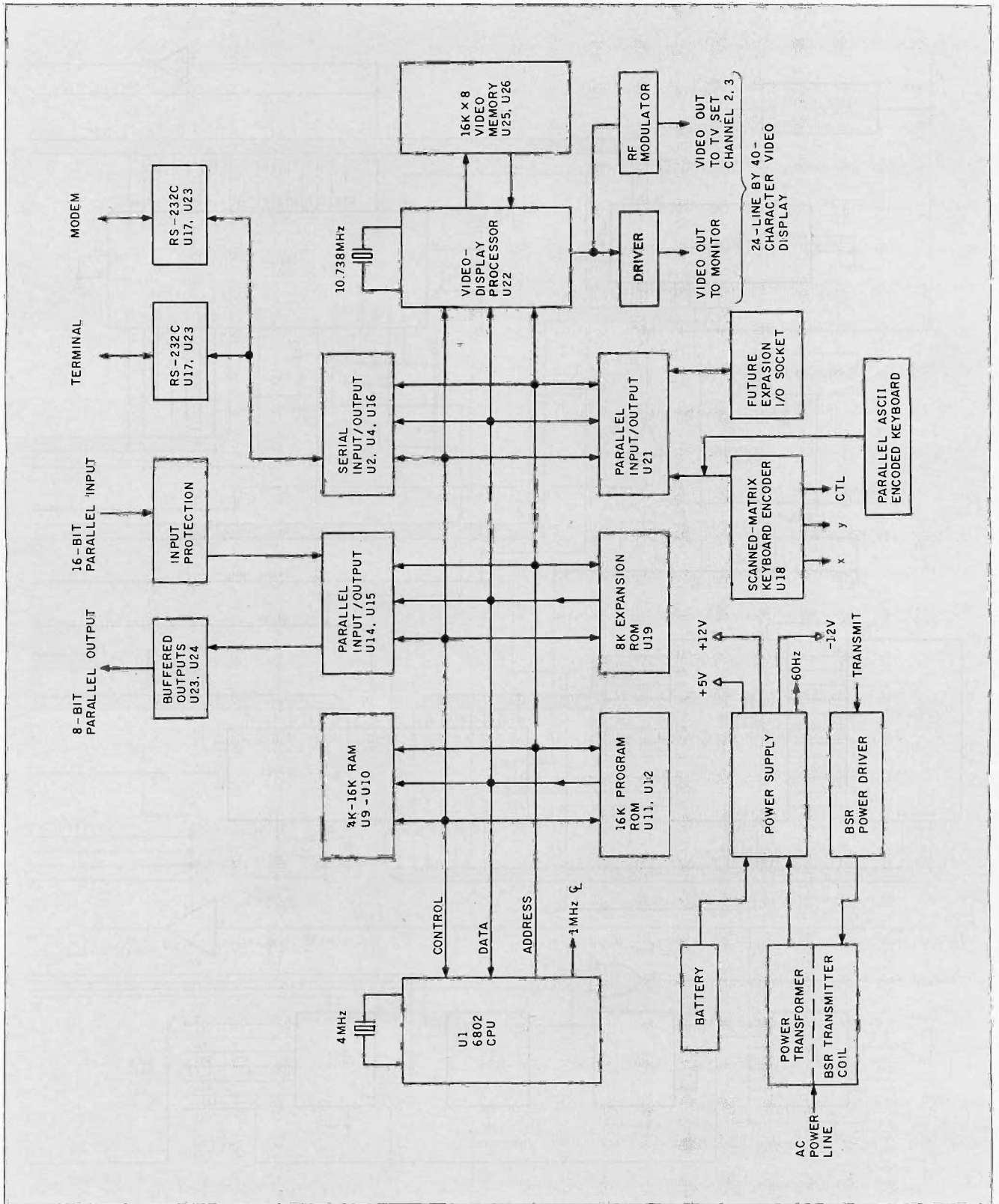

Figure 3: A block diagram of the Home Run Control System.

CIRCUIT CELLAR

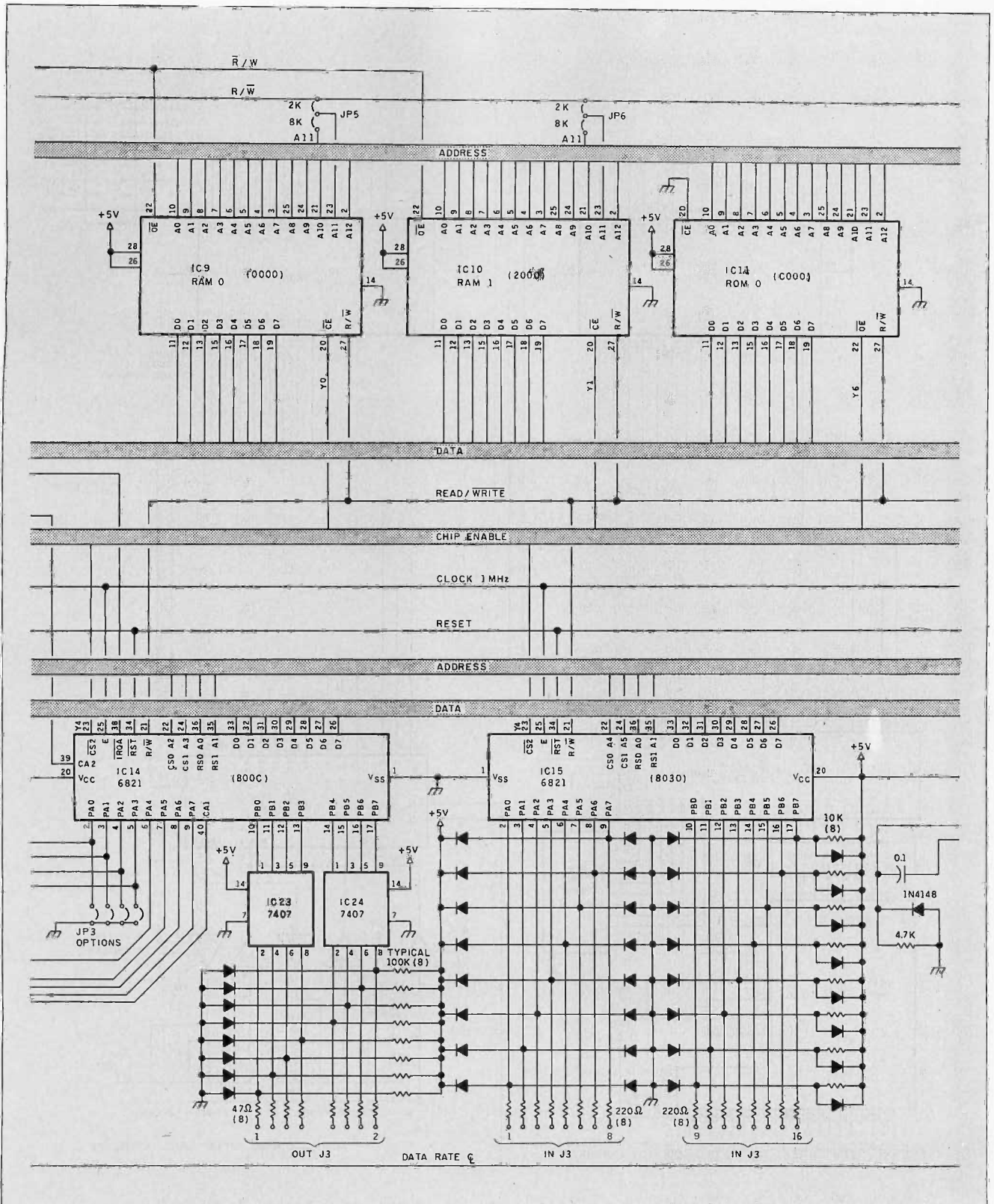
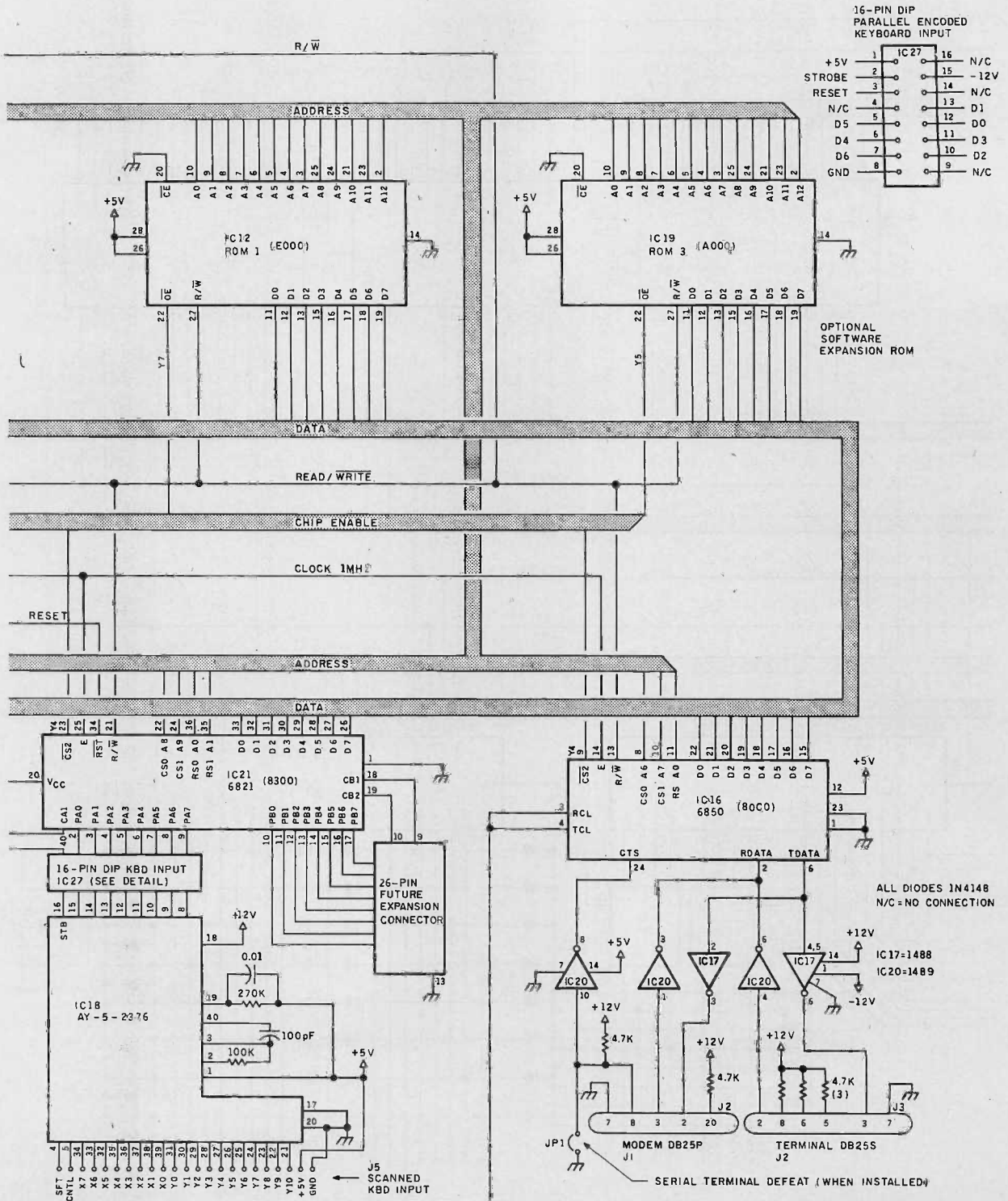

Figure 4 continued on page 118

Figure 4 continued



the I/O are also set aside for expansion.

TIMING LOGIC

Figure 6 outlines the section of the circuit that generates the timing signals. All the clocks are derived from a master 1-MHz clock produced by the processor. The 1 MHz is divided by 13 through a 74LS161 (IC2) to produce 76,923 Hz. This frequency is only 0.16 percent off the 76,800-Hz frequency normally used for communication at 4800 bits per second (bps). The other data-transmission rates (2400, 1200, 600, 300, 150, and 75 bps) are produced by further dividing this frequency through the binary counter, IC4. One of the seven output frequencies is jumper-selected as the terminal/modem communication rate and directed to the transmit/receive clock input of the serial I/O chip, IC16.

The frequency at the final output of IC4 is 601 Hz. This frequency is used as the master interrupt clock for the HCS. Every 601 times the interrupt is called, the real-time clock is incre-

mented 1 second. At various other increments in time, event and input status are checked and output set.

The BSR transmission timing is also controlled through this circuit. The 1-MHz system clock is divided by 8 through IC3 to produce 125 kHz. While slightly off the 121 kHz normally specified for BSR line transmission, it is within tolerance of the receivers. The 125 kHz is gated on and off through NOR gate IC7 by an output bit from IC14. An LM311 (IC29) high-speed comparator functions as a zero-crossing detector to let the processor know when to gate the 125 kHz onto the AC line.

The 1-ms pulse bursts are timed by IC6. The elapsed time between releasing the reset line of counter IC6, which is clocked at 125 kHz, and an output change of state is 976.56 μ s, or 1 ms in the real world. The clock period of the output waveform is 1 ms, but changes of logic state occur on the half period, 0.5 ms. By counting three of these changes of state, 1.5 ms, the typical time interval between 125-kHz

pulse bursts is also derived.

The BSR driver is functionally part of the power-supply section, and some elements will be explained later. Basically, it is a simple two-transistor power driver attached to the primary side of a tuned transmitter coil. NOR gate IC7 drives the output in 1-ms bursts of 125 kHz. The voltage swing is from +12 V to -12 V on the primary side through a high-voltage driver transistor, type NTE288 or equivalent ($I_c = 300$ milliamperes [mA], $V_{ce} = 300$ V). The secondary side of the transmitter coil is coupled to the AC line through a 0.22-microfarad (μ F) capacitor (400 V). A separate tuned secondary winding increases the transmission amplitude.

SERIAL AND PARALLEL I/O

Home Run uses three 6821 PIA (peripheral interface adapter) chips and one 6850 ACIA (asynchronous communications interface adapter) chip to connect real-world activities to the processor. Each 6821 has two 8-bit,

(continued)

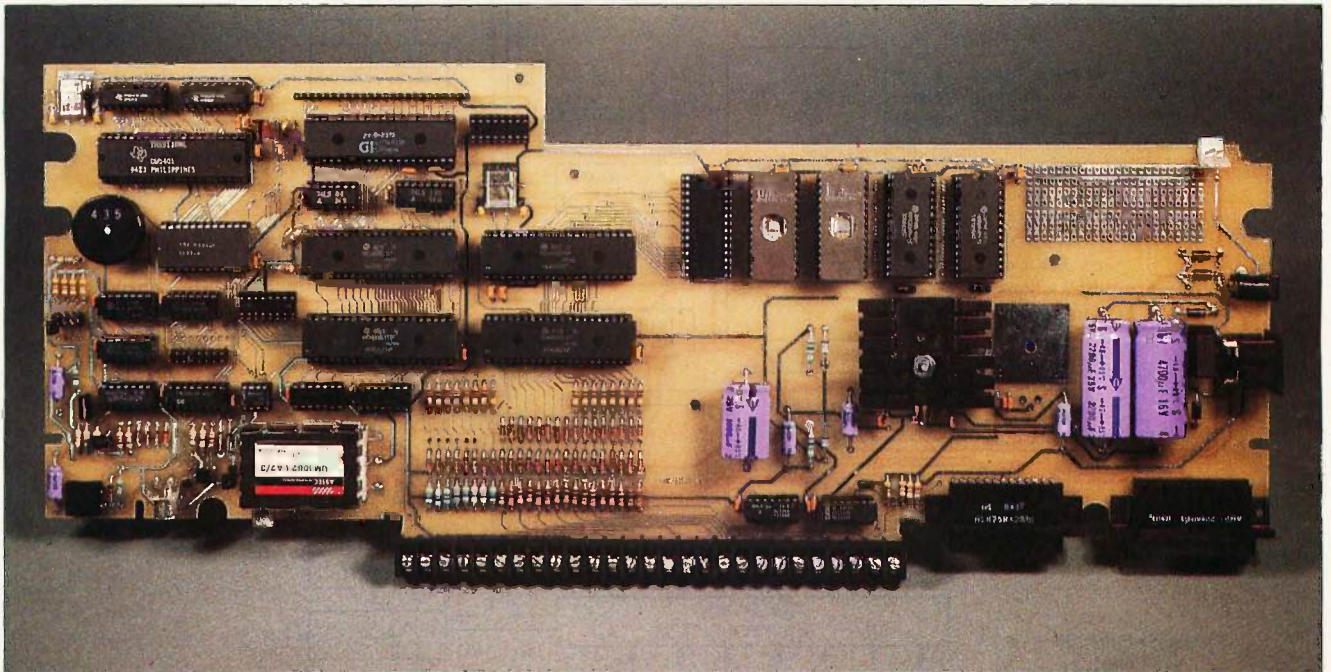

Photo 4: The Home Run Control System prototype printed-circuit board. Input and output connections are made via screw terminals at the bottom of the board. From bottom left to right, the connections are composite video out, RF video out, eight direct outputs, three ground pins, 16 direct inputs, DB-25S terminal connector, and DB-25P modem connector. The transformer/transmitter module connects to the board at center right.

Table 3: RAM configurations.

IC9	IC10	Memory Size (bytes)
6116	6116	4K
6264	EMPTY	8K
6264	6116	10K
6264	6264	16K

(Note: 6116 RAMs are 24-pin devices. They are inserted into the lower 24 pins of the 28-pin socket.)

bit-programmable, bidirectional parallel ports and four control lines, which serve primarily as interrupt inputs.

IC14 is the only 6821 that must be

installed for the HCS to run. Through port A it reads the 60-Hz zero-crossing signal, the 601-Hz "heartbeat" interrupt, the 1/1.5-ms timers, and sets the beeper output and the BSR transmitter gate. Four extra future-option jumpers are included should I need them when I expand the capabilities of the HCS. (If the HCS is fully populated as shown in figure 4, no jumpers need to be installed. If you configure an HCS video version or don't plan on including the serial-modem capability afforded through IC16, then install a jumper at PA0 and leave the 6850 out. This tells the processor to ignore serial I/O.)

Port B of IC14 drives eight open-collector output lines that are set or reset by the action of driver number

6 on the main menu. These lines are activated by following the same procedures as for the BSR modules. However, direct outputs such as these are immune from line transients and cannot be reset by errant use of a BSR command controller in another part of the house. Diagramed in figure 7, each output is protected against accidental shorts to a negative-voltage source and excessive current drain. A 100k-ohm resistor allows the outputs to be read with a meter during testing and will not interfere with normal operation. The 7407 drivers are rated for 30 mA at 30 V.

IC15 is entirely dedicated to input data acquisition. Each of the 16 inputs is diode-protected and current-limited. They will accept standard TTL

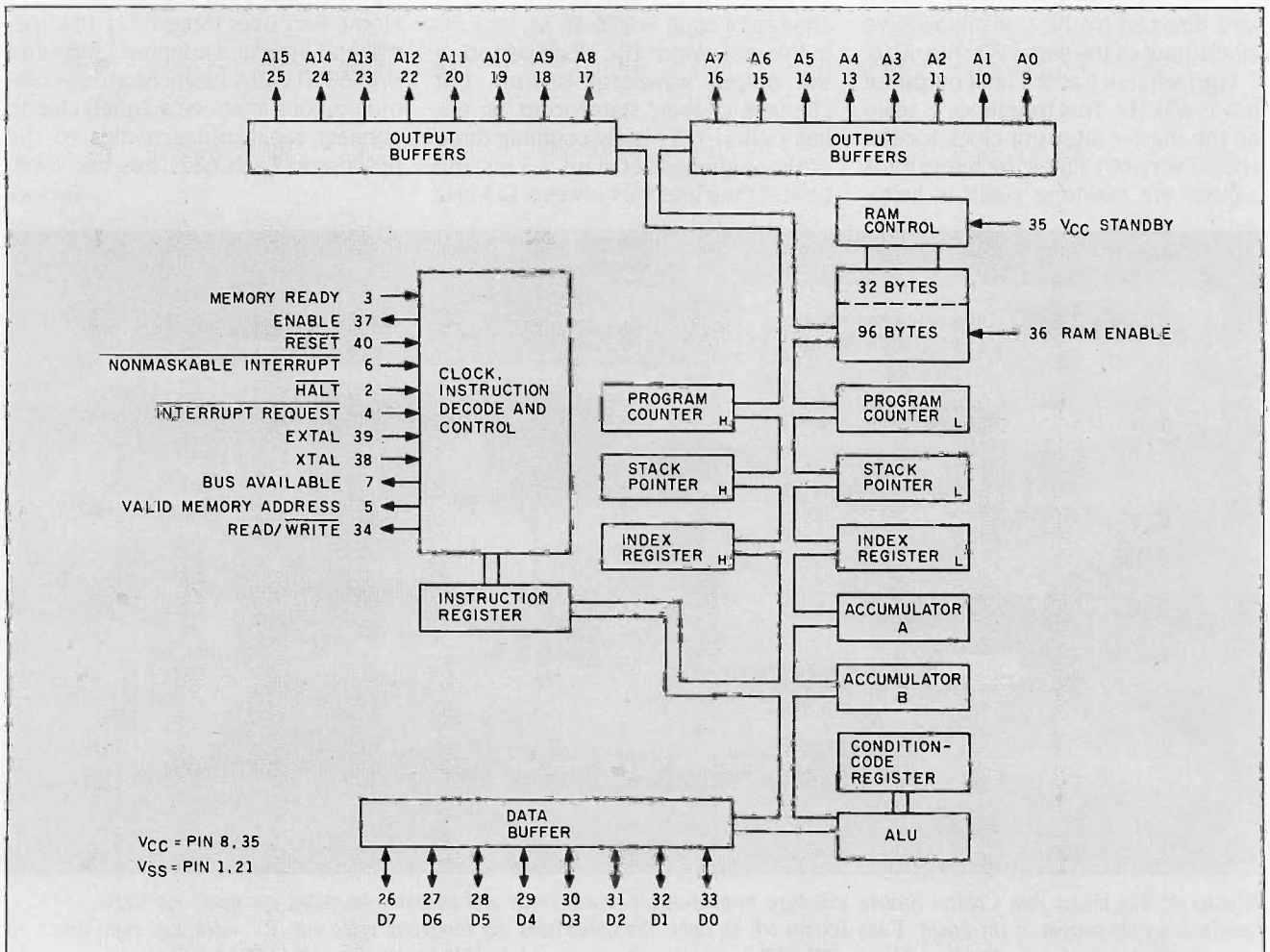

Figure 5: A 6802 block diagram.

CIRCUIT CELLAR

(transistor-transistor logic)-level input signals or any voltage between +9 and -9V. (The range 0 to -9 V is a logic 0. The range 2 to +9 V is a logic 1.) Contact closure should have an external voltage supply and should not rely on an open-circuit input always being a logic 1.

IC21 is dedicated to keyboard input and future expansion. Eight bits and a control line of port A receive ASCII (American Standard Code for Information Interchange) input data. This data can come directly from an ASCII-encoded keyboard via a 16-pin DIP (dual-inline package) socket (IC27) or from a scanned-matrix keyboard through a keyboard-encoder chip installed in IC18. The matrix keyboard is plugged into a 22-pin ribbon-cable

header adjacent to IC18.

One or the other keyboard option must be chosen and not both concurrently. If a parallel keyboard is used, no encoder chip should be inserted in IC18. Similarly, if IC18 is installed, a parallel keyboard should not be plugged in. (If you are using a terminal with the HCS, neither type of keyboard need be installed and both IC18 and IC21 can be removed.) The parallel-keyboard input socket, IC27, is compatible with the Apple IIe.

Port B of IC21 is reserved for future expansion. As previously mentioned, the HCS has an 8K-byte EPROM socket, four jumpers, and an 8-bit I/O port reserved for future expansion.

The HCS's serial I/O is through a 6850, IC16. The serial port is con-

nected through separate level shifters, IC17 and IC20, to two connectors. One connector is wired to attach to a modem (DCE), and the other is configured to connect to a terminal (DTE). The communication data rate is set by the data-transmission rate selection jumpers at IC4.

The HCS screen displays operate at different rates, depending upon whether the system is configured to use the internal video-display generator or an external terminal. If a terminal is attached (JP1 should not be installed), all displays are refreshed at the selected communication rate. (A terminal and a modem should not be trying to communicate at the same time.) When using a terminal, how-

(continued)

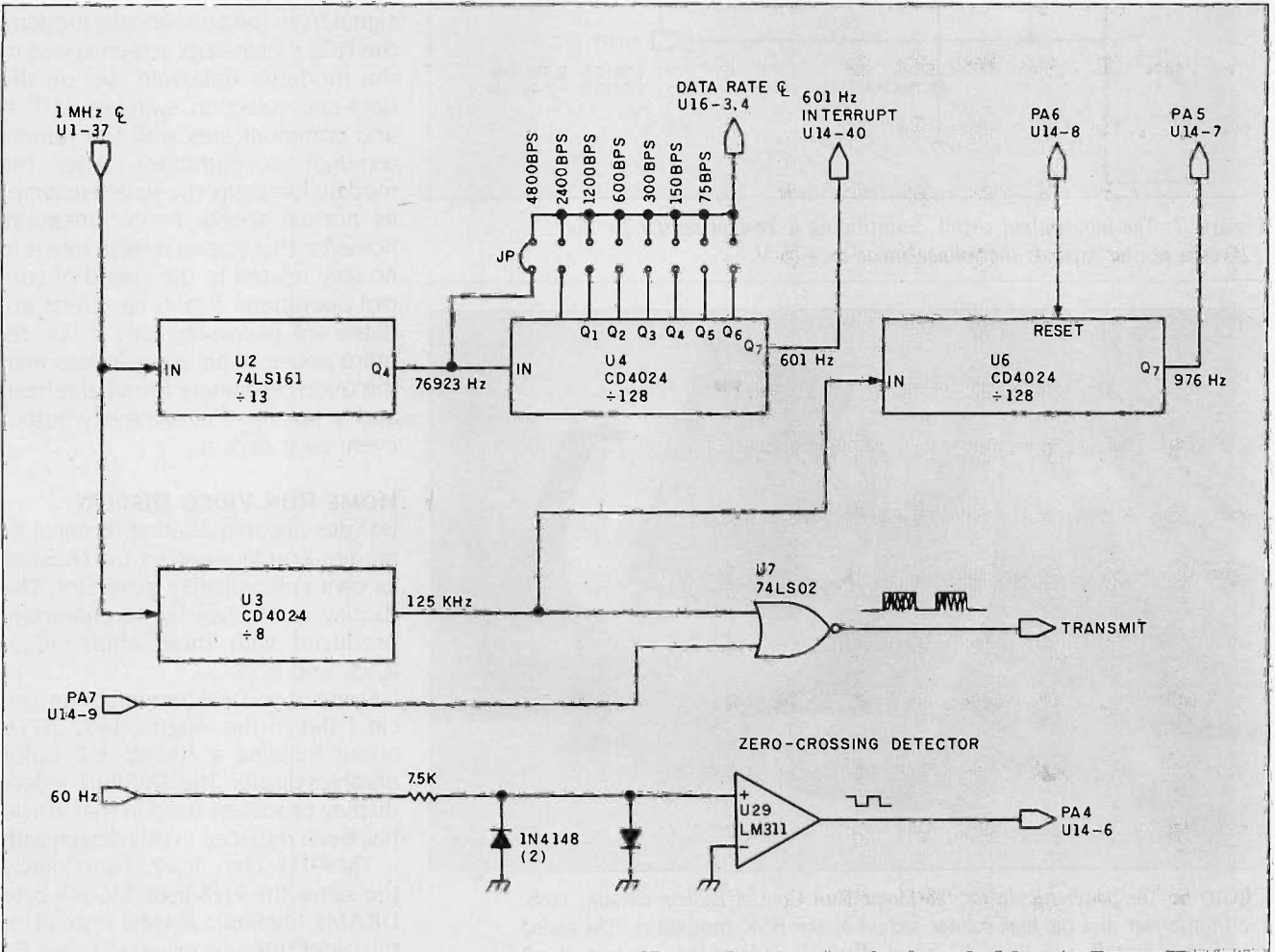

Figure 6: The timing-generator circuit.

ever, both the internal display and the terminal refresh at the same data-transmission rate, and status updates appear only once a minute. Physical

control operations still occur as serviced by the interrupts, but, because a terminal could be communicating at 75 bps, the status display is rewritten

only once per minute. (A status update can be forced at any time on the terminal by entering a carriage return.) When using the internal video display (JP1 installed or a shorting wire connected between pins 7 and 8 of J2), the screen refreshes at full processor speed (it appears to be about 9600 bps), and the status display is updated upon occurrence of any programmed event.

There is an effective compromise when using a modem, with JP1 not installed. With an auto-answer modem such as the Hayes 300 or 1200 attached to the modem input, the HCS will automatically switch communication rates. Using the internal video display and JP1 removed, the HCS updates the screen at high speed. Upon sensing a CTS (clear to send) signal from the auto-answer modem, the HCS switches its screen speed to the modem's data rate (set on the data-rate selection switches at IC4) and communicates with the remote terminal or computer. After the modem hangs up, the screen resumes its normal speed. I must mention, however, that screen refresh rate is in no way related to the speed of control operations. Real-time screen updates are necessary only if you require notice of an event in less than the once-per-minute terminal refresh and in fact need to see every output event as it occurs.

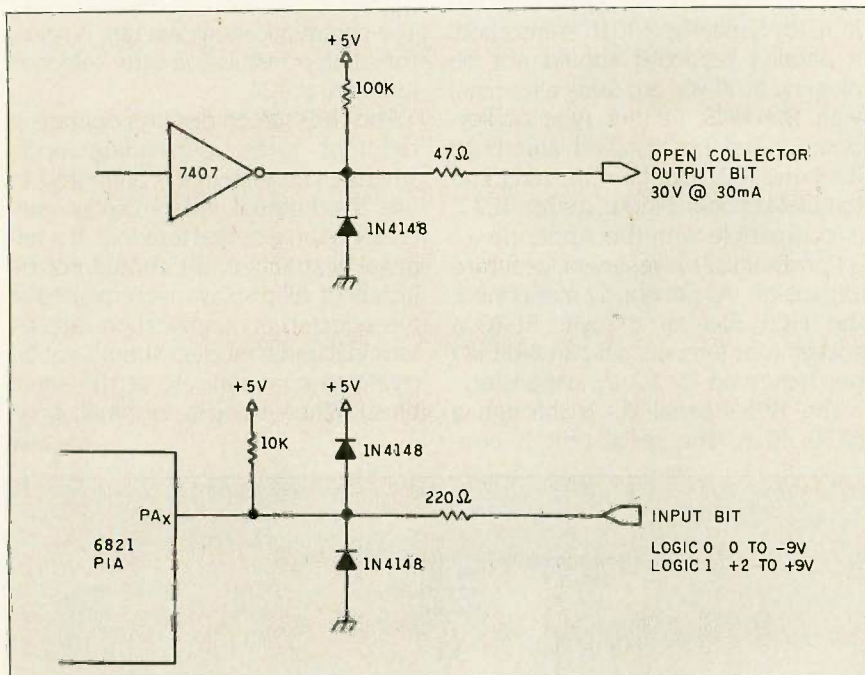

Figure 7: The input/output circuit. Substituting a 1k-ohm resistor for the 220-ohm resistor expands the voltage range to ± 15 V.

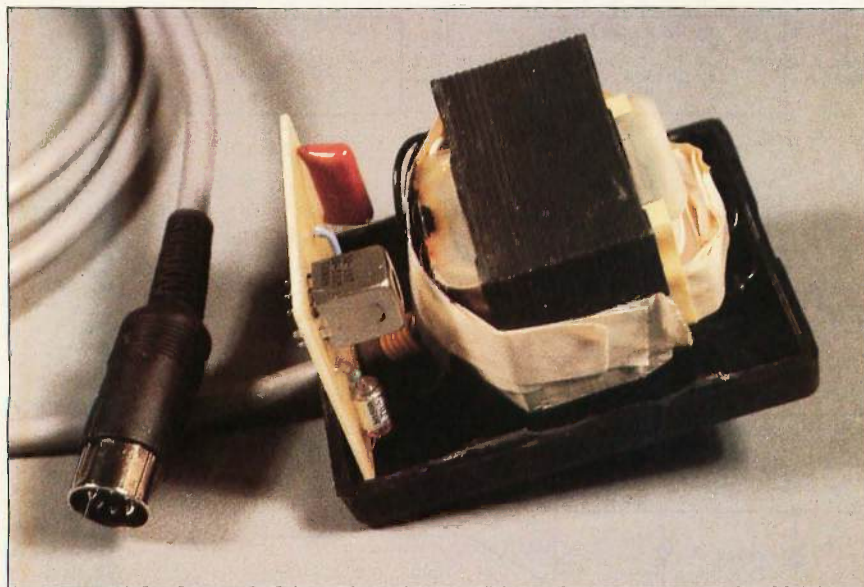

Photo 5: The power supply for the Home Run Control System contains both the transformer and the high-voltage section of the BSR transmitter. The sealed transformer module with BSR PC board effectively isolates the user from the AC power line. Connection to the circuit board is through a 7-pin DIN connector.

HOME RUN VIDEO DISPLAY

Besides accommodating terminal or modem communication, the HCS has its own video-display generator. The display is 24 lines by 40 characters produced with three chips: IC22, IC25, and IC26.

Some of you will remember an article I did in the August 1982 BYTE about building a 10-chip E-Z Color graphics display. The TMS9918 video-display processor used in that article has been replaced in this design with a TMS9118 chip, IC22. Functionally the same, the 9118 uses 5-V 64K-byte DRAMs (dynamic RAMs) instead of the older three-supply 4116 types. By using TMS4416 16K by 4-bit DRAMs,

(continued)

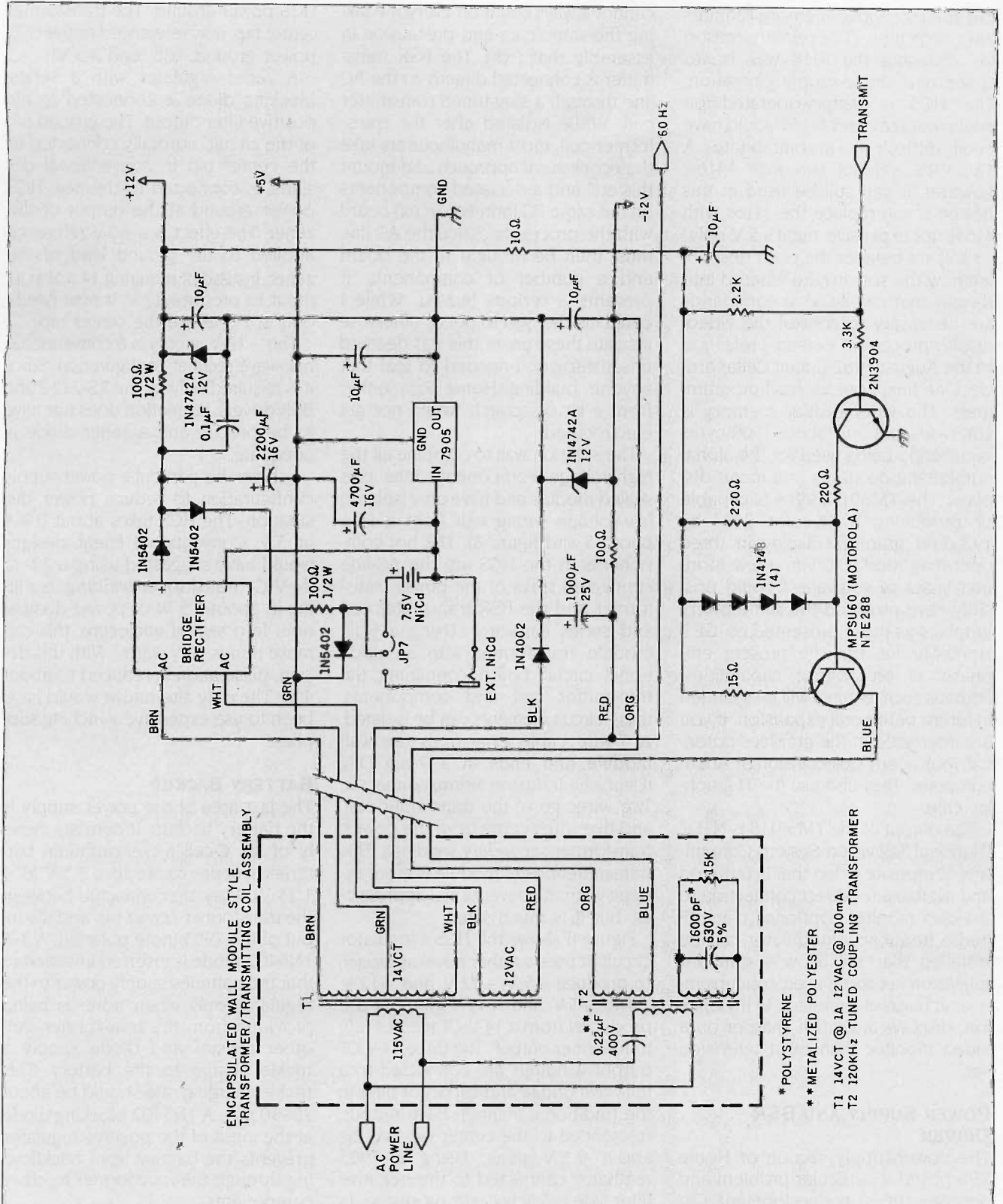

Figure 8: Power supply and transformer/transmitter assembly.

the 16K-byte video memory requires only two chips. (The primary reason for choosing the 9118 was board space and single-supply operation. The HCS is battery-operated on power outages, and 4116s would have been difficult to accommodate. A TMS9918 will not run with 4416s; however, it can still be used in this design if you replace the 4116s with 4164s. It's expensive, but it's 5 V only.)

I will not belabor the point describing how the screens are entered into display memory or what commands are necessary to control the video-display processor. Instead, I refer you to the August 1982 Circuit Cellar article. One final note for mad programmers. The video-display memory is 16K bytes, but only about 1500 bytes is currently being used for the alpha-numeric-mode status and menu displays. The TMS9118/9918 is capable of producing a 16-color 256- by 192-pixel graphics display in three operating modes. Given a few more man-years of software, I could possibly have provided the same pretty graphics as those presented on GE's HomeMinder, but the present emphasis is on control capabilities. Perhaps such features will be included in future peripheral expansion. If you are interested in the graphics potential, look at any ColecoVision or Adam computer. They also use the TI graphics chip.

The output of the TMS9118 is NTSC (National Television System Committee) composite video that is buffered and available for direct connection to a video monitor. Optionally, an RF (radio frequency) modulator can be installed that will allow a standard television set to be used concurrently or in place of a monitor. In my opinion, displays are much sharper on a video monitor than on a television set.

POWER SUPPLY AND BSR DRIVER

The power-supply section of Home Run posed a particular problem and almost scuttled its development. Circuit Cellar projects are designed to be built, not just read. Unfortunately, I

cannot always count on everyone taking the same care and precaution in assembly that I do. The BSR transmitter is connected directly to the AC line through a slug-tuned transmitter coil. While isolated after the transformer coil, most manufacturers take the economical approach and mount this coil and associated components on the same PC (printed circuit) board with the processor. Since the AC line must then be brought to the board and a number of components, it presents a serious hazard. While I could instruct you to pot or otherwise insulate these areas, this was deemed unsatisfactory. I needed to feel that anyone building Home Run either from a kit or scratch would not get electrocuted.

The solution was to combine all the high-voltage components into one sealed module and have only isolated low-voltage wiring exit from it (see photo 5 and figure 8). The hot components in the HCS are the AC-line connected sides of the power transformer and the BSR transmitter coil and series capacitor. Using a wall-module transformer with an additional circuit board containing the transmitter coil and components, these circuit elements can be isolated. A 7-wire cable exits from the wall module and ends in a 7-pin DIN (Deutsche Industrie Norm) connector. Two wires go to the transmitter coil, and five wires come from the power-transformer secondary windings. This transmitter/power module is more expensive than conventional approaches, but it is much safer.

Figure 8 shows the HCS's regulator circuit. It uses a rather novel approach to produce +5 V, +12 V, and -12 V.

The +5-V and +12-V outputs are produced from a 14-V CT (center tap) transformer output. The three 14-V CT output windings are connected to a full-wave bridge and capacitor filter in the traditional manner. Each output, referenced to the center tap, will be about 9.5 V peak. Using a 7905 regulator connected to the negative filter side, -5 V is easily produced. In this design, however, the output of the 7905 is reversed and connected to the

HCS power ground. The transformer center tap, now referenced to the HCS power ground, will read +5 V!

A zener regulator with a series-blocking diode is connected to the positive filter output. The ground pin of the circuit, normally connected to the center tap in conventional designs, is connected to the new HCS power ground at the output of the zener. The effect is a -5-V reference applied to the ground lead of the zener. Instead of requiring 14.5 V at its input to produce 12 V, it now needs only 9.5 V above the center tap.

The -12-V supply is a conventional half-wave rectifier configuration. Since it is required only by the RS-232C and BSR drivers, regulation does not have to be precise and a zener diode is adequate.

I chose this particular power-supply configuration to reduce power dissipation. The HCS takes about 0.9 A at 5 V. Conventional linear designs would have suggested using a 22- to 24-V CT transformer winding, resulting in about 8.5 W of power dissipation. In a sealed enclosure, this can make things very warm. With this design, dissipation is reduced to about 4 W. The only alternative would have been to use expensive switching supplies.

BATTERY BACKUP

The last area of the power supply is the battery backup. It consists merely of six C-cell nickel-cadmium batteries in series to produce 7.5 V (6 × 1.25 V). They are connected between the transformer center tap and the input of the 7905 (note polarity). A 3-A 1N5402 diode is inserted in series so that the batteries supply power to the regulator only when none is being provided from the transformer. Another resistor and diode supply a trickle charge to the battery. This trickle charging rate should be about 20-30 mA. A 1N5402 blocking diode at the input of the positive regulator prevents the battery from backflowing through the transformer to other components.

During a power outage, only the +5-V supply is maintained. If you

CIRCUIT CELLAR

have a battery-operated monitor, it will continue to receive status displays, but RS-232C, modem, terminal, and BSR functions will be suspended. (When the power returns, the HCS automatically restores all I/O to the proper state.) Direct outputs continue to occur on schedule. In my experience, power outages are either under a few minutes or for many hours. Experiments show that C-cell nickel-cadmium batteries last for about 90 minutes.

EXPERIMENTERS AND OEM USERS

As always, I try to support the computer experimenter by providing sources for many of the components. The Circuit Cellar Home Run Control System is a single-board design suitable for OEM applications as well. It is available in various configurations that are all ultimately upgradable to the same potential.

If you plan on building the unit from scratch, good luck and take heart. Send me a picture of your board, and I'll send you a 16K-byte hexadecimal dump of the control software, provided it is for noncommercial private use. If you're a bit more well-heeled, I'll supply the code on two 2764 EPROMs and a manual for \$32, post-paid in the U.S., \$5 extra overseas. (No picture is required.)

CIRCUIT CELLAR FEEDBACK

This month's feedback begins on page 424.

NEXT MONTH

I'll describe how the HCS software works specifically, explain each of the menu functions listed in the first article, and demonstrate a simple control application. ■

Special thanks to Bill Summers and Leo Taylor for their software expertise.

The following items are available from

The Micromint Inc.
25 Terrace Dr.
Vernon, CT 06066
(800) 635-3355 for orders
(203) 871-6170 for information

1. Home Run HCS—Complete assembled system with enclosure and parallel-encoded keyboard. HCS01. \$589
2. Home Run HCS—Populated PC board. Assembled and tested PC board. No enclosure or keyboard. . . . HCS02. \$429
3. Home Run HCS—Video-based kit. Includes PC board and all components except enclosure, keyboard, and serial-interface components (IC16, IC17, IC20, and two DB-25 connectors). . . . HCSV05. \$329
4. Home Run HCS—Terminal-based kit. Includes PC board and all components except video-display processor (IC22, IC25, and IC26). No keyboard, enclosure, or RF modulator. HCST06. \$289
5. 8K-byte static-RAM upgrade. Increases RAM to 16K bytes. HCS20. \$35
6. Apple II-compatible ASCII-encoded keyboard. HCS21. \$79
7. Wall transformer/transmitter module (available separately). HCS22. \$40
8. IBM PC Upload/Download event-schedule-storage software with terminal emulator, written in C, provided on IBM PC-DOS 2.0 disk HCS25. \$49

All kits and assembled units include operators manual, power supply with wall transformer/transmitter module, and 8K bytes of RAM. All units are supplied without keyboard-encoder chip (not necessary when using encoded keyboard, IC18—optionally available). All item numbers that list enclosures also include backup battery holder (six C cells), less batteries. Serial-port and video-display-processor upgrades for items 3 and 4 and various other components are also available.

Please include \$8 for shipping and handling in the continental United States, \$12 elsewhere. New York residents please include 8 percent sales tax. Connecticut residents please include 7.5 percent sales tax.

Editor's Note: Steve often refers to previous Circuit Cellar articles. Most of these past articles are available in book form from BYTE Books, McGraw-Hill Book Company, POB 400, Hightstown, NJ 08250.

Ciarcia's Circuit Cellar, Volume I covers articles in BYTE from September 1977 through November 1978. *Volume II* covers December 1978 through June 1980. *Volume III* covers July 1980 through December 1981. *Volume IV* covers January 1982 through June 1983.

To receive a complete list of Ciarcia's Circuit Cellar project kits, circle 100 on the reader-service inquiry card at the back of the magazine.

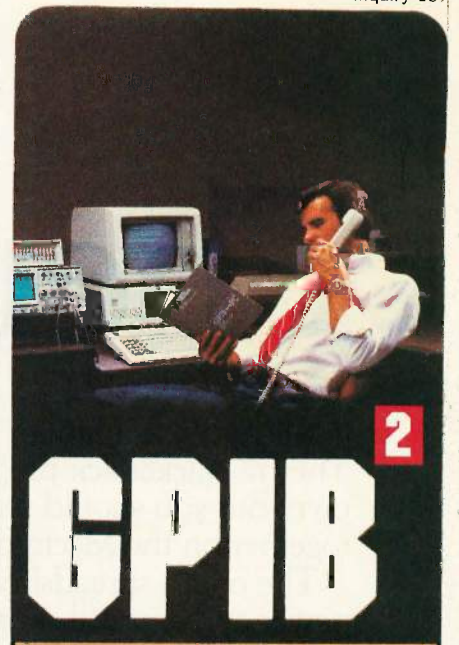

GPIB

IEEE-488 Interfaces and Bus Extenders For:

IBM PC, PCjr & COMPATIBLES

DEC UNIBUS, Q-BUS & RAINBOW 100

MULTIBUS, VMEbus STD & S-100

Full IEEE-488 functionality, with the most comprehensive language and operating system coverage in the industry. It takes experience to make IEEE-488 systems work with nearly 4000 devices available from more than 500 different manufacturers, and experience is what enables National Instruments to take the GPIB to the second power and beyond.



Your personal guarantee of unsurpassed customer support and satisfaction. CALL 1-800-531-GPIB for instant access to 100+ man-years of GPIB experience.

NATIONAL INSTRUMENTS
12109 Technology Blvd.
Austin, TX 78727
1-800-531-5088 512/250-9119
Telex: 756737 NAT INST AUS

IBM and PCjr are trademarks of International Business Machines, MULTIBUS is a trademark of Intel, DEC, UNIBUS, Q-BUS, and Rainbow 100 are trademarks of Digital Equipment Corporation.

Find the Then draw your

Microsoft® Multiplan® and Microsoft Chart. They're crackerjack programs working on their own. But you should see this pair in action together on the Macintosh.™

The one, a spreadsheet of dazzling analytical power and graceful simplicity.

The other, a picture perfect charting program that makes rows and columns of numbers graphically clear.

And the beauty is, they were literally made for each other. And for Macintosh.

Multiplan accepts you as you are.

Multiplan takes full advantage of Mac's simple, intuitive operating style. So you can work in a way that will come natural to you.

You don't have to memorize any arcane commands. Just point and click the mouse to move mountains of figures and formulas quickly and painlessly.

In addition, Multiplan gives you features that make hard copies gratifyingly readable. For instance, the enviable ability to print sideways.

So you can't run out of column room. No matter how wide your spreadsheet gets.

Chart makes people see what you mean.

Microsoft Chart gives you lots of ammunition for your arguments: Pie charts, bar charts, line, column, area and scatter charts. Or combinations.

MICROSOFT

The High Performance Software™

Pick the one that best illustrates your point. Then translate your numbers into pictures and have them on paper in a matter of moments.

Using the mouse, it's a cinch to fine tune the graphs to get exactly what you want. Move any section. Change its size, shape, or highlight it.

Chart can even be linked with Multiplan. So any change on your spreadsheet will show up automatically on the charts.

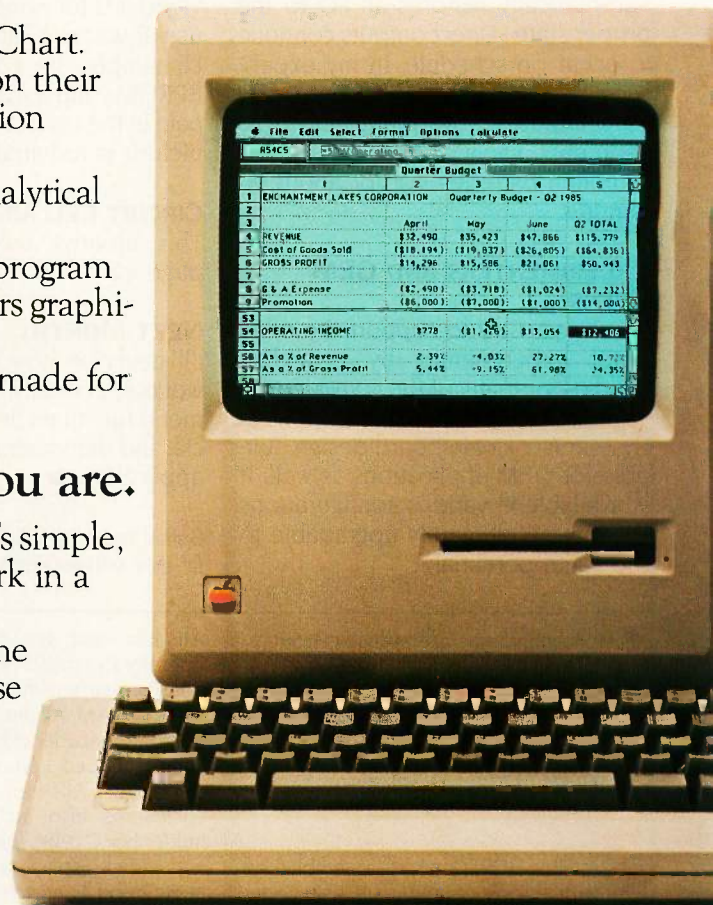

answer. own conclusions.

We get the max out of Mac.

It figures that we'd be the ones to make Mac work so well with figures. We've written more Macintosh programs than any other software company. Including Microsoft Word, Microsoft File. And Microsoft BASIC, Mac's first language.

That experience shows in programs which not only exploit all of Mac's unique features, but make it extraordinarily capable and productive.

In addition, all of Microsoft's Macintosh products can exchange data with each other.

And because our programs work alike, if you learn one, you're

well on your way to learning the rest.

To find the name of your nearest Microsoft dealer, call (800) 426-9400. In Washington State, Alaska, Hawaii and Canada, call (206) 828-8088.

Then check out Multiplan and Microsoft Chart. And watch them perform some nice little numbers.

Microsoft and Multiplan are registered trademarks and The High Performance Software is a trademark of Microsoft Corporation. Macintosh is a trademark licensed to Apple Computer, Inc.



MICROSOFT

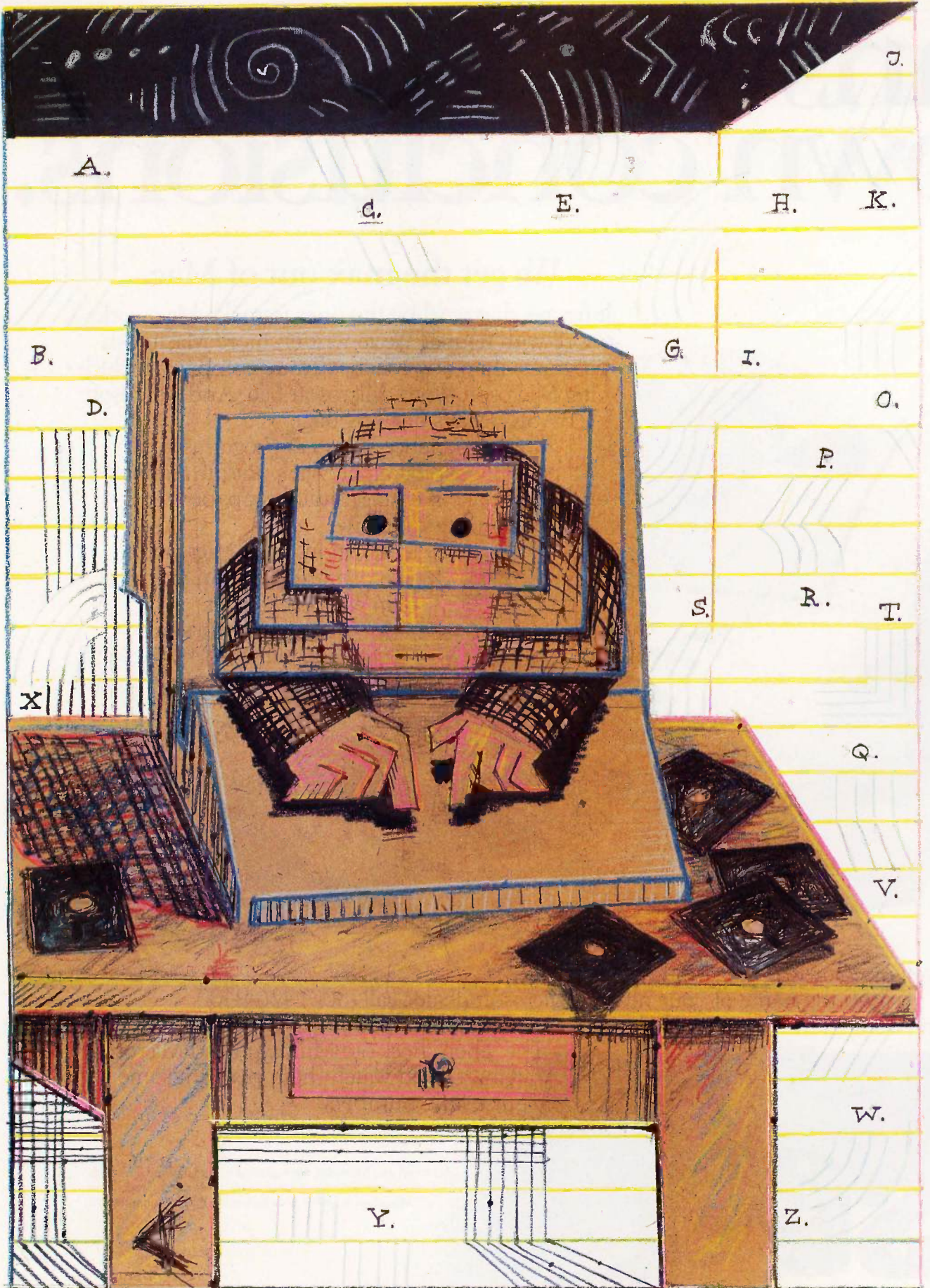

SET EXTENSIONS WITH APPLE PASCAL

Add useful set operations to your programs

Sets offer a powerful and logical construction in Pascal. In conjunction with user-defined types, they can significantly enhance program design, maintenance, speed, and readability. Unfortunately, many programmers shy away from using sets because of their high level of abstraction and a lack of understanding of how to implement sets at the machine level.

In order to promote a greater understanding of set constructions in Pascal, I will describe sets, their operators, and the logical machine equivalents used in relational set operations. Second, I will present a fast extension to Apple Pascal. The maximum set size and the number of set operations vary from implementation to implementation. This SuperSets program increases the size of Apple Pascal sets (from 512 to 65,536 elements per set) and adds more set operations. The program is written in 6502 assembly language and is, therefore, reasonably fast.

PASCAL SETS

To test for membership of characters in a set you might be tempted to use nested IF...THEN...ELSE state-

ments, such as IF ch = "a" THEN {execute code inserted here} ELSE IF ch = "b" THEN {execute code} ELSE IF ch = "c" THEN {execute code} ELSE {insert code for ch not in set}. A more elegant method uses the set operator IN to test for membership. With it you can reduce these statements to IF ch IN ['a','b','c'] THEN {insert code for ch in set} ELSE {insert code for ch not in set}.

A set in Pascal is a collection of objects of the same type (called the "base type" of the set). It may be any scalar type; it may not be a structured type. Size limitations on sets are defined by the particular implementation and generally range from 64 to 512 elements. Apple Pascal sets can have up to 512 elements and occupy memory according to the following formula: $((n-1) \text{ DIV } 16) + 1$ words, where n equals the number of elements. Conversely, UCSD Pascal sets may have (at most) 4080 elements and are limited in size to 255 words.

With set operators you can perform relational operations on sets of the same base type, such as testing for the inclusion of one set in another or for equality. In addition to the special membership operator IN, four relational operators are typically supported: set equality (=), set inequality (<>), inclusion/contains (>=) and inclusion/contained in (<=). Although these relational operators yield a Boolean result, you can also form sets logically from the union, dif-

ference, or intersection of two sets. The union ($A + B$) results in a set that contains all members of A and all members of B. The difference ($A - B$) results in a set that contains all members of A that are not members of B. And the intersection ($A * B$) results in a set of all members of A that are also members of B.

MACHINE-LEVEL STRUCTURE

To illustrate the machine-level structure of sets, I will first define a set (such as TYPE *charset* = set of characters) and define the variables Set_A and Set_B as that type. Internally, Apple Pascal allocates an array of 256 bits (16 words, each containing 16 bits) representing the 256 possible ASCII (American Standard Code for Information Interchange) values for characters. Individual elements occupy 1 bit, indexed by the scalar value of the character into the set. An element is considered to be in the set when its bit is turned on (has a binary value of 1).

To locate the word offset into the array containing a particular element's bit, the scalar value of the element is divided by 16 (or divided by 8 to locate the byte offset). The bit position

(continued)

Alfred L. Schumer (17 Pearl St., Wakefield, MA 01880) is assistant vice president of Bank of America in Boston. He is responsible for lending activities with newly formed high-technology companies in New England. He graduated from New York University's Graduate School of Business Administration in 1980.

SuperSets increases the size of Apple Pascal sets and adds more set operations.

tion within the word is merely the scalar value modulo 16, or the remainder from the division. You can add an element to a set by indexing into a set's array of words and turning the appropriate bit on. Similarly, to remove an element, turn the bit off. To test for an element's membership in a set, you use the same indexing technique to determine the state (off or on) of the appropriate bit.

LOGICAL OPERATORS

The logical operators on sets are somewhat tricky. While they don't require indexing individual elements—entire sets are operands—the Boolean logic of unions, differences, and intersections requires some explaining.

Testing for set equality (=) involves comparing all the words of one set against the other. If any two corresponding words differ (their bit patterns do not match), the sets are not equal. This follows from the logic that different bit patterns within a word indicate either Set_A contains a character not contained in Set_B, or Set_A does not contain a particular character that Set_B does.

You can test for the inclusion (< = or > =) of, for example, Set_A in Set_B at the word level by determining if for each bit turned on in Set_A, the equivalent bit (in the equivalent word) in Set_B is also turned on. However, the converse might not be true; Set_B may contain elements that are not in Set_A. In other words, Set_B may contain Set_A while Set_A does not contain Set_B unless the two are equal.

The union, difference, and intersection set operators differ from equality and inclusion in that they do not test bits but set or clear them. The resulting word is stored into the set

assigned as the result. The union (+) of two sets, word for word, produces a new set with the bits turned on if either or both bits in the operand sets are turned on. If both bits are off, the resultant bit in the new set is also off.

The intersection (*) of two sets resembles the union except that both corresponding bits must be on for the resultant word's bit to be turned on. If either bit is off, the resultant bit is also off.

Taking the difference (-) between two sets is the opposite of finding their union. However, unlike intersection and union, the order in which the sets are specified is important. (Set_A - Set_B is not the same as Set_B - Set_A unless the sets are equal.) An element common to both sets is removed—the appropriate bit is turned off—if the corresponding bits in each set are both on. However, if the first set's bit is on while the second set's bit is off, the resultant bit is turned on. If the opposite condition is true—the first set's bit is off while the second set's bit is on—the bit in the result remains off.

If you are an assembly-language programmer, you have probably noticed by now that these logical operators resemble the 6502 machine instructions AND, ORA, and EOR. In fact, the truth tables for each instruction are nearly the same as their counterparts in set operators.

For comparison, table 1 contains the truth tables for the machine instructions and those for relational set operators. If you examine both groups of truth tables, you will find that union is equivalent to ORA, intersection to AND, and equality to NOT EOR. You can build inclusion and difference from a combination of AND and EOR. Inclusion ($A \supseteq B$) may be constructed as $((A \text{ EOR } B) \text{ AND } A)$, and difference ($A - B$) as $((A \text{ AND } B) \text{ EOR } B)$. Bear in mind that the order in which you specify the sets as operands is important.

SETTING UP SUPERSSETS

How can you use this information to expand the set capabilities of the Apple implementation of Pascal? The

SuperSets program duplicates the standard Pascal set operators in assembly language with enhanced addressing and provides some procedures and functions to use the expanded set sizes. Because the technique used for indexing into the set uses a 16-bit value, sets can contain up to 65,535 elements. Before going into the specifics of the program, however, some housekeeping items are in order. [Editor's note: The listing for the SuperSets program is available for downloading via BYTEnet Listings. The telephone number is (603) 924-9820.]

First, Apple Pascal does not permit the declaration of a set size greater than 512 elements. Therefore, you must use a packed array of type Boolean as the data type declaration—which is what it is internally. For example, if you wish to use a set of 10,000 elements, the declaration must be `PACKED ARRAY [0..9999] OF BOOLEAN`. Note that `BOOLEAN` can be any user-defined type with either a base type of Boolean or scalar that occupies 1 bit. An example is `TYPE gender = (male,female)`.

Second, the set operators that use two operands or sets in the program are quite powerful and, used indiscriminately, can cause a system failure. Assignments or operations on sets of different sizes are not picked up by the compiler or the run-time code and might overwrite other data-storage areas. Even worse, such actions might destroy integral parts of the Pascal interpreter and cause unpredictable results or a system crash. To avoid this, you can assign as a result a set larger than either of the operands, provided you keep in mind that the elements beyond the operand set sizes are meaningless.

Third, your method of using SuperSets' procedures and functions is entirely up to you. If you choose to link the code in after compiling your host program, remember to declare the procedures and functions `EXTERNAL`. (This option is assumed in the listing.) If you choose to use the `LibraryCode` program that comes on Apple III to include the code as a unit

(continued)

IT SCREAMS!

PCturbo 186™

"The PCturbo 186 is a sophisticated product, jam-packed with goodies... Lightning-like, indeed."
— Winn L. Rosch, PC Magazine

"PCturbo 186...speeds up your IBM PC something wonderful...no glitches, no problems, and it's fast, FAST, FAST!" — Jerry Pournelle, BYTE

ADVANCED 8MHz
80186 MICROPROCESSOR

UP TO 640K 16-BIT
ONBOARD RAM

WORKS WITH 8088
ALREADY IN YOUR PC FOR
100% IBM COMPATIBILITY

EASY TO INSTALL AND
TRANSPARENT TO USE

DISK CACHING AND
RAM DISK BUILT-IN

CUSTOM VLSI TECHNOLOGY
WITH TURBOBUS EXPANSION

EXTENDS THE LIFE OF YOUR COMPUTER ■ SPEEDS UP YOUR EXISTING PC ■ FINISHES JOBS FASTER

■ Now from Orchid Technology — PCturbo 186, the most practical solution to upgrading the performance of your existing IBM PC, XT or compatible. Based on the new generation 80186 processor, the PCturbo 186 runs your application programs, such as databases and spreadsheets 200% to 400% faster.

■ Plugged into your PC, the PCturbo works together with the computer power you already own today. Unlike less powerful imitations, the PCturbo works in tandem with the 8088 in your PC. It does not replace it. In this design, the 8088 handles all the peripheral I/O while the PCturbo runs your programs concurrently and more efficiently.

■ The PCturbo is a high speed system, with built-in software tools designed to increase all aspects of computer performance. Innovative software allowed Orchid to enhance the PCturbo with many powerful features, such as Mainframe style Disk Caching and high capacity RAM Disks, speeding up the reading and writing of files.

■ To help take advantage of those powerful software tools, the PCturbo allows you to add up to

640K of its own RAM on board. With PCturbo you can now have up to 1.28 Megabytes of RAM in one system — double the previous limit of the IBM PC! This frees the extra RAM in your PC to be used for increasing I/O performance.

■ With the PCturbo there are no new Operating System manuals to read, keyboards to learn, or special software versions to buy. When you plug the PCturbo board into your IBM PC or compatible PC, everything works just like it did the day before — only faster! The PCturbo was designed to be easy to install and transparent to the user. Installation does not void the warranty on your PC, as with some other offerings. Just plug it in, turn it on, and speed it up!

■ The PCturbo is a proven product, introduced in 1984. Since then, we've created a custom VLSI (Very Large Scale Integration) chip which improves the cost/performance ratio of the board even more. Our exclusive TurboBus Expansion capability allows you to add on new Turbo options such as the Serial Port Daughtercard. Continuing in our tradition, Orchid is first with the most in high performance PC enhancements.

PCturbo 186 is the most practical solution to making your operation more efficient and productive. Now isn't that what you bought a computer for in the first place?



ORCHID TECHNOLOGY
47790 Westinghouse Drive
Fremont, CA 94539
(415) 490-8586 Telex: 709289

PCturbo 186 is a trademark of Orchid Technology. IBM and IBM PC are trademarks of International Business Machines Corporation.

TOTAL CONTROL:

FORTH: FOR Z-80®, 8086, 68000, and IBM® PC

Complies with the New 83-Standard

**GRAPHICS • GAMES • COMMUNICATIONS • ROBOTICS
DATA ACQUISITION • PROCESS CONTROL**

● **FORTH** programs are instantly portable across the four most popular microprocessors.

● **FORTH** is interactive and conversational, but 20 times faster than BASIC.

● **FORTH** programs are highly structured, modular, easy to maintain.

● **FORTH** affords direct control over all interrupts, memory locations, and i/o ports.

● **FORTH** allows full access to DOS files and functions.

● **FORTH** application programs can be compiled into turnkey COM files and distributed with no license fee.

● **FORTH** Cross Compilers are available for ROM'ed or disk based applications on most microprocessors.

Trademarks: IBM, International Business Machines Corp.; CP/M, Digital Research Inc.; PC/Forth+ and PC/GEN, Laboratory Microsystems, Inc.

FORTH Application Development Systems include interpreter/compiler with virtual memory management and multi-tasking, assembler, full screen editor, decompiler, utilities and 200 page manual. Standard random access files used for screen storage, extensions provided for access to all operating system functions.

Z-80 FORTH for CP/M® 2.2 or MP/M II, \$100.00;
8080 FORTH for CP/M 2.2 or MP/M II, \$100.00;
8086 FORTH for CP/M-86 or MS-DOS, \$100.00;
PC/FORTH for PC-DOS, CP/M-86, or CCPM, \$100.00; **68000 FORTH** for CP/M-68K, \$250.00.

FORTH + Systems are 32 bit implementations that allow creation of programs as large as 1 megabyte. The entire memory address space of the 68000 or 8086/88 is supported directly.

PC FORTH + \$250.00
8086 FORTH + for CP/M-86 or MS-DOS \$250.00
68000 FORTH + for CP/M-68K \$400.00

Extension Packages available include: software floating point, cross compilers, INTEL 8087 support, AMD 9511 support, advanced color graphics, custom character sets, symbolic debugger, telecommunications, cross reference utility, B-tree file manager. Write for brochure.



Laboratory Microsystems Incorporated
Post Office Box 10430, Marina del Rey, CA 90295
Phone credit card orders to (213) 306-7412



SET EXTENSIONS

*This code should work
on all present versions of
Apple Pascal, including
the Apple III's Pascal.*

in your System.Library, remember to declare the code at the start of your program by USES SUPERSETS; then call the procedures and functions normally.

Fourth, the procedures and functions in SuperSets require an unsigned integer to be the element type WORD. You should declare this as TYPE word = 0..65535. However, if you anticipate sets less than 32,767, you may declare WORD as type integer. Failure to observe these requirements can cause disastrous results.

Finally, this code should work on all present versions of Apple Pascal, including the Apple III's Pascal implementation. Be forewarned that future versions of Apple Pascal might not support these routines.

PROCEDURES AND FUNCTIONS

SuperSets includes 11 procedures and functions that can be grouped by the number of sets they take as operands. Membership, Include, Exclude, and Nullify each take a single-set operand, while Union, Difference, Intersection, Equality, Inclusion, Assignment, and Symmetrical all take two.

The single-set operators—with the exception of Nullify—share the subroutine Index__set, which performs the necessary address translation for the elements within the set. Index__set saves the 3 least significant bits of the element (modulo 8) in the X-Reg for indexing to the desired bit. Then the binary value of the element is divided by 8 (8 bits per byte) and the effective address of the byte within the set is formed from the set address, offset by the Y-Reg.

The value in the X-Reg is used to index into the 8 bytes beginning at

(continued)

New dimensions in Bible study.

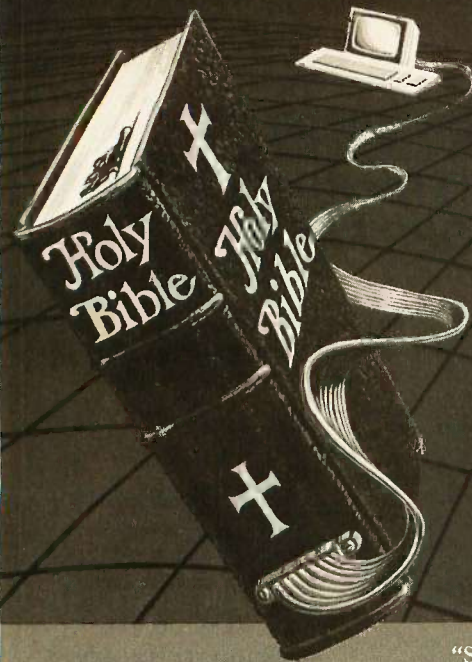

THE WORD processor

The KJV or NIV Bible on disks. Search for any word or phrase, create personal indexes, print any verse. Build your own library of Scripture references. \$199.95

THE GREEK transliterator

Start with any English word and find the original Greek, with definition and word roots. For any Greek word find every translation. Includes STRONG'S CONCORDANCE and the KJV New Testament. (Apple and IBM only.) \$199.95

Include \$3 postage/handling plus sales tax in Texas.

"Software for personal Bible study"

Bible Research Systems

9415 Burnet, Suite 208
Austin, TX 78758
(512) 835-7981

For Apple, IBM PC,
Commodore 64, TRS80,
Kaypro, CPM 2.2, MS-DOS.

BASF QUALIMETRIC™ FLEXYDISKS.® A GUARANTEED LIFETIME OF OUTSTANDING PERFORMANCE.

BASF Qualimetric FlexyDisks feature a unique lifetime warranty, firm assurance that the vital information you enter on BASF FlexyDisks today will be secure and unchanged tomorrow. Key to this extraordinary warranted performance is the BASF Qualimetric standard... a totally new set of criteria against which all other magnetic media will be judged.*

You can count on BASF FlexyDisks because the Qualimetric standard reflects a continuing BASF commitment to perfection in magnetic media. One example is the unique two-piece liner in our FlexyDisk jacket. This BASF feature traps damaging debris away from the disk's surface and creates extra space in the head access area for optimum media-head alignment. The result is a guaranteed lifetime of outstanding performance.

For information security that bridges the gap between today and tomorrow, look for the distinctive BASF package with the Qualimetric seal. Call 800-343-4600 for the name of your nearest supplier.

Visit BASF at Comdex/Spring,
Booth 650

*Contact BASF for warranty details.
Inquiry 48

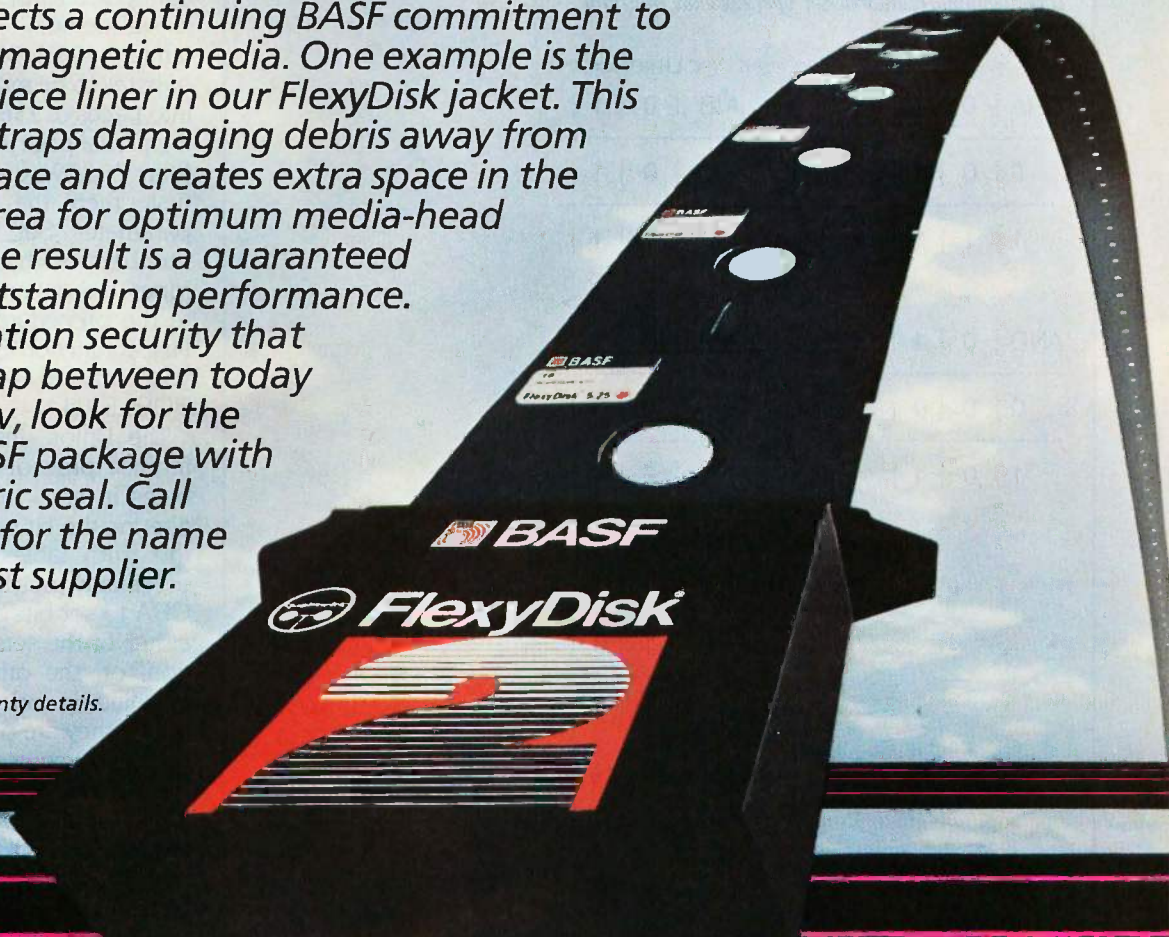

ENTER TOMORROW ON BASF TODAY.

© 1983 BASF Systems Corp., Bedford, MA



BASF

SET EXTENSIONS

the label `Bit_masks`, which are hexadecimal equivalents for each of the 8 bits per byte. The appropriate value is loaded into the accumulator to be used with the machine op codes `ORA` and `AND`, which set or clear the bit, respectively.

The function `Membership` uses the value in `Bit_masks` with the machine op code `AND` to zero out all the bits in the set except the one you're test-

ing. If the bit you're testing is on, the result of the `AND` is nonzero. (Testing for a nonzero result either increments the Boolean result to 1 indicating true—the element is there—or leaves it 0—it's not there.)

`Include`, rather than zeroing out all the bits except the one you're interested in, forces the bit on with the machine op code `ORA`, then stores the byte back into the set. Converse-

ly, `Exclude` forces the bit off; first, however, it must reverse the `Bit_mask` bit pattern—setting the bit you want to use explicitly off and all the rest on. Then, if you use an `AND` op code, you won't affect the other bits in the set, but the bit you wish to clear will be turned off. Again, the byte operated on is stored back into the set.

Dual-set operators require a somewhat different process, a sequential processing of each byte in a set, rather than the individual bits. The method used here is described in Bob Sander-Cederlof's article, "How to Move Memory" (*Apple Assembly Line*, January 1981). Basically, the number of bytes to be moved is broken down into pages of 256 bytes and a remaining partial page with a byte count less than 256. Whole pages are moved first, then the partial page. The parameter `Set_size` contains the number of bytes to be moved (operated on) and should be passed to the procedures using the built-in Pascal function `SIZEOF()` applied to your declared `PACKED ARRAY[n] OF BOOLEAN`.

The `Union`, `Intersection`, and `Difference` procedures scan sequential bytes in each of two set operands, altering the bit patterns according to the truth tables in table 1. `Union` essentially uses the machine op code `ORA` to set bits on if the bit is on in either of the sets involved. `Intersection`, on the other hand, uses the machine op code `AND` to turn bits on only if they are on in both sets. Finally, `Difference` uses a combination of the machine op codes `EOR` and `AND`: it first turns off bits that are common to both sets (`EOR`), then `ANDs` this bit pattern with the original operand, `Set_A`, to clear those bits not originally part of `Set_A`—those turned on by `EOR`. (This becomes easier to understand if you try to work out a couple of examples by hand using table 1.)

The function `Inclusion` `ANDs` the two sets together, yielding a bit pattern that contains only those bits common to both sets. This pattern is then compared to the bit pattern of

Table 1: Truth tables for machine instructions on the left, and their corresponding relational set operators on the right.

ORA 0 1	<Union> A/B 0 1
-----	-----
0 0 1	0 0 1
-----	-----
1 1 1	1 1 1
AND 0 1	<Intersection> A/B 0 1
-----	-----
0 0 0	0 0 0
-----	-----
1 0 1	1 0 1
<Inclusion> A/B 0 1	-----
-----	0 1 0
-----	-----
-----	1 1 1
<Difference> A/B 0 1	-----
-----	0 0 0
-----	-----
-----	1 1 0
<Equality> A/B 0 1	-----
EOR 0 1	-----
-----	0 1 0
-----	-----
1 1 0	1 0 1

(continued)



Draw Your Way to the Top

*PC-Draw Will Increase Your Office Productivity.
And Upward Mobility.*

Imagine. You now have the capability to graphically depict your best ideas, plans, designs and proposals. *In color or black & white. Accurately. Completely. Dramatically.* Concepts presented so forcefully—yet so simply—that you leave that critical meeting with upper management... *totally* confident of success.

And you win. Your secret weapon? PC-Draw. A powerful interactive graphics program for the IBM PC or XT™—*unlike anything else* on the market. Using PC-Draw you create virtually anything that can be drawn with pencil and paper. Quickly. Easily. With far greater detail.

PC-Draw is ideal for presentation graphics, proposals,

**10 DAY
TRIAL
PERIOD**

systems design, forms, diagrams... and an endless variety of charts, graphs and illustrations. PC-Draw allows you to produce drawings *up to 99 pages* long. Several templates come with PC-Draw including Flowcharting, Electrical Design, Office Layout, and Alternate Text. In addition you create and store your *own* unlimited supply of user defined symbols.

PC-Draw includes an *easy-to-follow* interactive tutorial. Requires IBM PC or XT™ or compatible, graphics adapter and graphics monitor. Version for PCjr available. Graphic boards, plotters at competitive prices.

Shhh! Don't tell your office competition about PC-Draw. They'll catch on soon enough. For free brochure or to order call 800/2PC-DRAW. In Texas or for customer service call 214/234-1769. Micrografx, Inc., 1701 N. Greenville Ave., Suite 305, Richardson, Texas 75081.

MICROGRAFX

The Picture of Success.

(Most popular plotters and printers supported.)

Inquiry 270

GET SERIOUS!

*** TAX RETURN SPECIAL ***

LOTUS 1-2-3 \$279.00

*** SYSTEMS ***

ITT EXTRA PC-256K

Two 1/2 Ht. 360 Dr's, Monochrome Board, 14" Amber/Green Monochrome Monitor, Serial & Parallel Port, Wordstar, Multiplan, Advanced Basic, DOS 2.1.

..... \$1,942.00
 * Same features in IBM PC \$2,624.00

IBM PC-256K

Two TEAC 360K Dr's, Color/Monochrome Graphics Board, Parallel Printer Port, Taxan Monochrome Display, DOS 2.1. ONLY \$2,145.00

IBM PC-256K

Two TEAC 360K Dr's, Color/Monochrome Graphics Board, AST 6-Pak Plus 64K, PRINCETON HX-12 Color Display, PANASONIC 1091 Printer, LOTUS 1-2-3, DOS 2.1. ONLY \$3,320.00
 10 Meg Upgrade \$680.00

*** SOFTWARE ***

LOTUS Symphony \$429.00
 dBASE III 359.00
 Wordstar Prof. Pack for IBM 299.00
 ASCII Express for IBM 109.00
 Framework 349.00
 MICROSOFT Word 229.00
 MICROSOFT Multiplan 129.00
 PFS Write/File/Report 85.00

*** HARDWARE ***

AST Six Pack Plus 64K \$264.00
 STB Rio Plus II 64K 249.00
 STB Color/Monochrome Graphics 269.00
 STB Monochrome Board 169.00
 HERCULES Monochrome Graphics 329.00
 HERCULES Color Card 179.00
 TEAC 55B 1/2 Height Dr's 129.00
 TANDON TM100-2 Dr. 169.00

*** PRINTERS DOT MATRIX ***

PANASONIC 1091 \$289.00
 PANASONIC 1092 395.00
 EPSON FX-80+ 395.00
 EPSON FX-100+ 644.00
 OKIDATA 92P 389.00
 BROTHER 2024L 995.00

*** PRINTERS LETTER QUALITY ***

BROTHER HR15 \$369.00
 BROTHER HR25 609.00
 BROTHER HR35 849.00
 PANASONIC 3151 495.00

*** MONITORS ***

TAXAN 121/122 Monochrome \$145.00
 PRINCETON HX-12 469.00
 PRINCETON MAX-12 179.00
 ZENITH Amber/Green 85.00
 NEC 1260 Green 85.00
 NEC 1305 RGB/T.V. 449.00

*** MODEMS ***

HAYES 1200B \$379.00
 HAYES Micromodem IIe 219.00
 HAYES 300 199.00
 ANCHOR Volksmodem 1200 185.00
 PROMETHEUS Promodem 1200 324.00

*** APPLE ***

80 COLUMN 64K IIe only \$99.00
 80 COLUMN Card II+ only 59.00
 VIDEX Ultraterm 179.00
 APPLEMOUSE II 125.00
 ASCII Express 79.00
 Z-80 Card 49.00
 APRICORN Serial Card 59.00
 MICROSOFT Premium IIe 269.00
 MICROSOFT Multiplan 129.00
 MAC MICROSOFT Multiplan 125.00
 MAC MICROSOFT Basic 105.00
 16K Card 49.00

Many items available. Please call for complete pricing.

714/840-2406
 Se Habla Espanol 

CALIFORNIA MICRO HOUSE

16835 Algonquin St., Huntington Beach, CA 92649

Corporate accounts welcomed, purchase orders accepted with net 30 day terms, subject to credit approval. All prices represent cash prices. All items shipped next day in factory sealed packages. We guarantee all items for 30 days. California residents please add 6% sales tax. Prices subject to change without notice.

SET EXTENSIONS

the set you wish to test for inclusion (Set_B). If the patterns match, you know that all bits common to both sets are contained in Set_B. If not, the loop is exited to the code located at local label \$4, which decrements the Boolean result to 0 (false) and returns to the caller.

The Assignment and Nullify procedures are fairly straightforward. Assignment copies the bytes from one set to another, while Nullify moves 0s—all bits off, thus no elements—to the operand set.

What would an extension to a language be without some new feature thrown in for good measure? How about a set operator from Modula-2, Niklaus Wirth's latest language? Titled Symmetrical, this dual-set operator is expressed as A/B (versus A - B for difference) and forms a new set with elements from either set, but not both. For example, *element* IN (A/B) is the same as NOT ((*element* IN A) AND (*element* IN B)). At the machine level, the op code used is EOR, which turns bits common to both sets off and turns on those bits not common to both. (Dyed-in-the-wool Pascal programmers should have some fun with this one.)

EXECUTION SPEED

As usual, there are trade-offs between the size of the code and its execution speed. Since the single-set operators

require one access into a set, it seems reasonable that they share the necessary overhead. However, because the dual-set operators must make several accesses, they should use their own code exclusively. If the dual-set operators were to share a main loop for accessing memory, the overhead of both testing for the operator desired and JUMPing to it would slow execution by at least a factor of two.

How fast does this make SuperSets compared to Apple Pascal? Table 2 lists the procedures and functions of SuperSets, their equivalent Apple Pascal statements, and the relative execution times of each. In order to get a meaningful comparison, I used a set of 512 elements to compare Apple Pascal and SuperSets. The third column gives the results for a set of 1024 elements using SuperSets only.

As table 2 indicates, SuperSets' procedures are about twice as fast as their counterparts in Apple Pascal. Equally important, SuperSets' ability to handle sets of an increased size—such as 1024 elements—does not significantly slow execution. One reason for the performance increase is that Apple Pascal cannot add or subtract single elements from sets but must use an entire set for each operand. Also, Apple Pascal compiles to p-code, which must then be interpreted at run time.

(continued)

Table 2: SuperSets' procedures and functions with their equivalent Apple Pascal statements and the relative execution times of each.

SuperSets Procedure	Apple Pascal Statement	Apple Set of 512	SuperSet of 512	SuperSet of 1024
Membership	element IN set_A	1.000	0.688	0.688
Include	set_A := set_A + [element]	1.000	0.274	0.274
Exclude	set_A := set_A - [element]	1.000	0.270	0.270
Union	set_C := set_A + set_B	1.000	0.265	0.415
Intersection	set_C := set_A * set_B	1.000	0.531	0.810
Difference	set_C := set_A - set_B	1.000	0.578	0.931
Equality	set_A = set_B	1.000	0.629	0.947
Inclusion	set_A >= set_B	1.000	0.640	1.005
Assignment	set_B := set_A	1.000	0.823	1.240
Nullify	set_A := []	1.000	0.721	1.031
Symmetrical	set_C := set_A / set_B	1.000	0.278	0.430
Average Relative Execution Times		1.000	0.518	0.731

Introducing the Most Powerful Business Software Ever!

TRS-80™ (Model I, II, III, or 16) • APPLE™ • IBM™ • OSBORNE™ • CP/M™ • XEROX™



The VERSABUSINESS™ Series

Each VERSABUSINESS module can be purchased and used independently, or can be linked in any combination to form a complete, coordinated business system.

VERSARECEIVABLES™ \$99.95
 VERSARECEIVABLES™ is a complete menu-driven accounts receivable, invoicing, and monthly statement-generating system. It keeps track of all information related to who owes you or your company money, and can provide automatic billing for past due accounts. VERSARECEIVABLES™ prints all necessary statements, invoices, and summary reports and can be linked with VERSALEDGER II™ and VERSAINVENTORY™.

VERSAPAYABLES™ \$99.95
 VERSAPAYABLES™ is designed to keep track of current and aged payables, keeping you in touch with all information regarding how much money your company owes, and to whom. VERSAPAYABLES™ maintains a complete record on each vendor, prints checks, check registers, vouchers, transaction reports, aged payables reports, vendor reports, and more. With VERSAPAYABLES™, you can even let your computer automatically select which vouchers are to be paid.

VERSAPAYROLL™ \$99.95
 VERSAPAYROLL™ is a powerful and sophisticated, but easy to use payroll system that keeps track of all government-required payroll information. Complete employee records are maintained, and all necessary payroll calculations are performed automatically, with totals displayed on screen for operator approval. A payroll can be run totally, automatically, or the operator can intervene to prevent a check from being printed, or to alter information on it. If desired, totals may be posted to the VERSALEDGER II™ system.

VERSAINVENTORY™ \$99.95
 VERSAINVENTORY™ is a complete inventory control system that gives you instant access to data on any item. VERSAINVENTORY™ keeps track of all information related to what items are in stock, out of stock, on backorder, etc., stores sales and pricing data, alerts you when an item falls below a preset reorder point, and allows you to enter and print invoices directly or to link with the VERSARECEIVABLES™ system. VERSAINVENTORY™ prints all needed inventory listings, reports of items below reorder point, inventory value reports, period and year-to-date sales reports, price lists, inventory checklists, etc.

VERSALEDGER II™ \$149.95
 VERSALEDGER II™ is a complete accounting system that grows as your business grows. VERSALEDGER II™ can be used as a simple personal checkbook register, expanded to a small business bookkeeping system or developed into a large corporate general ledger system **without any additional software.**

- VERSALEDGER II™ gives you almost unlimited storage capacity (300 to 10,000 entries per month, depending on the system),
- stores all check and general ledger information forever,
- prints tractor-feed checks,
- handles multiple checkbooks and general ledgers,
- prints 17 customized accounting reports including check registers, balance sheets, income statements, transaction reports, account listings, etc.

VERSALEDGER II™ comes with a professionally-written 160 page manual designed for first-time users. The VERSALEDGER II™ manual will help you become quickly familiar with VERSALEDGER II™, using complete sample data files supplied on diskette and more than 50 pages of sample printouts.

SATISFACTION GUARANTEED!

Every VERSABUSINESS™ module is guaranteed to outperform all other competitive systems, and at a fraction of their cost. If you are not satisfied with any VERSABUSINESS™ module, you may return it within 30 days for a refund. Manuals for any VERSABUSINESS™ module may be purchased for \$25 each, credited toward a later purchase of that module.

To Order: **Write or call Toll-free (800) 431-2818**
 (N.Y.S. residents call 914-425-1535)

- * add \$3 for shipping in UPS areas
- * add \$4 for C.O.D. or non-UPS areas
- * add \$5 to CANADA or MEXICO
- * add proper postage elsewhere

Inquiry 181

DEALER INQUIRIES WELCOME

All prices and specifications subject to change / Delivery subject to availability.



COMPUTRONICS

50 N. PASCACK ROAD, SPRING VALLEY, N.Y. 10977

* TRS-80 is a trademark of the Radio Shack Division of Tandy Corp. • APPLE is a trademark of Apple Corp. • IBM is a trademark of IBM Corp. • OSBORNE is a trademark of Osborne Corp. • CP/M is a trademark of Digital Research • XEROX is a trademark of Xerox Corp.

NOW AVAILABLE
THE MANUAL:
 THE MANUAL IS DESIGNED LIKE A POCKET DICTIONARY. COVERS ALL THE COMMANDS, FUNCTIONS AND FEATURES OF THE PROGRAM.

FOR ALL THE POPULAR PROGRAMS
 LOTUS 1-2-3
 SYMPHONY
 FRAME WORK
 dBASE II
 MULTIPLAN
 WORDSTAR
 APPLE WORKS
 JAZZ

A POCKET-SIZE MANUAL
 IN ALPHABETICAL ORDER
 ONLY \$14.95 EACH

1-800-MANUALS

VISA MasterCharge American Express

Please have your card number and expiration date ready when you make your call.

MANAGEMENT INFORMATION SOURCE, INC.
 3543 N.E. Broadway, Portland, Oregon 97232
 Telephone: (503) 287-1462

Lotus 1-2-3 is a trademark of Lotus Development Corp. Symphony and Jazz are trademarks of Lotus Development Corp. Framework is a trademark of Ashton-Tate. dBase II is a trademark of Ashton-Tate. Wordstar is a trademark of Micropro Corp. Apple Works is a trademark of Apple Computer Corp. Multiplan is a trademark of Microsoft Corporation. THE MANUAL is a trademark of Management Information Source, Inc.

SET EXTENSIONS

SuperSets permits set sizes significantly larger without much degradation in execution speed.

APPLICATIONS

You might keep in mind that SuperSets operates on packed arrays of type Boolean. Therefore, you can use SuperSets in Pascal applications that might not require abstraction at the set construct level—for example, bit-mapped graphics.

In addition to applications requiring larger set sizes, you can use SuperSets to formulate relational database requests that use large Boolean arrays, indexed by the record number, to construct subsets of the data. For example, several such subsets could represent an individual's gender, income, and whether he or she subscribes to a particular periodical.

By using the Union, Difference, and Intersection set operators, the database request can return those records where the individual is, for example, male and/or has a certain income and/or subscribes to a particular periodical. You can also use SuperSets in scientific sampling to operate on arrays of Boolean observations over time—the scalar index—to construct particular relationships among several such sets of observations.

You might find the equivalent machine op code for particular operators handy with graphics animation or bit-mapped character sets. Rather than redraw several sequences of an animation scene, you can use the operators to alter the bit pattern of the bit array and write it out to the graphics screen using the DrawBlock intrinsic provided with Turtle Graphics.

CONCLUSION

Sets are indeed powerful constructs in Pascal; take advantage of their ease of use, speed, and logical operators. In addition, knowledge of how sets work at the machine level can open new avenues of applications in areas other than the set construct. I hope SuperSets will expand your Pascal toolkit and enhance your program design. ■

The right place at the right price.

Make reservations at any Best Western, see your travel agent, or call **1-800-528-1234.**



"World's largest chain of independently owned and operated hotels, motor inns, and resorts"

©1985 Best Western International

COLOR GRAPHICS

On Any System...

In Any Language...

At **Applied Data Systems, Inc.**, we know that everyone requires a different level of graphics capability. That's why we've produced a line of graphics products tailored to fit anyone from novice to expert — on any system from a **personal computer** to a large-scale **mainframe**.

All products in the VectorScan product line feature:

- | | |
|--------------------------------|------------------------------------|
| 512 X 480 X 4 bit Frame Buffer | On board processor and firmware |
| Uses no host RAM address space | Color and Monochrome Map Registers |
| Color and Monochrome outputs | User programmable Shape Table |

For **ENGINEERS AND SYSTEMS INTEGRATORS:** The VectorScan 512 is a "black box" type peripheral that brings color graphic capability to any host computer or controller. The VectorScan provides:

- Application software that is transportable between minis, mainframes, and micros
- Up to 4 independent overlay planes
- An easy to use ASCII command structure
- An internal character generator
- Four graphic and text overlays, selective erasure, and graphic page switching
- A language and operating system independent device

Our approach greatly simplifies graphics integration into industrial process control, R&D applications and business reporting.

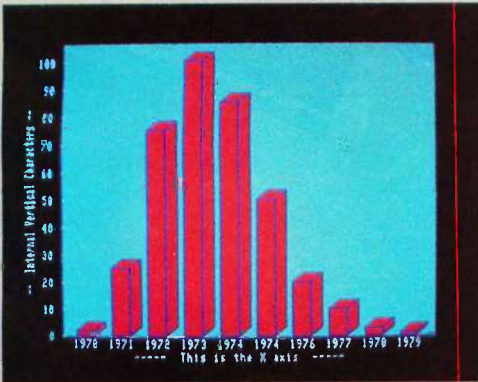
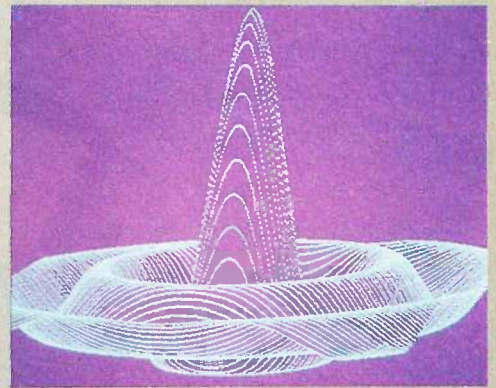

For **THE IBM-PC AND COMPATIBLES:** The VectorScan PC512 plug-in board brings "Black Box" graphics to the small computer user. This approach to high resolution graphics is important to the small computer user since processor speed and memory address space is at a premium. The PC512 provides:

- An on-board Z80B processor (6 Mhz).
- Firmware for graphic primitive execution and video memory addressing
- Operations transparent to the PC processor
- A fast, easy-to-use graphics peripheral
- A language and operating system independent device

VectorScan PC512

IBM-PC or compatible plug in board.
4096 Color Pallet
\$695/Assembled
\$450/Kit

VectorScan 512/IEEE

Aluminum Case and power supply.
IEEE-488 Interface
\$1975/with IEEE-488 interface

Vector Scan 512

Aluminum Case and power supply.
RS-232 Interface
Hardcopy output
\$975

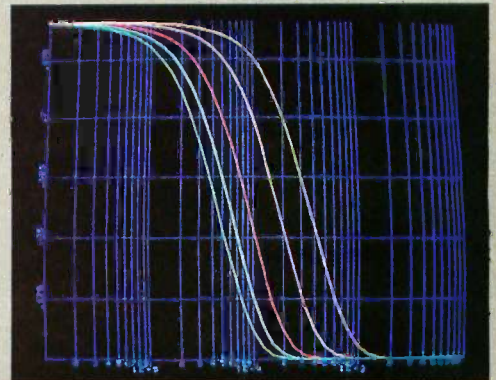

Applied Data Systems, Inc.

9811 Mallard Drive, Suite 213 • Laurel, Maryland 20708 • (301) 953-9326

**Three more firsts
from the people who
invented the wheel.**



**Xerox Advantage
D-80IF Diablo Printer**

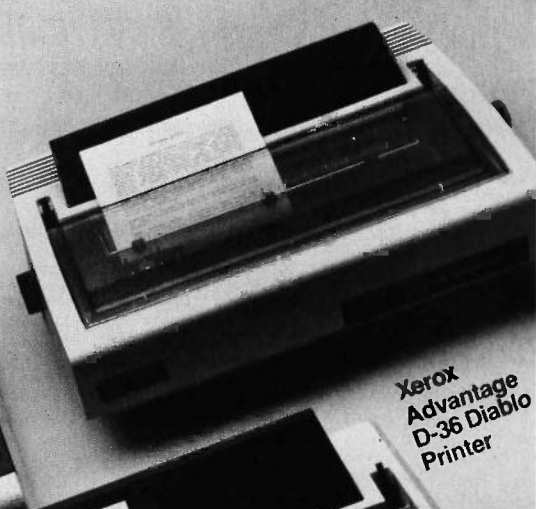

**Xerox
Advantage
D-36 Diablo
Printer**



XEROX

From day one, Xerox and Diablo have been known as the two best names in daisywheel printers. And now there are three more in the Xerox line to choose from.

The Xerox Advantage D-25 Diablo printer turns out letter quality documents quickly and quietly. And it does all that for the price of a dot matrix printer.

At 80

c.p.s., the D-80IF is the fastest daisywheel printer ever made by Xerox. It has a built-in double bin sheet feeder. As well as the capacity to handle up to 16 computers at once.

And the D-36 spells reliability. It averages 4,000 hours of printing between maintenance calls.

But Xerox didn't stop there. Each of these new machines is compatible with most computers on the market, including the IBM-PC. And they're all easy to use.

They're also a part of Team Xerox, so they can be serviced by the national Xerox service force and authorized service locations across the country.

So if you're looking for the latest in daisywheel printing technology, go with the people who've been in the business the longest. Call 1-800-833-2323, ext. 25, your local Xerox office, an authorized Diablo or Xerox dealer or send your business card to Xerox Corporation, Dept. 25192, P.O. Box 24; Rochester, NY 14692.

For more information from Xerox, Circle 424 on the Reader Service card.



Xerox Advantage
D-25 Diablo Printer



Move From General Ledger...



Directly Into Order Entry...

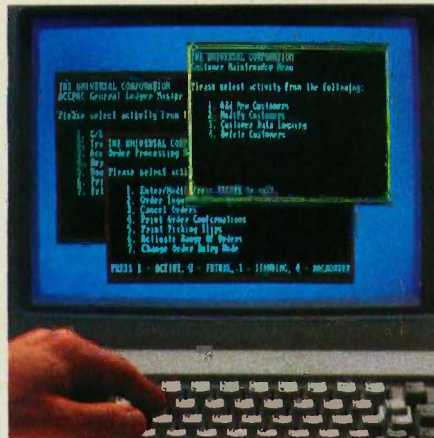

To Accounts Receivable...



To Inventory Control...



To Accounts Payable...



To Spreadsheet...



To Word Processing...

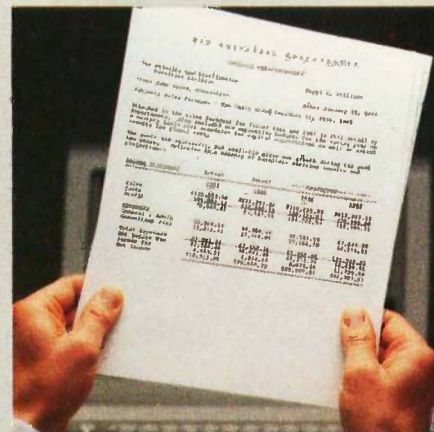

To Customized Reports.

WITH EASYBUSINESS SYSTEMS, THERE'S NO TELLING HOW FAR YOUR BUSINESS CAN GO.

When you add EasyBusiness™ Systems accounting software to your business, you'll be able to do far more than keep track of your company's time and money.

You'll get the information you need to take your company places.

First of all, EasyBusiness Systems is a sophisticated, yet easy-to-use integrated accounting system.

One that's recommended by accountants from independent CPAs all the way to the Big 8.

In fact, PC Magazine's Price Waterhouse Report has called EasyBusiness Systems "... an excellent set of accounting packages." and "... among the best on the market today."

And now with the EasyPlus™ windowing system, you can integrate all our accounting and productivity software on one screen.

Integration that no other software company can offer.

Which even includes leading spreadsheets like SuperCalc® 3 Release 2 and Lotus 1-2-3.™ Databases like dBASE™ II. And word processing programs like EasyWriter™ II and WordStar.™

So you'll be able to see your business in ways you never could before.

EasyBusiness Systems is powerful and flexible enough for any size business. Yet surprisingly easy to learn.

And should you have any problems in your first six months, free expert technical support is only a phone call away.

To find out more about EasyBusiness Systems, ask your accountant. Or see your authorized Sorcim/IUS dealer.

You'll never look at your business the same way again.

SORCIM/IUS
MICRO SOFTWARE

A Division of Computer Associates International, Inc.

© Computer Associates International, Inc. EasyBusiness, EasyPlus and EasyWriter are trademarks, and SuperCalc a registered trademark of Computer Associates International, Inc. Lotus and 1-2-3 are trademarks of Lotus Development Corp. dBASE is a trademark of Ashton-Tate. WordStar is a trademark of MicroPro Corp.
*PC Magazine 5/1/84.

Inquiry 372

BUILD A TALKING CLOCK SPEECH SYNTHESIZER

*This talking clock chip
circuit also allows
experimentation with an
unlimited-vocabulary
speech processor.*

Low-cost speech synthesis is now available for the computer hobbyist. Radio Shack has two speech-synthesis products (each selling for \$12.95) and both can be interfaced to the Commodore 64, VIC-20, and the TRS-80 computer. One product is the General Instrument Talking Clock chip set, and the other is the General Instrument SPO256-AL2 Allophone Speech Processor. I'll explain how to interface these chips to the above-mentioned computers and describe a program for the Commodore 64 and VIC-20 that will keep time and give a vocal

announcement of the time with the touch of a key.

Included in the General Instrument Talking Clock chip set are the SPO256-017 Speech Processor and the SPRO16-117 Speech ROM (read-only memory). A fixed vocabulary stored on the Speech Processor and the ROM contains 33 words and 3 melo-

(continued)

Ernest H. Piette is an off-site engineer in aerospace avionics presently working in the Republic of Korea for the Fairchild Republic Co. His interests include computers, and robotics. He may be contacted at PSC Box 905, APO, San Francisco, CA 96461-0006.

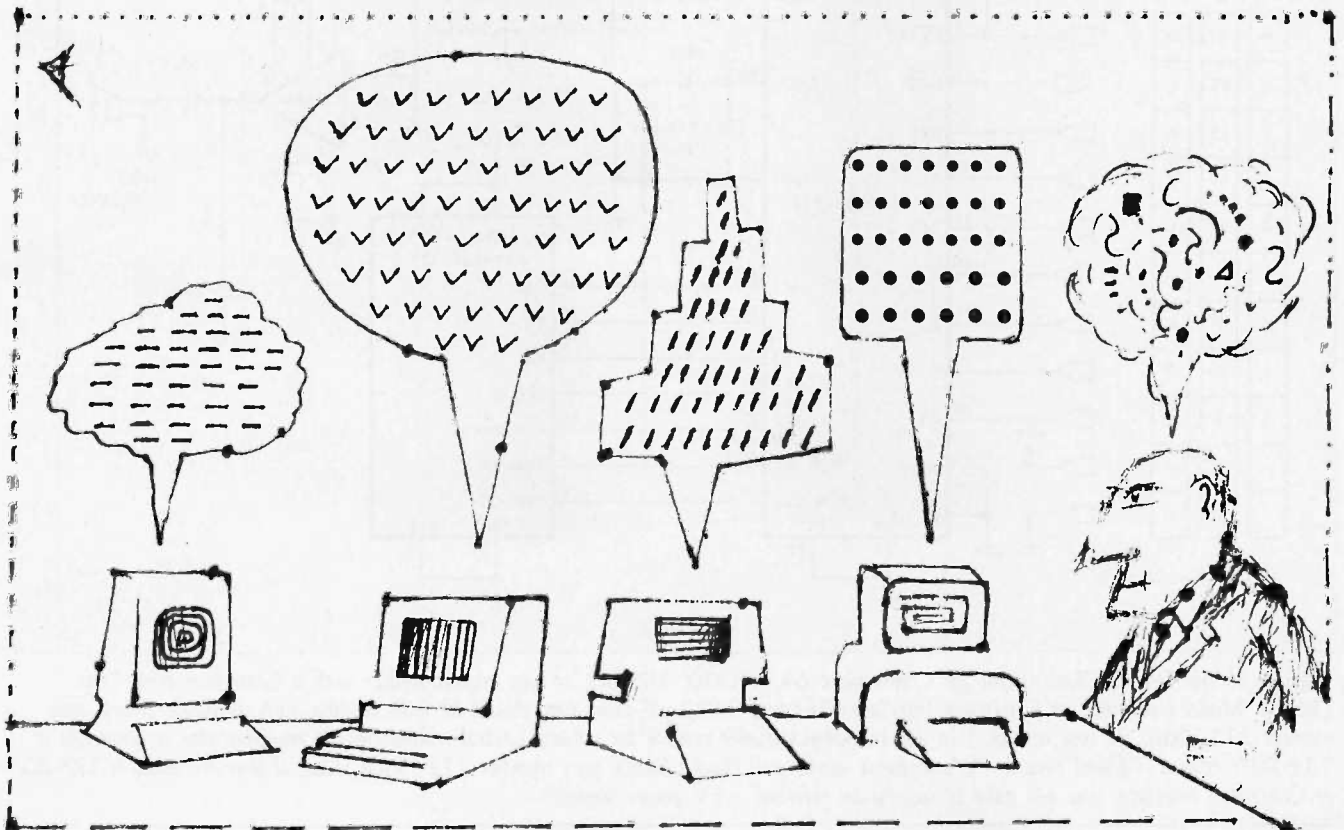

TALKING CLOCK

dies appropriate for a talking clock. The speech produced is highly intelligible and sounds natural.

The General Instrument SPO256-AL2 Allophone Speech Processor is capable of unlimited vocabulary speech using the allophone-synthesis technique. Stated simply, allophones are the basic sound components of any spoken English word. Radio Shack includes with the chip a data booklet that lists the guidelines for combining allophones to create words. (For a further discussion of allophones, see the text box "Speech and Voice Synthesis" by Tom Clune, September 1984 BYTE, page 340.)

Amazingly, a single circuit can be

used to interface either the Talking Clock chip set or the Allophone Speech Processor to your computer. Figure 1 shows a diagram of such a circuit that you can connect to a wide variety of microcomputers. The circuit is small, composed entirely of inexpensive parts, and can be connected to the user port on the Commodore 64 and VIC-20, the printer port on the TRS-80, or any computer with a Centronics printer port.

Circuit layout is not very critical; the SPO256-017 seems rather forgiving in this regard. However, use good construction techniques to keep AC (alternating current) hum and noise pickup to a minimum. Also, you

should use IC (integrated circuit) sockets for the Speech Processor and ROM chips.

You will notice that the circuit diagram shows the Talking Clock chip set in place. No physical modifications are necessary to switch to the Allophone Speech Processor; simply remove the SPO256-017 Speech Processor and the SPRO16-117 ROM and plug the Allophone chip into the Speech Processor's socket (the ROM socket remains empty). Always be certain that there is no power going to the circuit before doing this.

I've written two BASIC programs that you can use for experimentation

(continued)

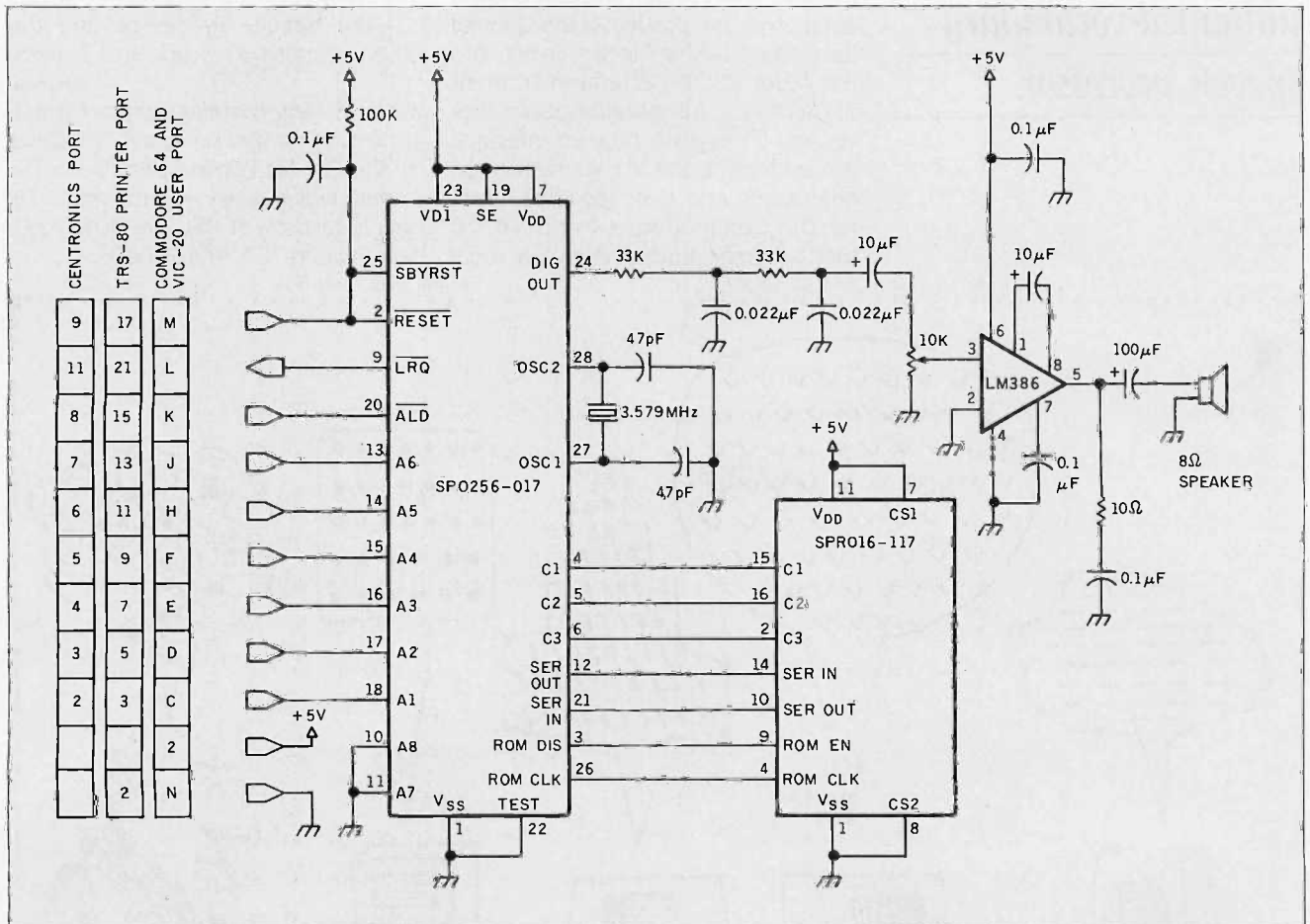

Figure 1: The Talking Clock circuit for Commodore 64, VIC-20, TRS-80, or any microcomputer with a Centronics port. (The TRS-80 Model I requires an Expansion Interface.) The two 0.022- μ F capacitors should be high quality, such as Radio Shack part number 272-1066, for best results. Use the 10k-ohm variable resistor for volume control. Although the manufacturer recommends a 3.12-MHz crystal, I found that a TV colorburst works well (Radio Shack part number 272-1310). Also, if you are using a TRS-80 or Centronics interface, you will have to supply an external +5-V power source.



Opening a Branch Office...

You're only a modem away from your DISCOVERY computer!

The Ultimate Solution.

Effective communication is today's business. Whether your requirements are real time data acquisition and retrieval, process control, or simply running your business from ten thousand miles away, the **DISCOVERY Multiprocessor** will meet your communication needs. No multi-tasking, single-processor computer can match the

DISCOVERY's responsiveness to your requests. No Local Area Network (LANs) can offer you the remote, global communications capability of the **DISCOVERY System**.

Take Action Today!

Call Toll Free: **1-800-821-6596**.
(In California, it's **1-818-351-5451**.)



ace The Multiprocessing Company

See us at COMDEX
Booth B208
Atlanta Apparel Mart

Corporate Headquarters: Action Computer Enterprise, 430 N. Halstead St., Pasadena, CA 91107 USA TWX 910-588-1201 ACTION PSD

In Europe: ACE (Europe), B.V., Paradijslaan 42, 5611 KP Eindhoven, The Netherlands Tel. (004) 045-2658 TLX: 51767 ACE E NL

In Australia: Archives Computers Australia Pty. Ltd., 64 Clarendon Street, South Melbourne, Victoria 3205, Australia Tel. (03) 699-8377 TLX: 39388 ARCAUS AA

In Asia: ACE (Asia), G/F, Lee Wah Mansion, 171-177 Hollywood Road, Hong Kong Tel. 5-441692 or 5-442310 TLX: 75332 PACIC HX

In Thailand: Action Computers (Thailand), Ltd., 5/26 Saladaeng Road, Silom, Bangkok, Thailand, Tel. 233-5274 TLX: 82792 ADAMINT TH

In Singapore: Action Computers Pte Ltd., 111 North Bridge Road, #05-01.04, Peninsula Plaza, Singapore 0617 Tel. 3390244 TLX: 37215 FIGTRA RS

Serviced nationwide by Bell & Howell Company

Inquiry 10 for Dealers. Inquiry 11 for End-Users.

DISCOVERY is a trademark of Action Computer Enterprises, Inc.

MAY 1985 • B Y T E 145

TOUGH PRINTER NETWORK PROBLEM:

"How do I get my computers to share three different printers and a plotter... without getting all tangled up in cables, switches, protocols and programming?"

SIMPLE SOLUTION: PrintDirector

PrintDirector — an automatic switch, buffer, and network controller product family — allows you to network your computers and printers... expandable from two to 35 of any mix of models and makes. Just plug it in. No worrying about protocols and baud rates. No cable changing or switch flipping. No modifications to your hardware or software. No problem. For information on the proven PrintDirector product family — and a configurator to tell you which particular PrintDirector can solve your tough printer network problem in a computer or PC center, or local work cluster — call or write:

PrintDirector

Digital Products Inc. • The Simple Network Solution Company
 600 Pleasant Street, Watertown, MA 02172
 (617) 924-1680 • Outside Mass., call 1-800-243-2333.
 And check out our 30-day trial evaluation.

TALKING CLOCK

with this circuit. The first, named TCLOCK.BAS, creates a Talking Digital Clock on your Commodore 64 or VIC-20. (Use it with the Talking Clock chip set in place.) Run the program, enter the correct time in response to the initial prompt, and watch the digital display begin ticking away. Press any key for a verbal announcement of the time. (Be sure to read all REM statements before running the program; they will indicate any code that is machine-dependent.)

The second program uses the Allophone Speech Processor and will say "Hello" on the Commodore 64. This program is named HELLO64.BAS. [Editor's note: The source-code listings for TCLOCK.BAS and HELLO64.BAS are available for downloading via BYTEnet Listings. The telephone number is (603) 924-9820.]

Although I haven't mentioned any uses for the talking clock program, I'm sure you have ideas that you might like to try. A subroutine could be included to input an alarm time that would wake you in the morning. For commercial applications, the circuit could be integrated into a workstation, notifying an employee of the time when a particular job should be started, etc. It could even be included in a punch-clock station.

Talking games, spelling programs, math programs, etc., are just a few applications for the Allophone speech synthesizer. In any case, the SPO256 series of speech processors offers an extremely low cost introduction to speech synthesis.

The items to follow are available from Microtalk Inc., 39 Raymond St., Providence, RI 02908. For \$18, the TT-1 Partial Kit includes an etched and drilled PC board, assembly instructions, and edge connector or ribbon cable (depending on computer: be sure to specify Commodore 64, VIC-20, or TRS-80). The SPO256-AL2 kit comes with the Allophone processor chip and the Allophone synthesis user's guide for only \$16. Include \$2 for shipping and handling in the continental United States, \$5 elsewhere. Residents of Rhode Island should include 6 percent sales tax. ■

- Multiple color, high-resolution raster & bit image Prism™ graphics.
- 200 cps data processing mode.
- 110 cps text quality mode.
- 35 cps letter quality mode.
- 10 ips graphics print speed.
- Serial and parallel interfaces.
- 5000-byte buffer.

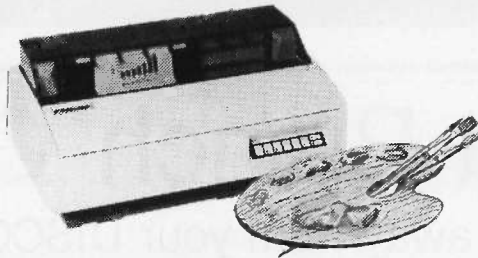

Color your graphics with the Dataproducts 8050. For sale, lease or rent from MTI.

The Dataproducts Model 8050 printer is one of the most economical yet highly versatile color printers available for use in today's professional microcomputer applications environment.

Whether you buy, rent or lease, MTI is the one source for all computer printers. And our prices are hard to beat. Call MTI and save.



A SUBSIDIARY OF DUCOMMUN INCORPORATED

Computer & Data Communications Equipment Sales / Leasing / Service / Systems Integration

Digital Equipment Corp., Intel, Texas Instruments, Hewlett-Packard*Qume, Dataproducts, Diablo, Epson, Lear Siegler, Esprit, Wyse, Link, C.Itoh, PCI, Racal-Vadic, MICOM, Vep-Tel, Develcon, U.S. Design, Digital Engineering.

New York:	New Jersey:	Ohio:	Kentucky:
212/226-2337	518/449-5959	201/227-5552	216/464-6688
718/767-0677		800/521-0167	502/426-1497
516/621-6200		412/931-9351	513/891-7050
			818/883-7633

*In MTI areas only.

All other areas: 800/645-6530



THE FLOPLESS FLOPPY

That's right. A StorageMaster® diskette is the one you can count on again and again for consistent performance. Because it's made beyond the standards by one of the world's largest manufacturers of storage media.

So if you won't settle for anything

less than extraordinary performance every time, reach for the floppless one. Reach for a StorageMaster diskette. For the location of your nearest distributor, see your local Yellow Pages or call toll-free 1-800-232-6789 ext. 370.

5018 Copyright © 1985 Control Data Corporation.

CONTROL
DATA

IBM's best efforts are now going into Macintosh.

Macintosh and IBM PC software. Compatible at last, thanks to MacCharlie, a rather innovative coprocessing system.

And imagine the consequences.

Nearly 10,000 IBM PC software programs designed for general business and specific applications in real estate, insurance, law, medicine, banking, etcetera, can now join forces with Macintosh's own popular programs.

And, the myriad of IBM PC-compatible software adopts Macintosh's many beloved features, including desktop utilities such as the clipboard and the calculator.

In addition, MacCharlie allows

IBM PC and Macintosh data files to be exchanged. Talk about flexibility.

But the good news gets better.

You see, MacCharlie delivers hardware compatibility, as well. For example, IBM letter-quality printers can be easily used with Macintosh.

Furthermore, MacCharlie

now allows Macintosh to perform virtually any networking an IBM PC can perform. Even to the extent of tying in with IBM mainframes.

In other words, your networking capability goes beyond the Apple family.

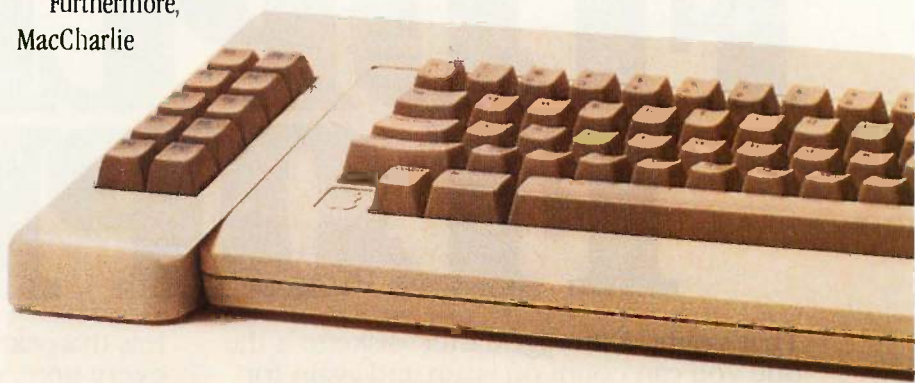

The Macintosh keyboard slides right into MacCharlie's keyboard. About as easy as slipping a letter in an envelope.



Macintosh sets snugly beside MacCharlie, on a custom-fit pedestal.



Once you plug in MacCharlie's power and keyboard cords, you're ready to enjoy a very happy marriage.

How does it happen? As easily as slipping on penny loafers.

In mere moments, MacCharlie combines the best features of the world's premier personal computers.

And despite the fact that it

turns one computer into two, MacCharlie adds but a handful of square inches to Macintosh's physique.

In short, one of life's most perplexing decisions—whether to buy a Macintosh or an IBM PC—

can now be made with the greatest of ease.

Ask for MacCharlie at your local computer store. Or, for more information, call Operator 14 toll-free, 1-800-531-0600. (In Utah, call 801-531-0600).

MacCharlie offers 256K RAM, with optional upgrade to 640K RAM; 360KB disk drive, and optional second disk drive.



MacCharlieTM

THE BEST OF BOTH WORLDS.

MacCharlie is a product of Dayna Communications,
50 S. Main, Salt Lake City, Utah 84144
Inquiry 126

Apple is a trademark of Apple Computer, Inc. Macintosh is a trademark licensed to Apple Computer, Inc. IBM is a registered trademark of International Business Machines Corporation.

The Dream, Knee-top PC with APL Productivity and Voice Networking too!

See us at
COMDEX Spring '85
May 6-9, 1985
Atlanta Apparel Mart,
Atlanta, Georgia



AMPÈRE WS-1



You have never seen a personal computer like the WS-1. This beauty introduces a whole new world of knee-top PC productivity. It combines the unheard of capability of APL programming with a host of 32-bit architecture desktop functions, a rugged keyboard and full-size LCD, plus the person-to-person convenience of an intelligent telephone — all in a smartly designed, portable package you can use anywhere!

- Battery operation
- 8 MHz 68000 CPU
- Up to 448K bytes of RAM
- 128K bytes of ROM
- 25 X 80 character LCD
- Bit-mapped graphics
- Multiple windowing
- Multijob, multitask OS for powerful networking
- Coherent DB-WP-CALC-Graphic software
- Intelligent phone function
- Microcassette voice/data storage

FOR DISTRIBUTORSHIP INFORMATION AND PRODUCT DETAILS, PLEASE CONTACT:

ampère

INCORPORATED

Asahi Bldg., 5-20, 7-chome Ni shi-Shinjuku, Shinjuku-ku, Tokyo, Japan
Phone: 03-365-0825, Telefax: 03-365-0999, Telex: J33101 AMPERE
IP Sharp Mail Box Code: AMP (Group Code APLWS)

U.S. Representative Office:

**WORK SPACE
COMPUTER INC.**

3848 Carson st. Suite 301 Torrance, California 90503, U.S.A.
Phone: 213-540-1553, Telex: 322800 WORK SPACE

SMALLTALK

COMES TO THE *Microcomputer World*

*t*he August 1981 issue of *BYTE* focused on Smalltalk, a highly unusual programming language. The Xerox Palo Alto Research Center (PARC) designed Smalltalk to be a complete development environment. The language is somewhat esoteric; it uses unfamiliar terms such as "methods," "classes," and "objects," instead of more conventional jargon. And, while most languages deal with algorithms, Smalltalk focuses on data structures (objects) and their interrelationships. Smalltalk's lack of "modes" is also unconventional; it has no edit, compile, link, or execute mode. Instead, Smalltalk allows you to do virtually anything, anytime. The Smalltalk environment pioneered the concept of displaying different tasks in multiple windows on the screen, an idea that, at the time, represented a radical departure from punched cards and 80-column by 24-line ASCII (American Standard Code for Information Interchange) CRTs (cathode-ray tubes). Using a mouse for screen interaction is another Smalltalk innovation.

When *BYTE* introduced its readers to this fascinating language, many of them expectantly awaited Smalltalk's appearance on microcomputers. They waited . . . and waited . . . and waited. Then they began to complain. "Why," they asked *BYTE*, "did you devote an entire issue to a language we can't use? When are we actually going to see a version of Smalltalk?" The *BYTE* staff grew weary of the complaints, especially because they were justified.

Therefore, it is with great interest and relief that we print this series of articles. First, Tom Yonkman and I evaluate *Methods* (page 152), developed by Digitalk Inc. of Los Angeles, California, which brings Smalltalk-80 to the IBM Personal Computer (PC) and compatibles.

Then Christopher Macie discusses Smalltalk-PC, a restricted Smalltalk implementation he's developing for the Apple II and other computers (page 155).

Finally, for those of you who don't have the August 1981 *BYTE* handy, "The Smalltalk Programming Language" by Jim Anderson and Barry Fishman of Digitalk (page 160) gives a brief review of Smalltalk-80, complete with an application that runs under *Methods*.

A review of the August 1981 issue shows how heavily the Xerox PARC Smalltalk project has influenced modern software, most notably that for the Lisa/Macintosh. However, development languages like BASIC, C, FORTH, and Pascal remain largely unaffected. Perhaps now that some "real" Smalltalk implementations are reaching the microcomputer market, the object-oriented approach to software development will get its first true test.

—Bruce Webster

METHODS: A PRELIMINARY LOOK

Part 1: *Methods is object-oriented* . . .

BY BRUCE WEBSTER

t

he influence of Smalltalk-80, particularly the Xerox PARC implementation, on the microcomputer world has become just about legendary. Windows, mice, and pop-up/pull-down menus now appear on everything from small portables with LCDs (liquid-crystal displays) to expensive terminals hooked up to even more expensive minicomputers and mainframes. Ironically, however, most of the emulation is of the appearance and not of the substance of Smalltalk—and with good reason. Most people have agreed that expensive hardware is required for an acceptable implementation of the Xerox standard. For example, Tektronix recently announced their 4404 Artificial Intelligence System, a marvelous single-user development system running Smalltalk-80. It has a Motorola 68010 processor, 1 megabyte of RAM (random-access read/write memory), and a 20-megabyte hard disk. But its \$15,000 cost will do little to bring Smalltalk to the masses. Yet, as the many articles in the August 1981 BYTE suggest, Smalltalk is a language from which the masses, from children on up, can profit.

A few years ago, two software engineers working on several large projects were frustrated with their development tools. Specifically, Jim Anderson and George Bosworth wanted a development environment that would help, rather than hinder, in producing solutions. They read the BYTE Smalltalk issue and found that many of the articles presented ideas similar to their own:

- Small personalized systems provide much more creative leverage for the user than large-scale standardized systems. (They had been using an extended Pascal under UNIX 4.2.)
- Complexity dilutes power. The UNIX systems certainly have power, but their complexities detract from their ability to harness it.
- A small number of concepts uniformly applied results in a powerful and understandable system.
- Self-organizing systems are the goal of the future.

Anderson and Bosworth decided that Smalltalk—or something like it—was their answer.

They wanted a commercially viable product, something that others could and would use. Initially, they approached

Bruce Webster is a BYTE contributing editor as well as a PMS commando. He works with several programming languages and is seldom afraid to tackle a new one. He can be reached at 6215 Thorn St., San Diego, CA 92115.

IN BRIEF

Name

Methods, version 1.0

Manufacturer

Digitalk Inc.
5200 West Century Blvd.
Los Angeles, CA 90045
(213) 645-1082

Type

Object-oriented program-development system,
based on Smalltalk-80

Environment

Text-based windowing system with cursor-pad "mouse"
and pop-up menus

Price

\$250

Computer

IBM PC and compatibles with two 360K-byte disk drives
(or a hard disk), at least 512K-bytes of RAM,
a monochrome or graphics card, and either
MS-DOS or PC-DOS

Documentation

Program-development-environment reference manual,
Smalltalk language reference manual

Audience

Software developers and interested programmers

Xerox but decided that the hardware demands and licensing fees of Smalltalk-80 were too great. So, not knowing that it was "impossible" to bring up Smalltalk on the current generation of microcomputers, they agreed to implement Smalltalk on an Olivetti computer, retaining the right to market the results for other microcomputers. They picked the IBM Personal Computer as their target machine, assuming that would give them the largest possible market, and they formed Digitalk Inc. with Barbara Noparstak and Alberto Della Ripa. The result, two years later, is Methods, version 1.0.

Methods attempts to recreate the Smalltalk development environment on an IBM PC (and compatibles) running under MS-DOS. You don't need a hard disk—two 360K-byte floppy disks are sufficient—but you do need 512K bytes of memory. Nonetheless, most IBM PCs and compatibles now come with at least 256K bytes of RAM, and expansion cards with another 256K bytes are readily available.

USING METHODS

Methods uses two disks. One contains SOURCES.SML, a 300K-byte ASCII file containing the source code for all methods in the system. The other has IMAGE.EXE, a RAM image of the Methods system, and CHANGE.LOG, an ASCII file containing the source code for all changed methods and for expressions executed with the `dolt` and `prntlt` menu commands.

It takes about a minute to load IMAGE.EXE, your development environment, into RAM. You can save new objects and methods to disk using one of the pop-up menus. Then, when you reload the image, you come up in the same environment you last saved, including all windows and their contents (definitions, commands, output).

Digitalk's biggest challenge was implementing the Smalltalk user interface. Windows, pop-up menus, and a free-roaming cursor are fundamental aspects of Xerox's Smalltalk systems, but not all IBM PCs or compatibles have graphics capability, and few support a mouse. Therefore Digitalk used a character-based windowing system and what they call the "right-hand-drive mouse."

The character-based windows, which use the IBM PC's extended character set and character attributes (bold, inverse, etc.), work well. Windows can overlap, move around, and change size. They can collapse down to their title, which can then be set off in a corner of the screen, or they can be removed altogether. They can hold more text than they show, and they support both vertical and horizontal scrolling. Furthermore, a given window can be divided into "panes," each with the same capabilities as windows. Two functions keys select the current window and pane: F9 cycles through the windows on the screen, activating each in turn by putting it "on top" of all others; F10 cycles through the different panes (if any) within the currently active window. Alternatively, placing the cursor

in a window or pane makes it active. With a color-graphics card, the windows are still text-based, but you gain the ability to select the background and text colors for each window.

Text-based windows have three main advantages. They lessen the need for a graphics card, reduce memory requirements (because text information is more compact than bit-map information), and increase system speed (because text can be manipulated more rapidly than bit maps). The disadvantage, of course, is that some of the fancier features often associated with Smalltalk—different text fonts, graphics images, and the like—aren't possible.

The right-hand-drive mouse uses the cursor keypad to perform most of the functions of a mouse, including moving the cursor, scrolling windows, popping up menus, and selecting text. The arrow keys move the cursor around; if you use them with the shift key, the cursor moves in larger increments. The Home and End keys let you scroll text left and right within the active window/pane; similarly, the Pg Up and Pg Dn keys let you scroll up and down. The Ins and Del keys pop up menus for the active window and pane, respectively. The + key selects a menu item or a location; the - key extends that selection over several lines.

SOME OBSERVATIONS

It was easy to evaluate Methods' user interface; it was more difficult to assess the language itself, especially to compare it with Smalltalk-80. Since I had little experience with Smalltalk (or, for that matter, any other object-oriented language), I asked someone with more experience and knowledge to perform that task. Tom Yonkman, who has developed object-oriented software applications for several years, graciously consented to write the second part of this article. I will share my own observations as a professional software engineer with a strong background in more traditional computer languages (Pascal, FORTH, FORTRAN, assembly). Keep in mind, however, that I worked with a prerelease version with no real documentation.

At first, I was very excited about Methods. I spent a few hours at the Digitalk offices watching the staff demonstrate the product. I was impressed with the user interface and amazed at how quickly they could create new applications and modify existing ones. I was anxious to start using it myself.

My initial sessions with Methods were frustrating. What seemed effortless and clear at Digitalk now seemed difficult and obscure. I had no problems with the user interface, but the language itself was challenging. In fact, I was probably a victim of my own training and experience, all geared towards "traditional" programming languages and techniques.

After a few days of playing around, I began to get results.

(continued)

I started to define some data structures and the methods needed to store and retrieve their information. The more I worked, the more potential I saw. Indeed, some of my long-term projects dealing with modeling large systems may be better implemented in Methods/Smalltalk than in any other languages with which I'm familiar.

My main difficulty with Methods was getting it to do something quickly. This was not an inherent problem with Methods; I had three handicaps: lack of documentation, lack of graphics and real numbers in my prerelease version (most of the examples in Smalltalk-80 books involve one or the other), and, of course, my own lack of familiarity

with object-oriented languages. None of these handicaps should remain when Methods is commercially released (probably by the time you read this).

The bottom line is that Methods is a legitimate object-oriented development system, running on widely available, standard hardware. Since it is a departure from traditional programming environments, you will need complete, clear documentation to avoid frustration. How Digitalk addresses that issue remains to be seen. A more complete evaluation will have to await the release of the final product; nonetheless, anyone with an interest in object-oriented languages should take a close look at Methods.

Part 2: . . . but is it Smalltalk?

BY TOM YONKMAN

Methods is a complete software-development system, with an editor, compiler, executor, and debugger all in a multiwindow environment. Methods does not require a linker or a loader.

The language is similar to Smalltalk-80 (see *Smalltalk-80: The Language and Its Implementation* by Adele Goldberg and David Robson, Addison-Wesley, 1983). The syntaxes of the languages are identical except for characters that don't exist in the IBM PC character set. On the basis of limited testing, the semantics of Methods (what the functions do) also seem identical to those in Smalltalk-80. The user interface is similar to that of Smalltalk-80; differences owe to the space limitations of the 80-column by 25-line character screen and to the memory limitations of the IBM PC.

Methods provides the standard System Transcript, Workspace, Class Hierarchy Browser, Class Browser, Inspector, and Walkback (Backtrace) windows. Multiple instances of each window ("views" in Methods and Smalltalk jargon) can appear on the screen. The Walkback window traces the sequence of operations that led to an error state. The System Transcript window displays messages for the user. Workspace is a general utility window for editing text and sending messages to objects (i.e., executing programs).

The Browsers look at the existing hierarchy of classes, the message names of existing classes, and the definitions of existing methods. You can add or delete classes, edit a class's definition, protocol, or redefine its methods. The Browsers can access the Methods system in its entirety. You can see how the system developers do certain operations, and you can copy any statements you like, paste them into your own methods, or modify them. The Inspector allows you to view or change the current values of in-

stance variables. Menu commands are provided so you can find all the senders and implementors of a specified method. These are very useful, given the inheritance mechanism of Methods.

You use Methods by sending messages to objects that perform some operation and return the result. If there is no class of objects with the capabilities you need, you can define new classes and associated protocols (message names and methods). Or you can edit existing methods or add new methods to existing classes. In any case, you are always interacting with the Methods system—a similarity this language shares with BASIC, LISP, and FORTH, among other highly interactive systems. Methods does not provide a System Workspace with templates for commonly used expressions, which would be a useful feature for users not yet familiar with the program.

The process of developing capabilities will involve testing your new methods. You do this by creating a new instance of your class, sending it a message, observing the response, and fixing the method if the response is incorrect. To fix the method, you select a Class Browser window, edit and recompile, select the Workspace where the message was sent, resend the message, etc.

While I know that I used a prerelease version of methods, I do have a "wish list" for the language. For example, it would be nice if more data were kept in memory at one time, so that browsing back and forth didn't require reloading the same source code as often. The designers may have traded memory for speed. I would also have preferred easier selection among panes of a window and among all windows. For example, a function key could cycle among the two most recently selected panes/windows or among the *n* most recently selected.

Despite the limitations of Methods, someone who becomes proficient with it should have no trouble with a "real" Smalltalk-80 system (like the Tektronix 4404). Best of all, you don't need to pay \$15,000 to use Methods. ■

Tom Yonkman is a member of the technical staff of VERAC Inc., San Diego, CA. He has been developing object-oriented software applications using Flavors for several years. He can be reached at 4182 Camino Islay, San Diego, CA 92122.

SMALLTALK-PC

BY CHRISTOPHER MACIE

Objected-oriented software on the Apple II

Smalltalk bridges the gap between human and computer problem-solving logic. Essentially, programming is the process of creating a model of an activity or thought process. In traditional programming languages a small change in a program can require a large change in the program code (owing to the languages' firm bases in machine representation). And many languages involve special, often particularistic, sets of skills. Higher-level programming languages are simply higher-level abstractions from machine logic.

Smalltalk, on the other hand, starts with an object-oriented model of problem-solving logic and deals with the machine logic internally and automatically. Where other languages need guiding constructs like "structured programming" to help control the complexity of machine representation, Smalltalk proceeds along more natural intuitive lines. And, as the needs of the Smalltalk user change, applications are easy to modify and maintain.

When I first saw Adele Goldberg demonstrate Smalltalk-72 at Xerox PARC in 1976, other programming languages and environments suddenly seemed obsolete. Between 1976 and 1981, I studied Smalltalk, applying its principles in new projects, and I decided that a full implementation would never work on the minicomputers then available.

But then the Apple II came along, with eXtensible architecture and a memory-mapped screen. When BYTE published the Smalltalk issue in August 1981, memory-extension cards were becoming available, and various game-paddle devices could simulate the functions of a mouse. The Apple II had become a candidate for Smalltalk experimentation. Smalltalk-80, the Xerox standard, had advanced and refined the Smalltalk concepts, but it seemed out of reach for the Apple II. Nonetheless, I began my own Smalltalk implementation on the basis of reverse engineering (see references 1 and 2).

SMALLTALK FOR LOW-COST PERSONAL COMPUTERS

I developed Smalltalk-PC to provide users with access to object-oriented programming on hardware systems like the Apple II and IBM PC. The language is intended for system designers and applications programmers who want a head start in object-oriented programming and for sophisticated users and programmers, especially those working with highly dynamic applications involving frequent reprogramming. Although Smalltalk-PC differs in several respects from Smalltalk-80, the general flexibility of the Smalltalk language will facilitate communication between the two.

Smalltalk-80 is written to such a deep level that it requires extraordinary processor power to perform adequately. Smalltalk-PC simplifies the hardware requirements by placing the entire system (which can be extended) in about 60K bytes of RAM (random-access read/write memory), using mass storage

(continued)

Christopher Macie (1255 Post St. #625, Box 138, San Francisco, CA 94109) is a software-systems designer. He has a B.A. in music and humanities from Stanford University and an M.A. in music history from the University of California at Berkeley. His interest in Smalltalk evolved from his efforts with the classical pipe organ and then with electronic music.

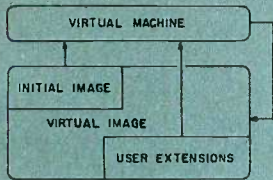

Figure 1: The overall structure of the Smalltalk-PC system. The virtual image drives the virtual machine. The initial image implements the dictionary, user interface, and language systems.

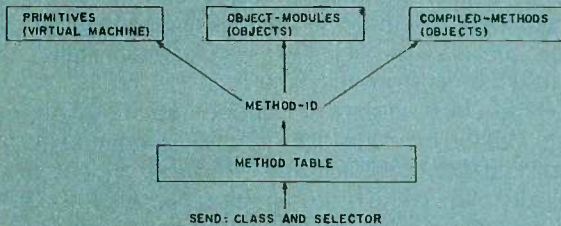

Figure 2: Unified message sending to the different method-implementation types. Message sends are handled as lookup keys into the method table, which determines the implementation type and the path to the method code.

for file I/O (input/output) and image storage but not for swapping. In Smalltalk-PC, therefore, the virtual machine (the lower level written in assembly code) is much larger than in Smalltalk-80, limiting modifiability at the lower systems' levels (such as object and class behavior, the system-level classes, including collections, and much of the user interface), but optimizing performance on the slower processors. Still, Smalltalk-PC preserves the flexibility of Smalltalk at its higher levels, those of interest to most personal computer and applications programmers. Smalltalk-PC embodies "open system" principles but also allows programmers to protect applications and their users from the pitfalls of fully open access.

SYSTEM STRUCTURES

Figure 1 shows the overall structure of the Smalltalk-PC system. The hardware is interfaced by the virtual machine or kernel system (see figure 3), which implements the class/object and message-passing machine. The virtual machine is in turn driven by the virtual image—the fundamental system classes and objects that implement the object-oriented modeling environment. The initial image, delivered with the system, implements the basic environ-

ment, including the dictionary, user interface, and language systems. It also contains some toolkit extensions for applications programming.

Methods can be redefined in the fundamental classes, as illustrated by the arrow leading from the virtual machine back to the virtual image. Smalltalk-PC thus preserves the essential flexibility of Smalltalk, although its speed suffers relative to the default-machine-coded versions when such methods are interpreted.

The package of modules has entry points for message sends (with arguments in an active context) and for message calls (with arguments in registers and internal global cells). Although the arrows in figure 3 go directly to modules, all message sends are in fact routed through the Virtual Environment (VE) module.

As you can see in figure 2, message sends are handled uniformly as lookup keys into the method table, yielding a method-ID (identification) whose encoding determines the implementation type and the path to the method code. The state of the system—all the data stored and retrieved as the virtual image—is structured as in figure 4.

THE SMALLTALK-PC LANGUAGE

The language system compiles Smalltalk-PC code into intermediate code in compiled methods, interprets it, and provides support for debugging and error handling. The language syntax is a modified form of Smalltalk-80 syntax (see reference 3).

There are three types of language tokens, each distinguished by their typography. Those beginning with lowercase letters represent selectors and context-dependent variables. Those beginning in uppercase letters but containing at least one lowercase letter signify global variables. Tokens that are completely in uppercase represent reserved words and are used for identifiers such as NIL, TRUE, FALSE, the pseudovariables SELF, SUPER, etc., and certain control-selectors that are treated as primitives.

The reserved-word syntax is also used to express an escape mechanism for encapsulating other "languages" in method code. This is used, for instance, for symbolic and hexadecimal representations of Smalltalk-PC intermediate code. Escape syntax is also used to specify a variety of modes affecting method compilation and execution. For instance, visibility layering and error handling are regulated by class- or method-level run-time modes.

THE CLASS SYSTEM

The Smalltalk-PC class system is structured in a hierarchical tree from the root class Object and resembles the basic parts of the Smalltalk-80 class tree. The metaclasses of Smalltalk-80, however, are not used in Smalltalk-PC, where class and instance behavior are both accessed through the class Class.

The class Collection has subclasses for RandomCollections (Bag, Set, Dictionary) and IndexableCollections, in-

cluding Arrays (Strings, Symbols) and Ordered- or Sorted-Collections. The class Matrix is a subclass of Indexable-Collections. There are further subclasses for ByteMatrix (for WYSIWYG text) and PointerMatrix. These classes allow for large regular structures without proliferating sub-objects.

In creating IndexableCollections, there is an optional virtual dynamic-size control that uses an internally maintained current end marker. The feature reduces the amount of allocation/deallocation of objects, which often change in size.

Other fundamental classes include Undefined (NIL), Boolean (TRUE, FALSE) and Measure. Measure is similar to Magnitude in Smalltalk-80 and has subclasses for Character, SearchKey, and Number (which includes Integers and Float). Floating-point numbers are implemented in BCD (binary-coded decimal) format, with a 7-bit signed exponent, sign bit, and a 6-byte mantissa (12-digit precision).

The user interface contains classes representing the devices (Screen, Mouse, and Keyboard), their configurations, and a variety of window types and components. At the elemental level are WindowDimensions and Window-Frames and their components—TitleBars, ScrollBars, MenuBars, and Corners. Panes include TextPanels, List-Panels, and LabelValuePanels. PopUpMenus are a variety of ListPanels.

Complex forms are built by combining panes and dimensions or frames. Scanners are combinations of ListPanels used to scan through hierarchical structures like categorized dictionaries. Examiners are pairs of coordinated ListPanels used to examine or edit the state of any object. PropertyLists, arrays of LabelValuePanels, display labeled data or switches.

Windows combine frames and panes with the Director function to assume the behavior of processes that can be independently scheduled user tasks that reside in screens and present data that can be transferred between windows. TextWindows contain workspaces and documents; they are used in combination with dictionaries (ListWindows and Scanners) to build information trees or plexes.

ClassEditor is a more complex window that combines LabelValuePanels, ListPanels, and TextPanels for the display, generation, and modification of class definitions and methods.

MULTITASKING AND MULTIPLE PROCESSORS

Smalltalk-PC provides run-time scheduling and multitasking, allowing multiple active processes to compute simultaneously. The basic system classes furnish multilevel scheduling, queue handling, and semaphores for synchronization.

A variant of Smalltalk-PC, called Smalltalk-Mate, will run on multiple-processor hardware systems, including the Apple II and IBM PC with added processor cards, as well

as newer machines with multiple processors on the motherboard. Smalltalk-Mate furnishes an interface to support multiple processing on a single-object memory or synchronization between different images and even between Smalltalk and other language systems. This capability allows Smalltalk-PC to run coresident with the p-System and MS-DOS, among others. Users can therefore take advantage of both preexisting software and the special strengths of Smalltalk.

RUNNING SMALLTALK-PC

The Smalltalk-PC boot disk contains the virtual-machine program and a prerun configuration routine that allows

(continued)

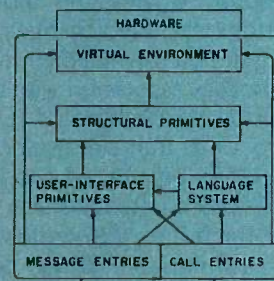

Figure 3: The structure of the virtual machine. The Virtual Environment (VE) module interfaces devices and memory, implements classes and message passing, and handles access to objects and their fields. The Structural Primitives module contains various primitive methods. The User-Interface module

carries out the primitive functions for screens and windows, while the Language System module contains the compiler, interpreter, and debugging subsystems.

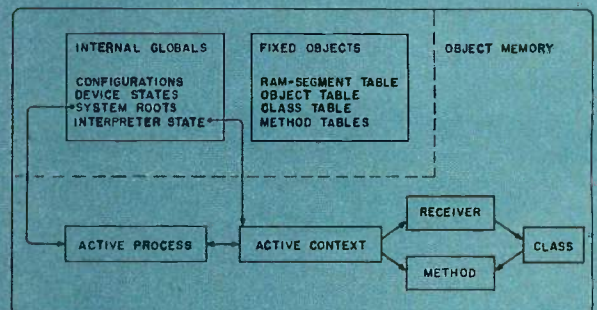

Figure 4: The Virtual Image Structure. Internal globals and fixed objects are stored in areas directly accessed by the virtual machine, although many of their elements are interfaced to the higher-level environment as bona fide objects. The state of execution is rooted in internal globals (used as registers) but largely contained in the objects of the active context. The running system makes no distinction between the initial image and user extensions.

the user to specify the current hardware configuration—mouse, screen, extended-memory types, and slots. A set configuration can be saved for future booting. A second disk loads the initial virtual image, which requires a minimum of 256K bytes of RAM. It is possible to configure additional RAM from within the system, but saving and loading extended virtual images may require multiple disks.

The initial image (see photo 1) displays the system screen, a logo, and elementary instructions. The system screen provides entry to the rest of the system through a pop-up menu that accesses a dictionary of system-task windows and the user-project screens.

THE USER INTERFACE

In the default user-interface configuration, the middle mouse button (or the one on the right on a two-button mouse) invokes a pop-up menu. Moving the mouse through the menu with the button depressed changes entries to inverse video. Releasing the button at a dictionary entry schedules and runs the process associated with that entry. Usually a framed window then appears. Data elements or ranges in a window or its frame are selected by clicking or dragging the button on the left. Pop-up menus, usually in combination with a data selection, invoke actions. Pop-up menus at the frame of a window offer the functions common to all windows—closing, positioning, and growing. Pop-up menus within the frame contain functions specific to the type of the window.

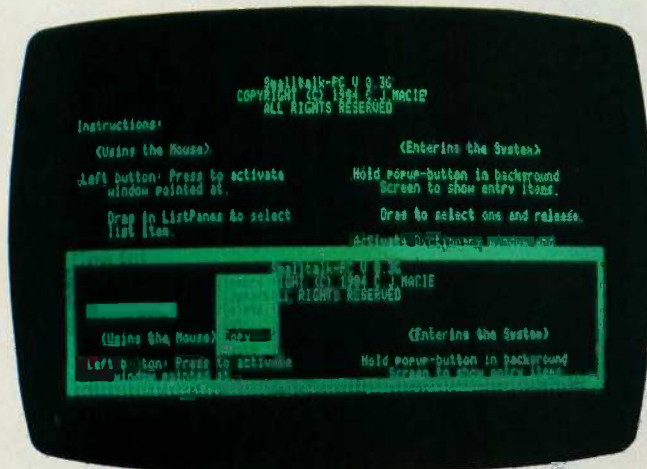

Photo 1: The Smalltalk-PC initial screen. This picture shows a text window with which instructions displayed on the screen can be modified. The selected text (inverse) is about to be captured for copying by means of the edit pop-up menu.

A project screen is a window that fills the whole screen, has no frame, and behaves much like the system screen, but contains a user-defined environment.

The fundamental pane and window types include options to configure the user interface according to personal preferences. For example, action selection can appear in PopUpMenus (as in later Xerox Smalltalks), in MenuBars at the top of the screen (as in the Lisa or Macintosh), or at the bottom (as in Visi On); TitleBars can appear at the top or bottom; ScrollBars can appear at the top, bottom, left, or right.

The user can configure the mouse to deliver the select, pop-up, execute (or do-it), and help functions from any choice of buttons (1, 2, 3, or simultaneous combinations).

The user can also configure key assignments for cursor and button control and assign up to 10 special-function keys as either soft interrupts that result in running processes or as pollable switches.

SYSTEM FEATURES

The task windows residing in the system screen provide interactive settings for dealing with system resources. One task window, for example, permits the reconfiguration of hardware and software features.

You can use Scanner windows to look around in hierarchically categorized dictionaries, and you can use an Examiner window to investigate the state of any object. For example, by nesting Scanner and Examiner windows, virtually anything in the system can be reached and viewed



Photo 2: A sampling of Smalltalk-PC windows. There is a scanner in the upper left showing class categories (left pane) and their classes (right pane). There is a form of class editor in the lower right. In the lower left is a text window, and in the upper right is a list, out of which the scanner was called. The two-line inverse window in top center is the pop-up menu of the screen (mouse button 2 is being held).

Toolkits are used in Smalltalk-PC to implement word processing, database processing, and spreadsheets.

in detail (the open-system concept).

A special window form supports the viewing, modifying, and adding of classes. Together with general-purpose workspaces and tracing and error windows, this special window form constitutes the programming environment. Photo 2 shows a screen full of typical windows.

You can create a project screen, which can be filled with task windows usually related by some application concept. Project screens use the same general tools as the system screen, including class programming, and you can install tools developed in a project screen in the system screen.

At almost any time, you can invoke a system task to save the current state of the virtual image on disk or to replace the current image by reading another. Alternatively, invoking automatic saving could periodically back up the system. An internal file and directory system provides file storage and retrieval on a special Smalltalk-PC disk format. Smalltalk-PC supports reading and writing of files in other formats, like Apple DOS, CP/M, MS-DOS, and the p-System.

For applications that do not need the full flexibility of the Smalltalk-PC environment, project screens can lock in specific tasks in much the same way as standard applications packages. Moreover, a feature called "visibility layering" can lock dictionaries at specific levels to prevent access beyond the scope of an application, and a special error-report control feature with a similarly layered structure can inhibit error messages from advanced system levels. These features are provided to protect application models from accidental disruption, but programmers could also use them to offer a degree of user programmability appropriate to the application, without requiring the user to master the full Smalltalk environment.

SMALLTALK-PC TOOLKITS

"Toolkits" are generalized, modular functions that support a family of application-oriented tasks. They are the best approach to applications programming in Smalltalk. In principle, they are extendable to other tasks, and they are used in Smalltalk-PC to implement word processing, database processing, and spreadsheets.

The word-processing toolkit has document windows providing page, margin, header, and other formatting controls. The database-processing toolkit has extensions to interface relational database functions to hard-disk- and network-based information systems.

Spreadsheet representation uses Smalltalk's object orientation to allow creation and maintenance of complex document forms whose elements are produced by arbitrarily complex processes. The capability called "Active

Data Modeling" services documents (text, charts, tables, etc.) whose contents are produced by information structures that can be viewed and manipulated at various levels of abstraction.

This spreadsheet format is free-form rather than a matrix of cells, and the order of evaluation is determined freely rather than by rows or columns. Data elements represented in the final document are not copied literally but remain linked to their source objects or processes. The data models therefore remain "active" in that they dynamically reflect changes from anywhere in the underlying structure.

IMPLEMENTATION ASPECTS

Methods implemented in machine code are important for the development of efficient application toolkits. These "object modules" can be compiled from a high-level language (for portability) and are installed into the virtual image as objects.

The coding of object modules uses table-pointed name strings to refer to system objects, both externally (other objects) and internally (the module itself and its entry points). An automatic installation procedure changes the string pointers to object identifiers of Smalltalk-PC symbols, binding the module into the virtual image. With this feature, interpreted Smalltalk code can be used for development, flexibility, and high-level control, and use of optimized machine code at strategic points can improve performance.

Smalltalk-PC does not run under a host operating system but drives the hardware directly from the virtual machine (VM), about 95 percent of which is portable across systems with the same microprocessor. The other 5 percent consists of the screen, keyboard, mouse, and virtual-memory management tailored to each host system. The system image (including user extensions and applications) is, in principle, portable across any system.

The memory system is fully object-oriented and supports up to 254 classes and 30K-byte objects in up to 4 megabytes of resident RAM. (IBS in West Germany and Legend Industries build 1-megabyte single-slot cards for the Apple II.) The object-memory system is largely derived from the OOZE system (see reference 4) but abandons those aspects directed at optimizing object swapping from disk. Reference counting is used to manage virtual memory, which is treated in 64K-byte segments to make scattered free space compact.

Object identifiers are used as direct indexes into a table containing virtual addresses and flags. Message lookup

(continued)

is done by hashing the class code and message selector into another large table.

The VM routines are optimized and shared to conserve space in main memory. Both the data-structure (collection) primitives and many of the user-interface primitives have a range of types and options specially encoded in their object structures, providing flexibility while conserving resources like space and classes.

Given the VM support for matrices as a form of collection, another technique to conserve object identifiers and to facilitate exploitation of the large virtual memory is to encourage the use of larger objects with complex but regular structures. The implementation of a matrix can then be a single object rather than an array containing additional array objects for each row. Otherwise, it would be possible to use up the object identifiers with a large portion of memory unused.

HARDWARE

I am implementing the Smalltalk-PC virtual machine for the 6502, 8088/8086, and 68000 microprocessors. The first version runs on Apple II-type systems (Apple II+, IIe, and compatible systems) with at least 80-column capability, an uppercase and lowercase keyboard, a 48K-byte motherboard RAM, one floppy-disk drive, and 256K bytes of memory on RAM card(s). (The Basis Computer BAS RAM, Legend Industries' S'Card, the Synetix Flashcard, the BAM-128 from Mikrotek, the Saturn/Titan card, and

the RAM cards from IBS are supported.)

The 8088/8086 versions (IBM-class systems) require one floppy-disk drive and 256K bytes of memory. The 68000 version is currently installed on a new system from the German manufacturer, Triumph-Adler.

Apple II graphics resolution is inadequate for 80-column text displays, so my first version of Smalltalk-PC used a memory-mapped 24-line by 80-column alphanumeric format rather than bit-mapped graphics. The choice helps performance (bit-mapped graphics are known to consume up to 50 percent of raw processing power), and adequately supports windowing, menus, and mouse control.

A medium-resolution mouse with at least two (preferably three) buttons is a necessity (Smalltalk-PC currently supports DePraz, Logitech, Mouse-House, Rikei Oku-MS mice with parallel interfaces, and the MSC serial mouse), although the pointing function is available through the keyboard. The minimum hardware configuration for the Apple II+ would include a Legend S'Card, a PIA-card for the mouse, and an 80-column card. ■

REFERENCES

1. Goldberg, Adele, and Alan Kay, eds. *Smalltalk-72 Instruction Manual*. Xerox PARC SSL 76-6. Palo Alto, CA: Xerox PARC, 1976.
2. BYTE, August 1981.
3. Goldberg, Adele, and David Robson, eds. *Smalltalk-80: The Language and Its Implementation*. Reading, MA: Addison-Wesley, 1983.
4. Kaehler, Ted. "Virtual Memory for an Object-Oriented Language." In [3], pages 378-387.

THE SMALLTALK PROGRAMMING LANGUAGE

BY JIM ANDERSON AND BARRY FISHMAN

An introduction to object-oriented programming

during the past year, we have used Smalltalk for application prototyping and system-software development. For us, Smalltalk simplifies programming and is fun. On the other hand, Smalltalk's new terminology and concepts generally complicate learning of the language, especially for experienced programmers (including ourselves). In this article we have attempted to demystify Smalltalk by relating it to other languages and by solving a moderately difficult problem in what we think is a straightforward and readable way.

Most people perceive Smalltalk as a "Macintosh-like" user interface with windows, mice, and bit-mapped graphics, but the Smalltalk group at Xerox PARC actually pioneered and blended together several technologies, including raster graphics, integrated environments, and object-oriented programming.

The last of these is our main concern.

Like FORTH, Smalltalk's core is small but its vocabulary can be extended. Like LISP, it has automatic memory management and capabilities for manipulating arbitrary data structures. Like Modula-2 and Ada, it encapsulates abstract data types (in objects).

The Smalltalk developers solved several interesting problems in graphics, text processing, simulation, and concurrency. Therefore, simply by reading Smalltalk programs, you may improve your programming ability in other languages. Fred Masterson has suggested that simplicity, power, compatibility, and cognitive richness are key attributes in a programming language (see reference 1). Except for Smalltalk, we don't know of a language that has all of these attributes while also being a practical tool for solving a wide range of problem types.

Smalltalk is well suited to rapid prototyping, the construction of software models that explore both the problem and its solution. This is especially important in interactive applications where perceptions of the problem can change after seeing a prototype solution (see reference 2). (Of course, a good programming environment is a big help here, too.)

A CLOSER LOOK AT OBJECTS

The Smalltalk-80 programming language (see references 3 and 4) is object-oriented in that all data is contained in record structures called objects. For translations of Smalltalk terminology, see table 1. The individually accessible components of an object (i.e., the fields of the record) are called instance variables, which either contain integer values in the range 0 to 255 or contain object identifiers.

Instance variables can be both named and indexed. For example,

1. An object of class Point has named instance variables *x* and *y*, which identify the coordinates of the point. A point has no indexed instance variables.
2. An object of class Array contains only indexed instance variables. These are identified with the integers 1 through the number of instance variables in the array.
3. An object of class Set has indexed instance variables and a single named instance variable *tally*, which totals the number of indexed instance variables that are not nil (the name for the special undefined object).

Objects are simpler than Pascal record structures in that either they contain all integer values or they contain all identifier values. Objects with integer instance variables define elementary data values like numbers and strings. Objects with identifier instance variables consist of pointers to other objects. The pointers organize the universe of all objects into a single directed-graph structure. Like a pointer value in Pascal, an identifier distinguishes each object.

Objects are "self-describing." They include information

Table 1: Some Smalltalk terminology translations.

Method _____	a function definition
Message _____	the invocation of a method, i.e., a function call
Protocol _____	the specification of how a message is sent to a method, including the method name and parameters
Object _____	a record of fields
Instance Variable _____	a field of a record
Class _____	a record type and all the functions that may be applied to the record type

defining their size (number of instance variables) and the class to which they belong. Computing in Smalltalk involves changing the instance variables of existing objects, creating new objects, and destroying objects (turning them into "garbage") by removing them from the graph structure. (See the text box on page 162 for a summary of Smalltalk statements.) The Smalltalk system automatically reclaims space for garbage objects.

Classes are the program modules of Smalltalk. Like the "abstract data types" provided by the modules of Modula-2 and the packages of Ada, a class specifies the instance variables contained in the objects of the class and the methods (functions) that operate on the objects. The internal details of an object are not visible from methods outside its class; therefore you cannot directly access its instance variables. Instead, you send a message to (invoke a function on) the object requesting the desired information.

Smalltalk classes are organized into a hierarchy with the class Object at the top. Superclasses are more generic; subclasses are more specialized. A class inherits the named instance variables and methods of its superclasses. Consider, for example, part of the Smalltalk hierarchy for class Magnitude:

```
Magnitude
  Character
  Date
  Time
  Number
  Float
  Fraction
  Integer
```

(continued)

Jim Anderson is president of Digitalk (5200 West Century Blvd., Los Angeles, CA 90045), a firm specializing in high-technology software products and consulting.

Barry Fishman (POB 626, Venice, CA 90291) is a software consultant specializing in the design and development of new products.

The generic class `Magnitude` contains methods for computing maximums and minimums in terms of comparison operators. The subclasses define more specialized functions, like doing the comparisons. Inheritance is a powerful abstraction technique that allows software to be reusable (see reference 5).

Inheritance is supported by "run-time binding," the dynamic determination (based on the class of the receiver, the object to which the message is sent) of which method responds to a message. Consider the method, implemented in class `Magnitude`, for taking the maximum of two magnitudes:

```
max: aMagnitude
  self < aMagnitude
    ifTrue: [^aMagnitude]
    ifFalse: [^self]
```

This generic method works for operands of any subclass of `Magnitude` if the subclass implements the "less-than"

(`<`) method. The class of `self` (the receiver of less-than) determines the choice of which less-than method to use. Thus we can take the maximum of two dates or two fractions, even though the `max:` method is not defined in either the date or fraction classes. Therefore the code works for operands that exhibit a generic behavior (here, comparing less-than), regardless of the details of the calculation.

SMALLTALK SYNTAX AND SEMANTICS

The syntax of Smalltalk methods has three parts: the message pattern, temporary variables, and statements. The message pattern defines the method name, method arguments, and the syntax for invoking the method with a message. Temporary variables are the method's local variables. Instance variables, method arguments, and global variables are the other variables accessible within a method. Global variables begin with uppercase letters. The others begin with lowercase letters.

A SUMMARY OF SMALLTALK STATEMENTS

a Smalltalk statement either assigns a value to a variable, exits a method and specifies the result, sends a message to an object, or does some combination of the three.

The following are three examples of assigning values to a variable:

```
a := true
```

In this example, the identifier of the object `true` is assigned to the variable `a`.

```
answer := index
```

Here, the identifier contained in the variable `index` is assigned to the variable `answer`.

```
i := j := 0
```

In this expression, the identifier of the object for the integer `0` is assigned to `i` and `j`.

To exit a method, Smalltalk uses the following syntax:

```
^answer
```

In this example, the object whose identifier is contained in `answer` is returned as the result of the method.

```
^'january'
```

In this expression, the identifier for `String 'january'` is returned as the result of the method.

To send a message, there are several possibilities:

```
a size
```

This is the syntax for a unary message. The message `size` is sent to the object in variable `a`.

```
count + 1
```

This is a binary message. The message `+` is sent to `count` with argument `1`.

```
a at: index
```

This is a keyword message. The message `at:` is sent to `a` with argument `index`.

```
a at: index put: count
```

In this multiargument message, the message `at:put:` is sent to `a` with arguments `index` and `count`.

There are several combinations of the above statements:

```
^count + 1
```

In this expression, the result of the message `count + 1` is returned as the result of the method.

```
x := a at: index
```

Here, the result of the message `a at: index` is assigned to the variable `x`.

```
^(a := b max: c + 1)
```

This statement is evaluated in the following steps. First, `+` is sent to `c` with argument `1`. Second, `max:` is sent to `b` with the result of the `c + 1` message as the argument. Third, the result of `max:` is assigned to `a`. Finally, the value assigned to `a` is returned as the result of the method.

*t*he syntax of Smalltalk methods has three parts: the message pattern, temporary variables, and statements.

A block, the part of a method enclosed in square brackets, is an object even though it represents executable code. Therefore, it is possible to assign a block to a variable or pass it as a message argument. The following example uses a block argument in a message to implement control structures:

```
[inputStream atEnd]
whileFalse:
  [outputStream nextPut: input Stream next]
```

The message `whileFalse:` is sent to the first block; the second block is an argument that will execute repeatedly until the first block returns true. If `inputStream` is of class `ReadStream` and `outputStream` is of class `WriteStream`, all the characters in `inputStream` will be copied to `outputStream`. (See references 3 and 4 for a complete description of control structures and blocks.)

SMALLTALK SYSTEM CLASSES

The Smalltalk language is a simple expandable core. The system is the core extended with several classes, including `Collection`, `Stream`, `Magnitude`, `DisplayObject`, `Point`, and `Rectangle`. (For a full discussion, see reference 4.)

`Collection` classes implement arrays, sets, dictionaries, and linked lists using common protocols for data-structure access. `Stream` classes implement external files as a sequence of randomly addressable bytes and, again with common protocols, streaming over arbitrary collections of internal objects. The `Magnitude` classes provide extensive facilities for date, time, and numeric calculations. The `DisplayObject` classes implement the representation and manipulation of graphical images (which are supported by classes `Point` and `Rectangle`, used respectively for representing graphical positions and areas).

In our example (which follows), we use system classes `Set`, `Dictionary`, and `FileStream`. Class `Collection`, of which `Set` is a subclass, allows its subclasses to create new collections, to add and delete collection elements, and to iterate over the elements of a collection while a block executes for each element. Instances of `Set` are efficiently searchable containers of unordered elements, which may not be duplicated.

`Dictionary`, a subclass of class `Set`, looks up values based on keys. An instance of class `Dictionary` associates pairs of keys and related values. Keys in a dictionary are unique.

The class `Dictionary` method `at: aKey ifAbsent: aBlock` returns the associated value if there is an entry in the dictionary with key equal to argument `aKey`. Otherwise the argument `aBlock` executes and determines the result of the `at:ifAbsent:` message. Consider

```
employees at: employeeNumber ifAbsent: [nil]
```

If `employees` contains a dictionary where each key is a number representing an employee's number and each value is an object representing all employee data, then the example message returns `nil` if the employee is not in the dictionary. Otherwise the employee object is returned.

The class `Dictionary` method `at: aKey put: aValue` places an entry for the pair `aKey`, `aValue` into the dictionary. This message always returns `aValue` as the result. For example, the message

```
employees at: employeeNumber put: employeeData
```

adds a value `employeeData` for the key `employeeNumber` to the dictionary `employees`.

The class `Dictionary` method `do: aOneArgumentBlock` iterates over the elements in the dictionary. The argument block is evaluated once for the value part of every key/value pair in the dictionary. In the next example,

```
employees do: [:employee |
  employee site = localSite
  ifTrue: [localEmployees add: employee]]
```

the message `do:` is sent to the dictionary `employees` with the block as argument. The block is executed once for each employee and builds a collection of local employees.

A SMALLTALK EXAMPLE— A DOCUMENT RETRIEVAL SYSTEM

Our Smalltalk example, which will run under `Methods` (see "Methods: A Preliminary Look" by Bruce Webster and Tom Yonkman, page 152) is a new class `WordIndex`, a simple document-retrieval system. An instance of `WordIndex` allows the retrieval of a list of all documents that contain a group of words. For example it could request a list of candidates whose résumés contain the words `UNIX`, `68000`, and `C`.

Our system maintains documents as ASCII files, one file per document. Queries that supply a list of words get back the names of all the documents that contain all the words. An instance of class `WordIndex` contains the document database for one application or category of documents. We have used classes `Collection` and `Stream` and their subclasses. Class `WordIndex` has instance variables `documents`, `words`, and `noiseWords`.

Instance variable `documents` contains a set of strings that identify the documents by their file pathnames. Instance variable `words` contains a dictionary representing the words in all documents. Each key is a word repre-

(continued)

sented as a string; the associated value is a set of all the documents that contain the word. Instance variable `noiseWords` contains a set of noise words, which reduce the size of the database. A word will not be entered in the words dictionary if it is included in the set of noise words.

The message `addDocument:` adds a document to the database by scanning the document as an instance of class `FileStream`. The message `nextWord` is sent repeatedly to the file stream to extract the next word as a string. Each word is entered into the words dictionary with the associated document included in the set of documents for the word.

The `locateDocuments:` message performs database queries with a collection of words as an argument. Each word is looked up in the words dictionary. The query returns a sorted collection of all documents appearing with all words.

The complete implementation of class `WordIndex` contains the following eight methods.

The method `initialize` initializes an instance of `WordIndex` by assigning empty sets to instance variables `documents` and `noiseWords` and an empty dictionary to instance variable `words`.

`initialize`

```
"Initialize the instance variables
of the WordIndex"
```

```
documents := Set new.
words := Dictionary new.
noiseWords := Set new
```

(Note: The symbol `:=` replaces the `←`, the conventional Smalltalk-80 notation.)

The `addDocument:` `aDocument` method adds the words in `aDocument` to the receiver word index. The method first tests if `aDocument`, the file pathname of the document, is already in the set of documents. If so, `removeDocument:` deletes the old version of the document. `Directory Disk` then opens the file, and a file stream on the file is assigned to temporary variable `wordStream`. The document name is added to the set of documents (instance variable `documents`). The while loop does the major work of the method. The next word, obtained as a string from the file stream, is converted to lowercase and added to the dictionary with the message `addWord:for:`.

`addDocument:` `aDocument`

```
"Add all words in aDocument to word Dictionary"
| aWord wordStream |
(documents includes: aDocument)
ifTrue: [self removeDocument: aDocument].
wordStream := Disk file: aDocument.
documents add: aDocument.
[[aWord := wordStream nextWord] == nil]
```

```
whileFalse: [
self addWord: aWord asLowerCase for: aDocument].
wordStream close
```

The `addWord: aWord for: aDocument` method records `aWord` if it appears in `aDocument` unless `aWord` is a noise word. If the word is not in the dictionary, the word and an empty set are entered. Finally, `aDocument` is added to the set of documents for the word. Note that we are able to deal simply with exceptional conditions by supplying a block of code in the `at:ifAbsent:` message.

`addWord:` `aWord for:` `aDocument`

```
"Add aWord to aDocument if it is
not a noise word"
(noiseWords includes: aWord) ifTrue: [~nil].
(words at: aWord ifAbsent: [words at: aWord put: (Set new)])
add: aDocument]
```

The `locateDocuments: aWordList` method queries the database. Given a collection of words in `aWordList`, it returns a sorted collection of all the documents that contain all the words. Note that `aWordList` can be any kind of collection, e.g., `Array`, `Bag`, `LinkedList`. The `select:` message described earlier under `Sets` continually removes documents that do not contain all words in `aWordList` from a temporary variable, `answer`, which starts as the set of all documents.

`locateDocuments:` `aWordList`

```
"Answer a SortedCollection of all documents
containing all words in aWordList"
| answer |
answer := documents. "start with all documents"
aWordList do: [:aWord | "iterate over words"
answer := answer select: [:aDoc |
(words at: aWord asLowerCase ifAbsent: [#()])
includes: aDoc]].
^answer asSortedCollection
```

The string `addNoiseWord: aWord` method adds `aWord` to the set of noise words.

`addNoiseWord:` `aWord`

```
"Add aWord string to noise words"
noiseWords add: aWord
```

The `removeNoiseWord: aWord` method removes `aWord` from the set of noise words. If `aWord` is not a noise word, nothing happens.

`removeNoiseWord:` `aWord`

```
"Remove aWord string from noise words"
noiseWords remove: aWord ifAbsent: []
```

The `removeDocument: aDocument` method scans the words dictionary to remove from every set all occurrences of `aDocument`. (Note that a set can have only a single occurrence of a document. This code also works for bags,

which can have multiple occurrences.) Finally, the message removeUnusedWords is sent to the word index to remove dictionary words with empty document sets.

```
removeDocument: aDocument
  "Remove aDocument from all words that contain it.
  If a word has no documents, remove it"
  words do: [:docs] "docs is Set or
  Bag of documents"
  (docs occurrencesOf: aDocument)
  timesRepeat: [ docs remove: aDocument]].
  self removeUnusedWords
```

The removeUnusedWords method replaces the words dictionary with a new dictionary containing only those entries in words that have nonempty document sets.

```
removeUnusedWords
  "Remove all words that have empty document collection"
  | newWords |
  newWords := Dictionary new.
  words associationsDo: [:anAssoc |
  anAssoc value isEmpty
  ifFalse: [newWords add: anAssoc]].
  words := newWords
```

For an example of class WordIndex, we have treated the sections of this paper (the article itself, the table, the text box, and the list of references) as separate documents. First we make the index:

```
ArticleIndex := WordIndex new initialize.
```

Then we add the figures to it:

```
#:('article' 'table' 'textbox' 'reflist')
  do: [:section | ArticleIndex addDocument: section]
```

The query

```
ArticleIndex locateDocuments: # ('Smalltalk' 'argument')
returns the list
```

article textbox

Smalltalk is powerful, simple, and fun. Because object-oriented programming may be new to you, it may not seem simple at first. We hope this article helps to show that it is. Now that Smalltalk is available for popular microcomputers, a lot more of us can experience the fun. ■

REFERENCES

1. Masterson, Fred A. "Languages for Students." BYTE, June 1984, page 233.
2. Martin, James. *Application Development Without Programmers*. Englewood Cliffs, NJ: Prentice-Hall, 1982.
3. BYTE, August 1981.
4. Goldberg, Adele, and David Robson. *Smalltalk-80: The Language and Its Implementation*. Reading, MA: Addison-Wesley, 1983.
5. Wegner, Peter. "Perspectives on Capital-Intensive Software Technology." IEEE Software, July 1984.



Our complete line says it all: Touchdown™ Keytop Expanders fit over existing keys on IBM PC and most PC lookalikes. Adhesive provided insures easy removal without damage to keyboard. Touchdown™ Key Overlays re-assign, clarify or blank-out PC keyboard commands; durable, non-glare surface looks and feels like original keytops.

P. O. Box 201, Dept. B, Cornville, AZ 86325

DEALER INQUIRIES INVITED—Add these unique items to your software line and reap immediate profits. Write us today or phone 602-634-7517 for complete details.

KEYTOP EXPANDERS		Qty.	Price*
IBM PC, PC/XT, PC Port (12 keys)	\$21.95	Compaq, Columbia (10 keys)	\$21.95
IBM 5291 Display Station (13 keys)	21.95	Corona, Eagle Spirit, Quibie, Keytronic (10 keys)	21.95

KEY OVERLAYS		Qty.	Price*
5250/5251 (48 keytops/Irons)	\$21.95	Do-it-yourself Kit (200+ pieces)	\$29.95
5520 (101 keytops)	29.95	MultiMate (44 keytops)	29.95
DisplayWrite 2 (40 keytops)	21.95	VisiCalc	24.95
Dvorak (43 keytops)	26.95	EasyWriter II (29 ktyp/Irons/Handy Card)	29.95
Wordstar (29 keytops)	26.95	Lotus 1-2-3 (24 keytops/Handy Card)	29.95
Control Key English (5 keytops)	6.95	WordPerfect (32 keytops/Handy Card)	29.95
Blank Overlays (99 keytops)	21.95	Volkswriter (18 keytops/Handy Card)	29.95
		AppleWriter II	

Visa MasterCard Exp. Date _____

Card # _____

Visa or MC orders phone 602-634-7517

Company Name _____ Custom Overlay, Other Software Kits. Write for information.

Attention _____

Address _____

City _____ State _____ Zip _____

*All prices include postage TOTAL \$ _____
Arizona residents add 5% tax
TOTAL ENCLOSED \$ _____

ONLY SERVICE AT A FRIENDLY PRICE

Friendly Computer Center, Inc.

1381 Coney Island Avenue, Brooklyn, New York 11230

<p>C.I.TOH PROWRITER w/I.B.M. ROM</p> <p>7500 105 C.P.S. 219.00 8510 120 C.P.S. 289.00 1550 120 C.P.S. - 15" 449.00 8600 180 C.P.S. 569.00</p> <p>STARWRITER</p> <p>F-10-40P 849.00 A-10-20 479.00</p>	<p>PRINTERS SPECIAL!</p> <p>OKIDATA</p> <p>Microline 84-200 C.P.S. 669.00 Microline 82-120 C.P.S. 225.00 Microline 92 359.00 Microline 92 w/Mac Compatible 459.00 Microline 93 589.00</p> <p>TOSHIBA</p> <p>New Toshiba-1340 699.00 Toshiba-1351 1249.00</p> <p>Juki</p> <p>Juki-6100 379.00 Juki-6300 call Juki Tractor 6100 109.00</p>	<p>Compare our Service and Price. Any product not listed? If you don't see it in our ad, call us. 1-800-258-5805</p> <p>This Month's Special Kensington Masterpiece \$99.00</p> <p>DISK DRIVES-FOR IBM</p> <p>Teac 1/2 ht. DS/DD 149 Rana 2000 IBM 149</p> <p>ADD ON BOARDS FOR IBM</p> <p>AST Six Pack Plus 64K 249.00 Quadram Expanded Quadboard w/64K 259.00 Hercules Graphics Board 319.00 Hercules Color Card w/Parallel Port 179.00 Koala Speed Key System 149.00 Mouse Systems Mouse w/Mouse w/P.C. Paint and Menu 159.00 Hayden Saragon III Chess 34.90 Microsoft Flight Simulator II 37.90 Hayden Saragon III for Mac 39.90 De Base III 349.00 Framework 379.00 SYMPHONY CALL Star Accounting Partner 2 749.00 Wordstar 2000 249.00</p>	<p>Peripherals by Apple</p> <p>Apple Drive IIc \$289 Apple IIc Mouse with paint \$89 Apple IIe Mouse with paint \$139 Apple 1200/300 Baud Modem \$389 APPLEWORKS for IIc or IIc \$219</p> <p>Apple IIe Professional System</p> <ul style="list-style-type: none"> • Apple IIe 128K Computer. • Apple Dual Disk Drive w/controller/card. • Apple Extended 80 column Display Card. • Apple Monitor II - 12" tilt/green • Pro-Dos Operating System <p style="text-align: right;">Special \$1439</p> <p>Apple IIc with Monitor and Stand Mac - IIc Special \$975.00 Macintosh 512K with Imagewriter Special \$2649</p>
<p>MODEMS</p> <p>Hayes 1200B IBM 379.00 Hayes 1200 RS232 459.00 Hayes 300 RS232 195.00 Micromodem IIe 235.00 HAYES 300 - for IIc 239.00 New Hayes 2400 CALL</p>	<p>PRENTICE POPCOM</p> <p>1200 External 349.00 120 Internal 329.00</p> <p>Compuserve Starter Kit 28.95 The Source Starter Kit CALL Grappler Bufferd Plus 16K w/cable 149.00</p>	<p>MONITORS</p> <p>Princeton HK-12 Graphics 459.00 New Amdek Color 300 299.00 Amdek 310A 175.00</p>	<p>TAXAN</p> <p>T115 12" Green 119.00 T116 12" Amber 129.00 T127 12" Green I.B.M. 149.00 T122 12" Amber I.B.M. 159.00 210 R.G.B. Color 259.00</p>

HIGH QUALITY SET OF 64K (8 chips) only \$29.90 Min. 6 sets

LETTER QUALITY PRINTERS

ONE TIME SPECIAL! LIMITED QUANTITY
C.I.TOH - Leading Edge 25 cps
15" Daisy Wheel \$449 1 YEAR WARRANTY
C. ITOH Tractor 129.00

FOR MAIL ORDERS: Send Money Order, Certified Check, Mastercard, VISA gladly accepted. Add estimated price for shipping, handling and insurance. WE WILL SHIP ORDERS AT THE ADVERTISED PRICES GUARANTEED UNTIL APRIL 30 '85. Apple is a registered trademark of Apple Computer, Inc. IBM is a registered trademark of International Business Machines.

TO ORDER CALL TOLL FREE **(800) 258-5805** FOR INFORMATION CALL **(718) 252-9737**

Friendly Computer Center, Inc.

1381 Coney Island Avenue, Brooklyn, New York 11230

CONROY

TELEX 910 380 3980

ALL MAIL: 12060 SW Garden Place, Portland, OR 97223

FOR YOUR APPLE

COMPUTERS

SYSTEMS	IN STOCK	CALL
FLOPPY DISK DRIVES		
MICRO-SCI, A2 Disk Drive, 143K	\$ 345	\$ 195
A2 Controller Card	\$ 100	\$ 60
Half Height Drive for IIC	\$ 269	\$ 195
Half Height Drive for IIc	\$ 299	\$ 209
RANA, Elite I, 163K, 40 Track	\$ 299	\$ 199
Elite II, 326K, 40 Track	\$ 499	\$ 359
Elite Controller	\$ 145	\$ 79
TEAC, T40 Half H. Drive, 163K, Direct	\$ 249	\$ 169
Controller Card for T40 by ComX	\$ 79	\$ 45
T80 Half H Drive, 326K, Double	\$ 399	\$ 299
Controller Card for T80 by Teac	\$ 85	\$ 59

HARD DISKS

QUARK, QC10 for IIc/IIe/IIIMAC	\$1985	\$1595
--------------------------------	--------	--------

OTHER HARDWARE

CCS, 771i or 7710-A Interface, ea.	\$ 115	\$ 85
CPASIDE, 3.5" Disk Copier, II+ IIe	\$ 440	\$ 99
COMX, 80 Col., 64K RAM Card (II+)	\$ 199	\$ 99
16K RAM Card (II+), 1 yr ltd wty	\$ 19	\$ 29
HAYES, Mach III/II Joystick (II+ IIe)	CALL	
KENSINGTON, System Saver Fan	\$ 90	\$ 65
KEY TRONIC, KB2000 Keyboard	\$ 298	\$ 188
KOALA, Muppet Keys	\$ 80	\$ 49
Touch Tablet w/Micro Illustrator (IIe/IIc)	\$ 125	\$ 75
KRAFT, Joystick (III+ IIe)	\$ 65	\$ 49
Game Paddles (II+ IIe)	\$ 50	\$ 39
MICROSOFT, Z80 Premium Softcard (IIe)	\$ 395	\$ 275
ORANGE MICRO, Grappler Plus (II+ IIe)	\$ 149	\$ 99
Serial Grappler	\$ 119	\$ 79
16K Buffer Board for Grappler Plus	\$ 99	\$ 59
Buffered Grappler Plus, 16K	\$ 239	\$ 159
PCPI, Applicard, 6 MHz, 14 features	\$ 375	\$ 250
RH ELECT., Super Fan II w/surge protector	\$ 89	\$ 59
TITAN, Accelerator IIe	\$ 319	\$ 219
128K RAM Card (II+)	\$ 269	\$ 189
TRACKHOUSE, Numeric Key Pad (II+ IIe)	\$ 149	\$ 94
TG, Select-a-Port	\$ 40	\$ 26
Joystick or Game Paddles, each	\$ 35	\$ 22
VIDEX, UltraTerm (II+ IIe)	\$ 379	\$ 229
VideoTerm 80 Col. Card (II+ IIe)	\$ 279	\$ 175
PSIO Interface Card	\$ 229	\$ 145
WICO, Smartcard (spec. III+ IIe)	\$ 199	\$ 159



MAGINTOSH

LIST	CONROY	
ASSIMILATION PROC. Turbo Touch	\$ 129	\$ 99
Mac to Epson Connection	\$ 89	\$ 69
BLUECHIP, Millionaire, Barron, Tycoon, ea.	\$ 50	\$ 39
CENTRAL POINT, Copy II Mac or MacTools, ea.	\$ 40	\$ 24
CONROY-LA POINTE, Diskettes, 10 pak	\$ 65	\$ 29
50 pak Diskettes	\$ 325	\$ 140
CONTINENTAL, Home Accountant	\$ 100	\$ 65
CREATIVE SOLUTIONS, MacForth Level I	\$ 149	\$ 99
CREIGHTON, Home Pak or Mac Office, ea.	\$ 39	\$ 25
Mac Spell+	\$ 99	\$ 65
DESKTOP, 1st Base	\$ 195	\$ 125
DOW JONES, Market Manager Plus	\$ 249	\$ 159
EXPERTLLIGENCE, ExperLogo	\$ 150	\$ 80
FIRST BYTE, Smooth Talker	\$ 150	\$ 95
FORETHOUGHT, Fact Finder	\$ 150	\$ 95
HAYDEN, Sargon III	\$ 50	\$ 31
HUMAN EDGE, Sales or Mgmt Edge, ea.	\$ 250	\$ 159
INFOCOM, Hitchhiker's Guide	\$ 40	\$ 25
INNOVATIVE, Flip-n-File, 40	\$ 30	\$ 19
KENSINGTON, Disk Case, 36	\$ 30	\$ 22
KOALA, Mac Vision	\$ 400	\$ 229
LIVING VIDEOTEK, Think Tank	\$ 145	\$ 85
LOVUS, Jazz	\$ 595	\$ 395
MAIN STREET, Filer or Writer, each	\$ 199	\$ 125
MEGAHAUS, Megafil	\$ 125	\$ 75
Megaworks or Megawriter	\$ 125	\$ 75
MICROSOFT, Business Pak NEW	\$ 595	\$ 395
Multiplan, Word, or File, each	\$ 195	\$ 129
MILES, Mac the Knife, v. 1	\$ 39	\$ 25
MONOGRAM, Dollars & Sense	\$ 150	\$ 95
NOVATION, Smartcat Plus Modem w/Software	\$ 499	\$ 349
OVESTA, Helix	\$ 395	\$ 265
PENQUIN, Graphics Magician	\$ 295	\$ 185
PROVUE, Overvue	\$ 295	\$ 185
SIMON & SCHUSTER, Typing Tutor III	\$ 50	\$ 30
SOFTV. PUBL., PFS: File or Report, ea.	\$ 125	\$ 79
PFS: File or Write, each	\$ 195	\$ 125
PFS: Graph or Report, each	\$ 125	\$ 79
STONEWARE, DB Master, v. 4	\$ 350	\$ 225
DB Utility Pak I or II, each	\$ 129	\$ 82
SOFTWARE PUBL. (specify II+ or IIe for all)	\$ 125	\$ 79
PFS: File or Write, each	\$ 125	\$ 79
PFS: Graph or Report, each	\$ 125	\$ 79
STONEWARE, DB Master, v. 4	\$ 350	\$ 225
DB Utility Pak I or II, each	\$ 129	\$ 82
UTILITIES SOFTWARE		
BEEGLE, GPLE, Alpha Plot or B.Basic, ea.	\$ 50	\$ 27
Portra DOS, Disk Quik, Ap. Mech. or I.O. Saver, ea.	\$ 30	\$ 30
Full line IN STOCK	CALL	
BORLAND, Turbo Pascal	\$ 55	\$ 33
3 Pak (Pasc, Turbo Tut, Toolbox) NEW	\$ 105	\$ 59
CENTRAL POINT Copy II Plus (bit copier)	\$ 40	\$ 23
Filer, Utility & Apple DOS 3.3	\$ 20	\$ 15

BUSINESS SOFTWARE

LIST	CONROY	
ALS, Word or List Handler, ea.	\$ 80	\$ 36
Handler Pak (Word/List/Spell)	\$ 170	\$ 73
APPLIED SOFT TECH., VersaFarm	\$ 289	\$ 179
ASHTON-TATE, dBASE II (Reg CPM 80)	\$ 495	\$ 269
BPI, Job Cost	\$ 595	\$ 365
AR, AP, PR or INV, each	\$ 395	\$ 240
BRODERBUND, Print Shop	\$ 50	\$ 29
Print Shop Graphics Library	\$ 25	\$ 18
Bank St. Writer or Speller, ea (specify II+ IIe/IIc)	\$ 70	\$ 45
Bank St. Combo (Writer & Speller)	\$ 140	\$ 85
CONTINENTAL, GL, AR, AP or PR, ea.	\$ 250	\$ 150
CDEX, for Visicalc, Multiplan, Apple IIe, ea.	\$ 60	\$ 40
DOW JONES, Market Manager Plus	\$ 249	\$ 159
Market Analyzer or Microscope, ea.	\$ 349	\$ 219
HAYDEN, Pie Writer (v2.2)	\$ 150	\$ 100
HOWARD SOFT, Tax Preparer for 84 taxes	\$ 250	\$ 165
Kit for California	\$ 95	\$ 63
HUMAN EDGE, Sales or Mgmt Edge, ea.	\$ 250	\$ 165
LIVING VIDEOTEK, Think Tank	\$ 145	\$ 89
MECA, Managing Your Money	\$ 200	\$ 125
MEGAHAUS, Megawriter	\$ 100	\$ 65
Megaworks	\$ 125	\$ 75
MICRO PRO, WordStar	\$ 350	\$ 189
WordStar w/ Starcard	\$ 495	\$ 265
WordStar Professional, 4 Pak	\$ 495	\$ 265
MailMerge, SpellStar, or Starindex, ea.	\$ 99	\$ 54
InfoStar and StarCard Combo	\$ 595	\$ 295
Multi-Plan (AP DOS)	\$ 95	\$ 62
QUARK, Word Juggler & Lextcheck (IIe/IIc)	\$ 189	\$ 129
SENSIBLE, Sensible Speller	\$ 125	\$ 79
SIERRA/ON-LINE, Homework	\$ 50	\$ 45
General Manager II	\$ 230	\$ 155
Screen Writer II, 2 Pak w/Dictionary	\$ 130	\$ 89
SOFTWARE PUBL. (specify II+ or IIe for all)		
PFS: File or Write, each	\$ 125	\$ 79
PFS: Graph or Report, each	\$ 125	\$ 79
STONEWARE, DB Master, v. 4	\$ 350	\$ 225
DB Utility Pak I or II, each	\$ 129	\$ 82

UTILITIES SOFTWARE

LIST	CONROY	PRICE	PRICE
EINSTEIN/ALISON, Compiler	\$ 129	\$ 95	\$ 77
ESON, Graphics Dump	\$ 15	\$ 7	\$ 60
FUNK, Sideways	\$ 60	\$ 40	\$ 99
HAYES, Terminal Pro, for Smartmodem	\$ 99	\$ 65	CALL
MICROSOFT, Full Line IN STOCK	\$ 100	\$ 70	\$ 80
OMEGA, Locksmith	\$ 100	\$ 70	\$ 80
PENQUIN, Complete Graphics System II	\$ 80	\$ 49	\$ 60
Graphics Magician	\$ 60	\$ 40	\$ 34
PHOENIX, Zoom Gratix	\$ 60	\$ 40	\$ 29
QUALITY, Bag of Tricks	\$ 60	\$ 40	\$ 130
UNITED SWI, ASCII Express-The Pro	\$ 130	\$ 82	\$ 80
UTILICO, Essential Data Duplicator III	\$ 80	\$ 49	

HOME & EDUCATIONAL

BEEGLE BROS., Full line IN STOCK	CALL	
BRODERBUND, Print Shop	\$ 50	\$ 29
CONTINENTAL, Home Accountant	\$ 75	\$ 43
DOW JONES, Home Budget	\$ 99	\$ 69
KOALA, Full line IN STOCK	CALL	
MICROSOFT, Typing Tutor II	\$ 25	\$ 17
MONOGRAM, Dollars & Sense or S.A.M., ea	\$ 100	\$ 59
Dollars & Sense	\$ 120	\$ 69
SCARBOROUGH, Masterytype	\$ 80	\$ 50
Your Personal Net Worth	\$ 80	\$ 50
SIERRA/ON-LINE, Homework	\$ 50	\$ 45
SIMON & SCHUSTER, Typing Tutor III	\$ 50	\$ 33

PLUS: BARRONS, CBS, DAVIDSON, EDU-WARE, HARCOURT, LEARNING CO., TERRAPIN

RECREATIONAL SOFTWARE

BLUECHIP, Millionaire, Squire, Barron, ea.	\$ 50	\$ 32
DATASOFT, Aztec or Zaxxon, each	\$ 40	\$ 27
ELECTRONIC ARTS, Sky Fox	\$ 40	\$ 29
Pindal or Music Construction, ea.	\$ 40	\$ 29
HAYDEN, Sargon III (Chess)	\$ 50	\$ 30
INFOCOM, Zork I, II, or III, ea	\$ 40	\$ 25
ORIGIN, Ultima II	\$ 60	\$ 37
PENQUIN, Transylvania	\$ 35	\$ 24
PROFESSIONAL, Trivia Fever	\$ 40	\$ 25
SIERRA/ON-LINE, Ultima II	\$ 60	\$ 37
SIR-TECH, Wizardry	\$ 50	\$ 30
SW LOGIC, Flight Simulator II	\$ 50	\$ 30

PLUS: BRODERBUND, DATAMOST, MUSE, SIR-TECH, SPINNAKER

DISKETTES

*** CONROY-LAPOINTE* DISKETTES ***
 We guarantee these top quality products with our name's YEAR-LIMITED WARRANTY. Discounts on orders w/elect. labels.

10 ea. SS/SD, (Apple, etc) 35 Trk, W/FLP BOX	\$ 12	\$ 9
100 ea. SS/SD, (Apple, etc) 35 Trk	\$ 99	\$ 69
1000 ea. SS/SD, (Apple, etc) 35 Trk	\$ 840	\$ 590
10 ea. DS/DD, (IBM, H/P) 48 Trk, W/FLP BOX	\$ 15	\$ 11
100 ea. DS/DD, (IBM, H/P) 48 Trk	\$ 119	\$ 89
1000 ea. DS/DD, (IBM, H/P) 48 Trk	\$ 859	\$ 599
10 ea. DS/DD, 3 1/2" (MAC, H/P), W/FLP BOX	\$ 29	\$ 21
50 ea. DS/DD, 3 1/2" (MAC, H/P)	\$ 140	\$ 100
100 ea. DS/DD, 3 1/2" (MAC, H/P)	\$ 270	\$ 190

* CONROY-LAPOINTE* 48 MB PRE-FORMATTED

10 ea. DS/DD, 48 Trk W/FLP BOX	\$ 19	\$ 14
100 ea. DS/DD, 48 Trk	\$ 149	\$ 109
1000 ea. DS/DD, 48 Trk	\$ 959	\$ 699

SINGLE-SIDED, DOUBLE DENSITY

LIST	CONROY	
CDC, 10 ea. SS/DD, 40 Trk (Apple, etc)	\$ 55	\$ 19
100 ea. SS/DD, 40 Trk (Apple, etc)	\$ 550	\$ 195
DYSAN, 10 ea. SS/DD, (Apple, etc.)	\$ 40	\$ 27
MAXELL, 10 ea. SS/DD, MD1 (Apple)	\$ 55	\$ 19
VERBATIM, 10 ea. SS/DD, MD515-01 (Apple)	\$ 49	\$ 25

DOUBLE-SIDED, DOUBLE DENSITY

CDC, 10 ea. DS/DD, 40 Trk (IBM, H/P)	\$ 75	\$ 23
100 ea. DS/DD, 40 Trk (IBM, H/P)	\$ 750	\$ 295
DYSAN, 10 ea. DS/DD, (IBM, H/P)	\$ 69	\$ 35
MAXELL, 10 ea. DS/DD, MD2 (IBM)	\$ 75	\$ 35
VERBATIM, 10 ea. DS/DD, MD34 (IBM)	\$ 84	\$ 29

3 1/2" MICRO DISKETTES

CONROY-LAPOINTE, 10 ea. DS/DD (MAC, H/P)	\$ 29	\$ 21
MAXELL, 10 ea. SS/DD (MAC, H/P)	\$ 60	\$ 35
MEMOREX, 10 ea. SS/DD (MAC, H/P)	\$ 60	\$ 35
VERBATIM, 10 ea. SS/DD (MAC, H/P)	\$ 65	\$ 35

HIGH DENSITY DISKETTES FOR IBM-AT

MAXELL, 10 ea. DS/QD (IBM-AT)	\$ 77	\$ 49
MEMOREX, 10 ea. DS/QD (IBM-AT)	\$ 84	\$ 54

* GENERIK DISKETTES *

Top quality, w/labels, no labels. Quantity discounts.		
90 day "No hassle, money back guarantee."		
100 ea. SS/DD, 35 Trk (Apple, etc)	\$ 80	\$ 55
250 ea. SS/DD, 35 Trk (Apple, etc)	\$ 195	\$ 139
100 ea. DS/DD, 48 Trk (IBM, H/P)	\$ 95	\$ 69
250 ea. DS/DD, 48 Trk (IBM, H/P)	\$ 229	\$ 169

MODEMS

LIST	CONROY	
ANCHOR, Signalman Mark XII (IBM)	\$ 399	\$ 259
HAYES, 2400B External Modem (IBM)	\$ 899	\$ 699
Smartmodem 1200B (IBM)	\$ 549	\$ 389
Smartmodem II Software (IBM)	\$ 149	\$ 107
Stack Chronograph (RS-232)	\$ 249	\$ 189
Stack Smartmodem 300 (RS-232)	\$ 289	\$ 219
Smartmodem 1200 (AP or IBM)	\$ 599	\$ 429
MicroModem IIe w/Smartcom (AP)	\$ 329	\$ 239
MicroModem 1200A (AP)	\$ 140	\$ 109
NOVATION, J-Cat, 300 Baud Modem	\$ 399	\$ 289
ACCESS 1-3-3 1200B Modem+Crossstalk (IBM)	\$ 595	\$ 369
Apple Cat II 300 Baud (AP)	\$ 389	\$ 219
212 Apple Cat, 1200 Baud (AP)	\$ 725	\$ 419
SmartCat Plus w/software (MAC)	\$ 499	\$ 349
PROMETHEUS, 1200 Standalone Modem	\$ 495	\$ 345
ProModem 1200 w/software (MAC)	\$ 549	\$ 429
ProModem 1200A (AP)	\$ 449	\$ 349
ProModem 1200B (IBM)	\$ 499	\$ 349
QUADRAM, Quadmodem, Internal (IBM)	\$ 595	\$ 425
Quadmodem, External, (IBM)	\$ 695	\$ 495
VENTEL, PC Half Card (IBM)	\$ 549	\$ 389
1200 Plus, External (IBM)	\$ 499	\$ 429
PC 1200, Internal (IBM)	\$ 499	\$ 379

MONITORS

AMDEK, Color 300 Comp/Audio	\$ 349	\$ 249
Color 500 Comp/VCR/RGB/Audio	\$ 525	\$ 385
Color 500 Hi Res, RGB/Audio	\$ 599	\$ 459
Color 700 Ultra Hi Res, RGB	\$ 799	\$ 599
Color 710 Ultra Hi Res, Phos	\$ 799	\$ 599
300G, 12" Green	\$ 179	\$ 129
300A, 12" Amber	\$ 199	\$ 149
310A, 12" Amber, (IBM)	\$ 230	\$ 159
PRINCETON, HX-12, Hi Res, RGB	\$ 795	\$ 495
SR-12, Hi Res, RGB	\$ 799	\$ 599
Scan Double for SR-12	\$ 399	\$ 289
MAX-12, Amber (monochrome)	\$ 249	\$ 199
QUADRAM, Amberchrome, 12" Amber	\$ 250	\$ 165
Quadchrome		

-LA POINTE INC.

SM

B17

SAVE 25% - 75% OFF LIST !!!

© 1984 by Conroy-LaPointe, Inc. All Rights Reserved

ORDER NOW (800) 547-1289

FOR YOUR IBM-PC, XT, AT or JR

COMPUTER SYSTEMS

— Call for Details —

256K IBM - PC

360K Disk Drives by CDC



90 Day Limited Warranty By Us

COMPAQ Portable, 256K, 2 360K Disk Drives

SANYO 555-2, 256K, 2 320K Disk Drives

ZENITH Z150, 256K, 2 320K Disk Drives, MS DOS 2.1, 8088 Chip, 2 S/P

HARD DISKS & TAPE BACKUP

KAMERMAN, Internal 10 meg kit (Megaflight 100)	\$ 995	\$ 749
External 10 meg kit	\$1292	\$1095
MF-1010, H Disk, tape back, cont, power	\$2295	\$1795
MAYNARD, Internal 10 meg kit w/cont. (WS)	\$1585	\$1150
MICRO SCIENCE, 10 meg w/controller	\$ 895	\$ 695
QUADRAM, Quad disks Int. w/controller	IN STOCK	
RANA, External 10 meg w/controller	\$1495	\$1095
Internal 10 meg w/controller	\$ 995	\$ 795
TALLGRASS, 12 meg disk, 20 meg tape, Int'l.	\$3044	\$2124
25 meg disk, 55 meg tape, Int'l.	\$3680	\$3160

FLOPPY DISK DRIVES

CDC, Limited 30 day warranty; Call for quantity prices

FULL HEIGHT, 5 1/4"	\$149
HALF HEIGHT, 5 1/4"	\$129

IBM, Disk Drive Controller Card	\$ 195	\$ 125
MAYNARD, Controller Card w/para port	\$ 300	\$ 185
Controller Card w/serial port	\$ 310	\$ 195
SandStar Cont Card (accepts 3 modules)	\$ 265	\$ 205
PERFECT DATA, Head Cleaning Kit	\$ 16	\$ 12

OTHER HARDWARE

AST, LIST PRICE	CONROY PRICE
SixPak Plus, 64K	\$259
SixPak Plus, 256K, S/P/CC + S/W	\$ 695 \$ 395
SixPak Plus, 384K, S/P/CC + S/W	\$ 895 \$ 465
Game Port for SixPak	\$ 50 \$ 39
Preview™ Graphics Card w/para, 64K	\$ 399 \$ 299
Advantage™ Multif. Bd. for AT, 128K	\$ 595 \$ 445
I/O Plus II, S/P/CC	\$ 215 \$ 150
I/O Plus II, S/P/CC/G	\$ 265 \$ 185
I/O Plus II, 2S/P/CC/G	\$ 315 \$ 215
Port Kds - ser, para, or game; ea.	\$ 50 \$ 39
MonoGraphPlus™ P/CC (for Lotus)	\$ 495 \$ 375
PCNet, Starter Kit, PC002	\$1090 \$ 790
PCNet, Circuit Board, PC001	\$ 695 \$ 365
MegaPlus Products IN STOCK	CALL
COMX, NEW	
EconoRAM™ Plus, 384K to 1.5 meg. board, S/P/CC/G Fastrak & Spooler	\$265
EconoRAM™, full 384K board	\$ 295 \$ 195
CURTIS, UNI-I Monitor tilt/swivel base	\$ 50 \$ 39
3-9 foot Keyboard Extension Cable	\$ 40 \$ 30
HAUPPAGE (HCW), 8087 Chip	\$ 175 \$ 149
8087 Math Pak (Chip & softw.)	\$ 285 \$ 235
8087 Software Pak	\$ 180 \$ 138
HAYES, Mach II Joystick	\$ 45 \$ 29
Mach III (PC or Jr.)	\$ 55 \$ 35
HERCULES, Color Card w/para. Mono Graphics Card	\$ 499 \$ 329
IBM, Disk Drive Controller Card	\$ 195 \$ 125
KENSINGTON, Masterpiece™ PC Server™ Line Cord w/Filter	\$ 140 \$ 99
KEY TRONIC, KB5151, Std. Keyboard	\$ 255 \$ 195
KB5150, Std. Keyboard	\$ 209 \$ 159
KOALA, Speed Key System	\$ 100 \$ 63
Speed Key Tables w/software	\$ 200 \$ 139
Koala Pad w/PC Design	\$ 150 \$ 89
MAYNARD, SAND STAR SERIES	
Multifunction (B) Card	\$ 89 \$ 79
Memory Card no RAM	\$ 199 \$ 159
Memory Card 256K	\$ 495 \$ 395
Floppy Cont. Card (accepts 3 modules)	\$ 285 \$ 205
Hard Disk I/F Module	\$ 499 \$ 399
Hard Disk Cable	\$ 30 \$ 27
Serial Port Module	\$ 95 \$ 79
Para or Clock Cat. Module, ea.	\$ 59 \$ 49
Game Adapter Module	\$ 49 \$ 43
Memory Module, OK	\$ 122 \$ 99
Memory Module 256K	\$ 422 \$ 357
10 meg. Hard Disk Kit & Cont. Card	\$1585 \$1150

OTHER HARDWARE

LIST PRICE	CONROY PRICE
MICROSOFT, Mouse (for PC) Serial Mouse	\$ 195 \$ 135
System Card, 64K	\$ 395 \$ 275
System Card, 256K	\$ 625 \$ 450
PARADISE, Modular Graphics Card	\$ 395 \$ 285
Parallel or Serial Port, ea.	\$ 95 \$ 65
PERSYST, NEW	
PC/Mono Board, w/para port	\$ 250 \$ 195
PC/Color Graphics Bd w/light pen & I/F	\$ 244 \$ 176
BOB Board Color Adapter, hi res.	\$ 595 \$ 465
PLANTRONICS, Color Bd & Colormagic, 16 color w/para	\$ 559 \$ 395
Color Bd & Draftsman, 16 color w/para	\$ 559 \$ 395
QUADRAM, Quadboard 64K, to 384K, S/P/CC/G	\$245
Quadboard, no RAM, expand to 384K	\$ 295 \$ 225
Quadboard 256K, to 384K, S/P/CC	\$ 395 \$ 295
Quadboard, 384K (full), S/P/CC/G	\$ 795 \$ 495
Quadboard II, no RAM, to 256K	\$ 295 \$ 215
Quadboard II, 64K, to 256K, 2S/CC	\$ 395 \$ 265
Quadboard II, 256K, 2S/CC	\$ 595 \$ 395
Quad 512 + 64K w/serial port	\$ 325 \$ 245
Quad 512 + 256K w/serial port	\$ 550 \$ 399
Quad 512 + 512K w/serial port	\$ 895 \$ 625
Quadcolor I, board, 4 colors	\$ 295 \$ 195
Upgrade Quadcolor I to II kit	\$ 275 \$ 199
Quadcore, board, Mono, S/P/CC	\$ 345 \$ 259
Quadochrome Monitor, 12" RGB Color	\$ 695 \$ 495
Quadchrome II Monitor, 14" RGB Color	\$ 650 \$ 450
Amberchrome Monitor, 12" Amber	\$ 250 \$ 165
Quad 3278	\$1195 \$1050
Quadnet VI	\$2295 \$1545
Quadnet IX	\$1995 \$1745
Quadlink	\$ 495 \$ 385
Quadprint	\$ 645 \$ 495
TC PRODUCTS, Joystick	\$ 45 \$ 29
WICO, Smartboard Keyboard	\$ 400 \$ 279

★ ★ FOR YOUR PC-JR ★ ★

LIST PRICE	CONROY PRICE
KEY TRONIC, KB5151 Jr. Keyboard	\$ 255 \$ 195
KOALA, Touch Tablet for Jr.	\$ 125 \$ 75
MICROSOFT, Booster 128K w/Mouse	\$ 495 \$ 339
Serial Mouse	\$ 195 \$ 135
MOUSE SYSTEMS, Mouse (for Jr.)	\$ 195 \$ 125
QUADRAM, Expansion Chassis	\$ 695 \$ 540
Memory Expansion Board (128K, P/CC)	\$ 275 \$ 155
TECMAR, Jr. Cap/Jan	\$ 395 \$ 325

★ 256K ★ CHIP KIT \$99

9 Each, 4256 chips 150 ns

\$13 ea.

4256 chip, 150 ns

★ 64K ★ CHIP KIT \$19

9 Each, 4164 chips 90 Day Warranty by us

Call for Larger Quantity Prices

★ ComX ★ NEW! EconoRAM Plus™

\$265

384K Multifunction RAM Board expandable to 1.5 Megabyte Works like AST SixPakPlus™ with capacity for up to 1.5 meg. game port. Fastrak™ RAM Disk and Spooler Software.

EconoRAM™ 384K

Single Function Board

\$195

With Fastrak™ and Spooler. Fully Compatible, 1 Year Limited Warranty. Works on DOS 1.1, 2.0 or 2.1 Prices and availability subject to change. Call.



PRICES ARE DROPPING, SO CALL!

SOFTWARE FOR YOUR IBM-PC, XT, AT or JR

BUSINESS

LIST PRICE	CONROY PRICE
ASHTON-TATE, Framework	\$ 695 \$ 349
dBase III	\$ 695 \$ 359
dBase II, (req. PC-DOS & 128K)	\$ 495 \$ 289
Upgrade II & III	\$ 200 \$ 119
ATI, Training Programs - Large Inventory	\$ 75 \$ 50
BPI, Job Cost Accounting or Inventory, ea.	\$ 795 \$ 495
General Acctg. AR, AP, or PR, each	\$ 595 \$ 365
BRODERBUND, Bank St. Writer (PC or Jr.)	\$ 800 \$ 49
CODEX, Training Programs - Large Inventory	\$ 70 \$ 45
CONTINENTAL, Ultrafile (PC)	\$ 195 \$ 115
Tax Advantage (PC or Jr.)	\$ 70 \$ 40
FCM (Filing, Cataloging, Mailing)(PC)	\$ 125 \$ 75
Property Management (PC)	\$ 495 \$ 295
DATA TRANS., Fontrix	NEW \$ 125 \$ 75
DOW JONES, Investment Evaluator	\$ 149 \$ 99
Market Manager Plus	\$ 249 \$ 219
Market Analyzer or Market Microscope	\$ 349 \$ 219
Spread Sheet Link	\$ 249 \$ 159
FOX & GELLER, Quickcode III	\$ 295 \$ 185
Quickcode or dGraph, each	\$ 295 \$ 185
dJuli (DOS or CP/M86)	\$ 95 \$ 59
HARVARD, Total Project Manager	\$ 495 \$ 295
Harvard Project Manager	\$ 395 \$ 225
HAYDEN, Pie Writer	\$ 200 \$ 125
Pie Speller	\$ 50 \$ 30
HOWARDSON, Tax Preparer '85	\$ 295 \$ 195
Kit for California	\$ 125 \$ 83
HUMAN EDGE, Mind Prober (PC or Jr.)	\$ 95 \$ 32
Communications Edge (PC)	\$ 195 \$ 119
Sales Edge	\$ 250 \$ 159
Management Edge	\$ 250 \$ 159
Negotiation Edge	\$ 295 \$ 185
IUS, EasyWriter II System	\$ 350 \$ 250
EasySpeller II	\$ 85 \$ 125
GL, AR, AP, PE or INV, each	\$ 595 \$ 375
KENSINGTON, Easy Link Mail Manager	\$ 95 \$ 59
LIFETREE, Volkwriter Deluxe	\$ 295 \$ 159
LIVING VIDEOTEK, Think Tank	\$ 195 \$ 105
LOTUS, 1-2-3	\$ 495 \$ 309
Symphony	\$ 695 \$ 465

BUSINESS

LIST PRICE	CONROY PRICE
MOBS, KnowledgeMan	\$ 500 \$ 300
MECA, Managing Your Money (PC)	\$ 195 \$ 125
Managing Your Money Cartridge (Jr)	\$ 199 \$ 177
MICROPRO, WordStar (PC)	\$ 350 \$ 189
WordStar (Jr)	\$ 195 \$ 115
WordStar 2000 Plus	\$ 495 \$ 295
WordStar Professional Plus	\$ 695 \$ 325
WordStar Professional, 4 Pak	\$ 495 \$ 265
MailMerge, SpellStar or StarInch, ea.	\$ 99 \$ 54
ProOptions Pak (MM/SS/IS)	\$ 195 \$ 105
WordStar Plus (+Starburst)	\$ 595 \$ 375
Correct Star	\$ 145 \$ 77
MICROIR, RBase Series 4000	\$ 495 \$ 259
Extended Report Writer	\$ 150 \$ 95
RBase Cloud	\$ 195 \$ 125
MICROSOFT, Spell	\$ 50 \$ 32
Multipan (PC or Jr)	\$ 195 \$ 125
Chart or Project, each	\$ 250 \$ 159
Word	\$ 375 \$ 235
MONOGRAM, Dollars & Sense w/Forecast	\$ 180 \$ 99
MULTIMATE, Multimate Var. 4.0	\$ 495 \$ 295
OPEN SYS, GL, AR, AP, PR, INV, or PO, ea.	\$ 695 \$ 420
PEACHTREE, Back to Basics GL	\$ 295 \$ 175
Peach Pak (GL/AR/AP)	\$ 395 \$ 225
Peach Text 5000	\$ 295 \$ 179
QUADRAM, Tax Strategy	\$ 395 \$ 295
Investment Strategy	\$ 395 \$ 295
QUES, Using 1-2-3	\$ 15 \$ 12
1-2-3 for Business	\$ 15 \$ 12
Using Symphony	\$ 20 \$ 15
SAMNA, Word Plus	\$ 295 \$ 185
Word III	\$ 550 \$ 279
SATELLITE, WordPerfect (PC)	\$ 495 \$ 335
WordPerfect (Jr)	\$ 69 \$ 45
SOFTW. ARTS, Visicalc	\$ 170 \$ 109
Spotlight	\$ 150 \$ 95
TK Solver (specify DOS)	\$ 399 \$ 269
SOFTWARE INTL., Open Access	\$ 695 \$ 379

BUSINESS

LIST PRICE	CONROY PRICE
SOFTWARE PUBL. PFS:Report	\$ 125 \$ 79
PFS:File	\$ 140 \$ 89
PFS:Write	\$ 140 \$ 89
PFS:Graph	\$ 140 \$ 89
PFS:Plan	\$ 140 \$ 89
PFS:Proof or PFS:Access, each	\$ 95 \$ 59
SORCIM, SuperCalc III	\$ 395 \$ 245
STONEWARE, Advanced DB Master	\$ 595 \$ 375
THORN EMP, Perfect Pak (Jr) (Writer/Spell/Thesaurus)	\$ 139 \$ 89
VISICORP, Visicalc 4	\$ 250 \$ 159
WARNER, Desk Organizer (PC or Jr)	\$ 195 \$ 125

UTILITIES

LIST PRICE	CONROY PRICE
BORLAND, Sidekick (PC or Jr)	\$ 55 \$ 32
Sidekick (Copicable PC or Jr)	\$ 85 \$ 50
Turbo Pascal (PC or Jr) NEW VERSION	\$ 70 CALL
Toolbox (PC)	\$ 50 \$ 32
3 Pak (Pascal, Turbo Tut, Toolbox)	\$ 105 \$ 65
CENTRAL POINT, Copy II PC NEW VERSION	\$ 40 \$ 23
COMX, Fastrak™, RAM/Disk emulator & printer spooler.	
For any PC/DOS or RAM Card. Menu Driven	\$ 100 \$ 59
DIGITAL RES., CP/M-86™ (PC/XT)	\$ 100 \$ 64
IBM BASIC Cartridge (Jr)	\$ 200 \$ 135
CBASIC Compiler (CP/M-86 or PC/DOS, ea)	\$ 600 \$ 395
Concurrent CP/M-86™ w/windows	\$ 350 \$ 225
PL/1 (PC/DOS)	\$ 750 \$ 495
Speed Prog. Pkg. (CP/M-86)	\$ 200 \$ 135
DR LOGO-86 (CP/M-86)	\$ 150 \$ 99
EPYX, In Stock	
FUNK SOFTWARE, Sideways	\$ 60 \$ 40
IBM BASIC Cartridge (Jr)	\$ 75 \$ 69
HAYES, Smartcom II (Data Comm.)	\$ 149 \$ 99
LIFEBOAT, Lattice C	\$ 500 \$ 295
MICROSOFT, Macro Assembler	\$ 100 \$ 69
BASIC Compiler	\$ 395 \$ 259
Business BASIC Compiler	\$ 450 \$ 300
C Compiler	\$ 500 \$ 259
C/C++ Compiler	\$ 700 \$ 459
FORTRAN Compiler	\$ 350 \$ 225
PASCAL Compiler	\$ 300 \$ 199

HOME & EDUCATIONAL

ARMONK Executive Suite	\$ 40 \$ 27
BPI, Personal Accounting	\$ 99 \$ 63
CONTINENTAL, Home Accountant (Jr)	\$ 75 \$ 59
Home Accountant Plus (PC)	\$ 150 \$ 90
DOW JONES, Home Budget	\$ 139 \$ 92
KOALA, Graphics Exhibitor (Jr)	\$ 180 \$ 110
MONOGRAM, Dollars & Sense w/forecast	\$ 40 \$ 25
SCARBOROUGH, MasterType (PC or Jr)	\$ 40 \$ 25
Your Personal Net Worth	\$ 100 \$ 63
SIMON & SCHUSTER, Typing Tutor III	\$ 50 \$ 33

PLUS: BPI, CBS, COMPREHENSIVE, DAVIDSON, HARDCOURT, PBL CORP.

RECREATIONAL

BLUECHIP, Millionaire, Barron, Tycoon, ea.	\$ 60 \$ 39
BRODERBUND, Large Inventory In Stock	CALL
ELECTRONIC ARTS, Large Inventory In Stock	CALL
HAYDEN, Sargon III (Chess)	\$ 50 \$ 34
INFOCOM, Large Inventory In Stock	CALL
Hitchhiker's Guide	\$ 40 \$ 25
Zork I, II, or III, ea.	\$ 40 \$ 25
MICROSOFT, Flight Simulator (PC or Jr)	\$ 50 \$ 33
ORIGIN, Ultima III (PC or Jr)	\$ 60 \$ 39
PROFESSIONAL, Trivia Fever (PC or Jr)	\$ 40 \$ 25
SIERRA/ON-LINE, Ultima II (PC or Jr.)	\$ 60 \$ 49
Frogger	\$ 35 \$ 23
SPECTRUM HOLOBYTE, Gato	\$ 40 \$ 25
SPINNAKER, President's Choice, Amazon	
Fahrenheit, Rendezvous, Oregon, each	\$ 40 \$ 25

CASH-N-CARRY COMPUTER STORES, INC.

Retail Sales only. Store prices may vary.
SAN FRANCISCO 550 Washington Street (at Montgomery, opposite the Pyramid), Interstate 80, to Highway 480; take Washington Street Exit. CALL (415) 982-6212.
PORTLAND, OREGON - At Park 217, Tigar at intersection of Highways 217 and 99W. CALL (503) 620-5595.
SEATTLE, WASH. - 3540 128th Ave. SE, Bellevue 98006. In Loehmann's Plaza near Factoria Square. SE of Highway 405 & 90 and at SE 36th and Richards. CALL 641-4736.

OUR REFERENCES:

We have been in computers and electronics since 1958, a computer dealer since 1978 and in computer mail order since 1980. Banks: 1st Interstate Bank, (503) 643-4678. We belong to the Chamber of Commerce (503) 228-9411, and Direct Marketing Association, or call Dunn and Bradstreet if you are a subscriber. Recipient of OREGON BUSINESS MAGAZINE'S 1984 Enterprise Award.



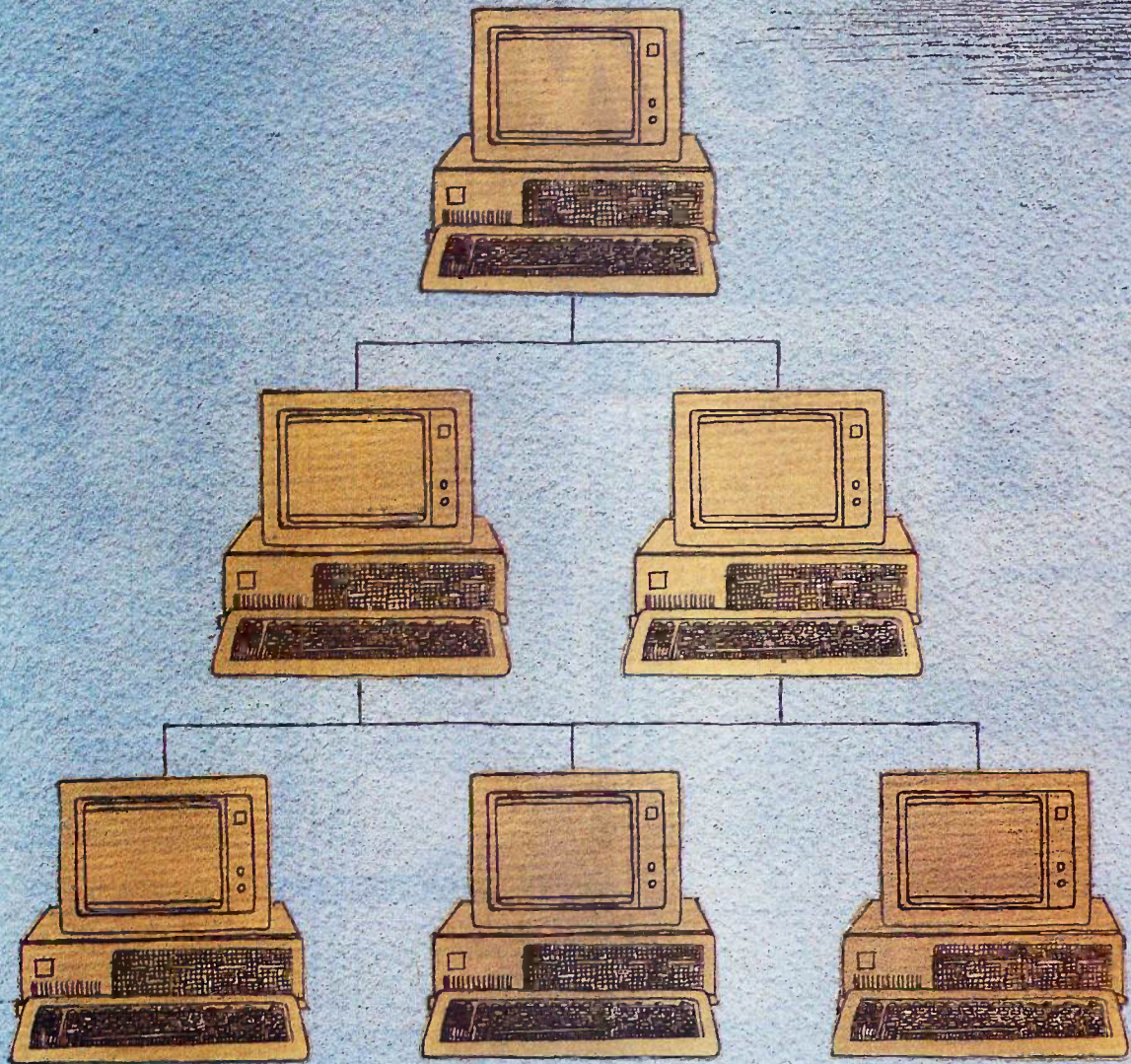

Multiprocessing

MULTIPROCESSING: AN OVERVIEW by Rich Krajewski	171
EXTENDING MICROPROCESSOR ARCHITECTURES by Gary D. Beals	185
APPLYING DATA FLOW IN THE REAL WORLD by William Gerhard Paseman	201
THE TRANSPUTER by Paul Walker	219
DATA-MOVEMENT PRIMITIVES by J. Eric Roskos and Ching-Dong Hsieh ..	239

"The machine can be brought into play so as to give several results at the same time, which will greatly abridge the whole amount of processes."—General Menabrea, 1842

THESE WORDS BY NINETEENTH-CENTURY military engineer Luigi F. Menabrea concerning Charles Babbage's Analytical Engine may well have constituted the first recorded proposal of automated multiprocessing in history. Multiprocessing, the processing of more than one computer instruction or item of data at once, is the underpinning of much of the new development in computers. Without the ability to process several tasks at once, the usefulness of computers cannot grow for long. Most of the big, glamorous advances in computing, such as artificial intelligence, speech recognition, and image processing, will depend on the speed granted by multiprocessing.

In this issue, we examine some of the concepts of multiprocessing, beginning with my article, "Multiprocessing: An Overview." We also examine some ideas that, strictly speaking, aren't part of multiprocessing but are thought to be by the public—for example, coprocessors. Coprocessors are specialized processors that perform certain tasks for the master microprocessor, such as floating-point operations or string comparisons. The master processor will wait for the result rather than continue to operate, so the arrangement is not strictly within our definition of multiprocessing. Gary Beals explores coprocessors in "Extending Microprocessor Architectures" to nail down the difference between multiprocessors and coprocessors.

William Paseman's article, "Applying Data Flow in the Real World," is a look at one kind of true multiprocessor, the data-flow parallel processor. This is the area where much of the money is riding in the race to increase computer speed.

The best architecture for parallel processors is still being sought, but a convenient means to achieving that architecture may be the Transputer, a microprocessor that was designed for parallel processing. Paul Walker gives a closer look at this device than we have had before in these pages.

Finally, "Data-Movement Primitives" by J. Eric Roskos and Ching-Dong Hsieh demonstrates a method of sharing data on a \$450 three-processor system. This is a system that we hope will inspire some of our readers to experiment in this important area.

I wish we could have published more articles about multiprocessing in this issue, but unfortunately we ran out of space. However, we plan to do more about multiprocessing in the future. Let us know what you'd like to see.

—Rich Krajewski, Technical Editor

Golden Common LISP

Gold Hill Computers brings the language of Artificial Intelligence to Your Personal Computer.

Why every Computer Professional should know COMMON LISP.

You know how frustrating it is to deal with programs that are stupid and inflexible like those buried inside automated bank teller machines and airline reservation systems. You also know how frustrating it is to engineer solutions to today's information-processing problems with languages designed mainly for number crunching. *It doesn't have to be this way.*

Programs based on the ideas of Artificial Intelligence and implemented in COMMON LISP can be intelligent, flexible, and human-like. When you use COMMON LISP in combination with artificial intelligence techniques, you will be able to *solve problems you could never solve before*. You will be able to write powerful programs that can accommodate naive computer users who want intelligible answers to questions quickly.

The best way to get started is to buy GOLDEN COMMON LISP™, the first COMMON LISP for personal computers.

GOLDEN COMMON LISP: The AI Tutor

GOLDEN COMMON LISP makes it easy for you to learn to use COMMON LISP, on your personal computer, by yourself, at your own pace. The San Marco LISP Explorer™, a 1000-frame interactive software slide show developed by Patrick H. Winston and San Marco Associates, takes you through COMMON LISP and exciting *artificial intelligence applications* like expert systems, intelligent data-access systems, and natural language interfaces.

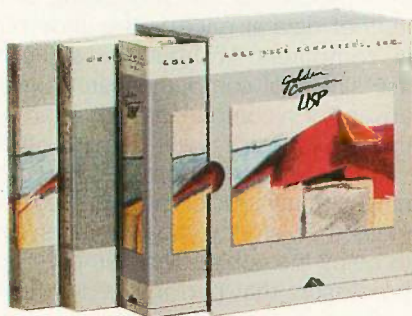

GOLDEN COMMON LISP: The Complete LISP Environment

The GOLDEN COMMON LISP package includes:

- the GCLISP interpreter
- the GMACS editor
- the San Marco LISP Explorer
- the On-line Help system
- *LISP*, 2nd edition by Winston and Horn
- the *COMMON LISP Reference Manual* by Steele
- the GOLDEN COMMON LISP User's Manual

GOLDEN COMMON LISP: The Powertool for Personal Computing

GOLDEN COMMON LISP is an extensive subset of COMMON LISP, supporting more than 400 *LISP primitives*. Advanced features of GOLDEN COMMON LISP include co-routines for multi-tasking, macros for code clarity, streams for I/O, closures for object-centered programming, and multiple-value-returning functions for efficiency.

GOLDEN COMMON LISP requires an IBM, PC XT, PC AT, or 100% IBM PC compatible computer with 512K bytes of memory and PC-DOS 2.0 or higher. More memory is recommended for applications development.

ORDER GCLISP TODAY using the coupon below. Or call our Sales Department at:

617-492-2071

Gold Hill Computers		BI-85	
163 Harvard Street Cambridge, MA 02139			
Name _____			
Title _____			
Department _____			
Organization _____			
Address _____			
Phone _____		Today's Date _____	
Type of computer _____			
<input type="checkbox"/> Enclosed is a check to Gold Hill Computers for GCLISP.			
<input type="checkbox"/> Please bill my <input type="checkbox"/> MasterCard <input type="checkbox"/> VISA card.			
Card # _____		Expiration Date _____	
Signature _____			
Quantity	Description	Unit Price	Total Price
	GOLDEN COMMON LISP	\$495	
Subtotal			
MA residents add 5% Sales Tax			
Total Amount			
We welcome inquiries about volume discounts, dealer discounts, and educational discounts for university-affiliated purchasers.			
<input type="checkbox"/> Please send me more information.			

G O L D H I L L C O M P U T E R S

163 Harvard Street, Cambridge, Massachusetts 02139

Inquiry 177

GOLDEN COMMON LISP and GCLISP are trademarks of Gold Hill Computers. The San Marco LISP Explorer is a trademark of San Marco Associates. LISP is copyrighted by Addison-Wesley Publishing Company, Inc. The *COMMON LISP Reference Manual* is copyrighted by Digital Equipment Corporation. IBM PC, PC XT, PC AT, and PC-DOS are trademarks of International Business Machines.

MULTIPROCESSING: AN OVERVIEW

BY RICH KRAJEWSKI

*A brief look at the latest quest
for computer speed*

MICROPROCESSORS HAVE MADE the development of multiprocessing possible by providing cheap, compact processing power. When electronic computers were first developed, single-processor architecture was inevitable because of the enormous cost and unreliability of the processing unit. Even into the 1960s and early 1970s, computers were too costly to easily combine on any massive scale. Now multiprocessors containing several thousand processing units are not unheard of.

Multiprocessing is a frustrating word because it can mean several things. To one person it may mean two independent Z80 computers sharing only the same hard disk; to another, it may mean two million 68000s sharing everything from resources to the same program. This causes confusion, especially when inventors and manufacturers use the same term to describe wildly different machines. To compound the misunderstanding, many of the celebrated benefits of multiprocessing are misstated, or at least not well explained. A manufacturer might tell you that multiprocessor *x* has one-tenth the power of a Cray-1 for one-hundredth the price,

which is exciting, until you realize that the measurement applies only to a limited class of programs. In fact, with programs that can't readily be written as parallel processes, multiprocessor *x* may perform worse than your average desktop computer.

To remove some of the confusion, I'll try to define multiprocessing and classify its different forms. I'll save the discussion of actual multiprocessor computers for another time, when we can devote an entire article or review to them.

WHAT IS MULTIPROCESSING?

Multiprocessing can be broadly defined as the use of several microprocessors to perform a single task or several tasks, usually at the same time. The typical desktop computer fits into this definition if you call its CRT (cathode-ray tube) controller, disk controller, and peripheral interface all specialized processors. These specialized processors make your computer run faster by freeing the microprocessor from housekeeping chores and giving it more time to work on your program.

On the more obvious and less debatable side, a computer with a

million microprocessors all working on the same problem is also a multiprocessor. It's plain to see that, since such a wide range of machines fall under the category of multiprocessing, we need some method of subdividing the category.

WHAT IT IS NOT

Before we go into the classes of multiprocessing, we ought to decide what it is not. A few folks have the idea that all multitasking and multiuser systems are multiprocessing systems. But as I see it, the emphasis in a multiprocessing system is on the number of processors rather than on the number of processes or users. Besides, high numbers of processes would choke a single microprocessor, so we won't consider single-processor multiuser or multitasking systems.

CLASSIFYING MULTIPROCESSORS

There are almost too many ways to classify multiprocessors. Some of the classifications we'll consider are those of structure, communications, and

(continued)

Rich Krajewski is a BYTE technical editor. He can be contacted at POB 372, Hancock, NH 03449.

data and instruction streams.

The classifications of multiprocessor structure are pipeline, coprocessor, array processor, and parallel processor.

PIPELINE PROCESSORS

Most processors, micro or otherwise, perform several tasks in the execution of an instruction. For instance, in multiplying decimal numbers (say 340 and 2.6), imagine that the computer represents the numbers in scientific

notation (3.4×10^2 and 2.6×10^0). The computer then multiplies the mantissas ($3.4 \times 2.6 = 8.84$) and adds the exponents ($2 + 0 = 2$). The scientific representation of the number (8.84×10^2) is then "normalized" so that the power of 10 is removed and the decimal point is placed in its proper position (884.0).

Three circuits could perform the three tasks—multiply mantissas, add exponents, and normalize the result. Rather than let the mantissa and ex-

ponent circuits do nothing while normalizing is going on, we can give those two circuits another set of numbers to work on. Now, twice as many floating-point operations are taking place as before.

This is pipelining, the simultaneous execution of different parts of different instructions in an assembly-line fashion. One of the first examples of pipelining was the look-ahead, or pre-fetch. In this arrangement, the processor begins execution of one instruction while simultaneously obtaining the next instruction. The text box "The Z80000 Pipeline" describes a modern microprocessor pipeline.

COPROCESSORS

Many microcomputers have multiprocessing in the form of specialized slave processors, or coprocessors. These coprocessors, such as floating-point processors or string comparators, help speed execution time by handling certain complex instructions that the central microprocessor can't handle or can't handle well. Most microcomputer coprocessors, however, don't operate simultaneously with the central microprocessor, so calling the arrangement multiprocessing may be stretching things. Steve Ciarcia's Trump Card is an example of a processor that makes the IBM PC's microprocessor into a slave I/O (input/output) processor (see "Trump Card, Part I: Hardware," May 1984 BYTE, page 40, and "Trump Card, Part II: Software," June 1984 BYTE, page 115).

ARRAY PROCESSORS

Array processing takes place when a collection of processors performs the same instruction simultaneously on an array of data. Sometimes the processors themselves are arranged in an array, but sometimes they are pipeline processors.

PARALLEL PROCESSORS

Parallel processors are collections of independent processors that work together. They can run different but related programs. There are several types of parallel processors (Charles

(continued)

THE Z80000 PIPELINE

BY ROBERT ANDREWS

The instruction cycle of the Z80000 is divided into six stages. Each of these stages is subdivided into two minor cycles according to the following breakdown:

1. Instruction Fetch:

Cycle 1: Increment the program counter.
Cycle 2: Compare cache tags and initiate the instruction fetch.

2. Instruction Decode:

Cycle 1: Instruction is available (assume cache hit).
Cycle 2: Generate microword.

3. Address Calculation:

Cycle 1: Calculate effective address of operands.
Cycle 2: Compare logical address with TLB tags for physical address.

4. Operand Fetch:

Cycle 1: Read the physical address from TLB (assuming TLB hit) and compare it with cache tag for operand.
Cycle 2: Operand is available into temporary register (assuming a cache hit).

5. Execution (may have multiple cycles):

Cycle 1: Read from register and start execution.

Cycle 2: Write to register and set flags.

6. Operand Store:

Cycle 1: Check the results and write to memory.
Cycle 2: Write to cache.

Consider a sequence of instructions as shown below:

```
LDL      RR0,@RR2
ADDL     RR0,FP[INDEXB]
SUBL     RR0,FP[INDEXC]
CPL      RR0,FP[INDEXD]
JR       RR0,FP[INDEXD]
LDL      FP[INDEXD],RR1
```

Assuming instructions and operands are in cache, figure A shows the flow of instructions in several stages of the pipeline.

The result is faster throughput in the microprocessor than if the instructions were executed sequentially.

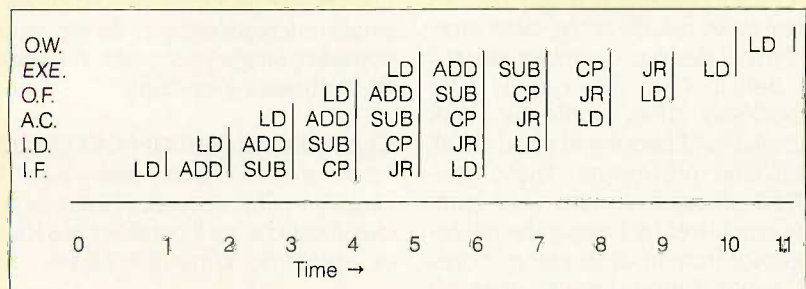
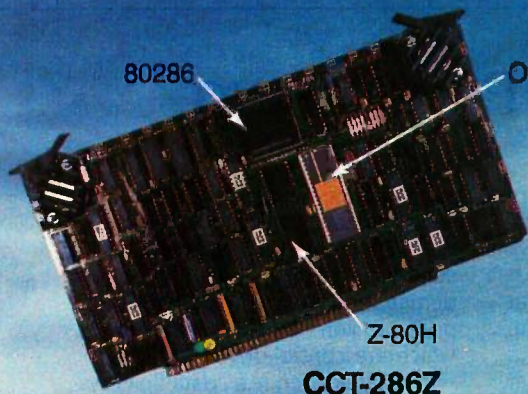

Figure A: Instruction flow in the Z80000 pipeline.

Resource Technology — What's it all about?

IT'S ABOUT TIME!

...and Time is relative. In business, time is profitability!



CCT-286Z



CCT-M512

Given enough time, an end result of the desired quality may be finally attained - (see natural examples). In business, however, the bottom line is directly proportionate to the quality of, and the time consumed by, the tools employed - (see digital examples).

CCT teams up with MACROTECH to bring these ultimate speed and power tools to the serious business/scientific market. State-of-the-art processors, with super high-speed/high-density memory boards, form the basis for CCT machines with bottom-line computing power PCs can't touch.

CCT Implements Tomorrow's Technology Today!

Join some of the serious CCT clientele: U.S. Dept. of State, Uniroyal, Miles Labs, Univ. of Massachusetts, UCLA, Teledyne Semiconductor, UC Berkeley, U.S. EPA, Procter & Gamble, MIT, Lockheed, Corps of Engineers, U.S. Navy, U.S. Coast Guard, Jet Propulsion Labs, Hallmark, McGraw-Edison, Sperry, International Paper, 3M, Beech Aircraft, LSI, Eastman-Kodak, Western Electric, Nat'l. Bureau of Standards, USC, Cornell University, British Cable and Wireless, USAF, and thousands more, worldwide.

For further details, see our technical ad on page 483 of this issue, or contact our technical staff at (602) 282-6299. For system quotations and ordering only, call our sales building at (800) 222-8686.

CUSTOM COMPUTER TECHNOLOGY / 1 CCT PLAZA / SEDONA, AZ 86340

Photograph: Sedona's famous Red Rock Crossing, taken with Nikon FE-2 and Nikkor 35-105mm lens, at 40mm, at f11-1/60th, with special Kodak 5294 movie film-ASA 320.

THOUGHTS ON PARALLEL PROCESSING

BY VIPIN KUMAR

Parallel processing is important for several reasons. There is an insatiable demand for faster and cheaper computers. Sequential computers have been becoming faster due to the advances in hardware technology, but there are indications that limits imposed by solid-state physics may soon come in the way, and the only way out might be parallel processing. With the emergence of VLSI (very large scale integration) technology, it is becoming easier and cheaper to construct large parallel-processing systems as long as they are made of fairly regular patterns of simple processing elements, and thus parallel processors should become cost-effective. Many applications have real-time constraints, e.g., real-time speech understanding, warning systems, navigation, etc. For these tasks, high-speed requirements should be met at any cost. A warning system would not be of much use, for example, if it warned of a nuclear attack after the missiles had exploded.

Parallel processing may be especially necessary for artificial intelligence (AI). Very little success has been achieved in AI in representing and using large bodies of knowledge and in dealing with recognition problems. The human brain can perform these tasks remarkably well using a large number of slow neurons in parallel. This suggests that conventional architectures may be ill suited for these tasks and some kind of parallel architecture may be needed. You could argue that the conventional architectures are theoretically as powerful as any parallel machine (i.e., any task that can be done by a parallel machine can also be done by a conventional machine, although slowly). But architectures can significantly influence the way we program them, and perhaps if we had the right kind of architecture, programming it for perception and knowledge representation would be easy and natural.

In the last several decades many parallel variations of the von Neumann architecture have been developed. The idea behind them has been to take

several processing units and memory modules and connect them in some network configuration. One prominent example of such systems is C.mmp, a multiprocessor system developed at Carnegie-Mellon University. C.mmp consists of 16 processors connected to 16 memory modules via a crossbar switch. The crossbar switch permits communication between any memory modules and any processor. The existence of common memory permits close coupling between processors and thus reduces communication costs. But the complexity of the crossbar switch grows quite rapidly with the number of processors and memory modules involved, making it difficult to build these systems for more than 20 or 30 processors. In some systems each processor is allowed to have private memory, and these processor/memory pairs are connected to each other via a common bus. These systems are easy to build for hundreds of processors. But the processes can talk to each other only by sending messages over a common bus, which makes interprocess communication very expensive. Hence, these systems cannot effectively exploit fine-grain parallelism in an application. TRAC, the Texas Reconfigurable Array Computer, developed at the University of Texas at Austin, provides a middle ground. TRAC connects a number of processors to a number of memory elements via a Banyan network, which is far less complex than the crossbar switch but provides reduced connectivity (as compared to the crossbar switch) between processors and memory elements.

The biggest problem with all these machines is that to exploit parallelism it has to be explicitly specified, something that has turned out very hard to do in practice. Furthermore, parallelism achieved using these machines has been quite limited, rarely reported above 10. Hence it seems hopeless to believe that these machines could be used to get speedups of thousands or even hundreds. Due to limited success with these kinds of parallel processors

and to some inherent problems with the traditional von Neumann model of computing, many researchers have started investigating data-driven and demand-driven architectures, as opposed to von Neumann architectures, which are control-driven.

In a data-driven (e.g., data-flow) system, an instruction can be executed as soon as the input data it requires is available. After the instruction is executed, its result is made available to the successive instructions. In a demand-driven (e.g., reduction) system, an instruction is triggered when the results it produced are demanded by other instructions. These demands cause further demands for operands unless the operands are locally available, in which case the instruction is executed and the results are sent back. The advantage of a demand-driven system over a data-driven system is that only instructions whose results are needed are executed. The disadvantage is in those computations in which every instruction always contributes to the final result; propagating demands from top to bottom is a wasted effort.

In both of these systems, as a result of data- or demand-activated instruction execution, many instructions can become available for execution at once, and it is possible to exploit all of the parallelism in the program. Furthermore, parallelism does not have to be explicitly specified; it is automatically extracted as long as the program is written in an applicative language (e.g., pure LISP). It is expected that these architectures can efficiently exploit concurrency of computation on a very large scale.

A number of such systems are being developed around the world. Most notably, the Japanese have chosen data flow as the underlying architecture for the fifth-generation machines. Data-flow and reduction architectures hold great promise, but there are some important problems to be solved before they can be used effectively to provide large-scale parallelism.

The realization that the human brain performs many difficult cognitive tasks

effortlessly using neurons, which are quite slow in comparison to today's microelectronic devices, has led researchers to look into massively parallel architectures. The earliest computational models along these lines were inspired by neurophysiology. Most well known of these is "perceptron," developed by Frank Rosenblatt in the late 1950s. A pattern-recognition system that is able to learn from experience, perceptron's basic building block is an element that is intended to be a model of a neuron. The element accepts a number of inputs, takes their weighted sum, and produces an output of 0 or 1 depending on whether or not the sum exceeds a threshold value associated with the element. Inputs to the element are features extracted from the patterns to be recognized. A perceptron can be used to distinguish between two given sets of patterns, and its design involves adjusting the weights and the thresholds of its elements. Rosenblatt gave a procedure for training perceptrons, by which a perceptron can automatically adjust its weights to cause correct classification of patterns. Initial success of perceptrons started a flurry of activity in this area, but the excitement waned when the models based upon neuroscience were found to be too simple for most problems of interest. In particular, Marvin Minsky and Seymour Papert proved that perceptrons have serious limitations and can be used to recognize only very simple kinds of patterns.

NETL, developed by Scott Fahlman at Carnegie-Mellon University, represents a different approach to building a massively parallel machine. NETL represents real-world knowledge in the form of a hardware semantic network. It consists of nodes that are used to represent concepts and links that are used to represent the relationship between the concepts. Each node can store a few distinct marker bits, and a link can propagate these markers from node to node in parallel. Nodes and links are connected via a common bus to a central computer that controls the marker propagation. By moving

markers from node to node in parallel, NETL can perform certain deductions and searches (e.g., property inheritance) very quickly. On a uniprocessor these operations can take a long time.

The biggest problem with NETL is its actual hardware implementation. It is easy, with the current hardware technology, to put thousands of nodes and links on a chip. But the problem is in forming connections between nodes and links as new knowledge is added. These connections must be private lines between nodes and links; otherwise, all of the parallelism will be lost. Fahlman has recently proposed a solution to this using a hashnet scheme and has sketched a design for a million-element machine.

Another problem with NETL is locality. A concept is represented by only a node, and if this node is damaged, it will be hard to reconstruct the associated information. The Boltzmann machine being developed by Geoffrey Hinton (see "Learning in Parallel Networks" by Geoffrey E. Hinton, April BYTE, page 265) and many other researchers attempts to solve this problem. In the Boltzmann machine, a concept is represented by a pattern of activity in a large number of units. Each unit is a probabilistic processing element. The failure of a unit has little effect because each piece of information is distributed throughout the network of units. Preliminary simulation results of the Boltzmann architecture are encouraging, but there is a lot to learn about its limits and capabilities.

We've looked at only a few of the dozens of parallel architectures that various researchers have proposed. Many of them are being tested via simulation or actual implementations. Most of the work is primarily exploratory in nature and is meant to find out which architectures might be suited for which problems. Parallelism holds great promise for AI not only in terms of cheaper and faster computers but also as a novel way of viewing computation. "What form will it take?" is a question that can be answered only with time.

Babbage's contemporaries talked about making one in 1842 out of several of his Analytical Engines), but we'll discuss only data-flow machines. (See the "Thoughts on Parallel Processing" text box for a discussion of other kinds of parallel processors.)

Traditional methods of processing execute a program by calling the instructions one by one with a program counter. The instructions then call the data they need from memory. But data flow has the data calling for instructions when the data needs them.

Figure 1 is a block diagram of the Manchester University data-flow architecture. The "data packet" you see in the diagram contains a data value and a control field. (The control field, or message, tells the computer which instruction is to act upon the data.) This data packet is matched—by the packet matcher, of course—with another data packet that has the same control field. These two packets become one "data-data" packet (which sounds like something from a 1950s rock-and-roll song). The new packet goes to the instruction fetcher, which retrieves the instruction that the packet needs by using the address supplied in the control field. We now have a "data-data-instruction" packet. But that's not all. The fetcher's last duty is to check its data-flow graph to see to which new operation the result of the current operation should go. This address is added to the packet, and away it goes to the processing units, where the packet is assigned to a free processor. The processor produces a result packet, which is just a data packet. The new data packet goes to the packet matcher to start the process all over again.

In this system, many processors are working at the same time, and many packets are circulating through the system. There is no need in this arrangement to worry about one processor communicating with another, so high task-execution speeds should be possible.

Notice that there is no program counter here, as in a von Neumann computer. Instructions are not called

(continued)

LOOK AT THESE PRICES!



maxell®

A disk for every need, every one backed with a lifetime warranty.

- GOLD STANDARD FLOPPY DISKS**
- 5 1/4" Single Sided/Double Density \$1.54 ea. \$1.45 ea. 100+
 - 5 1/4" Double Sided/Double Density \$2.04 ea. \$1.95 ea.
 - 5 1/4" High Density \$4.08 ea. \$3.99 ea.
 - 3 1/2" Micro Single Sided/Double Density \$3.24 ea. \$3.15 ea.
- Minimum order 50 diskettes.

DATA-CASE

Stores and files up to 50 5 1/4" diskettes. Made from durable styrene plastic. With order of 100 or more diskettes

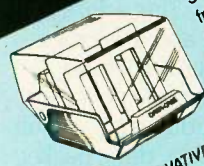

Only Regular \$8.95 \$9.95

CALL TOLL FREE 1-800-USA-FLEX
IN ILLINOIS 1-312-351-9700

Please mention this ad when calling in your order. MasterCard, Visa, C.O.D. or net 30 days with approved credit on purchases over \$200.00. Prices subject to change without notice.

COMARK

COMARK, INC. 135 N. Brandon
Glendale Heights, Illinois 60139

OVERVIEW

first and data next. Just the opposite happens.

The advantage of working this way is that we can more easily see the data dependencies between processes, so it is easier to program parallel routines. Figure 2 shows a data-flow graph of the simple calculations

$$A = B + C - F$$

$$D = B * C - F$$

$$E = A - D$$

In the data-flow graph, we show the input data (the data with no dependencies on other data) first, as many times as necessary, depending on how many different operations require the data. Then they are combined as the calculations specify, and the new values, which are dependent

on the original values, are combined again until all data items are combined.

With this kind of system, the dependencies of one value on another are obvious, and the parallelisms stand out. Of course, the drawback here is that the data values have to be repeated several times in data-packet memory, each time with a different control field. For instance, there are two B data packets, but one specifies a multiplication operation and the other specifies an addition operation.

Figure 3 shows how these calculations might be first specified on an ordinary computer. Here, we start simply with the first calculation rather than with all the initial data. Instructions call data rather than the other way around, so data need only be

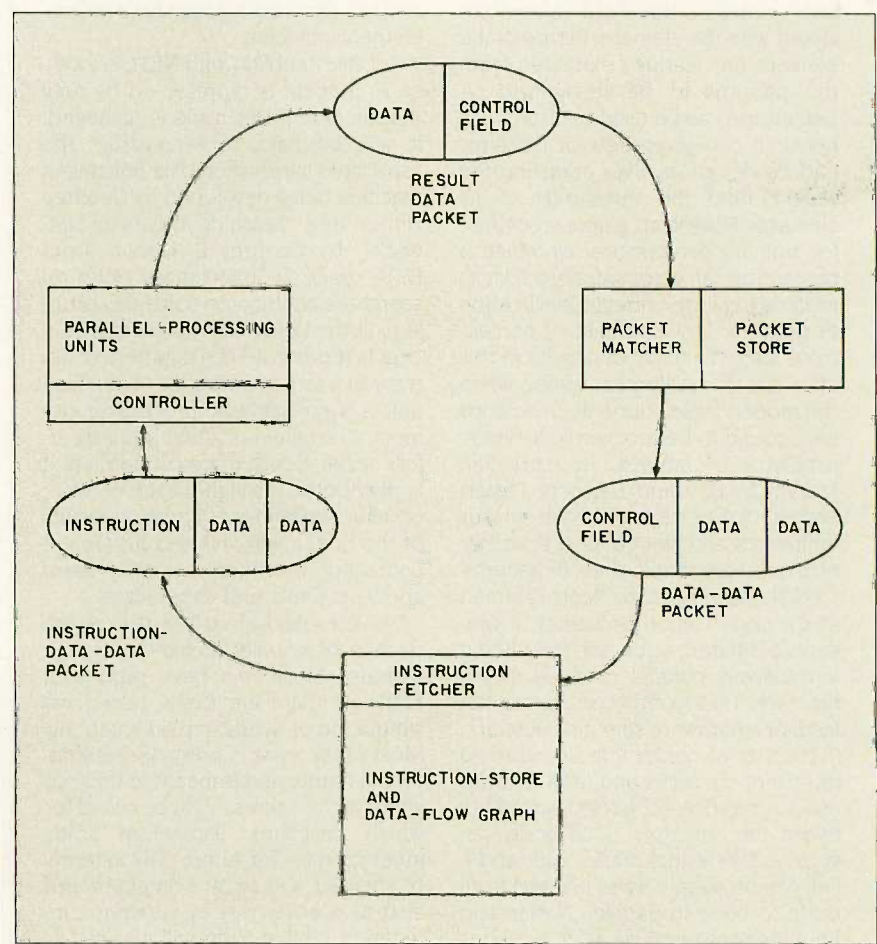

Figure 1: The Manchester data-flow architecture. How packets are allocated to processors is not shown.

listed once in memory and called as needed. But the data dependencies are not obvious, and finding ways to execute instructions concurrently becomes more difficult. It can be done, but perhaps not as well.

COMMUNICATION METHODS

Another classification of multiprocessors is their communication method. This is a crucial issue in multiprocessors because as the number of processors increases, so does the communication problem.

We will examine three communication methods: bus, circuit switch, and packet switch.

BUS

Figure 4 shows a bus-connected parallel processor. In the diagram, all communications are broadcast on the bus. Unfortunately, with a large number of processors, even high-speed buses can't handle all of the communications traffic.

Because all communications between processors are handled sequentially on the bus, it becomes a bottleneck as the number of processors grows, since only one transfer of information can occur at any one time. The answer is to have several buses or another communication technique.

CIRCUIT SWITCH

Circuit switching is the direct connection of one processor to any other processor through a switch (see the "Crossbar Circuit Switch" text box on page 180 for a discussion of a type of circuit switch). Your phone company's central office uses a circuit switcher to switch your calls.

This method has problems at high volume and high speeds. In a parallel processor, with perhaps millions of processors, a single circuit switcher would be hard-pressed to keep up. Perhaps the answer will be to use several switchers.

PACKET SWITCH

In a packet-switched system of parallel processors, the processors not only process their own programs but relay

programs and data to other processors. Figure 5 shows a system like this. There are two kinds of packets in this system: instruction and data packets. A packet consists of an address, its contents, and a checksum or some other error-checking mechanism.

The instruction packets are addressed to specific processors if there is a central controller processor to keep track of processor usage. If the

packet is unaddressed, it is taken up by the first available processor that receives it. Data packets may be addressed to specific processors or to the processes, depending on how processes are assigned to processors. When a process or processor receives a packet, it must tell the sender that the message was properly received. This requirement doubles the traffic that the system must handle.

(continued)

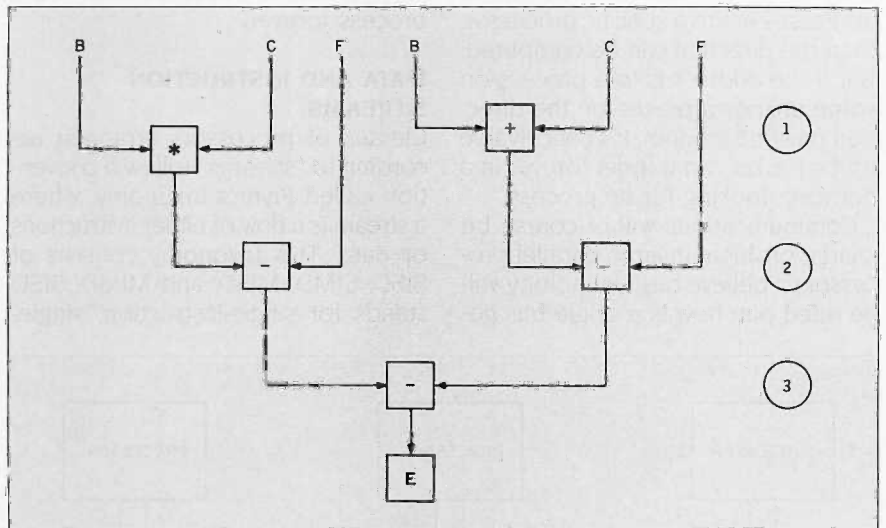

Figure 2: The data-flow graph. Notice the duplication of input data.

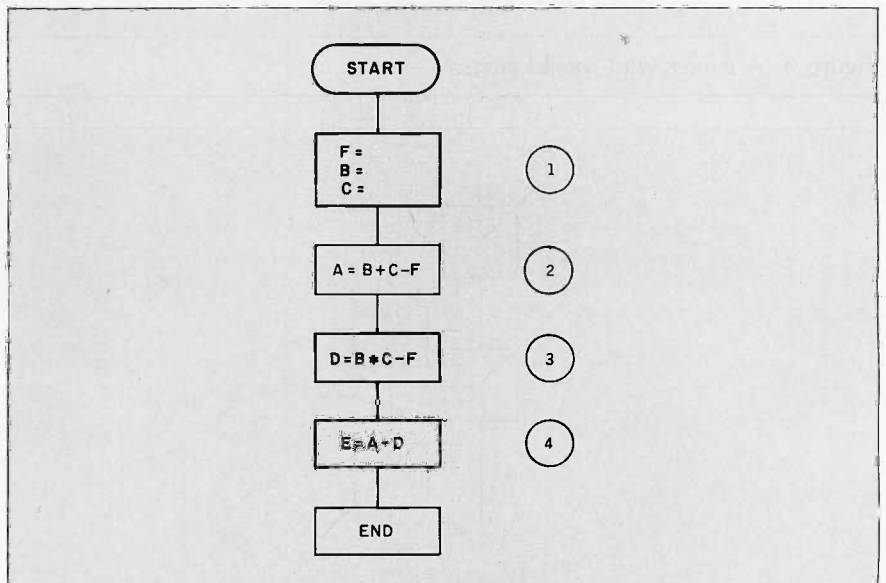

Figure 3: An ordinary flow chart. Notice that, without the parallelism of data flow, the number of execution steps is greater.

In the figure, processors are connected to their nearest neighbors in three dimensions, for a total of six connections. How much of a processor's time is devoted to relaying information? It has to be enormous, when you realize that the processor is not only receiving and transmitting but checking the address of the packet to see if it should be acted on rather than retransmitted. And which direction should the processor send the packet, if it should be sent? If the addresses are to a specific processor, then the direction can be computed. But if the address is to a process on some unknown processor, the direction must be random. It's conceivable that a packet can wander forever in a network, looking for its process.

Communications will of course be a large problem in large parallel processors. I believe bus technology will be ruled out; how is a single bus go-

ing to carry the load of a million processors when the communications must be sequential? There will be a lot of idle processors in a system like that. And what kind of circuit switcher will be able to handle the millions of processor connections at once? Moreover, if processors are really independent of processes, how will a packet-switched message quickly find its target process in a vast net of processors? I can imagine the packet playing hide-and-seek with its target process forever.

DATA AND INSTRUCTION STREAMS

Classes of processors arranged according to "streams" follow a convention called Flynn's taxonomy, where a stream is a flow of either instructions or data. This taxonomy consists of SISD, SIMD, MISD, and MIMD. SISD stands for single-instruction, single-

data stream computer, which is a von Neumann machine. SIMD stands for single-instruction, multiple-data stream, which is an array processor. MISD stands for multiple-instruction, single-data stream, which is a pipelined processor. MIMD stands for multiple-instruction, multiple-data stream, which is a parallel processor.

Some people prefer a convention called Shore's taxonomy because it subdivides the Flynn's array processor class.

SOFTWARE

The real problem in parallel processing is not the hardware but the software. The problem in software, to my mind, will not be partitioning applications programs into independent modules but scheduling those modules onto available processors and providing communication between the modules. These tasks are part of the job of an operating system, which is responsible for managing the resources of the computer.

The software problem raises a sticky point in the whole philosophy of multiprocessing. From the beginning in multiprocessing, the driving motivation has been that if one processor can do a certain amount of work, then two can do twice as much, and so on. The situation is analogous to building a house. If you were to build a house by yourself in one year, then the job should take two people half a year and three people one-third of a year. And every so often you hear about a team of hundreds putting up a house in an afternoon. Multiplicity of effort is the idea behind some of civilization's great achievements. So, the reasoning goes, why not require computers and microprocessors to work in similar harmony?

Unfortunately, as the software shows, there's a problem with this idea. First of all, more doesn't always mean better. Just as too much medicine can harm you, so can too many processors actually slow down the processing of information. Communication between processors can become a bottleneck, as can all of the

(continued)

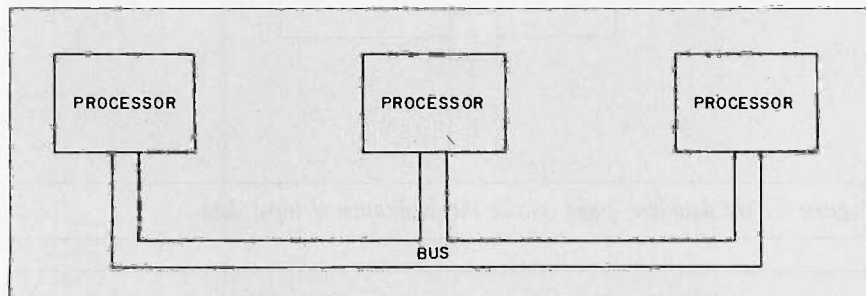

Figure 4: A bus-connected parallel processor.

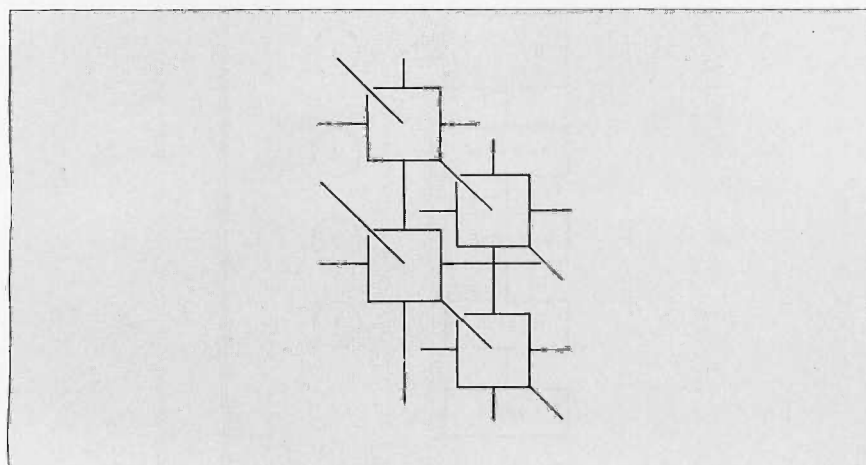
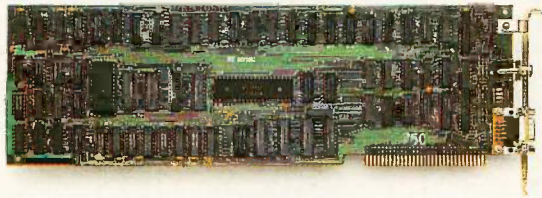

Figure 5: A section of a packet-switched parallel processor. Packets of instructions and data are passed from one processor to the next.

Compare the Hercules™ Color Card to IBM's®.

Five reasons why the Hercules Color Card is better.



IBM Color Adapter \$244

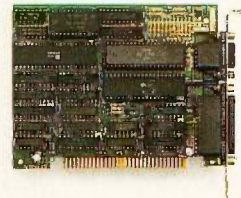

Hercules Color Card \$245

1. Compatibility

Runs hundreds of graphics programs.

Runs the same hundreds of graphics programs. "The Hercules Color Card is so nearly identical to the IBM Color/ Graphics Card that it's almost uncanny." PC Mag.

2. Printer port.

None.

Standard. Our parallel port allows you to hook up to any IBM compatible printer.

3. Size.

13.25 inches. Limited to long slots.

5.25 inches. Fits in a long or short slot in a PC, XT, AT or *Portable*.

4. Flexibility.

Can't always work with a Hercules Graphics Card.

Always works with a Hercules Graphics Card by means of a software switch.

5. Warranty.

90 days.

Two years.

Any one of these five features is enough reason to buy a Hercules Color Card. But perhaps the most convincing reason of all is just how easy the Hercules Color Card is to use: "Right out of the box, the Hercules Color Card goes into an empty expansion slot, ready for you to plug in . . . and go to work—no jumpers, no software. For most applications, it's just that easy." PC Magazine.

Call 1-800-532-0600 Ext. 421 for the name of the Hercules dealer nearest you and we'll rush you our free info kit.

Hercules.
We're strong on graphics.

CROSSBAR CIRCUIT SWITCH

BY HOWARD W. JOHNSON

The interconnection problem, in one form or another, is a vital part of every parallel-processing design. It is not enough to postulate the existence of " n processors" and explain how they will divide up the work on some task. The actual interconnection scheme used must also be carefully laid out. The failure of most parallel-processing algorithms to scale well up to implementations involving more than a few processors is usually attributed to a glut of communications overhead. That is another way of saying that the interconnection scheme did not work as planned.

SPATIAL SOLUTIONS TO INTERCONNECTION

Historically, the " n by n Space Switch" was the first solution to the interconnection problem. This solution was used for decades, in many forms, in the telephone industry to interconnect callers. Because this method is closely related to the "crossbar switch," we will discuss them both. Neither is used in large data-switching installations because the complexity of such an implementation grows as the square of the number of devices interconnected. For instance, doubling the number of devices served would necessitate quadrupling the total hardware involved in the interconnection process, as we will see later.

The basic tenet of the n by n space switch method is that if you could run a separate wire from each source to every destination and then somehow switch on only the wires corresponding to the connection pattern desired at a given point in time, the problem would be solved.

Here are three equivalent forms of this basic idea:

1. There is a separate wire leading from each source to every sink. Each source continuously transmits all of its data onto all wires leading from that source. At each sink, there is a large switch to select only the wire leading to the desired source.
2. There is a separate wire leading

from each source to every sink. At each data source, place a large switch, which will send the output of that data source onto one and only one of the wires leading from that source. At every sink, tie together all of the wires leading to that sink in a wired-OR fashion. This solution is the opposite of the first solution.

3. Start with a regular square grid of n wires running horizontally and n wires running vertically (see figure B). At each juncture, place a switch that can either be open or closed. Start out with all the switches open. Next, permanently connect the first source to the first horizontal wire, the second source to the second wire, and so forth, until all the sources have been connected. Then connect the sinks one at a time to vertical wires, starting with the first sink on the left-hand side and

working to the right. This arrangement has traditionally been called the n by n space switch. Closing the switch at the juncture of the first column and first row will connect source 1 to sink 1.

All three methods accomplish virtually the same thing. One exception worth noting is that in methods 1 and 3 one source may be broadcast to several sinks, while in method 2 this is impossible unless the switch is designed to permit multiple simultaneous closures. I have seen many small computer installations that successfully use either method 1 or method 2 for interconnecting terminals to a limited variety of computers.

In all methods, the number of switching junctures required is proportional to the number of sinks times the number of sources. Therefore, for large problems it is generally not acceptable.

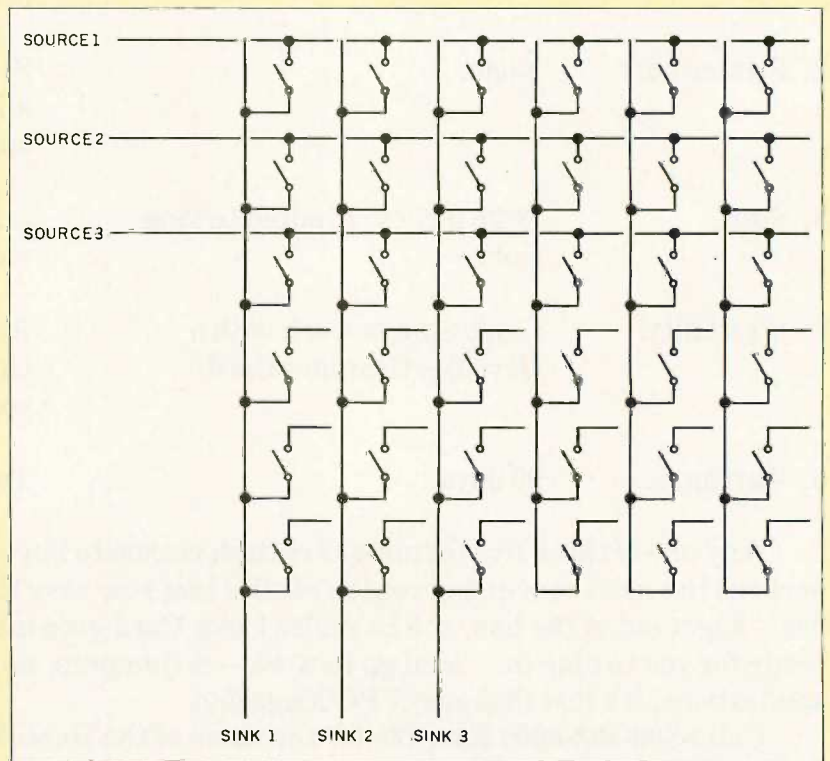

Figure B: Part of an n by n space switch. This architecture can connect any pattern of input to outputs.

OVERVIEW

other resource-allocating tasks of the operating system.

HARDWARE PROBLEMS

In large memory banks, the failure of a single bit in the memory can be detected easily. However, how easy will it be to detect a malfunctioning processor in a bank of a million parallel processors? This disadvantage of multiprocessing hasn't been fully addressed yet because computers of sufficient complexity haven't been built yet. The operating system of the parallel processing computer, if you can call many independent simultaneously operating programs a single operating system, will have to be able to tell if its neighbors are acting all right. This, of course, adds overhead that takes away from the applications program.

CONTROVERSIES

How do you measure the increase in speed of the multiprocessor? A computer with 10 processors may execute 10 times as many instructions as a computer with a single processor. But if 50 percent of those instructions are overhead—housekeeping and communications instructions—the real increase is less than 10 times.

There is also controversy over how to justify the design of multiprocessors. If, for instance, a new and faster design requires difficult and slower programming time, is the efficiency in execution outweighed by the higher cost in programming? Interested parties such as the military are willing to pay the cost of programming because the goal is worth the additional cost.

CONCLUSION

There's not much use for a million-processor computer in running the kind of programs we microcomputer users are most familiar with. After all, how many processors do you need to move a paragraph? But if the million processors edit the paragraph as well as move it, then what you have is not a faster way to do old things but a new way to do new things. And that is the promise of multiprocessing, if only we should live so long. ■

For instance, a 200 by 200 processor array would require, for full flexibility, 40,000 individual switches, or 200 switch boxes with 200 switch settings each.

The network can be pared down somewhat to limit its complexity, but at the expense of a loss in generality. A direct method is to assess which sources might ever need to be connected to which sinks and wire only those data paths that might ever be used. The problem with this approach is that one never knows with certainty how a particular network will be used, so it is difficult to predict which connections to eliminate.

In the crossbar method, it is assumed that although there are *n* sources and *n* sinks, only *t* percentage of them will be active at any given moment. This is the same sort of traffic-limiting assumption used in local-area network design. The crossbar method uses a cascade of two space switches to achieve any interconnection pattern involving less than *n * n* total connections. The first space switch connects the *n* sources onto a total of *n * t* intermediate wires. The intermediate wires are then run into a second space switch, which can connect its *n * t* inputs to any of the *n* sinks. As long as there is an intermediate wire available, the first section can switch a source on to it and the second section will forward that data on to the appropriate sink. The total interconnection hardware is proportional to the sum of the two sections. The first section has *n* inputs and *n * t* outputs, and the second has *n * t* inputs and *n* outputs, making a total of $2 * n * n * t$ switches. This may be compared to the *n * n* switches required for a one-stage design. If *t* is less than 1/2, then the crossbar design is preferable. In office telephone applications, *t* is on the order of 1/3, so crossbar switches were used successfully for many years. Space switches may be used in small parallel processors, but as the number of processors increases, so must the complexity of the switching network, until it becomes impractical to build such a large space switch.



• COMPUTERS • VIDEO • PHOTOGRAPHIC • ELECTRONICS

FOR INFO CALL (212) 725-1234 TOLL FREE (800) 221-3160 FOR ORDERS

<p>IBM PC & COMPAT.</p> <p>IBM PC w/Drive, monitor.....1695 IBM PC w/256k (2) 360 drives, keyboard, monitor & monitor aggr/Call IBM PC As Above w/RGB Color Monitor.....2419 IBM PC-XT w/256k.....3199 IBM AT Enhanced.....Call PC JR w/128k.....849 CANON Athena.....Call LEADING EDGE PC w/128k (2) 360 disc drives, monitor & adapter, basic DDS 2.11.....1499 LEADING EDGE PC w/256k as above but RGB Color.....1995 LEADING EDGE PC w/256k (1) 360 & (1) 10Mb hard disc, RGB Color, Adapter, DDS 2.11 & Basic.....2795 ZENITH ZF 151-52 w/(2) 360k Disc Drives, 320k RAM, IBM Compatible, w/Free Microsoft Word & Free Microsoft Multiplan & Color Graphics Ready.....2099 COMPAQ PORTABLE w/256k (2) 360 disc drives, DDS, basic.....2199 COMPAQ PLUS.....Call COMPAQ Desk Pro.....Call</p> <p>LAP COMPUTERS</p> <p>HP 110 w/27k RAM, Lotus 123 80 Col Display, 95Lbs.....2295 MORROW w/(2) 360k, 13Lbs, Disc Drives, 256k, IBM Compatible Call SANYO 550 2.....699 SANYO 555 2.....979</p> <p>APPLE COMPUTERS</p> <p>APPLE Iie w/Drive.....849 APPLE Iic.....899 APPLE Macintosh.....1699 APPLE Iie Professional System w/128k (2) Duo Disc Drives & 80 Col Card.....1429 APPLE Image Writer w/Printer & Specify.....499</p> <p>BOARDS FOR IBM</p> <p>AMDEK MIA.....389 AST 6 Pak Plus.....219 AST mega Plus.....269 AST I/O Plus.....139 Game port adapter.....44 HERCULES color card.....179 HERCULES graphic card for TTL mono monitor.....324 KOLA game controller.....174 PERYSST mono board.....174 PERYSST color.....169 STB GRAPIX Plus II.....349 QUABOARD w/6k.....269</p> <p>PRINTERS PLOTTERS</p> <p>EPSON: RX 80.....234 LO 1500.....1069 JUJKI: 6100.....399 6300.....799 HP: Laser Printer.....2795 HP: Plotter.....Call Sweet Pea Plotter.....Call NEC: 3550.....1369 OKIDATA: 82.....259 92.....355 84.....679 93.....575 2410.....Call OLYMPIA: RD.....339 SILVER REED: 400.....249 500.....289 550.....449 770.....769 TOSHIBA: 1340.....598 1351.....1239</p> <p>CANON COPIERS</p> <p>PC 10.....479 PC 20.....689 PC 25.....989 Copier Stand.....99 4 Black Cartridges.....199</p> <p>IBM PC</p> <p>W/64k (1) 360 Disc Drive, & Keyboard.....1499 IBM PC W/256k (2) 360 Disc Drives, Graphics Monitor Card, Mon., Keybd & Software Kit.....Call IBM PC AT.....Call</p> <p>LEADING EDGE PC</p> <p>W/12k, Leading Edge Monitor, Keyboard, Monitor & Printer Adapter.....1499</p> <p>ZENITH ZF 151-52</p> <p>W/(2) 360k Disc Drives, 320k RAM, Microsoft Word, Multiplan, Keyboard, & 90 Day On Sight Service.....2099</p>	<p>SOFTWARE I/IBM</p> <p>IBM Topview.....Call Framework or dBase III.....365 Lotus 123.....289 Symphony.....419 Flight Simulator.....39 Word Star.....189 WordStar Pro.....289 Word Star 2000.....269 Multimedia.....249 Word wSpell.....229 Turbo Pascal.....32 SideKick.....32 Master Type.....34 PC Paintbrush w/Mouse.....149 NDRITON utilities 3.0.....59 Copywrite.....48 Sideways.....56 Sargon III.....38 Zork.....29 R Base.....300.....256 Managing Your Money.....119 Typing Tutor II.....34 Master Type.....34 Print Works.....88 Desk Organizer.....129 Electric Desk.....199 HowardSoft Tax Preparer.....170 XY Write II Plus.....219 Quick Code III.....149 Word Perfect 4.0.....249 Peachtree Decision Manager.....319 TKI Solver.....248 Think Tank.....129</p> <p>MONITORS</p> <p>AMDEK 310A.....159 GORILLA Green.....89 LEADING EDGE RGB Color.....399 TTL Green.....139 TTL Amber.....149 PRINCETON GRAPHICS: HK12.....458 Max-12.....149 SR-12 w/Scan Doubler.....896 SANYO CRT30.....95 CRT36.....129 CRT70.....549 TAXAN 410 IBM RGB.....349 TAXAN 420 Hi Res RGB I/IBM.....419 XTRON 1000 Lines Hi Res Amber I/IBM TTL.....149 ZENITH: 122.....89 123.....98 124 IBM Compatible.....139 135 RGB.....999 136 Hi-Res RGB.....748</p> <p>MODEMS</p> <p>HAYES: 300/200 1200.....449 1200k w/Smartcom II.....389 SMARTCOM II.....95 2400.....Call Micro Modem Ie.....249 NOVATION SMARTCARD: Internal.....348 Extn.....348 US ROBOTICS: Password 1200/349</p> <p>COMPUTER ACCESS</p> <p>Disc Bank holds 50.....14 HEAD disc drive cleaner.....13 VERBATIM IBM drive analyzer.....29 SURGE PROTECTORS: Network cube w/RF filter.....29 Network 4 outlet w/RF filter.....59 Gemini outlet w/RF filter.....59</p> <p>DISKETTES</p> <p>SSDD DS/DD: Verbatim Data Life (10/21) 29 FLJI (10).....18 24 MAXELL (10).....19 28 BASF (10).....17 23 IBM (X).....22 29 FOM (X).....13 19 SPECIAL 1 TDK Quantities of 100 ea 1.35 ea 1.55</p> <p>TYPEWRITERS</p> <p>CANON Tpestar 5.....158 CANON Tpestar 6.....258 BROTHER CE 58.....458 OLYMPIA Compact II.....399 SMITH CORONA 350M.....318 *After Manufacturer's Retail</p> <p>SANYO 550-2</p> <p>Now Runs Lotus 123 IBM PC Compatible, 360k Disc Drive, 128k RAM, Word Star, Calc Star & Easy Writer RGB VIDEO CARD.....699</p> <p>OLYMPIA RO</p> <p>Daisy Wheel Letter Quality, 14 Cps w/Parallel & Serial Ports w/Built-In Tractor Feed, 3 Pitch/DNLY!.....339⁹⁵</p> <p>COMPAQ</p> <p>Portable W/(2) 360k Disc Drives, DDS & Basic Keyboard.....2199 COMPAQ Plus w/Hard Disc.....In Stock</p>
---	--

1265 Broadway at 32nd St., New York, New York, 10011

50% OFF CORPORATE ACCOUNTS WELCOME. Minimum Shipping Order: \$50. \$2.50 Service Charge for Orders Under \$50. Minimum Shipping \$4.95. We Are Not Responsible For Typo. © Manufacturer's Prices Change. Prices Effective June 1, 1985 July 1, 1985.

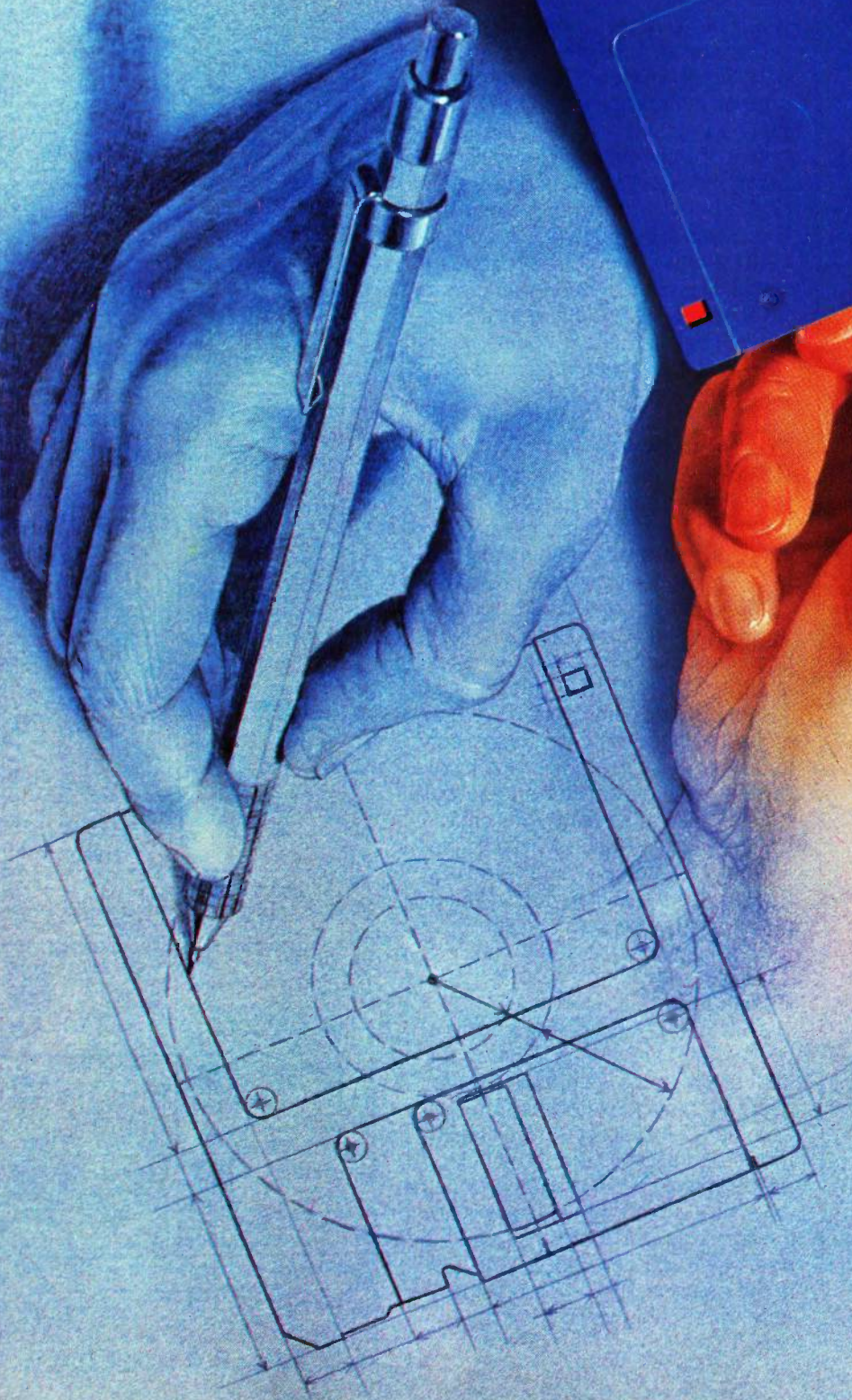

WHO MAKES THE HIGHEST QUALITY 3.5" DISK? ASK SONY. WE INVENTED IT.

Long before there was a market for 3.5" disks, in fact, four years before, there was Sony.

And while every single 3.5" disk manufacturer has duplicated the Sony design, there's one thing they haven't been able to duplicate. Sony quality.

Such error-suppressing materials as VIVAX™ magnetic particles (the very core of the disk itself) have been developed by Sony. As is the case for our manufacturing process. It includes a burnishing technique that eliminates projections as small as 1/1,000,000 of a millimeter from the disk's surface.

The result? Every time you use a Sony 3.5" disk you're assured you're using the best magnetic medium you can buy.

With somebody else's, you can only guess.

SONY®

*Imagine
dBASE III™
running up
to 20 times
faster.*

*The time
for Clipper
has arrived.*



Clipper introduces you to the time of your life

Time is your most valuable commodity. Because how you spend your time, is how you live your life.

At Nantucket, we believe you should live life to the fullest.

Clipper, the first true compiler for dBASE III™ is a timely example. Now, dBASE compiled by Clipper runs 2 to 20 times faster than dBASE with its standard interpreter.

A dBASE interpreter painstakingly checks and executes your source code one line at

a time, every time you run a program. With Clipper, once you've debugged your source code, it's compiled into more efficient machine code. Your program runs without the time-consuming overhead of redundant translation. Clipper compiles all your existing and future dBASE III programs.

Developing a compiler for dBASE III was just a matter of time. Call your dealer or our toll free 800 number and ask for Clipper.

Then go make the most of your life time.



nantucket

EXTENDING MICROPROCESSOR ARCHITECTURES

BY GARY D. BEALS

Extended-processing units can significantly broaden a microprocessor's instruction set

BECAUSE MOST microprocessors are designed to meet the widest possible range of applications, they use a very general purpose set of instructions. Unfortunately, microprocessors are also limited by the size of the silicon wafer used to make them. Every instruction takes up "silicon real estate" on the chip and must be justified. Much time and effort goes into selecting the best possible instruction set that uses the least amount of silicon.

Additional instructions are expensive in terms of the space used to implement them because the cost of building the central processing unit (CPU) is directly linked to the size of the chip. The more CPU chips on a single silicon wafer, the cheaper CPUs will be to manufacture.

In order to avoid limiting the instruction set and still conserve silicon, many of the more advanced microprocessor designs incorporate custom instructions that the user can modify.

Most coprocessors were designed to extend the processor instruction set by using a separate chip, or extended-processing unit (EPU). The

CPU uses its custom instructions to pass information to and from the EPU as if it existed on the same chip. This means that if specialized instructions are not implemented on the CPU but are required in a design, an EPU can be built to execute those instructions. A good example is floating-point mathematics instructions, which are not required by all microprocessor designs but are critical for some. Floating-point instructions also tend to be very costly in terms of silicon space.

Intel, Motorola, National Semiconductor, and Zilog have implemented extended-processing architectures (EPAs) on their more advanced CPU chips. The devices used to extend the CPU are called coprocessors, slave processors, and sometimes numeric data processors. I will refer to them as EPUs.

I will focus on four different extended-processing architectures and discuss their similarities and differences.

INSTRUCTION TEMPLATES

All of the extended-processing architectures in this article use an instruc-

tion "template" to implement custom instructions. This is usually a set of reserved op codes identified by the CPU as a particular bit pattern at a particular location. In the example in figure 1, an F-line code, or a word that begins with all 1s in the most significant bits, is used to decode a template instruction.

The CPU recognizes four 1s in bits 15 through 12 as an EPU instruction and allows the user to use the remaining bits for custom instructions. Of course, the extended-processing architecture for each manufacturer specifies how the rest of the bits should be structured. In some architectures, this includes specifying an ID code to identify which specific EPU should decode the template. This allows for multiple EPUs. In figure 1, the 3-bit ID field allows up to eight separate EPUs.

Once a template instruction has been detected by the CPU, it must be detected and decoded by the specif-

(continued)

Gary D. Beals is a senior field applications engineer at Zilog Inc. (Suite 23, 2885 Aurora Ave., Boulder, CO 80303).

ically identified EPU. The most popular method is to have the EPU directly connected to the address and data bus of the CPU and watch for the template itself. The EPU takes advantage of whatever status information and timing signals the CPU has to offer to allow the EPU to detect the template op code at the proper time. This tightly coupled system requires little or no extra decoding logic. The EPU performs all the decoding.

Another method produces a particular status code when a template instruction is executed and uses external hardware to decode a separate EPU address space. This requires additional hardware but does not require the EPU to do the decoding. Either way, the template instruction is decoded as an EPU instruction and the information is passed to or from the EPU.

The actual information transfer differs from one architecture to another, but it generally takes one of two forms. In the first, the CPU provides all the addressing and the EPU takes the data and manipulates it in an appropriate manner. In the second, the EPU gets an address from the CPU, then takes control of the CPU bus and directly accesses memory.

All of the architectures support the first method, some better than others. The second method, direct memory

access (DMA), is supported by the CPU itself and is not generally included in an extended-processing architecture. DMA transfers can be useful for some applications but cause the CPU to lose control of the bus. This is contrary to the architecture-extension idea and can cause some problems.

In short, all of the CPUs mentioned here support DMA transfers, although DMA transfers may not be part of a particular CPU extended-processing architecture.

SOFTWARE EMULATION

Another requirement for an extended-processing architecture is the ability to emulate the EPU in software if the hardware chip is not present in the CPU.

The EPU trap is a bit in a CPU control register that is set if the EPU chip hardware is in the system or reset if it is not. Any time the CPU uses an extended instruction when the bit is reset, a software trap is activated. This means that the CPU will jump to a specific address where software routines are located that will emulate the EPU instructions.

The hardware and software are interchangeable, so they can be used to debug each other in the initial design or replace each other in the final system, depending on the requirements.

If there is no provision for a software trap, the designer must know before code is compiled or assembled if an EPU is not in the system. A jump instruction replaces each EPU instruction, and the software routines are placed at the end of the jump. If this is not done, the EPU instructions become NOPs, or no-operations, and do not execute.

CONCURRENT OPERATION

There are a couple of buzzwords associated with EPUs. They are non-concurrent, or synchronous, mode, and concurrent, or asynchronous, mode of operation in an EPU.

Nonconcurrent mode means that the CPU will always wait for the EPU before it begins another instruction. This could also be called serial execution. Concurrent mode, or parallel execution, means that the CPU and EPU can be processing simultaneously. This has an obvious performance advantage over nonconcurrent mode. However, if the CPU modifies memory before the EPU has a chance to read it, or if the EPU modifies memory without informing the CPU, synchronization problems can occur. If the CPU is always in control of the bus, this does not happen. However, if the EPU requires DMA in order to modify memory, provisions must be made to synchronize the EPU and CPU or pre-

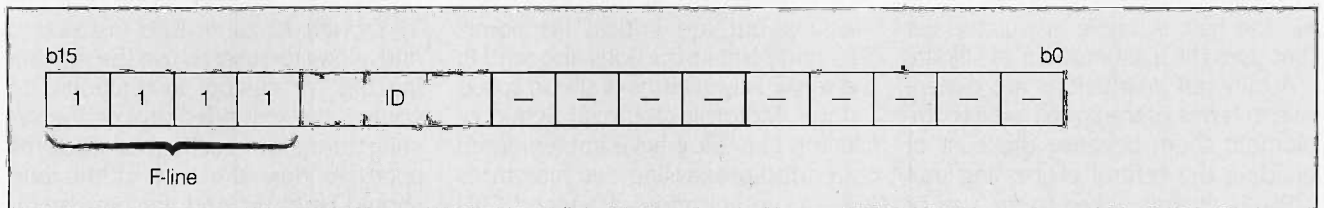

Figure 1: A sample template for an EPU instruction. The CPU will recognize the pattern of four 1s in the high bits as an indicator of an EPU instruction (called an "F-line" since a binary 1111 equals F in base 16). The ID field can be used to select among eight EPUs, and the remaining bits are available to the EPU designer for custom instructions.

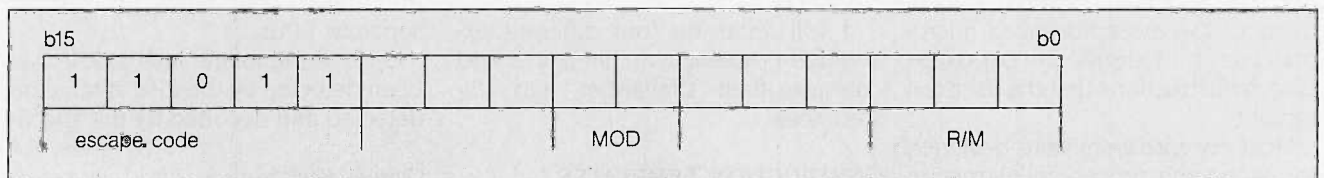

Figure 2: The format of an Intel 8086/8088 EPU instruction.

vent one or the other from using invalid data. Forcing temporary nonconcurrent operation in software is one way of solving the problem.

As mentioned, by not allowing DMA in concurrent mode, synchronization problems are avoided. Another requirement for concurrent mode is a method of determining if the EPU has finished execution. This is done with either a hardware EPUBUSY line or a software register. If a register is used, some precautions in software must be followed to prevent problems.

The following sections give more detailed information on each manufacturer's extended-processing architecture. They are listed in the order in which they were first implemented on a chip.

INTEL 8086 COPROCESSOR INTERFACE

The Intel 8086 Coprocessor Interface is implemented in the 8086/8088 and 80186/80188 microprocessors, although there are slight hardware differences between the implementations. The two coprocessors designed for this interface are the 8087 numeric data coprocessor and the 8089 I/O processor. The 80286 has its own coprocessor interface and a numeric data coprocessor, the 80287, designed for it.

In the Intel system, the EPU is tied directly to the address/data bus, the CPU status lines, and the queue status lines. It uses the same clock as the CPU and also sends busy and interrupt signals to the CPU. Because the 8086 has an internal instruction queue, the EPU must use the CPU and queue status lines to track this queue internally in order to decode an EPU instruction.

The 8086 has two prioritized lines, *rq/gt0* and *rq/gt1*, called request/grant lines. These allow two EPUs to request the CPU address/data bus. (The number is not limited to two, but additional hardware is needed to resolve EPU priority.) The 8087 and 8089 have a daisy-chain priority scheme that allows them to pass bus control to an EPU tied to their request/grant (*rq/gt1*) line.

Table 1: An example of synchronization using 8087 instructions.

	Unsynchronized	Synchronized
case 1	FISP I	FISTP I
	MOV AX,I	FWAIT
		MOV AX,I
case 2	FILD I	FILD I
	MOV I,5	FWAIT
		MOV I,5

To execute an EPU instruction, the architecture uses an escape code, 11011, in the most significant bits of the instruction. The format for the instruction is shown in figure 2. There are 64 memory-reference op codes and 512 nonmemory-reference op codes available. The 8087 uses 57 of the memory-reference and 406 of the nonmemory-reference op codes. If there is a requirement for both a custom EPU and an 8087, the designer should not use any of the 8087 op codes for the custom device.

The escape code identifies the escape (ESC) instruction, and the MOD and R/M bits determine the addressing mode used by the 8086. The rest of the bits are available for EPU instructions.

If the EPU only needs to read memory values of 16 bits or less, the host CPU performs all of the necessary addressing. The EPU simply latches the data value as it appears on the bus during the CPU-generated memory read cycle.

To write to memory or read values of data greater than 16 bits, the EPU must latch the 20-bit address placed on the address/data bus during the T1 clock cycle. It then becomes bus master through the request/grant line and operates as a DMA device, accessing the memory on its own.

Because the CPU and EPU can operate concurrently, when the EPU uses direct memory access there is a synchronization problem. In other words, the EPU can modify memory without informing the CPU. This means that, with some instructions, the CPU must wait to be sure that the EPU is finished and that the final value has been transferred to or from

memory.

The reverse is also true if the CPU is loading a value into the EPU that is larger than 16 bits. The CPU could modify memory before the EPU had a chance to read it. To prevent this, the WAIT instruction is used. WAIT causes the CPU to monitor the EPU Busy line and will not allow the CPU to continue until the EPU is finished processing and accessing memory.

Intel's numeric data processor application note (reference 1) gives several examples of how to avoid synchronization problems. Synchronization can be done explicitly by the programmer, or the compiler can be written to add necessary code automatically. In the latter case, WAIT instructions are automatically inserted after every ESC instruction.

Table 1 is an example of synchronization using 8087 instructions. In the unsynchronized case 1, the CPU might move the value of I before the EPU could modify it. The FWAIT instruction forces the CPU to wait until the EPU is done with the value I. In case 2, the CPU could replace the value of I with 5 before the EPU could read the original value.

One more problem in the 8086 associated with synchronization is known as deadlock. This occurs when the CPU is executing a WAIT instruction and the interrupt path from the CPU to the 8087 is broken. If the 8087 needs to interrupt the CPU for the current instruction, it cannot, and both the CPU and the 8087 sit and wait for each other. Intel's application note on the numeric data processor details ways to avoid deadlock.

There are some special control in-
(continued)

*The CPU performs
all transfers to
and from the EPU.*

structions in the 8087 that do not require synchronization. The 8087 takes exclusive control of the memory bus and prevents the host CPU from interfering with the data values. These instructions do not require a WAIT instruction and cannot cause a deadlock.

The Intel implementation of concurrent processing has some drawbacks, but they can generally be taken care of by the compiler or assembler. The user can either implement concurrency for improved performance or remove it by adding a WAIT after every EPU instruction. Concurrency's major advantage is its inherent performance improvement when both the CPU and the EPU operate in parallel.

If there is no EPU in the system, the host will execute an ESC instruction as if it were an NOP. Although an address is output, the data returned is ignored. This ensures that the CPU will continue to execute the program if the EPU is not there. It also means that the EPU instructions will be ignored.

Because there is no trap mechanism in the EPU architecture for the 8086/8088 and 80186/80188, a decision must be made at compile or assembly time whether to use a hardware EPU or to emulate the function in software. Emulation software for the 8087 is available from Intel. The 80286 does implement an EPU software trap.

ZILOG EXTENDED-PROCESSING ARCHITECTURE

The Zilog extended-processing architecture is supported on the Z8000, the Z800, and the Z80000 CPUs. Zilog has implemented an extended-processing architecture with templates for the custom instructions and a software trap available in case the EPU hardware is not in the system. The first

Zilog EPU is the Z8070 arithmetic processing unit (APU).

The Zilog architecture does not consider memory management an EPU function. The Z8000 implemented memory management is in a separate privileged I/O space, and the Z800 and Z80000 have memory management on chip. Some of the memory-management provisions and exception handling of other architectures are therefore not required.

The general instruction template format is illustrated in figure 3. The first word of the instruction contains a code that identifies it as an EPU instruction and mode information about the data-transfer direction. It also has a 2-bit field defining which of four EPUs will decode the instruction. The blank areas in the template are available for custom EPU instructions. The $n-1$ value means that up to $16n$ words or bytes of data will be transferred. The transfers can take advantage of the 32-bit bus of the Z80000 by transferring two 16-bit words at a time.

Templates include EPU to memory, memory to EPU, EPU to CPU, CPU to EPU, FCW (flag and control word) to EPU, FCW from EPU, and EPU internal operation.

The templates include all of the transfers shown above. This allows the designer to implement memory transfers, EPU to CPU communications, flag test and branch instructions, and internal EPU calculations. Figure 4 shows some sample Z8070 APU instructions. Note that they follow the templates exactly and that only the blank area of the template is used specifically for the custom instruction.

The EPU operates by sitting on the address/data bus and watching the instruction stream. When it sees a bit pattern that it recognizes as an EPU instruction, it will decode it and act accordingly. The EPU uses the CPU status lines in order to determine when to look for its instruction templates.

To allow concurrent operation, the EPU does not do any addressing or data passing on its own. The CPU is in control of the bus and provides all

of the address information to the memory and EPU. This means that within this extended-processing architecture, the EPU cannot operate on its own. It also means that the CPU can respond to interrupts and bus requests and continue to execute other instructions while the EPU is operating on the data. As long as the CPU does not request data from the EPU before it is ready, the CPU continues to operate normally.

If the CPU tries to use an EPU that is busy, in most cases the EPU will respond by temporarily halting the CPU until it finishes its current tasks. This is taken care of by a line coming from the EPU called EPUBUSY. On the Z8000, the CPU STOP pin is connected to EPUBUSY, and the processor can continue only when the EPU comes free or a CPU reset occurs. The Z800 has a PAUSE pin that should be connected to EPUBUSY. A PAUSEd Z800 can continue to respond to refresh requests, bus requests, and CPU resets.

The Z80000 CPU samples the EPUBUSY line, and although it cannot execute instructions, it can accept bus requests and interrupts. If an interrupt or bus request occurs, the CPU saves the address of the extended instruction. The Z80000 also has an EPU Overlap Mode Bit, which can be set or reset by software to enable or disable concurrent operation. This is useful for debugging.

Because the CPU performs all transfers to and from the EPU, all transactions are done at the maximum CPU memory bus speeds. The EPU can also take advantage of any special transfer modes in the CPU, such as "burst mode." Burst mode means that if a single burst memory location is addressed, several data transfers can be made from consecutive addresses. For example, the CPU could send one address to the memory, and the memory would transfer back several consecutive words of data, as opposed to one word of data, for each address. This requires added intelligence in the memory and is taken advantage of by the Z80000 and Z800.

(continued)

2 Megabytes

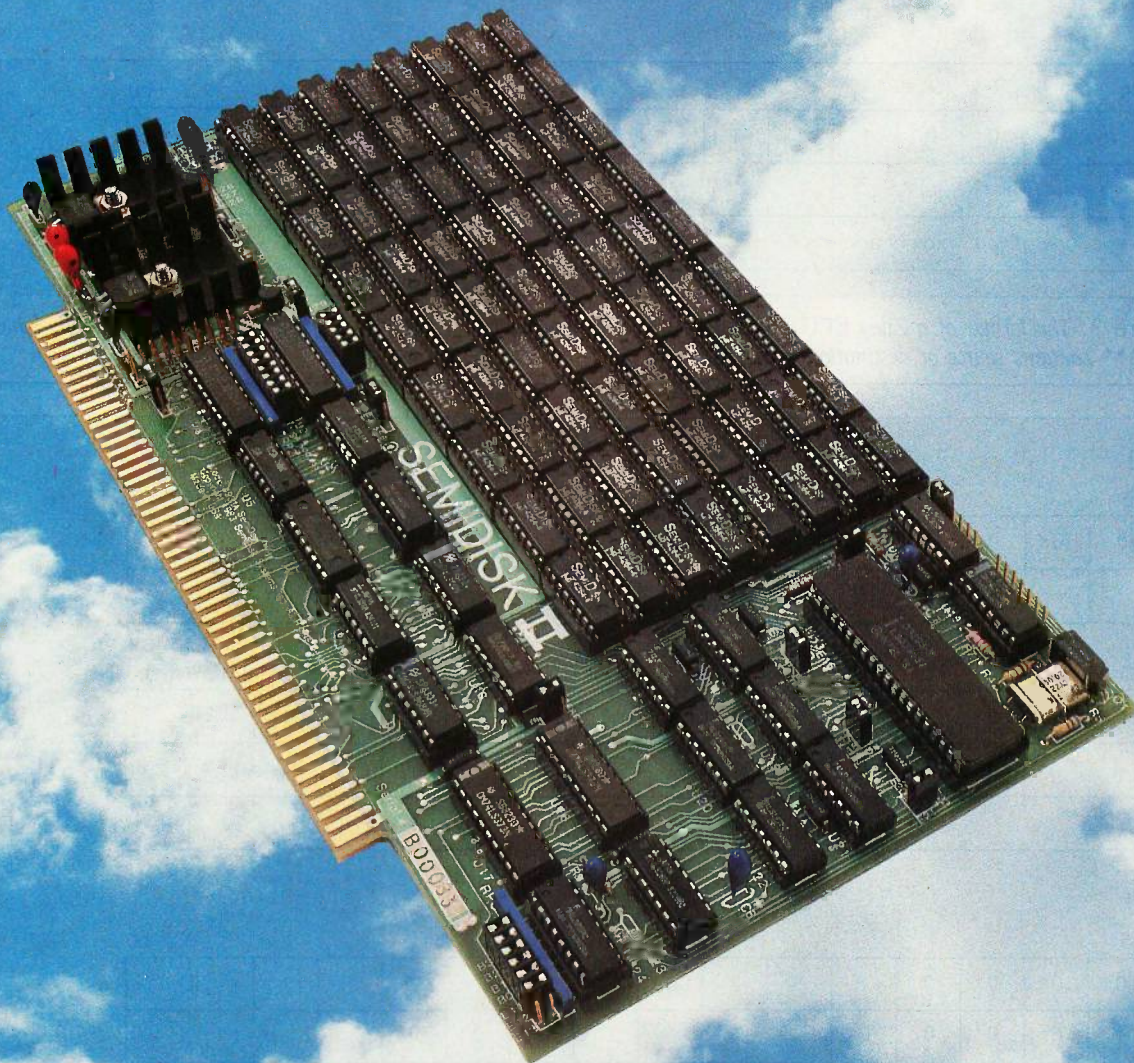

THE LARGEST CAPACITY DISK EMULATOR YOU HAVE EVER SEEN.

You know about disk emulators. They're fast semiconductor disk drives. Very fast. But until now, the most disk storage you could get on a single board was 1Mbyte. (That was from us, too.) Now we have news that'll really blow your socks off... 2 Megabytes on a single board. Available NOW. That's not a pie-in-the-sky promise.

That's enough storage for dozens of large programs and hundreds of kilobytes of data files. Enough for almost anything you want to do with a disk drive. But that's not all. With SemiSpool, our CP/M print spooler, you can implement a print buffer hundreds of kilobytes long in seconds. All in software. At no extra cost.

Another thing about disk emulators. Unless they're from SemiDisk Systems, they're probably afraid of the dark: Lose power or turn the computer off, and your valuable data goes to that big backup disk in the sky. But our Battery Backup Units keep SemiDisk data flying high while your computer is off, and up to 10 hours during a complete blackout.

So remember this: SemiDisk Systems has been building dedicated microcomputer disk emulators longer than anyone. And larger. And faster. And at a much lower cost. And that's not a lot of hot air.

AT A PRICE YOU NEVER THOUGHT YOU'D SEE

	512K	1Mbyte	2Mbyte
SemiDisk I, S-100	\$995	\$1795	
SemiDisk II, S-100	\$1295	\$2095	\$2549
IBM PC, XT, AT	\$945	\$1795	\$2499
QX-10, QX-16	\$799		\$2499
TRS-80 II, 12, 16	\$995	\$1795	\$2499
Battery Backup Unit	\$150		

SEMIDISK

SemiDisk Systems, Inc.
P.O. Box GG, Beaverton, Oregon 97075
503-642-3100



Call 503-646-5510 for CBBS/NW, 503-775-4838 for CBBS/PCS, and 503-649-8327 for CBBS/Aloha, all SemiDisk-equipped computer bulletin boards (300/1200 baud). SemiDisk, SemiSpool trademarks of SemiDisk Systems. CP/M trademark of Digital Research.

MICRO ARCHITECTURES

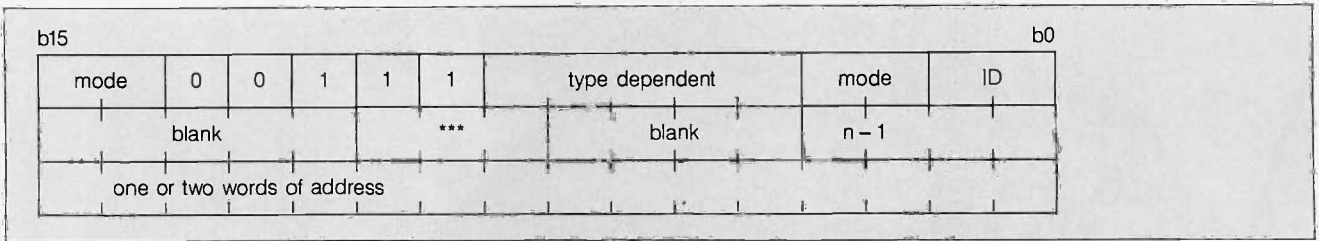

Figure 3: The format of a Zilog EPU instruction. ID selects among four EPUs, $n-1$ specifies number of words or bytes loaded, and *** contains source or destination information.

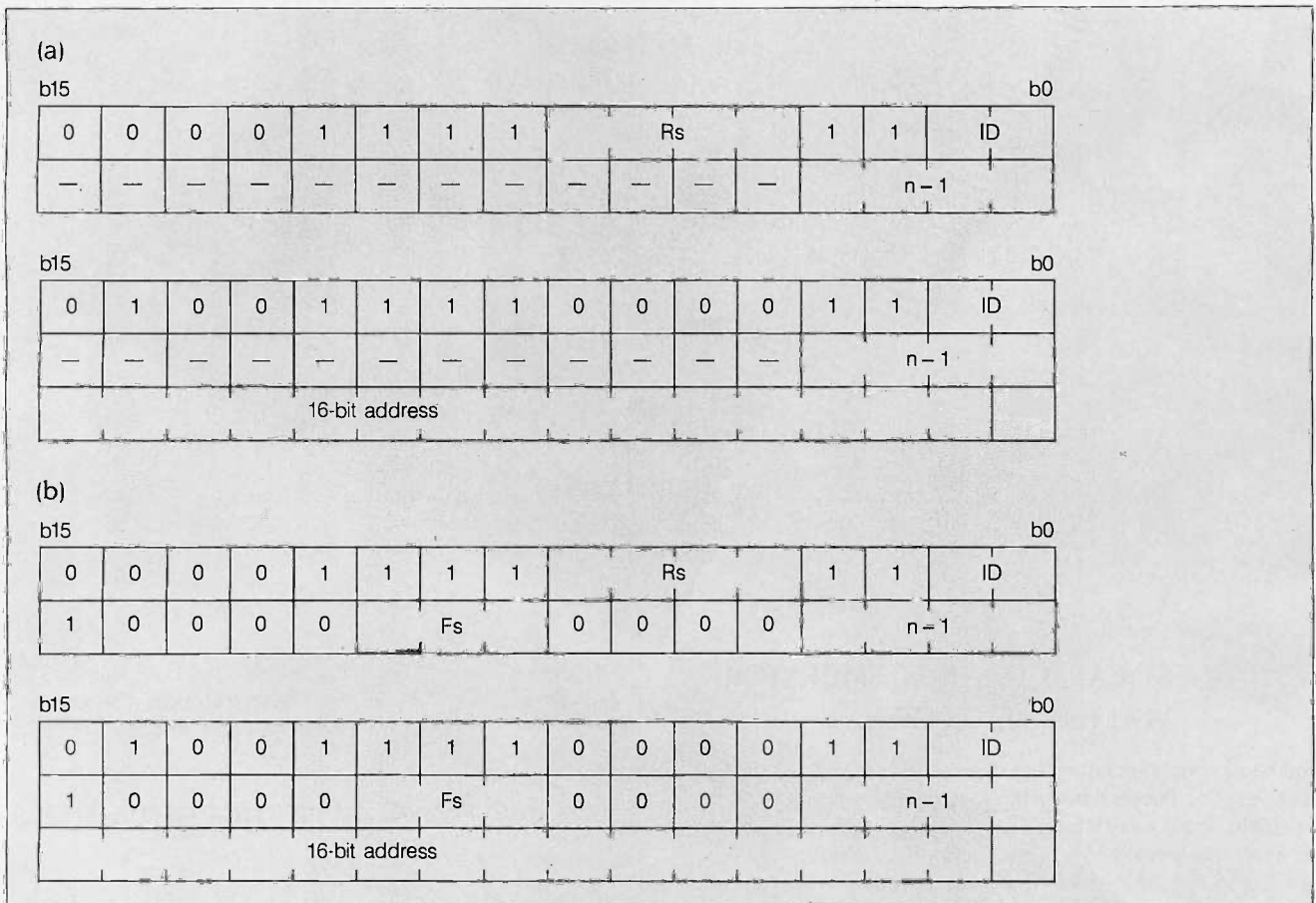

Figure 4: (a) A Zilog EPU-to-memory transfer instruction template for indirect register (IR) addressing mode (above) and direct addressing (DA) mode (below). Rs is the CPU register used in the IR addressing mode. (b) Actual Z8070 instructions using the templates in (a). This is a floating-point number load (FLD) instruction. Fs is the EPU register loaded; $n-1$ indicates the floating-point number's precision—single, double, or double-extended.

The Z8070 APU will have some speed advantages of its own. It will have two simultaneous clock speeds, one for its bus interface and one for its internal operation. This means that the APU will operate internally at its maximum speed while transferring data at a speed that the CPU and

memory can handle. It also will allow the CPU to load data while the APU is executing instructions. This feature is very handy for matrix calculations and speeds up the total execution time.

The Z8070 also will have four separate interfaces, which are select-

able by two input lines. These include the Z8000, Z80000, and Z800 as well as a universal interface. The universal interface makes the Z8070 look like a peripheral on the CPU bus. The Z8070 is not yet available, although it should be out in 1985.

(continued)

Princeton Graphic Systems and Sigma Designs team up to give you a brighter, sharper display.

SR-12 and Color 400. A brilliant combination for super-high resolution graphics and a crisp character display. For a brighter, sharper display with all your IBM PC-compatible software here's a team that can't be beat. The SR-12 super-high resolution RGB monitor from Princeton Graphic Systems and Color 400, the advanced color graphics adapter card from Sigma Designs.



SR-12

Snap in Color 400. Begin by snapping Color 400 in to your IBM PC, XT, or AT. No switches to set. No cables to confuse. Color 400 gives you a razor sharp 640 x 400 display. It

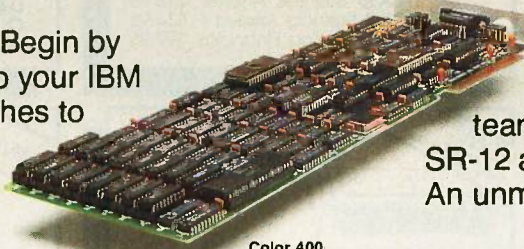

Color 400

automatically *doubles* the number of lines on standard 200 line software. Watch your graphics come to life. Enjoy fully formed, monochrome-quality characters in text mode. Just turn on your PC and tune in a whole new world of vibrant color.

**COLOR
400**

Turn on SR-12 for the impressive results. The SR-12 displays your Color 400 image with unmatched clarity and brilliant color. Because the SR-12 combines a .31mm dot pitch tube and a non-glare screen with an incredible 640 x 400 non-interlaced resolution, you get a flickerless image that's as crisp and clean as a personal computer can produce.

See how impressive this state-of-the-art image can be on your own PC system. Visit your local retailer today and ask about this new color graphics team. Princeton Graphic System's SR-12 and Sigma Designs' Color 400. An unmatched, brilliant combination.

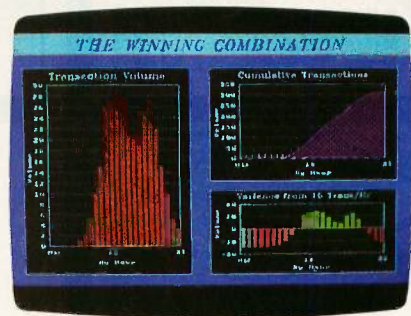

SIGMA DESIGNS, INC., 2023 O'Toole Avenue, San Jose, CA 95131
(408) 943-9480 Telex: 171240



Princeton Graphic Systems, 601 Ewing Street, Bldg. A, Princeton, N.J. 08540
(609) 683-1660, Telex: 821402 PGS PRIN, (800) 221-1490 Ext. 204

Graphic Screens courtesy Mouse Systems, Inc. and Forthright Systems, Inc.

IBM PC, PC XT, and PC AT are registered trademarks of International Business Machines, Inc.

MICRO ARCHITECTURES

The Z8000, Z800, and Z80000 all have this extended-processing architecture implemented in their instruction sets. Except as noted on the Z80000, they are very similar. Although the Z8070 APU for floating-point math will be the first EPU from Zilog, almost any custom chip can be designed to work with the EPU architecture.

In addition, the EPU interface can be used for non-EPU applications.

The interface can be used to provide a separate workspace outside of memory or I/O space and implement multiple stacks, slave buffers, or a high-speed block-transfer mechanism. (See reference 14.)

NATIONAL SEMICONDUCTOR'S SLAVE PROCESSOR INTERFACE

National Semiconductor has implemented an extended-processing architecture for the Series 32000 micro-

processor family. It is designed to support floating-point operations, memory management, and custom processors. In addition, it will allow compatibility with a later version device, which will integrate some or all of the functions on one chip when the technology is feasible.

National refers to its EPU as a "slave" processor because the host CPU performs all addressing and data trans-

(continued)

FREE SHIPPING ON ORDERS OVER \$100

HEWLETT-PACKARD

10 SERIES

Scientific

HP-11C \$ 55.95
HP-15C \$ 87.95

Financial

HP-12C \$ 87.95

Computer Science

HP-16C \$ 87.95

Solutions Books

HP-12C Training Guide \$ 15.00
HP-15C Advanced Functions \$ 20.00

TEXAS INSTRUMENTS

CALCULATORS

Scientific

TI-35II \$17.95
TI-55II \$42.95

Financial

TI-BA35 Business Analyst \$18.95
TI-BA-II Business Analyst II \$34.95
TI-5310 Printing Financial \$99.95

DIABLO PRINTER

Diablo

630/API Daisywheel \$1459
630/ESC Daisywheel \$1615
D-25 Daisywheel \$ 599
D-80 Daisywheel \$2395
C-150 Color Inkjet \$ 985

HEWLETT-PACKARD

40 SERIES

HP-41CV Scientific . . \$169.95
HP-41CX Scientific . . \$239.95

Peripherals

82160A HP-IL Interface \$ 96.25
82104A Card Reader \$150.15
82181A Extended Memory \$ 60.00
82059D Recharger \$ 16.00
82120A Battery Pac \$ 28.00

HEWLETT-PACKARD

THINKJET PRINTER

\$399.00

Accessories

92261A Ink cartridge \$ 7.95
92261N Fanfold Paper (2500shts) \$ 44.95
92261S Printer Stand \$ 39.95
82199A Replacement Battery Pac \$ 39.95

COMREX

\$ 750

The **Comrex IV** is a low-price, reliable, 36 cps Daisywheel printer manufactured by Brother and distributed by Epson (Mid-Atlantic).
Brother is a trademark of Brother International.
Epson is a trademark of Epson America Inc.

HEWLETT-PACKARD

70 SERIES

HP-71B Handheld Computer **\$389.95**

Peripherals

82400A Card Reader \$127.05
82401A HP-IL Interface \$ 96.25
82420A 4K Memory Module \$ 60.00
82490A 7/141 Transistor Pac \$ 96.25
82441A FORTH Assembler . . \$115.50



CAPITAL MICRO

Washington, DC 20912

(800) 544-4442

Western U.S. and Maryland
Call Collect
(301) 565-3595

TERMS:

- * Free Shipping on orders over \$100.
- * **NO ADDITIONAL CHARGE** for credit cards.
- * MD residents add 5% sales tax.
- * Credit references required for open account.
- * Allow 2 weeks for personal checks.



HEWLETT-PACKARD

ADDITIONAL ITEMS

82161A Cassette Drive . . **\$423.00**
82162A Thermal Printer **\$349.50**
9114A HP-IL Disc Drive **\$625.00**
82143A Printer **\$295.00**
92192A DS/DD Discs . . . **\$ 55.20**
82164A IL/RS-232 Interf. . . **\$227.15**

PRINTERS



EPSON

RX80 Dot Matrix \$ 229
RX80-FI Dot Matrix \$ 289
RX100 Dot Matrix \$ 389
FX80 Dot Matrix \$ 409
FX100 Dot Matrix \$ 569
LQ1500 NLQ \$1099
LX80 Dot Matrix CALL
LX100 Dot Matrix CALL

OKIDATA

92 Dot Matrix \$ 365
84 Dot Matrix \$ 679

BROTHER

HR-15XL Daisywheel \$ 349
HR-35 Daisywheel \$ 799
2024 NLQ \$ 899

RamTape-PC.™

Because backups should do more than just take, take, take.



The trouble with conventional hard disk backups is that backing up is all they do. They take and store information—and can take a lot of time and effort doing it—but they don't help you use that information.

RamTape-PC is a complete data storage peripheral that does more than just take data from your PC; it gives you new and advanced capabilities.

It gives you: Electronic disk—a RamTape-PC exclusive. Load data into its 360 Kbyte RAM, without reducing user's memory. Breeze through file editing and spread sheets. With an access

time measured in nano-seconds, the electronic disk speeds every function.

It gives you: A floppy library capability—another RamTape exclusive. Store the contents of 32 double-sided floppies on one cartridge; it's more manageable, less expensive. And you access files up to 50 times faster.

It gives you: A choice of hard disk backup, either file or image oriented. A complete 10MB file by file backup requires less than 15 minutes, with no user intervention. Image backup is even faster. The file mode of backup allows great flexibility providing for backup and restoration of specific files

which meet selected criteria.

Even with its exclusive features, RamTape-PC costs no more than ordinary backups. So why settle for a system that only takes, when the RamTape-PC gives, gives, gives?

For details contact Qantex, 60 Plant Ave., Hauppauge, NY 11788. Call toll-free 800-645-5292; in NY State 516-582-6060.

 **north atlantic**
Qantex

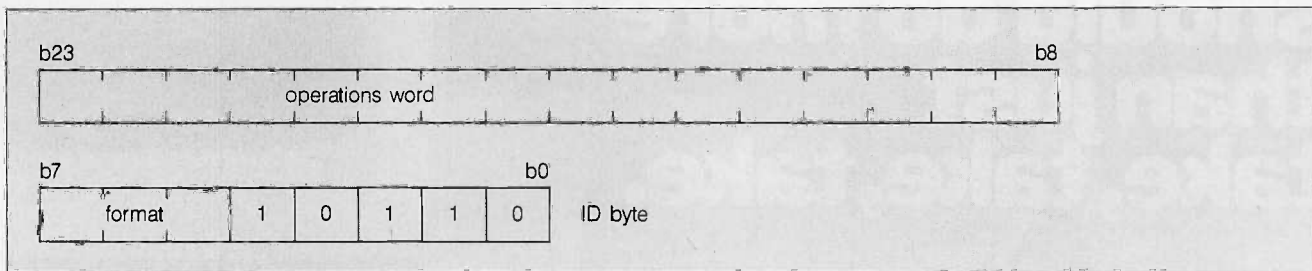

Figure 5: The format of a National Semiconductor Series 32000 microprocessor EPU instruction.

Table 2: The National EPA protocol.

Step	Status	Action
1	1111	CPU sends ID byte
2	1101	CPU sends operation word
3	1101	CPU sends required operands
4	—	EPU starts execution; CPU prefetches
5	—	EPU pulses AT/SPC low
6	1110	CPU reads status word
7	1101	CPU reads results, if any

fers. The EPU sits on the address/data bus and watches for the ID byte that identifies an EPU instruction, the operand word format, and (in case of a multi-EPU system) which EPU will manipulate the data. The host CPU routes the data to the specified EPU, and the EPU then performs whatever action the instruction specified. Each instruction consists of 24 bits—the ID byte and an operation word that specifies size and number of operands, addressing modes, and the type of operation (see figure 5).

The 32032 CPU contains 3 bits in its configuration (CFG) register that correspond to custom (C), memory-management (M), and floating-point (F) EPUs. The bits are set on initialization of the CPU, using the SETCFG command. If EPU hardware is in the system, the appropriate bit should be set and the EPU instructions will execute. If the bit is reset, an EPU instruction will trap to a software routine.

In order to maintain software compatibility with a future device, which could integrate memory-management and floating-point math functions on a single chip, National has specified both floating-point and memory-management operation codes in its in-

struction set. These instructions each have separate ID byte codes.

National also specifies a set of custom EPU instructions, including those to calculate, move, compare, convert, and load and store status registers. Three privileged instructions can be executed only in supervisor mode: test, and custom register load and store. The designer can specify the op codes and data types for these instructions in the operand word. Operand transfers can use any of the addressing modes.

The actual EPA protocol uses the host CPU status lines and a line called slave processor control (AT/SPC). Four status codes are used for the protocol:

Send ID	1111
Xfer operand	1101
Read status	1110
Waiting for EPU	0011

The AT/SPC line is bidirectional and pulsed low for transactions.

The EPA protocol shown in table 2 is documented in reference 8. In step 1, the CPU starts to execute an EPU instruction and outputs the ID byte on the address/data bus and status 1111 on the status lines. The EPUs decode

the ID, and only the appropriate EPU continues to talk to the CPU. In step 2, the CPU outputs the operand word, with 1101 on the status lines.

At this point, both the CPU and the EPU have decoded the operand word, and the CPU transfers as many operands as were specified, with 1101 on the status lines. Once all the operands are transferred, the EPU begins execution, signaling this by pulsing the AT/SPC line.

The CPU can continue to fetch instructions into the 8-byte prefetch until it is filled. At that point, the CPU waits for the EPU to finish and places 0011 (waiting for EPU) on the status lines. The CPU and EPU do not execute concurrently.

When the EPU is finished or wants to communicate with the CPU, it will pulse the AT/SPC line and the CPU will read a status word in the EPU by placing 1110 on the status lines. The status word contains a number of flags set depending on the results of the EPU's operations, including a Q flag that indicates an error detected by the EPU.

In the last step of the protocol, the CPU transfers any results from the EPU to their destinations and places 1101 on the status lines. There are two exceptions to this protocol: the load-memory-management-register (LMR) and the load-custom-register (LCR) instructions. These are direct transfer instructions and do not require any acknowledgment or status information from the EPU.

MOTOROLA COPROCESSOR INTERFACE

The Motorola Coprocessor Interface is implemented in the recently re-

(continued)

NOW THAT THE PC FAD IS OVER, IT'S TIME TO GET DOWN TO BUSINESS.

Like hordes of locusts, the PC swept the business community. Corporations bought them like electronic calculators by the thousands to improve the productivity of their executives. Portables were carried home from the office every evening and on trips. Computerization was even affordable to the small business for the first time. Programmers put their unique genius to work to develop some of the best software ever written. Productivity tools like word processing, electronic spread sheets, data base management and accounting was placed into the hands of new computer users. Productivity improved for everyone. From the CEO . . . to his staff . . . to the salesman . . . to his secretary. Forecasts for continued PC growth were nothing but highly optimistic. One at every desk. One in every home. What happened?

"Networking won't solve the multiuser problem either economically or functionally."

Like the first crust of any marketplace it saturated quickly. Those that are the first to buy almost anything new and promising, bought. There are no more computer hackers and hobbyists to sell to. They all have one. Applications for the home that made any sense didn't develop. Corporations found that they needed PCs to "talk" to each other. That solution is distant because networking won't solve the problem either economically or functionally. Most available networking does nothing more than messenger floppies around. The small business found that as soon as its first PC was operational and productive, a second one was needed to satisfy demand usage. The PC, with all its promises, turned out to be a dead end for the business environment. The PC and clones just haven't been the godsend for business that was predicted. Why?

The PC is a personal computer. Just that. Not a business computer. That's because PCs are single user computers with single user software. Good for one person but not good enough for a whole company. Even if the company is two people.

Every computerized business has someone entering information while someone else is looking up information.

That's two users. And every business has more than two users who need access to the computer. That's a multiuser computer environment.

"The small business needs a second PC as soon as the first one is working."

It's now hard to justify PCs in a business environment. A multiuser computer capable of supporting up to five users is available for the price of a single IBM PC XT. It has more storage and a business oriented operating system. Supermicros are available that have the power of minicomputers without the accompanying price tag. Ten unconnected PCs, sitting around worth about \$50,000, doesn't make sense when for much less you can get a lot more computing power in a supermicro that accommodates 20 or more users. But don't let even that price tag scare you. On a per user basis, multiuser computers cost about \$1500 less than a PC. New users can be added for less than \$600 with a dumb terminal. And they're upgradable.

"A six port multiuser computer is now available for the price of a single IBM PC XT . . . micro-computer systems cost \$1500 less per user than multiple PCs."

Multiuser computers communicate with each other. They share the same data base, software and peripherals. They have sophisticated business features such as record locking, user accounting privilege levels and system security. They are business oriented and priced well within the reach of the first time computer user.

But what about all the PCs already in place? Don't ask the PC manufacturer for a solution. They're concentrating on selling more single user systems. The real solution is to get started with a true multiuser computer in the first place. With multiuser business computers now in the same price range as a PC, it doesn't cost any more to make the first step the right step.

The PC has seeded the next wave. It's here now. Supermicro multiuser computers that can support up to 32

users. If you don't believe it just look at the new product introductions from IBM, DEC and AT&T, let alone the smaller companies like Altos, Plexus and IBC. Big system features for every end user. Software for every conceivable specialized business application. That's not the end of it. New challenges are there for everyone. Opportunities abound. Software companies are already applying their talents to multiuser operating systems, disk conversion and even more powerful and productive software. Companies are shifting their emphasis to provide multiuser system enhancements as they did for the PC. Value added resellers and specialist dealers will give the end user the support that's been terribly lacking from department store retailers. It's a great day for someone who needs a multiuser computer. And everyone does.

"Multiuser computers share everything . . . they have business features such as record locking, user accounting, privilege levels and system security."

Thanks PC! You've whetted the appetite of a large new business environment for computerization. One that is bigger, more demanding, and more sophisticated than we've ever seen before. There's no turning back now. You were a fad, but now it's time to get down to business . . . multiuser business.

Randy L. Rogers

Randy L. Rogers
President and CEO
IBC/Integrated Business Computers
Manufacturer of Multiuser Computers
Chatsworth, California.

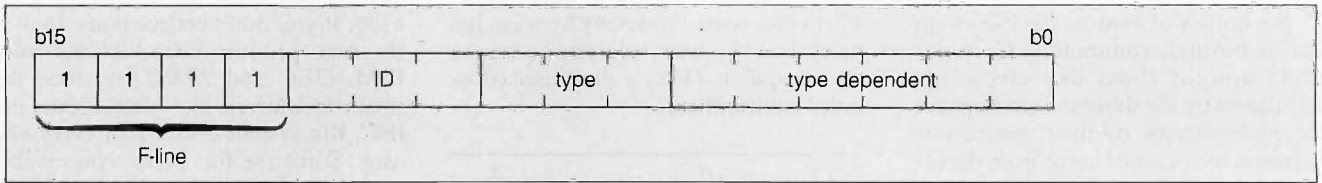

Figure 6: The format of a Motorola EPU instruction for the 68020 microprocessor. "Type" and "type dependent" are defined for each specific instruction.

Table 3: The 11 registers in the Motorola EPU architecture register space.

Register	Description
Response	16-bit, used by the EPU to request action
Control	16-bit, used to acknowledge or abort an EPU instruction
Save	16-bit, used to initiate save operation
Restore	16-bit, used to initiate restore operation
Operation	16-bit, saves EPU operation word
Command	16-bit, used for general instructions
Condition	16-bit, used for branch and conditional instructions
Operand	32-bit, passes data operands
Register	optional, used for register primitives
Instruction	optional, instruction address
Operand Address	optional, operand address

leased 68020 32-bit microprocessor. It is not implemented in the 68010, 68012, 68000, or 68008, but a software trap is available in those processors to allow software emulation of the coprocessor instructions.

In the Motorola system, the EPU is a peripheral on the bus but operates in the CPU address space. An EPU instruction will automatically access this address space by producing the status code 111 on the processor status lines. Decoding logic is required to recognize the status 111 and differentiate among up to eight EPUs. Two of the eight EPU identity codes are reserved for user-definition; one specifies the 68851 Paged Memory-Management Unit, and one is for the 68881 Floating Point Coprocessor. The remaining four are reserved by Motorola. The EPU must also decode address lines A4 through A0 to specify the register set.

Externally, the 32 bits of address are as follows:

A31-A20	xxx	Don't care
A19-A16	0010	EPU operation
A15-A13	ID	EPU identity

A12-A5	0..0	Operation as an EPU
A4-A0	R	EPU register

In addition to the status lines indicating a CPU space access, address bits A19-A16 define an EPU operation. Bits A15-A13 define which EPU, and A4 through A0 tell which register (specified in the EPU architecture). The first 16 bits of each instruction are shown in figure 6.

The CPU recognizes an EPU instruction in the microcode and will go to supervisor, or privileged, mode. The 68020 will then produce the status code 111 and expect to receive a data transfer and size acknowledge signal (DSACKx) if there is an EPU resident in the system. If no acknowledgment is received, a bus error occurs. The CPU then generates a software trap and jumps to a specific address where the EPU function can be emulated in software. This trap is completely automatic and does not require any system-initialization software.

The EPU instruction set is defined by the "type" code in the EPU instruction. This 3-bit code defines eight dif-

ferent instruction formats, including the following:

- general instructions that are used for passing EPU specific commands in a template format
- conditional and branch instructions, including word and long word branches, set conditional and decrement-and-branch conditional, and trap conditional instructions
- save and restore instructions to save and restore the internal state frame of the EPU, a variable size block of status, or other information in the EPU on demand (see reference 9 for further information)

The EPU architecture specifies 11 registers in the register space, 8 of which are required by the EPU instructions. Table 3 lists the 11 registers.

There are also 18 EPU primitives, or responses and commands, passed from the EPU to the CPU. These include exception handling, synchronization, instruction stream manipulation, and operand and register transfer. These primitives use the response register to talk to the CPU.

The transfer of operands to and from memory and between the CPU and EPU is made using the operand register. CPU and EPU transfers simply read and write to the operand register. Memory and EPU transfers require that the operand pass through a temporary register in the CPU and use the CPU to EPU transfer. If the EPU has DMA capability, it can transfer data directly to and from memory after first taking control of the memory bus.

In addition, the instruction stream manipulation primitive allows a kind of block move; up to 256 bytes can be transferred to and from memory

(continued)

MARCH INTO SPRING WITH.....

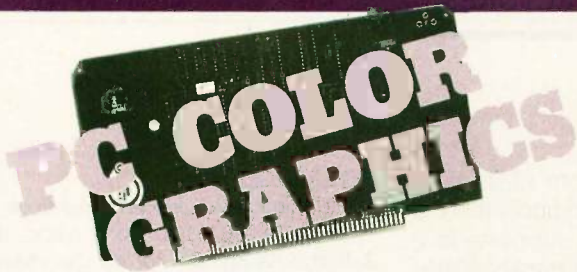

COLOR MAGIC: IBM-PC compatible \$100 BUS graphics board.

Gives your 16 bit S100 BUS system IBM-PC compatibility. ■ RGB and composite outputs ■ IBM PC keyboard port ■ All IBM-PC display modes plus two higher resolution modes
PRICE16K — \$595.0032K — \$695.00



LIGHTNING ONE: The standard by which other 16 bit boards are judged.

The LIGHTNING ONE offers math processing capabilities only available on large mainframes previously. ■ Up to 10MHz operation ■ 8MHz 8087 option ■ Optional 8089 coprocessor
PRICES start at \$425.00 8086/87 (8MHz) \$900.00
 8086 (10MHz) \$625.00

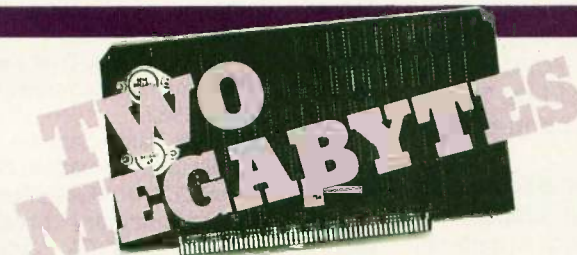

MEGARAM: High performance high density Dynamic RAM.

Offers cost effective memory expansion in 16 bit systems. ■ No wait states with 8086's up to 10MHz ■ Only one wait state with 6MHz 80286 ■ Up to two MegaBytes of memory
PRICE ... 256K — \$595.00 ... 512K — \$1095.00
 1024K — \$1995.00 ... 2048K — \$3795.00



THUNDER 186: Single board 16 bit microprocessor offers 10MHz 8086 performance.

THUNDER requires no other support boards. ■ 256K RAM ■ FDC controller ■ 2 Serial ports ■ Parallel printer port ■ Concurrent DOS is included
PRICE \$1595.00



LIGHTNING 286: Highest performance processor available on the S100 BUS.

This 6MHz 80286 offers performance equivalent to a 14 MHz 8086. ■ 5 times IBM-PC performance ■ 16 Mbyte physical memory space ■ 1 Giga byte virtual address space
PRICE 80286 — \$1095.00 80286/287 — \$1649.00

NEW PRODUCTS!

■ WINCHESTER/FLOPPY CONTROLLER

Controls both floppy drive and Winchester drives from one board. Save slots and money. Features include: error correction, 16 head control, mixed 5¼ and 8" floppy drives. The price is less than one popular manufacturer charges for a floppy only controller. **PRICE** \$649.00

■ MEMORY DISK

I/O mapped memory drive expandable to 16 Mbytes by cascading boards. Each board may contain up to 2 Mbytes and may be battery protected. Parity is included to insure corrupted data does not go undetected. The board is entirely COMPUPRO software compatible. **PRICE** 2 MBYTES \$2595.00

Dealer inquiries invited.

Computer Systems . . .

LOMAS DATA PRODUCTS offers a full line of single and multi-user computer systems, including systems compatible with the IBM-PC and PC-AT. If you have a requirement for a high performance 16 bit computer system and require IBM-PC compatibility call LOMAS DATA PRODUCTS, the only supplier of S100 BUS PC compatibles.



LOMAS DATA PRODUCTS, INC.

66 Hopkinton Road, Westboro, MA 01581
 Tel: (617) 366-6434 □ Telex: 4996272

For orders outside the U.S., contact our dealers:
 □ **Australia** — LAMRON PTY. LTD., (02 808-3666)
 □ **England** — FULCRUM 0621828763; RATIONAL SYSTEMS 0908-613209 or 0908-611349.

Prices and specifications are subject to change.

*CP/M-86, MP/M-86 and CONCURRENT DOS are trademarks of Digital Research.
 **MS-DOS is a trademark of Microsoft
 ***Lightning One is a trademark of Lomas Data Products, Inc.
 ****PC-DOS is a trademark of IBM

with a single instruction.

The architecture is designed to support nonconcurrent operation and does not address the synchronization problems of a concurrent system. However, some concurrent extensions are provided. For example, although there is no hardware "busy" line from the EPU, the CPU can monitor the response register to determine if the EPU has finished executing. Of course, this requires some provisions in software for full implementation.

The architecture also covers exception handling of protocol violations, illegal instructions, bus errors, reset, and trace instruction execution on the main processor. These are generally handled by using the DSACKx signals and the trap mechanism of the 68020.

CONCLUSION

It is only fair to note that the architecture that has the most problems was also the first implementation. The Intel 8086/8088 architecture is the most primitive and the least general purpose. It does support some concurrent operation, but not easily. However, some of the problems have been addressed on the 80286, including a software-trap provision.

The Zilog architecture is general purpose enough for custom applications but also tightly coupled to allow high performance. Placing the EPU on the address/data bus with its own decoding capability allows a very transparent operation, with a minimum of external hardware. This does

require that any custom EPUs have some intelligence. In addition, it is the only architecture that supports true concurrent processing transparently.

The National implementation was designed to allow later integration of its EPUs on the same chip with the CPU without requiring software modification. It specifies three separate sets of EPU instructions, including floating-point, memory-management, and custom. The design, which is also tightly coupled with the CPU bus, requires fairly intelligent EPUs. The architecture does not support concurrent operation.

Motorola has the most elaborate set of instructions, including compare and branch instructions and a general-purpose instruction. It is probably also the most general purpose of the four architectures, because it uses a separate address space and does not place many requirements on the EPU. It is not as tightly coupled with the CPU and lacks hardware definitions. Introduced on the 68020, it is not implemented on any other CPU, although Motorola notes that it can be emulated in software. It does not directly support concurrent operation.

Extended-processing architectures, in their various forms, serve to extend a general-purpose processor instruction set for specialized applications. Many newer EPAs offer both transparency and concurrency; strong trends toward these features can be expected in future development. ■

REFERENCES

1. *Intel Microsystem Components Handbook*, Vol. 1. Santa Clara, CA: Intel Corporation, 1984.
2. *Intel iAPX 86/88, 186/188 User's Manual*, programmer's reference. Santa Clara, CA: Intel Corporation, 1983.
3. *Zilog 1983/84 Components Data Book*. Campbell, CA: Zilog Inc., 1983.
4. *Zilog Z8000 CPU Technical Manual*. Campbell, CA: Zilog Inc., January 1983.
5. *Zilog Z80,000 CPU Preliminary Technical Manual*. Campbell, CA: Zilog Inc., September 1984.
6. *Zilog Z8070 Z8000 Floating-Point Emulation Package*, user's manual. Campbell, CA: Zilog Inc., March 1983.
7. *NS16000 Databook*. Santa Clara, CA: National Semiconductor Corporation, 1983.
8. *NS32032-6, NS32032-10 High-Performance Microprocessors*, preliminary product specification. Santa Clara, CA: National Semiconductor Corporation, February 1984.
9. *Motorola MC68020 32-bit Microprocessor User's Manual*. Englewood Cliffs, NJ: Prentice-Hall, 1984.
10. Groepler, Paul F., and James Kennedy. "The MC68020 32-bit Microprocessor." *BYTE*, November 1984, page 159.
11. Simington, R. B. "The Intel 8087 Numerics Processor Extension." *BYTE*, April 1983, page 154.
12. MacGregor, Doug, Dave Mothersole, and Bill Moyer. "The Motorola MC68020." *IEEE Micro*. Volume 4, No. 4, August 1984, page 101.
13. Huntsman, Clayton, and Duane Cawthron. "The MC68881 Floating-Point Coprocessor." *IEEE Micro*. Volume 3, No. 6, December 1983, page 44.
14. McMahon, Steve. "Extended Processing Units Expand Microprocessor Computing Power." *EDN*. Volume 24, Issue 24, November 29, 1984, page 139.

THE \$2395 DEVELOPMENT SYSTEM

Turns any personal computer into a complete micro-computer DEVELOPMENT SYSTEM. Our integrated control/display program runs under MS-DOS, CP/M, ISIS, or Apple and controls the UDL via an RS-232 port.



Up to 128K bytes of EMULATION ROM (8K standard) allows you to make program patches instantly. Since the target ROM socket connects data and address lines to both the analyzer and the emulator, no expensive adaptors or personality modules are needed.

The powerful BUS STATE ANALYZER features four-step sequential triggering, selective trace, and pass and delay counters. Symbolic trace disassemblers and debuggers are available for Z-80, 8048, 6500, 6800, 8031, 8085, Z-8, 1802, 8088/80188, 8086/80186, R65 and 68000.

PROM PROGRAMMER also doubles as a STIMULUS GENERATOR.

For further information, call or write:
ORION Instruments
 702 Marshall St., Suite 614
 Redwood City, CA 94064

(415) 361-8883

INTRODUCING ANTHROCART.™

WORKSPACE FOR THE HUMAN RACE.

AnthroCart is a serious workstation. Designed specifically with your uses in mind, the AnthroCart takes up little space, yet expands to grow right along with you and your system. Adjustable shelves, swing-out baskets and other modular components give you the flexibility you need.

AnthroCart is also a real beast of burden, tough enough to support up to 150 lbs., yet mobile enough to roll next door or down the street. And its durable steel-base construction stands up to both human and machine (so much so, we offer a five-year, unconditional guarantee!).

To order your AnthroCart, or to get more information, call toll free:

1-800-547-4000, Dept. 501

In Oregon, call (503) 684-3000, Dept. 501.

VAR and dealer inquiries welcome.



AnthroCart shown with printer basket option.

Basic AnthroCart list price \$495.

Also available in Oak Finish.

ANTHRO
A subsidiary of
TEKTRONIX, INC.

Anthro Corporation
3221 NW Yeon Street
Portland, OR 97210
TWX (910) 333-6481
Inquiry 31

TIE IT ALL TOGETHER WITH THE ANY-PORT-TO-ANY-PORT SMART SWITCH. \$1895.

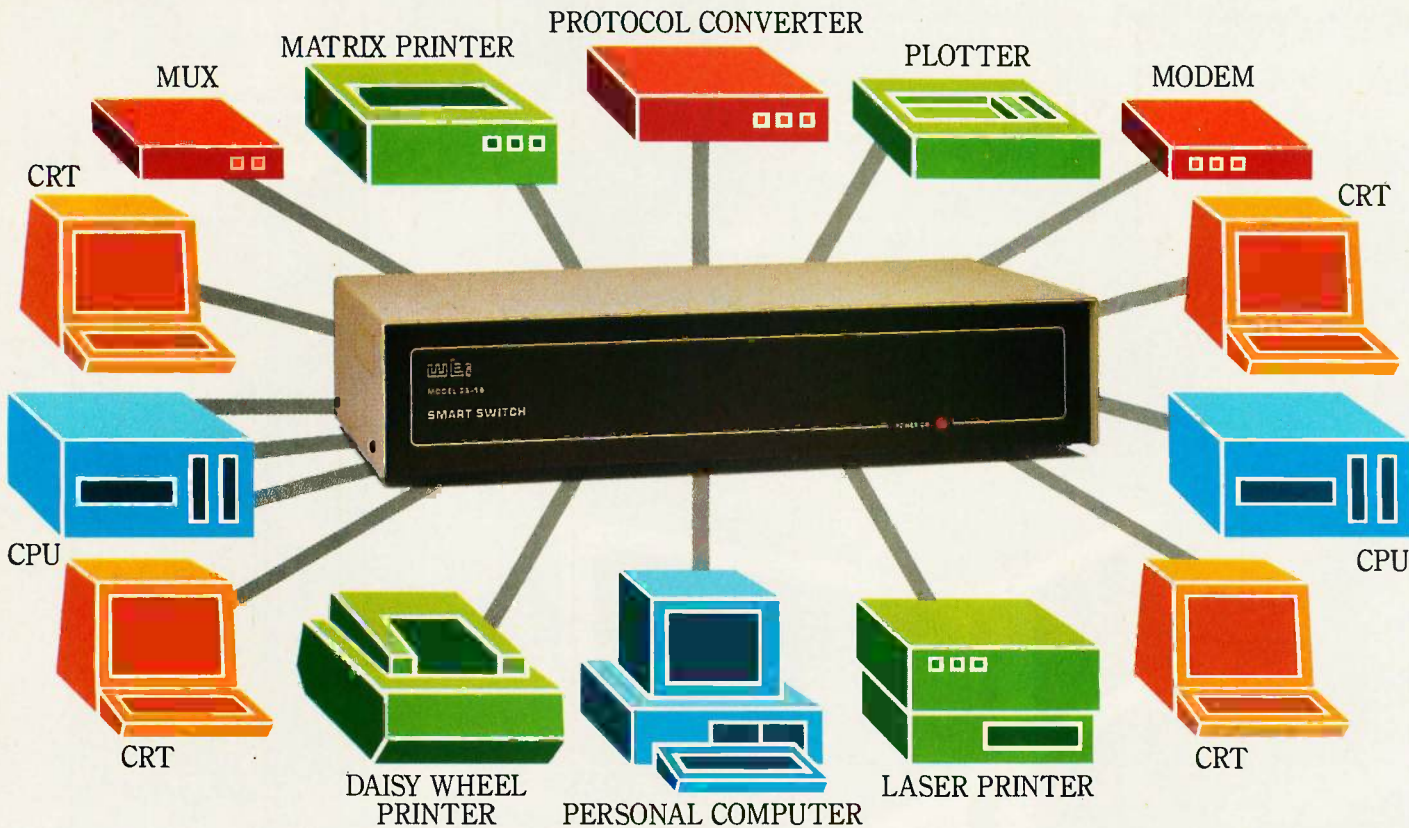

Here's an affordable way to switch up to sixteen RS-232 ports in any interconnection. It's called the Smart Switch™ controller.

The SS-16 accommodates any peripheral: terminals, printers, CPUs and modems. Any port can select any other port. With up to eight pairs of ports communicating at the same time.

Create your own local network. The SS-16 is ideal for computer port expansion, computer sharing, engineering work clusters, and much more.

Each port has its own spooling buffer. So any baud rate can

communicate with any other baud rate. Anywhere in the system.

You can name your ports. Like "PRINTER," "MODEM," or whatever. Or give multiple ports the same name, like "CPU," and the SS-16 will connect you to the first "CPU" port available.

A battery backup system ensures your system configuration and port names are maintained anytime the system is shut off.

A special supervisory port lets you monitor any other port. Connect ports together. Broadcast messages. Or designate the same supervisory power to other ports.

You'll also find the SS-16

user-friendly. It tells you when your selected port is busy. Sends a "port available" message if you choose to wait. And optionally times-out ports not in use.

There's even a HELP command.

And for quick and easy installation, a push button defines each port for either DTE or DCE.

So if you need an intelligent, affordable way to link your RS-232 system, you're ready for WTI's Smart Switch.

For more information on the SS-16, or our other RS-232 switches, call Western Telematic toll-free at (800) 854-7226. In California call (714) 979-0363. Or write WTI, 2435 South Anne Street, Santa Ana, California 92704. Or telex 467741.

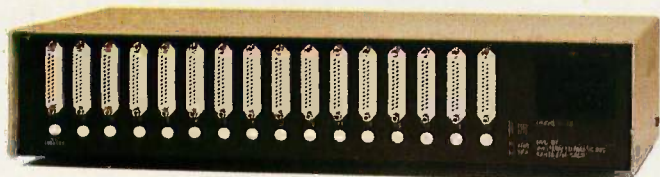

wte western telematic inc.

APPLYING DATA FLOW IN THE REAL WORLD

BY WILLIAM GERHARD PASEMAN

*This model for parallel processing is finding its way
into commercial applications*

VON NEUMANN MACHINES support a paradigm, a way of thought, that has been used successfully for 35 years. (See the text box entitled "The Von Neumann Paradigm" on page 214.) In a world in which thousands of PCs are sold in a month, the von Neumann computational model is not going to be replaced by an alternate model any time soon. However, valid reasons exist for using architectures based on alternatives to the von Neumann model of computation.

One reason is that many algorithms perform better and more inexpensively on other architectures than on von Neumann machines. It is not simply raw horsepower that produces this performance increase; it is horsepower that is tailored to the operations that the algorithm uses. Algorithms that can be expressed easily and coherently using the set of operations that the architecture provides usually perform better than those that cannot.

When algorithms and architectures mesh well together, we say that the architecture supports the algorithm. When an architecture makes imple-

mentation of the algorithm feasible, but not convenient, we say that the architecture weakly supports the algorithm. The better the mesh between the two, the better the price/performance ratio of the combination will be.

The von Neumann paradigm supports many algorithms well and weakly supports others. In this article, we will briefly review the relationship between several non-von Neumann paradigms then examine one non-von Neumann paradigm, data flow, in detail. Finally, we will look at some commercial architectures that support this model.

WHY WE SHOULD CARE ABOUT PARALLELISM

There are many ways to decrease the time an algorithm takes to complete on a given processor. If the processor is a general-purpose computer, one good way is to put the part of the algorithm that takes the most time into hardware. This is called *functional specialization*. An example of this is the Z80 IX.IY register instruction set. The instructions in this group were added

to support procedure parameter passing.

Another method of speeding things up is to break the algorithm into parts and devote a separate processor to each part. This type of parallelism is called *functional decomposition*. It works well only if the processors have the work divided evenly among them. If the work is not divided evenly, one processor will become a bottleneck.

Finally, you can break the algorithm's input data into parts and have a set of identical processors handle each part. This type of parallelism will not work on all algorithms.

Of course, all these methods potentially can be used at the same time. Functional specialization usually provides the greatest speedup; however, that speedup usually is very specialized. Parallelism provides less speedup, but it is applicable to a broader range of problems.

Computer architectures that effec-

(continued)

William Gerhard Paseman is a software manager at Daisy Systems. He can be reached at 330 Sierra Vista, Apt. #3, Mountain View, CA 94043.

tively use processor parallelism possess linear price/performance curves over a wide performance range. For example, if a given algorithm takes 4 minutes to complete with \$1000 worth of fifth-generation hardware, then it should take 2 minutes to complete with \$2000 worth of hardware and 1 minute to complete with \$4000 worth of hardware. (See the text box entitled "Linear Price/Performance and Incremental Performance," page 212).

Conventional (von Neumann) computer architectures do not have linear price/performance curves over a wide performance range. In order to make a conventional computer perform general algorithms faster, you don't simply add more components. Instead, you make its individual components faster. (There are some special cases in which you can improve performance by adding components; for example, adding more memory to a demand-paging environment.) Another way of saying this is that von Neumann architectures are

not designed to be scaled over a wide range with respect to performance.

The price/performance relationship between the two approaches is illustrated in figure 1. The graph indicates that von Neumann computer architectures will experience a performance cutoff at some point. This point will occur when all the components reach the theoretical performance limit of the technology upon which they are based.

Parallel architectures will also experience a performance cutoff at some point. This point will occur when the cost of coordinating two pieces of work between two components exceeds the cost of having one component do both pieces of work. In the general case, this point must eventually occur regardless of the size or speed of the components, regardless of the speed of communication, and regardless of the complexity of the work that the components must do.

Until they reach the von Neumann cutoff, von Neumann machines probably will perform better than their

parallel counterparts. This is because parallel architectures usually have a communication overhead that von Neumann architectures lack.

MODELS OF COMPUTATION THAT SUPPORT PARALLELISM

There are several paradigms for which it is currently popular to design parallel machines. The oldest is the control-flow paradigm.

The control-flow paradigm assumes that two or more processors share common memory. A control-flow architect usually views algorithmic parallelization and processor synchronization as being the programmer's problem. The architect supports the programmer by providing machine instructions that allow the programmer to do explicit processor synchronization in his code. Due to the wide interface between processes (i.e., the common memory), it is easy to write poor code that uses the interface in an undisciplined way. As a result, such systems have gotten bad press from many in the research community.

Most of the other paradigms are based around a weaker, more theoretically tractable concept in which, conceptually, memory sharing is not required. This concept is called message passing. Message-passing architectures allow programmers to structure their programs into islands of computation. These islands process asynchronously and communicate by passing messages to one another.

The data-flow paradigm is a message-passing model in which each island of computation is very small and usually performs the same operation repetitively on streams of values. Data-flow computation is data-driven, which means that each island starts processing whenever all data necessary to its computation is available.

The reduction paradigm is similar to the data-flow paradigm, except that a strong separation is made between the spawning of a computation and the computation itself. Here, computation is demand-driven, which

(continued)

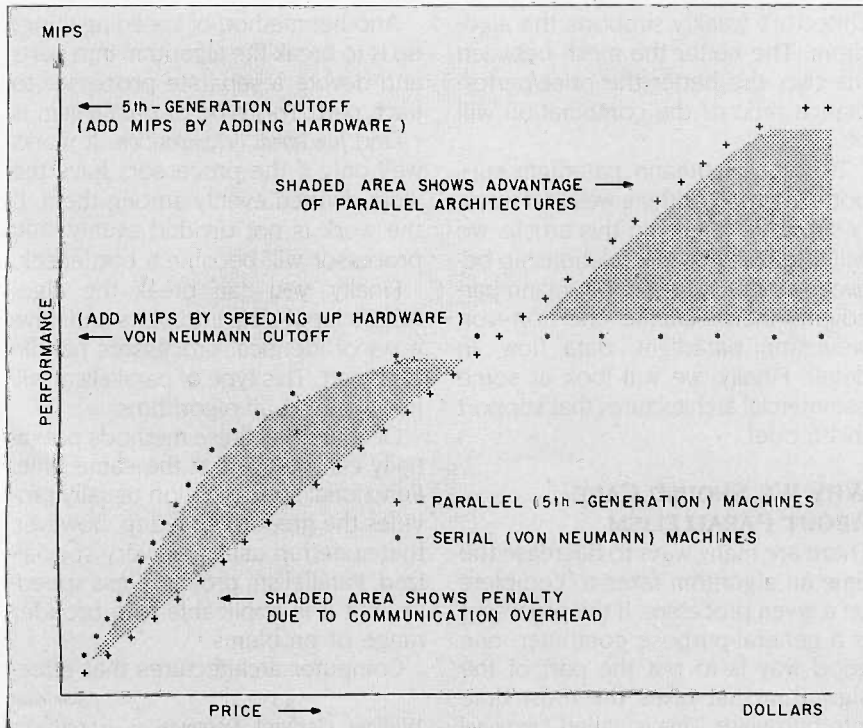
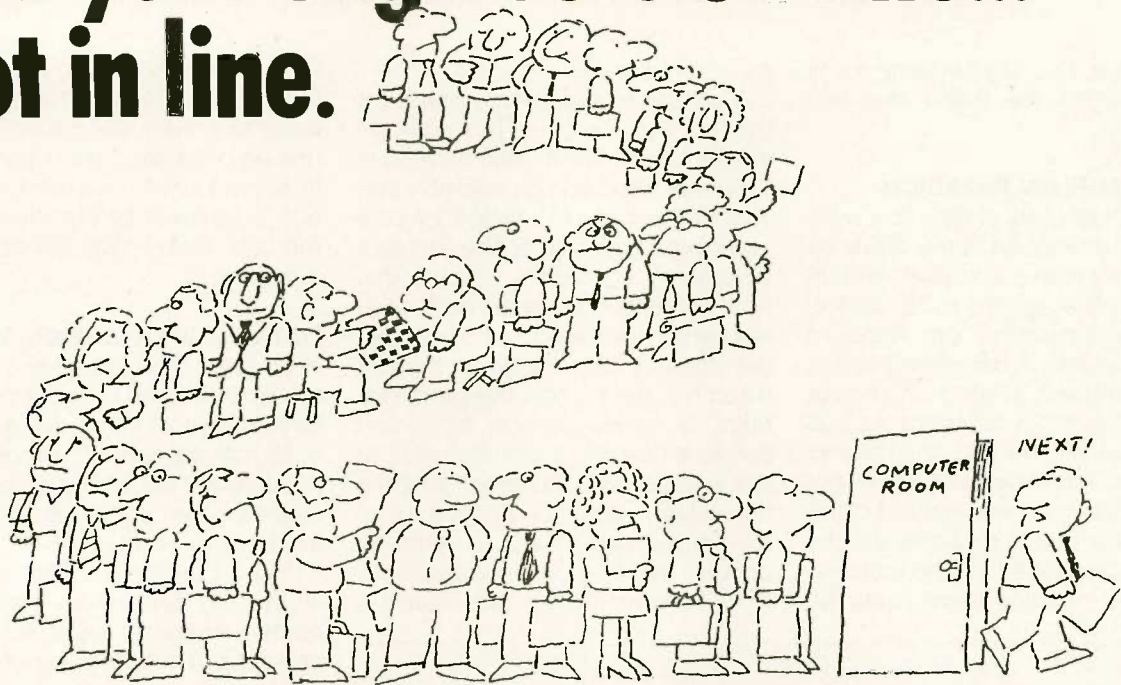
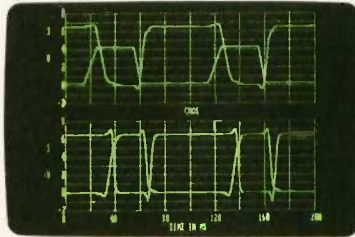

Figure 1: A comparison of the price/performance aspects of serial and parallel computing architectures.

MICRO CAP and MICRO LOGIC put your engineers on line... not in line.



MY OWN WORKSTATION



"Typical MICROCAP Transient Analysis"

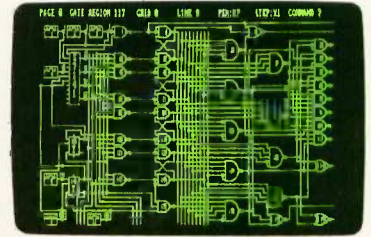

"Typical MICROLOGIC Diagram"

How many long unproductive hours have you spent "in line" for your simulation? Well, no more. MICROCAP and MICROLOGIC can put you on line by turning your PC into a productive and cost-effective engineering workstation.

Both of these sophisticated engineering tools provide you with quick and efficient solutions to your simulation problems. And here's how.

MICROCAP: Your Analog Solution

MICROCAP is an interactive analog circuit drawing and simulation system. It allows you to sketch a circuit diagram right on the CRT screen, then run an AC, DC, or Transient analysis. While providing you with libraries for defined models of bipolar and MOS devices, Opamps, transformers, diodes, and much more, MICROCAP also includes features not even found in SPICE.

MICROCAP II lets you be even more productive. As an advanced version, it employs sparse matrix techniques for faster simulation speed and larger net-

works. In addition, you get even more advanced device models, worst case capabilities, temperature stepping, Fourier analysis, and macro capability.

MICROLOGIC: Your Digital Solution

MICROLOGIC provides you with a similar interactive drawing and analysis environment for digital work. Using standard PC hardware, you can create logic diagrams of up to 9 pages with each containing up to 200 gates. The system automatically creates the netlist required for a timing simulation and will handle networks of up to 1800 gates. It provides you with libraries for 36 user-defined basic gate types, 36 data channels of 256 bits each, 10 user-defined clock waveforms, and up to 50 macros in each network. MICROLOGIC produces high-resolution timing diagrams showing selected waveforms and associated delays, glitches, and spikes—just like the real thing.

Reviewers Love These Solutions

Regarding MICROCAP . . . "A highly recommended analog design program" (PC Tech Journal 3/84). "A valuable tool for circuit designers" (Personal Software Magazine 11/83).

Regarding MICROLOGIC . . . "An efficient design system that does what it is supposed to do at a reasonable price" (Byte 4/84).

MICROCAP and MICROLOGIC are available for the Apple II (64k), IBM PC (128k), and HP-150 computers and priced at \$475 and \$450 respectively. Demo versions are available for \$75.

MICROCAP II is available for the Macintosh, IBM PC (256k), and HP-150 systems and is priced at \$895. Demo versions are available for \$100.

Demo prices are credited to the purchase price of the actual system.

Now, to get on line, call or write today!

Spectrum Software

1021 S. Wolfe Road, Dept. B
Sunnyvale, CA 94087
(408) 738-4387

Inquiry 374

means that the requirement for a result triggers the island that will generate it.

THE DATA-FLOW PARADIGM

The basic concepts of data flow were originally developed in the 1960s by compiler writers. Compiler writers used data-flow graphs to do performance optimization on standard serial programs. A data-flow graph is a directed graph in which the nodes represent primitive functions such as addition and subtraction, and the arcs represent data dependencies between functions. It was realized in the early 1970s that if data-flow graphs were executed directly, the architectures that executed them could be

massively parallel.

A picture of a data-flow graph for the function $z = 3 * (y + F(x))$ is shown in figure 2. In this model, nodes are viewed as stations in an assembly line. The stations are connected by conveyor belts (called arcs). The conveyor belts carry containers (tokens) that hold contents (values). At each node is a person (processor) who operates the station's function. When the first token hits the F node, the processor takes its value, operates on it, and passes a new token with the result to the + node. As F was processing the first value, + could do nothing, since it required two tokens in order to operate and had only one available. Now, however, + has two values: 1

from F and 9 from y , so it adds them together and passes a token with the result to *. As + was operating on its first set of tokens, F was operating on its second token. Thus, parallel operation is achieved by pipelining values through nodes that execute fixed functions.

DATA-FLOW EXECUTION MODELS

Normally, a data-flow graph has many more nodes than processors. Therefore, an execution model, a method of allocating nodes to processors, is needed. We will briefly describe two models, the static and dynamic models of execution.

Figure 3 depicts the static model, in which the processors run to the nodes, where all input tokens are present and no tokens are on the output arcs.

However, this method leads to situations like that mentioned above, where the + node was bottlenecked by the F operation. In order to rectify this problem, the dynamic model was invented. In the dynamic model, instead of waiting idle, the processor at the + node would help the F processor by processing its second token for it. Figure 4 depicts the dynamic model.

DATA-FLOW ARCHITECTURE

It is still unclear exactly how to construct expandable hardware to support any of the above execution models.

One common data-flow architecture is shown in figure 5. Here, the data-flow machine consists of three stages—a matching unit, a fetch/update unit, and a processing unit (perhaps more than one). Let's see how these parts interact on the previous example. Let's refer to the nodes by symbolic name. We will call the + node PLUS and the * node MUL. At some point in the calculation, the matching unit has two tokens passed to it by the processing units. The first token indicates that the left (L) arc of the PLUS node has been set to 10 (a). Later, it receives a token indicating that the right (R) arc of the

(continued)

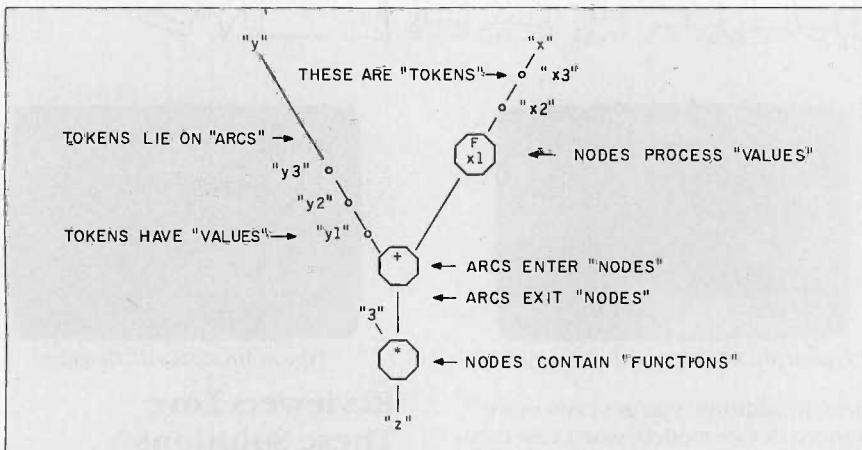

Figure 2: A simple data-flow graph of the function $z = 3 * (y + F(x))$.

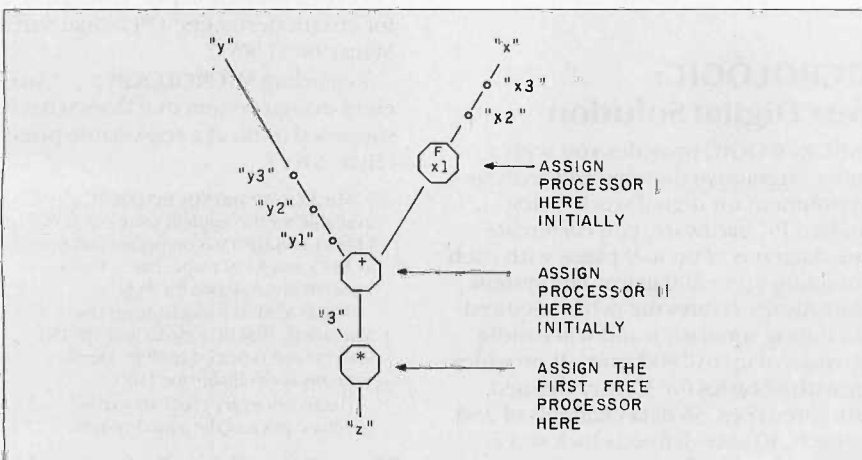

Figure 3: A data-flow graph of the function $z = 3 * (y + F(x))$ illustrating static processor allocation; processors are assigned to nodes at compile time.

GenTech

COMPUTERS

- IBM SYSTEM SPECIALS**
- 256K, 2 Drives. \$CAll
 - 256K, 2 Drives, Color Graphics, Printer Adapter & PGS HX-12 Monitor. . . \$2459
 - 256K, 1 Drive & 10 MB Hard Disk. . . \$CAll
 - TWO USER SYSTEM (incl. 10 MB Hard Disk, Advanced Digital PC Board & Terminal). . . \$CAll
- COLUMBIA**
- MPC 4220 (256K, 2 Drives). . . \$1899
 - PROFESSIONAL (Hard Disk w/Tape Backup). . . \$CAll
 - VP 2220 (Portable w/256K). . . \$1899



- CORONA All Models. \$CAll**
- FUJITSU Micro 16s (8086/Z80A). . . \$1995
 - LEADING EDGE PC Mono & Color. . . \$CAll
 - MORROW DESIGNS Pivot/MD2/MD3/MD5/MD11. . . \$CAll
- NEC APC-III PACKAGES**
- APC-III w/2 Dr. Wordstar Pro Pk, 2050 above with 3550 printer. . . \$2299
 - APC-III w/384K, Multiplan, BPS Graphics, and P313 Pinwriter (15" carriage). . . \$2799
 - APC-III w/1 Dr, 10 MB, & Mono CRT above with Color CRT. . . \$2379
 - APC-III w/plotter, digitizer & AutoCAD. . . \$CAll
 - SANYO MBC 555-2 (8088, 2 DSDD, sftw). . . \$1099
 - SEEQUA.Chameleon/Plus (8088/Z80). . . \$CAll
- SWP Micro Computer Products**
- Co-Power-89 Board (8088 w/256K, 1 MB). . . \$CAll
 - For Kaypro 2, 4 & 10. . . \$CAll
- TELEVIDEO**
- 1605/TPC-II (8088, 256K). . . \$CAll
- ZENITH**
- ZF-151-52 (8088, 2 Dr.) w/Zenith CRT. . . \$1899
 - ZF-151-21 w/1 Dr, 10 MB Hard Disk. . . \$2399
 - ZFA-161-52 (Portable, 2 Dr, 320K). . . \$1929

FOR IBM PC/AT/JR & COMPAQ

- ADVANCED DIGITAL Multi User Bd (8086). . . \$CAll**
- AST RESEARCH INC.**
- ADVANTAGE (Multi Fin Bd for AT). . . \$CAll
 - MEGA PLUS II (64K, Ser & Ck). . . \$279
 - SIX PACK PLUS (64K, Ser/Par, Ck). . . \$245
 - jrCMBD (exp. to 512K, Par, Ck). . . \$CAll
- QUADRAM**
- EXPANDED QUADBOARD (Ser/Par/Game, Ck) 64K. . . \$249 384K. . . \$429
 - QUAD 5i2+ (Serial Port, Exp. to 512K) 64K. . . \$229 256K. . . \$349
 - QUADCDLDR I (Video Board). . . \$199
- HERCULES Graphics Card (720x384). . . \$339**
- Color Card (RGB, Composite, Parallel). . . \$169
 - INTEL 8087/80287 Math Co-Processor. . . \$CAll
 - KEYTRONIC 5151 Keyboard. . . \$199
 - MICROLOG Baby Blue II (Z80B, 64K, Parallel & Serial Ports, Clock/Calendar). . . \$519
 - DRCHID PC Turbo (80186, 8 MHz). . . \$829
 - PANASONIC JA 551-2 (DSDD Thinline Drive). . . \$119
 - PARADISE SYSTEMS Multi-Display Card. . . \$285
 - Modular Graphics Card. . . \$275
 - Module A/B. . . \$75/\$179
- PLANTRONICS ColorPlus. . . \$CAll**
- SIGMA DESIGNS Color 400 w/Mouse. . . \$275
 - STB SYSTEMS Graphix Plus II. . . \$275
 - Super Rio w/64K. . . \$285
 - TANDON TM 100-2 (DSDD Disk Drive). . . \$149
 - TEAC FD-55B (DSDD Thinline Drive). . . \$125
 - TECMAR Graphics Master (640x400 RGB). . . \$485
 - The Captain w/DK (Par/Ser/Ck/Cat). . . \$239
 - jrCaptain (128K, Parallel Port). . . \$309
 - TSENG LABS Ultra Pak. . . \$489

HARD DISK

- APPLE MACINTOSH HARD DISKS NOW AVAILABLE! CORVUS, DAVONG & TECMAR . . . CALL FOR PRICES!**
- AMPEX 20 MB w/25 MB Tape Backup. . . \$CAll**
- MICROSCIENCE Internal 10 MB for IBM CORVUS**
- 11.1 MB Omnidrive Starter Kit. . . \$1649
 - 45 MB Omnidrive. . . \$4149
- DAVONG**
- Datasytems w/24 MB Tape Backup. . . \$CAll
-
- IOMEGA Bernoulli/Plus. . . \$CAll**
- MAYNARD ELECTRONICS 10/20/30 MB**
- PEGASUS-GREAT LAKES**
- 23 MB External w/Controller. . . \$CAll
- SYSGEN**
- 10/20 MB w/Tape Backup. . . \$2295/\$2849
 - Image/Qic-File. . . \$799/\$1199
- TALLGRASS**
- TG-5025 (25 MB w/60 MB Tape Backup). . . \$2899
 - TG-6180 (80 MB w/60 MB Tape Backup). . . \$6399
- TECMAR**
- Remov. Cartridge Winchester in PC (5 MB). . . \$1479
 - 10 MB w/5 MB Cartridge in Chassis. . . \$2459
 - XCOMP 16 MB External (for IBM). . . \$1749

DOT MATRIX PRINTERS

- C-1T0H Prowriter I 8510 AP. . . \$325**
- Prowriter 2 1550 P (15", 120 CPS). . . \$569
- CITIZEN**
- MSP-10. . . \$329 MSP-15. . . \$489
 - MSP-20. . . \$CAll MSP-25. . . \$CAll
- EPSON JX-80 Color**
- LQ-1500. . . \$1109 RX-100. . . \$CAll
 - RX-80/80 F/T. . . \$CAll FX 80+/100+. . . \$CAll
-

- MPI Sprinter/SX (Portable, 300 CPS). . . \$CAll**
- NEC**
- P2/P3 Pinwriter (180 CPS). . . \$525/\$735
 - P2/P3 Color Pinwriters. . . \$CAll
- OKIDATA**
- ML 92/93. . . \$CAll ML 84 (P). . . \$CAll
 - Okimate 20. . . \$CAll Pacemark. . . \$CAll
- PANASONIC KX-P1091/1093. . . \$CAll**
- STAR MICRONICS**
- Gemini 10X. . . \$249 SG-10/15. . . \$CAll
 - SD-10/15. . . \$CAll SR-10/15. . . \$CAll
- TEXAS INSTRUMENTS**
- 850/855/860/865. . . \$CAll
- TOSHIBA**
- P1340. . . \$719 P1351. . . \$1289

LETTER QUALITY PRINTERS

- ABATI (LQ-20 (18 CPS, 15" Carriage). . . \$359**
- AMDEK 5040 (40 CPS). . . \$1299
- BROTHER/DYNAX**
- HR-15 XL (20 CPS, Diablo Compat.). . . \$369
 - HR-25/HR-35. . . \$CAll/\$869
- HEWLETT-PACKARD Laser Printer. . . \$CAll**
- DIABLO**
- 620 API. . . \$779 630 ECS/IBM. . . \$1799
- JUKI 6100 (18 CPS, Diablo, Compat.). . . \$CAll**
- 6300 (40 CPS, Diablo Compat., 3K Buf.). . . \$CAll
- NEC**
- ELF 360. . . \$CAll 2030. . . \$659
 - 3550. . . \$CAll 8850. . . \$1829
- OLYMPIA Compact RD/2. . . \$349/\$419**
- QUME Letterpro 20. . . \$CAll
 - Sprint 1140/1155. . . \$1299/\$1479
 - SILVER-REED EXP 500 (parallel or serial). . . \$369
 - EXP 550 (p or s, 15" Carriage). . . \$449
- STAR MICRONICS Power Type (18 CPS). . . \$339**
- TRANSTAR T120/T130. . . \$409/\$569**

PLOTTERS & DIGITIZERS

- POLAROID PALETTE. . . \$1175**
- ENTER COMPUTER**
- Sweet-P. . . \$CAll Six Shooter. . . \$785
 - EPSON HI-80 Color Plotter. . . \$429
- HOUSTON INSTRUMENTS**
- PC-595. . . \$465 PC-695. . . \$549
 - DMP-29. . . \$1799 DMP-41/42. . . \$2349
 - DMP-51/52. . . \$3529 DMP-51/52 MP. . . \$CAll
 - DT-11 Digitizer (1 Button Cursor). . . \$679
 - DT-114 Digitizer (4 Button Cursor). . . \$739
 - NEC Briterwriter. . . \$CAll
 - ROLAND DXY-1D1/800/880. . . \$529/699/949
 - SUMMAGRAPHICS SummaSketch. . . \$CAll

MONITORS

- AMOEK**
- Video 300/300A/310A. . . \$135/145/165
 - Color 300. . . \$249 Color 500. . . \$379
 - Color 600. . . \$429 Color 710. . . \$579
 - DYNAX Fortis FC10 (13" RGB). . . \$CAll
- PRINCETON GRAPHICS HX-12**
- SR-12 (690x480). . . \$609
 - Max-12 (12" Amber TTL). . . \$179
 - QUADRAM Amberchrome. . . \$155
 - Quadchrome II. . . \$435
- ROLAND**
- MB-121G. . . \$135 MB-122G. . . \$155
 - CB-141. . . \$269 CC-141. . . \$559



- TAXAN**
- Model 115. . . \$119 Model 116. . . \$129
 - 420/L. . . \$CAll 440 (720x400). . . \$CAll
- ZENITH**
- ZVM-123A. . . \$79 ZVM-122A. . . \$85
 - ZVM-135. . . \$439 ZVM-136. . . \$CAll

TERMINALS

- ESPRIT**
- Esprit I. . . \$CAll Esprit II. . . \$479
 - Esprit III. . . \$CAll ESP-6310. . . \$559
 - QUME 102/102A. . . \$449/\$469
 - 103/108/109. . . \$CAll
 - TELEVIDEO 914/924. . . \$575/\$699
 - 950/970. . . \$CAll
 - Personal Terminal. . . \$419
 - w/300 Baud Modem. . . \$528
- VISUAL All Models. . . \$CAll**



- WYSE**
- WY-50. . . \$519 WY-75. . . \$609
 - WY-100. . . \$CAll WY-300. . . \$819
- ZENITH**
- Z-29. . . \$649 Z-49. . . \$CAll
 - ZTX-10. . . \$329 ZTX-11. . . \$389

COMMUNICATIONS FOR IBM

- BLUE LYNX 3278. . . \$CAll
 - DCA l/rma/lrmaKey. . . \$CAll
 - IDEAComm 3278. . . \$CAll
- ANCHOR**
- Volksmodem 1200. . . \$CAll Mark XII. . . \$249
- HAYES**
- Smartmodem 1200/2400. . . \$CAll
 - Smartmodem 1200B w/Smartcom II. . . \$CAll
- NOVATION**
- Smart Cat Plus 300/1200 w/Mite. . . \$329
 - PRENTICE PDPCOM C100/X100. . . \$289/\$299
 - QUADRAM Quadmodem. . . \$445
 - TRANSEND PC Modem Card 1200. . . \$419
 - VEN-TEL 300/1200 Half Card. . . \$409

SOFTWARE

- ASHTON-TATE dBase III/FrameWork. . . \$CAll
- AUTODESK INC. AutoCAD. . . \$CAll
- CENTRAL POINT Copy II PC/Plus. . . \$29
- DEC. RESOURCES Chart/Signmaster. . . \$239/\$185
- LOTUS 1-2-3/Symphony. . . \$319/\$429
- MICROPRO WordStar Pro Pack/2000. . . \$CAll
- MICRODRIM R:Base 4000/Clout. . . \$CAll
- PRENTICE HALL VCN ExecuVision. . . \$CAll
- REAL WORLD MBSI Accounting. . . \$CAll
- SAMNA Word III/Plus. . . \$CAll
- SATELLITE SOFTWARE WordPerfect. . . \$265

FOR APPLE II/IIe

- ALS CP/M Plus Card. . . \$299
 - Smarterm II (80 Column Card). . . \$129
 - AST RESEARCH INC. Multi I/O Card. . . \$CAll
 - DIGITAL RESEARCH CP/M Gold Card w/64K. . . \$269
 - FOURTH DIMENSION 16K RAM Card 80 Column Card. . . \$55
 - HAYES
 - Micromodem IIe w/Smartcom I. . . \$239
 - Smartmodem 300/1200. . . \$CAll - INTERACT.STRU. PKASO Universal. . . \$125
 - MICROSOFT Premium Softcard (IIe) Softcard II (for II/IIe). . . \$339
 - MICROTEK Dumping GX. . . \$69
- NOVATION**
- J-Cat (Auto Drig/Answer, 300 Baud). . . \$99
 - Apple Cat II (300 Baud). . . \$209
 - 212 Apple Cat II (1200 Baud). . . \$389
 - ORANGE MICRO Grappler + Buffered Grappler + (16K). . . \$169
 - Grappler Interface for ImageWriter. . . \$CAll
 - PCPI Applicard 6 MHz. . . \$249
 - RANA Elite I/II/III. . . \$CAll
 - TRANSEND ASID. . . \$125
 - Modemcard w/Source. . . \$239

MISCELLANEOUS

- RAM CHIPS**
- 64K SET. . . \$20 256K SET. . . \$CAll
- DOUBLE-SIDED DISKETTES**
- 3M. . . \$30 Dysan. . . \$31
 - Maxell. . . \$30 Wabash. . . \$20
- PRINT BUFFERS**
- QUADRAM Microfazer**
- Parallel/Parallel
 - 16K. . . \$139 64K. . . \$185 128K. . . \$239
 - Serial/Serial, Ser/Par, Par/Ser
 - 8K. . . \$145 16K. . . \$155 64K. . . \$209
- INTERACT.STRUCT. Shufflebuffer 32K. . . \$269**
- PRACTICAL PERIPHERALS Microbuffer 32K. . . \$209**
- SURGE PROTECTORS**
- EPD/CURTIS All models. . . \$CAll
 - NETWORK Wire Tree/Plus. . . \$45/\$60
 - ULTIMA SF-600. . . \$39
- EMERGENCY POWER SYSTEMS**
- TrippLite BC200-10 (battery incl). . . \$270
 - TrippLite BC425-FC (425 Watts). . . \$415
- SWITCHBOXES**
- CABLECO 3 Way Centronics. . . \$CAll
 - 3 Way Serial. . . \$CAll
- COMPUTER ACCESSORIES**
- Data Directors (All Models). . . \$CAll

CUSTOMER SERVICE

401-781-0020

ORDERS ONLY

800-843-4302

150 Broadway, Suite 2212, N.Y., NY 10038
 HOURS 9 - 8 EST, MONDAY-SATURDAY
 Personal Ck (2 Weeks To Clear), Cashier's Ck, Money Order
 APO Orders Add 6% (minimum \$7), Add 3% For Not Terms.
 All Returned Non-Defective Merchandise Are Subject To A
 20% Restocking Charge.
 GenTech Reserves the Right to Change Advertised Prices.



PLUS node has been set to 7 (b). The match unit knows that PLUS has only two inputs, so at this point it sends a token set to the fetch/update unit for processing (c). The fetch/update unit knows that PLUS performs the + function and that it fans out to MUL's arc L, so it sends this information to an arbitrary processing unit (d). The

processing unit performs the addition and sends the result to the match unit (e).

If the system allows more than one instantiation of an instruction to be active at a time (this would occur if the machine were executing the same instruction for the i and $i+1$ instantiations of a loop simultaneously), then

the descriptors must also be tagged with a process ID. This is done in a dynamic data-flow system.

PROPERTIES OF THE DATA-FLOW PARADIGM

The data-flow model makes many assumptions about the nature of the algorithms it runs. Some are:

- All information needed to execute the algorithm must be contained in its data-flow graph. That is, the paradigm does not use any structures other than the data-flow graph in order to execute the algorithm that the graph represents. The graph is the data-flow machine's "machine language" for the algorithm. The machine takes advantage of the graphical nature of the program in order to produce the speedup.

- The algorithm should not have a single locus of control. That is, the data-flow graph should allow more than one node on the graph to be executed at a time. If the algorithm has a single locus of control, it will run slower on a data-flow machine than on a von Neumann machine (due to the communications overhead).

- The data-flow graph must have a high degree of granularity. In other words, the graph nodes must contain things like + primitives and not "sort" primitives. One reason this is important is that graphs with granular primitives contain the potential for more parallelism. Note that this implies that the time for a "context switch," which is the time for a processor to switch from processing one node to processing another, must be small.

- The data-flow graph must have locality of effect. This means that the nodes do not fan out to a large number of other nodes. This is important, since nonlocality would stress the communication network of the data-flow machine.

These assumptions can be used to judge whether or not an algorithm matches well with the data-flow paradigm. If the algorithm to be executed does not have the above

(continued)

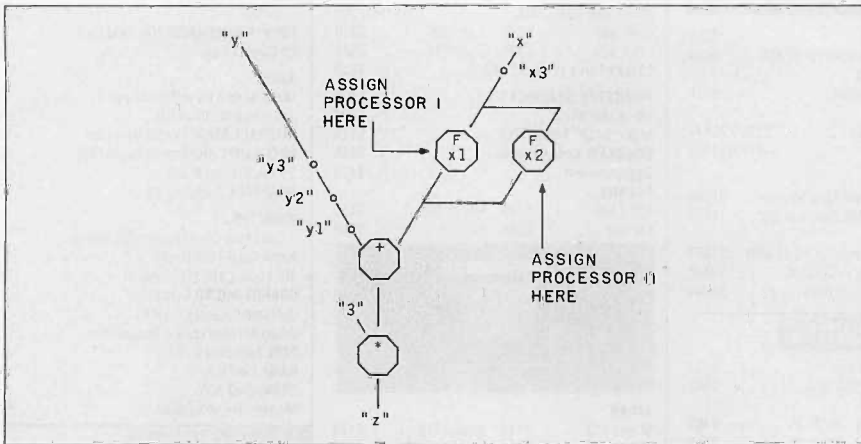

Figure 4: A data-flow graph of the function $z = 3 * (y + F(x))$ illustrating dynamic processor allocation; processors are assigned to nodes at run time.

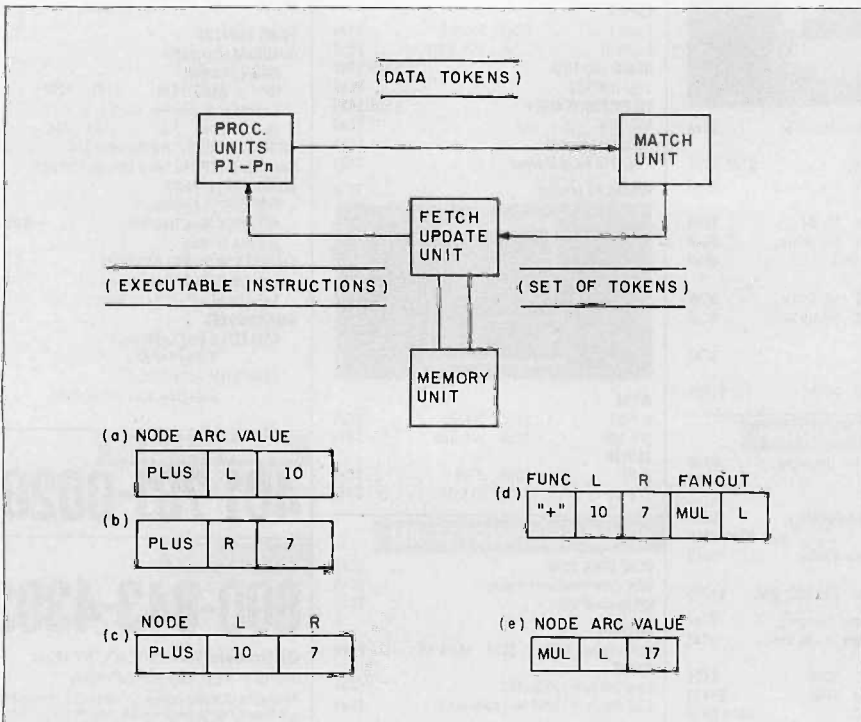

Figure 5: An example of data-flow architecture, with packet communication and token matching.

COMPUTER CRIME PAYS.

An estimated \$3 billion plus annually. What's more, there's practically no risk. Computer data thieves rarely get caught. And when they do, inadequate laws and the fear of publicity keep most victims from taking legal action.

Don't assume that just because you're not involved in anything top-secret, nobody's interested in your data files.

Computer thieves know that someone's always willing to pay a handsome price to get confidential corporate and professional information. Or pay to get it back.

AND THEY KNOW JUST WHAT TO LOOK FOR:

ACCOUNTING RECORDS
PRODUCT DESIGN DATA
RESEARCH DATA
MARKETING PLANS
CUSTOMER LISTS
PRIVILEGED CLIENT DATA
BANK FILES
CREDIT INFORMATION

Clearly, it's you vs. them. And the time to do something about it is now.

The Federal Government has spelled out the solution in no uncertain terms. It's called the Data Encryption Standard. And it's the basis for the DES 2000™ computer security system.

MAXIMUM PROTECTION WITH THE DES 2000

The DES 2000 protects your data files by encrypting transmitted and/or stored information—rendering it totally unintelligible without the proper access code.

DES 2000™

DATA ENCRYPTION SYSTEM



from: **PRACTICAL™**
PERIPHERALS

31245 La Baya Drive, Westlake Village, CA 91362 • (818) 991-8200 • TWX 910-336-5431

The code—one of 72-quadrillion possible 16-digit key combinations—is required at all times to command the DES 2000 to decipher the encrypted data.

So whether there's an intrusion from the outside via modem or phone line tap...or from the inside through a terminal or by outright disk theft...no key, no information.

You can't buy better protection than that.

ALSO THE MOST COST-EFFECTIVE SOLUTION

Equally important, the DES 2000 for the first time makes this level of security truly cost-effective. Priced under \$500, it offers the same protection, the same reliability as systems now in use by banking institutions and costing upwards of \$15,000.

Considering how well computer crime pays off these days, the DES 2000 is the most effective way to make sure your company's data doesn't become someone else's profit.

For more information on computer crime and the DES 2000 Data Encryption System—call (818) 991-8200 or Toll Free outside California 1-(800) 641-0814.

Give us your stained your filthy dirty,

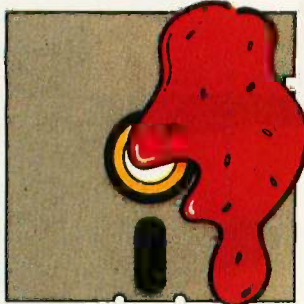

Aunt Molly's jam

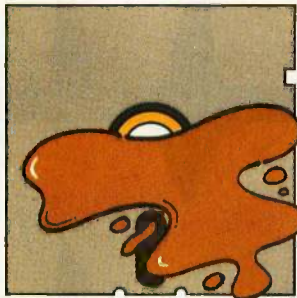

Regular coffee, two lumps

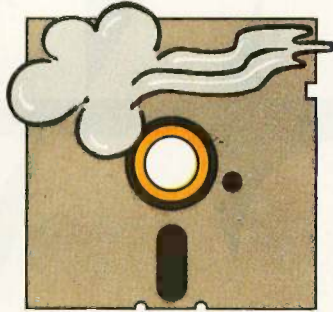

Clouds of smoke



Maria's liquid cover

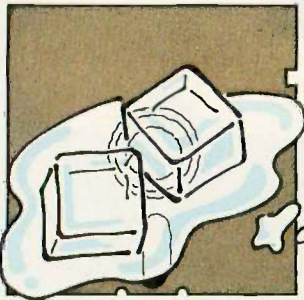

The big chill

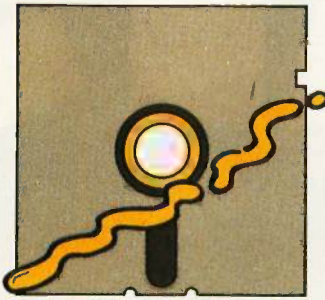

Hot dog mustard

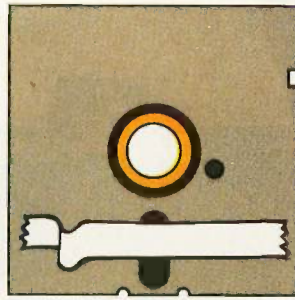

Tacky white tape



Lunchcounter ketchup

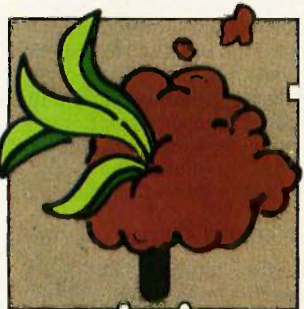

Potted plant—no pot

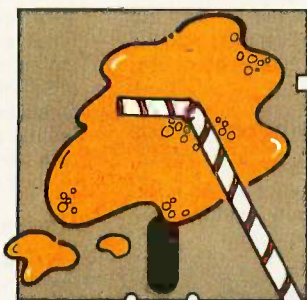

Fizzy orange soda

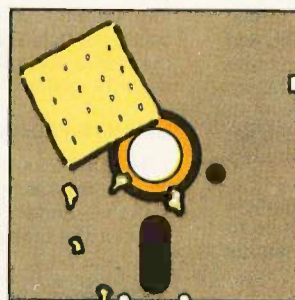

Cracker crumbs

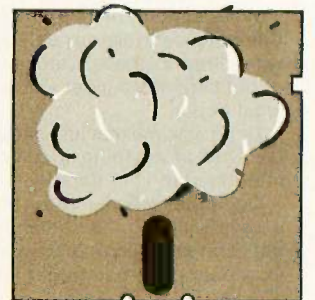

Dust (cough-cough)

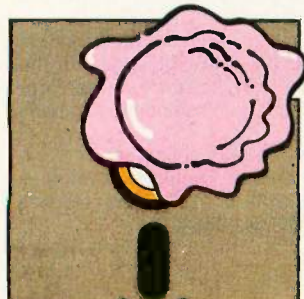

One scoop of ice cream



Sudsy soap bubbles



Chocolate fingerprints



Polaroid

PerfectData

10

d, your dog-eared, your mistreated:

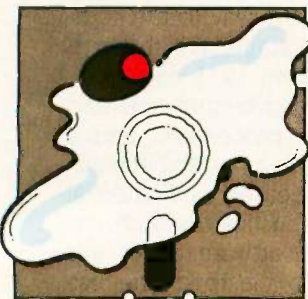

Dry martini, one olive

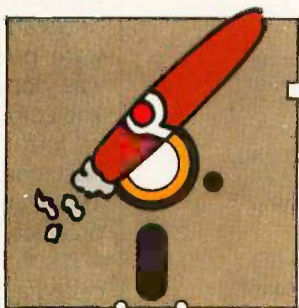

Boss's cigar ashes

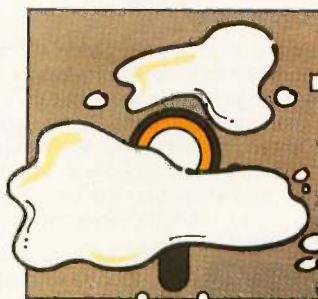

Spilled milk

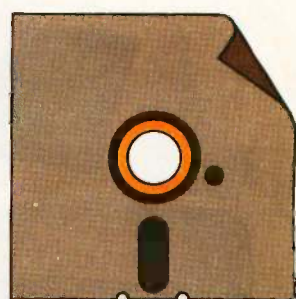

Dog-eared jacket

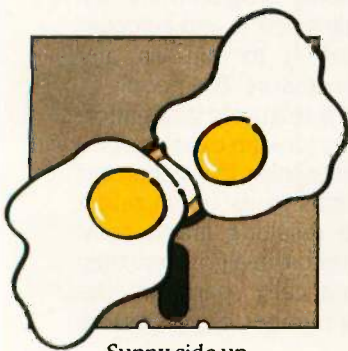

Sunny side up

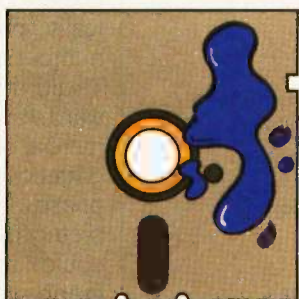

Waterbased ink spots

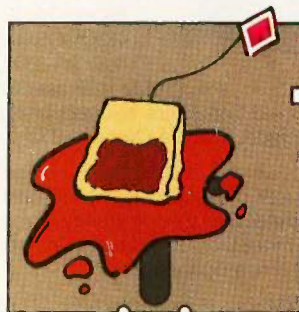

English breakfast tea

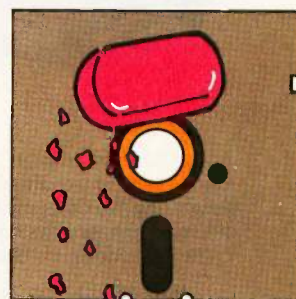

Eraser bits

If it's a Polaroid diskette, we'll fix it.

Accidents can be fatal to floppy disks. But now Polaroid introduces a free data recovery service.

So, if you spill coffee on a Polaroid Professional Quality Diskette, we can help recover your data. (And most other accidents, too.) Call 800-241-4403

and we will tell you how our service works.

These Polaroid floppy disks boast a 20-year guarantee and are certified 100% error-free. And only Polaroid offers a free data recovery service. Because accidents happen.

One Board... One Family



At the heart of every Stride 400 Series micro-computer, from the floppy-based 420 to the 448M byte 460, is an identical CPU board. This guarantees compatibility throughout the entire product family. And it means, our CPU board was designed with standard features that are either options or simply unavailable on other microcomputers:

- 68000 microprocessor (10 MHz with no wait states)
- VMEbus
- 256K bytes RAM
- 5¼" 640K byte floppy
- Battery-backed real time clock
- 4K CMOS RAM
- Four RS-232C serial ports (Stride multiuser BIOS)
- Centronics bi-directional parallel port
- Omninet Local Area Network (Liaison LAN software)

With this basic design, Stride is able to explore the full range of 68000 applications from an advanced multiuser, multi tasking BIOS to built-in local area networking. No other microcomputer offers the flexibility to run over a dozen different operating systems and more than 30 languages/compiler.

The basic design is backed by a rich option list:

- 12 MHz 68000 processor
- VMEbus (Eurocard) cage
- Low cost, high speed graphics
- NOD™ cursor control
- 12M bytes of RAM
- 448M bytes of hard disk storage
- 22 serial ports
- Floating point processor (NSI6081)
- Cartridge streaming tape backup
- Memory Management Unit

CBASIC COBOL
Modula-2
Pascal FORTRAN
RM/COS Lisp
UNIX System V
Cp-System
CP/M68K

All this, and still the best price/performance ratios in the industry: from \$2900 to over \$60,000. But it begins with the powerful Stride CPU board, a standard feature of every 400 series system. It's what we call "Performance By Design."



STRIDE
MICRO

Formerly Sage Computer

For more information on Stride or the location of the nearest Stride Dealer call or write us today. We'll also send you a free copy of our 32 page product catalog.

Corporate Offices:
4905 Energy Way
Reno, NV 89502
(702) 322-6868

Regional Offices:
Boston: (617) 229-6868
Dallas: (214) 392-7070

APPLYING DATA FLOW

properties, then the data-flow model is not the one to use to execute it.

COMMERCIAL POSSIBILITIES OF DATA FLOW— TEXAS INSTRUMENTS

Texas Instruments was one of the first companies to investigate the viability of data flow all the way to the hardware prototype stage. TI's research was done between 1975 and 1980. The company's architecture consisted of four "simple processors" and a host, connected in a ring architecture. TI has not yet released a commercial product based on this research.

TI's hardware/software effort was called a Data Flow Testbed. The testbed could accept a program written in a conventional programming language, compile it, link it, and automatically partition it to run on any number of processors. The people at TI did this in a relatively straightforward way. They took an existing commercial compiler/linker that generated data-flow graphs in its optimization phase. If the resulting graph completely described the algorithm, they could automatically partition the graph onto a number of processors and run it.

TI recognized that it is currently very difficult (i.e., commercially impractical) to generate data-dependence graphs for most real programs written in standard languages. The company knew this meant that "pure" data-flow processors cannot run standard software. Therefore, TI's system used a mixture of data-flow and classical control-flow techniques. That is, the computer was not a "pure" data-flow machine but rather used data-flow constructs where appropriate.

TI's primary interest was the application of data-flow concepts to large-scale machines running standard (unmodified) high-level language programs. The company investigated whether compilers could extract enough of the latent parallelism in standard programs to produce significant speedup in a data-flow architecture. One of TI's most interesting results was that the average amount

(continued)

"... innovation, not compatibility, is what we think microcomputers are all about."

[This is one of a series of design philosophy discussions with Rod Coleman, President of Stride Micro (formerly Sage Computer)]

RC: When the 68000 micro-processor was first introduced, many saw it as a minicomputer replacement. They rolled up

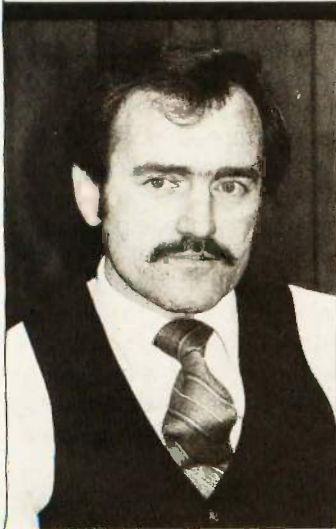

a disk drive unit, plugged in a bunch of terminals and ported a mainframe operating system like UNIX.[™] At Stride, we had a completely different perspective. We saw the 68000 at the center of a dream MICROcomputer; we envisioned (pardon the expression) a turbocharged Apple.[™]

Q: What's the real difference between the two approaches?

RC: It's reflected in both our product mix and our design. To begin with, price has always been a key point. The pioneers in the micro world were simply not ready to jump from a \$2,000 machine to a \$25,000 system overnight, leaving behind everything they'd come to admire about micros. That's why the price/performance ratio plays such a major role in every design decision we make.

Q: Such as?

RC: When we evaluated local area networks for the new Stride 400 Series we looked at everything available. From reading the press clips, Ethernet[™] and ARCNET[™] looked like the sure bets. Upon closer examination, we found that OMNINET[™] was at least comparable, and sometimes superior in actual performance. But when we figured in the factor of cost, it was suddenly no contest. OMNINET uses twisted pair cabling instead of expensive coax, and the per node cost was so low that we could offer the transport hardware on every system as a standard feature. With other LANs, this runs \$700 to \$3000 per station! So when you talk price/performance, OMNINET clearly emerges as a better solution for microcomputer folks.

Q: Does the same philosophy apply to software?

RC: You bet. I mentioned UNIX above as a standard multiuser solution for 68000-based systems. We agree that UNIX will certainly be one of the prominent multiuser applications, but not for everyone. UNIX was designed on systems with fast disks and slow processors; that's the opposite of what micros are all about. Our approach to multiuser is somewhat unique. We sought a way to use the traditional single user microcomputer operating systems in a multiuser mode. Our solution was to create a MUBIOS (multiuser basic input/output system) that resides below the operating system. Thus the user continues to use familiar software, but can also take advantage of the multiuser benefits of hardware cost-efficiency and software features such as shared data.

Q: Can you give me an example?

RC: Sure. Advanced DB Master[™] from Stoneware is a leading single user DBMS package that

is popular on a number of systems including the IBM[™] PC. On the Sage and Stride 400 Series machines, this database is also a true multiuser solution with complete file and record locking. Better yet, the MUBIOS even allows you to combine these

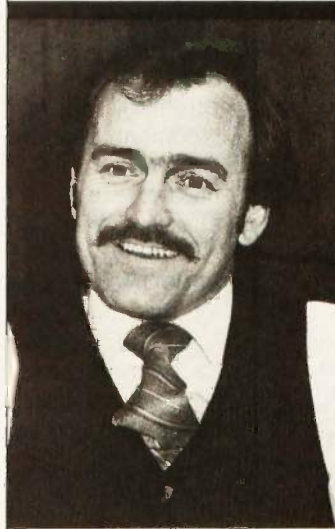

"... we sought a way to use the traditional single user microcomputer operating systems in a multiuser mode."

users on a single terminal. That means you could have different users residing in foreground/background, accessing each with a keystroke. The effect is concurrent multitasking. This even works with different operating systems in residence at the same time. For example, you could have your favorite CP/M-68K editor in the foreground, while a p-System compiler is cranking away at low priority in the background. The same holds true in the office environment where you can switch from a standard word processor to a spreadsheet instantaneously. The user has the

ability to set priorities, time slicing, access, etc.

Q: So why are traditional multiuser operating systems like RM/COS[™] and UNIX and Idris[™] on your price list?

RC: Actually that's another of the key ingredients in being a leader in microcomputers: flexibility. There's no doubt that UNIX, or the UNIX-like Idris, will be right for many users. And RM/COS, for instance, is an excellent solution for serious business and COBOL customers. We actively support these and 10 other operating systems, adding some of our advantages of performance and price to each one. But we're also convinced that the ultimate operating system is still years in the future, and that's why we continue to encourage research and development in new environments such as Modula-2, LISP and APL. Innovation, not compatibility, is what we think microcomputers are all about. That's why when we switched our name from Sage to Stride, we made sure there was no doubt as to our roots: Sage Computer became Stride Micro.



Formerly Sage Computer

For more information on Stride or the location of the nearest Stride Dealer call or write us today. We'll also send you a free copy of our 32 page product catalog.

Corporate Offices:
4905 Energy Way
Reno, NV 89502
(702) 322-6868

Regional Offices:
Boston: (617) 229-6868
Dallas: (214) 392-7070



Keep Your Computer Fit With CROSS-CHEX™

Cross-Chex is the complete menu-driven system of hardware diagnostics. It analyzes performance levels of Winchester and floppy disk drives, video display, RAM memory, video memory, ROM character generator and keyboard. Includes (1) Diagnostic Diskette (1) **Cross-Chex** Program Diskette (1) Users Manual. Let **Cross-Chex** keep your computer fit, ensure the performance of your computer, maximize your uptime and maintain the integrity of your data **all for the low price of \$99.00.**

Convert any CP/M to DOS with CROSSDATA®

Crossdata is the low-cost utility software that converts data/text file formats from CP/M to MS/PC-DOS and back again on any IBM PC/XT or clone.

It is a self-contained program, ready to run, that reads/writes CP/M and MS/PC DOS Diskettes using MS/PC-DOS 2.0, 2.1 or 3.0 and comes with 28 formats—plus you can add your own!

Solve your computer incompatibility problems fast with **Crossdata**, the proven conversion package, by ordering one today **for only \$99.00.**

Backup/Restore for Winchester under PC/MS-DOS, CP/M86 and CCPM with CROSSAVE™

Now you can back-up large data base files from a Winchester to a floppy for files that exceed the diskette capacity.

Crossave will save and/or restore a file or a selected group of files that have been updated. It also backs up and restores all of the files on the Winchester. It uses compression to reduce storage space requirements on the floppy and expands the file upon restoration. Requires IBM PC/XT or clone. **Reasonably priced at \$99.00.**

No risk 10-day money back guarantee on all products

Don't delay. Call us today: (408) 395-2773 or write:



AWARD SOFTWARE, INC.

236 North Santa Cruz Ave.,
Los Gatos, CA 95030

All major credit cards accepted

APPLYING DATA FLOW

NEC's chip is oriented toward image processing.

of parallelism available in standard FORTRAN programs was between 5 and 20. This meant that the maximum theoretical speedup TI could achieve (using "off the shelf" hardware) in these cases was 5 to 20 times. (Data flow can take advantage of parallelism only where it exists. If the programmer writes an algorithm so that no parallelism can be extracted from it, then a data-flow version of the algorithm will run no faster than a von Neumann version of the algorithm.) Currently, using high-performance hardware in a von Neumann machine affords a much greater speedup.

NIPPON ELECTRIC CORPORATION

Of the three companies discussed here, NEC's approach comes closest to the pure data-flow paradigm. The company's approach is based on a single chip that can contain up to 64

nodes and 128 arcs. Systems can incorporate up to 14 of these chips by connecting them into a ring in a very straightforward way. (It is possible to extend the limit beyond 14 chips, but the arrangement is much more complex.) A complete standard system, then, could run up to 896 two-input nodes distributed across 14 processors.

NEC's chip is oriented toward image processing. In the company's own words, "Because the majority of application programs for image processing execute iterative operations for large volumes of data, image-processing programs are relatively small compared to general data-processing programs." Although NEC's machine has a relatively small number of arcs and nodes in its system, each node can execute a high-performance operation.

NEC's initial focus is not on running existing high-level language programs but rather on running small, easy-to-rewrite programs that require high performance. That is not to say that NEC does not address these issues; rather, that the company is first entering the market where data flow's

(continued)

LINEAR PRICE/PERFORMANCE AND INCREMENTAL PERFORMANCE

Suppose a salesman sells you a processor for \$1000 and tells you that it will run your favorite program in just eight hours. He then tells you that due to the marvels of fifth-generation computing technology, you can bolt in another processor for another \$1000 and your program will run twice as fast. It will now take only four hours to complete. You happily buy two processors. Still, four hours is a long time, so you call your salesman and tell him that you want to halve the time to two hours. The salesman now sells you not one but two more processors in order to do this. You realize

that for each processor you buy, you incrementally increase performance by $(P+1)/P$. For one processor, this is $(1+1)/1 = 2x$, or a 100 percent speedup. For two processors, this is $(1+2)/2 = 1.5x$, or a 50 percent speedup. For three processors, this is $(1+3)/3 = 1.33x$, or a 33 percent speedup.

This is an extremely attractive situation for the salesman, of course, since he gets an order of magnitude increase in commissions every time you want to get an order of magnitude increase in performance. It is, of course, not a very good situation for you.

\$198

IBM PC/XT/AT MODEM CARD COMPLETE WITH SOFTWARE

**HAYES COMPATIBLE MODEM,
INCOMPATIBLE PRICE!**

FEATURES

	HAYES SMART- MODEM 1200 B	INFO- MATE 1200 TPC
PRICE	\$ 489	\$ 198
HAYES "AT" COMMAND COMPATIBLE	YES	YES
Communications software included	YES	YES
1200/300/110-bits per second	YES	YES
Bell 212A and 103 compatible	YES	YES
Auto-dial, Auto-answer	YES	YES
Auto-speed, Auto-parity	YES	YES
Built-in speaker	YES	YES
Volume control	YES	YES
Dual phone jack	YES	YES

SHIP TO:

NAME _____

ADDRESS _____

DAY PHONE _____

CHECK ENCLOSED

VISA

MASTERCARD

ACCT. NO. _____

EXP. DATE _____

SIGNATURE _____

California residents add 6 2/3% sales tax. All orders add \$4 per modem card for shipping and handling. Additional freight charges will be added for Canadian and international orders. No C.O.D.s or purchase orders accepted. Please allow four weeks for delivery. (800) 862-6271 (CALIF. (408) 752-5095).

MAIL TO:

SUNNYVALE COMMUNICATIONS COMPANY
1308 BORREGAS AVENUE
SUNNYVALE, CA 94088-3565

INFO-MATE 1200 TPC

LIMITED QUANTITIES AVAILABLE!

benefits are the strongest. In fact, NEC is now working on an integrated system in which to embed its chips. How the company approaches system-level problems (language definition, translation, and debugging) remains to be seen.

In summary, NEC was able to use the data-flow model by applying it to a domain in which

- The algorithms are easily expressed in terms of a data-flow graph.
- The algorithms contain a great deal of inherent parallelism.
- The architecture can run small, easy-to-program algorithms.
- There is a great need for fast execution. (Image processing is computer-bound.)

DAISY SYSTEMS CORPORATION

Daisy Systems started selling a commercial data-flow architecture in the first quarter of 1984. The company's approach is based on a set of board-level processors connected in a ring. The basic configuration consists of three or four processing units plus a host processor. The units are capable of processing 65,000 to 1,000,000 nodes, depending on the level of modeling. Each node can have up to 256 inputs.

Daisy Systems' data-flow architecture is the first to respond to the customer's need for high-speed discrete logic simulation. In essence, a discrete logic simulator runs an algorithmic description of a piece of hardware. By their very nature, these algorithms are expressed in terms of graphs in which each node is a simple operation.

The hardware designer of these algorithms consciously works to make his design exhibit a high degree of parallelism. Therefore, Daisy did not have to worry about the algorithm "running out of parallelism" of which to take advantage. Even better, the parallelism is very great at the machine-instruction level.

Like TI, Daisy recognized that the "pure" data-flow paradigm did not completely address all of simulation's problems satisfactorily. For example, the "pure" data-flow model has no way of handling stored state (side effects). Daisy addressed this and other similar problems by extending the paradigm.

At the programming level, Daisy recognized that the programming task in advanced architectures is difficult and error-prone. In many approaches, the user must adapt to a paradigm that is unfamiliar, unintuitive, and dif-

operands. In the von Neumann model, program control is sequential and centralized. It is upon this paradigm that most commercial computer architectures are based.

Strictly speaking, a non-von Neumann paradigm is one that departs from any of these concepts. For example, a machine that keeps its data and memory in two separate banks is not a von Neumann machine. Recently, however, "non-von Neumann" has come to mean a paradigm that differs primarily in the last of the above properties, that of sequential, centralized program control.

Daisy Systems'

data-flow architecture

is the first to respond

to the customer's need

for high-speed discrete

logic simulation.

ficult to use. Daisy overcame this problem by allowing users to communicate in the languages that they have always used: graphics, Boolean expressions, and a standard behavioral language. Daisy was able to do this well because the primitives that the designer uses map easily to the primitives that Daisy's architecture supports. The mapping process (compilation, linking, and code generation) is totally automatic.

Daisy was able to use data flow by applying it to a domain in which

- The algorithms are naturally expressed in terms of a data-flow-like graph.
- The algorithms contain a great deal of inherent instruction-level parallelism.
- There is a great need for fast execution. (Logic simulators implemented on von Neumann machines may take days to run big simulations.) Daisy's machine runs approximately 100 times faster than most software simulators.

SUMMARY

NEC and Daisy have successfully used data flow to solve two different commercial problems in an appropriate manner. Both problems are easily expressed using data-flow graphs, have a great deal of instruction-level parallelism, and require scalable execution and high performance.

As more companies discover problems for which data flow is the best solution, the repertoire of practical parallel algorithms using the data-flow model will grow. ■

THE VON NEUMANN PARADIGM

Mathematicians have been proposing computational paradigms, or "models of computation," since the time of Charles Babbage (witness Turing machines, Markov productions, and Church's Lambda calculus). However, the most well known paradigm was pioneered by John von Neumann. Von Neumann's model is based on the concept of a single central processing unit that accesses a linear array of fixed-size memory cells. These cells can contain either instructions or data. Instructions are relatively low-level. They perform simple operations on elementary



BY THE YEAR 2000, THE WORLD MAY CATCH UP WITH THE WAY COMPU SERVE'S ELECTRONIC MALL™ LETS YOU SHOP TODAY.

Presenting the computer shopping service that delivers discount prices, name-brand merchandise, and in-depth product information.

To make your computer even more useful, join CompuServe and shop in our Electronic Mall. Easy enough for beginners, it's open 24 hours a day, 7 days a week. And it offers a wide range of goods and services from nationally known stores and businesses including Bloomingdale's, Waldenbooks, American Express and Commodore.

CompuServe's Electronic Mall™ lets you shop at your convenience in all these departments:

The Auto Shop, Book Bazaar, Financial Mart, Leisure Center, Merchandise

Mart, Newsstand, On-line Connection, Personal Computer Store, Record Emporium, Specialty Boutique and Travel Agency.

Take the CompuServe Electronic Mall 15-Minute Comparison Test.

What you can do in 15 minutes shopping the Electronic Mall way.

- Access descriptions of the latest in computer printers, for instance.
- Pick one and enter the order command.
- Check complete descriptions of places to stay on your next vacation.
- Pick several and request travel brochures.
- Access a department store catalog and pick out a wine rack, tools, toys... anything!
- Place your order.

What you can do in 15 minutes shopping the old way.

- Round up the family and get in the car.

The Electronic Mall—A Valuable Addition to the Vast World of CompuServe.

CompuServe Information Services bring you information, entertainment, personal communications and more.

You can access CompuServe with almost any computer and modem, terminal or communicating word processor.

To buy a CompuServe Subscription Kit, see your nearest computer dealer. To receive our informative brochure, or to order direct, call or write:

CompuServe

Information Services, P.O. Box 20212,
5000 Arlington Centre Blvd., Columbus, OH 43220

800-848-8199

In Ohio call 614-457-0802



A seat on the Exchange.





Step beyond the limits of personal computing, and into the action on Wall Street. Or right through the doors of the world's finest stores. Browse, buy, sell or trade. Stocks, information, Maine lobster, airline tickets. Without leaving your chair.

With an Avatex™ modem, your personal computer can take you wherever you want to go, on your schedule. As far, as fast, as often as you like, at a price that won't stop you in your tracks.

Avatex gives you the power, speed and intelligence of a serious piece of communications equipment, streamlined so anyone can use it easily and productively. Immediately.

So with Avatex the possibilities are astronomical, but the price of owning one is not: Avatex 300—\$64.95*, Avatex 600—\$99.95*, Avatex 1200—\$299.95*.

For the name of the Avatex dealer nearest you, call 800-4-AVATEX.

Avatex™ Modems

The next step in personal computing.



Avatex™ is a trademark of E-Data Comm. U.L., C.S.A. & P.C.C. Pat. 15 and 68 approved. Copyright 1985 by E-Data Comm. *Suggested retail price.



NUMBER SMASHER

Speeds Up Everything...Especially 1-2-3™!

The MicroWay NUMBER SMASHER triples the speed of all cpu bound software while doubling the speed of 8087 bound software. When combined with MicroWay's FASTBREAK™ it results in an increase in the speed of 1-2-3™ of up to 80 to 1! If you're tired of WAITing, the SMASHER is the card for you!

The heart of the NUMBER SMASHER is a 9.54 mhz 8086 working with a matched high speed 8087. The card comes standard with 512K of 16 bit RAM and can be expanded to 640K. It triples the throughput of your original 8088 by doubling the system clock speed and quadrupling the data bus bandwidth.

Software compatibility is guaranteed by the nature of our card. It does not augment the 8088, but replaces it with a special 8086 that runs as a true 16-bit processor in the first 640K of ram and as an 8-bit processor everywhere else.

Examples of software which show dramatic speed-ups include AUTOCAD, 1-2-3™ worksheets which depend heavily on financial or transcendental functions, and multi-user operating systems. Any program written with an MS-DOS compiler that supports the 8087, such as MS-FORTRAN or 87BASIC, will run on the NUMBER SMASHER at least a factor of 2.5 times faster! Software that comes with the card also increases the throughput of I/O bound programs and includes a disk cache routine, ram disk and print spooler.

The NUMBER SMASHER is an upgrade product for 8088 based PCs and compatibles. It works on the IBM-PC and XT, the COMPAQ and compatibles manufactured to the IBM-PC hardware standard. Contact MicroWay or your local MicroWay Installation Center for technical specifications and supporting benchmarks.

**Micro
Way**

The World Leader in 8087 Support

P.O. Box 79, Kingston, Mass. 02364 USA (617) 746-7341

NUMBER SMASHER and FASTBREAK are trademarks of MicroWay, Inc. LOTUS and 1-2-3 are trademarks of Lotus Development Corp.

THE TRANSPUTER

BY PAUL WALKER

*A building block
for parallel processing*

THE TRANSPUTER is a small but complete computer that can be used as a building block with other Transputers to construct extremely high performance computing networks. A *BYTE* article by Dick Pountain (see reference 1) introduced the idea of the Transputer and its programming language, Occam. (Occam is a trademark of the INMOS group of companies.) In this article we'll take a look at Transputers and how they can meet the computing requirements of the future.

A rough yardstick of performance is given by the more recent personal computers, which run at around a million instructions per second (MIPS). By contrast, supercomputers offer the equivalent of around a thousand MIPS. Tomorrow's applications, such as the Japanese Fifth Generation Project, require up to a million MIPS. The needs of home and personal computers are more modest. But as the performance requirements in low-end systems evolve, the price/performance benefits of small clusters of Transputers will begin to attract small-system designers.

Advances in semiconductor technology are improving performance. But it takes 10 years for technology

to improve the processing power of current architectures by an order of magnitude. At that rate, it will be well into the 21st century before the current architectures provide the performance required. But the applications need the performance now. A different architecture is needed to provide the performance with today's technology.

THE EVOLUTION OF COMPUTER ARCHITECTURES AND LANGUAGES

One of the first architectures of a general-purpose computer was the von Neumann architecture, in which a single central processor is connected by a single data bus to memory. This has been adapted in various ways over the years, but even today almost all computers conform to the basic von Neumann architecture; they have merely added processing power and memory. As the processing power and memory of the computer are increased, however, the bus becomes a bottleneck. And when processing power is further increased by the utilization of multiple processors and DMA (direct memory access) controllers sharing the bus, the

effect of the bottleneck is even more pronounced.

Along with the evolution of computer architectures, computer programming languages have evolved to make programming more reliable and cost-effective. The languages, however, have been constrained by the computer architecture. Computers obey instructions in sequence and can do only one job at once, and this is reflected in the languages. The real world, however, has many activities, or "processes," happening concurrently, and programming languages should be capable of modeling the behavior of these concurrent processes.

THE TRANSPUTER ARCHITECTURE AND OCCAM

Although the von Neumann architecture is limited by its bus, it is an excellent architecture for a small, single-processor computer. A Transputer is a small but complete von Neumann computer (figure 1a). The difference between a Transputer and an ordinary

(continued)

Paul Walker is a member of the Transputer development team at INMOS Limited (Whitefriars, Lewins Mead, Bristol BS1 2NP, England).

*An Occam process
is a black box
that works with
its own local
information.*

microcomputer is that Transputers can readily be built into networks and arrays (figure 1b). Each Transputer works on its own job, using its own local memory. A system with many Transputers has as many buses as it has Transputers, so the bus throughput is multiplied by the number of Transputers in the system. Another gain in bus throughput is achieved by putting the processor and memory on the same chip.

The Transputers in a system need to communicate with each other so that they can cooperate. Transputer chips therefore have four link interfaces, each with an input signal and an output signal. The output signal of a link interface on one Transputer is connected to the input signal of a link interface on another Transputer, and vice versa. The two-wire, point-to-point connections between two Transputers (figure 2) are described as "links."

The programming language Occam (see reference 2) is designed to handle the mixed sequential and concurrent nature of real-world processes. Such processes are modeled as Occam processes, each of which can be regarded as a black box that works with its own local information. A process cooperates with other processes using point-to-point communication channels. A collection of Occam processes is itself a process, so a hierarchy of processes can be built up to reflect the structure of the real-world process.

The Occam model is suitable for mapping onto an array of computers, each of which has its own local memory and communicates with other computers via point-to-point links. It is particularly appropriate, therefore, for a network of Transputers.

THE TRANSPUTER CHIP

The Transputer, then, is a single-chip computer with a processor, local memory, link interfaces for linking to other Transputers, and all the necessary system services such as reset and clock.

When Transputers are programmed in Occam, each Transputer implements an Occam process and each link implements an Occam channel in each direction between two Transputers.

Particular examples of Transputers are the IMS T424 (see reference 3)

and the IMS T222, which are 32-bit and 16-bit Transputers, respectively. Both devices have four links and 4K bytes of on-chip RAM (random-access read/write memory). In addition, they have interfaces to external memory for applications in which 4K bytes are not enough; T424 addresses up to 4 gigabytes, T222 up to 64K bytes. Both have high-performance processors, achieving 5 to 10 MIPS.

To fit a processor, link interfaces, and RAM onto a single chip, the processor must be small. The Transputer processor (see reference 4) is indeed small, occupying about a quarter of the chip. Being small, in some ways like a reduced instruction set computer (RISC), it is fast. Unlike some of the RISCs, however, the Transputer processor has short, 8-bit instructions and uses an evaluation stack of three registers rather than a register file. Both of these improve performance. The short instruction format efficiently encodes the most frequently accessed instructions and data. Infrequent instructions, large constants, and nonlocal variables are accessed by short sequences of 8-bit instructions. The use of an evaluation stack means that instructions do not have to specify the registers for operands; the instructions always work on the top of the stack.

The performance of the processor is shown by the Occam assignment

(continued)

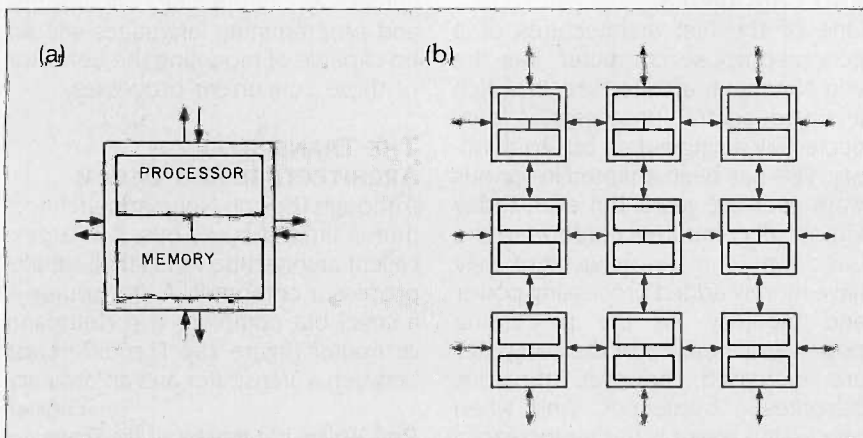

Figure 1: (a) A Transputer is a von Neumann computer with link interfaces. (b) Transputers can be readily built into networks and arrays.

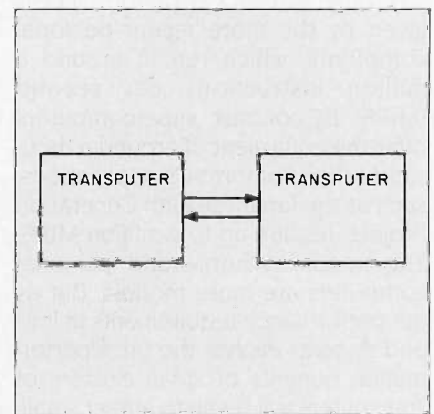

Figure 2: A link consists of two wires, one in each direction, between two Transputers.

POWERFUL CP/M® SOFTWARE

Diskette & Manual \$29.95

NEVADA FORTRAN™ DISKETTE & MANUAL

NEVADA COBOL™ DISKETTE & MANUAL

Nevada FORTRAN is based upon the ANSI-66 standards (FORTRAN IV) with some 1977 level features. Advanced features include: IF... THEN... ELSE statement; COPY (include); CHAINING with COMMON; and TRACE debugging. Package includes a diskette, 214-page manual and 5 sample programs. Included also is an 8080 assembler. Requires 48K RAM.

\$29.95

Nevada COBOL, based upon the ANSI-74 standards, has all the popular features. Powerful level 2 features include: compound conditionals and full CALL CANCEL. This software package includes a diskette, 165-page manual, plenty of examples and 16 complete COBOL source code programs.

\$29.95

NEVADA BASIC™ DISKETTE & MANUAL

NEVADA PASCAL™ DISKETTE & MANUAL

With the built-in, full-screen text editor, you can easily develop programs for 1/10 the cost of a comparable BASIC interpreter. What's more, Nevada BASIC has full Matrix operations, Single- and Multi-Line functions, and BCD math (no round-off errors). You get a diskette and a 220-page manual. Requires 48K RAM.

\$29.95

Advanced features include: 14-Digit precision; BCD math (no round-off errors); Floating point + 63 -64; TRACE debugging; Arrays up to 8 dimensions; 64K strings; External procedures; and Dynamic Module loading. You get a diskette and a 184-page manual. Requires 60K RAM and one disk drive with at least 90K storage.

\$29.95

NEVADA PILOT™ DISKETTE & MANUAL

NEVADA EDIT™ DISKETTE & MANUAL

Nevada PILOT, written by Prof. John Starkweather, the language's creator, meets and exceeds all PILOT-73 standards. See the review in January 1983 MICROCOMPUTING. This package includes a diskette, 131-page manual, and 10 useful sample programs.

\$29.95

Nevada EDIT, a full-screen, video-display text editor, is designed specifically for computer program text preparation. Nevada EDIT is completely user-changeable, can be configured to almost any terminal and takes up only 12K of disk space. This package includes a diskette and 59-page manual.

\$29.95

WHY WAIT? ORDER YOURS TODAY!

Satisfaction guaranteed—or your money back. If for any reason you're not completely satisfied, just return the package—in good condition—with the sealed diskette unopened, within 15 days and we'll refund your money.

Checks must be in U.S. Dollars and drawn on a U.S. Bank.

California deliveries add 6% or 6.5% sales tax.

SHIPPING AND HANDLING FEES: Add \$4.00 for the first package or manual and \$2.00 each additional. **OVERSEAS:** Add \$15.00 for the first package or manual and \$5.00 each additional. **COD's:** Add \$4.00.

ALSO AVAILABLE:

- ★ EXTRA MANUALS \$14.95
- ★ COBOL Application Packages, Book 1 \$ 9.95
- ★ BIG PRINT-Diskette \$19.95

The CP/M Operating System, an 8080, 8085, or Z-80 (8-Bit) microprocessor, and 32K RAM are required, unless otherwise stated above.

WHEN YOU ORDER, PLEASE SPECIFY ONE OF THE FOLLOWING DISKETTE FORMATS:

- 8" SSSD (Standard CP/M IBM 3740)
- Kaypro Double Density (NCR)
- 5¼" Diskettes for:
 - Access/Actrix
 - Apple CP/M
 - DEC VT 180
 - DEC Rainbow
 - Epson QX-10
 - Heath Hard Sector (Z-89)
 - Heath Soft Sector (Z-90, Z-100)
 - IBM-PC (Requires Z-80, Baby Blue II Card)
 - Kaypro Mod II
 - NEC PC 8001
 - North Star Double Density
 - North Star Single Density
 - Osborne Single Density
 - Sanyo 1000, 1050
 - Superbrain DD DOS 3.X (512 byte sec)
 - Televideo
 - TRS-80 Model 1 (Base O Mapper)
 - Xerox 820 Single Density

WE WELCOME C.O.D.'s



(415) 753-0186

ELLIS COMPUTING, INC.
3917 Noriega Street
San Francisco, CA 94122



Since 1977

ELLIS COMPUTING™

CP/M is a registered trademark of Digital Research, Inc. Microsoft is a registered trademark of Microsoft Corp. TRS-80 is a registered trademark of Tandy Corp. Apple II is a trademark of Apple Computer, Inc. Osborne is a registered trademark of Osborne Computer Corp. Xerox 820 is a trademark of Xerox Corp. Kaypro is a trademark of Non-linear Sys. Heath/Zenith is a trademark of Heath Corp. IBM is a registered trademark of International Business Machines, Corp. Nevada BASIC, Nevada COBOL, Nevada FORTRAN, Nevada PILOT, Nevada EDIT, Nevada PASCAL, and Ellis Computing are trademarks of Ellis Computing, Inc. © 1984 Ellis Computing, Inc.

A hardware kernel implements Occam processes and communication.

$x := y + 10$. This compiles into the instructions

```
load local y
load constant 10
add
store local x
```

Each of these instructions is a single byte, and all the instructions except load local are executed in a single processor cycle. The load local instruction takes two processor cycles, one to calculate the address and the other to access the data. The instruction fetch is overlapped with those processor cycles that do not access memory. The above assignment statement takes a total of five processor cycles. The T424-20, with a 20-MHz processor cycling in 50 nanoseconds (ns), takes 250 ns for the statement. Executing four instructions in 250 ns is equivalent to 16 MIPS. The quoted figure of 10 MIPS allows for larger constants, nonlocal accesses, and more complex instructions. The language used for the assignment statement in this example is Occam, but similar statements can be written in many other languages. The high performance, therefore, is not limited to

Occam but is available to languages such as C, Pascal, and FORTRAN as well.

The processor includes a small hardware kernel to implement Occam processes and communication between them. Communication is handled directly by instructions, which pass the messages and schedule or deschedule the processes as appropriate. The kernel includes two levels of priority, the higher of which provides minimal latency for response to external events or for routing messages between Transputers that are not linked directly. A timer implements the Occam handling of time.

Use of multiple processes, communication, scheduling, and the handling of time is shown by the Occam program in listing 1. It describes two processes—one outputs a thousand messages and the other inputs a thousand messages. The timer records how long it takes to transfer the thousand messages.

Using on-chip RAM, the program in listing 1 performs approximately 125,000 message passes per second on a T424-10 with a 100-ns processor cycle and 250,000 message passes per second on a T424-20 with a 50-ns processor cycle.

The links are also fast, with a data rate of 10 megabits/second. Communication can occur at this speed simultaneously on all links and in both directions. With the four link interfaces on T424 and T222, this results in a throughput on each Transputer equal to eight full-speed Ethernets.

The link interfaces are autonomous. When a process in one Transputer has output to a link and a process on another Transputer has input from the same link, the link interfaces of the two Transputers transfer data across the link. The data is accessed from each Transputer's memory by a DMA controller within each link interface. While the transfer is taking place, the two communicating processes are descheduled, allowing the processor to execute other processes that are not waiting for communication. When the transfer is completed, the processes are scheduled, without the processor having to poll for transfer completion. If either process has high priority, it is run as soon as the transfer completes. A low-priority process takes its turn with other processes that are ready and able to run.

Communication between processes on a single Transputer is programmed in exactly the same way as communication through links. The only difference is that the channel associated with the link is allocated to a particular link interface. The same instructions are used for internal communication as for external communication, the only difference being the address of the channel.

Both the processor and the link interfaces use very high frequency clocks—up to 80 MHz. It is difficult to supply such a clock to one chip; to distribute high-frequency clocks around a large system is next to impossible. Therefore, the Transputer uses a low-frequency (5-MHz) external clock and generates all the high frequencies internally. Even with a low-frequency clock, it is impossible to ensure that all Transputers "see" a clock edge at the same time. The Transputer, therefore, has been designed so that the only important parameter of the input clock is its frequency, which can be tightly controlled by a crystal.

Similarly, it is difficult to synchronize the clock with the data on the links. So the data reception of the links is asynchronous, as is the case with RS-232C. But unlike RS-232C connec-

(continued)

Listing 1: A simple input/output program in Occam.

```
— Message passes per second
CHAN c:
VAR MPPS, StartTime, EndTime, ElapsedTime:
SEQ
  TIME ? StartTime
  PAR
    SEQ i = [0 FOR 1000] c ! 0
    VAR x:
    SEQ i = [0 FOR 1000] c ? x
  TIME ? EndTime
  ElapsedTime := EndTime - StartTime
  MPPS := (1000000/ElapsedTime) * 1000
```

TRANSTECTOR Has A Better Way To Eliminate Computer Malfunctions.

Computer foul-ups are enough to bring out the beast in even the most patient of individuals. But when random logic errors, memory loss, software damage or component failures have driven you to the brink, don't resort to wielding a sledgehammer. Fight back with TRANSTECTOR SYSTEMS.

TRANSTECTOR is the world's leading manufacturer of transient overvoltage protection systems for sensitive electronics. In fact, many FORTUNE 500 companies, such as NCR, General Electric Medical Systems and Johnson Controls, have chosen TRANSTECTOR to safeguard equipment they sell.

Now, that same famous technology is available to you. Ask your dealer for details on how TRANSTECTOR protectors can save you money—not to mention your mental health.

TRANSTECTOR

10701 Airport Dr.
Hayden Lake, ID 83835
(208) 772-8515

For the name of the TRANSTECTOR SYSTEMS authorized dealer nearest you, call toll free:

800-635-2537

FREE POSTER!
If you can empathize with the poor soul in this photo, you'll want an attractive, color poster (a \$7.50 value) to remind you that There Is A Better Way.
Get your very own poster FREE with the purchase of any TRANSTECTOR protector from your local authorized TRANSTECTOR dealer.

tions, the links are fast. They also have a protocol that matches the Occam model of communication between processes.

The on-chip RAM provides local memory that cycles at the same speed as the processor. External

memory cycles more slowly: The T222's memory interface cycles in two processor cycles, the T424's in a minimum of three processor cycles. T424 uses a multiplexed 32-bit address/data bus and is optimized for accessing dynamic RAM. A simple

configuration is shown in figure 3. Here the T424 is connected to four 8K by 8-bit (such as the IMS 2630) or 32K by 8-bit dynamic RAMs with no interfacing "glue" logic. The T424 generates all the required refresh addresses and cycles. It also generates

RAY TRACING WITH AN ARRAY OF TRANSPUTERS

The ray-tracing algorithm that generated the pictures in photos A and B takes a long time to draw them. For example, the Sage IV takes three hours to draw the 500 by 500 pixels in photo B. The algorithm calculates each pixel independently, so it is eminently suitable for parallel processing by sharing the pixels among a number of Transputers.

We first developed the program as a number of concurrent processes running on a single computer. The Sage, simulating concurrency, takes five hours to draw the picture when the pixels are shared among 64 processes. Photo A shows the picture when it is half complete.

The debugged program can then be mapped on to a network of Transputers. Figure A can be regarded as a block diagram of either the processes or the Transputer network. A Transputer implementing the ray-tracing process can even be regarded as a hardware ray-tracing machine.

The network of 64 (plus one screen driver) Transputers shown in figure A will draw the picture in about half a minute.

As well as calculating their own share of pixels, each of the 64 Transputers routes pixels along the pipeline toward the screen driver Transputer. A diagram of the processes and

channels on each Transputer is shown in figure B. An Occam program to describe these processes is

```
CHAN LocalChannel:
```

```
PRI PAR
```

```
... Routing process
```

```
... Pixel calculator
```

The routing process expands to:

```
SEQ k = [0 FOR (NumberOfPixelsRoutedByThisProcess)]
```

```
VAR Pixel:
```

```
ALT
```

```
LinkIn ? Pixel
```

```
LinkOut ! Pixel
```

```
LocalChannel ? Pixel
```

```
LinkOut ! Pixel
```

The expression (NumberOfPixelsRoutedByThisProcess) depends on where the Transputer is in the pipeline. The processes assume that the pixel sent through the pipeline of Transputers includes both the value of the pixel and an iden-



Photo A: The ray tracing is half done.

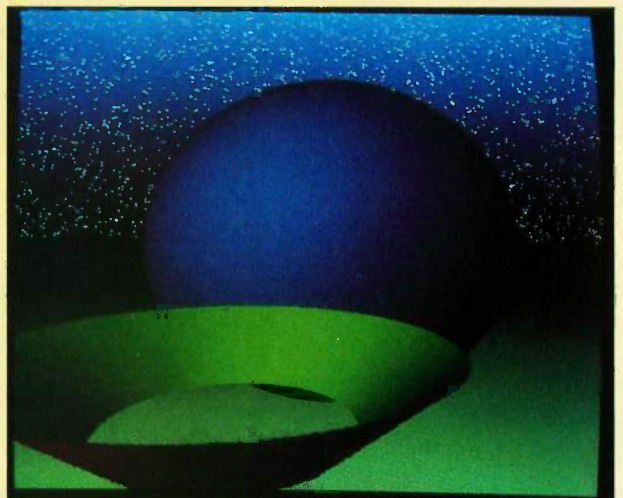

Photo B: The completed ray-tracing output.

THE TRANSPUTER

a number of configurable strobes, which can be used to generate the control signals for dynamic RAMs.

TRANSPUTER SYSTEMS

A system can be built with a single Transputer; some ROM (read-only

memory) and perhaps some peripherals can be put on the memory interface—the Transputer then behaves as a high-performance microprocessor. This single Transputer system can be enhanced by adding another Transputer, programmed to do a spe-

cialized job, and linked to the first Transputer as a coprocessor. The text box shows a number of Transputers connected in pipelines. Figure 1b shows a number of Transputers linked together in an array.

(continued)

tifier to enable the screen driver Transputer to determine which pixel it is receiving.

Sixteen Transputers are programmed as a pipeline with this program:

```
CHAN PixelPipeline [0 FOR TransputersDeep + 1]:
PAR i = [0 FOR TransputersDeep]
... Pixel calculating and routing Transputer
```

Four of these pipelines hooked up to the screen-driver Transputer are described by the program

```
DEF PixelsWide = 512:
DEF PixelsDeep = 512:
DEF TransputersDeep = 16:
DEF TransputersWide = 4:
CHAN PixelPipeline [(TransputersDeep + 1)*TransputersWide]:
PAR
... Screen Driver Transputer
PAR j = [0 FOR TransputersWide]
PAR i = [0 FOR TransputersDeep]
... Pixel calculating and routing Transputer
```

This program corresponds directly to figure A.

In this example, extensive use has been made of the `...` comment facility used by the Occam programming system to hide unwanted detail and help structure the program. The technique, known as "folding," allows quick and efficient navigation through a large program.

It is interesting to consider the communication overhead of the pipeline in this application. Each Transputer linked directly to the screen driver passes along data for 64,000 pixels. The routing process takes about 10 microseconds per pixel, which makes for an overhead of 0.64 second out of 30 seconds—about 2 percent. Grouping the pixels together and sending them in blocks of 32 pixels would reduce this to less than 0.1 percent overhead. The remaining 99.9 percent of each Transputer's processing power can be used for calculating pixels.

The number of Transputers used is defined as a set of constants at the start of the program. Reconfiguring for a different number of Transputers requires no more than changing these definitions. Writing the program this way makes it particularly easy to choose a number of Transputers to provide the appropriate cost/performance for the application.

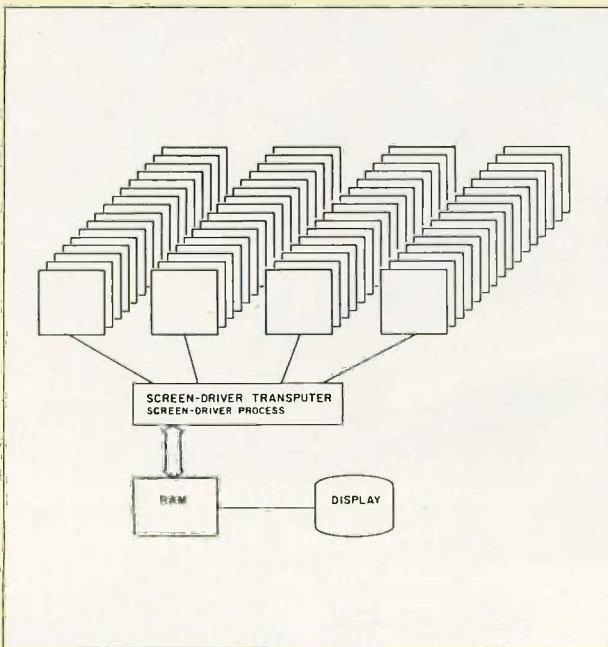

Figure A: Arrangement of 64 Transputers (plus one screen driver) for ray tracing.

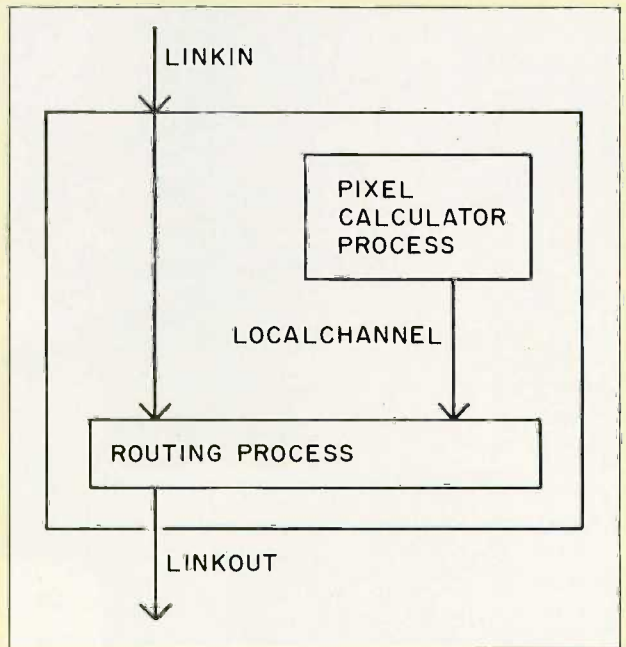

Figure B: Processes in each of the 64 Transputers shown in figure A.

X Turbo Board™ :

- On-Board 8088-2 Processor
- Optional Configuration of 8087 Numeric Processor
- On-Board Maximum RAM Capacity of 640K
- Extended Rom Capability of 8K BIOS and 40K for Basic or other programs
- Peripheral Support Circuits as on PC
- Configuration Switches as on PC
- Eight PC Compatible I/O Interface SLOTS
- Standard Key-Board Interface
- Speaker/Audio Port
- Two LED Ports for Turbo and power level indication
- PC Compatible Power Connectors
- All features — including board size — same as PC

7 Plus™ :

When you use X Turbo Board™ with the 7 Plus™ multifunction card it makes up the most advanced and compact system available.

Seven Reasons for the 7 Plus™ :

- To leave as many of your expansion slots as possible free for future use.
- To minimize your component cost in completing your system.
- To reduce your installation time.
- To maximize your computer productivity.
- To keep your system's temperature down.
- All the functions that the ideal PC should possess.
- And finally our desire to set an industry all-in-one Standard.

The Most Advanced System :

The advantages of using the X Turbo Board in conjunction with the 7 Plus are many. It contains all the functions you need in one system — the X Turbo System.

- 640K on board
- 2 Serial Port
- Parallel Printer Port
- Game Port
- Clock Calendar
- Printer Spooler
- Ram Disk
- 2 Floppy Disk Controllers

X Turbo System is fully compatible with both software and hardware designed for IBM PC/XT.

THE MOST ADVANCED SYSTEM AVAILABLE

**X Turbo Board + 7 Plus
= The Most Advanced System**

IBM XT COMPATIBLE

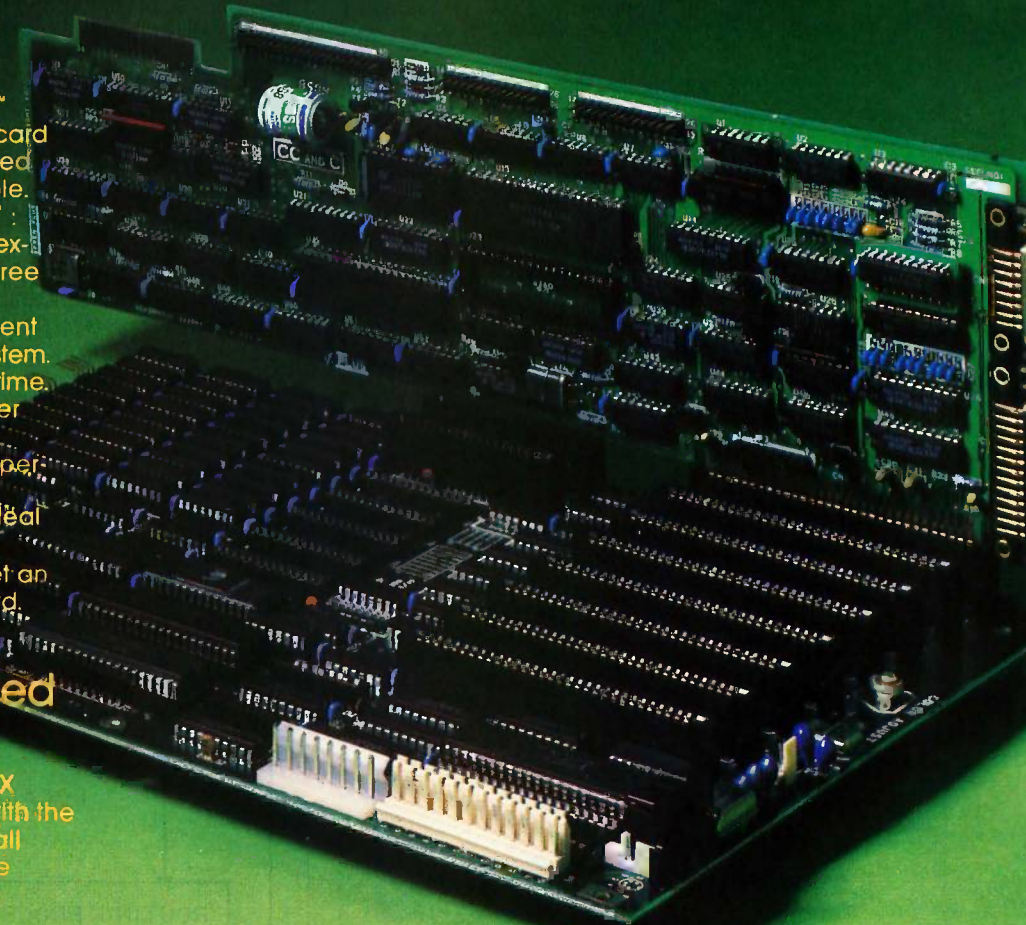

**OEM, Distributor and Dealer
Inquiries Welcome !**

ARC

**AMERICAN
RESEARCH
CORPORATION**

2001 W. Chestnut St., Room 103
Alhambra, CA 91803
Telex: 285653

(818) 289-8742

IBM and IBM PC/XT are trademarks of IBM Corp.

THE TRANSPUTER

*There is no limit
to the size,
function, or shape
of a network
of Transputers.*

Other networks can be built. A functionally distributed network might have random interconnections between Transputers (figure 4). An array could have its ends connected toroidally (figure 5) to simulate an infinite network in a similar way to the Bagel developed by Shapiro (reference 5). Systolic arrays developed by H. T. Kung (reference 6) and wavefront processors developed by S. Y. Kung (reference 7) map naturally onto networks of Transputers. (Incidentally, the systolic and wavefront architectures are easy to model in Occam, even if the final implementation is intended to be special-purpose hardware, as shown by Fujitsu in reference 8.)

There is no design limit to the size, function, or shape of a network of Transputers. Further, provided the network of Transputers is programmed so that they cooperate—rather than one Transputer waiting for another that waits for another, and so on—the performance of a network is directly proportional to the size of the network. For example, the ray tracing described in the text box shows a negligible 0.1 percent overhead of communication between Transputers.

BUILDING BLOCKS

Because Transputers can be built into systems of arbitrary size, function, or shape, they can be thought of as building blocks. Making a link between two Transputers is as simple as joining together the lug and hole on two Lego bricks; both are standardized connections.

Another respect in which the analogy holds is that a network of

(continued)

Call for pricing on other Sperry Computers.

SPERRY PC COMPUTERS

Authorized Sperry Distributor. Dealer Inquiries Invited.

Mono Desktop 256K, 2 Drives, Serial Port, Par. Port, Clock, MSDOS 2.11, GWBasic plus Other Software	\$1650
Portable Computer 256K 2 Drives Full IBM Compatibility	\$1650

DATA BASE

MANAGEMENT SYSTEMS

Fox and Geller Quickcode	\$125
Knowledgeman	\$225
Condor III	\$289
NWA Statpak	\$265
Tim IV	\$219
DBase Manager II	\$165
FRIDAY	\$159
Personal Pearl	\$215
PFS File	\$78
Nutshell	\$65
RBase 4000	\$240
CLOUT 2	\$129
Power Base	\$219

WORD PROCESSING

Wordstar Pro Pack	\$240
Samna III	\$265
Wordstar 2000 for IBM PC	\$238
Wordstar 2000 +	\$285
Leading Edge Word Processor/Merge	\$95
Microsoft Word	\$225
Word Perfect	\$219
Volkswriter for the IBM PC	\$110
Volkswriter DeLuxe	\$149
Random House Spell Checker	\$36
PFS Write	\$78
Multimate	\$255
Peachtext 5000	\$185

SPREADSHEETS

Supercalc II	\$145
Supercalc III	\$159
Microsoft Multiplan	\$119
!TK Solver	\$239
Lotus 123	\$294
Symphony	\$415

ACCOUNTING

TCS. Big Four equivalent of Peachtree Series 4 - Specially augmented and customized for your IBM PC Terminal and Printer - GL, AR, PA, AP, CP/M-80, CP/M-86 for PC XT, DOS 1.1, 2.0. Each Module . . . **\$65 For All Four \$249**

CYMA	Call
Dollars & Sense	\$95
MBSI Accounting (Real World)	\$350
Tobias Managing Your Money	\$99

TRANSFER PROGRAMS

Hayes Smartcom	\$85
Move-it	\$79
Microstuff Crosstalk	\$95

BEST PRICE IN U.S. FOR IBM PC OR CLONES
Multifunction Board - Includes Async Adapter, Parallel Adapter, Clock with battery back-up and Software, 64K memory expandable to 384K. 1 year warranty . . . **\$235**

LANGUAGES

Lifboat Lattice C Compiler	\$265
Lattice C Interpreter	\$100
Microsoft C Compiler	\$299
Microsoft Pascal Compiler	\$180
Microsoft Basic Compiler	\$235
Microsoft Basic Language	\$225

FOR PC DOS

PC Paint Brush	\$85
Norton Utilities	\$54
Copy II PC	\$24
Prokey V3.0	\$69
Harvard Project Manager	\$199
Microsoft Flight Simulator	\$32
Think Tank	\$98

HARDWARE

ABC Printer Switch	\$85
Micro Fazer Parallel 64K	\$185
Hayes 1200 Modem	\$395
Hayes 1200b Modem for IBM PC	\$349
64K RAM Chips (9) 150 NSEC	\$18
Anchor Signalman 1200 baud Modem	\$245
IOmega Bernoulli 20 Megabyte	\$2495
Princeton RGB Monitor	\$459
Taxan RGB Vision 425	\$399

Diskette Super Special!
10 D/S D/D (Qty 100) . . . **\$12.95**

COMPUTERS

IBM Computer . . . **Call**

BOARDS FOR THE IBM PC OR LOOKALIKES

Hercules Color Board with Par. Port.	\$149
AST Six Pack	\$249
384K Board with 256K	\$220
Quadcolor I	\$185
STB Graphics II Board	\$245
Paradise Graphics Board	\$275
New Quadram Multifunction Board	\$225

PRINTERS

FREE! PRINTER SET SOFTWARE

Purchase an Okidata, Epson or Gemini printer and receive at no charge a menu driven program to set print characteristics or to make your computer function as a correcting typewriter. Retail value \$35. Available for most disk formats.

Gemini SG/10	Call
Gemini SG/15	Call
Okidata 82A, 83A, 93P	Call
Okidata 93P	\$569
Okidata 84P	\$650
Juki 6100	\$389
Juki 6300	\$689

Call on all Epson Models

Silver-Reed EXP 400	\$235
Silver-Reed EXP 550	\$395
Toshiba 1351	\$1164
NEC, Diablo,	Call

TERMS: Prices include 3% cash discount. Add 3% for charge orders. Shipping on most items \$5.00. AZ orders +6% Sales Tax. Personal check, allow ten (10) days to clear. Prices subject to change.

Se habla Español

Call for programs not listed



WAREHOUSE DATA PRODUCTS

2701 West Glendale Ave., Suite 6, Phoenix, Arizona 85021
Technical & Other Information (602) 246-2222
TOLL FREE ORDER LINE 1-800-421-3135



7400 74F00 74ALS00 DISK CONTROLLERS

Part No.	Price	Part No.	Price	Part No.	Price
SN7400N	14.29	SN74126N	14.39	SN74159N	24.195
SN7401N	14.29	SN74127N	14.39	SN74160N	16.59
SN7402N	14.29	SN74128N	14.495	SN74161N	16.59
SN7403N	14.29	SN74129N	14.495	SN74162N	16.59
SN7404N	14.29	SN74130N	14.495	SN74163N	16.59
SN7405N	14.29	SN74131N	14.495	SN74164N	16.59
SN7406N	14.29	SN74132N	14.495	SN74165N	16.59
SN7407N	14.29	SN74133N	14.495	SN74166N	16.59
SN7408N	14.29	SN74134N	14.495	SN74167N	16.59
SN7409N	14.29	SN74135N	14.495	SN74168N	16.59
SN7410N	14.29	SN74136N	14.495	SN74169N	16.59
SN7411N	14.29	SN74137N	14.495	SN74170N	16.59
SN7412N	14.29	SN74138N	14.495	SN74171N	16.59
SN7413N	14.29	SN74139N	14.495	SN74172N	16.59
SN7414N	14.29	SN74140N	14.495	SN74173N	16.59
SN7415N	14.29	SN74141N	14.495	SN74174N	16.59
SN7416N	14.29	SN74142N	14.495	SN74175N	16.59
SN7417N	14.29	SN74143N	14.495	SN74176N	16.59
SN7418N	14.29	SN74144N	14.495	SN74177N	16.59
SN7419N	14.29	SN74145N	14.495	SN74178N	16.59
SN7420N	14.29	SN74146N	14.495	SN74179N	16.59
SN7421N	14.29	SN74147N	14.495	SN74180N	16.59
SN7422N	14.29	SN74148N	14.495	SN74181N	16.59
SN7423N	14.29	SN74149N	14.495	SN74182N	16.59
SN7424N	14.29	SN74150N	14.495	SN74183N	16.59
SN7425N	14.29	SN74151N	14.495	SN74184N	16.59
SN7426N	14.29	SN74152N	14.495	SN74185N	16.59
SN7427N	14.29	SN74153N	14.495	SN74186N	16.59
SN7428N	14.29	SN74154N	14.495	SN74187N	16.59
SN7429N	14.29	SN74155N	14.495	SN74188N	16.59
SN7430N	14.29	SN74156N	14.495	SN74189N	16.59
SN7431N	14.29	SN74157N	14.495	SN74190N	16.59
SN7432N	14.29	SN74158N	14.495	SN74191N	16.59
SN7433N	14.29	SN74159N	14.495	SN74192N	16.59
SN7434N	14.29	SN74160N	14.495	SN74193N	16.59
SN7435N	14.29	SN74161N	14.495	SN74194N	16.59
SN7436N	14.29	SN74162N	14.495	SN74195N	16.59
SN7437N	14.29	SN74163N	14.495	SN74196N	16.59
SN7438N	14.29	SN74164N	14.495	SN74197N	16.59
SN7439N	14.29	SN74165N	14.495	SN74198N	16.59
SN7440N	14.29	SN74166N	14.495	SN74199N	16.59
SN7441N	14.29	SN74167N	14.495	SN74200N	16.59
SN7442N	14.29	SN74168N	14.495	SN74201N	16.59
SN7443N	14.29	SN74169N	14.495	SN74202N	16.59
SN7444N	14.29	SN74170N	14.495	SN74203N	16.59
SN7445N	14.29	SN74171N	14.495	SN74204N	16.59
SN7446N	14.29	SN74172N	14.495	SN74205N	16.59
SN7447N	14.29	SN74173N	14.495	SN74206N	16.59
SN7448N	14.29	SN74174N	14.495	SN74207N	16.59
SN7449N	14.29	SN74175N	14.495	SN74208N	16.59
SN7450N	14.29	SN74176N	14.495	SN74209N	16.59
SN7451N	14.29	SN74177N	14.495	SN74210N	16.59
SN7452N	14.29	SN74178N	14.495	SN74211N	16.59
SN7453N	14.29	SN74179N	14.495	SN74212N	16.59
SN7454N	14.29	SN74180N	14.495	SN74213N	16.59
SN7455N	14.29	SN74181N	14.495	SN74214N	16.59
SN7456N	14.29	SN74182N	14.495	SN74215N	16.59
SN7457N	14.29	SN74183N	14.495	SN74216N	16.59
SN7458N	14.29	SN74184N	14.495	SN74217N	16.59
SN7459N	14.29	SN74185N	14.495	SN74218N	16.59
SN7460N	14.29	SN74186N	14.495	SN74219N	16.59
SN7461N	14.29	SN74187N	14.495	SN74220N	16.59
SN7462N	14.29	SN74188N	14.495	SN74221N	16.59
SN7463N	14.29	SN74189N	14.495	SN74222N	16.59
SN7464N	14.29	SN74190N	14.495	SN74223N	16.59
SN7465N	14.29	SN74191N	14.495	SN74224N	16.59
SN7466N	14.29	SN74192N	14.495	SN74225N	16.59
SN7467N	14.29	SN74193N	14.495	SN74226N	16.59
SN7468N	14.29	SN74194N	14.495	SN74227N	16.59
SN7469N	14.29	SN74195N	14.495	SN74228N	16.59
SN7470N	14.29	SN74196N	14.495	SN74229N	16.59
SN7471N	14.29	SN74197N	14.495	SN74230N	16.59
SN7472N	14.29	SN74198N	14.495	SN74231N	16.59
SN7473N	14.29	SN74199N	14.495	SN74232N	16.59
SN7474N	14.29	SN74200N	14.495	SN74233N	16.59
SN7475N	14.29	SN74201N	14.495	SN74234N	16.59
SN7476N	14.29	SN74202N	14.495	SN74235N	16.59
SN7477N	14.29	SN74203N	14.495	SN74236N	16.59
SN7478N	14.29	SN74204N	14.495	SN74237N	16.59
SN7479N	14.29	SN74205N	14.495	SN74238N	16.59
SN7480N	14.29	SN74206N	14.495	SN74239N	16.59
SN7481N	14.29	SN74207N	14.495	SN74240N	16.59
SN7482N	14.29	SN74208N	14.495	SN74241N	16.59
SN7483N	14.29	SN74209N	14.495	SN74242N	16.59
SN7484N	14.29	SN74210N	14.495	SN74243N	16.59
SN7485N	14.29	SN74211N	14.495	SN74244N	16.59
SN7486N	14.29	SN74212N	14.495	SN74245N	16.59
SN7487N	14.29	SN74213N	14.495	SN74246N	16.59
SN7488N	14.29	SN74214N	14.495	SN74247N	16.59
SN7489N	14.29	SN74215N	14.495	SN74248N	16.59
SN7490N	14.29	SN74216N	14.495	SN74249N	16.59
SN7491N	14.29	SN74217N	14.495	SN74250N	16.59
SN7492N	14.29	SN74218N	14.495	SN74251N	16.59
SN7493N	14.29	SN74219N	14.495	SN74252N	16.59
SN7494N	14.29	SN74220N	14.495	SN74253N	16.59
SN7495N	14.29	SN74221N	14.495	SN74254N	16.59
SN7496N	14.29	SN74222N	14.495	SN74255N	16.59
SN7497N	14.29	SN74223N	14.495	SN74256N	16.59
SN7498N	14.29	SN74224N	14.495	SN74257N	16.59
SN7499N	14.29	SN74225N	14.495	SN74258N	16.59
SN7500N	14.29	SN74226N	14.495	SN74259N	16.59

Part No.	Price	Part No.	Price	Part No.	Price
74F00	14.29	74F01	14.29	74F02	14.29
74F03	14.29	74F04	14.29	74F05	14.29
74F06	14.29	74F07	14.29	74F08	14.29
74F09	14.29	74F10	14.29	74F11	14.29
74F12	14.29	74F13	14.29	74F14	14.29
74F15	14.29	74F16	14.29	74F17	14.29
74F18	14.29	74F19	14.29	74F20	14.29
74F21	14.29	74F22	14.29	74F23	14.29
74F24	14.29	74F25	14.29	74F26	14.29
74F27	14.29	74F28	14.29	74F29	14.29
74F30	14.29	74F31	14.29	74F32	14.29
74F33	14.29	74F34	14.29	74F35	14.29
74F36	14.29	74F37	14.29	74F38	14.29
74F39	14.29	74F40	14.29	74F41	14.29
74F42	14.29	74F43	14.29	74F44	14.29
74F45	14.29	74F46	14.29	74F47	14.29
74F48	14.29	74F49	14.29	74F50	14.29
74F51	14.29	74F52	14.29	74F53	14.29
74F54	14.29	74F55	14.29	74F56	14.29
74F57	14.29	74F58	14.29	74F59	14.29
74F60	14.29	74F61	14.29	74F62	14.29
74F63	14.29	74F64	14.29	74F65	14.29
74F66	14.29	74F67	14.29	74F68	14.29
74F69	14.29	74F70	14.29	74F71	14.29
74F72	14.29	74F73	14.29	74F74	14.29
74F75	14.29	74F76	14.29	74F77	14.29
74F78	14.29	74F79	14.29	74F80	14.29
74F81	14.29	74F82	14.29	74F83	14.29
74F84	14.29	74F85	14.29	74F86	14.29
74F87	14.29	74F88	14.29	74F89	14.29
74F90	14.29	74F91	14.29	74F92	14.29
74F93	14.29	74F94	14.29	74F95	14.29
74F96	14.29	74F97	14.29	74F98	14.29
74F99	14.29	74F00	14.29	74F01	14.29

Part No.	Price	Part No.	Price	Part No.	Price
74ALS00	14.29	74ALS01	14.29	74ALS02	14.29
74ALS03	14.29	74ALS04	14.29	74ALS05	14.29
74ALS06	14.29	74ALS07	14.29	74ALS08	14.29
74ALS09	14.29	74ALS10	14.29	74ALS11	14.29
74ALS12	14.29	74ALS13	14.29	74ALS14	14.29
74ALS15	14.29	74ALS16	14.29	74ALS17	14.29
74ALS18	14.29	74ALS19	14.29	74ALS20	14.29
74ALS21	14.29	74ALS22	14.29	74ALS23	14.29
74ALS24	14.29	74ALS25	14.29	74ALS26	14.29
74ALS27	14.29	74ALS28	14.29	74ALS29	14.29
74ALS30	14.29	74ALS31	14.29	74ALS32	14.29
74ALS33	14.29	74ALS34	14.29	74ALS35	14.29
74ALS36	14.29	74ALS37	14.29	74ALS38	14.29
74ALS39	14.29	74ALS40	14.29	74ALS41	14.29
74ALS42	14.29	74ALS43	14.29	74ALS44	14.29
74ALS45	14.29	74ALS46	14.29	74ALS47	14.29
74ALS48	14.29	74ALS49	14.29	74ALS50	14.29
74ALS51	14.29	74ALS52	14.29	74ALS53	14.29
74ALS54	14.29	74ALS55	14.29	74ALS56	14.29
74ALS57	14.29	74ALS58	14.29	74ALS59	14.29
74ALS60	14.29	74ALS61	14.29	74ALS62	14.29
74ALS63	14.29	74ALS64	14.29	74ALS65	14.29
74ALS66	14.29	74ALS67	14.29	74ALS68	14.29
74ALS69	14.29	74ALS70	14.29	74ALS71	14.29
74ALS72	14.29	74ALS73	14.29	74ALS74	14.29
74ALS75	14.29	74ALS76	14.29	74ALS77	14.29
74ALS78	14.29	74ALS79	14.29	74ALS80	14.29
74ALS81	14.29	74ALS82	14.29	74ALS83	14.29
74ALS84	14.29	74ALS85	14.29	74ALS86	14.29
74ALS87	14.29	74ALS88	14.29	74ALS89	14.29
74ALS90	14.29	74ALS91	14.29	74ALS92	14.29
74ALS93	14.29	74ALS94	14.29	74ALS95	14.29
74ALS96	14.29	74ALS97	14.29	74ALS98	14.29
74ALS99	14.29	74ALS00	14.29	74ALS01	14.29

DISK CONTROLLERS

Digitalker™

DT1050 - Application: handling platters, checks, annotations, microcomputations. Language translations, etc. The DT1050 is a standard DIGITALKER for encoded with 17 separate and useful words; 2 lines, and 5 different sentence delimiters. The words and lines have been analyzed (discrete analysis), making it possible to input single words or words consecutively as phrases or sentences. The "output" of the DT1050 is a highly intelligible mail voice. The DT1050 consists of a **Jameco Processor Chip (MS14100)** and **two CD ROMs (MS14100A and MS14100B)** (2" x 2" x 1/16" thick) along with a Master Disk and a recommended schematic diagram on the application sheet.

DT1050 Digitalker™ \$34.95 ea.
MM54104 Processor Chip..... \$14.95 ea.

DT1057 - Expands the DT1050 vocabulary from 17 to over

Commodore® Accessories



RS232 Adapter for VIC-20 and Commodore 64

The JE232CM allows connection of standard serial RS232 printers, modems, etc. to your VIC-20 and C-64. A 4-pole switch allows the inversion of the 4 control lines. Complete installation and operation instructions included.

• Plugs into User Port • Provides Standard RS232 signal levels • Uses 6 signals (Transmit, Receive, Clear to Send, Request to Send, Data Terminal Ready, Data Set Ready).
JE232CM \$39.95

VOICE SYNTHESIZER FOR APPLE AND COMMODORE

Plug-In - Talking in Minutes!



JE520CM

JE520AP

• Over 250 word vocabulary - affixes allow the formation of more than 500 words • Built-in amplifier, speaker, volume control, and audio jack • Recreates a clear, natural male voice • Plug-in user ready with documentation and sample software • Case size: 7 1/4" L x 3 1/4" W x 1-3/8" H

APPLICATIONS: • Security Warning • Telecommunication • Teaching • Handicap Aid • Instrumentation • Games

Part No.	Description	Price
JE520CM	For Commodore 64 & VIC-20	\$114.95
JE520AP	For Apple II, II+, and IIe	\$149.95

All Major Manufacturers - Not Micron

Computer Memory Expansion Kits

IBM PC, PC XT and Compatibles

Most of the popular Memory Boards (e.g. Quadram® Expansion Boards) allow you to add an additional 64K, 128K, 192K or 256K. The IBM64K Kit will populate these boards in 64K byte increments. The kit is simple to install - just insert the 9 - 64K RAM chips in the provided sockets and set the 2 groups of switches. Complete conversion documentation included.

IBM64K (Nine 200ns 64K RAMs)..... \$33.49

IBM PC AT

Each kit comes complete with nine 128K dynamic RAMs and documentation for conversion.

IBM128K (Nine 250ns 128K RAMs)..... \$199.95

APPLE IIe

Extended 80-Column/84K Base CPU kit expands memory by 64K to give 128K when used with programs like VisiCalc™. Fully assembled and tested.

JE864..... \$99.95

TRS-80 MODEL I, III

Each Kit comes complete with eight MM5290 (UP0416/1116) 16K Dynamic RAMs and documentation for conversion. Model 1: 16K equipped with Expansion Interface can be expanded to 48K with 2 Kits. Model III: Can be expanded from 16K to 48K using 2 Kits. Each Kit will expand computer by 16K increments.

TRS-16K3 200ns (Model III)..... \$6.29
TRS-16K4 250ns (Model I)..... \$5.49

TRS-80 MODEL IV & 4P

Easy to install Kit comes complete with 8 ea. 4164N-20 (200ns) 64K Dynamic RAMs and conversion documentation. Converts TRS-80 Model IV computers from 16K to 64K. Also expands Model 4P from 64K to 128K.

TRS-64K-2..... \$29.95

(Converts the Model IV from 16K to 64K or will expand the Model 4P from 64K to 128K)

TRS-64K2PAL (Model IV only)..... \$49.95

(8 - 4164's with PAL Chip to expand from 64K to 128K)

TRS-80 COLOR AND COLOR II

Easy to install Kit comes complete with 8 ea. 4164N-20 (200ns) 64K Dynamic RAMs and documentation for conversion. Converts TRS-80 Color Computers with D, E, ET, F and NC circuit boards to 32K. Also converts TRS-80 Color Computer II to 64K. Flex D05 or QS-9 required to utilize full 64K RAM on all computers.

TRS-64K-2..... \$29.95

INDUSTRIES

PROTECT YOURSELF... DATASHIELD Surge Protector

Eliminates surge damage and data loss. It can damage your equipment or cause data loss. 6-mo. warranty. Power dissipation (100 microseconds): 2,000-80 watts

Model	DESCRIPTION	PRICE
100		
PART NO.		
MODEL 75	4 Sockets, On/Off Switch.....	\$49.95
MODEL 85	6 Sock., Super Filters, On/Off Switch.....	\$59.95
MODEL 100	6 Sock., Super Filters, Low Volt. Alarm.....	\$69.95
MODEL 110AS	6 Sockets, Super Filters, Auto. Master Switch.....	\$99.95

DATASHIELD® Back-Up Power Source

Protect your computer from black-outs, brown out power surges and line noise. The PC200 is designed for PCs with floppy disk memory, the XT300 for hard disk memory and the AT500 for multi-user systems. A typical compatible PC for each of these standbys will be supported for 15 to 25 minutes after power is lost. Weight (PC200: 24 lbs.) - (XT300: 37.5 lbs.) - (AT500: 83 lbs.)

PC200	(200 Watt Rating).....	\$299.95
XT300	(300 Watt Rating).....	\$399.95
AT500	(500 Watt Rating).....	\$699.95
AT800	(800 Watt Rating).....	\$799.95

ProModem 1200 and Options



Intelligent 300/1200 Baud Telephone Modem with Real Time Clock/Calendar

The ProModem™ is a Bell 212A (300/1200 baud) intelligent stand-alone modem • Full featured expandable modem • Standard features include Auto Answer and Auto Dial, Help Commands, Programmable Intelligent Dialing, Touch Tone™ and Pulse Dialing & More • Hayes command set compatible plus an additional extended command set • Shown w/alphanumeric display option.

Part No.	Description	Price
PM1200	RS-232 Stand Alone Unit.....	\$349.95
PM1200A	Apple II, II+ and IIe Internal Unit.....	\$369.95
PM1200B	IBM PC and Compatible Internal Unit.....	\$269.95
PM1200BS	IBM PC & Comp. Int. Unit w/ProCom Software.....	\$319.95
MAC PAC	Macintosh Package.....	\$399.95
	(Includes PM1200, Cable, & ProCom Software)	

OPTIONS FOR ProModem 1200

PM-COM	(ProCom Communication Software).....	\$79.95
PM-OP	(Options Processor).....	\$79.95
PMO-16K	(Options Processor Memory - 16K).....	\$10.95
PMO-32K	(Options Processor Memory - 32K).....	\$20.95
PMO-64K	(Options Processor Memory - 64K).....	\$39.95
PM-ALP	(Alphanumeric Display).....	\$79.95
PM-Special	(Includes Options Processor, 64K Memory and Alphanumeric Display).....	\$189.95

KEYBOARDS



Mitsumi 54-Key Unenclosed All-Purpose Keyboard

• SPST keystrokes • 20 pin ribbon cable connection • Low profile keys • Features: cursor controls, control, caps (lock), function, enter and shift keys • Color (keycaps): grey • Wt.: 1 lb. • Pinout Included
KB54..... \$14.95

New!



82-Key ASCII Cherry Keyboard

• 7-bit parallel ASCII • 11-key numeric keypad • Cursor keypad • SPST mechanical keyswitches • 4 illuminated keys • 26-pin header connector • Color: white • Size: 18" L x 6 1/4" W x 1 1/4" H • Spec included
KB8201..... (1700 avail.)... \$29.95



Apple Owners!

SPECIAL FUNCTIONS!

Apple Keyboard and Case for Apple II and II+

Keyboard: • 68 keys • 15-key keypad • Direct connection with 16-pin ribbon connector • 26 special functions • Size: 14 1/4" L x 5 1/2" W x 1 1/4" H

Case: Accommodates KB-A68 • Pop-up lid for easy access • Fits power supply and motherboard too • Size: 15 1/4" L x 18" D x 4 1/4" H

Part No.	Description	Price
KB-EA1	Apple Keyboard and Case (pictured above).....	\$134.95
KB-A68	68-Key Apple Keyboard only.....	\$ 79.95
EAEC-1	Expanded Apple Enclosure Case only.....	\$ 59.95

POWER SUPPLIES



Power/Mate Corp. REGULATED POWER SUPPLY

• Input: 105-125/210-250 VAC at 47-63 Hz • Line regulation: ±0.05% • Three mounting surfaces • Overvoltage protection • UL recognized • CSA certified

Part No.	Output	Size	Weight	Price
EMAS/6B	5V@3A/6V@2.5A	4 1/2" L x 4" W x 2 1/2" H	2 lbs.	\$29.95
EMAS/6C	5V@6A/6V@5A	5 1/2" L x 4 1/2" W x 2 1/2" H	4 lbs.	\$39.95



KEPCO/TDK 4-OUTPUT SWITCHING POWER SUPPLY

• Ideal for disk drive needs of CRT terminals, microcomputers and video games • Input: 115/230VAC, 50/60Hz • Output: +5V @ 5 Amp, +12V @ 1.8 Amp, +12V @ 2 Amp, -12V @ 0.5 Amp • UL recognized • CSA certified • Size: 7 1/4" L x 6-3/16" W x 1 1/4" H • Weight: 2 lbs.

\$59.95 each or MRM 174KF..... \$29.95



Switching Power Supply for APPLE II, II+ & IIe™

• Can drive four floppy disk drives and up to eight expansion cards • Short circuit and overload protection • Fits inside Apple computer • Fully regulated +5V @ 5A, +12V @ 1.5A, -5V @ 5A, -12V @ 5A • Direct plug-in power cord included • Size: 9 1/4" L x 3 1/2" W x 2 1/4" H • Weight: 2 lbs.

KHP4007 (SPS-109)..... \$59.95



4-CHANNEL SWITCHING POWER SUPPLY

• Microprocessor, mini-computer, terminal, medical equipment and process control applications • Input: 90-130VAC, 47-60Hz • Output: +5VDC @ 5A, -5VDC @ 1A, +12VDC @ 1A, -12VDC @ 1A • Line regulations: ±0.2% • Ripple: 30mV p-p • Load regulation: ±1% • Overcurrent protection • AD: 5V main output ±10% • Size: 6 1/2" L x 1 1/4" W x 4-15/16" H • Weight: 1 1/2 lbs.

FCS-604A..... \$69.95



IBM PCXT EQUIVALENT 130 WATT POWER SUPPLY

• Upgrade your PC • Input: 100V-130V/200V-260V selectable @ 4.2 to 63Hz • Output: +5VDC @ 15A, -5VDC @ 0.5A, +12VDC @ 4.2A, -12VDC @ 0.5A • Plug compatible connectors • Fits into IBM PC • Weight: 6 lbs.

IBM-PS..... \$169.95

\$10 Minimum Order - U.S. Funds Only CA Residents: Add 6 1/2% Sales Tax Spec Sheets - 30¢ each
Shipping: Add 5% plus \$1.50 Insurance Send \$1 Postage for FREE 1985 Jameco Catalog Prices Subject to Change
Send stamped, self-addressed envelope to receive a Monthly Sales Flyer - FREE!



1355 SHOREWAY ROAD, BELMONT, CA 94002

5/85 PHONE ORDERS WELCOME - (415) 592-8097 - Telex: 176043

Apple® Accessories

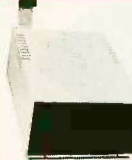

5 1/4" APPLE™ Direct Plug-In Compatible Disk Drive and Controller Card

The ADD-514 Disk Drive uses Shugart SA390 mechanics - 143K formatted storage - 35 tracks • Compatible with Apple Controller & ACC-1 Controller • The drive comes complete with connector and cable - just plug into your disk controller card • Size: 6" L x 3 1/2" W x 8-9/16" D • Weight: 4 1/2 lbs.

ADD-514 (Disk Drive)..... \$169.95
ACC-1 (Controller Card)..... \$ 49.95

More Apple Compatible Add-Ons...

APF-1	(Cooling Fan with surge protection).....	\$99.95
KHP4007	(Switching Power Supply).....	\$59.95
JE614	(Numerical/Aux. Keypad for IIe).....	\$59.95
KB-A68	(Keyboard w/Keypad for II & II+).....	\$79.95
MON-12G	(12" Green Monitor w/swivel stand).....	\$99.95
JE864	(80 Cot. + 64K RAM for IIe).....	\$99.95
ADD-12	(5 1/4" Half-Height Disk Drive).....	\$179.95



ADDITIONAL APPLE™ ADD-ONS AVAILABLE

ARC-16K (16K RAM Card for Apple II & II+)..... \$39.95
AEB-2 (EPROM Burner for Apple II, II+ & IIe)..... \$69.95
Allows copy of standard EPROMs 2708, 2716, 2732, 2764

ASSC-P (Super Serial Card for Apple II, II+ & IIe)..... \$99.95
ADD-IIc (5 1/4" Half-Ht. Disk Drive for Apple IIc)..... \$189.95

DISK DRIVES



Documentation Included Best Buy!

MP151S	(MPI 5 1/4" SS full-ht.).....	\$ 89.95
RFD480	(Remex 5 1/4" DS full-ht.).....	\$109.95
TM100-2	(Tandon 5 1/4" DS full-ht.).....	\$159.95
FD55B	(Teac 5 1/4" DS half-ht.).....	\$149.95
SA455	(Shugart 5 1/4" DS half-ht.).....	\$159.95
FDD100-8	(Siemens 8" SS full-ht.).....	\$119.95
PCK-5	(5 1/4" Power Cable Kit).....	\$ 2.95
PCK-8	(8" Power Cable Kit).....	\$ 3.95

UV-EPROM Eraser



8 Chips - 21 Minutes 1 Chip - 15 Minutes

Erases all EPROMs. Erases up to 8 chips within 21 minutes (1 chip in 15 minutes). Maintains constant exposure distance of one inch. Special conductive foam liner eliminates static build-up. Built-in safety lock to prevent inoperative. Compact - only 9.00" L x 3.70" W x 2.60" H. Complete with holding tray for 8 chips.

DE-4 UV-EPROM Eraser..... \$74.95
UVS-11EL Replacement Bulb..... \$16.95

JE664 EPROM PROGRAMMER

See Our New IBM Communications Program!



24 & 28 PIN PACKAGES
8K to 64K EPROMS

REQUIRES NO ADDITIONAL SYSTEMS FOR OPERATION

Programmer and validates EPROMs • Checks for properly erased EPROMs • Emulates PROMs or EPROMs • Loads data in RAM by keyboard • Changes data in RAM by keyboard • Loads RAM from an EPROM • 64 RAMs can be used for external microprocessor development • Compares EPROMs for content differences • Copies EPROMs • Input: 115VAC 60Hz • Assembled and tested • Size: 15 1/4" L x 8 1/2" W x 3 1/2" H • Wt: 5 1/2 lbs. • 2716 Module included

JE664-A EPROM Programmer..... \$995.00

JE664-ARS COMMUNICATION PROGRAM

w/JE665 Option..... \$1195.00

JE664-ARS COMMUNICATION PROGRAM For IBM-PC or XT and Compatibles

• Fast compiled BASIC program • Easy to use, menu-driven • Print hard-copy of EPROM data • View data in HEX and ASCII
NEW! The JE664-ARS Communication Program was written for quick interfacing between the JE664-ARS EPROM Programmer and the IBM-PC computer and compatibles. Menu-driven program allows user to Load and Save EPROM data to and from the computer or floppy disk. Data entered by the computer can be viewed in Hex & ASCII formats. Printed hard-copy reports are also displayed in both formats. Program is ideal for archiving archives of master EPROMs on disk. The program is compatible for all EPROMs listed with the JE664. Computer requirements: IBM-PC, XT (or eq) with at least 128K RAM and one serial port. Optional: One parallel port for printer.

JE664-ARS-CP..... \$49.95

JE664-ARS-CP CABLE..... \$29.95

Cable for IBM-PC to JE664-ARS Program (5 Shielded Cable Assembly)

JUMPER (Personality) MODULES - Jumper (Personality) Modules for BK, 16K, 32K, & 64K EPROMS. Please specify EPROM and manufacturer.

JUMPER (Personality) MODULE..... \$14.95 each

Little Board™ \$349*

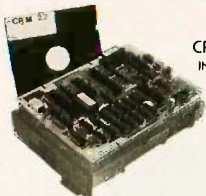

CP/M 2.2
INCLUDED

*UNDER \$200 IN
OEM QUANTITIES

- 4-MHz Z80A CPU, 64K RAM, Z80A CTC, and 2732 Boot ROM
- Mini/Micro Floppy controller (1-4 Drives, Single/Double Density, 1-2 sided, 40/80 track)
- Only 5.75 x 7.75 inches, mounts directly to a 5 1/4" floppy drive
- Two RS232C Serial Ports (75-9600 baud and 75-38,400 baud), 1 Centronics Printer Port
- Power Requirements: +5VDC at 0.75A; +12VDC at 0.05A/On-board -12V Converter
- CP/M 2.2 BDOS • ZCPR3 CCP
- Enhanced AM-PRO BIOS
- AMPRO Utilities included:
 - Read/write to more than two dozen other formats (Kaypro, Teletideo, IBM CP/M86...)
 - Format disks for more than a dozen other computers
 - Menu-based system customization
- BIOS and Utilities Source Code available

BOOKSHELF™ Series 100

AS LOW AS \$635 IN OEM QTY

MODEL	QTY	PRICE
121 1 400K DSDD Drive	1	\$ 895.00
122 2 400K DSDD Drives	2	995.00
142 2 800K DSQD Drives	2	1,095.00



- Little Board CPU
- Runs thousands of CP/M programs
- Enhanced Operating System including ZCPR3 CCP and FRIENDLY™ Integrated Operating Environment
- Word Processing, Electronic Spreadsheet, Database Management, Spelling Checker all included (complete T/maker Pkg.)
- 10 MB hard disk version available
- 6 1/2" high, 7 1/4" wide, 10 1/4" deep, 12 1/2 lbs.

SCSI/PLUS™ Adapter

Compatible with most Z80 Systems
(send \$10 for complete specifications)

- Mounts directly to Little Board
- Multi-Master high-speed parallel bus
- SASI-SCSI compatible \$99
- General purpose I/O expansion bus QTY 1
- Supports up to 64 bus devices
- Allows multi-Little Board Systems and resource sharing
- Little Board hard disk software/source \$79 QTY 1

DISTRIBUTORS

Argentina-Factorial, S.A.	1-41-0018
Australia-ASP Microcomputers	613-500-0628
Belgium-Centre Electronique Lempereur	041-23-45-41
Canada-Electronic Sales Assoc	(604) 986-5447
Denmark-Danbit	03-66-20-20
England-Quant Systems	01-534-3158
Finland-Symmetric OY	358-0-585-322
France-EGAL+	1-502-1800
Israel-Alpha Terminals	03-491695
Spain-Xenios Informatica	3-593-0822
Sweden-AB AKTA	08-54-20-20
USA:	CALL AMPRO

Z80A is a registered trademark of Zilog, Inc.
CP/M is a registered trademark of Digital Research.

AMPRO
COMPUTERS, INCORPORATED
67 East Evelyn Ave. • Mountain View, CA 94041
(415) 962-0230 • TELEX 4940302

THE TRANSPUTER

Transputers has the same interface as a single Transputer in much the same way as an assembly of Lego bricks has the same interface (lugs and holes) as a single brick. A big Transputer can be built out of four Transputers, as shown in figure 6a. This Transputer can in turn be used as a building block to make a bigger Transputer (figure 6b), and so on. These big and bigger Transputers present the user with exactly the same four link interfaces as did the original Transputer.

A further analogy with Lego bricks is that they come in different shapes and sizes and with different numbers of lugs and holes. Transputers will

have different word lengths, different processor speeds, and different memory interfaces, but they will all use the same links, run off the standard 5-MHz input clock, and be programmable in Occam.

The analogy holds just as well with Occam processes as it does with Transputers.

One respect in which the analogy with Lego bricks does not hold is that Lego bricks are constrained to connect to their immediate neighbors. In many Transputer networks, most of the connections will also be between adjacent Transputers, but the links do

(continued)

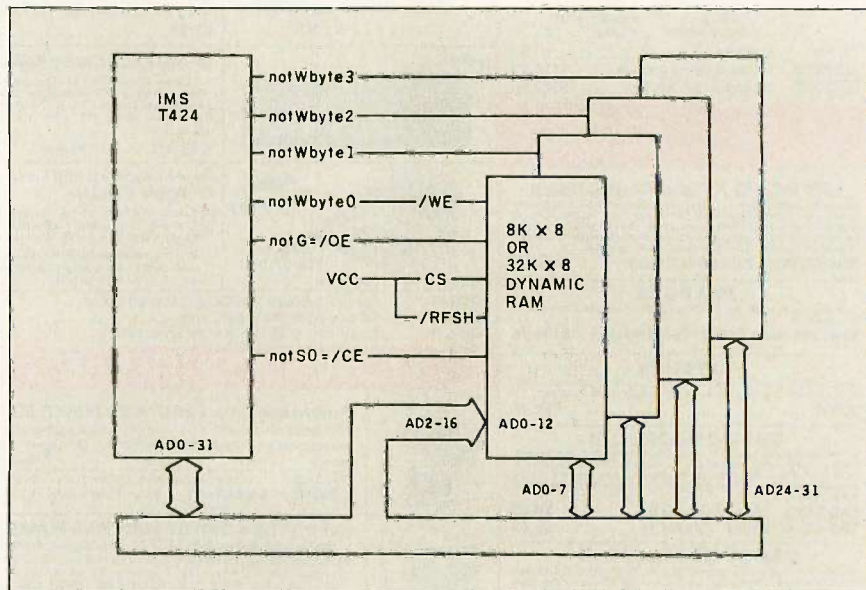

Figure 3: Four byte-wide RAMs connected to a T424.

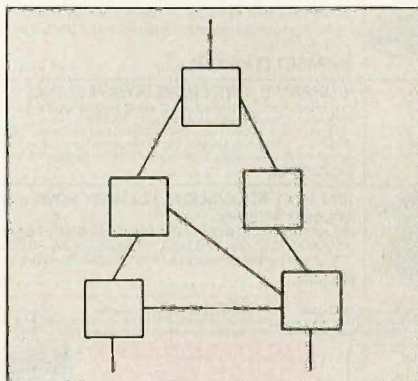

Figure 4: A random, possibly functionally distributed, network.

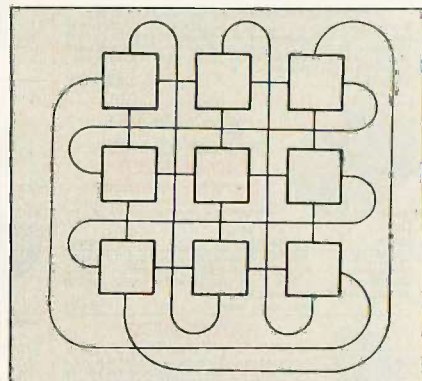

Figure 5: A toroidally connected array.

The right network isn't a matter of choice. It's a matter of fact.

Fact: You can't buy smarter than an OMNINET™ Network.

Whether you have 2 microcomputers or 200, you bought them to handle information. If each micro has to handle it separately, both your equipment and your people are working inefficiently.

Because they could network with OMNINET. Sharing information — as well as the printing and data storage equipment that really puts information to work.

Add CORVUS' SNA Gateway, and you can link your entire network directly to your mainframe.

That's why an OMNINET Network uses simple, telephone-type line. Even relocating the system to a whole new building is just a move. Instead of a construction project.

Fact: OMNINET Networks offer unmatched compatibility.

From Apples to Zeniths, OMNINET handles more varieties of computers than any other network.

So keep the DEC's in Data Processing and the PC's in Purchasing. OMNINET will keep them all on speaking terms.

The price? At under \$500 per hookup, OMNINET is the most cost-effective network you can install. Or expand.

Fact: This network was designed for microcomputers.

Micros get moved. Businesses expand.

Your network should be able to grow and change just as fast as your business does.

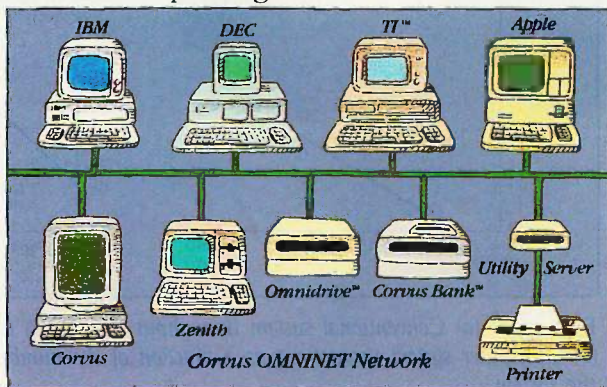

Fact: The experts network with OMNINET.

Over 30 of the major computer companies have licensed OMNINET for networking their micros. So you don't have to worry about support tomorrow for the system you pick today.

And OMNINET already has the most software options around — over 500 programs to choose from, according to your people's needs. Not their network's limitations.

Fact: The facts have made us #1.

CORVUS pioneered local area networking for microcomputers, and we've never stopped working on ways to improve it.

Just give us a ring at 800-4-CORVUS to find out more.

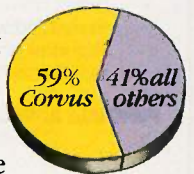

Because while calling ourselves the best is a matter of opinion, telling you that 3 out of every 5 locally networked micros work on a CORVUS network is something else.*

It's a matter of fact.

CORVUS
The Networking Company.

*59% of all locally-networked micros operate in a CORVUS network, according to InfoCorp. CORVUS, THE NETWORKING COMPANY, OMNINET, OMNIDRIVE and CORVUS BANK are trademarks of CORVUS SYSTEMS, INC. IBM PC is a trademark of International Business Machines. APPLE is a trademark of APPLE COMPUTER INC. DEC is a trademark of DIGITAL EQUIPMENT CORPORATION. Zenith is a trademark of Zenith Corporation.

THE TRANSPUTER

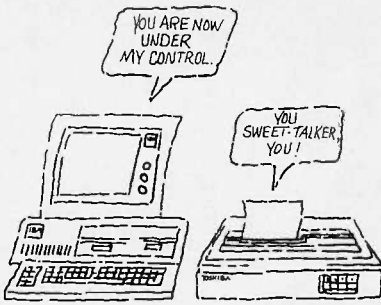

**NOW
THERE'S
AN EASIER
WAY TO
CONTROL
YOUR
PRINTER.**

ADAPTA-PRINT[®] SOFTWARE

FAST AND EASY FINGERTIP
CONTROL OF YOUR PRINTER

- Adapta-Print's pop-up menu lets you use your printer to its fullest capability—without having to exit whatever program you're working on. That includes full control of form layout, type style, and general printer functions.
- For non-IBM compatible printers, a built-in translator makes your printer compatible with the IBM printer, allowing it to generate pictures using Lotus 1-2-3[®] and most other software.
- There's an option available called TURN that gives Adapta-Print the capability to print sideways.
- A built-in spooler allows your printer to print one job while you work on another.
- Available for many brands of dot matrix printers, including Epson, Okidata, Hewlett-Packard, NEC, Toshiba, Mannesmann, Tally, C. Itoh, Datasouth, and most other dot matrix printers.

PURCHASE ADAPTA-PRINT FOR ONLY \$65.

(Plus \$2 shipping and handling).

(TURN option is \$24 additional)

Call 615-966-1399 with your Visa or MasterCard number. Operators are on duty weekdays until 9:00 EST. Or send your check or money order to the address below.



Computational Systems Incorporated
Dept. BY
One Energy Center
Pelissippi Parkway
Knoxville, Tennessee 37922

*Lotus and 1-2-3 are trademarks of Lotus Development Corporation.

not force this constraint, as the toroidal network in figure 5 shows.

USING TRANSPUTERS

For the small computer, a simple base product might contain one to four Transputers, probably in a functionally distributed network with one Transputer handling file I/O (input/output) and another handling the screen. More performance could be achieved with add-on boards; it would be possible to add Transputers and memory in much the same way that memory add-on boards are used now.

If the add-on board has four Transputers, each with four 32K by 8-bit

RAMs, as in figure 3, the board would have a processing power of 20 to 40 MIPS and a memory of ½ megabyte. Four boards would produce 80 to 160 MIPS and 2 megabytes. An alternative, densely packed add-on board might have two Transputers, each with thirty-two 256K by 1-bit dynamic RAMs. Four of these boards would produce 40 to 80 MIPS and 8 megabytes. Four of either add-on board produces a machine that could fairly be described as a "personal super-computer."

Transputer-based add-on boards could alternatively be used with an

(continued)

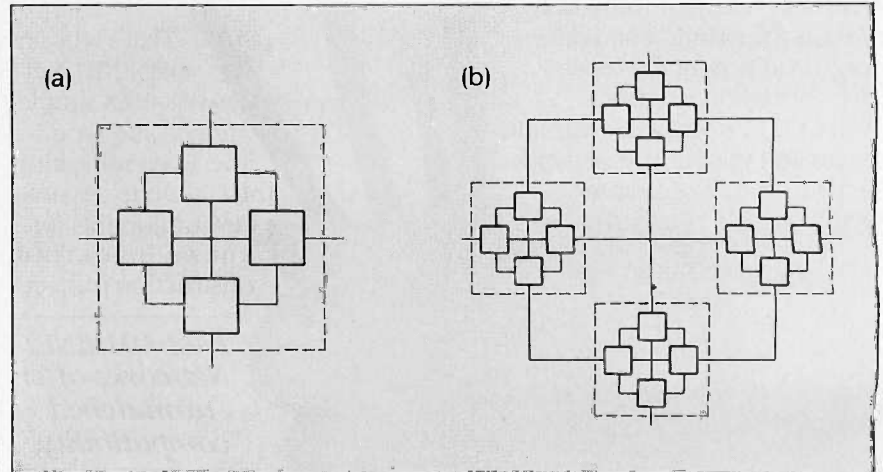

Figure 6: (a) A big Transputer built from four Transputers. (b) A bigger Transputer built from four big Transputers.

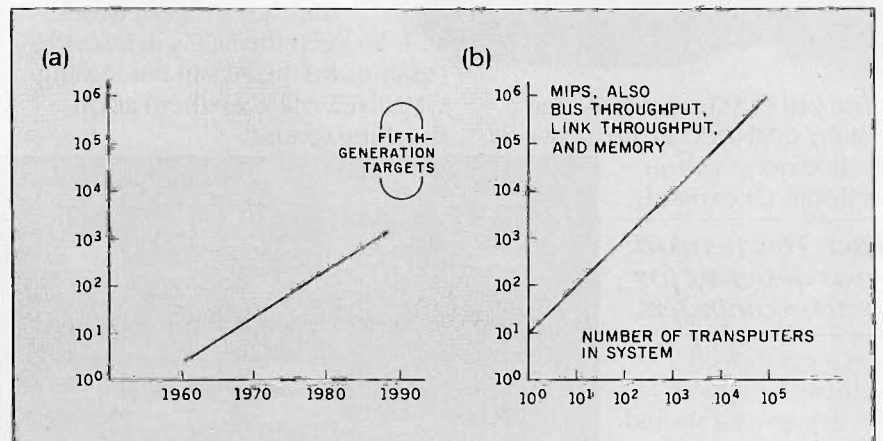
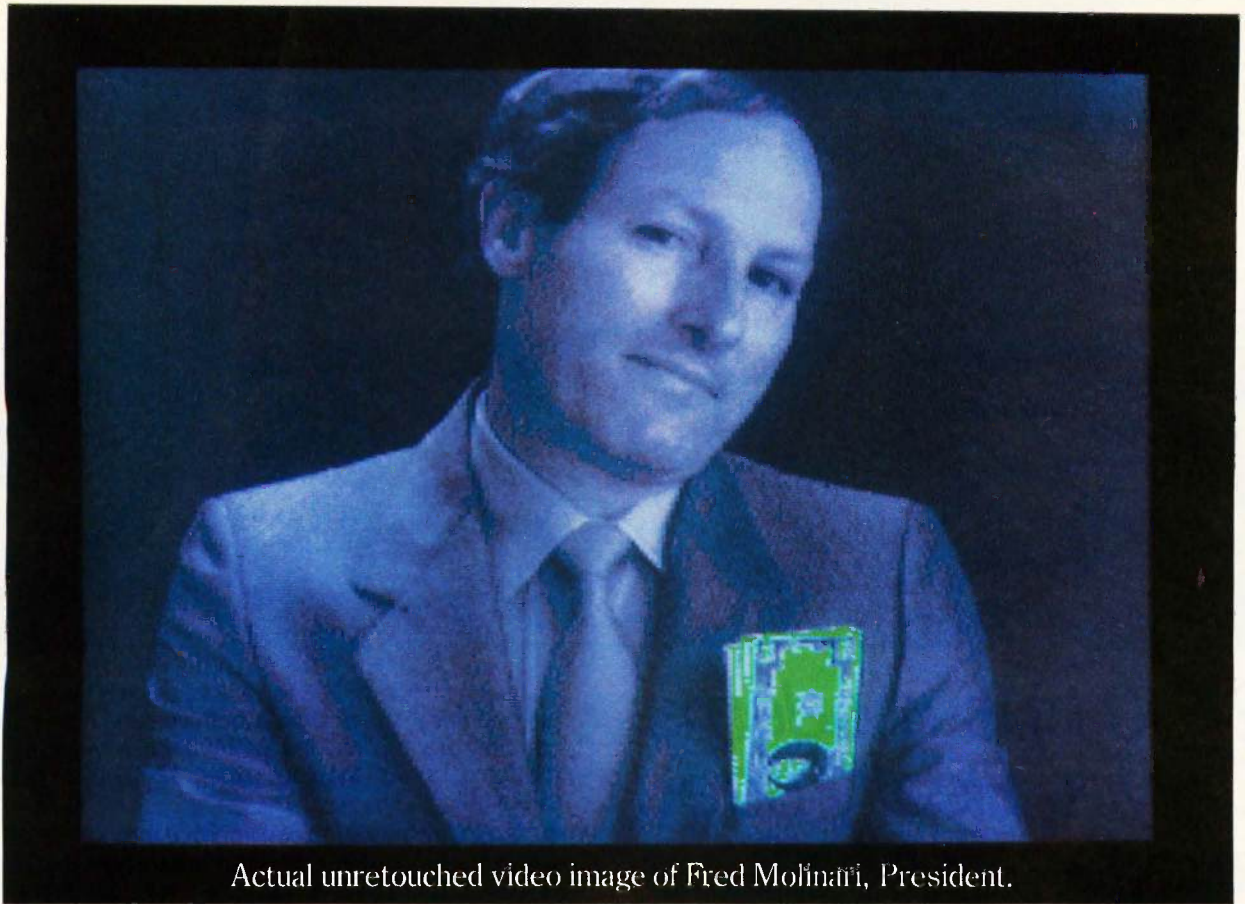

Figure 7: (a) Conventional system throughput (in MIPS) by year (very approximate). (b) Transputer system throughput as a function of the number of Transputers in the system.



Actual unretouched video image of Fred Molinari, President.

“It’s easy to spot the difference between our IBM PC™-based frame grabber and the others”

High performance and affordable cost, just \$1495 for a single plug-in board.

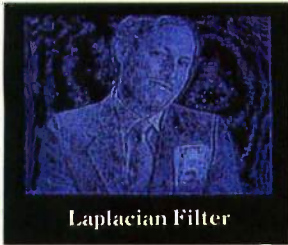

Laplacian Filter



False Color

Unlike other video I/O systems, the new DT2803 provides real-time image capture capabilities, digitizing a 6-bit video field every 1/30 second. An on-board, memory-mapped, dual-ported frame store memory (256 × 256 × 8) makes it ideal for the IBM PC's 64K buffer size. And for real number crunching,

the DT2803's external ports interface to high speed co-processors.

With our software package, VIDEOLAB™, the DT2803 is easy to use for image operations like averages, histograms, and convolutions.

So, if your application is manufacturing/automatic inspection, robotics, or medical research,

our new high performance video I/O board will really open your eyes – at an unbeatable price.



Call for our new 576 pg. catalog/handbook or see it in Gold Book 1985.

SPECIFICATIONS: DT2803

A/D Input	RS-170 (CCIR), 6-bits at 5MHz
Frame Grab	1/30 (1/25) second per field
LUT's	8, 64 × 8 input; 4, 256 × 12 output
D/A Output	64 colors × 64 intensities, R-G-B; 64 grey levels, monochrome
Frame Memory	256 × 256 × 8 (2-bits for graphic overlays)

Call (617) 481-3700

DATA TRANSLATION

World Headquarters: Data Translation, Inc., 100 Locke Dr., Marlboro, MA 01752 (617) 481-3700 Tlx 951 646.

European Headquarters: Data Translation, Ltd., 13 The Business Centre, Molly Millars Lane, Wokingham Berks, RG112QZ, England Tlx: 851849862 (#D)

In Canada: (416) 625-1907.

IBM PC is a registered trademark of IBM. VIDEOLAB is a registered trademark of Data Translation, Inc.

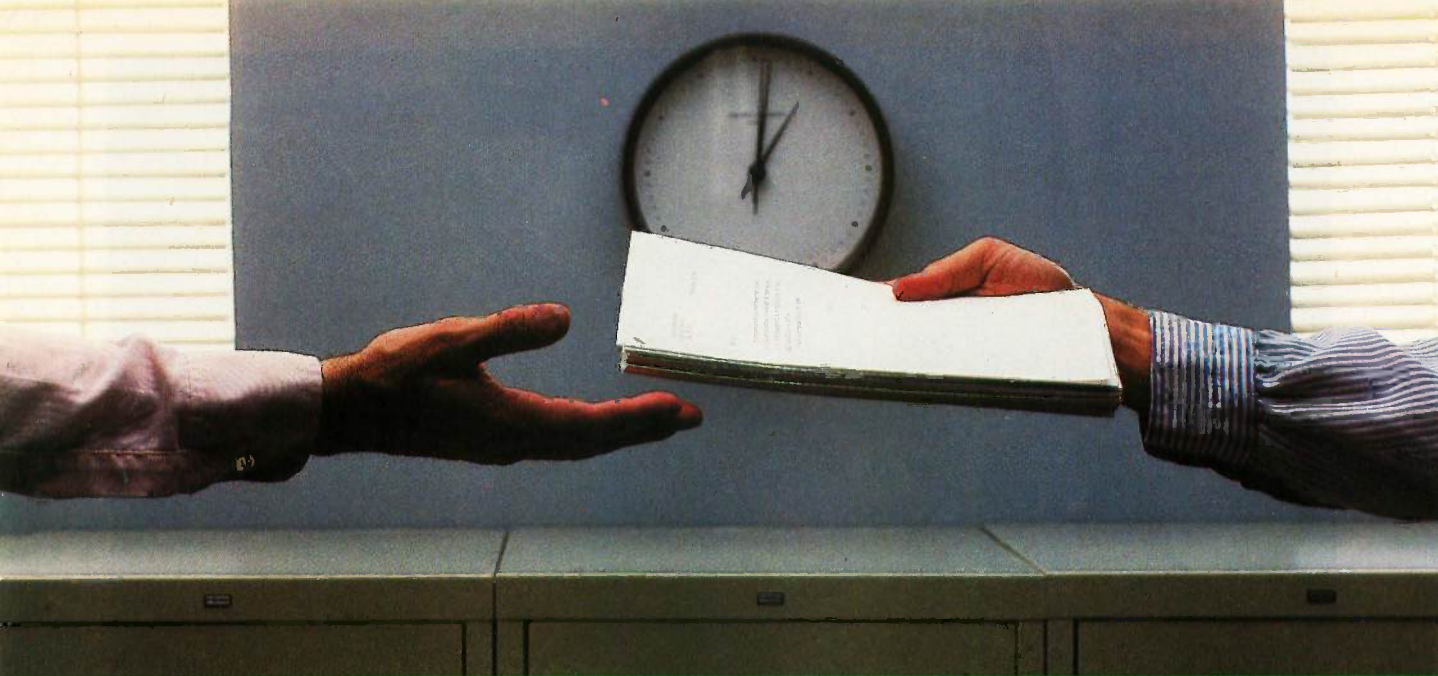

2400 bps modems: Do you Really need another speed?

- Is the shift from 300 to 1200 bps going to repeat itself at 2400 bps? The answer is both yes and no. There certainly are applications for 2400 bps asynch dial-up modems, but we shouldn't expect 1200 bps to die overnight.
- 2400 bps modems can improve throughput, thereby getting tasks done quicker and more economically. However, 1200 bps has become the virtual standard for professional dial-up communications, and most users are satisfied with it. So why consider a 2400 bps modem at all?
- One reason is flexibility. If the modem you select operates at all three speeds (300, 1200 & 2400) in accordance with accepted industry standards, it will serve virtually all dial-up applications now and in the foreseeable future.
- The modem you select should be the MultiModem224. It is Bell 212A and 103 compatible at 1200 and 300 bps, and CCITT V.22bis compatible at 2400. It is also 100% compatible with the Hayes command set, meaning that it will work with virtually all communications software packages, at all three speeds. Other features include both synchronous and asynchronous operation, full intelligence and a phone number memory.
- The MultiModem224 is available in both desktop and IBM PC™ internal card versions. (There is also a rack-mounted version for central sites.) And as a bonus, we provide free offers from ten of the most popular on-line information services, including CompuServe™, Dow Jones™ and The Source™.
- A 2400/1200/300 bps modem is just a plain good investment. Why not let the MultiModem224 provide your communications for both today and tomorrow?

Inquiry 282

MultiTech
Systems 

The right answer every time.

82 Second Ave. S.E., New Brighton, MN 55112 (612) 631-3550, TWX: 910-563-3610

MultiTech
Systems 

MultiModem 224
2400/1200/300 BPS Intelligent Modem

1200
300 Ans

Performance is
a function of the
number of Transputers.

existing computer, similar to Steve Garcia's Trump Card (reference 9).

The linear increase in performance with the number of Transputers used makes the Japanese Fifth Generation targets achievable as a function of the number of Transputers rather than as a function of years (figure 7). ■

ACKNOWLEDGMENTS

I would like to acknowledge the help of colleagues in Bristol, England, and Colorado Springs, Colorado, in the preparation of this article. Particular thanks to Phil Atkin and Owen Ransen, who developed the ray-tracing program used in the panel.

REFERENCES

1. Pountain, Dick. "Microprocessor Design." *BYTE*, August 1984, page 361.
2. INMOS Limited. *Occam Programming Manual*. Englewood Cliffs, NJ: Prentice/Hall, 1984.
3. INMOS Limited. *IMS T424 Transputer Reference Manual*. 1984.
4. May, David, and Roger Shepherd. "The Transputer Implementation of Occam." *Proceedings of the International Conference on Fifth Generation Computer Systems 1984*, November 6-9. Tokyo, page 533. Published by ICOT.
5. Shapiro, Ehud. "Systolic Programming: A Paradigm for Parallel Processing." *Proceedings of the International Conference on Fifth Generation Computer Systems 1984*, November 6-9. Tokyo, page 458. Published by ICOT.
6. Kung, H. T. "Why Systolic Architectures?" *IEEE Computer*, 15(1), page 37, 1982.
7. Kung, S. Y., et al. "Wavefront Array Processor: Language, Architecture and Applications." *IEEE Transactions on Computers* (Special issue on parallel and distributed computers), C-31 (11) November 1982, page 1054.
8. Maruyama, Fumihiko, et al. "Prolog-Based Expert System for Logic Design." *Proceedings of the International Conference on Fifth Generation Computer Systems 1984*, November 6-9. Tokyo, page 563. Published by ICOT.
9. Ciarcia, Steve. "Trump Card." *BYTE*, May 1984, page 40.
10. INMOS Limited. "Occam Programming Manual." (Japanese edition) KEI GAKU Publishing Co. Ltd., Japan, 1984.

The Brand NEW
Fancy Font 2

printed this ad on an Epson FX printer

Letter Quality

Say goodbye to correspondence quality and hello to *Fancy Font's* high-resolution, proportionally spaced, letter quality. Fonts are available in sizes from 6 to 72 points; styles include Roman, Bold, Italic, Script, Old English, and more. All this on low-cost dot-matrix printers. *Fancy Font* is an easy-to-use software package, developed by SoftCraft, Inc., for IBM PC compatible systems and CP/M systems; no special hardware or installation is required.

New Features Now Available in Version 2

The latest version of *Fancy Font* takes advantage of the phenomenal resolution of the Epson FX and RX printers to achieve laser printer quality. High resolution versions for the Toshiba 1350, 1351, 1340 and the Epson LQ-1500 will soon be available.

This version boasts a greatly expanded set of formatting commands, including word-wrap. Special typesetting features such as kerning and automatic ligature formation are provided by an optional utility.

As part of our library of fonts and utilities we have packages that make *Fancy Font* directly compatible with **Microsoft Word**, **Wordstar** and **Valdocs**; if you know how to use any of these word processors then you already know how to use *Fancy Font*. Alternatively, you can still use almost any word processor to create a text file to be printed with *Fancy Font*.

Numerous Applications

Fancy Font customers are constantly discovering new applications.

- Business and personal letters
- Mailing labels from databases
- Custom forms, invoices, signs
- Foreign Languages
- Mathematical Notation, Greek
- Super- and Sub-scripts
- View Graphs
- Custom Letterheads
- Name tags, badges
- Articles for publication
- Newsletters, brochures
- Complete manuals
- Advertisements
- Resumes, invitations

Create Your Own Characters

Hundreds of fonts are available in our font library, and furthermore, you can create any new characters or logos you like, up to 1 inch by 1 inch. A database of over 1500 characters is included that makes it possible to print foreign languages and mathematical notations.

Font Style Samples

small large **Bold** *Italic*

Sans Serif *Script* Old English

Φ Ψ Ω Β Ε Ϟ ϟ Ϡ ϡ ± ÷ ≠ Η Β § Ω Ⓞ # ♪ ♫ ♪ ♫

"The quality of print is excellent and the variety of type styles is even better."

Pat McKeague, Infoworld 6/2/88

Trademarks: Fancy Font (SoftCraft), Wordstar (Micropro), CP/M (Digital Research), Valdocs (Rising Star), Microsoft, IBM

Order NOW - (800) 351-0500 - M/C Visa

MSDOS and CP/M versions are available for the following printers: Epson MX FX RX, IBM Graphics, Star Gemini 10X Radix Delta, TI 860 865, Inforunner. MSDOS versions only are available or will soon be available for: Toshiba 1350 1351 1340, Epson LQ-1500, C.Itoh Prowriter, NEC 8029. Specify printer when ordering.

SoftCraft, Inc., 222 State St. #400, Madison, WI 53708 orders:(800)351-0500
(We've moved from California) from Wis: (608)257-8300
Fancy Font System \$180
Fancy Font Demo Disk \$10
[Calif. and Wisc. residents add sales tax 6.5% or 5%
[Outside US add \$10 postage (only \$2 for demo) \$10 or \$2
[Diskette Format: (IBM PC, Epson QX10, Osborne DD, Kaypro, 8" CP/M, Apple CP/M, Victor) _____
[Printer: (Epson FX, Epson MX, etc.; see box at left) _____
[\$7.50 of demo cost is applicable towards Fancy Font purchase. _____
[CP/M requires 64K, MSDOS 128K memory. _____
[Fully transparent 8-bit printer interface required on Apple and CP/M. _____

Super assemblers plus the world's largest selection of cross assemblers!

All 2500AD Assemblers and Cross Assemblers support the following features:

POWERFUL LINKER

- Links up to 128 files
- Allows files to be used just for external reference resolution
- Separate code and data space
- Unlimited global and external symbols
- 10 **significant** characters per symbol, no limit to length
- Submit or batch mode as well as command invocation, for easier linking of a large number of files

ASSEMBLER DIRECTIVES

Storage Control:

- ORG, ORIGIN
- END
- DB, DEFB, BYTE, STRING
- DW, DEFW, WORD
- LWORD, LONGW
- ASCII
- DS, DEFS, BLKB
- BLKW

Definition Control:

- EQU, EQUAL
- VAR, DEFL
- MACRO
- ENDM, MACEND
- MACEXIT
- EXTERN, EXTERNAL
- GLOBAL, PUBLIC
- ASK

Assembly Mode:

- RADIX
- DATA
- CODE
- MOD32 ON & OFF
- COMMENT
- INCLUDE
- DRIVES

Conditional Assembly:

- IFZ, IFNZ, COND
- IFTRUE, IFFALSE
- IFDEF, IFNDEF
- IFSAME, IFDIFF
- IFEXT, IFNEXT
- IFABS, IFREL
- IFMA, IFNMA
- ELSE
- ENDC, ENDIFT
- IFCLEAR

Listing Control:

- LIST ON/OFF
- MACLIST ON/OFF
- CONDLIST ON/OFF
- PASS1 ON/OFF
- PAGE, EJECT
- TITLE, HEADING
- SUBTITLE
- PW
- PL
- TOP

Additional Motorola Directives:

- FCC
- SET, SETDP
- PAG
- NAM
- STTL
- XDEF
- XREF
- FCB, FDB, RMB
- LONG

Run time commands (invoked while assembly is in progress):

- ^S—Alternately start and stop assembly
- ^C—Terminate assembly
- ^T—Display output at terminal
- ^P—Display output at printer
- ^D—Send output to disk
- ^B—Both terminal and printer or disk
- ^N—Turn off output display

1 Year of free support and updates now included!

You will receive a special support phone number on all products purchased after 3/1/85 allowing free updates and a full 12 months of

support, included in the purchase price.

Features unique to these 2500AD products:

6800 FAMILY—"S"-record output option, special directives for dealing with page zero, absolute or relocatable modes.

68000—"S"-record output option, S-19, S-28 and S-37.

65XX FAMILY—Special directives for dealing with page zero.

Z-8—Register naming supported, TEK HEX output format.

8748—Register naming supported, INTEL HEX output.

8051/44—Register naming supported, INTEL HEX output.

8096—Register naming supported, INTEL HEX output, works for the 8097 as well.

"Generic" calls and jumps allow assembler to determine long or short jumps.

Z-8000—Includes 8080/Z-80 to Z-8000 source code translator, uses the 2500AD syntax, not source compatible with Zilog. Includes powerful segmented linker.

Z-80—Includes an Intel 8080 to Zilog Z-80 source code converter. Includes the 2500AD linker, not compatible with Microsoft at the link level.

8086/88 & 80186—Includes an 8080/Z-80 to 8086 source code translator that will convert 8080/Z-80 source code to 8086/88 source code. Includes linker, not link compatible with Microsoft. Code, Data, Stack, and Extra segments supported.

	Z80 CP/M®	ZILOG SYSTEM 8000 UNIX	IBM PC MSDOS	IBM PC CP/M 86	OLIVETTI M-20 PCOS
Z8000™	\$299.50	\$750.00	\$299.50	\$299.50	\$299.50
Z80	99.50	500.00	199.50	199.50	199.50
Z8	199.50	500.00	199.50	199.50	199.50
8086/88	199.50	750.00	99.50	99.50	199.50
80186	199.50	750.00	199.50	199.50	199.50
8748	199.50	500.00	199.50	199.50	199.50
8400/84C00	199.50	500.00	199.50	199.50	199.50
83C351	199.50	500.00	199.50	199.50	199.50
8044/51	199.50	500.00	199.50	199.50	199.50
8080	199.50	500.00	199.50	199.50	199.50
8085	199.50	500.00	199.50	199.50	199.50
8096	199.50	500.00	199.50	199.50	199.50
68020	399.50	750.00	399.50	399.50	399.50
68000,08,10	299.50	750.00	299.50	299.50	299.50
6800,02,08	199.50	500.00	199.50	199.50	199.50
6801,03	199.50	500.00	199.50	199.50	199.50
6804	199.50	500.00	199.50	199.50	199.50
6805	199.50	500.00	199.50	199.50	199.50
6809	199.50	500.00	199.50	199.50	199.50
68C11 <i>new</i>	199.50	500.00	199.50	199.50	199.50
32000	399.50	750.00	399.50	399.50	399.50
COPS400	199.50	500.00	199.50	199.50	199.50
NSC800	199.50	500.00	199.50	199.50	199.50
6301	199.50	500.00	199.50	199.50	199.50
62801 <i>new</i>	199.50	500.00	199.50	199.50	199.50
6501/11	199.50	500.00	199.50	199.50	199.50
6502	199.50	500.00	199.50	199.50	199.50
65C02	199.50	500.00	199.50	199.50	199.50
1802	199.50	500.00	199.50	199.50	199.50
F8/3870	199.50	500.00	199.50	199.50	199.50
NEC7500	199.50	500.00	199.50	199.50	199.50
NCR/32	399.50	750.00	399.50	399.50	399.50

Subtotal \$ _____ \$ _____ \$ _____ \$ _____ \$ _____

Name _____
 Company _____
 Address _____
 City _____ State _____ Zip _____
 Phone _____
 Make and model of computer system _____
 COD (2500AD pays COD charges)
 VISA or MasterCard
 Number _____
 Expiration Date _____

TO ORDER. Simply circle the product or products you want in the price columns, and add up your order.

- Check one:**
 8" Single
 Osborne
 IBM PC
 Cartridge tape
 Apple (Softcard)
 Kaypro DSDD
 other formats available, please call!

Total \$ _____
 Shipping UPS Blue Label no charge, \$20.00 shipping for International per unit. \$ _____
Total Order \$ _____

Signature _____ 221

25004D SOFTWARE INC.

P.O. Box 4957, Englewood, CO 80155, (303) 790-2588 TELEX 752659/AD

The first complete programming environment brings the industry to an all-time low.

\$80.88

Modula-2 has been hailed as the programming language of the future. Its modular design and built-in error-control features make programming more efficient than ever.

And now there's a system that makes programming more affordable than ever. Interface Technologies' Modula-2 Software Development System (M2SDS).

EASY TO LEARN.

EFFICIENT TO USE.

M2SDS features a "syntax-directed" editor that makes programming easy for beginners to learn. And faster for professionals to use.

With our editor you can enter full statements with a single keystroke. And save up to 90% on typing time. It also gives on-line help in correcting undefined variables and syntax errors—which saves even more time.

Multiple editor windows let you refer to one file while you edit another. That's one more way M2SDS adds hours of more creative, more productive time to your day.

Work faster and easier with multiple editor windows.



TURN "WAIT TIME" INTO "WORK TIME." When there's no time like real-time, you can count on the M2SDS compiler. Up to 100 lines of Modula-2 text can be turned into native machine code in less than five seconds.

To create programs using your computer's full capacity, there are 18 library modules. And unlike

other low-priced compilers, M2SDS has a linker that assembles the components of your program. Automatically.

BREAKTHROUGH TECHNOLOGY.

BREAKTHROUGH PRICE. M2SDS works with IBM® PC, XT, AT or any other 100% compatible computer.

Any programs you develop, you own. And M2SDS is non-copy protected.

For just \$80.88, M2SDS is the complete programming environment. Including editor, compiler, linker, library modules, 8087 support and more.

Or choose the expanded, fully upgradeable SDS-XP for just \$249. Later you can add a debugger, foreign object import module and tool box for even more programming capability. And efficiency.

So whether you're a professional looking for a faster way to program, or a novice looking for an easier way to learn, there's a Modula-2 Software Development System just for you.

Call us today for more information or to order your M2SDS. Find out how our new low in system pricing can put your programming efficiency at an all-time high.

WE ACCEPT CHECKS, MASTERCARD, VISA AND AMERICAN EXPRESS. Price does not include shipping and handling. Texas residents add 6.125% Sales Tax. International orders add \$30.

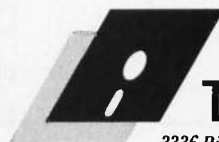

INTERFACE TECHNOLOGIES

3336 Richmond, Suite 200, Houston, TX 77098

GET MORE PROGRAMMING EFFICIENCY IN A SYSTEM THAT COSTS LESS. IN TEXAS, CALL (713) 523-8422.

CALL 1-800-922-9049

DATA-MOVEMENT PRIMITIVES

BY J. ERIC ROSKOS AND CHING-DONG HSIEH

*A low-cost implementation of an innovative technique
for sharing memory*

THE MOST COMMON digital-computer architectures use primary memory having two access primitives. These primitives are the lowest-level operations in the system. Typically, the *read* operation nondestructively copies a value stored in a memory location to a location in the central processing unit (CPU) known as a *register*. The *write* operation writes over an existing value in primary memory with a value from the processor's registers.

In single-process systems, and in multiprocess systems that do not use shared memory, these operations are generally sufficient for the manipulation of data. Although a time lapse occurs between the reading and re-writing of data, no problems will result since only one process is accessing the data.

In multiprocess systems accessing shared data, this is not the case. Two processes that execute a statement on a common variable in overlapping time will both read the same value, increment it, and rewrite it; the second process writes over the value produced by the first process without taking that value into account.

Other problems exist in multipro-

cess data sharing. In *producer/consumer* process pairs, for example, one process produces a data stream that the other process consumes. Problems include preventing the consumer from accessing memory locations that have not been filled by the producer and the producer from writing over data in the shared buffer before the consumer has acquired the previously written data.

To solve these problems, we have defined *data-movement primitives*, which are concerned with the movement of data between the central processor(s) and main memory. These primitives actually remove data from a location upon reading it. Thereafter, if a second process tries to read at that location, an interrupt is generated—the process has to wait until data is present to continue. Similarly, if a location already has data and a second process attempts to write over it, an interrupt is generated. We have defined the data-movement primitives as *get* and *put*.

To demonstrate the feasibility of constructing a multiprocessor system using data-movement primitives, our research team built a three-CPU multiprocessor based on the Motorola

6800 microprocessor. On September 27, 1984, this system successfully executed its first concurrent program, an implementation of Per Brinch Hansen's "incorrect" program (see reference 1). Such a system is not only feasible, it is inexpensive; the cost of the entire multiprocessor system was around \$450. The project also demonstrated the effectiveness of the data-movement primitives by successfully executing a program that would not have functioned correctly on a conventional machine.

SELECTION OF HARDWARE

Planning for a multiprocessor system began in late summer of 1983. We examined several implementation methods. The first of these involved the use of 6502-based Apple II CPU boards. These had two significant advantages: a "set overflow" (SO) pin could be used to set a condition code indicat-

(continued)

J. Eric Roskos (2486 Sand Lake Rd., Orlando, FL 32809) is a senior member of the technical staff of Perkin-Elmer Corporation's Southern Development Center. Ching-Dong Hsieh is a graduate student at Vanderbilt University (Computer Science Dept., Box 1679, Station B, Nashville, TN 37235).

ing the no-data-present condition, and no debugging of the CPU hardware itself would be necessary. The boards were also available at low cost. We discarded this option, however, because no test equipment for 6502s was available to us.

We next examined the use of an IBM CS9000 system, which is based

on the Motorola 68000, with additional 68000s for the added CPUs. Unfortunately, time constraints and other difficulties made this implementation impossible.

We decided finally on the use of Motorola 6800s. Such a design had several disadvantages. The 6800 is an old-technology microprocessor. You

cannot stop the instruction-execution sequence for more than a few milliseconds once an instruction has begun execution; thus we could not implement the primitive wait at the hardware level as we could have with the 68000 processor. Also, the 6800 does not have an SO pin as the 6502 does. Thus, interrupts would have to be used to signal the exception condition, with software simulating the wait primitive. The 6800 also has no support for multiprocessor operation; it has no test-and-set instruction. This meant that we would not be able to obtain empirical results comparing the traditional synchronization primitives with the data-movement primitives, without the use of indirect simulation methods.

On the other hand, we had considerable resources in the form of test equipment lent to us by Vanderbilt's electrical engineering department, which uses the 6800 in its microprocessor course. Furthermore, we could implement the machine easily and at low cost, thanks to the low price of 6800s and our prior experience with 6800 system design. The graduate school was also willing to provide funding for such a project.

We selected an IBM Personal Computer, based on the Intel 8088, to serve as the host processor for the system. Again, this choice was largely practical in nature; an IBM PC was available, and Eric Roskos had very extensive experience with the machine, having previously constructed peripheral control interfaces for it and written a 6800 cross-assembler for use with it.

SYSTEM DESIGN

We designed the system with three 6800 microprocessors, each with its own private memory, and a memory shared by all three CPUs, supporting the data-movement primitives. The IBM PC would serve as a host machine, on which we could quickly edit, assemble, and download programs to the multiprocessor.

Each CPU's private memory was shared with the IBM PC and would be

(continued)



PROMPRO-XP™: The sweet way to program PROMs.

Whatever memory devices you need to program, the compact, versatile PROMPRO-XP Universal Programmer makes sweet work of them.

It programs, verifies and tests most CMOS and bipolar PROMs, EEPROMs, EPROMs, PALs, HPLs and IFLs. And it supports Motorola S1, S2, S3 and Intel hex extended formats (8, 16 and 32-bit files).

Its internal RAM buffer 32K x 16 (512K bit) can simultaneously program two EPROMs with different data — and expand to 64K x 8.

You'll like its fast, intelligent algorithms and its great features. Like a serial RS-232 port and parallel printer port for simple connection to any micro, mainframe, terminal or printer. Range oriented commands. Optional in-circuit 16-bit emulator. Built-in UV eraser. And non-volatile memory.

All at a very sweet price.

Logical Devices also provides a family of low-cost dedicated EPROM and PAL programmers and a wide range of UV EPROM erasers.

PAL is a registered trademark of MMI.
HPL is a trademark of Harris Corporation.



It's only Logical.

LOGICAL DEVICES, INC.

1321 N.W. 65th Place • Fort Lauderdale, FL 33309
(305) 974-0975 • toll-free 1-800-EE1-PROM • TELEX: 383142

MEDIA MATE.™ NO OTHER DISKETTE FILE COMES UP TO ITS STANDARDS AND DOWN TO ITS PRICE.



Pick the Media Mate up by the self-latching handle, and take it with you.

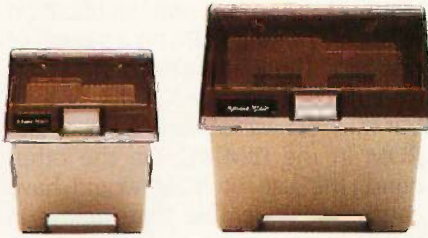

Whether you use 3 1/2" or 5 1/4" diskettes, there's a Media Mate that's right for you.

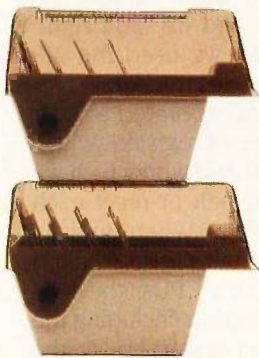

Here's organization that really stacks up. And solid construction that keeps dust out.



These ridges keep the dividers in place and your disks in order.

The Media Mate stands firm, thanks to its non-skid feet.



For organizing and protecting your diskettes, the Amaray Media Mate™ is the best file you can own. And you can buy it for just \$15.95.*

So be sure you don't settle for less. Or pay more.

The Media Mate from Amaray. Available in two sizes to hold up to fifty 5 1/4" diskettes, or thirty 3 1/2" diskettes. Ask for it anywhere floppy disks are sold. Or call 800-4-AMARAY for the dealer nearest you. Amaray International Corporation, 14935 N.E. 95th Street, Redmond, WA 98052.

*\$15.95 suggested retail price, Media Mate 5; \$14.95 suggested retail price, Media Mate 3.

AMARAY
Makers of Media Mate

Inquiry 22



accessible to the IBM PC only when its CPU was halted; we made this design decision to simplify design of the interface for the private memories.

We designed the multiprocessor with no read-only memory (ROM) whatsoever. While most people considered this a somewhat radical design decision, it was a carefully

planned one. No real justification exists for putting ROM on a system of this sort. The ROM is needed to start execution of one CPU in the system, but this role was already filled by the ROM in the IBM PC. On the other hand, the use of ROM would have caused considerable time delays in loading test programs and debugging

software (which requires erasing old ROMs and reprogramming new ones) and would have placed physical stresses on the CPU boards due to repeated removal and insertion of ROMs. Also, the use of ROM requires an unnecessary design trade-off: Code in ROM is immediately available at power-up, but you cannot modify it without physically replacing the ROM. We expected that we would need the ability to modify a test system such as this, and we were right.

Instead of ROM, we used the 2K-byte private memories to contain programs. We also incorporated a "halt register" and a "reset register," which are simple latches and with which we could individually halt or reset each of the three CPUs. When initially powered up, the halt register halted the multiprocessor's CPUs, the IBM PC loaded the program (including the RESET vector used at start-up) via the private memories, and the reset register then started the CPUs. To simplify implementation, we did not include a register to indicate whether a CPU had halted via the programmed halt instruction—although this would have been beneficial. This information is available on the processor's "bus available" (BA) pin.

IMPLEMENTATION DETAILS

The implementation for the multiprocessor system is shown in figure 1. The IBM PC is interfaced to the halt and reset registers via the PC's I/O (input/output) instructions, and the addresses of the registers are in the I/O address space of the PC at addresses 300 and 301 (hexadecimal). The IBM PC also interfaces to 3 three-state controllers. These controllers connect the private memories to the PC's bus—during reads or writes to their respective addresses—only if the corresponding CPU is halted via the halt register. The private memories start at the PC's memory addresses C0000, C0800, and C1000 for Processor 0, Processor 1, and Processor 2, respectively. Each memory is a 2K-byte Hitachi 6116 static RAM (random-access read/write memory), which is

(continued)

Graphics Takes A Quantum Leap Forward!



THE INOVION PERSONAL GRAPHICS SYSTEM FEATURES:

- The most advanced color mapping capabilities available.
- 250,000 simultaneously displayable colors.
- A palette of 2.1 million colors.
- Frame Grabber/Digitizer to capture TV, VCR or Video Camera pictures.
- Quality three-dimensional texture capabilities.
- Built-in Icon/Menu software.
- Completely Mouse/Trackball driven.
- Fonts, Brushes, Microscope, Patterns, and Rotations.
- A complete stand alone system.
- A 19" enhanced color monitor.
- 780K Graphics Memory.
- 512 x 480 pixel display with 24 bits per pixel.
- RS232C port allows access to all system functions and memory.
- NTSC composite video and NTSC RGB signal.
- 1-year warranty on graphics generator and 90-day warranty on enhanced monitor.
- Special Introductory 30-day satisfaction guarantee.
- **Complete system for \$4,495**

INOVION

East Gentile Street
 Layton, Utah 84041
 (801) 546-2850

HOW TO BUY SOFTWARE WHEN ALL THE ADS LOOK THE SAME.

We know it's hard to choose a software house. All the ads say the same thing—"Lowest prices," "fastest delivery," "best support," "biggest inventory."

Trouble is, although the claims are the same, the companies are very different. Which is why we want you to know some important facts about us:

1. 800-SOFTWARE is one of the oldest and most reputable firms in the industry. Our customers include Coca-Cola, GE, Hewlett-Packard, Xerox, AT&T, and thousands of other satisfied buyers.

2. Our National Accounts Program offers volume discounts and valuable services to large software users. We offer *incredibly* low prices on large bids!

3. We have a giant, \$1,000,000 inventory. Which means we can offer next-day delivery if needed.

4. With every product you get friendly, expert technical support. Have a question? You'll be glad you bought from 800-SOFTWARE!

5. We'll match our competitors' prices on most products. We *never* cut service.

6. We never charge extra for credit card purchases, nor do we process for payment until the product is shipped. (Our competitors don't make this claim!)

7. You'll automatically receive our Technical Support Newsletter—a great way to stay up-to-date.

8. We are members of the Better Business Bureau and the Direct Marketing Association.

9. We want your business. *And* your repeat business. Which is why we work so hard to keep you happy. Give us a call and let us *prove* it!

CHECK OUT ALL OUR INCREDIBLE PRICES:

Lotus 1-2-3 \$295	dBase II/III CALL	Framework CALL	WordStar 2000/2000 Plus CALL
Lotus Symphony \$425	Crosstalk \$95	PFS File/Graph/Write \$84	IUS Accounting \$299/mod.
SOFTWARE	MICROPRO®		Super Project \$209
ASHTON-TATE™	WordStar \$209		All Other Products CALL
dBase II/III CALL	WordStar 2000/2000 Plus CALL		HARDWARE, ETC
Framework CALL	WordStar Pro Package/P.P. Plus \$259/\$359		AMDEK™ Monitors CALL
BORLAND SOFTWARE™	InfoStar CALL		AST™ Products CALL
Sidekick CALL	All Other Products CALL		ATI™ & CDEX™ TRAINING CALL
Turbo Pascal/8087 \$39/\$79	MICROIM™ RBase 4000 \$259		CODE-A-PHONE Tel-A-Modem \$479
BOURBAKI™ 10ir \$ 79	MICROSOFT®		EPSON™ PRINTERS
DECISION RESOURCES™	Multiplan \$125		FX 80, FX 100 & LD 1500 CALL
Chartmaster \$249	Fartran \$269		HAYES™
Signmaster \$189	All Other Products CALL		Smartmodems 1200/1200B CALL
DIGITAL RESEARCH™ CALL	MICROSTUF™ Crosstalk \$ 95		HERCULES™
FOX & GELLER™ CALL	MULTIMATE™ \$255		Color Card \$199
FUNK SOFTWARE™ Sideways \$ 49	NORTON UTILITIES™ \$ 74		Graphic Card \$325
HARVARD SOFTWARE™	ROSESOFT™ Pro Key \$ 99		MAXELL™ & MEMOREX™ DISKETTES CALL
Harvard Project Manager \$289	SOFTWARE PUBLISHERS™		MEMORY CHIPS CALL
IMSI™ PC Paintbrush \$ 99	PFS File/Graph/Write \$ 84		OKIDATA™ PRINTERS
LIFEBOAT™ LATTICE™ C COMPILER \$359	PFS Report \$ 75		92 IBM \$389
LIFETREE™ Volkswriter Deluxe \$179	SORCIM/IUS™		93 IBM \$629
LOTUS™	SuperCalc 2/3 \$159/\$195		PRINCETON GRAPHICS™ MONITORS CALL
1-2-3 \$295	EasyWriter II System \$185		QUADRAM™ CALL
Symphony \$425	IUS Easy Business Accounting \$299/mod.		WESTERN UNION EASY LINK® FREE

WE ALSO CARRY HUNDREDS OF OTHER PRODUCTS FOR THE IBM-PC® AND COMPATIBLES, MACINTOSH®, APPLE II® AND CP/M®!

 **800-SOFTWARE, INC.**
940 Dwight Way
Berkeley, CA 94710



 **800-SOFTWARE**

To order call toll-free:
800-227-4587 OR 415-644-3611

- Dealer inquiries welcome.
- Quantity discounts available through our National Accounts Program.
- Purchase orders accepted. Please call us in advance.
- Call for shipping charges. Overnight delivery available.
- We do not add surcharge for credit card purchases.
- Prices may change. Above prices are for IBM-PC and compatibles.
- International orders welcome: TELEX #751743 800 SOFTWARE UD.

pin-compatible with 4116 EPROMs (erasable programmable read-only memories).

Each processor is interfaced directly to its respective private memory. Since the 6800's bus interface is in the high-impedance state whenever it is halted, and since the IBM PC interface's three-state controllers are only

enabled when the corresponding CPU is halted, this guarantees mutually exclusive access to the private memory. The IBM PC can, in the worst case, attempt to access the private memory when the attached CPU is running; but since the three-state controller will be disabled, data written will not be passed through to the private mem-

ory, and reads will return meaningless data since nothing will be driving the bus during the read—no damage to the system will occur.

The interface between the CPUs and the shared memory is considerably more complex. Each CPU is interfaced through a three-state controller that switches both address and data lines onto the shared-memory bus. When a CPU outputs an address in the address space occupied by shared memory (which starts at address 3000 [hexadecimal] for all three processors), the address is immediately decoded by the address-decode logic (which appears to the right of each CPU in figure 1) and asserts request line R_n , where n is the number of the CPU making the request. This line transmits the request to the arbitration logic, described in detail below, which asserts grant line G_n if and only if Processor n is currently allowed to access shared memory. If a request line is asserted but the arbitrator does not assert the corresponding grant line, the processor's clock is immediately halted, suspending instruction execution until the grant line is asserted. (This is not shown on the diagram in figure 1, which does not include the processor clock logic. The clock-halting function is controlled by a Motorola 6875 clock generator, which has a Memory Ready control pin designed for this purpose. We specifically chose the 6875 clock generator for this feature.) The three-state controller assures that a CPU that has not been granted access to the shared memory will not output data onto the shared-memory bus.

ENTERING ARBITRATION

The arbitrator guarantees all CPUs equal access to the shared memory. We designed and implemented our memory arbitrator using a National Semiconductor PAL (Programmable Array Logic), a trademarked PLA (programmable logic array) having only one programmable-gate plane. The other plane normally found in PLAs is replaced by a fixed set of gates, with different PALs available for dif-

(continued)



**C Productivity Series—
The Professional's Edge**

Blaise Computing has a range of programming aids for the most popular C compilers in the IBM environment that no serious system developer should be without. These packages help you to easily access advanced capabilities of the hardware and operating system, and to finish your projects with a substantial saving of time and effort. With software development costs and pressures as great as they are, can you afford not to take advantage of the finest tools available?

- ◆ **C TOOLS™** puts advanced string handling functions at your disposal and provides a high-level interface to all BIOS functions from your C program. Complete screen handling, graphics primitives, and a substantial group of useful, general-purpose functions are also featured. **\$125**
- ◆ **C TOOLS 2™** lets your program perform all the advanced DOS 2.0 services. Program chaining, software interrupt handling, and dynamic memory allocation are all done "right." Buffer and file handling functions are provided, as well as a general DOS gate. **\$100**
- ◆ **C VIEW MANAGER™** is our display screen management system that makes screen development and documentation much faster. It comes with a complete library of C functions which use the screens you have developed to recall and display information, capture and validate field data entry, and provide context-relevant help files. **\$275**
- ◆ **ASYNCH MANAGER™** is a library of interrupt-driven routines providing a general interface to both COM ports for your asynchronous communications applications. Introductory price of **\$175** includes all source.

All of these products may be used by developers with no royalty payments to Blaise Computing. Source code either comes with the package, or is available. We support Lattice, Computer Innovations, and Microsoft C compilers. To expedite your order or to obtain further information, call or write us directly.

Blaise Computing's Programmer Productivity series is also available in versions for the Pascal language.

BLAISE COMPUTING INC.
2034 Blake Street Berkeley, CA 94704
(415) 540-5441

PRIMITIVES

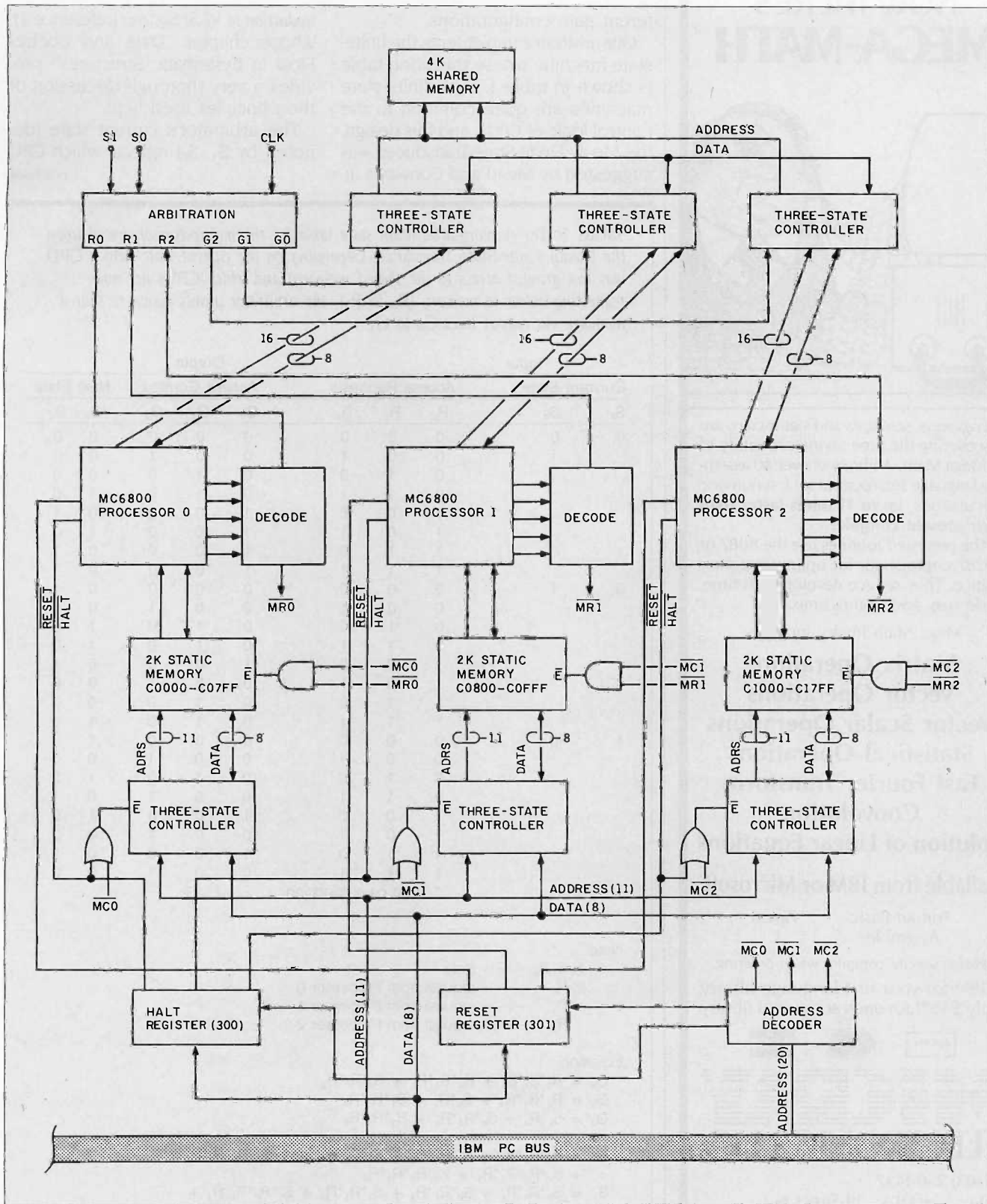
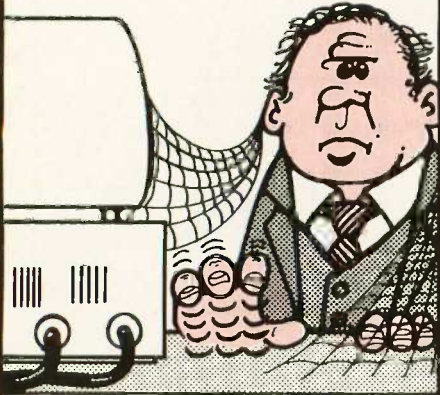

Figure 1: A block diagram of the multiprocessor, built around three MC6800 microprocessors and controlled by an IBM PC.

Why wait for ANSWERS FROM YOUR IBM PC/AT/XT NOW THERE'S MEGA-MATH™



Engineers, scientists and statisticians are discovering the time saving capability of Mega Math. A library of over 40 assembly language sub-routines for fast numeric calculations, **up to 11 times faster than your present compiler.**

The pretested routines use the 8087 or 80287 coprocessor for optimum performance. They reduce development time, code size, and testing time.

Mega Math library includes:

- Matrix Operations**
- Vector Operations**
- Vector Scalar Operations**
- Statistical Operations**
- Fast Fourier Transform**
- Convolution**
- Solution of Linear Equations**

Callable from IBM or Microsoft:

Fortran Basic Pascal
Assembler C

Please specify compiler when ordering.

\$99⁰⁰ for your first language library,
only **\$49⁰⁰** for each additional library.



MICRAY ELECTRONICS LTD.

(403) 250-1437

Bay 1, 4001A - 19 Street N.E.
Calgary, Alberta Canada T2E 6X8

TM - (IBMPC/AT/XT) IBM, (8087-80287) Intel,
(Microsoft) Microsoft Corp. (MEGA MATH) Micray

PRIMITIVES

ferent gate configurations.

Our arbitrator implements the finite-state machine whose transition table is shown in table 1. Such finite-state machines are quite common in the control logic of CPUs, and this design, the Mealy Finite-State Transducer, was suggested by Mead and Conway's In-

roduction to VLSI Systems (reference 2), whose chapter "Data and Control Flow in Systematic Structures" provides a very thorough discussion of the principles used here.

The arbitrator's current state (denoted by S_1, S_0) reflects which CPU (continued)

Table 1: The memory-arbitration state table for the multiprocessor, based upon the Mealy Finite-State Transducer. Depending on the current state (which CPU was last granted access to the shared memory) and which CPUs are now requesting access to memory (R_0 to R_2), the arbitrator grants access to shared memory, via output lines G_0 to G_1 .

Input			Output						
Current State		Access Requests			Access Granted			Next State	
S_1	S_0	R_0	R_1	R_2	G_0	G_1	G_2	S_1	S_0
0	0	0	0	0	0	0	0	0	0
		0	0	1	0	0	1	0	0
		0	1	0	0	0	1	0	0
		0	1	1	0	0	1	0	1
		1	0	0	0	1	0	0	0
		1	1	0	0	1	0	0	0
		1	1	1	0	1	0	0	0
0	1	0	0	0	0	0	0	0	0
		0	0	1	0	0	0	1	0
		0	1	0	0	0	1	0	1
		0	1	1	0	0	1	0	1
		1	0	0	0	0	0	0	0
		1	0	1	0	0	0	1	0
		1	1	0	0	1	0	0	0
1	0	0	0	0	0	0	0	0	1
		0	0	1	0	0	0	1	0
		0	1	0	0	0	1	0	1
		0	1	1	0	0	0	1	0
		1	0	0	0	1	0	0	1
		1	0	1	0	0	0	1	0
		1	1	0	0	1	0	0	0
1	1	1	1	1	0	0	1	0	0
		* don't care condition							
		1							

Note:

1. S_1, S_0 ---- state
2. R_0 ---- request from Processor 0
- R_1 ---- request from Processor 1
- R_2 ---- request from Processor 2

Equation

$$G_0 = R_0 * S_1 * S_0 + R_0 * R_1 * R_2 + S_0 * R_0 * R_2$$

$$G_1 = R_2 * R_1 * R_0 + S_0 * R_1 + S_1 * R_1 * R_0$$

$$G_2 = S_1 * R_2 + S_0 * R_2 * R_1 + R_2 * R_1 * R_0$$

$$S_0 = S_0 * R_0 * R_1 + S_0 * R_1 * R_2 + S_1 * S_0 * R_0 * R_1 + S_1 * R_0 * R_1 * R_2$$

$$+ S_1 * R_0 * R_1 * R_2 + S_1 * R_0 * R_1 * R_2$$

$$S_1 = S_0 * R_0 * R_1 + S_0 * R_1 * R_2 + S_1 * R_1 * R_2 + S_1 * R_0 * R_1 * R_2 +$$

$$S_1 * S_0 * R_2 * R_1 * R_0 + S_1 * R_0 * R_2$$

Look to the Leader

I² has been delivering low-cost storage products since 1978



For affordable, expanded storage for your IBM PC or PC compatible, look to the leader—I² Interface, Inc. With I² Interface Winchester DiskSystems, you can have levels of storage typically associated with larger, more expensive computer systems. Our DiskSystems are available with formatted storage capacities of 10, 15, 22, 33, 55, 87 and 119 megabytes. These DiskSystems are bootable from the Winchester

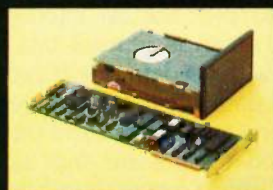

Internal Winchester DiskSystem

on some PCs. Plus, I² Interface has more to offer:

- Internal-mounted

Winchester system with 10 megabytes

- Removable cartridge DiskSystem with 10 megabytes

- Cartridge TapeSystems with 10 to 60 megabytes

- Plus an array of other peripheral products

Simple and fully compatible

I² DiskSystems and TapeSystems are simple to install and have proven reliability. All are FCC Class B approved and undergo an extensive 48 hour test period prior to



Cartridge TapeSystem

shipment. All are backed by a 90-day warranty that covers parts and labor with an extended one-year warranty available. I² Interface products are compatible with IBM PC, XT and portable models, plus other popular PC compatible computers.

See your dealer today to get the affordable means to expand the capabilities of your IBM PC and PC compatible. Look to the leaders—look to I² Interface.



Removable Cartridge DiskSystem

See us at
Comdex Atlanta
Booth #4355



Interface, Inc.

21101 Osborne Street
Canoga Park, CA 91304
(818) 341-7914 Telex 662949 CNPK

More data, less dollars.

Introducing affordable tape backup and hard disk for IBM PCs.

MicroSystems MT25 high-capacity cartridge tape subsystem gives you the secure and easy-to-use file-oriented disk backup you need. And the MicroSystems MD20 and MD52 offer complete, full-featured, ready to boot hard disks. All three fine products come complete with software. Just plug and play. So expand your system, not your budget. Call MicroSystems International today.



MicroSystems International Corporation An **ALLOY** Company
 100 Pennsylvania Ave., Framingham, MA 01701 (617) 875-9700 TWX 710-346-0394

PRIMITIVES

was last granted access to shared memory. The arbitrator's input indicates the shared-memory requests currently outstanding (R_0 to R_2), and its output on each transition (G_0 to G_2) indicates which CPU is allowed to proceed with the memory access.

An arbitrator of this complexity was made necessary for two reasons: first, simple fairness; second, and more seriously, the 6800 processor can only be halted for a few milliseconds via the 6875's Memory Ready pin, after which the contents of the processor's internal registers disappear. The processor's registers are implemented via simple MOS circulating-data registers, which require continuous clocking to keep the data circulating and refreshing the registers. When the clock is stopped, refreshing stops, and the charge representing the data in the registers leaks off over a period of several milliseconds, until the data values are no longer detectable when the clock is restarted. Thus, the arbitrator has to guarantee that a CPU will never be halted for more than the allowed period; the arbitrator does this by not allowing any CPU to have two consecutive accesses until all other CPUs simultaneously requesting access have been granted their turns.

The 4K-byte shared memory to which the arbitrator controls access includes 8 bits of data for each address and a "present" bit indicating whether a data object is present or absent at each address. The present bit is gated with the memory read/write line to produce an interrupt when a CPU attempts to read data at an address with no data object present or write data when a data object is already present. The present bit is also updated to indicate "no data present" following a successful read, or to indicate "data present" following a successful write. Because of the way the 6800 microprocessor operates, the interrupt occurs following completion of the read or write operation. In either case, no access to shared memory actually occurs when an interrupt is generated: With data

(continued)

Brainy Buffer.

Do you press "print" and wait?
 And wait? And wait?

HanZon's 64K Universal Data Buffer is the only self-configuring intelligent device that gives you uninterrupted use of your personal computer.

With four standard interface ports, now you can share output devices with two micro systems. Just plug them in and you're ready to go. And it's expandable up to 256K.

Call HanZon today for more information and the name of your nearest dealer: 206-487-1717.



HANZON
 "Computer Enhancements"
 18732 142nd Ave. N.E.
 Woodinville, WA 98072

Suggested retail price: \$385.



Resolution That Blows You Away

Being #1 has its advantages!
Our Model 440 (720 by 400) Ultra High-Res monitor is the Worlds standard for excellence. Its capabilities will out-rank

those of our competitors for a long time.
We won't Stop producing the finest!
You can't!
Not when you're Number One!



MODEL 440

12 inch Ultra High-Res RGB Color Monitor
Designed for up-grading display of IBM PC
720 x 400 line resolution in non-interlaced mode
4000 character display capability
Switchable to green character display



MODEL 425

12 inch Super High-Res RGB Color Monitor
Fully compatible with IBM PC and PC Compatibles.
640 x 262 line resolution
Switchable to green character display
Built in audio

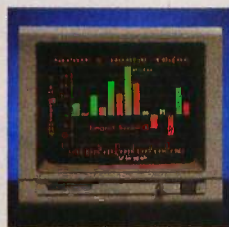

MODEL 420L

12 inch Super High-Res RGB Color Monitor
Long Persistence Phosphor Tube
Fully compatible with IBM and most other personal computers.
640 x 262 line resolution in non-interlaced mode
640 x 525 line resolution in interlaced mode
Unlimited colors available through analog video circuit



MODEL 411

12 inch High-Res RGB Color Monitor
Fully compatible with IBM PC and PC Compatibles.
510 x 262 line resolution
Switchable to green character display
Built in audio

**COMDEX™ /
Spring '85**

See you at Comdex
Booth #4342

Inquiry 390 for Dealers. Inquiry 391 for Epd-Users.



MODEL 122

12 Inch Super High-Res Amber Display
Fully Compatible with IBM TTL Monochrome Display
Horizontal scan.
Rate 8,432 Khz
Optional Tilt/Swivel Base available (Model 110-12)
Green phosphor available (Model 121)

TAXAN

The Smart Choice.

18005 Corney Ct. City of Industry, CA 91748 **(818) 810-1291**

© 1985 TAXAN Corporation

*IBM is a registered trademark of International Business Machines, Inc.

already present, the CPU attempting to write data will discard that data; with no data present, the CPU attempting to read data gets back meaningless data.

IMPLEMENTATION RESULTS

Implementation of the multiprocessor was successful; we demonstrated this by executing a test program based on Hansen's "incorrect" program (listing 1). [Editor's note: A complete listing of the test program is available for downloading via BYTEnet Listings. The number is (603) 924-9820.]

The test program consists of three concurrent parts, each running on a distinct CPU. The first, simulating the input device, simply produces a sequence of data objects in the form of consecutive integers, which it writes into location 3000 (hexadecimal) of the shared memory. Once the first object is written, the next write will not suc-

Listing 1: A high-level outline of the test program described in the article.

```

program pbh:
shared
    t,s: integer;
var
    eof: boolean;
    f,g: file of integer;
begin
    while not eof do
    cobegin
        t := s;
        output(g,t);
        input(f,s,eof);
    coend;
end.
    
```

ceed until the first object has been removed. The removal is accomplished by the second concurrent part (running on the second CPU), which reads from location 3000 and writes the object it read into location 3001. Here, the read will not succeed until a data

object has been written into location 3000, and the subsequent write will not succeed until the previous data object has been removed from location 3001. Finally, the third concurrent part, running on the third CPU and simulating the output device, reads the object from location 3001 and writes it into a circular buffer in its private memory. Once again, the read from location 3001 will not proceed until a data object is present there. To ensure that the other two CPUs will have to wait, the third CPU executes a delay loop between each access to shared memory to slow it down.

We verified successful operation of the multiprocessor by first checking that the circular buffer of the third CPU contained data other than consecutive integers, starting the program for a time, then stopping it and verifying that the circular buffer did then

(continued)

Products for the Expanding Universe



1800 Michael Faraday Drive, Suite 206, Reston, VA 22090
 (703) 471-5598 Order Line (800) 368-3359
 Telex: 750417 NEW GEN SYS UD.

	Price		Price
MicroShell UNIX-like Commands for CP/M Fast command (submit) files, I/O redirection, command line editing, auto disk and user searches. (Usable under CCP/M). [CP/M-80]	125.00	BRX-80/86 Fast Hard Disk Backup (16 bit version 30-100% faster than PIP), handles random files, files larger than a floppy disk, backup only changed files (86 version only), selective restore. [CP/M-80, 83; MP/M-816; CCP/M-816]	195.00
Tool Pax UNIX-like Utilities Sorting, searching, print formatting, file differences, vertical cut/paste, etc. [CP/M-80, 83; MP/M-816; CCP/M-816]	150.00	Intro. C Learn C on your PC Complete, comprehensive introductory course in C with a C interpreter to run your programs as you write and change them. [PCDOS 2.0]	95.00
MicroTree Named Directory Areas Hierarchical file directories and utilities. Permits named directory areas under CP/M, MP/M 816 with: change/make/list/remove directories, rename, copy and show directory tree. [CP/M-80, 83; CP/M-86; MP/M-816; CCP/M-816; CP/M-68K]	99.00	CI C86 Full 16-bit C Compiler Computer Innovations' fast, optimized, 16-bit full C compiler. With source code for all library functions, 8087, small/big model support, comprehensive manual. We use it for all 16-bit programs; it's great!	349.00
CPRO-UTIL Multiuser Utilities Schedule and time commands, printer setup, disk utility (DU-like: unerase, view, change, etc.), write to terminals, electronic mail and others for CompuPro Concurrent CP/M systems.	99.00	BDS C The Original—Still Fastest! Ultrafast C compiler for CP/M-80 with symbolic debugger, full library and run time source code. Large public domain library of programs available.	140.00
TexSys Text Control System Multiple versions of text files—source code, letters, spread sheets, contracts, any text. Keeps record of changes allowing any version to be recovered. Twenty revisions normally only require three times the disk storage space. [CP/M-80, 83; MP/M 816; CCP/M-816; PCDOS/MSDOS, Macintosh, Lisa]	99.00	AMCALL Multiuser Modem Program Both AMCALL and MCALL-II specially configured for CompuPro 816, CompuPro 10, or Gifford MP/M, CCP/M or MC-DOS Multiuser systems. Supports 7 file transfer protocols with the Hayes 300/1200 Smart-Modem. Baud rates to 19,200. Single-user AMCALL 150.00 / MCALL-II 125.00	300.00
Bibliofile Bibliographic Data Base Maintain, search and format bibliographies. Compatible with most word processors. [CP/M-80, 83; MP/M & CCP/M-816; PCDOS/MSDOS]	250.00	Disk Maker A Disk Maker System for Your Needs Moves programs, data, any files among over 200 different floppy disk formats. Can format, read, write and duplicate 3 1/2", 48/96 tpi 5 1/4", IBM PCAT, and 8" diskettes (with appropriate drive options). Available options include 10, 15, 20Mb hard disks, 8086 Coprocessor, Word Processing/Typesetting Disk Maker I: For existing S-100 computers From 1695.00 Disk Maker II: Standalone Disk Maker From 3695.00	
DSD Dynamic Screen Debugger Symbolic, full screen program debugger for assembly language, BDS C, etc. programs. Dynamically displays instructions, registers, memory, and stack areas: 8080, 8085 and Z80-compatible. [CP/M-80, 83; MP/M-816; CCP/M-816]	125.00		



NEW

A powerful multfile database with a programming language for only \$99

Versaform's new XL database isn't just promises—it's here now! And it offers—YES, FOR ONLY \$99—all the features you'd expect in a database costing 4 times as much.

Accounting applications are XL's strength. Invoicing, purchasing, receivables, and shipping almost create themselves as you design the forms—and XL transfers data between them. There's an Invoicing, A/R and Inventory application—source code included—in the package that shows how it's done. The power's there. And unlike packaged accounting programs, you can do them YOUR way.

	VersaForm XL	dBASE III*	R-BASE 4000*
PRICE	99	695	495
STRUCTURED LANGUAGE	Y	Y	Y
MULTI-FILE	Y	Y	Y
COLUMNS WITHIN DATA RECORD	Y	N	N
DATA ENTRY CHECKING	BUILT-IN	MUST WRITE PROGRAM	BUILT-IN
ON-SCREEN CALC	BUILT-IN	MUST WRITE PROGRAM	MUST WRITE PROGRAM
FORMS OUTPUT	BUILT-IN	MUST WRITE PROGRAM	MUST WRITE PROGRAM
DATE ARITHMETIC	Y	Y	N
DATA TYPES	DYNAMIC	FIXED	FIXED
COLUMN TOTAL OPERATOR	Y	N	N
QUERY BY EXAMPLE	Y	N	EXTRA
MAX FILE SIZE	4 MB	OPEN	OPEN
MAX RECORD SIZE	4000	4000	1530

*dBASE III is a registered trademark of Ashton-Tate. R-BASE 4000 is a trademark of Microrim, Inc.

- XL's structured language can access multiple files. 48 built-in functions give control of file access, printing, and user dialogues. You'll develop transaction-based applications with an ease you've never experienced before. And all at this unheard-of low price.
- VersaForm XL's unique form-oriented data structures let you easily set up forms and ledgers—even those with columns! Application development is FAST, FAST, FAST. And since forms are the way that businesses already store their data, the transition is smooth. That's why VersaForm XL is so easy to operate even for high-turnover clerical people—it starts from where they are now.
- Automatic data entry checking and on-screen calculation make transactions error-free. Stored print formats make output formatting a snap—you can quickly match existing paper forms. VersaForm XL's report generator is clear and intuitive. Designers can pre-install reports,

users can set up their own.

- Query-by-forms (at no extra cost) lets users go right to the data they need. No query language to learn—forms are the natural language of business.

Ironclad Money-Back Guarantee

Try VersaForm XL for 30 days. If you're not fully satisfied, return it. We'll gladly refund your money.

Order now, and have the pleasure of using the right tool at the right price. You can't lose!

VersaForm XL runs on IBM PC, XT, AT and compatibles. Requires 192K, two 360KB drives, DOS 2.0 or later. Hard disk recommended.

Standard VersaForm (single file, no language) available for 64K, 2-drive Apple II or 128K IBM PC. \$69.



VersaForm XL

Applied Software Technology, Dept 585, 1350 Dell Ave., Suite 206, Campbell, CA 95008 (408) 370-2662

Yes! Rush me Versaform XL for the IBM PC (\$99) _____

Standard Versaform (Single file, no language) for the IBM PC (\$69) _____

Apple II (+, E, C) (\$69) _____

Credit card members can order by phone.  

Toll-Free: 1-800-824-8145

In California

Toll-Free: 1-800-854-4448

Enclose check or money order with coupon. Include \$4.50 for U.S. Shipping and handling. \$7.00 for C.O.D. California residents add 6.5% tax.

____ My check or money order is enclosed ____ Send C.O.D.

Charge my ____ MasterCard ____ Visa

Account No. _____ Expires _____

PLEASE PRINT CLEARLY

585

Name _____

Address _____

City _____ State _____ Zip _____

Phone _____ Signature _____

FORTRAN, C Language and BASICA

Scientific Subroutine Libraries

From Wiley Professional Software

You are a serious programmer. You need to quickly generate dependable, accurate and error-free code. Whether you are programming in FORTRAN, C, or BASIC... Wiley Professional Software has a powerful Scientific Subroutine Library that can save you considerable programming time and development money.

Each Library consists of 114, (C Language 112) pretested and precompiled mathematical and statistical subroutines, supplied on disk as a linkable library and as source code. The subroutines cover formulas for:

General statistics	Cross tabulations
Probability	Differential equations
Analysis of variance	Roots of biquadratic equations
Regressions	Function evaluations
Matrices	Systems of equations
Interpolations	Solution of equations
Fourier analysis	Time series analysis and more

Each package includes 400-plus pages of documentation, providing you with extensive reference material, a listing of the subroutine's source code, complete test programs and the results of running each test.

LIBRARY	PRICE	REQUIREMENTS
FORTTRAN Library	\$175	Microsoft FORTRAN ver. 3.13 or later or IBM 2.0
C Language Library	\$175	Lattice C Compiler ver. 2.12 or later
BASICA Library	\$125	BASICA

Developed by Peerless Engineering Service

TO ORDER OR FOR FREE LITERATURE CALL 212-850-6788

Or write:

Leslie Bixel
Wiley Professional Software
605 Third Avenue
New York, NY 10158

A division of John Wiley & Sons, Inc.



wiley
PROFESSIONAL
SOFTWARE

6-0031

contain consecutive integers.

Each CPU's program part contains an identical interrupt procedure to simulate the primitive wait. This interrupt procedure simply decrements the interrupt return address on the stack to retry the unsuccessful read or write and then returns from the interrupt. This causes the CPU to repeatedly execute the memory access until it succeeds.

The multiprocessor successfully executed the test program on September 27, 1984, after several months of debugging. Almost all of this debugging time involved debugging the memory arbitrator and synchronization of shared memory access with the arbitration logic and not debugging the data-movement primitives. The implementation of the data-movement primitives is quite elegant; this elegance is reflected in the fact that, although many PALs were used to reduce the parts count of the multiprocessor (which otherwise would have been very large), no PALs were needed for the portion of the circuit implementing the data-movement primitives.

CONCLUSIONS

This project successfully demonstrated the feasibility of implementing a multiprocessor system with data-movement primitives using off-the-shelf hardware. We have demonstrated the success of the data-movement primitives by using them to correctly execute a concurrent program, without using the software-synchronization primitives that would be required otherwise. Furthermore, the cost of implementing this machine (\$450) shows that such an implementation is affordable; the large portion of this cost was for the CPUs, interface hardware, and conventional memory components. ■

REFERENCES

1. Hansen, Per Brinch. "Structured Multiprogramming." *Communications of the ACM*, 15(7), 1972, page 574.
2. Mead, C., and L. Conway. *Introduction to VLSI Systems*. Reading, MA: Addison-Wesley, 1980.

Obsolete technology — it's not just a hardware problem!



You wouldn't dream of wiring your state-of-the-art modem to turn-of-the-century technology. Why strangle your computer with an antique communications program?

NightOwl Software believes your modem should open a window on the world — but without slamming a door on the power of your IBM-PC or compatible. That's why we designed our MEX-PC communications package to allow you complete access to your operating system, utilities and software while connected to a remote system.

Other communications programs limit your on-line options to a small set of built-in commands. Not MEX-PC. Our SHELL feature lets you run your spreadsheet, word processor, database management system, or any other program, from within MEX-PC while you're on-line — and without loss of text or data.

That's a claim no other communications software can make — and it's just one of many reasons MEX-PC is setting new standards for power, flexibility and performance in the world of telecomputing.

Consider the features:

- **A powerful command processor** allows fully automated dialing, log-ons, uploads, downloads and log-offs.
- **A built-in HELP program** explains all aspects of the software, on-line or off. A complete status screen immediately lists all current settings.
- **Command driven.** No need to wade through level after level of menus in a time-consuming search for the commands you want to enter or the features you need to change.
- **Fully documented.** Includes a typeset, ring-bound, 180-page user's manual and complete tutorial, fully indexed.
- **Wide range of protocols**, including Christensen XMODEM with both CRC and Checksum error correction.

\$59.95*

Why spend more for a lot less power?

Write or call to request our free brochure.
Credit card orders welcome.

Give us a toll-free call at 1-800-NITEOWL. (In Wisconsin, call 1-414-563-4013)

NightOwl Software, Route 1, Box 7, Fort Atkinson, WI 53538



* Plus \$5 shipping. Wisconsin residents add 5 percent sales tax.

Inquiry 295



MAY 1985 • BYTE 253

We don't have all the answers you need, but we'll do all we can to find them!

IBM/PC SOFTWARE

Alpha Software
Data Base Mgr II \$179
Electric Desk (Jr) 199

Anderson Bell
Abstat \$289

Arrays, Inc.
Home Acct. + \$ 90
Home Acct. w/
Tax Advntg..... \$139

PC PROGRAMMERS CORNER

Borland
Turbo Pascal \$ 37

CompuView
Vedit \$130
Vedit+ 179

Digital Research
Access Mgr \$229
C Basic Comp
(CB-86) 339
CP/M-86 45
Concurrent CP/M
w/ Windows 119
Concurrent DOS..... 179
Display Mgr..... 279
DR Assem & Tools... 129
DR Graph 119
Fortran 77-DOS
or CP/M 279
Pascal MT+ 339
Personal Basic..... 99

Emerging Technology
Edix (editor)..... \$139

Heritage
Smartkey II+ \$ 75

Microsoft
C Compiler \$319
Pascal Comp 199
Basic Comp 249

Morgan Computing
Prof Basic..... \$ 79
Trace 86 99

Peter Norton
Norton Util 3.0..... \$ 69

Supersoft
Fortran \$299

Lifeboat
Lattice C..... \$419
Lattice Windows... 249
Run-C 99
Dr Halo (Graphics). 79
P Mate 189

Ashton-Tate
dBase II Call
dBase III (v. 1.1) Call
Framework (v. 1.1) Call
Friday Call

Central Point
Copy II PC..... \$ 34

CompuView
V-Print \$ 99
V-Spell 99

Connecticut Software
Printer Boss w/
Letter Boss & Sideline \$119

Dow Jones
Market Analyzer \$229
Market Manager 189
Spreadsheet Link..... 179

Ecosoft, Inc.
Microstat \$239

Enertronics
Energraphics \$219
w/ Plotter Option..... 279

Fastware Thor..... \$245

Financier, Inc.
Financier II \$119
Tax Series 105

Fox & Geller
Grafox \$159
dGraph 159
Quickcode (III or II).... 159
Quick Report 159
dUtil (III or II)..... 58

FYI
Superfile \$139
FYI 3000..... 259
Sort Facility 99

Harvard Software
Project Manager..... \$249

Lifetree
Volkwriter Deluxe..... \$155
Volkwriter Scientific... 359

Living Videotext
Think Tank (256K)..... \$119

MDBS
Knowledge Man \$275

Menlo Corp.
In Search..... \$279

Micropro
Wordstar ProPak..... \$255
Wordstar 2000 289
ProPak Plus (WS,
CS, MM, SI, TM) \$369

Microrim
R-base 4000 \$265
R-base Clout (V 2.0)... 139
R-Writer 95
Prog Interface 259

Microsoft
Flight Simulator II..... \$ 39
Project 1.01 169
Word 1.15..... 229
MuMath/MuSimp 179

Microstuf
Crosstalk \$ 99
Multimate (V 3.3)..... \$289

Northwest Analytical
Statpak..... \$365

Open Systems
Acct'g Programs .. ea \$399
Buy 3 or more ea 379

Peter Norton Computing
Norton Utilities (3.0)... \$ 69

Peachtree
Series 8 Account-
ing Modules \$359

Samna Corp.
Samna Word III 349

Satellite Software
Word Perfect w/ Sp..... \$255

Sensible Designs
d Programmer..... \$199

Software Arts
Spotlight \$109

Software Publishing
(PC Jr. Compatible)
PFS: File, Graph
Write, Plan ea \$ 89
PFS: Report 79
PFS: Access, Proof. ea 59

Sorcim
Supercalc III..... \$249

Star Software Systems
Acct'g Partner \$219
Acct'g Partner II 599

Wamer Software
(PC Jr. Compatible)
Desk Organizer \$129

Westminster Software
Pertmaster Call
..... and many more!

APPLE SOFTWARE

Alpha Software
Apple-IBM
Connection \$169
Typefaces 69

Arrays, Inc.
Home Acct. \$ 59
F CM 79

Ashton-Tate Call

BPI Call

Broderbund
Bank Street Writer \$ 45
Bank Street Speller 45

Cdex
All Trng Prog's..... ea \$ 49

Dow Jones
Market Analyzer \$229
Market Manager 189
Spreadsheet Link..... 179

Eduware Call

Living Videotext
Think Tank \$ 99

Micropro
Pro Pak \$349
Microsoft Call

Peachtree
Back to Basics \$149
PeachPak
Series 40 or 80..... \$229

Penguin Software ... Call

Software Publishing
PFS: File, Graph,
Report ea \$ 79

Spinnaker Call

Xerox Education
Sticky Bear Series... ea \$ 35

CP/M SOFTWARE

All prices below are for
8" standard.

ATI
All Trng Prog's..... ea \$ 52

Ashton-Tate
dBase Call

CompuView Call

Digital Research
DR Assem & Tools 86.. \$119
C Basic Comp (CB-80) 289
SPP (86) 149
Display Mgr 80 239
Display Mgr 86..... 279
Pascal MT+ 80 199
Pascal MT+ 86 349
PL/1 86 399
Access Mgr 86..... 239
Fortran 77 86..... 199

Infocom
All Games Call

Micro Pro
WordStar \$250
InfoStar 265
Pro-Pak (WS,
MM, SI, SS)..... \$359
All Others Call

Microsoft Call

Microstuf
Crosstalk \$ 99

Northwest Analytical
Statpak \$365

Oasis
Word Plus \$110
Punctuation & Style... 99

Supersoft
Disk Doctor \$ 74

MACINTOSH CORNER SOFTWARE

ATI
MacCoach \$ 50

Arrays, Inc.
Home Acct..... \$ 69

Creative Solutions
daVinci \$ 99
MacForth II 169

Hayden Software
Sargon III..... \$ 39
daVinci: Bldgs, Land-
scapes, Interiors. ea 39

Human Edge Software
Sales, Mgmt Edge ea \$159
Commun. Edge 139

Infocom Call

Living Videotext
Think Tank \$ 89

Microsoft
Basic Interp \$ 99
Chart 79
File 139
Multiplan 139
Word 139

Main Street Software
Main St. Filer \$ 99

Monogram
Dollars & Sense..... \$ 99

Penguin Software
Pensate, Transyl-
vania, Quest ... ea \$ 32

Scarborough Systems
Mastertype \$ 37

Simon/Schuster
Typing Tutor III \$ 45

Sierra On-Line
Frogger \$ 32

Software Publishing
PFS: File &
Report Combo..... \$119

Telos Software
Filevision..... \$109

T/Maker
Click Art \$ 39

HARDWARE

Davang
Disk Drives Call

Intermatrix
MacPhone..... \$149

Kensington Microware
Surge Suppressor..... \$ 45
Modem \$399

Memorex
3 1/2" Diskettes..... \$ 49

Quadram Call

Tecmar
Disk Drives Call

APPLE/ FRANKLIN BOARDS

ALS	
CP/M Card.....	\$269
Smarterm II.....	119
Z-Engine.....	139
CCS	
7711 Asynch Serial.....	\$ 99
Microsoft	
Softcard +.....	\$449
Prem Softcard (IIE).....	295
Microtek	
Printer I/F.....	\$ 75
Dumpling-16K.....	169
Dumpling-GX.....	89
Orange Micro	
Gropper + w/ buffer.....	\$175
Prometheus	
Versacard.....	\$159
Videx	
Videoterm VT-602.....	\$249
Ultraterm.....	249

IBM/PC BOARDS

AST Research	
Six Pak + 64K	
(exp 384K, S/P, Clk) ..	\$265
MegaPlus 64K, (CI/Cal,	
S Port, 512K cap	
w/ Megapak).....	\$269
Megapak 256K up-	
grade for Megaplus. Call	
BYAD, Inc.	Call
Maynard Electronics	
Floppy Drive Cntrlr.....	\$119
w/ Par Port.....	169
w/ Ser Port.....	179
Sandstar.....	Call
Memory Chips.....	Call
Orange Micro	
Mr. Chips.....	Call
Orchid Technology	
"Orchid Blossom".....	Call
Quadram	
Quadboard 64K, (exp	
384K, Clk/Cal, S&P	
Ports, Software).....	\$269
Microfazer Stack Printer	
-P/P 8K (exp 512K).....	\$139
-S/P 8K (exp 64K).....	149
-S/S 8K (exp 64K).....	149

Quadram (continued)
 Quadlink 64K Mem... 469
 Other Products..... Call

Tecmar	
Captain's Bd w/64K ...	\$299
1st Mate.....	259
2nd Mate.....	250
3rd Mate.....	379
Xedex/Microlog	
Baby Blue.....	\$325
Baby Blue II.....	525

DISPLAY CARDS

Fredericks/Plan-	
tronics Colorplus...	\$399
Hercules	
Graphics Board.....	\$339
Color Board.....	199
MA Systems	
PC Peacock	
Color Board.....	\$249
Paradise	
Display Card	
(clr/monochrome).....	\$349
Modular/Display.....	309
Quadram	
Quadcolor I.....	\$199
Quadcolor II.....	389
Tecmar	
Graphics Master.....	\$479

MODEMS

Hayes	
Smartmodem 300.....	\$195
Smartmodem 1200	429
Smartmodem 1200B...	369
Prometheus	
Promodem.....	\$399
Quadram	
Quadmodem.....	\$529
US Robotics	
Auto-Dial 300/1200 ...	\$459
S-100 Modem.....	349
Password.....	325
Zoom Telephonics	
Networker w/o SW ...	\$109

PRINTERS

C. Itoh Electronics, Inc.	
Starwriter	
F10-40P (40cps).....	\$999
A10-20S (20cps).....	529
Diablo	
630 ECS.....	Call
Epson	Call
NEC	Call
Okidata 82-93	Call
Quadram	
Quadjet.....	Call
Star Micronics	Call
Teletex T1014.....	\$399
...and much more.	

DISKETTES

3M, Maxell, Verbatim
 Ultra Magnetics..... Call

MONITORS

Amdak	
300A Amber.....	\$149
310A.....	199
300 Clr.....	265
500 Clr RGB.....	385
600 Clr HR.....	455
700 Clr Ultra HR.....	535
NEC	
JB1260-12" Green....	\$119
JC1216 RGB.....	429
PGS	
HX12 RGB Clr.....	\$489
MAX 12.....	189
SR12 (690 x 480 Res) ..	639
Doubler Card.....	175
Quadram	
Quadchrome.....	\$489
Quadchrome II.....	429
Amberchrome.....	175
Quadscreen HiRes....	1449
Sanyo	
8112 12" HR Green....	\$169
Taxan	
440.....	\$679
420L.....	499
425 w/ video.....	499
Zenith	
135 (RGB or comp)....	\$499
136.....	669
Others.....	Call

PC Jr ACCESSORIES

KeyTronic	
KB 5150 Jr.....	\$159
KB 5151 Jr.....	175
KB 5149 Numeric	
Keypad.....	89
Legacy	
Legacy I.....	\$289
Legacy II.....	599
MA Systems	
Jr Expander.....	\$109
Dateline.....	159
Quadram	
Quad Jr	
Exp Chassis.....	Call
Quad Jr Exp Mem	
(for Chassis).....	Call
Quadmem Jr 128K. Call	
Tecmar	
Jr. Captain	
(128K,C,P).....	\$329
Jr Wave (64K exp). 259	
Jr 2nd Mate	
(No Mem,C,P).....	129
Jr Cadet (64K exp	
for Jr Captain).....	169

DISK DRIVES

CDC 1800	Call
Corvus Hd	Call
Davong Hd	Call
I-Omega	
Bemoulli Box.....	Call
Maynard Electronics	
Maynstream: Port-	
able back-up for HD	
System 27 (incl	
1 cntrlr cd).....	\$1495
System 60 (incl	
1 cntrlr cd).....	\$1695
Mountain, Inc.	
FileSafe Combo	
Disk/Tape Pack for	
the IBM PC or XT	
For more info.....	Call
Tall Grass	
For Wisconsin customers Call	
Tandon TM-100-2	Call

PLOTTERS

Amdak	
DXI-100.....	\$599
Amplot II.....	899
Enter	
Sweet P Six Shooter... Call	
Houston Instruments Call	
Panasonic	
VP6801P Plotter.....	\$1375

MISC.

Alpha-Delta "MACC 8"
 Surge Protector..... \$ 69

Computer Accessories	
Power Directors	
P2 Mtr Base.....	\$109
P12 IBM PC.....	145
P22 Stand Alone..	75

Electronic Protection Devices	
Lemon / EC I.....	\$ 38
Lime / EC II.....	55
Orange / EC IV.....	75

Hauppauge	
8087 w/o software	\$149
8087 w/ software.....	255
80287 AT Chip w/o....	289
Other Products.....	Call

Kensington	
Masterpiece.....	\$109
Keytronic	
K8 5150.....	\$169
KB 5151.....	175
KB 5151 Dvorak.....	175

Mouse Systems	
PC Mouse.....	\$159

Touchtone Technology	
Touchtone II	
(PC Keypad).....	\$169

Versa Computing	
VersaWriter.....	\$239

WICO	
Joysticks (Ap).....	\$ 39

For assistance in determining your needs use our technical line.* We will be happy to provide full support.

POLICY:

- ▶ Wisconsin residents add 5% for sales tax.
- ▶ Minimum \$4.00 for shipping, handling and insurance for orders to \$200.
- ▶ For orders over \$200, add 2½% for shipping, handling and insurance.
- ▶ For cash prepayment of orders \$200 or more, add ONLY 2% for shipping, handling and insurance.
- ▶ Foreign — either add 15% handling & shipping (Int'l money order) or inquire.
- ▶ Prices are subject to market fluctuations.
- ▶ All items subject to availability.

WE WELCOME:

- ▶ Visa, MasterCharge and American Express. (No charge for credit cards.)
- ▶ Corporate, government or educational volume purchases, please ask for special accounts desk for additional discount. (1-715-848-1374)
- ▶ COD (Add \$2.00 per box/parcel. Cash or certified check required.)
- ▶ Checks. (Allow 1-2 weeks for clearing.)

WORKING HOURS:

Monday-Friday 8:30-6:00 • Saturday 10:00-2:00 (Ordering Lines only) • Central Time
 For tech. support, order status and customer service, call (715) 848-1374 (M-F, 8 am to 5 pm)

BYAD 0585

Inquiry 304 for Hardware. Inquiry 305 for Software. Inquiry 306 for May Specials.

ORYX SYSTEMS, INC.
 CRAFTSMEN OF THE NEW TECHNOLOGY

1 800 826-1589

WITHIN WISCONSIN **1 800 472-3535**

425 First Street • P.O. Box 1961
 Wausau, Wisconsin 54401
 INT'L TELEX: 260181 ORYX SYS WAU



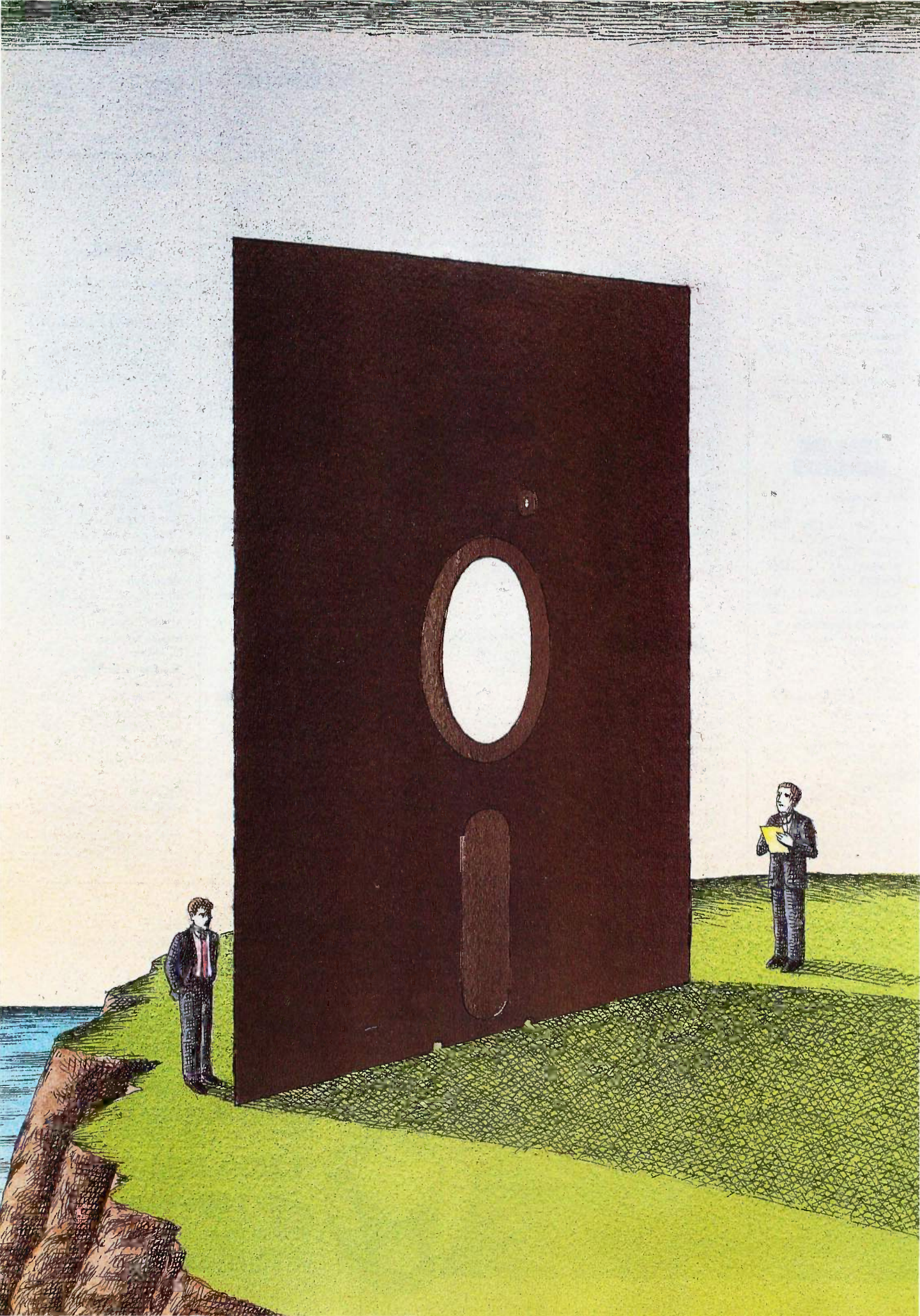

Reviews

REVIEWER'S NOTEBOOK <i>by Glenn Hartwig</i>	259
THE COMPAQ DESKPRO <i>by Jerry Grady</i>	260
IBM PC AT <i>by Alan Finger</i>	270
TRUE BASIC <i>by G. Michael Vose</i>	279
THE GTX-100 MODEM <i>by Mark Haas</i>	291
REVIEW FEEDBACK	299

THE DESKPRO LINE of computers (there are four models) from Compaq Computer Corporation, Houston, Texas, all come with an extra boost in the form of a dual-speed processor. Starting from this common base, each successive model builds on its predecessor with more memory, bigger power supplies, additional drives, and a hard disk. The culminating unit, the Model 4, has everything that's built into the other three units plus a 10-megabyte tape-cartridge drive for hard-disk backup. It also carries a \$7195 price tag. In our first review, Jerry Grady takes a close look at the Model 4 and presents his findings. There's much to like about the Model 4, in Mr. Grady's view, and the breadth of the product line helps a lot if you like the basic technology but can't spring for, or don't need, all the bells and whistles.

Next, Alan Finger takes us through the IBM PC AT. Here, the ability to expand is limited to a basic unit and an enhanced unit. The major benefits of the enhanced unit are a 20-megabyte hard-disk drive, 256K bytes of additional memory, and a serial/parallel interface adapter. While it doesn't give you the option of two clock speeds like the Compaq, its Intel 80286 is quite fast enough for most applications, all by itself. The too-often-politely-ignored point about the IBM PC AT, however, is the fact that it's IBM's top-of-the-line personal computer. Is it worth all the hoo-ha it has inspired? Is it really fair to use the initials AT to signify Advanced Technology? Mr. Finger's analysis is just what you need if you're trying to figure out what's going on.

The BASIC programming language has more idiosyncratic versions than just about any other. Each version attempts to be just a little better (and just a little different) than all of the others for either technical or commercial reasons. The result, of course, is a Babel-like situation. With so many "dialects" running around it's hard to know which features are applicable across product lines and, in the end, which are really BASIC and which are just using the name. BASIC's creators, John Kemeny and Thomas Kurtz, set out to rectify this confused situation. With associates, they set up their own company called True BASIC Inc. and brought out a version of BASIC for microcomputers that conforms to the standard proposed by the American National Standards Institute's subcommittee X3J2. Called True BASIC, this version is a major departure from previous microcomputer BASICs. Michael Vose, a BYTE senior technical editor, shows you exactly how, where, and why to look for a fresh approach from True BASIC.

Finally, Mark Haas reviews the GTX-100 from Lockheed-GETEX. It's an intelligent dual-speed modem that includes four levels of protection for your computer. Some of the interesting features of this modem have more to do with its intelligence than its security-providing aspects. For example, Mr. Haas points out that the modem's software lets you select the data rate, dial the phone automatically, dial the phone manually, re-dial the last number, and select the desired level of security. This modem has quite a large number of special features—with just one of these being the ways it lets you control access to your computer.

—Glenn Hartwig, *Technical Editor, Reviews*

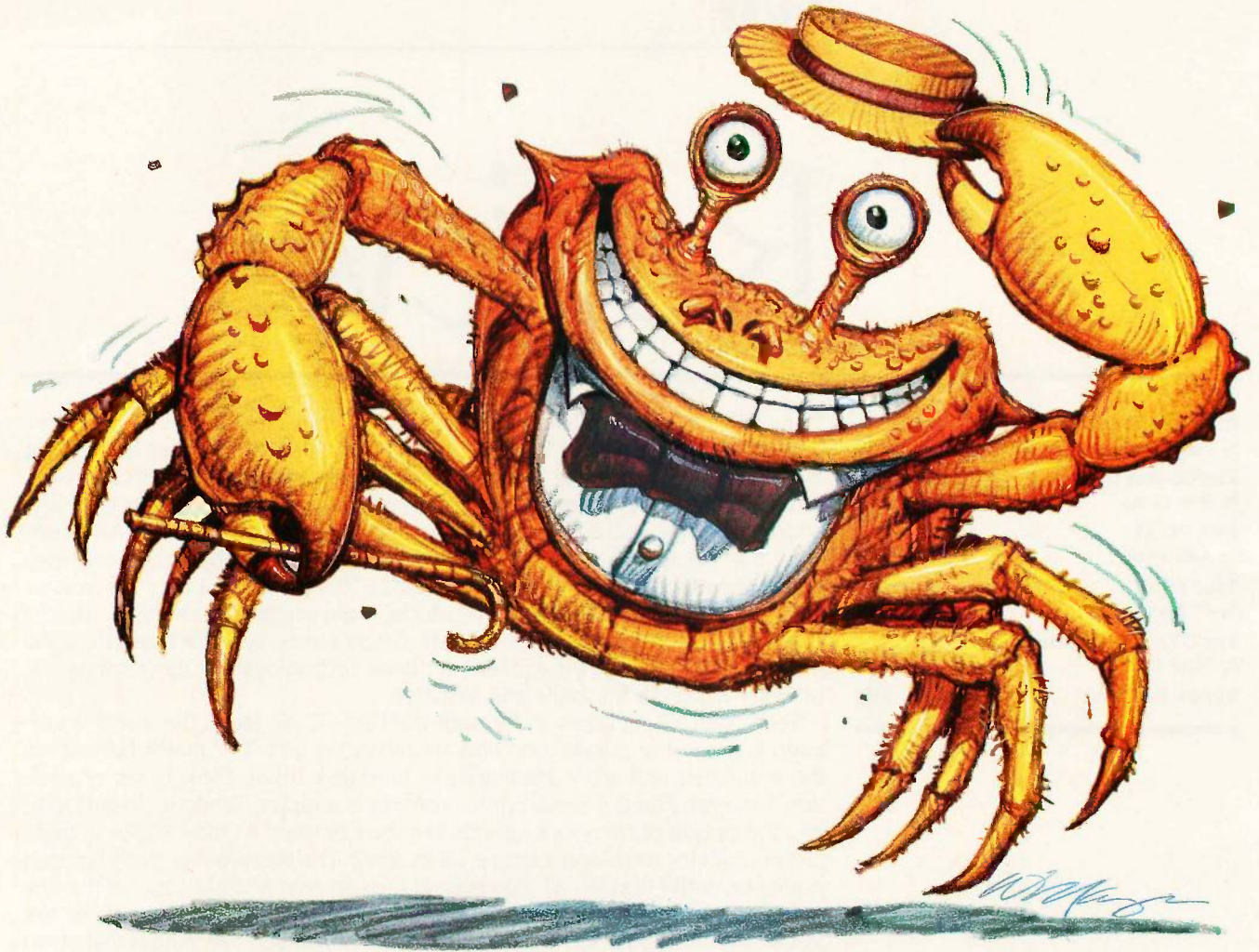

Sometimes the best way to get ahead is to go sideways.

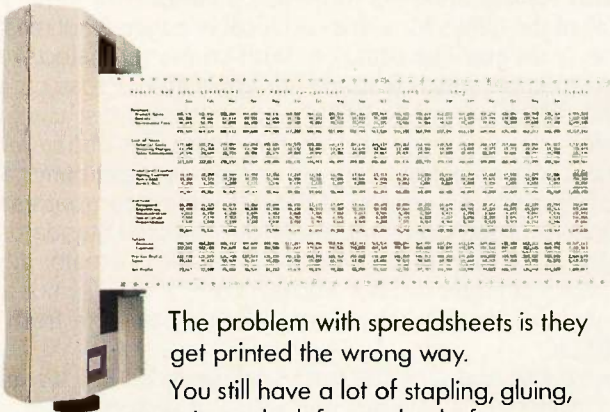

The problem with spreadsheets is they get printed the wrong way.

You still have a lot of stapling, gluing, or taping to look forward to before your printout is readable.

To really get ahead, go Sideways.™

Sideways is the clever software program that prints your spreadsheets—you guessed it—sideways. So your spreadsheet columns need never fall off the edge of your printer paper again.

With Sideways on your side, no spreadsheet you invent with Lotus 1-2-3,® Symphony,™ VisiCalc,® Multiplan,® or SuperCalc™ is too wide! And it's just as powerful an ally when you're creating far-into-the-future schedules and pert charts. So for a presentable printout, get rid of that glue stick and scotch tape—put your best foot forward and go Sideways.

You can go Sideways today with an IBM® PC or an Apple® II, and over a dozen different printers, including Epson,® Okidata, IBM,® Apple,® C. Itoh and Mammesmann Tally. Ask for Sideways at your local Computer-Land,® Entre, or other computer store. Or mail a \$60 check to Funk Software, P.O. Box 1290, Cambridge, MA 02238. Or call 617-497-6339. MC/Visa accepted.

SIDEWAYS™
SIDEWAYS PRINTS SPREADSHEETS SIDEWAYS.

Two portable computers, both previously described in *BYTE*, have now come back for full scrutiny in the Review department. In different ways each has aroused a good deal of speculation. First, the Hewlett-Packard Integral is just so different from a laptop computer that it deserves attention. A UNIX-based system with an electroluminescent screen, built-in printer, 3½-inch disks, a mouse, and a silhouette more like a sewing machine than a briefcase, it gives the definite impression that it is self-consciously incompatible with anything IBM would ever dream of producing.

All well and good. You really do get points for independence of spirit—but it still has to work.

So far, trying to use the Integral has resulted in a curious blend of appreciation and irritation. It doesn't come with much in the way of bundled software for things like word processing or communications. On the other hand, it hadn't been here a week before we got a copy of Multiplan designed especially for it. Hewlett-Packard apparently intends to support the Integral with its own considerable resources. Watching this one develop ought to be interesting. A full review is in the works and will probably be printed here in the near future.

Going almost entirely the other way from the Hewlett-Packard Integral is the Data General/One, first featured in *BYTE* as a product description last November (see page 102). In case you missed it, this one arrived amid great expectations. It's touted as having a high degree of compatibility with IBM's Personal Computer (PC), especially when used with the 5¼-inch external disk drives. And people I know have been very impressed with its capabilities.

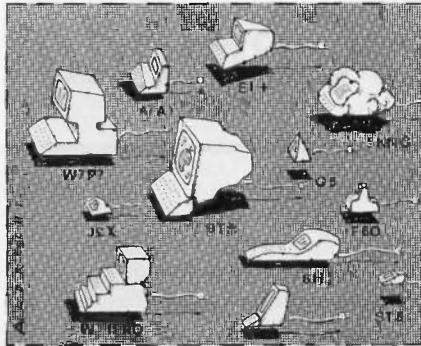

The main source of discontent, both in the *BYTE* preview and elsewhere, has been the poor quality of the screen design. LCD (liquid-crystal display) screens suffer from lack of definition to begin with. When one is also saddled with a fixed viewing angle, the problem of seeing what you're writing goes beyond a reasonable level. Attempting to respond to criticism, Data General brought out what it hopes will be a better screen and is said to be retrofitting (for \$350) all those sold. Our review unit is equipped with one of these newly designed screens; the upcoming review ought to show how well the company has succeeded in answering its critics.

Aside from that, the DG/One, as I said, generally has been met with warm words for its high degree of compatibility with most IBM PC-oriented software. Whether this is enough to endear it to a reviewer remains to be seen.

Perhaps more intriguing than what our reviewers think of these machines is the question of which one is more representative of what the user expects from a true portable computer. Is the portable's major function that of a drone for a desktop unit—and thus useful only if compatibility is very high? Or is the user of a small portable looking for something different enough from a desktop unit that questions of compatibility are irrelevant? These questions really go beyond the scope of reviews, but they do set the stage on which these machines will be more broadly judged.

Another subject for upcoming review is a very curious printer/plotter/typewriter combination from Panasonic. Instead of a dot-matrix or daisy-wheel-type print head, this unit comes equipped with four colored pens. By moving the print head/pen-holder back and forth while the platen moves the paper up and down, the unit draws each character—a typewriter that actually writes. Besides writing text, it draws an assortment of graphs and connects serially to a computer. It has direct, line-by-line, and block printing modes; a full-line preview window to show your text before you commit it to paper; a 4K-byte memory; word-search capability; two switch-selectable keyboards plus an extended character set; and the ability to print wide characters, tall characters, italics, underlining, and top-to-bottom or bottom-to-top vertical lines. At about five pounds and about \$350, this one made a lot of friends right out of the box.

An editor's note about an IBM PC-compatible operating-system patch for the NEC APC III appeared with John Unger's review in March (see page 338) and has generated a lot of interest. Just to keep you updated, we're still running tests and have found that it works in some cases—and in some it doesn't.

We'll be running the code as part of a feature article in an upcoming issue. You'll undoubtedly run across programs that we either don't have or haven't yet had the time to test. Either way, when the time comes, let us know how you make out. This approach may also work with other close-but-no-cigar compatibles. We'd like to hear about any experiments you make with those as well.

—Glenn Hartwig, Technical Editor, Reviews

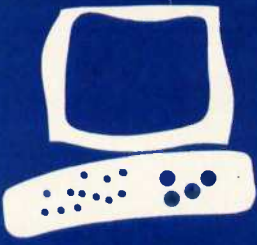

The Compaq Deskpro

A faster
processor
and an
optional tape
backup
system

BY JERRY GRADY

How is Compaq Computer Corporation of Houston, Texas, establishing itself as more than just another IBM PC-clone company? By introducing a desktop that is yet another IBM PC work-alike, plus a little extra.

The new desktop is called the Deskpro (see photo 1), and it comes in four new versions that are labeled models 1, 2, 3, and 4. The little extra is an Intel 8086 processor with dual clock speeds on all models and a tape-cartridge backup system on the Model 4. A status light to the left of the disk drives indicates the operating speed: red if you are in PC-compatible common mode (4.77 MHz) and green if the processor is in "fast" mode (7.14 MHz). The switchable clock speed lets the Deskpro maintain what Compaq calls 99.9 percent IBM PC compatibility while providing the option of better performance. The availability of a 10-megabyte tape cartridge to back up the hard disk fills the need for a fast, economical, hard-disk backup system.

HARDWARE

All models in the Deskpro line are configured from the same basic unit, the Model 1. This is an important point for users who want to build their systems gradually.

Compaq considers the Deskpro Model 1 its smallest business system. The machine has 128K bytes of RAM (random-access read/write memory), one half-height 5¼-inch disk drive (360K-byte capacity), a parallel printer interface, the Compaq dual-mode monochrome-text/color-graphics display adapter board, and six IBM PC-compatible expansion slots. It has a current list price—without a monitor—of about \$2240. The monitor sells for \$255.

The Deskpro Model 2 is the system that Compaq expects to be most popular. This computer is similar to the Model 1 except that it has 256K bytes of memory and two floppy-disk drives. Weighing in at a little over 30 pounds, the Model 2 system unit is heavier than the IBM PC. This might be

due to its steel casing and heftier power supply. With a monitor, it lists for \$2995.

The Model 3 is the IBM PC XT work-alike with its 10-megabyte hard-disk drive. The Model 3 also has 256K bytes of RAM, one floppy-disk drive, an on-board parallel printer interface, a hard-disk controller capable of supporting the tape cartridge, a half-size card with a serial port and clock, and four IBM PC- or XT-compatible expansion slots. With a monitor, it costs \$4995.

Finally, the top-of-the-line Model 4 includes everything the Model 3 has plus a 10-megabyte tape-cartridge drive for hard-disk backup and the maximum of 640K bytes of RAM on the motherboard. It sells for \$7195 with a monitor. See "The Deskpro Model 4" text box on page 264.

As options, Compaq offers a 12-inch, high-resolution, amber- or green-phosphor monitor; a tilt/swivel mount for the monitor (\$50); an option labeled the Desk-Saver, a small platform that raises the base unit off the work surface for enough clearance to store the keyboard; 128K-byte and 512K-byte memory upgrades; and a second disk drive for Models 1, 3, and 4.

MS-DOS 2.11 for the Compaq is not included with any model; it costs an additional \$60. This customized version of MS-DOS recognizes the Deskpro's dual processor speed and battery-operated clock (if present) at boot time. BYTE's standard configuration of a monitor, two floppy-disk drives, 256K bytes, serial port, parallel port, MS-DOS, and BASIC costs \$3205.

MONITOR

If you purchase the optional Compaq monitor, you can choose a green or amber display. The monitor is a 12-inch version of the Compaq Portable Computer's 9-inch display. The character display is sharp and the display contrast is good due to the monitor's etched screen. A single knob on the left adjusts brightness and contrast.

The monitor's case is angled at 10 degrees, so the display is at a comfortable

Jerry Grady (10911 East Mercer Lane, Scottsdale, AZ 85259) is the president and owner of The Grady Works, a company that specializes in microcomputer systems consulting and services. He has a BS. in computer science from Northern Arizona University and an M.S. in the same field from the University of Arizona.

viewing angle if it is resting on the system unit. The casing is plastic and about the same size as the IBM monochrome monitor.

Two cables connect the display to the system unit. The power cable uses an unusual three-pin DIN circular connector, not the usual three-prong AC-style connector. Perhaps this is to ensure that you will not plug a Compaq monitor into your IBM PC. The second cable is a nine-pin connector that plugs into the RGB (red-green-blue) connector of the system unit's display card. Like the Compaq Portable and unlike the IBM PC, the Deskpro display adapter can display shades of green or amber on a monochrome display as well as colors on an RGB display (see photo 2).

Another good feature taken from the Compaq Portable is the Deskpro's two display modes. The monochrome-text mode is very similar to the IBM monochrome monitor. It can display high-resolution text and graphics characters, but not colors or bit-mapped graphics. You can display this mode only on the Compaq monochrome monitor. You can display the color-graphics mode on any IBM PC-compatible RGB monitor, as well as on the Compaq monochrome monitor. This mode displays up to 16 colors or shades of green or amber and bit-mapped graphics.

Both modes use character sets almost the same as the IBM's equivalent character sets, including the graphics characters (see photo 3). The high-resolution monochrome character set occupies a 9- by 14-dot matrix. Most characters occupy an 8- by 12-dot area inside this matrix; the exceptions are special and graphics characters.

The color-graphics character set is much coarser but matches the IBM PC color-graphics set. Each character occupies a 7- by 7-dot area inside an 8- by 8-dot matrix.

It is easy to switch modes on the Deskpro. As with the Compaq Portable, you can toggle the display mode to color-graphics mode from the keyboard by pressing the Ctrl, Alt, and < keys simultaneously. To

return to the monochrome mode, press Ctrl-Alt->. In color-graphics mode, you can use high-resolution graphics (640 by 200 pixels by two colors) or medium-resolution graphics (320 by 200 pixels by four colors), just as you can with the IBM PC.

In addition, the display-adapter card has an output for a composite monitor and an RF (radio frequency) modulator to attach to your color television. I connected a short stereo patch cord from the RCA jack on the display adapter to my television and was rewarded with color graphics, though the actual display left something to be desired.

KEYBOARD

The keyboard, which is enclosed in plastic, is extremely light: 2½ pounds. This is nice

(continued)



Photo 1: The Compaq Deskpro Model 4 with 10-megabyte hard-disk drive, 10-megabyte tape-cartridge system, optional second floppy-disk drive, and optional 12-inch green monitor. Note the clock-speed indicator light and keyboard plug to the left of the disk drives.

if you like to position the keyboard in your lap, especially since the keyboard's six-foot coiled cord plugs into the unit's front. But for those who prefer a more solid feel to the key-

board, this lightweight device can be disconcerting. Also, the Deskpro keyboard lacks crispness. I find it mushy and hard to use. It seems I must press harder to make the keys register.

The Deskpro system speaker emits a small click when you press a key. You control the volume of this click by pressing the Ctrl, Alt, and gray minus key to lower the volume and the Ctrl, Alt, and gray plus key to raise it.

The keyboard has a 16-character buffer that causes a beeping from the speaker when it is full. Unlike the other clear sounds that issue from the speaker, this beep sounds as though the speaker is cracked. This is caused by the keyboard click competing with the buffer overflow warning, each at different frequencies.

This keyboard, manufactured by Advanced Input Devices, complies with the IBM PC's nonstandard standard keyboard layout (see photo 4). The 10 function keys to the left, the numeric keypad to the right, and the undersize Enter and Shift keys all say clone. About the only noticeable visual difference is the LED (light-emitting diode) indicators on the Num Lock and Caps Lock keys. Unfortunately, these indicators do not always reflect the state of the computer. Occasionally I noticed that the Caps Lock LED was lit to indicate uppercase mode, but the input was in lowercase. After some investigation, I discovered that if you press the Shift and Caps Lock keys simultaneously, this reverses the current state of the indicator light.



Photo 2: A display of the graphics capability of the color-graphics mode on the Compaq Deskpro. Shown is the display from Microsoft's Flight Simulator.



Photo 3: A display of the high-resolution, monochrome-text-mode character set on the Compaq Deskpro.

PROCESSOR AND MEMORY

At the heart of the Deskpro is the Intel 8086 microprocessor. The processor has a top clock speed of 7.14 MHz, but to maintain compatibility with its portable systems and the IBM PC, Compaq built a switchable clock speed into this system. Pressing the Ctrl, Alt, and \ keys toggles the Deskpro between common mode (4.77 MHz) and fast mode (7.14 MHz).

To emulate the IBM PC 8088 microprocessor, the 8086 must be slowed down to the IBM's 4.77-MHz clock speed. Not only is the 8088 clock speed slower, but its internal instruction cache is smaller. This instruction cache is a series of internal registers on the 8088 and 8086 processor chips that hold a queue of instructions retrieved from memory. On the

8088, the length of this queue is four instructions; the 8086 can hold six instructions. To make the 8086 match the performance of the 8088, Compaq had to slow the clock rate and buffer the instructions so the 8086 did not exceed the four-instruction cache.

The 8086 is a true 16-bit processor with 16 address lines and 16 data lines (as compared to the 8088's 8 data lines). This means that data is retrieved from memory 2 bytes at a time and that memory upgrades must be performed in 16-bit-wide banks. With 64K-bit chips, this means you must add 128K bytes or 512K bytes (with 256K-bit chips) at a time on the motherboard.

The Deskpro Model 1 has a standard 128K bytes of RAM in two rows of nine chips soldered on the motherboard (in each row, eight of the chips hold the data and the ninth chip is for parity check). Models 2 and 3 add 18 more 64K-bit chips into sockets to give 256K bytes as standard. The Deskpro Model 4 comes standard with 640K bytes of memory on the motherboard. To accomplish this, Compaq fills the two rows of sockets (18 sockets) with 256K-bit chips. All the models can be upgraded to 640K bytes on the motherboard. On the Model 1, this means installing the 18 256K-bit chips in the open sockets. On Models 2 and 3, you must remove 128K bytes of 64K-bit chips, then install 512K bytes of the 256K-bit chips. This arrangement means you can have only 128K, 256K, or 640K bytes of RAM on the motherboard—nothing in between.

As an option, you can install a 7.14-MHz 8087 math coprocessor in the socket on the motherboard. This chip is more expensive than its 4.77-MHz counterpart. Since this chip was not available at the time of this review, I could not test whether the switchable clock rate also works with the 8087.

POWER SUPPLY AND EXPANSION SLOTS

The Deskpro offers a large 200-watt power supply. This is probably sufficient to handle about any expansion

board (or combination thereof) added to the computer. The fan is quiet, more so than that on the IBM PC or Compaq Portable.

The Deskpro has eight expansion slots on the motherboard, although either two or four of them might already be occupied. Compaq has engineered the data bus to let you add third-party memory-expansion boards but warns that these might decrease the Deskpro's performance by slowing the memory accesses. Memory accesses on the motherboard are done 16 bits at a time, but to ensure that all optional expansion boards compatible with the IBM PC (and the Compaq Portable) will work, access to the expansion slots is done 8 bits at a time.

On all four models, a floppy-disk controller card occupies slot 7. This controller also provides the electronics for the parallel printer interface. Slot 5 is occupied by the monochrome-text/color-graphics video-display board.

On Models 3 and 4, the hard-disk controller board occupies slot 6. This controller also supports Compaq's tape cartridge. Slot 8 holds the short board that contains the serial port and clock. This board contains a battery to power the clock when main power is off; the battery recharges when the power is on. This is a nice convenience for anyone who has ever had to change the battery on a clock board.

The half-height floppy-disk drives in the base unit are manufactured by Mitsubishi. These are double-sided double-density drives capable of handling both single-sided and double-sided disks. Formatted capacities of disks are 160K, 320K, or 360K bytes. The operation of the drives is smooth and quiet. In fact, except for the rasping of the disk in its plastic jacket, there is no noise at all. Each floppy-disk drive occupies one of four identical half-height compartments in the chassis, so you can reposition the drives to fit your personal preference.

SOFTWARE

Compaq offers the MS-DOS 2.11 operating system, but it is not included in the unit's cost. Compaq has matched IBM's PC-DOS with all the Microsoft utilities or lack thereof. The major command processor (COMMAND.COM) has been modified to recognize some of the special Deskpro hardware. The dual-speed processor is recognized upon booting and the clock rate is set to fast mode. If the Compaq asynchronous communications/clock board (or any other clock using the National Semiconductor MM58167A chip) is present, the time and date are automatically read and the clock is set. Setting the time or date with the TIME and DATE MS-DOS commands resets the stored time or date value for use the next time you boot the Deskpro.

(continued)



Photo 4: The Compaq Deskpro keyboard. Note the LED indicators on the Caps Lock and Num Lock keys.

THE DESKPRO MODEL 4

BY RICH MALLOY

The Compaq Deskpro Model 2, with its two floppy-disk drives, fast processor, and dual-mode display, represents an impressive value in desktop systems. But the real power of the Deskpro series is embodied in the top-of-the-line Model 4, with its 10-megabyte hard-disk drive, 10-megabyte tape-cartridge backup system, and 640K bytes of memory. At BYTE I had a chance to use one of these systems. In fact, it even had an optional second floppy-disk drive, which gave me a large array of storage options.

The Model 4's most noteworthy feature is its tape-cartridge backup system. As of this writing, Compaq is still the only major microcomputer manufacturer that I know of to offer such a device. Admittedly, a tape backup system is not high on everyone's shopping list. But after a hard disk suddenly loses about nine months of data (an event that is not highly unlikely), the extra \$1000 for a tape backup system

seems less of an extravagance.

The Model 4 works quite well. Table A compares the Deskpro hard-disk drive with that of the IBM PC XT. The tape seems slow by disk standards, but usable. It took about 7 minutes to back up the 4.6 megabytes of data we had on our hard disk. A full 10 megabytes should take about 20 minutes.

Unfortunately, you cannot use the tape drive as an extra disk drive. Nor can you back up selected individual files. (These features are advertised by some third-party tape-drive manufacturers.)

Another nice feature of the Deskpro Model 4 is its ability to accommodate a second floppy-disk drive. This makes it easy to copy floppies and to run copy-protected programs.

Although somewhat expensive, the Model 4 is a good alternative to the IBM PC XT and AT. It might be even better with its recently announced 30-megabyte hard-disk drive (\$2995).

Table A: A comparison of the hard-disk drive performance of the Compaq Deskpro Model 4 with that of the IBM PC XT. The Deskpro's 8086 processor was tested in both fast (7.14 MHz) and common mode (4.77 MHz). The Deskpro used MS-DOS 2.11; the IBM PC XT, PC-DOS 2.0.

Hard-Disk Benchmark Test	Times (seconds)		IBM PC XT
	Compaq Deskpro 7.14 MHz	4.77 MHz	
BASIC			
Hard-Disk Write	19.0	33.8	43
Hard-Disk Read	16.4	29.4	28
System Utilities			
40K File Copy	2.4	2.6	2.8
Spreadsheet			
Load	2.1	3.5	3.8

With the purchase of Deskpro, Compaq supplies a hardware diagnostics test disk with a single program, TEST.EXE. This set of diagnostics is complete, testing everything from the keyboard through memory and mass-storage devices. The diagnostics will

even test a light pen and other third-party options. Unfortunately, you cannot run the diagnostics without purchasing MS-DOS.

Other than the demonstration programs, the only difference in the MS-DOS software is the BASICA inter-

preter. Unlike IBM, Compaq puts all the BASICA code in RAM. This interpreter lacks no IBM BASICA features and actually gives you about 1000 bytes of extra memory space for your programs. I have seen Compaq's BASICA interpreter used on other manufacturers' PC-compatibles when their own interpreters didn't live up to the required PC compatibility.

DOCUMENTATION

The Deskpro comes with a thick, spiral-bound operations guide and a pocket-size quick-reference guide. The contents of the operations guide are organized and clear. The information covers installing and setting up, installing options, running diagnostics, and programming in BASIC.

The only typographical error I noticed in the operations guide is the diagram for the switch settings for memory size on the motherboard. Two of the three displayed settings for switches 3 and 4 do not correspond to the table on the previous page.

The operations guide indicates that a flat-bladed screwdriver or Phillips screwdriver will be the only tools required for installing internal options. This is not true because Compaq uses Torx head screws. These require a special screwdriver with a star-shaped end.

In addition to the operations guide, each piece of hardware has its own installation guide. The installation guides are a nice touch but are awkward because you cannot insert them into the operations guide's binder.

The MS-DOS and BASIC manuals are definitely for reference and not intended to teach you how to use MS-DOS or how to program in BASIC. Though fairly complete, the MS-DOS reference manual is missing the appendix on DOS function calls.

COMPATIBILITY

The name of the game for Compaq is IBM PC compatibility. With the Deskpro, Compaq has maintained the high level of compatibility demonstrated with its Portable Computer.

The Deskpro will read and write all

(continued)

AT A GLANCE

Name

Compaq Deskpro, Models 1, 2, 3, and 4

Manufacturer

Compaq Computer Corp.
12330 Perry Rd.
Houston, TX 77070
(713) 370-7040

Size

System unit: 5 by 19 by 16 inches; 40 pounds for a Model 4

Components

Processor: 8086, 4.77 MHz or 7.14 MHz (switchable)

Memory: 128K, 256K, or 640K bytes

Display: Dual-mode display adapter, monochrome-text/graphics (switchable); IBM PC-compatible in both modes
Keyboard: IBM PC-compatible 83-key layout, two LED indicators

Mass storage: Model 1: One or two 360K-byte, double-sided, half-height, 5¼-inch, floppy-disk drives

Interfaces: Parallel printer
Expansion: Four to six IBM PC-compatible expansion slots

Optional Hardware

128K bytes RAM	\$170
512K bytes RAM	\$1295
Monochrome display	\$255
8087 coprocessor	\$375
Floppy-disk drive	\$430
10-megabyte hard-disk drive	\$2280
10-megabyte tape-cartridge backup	\$1075
30-megabyte hard-disk drive	\$2995
Serial port/clock board	\$150

Optional Software

MS-DOS 2.11/BASIC 2	\$60
---------------------	------

Documentation

Operations guide

Price (standard configuration with monitor)

Model 1	\$2495
Model 2	\$2995
Model 3	\$4995
Model 4	\$7195

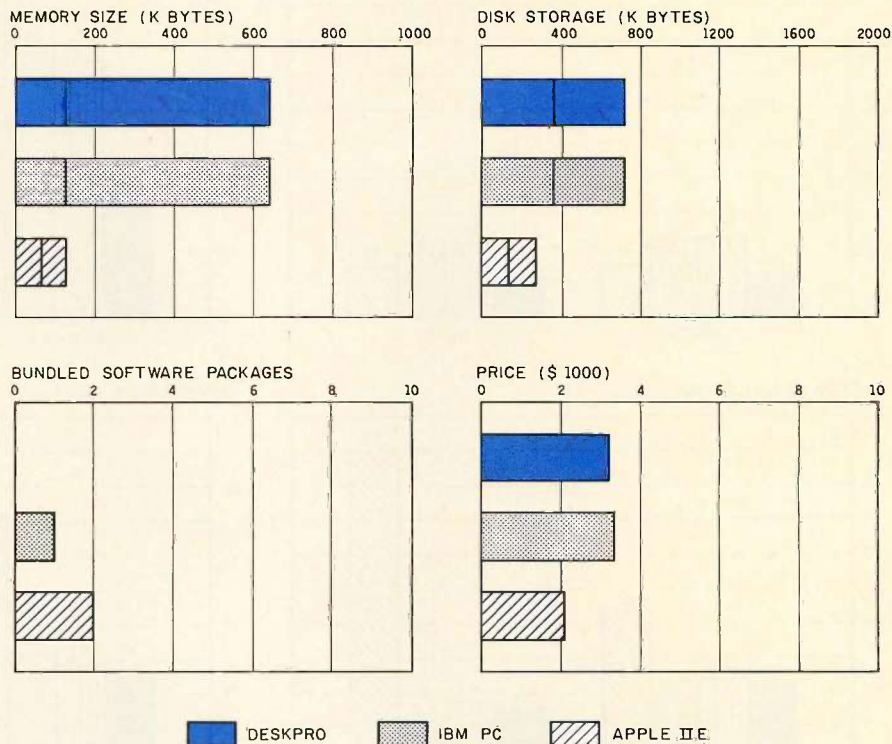

The Memory Size graph shows the standard and optional memory available for the computers under comparison. The Disk Storage graph shows the highest capacity of one and two floppy-disk drives for each system. The Deskpro can also support a 10- or 30-megabyte hard-disk drive. The Bundled Software Packages graph shows the number of software

packages included with each system. The Price graph shows the list price of a system with two disk drives, a monochrome monitor, a printer port and a serial port, 256K bytes of memory (64K bytes for 8-bit systems), the standard operating systems for the computers under comparison, and the standard BASIC interpreter for each system.

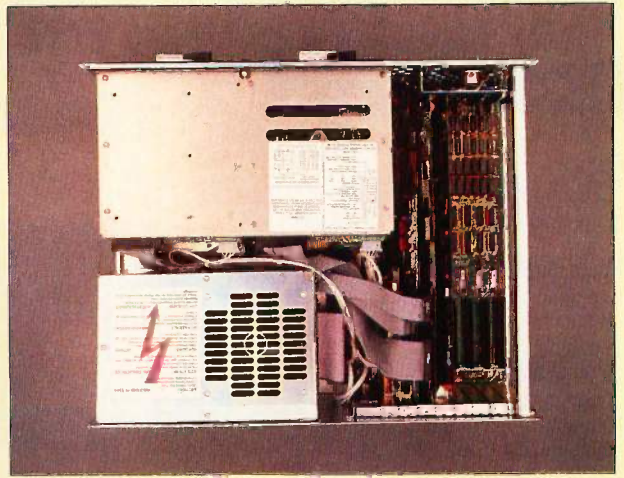
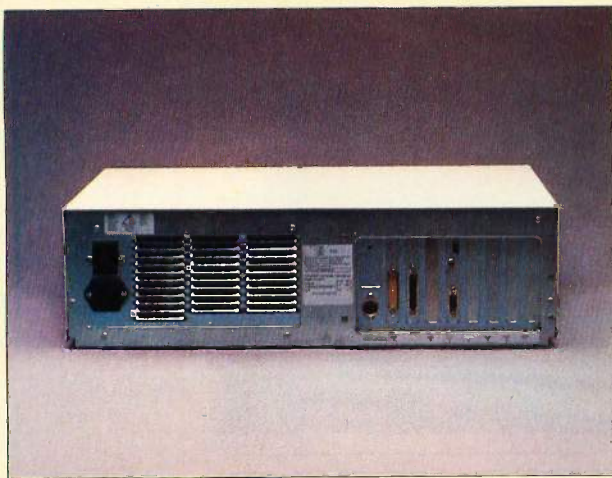

Compaq Deskpro with the serial/clock card in slot 1, the floppy-disk-controller/parallel-printer interface in slot 2, and the dual-mode display adapter in slot 4.

Inside the Compaq Deskpro Model 4 with 640K bytes of RAM installed.

DISK ACCESS IN BASIC (SEC)

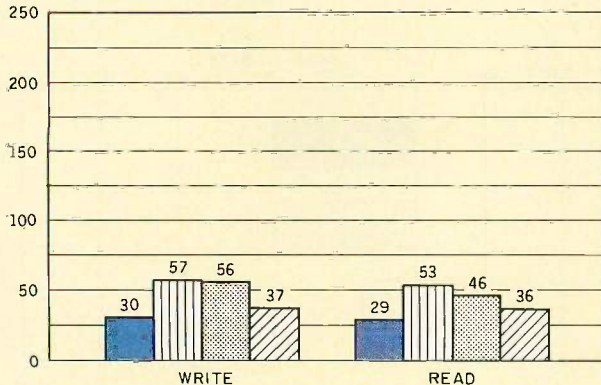

BASIC PERFORMANCE (SEC)

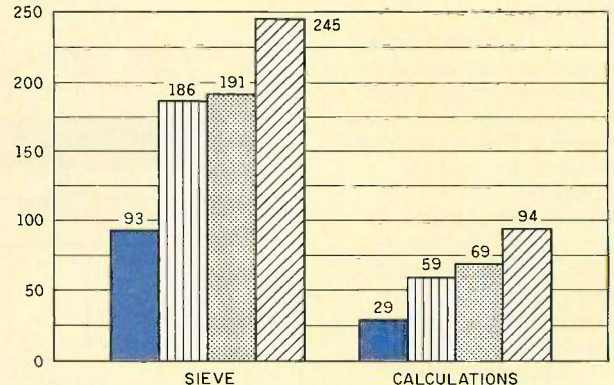

SYSTEM UTILITIES (SEC)

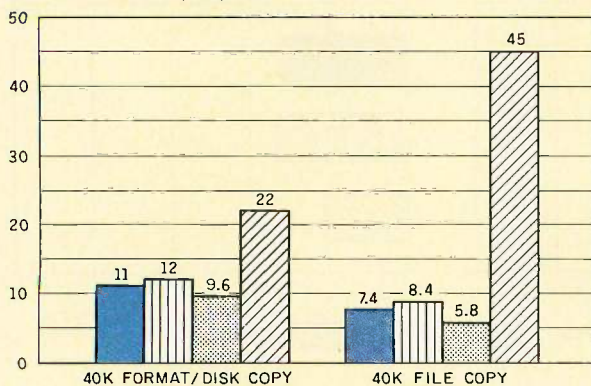

SPREADSHEET (SEC)

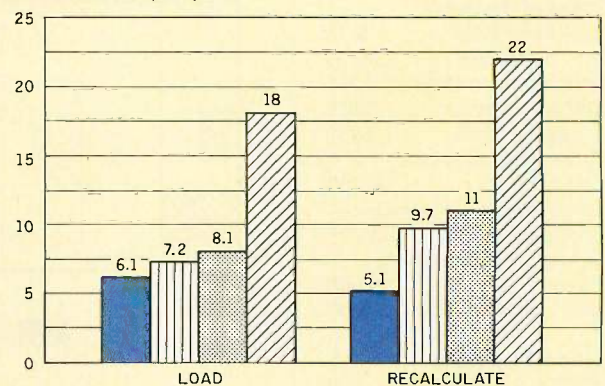

DESKPRO (7.14MHz)
 DESKPRO (4.77MHz)
 IBM PC
 APPLE II E

The graphs for Disk Access in BASIC show how long it takes to write and to read a 64K-byte sequential text file to a blank formatted floppy disk. (For the program listings, see "The Chameleon Plus" by Rich Krajewski, June 1984 BYTE, page 327, and October 1984, page 33.) The Sieve columns in the BASIC Performance graph show how long it takes to run one iteration of the Sieve of Eratosthenes prime-number benchmark. The Calculations column shows how long it takes to do 10,000 multiplication and 10,000 division operations using single-precision numbers. The System Utilities graph shows how

long it takes to format and to copy a disk (adjusted time for 40K bytes of disk data) and to copy a 40K-byte file using the system utility programs. The Spreadsheet graph shows how long it takes to load and recalculate a 25- by 25-cell spreadsheet where each cell equals 1.001 times the cell to its left. Microsoft Multiplan was the spreadsheet used. The tests for the Deskpro used MS-DOS 2.11 and BASIC 2.10. Tests for the Apple IIe were done with the ProDOS operating system except for the spreadsheet test, which was done with DOS 3.3. The IBM PC was tested running under PC-DOS 2.0.

levels of IBM PC disks, except the new AT 1200K-byte disks. The hardware options I tried, including memory-expansion and multifunction boards, all work properly in common mode. Almost all of them work in fast mode. The Iomega Bernoulli Box (10-mega-byte disk-cartridge system) works well in common mode, but it will generate occasional read or write errors in fast mode. This is due to the use of software loops in the device handler. The problem has been corrected in the latest version of Iomega's device handler.

Software compatibility is equally high. None of the software packages I tested show any operational deficiencies. Turbo Pascal, WordStar, dBASE II and III, Microsoft's Flight Simulator, and Microsoft's compilers for C and Pascal all work without modification. WordStar and Turbo Pascal perform much better in the fast mode because of the faster screen refresh and memory access. dBASE II and III show marginal improvement due to the disk-intensive nature of their operation.

Comparing the Deskpro's benchmark results with the IBM PC shows a somewhat better performance by the Deskpro (see the "At a Glance" box). Hard-disk input and output for the Deskpro is appreciably faster, while the floppy disk is usually slightly slower. For pure calculation speed, the Deskpro is faster than the IBM PC in common mode as well as in high-speed mode due to the 16-bit memory accesses that the Deskpro performs. When combined with other processing (memory access, instruction fetching), the Deskpro is not quite twice as fast as the IBM PC.

In WordStar (see table 1) or Multiplan, the display screen repaints about twice as fast in the high-speed mode. Overall the Deskpro common mode is compatible with the IBM PC, while fast mode averages an improvement of about 90 percent.

LIMITATIONS

The Deskpro's limitations are few and relatively minor in comparison to its features. Aside from those already

Table 1: A comparison of the Compaq Deskpro with the IBM PC and the Apple IIe using WordStar and dBASE II. The word-processing tests involved a 4000-word document (21K bytes). The Load and Save tests measure how long it takes to load and then save the document. The Search and Scroll tests measure, respectively, how long it takes to find the last word in the document and to scroll through the document line by line as fast as possible. The database tests measure how long it takes to sort a 2000-record data file (200K bytes) and to retrieve the last record using a nonindexed data field. These tests used an IBM PC with PC-DOS 2.0, 512K bytes of memory, a monochrome display, WordStar 3.3, dBASE II, and an Apple IIe with Microsoft's Softcard and WordStar 3.3. The Deskpro tests used a Deskpro Model 2 with MS-DOS 2.11 and WordStar 3.3.

Test	Compaq Deskpro		IBM	Apple IIe
	7.14 MHz	4.77 MHz		
Word Processing				
Document Load	5.8	6.7	9.9	10.3
Document Save	17.9	18.7	24.2	32.3
Search	6.9	8.8	10.5	6.6
Scroll	7.7	10.6	41.2	46.4
Database				
Sort	702	798	765	N/A
Record Access	44.2	44.2	43	N/A

mentioned, the only problem I found is with a chassis brace on the inside of the Deskpro chassis. This brace is directly above slot 1 and interferes with insertion or removal of any option board.

The Deskpro is also priced somewhat high in comparison to its competitors. The Deskpro Model 2 with two disk drives and 256K bytes of memory can cost several hundred dollars more than a comparably equipped IBM PC. Although the Deskpro is being sold by over 500 retail outlets, it is just becoming available through discount houses, so it is often costly in comparison to discounted compatibles.

Although the 8086's faster processing in high-speed mode is nice, it only slightly improves the performance of any system limited by floppy-disk accesses.

One reason for the IBM PC's success (and the birth of the Compaq Portable) was the availability of the IBM PC's technical reference manual. Compaq does not produce a comparable document for the general public. Because of the internal differences between the Deskpro and the IBM PC,

Compaq should make its own technical reference manual available.

SUMMARY

Service for the Deskpro is provided by the retail outlets where you purchase the computer or by any authorized Compaq dealer. The Compaq service program is similar to the IBM program for training technicians of the authorized dealers. Compaq does not use a third-party maintenance organization for service.

Anyone who heavily uses spreadsheets, word processors, or monochrome graphics should buy the Deskpro. The improved performance of the 8086 in fast mode can increase your productivity if you use a spreadsheet for numerous calculations. It also improves the throughput of word processors and other applications that display a lot of text. Compaq's dual-mode display adapter lets you use applications requiring graphics without additional hardware or cost.

Would I buy the Compaq Deskpro? Yes, I would and did. And I recommend the Deskpro to others. It is a well-engineered and well-manufactured product. ■

SOLID CITIZENS.



Presenting four fine, upstanding Citizens who'll give you service and value above and beyond the call of duty for many years to come. Citizen™ dot matrix printers, precision-engineered by the people who've become a wristhold word in fine, precision-engineered watches.

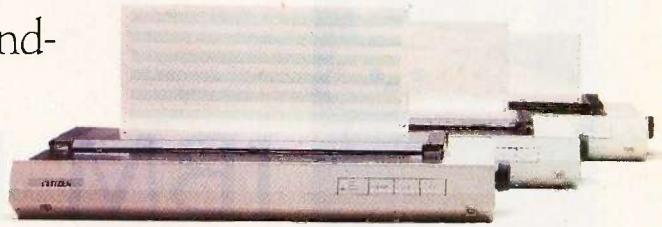

The Citizens are very sleek, very quiet, and reliable as the day is long. They're also exceptionally easy to use, thanks to a unique new push-feed paper loading system. What's more, the Citizens are very versatile. They're IBM® and Epson®-compatible. Can print graphics.

And give you output speeds of 160 cps (40 cps correspondence-quality) or a blazing 200 cps (50 cps correspondence-quality).

The Citizen MSP-10 and 15, and MSP-20 and 25. Precision-engineered printers at a price precision-engineered to put a smile on your face.

Stop by one of our dealers today and watch what the Citizens can do for you.

For more information, call 1-800-556-1234, Ext. 34. In California, 1-800-441-2345, Ext. 34. Or write Citizen America Corporation, 2425 Colorado Avenue, Santa Monica, CA 90404.



© 1984 Citizen America Corporation

Citizen and the Citizen logo are trademarks of Citizen America Corporation. IBM is a registered trademark of International Business Machines Corporation. Epson is a registered trademark of Epson Corporation.

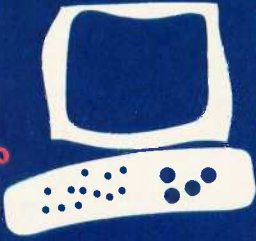

IBM PC AT

The PC gets down to business

BY ALAN FINGER

The IBM PC AT comes in two basic configurations. The basic model (\$3995) comes with 256K bytes of RAM (random-access read/write memory), one of IBM's new high-capacity 1.2-megabyte disk drives, and a combination floppy-disk/hard-disk controller card. Available for an additional \$1800, the enhanced model adds 256K bytes of memory, a 20-megabyte hard-disk drive, and a serial/parallel interface adapter (see photo 1). Both systems are based on Intel's 80286 processor and have eight I/O (input/output) expansion slots and a battery-backed clock/calendar.

The AT comes with IBM's usual voluminous documentation. It includes a setup guide, an operations guide, and a BASIC manual, all in IBM's standard boxed loose-leaf format. An unwelcome addition is a variety of small pamphlets packed in each box. While these are intended to be helpful quick guides, they are easy to misplace and might confuse as much as inform.

By the way, the BASIC manual is now complete. You don't have to send in a coupon and replace pages to get up-to-date documentation.

POWER SUPPLY AND KEYBOARD

The power supply is 190 watts, as opposed to the 63 watts in the PC and 130 watts in the XT. This much power is needed. The PC is underpowered, causing many users to have hard-to-trace problems when adding to their systems. The XT's supply is much better but would be inadequate for the AT's two hard-disk drives. Since what goes in as electricity always comes out as heat, IBM has incorporated an innovative variable-speed fan that runs faster (and louder) as the internal temperature rises. Since my system was lightly loaded, the noise level never became obtrusive. A notable addition to the AT is a line-voltage select switch that lets it run on European 220-volt power.

The AT's keyboard and interface are more sophisticated than those on the PC and they

are not compatible. You cannot use an AT keyboard on a PC. A single-chip microcomputer on the system board manages the keyboard and related functions. Any PC software that goes directly to the keyboard interface hardware, some key-translation programs, and many games will not work on the AT.

The keyboard layout is similar to that used on an IBM Selectric typewriter (see photo 2). The Shift, Control, Enter, and backspace keys have all been enlarged. Some of the less frequently used keys, such as backslash, grave accent, Print Screen, and Escape, have been moved to peripheral portions of the keyboard.

Three status lights have been added to the Caps Lock, Scroll Lock, and Num Lock keys—this is a welcome feature. The only new key, Sys Req, causes the keyboard-handling software that's in ROM (read-only memory) to generate a software interrupt whenever the key is pressed or released. This lets the user signal the operating system for attention. PC-DOS currently ignores Sys Req.

To go with its international power supply, IBM provides six different versions of the AT's keyboard for foreign languages. The layout and internal scan codes are all identical, but some of the key legends are different to permit use of symbols peculiar to specific languages. The standard display adapters can display these characters, and DOS 3.0 has a set of utilities to adapt itself to the specific keyboard type.

On the output side, the AT uses the standard PC display cards and so is completely compatible. Graphics generation is much faster than it is on the PC.

Much has been said about the inclusion of a key switch that disables the keyboard and locks the cover in place. It seems to me that this feature is of limited usefulness. You would have to secure the entire system and external wiring to prevent someone with malicious intent from interfering with a running program. A program can test the state

Alan Finger is a vice president of Comprehensive Computer Consultants (270 Littleton Rd., Building 14, Westford, MA 01886).

of the keylock and override its function to selectively get input from the keyboard.

THE SYSTEM BOARD

The system board itself is a completely new design. Instead of the 8088 processor found in the PC, Intel's high-performance 80286 provides the horsepower. An empty socket is provided for the companion 80287 numeric coprocessor. The board contains a number of familiar components and many new ones.

At start-up, the 80286 is operating in what is referred to as the "real address mode" and has an architecture identical to that of the 8088 used in the PC and XT. Like the 8088, it uses a segmented addressing scheme to access up to 1 megabyte of memory. It has the same instruction set with a few extensions and incompatibilities (see BYTE's product description "The IBM PC AT," October 1984, page 108).

The most important difference is that the 80286 runs faster; it uses a faster clock (6 MHz versus 4.77 MHz) and has a 16-bit data bus instead of an 8-bit data bus. The bulk of the speed increase, however, comes from internal improvements that let it execute most instructions in about half the number of clock cycles that the 8088 requires. The net effect is a two to three times increase in speed over a PC or XT when running computation-intensive programs.

Things get more interesting when the 80286 enters its "protected address mode." Although it still executes the same basic instruction set, its operation more closely resembles that of a large minicomputer or mainframe and is specifically geared toward multitasking and multiuser applications. (For an introduction to 80286 operation in the protected mode, see "The 80286 Microprocessor" by Paul Wells, November 1984 BYTE, page 231.)

While the 80286 packs quite a wallop in its 68-pin package, it is not the ultimate processor. It is very good at performing certain types of functions, such as cost-

effective virtual memory and fast task switching for real-time applications, but it does have disadvantages. Like the 8088, the 80286's major problem centers around the use of segmentation. Since a segment has a size limit of 64K bytes, dealing with large arrays such as those found in graphics and signal processing becomes cumbersome. For these applications, a processor with a large linear address space, such as Motorola's 68000, is generally more efficient.

Software compatibility is another problem. Programs written for real mode will not usually run in protected mode and vice versa. For applications programs the changes required are small (generally just

(continued)



Photo 1: The IBM PC AT with a 20-megabyte hard-disk drive, 1.2-megabyte floppy-disk drive, and 360K-byte floppy-disk drive.

a recompilation), but you cannot plug your existing software into a protected mode 80286 and expect it to work. System software is more tightly tied to the processor architecture. PC-DOS works only in real mode. Even IBM's own ROM BIOS (basic input/output system) becomes unusable once you enter the protected mode. Microsoft's XENIX is the only announced operating system that claims to use the power of protected-mode operation, but it was not available for the AT at the time of this review.

The AT supports the 80287 numeric coprocessor as a \$375 option. While the changes required are not especially great, the 80287 is not totally software-compatible with the 8087 used in the PC, so programs written to use the 8087 might not work in the AT. As with the 8087, the actual increase in performance you can expect depends on the application.

The system board has room for 512K bytes of parity-checked RAM. The basic AT has 256K bytes, while the enhanced model has 512K bytes. You can get 128K-byte modules that consist of two special 64K-byte RAM packages soldered together in piggy-back fashion; they have Mostek part number MK4128N-15. IBM has never been the least expensive source for PC memory, and expanding the basic model to 512K bytes with IBM RAMs

costs \$495. I called the Mostek local sales office to find out if these parts were available from its distributors. The answer I got was "They used to be, but not anymore."

On the system board are eight full-length I/O slots; these give you more expansion capability than the XT's six full and two short slots. Also, the floppy- and hard-disk functions are combined on one card to free up an additional connector.

Each slot is equipped with the usual 62-pin connector. These connectors carry the same signals as those on a PC, although the timing is not identical. Six of these slots have an additional 36-pin connector intended for AT-specific cards and contain the extended address lines (A20-A23) to let you place up to 16 megabytes of memory in the system. The upper 8 bits of the data bus are here, too. To accommodate existing 8-bit I/O cards, hardware on the system board automatically converts each processor-initiated 16-bit data or I/O transfer to two 8-bit transfers. Any card that can support 16-bit transfers can send a signal back through this connector to disable the translation.

An interesting signal, Master, lets a processor on an I/O card temporarily take control of the system and access any memory or peripheral device. This capability opens up new possi-

bilities for intelligent peripherals and coprocessor cards.

Compatibility with PC I/O cards is good, but not 100 percent. The higher clock rate and timing differences render many cards inoperative in the AT. None of the PC memory-expansion and multifunction boards are likely to work. On the other hand, the AT's added memory and clock features make the boards somewhat superfluous, and new memory boards for expansion above 1 megabyte are available from IBM and other vendors. Table 1 lists which expansion options IBM supports.

A few cards, such as IBM's color-graphics adapter, won't fit in the double-connector slots because they extend below the connector top. These cards must be placed in one of the two available single-connector slots. Since the chassis is higher than the PC's, cards designed for the AT can be about an inch taller.

MASS STORAGE

The AT is the first major personal computer to use the new generation of high-capacity floppy-disk drives. These drives are capable of placing 1.2 megabytes on a special 5¼-inch disk. The data is stored on 160 tracks (80 per side) with fifteen 512K-byte sectors on each track. At 500K bps, the data-transfer rate is twice as great as for a standard disk. Rotation speed is greater too: 360 instead of 300 revolutions per minute.

To get this kind of density, you have to use special "high-coercivity" disks. Because the bits are crammed so closely together, as much as 10,000 per inch, the magnetic field used to write the data tends to spill over onto adjacent bits. The high-coercivity recording media requires a more intense magnetic field to set or "coerce" a bit. It ignores the less intense stray fields and is only affected by the strong field directly under the recording head.

To handle these drives, IBM developed a new disk-adaptor card. They also threw in the standard floppy- and hard-disk controller. Unlike the old

(continued)



Photo 2: Close-up of the IBM PC AT keyboard shows the repositioning of the grave accent, Print Screen, Escape, and backslash keys.

AT A GLANCE

Name

IBM Personal Computer AT

Manufacturer

IBM Corporation
Entry Systems Division
POB 1328
Boca Raton, FL 33432

Processor

Intel 80286

Memory

256K bytes (basic); 512K bytes (enhanced)
Up to 16 megabytes supported by hardware

Display

Uses standard IBM PC display adapters

Keyboard

84 keys, Selectric layout, 10 function keys

Disk Storage

Floppy: standard 360K bytes; high-capacity 1.2 megabytes
Hard disk: 20 megabytes (enhanced system)

Expansion

Eight I/O slots

Software

BASIC in ROM, diagnostic disk, tutorial

Price

Basic system \$3995
Enhanced system \$5795

Software Options

PC-DOS 3.0 operating system \$65
XENIX operating system \$395
XENIX software-development system \$455
XENIX text-formatting system \$145

Documentation

Guide to operations included
Installation and setup included
Technical reference manual \$30
PC-DOS technical reference \$40
Maintenance and service manual \$295

Audience

Business and scientific users

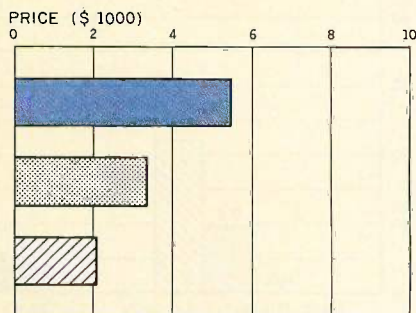
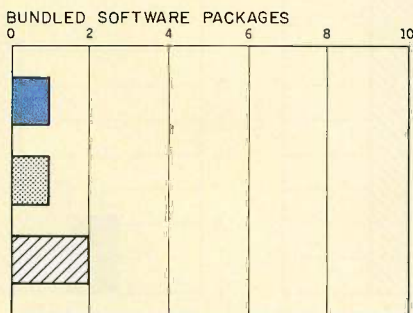
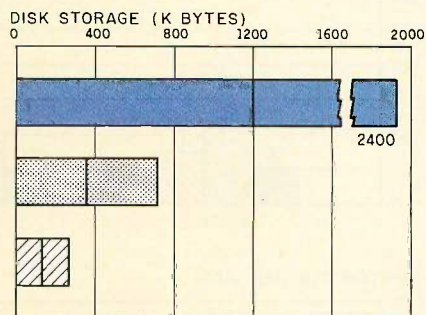
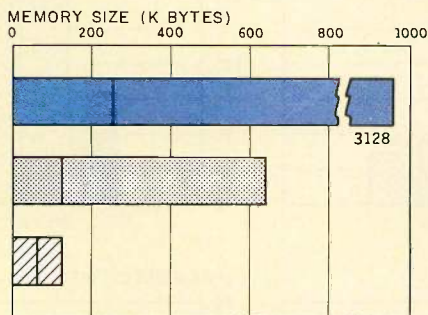

■ IBM PC AT ■ IBM PC ■ APPLE II E

The Memory Size graph shows the standard and optional memory available for the computers under comparison. The Disk Storage graph shows the highest capacity for one and two floppy-disk drives. The Bundled Software Packages graph shows the number of software packages included with each system. The Price

graph shows the list price of a system with two disk drives, a monochrome monitor, a color-display adapter, a printer port and a serial port, 256K bytes of memory (64K bytes for 8-bit systems), the standard operating system for the computers under comparison, and the standard BASIC interpreter.



A rear view of the IBM PC AT.

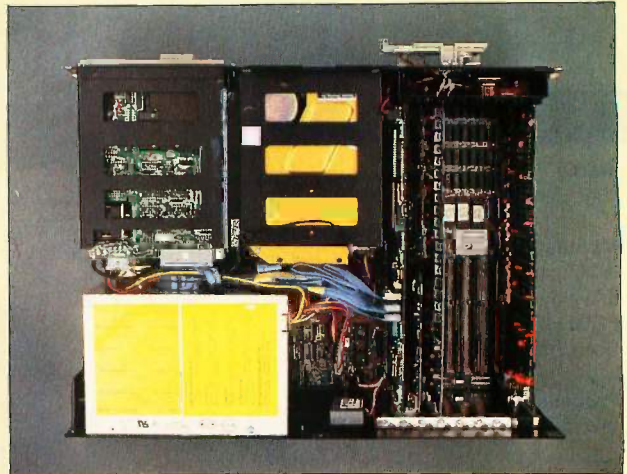

Inside the IBM PC AT. The expansion bus is at the right, hard-disk drive is top center, and power supply is bottom left.

DISK ACCESS IN BASIC (SEC)

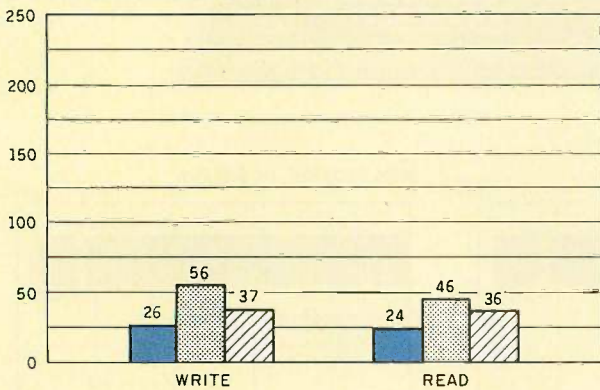

BASIC PERFORMANCE (SEC)

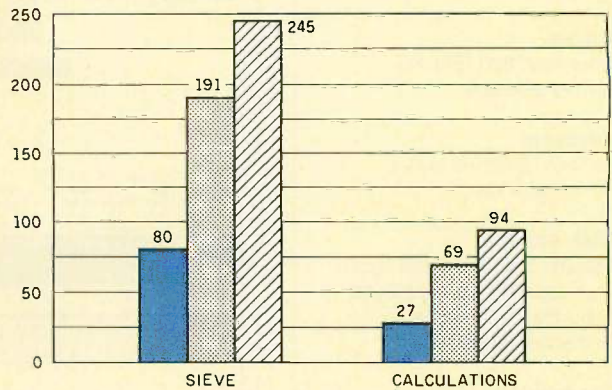

SYSTEM UTILITIES (SEC)

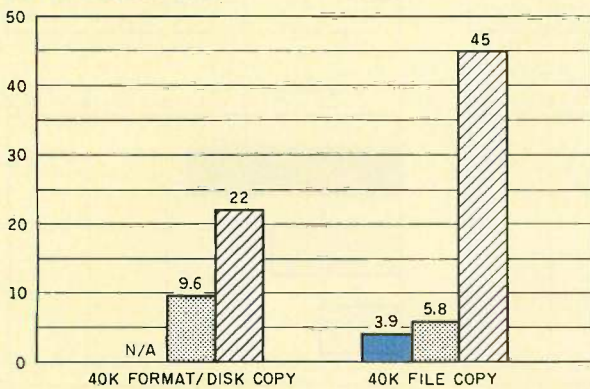

SPREADSHEET (SEC)

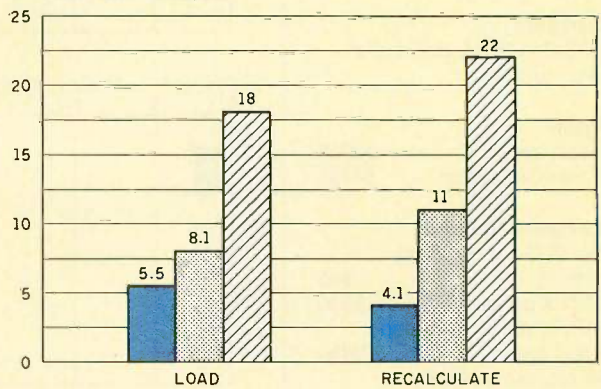

■ IBM PC AT ▨ IBM PC ▩ APPLE II E

The graph for Disk Access in BASIC shows how long it takes to write and read a 64K-byte sequential text file to a blank formatted floppy disk. (For the program listings, see "The Chameleon Plus" by Rich Krajewski, June 1984 BYTE, page 327, and October BYTE, page 33.) The Sieve column in the BASIC Performance graph shows how long it takes to run one iteration of the Sieve of Eratosthenes prime-number benchmark. The Calculations column shows how long it takes to do 10,000 multiplication and 10,000 division operations using single-precision numbers. The System Utilities' Format/Disk Copy graph shows how long it takes to format and copy a standard text file to disk (adjusted time for 40K bytes of disk data). The File Copy

column shows how long it takes to copy a 40K-byte file using the system utility programs. The File Copy test on the AT copied from the hard-disk drive to the floppy-disk drive. The Systems Utilities graph does not include format/disk copy on the IBM PC AT because the review unit had one hard- and only one floppy-disk drive. The Spreadsheet graph shows how long it takes to load and recalculate a 25-by 25-cell Microsoft Multiplan spreadsheet where each cell equals 1,001 times the cell to its left. The IBM PC AT used PC-DOS 3.0 and BASICA. The Apple IIe used ProDOS, except for the spreadsheet running under PC-DOS 2.0.

disk adapter, this new card can handle only two floppy-disk drives. However, you can use two controllers if you can find operating software and a place to put the drives.

Since no software is currently available in the high-capacity format, the high-capacity drive and controller can read standard disks. You can also write on them, but you probably won't be able to read that disk on a standard drive due to the much narrower track that is recorded. This means that the AT owner who needs to transfer data to PCs will be forced to either sacrifice a high-capacity drive for a standard drive or use a serial-communication hookup.

In my experience with the high-capacity drive, I never saw any data errors or even retries using the special IBM disks that came with the system.

The ROM BIOS automatically determines the drive/format combination after a drive reset; this makes the actual controller mechanics transparent to a program. It also makes many copy-protection schemes incompatible. One exasperating attribute of the disk system is the one-eighth-second minimum motor-start delay that the BIOS imposes. It makes each initial disk access take longer than it would on a PC. I realize that the half-height drives take longer to start, but I still wish this parameter had remained variable.

If you need hard disks, the enhanced AT comes with a 20-mega-byte, full-height, hard-disk drive tucked inside the cabinet (for benchmark times comparing three hard-disk systems, see table 2). You can add a second drive in the spot where a second floppy would go.

THE ROM BIOS

The ROM contains a cassette-BASIC interpreter (the AT does not have a cassette interface), a power-up self-test (POST) program, and the BIOS functions in four 16K by 8-bit devices. If you moved a jumper, a pair of 32K by 8-bit ROMs could do the same job and leave two sockets open for expansion. As with the PC, expansion ROMs can be recognized by the ROM BIOS

and incorporated into its functions.

The AT has a new version of the BIOS that provides a number of new features. The most notable is the addition of support for multitasking operating systems. Quite a few PC operating systems currently available can run more than one program at a time. Digital Research's Concurrent DOS and the multitude of UNIX-based packages are the best known. In all cases, these operating systems must supply their own BIOS because the one in the PC is single-threaded. Once you call it to initiate an operation (accessing the disk, for example), you cannot do anything else until the BIOS is finished—even if the processor is going to spend most of its time waiting. This is why your keyboard input seems to come to a grinding halt periodically while the PC-DOS print spooler is in operation and a disk access is necessary.

However, the AT BIOS functions can return to the caller with a flag that says "This will take a while." The operating system then runs another program while the hardware does the work. When the operation is done, the

BIOS sets another flag saying "I'm ready to finish up" and the software can go back to the original program.

While this feature is helpful, it (and the ROM BIOS in general) is only available in real-memory mode. With the possible exception of the multitasking facility built into IBM's TopView, new multitasking or multiuser systems are likely to operate in virtual mode and include their own BIOS.

Other new features are designed to isolate programs from the hardware for back and future compatibility. These include joystick support and a short-interval (microseconds) timer.

One potentially useful new function has some hidden problems. Since PC-DOS supports only the first 640K bytes of memory, IBM built a function into the BIOS to allow block transfers between standard and extended memory including a device driver to use this memory as a virtual disk.

The way the BIOS Move Block function operates is simple: You put the processor into protected mode, make the transfer, and go back to real mode again. The one problem is that the

(continued)

Table 1: IBM PC hardware compatibility with the AT.

Supported	Not Supported
IBM monochrome display adapter	IBM asynchronous communications adapter
IBM color display adapter	IBM printer adapter
IBM SDLC communications adapter	IBM expansion unit
IBM binary synchronous communications adapter	IBM compact printer
IBM cluster network adapter	Other memory-expansion options
IBM PC network adapter	Other keyboards
IBM graphics printer	Other disk and fixed-disk drives
IBM color printer	

Table 2: Some benchmark times in seconds for the AT with a hard-disk drive.

Test	IBM PC AT	IBM PC XT	Apple IIe (Profile)
BASIC			
Hard-disk Write	17	43	22
Hard-disk Read	12	28	13
System Utilities			
40K File Copy	12	2.8	20
Spreadsheet			
Load	1.7	3.8	N/A

only way to get back to real mode from protected is to literally reset the processor. But first a flag is set in the battery-backed configuration RAM signaling that the reset is for this particular reason. Near the beginning of the initialization routine, the flag is detected and the program returns to Move Block again for cleanup.

There are two key failings to this method. First, the entire operation, taking as much as 4 or 5 milliseconds, must be done with all interrupts shut off. This can delay interrupt-intensive operations to the point where critical events might be missed. You could lose characters coming in on a 9600-bps serial port, for example. The second problem is even more serious. If the power or the system fails in the small time-window during which the flag is set, each time the system is powered up or reset it will think it is coming back from a Move Block and

lose control. The only way to get the system working again is to open it up and disconnect the battery for a moment to kill the flag. You will also have to reset the clock and rerun the configuration program. You are better off to stick to the hard disk for fast storage. It's less expensive and more reliable.

A NEW PC-DOS?

A new version of PC-DOS accompanies the AT. The release of DOS 3.0 serves two purposes. First, it provides the internal changes necessary to run on the AT. It also serves as an interim release to let programmers begin to interface their software with the file-sharing facilities required to operate in the local-area-network environment that IBM announced with the AT.

File sharing is required in multiuser or networked systems to ensure that only one user can change a file or

record at a time. Otherwise, a change or update might not be recorded properly. Although local-area networks for the PC have been around for some time, they each had different sharing mechanisms. Software developers tended to ignore the issue rather than build separate versions for each brand of network. Although the actual network software will not be available until DOS 3.1 appears, DOS 3.0 standardizes the software interface for developers.

DOS 3.0 fixes a few minor bugs in DOS 2.1 and also adds some new commands. The ones I am particularly pleased to see fixed are the ability to use a pathname before a command and correction of the FOR batch command that previously could not deal with sets longer than 64 characters. Functions of the new commands include supporting foreign-language keyboards, making files read-only, and

Last year the experts tested the top-of-the-line Toshiba 3-in-One™ printer.

Here's what they said.

“When Toshiba America called to see if there were problems testing their printers, I responded, ‘You bet—I can’t get the P1351 off Bill Machrone’s desk long enough to get its picture taken!’ It’s that good.”

(Bill Machrone is the editor of PC Magazine.)

PC Magazine
November 27, 1984

“It is setting new standards for quality and performance in the dot matrix arena.”

Computers & Electronics Magazine
November 1984

changing the volume label on a disk.

A major internal change lets PC-DOS handle up to 65,526 allocation blocks on disk, up from 4086. This allows much more efficient use of disk space on larger hard-disk drives.

BASICA has also been enhanced, but the changes are really to the documentation. A number of keywords that were reserved but undefined, such as SHELL, ENVIRON\$, and IOCTL, have finally been included in the manual as commands and functions. Most of these existed in previous versions, albeit with some bugs. This release simply acknowledges them.

Minor changes to some of the system calls can cause problems for programs that don't play by the rules. One such change is the use of all 8 bits in filename characters to support the foreign character sets. This made my version of Digital Research's GSX

Table 3: IBM PC/PC AT software compatibility.

Compatible	Not Compatible
PMATE Editor	Flight Simulator
Ci-C86 C compiler	J-Bird
Lotus 1-2-3	Frogger
WordStar	Burgertime
MultiMate	PC-Man
XyWrite	CP/M-86
Multiplan	Concurrent CP/M
SuperCalc2	DR's GSX
PeachText	
ASCOM	
dBASE II	

graphics extension unusable on the AT and the PC. I understand that DR's latest release fixes the problem.

SUMMARY

All the programs I tried, except the

games, stand-alone programs, and GSX, ran perfectly. Table 3 lists what worked and what didn't. IBM supplies a pamphlet with the AT telling you which programs the company knows won't run and mentioning any special considerations for supported software. Mostly this consists of instructions on how to copy a program to a high-density disk.

IBM states that a number of programs won't run on these disks because of copy-protection techniques or assumptions the program makes about disk layout. You have to run these on a standard drive.

To sum this all up, the IBM PC AT is a powerful machine that you can use in place of a PC or XT system for a two or three times increase in performance and storage. As a small, cost-effective, multiuser business system? I'll just have to wait and see what XENIX looks like. ■

“

”

Imagine what they will say about its successor.

The New Toshiba P351 3-in-One printer. They could say that inside the sleek new Toshiba P351 you'll find the ultimate 3-in-One printer. Because it offers a combination of:

Letter-quality printing. Perfectly translated graphics. And speed. (100 cps letter. And draft speed improved to 288 cps.)

They could say you'll appreciate the 24-pin dot matrix head that gives the P351 its exemplary letter and graphic quality.

They could say the new P351 gives you an almost unlimited number of ways to express yourself. With both downloadable software fonts and new plug-in font cartridges.



And they could say the new P351 is not only the best looking printer in the \$1,000 to \$2,000 range. But also the most reliable.

Of course, we're not putting words in their mouths. Just the ultimate 3-in-One printer in their hands. And yours.

For complete information call 1-800-457-7777, Operator 32.

In Touch with Tomorrow

TOSHIBA

TOSHIBA AMERICA, INC. Information Systems Division

Why Would Anyone Pay More?

Highest Quality at the Lowest Price.

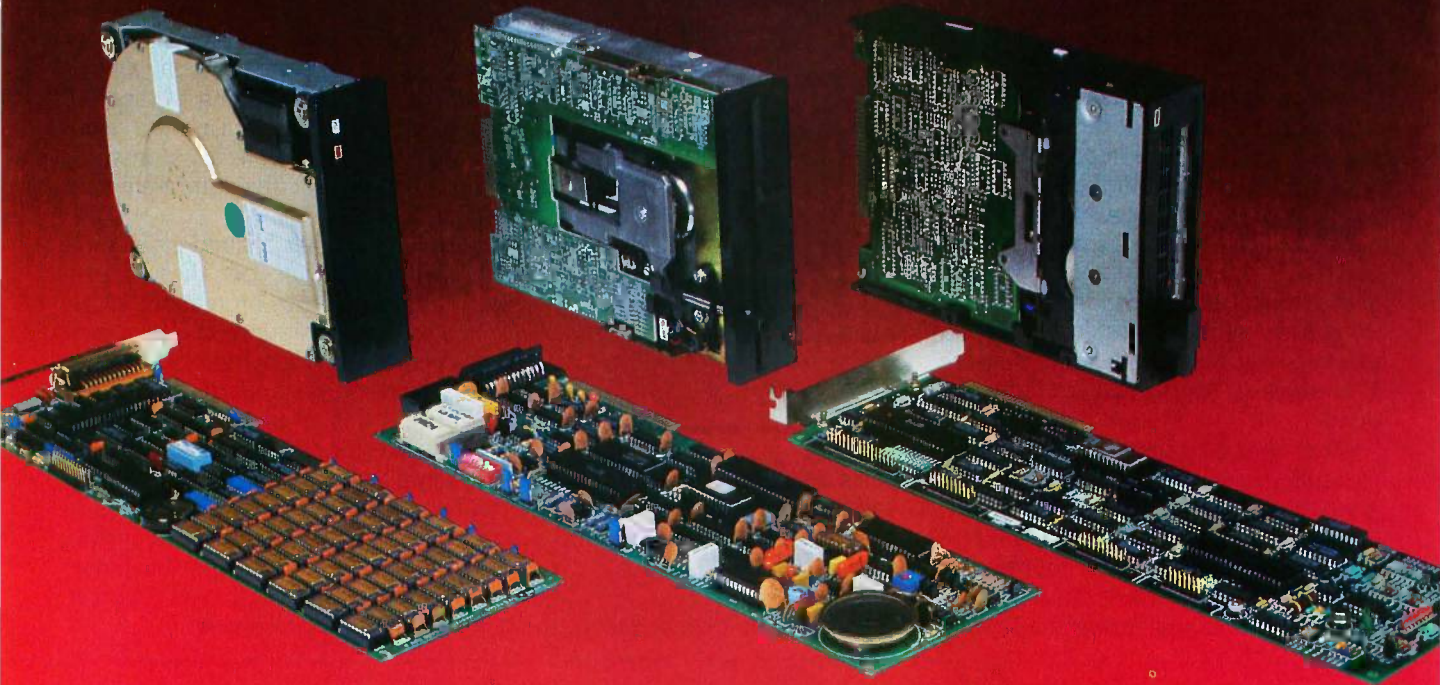

\$675⁰⁰ Hard Disk Drive

- 10 MB internal subsystem
- Half-height with controller
- XT compatible
- Low power usage
- Software and cables included
- Inquire about 20MB drives

\$199⁰⁰ Multifunction Card

- 0-384K memory
- One parallel port
- One serial port
- One game port
- One clock/calendar
- RAM disk
- Print spooler
- Clock utilities

\$119⁰⁰ Floppy Disk Drive

- Half-height
- IBM compatible
- 360K, 48 TPI
- Double sided/double density

\$265⁰⁰ 300/1200 baud Modem

- Auto speed detection
- Hayes and Bell 103/212 compatible
- Auto dial/auto answer
- On-board speaker
- Software volume control
- Internal plug-in or external
- FCC certified

\$725⁰⁰ Floppy Tape/ Streaming Cassette Tape

- Half-height internal subsystem
- Quick back-up system
- Low power usage
- Software and cables included
- Image or file by file back-up

Inquire about our graphics controller!

Shipping charges are extra.
Visa and MasterCard, add 3% more.

JEDEN

1318 W. Sepulveda Blvd.
Harbor City, CA 90710

912 Barton Street East
Suite 26
Hamilton, Ontario
Canada L8L 3C2

In USA call:
(714) 545-8108

In Canada call:
(416) 549-2303

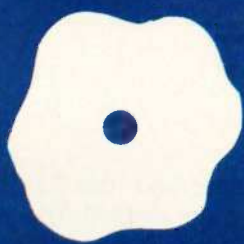

True BASIC

Bringing
structure
to the realm
of "spaghetti
code"

BY G. MICHAEL VOSE

Eighteen months ago, BASIC's originators, John Kemeny and Thomas Kurtz, informed the world they planned to port their creation to microcomputers. The intention of Kemeny, Kurtz, and associates Chris Walker, Brig Elliot, and Dave Pearson at True BASIC Inc. focused on cleaning up "Street BASIC," their name for the widespread but limited versions of BASIC that dominated the microcomputer world. These men view Street BASIC as a weak sister to the substantially evolved Dartmouth BASIC. Calling Street BASIC "a horrible dialect of a beautiful language," they bemoan its hardware specificity and lack of modern structure.

Secondarily, they were keen to create a BASIC that conformed to a standard. They wanted it to be widely disseminated and, therefore, wanted it to be uniform for textbooks and other educational materials that need program listings. The standard to emulate, in their estimation, was the embattled American National Standards Institute (ANSI) X3J2 subcommittee's proposed standard (see the text box "ANSI Standard BASIC" on page 288). Kurtz had served as chairman of the subcommittee for 10 years.

The result is True BASIC, a compiled ANSI standard BASIC distributed by textbook publisher Addison-Wesley of Reading, Massachusetts. In this review, I look at the first implementation of True BASIC, the IBM Personal Computer (PC) version. It requires MS-DOS 1.1, 2.0, 2.1, or 3.0 and 128K bytes of memory, plus a disk drive. The PC version's price is \$149.90.

A version for the Apple Macintosh is slated for late spring, and a PCjr version reportedly will be ready by the time you read this. All versions of True BASIC are intended to be identical at the source-code level, but the Macintosh version proposes to exploit the machine's icon/mouse-oriented user interface at the command level.

The unique features of True BASIC, and those that will be closely examined here, in-

clude its user interface, use of external subroutines and libraries, floating-point math package, graphics and sound capability, debugging tools, and availability of access to the machine. (Table I offers a comparison of True BASIC, PC-BASIC, BetterBASIC, and Turbo Pascal.)

A major departure from previous microcomputer BASICs, True BASIC is compiled instead of interpreted. The compiler produces an intermediate code. A pseudo-microprocessor interprets this code at run time and uses the resulting interpretation to generate machine code for the IBM PC's 8088 CPU (central processing unit). This compilation technique enhances program-execution speed and permits execution of programs from within the True BASIC editor, using the familiar BASIC command RUN. All activity in True BASIC happens within the numerous windows of the system's editor.

Users view the True BASIC world through the editor's three windows—the source window, the command (or history) window, and the graphics window. The True BASIC editor functions as a screen editor within a window; movement is controlled by the cursor keys. The first two windows dominate the screen display during a programming session.

The source and command windows share the screen and can be adjusted by the user. On the IBM PC, you move between windows using function keys F1 and F2. You use the Home, End, PgUp, and PgDn keys to move through a file within a window.

The source window is for entering and modifying source code. The PC's Insert and Delete keys function within this window to aid the editing process.

The command window lets you issue commands (like RUN and SAVE), and it displays all nongraphic program output. In addition, the command window preserves all the command-line activity during a programming session. With the cursor keys, you

(continued)

G. Michael Vose is a BYTE senior technical editor. He can be reached at POB 372, Hancock, NH 03449.

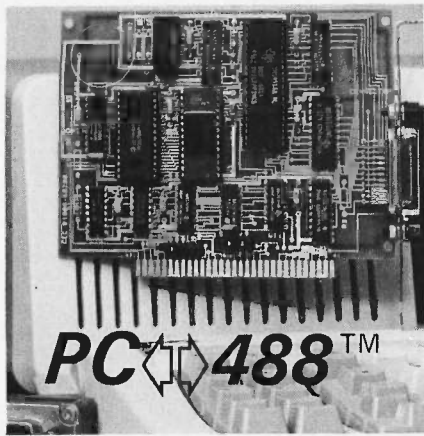

An IEEE-488 interface for all IBM-PC's and COMPATIBLES

VERSATILE

Easy-to-use commands for all IEEE-488 (GP-IB, HP-IB) functions.

Resident firmware supports **BASIC, Pascal, C, and FORTRAN.**

Emulates Hewlett-Packard controller functions and graphics language statements.

Supports Tektronix® Standard Codes and Formats.

Print listings, plot graphs, and use **Lotus 123™** with IEEE-488 peripherals.

FAST

Direct memory transfer rates to 800K bytes/second.

PROFESSIONAL

Clear and concise documentation includes a complete tutorial, programming examples, and application programs.

\$395.00 complete. There are no additional software charges.

Find out why **PC 488** is the first choice of over 500 companies.



CAPITAL EQUIPMENT CORP.

10 Evergreen Avenue
Burlington, MA. 01803
(617) 273-1818

IBM is a trademark of International Business Machines Corp.
Lotus 123 is a trademark of Lotus Development.
Tektronix is a trademark of Tektronix, Inc.

REVIEW: TRUE BASIC

can move back through all command-window activity to look at any sequence of actions. Within this window, the PC function key F9 enters the

RUN command, and the F7 key recalls the last line entered. The F10 key is the help key.

Since you both enter and execute

Table 1: A comparison of features and capabilities.

	True BASIC	PC-BASIC	BetterBASIC	Turbo Pascal
Hexadecimal numbers	no	yes	yes	yes
8087 support	yes	no	yes	yes
Maximum string length (bytes)	32K	255	32K	256
Binary-coded-decimal math	no	no	yes	no
Byte	no	no	yes	yes
Windows	yes	no	yes	yes
DOS call	no	no	yes	yes
DOS 2.0 files	yes	no	yes	no
Chaining	yes	yes	yes	yes
Overlays	yes	yes	no	yes
Libraries (modules)	yes	no	yes	yes
Procedures	yes	no	yes	yes
Functions	yes	yes	yes	yes
DO loops	yes	no	yes	yes
ELSEIF/ENDIF	yes	no	no	no
CASE	yes	no	no	yes
Scoped variables	yes	no	yes	yes
Recursion	yes	no	yes	yes
PEEK/POKE	yes	yes	yes	no
Number of open files	10	2	5	15
Array dimensions	10	255	unlimited	255
Option base	declarable (default = 1)	0 or 1 (default = 0)	0 or 1 (default = 0)	declarable

Table 2: The largest number for which the respective languages can calculate the factorial, followed by the factorial.

	Factorial Calculations	
	Largest Number	Factorial Computed
True BASIC	170	7.25742E + 306
BetterBASIC	145	8.0479272E + 251
PC-BASIC	33	8.6833176187E + 36
Turbo Pascal	33	8.683317E + 36

Listing 1: The factorial program coded in True BASIC.

```

10 ! Program to Calculate and Print Factorials
20 ! Requires the Input of a Base Number
30 PRINT "Type a Number :";
35 INPUT number
40 LET dummy = number
50 IF number < 2 then LET fact = 1
60 LET dummy = dummy - 1
70 LET number = number * dummy
80 IF dummy < > 1 then GOTO 60
90 PRINT "The Factorial is "; number
95 GOTO 30
100 END
    
```

REVIEW: TRUE BASIC

programs from within the editor, True BASIC spots and reports errors as it encounters them during the compilation of the source program. The RUN command initiates the compiler, and there is a noticeable delay from when you enter the RUN command until True BASIC successfully completes the compile cycle. Errors make the compiler stop, display an error message in the command window, and move the cursor to the beginning of the line containing the error in the source window. Often, the cursor moves to an improperly placed keyword or punctuation character.

Another interesting component of the True BASIC user interface is that it lets you execute DO files. A DO file is a filter program or utility. For example, the True BASIC program disk contains a DO file called FORMAT that produces a formatted ("prettyprint") listing of the program file in the source window. Renumbering True BASIC's optional line numbers is accomplished with another DO file called RENUM.

DO files written in True BASIC are coded as external subroutines and compiled to object files using the command COMPILE. The resulting object file can then be saved on disk, where it resides until called by the DO filename command.

The final component of the user interface is the on-screen help facility. Engaged by pressing F10 or typing HELP, the on-screen assistance is not context-sensitive. To get help on a specific topic, like saving source files, you must enter HELP SAVE.

EXTERNAL SUBROUTINES AND LIBRARIES

Most BASIC programmers use subroutines, sections of code within a program that perform often-repeated functions. True BASIC similarly provides for subroutines, although you call them by name and they permit parameter passing. But the language also includes a mechanism for calling routines that reside outside a program—external subroutines and libraries.

A library is merely a collection of

external subroutines grouped within a file. External subroutines allow parameter passing and look identical to internal subroutines, except that they stand alone or occur after a program END statement. The keyword EXTERNAL identifies a subroutine or group of subroutines and functions as a LIBRARY. External subroutines can reside independently on disk. To call a library, use a LIBRARY filename header at the beginning of the source program that calls the external subroutines.

Variables within True BASIC's external subroutines are local to that program unit; they are unknown to other external subroutines or to programs. But within any subroutine or program, all variables are global in scope. Subroutines, internal or external, may have any number of arguments, but the arguments passed must match the data type (string or numeric) of the arguments as originally declared.

Functions in True BASIC can also be external, in which case they use local variables.

True BASIC has several libraries on its program disk. A graphics library provides routines to draw an *n*-sided polygon, a filled-in circle, or six other shapes. The four mathematical libraries offer hyperbolic functions, trigonometric functions in either radians or degrees, and such functions as *n* factorial or binomial coefficients. A menu library contains five subroutines that let you use menus within programs. By invoking them you can open a window for a menu, display the menu, get a reply, clear the menu, and return to the working program window.

FLOATING-POINT MATH

To test the dynamic range of True BASIC, I ran the short factorial program shown in listing 1. Table 2 shows the largest number for which this algorithm can calculate the factorial for a variety of languages on an IBM PC. The dynamic range claimed for the PC version of True BASIC is 1.11254E-308 to 3.59539E+308, a claim verified by this test. True BASIC Inc. says that the minimum dynamic range

(continued)



WAREHOUSE EXPRESS BEST SAVINGS

ORDER TOLL FREE
1-800-428-7979

"LAST CALL FOR SAVINGS"
FREE \$20 PRINT WHEEL*

NEW OMNIREADER (OPTICAL READER) \$399

PRINTERS • PLOTTERS

C. Itoh (Riteman, Epson Exacts)	Call
Epson (All Models)	LOW
Enter (Sweet-P 6 Pen Plotter, HP)	\$1095
Sweet-P 6 Pen Plotter, HP	CLOSEOUT

Juki

6100 Letter Quality Daisywheel	\$599	\$383
6300 L.O. Daisywheel 40CPS	995	679

Legend (Square Dot, Epson Compatible)

880 100CPS	\$279	\$199
1080 120CPS	339	239
1380 160CPS (IBM)	359	279
1385 160CPS (IBM) 15" wide	449	Low
CPVII 180CPS 7-Color 15" wide (IBM)	1195	799

Silver Reed (Free Print Wheel-Ltd. Qty.)

EXP400 L.O. Daisywheel	\$399	Low
EXP500 L.O.	499	\$287
EXP550 L.O.	849	389
EXP770 L.O. 36CPS	1295	687

Toshiba (3 in 1 Printers, 1340, 1351)

Siemens (Ink Jet PT-88, PT-89)	Call
--------------------------------------	------

MODEMS • MONITORS • DRIVES

Anchor Automation (Modems)

Volksmodem 12 (1200 Baud)	\$300	\$179
Mark XII 1200 Baud	400	229
Express 1200 (Hayes Exact)	439	Call
Hayes (1200, 1200B)	Call	

Novation (Hayes Compatible)

Smart Cat + 2400 Baud (IBM, MAC)	\$795	\$549
Smart Cat + 1200 w/Mite (IBM, MAC)	499	299
Access 1-2-3 1200 w/Crosstalk (IBM)	SPECIAL	CHEAP

Encryption (Be Safe!)

DES 2000 (Data Encryption System)	\$460	Call
---	-------	------

Taxan (Monitors)

116 Amber	\$180	\$115
122 Amber (IBM)	230	131
420 RGB (IBM) HI-RES w/Cable	560	389
425 RGB (IBM) HI-RES	609	409
440 RGB (IBM) ULTRA HI-RES	800	Call

Drives (E-Z Install)

10 Megabyte Int. H.D. w/Cntrl Card (IBM)	\$699
20 Megabyte Int. H.D. w/Cntrl Card (IBM)	999
Kodak 3.3 MEG 1/2 H.T. Disk Int. 1103	\$945
698	

Panasonic (Drives)

5 1/4 Half Height DS DD (IBM)	\$109
Controller Card (w/Drive Only)	69

COMPUTERS • CARDS • CHIPS

IBM (PC-AT Systems)	Call
Leading Edge	Call
Macintosh	Call
NEC (LAP Computers & Accessories)	Low
Panasonic (Sr. Partner-PC & HHC)	Call
Zenith (PC's)	Call

Paradise (Cards)

Modular Graphics Card	\$395	\$269
Fivepack	229	155
Maxpack (MGC + A1 + A2)	725	489

Six Pack (Card-IBM)

Ram (64K Chips (9) 150 NSEC)	\$27
------------------------------------	-------------

SOFTWARE • DISKETTES

Auto Cad (Software, Digitizers, Plotters)	Call	
CPA+ (For Lotus 1-2-3) GL, AP, AR, PR	\$695	Call
Enable	\$695	Call
Lotus 1-2-3 & Symphony	Call	

Micropro

WordStar	\$350	\$172
WordStar Professional	495	Low
WordStar 2000	495	Low
WordStar 2000+	595	Low

Maxell (100 Qty.) IBM, MAC, HP

Fuji (100 Qty.) IBM, MAC, HP	Cheap
------------------------------------	-------

MINORITY HI-TECH INDUSTRIES

5021 N. 20th Street, #10261

Phoenix, Arizona 85064

Other Information: (602) 890-0596

★ WE BUY ★

SURPLUS GOODS

Prices reflect 3-5% Cash Discount. Shipping on most items \$8.00. Prices and availability subject to change without notice. Send cashier's check or money order. All other checks delay shipping 2 weeks.

ADD #185

ADD #185

ADD #185

ADD #185

ADD #185

ADD #185

ADD #185

ADD #185

ADD #185

ADD #185

ADD #185

ADD #185

ADD #185

for True BASIC, regardless of the computer, is 1.0E-99 to 1.0E+99.

The numeric precision of True BASIC is 14 digits of accuracy on the PC, except for the built-in transcendental functions, where the accuracy is 10 digits. The external format for True BASIC numbers conforms to the IEEE 754 floating-point standard. The lan-

guage's implementors sacrificed some of the standard's precision to obtain greater speed and produced a math package with better speed and precision than most languages offer (see the "Benchmarks" section). In accordance with the ANSI standard, only 6 digits of a number are displayed unless you invoke special format com-

mands, like PRINT USING. (Other True BASIC limits include a maximum string length of 32,767 and a maximum of 255 array dimensions.)

The traditional BYTE calculations benchmark, rewritten in True BASIC and shown in listing 2 (the standard BYTE calculations benchmark is shown in listing 3 for comparison), reveals that True BASIC's round-off error is substantially lower than that of the PC-BASIC interpreter (see table 3 and the graphs on the "At a Glance" page). True BASIC also automatically senses, and uses, the Intel 8087 coprocessor when installed. The 8087 further enhances the speed and accuracy of floating-point math, fully conforming to the IEEE 754 standard.

GRAPHICS AND SOUND

True BASIC places a substantial emphasis on graphics. Most of the sample programs on the distribution disk generate graphics output. The design goals of the graphics command set were portability and elimination of pixel calculations.

To eliminate pixel math, True BASIC performs *x, y* coordinate graphics using statements like PLOT, BOX, and DRAW. You can plot lines, points, or areas to create simple shapes. The only concern is the character of the graphic, such as the length of the sides of a triangle, and not pixel positioning on the screen. The graphics statements make all the pixel calculations. BOX statements let you draw and redraw graphics fast enough to create animated displays.

The PICTURE construct allows more sophisticated graphics. PICTUREs are special graphics subroutines called with the DRAW state-

(continued)

Listing 2: The BYTE calculations benchmark coded in True BASIC. Note that line numbers are optional.

```
LET starttime = time
LET nr = 5000
LET a = 2.71828
LET b = 3.14159
LET c = 1
FOR i = 1 TO nr
    LET c = c*a
    LET c = c*b
    LET c = c/a
    LET c = c/b
NEXT i
PRINT "Done"
LET finishtime = time
PRINT "Error = ";c-1
PRINT finishtime-startime;" seconds"
END
```

Listing 3: The standard BYTE calculations benchmark.

```
5 REM: THE CALCULATIONS BENCHMARK
10 NR=5000
20 DEFSNG A-Z
30 A=2.71828
40 B=3.14159
50 C=1
60 FOR I=1 TO NR
70 C=C*A
80 C=C*B
90 C=C/A
100 C=C/B
110 NEXT I
120 PRINT "done"
130 PRINT "error = ";C-1
```

Table 3: The BYTE benchmarks for several languages. Times are in seconds.

	True BASIC	PC-BASIC	BetterBASIC	Turbo Pascal
Sieve	21.2	190.7	31.4	15.4
Calculations	19.7	69.2	91.3	82.6
(Error)	-4.5830006457E-13	-1.788139E-07	0 (uses binary-coded-decimal notation)	-1.3384124031E-08

Potent Pascal.

Microsoft® Pascal may be the most powerful software development environment available for the MS™ DOS system. It combines the programming advantages of a structured high-level language with the fast execution speed of native code compilation.

And it exceeds the proposed ISO and ANSI standards with logical extensions that make the language more powerful and versatile. For example, programming capabilities even allow you to manipulate data at the system and machine level.

It gives you single and double precision IEEE floating point arithmetic. Numeric operations take advantage of the 8087. Or automatic software emulation is

provided if the coprocessor is not installed.

Support for long heap allocation and separate module compilation gives you the flexibility to create large programs up to one megabyte.

And the standard linking interface makes it easy to combine Microsoft FORTRAN or assembly language subroutines.

Call 800-426-9400 to order the potent Pascal. \$300*

In Washington State, call 206-828-8088. Ask for operator A5, who will rush you your order, send you more information, or give you the name of your nearest dealer to see Microsoft Pascal in action.



AT A GLANCE

Name

True BASIC

Manufacturer

True BASIC Inc.
39 South Main St.
Hanover, NH 03755

Distributor

Addison-Wesley
Publishing Co.
Reading, MA 01867
(617) 944-3700

Price

\$149.90

Computer

IBM PC with 128K RAM and
a disk drive

Features

An ANSI standard BASIC
language compiler with a
window-oriented user
interface, characterized
primarily by its outstanding
math package

Documentation

A reference manual and a
user's guide plus on-screen
help

SIEVE OF ERATOSTHENES (SEC)

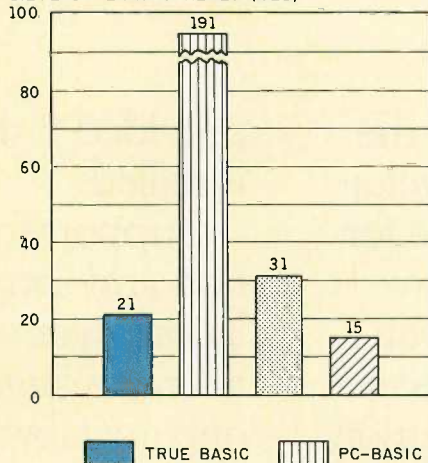

CALCULATIONS (SEC)

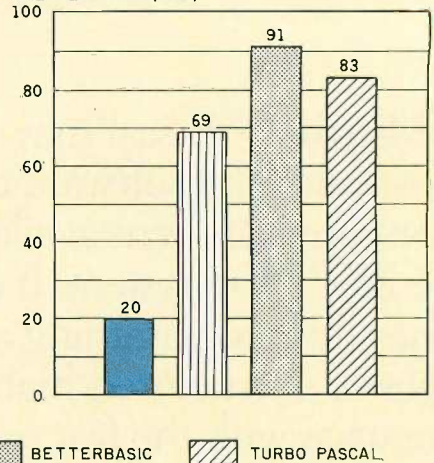

The benchmark for the Sieve of Eratosthenes measures (in seconds) how long it takes for each of the tested languages to run one iteration of a program that determines all of the prime numbers up to 7000. The Calculations graph shows how long it takes to do 10,000 multiplica-

tion and 10,000 division operations using single-precision numbers. Listings 2, 3, 4, and 5 show the standard BYTE benchmarks for calculations and the Sieve—as well as how they were modified to accommodate True BASIC's slightly different syntax.

ment. Since a PICTURE emulates a regular True BASIC subroutine, it can be called with parameters. For example, a PICTURE that draws a square can be called with an argument that determines the length of the square's side.

Sophistication in picture graphics is made possible by what True BASIC calls transformations. These transformations include the ability to rotate a picture, shift a picture right or left on the screen, change the size of a picture, or even shear the picture (tilt all its vertical lines forward by a specific number of radians or degrees).

Like regular True BASIC subroutines and functions, PICTUREs can be either internal to the program or external. They may even reside with other PICTUREs in a library.

The graphics functions of True BASIC also include the ability to combine text and graphics (using the

PLOT TEXT statement) and the use of adjustable windows. To enhance output within the system graphics window, you can open separate windows of any size and divide the output among them any way you like. The windows in True BASIC do not overlap.

To create music or sound in the language, you use common keywords like PLAY, SOUND, and PAUSE. On the IBM PC, you can play music in either foreground or background mode so your programs can provide music along with other activity. Background music is limited to a string of 32 notes or pauses, played repeatedly until the program's end.

CHAINING AND DEBUGGING

The CHAIN statement in True BASIC functions like a subroutine call. Program flow can pass to another program and then return to the original program when the second program

completes execution. CHAINED programs can even accept arguments.

You can write and call assembly-language subroutines from within True BASIC programs, and you can perform traditional BASIC memory examination and assignment operations using PEEK and POKE. On the IBM PC, True BASIC's memory addresses do not use the Intel 8086 conventions of segment and offset. Instead, they use a simple decimal address. Programmers will have to calculate this address, using the formula $segment * 16 + offset = address$, before performing PEEKs and POKEs.

This version of BASIC treats assembly-language routines the same way it treats libraries. Therefore, assembly-language subroutines need preface bytes identical to those in a library file. Assembly-language routines can accept arguments. Once created, assembled, linked, and

(continued)

New Version

Mighty Macro Assembler.

The new Microsoft® Macro Assembler package. A complete development environment that makes you a more productive programmer. Whether you're using Macro Assembler or any Microsoft high level language.

A common calling convention lets you easily call assembly language routines from any high level Microsoft language to add an extra burst of blinding speed.

Better Debugging.

The new Symbolic Debug Utility lets you stay close to the source. Now you can step through your assembled or compiled code by name rather than by address. Source level display for Microsoft Pascal, FORTRAN, and C allows you to view both your original source and the resulting code.

And we stuffed our package with a full set of the most useful utilities around. So that you can link, maintain and organize your programs like never before.

Who else but Microsoft could build so much into one package for \$150?

For the name of your nearest Microsoft dealer call (800) 426-9400. In

Washington State, Alaska, Hawaii and Canada, call (206) 828-8088. And if you're already using Microsoft **MICROSOFT**™ The High Performance Software™ or IBM® Macro Assembler, ask us how you can upgrade to the mightiest Macro of them all.

Microsoft Macro Assembler Package:

Macro Assembler

- ♦ For the 8086/8087/8088 and now the 186/286/287.
- ♦ Define macros.
- ♦ Conditional Assembly.
- ♦ Case sensitivity for symbols.

New Interactive Symbolic Debug Utility

- ♦ Controlled testing environment for debugging.
- ♦ Source line display of Microsoft FORTRAN, Pascal and C Programs.
- ♦ Set breakpoints on line numbers and symbols.
- ♦ Single step to follow program execution.
- ♦ Disassemble object code.
- ♦ Display values.
- ♦ Make minor changes without reassembling.

New Program Maintenance Utility

- ♦ Rebuilds your applications after your source files have been changed.
- ♦ Similar to UNIX™ Make utility.

Library Manager

- ♦ Create, organize and maintain your object module libraries created with Microsoft Languages.
- ♦ Set page size (default of 16 bytes).

Object Code Linker

- ♦ Simple overlaying linker combines relocatable object modules created using Microsoft Languages into a single program.
- ♦ Load Map generation.
- ♦ Specify from 1 to 1024 segments.

Cross Reference Utility for the Macro Assembler

- ♦ Creates a cross-reference listing of the definitions and locations of all symbols used in an assembly language program.



MICRO
SOFT

Microsoft is a registered trademark and The High Performance Software is a trademark of Microsoft Corporation. IBM is a registered trademark of International Business Machines. UNIX is a trademark of Bell Laboratories.

filtered by EXE2BIN, an assembly-language subroutine is treated just like any True BASIC library routine.

Bit manipulation is not provided in True BASIC, other than that allowable by PEEK and POKE routines and the bit-packing routines, PACKB and UNPACKB. The logical operators AND, OR, and NOT are relational, not Boolean. You can use them on expressions but not on variables, meaning that you can't use them to mask all

but certain bits of a byte. PACKB and UNPACKB place integers into strings and retrieve integers from strings, respectively. This allows storing numbers between 0 and 255 more economically.

True BASIC provides no special debugging aids. The manual suggests using BREAK to set breakpoints and CONTINUE to resume program execution after a breakpoint-defined halt. The editor provides a global

search-and-replace command called CHANGE.

BENCHMARKS

Table 3 and the graphs on the "At a Glance" page show benchmark results for several languages on the IBM PC. The benchmarks indicate that True BASIC is an average of 6.4 times faster than interpreted PC-BASIC, 3 times faster than BetterBASIC, and twice as fast as Turbo Pascal. True BASIC performs particularly well on the calculations benchmark. Listing 4 shows the Sieve benchmark program coded in True BASIC. Compare this with the standard BYTE benchmark for the Sieve in listing 5.

CONCLUSIONS

The True BASIC compiler conforms closely to the ANSI standard for BASIC but is not identical to the standard. It is likely, due to hardware anomalies, that there will never be a compiler that is 100 percent compatible. Even compilers for C, held up to the world as the most portable of languages, show variation from compiler to compiler; even C compilers from the same vendor can differ on different machines.

The principal advantage of ANSI compatibility is portability. In educational institutions, where there are as many different hardware brands as there are pencils, portability is crucial to BASIC's continued usage. Secondly, ANSI BASIC conforms more closely to the structured programming precepts that computer scientists see as essential to learning effective programming.

The disadvantage of ANSI compatibility is its nonconformity to the massive existing BASIC software base. Laborious recoding will be necessary to port existing programs to new BASICs like True BASIC.

Another, more subtle, disadvantage is aesthetics. I do not like the use of LET statements, for example, to assign values to variables. Though aesthetic considerations may seem arbitrary, they are important to a product's acceptance. People resist learn-

(continued)

Listing 4: BYTE's Sieve benchmark in True BASIC.

```

10 let starttime = time
20 let size = 7001
30 dim flags(7002)
40 print "Start One Iteration"
50 let count = 0
60 for i = 1 to size
70 let flags(i) = 1
80 next i
90 for i = 1 to size
100 if flags(i) = 0 then goto 180
110 let prime = i + i + 3
120 let k = i + prime
130 if k > size then goto 170
140 let flags(k) = 0
150 let k = k + prime
160 goto 130
170 let count = count + 1
180 next i
190 print "Done: ";count;" Primes Found"
200 let finishtime = time
210 print finishtime - starttime; " seconds"
220 end
    
```

Listing 5: The standard BYTE Sieve benchmark.

```

5 REM: THE SIEVE BENCHMARK
10 SIZE = 7000
20 DIM FLAGS(7001)
30 PRINT "start one iteration"
40 COUNT = 0
50 FOR I = 0 TO SIZE
60 FLAGS(I) = 1
70 NEXT I
80 FOR I = 0 TO SIZE
90 IF FLAGS(I) = 0 THEN 170
100 PRIME = I + I + 3
110 K = I + PRIME
120 IF K > SIZE THEN 160
130 FLAGS(K) = 0
140 K = K + PRIME
150 GOTO 120
160 COUNT = COUNT + 1
170 NEXT I
180 PRINT "done: ";COUNT;" primes found"
    
```

Ferocious FORTRAN.

Microsoft® FORTRAN crunches numbers with a vengeance!

It combines fast and efficient native code compilation with built-in 8087 coprocessor support. The result? Mini and mainframe performance from your MS™ DOS micro.

Based on the '77 standard, Microsoft FORTRAN supports extensive statements and data types—including complex numbers and IEEE single and double-precision floating point accuracy.

Support for large arrays (greater than 64K bytes), separate module **MICROSOFT** compilation, The High Performance Software® and overlays, allow you to create very large programs—up to one megabyte, with access to more than 65 thousand records in a file as large as four gigabytes.

How do programmers feel about Microsoft FORTRAN?

“The first FORTRAN compiler

that takes advantage of the full addressing capability of the 8088 and the power of the 8087.”

—Jack Wilschke, *Softalk*

“We decided to use the Microsoft FORTRAN Compiler for its INTEGER 4 capability and the flexibility of its 8087 implementation.”

—Charlie Huizena &
Chip Barnaky, *PC World*

Call 800-426-9400 to order
the ferocious FORTRAN.
\$350*

In Washington State, call 206-828-8088. Ask for operator A4, who will rush you your order, send you more information, or give you the name of your nearest dealer to see Microsoft FORTRAN in action.



ing new syntax that they find inelegant. Since the ANSI standard requires only that a conforming language *correctly process* LET statements, True BASIC should make them optional.

Minor syntax variations can also cause headaches. For example, True BASIC uses semicolons to separate multiple statements on a line, in a manner similar to Pascal. Microsoft BASIC and C use semicolons for completely different functions (for screen formatting and ending lines, respectively); these subtle differences will probably frustrate first-time users of True BASIC.

In keeping with the goal of aiming True BASIC at education, the refer-

ence manual and user's guide are written for the learner. But they do not condescend or oversimplify, presumably because they will be used in conjunction with a textbook or a class in programming. The documentation will be suitable for use outside of schools as well. The manuals are above average in content, style, and presentation. They avoid cute graphics and convey a sense of academic authority without being dull.

Surprisingly, True BASIC stacks up well as a software-development tool. Its structure allows the writing of easily maintainable programs, and its modularity—with external subroutines, libraries, and chaining capability—makes it suitable in team-

The company reportedly has a run-time package under development that will eventually permit the distribution of executable programs.

ANSI STANDARD BASIC

Expected to be formally adopted this year, the ANSI standard for BASIC calls for a broad and powerful set of control and command structures (see references 1, 2, and 3). In addition to a language core, the standards document specifies extensions for graphics, sophisticated file structures, real-time control, fixed decimal arithmetic, and editing. Unfortunately, conformity to the ANSI standard produces headaches for people using an existing BASIC, since its syntax almost certainly won't conform to the standard. Transporting existing programs to the new ANSI environment necessitates substantial rewriting of code. For example, all assignment statements, such as `a = 1`, must process the word LET (for example, `LET a = 1`) in ANSI BASIC.

The thrust of the proposed standard is to add structure to microcomputer BASIC, which has long been criticized as the language of "spaghetti code" with multiple conditional and unconditional branches, plus no satisfactory method of naming and labeling functioning blocks of code. The de facto industry standard, Microsoft BASIC, also suffers from limited variable names and a bewildering variety of keywords from machine to machine.

ANSI BASIC provides a full comple-

ment of advanced control structures, named subroutines, long variable names, and array-manipulation statements. Array manipulation statements use the keyword suffix MAT, an abbreviation for matrix. With the MAT suffix, you can read data into arrays, put data into arrays, add or subtract or multiply arrays, and print arrays. In most microcomputer BASICs, these operations require looping, using the loop index as the array subscript.

Because ANSI BASIC attempts to make the GOTO and GOSUB statements unnecessary (although it does include them), it replaces the `ON . . . GOTO/GOSUB` construct with the SELECT/CASE structure. Similar to Pascal's CASE statement, ANSI BASIC's SELECT/CASE allows multiple path branches according to evaluated expressions. True BASIC even allows ranges within the CASE evaluation, as in `CASE 0 TO 9`.

Control structures in ANSI BASIC include DO loops, using both WHILE and UNTIL modifiers at either the beginning or the end of the loop block, as well as the common FOR/NEXT loop. In addition to older IF/THEN decision structures, ANSI BASIC adds multiway decision coding using the ELSEIF/ENDIF construct.

programming situations. The programs execute a speeds that are comparable to those of other compiled BASICs. The company reportedly has a run-time package under development that will eventually permit the distribution of executable True BASIC programs.

The lack of a screen display during the compile process is a substantial error. Many people will get nervous during long program compilations, which could be several minutes, when the machine appears to be hung, doing nothing. A simple PROGRAM NOW COMPILING message might alleviate this tension.

The ultimate conclusion I draw about True BASIC is that it is superior to Microsoft BASIC as a programming language. Its strengths are its modularity, portability, graphics, and high-quality math package. Its weakness is its lack of compatibility with existing BASICs. ■

REFERENCES

1. Kurtz, Thomas E. "On the Way to Standard BASIC." *BYTE*, June 1982, page 182.
2. Anderson, Ronald. "The Proposed ANSI BASIC Standard." *BYTE*, February 1983, page 194.
3. ANSI X3J2. "Draft Proposed—ANS for BASIC." *X3J2 Report 84-10*, 1984.
4. Stewart, George. "True BASIC." *Popular Computing*, November 1984, page 95.
5. Wadlow, Tom. "Turbo Pascal." *BYTE*, July 1984, page 267.

BYTE International Advertising Section



Microcomputer Cost Comparisons

Percent of suggested retail prices, minimum configuration

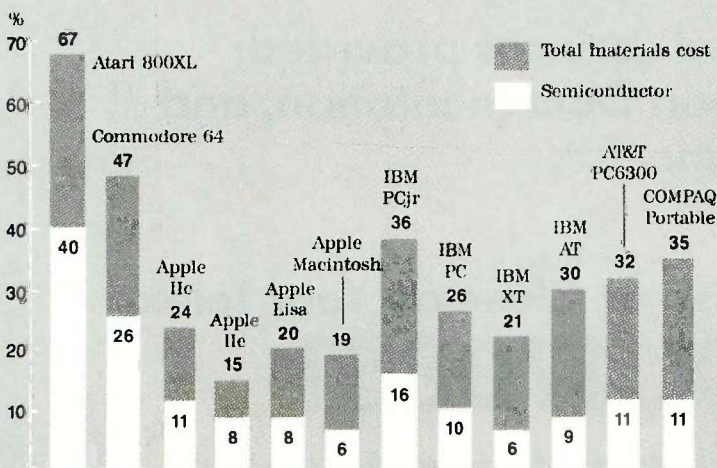

Source: *Future Views*, 2/4/85; Future Computing Inc. ©

Advertisers in this Section

Inquiry No.	Page No.
500 AMERICAN BUYING & EXPORT	288B
* BYTE	288D, 288J, 288K
501 CASIO	288C
504 DYADIC SYSTEMS LTD.	288F
505 ENTER COMPUTER	288L
506 ENTER COMPUTER	288I
503 GREY MATTER	288F
502 HELIX EXPERT SYSTEMS	288E
* MICROMINT	288H
512 MULTITECH INDUSTRIAL CORP.	288G
522 MULTITECH INDUSTRIAL CORP.	288I

No domestic inquiries, please.

For Advertising Information, Call:

England: Arthur Scheffer, 44-01 493 1451
France: Jean-Christian Acis, 33-720 33 42
Italy: Savio Pesavento, 39-86 90 656
Japan: Hiro Morita, 81-581-9811
U.S.A.: J. Peter Huestis, 1-603-924-9281
West Germany: Fritz Krusebecker, 49-72 01 81

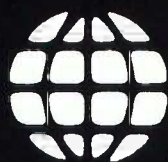

Exporting Services

**We Are Buyer's Agent for
Overseas Dealers and Distributors**

- Lowest prices, immediate quotations,
prompt delivery.**
- Access to all major hardware and
software manufacturers.**
- All professional services provided:
Licensing, Export Documentation, and
Follow-through.**

**24-Hour Response as Close as Your Telex
TELEX 470851**

**American Buying and Export Services
1042 Country Club Drive, Moraga, CA 94556
(415) 376-7600**

CASIO®



Get It Right The First Time!

CASIO FP-6000S MEANS BUSINESS

Improves Efficiency, Increases Productivity

Casio puts a powerful management tool at your fingertips with the FP-6000S. Business oriented architecture and secretarial support functions improve the quality of office work and increase productivity. In fact, the entire system has been designed with the needs of the modern office in mind.

State of the Art Precision and Performance

Decimal based arithmetic functions allow computational accuracy available only with the FP-6000S. High speed, high resolution graphics supply the tools for presentation of complex ideas. Extensive software provides wide versatility.

Superlative Cost Performance

The cost effectiveness of the FP-6000S is almost too good to be true! A wide range of peripherals keep pace with organizational growth making expensive system upgrading unnecessary. Discover a new dimension of office management systems with the FP-6000S personal computer.

CASIO
FP-6000S
16-BIT PERSONAL COMPUTER

CASIO COMPUTER CO.,LTD.

2-6-1, Nishi-Shinjuku, Shinjuku-ku, Tokyo, Japan TEL. 347-4814 TELEX J26931 CASIO



BYTE. International Trader To The World Micro Market.

If you've been waiting for the lines of communication to open up in the international micro market, you've been wasting your time. **BYTE** is not only in touch with the market: *BYTE is the market.* We communicate regularly with the top microcomputing professionals and business people all over the world.

We are *the* international standard in micro publications. That's why our readers rely on our editorial *and* ads to deliver the latest in available micro products and services. And when we deliver, 94.5% of our readers take action on the ads they read.*

If you need a communications link to impact the international marketplace, or for the International or Domestic Subscriber Profile, call your **BYTE** sales representative now. The waiting is over.



*Source: 1984 Subscriber Profile

For subscription information in Europe, call
Jean Tobias in England: 062-23431

For advertising information, call:

Austria	Hans Csokor	75 76 84
Israel	Gurit Gepner	866 561 321 39
W. Germany	Fritz Krusebecker	72 01 81
Spain	Maria Sarmiento	45 52 891
Sweden	Andrew Karnig	46-8-44 0005
France	Jean Christian Acis	720 33 42
England	Arthur Scheffer	01 493 1451
Italy	Savio Pesavento	86 90 656
Singapore	Seavex Ltd.	734-9790
Hong Kong	Seavex Ltd.	5-260149
Japan	Hiro Morita	581-9811
U.S.A.	Peter Huestis	(603) 924-9281

When Byte Speaks Micro,
The World Listens.

BYTE

THE SMALL SYSTEMS JOURNAL

Helix Expert Systems Ltd brings you

the **Expert System Shell**

for the rapid development of sophisticated rule based expert systems.

- Programmed in 'C' for ultra fast execution.
- Runs on the IBM PC and PC Compatibles.
- Handles uncertainty and fuzzy logic.
- Exceptionally easy to use in creating and amending a knowledge base.
- Extensive windowing capabilities which can be tailored to user's own requirements.
- Other features include
 - 'Why' facility explains current line of reasoning.
 - 'How' facility explains deductive chain.
 - Context sensitive Help text.
 - Menu option selection.
 - Interactive and batch rule input.
 - Natural language interface.
 - Multilevel general and specific rule facility
- **tess** was developed by Helix Expert Systems Ltd. as the Nucleus Expert User System (NEXUS) Inquiry 502

I am very keen to find out more about **tess**

- Please send me further information
- Please send me a demonstration system. I enclose my cheque for £60.00 made payable to Helix Expert Systems Ltd.

(Please allow 28 days for delivery)

Name:

Position:

Company Name:

Address:

Telephone:

Helix Expert Systems Ltd., 11 Ludgate Circus, London EC4M 7LQ
Tel. 01-248 1734

PASCAL COMPILERS

Our wide range includes the new version 3.0 of TURBO Pascal and Microsoft & DR products at bargain prices. We also have a selection of Pascal Libraries and Toolboxes.

8-bit Nevada Pascal (JRT4) £ 40
Turbo Pascal v3.0 £ 65
DR Pascal/MT+ £ 99
Pro Pascal £199

16-bit Utah Pascal (JRT) £ 40
Turbo Pascal v3.0 £ 65
Microsoft Pascal £ 95
SBB Personal £160
SBB Professional £395
Practical Pascal £145
Pro Pascal £290
DR Pascal/MT+86 £295

Prices include delivery in Europe but not VAT or other local taxes.
For information or advice call us.

GREY MATTER
4 Prigg Meadow, Ashburton, Devon TQ13 7DF.
TEL. (0364) 53499

Inquiry 503

REDUCE

YOUR APPLICATION
DEVELOPMENT TIME BY

OVER 70%

WITH

dyalog APL

Dyalog APL is available for most UNIX* systems at prices ranging from under £1,000 for the IBM PC/AT to as little as £5,000 on a VAX, and is backed by Dyalog's expert and professional support, training and consultancy services.

Call or write today to
Sales Department, Dyalog Systems Limited, 30 Camp Road, Farnborough
Hampshire GU14 4EW, England. Telephone: (0252) 547222 Telex: 858811
Dyalog is a member of the ICL Group of companies.
IBM is a registered trademark of International Business Machines Corp
*UNIX is a trademark of AT&T Bell Laboratories
VAX is a trademark of Digital Equipment Corp

Inquiry 504

MODULA-2 & ADA

New this month to our large range of Modula-2 and Ada subset compilers is the Interface Technologies Compiler, a delightful product for the IBM PC.

MODULA-2 COMPILERS

Modula Corp (MS-DOS, Apple) £ 85
JRT (CP/M-80) £ 90
Volition (various) from £ 265
Logitech (MS-DOS, CP/M-86) £ 380
Interface Technologies (PC-DOS) £ 250

ADA (subset) COMPILERS

Augusta (CP/M-80) £ 80
Supersoft (CP/M-80) £ 180
Janus (CP/M-86, MS-DOS) £ 895

Prices include delivery in Europe but not VAT or other local taxes.

For information or advice call us.

GREY MATTER
4 Prigg Meadow, Ashburton, Devon TQ13 7DF.
TEL. (0364) 53499

Inquiry 503

C COMPILERS

We have new versions from Aztec, Wizard and Toolworks and several new libraries this month, and also lower prices for Lattice & Aztec.

8-bit Aztec C II v1.06D £165
Aztec C65 v1.05C £165
BDS C v1.50a £110
Toolworks C/80 v3.1 £ 49
Eco-C v3.1 £185
Q/C v3.2c £ 80

16-bit Aztec C86/BAS v1.06D £165
Aztec C86/PRO v3.2 £375
CI Optimizing C86 v2.2 £360
C-Systems C v2.0 £210
De Smet C88 v2.4 £145
Digital Research C v1.1 £265
Instant-C v1.01 £425
Lattice C v2.14 £375
Mark Williams MWC86 2.0 £450
Microsoft C v2.03 £435
RUN/C v1.1 £130
Toolworks C/86 v3.1 £49
Wizard C v2.1 £425

C LIBRARIES

Data base C-tree (source) £395
Multikey £170
db-VISTA (source) £465
V-FILE £295
Btrieve £245
C-to-dBase (source) £150
Phact £250
SoftFocus Btree (source) £ 90

Graphics Halo £200
C Tools (source) £110

Screen Panel £245
Lattice Windows £295
Windows for C £195

Misc Greenleaf Functions, scc £175
C Food Smorgasbord £150
Plink-86 £395
C Helper, source £135
C Refiner £145
Basic C £175
Bastoc £325

More libraries not listed here.
Prices include delivery in Europe but not VAT or other local taxes.
For information or advice call us.

GREY MATTER
4 Prigg Meadow, Ashburton, Devon TQ13 7DF.
TEL. (0364) 53499

Inquiry 503

TO ADVERTISE IN
BYTE EUROBITS
FOR AS LITTLE AS
\$300
CALL EITHER YOUR
LOCAL BYTE OFFICE
OR
BRENDA COOMBER
AT GREY MATTER ON
(UK) 0364 - 53499

DISK COPYING SERVICE

Moving data and program files from one machine to another is often made difficult because different manufacturers have adopted different disk format standards.

We can copy your files to and from over 400 disk formats including CP/M, CP/M-86, MS-DOS, PC-DOS, ISIS, APPLE, SIRIUS, TORCH, APRICOT, HP150, TRSDOS, DEC RT-11, and IBM BPF.

Disks are normally despatched within 48 hours of receipt.

Our charge is £10.00 + disk and we give quantity discounts. Our price includes return delivery by first class mail in Europe but not VAT or other local taxes.

For more information call us.

GREY MATTER
4 Prigg Meadow, Ashburton, Devon TQ13 7DF.
TEL. (0364) 53499

Inquiry 503

HIGH-LEVEL LANGUAGES

The products listed here are crudely grouped as very high level languages. In fact there are great differences between them. If you suspect that you need more than a conventional 'procedural' language to solve your problem then we can advise you.

PROLOG

8-bit micro-PROLOG £ 75
PROLOG-1 £225

16-bit PROLOG-86 £135
micro-PROLOG £180
micro-PROLOG + APES £350
PROLOG-1 £299

LISP

8-bit Toolworks LISP/80 £ 45
iLisp £ 80
Waltz Lisp £170
mLisp-80 £190

16-bit Toolworks LISP/86 £ 45
BYSO LISP £ 95
IQ Lisp £195
mLisp-86 £240
Gold Common Lisp £550

NIAL, SNOBOL, muMATH

muMath/muSimp from £240
Q'Nial (IBM PC) £350
SNOBOL+ £ 85

EXPERT SYSTEM SHELLS

Micro Expert £500
APES £180
ES/P ADVISOR £595

SMALLTALK

Methods (PC-DOS) £280

Prices include delivery in Europe but not VAT or other local taxes.
For advice or information call us.

GREY MATTER
4 Prigg Meadow, Ashburton, Devon TQ13 7DF.
TEL. (0364) 53499

Inquiry 503

What others call options Multitech calls standard

With most computers, multitasking systems are expensive extras. But with the Multitech MPF-PC, the multitasking Concurrent DOS operating system is standard.

12 34 IBM Compatibility and Multitasking

Concurrent DOS handles all the most popular software written for the IBM PC, while multitasking increases your productivity by dividing your video display into as many as four different windows, providing simultaneous viewing and access to all your favorite application software programs.

Keyboards In Nine Languages

Yet besides these standard features, we still offer an impressive array of options, including a choice of nine keyboards—German, English (U.K.), French, Danish, Norwegian, Swedish, Finnish, Italian, and Spanish—plus a 10MB hard disk drive and software options of Personal BASIC and MS DOS.

Authorized Distributors: **TAIWAN:** Sertek International Inc., Taipei, tel. 7134022, **SINGAPORE:** AVS Electronics Pte Ltd., tel. 2967211; **HONG KONG:** Dragon Computers Ltd., Kowloon, tel. 3-7443516, **THAILAND:** Sahavirlya Infotech Computer Ltd., Bangkok, tel. 235-1887; **PHILIPPINES:** Philand Group, Makati, tel. 85-54-12; **INDONESIA:** PT. Bukit Centera Graha Scientific, Jakarta, tel. 760733; **AUSTRALIA:** Sigma Data Co., North Sydney, tel. 439-6211.

Specifications:

Microprocessor:
16 bit 8088, with optional 8087

User Memory:
Standard 256K,
expandable to 640K bytes

ROM Memory:
8K byte bootstrap routines

Auxiliary Storage:
Dual 5.25 inch floppy disk drives

Communications:
One RS-232C port, fully
programmable
One parallel port with Centronics
interface

Color Graphics Text:
40x25 or 80x25 text
16 foreground and 8 background
colors 256 character ASCII set

Graphics Mode:
320x200 4 color display
or 640x200 black-and-
white display

Interface:
NTSC composite or RGB output

Standard Operating System:
Concurrent CP/M-86, Version 3.1

System Expansion Ports:
5 IBM PC compatible slots

Optional Software:
Personal BASIC
MS-DOS operating system

OEM AND DISTRIBUTOR ENQUIRIES WELCOME

For more information on
the MPF-PC, contact us at:



Multitech INDUSTRIAL
CORP.

9Fl., 266 Sung Chiang Road, Taipei 104, Taiwan, R.O.C.
Tel: (02)551-1101 Telex:19162 MULTIC FAX: (02)542-2805

NYD-85-188

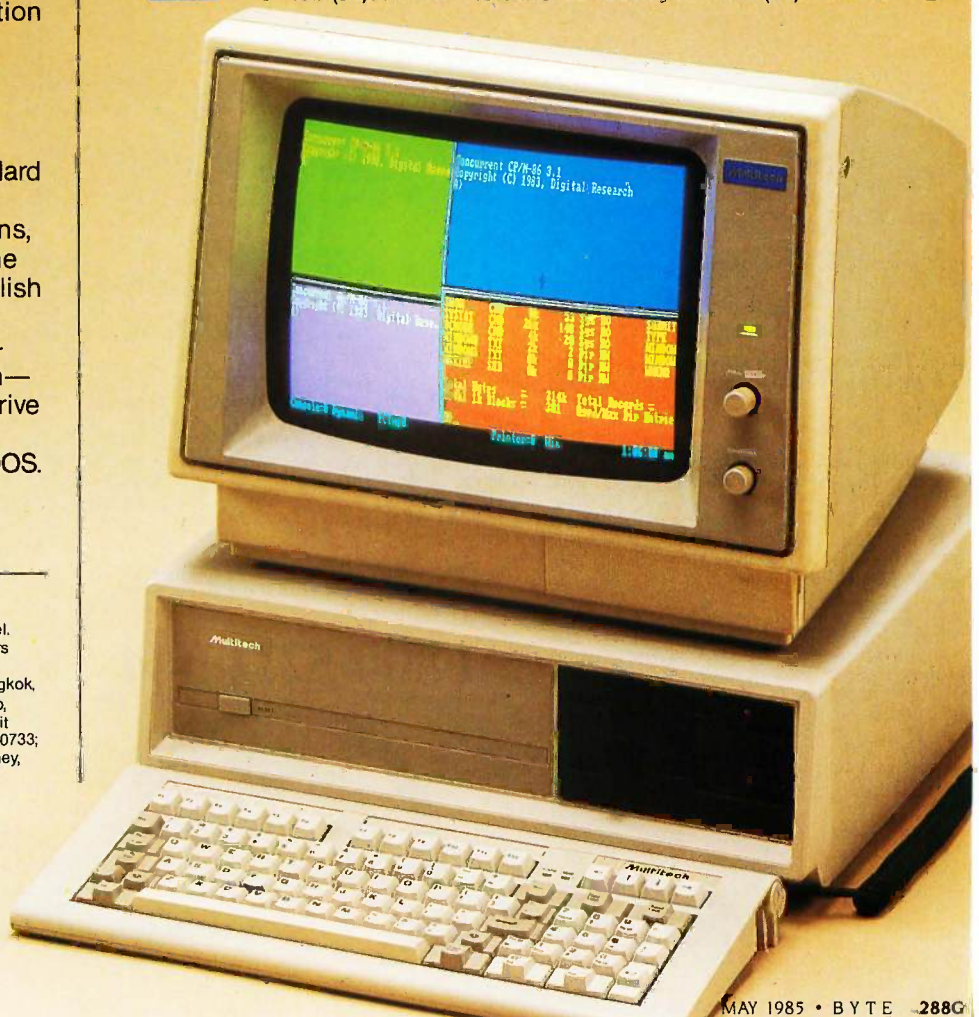

Cure development headaches with our \$105* Controller

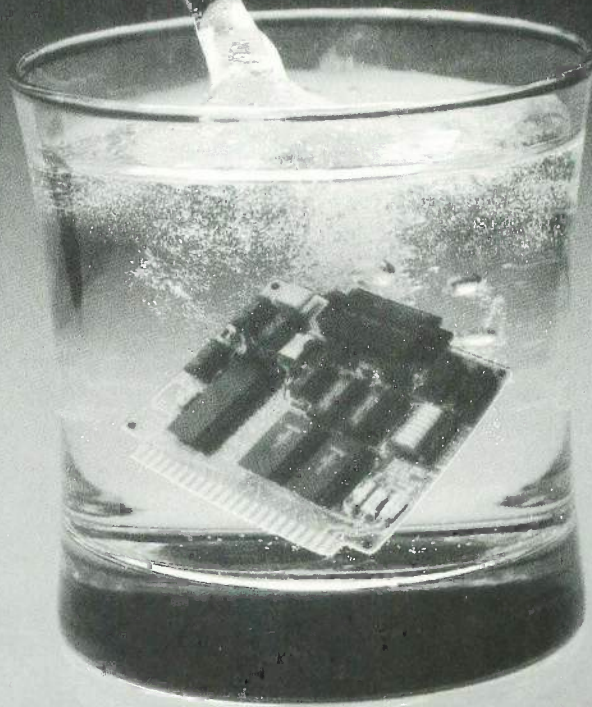

* BCC11 100 quantity of
qualified buyers' price.

At \$105, Micromint's System Controller is a dirt cheap development tool without equal.

It'll turn your IBM PC into a design laboratory that saves your company thousands of dollars and months of evaluation. You'll save headaches, too. When you tell your boss the first phase of your pet project is only going to cost \$105, watch the relief begin.

Micromint's Z8 System Controller, the tiny computer on a board, is the cornerstone of an entire family of integrated, intelligent products from AC/IO to smart terminals. Able to speak three languages (BASIC, FORTH and Assembly), this tiny 4" x 4 1/2" computer supports 6K bytes of EPROM or 4K bytes of RAM, two parallel ports and an RS-232 serial port.

If learning a new language isn't in your future, no problem. **WRITE YOUR PROGRAMS IN BASIC AND TRANSLATE THEM INTO FORTH WITH A SINGLE KEY STROKE.** Our specially masked chip will let you know in an instant whether your program is operational. You'll be building before the competition is de-bugging.

For OEM Orders and Customer Assistance Call Our Toll Free Line

1-800-521-0044



Call or write for a complete product line brochure. Or order our complete set of 12 fully detailed owners' and technical reference manuals for only \$29.95. This set includes all of the following manuals:

- Z8 FORTH System Controller
- Z8 BASIC System Controller
- BASIC/Debug Software Reference
- Z8 Microcomputer Assembly Language/Hardware Technical Reference
- Memory and I/O Expansion
- EPROM Programmer
- Analog to Digital Converter
- 16K Memory Expansion
- Serial I/O Expansion
- RS-232/20mA Converter
- Smart Video Terminal
- AC/DC Power I/O

ORDER PRODUCT CODE BCC99.

Micromint, Inc.

Dept. 14, 25 Terrace Drive, Vernon, CT 06066

**The Compact
Microcomputer
Learning Kit That's
a Hands On Library
of Hardware And
Software Instruction**



MEET THE MICROPROFESSOR I/88

Learn the 8088

The MicroProfessor I/88 has everything you need to understand the fundamentals of the 8088 microprocessor.

Improve Your Computer Skills

Your computer skills will increase dramatically as the MicroProfessor translates important concepts into practical experience. Learn programming, assembly language, and also how to burn in your own chips. And with a wealth of accessories, including a printer, EPROM programming board and Forth Language option, there's no limit to the applications you can develop.

A Portable Learning Environment

Learning shouldn't be limited to the classroom. That's why we made the MicroProfessor lighter and less bulky than the average textbook. Supported by easy to understand manuals, the MicroProfessor leads you through

dozens of experiments. You can even open the MicroProfessor's case to look at the system board's components as you learn their functions.

An Affordable Computer Education

Today, tight budgets are a fact of life. At less than half the price of comparable learning kits, the MicroProfessor is a very attractive educational resource.

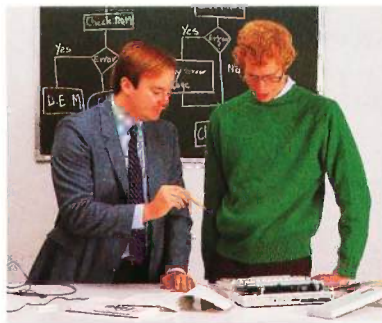

For more information about putting the MicroProfessor to work in your computer education, please contact the Multitech distributor in your area.



Multitech INDUSTRIAL CORP.

9FL 266 SUNG CHIANG ROAD, TAIPEI 104, TAIWAN, R.O.C.
TEL: (02)551-1101 TELEX: 19162 MULTIC FAX: (02)542-2805

Inquiry 522

Authorized Distributors: **WEST GERMANY:** Conrad Electronics GmbH, Hirschau, tel. 9622/30148; **UNITED KINGDOM:** Flight Electronics Ltd., Southampton, Hampshire, tel. 0703-34003; **FRANCE:** Sari Zading Micro, Cote La Foret, tel. 657-14-24; **ITALY:** Zelco S.R.L., Milano, tel. 803336; **NETHERLANDS:** Sciento B.V., 's-Hertogenbosch, tel. 424022; **SWITZERLAND:** Simpex Electronics AG, Zurich, tel. 418111; **SWEDEN:** Roslagsdata, Bromma, tel. 26-86-56; **NORWAY:** Elektronix A/S, Oslo, tel. 56-71-40; **FINLAND:** Ring-Master OY, Helsinki, tel. 544-544; **DENMARK:** Ditz Schweitzer A/S, Glostrup, tel. 45-30-44; **GREECE:** Athens Microcomputers Ltd., Athens, tel. 644-8263; **TURKEY:** Imper Elektrik Sanayi Ve Ticaret AS, Istanbul, tel. 1450084; **AUSTRALIA:** Emona Enterprises Pty Ltd., Sydney, tel. 212-4815; **SOUTH AFRICA:** Embel Micro Systems (Pty) Ltd., Cape Town, tel. 23-6177; **CHILE:** Cientec Instrumentos Ltd., Santiago, tel. 747028; **HONG KONG:** Idealand Electronics Ltd., Kowloon, tel. 3-7443516; **TAIWAN:** Seritek Int'l Inc., Taipei, tel. 713-4022; **SINGAPORE:** AVS Electronics Pte Ltd., tel. 2932937; **THAILAND:** Sahaviriya Inforteck Computer Co. Ltd., Bangkok, tel. 235-7366; **INDONESIA:** P.T. Bukit Centera Graha Scientific, Jakarta, tel. 760-7333; **INDIA:** Kryptonix Int'l, Trivandrum, tel. 63805; **SAUDI ARABIA:** Modern Electronic Systems Co. Ltd., Riyadh, tel. 4650041; **KUWAIT:** Commerce & Technology Co., tel. 424525; **BAHRAIN:** Computer World, Manama, tel. 455566; **PAKISTAN:** East & West Systems, Karachi, tel. 516635; **USA:** Multitech Electronics Inc., Sunnyvale, California, tel. (408)733-8400

This advertising success story is part of a series which measures the results of advertising placed in BYTE magazine. Remember, *BYTE means business*, and the *business is micros!*

Micro Design International Inc.

"BYTE readers have a knowledge profile that allows us to sell our products direct, without any costly education cycle."



William W. Bussey

Bill Bussey
Vice-President
Micro Design International Inc.

Douglas & Caldes

Douglas Caldes
President
Micro Design International Inc.

1

The BYTE Choice:

First in the 1985 Series

Why Micro Design International Inc. chose BYTE:

"After testing the direct sales market through several microcomputer publications, we found that BYTE simply outperformed the others in many ways. First, it reached a broader range of readers, from technical people to hobbyists. Second, BYTE's readers have a knowledge profile that allows us to sell our products direct, without any costly education cycle. And third, BYTE has a built-in reputation with its readers, which was absolutely essential to a new company like ours."

THE FOOL PROOF XT/PC TAPE BACKUP

THE WORLD OF PC UPGRADES

MT10	10 Mega-Byte Tape Backup "Add it to your XT"	\$995
XT01	Micro Tape Backup and 1/2 High floppy "Add it to your XT"	\$695
SD10	10 Mega-Byte Hard Disk with Controller	\$795
SD10R	10 Mega-Byte Removable Hard Disk/Controller	\$1295
Z501	50 Mega-Byte Hard Disk with Controller	\$1095
SD33	33 Mega-Byte Hard Disk/Controller & Power Supply	\$1995
PS5	Power Supply "Mount it (100 Watts)"	\$695
SD33	33 Mega-Byte Hard Disk/Controller Card (10 Mega-Byte Removable)	\$895
SD33	33 Mega-Byte Hard Disk/Controller Card (10 Mega-Byte Removable)	\$1195

WITH THE PURCHASE OF ANY HARD DISK

FREE

COMMAND/ASSIST \$49.95 (DOS manual on disk) (not removed in PC Upgrade)

AND

CRASH/RESIST \$49.95 (for hoster disk access)

TO ORDER CALL COLLECT (305) 677-8333
MasterCard/Visa/Credit or Money Order

Micro Design International Inc.
6500 University Blvd., Winter Park, Florida 32792 (305) 677-8333

About the Ads:

"Our ads concentrate on value—what the buyer gets for his money. We don't need to use persuasive copy because our prices do all the selling. We have no reason to hide our prices because our buyers realize they're the best around. Our headline spells it out."

"With the large success we've had selling sub systems direct through BYTE, we're anxious to begin marketing our latest development, the Command/Assist™ program which has taken the DOS manual and put it on disk."

- Ad prepared in house.

About the Results:

"Because of its solid reputation and credibility with its readers, the first ad we ran in BYTE started bringing in orders for us. No other publication brought us such fast results."

"Most of our sales are made direct by phone, so it's difficult for us to track the exact number of leads that BYTE generates, but we do know that about 65% of our sales are attributed to our exposure in BYTE."

"... about 65% of our sales are attributed to our exposure in BYTE."

Company History:

"Micro Design International Inc., located in Winter Park, Florida, was formed in 1977 as a research, development and service support company by Douglas Caldes and William Bussey. In 1984 Micro Design International Inc. entered the IBM peripherals add-on market and hired Arnold Jones to head the software support department."

"With its first product, a 10 Mega-Byte Winchester disk upgrade kit for the IBM-PC, which sold for only \$995, the company expanded its product line to include Winchester disk drives from 10 to 40 mega-bytes, tape drives, floppy diskette drives, various controllers and upgrade power supplies. Through this wide assortment of products MDI has positioned itself as a company that can furnish a total internal solution to its customers."

"Micro Design International Inc. is now expanding further into the software market with its introduction of Command/Assist™, a program which has taken the DOS manual and put it on disk. In this way your DOS manual is available any time you need it with just a few key strokes."

BYTE

For advertising information, call:

England: Arthur Scheffer, 44-01 493 1451; France: Jean-Christian Acis, 33-720 33 42; Italy: Savio Pesavento, 39-86 90 656; Japan: Hiro Morita, 81-581-9811; United States: J. Peter Huestis, 1-603-924-9281; West Germany: Fritz Krusebecker, 49-72 01 81



You will save millions with...

INTERNATIONAL DISTRIBUTORS

Australia

Kenelec (Aust) Pty. Ltd.
Phone: (61)(03) 560-1011
Telex: 35703

Belgium

T. M. Data Belgium N.V.
Phone: (32) (2) 721 48 30
Telex: (846) 23940 TMART B

Denmark

E. V. Johanssen Elektronik A/S
Phone: (45) (1) 83 90 22
Telex: (855) 16522 EVICAS

Finland

OY Fintronic AB
Phone: (358) (0) 692-6022
Telex: (857) 124224 FINTRON

France

Technology Resources
Phone: (33) (1) 757 3133
Telex: (842) 610657 TERES

Germany (West)

Computer 2000 GmbH
Phone: (49) (89) 260-9466
Telex: (841) 5214562

Neumueller GmbH

Phone: (49) (89) 611 2080
Telex: (841) 529707 NEUM D

Hong Kong and Taiwan

Gemini International Corporation
Phone: (818) 355-1016
Telex: 67-5348

Greece

Marathon Data Systems
Phone: (30) (01) 7245541
Telex: 210597

Israel

MLRN Electronics Corporation
Phone: (972) (03) 700041
Telex: 342107

Italy

D. D. P. SRL
Phone: (39) (11) 650 51 85
Telex: (843) 224016

Japan

Columbia Import + Export Co. Ltd.
Phone: (03) 291-0641
Telex: (781) 262-79

Jordan

Pan Arab Computer Center
Phone: (962) (06) 674635
Telex: 21279

Kuwait

Marafie Sons Company
Phone: (965) 424943
Telex: 22661

Netherlands

TM Data Netherland or Terminal Mart
Holding
Phone: (31) (2159) 46814
Telex: (844) 73060

Norway

T. M. Data Norge
Phone: (47) (2) 703120
Telex: (856) 17452

Qatar

Qatar Computer Services
Phone: (974) 873113

Saudi Arabia

Canar Trading Establishment
Phone: (966) (03) 8985196
Telex: 670729

Al-Dabal Company

Phone: (966) (03) 820578
Telex: 601124

South Africa

Spescom (Pty) Ltd.
Phone: (27) (11) 836-9181
Telex: (960) 486273 or 421628

Spain

First S.A.
Phone: (34) (3) 323 03 90
Telex: (831) 53947 FIRS E

Sweden

TM DATA Sverige AB
Phone: (46) (8) 714 07 70
Telex: (854) 16737 TMART S

Switzerland

Rodata AG
Phone: (41) (1) 820-1613
Telex: (845) 59471



United Kingdom

Electroplan Limited
Direct Order: (763) 48145
Phone: (44) (763) 41171
Telex: (851) 81337

Reflex Ltd.

Phone: (44) (734) 884611
Telex: (851) 848927

Middle East and Far East

American Steel Export Co.
Phone: (212) 661-2700
Telex: (71) 427284

Enter Computer's
international distribution
provides super fast
access and delivery for
your

Sweet-P®

Enter Computer's Sweet-P®

Sweet-P Model (SP600)

A six-pen graphics plotter that's more compatible . . . uses more software.

Last year 430 million business slides were made at a cost of \$3.2 billion. Most of these slides were manually generated.* These slides could have been made on Sweet-P® Personal Plotters™. Faster and better. With a savings of millions of \$!

The Sweet-P SP600 is a high quality American made precision machine. It's fast. It plots 14 inches per second. It's beautiful for office and technical work.

Over 100 graphics software packages drive the Sweet-P™ world famous packages like Lotus 1-2-3™, Framework™ and Super-Calc™ technical software like AutoCAD™, PCAD Robographics™ and dedicated business graphics software such as Micro-soft Chart, ChartStar™, Energraphics™, Chart-master™ and pfs Graph™.

Pens are capped automatically when not in use, so that pens last longer and start quicker.

only \$1,095

The Sweet-P easily connects to almost any computer. It has RS-232 serial and Centronics™ parallel connectors. And it supports two standard graphics languages—Sweet-P Graphics Language (SPGL™) and Hewlett-Packard Graphics Language (HPGL™).

The Sweet-P plots on almost any media. Make brilliant overhead transparencies. Plot on film, and on plain and coated papers.

Save on wiring costs too. The Sweet-P will "eavesdrop" on the RS-232 cables that connect your terminals now. (This makes it easy for Sweet-P to join local and long distance networks.)

What about support? Sweet-P customers get fast professional help with software, hardware and interface questions. And warranty and service support is quick.

Sweet-P Model 600 also comes with 18 ANSI ASCII internal character sets.



U.S. DISTRIBUTORS

Arizona

First Source Distributing
(602) 263-1950

California

Zenith Data Systems • (415) 621-8545

Softsel Computer Products, Inc.
(213) 412-1700 • (800) 645-7777 Toll Free

Colorado

Ares Distributing • (303) 752-2972

Georgia

Pryor Corporation • (404) 987-0300

Illinois

PC Distributing • (312) 356-4812
Zenith Data Systems • (312) 562-7300
Pryor Corporation • (312) 736-0855
(309) 688-9585

Kansas

Inland Computer • (913) 492-9100

Maryland

Federal Data • (301) 986-0800
Pryor Corporation • (301) 992-0040

Massachusetts

IMF Sales Associates • (617) 245-8900

Missouri

Computime, Inc. • (314) 991-2991

North Carolina

Allison-Erwin • (704) 334-8621

New Jersey

Pryor Corporation • (201) 935-2525

Ohio

Pryor Corporation • (614) 436-8281

Pennsylvania

Peirce Phelps, Inc. • (215) 879-7068
Pryor Corporation • (412) 741-2920
Chessell Robocom • (215) 968-4422

Tennessee

Multi Computer Products
(615) 528-7777

Texas

AMCAD, Inc. • (214) 323-0700
National Marketing Inc.
(214) 386-8151

Washington

Comquest Systems • (206) 641-7650

Wisconsin

Pryor Corporation • (414) 778-3865

Canada

Altel Data • (403) 259-7814
Interworld Electronics Inc.
(604) 984-4171
The Pringle Group
(416) 449-5640

Enter Computer Inc.
6867 Nancy Ridge Dr.
San Diego, CA 92121

619-450-0601

California-800-227-4371

800-227-4375 • TELEX-181740

Come see us at Comdex Spring/
Atlanta, GA, May 6-9, Booth 2636

Trademarks: Sweet-P, Six Shooter, Personal Plotter, SPGL, Enter Computer, Inc., HPGL, Hewlett-Packard, Lotus, Lotus Development Corp., Framework, Ashton-Tate, Super-Calc, Sorcim, Inc., AutoCAD, Autodesk, PCAD Robographics, Chessell-Robocom, Inc., Chart Star, Micro-Pro Int'l Corp., Energraphics, Enertronics Research, Inc., pfs Graph, Software publishing Corp., Chart-Master, Decision Resources, Centronics, Centronics Corp.

Source notes *Yankee Group, The Technical Office, Vol. III 1983
**Winham School Study, September 1991

Inquiry 155 for Dealers.

Inquiry 156 for End-Users.



*Equipping a PC for business takes a hard disk. Turn to **SYSGEN™** when you want the best.*

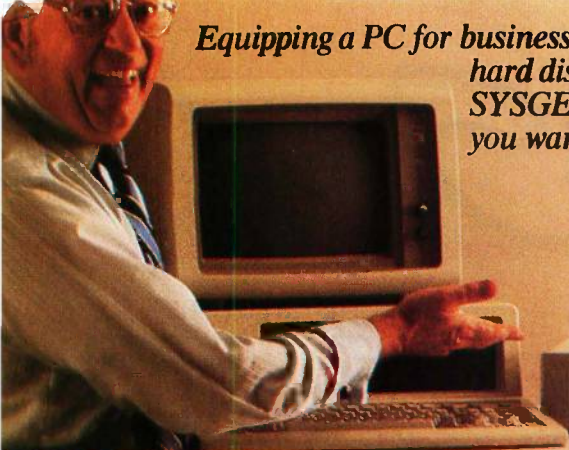

Smart disk users insist on tape for data file back-up.

***SYSGEN** is the leader.*



*And, if your needs begin to exceed the limits of PC memory and slot expansion, **SYSGEN** has the solution.*

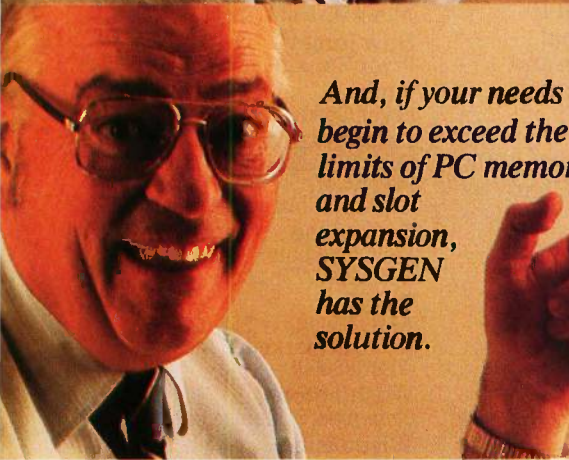

18 Megabytes and 6 expansion slots for the PC, XT, or AT™. \$1995.

For demanding PC owners who need more versatility and memory, Sysgen introduces a powerful, reliable, and unique solution: The DISK I/O™.

It includes 6 new expansion slots for your choice of plug-in



boards, plus, an 18 MByte hard disk—all for slightly more than a hard disk alone.

Sysgen offers the full range of expansion, storage, and tape back-up solutions with the best performance ratings for the IBM® PC, XT, AT and compatibles.

For more information on the Sysgen family of expansion products contact your local dealer.

SYSGEN 47853 Warm Springs Blvd.,
Fremont, CA. 94539
INCORPORATED (415) 490-6770 Telex 4990843

Trademarks: Sysgen, DISK I/O—Sysgen, Inc.; AT—International Business Machines Corporation. Registered trademarks: IBM—International Business Machines Corporation.

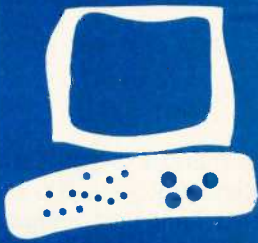

The GTX-100 Modem

An intelligent device with built-in security functions

BY MARK HAAS

The GTX-100 is an intelligent 300/1200-bps (bits per second) modem that claims to provide four levels of security for the computer to which it is attached. Until recently, Lockheed-GETEX, makers of the GTX-100, called it the Data Sentry and advertised it as "so secure even Mata Hari couldn't hack it."

The GTX-100 contains a Z80 microprocessor that controls all of the modem's functions. CMOS (complementary metal-oxide semiconductor) memory with battery back-up stores the data the security functions are based on. The unit measures 8½ inches wide, 10 inches deep, and 2 inches high; it's constructed of good-quality plastic.

The GTX-100's front panel contains eight LEDs (light-emitting diodes) that indicate the modem's status (off hook, carrier detect, etc.). Also on the front panel are three rocker switches. The first is an Answer/Originate switch that you use to set these protocols when connecting without dialing, as when using a leased line. The center position of this switch permits voice operation with a telephone connected to one of the jacks on the rear panel. The Test switch puts the modem into an analog loop so that what the connected terminal sends is echoed back. After a while this function automatically times out and puts the modem back into normal operation. The Remote/Local switch controls an optional power-on device and does not control the modem's remote and local modes.

The rear panel contains two RJ11C jacks for connection to the phone line and the telephone; a DB-25 connector; a four-position miniature switch that sets the data format, parity, carrier-detect/data-terminal-ready signal activation, and mode of operation (English responses or single-character codes); and a voltage regulator mounted on a heatsink.

Connecting the modem to my office computer was fairly straightforward, and the manual provided good directions. An RS-232C cable (not supplied) connects the

rear-panel jack to the computer's RS-232C port. Tapping a few keys on the keyboard while my communications software was in Terminal mode confirmed proper operation.

MODEM SMARTS

When you first turn the GTX-100 on, it runs a diagnostic on itself and then awaits a carriage return from the terminal (or computer) connected to it. This allows the modem to determine the proper data rate (300 or 1200 bps) automatically.

You are then ready to enter commands. The GTX-100 contains what could be called its own minicomunications package. From its Help menu, the modem's software lets you select the data rate, dial the phone automatically (speed dialing), dial the phone manually by entering a number, dial again the number last dialed, and go to the Security menu.

Speed dialing lets you store up to ten 62-character telephone numbers, including special dialing characters that direct the GTX-100 to pause 5 seconds, wait for a dial tone, or use tone or pulse dialing. Another character lets you link multiple numbers as one entry, causing the modem to dial each number in turn until it detects a carrier. An F in front of a number (or linked list of numbers) tells the modem to dial the number "forever;" and the pause between repeated dialings can be set for 20 to 180 seconds. You can also enter remarks to help identify phone numbers or use the special characters just mentioned while dialing manually. Entering, changing, and erasing numbers is easy.

The GTX-100 can detect several line conditions—dial tone, busy signal, ringing, dead line, and excessive noise—and report these conditions to the operator in English or single-letter codes, as determined by a switch on the rear panel. The modem contains no speaker, but indicators make up for this.

(continued)

DeSmet C

8086/8088
Development
Package

\$109

FULL DEVELOPMENT PACKAGE

- Full K&R C Compiler
- Assembler, Linker & Librarian
- Full-Screen Editor
- Execution Profiler
- Complete **STDIO** Library (>120 Func)

Automatic DOS 1.X/2.X SUPPORT

**BOTH 8087 AND S/W FLOATING POINT
OVERLAYS**

OUTSTANDING PERFORMANCE

- First and Second in AUG '83 BYTE benchmarks

SYMBOLIC DEBUGGER

\$50

- Examine & change variables by name using C expressions
- Flip between debug and display screen
- Display C source during execution
- Set multiple breakpoints by function or line number

DOS LINK SUPPORT

\$35

- Uses DOS .OBJ Format
- LINKs with DOS ASM
- Uses Lattice® naming conventions

Check: Dev. Pkg (109)
 Debugger (50)
 DOS Link Supt. (35)

SHIP TO: _____

_____ ZIP _____

CWARE
CORPORATION

P.O. BOX C
Sunnyvale, CA 94087
(408) 720-9696

All orders shipped UPS surface on IBM format disks. Shipping included in price. California residents add sales tax. Canada shipping add \$5, elsewhere add \$15. Checks must be on US Bank and in US Dollars. Call 9 a.m. - 1 p.m. to CHARGE by VISA/MC/AMEX.

Street Address: 505 W. Olive, #767, (94086)

REVIEW: GTX-100

AT A GLANCE

Name
GTX-100

Manufacturer
Lockheed-GETEX
1100 Circle 75 Parkway
Atlanta, GA 30339
(404) 951-0878

Type
Intelligent modem with security features

Size
8½ by 10 by 2 inches

Equipment Needed
Terminal, or computer with simple communications software and an RS-232C port

Features
300/1200-bps operation, automatic detection of data-transmission rate, automatic dialing and answering, battery backup of memory (protects all menus and tables), force answer/originate mode for leased-line operation, analog loop test with automatic time-out, pulse or tone dialing

Options
Remote-ON power regulation to turn computer on or off remotely

Documentation
48-page manual

Price
\$795

Warranty
1 year, limited

The Modem menu lets you set a variety of modem functions. You can set the modem's hang-up command code, dialing speed (slow or fast only), and local echo, and you can set the modem to answer on a specific ring. You can suppress the status reports from the modem to avoid interference with some communications packages, and you can suppress hang-up upon loss of carrier, thus allowing a mix of voice and data during the same call. The commands the GTX-100 accepts are not compatible with the Hayes Smartmodem.

Note that you can enter commands only from the host terminal. This means no one can "bump" the modem into command mode from a remote terminal and access your files.

SECURITY

What sets this modem apart from other intelligent modems (such as the Hayes Smartmodem) is its built-in security measures. The GTX-100 has four levels of security: call back from list, call back any number, password without call back, and modem only.

In modem-only mode there is no added security and the GTX-100 acts like any other modem. The three remaining levels of security all involve the use of passwords. You can store up to sixteen 20-character passwords in the modem. Entering any one of the passwords is sufficient to gain access to the system. The modem also keeps a log of the last 16 numbers called back and the last 16 passwords entered (whether valid or not). These logs are useful in tracking potential breaches of security.

The highest level of security is the call-back-from-list mode. In this mode, the remote caller dials the modem's number. Upon connection, the modem requests from the caller a phone number it can call back. The modem checks the number entered against a table of authorized call-back numbers. Assuming the number checks out okay, the modem hangs up and then proceeds to dial the call-back number. Once connection is re-established, the modem asks for a

(continued)

Sord Computer Sales Info Hotline

Professional Word Processor/Electronic Mail Portable Computer System IS-11C

- Large 80 × 25 character LCD display
- 80K RAM memory (max. 80KB)
- Notebook size
- Weight 7 lbs.
- Electronic notebook/desk organizer software for busy executives
- Built-in RS232C interface and modem
- Calendar/clock, calculator functions
- Optional Microsoft-compatible BASIC cartridge for software development
- IBM PC data transferability
- Built-in microcassette tape drive
- Optional 3.5 inch floppy disk drive, bar code reader, portable printer, ten-key data-entry pad, 64K CMOS RAM pack with backup battery, spread sheet program

Advanced Word Processing Power

The IS-11C features one of the best word processors available in its class. Full-sized display screen of 80 × 25 lines, multi-windows, storage capacity of over 600 lines of text. Expand, underline, and center text functions.

Sophisticated Electronic Mail System

Link the various offices of your company with the IS-11C's electronic mail capability. Edit text with the word processor, then use the built-in modem and communications software to speed data to its destination thousands of miles away. Connects to any of the popular electronic mail or data base services such as Infonet, CompuServe, OAG, Dow Jones, and the Source.

Software Development Made Easy

Software can be developed for the IS-11C using Microsoft-upwards-compatible BASIC (with multi-windows and communications) or assembler. Plug-in ROM cartridges can be created for instant access to custom application packages.

Phone SORD toll-free on 1-800-223-1796 for:

- Special price for evaluation units
- Special price for journalists
- Student group prices
- Other special discounts to meet your needs (specify quantity, purpose, location to be used)



Mail This Coupon for More Information

Please rush me full information on the top-selling IS-11C.

Name: _____

Address: _____

City: _____

State: _____ Zip: _____

Computer innovator **SORD** SORD COMPUTER CORPORATION

New York Office: Olympic Tower 6F, 645 Fifth Avenue, New York, NY 10022. Tel (212) 759-0140 Los Angeles Office: 723 West 7th Street, Los Angeles, CA 90017. Tel (213) 622-0244 Chicago Office: OS 169 Church Street, Winfield, IL 60190. Tel (312) 690-8019

***FREE 3M
Flip 'n' File™
Offer...**

One less
thing to
worry
about.™



Lifetime Warranty

SS-DD **\$1.52*** DS-DD **\$2.05**
5 1/4 QTY. 20

2200 ← 96 TPI → **2540**

2200 ← 3-5" SS-135 TPI
*With FREE 3M Flip 'n' File

If it's worth remembering, it's worth Scotch. Factory fresh and prepacked with 10-5 1/4" 3M diskettes in 3M Flip 'n' File. Includes Tyvek envelopes, reinforced hubs, user ID labels and write-protect tabs.

Special Bonus Offer

As an introductory offer, for every other box of 3M-5 1/4" diskettes you order you get FREE, 3M's new Flip 'n' File™. 50% more storage capacity, sturdy and with compact design that swings open to an easel-type work station in one quick motion. A moveable front panel and see-through window in front and back feature index cards. Holds very comfortably 15-5 1/4" diskettes. From a tradition of excellence—now comes disk storage. A \$10.00 value is offered free of charge while supply lasts.

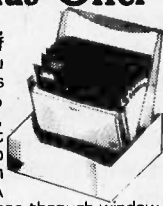

3M Headcleaning Kit

Without disassembly or mess, without abrasion worries. 3M Headcleaning Kit has everything you need for 10 headcleaning operations. **\$7.95**

Disk Storage

Amaray Media Mate 50 (Holds 50-5 1/4" diskettes) ... **\$9.95**



Disk Minder II-75 (Holds over 75 5 1/4" diskettes) ... **\$11.95**

Micro Disk Minder 36 (Holds 36-3 1/2" micro diskettes) ... **\$8.75**

PRINTER RIBBONS	EA.	DZ.
Epson MX-70/80	\$3.53	\$40
Epson MX-100	\$4.90	\$55
Okidata-80/82/83/92	\$1.45	\$17
Okidata-84	\$3.50	\$41

Price Promise

We will better any lower delivered price on the same products and quantities advertised nationally!

TERMS: FREE USE OF VISA & MASTERCARD. American Express also accepted. COD orders add \$3.00 handling charge. **Shipping:** Add \$3.00 per 100 diskettes or fraction thereof. **Other Items:** Add \$2.00 for disk storage or headcleaning kit or each multiple of 8 ribbons. P.O. accepted. Utah residents add 5% sales tax. Minimum order \$30.00.

TOLL FREE ORDER LINE:

**1-800-233-2477
(1-800-AFFAIRS)**

INFORMATION AND INQUIRIES:

1-801-942-6717

HOURS: 9AM - 5 PM M-F (MT. STATE TIME)

© Computer Affairs, Inc. 1985

Computer Affairs, inc. 2028 E FT UNION BLVD 105 SALT LAKE CITY UTAH 84124 CALL 1-800-AFFAIRS

REVIEW: GTX-100

password. If the caller enters a correct password (one of the 16 possible), access is permitted.

The call-back-from-list mode provides several security measures. Even if someone steals a password, the modem will call back only numbers contained in the list of authorized numbers. Any intrusion would have to originate from one of these numbers. Assuming the perpetrator is calling from one of the authorized numbers, he will gain access only after entering a correct password. You can control the number of incorrect attempts at entering the password, and if an intruder exceeds that number, his phone number is placed in a "not allowed" list. Any numbers appearing on the list will not be called back, even if they are also on the list of authorized numbers.

The main drawback to this level of security is the limited number of call-back numbers. Since the system can contain only 16 numbers on the authorized list, users can access the system from, at most, 16 locations. If any user needs to have access from more than one location, then each possible call-back number would have to be listed, cutting down the space remaining for other users (unless your phone has automatic call-forwarding and you remember to set it).

Breaking this level of security would not be an easy task, probably impossible for the average person. Any break-in would probably have to be an "inside job." The next level of security, call-back-any-number mode, is another story.

In call-back-any-number mode, users can call from anywhere: the modem calls back any number not on the not-allowed list. Again, if the number of attempts to enter a correct password exceeds the limit, the modem enters that phone number into the not-allowed list. Unfortunately, there is a simple way around this security measure, but I will not describe it here. Suffice to say that you don't have to be Mata Hari to figure it out.

This mode enables you to provide a unique service, however, by paying

the phone bill for most of the time the caller is on the line. The caller pays only for the first call to the modem, usually no more than one minute.

In the password-without-call-back mode the modem merely asks for a password. The list of authorized passwords may contain 16 passwords, and you can limit the number of tries that a user gets with each call.

All the features of the secure modes are controlled from the Security menu, which is password-protected itself. From this menu you can choose the mode of security, enter allowable call-back numbers and passwords, and set the limit on the number of password attempts. You can change the password for entry into the Security menu. This menu also gives you access to the call-back-number and password logs.

Research has shown that the best way to secure a computer system is through the use of passwords and by changing the passwords regularly. The GTX-100 allows up to 20-character passwords, which should keep any potential intruder busy for a while. The question is, Do you need to spend \$795 for a modem just to get password protection?

CONCLUSIONS

The GTX-100 is a high-quality 300/1200-bps intelligent modem offering varying levels of security. Overall I found its performance to be excellent. Security in the call-back-from-list mode is very good but has its limitations. Security at the next level, call-back-any-number mode, is no better than password-without-call-back mode. It may be useful, however, as a service to the caller, who usually has to pay only for the first minute of the original call to the modem.

I doubt most personal computer users will need the highest level of security or the call-back feature. You could build these features into your application software and use a less-expensive intelligent modem. However, commercial users requiring these security features could probably benefit from purchasing the GTX-100 modem. ■

Here's The Savvy-est True Dual Trace 10 MHz
Digital Storage Scope You Ever Saw
... At The Saving-est Price. Only \$595.

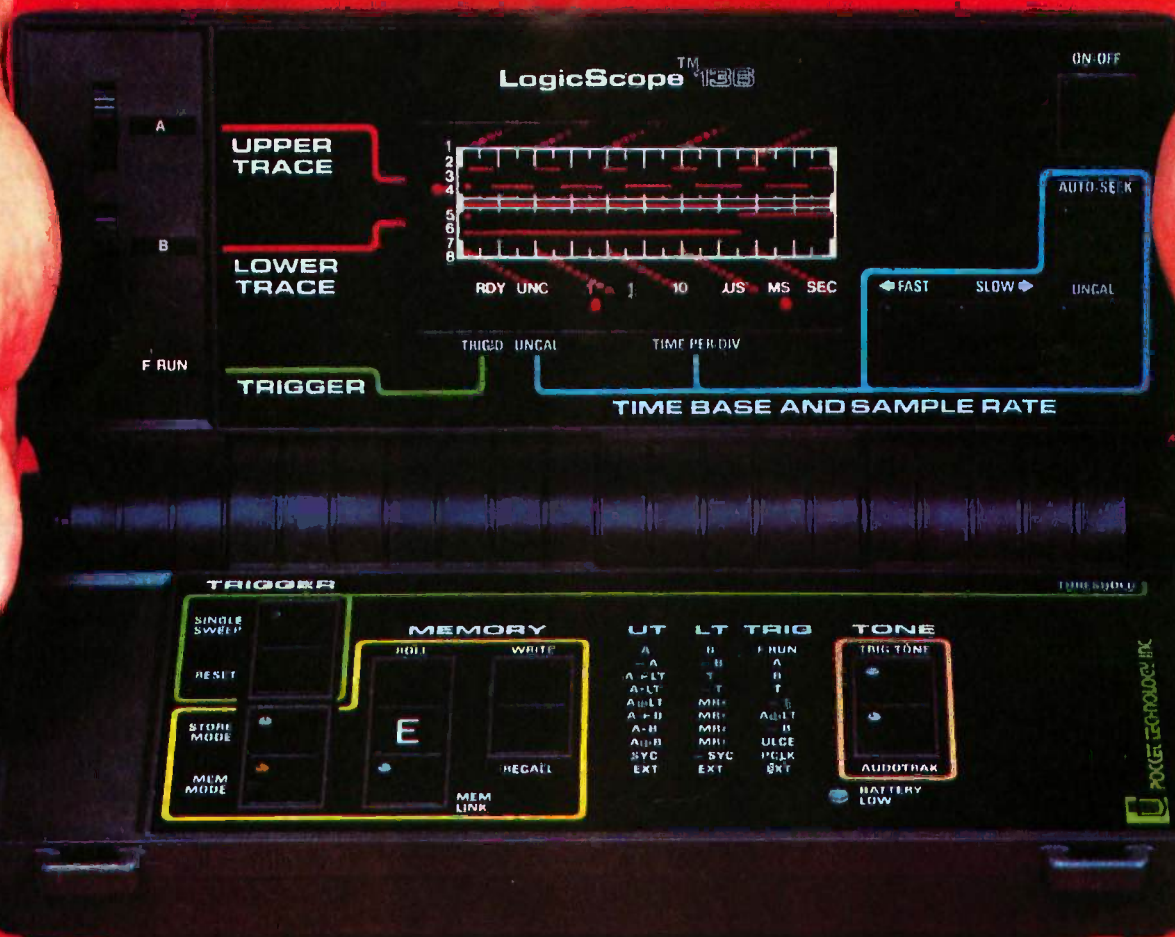

The Handy New LogicScope™ 136

True Dual Trace • 10 MHz Real Time Bandwidth • 3 Input Channels • I/O Port
Digital Waveform Storage • Boolean Waveform Operations • Audio Functions
8.0 (L) x 4.5 (D) x 1.75 (H) Inches • 1.25 Pounds • 9 Volt Battery/AC Operation

Consider the LogicScope 136

- The LogicScope 136 is the next logical step in test instrumentation for you. It combines many of the features and capabilities of sophisticated logic analyzers and oscilloscopes . . . and it fits in your hand. Never before has so much technology been available in so small an instrument, at such a low price.
- The pocket-sized LogicScope 136 is made possible by a patented breakthrough in display technology. The conventional CRT has been replaced by a unique array of 400 LED's that permits simultaneous display of two digital waveforms.
- The 136 can be used for viewing single shot events, or repetitive waveforms. It can be operated in real time mode, or in memory mode which permits acquisition and storage of up to 50-100 bit waveforms. These can be recalled, logically compared (AND, OR, EXCLUSIVE OR) to other input waveforms, or output to an external device via an I/O port. This I/O port will also accept future add-on 136 Modules.
- Its very low cost, convenience and ease-of-use make the LogicScope the ideal instrument, for designing, troubleshooting or repairing digital systems. Made in U.S.A.

Consider its Engineering & Field Service Applications:

- On microprocessor-based systems, check the timing relationship of various parameters relative to the system clock and other key events. Its storage capability allows visual and logical comparison of non-repetitive waveforms to known reference signals. Output in the start-up of the digital device can be compared to reference signals to determine the operating state of the device. Questionable waveforms can be stored for analysis.
- Its light weight and small size make the LogicScope convenient to take on every service call. The 136 provides much more information for trouble shooting a digital system or peripheral than a logic probe or digital counter without having to lug an oscilloscope or logic analyzer along.

Contact us for the name of your local distributor



POCKET TECHNOLOGY, INC.

7320 Parkway Drive, Hanover, MD 21076 U.S.A.
301-796-3300 TELEX 908207
Division of Renaissance Technology Corp.

The TI Pro where no

Now you can have true CAD at an affordable price. Plus an out-of-this-world PC package for your unique computing needs.

High quality computer-aided design has usually meant working with highly expensive mainframes.

But now, with the TI Professional Computer and AutoCAD™ 2 software from Autodesk, Inc., you can put real CAD on your desk for under \$10,000. And you'll have a superior PC system for other computing needs —available in a package of hardware, service, training and support *no other PC offers.*

TI and AutoCAD 2 let you explore the outer limits of your imagination.

AutoCAD 2 gives you mainframe capabilities like multilayering and precise dimensioning, plus isometric design and piece part takeoff attributes. You can create your own symbol and parts libraries. Use bi-directional zoom to go from a full building elevation to the smallest bolt with trillion-to-one precision. And move, copy, rotate or delete any part of your drawing.

"You can use your imagination more and come up with much better designs much faster."

*-Lansing Pugh,
Architect,
Austin,
Texas.*

The perfect match of CAD and machine.

Running AutoCAD 2 on the TI Professional Computer can yield spectacular results. High resolution graphics (720 x 300 pixels) give you crisp characters, lines and curves. Unlike many PCs, TI shows up to 8

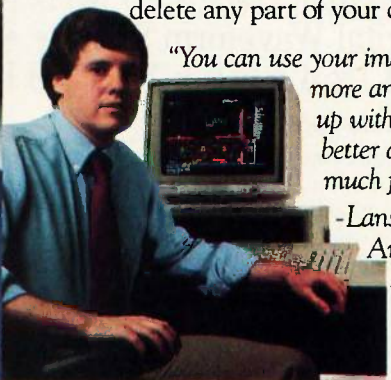

Professional Computer takes CAD PC CAD has gone before.

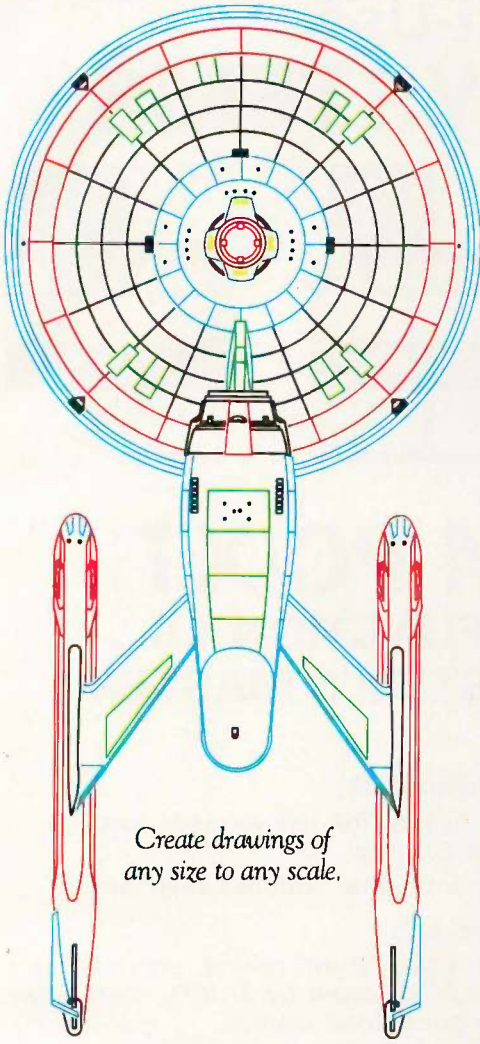

Create drawings of any size to any scale.

colors simultaneously. And lets you mix and display text and graphics at once.

The TI Professional Computer is part of a complete system that gives you better performance from the best-selling software for other applications, too. It's an uncommonly expandable system that works with a vast range of peripherals. It can all be configured to your own individual needs. And grow as you grow.

We also offer optional service and support packages unobtainable anywhere else. Like a 24-hour customer support line. Extended 1- or 5-year service and support programs. And regional training seminars to get you started.

Is this the right CAD system for you? TI has the answers.

You have your own special way of working, your own unique needs. If the answers below apply to you, the TI/AutoCAD 2 system is your best choice.

Q. Are your drawings dimensioned?

A. If they are, our system automatically computes them with a choice of linear, angular, aligned, circular and leader options.

Q. Do you often modify existing drawings?

A. We make it fast and simple, with a revised, plotted drawing that looks as good as the original. So, your productivity will be greatly improved.

Q. Are overlays useful to you?

A. If so, you can store information in unlimited, named layers, and turn them on or off for display or plotting in any color combination.

Q. Do you use standard symbols or parts?

A. AutoCAD 2 offers optional symbol libraries and lets you create your own.

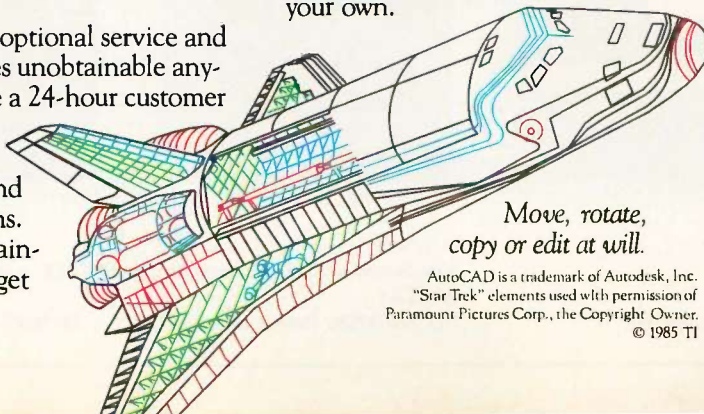

Move, rotate, copy or edit at will.

AutoCAD is a trademark of Autodesk, Inc. "Star Trek" elements used with permission of Paramount Pictures Corp., the Copyright Owner. © 1985 TI



Beam down from the big picture to the smallest detail.

Q. What size drawings do you use?

A. Our system works with a wide variety of leading plotters for drawings from A-size (8½" x 11") to E-size (36" x 48").

Q. Do you have other PC needs?

A. The TI Professional Computer isn't just a dedicated CAD workstation. It runs over 1000 popular software programs for word processing, spreadsheets, accounting or other business needs.

Q. Is expandability important?

A. TI supports many expansion options, from communications to larger disks, printers, even to speech recognition, to improve your productivity.

Explore the possibilities.

Draw your own conclusions. For more details, or to arrange a demonstration at your nearest TI dealer, mail this coupon or call us at 1-800-527-3500. In Canada (416) 884-9181.

Name _____
 Company _____
 Address _____
 City _____ State _____ Zip _____
 Phone _____
 Mail to: Texas Instruments Incorporated, P.O. Box 809063,
 Dept. DCC052BY, Dallas, TX 75380-9063.

TEXAS INSTRUMENTS
 Creating useful products and services for you.

CASHCOM

Stand Alone or Multi-User POINT OF SALE SYSTEMS



IBM PC/XT CAN FUNCTION AS THE SYSTEM'S MASTER

AS A COMPUTER

- The stand alone system can be upgraded into a multi-user system to meet growing business needs.
- Uses CP/M or MS-DOS (multi-user system only) to run thousands of dedicated software packages available to users.
- Displays transactions on a 9" CRT utilizing large characters for easy customer viewing.
- Utilizes two way data communications allowing quick and accurate price changes, order processing and file updates.
- Can be programmed using familiar languages for easy customization of vertical markets.
- Utilizes a database management system to produce meaningful reports on demand.
- Can be configured with floppies or Winchester drives (storage capacity-640KB to 80MB).

AS A CASH REGISTER

- Its flexibility in function use exceeds industry standards for E.C.R.'s.
- Uses a programmable, buffered keyboard.

IT IS CAPABLE OF:

- error correct, void, return, refund, entire ticket voiding, manual discount by \$ or %, mark down, mark up, coupons, food stamps.
- payment by cash, cheques or credit cards.
- charge and payment posting to in-house accounts.
- H.A.L.O./L.A.L.O. protect on open departments and discounts.
- black list and credit authorization.
- electronic funds transfer.



**Advanced
Business
Computer
Systems International, Inc.**
Inquiry 13

In Canada:
4088 Sandwich Street, Windsor, Ontario N9C 1C4 (519) 255-9199
In U.S.A.:
P.O. Box 32524, Detroit, Michigan 48232 (313) 961-3406

TANDY 2000 UPGRADE

The review "The Tandy Model 2000" by Mark S. Jennings (December 1984 BYTE, page 239) states, as does literature from Radio Shack, that maximum RAM (random-access read/write memory) capacity is 768K bytes. The service manual for the 2000 (page 252) states that RAM capacity of 896K bytes is attainable by using all three available slots for upgrade RAM boards and kits.

A string in the last line of a 338K-byte file was located by the Find command in 18 seconds. When I added a RAM-disk utility, the same string was picked up in 3 seconds.

As your review indicates, RAM upgrade cost is high indeed. The cost for adding 512K bytes of RAM to the 256K bytes of RAM that came with my hard-disk model is \$1596. I am not aware of any other computer that costs as much for a RAM upgrade.

Apart from this one complaint, I am delighted with my 2000 and with the cooperation I have received from the Tandy/Radio Shack home office.

GREGORY GROVER
Los Angeles, CA

THE H-150 KIT

In the text box "Building the H-150 Computer Kit" (December 1984, page 258), Henry B. Cohen might have done a disservice to kit builders, especially novices, with some of his advice. I have constructed many kits, printed-circuit (PC) boards, and other electronics projects, so I speak from experience.

Mr. Cohen recommends working around parts that you can't locate immediately and then putting them on when they turn up. This is a poor practice, especially for novices. Often the order in which parts go on PC boards is important for ease of installation and because a certain sequence might be required if you are to install the part at all. Always install parts in the order specified in the instructions.

Mr. Cohen's suggestion that you should solder for integrity first and then go back and solder for appearance is also not a good practice. Each connection should be

soldered only once. Reheating a solder connection on a PC board to improve appearance is unnecessary and could damage the part, increase the probability of solder bridges, and degrade the integrity of the traces on the board (particularly on multilevel boards). Soldering integrity is the only consideration.

Mr. Cohen is incorrect when he states that a VOM or multimeter is necessary to build the Heath H-150. I constructed the H-160 (the transportable model) and did not need test instruments. With these computers, Heath supplies a tester that you must also solder together. All the testing described in the Heath construction manuals refers to this tester, which uses a generated tone for test measurements. In fact, you would have to refer to other technical data to use another type of tester (to get voltage levels and to understand what the tests accomplish).

Other advice offered by Mr. Cohen was very good, and I would like to confirm that the PC-compatible H-150/160 is a fine computer. You get additional technical documentation with Heathkit products that can prove extremely valuable when you run into problems in the future.

LOREN D. MARTINDALE
Yuma, AZ

WORDPERFECT

I was happy to read Ricardo Birmele's enthusiastic review of WordPerfect (December 1984, page 277). This program is by far the best of the dozen word processors I have sampled. I believe that several of the problems Mr. Birmele acknowledges are easily solved or are not WordPerfect's fault.

Mr. Birmele states, "Any characters underlined on a monochrome monitor will appear in blue on a color monitor; if fed by a color video drive board, they will appear in reverse video on the monochrome monitor." My experience with WordPerfect on the IBM PC suggests that it is the computer's fault that underlining is not available on a color monitor. When you run WordPerfect with the /S option (by typing WP/S from MS-DOS) and exercise the "Set Colors for Color Monitor" option, the program prompts for the color it should use

to represent underlined words. You can select whatever color you like from the IBM repertoire; underlined words will be displayed in that color, or in reverse if you select this option. I believe that Mr. Birmele will find that a document's underlined words will appear as such on a monochrome monitor driven by the IBM monochrome card, while on another machine with a color-display card the same words will be in color or reversed. Finally, it is not technically possible to successfully drive the IBM monochrome display with the color card.

Mr. Birmele is correct in mentioning that setting tabs is not convenient. But WordPerfect already provides tabs at even intervals; setting a tab at the current cursor position entails remembering the column number before pressing the Set Format key and selecting Tabs, then typing the number of the column where you want a tab. The WordPerfect manual explains this procedure.

It is also an injustice to imply that WordPerfect runs only on the IBM PC, Victor 9000, DEC Rainbow, Tandy 2000, and Zenith Z-100; indeed, there are customized versions of WordPerfect for nearly any MS-DOS computer in existence, and it is compatible with a wide variety of computers including the Victor, the TI Professional, the Data General/One, and others.

JOE CLARK
Halifax, Nova Scotia, Canada

TOSHIBA P1340

In Ken Sheldon's review "The Epson LQ-1500" (December 1984, page 293), I believe that the author makes a misleading comparison. He compares a properly operating LQ-1500 with an improperly operating Toshiba P1340. As a happy owner of a Toshiba P1340, I know that it is capable of producing much higher quality output than is shown in the sample.

From the sample, it looks like at least three of the pins in the unit are failing to drive. My guess is pins 8, 12, and 18. It might be that this P1340 is simply in need of its regular print-head cleaning, as specified in Section 5 of the owner's manual. A toothpick will remove the paper and rib-

(continued)

C Programmers: Program three times faster with *Instant-C*TM

*Instant-C*TM is an optimizing interpreter for the C language that can make programming in C three or more times faster than using old-fashioned compilers and loaders. The interpreter environment makes C as easy to use as Basic. Yet *Instant-C*TM is 20 to 50 times faster than interpreted Basic. This new interactive development environment gives you:

Instant Editing. The full-screen editor is built into *Instant-C*TM for immediate use. You don't wait for a separate editor program to start up.

Instant Error Correction. You can check syntax in the editor. Each error message is displayed on the screen with the cursor set to the trouble spot, ready for your correction. Errors are reported clearly, by the editor, and only one at a time.

Instant Execution. *Instant-C*TM uses no assembler or loader. You can execute your program as soon as you finish editing.

Instant Testing. You can immediately execute any C statement or function, set variables, or evaluate expressions. Your results are displayed automatically.

Instant Symbolic Debugging. Watch execution by single statement stepping. Debugging features are built-in; you don't need to recompile or reload using special options.

Instant Loading. Directly generates .EXE or .CMD files at your request to create stand-alone versions of your programs.

Instant Floating Point. Uses 8087* coprocessor if present.

Instant Compatibility. Follows K & R standards. Comprehensive standard library provided, with source code.

Instant Satisfaction. Guaranteed, or your money back. *Instant-C*TM is available now, and works under PC-DOS, MS-DOS*, and CP/M-86*.

Find out how *Instant-C*TM is changing the way that programming is done. *Instant-C*TM is \$495. Call or write for more information.

Rational
Systems, Inc.

(617) 653-6194

P.O. Box 480

Natick, Mass. 01760

Trademarks: MS-DOS (Microsoft Corp.), 8087 (Intel Corp.), CP/M-86 (Digital Research, Inc.), Instant-C (Rational Systems, Inc.)

REVIEW FEEDBACK

Table A: Benchmark results for the Aztec, Eco-C, and OS-9 compilers. The code sizes are reported in bytes.

Compiler	Comp.	Assem.	Link	Size	Execution
Aztec	0:25	0:20	0:45	9096	2:06
Eco-C	1:08	0:24	0:52	7280	1:41
OS-9	2:13	1:18	0:59	5805	1:19

bon debris that can cause the pins to stick.

MAXIM G. SMITH
Natick, MA

C BENCHMARKS

Review Feedback (December 1984, page 301) contains another benchmark program for C compilers (listing 1, page 302). According to author David C. Clark, the program is designed "to examine the quality of the implementation of long integers among various versions of C." Mr. Clark gives results for two fully implemented C compilers running on a 4-MHz Z80 system (table 1).

Curious to see what would happen, I ran the same test on a Tandy/Radio Shack Color Computer with the OS-9 C compiler (no flags set). I won't guarantee the clock times closer than a second either way, but as you can see (table A), a few seconds make no difference at all.

My question is: What would a full-featured Gimix system with a 2-MHz clock make of this?

R. W. ODLIN
Sedro-Woolley, WA

ALF 8088 COPROCESSOR

David Morganstein's review "ALF's 8088 Coprocessor for Your Apple" (in the *Guide to the Apple Personal Computers*, December 1984 BYTE, page A38) gives an objective and fair assessment of this coprocessor for the Apple II. However, when speaking of reading IBM PC-compatible disks, Mr. Morganstein mentions the Rana 8086 coprocessor system, which includes IBM PC-compatible disk drives. I cannot understand why he does not mention ALF's own IBM PC-compatible Apple II disk-drive system, which has been available for the better part of a year to support ALF's coprocessor.

Mr. Morganstein was unable to get his Videx 80-column board working on the

ALF board. This is, in fact, the only bug I have found in the product, and I believe it is an outcome of ALF developing the product-support software on Franklins rather than Apples. I finally got my 80-column board running under CP/M-86 by using two different drivers.

I originally bought my ALF 8088 coprocessor because of its support of the 8087 math coprocessor. Mr. Morganstein reports only a modest improvement in processing speeds using the FTL program. However, anyone doing large numbers of trigonometric and log functions in Applesoft using ALF's FTL87 8087 Applesoft support will have a pleasant surprise—a hundred-or-more-fold speed increase.

Mr. Morganstein points out that you need to take care, when running the ALF coprocessor under MS-DOS or CP/M-86, to ensure that software written for an IBM-type personal computer will run in the Apple environment. However, it is not necessary to purchase software that is not copy-protected in Apple-compatible format, since commercial services are readily available to perform this conversion.

The ALF 8088 coprocessor is not for everyone. But for those who can integrate it into their Apple system, it can be a useful addition. I have found the ALF technical-support people helpful, supportive, and knowledgeable. The hardware and software are reliable and perform as ALF says they do. I have had my ALF board two years and have had no problems with it.

DWIGHT WILLIAM JOHNSON
San Diego, CA

REVIEW FEEDBACK is a column of readers' letters. We welcome responses that support or challenge BYTE reviews. Send letters to Review Feedback, BYTE Publications, POB 372, Hancock, NH 03449. Name and address must be on all letters.

As a programmer, you're already respected.

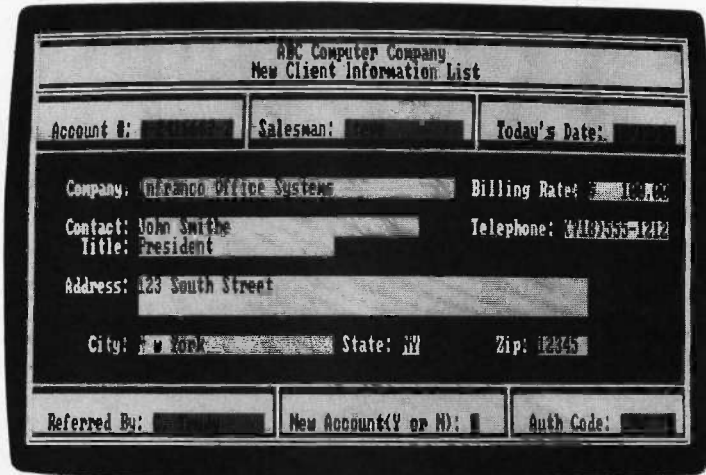

With better-looking screens, you could be loved.

You write wonderful programs.

Their logic is elegant. Their organization is solid. They work like a charm.

But how do they look?

Maybe appearance shouldn't count, but it does. Because not only is a well-designed screen impressive to look at—it also makes the program easier to work with. And that makes you look good, too.

It takes you days, perhaps weeks of effort to make a program right. Isn't it worth a few minutes to make it beautiful?

A few minutes. That's all it takes for you and Screen Sculptor to create a glorious-looking screen. And once it's done, Screen Sculptor automatically writes the program—in IBM Basic, IBM Pascal, or Turbo Pascal—to display the screen and allow the user to enter data.

There's no limit to what you can do with Screen Sculptor. Design a screen you like and rearrange it whenever you like. Select colors from a mouth-watering menu. Choose special characters, draw lines and boxes, paint in areas, repeat a character in any direction!

Specify input fields, variable names, data types, acceptable data ranges and more. Then Screen Sculptor generates actual program source code based on your screen design.

You'll need an IBM PC, XT, PCjr, PC AT or 100% compatible, 128K, DOS, one 320K disc drive and any 80-column display.

Screen Sculptor does more than design screens. For \$125, it will enhance your creative reputation and thoroughly impress your users.

Because people don't expect a beautiful screen. But they sure do appreciate it when they see it.



SOFTWARE BOTTLING COMPANY

Try it FREE for 30 days!

We're so sure you'll find Screen Sculptor indispensable that we make you this no-risk offer: Order now and you'll also receive a full demo disk. Use it and the manual for 30 days. Then, if you can bear to give it up, return the package for a full refund!

Credit card orders only call 24 hours a day, 1-800-824-7888, operator 268.

For all other orders and inquiries call or write: The Software Bottling Company of New York, 29-14 23rd Avenue, Long Island City, NY 11105. (718) 728-2200. If we're shipping to a NYS address, please add 8¼% sales tax.

Buy 10 flo
stop worrying



Free Flip 'n' File™/15 (\$10 Retail Value)

floppies and about dust storms, lint attacks, or the bends.

The Flip 'n' File™/15 is an island of calm and order in the savage environment of the modern office.

It's also free, when you buy a specially marked package of 10 double or single sided, double density 3M diskettes. They're the certified 100% error-free diskettes; no floppies

are more reliable.

With this kind of protection, all you have to worry about now is when this limited special offer sells out.

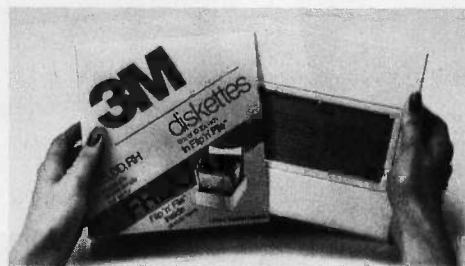

Offer available from participating distributors, personal computer dealers and office supply dealers.

Which, if you don't hurry, could be before the next major coffee spill.

One less thing to worry about.™

Inquiry 397

3M
diskettes

The PC Plotter: It will change the way business looks at graphics.

The lowest-priced professional plotter on the market today is Houston Instrument's new four-pen PC Plotter. It is designed to produce the crisp graphics you need to compete — and communicate — in business. Just what makes this plotter so competitive? Let's take a look:

Price — A multi-pen, compact, single-sheet plotter at \$595* isn't just a low price — it's an unbelievably low price. What an affordable way to link the power of graphics communication to your personal computer.

Performance — Yours and Ours — Until the PC Plotter was born, it was too expensive to let the pictures do the talking. Now that's no longer true. So, the next time the boss walks into the office needing some "nice charts and graphs," you can quickly fill the request with clean, colorful, wonderful graphics. Who knows, you might even get a raise!

As to our performance, we're the only plotter manufacturer offering you hundreds of graphics software packages which are

compatible with the PC Plotter. That means you can produce any type of drawing you require.

Flexibility — Depending on your needs, you can select from two PC Plotter models. One (PC Plotter Model 595 for \$595.00*) allows you to produce graphics on overhead transparencies on 8½" × 11" paper or film; the other (PC Plotter Model 695 for \$695.00*) permits either 8½" × 11" or 11" × 17" graphics. And we didn't forget the OEM. Houston Instrument will work with you to configure a plotter that's perfect for your particular application.

For the name of your closest PC Plotter distributor or dealer, contact Houston Instrument, P.O. Box 15720, Austin, Texas, 78761 or call (512)835-0900. Outside Texas call 800-531-5205. In Europe, contact Houston Instrument, Belgium NV., Rochesterlaan 6, 8240 Gistel, Belgium. Tel. 059-27-74-45, Tlx. 846-81399.

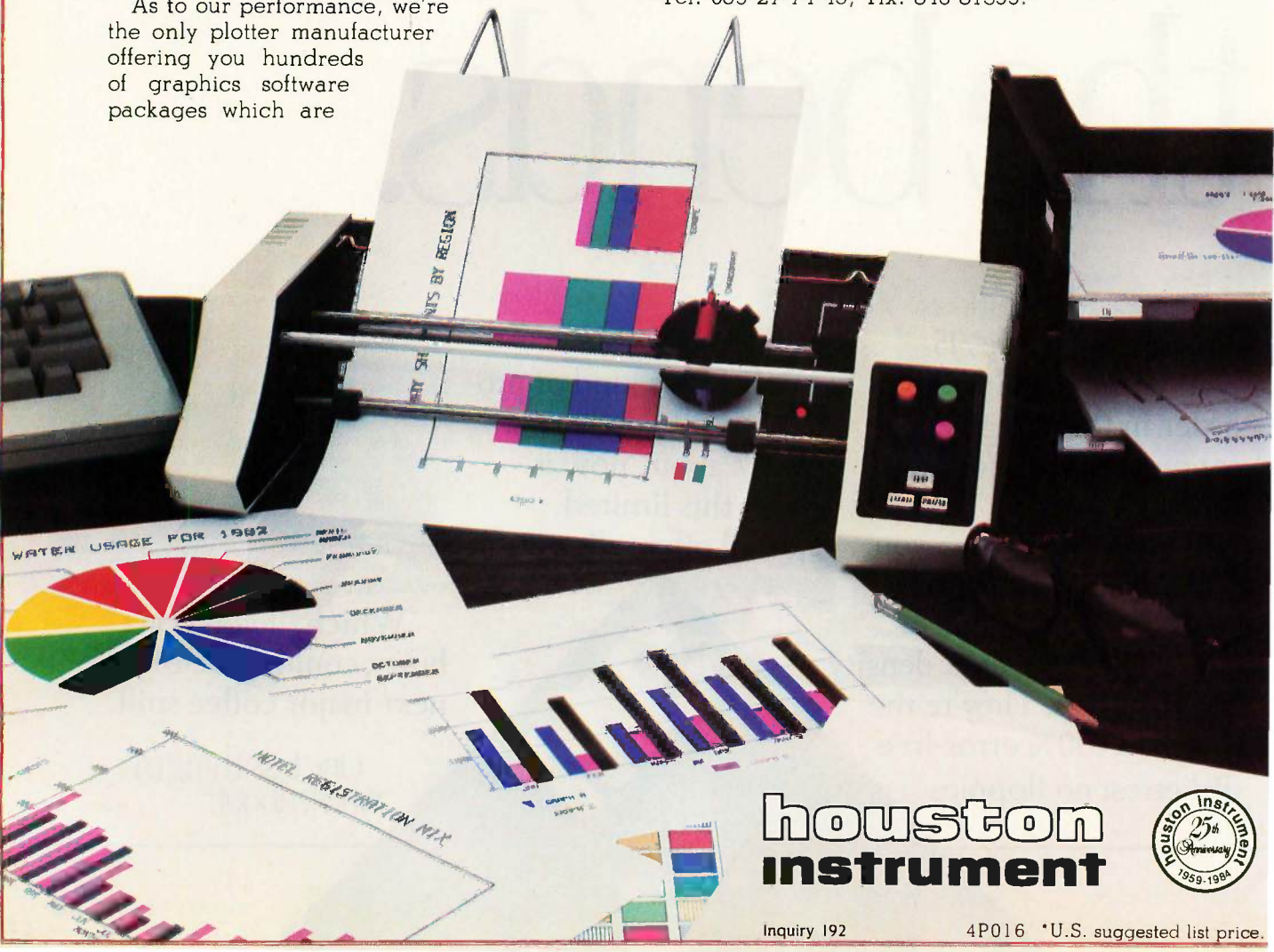

**houston
instrument**



Kernel

IN SPITE OF A FLU BUG, Jerry Pournelle was up to picking his favorite products of the year for 1984. As he says, "Purely subjective."

Bill Raike reports on IBM Japan Ltd.'s test production of 1-megabit RAM chips and takes a look at some new microcomputers.

The BYTE West Coast editors describe an economical approach to custom chip manufacturing and give us their impressions of some new software.

Dick Pountain deals with this month's theme as he acquaints us with ALICE and Hope, two components of a parallel-processing approach in the U.K.

In Computers and Law, Robert Sterne and Perry Saidman shed some legal light on buying and selling computer products.

Bob Kurosaka uses the game of Nim in an exercise in BASIC bitwise logic operation in this month's Mathematical Recreations.

And Steve Ciarcia replies to readers who have built his Circuit Cellar projects.

COMPUTING AT CHAOS MANOR: IN SEARCH OF THE PERFECT PRODUCT <i>by Jerry Pournelle</i>	307
CHAOS MANOR MAIL <i>conducted by Jerry Pournelle</i>	347
BYTE JAPAN: MEGABITS AND GIGAFLOPS <i>by William M. Raike</i>	355
BYTE WEST COAST: HOMEBREW CHIPS <i>by John Markoff, Phillip Robinson, and Donna Osgood</i>	363
BYTE U.K.: PARALLEL PROCESSING <i>by Dick Pountain</i>	385
COMPUTERS AND LAW: THE SALE OF COMPUTER PRODUCTS <i>by Robert Greene Sterne and Perry J. Saidman</i>	399
MATHEMATICAL RECREATIONS: AN EXERCISE IN BASIC BITWISE LOGIC OPERATION <i>by Robert T. Kurosaka</i>	417
CIRCUIT CELLAR FEEDBACK <i>conducted by Steve Ciarcia</i>	424

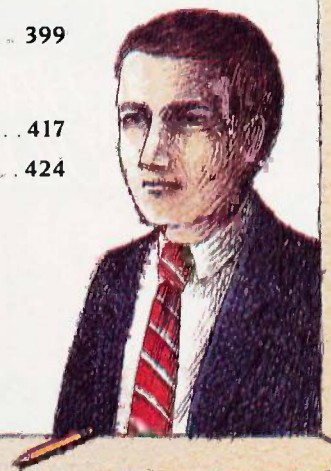
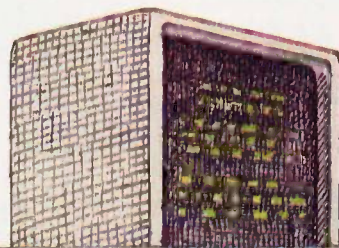

MICROSOFT
PRESS

Your antidote to the rising epidemic of computer crime

Here ... for the first time ... is an inside look at America's underground hacking culture ... by "The Cracker," the 19-year-old systems hacker apprehended by the FBI.

Set against the fascinating backdrop of "The Cracker's" infamous capers with his "Inner Circle" band of hacking wizards, *Out of the Inner Circle* is packed with vital information to protect your data from unwanted intruders.

To best protect your system, you must penetrate the hacker mentality. How does a hacker think? What is he really after? What are his favored methods of hacking, and how do you guard against them? How vulnerable is your system? What are the tell-tale signs of a computer break-in? How do you catch a hacker? What in the world do you do with one once you've caught him?

You'll find it all in *Out of the Inner Circle*, along with a security checklist that details the points of vulnerability in today's popular mini- and main-frame operating systems.

\$9.95, softcover
\$19.95, hardcover

Wherever books and software are sold.

Microsoft Press
10700 Northup Way
Bellevue, WA 98004

O U T O F T H E

INNER CIRCLE

A HACKER'S GUIDE TO COMPUTER SECURITY

MICROSOFT
PRESS

BY "THE CRACKER"
BILL LANDRETH
THE TEENAGE COMPUTER WIZARD
APPREHENDED BY THE FBI

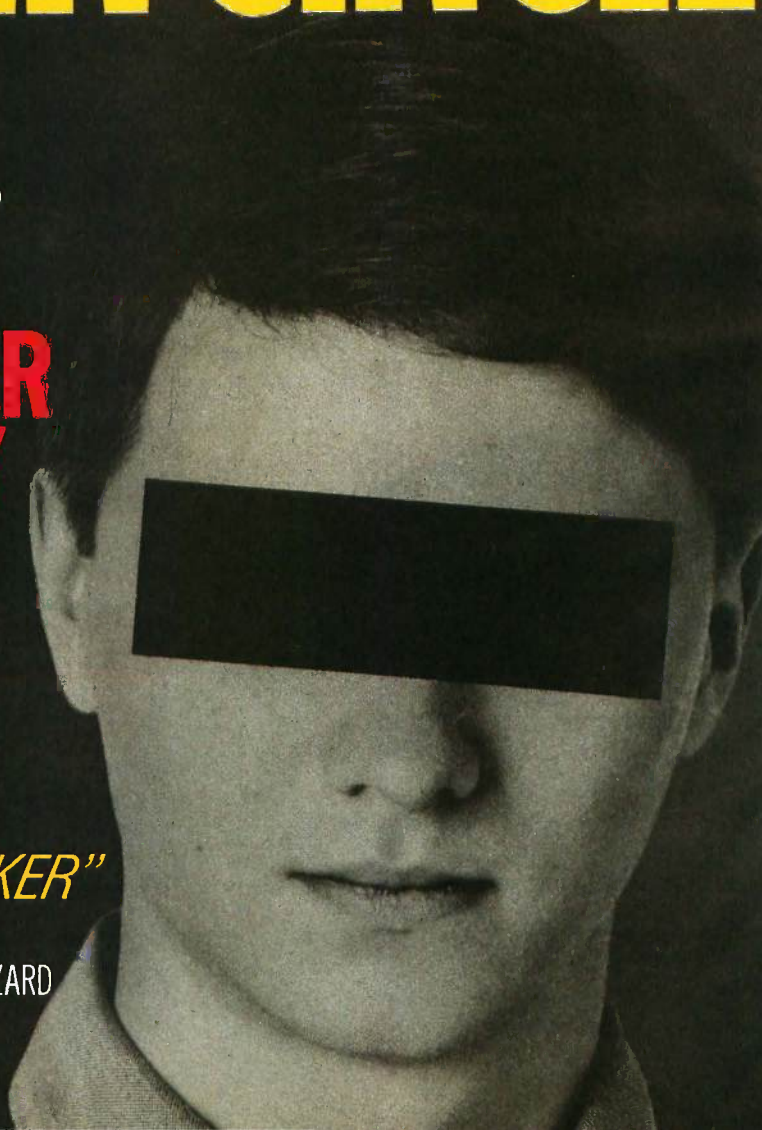

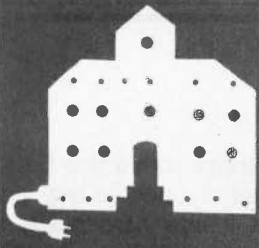

C·O·M·P·U·T·I·N·G A·T· C·H·A·O·S M·A·N·O·R

In Search of the Perfect Product

LaserJet

The Tweek Cure

Tutsim

Universe

Professional BASIC

The Companion

A+ Mouse

MTBASIC

Expert-Ease

Encore 1200B

SemiDisk

Tunesmith

Fontrix

BY JERRY POURNELLE

The good news is that this is the last of the one-every-three-weeks columns. The bad news is that it's just past the New Year and I've spent the past three weeks nursing a flu bug that won't go away and leave me alone. Between that and the holidays, I have done less with computers than I intended. I *have* seen more television than I've watched for the past three years, and I'm now in a position to state for the record that even with the 20 channels we get in Los Angeles, there's little worth watching. You need mush for brains to watch the tube for long—or you'll get mush for brains if you do.

Even with flu, holidays, and TV, there's a fair amount to cover.

CHAOS MANOR'S PRODUCTS OF THE YEAR

Many magazines have special product-of-the-year features this month. I'm a mite late with mine. Of course, my rules are a bit different from other people's. I pick the products I like best. Purely subjective. And "year" doesn't necessarily mean it came out in 1984, only that I acquired it then. With those ground rules, here goes.

LASERJET

First choice, hands down, is the Hewlett-Packard HP 2686A LaserJet printer. That sucker has changed my life. It replaces the big and noisy Diablo 1620. The Diablo has served me well in the past eight years, and it's still in good shape, but I'll probably donate it to a prospace organization because I'll never go back to it.

The LaserJet runs off Zeke II, the Viasyn CompuPro Z80 I'm writing this on. It's *quiet*. The main printer used to be the NEC 7710 Spinwriter, which runs off the CompuPro 8/16 workhorse we use for everything except writing. For the past week, the 7710 has been loaded with fanfold checks because nobody bothered to feed it normal paper; it's so much easier to use the LaserJet for everything except checks.

It's easy to feed single sheets of letterhead to the LaserJet. It's not much harder to put a stack of letterhead in; or a mix of letterhead and second sheets. The LaserJet will feed sheets from its magazine or accept single sheets as you insert them.

The LaserJet is quiet. Whisper quiet. So quiet that it's uncanny; the noisiest thing about it is the *schlap* when it feeds a sheet of paper. And it's *fast*. Eight pages a minute, just like clockwork. It eats characters at 9600 bits per second (bps), and while it can't keep up with WRITE (my word-processing software), it almost does. Because the LaserJet is so fast, there's no pressing need for a printer buffer. In contrast, we feed data to the NEC Spinwriter through a dandy little Applied Creative Technology Printer Optimizer. The Optimizer is a box full of memory that the computer thinks is a really fast printer, and I'd name it as a product of the year except that I've had it more than a year. I suppose one day I'll get around to hooking the LaserJet to the Optimizer, but there's no hurry.

The LaserJet is smart, too. We've never had a paper jam, although my friend Tony managed one with his. The LaserJet will print both sides of a sheet, but it's a heat and dry powder process, meaning that you want to be careful about loading and stacking paper already printed on one side. Tony was recycling paper and put some in carelessly. A sheet jammed. He cleared it. The LaserJet automatically repeated the page—from the top, complete with header and proper page number.

LaserJet, I love you.

TWEEK IT

The second product of the year goes by the unlikely name of Tweek, which advertises itself as a "contact enhancer." It's a clear liquid you dab onto places where you suspect you're getting bad contact: IC sockets, edge connectors, RS-232C plugs, that sort of thing. It comes in a kind of

(continued)

Jerry Pournelle holds a doctorate in psychology and is a science-fiction writer who also earns a comfortable living writing about computers present and future.

PROFESSIONAL PROGRAMMER'S BULLETIN:

Be Productive, Be

BRIEF™

The Programmer's Editor

TRY BRIEF RISK-FREE FOR 30 DAYS WITH OUR MONEY-BACK GUARANTEE!

BRIEF's power and flexibility provide dramatic increases in programming productivity. BRIEF's ergonomically designed human interface becomes a natural extension of your mind, allowing you to eliminate tedium and concentrate on creativity.

AVAILABLE FOR PC-DOS, IBM-AT, AND COMPATIBLE SYSTEMS

ONLY \$195.

DEMO AVAILABLE FOR ONLY \$10 (applicable to future purchase)

CALL TOLL FREE
800-821-2492

for "Technical Description" or to order.



335-B Washington St., Norwell, MA 02061
617-659-1571

- WINDOWS
- Full UNDO (N Times)
- Compile within BRIEF
- Keystroke Macros
- Exit to DOS inside BRIEF
- Programmable Macro Language
- Multiple files, unlimited size
- "Regular Expression" search
- Reconfigure keyboard
- Language sensitive user controllable features (such as Auto-Indent for C)

BRIEF is a trademark of UnderWare. Solution Systems is a trademark of Solution Systems.

PROLOG-86™

Become Familiar in One Evening

Thorough tutorials are designed to help learn the PROLOG language quickly. The interactive PROLOG-86 Interpreter gives immediate feedback. In a few hours you will begin to feel comfortable with it. In a few days you are likely to know enough to modify some of the more sophisticated sample programs.

Sample Programs are Included like:

- an EXPERT SYSTEM
- a NATURAL LANGUAGE INTERFACE (it generates a dBASEII "DISPLAY" command)
- a GAME (it takes less than 1 page of PROLOG-86)

PROTOTYPE Ideas and Applications QUICKLY

1 or 2 pages of PROLOG is often equivalent to 10 or 15 pages in "C" or PASCAL. It is a different way of thinking.

Describe the FACTS and RULES without concern for what the computer will have to do. Maybe you will rewrite in another programming language when you are done.

Programming Experience is not required but a logical mind is. PROLOG-86 supports the de facto STANDARD — in "Programming in Prolog" by Clocksin & Mellish.

AVAILABILITY: PROLOG-86 runs on MSDOS, PCDOS or CPM-86 machines. We provide most formats. The price of PROLOG-86 is **only \$125.**

Full refund if not satisfied during first 30 days.
800-821-2492



335-B Washington St.,
Norwell, Mass. 02061
617-659-1571

CHAOS MANOR

hypodermic syringe with a thin flexible tube instead of a needle, making it easy to get it into hard-to-reach places.

My first use was on a sticky Reset button. I didn't bother to turn off the machine, just pulled the top off the button and squirted in the merest drop. Voilà!

Last week my telephone started to make horrible static noises, which could be cured by violently shaking the instrument, only they'd come back. I took it apart, took off the plastic cover over the little relay contacts activated by hanging up the phone, and squirted. The noise went away. Faulty TV remote controller: squirt. Noise in an audio system: squirt. So far, Tweek has cured about a dozen annoying problems. A little bit of the stuff goes a long way. Get some. You'll love it.

FIXING UP A PC

Four products of the year for the IBM PC. First, the outstanding Wico Smart-line Smartboard keyboard, which is very nearly everything I ever wanted a keyboard to be.

My other three choices of outstanding PC products are: Orchid Technology's PCturbo 186 board, which makes the PC at least as fast as a PC AT and gives you RAM (random-access read/write memory) disk capability in the bargain; Borland International's SideKick, which lets you take notes, send messages, fix your calendar, and look up phone numbers anytime you have your PC turned on and no matter what you're doing with it; and Living Videotext's ThinkTank. Writers who use a PC and don't use ThinkTank are working too hard. Believe me.

TUTSIM

It's not exactly a product of the year, but one of the most improved programs I've seen lately is Tutsim. If you have any interest at all in mathematical modeling, the short form of Tutsim for \$29.95 is a pretty good deal if you want to know something about analog block-structure models.

(continued)

THE PROGRAMMER'S SHOP™

helps compare, evaluate, find products. Straight answers for serious programmers.

SERVICES

- Programmer's Referral List
- Compare Products
- Help find a Publisher
- Evaluation Literature free
- BULLETIN BOARD - 7 PM to 7 AM 617-826-4086
- Dealer's Inquire
- Newsletter
- Rush Order
- Over 700 products

Free Literature - Compare Products

Evaluate products Compare competitors. Learn about new alternatives. One free call brings information on just about any programming need. Ask for any "Packet" or "Addon Packet": ADA, Modula "AI" BASIC "C" COBOL Editors FORTH FORTRAN PASCAL UNIX/PC or Debuggers, Linkers, etc.

RECENT DISCOVERIES

FASTER C - Lattice users eliminate Link step. Normal 27 seconds, FASTER C in 13 secs. MSDOS \$95

ARTIFICIAL INTELLIGENCE

EXSYS - Expert System building tool. Full RAM, Probability, Why, Intriguing, serious. PC DOS \$275

GC LISP - "COMMON LISP", Help, tutorial, co-routines, compiled functions, thorough. PC DOS \$455

IQ LISP - MACLISP & INTERLISP. Full RAM. Liked. PC DOS \$155

TLC LISP - "LISP-machine"-like, all RAM, classes, turtle graphics 8087. CP/M-86, MSDOS \$235

INSIGHT 1 - Expert Sys. Dev't, decent PC DOS \$95

PROLOG-86 - Learn fast, Standard, tutorials, samples of Natural Language, Exp. Sys. MSDOS \$125

Expert System front-ends for PROLOG: APES (\$275), ES/P (\$895)

Other solid alternatives include: MuLISP-86 (\$189), WALTZ LISP for CPM (\$159), MicroPROLOG (\$275)

EDITORS FOR PROGRAMMING

BRIEF Programmer's Editor - undo, windows, reconfigurable, macro programs, powerful. PC DOS \$195

VEDIT - well liked, macros, buffers, CPM-80-86, MSDOS, PC DOS \$119

MACINTOSH

We evaluate, carry every available programmers product. Ask.

C LANGUAGE

INSTANT C - Interactive development - Edit, Source Debug, run. Edit to Run - 3 Secs. MSDOS \$495

"INTRODUCING C" - Interactive C to learn fast. 500 page tutorial, examples, graphics. PC DOS \$95

MEGAMAX C - native Macintosh has fast compile, tight code, K&R, toolkit, .OBJ, DisASM MAC \$275

Audio-based C tutorials. Overview \$95. Full \$295

C LIBRARIES

COMMUNICATIONS by Greenleaf (\$159) or Software horizons (\$139) includes Modem7, interrupts, etc. Source. Ask for Greenleaf demo.

C SHARP Realtime Toolkit - well supported, thorough, portable, objects, state sys. Source MANY \$600

APPLICATION TOOLKIT by Shaw - Complete: ISAM, Screen, Overlay mgnt, report gen, Strings, String math. Source. CPM, MSDOS \$495

ROMPack - special \$Main .EXE editor, source, tech support, 8086. \$185

DEBUGGERS

PERISCOPE DEBUGGER - load after "bombs", symbolic, "Reset box", 2 Screen, own 16K. PC DOS \$279

SOURCE PROBE by Atron for Lattice, MS C, Pascal. Windows single step, 2 screen, log file. \$395

FORTRAN LANGUAGE

MacFORTRAN - full '77, '66 option, toolbox, debugger, 128K or 512K, ASM-out option MAC \$375

DR/Fortran-77 - full ANSI 77, 8087, overlay, full RAM, big arrays, complex NUMS., CPM86, MSDOS \$249

Ask about Microsoft, Supersoft, others.

OTHER LANGUAGES

ASSEMBLER - ask about FASM-86 (\$95), ED/ASM (\$100) - both are fast, compatible, or MASM (\$125), improvements.

BetterBASIC all RAM, modules, structure. BASICA - like \$185

HS/FORTH - '79 & '83 Standards, full RAM, ASM, BIOS, interrupts, graph, multi-task, optimizer MSDOS \$250

MBP COBOL has screen control, strong doc, '74 intern., fast. MSDOS \$680

SUPPORT PRODUCTS

BASIC DEVELOPMENT SYSTEM - (BDS) for BASICA; Adds Renum, crossref, compress. PC DOS \$115

PLINK-86 for Overlays, most lang., segment control. MSDOS \$325

ProYAM Communications Package - All a programmer'd want. TTY, VT 100, 3101, MODEM7, BBS. Remote, macros, windows MSDOS \$139

CODESMITH - visual, interactive debugger. Symbolize, modify code \$129

"C" LANGUAGE

	OUR PRICE
MSDOS: C86-8087, reliable	call
Instant C - Inter., fast, full	495
Lattice 2.1 - improved	call
Microsoft C 2.x	279
Williams, debugger, fast	call
C Systems & debugger	175
CPM80: EcoPlus C - faster, SLR	275
BDS C - solid value	125
MACINTOSH: Softworks	365
Megamax-object, full	275
Consulair's MAC C	275
Compare, evaluate, consider other C's	

BASIC

	RUNS ON
Active Trace-debug	86/80 75
BASCOM-86 - MicroSoft	8086 279
BASIC Dev't System	PCDOS 115
BetterBASIC - 640K	PCDOS 185
CB-86 - DRI	CPM86 419
Prof. BASIC Compiler	PCDOS 89
Databurst - screens	MSDOS 215
SCREEN SCULPTOR	PCDOS 115
Ask about ISAM, other addons for BASIC	

SERVICE

ALL PRODUCTS - We carry 700 products for MSDOS, CP M 86, CP/M 80, Macintosh and key products for other micros.

EDITORS Programming

	RUNS ON	OUR PRICE
BRIEF - Intuitive, flexible	PCDOS 195	
C Screen with source	86/80 75	
Epsilon - like EMACS	PCDOS 195	
FINAL WORD - for manuals	86/80 215	
MINCE-like EMACS	PC80 149	
PMATE - powerful	8086 185	
VEDIT - full, liked	86/80 119	

UNIX PC

	PClike	475
COHERENT - for "C" users	PClike	call
COHERENT-NCI-Realtime	PC	1275
XENIX - plus C to MSDOS		

Ask about run-times, applications, DOS compatibility, other alternatives. UNIX is a trademark of Bell Labs

LANGUAGE LIBRARIES

	MSDOS	219
GRAPHICS: GraphiC-source in C	MSDOS	219
GRAPHMATIC-3D. FPN, PAS	PCDOS	125
HALO-fast, full-all lang.	PCDOS	139
FILE MGMT: BTRieve-all lang.	MSDOS	215
Cindex + -source, no royal.	86/80	369
CTree-source, no royal	ALL	369
dBC ISAM by Lattice	8086	229
dB VISTA - "Network" Structure	MSDOS	465
PHACT-up under UNIX, addons	MSDOS	225
OTHER: Cutil by Essential	MSDOS	129
Greenleaf - 200 +	MSDOS	159
CSharp - Real-Time	MSDOS	600
PORTABLE C to PC, Mac, II	Many	125
SOFT Horizons - Blocks I	PCDOS	139
SCREEN: CURSES by Lattice	PCDOS	125
C/view - input, validate	PCDOS	195
MetaWINDOW - icons, clip	PCDOS	139
PANEL - many lang, term	MSDOS	249
ProScreen - windows, source	PCDOS	415
Windows for C	MSDOS	175

FORTRAN

	OUR RUNS ON PRICE
MS FORTRAN-86 - Impr.	MSDOS \$ 239
DR Fortran-86 - full '77'	8086 249
PolyFORTRAN-XREF, Xtract	PCDOS 165

OTHER PRODUCTS

Assembler & Tools - DRI	8086	159
Atron Debugger for Lattice	PCDOS	395
cEnglish - dBase to C	MSDOS	750
C Helper: DIFF, xref, more	86/80	135
CODESMITH-86 - debug	PCDOS	125
MacASM-full, fast, tools	MAC	115
MBP Cobol-86 - fast	8086	680
Modula 2 for	MAC, PCDOS	90
Micro: SubMATH-FORTRAN full	86/80	250
Microsoft MASM-86	MSDOS	125
MSD Debugger	PCDOS	119
Multilink - Multitasking	PCDOS	265
PC/FORTH + - well liked	MSDOS	219
PFIX-86 Debugger	MSDOS	169
PL1-86	8086	495
Polylibrarian - thorough	MSDOS	95
PolyMAKE	PCDOS	95
PROFILER by DWB - flexible	MSDOS	109
Prolog-86-Learn, Experiment	MSDOS	125
SLK/F - Copy Protection	PCDOS	145
SYMD debugger-symbols	PCDOS	119
TRACE86 debugger ASM	MSDOS	115

Note: All prices subject to change without notice. Mention this ad. Some prices are specials. Ask about COD and PDs. All formats available

Call for a catalog, literature, and solid value

800-421-8006

THE PROGRAMMER'S SHOP™

128-B Rockland Street, Hanover, MA 02339.

Visa Mass: 800-442-8070 or 617-826-7531 MasterCard 8517

The C Compiler Thousands Rely On

C-86™

NEW-IMPROVED Version 2.2 Compiles 25% Faster
IBM-PC AT Support

When the going gets tough, Optimizing C86 comes through time and time again. C86 is a highly dependable C compiler that has been optimized through the years to provide the best combination of reliability, speed, and performance.

FAST, IN-LINE 8087/80287 SUPPORT

Now you can take full advantage of 8087/80287 capabilities, allowing your programs to run many times faster than possible with other C compilers. Plus the source code to all routines is included, so you have complete control over all functions.

MORE OF THE FEATURES YOU WANT

- **SOURCE** is provided to all libraries for total programming control. The source includes a set of standard UNIX routines plus many DOS specific functions.
- **SPECIAL IBM-PC LIBRARY** including communication, screen, and keyboard handling functions.

- **COMPATIBLE WITH WIDELY AVAILABLE LIBRARIES** such as HALO screen graphics and many, many others (call for list).
- **TOPVIEW SUPPORT LIBRARY** provides windowing capabilities.
- **SPEED OPTIMIZATION** — there's always room to tighten your code, and Computer Innovations has the tools to help. For example, *PROFILER-86* helps identify key areas for optimization.

TECHNICAL SUPPORT, NOBODY DOES IT BETTER

Computer Innovations has earned a reputation for providing customer support that is **unequaled** in the industry. This includes a user's group, an on-line bulletin board, and a user's newsletter.

JOIN THE THOUSANDS OF PROGRAMMERS WHO TRUST AND RELY ON C86

For Further Information Call 800-922-0169. Technical Assistance Call (201) 542-5920. Computer Innovations features a full line of C products including **C-to-dBase** (dBase development tool) and **Introducing C** (C Interpreter Language Learning System). Call or write for a product profile.



**COMPUTER
INNOVATIONS, INC.**

980 Shrewsbury Avenue, Tinton Falls, NJ 07724

© 1984 Computer Innovations, Inc.

For Further Information Call
800-922-0169

Technical Assistance Call (201) 542-5920

Inquiry 101

CHAOS MANOR

Tutsim is a rather odd program that turns your digital computer into a whole mess of op-amp (operational-amplifier) analog amplifiers. If you don't know what that means, you'll have a bit of work puzzling out how to use the program. If you haven't had elementary calculus, it's unlikely you'd want Tutsim, but you might. One of my boys is in precalculus in high school, and it's interesting to watch him play with dynamic models.

The last time I mentioned Tutsim, I said, "It ain't easy to use, and the manual's lousy." Since then the people at Applied i have added examples, rewritten the manual, and provided help files. Even if you've never done block-structure simulation, if you read the whole manual about five times you'll begin to get the idea. A couple of hours of mucking around with Tutsim taught me more about simulation than I'd have thought I could learn in a week.

It's simple enough to use Tutsim once you cotton on to how to do simulations with blocks. There are clock-function blocks, Booleans, integrators, delays, random-noise-generator blocks, etc.; certainly a rich enough variety to build some pretty complex models of things changing over time. Those with experience in this sort of modeling will find Tutsim a delight. Those who haven't done op-amp modeling can learn about it and have fun at the same time.

There are versions of Tutsim for CP/M-80, the Apple II, and the IBM PC. There is an IBM PC version making use of the 8087 and another to support the Hercules high-resolution graphics board; there's no install program, but the IBM PC review copy I received had both the regular and the 8087 versions on it.

The demonstration or short form of the program is limited to 15-block models, which is big enough to allow you to learn the principles of simulation. The professional version lets you build models up to 999 blocks, but Applied i wants \$495 for it. That seems a bit steep to me. I suppose if you need this kind of thing it might be worth the price, but I'd be sur-

prised if they sold many of them.

Tutsim is not copy-protected, and it works like a bomb with the Orchid PCturbo 186 board; it also runs fine on the Z-150 and Z-160 PClones. The CP/M-80 version works with a Z-100. I recommend Tutsim for anyone teaching calculus or engineering, and if you have any interest in math, you ought to be able to get as much fun out of the \$29.95 short form as you would get from a game at the same price.

UNIVERSE

Speaking of games, an outfit called Omnitrend Software has come up with the most complicated game I ever did see. It's called Universe, and it runs on an IBM PC (color only) or the Z-100; the version I have can figure out which machine it's running on, which is pretty clever. It will also run on the Z-160 without a color screen. There are versions for Apple and Atari, but I've never seen them.

Universe has some of the features of the Imperial Trader game I've been writing off and on for a year now. In fact, it has some of the features of nearly every game I ever heard of. It takes *time*; it took me nearly five hours to take out a mortgage loan, buy and equip a ship, and get started loading cargo and passengers; that, however, was before I got the manual updates.

Once I get financing and choose a ship and equipment, I can make some trading runs. There are a lot of options. I may try my hand at piracy, but not just yet, since I couldn't afford to buy any weapons for my ship, and the bank will want its payments in a few short years. First task is to pick up some profits carrying passengers.

Universe comes on two disks with an enormous manual. The first version I got didn't have enough examples, so that it was pretty hard to figure out what to do. I complained, and Omnitrend added a scenario getting you through the early purchase and jump-off.

There are about a zillion decisions to make. I confess that the silly game has got me interested; even with the

(continued)



BOY! did we GOOF!

We made **ReadiWriter™** so *terrific*, we're losing money! We'll honor the old \$125. price until May 31, 1985. After that, the price goes up to \$395.

ReadiWriter® the **ONLY** choice for formatting Large Documents

- ReadiWriter is a word processor utilizing imbedded "Tags." It comes with a full screen editor and 3 indexed manuals.
- Precision control over document layout—reformats and rennumbers after changes—automatic Table of Contents—Indexing rebuilt automatically.
- Footnotes—bottom of page; end of chapter; automatic numbering; auto flow to next page.
- Rich set of features—Lists; Figures; Macros; Fonts; Proportional spacing.

Remember! Order now at the original price of \$125.

IBM/PC and Compatibles, 128K, 2 Drives **\$395.**

ReadiWriter and Manuals	\$395.00
Manuals and Demo Disc	35.00
Shipping and Handling	3.00

Visa, Mastercard or MO.
MI & CT residents add sales tax.

At your Computer Store or order direct: (616) 327-9172

ReadiWare Systems, Inc.
P.O. Box 515, Portage, MI 49081

flu, I found myself working on ship-design trade-offs and the like. There are a *lot* of choices. It's all logically structured and pretty realistic.

Universe is copy-protected, which is acceptable for a game. If you have a two-drive system, you can put the player data on your own disk. The player files are copyable, so you can start from any saved point if you don't like the way things turned out.

There's one "feature" I don't much care for. The game manual is enormous and fairly well organized (although the index leaves a lot to be desired). The manual includes a partial list of the products that you, the trader, can deal in—and an offer to sell you the complete list for about 15 bucks. Omnitrend claims you don't *need* the complete list, and you could make a good case that it's more realistic not to have it; but in my first play of the game I found it useful, and

it seems a bit unreasonable to charge that much money for five sheets of paper.

Another feature that's going to drive me nuts is the control system. Universe is largely menu-driven, and to select items on the menu you can't just put in the item number. You have to move a cursor arrow up and down a menu (with as many as 35 items)—but the arrow keys won't always do that. Generally, you must use the Select, Start, and Option keys. Of course, the IBM PC doesn't have those keys—the manual was evidently written for the Atari version—so you must use F1, F2, and F3. Alas, while Select and Start may have intuitive meanings, F1 and F2 don't, and they don't always do what you expect them to do. I found myself wasting a lot of time giving inappropriate commands. Just how much trouble would it be to implement the arrow keys?

Quibbles aside, there's a lot of good planning in this game, and I'm impressed. Ordinarily I wouldn't review a game until I'd played it all the way through—but with Universe that's likely to take quite a long time. If you like complicated games, you might like this one.

Later: Aaarrggghh!!! I have managed to make an *enormous* profit, but I seem to be stranded in space. I quit in disgust, but after all, I did save the game at many stages, so I won't have to backtrack too far. The worst of it is, I expect I will have another shot at it. I did, too. And more after that . . .

PROFESSIONAL BASIC AND TRACE86

Another greatly improved program is Morgan Computing's Professional BASIC for the IBM PC. Alas, it won't work with SideKick. It doesn't work

THE SPORTS HOTEL. GOOD HEALTH IS GOOD BUSINESS.



with Magic Keyboard either, but that doesn't bother me now that I have the Wico Smartline Smartboard. Professional BASIC is a complete interactive debugging system that makes it considerably easier to write large and complex BASIC programs. Morgan has recently dropped the price to \$99.

Morgan also markets a program called Trace86. This was written by Dr. Neil Bennet, author of Professional BASIC. It's somewhat similar to the MS-DOS Debug utility, but it gives more information and is a bit easier to use. I haven't had extensive experience with it, but I did use it to see if it would be useful in writing demons to defeat copy protection. It is, but some copy-protected programs are also "Trace-protected," meaning that extra code has been put in to make the programs unrunnable under Trace utilities. This also makes the programs

fragile and hard to debug, but many publishers seem to think they need protection more than customers. Trace86 is not copy-protected and has a reasonable license policy.

The Trace86 manual is as good as Digital Research's DDT and SID manuals were; if you're familiar with debugging tools, you'll have no problem with this one. If you're not, you'll have to learn the theory elsewhere; this will teach you how to use Trace86, but not why you need it.

COMPUTER COMPANION

Back in the seventies when I first got Ezekial, my friend who happened to be a Z80 computer, the big problem was systems integration. When you bought a computer, you got several boxes of parts, and even if you bought everything "assembled and tested," you had problems getting the computer to talk to the outside world.

Professional BASIC makes it considerably easier to write large and complex BASIC programs.

Zeke used a memory-mapped video board and separate keyboard, mostly because in those days the best text editor I'd ever seen was Electric Pencil, and Pencil didn't know how to work with a terminal. Also, in those days it wasn't so easy to hook up to a terminal.

Then came Adam Osborne with the first low-cost all-up computer: you

(continued)

© 1985 Holiday Inns, Inc.



As the world's hotel leader, we have a commitment to your good health. And it shows.

Over 900 of our hotels offer facilities for sports enthusiasts, like tennis courts and running courses. In our 200 Holidome® indoor recreation centers, you can swim in an enclosed pool, use a whirlpool or sauna...or just relax and think about it all.



Helping you keep fit is one reason Holiday Inn® hotels are the number one choice of America's business travelers. And we're working to keep it that way...to give you

one more good reason to call 1-800-HOLIDAY for all your travel reservations.



HOLIDAY INN. A BETTER PLACE TO BE.™

took it home, plugged it in, and it ran. It set the style for what a computer should look like: two built-in disk drives, a screen, and a keyboard. Pretty soon most of us decided those were the minimum requirements for a real computer, as opposed to toys.

It made sense. Real computers do important work. Important work needs backup copies. Making backup copies requires two disk drives, because if you don't have two disk drives, you won't make the copies. Nobody wants to sit there swapping disks back and forth. As for keyboard and screen, it was true that some systems didn't have them built in, but that was advanced equipment, suitable for experts who knew about smart and dumb terminals, and data-transmission rates, and complicated stuff like that. Computers for the rest of us came with everything.

It was easy enough to fall into the

habit of thinking that way. Comes now the Companion to challenge that notion.

The Companion is about as simple as a computer system can get. It consists of a smooth gray metal box 13½ inches long by 6¾ inches high by 3½ inches wide. It weighs maybe eight pounds. There's one 5¼-inch disk drive; an on/off switch; a Reset button; two RS-232C jacks; one parallel output jack; an edge connector; a handle; and a power cord. Packed in with it is one floppy disk and a 50-page manual.

That's it. No keyboard, no screen, no mice. The manual tells me the Companion is a 4-MHz Z80A. The disk drive formats floppies in the Morrow single-sided double-density format. According to the manual, the disk drive knows how to read and write to IBM, Kaypro, and Osborne disks, although it won't format them.

The manual doesn't say it, but the disk drive won't read double-density Osborne disks or Osborne Executive disks. There is apparently a model of the Companion that accepts double-sided disks, but mine doesn't.

In other words, the Companion is strictly a no-frills job—but within those limits it's quite a lot of machine.

The Companion actually has *three* disk drives. Drive C: is the regular floppy. Drive B: is a small ROM (read-only memory) drive that boots the Companion with CP/M 2.2. The ROM also contains a general utility program with Copy and Format commands and a terminal-emulation program.

Drive A: is a 190K-byte RAM disk. That makes a *lot* of sense. Except for power failures, a RAM disk is more reliable than a floppy and certainly faster. The Copy routine lets you copy from the RAM disk to the floppy and vice versa. The theory is that you do most of your work on the super-speedy drive A: and from time to time save the results onto the floppy. That works, too, since copying is pretty fast. My first thought was that 190K bytes (186K on the floppy) isn't really enough disk space, but then I recalled that my first machine's 8-inch drives didn't hold but 240K bytes and were noisy to boot, and I thought Zeke was *wonderful*. Zeke and I did a lot of writing, kept my accounts, did my taxes, and managed my files. Zeke's old iCOM drives were slower than the Companion's floppy, and Zeke never ran faster than 2 MHz.

That got me to thinking. I'd have been thrilled to have the Companion back when I first started. With a good terminal and the WRITE text editor I use, the Companion would be one heck of a writer's engine; and depending on which terminal and printer were selected, the cost could be kept low. Up to now I've tended to recommend the Kaypro to colleagues asking for low-cost entry-level equipment; but some of them don't like the keyboard and/or the small screen. The Companion might just be the ideal first computer for a writer.

One problem, though: how hard

(continued)

ULTIMATE PLACE FOR YOUR COMPUTER SOFTWARE AND COMPONENTS

LOOK WHO WE SELL TO

Hughes Aircraft

Northrop

Rockwell International

IBM

Price Waterhouse

TRW

Plus Many More . . .

AND WHAT WE SELL

Lotus 1-2-3

dBASE III

Hayes 1200B

Microsoft

Epson

Okidata

Anchor

Orchid Technology

Paradise

Plus Many More . . .

Call today for our quote — You'll be glad you did!

TOLL FREE OUTSIDE CALIF.

1-800-423-6326

IN CALIFORNIA

(213) 827-1851



SOFTWARE GALORE, INC.

4079 GLENCOE AVENUE • MARINA DEL REY, CALIFORNIA 90292

A COMPUTER PROGRAM THAT SPEAKS YOUR LANGUAGE



The Computer Chronicles, a half-hour weekly television series brings you news and information from Silicon Valley and around the world. Correspondent Stewart Cheifet and Gary Kildall, creator of CP/M cover today's headlines and the stories behind them. Find out what is, what was and what will be, with the only computer program you're ever going to need. **The Computer Chronicles**, every week on a public television station near you. (Check local listings for time and channel.)

Produced by KCSM, San Mateo, CA and WITF, Harrisburg, PA with funding from McGraw-Hill's **BYTE** and **POPULAR COMPUTING** magazines.



FlashCalc

June	July	August	September	October	November	December	TOTAL 1986
86,857	81.1 87,282	81.1 87,282	81.1 87,940	81.1 88,237	81.1 90,754	81.1 89,192	81.1 85,540
8086	2.4 8216	2.4 8216	2.4 8238	2.4 8258	2.4 8263	2.4 8276	81,135
8183	1.2 8100	1.2 8113	1.2 8119	1.2 8125	1.2 8131	1.2 8138	3.1 81,883
9253	1.1 8977	1.1 8987	1.1 8997	1.1 9010	1.1 9018	1.1 9024	2.8 91,150
8183	1.9 8173	1.9 8181	1.9 8184	1.9 8187	1.9 8190	1.9 8192	4.9 82,952
8154	1.0 8158	1.0 8162	1.0 8167	1.0 8171	1.0 8175	1.0 8179	3.9 81,949
872	4.9 876	4.9 879	4.9 879	4.9 883	4.9 885	4.9 887	2.1 89,010
8163	2.9 8177	2.9 8184	2.9 8184	2.9 8185	2.9 8187	2.9 8188	8.0 82,226
8267	3.2 8281	3.2 8295	3.2 8310	3.2 8325	3.2 8341	3.2 8358	8.0 83,336
8462	1.8 844	1.8 851	1.8 858	1.8 865	1.8 872	1.8 879	5.9 84,826
8162	1.8 8173	1.8 8181	1.8 8184	1.8 8187	1.8 8190	1.8 8192	4.9 82,952
125.5	100.0 0.081	100.0 0.325	297.4 0.751	190.8 0.280	100.0 0.179	100.0 0.134	252.1 8155.440
6.26	1.3 125	1.3 144	1.3 143	1.3 153	1.3 154	1.3 173	1.3 81,266
29	0.3 31	0.3 35	0.3 34	0.3 33	0.3 33	0.3 33	0.3 81,266
57	0.7 81	0.7 85	0.7 84	0.7 83	0.7 82	0.7 77	0.7 81,266
842	3.8 848	3.8 856	3.8 857	3.8 867	3.8 867	3.8 867	3.8 81,266
8136	96.9 8,141	96.8 8,205	96.8 8,293	97.2 8,362	96.9 8,424	96.8 8,478	248.9 81,821
887	19.4 838	19.4 825	19.4 822	19.4 819	19.4 818	19.4 819	9.2 81,758
758	8.9 712	8.8 728	8.8 742	8.8 751	8.8 755	8.8 755	8.8 81,758
794	9.4 754	9.3 769	9.2 782	9.1 793	9.0 804	8.9 815	8.9 81,758
8,429	28.7 2,384	28.7 2,358	28.7 2,275	28.7 2,194	28.7 2,100	28.7 2,026	28.7 81,758
5,771	68.2 6,297	78.9 6,473	71.6 6,218	63.5 5,915	68.2 7,524	78.9 8,114	71.6 81,758
191	-8.1 191	0 8.8	11 8.1	191 -8.1	191 -8.1	8 8.8	8 8.8
5,782	68.1 6,388	78.8 6,473	71.6 6,229	63.6 5,906	68.1 7,545	78.8 8,114	71.6 81,758
8 8.8	8 8.8	8 8.8	8 8.8	8 8.8	8 8.8	8 8.8	8 8.8
85,742	68.1 84,288	78.8 86,373	71.6 84,229	63.6 81,006	68.1 87,645	78.8 93,214	71.6 85,742

If you use an Apple® II Plus, IIe or IIc, now there's a spreadsheet that won't invade your space. FlashCalc™ from Paladin™. It allows you to finally expand your spreadsheet powers beyond 128K. At 256K, FlashCalc provides nearly twice the model size of VisiCalc® or AppleWorks®. And five times the capacity, when memory is increased to 512K. It's also more than 3 times faster than VisiCalc. Or AppleWorks.

To further prove our case, consider FlashCalc's extra features. Like variable column widths, so you won't have to abbreviate Interdepartmental Amortization Analysis. (You'll also have room for the total total.)

More ready-to-use financial functions, which you'll appreciate when you depreciate. More printer options, so you can easily adjust the size of your printed spreadsheet.

In fact, FlashCalc gives you lots of features not available on most spreadsheets. At a price not available on most spreadsheets—\$99*.

A built-in conversion program even allows VisiCalc owners to easily transfer files and formulas.

And, of course, FlashCalc also runs on the entire IBM® PC family, including PC jr.

So call 800-4-PALADIN for the name of the FlashCalc dealer nearest you. They'll give you all the details. We've just run out of space.

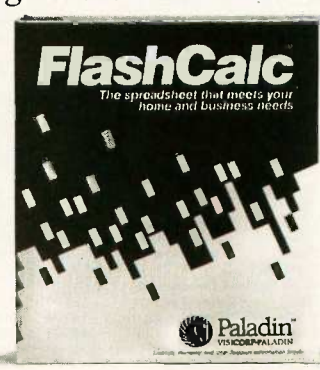

Paladin™
VISICOMP-PALADIN

IBM is a registered trademark of International Business Machines Corporation. VisiCalc is a registered trademark of Software Arts. Apple and AppleWorks are registered trademarks of Apple Computer, Inc. *Suggested retail price.

Shopper's Guide

for ELECTRONIC & COMPUTER

RS-232 DATA LINE MONITOR

A miniature Data Line Monitor determines the status of the seven key signals of the RS-232 data path. All 25 pins wired through, and dedicated red LED's report the status of: Transmit Data, Receive Data, Request to Send, Clear to Send, Data Set Ready, Data Carrier Detect, Data Terminal Ready, LED's glow at 3 Volts.



MODEL	GENDER	1-9	10-24
DLMS	M-F Shielded	37.35	33.99
NEW Deluxe Monitor now available with red/green LED's to indicate a hi, low or open condition. Metal shield.			
DLMS-2	M-F Shielded	46.95	42.72

DATA LINE GENDER CHANGERS

Needed when connectors won't mate. Choice of shielded, unshielded, or Centronics.



RS-232 Gender Changers			
DG-25F	(F-F) Unshielded	16.95	15.42
DG-25M	(M-M) Unshielded	16.95	15.42
DGS-25F	(F-F) Shielded	18.65	16.97
DGS-25M	(M-M) Shielded	18.65	16.97

Centronic Gender Changers			
DGS-36F	(F-F) Unshielded	36.95	33.62
DGS-25M	(M-M) Shielded	36.95	33.62

RS-232 DATA JUMPER BOX ADAPTER

Used to customize RS-232 interfaces. All 25 pins terminate to 25 solder pads. The PC board is already wired to the D-Subs. Includes 25 stripped leads for custom wiring. Many interfaces could be built. Null Modems, Pin Reversers, etc. Metal snap-on covers, hardware supplied.



DJBS	(M-F) Shielded	21.95	19.97
DJBS-M	(M-M) Shielded	21.95	19.97
DJBS-F	(F-F) Shielded	21.95	19.97

RS-232 DO IT YOURSELF KIT

Allows the creation of many RS-232 variations. The following components are included in the assortment: two 25-pin D-Sub Connectors, two metal Snap-on half covers, 1 set Hardware, DIYS (M-F) Shielded 12.95 11.78, DIYS-M (M-M) Shielded 12.95 11.78, DIYS-F (F-F) Shielded 12.95 11.78



RS-232/CENTRONICS ADAPTER BOX

Used to customize printer adapters. The DB-25 has 25 flying leads, ready to be soldered to any of the 36 pin female Centronics.



DJBA	(M-F) Shielded	24.95	22.70
------	----------------	-------	-------

RS-232 SURGE PROTECTOR

Guard against voltage spikes entering your RS-232 ports. Metal varistors on lines 2, 3 & 7 clamp surges above 25 volts without affecting normal operation. This compact protector mounts in series. All 25 lines are wired through. DSP (Male-Female) 24.95 22.70



TOLL FREE ORDERING • ADD \$4.50 Shp. & Hand.
800-343-1455 MA & Technical Calls
 617-682-6936

DATA TRANSFER SWITCH BOXES

- Sturdy Aluminum Cases
- RFI Safety Proof
- Light Tan Color
- High Grade Rotary Switch
- Size: 2.25" x 7.25" x 5"
- 6 LED Hi-Lo Monitor (Optional)



RS-232 12 Lines Switched	1-4	5-9
DT2512-2	2 Way (1in-2out)	99.00 94.05
DT2512-3	3 Way (1in-3out)	115.00 109.25

RS-232 All 25 Lines Switched	1-4	5-9
DT2525-2	2 Way (1in-2out)	115.00 109.25
DT2525-3	3 Way (1in-2out)	130.00 123.50
Optional 6 LED (Hi-Lo) Monitor Add \$30.00		

Centronics 25 Lines Switched	1-4	5-9
DT3625-2	2 Way (1in-2out)	155.00 147.25
DT3625-3	3 Way (1in-2out)	175.00 166.25
Switches: 1-16, 18, 31-36, 19-30		

DATA TRANSFER SWITCH BOXES

- Sturdy Steel Cases
- RFI Safety Proof
- Dark Tan Color
- Molded Rotary Switch
- Size: 3.2" x 6" x 5.9"
- Unconditionally Guaranteed



RS-232 12 Lines Switched	1-4	5-9
DB2512-2V	2 Way (1in-2out)	99.00 94.05
DB2512-3V	3 Way (1in-3out)	115.00 109.25
DB2512-4V	4 Way (1in-4out)	135.00 128.25
DB2512-X	Crossover	120.00 114.00

RS-232 All 25 Lines Switched	1-4	5-9
DB2525-2V	2 Way (1in-2out)	120.00 114.00
DB2525-3V	3 Way (1in-3out)	140.00 133.00
DB2525-4V	4 Way (1in-4out)	165.00 156.75
DB2525-X	Crossover	150.00 142.50

Centronics 25 Lines Switched	1-4	5-9
CN3625-2V	2 Way (1in-2out)	155.00 147.25
CN3625-3V	3 Way (1in-3out)	175.00 166.25
CN3625-4V	4 Way (1in-4out)	195.00 185.25
CN3625-X	Crossover	180.00 171.00

Centronics All 36 Lines Switched	1-4	5-9
CN3625-2V	2 Way (1in-2out)	170.00 161.50
CN3625-3V	3 Way (1in-3out)	195.00 185.25
CN3625-4V	4 Way (1in-4out)	225.00 213.75
CN3625-X	Crossover	205.00 194.75

ecom DATA PRODUCTS
 1755 Osgood St. Rte 125
 No. Andover MA 01845

CHAOS MANOR

would it be to set up? One reason we used memory-mapped video instead of terminals in the old days was the difficulty of hooking up a terminal. RS-232C connections are anything but standard, and how do you explain data-transmission rates and the like to a beginning writer?

SETTING UP

I got the Companion running while I was talking on the telephone about something else. The only hard part was finding an RS-232C cable with which to hook up to the terminal. Then I remembered one I'd bought and never used: Priority One's "Shielded RS232 Serial Cable Pin 1 THRU 8 and Pin 20 Male to Male." There was a lot more than I needed—the cable was 25 feet long—but that would be a good test, too, since some systems can't handle long cables due to excessive noise pickup (the cable acts as an antenna). I took the Companion out of its box and plugged it in; plugged the RS-232C cable into the plainly marked Terminal Port on the Companion; and plugged the other end of the cable into the Tele-Video 950 that my CompuPro 8/16 normally talks through at 19,200 bps. Then I turned on the Companion and hit Return on the terminal. According to the manual, the Companion was smart enough to figure out the data-transmission rate for itself.

It did, too. I'd left the Companion's drive door open, so it booted off the ROM just as it's supposed to. It comes up in a little utility shell program that offers you the alternative of typing 0 through 5; 0 puts you into CP/M, 1 will copy a disk, and so forth. Since I could read the messages, it was obvious that the terminal was properly set up—data-transmission rate, data and stop bits, and so forth; and sure enough, pressing the 0 put me into standard CP/M.

Next the acid test. I let the Companion format a disk for me, put that into the CompuPro 8/16 (I had to switch the terminal from the Companion to the CompuPro, of course, but that was no problem), used the CompuPro's Newmedia program to tell it we were

going to work with the single-sided double-density Morrow format, and used PIP to transfer WRITE.COM from the 8/16 to the Companion's disk. Brought the floppy back to the Companion, fired up WRITE—

Bingo. Worked fine.

By golly, I thought, this just very well may be the entry machine for writers. But I'd better make sure...

GLITCHES

Alas, there are glitches. One is serious. I'll get to it in a minute. The others are irritants that common sense will cure. Of course, I don't know how much common sense a new user will have.

For example: the floppy-disk drive is mounted vertically. There's no indication of which side is "up." I happen to know that drive doors generally close from the top, but does everyone? If you put the disk in upside down and try to access the disk, the drive motor goes on and the disk's little LED (light-emitting diode) lights up—and that's the way things will stay until doomsday. Reset will cure the problem. Turning the machine off will do it, too, but that's not a wise idea, since it's possible for a disk drive to write garbage during power-down.

CP/M 2.2 requires you to do a Control-C every time you change disks. WRITE is set up to do the equivalent of Control-C each time you do disk accesses; this is so that you can change disks without exiting WRITE. When we designed WRITE I insisted on this feature, because it lets me make intermediate backup copies of my work and physically remove them from the machine. Also, if I overfill a disk, I can still save the work simply by putting in a disk with more room on it. Once in a great while WRITE will still get confused when we not only change disks but change disk formats by switching from single to double density, but even then WRITE will recover from the error; at worst you have to log onto the new disk.

It doesn't quite work that way with the Companion. Somehow the Companion's interrupt-driven BIOS (basic input/output system) defeats all of

(continued)

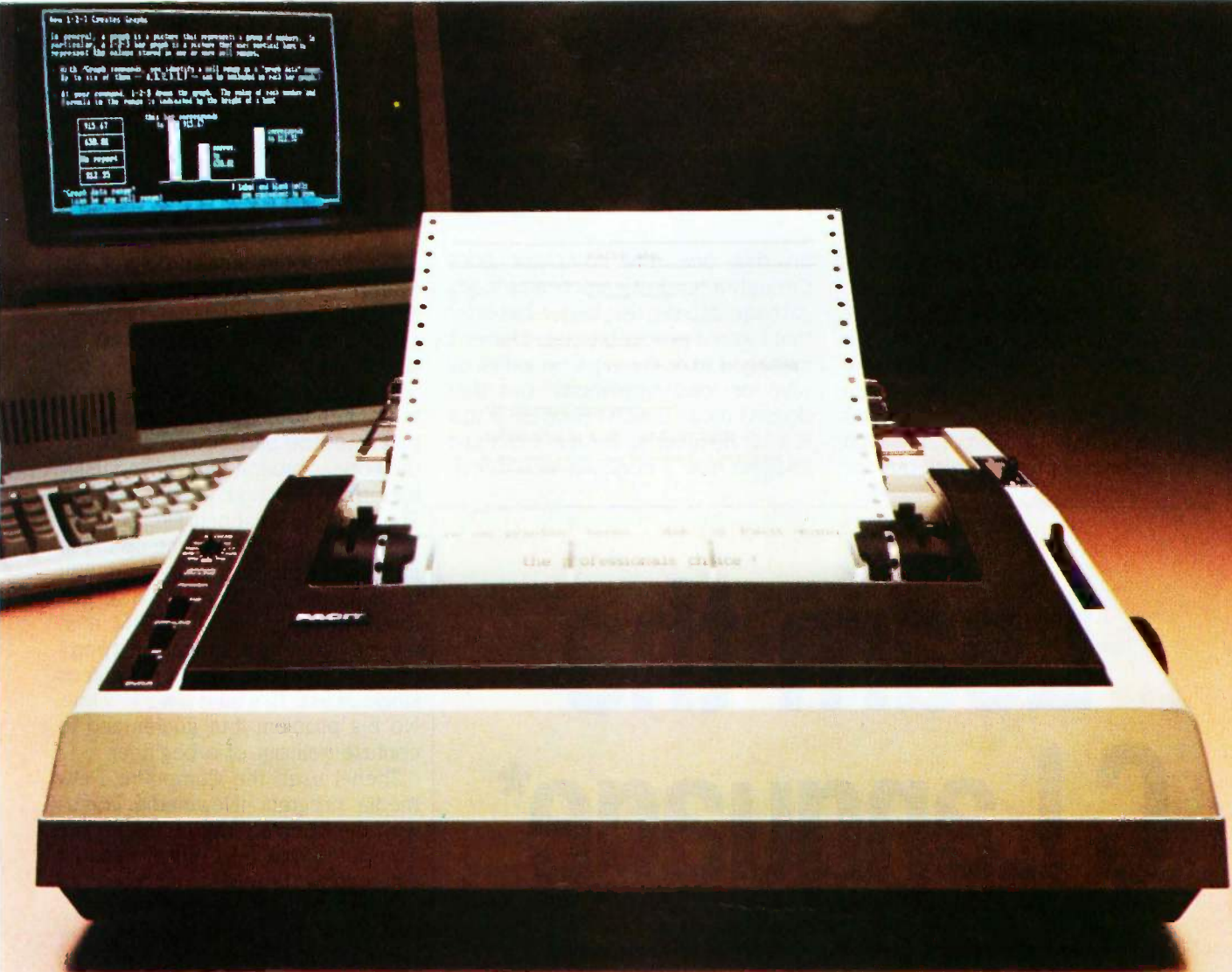

YOUR IBM PC PERSONAL PRINTERS

What your IBM Personal Computer* commands, the new Facit 4511 and Facit 4512 Serial Matrix Printers will reproduce in quality letters and graphics.

All perfect, at a speed of 160 CPS. Twice as fast as the IBM PC printers.

The combination of high throughput with Facit quality and reliability in printing performance keep pace with professional PC developments.

Your printout possibilities are completed by:

- printing in 9×9 matrix
- 10 or 17 pitch printing
- fan-fold tractor feed, single sheet with friction feed
- 80 or 132 column paper width (4511 or 4512 versions)

Take pride in your printouts with Facit 4511 and Facit 4512.

At a price every PC-owner can afford.

**Printer
Perfect** ✓

FACIT

Inquiry 166

IBM PC is a trademark of International Business Machines Corporation.

Head Office: *Facit AB, S-172 91 Sundbyberg, Sweden. Phone: (8) 764 3000. USA: Facit Inc. P.O. Box 334, Merrimack, NH 03054. Phone: (603) 424-8000*

AUSTRALIA: EAI Electronics Associates Pty Ltd., 427-3322. AUSTRIA: Ericsson Information Systems GmbH, 0222-43 95 01. BELGIUM: Ericsson S.A., 02-243 82 11. CANADA: Facit Canada Inc., 416-821-9400. CYPRUS: LBM (Lillytos) Ltd. DENMARK: Facit A/S, 02-92 24 00. FINLAND: OY Facit, 90-770 01. FRANCE: Facit S.A., 1-780 71 17. GREAT BRITAIN: Facit, 0634-4017 21. GREECE: Computer Application Co., Ltd., 01-671 97 22. HONG KONG: Gilman & Co. Ltd., 5-790 95 55. ICELAND: Gisli J. Johnsen HF, 354-17 31 11. INDIA: Forbes Forbes Campbell & Co. Ltd., 22-26 80 81. IRELAND: Memory Ireland Computers Ltd., 1-98 97 33. ITALY: Facit Data Products S.p.A., 0039-63 63 31. JAPAN: Electrolux (Japan) Ltd., 03-479-3411. THE NETHERLANDS: Ericsson Information Systems B.V., 03480-709 11. NEW ZEALAND: McLean Information Technology Ltd., 501-801, 501-219. NORWAY: Ericsson Information Systems A/S, 02-35 58 20. PORTUGAL: Regisconta Sarl, 1-56 00 91. SINGAPORE: Far East Office Equipments Pte Ltd., 745 82 88. SPAIN: Facit, 91-457 11 11. SWEDEN: Ericsson Information Systems Sverige AB, 08-29 00 20. SWITZERLAND: Ericsson Information Systems AG, 01-391 97 11. USA: Facit Inc., 603-424-8000. WEST GERMANY: Ericsson Information Systems GmbH, 0211-79 93 31.

WRITE's safeguards. The result is that I can, within WRITE, save a file onto the C: disk; change disks; log onto the A: disk; log back onto the C: disk; but when I get the C: directory, I get the directory of the *previous* disk! I can force it to log onto the current disk by attempting to load a file that existed on the previous disk but not

on this one; the computer goes through a read operation and loads garbage into the text buffer, but after that has the proper bit map. I haven't managed to really mess up a disk by save or load operations, but that doesn't mean it won't happen. If this is a bit disquieting for me, I can just imagine how a beginner would feel.

There are other small problems. For example: if you accidentally (forgetting that the Companion uses single-sided disks) try to format a disk as double-sided, the disk spins, the Select LED lights up—and you can sit there until you reset or starve. Okay, that's not too bad. You reset, invoke the Format program again, and tell it to format that disk as single-sided. The same thing happens! Reset again. When you reset, you come up in the little utility program that offers you the opportunity to format a disk; just for the hell of it, I exited to CP/M, then instantly went back into the utility program and told it to format the disk as single-sided. This time it worked fine. No big problem, but guaranteed to confuse hell out of a beginner.

Then I used the CompuPro Newmedia program (Newmedia comes with the updated TMX BIOS for the CompuPro Disk I-A Controller, and it can read, write, and format about 40 different 5¼-inch disk formats) to format a disk as double-sided Morrow and put some files on it. Remove from CompuPro and put into Companion. Do Control-C. Try to read the disk.

What I get is garbage. It pretends there's a directory on there, but with weird filenames like blank.blank and @.blank. Just for the hell of it, I used the Copy utility; worked fine, copying the garbage onto the A: RAM disk. None of it was readable, of course. No harm done. Now to invoke the Format program and reformat that disk so I can use it—

Drives spin. LED comes on. Wait a while. Reset. Fool around, exit Format, do Control-C, go back to Format. Same result. It will not format that disk. Finally, I took a small magnet to the disk. That took care of the problem. It formatted fine. Okay, I knew to do that. Would a beginner? Incidentally, as part of the Format process the Companion writes CP/M onto the floppy's system tracks, although the manual nowhere tells you that.

DOCUMENTS

The Companion comes with a 50-page manual. It's an interesting at-

(continued)

Learn the C Language*

Introducing
C

C LANGUAGE TRAINING SOFTWARE
IBM PC-DOS 2.0 +

INTRODUCING C is a C language interpreter and learning guide that teaches the fundamentals of C programming. You'll learn program structure, syntax, and all about libraries - QUICKLY and EASILY. Join the C revolution with INTRODUCING C - from Computer Innovations. Introductory price \$95.

For further information or to order call 800-922-0169.

 **COMPUTER INNOVATIONS, INC.**

980 Shrewsbury Avenue, Tinton Falls, NJ 07724 • (201) 542-5920

***As Fast As You Can Learn BASIC**

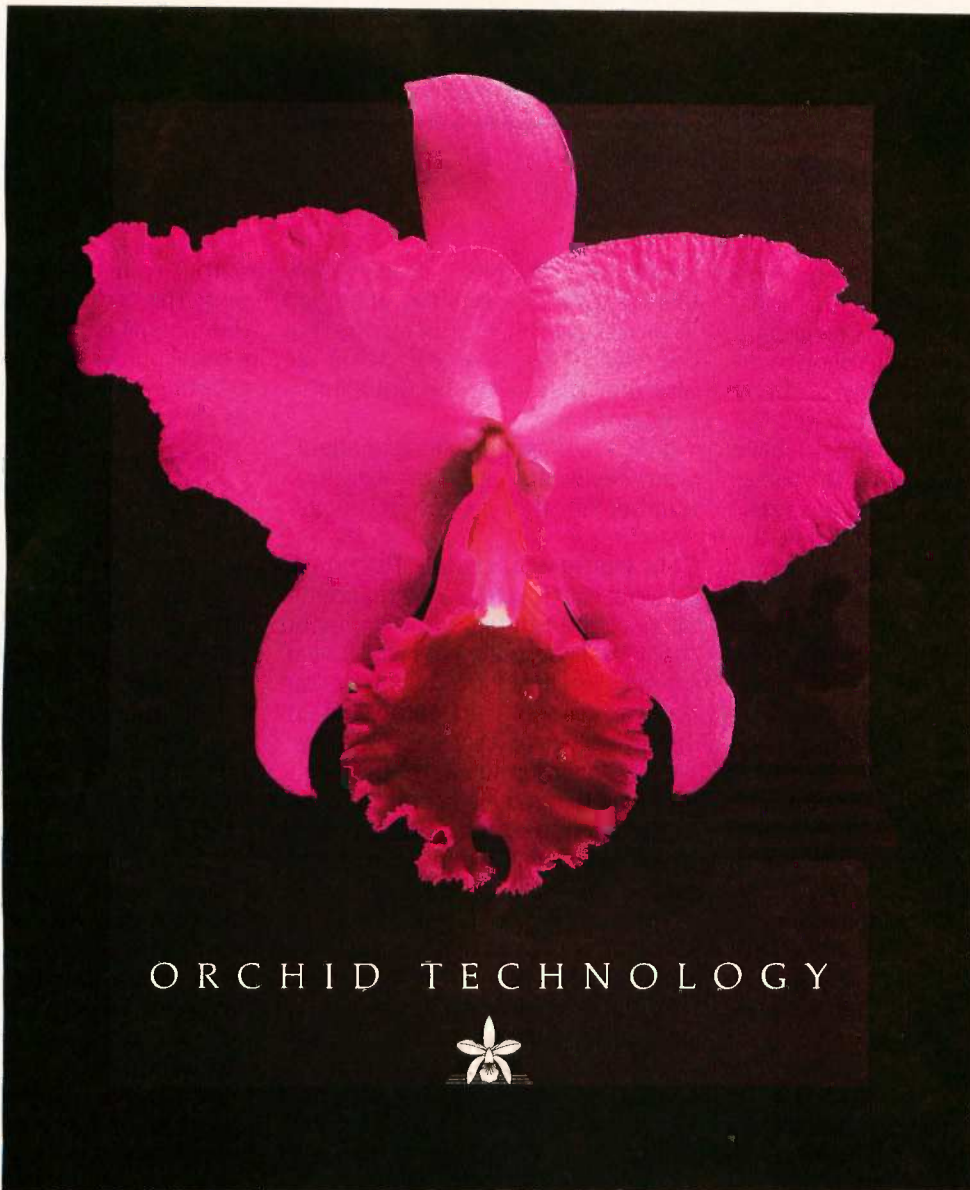

Actual size: 21" x 28"

What is beauty?

*"Beauty is truth, truth beauty,
That is all ye know on earth,
and all ye need know."*

John Keats

ORCHID TECHNOLOGY is among the innovative leaders in PC productivity enhancements. From Local Area Networks to high performance expansion products such as PCTurbo, Orchid is applying cutting edge technology to meet the needs of personal computer users. That is our Truth.



If you would like a 21" x 28" orchid poster, suitable for framing (depicted above), send five dollars which includes postage and handling to ORCHID POSTER at Orchid Technology.

ORCHID TECHNOLOGY
47790 Westinghouse Drive • Fremont, CA 94539
(415) 490-8586 • Telex 709289

tempt to pack in a short course on CP/M, some beginner's instructions, and all the necessary technical data about the Companion. In trying to do them all, it doesn't do any of them.

Even so, in some respects it's the best short computer manual I have ever seen—but it's written for someone with at least my level of understanding. They recommend that the new computer owner get a decent CP/M book. Since the usual CP/M 2.2 documents (which aren't very useful anyway) aren't furnished, the beginner will certainly need one of the myriad introductions to using CP/M; the Companion's manual explains just enough to get a completely naive user confused and into trouble. There's a one-page "Command Reference" for DDT, and another for ED.COM, and sandwiched in between those two pages is a very cryptic one-page "explanation" of DIR, LOAD.COM, and a program called XDIR.COM that was not, in fact, on the disk furnished with the Companion.

On the other hand, there's a very complete listing of the pin-outs for the three communications ports, an I/O Port Address Table, an Interrupt Vector Table, and lots of other information that should be available to buyers. There are a whole bunch of

references to the BIOS, given in a way that makes it look as if they intended to furnish the BIOS source code; but there wasn't any source code on the disk that came with the Companion I received.

It also explains how to reconfigure your keyboard and how to do a number of other interesting things.

THE INSURMOUNTABLE PROBLEM

General Curtis LeMay, commander in chief of the Strategic Air Command many years ago, used to insist that all his subordinates think positively. One day a colonel ran into General LeMay's office and shouted, "General, we have an insurmountable problem!" LeMay banged his fist on the desk. "Colonel, in this command we don't have problems! We have opportunities!"

The colonel saluted. "Yes, sir. General, we have an insurmountable opportunity."

At the moment the Companion has an insurmountable problem. If I had the BIOS code, I might have treated it as an opportunity to get my hands dirty; I haven't hacked a BIOS in a couple of years. I didn't have the BIOS, though, and so I never did get a printer hooked up.

The Companion normally sends

output to be printed to the parallel port. This is documented, after which the manual explains how to connect a serial printer to the second RS-232C output port. It tells you that you have to do

d:STAT LST: = TTY:[RTN]

which is not really a very clear instruction for a beginner; if you treat that like a cookbook and type the d:, it not only isn't going to work (since there is no d: disk drive), but you will get an endless series of messages saying, "Not ready error."

Note that you do not get a BDOS (basic disk operating system) error. The Companion's BIOS has been jiggered around to defeat CP/M's BDOS errors. The Companion's manual doesn't tell me that, of course; in fact, it never mentions error messages at all. Note that the new user has been instructed to get a book on CP/M. That's going to tell him to expect the infamous BDOS errors. It isn't going to tell him what to do about a "Not ready error" on a nonexistent disk.

Incidentally, if you try to access a nonexistent drive other than D: or E:, you *do* get the message: "BDOS Err on K: Select," and neither Return, nor Escape, nor Control-C will get you out

(continued)

You can pay more, but you can't find better

• Complete CPU Board with 256K Memory and up to 640K on board, serial and parallel ports. Runs MS-DOS and CP/M-86. Complete documentation included.....\$399

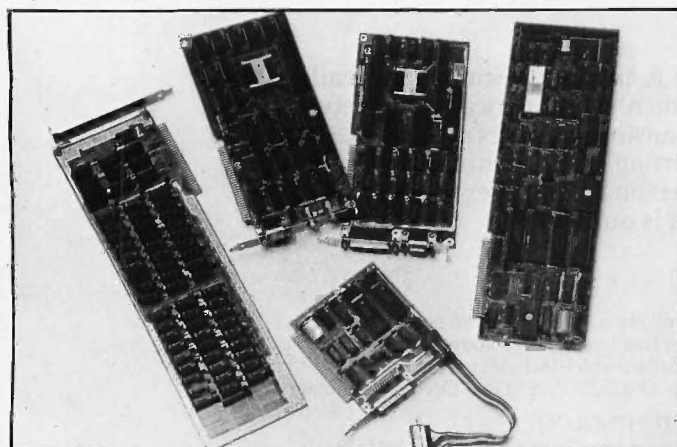

- Floppy Drive Controller.....\$ 89
- Winchester Hard Disk Subsystem for IBM PC, 20MB.....\$ 850
- Monochrome Card.....\$139
- Color Graphics Card.....\$155
- IBM Compatible Keyboard.....\$ 89
- Multifunction Board (64K).....\$210
- (384K).....\$350
- Memory Expansion Board (64K).....\$125
- (384K).....\$300
- Serial Card (2 ports).....\$ 50

One-year warranty for all add-on cards!

CALL TOLL FREE TO ORDER (800) 536-1542
in California call (408) 730-1795 Technical Support Service (408) 773-8400

U.S. SERVEX 195 West El Camino Real
Sunnyvale, California 94087

THE ADVENTURE CONTINUES . . .

THE EXCITEMENT IS BACK!

HOMEBASE

\$49.95

Resident Software
Always available . . .
At the touch of a hotkey . . .

Regardless of whatever else you're running.

INSTANT DATABASES . . . BECAUSE THAT'S HOW MOST OF US NEED INFORMATION . . . INSTANTLY!

Homebase provides you instant access to your own private universe of databases. Just hit the hotkey to freeze whatever software you're working in, and you're ready to find, insert or manipulate data. Hit it again, and you're back working in your original software, without skipping a beat.

DOS SERVICES

Need to shift a file up a directory while you're working in Wordstar? It's just a keystroke away with Homebase. You can open multiple directories and sub-directories onscreen, move, copy, view and even edit files from within this powerful Homebase feature.

AND A VERY FULL TOOLCHEST

Tools that will save you time and help you organize information, schedule, calculate, file and notate. You can even set up your own reference pages for instant recall.

ORDER YOUR COPY OF HOMEBASE TODAY!

For Visa and MasterCard Orders Call Toll Free: 800-538-8157 Ext. 824

Call Mon.-Fri. 6 A.M. to 12 P.M., Sat. & Sun. 6 A.M. to 8 P.M. (P.S.T.) In CA 800-672-3470 Ext. 824

Or fill in this ORDER FORM and enclose a check, money order or your VISA or MasterCard number.

Homebase is available for the IBM PC, XT and True Compatibles — \$49.95 + \$5 for shipping and handling*

A COMMUNICATIONS BREAKTHROUGH!
ELECTRONIC MAIL THAT TAKES CARE OF ITSELF . . .
IN THE BACKGROUND

(While you're running Wordstar, Lotus, a compiler or whatever.)

It's reason enough to own a modem.

With HOMEBASE, Electronic Mail arrives, automatically, while you're working in another piece of software. Up in the corner of your screen, a signal flashes to tell you when there's incoming mail. You can choose to read it as it arrives, or you can ignore it, and your mail will automatically file itself . . . to be read at your leisure.

AMBER'S HOMEBASE—CHECK THE DIFFERENCE IN VALUE!

HOMEBASE™	SIDEKICK™	POLY WINDOWS™	SPOTLIGHT™
Notepad Calendar Calculator Phone Directory DOS Services Databases Auto Dialer Alarm Phone Directory Card Printer Tables & Pages Template Maker Data Transfer Cut & Paste Programmable Hotkey Phone Message Pad Time & Expense Diary To-do List Electronic Mail Quickterm Terminal Mailing Label Printer	Notepad Autodialer Calendar Calculator ASCII Table Phone Directory Card Printer	Notepad Keyboard Macros Calendar Calculator Game Alarm File Cards	Notepad Calendar DOS Services Calculator Phone Directory Card Printer File Cards
\$49.95!	\$49.95	\$49.95	\$149.95

Sidekick is a trademark of Borland International Inc. Poly Windows is a trademark of Polytron Corp. Spotlight is a trademark of Software Arts. Homebase (H and B) is a trademark of Ashton-Tate. Lotus (1-2-3) is a trademark of Lotus Development Corp. Wordstar is a trademark of MicroPro.

YES! Site licenses are available for companies . . . large and small. If you would like to order a single copy, now, to examine and show around your company, its cost can be deducted, later on, from your site license.

For further information on site licenses call 408-996-1883.

Inquiry 23

NAME _____
 TITLE _____
 COMPANY NAME _____
 ADDRESS _____
 CITY _____ STATE _____ ZIP _____
 HOME PHONE () _____ WORK PHONE () _____

CHECK MONEY ORDER VISA MASTERCARD Card # _____ Exp. date _____
30 day money-back guarantee!

AMBER'S HOMEBASE
\$49.95 and \$5 for shipping and handling*

SEND TO:

AMBER

Amber Systems, Inc.
AMBER SYSTEMS, INC.
1171 S. Saratoga-Sunnyvale Road
San Jose, CA 95129

*California residents add 6% sales tax. Outside U.S. please add \$15. Checks must be on a U.S. bank and in U.S. dollars. Sorry, no C.O.D. or purchase orders.

For dealer and site license information, call 408 996-1883.

The fastest micro in the world



No micro in its right mind would want a showdown with Pinnacle.

Its awesome fire power is provided by the superb Motorola 68000 charging along at 12MHz with no wait states (giving about 3MIPS).

And Pinnacle's ammo belt is just bristling with high powered options to give rapid fire to all seven users.

P-System, Unix,[™] CP/M-68K,[™] Mosys, BOS, Mirage, Tripos all obey instantly – along with their armies of applications.

Up to 8 Megabytes of directly addressable RAM and 110 Megabytes of Winchester storage dance when Pinnacle barks its sharp orders.

And that's just for starters. There's also the Pinnacle IX with TWO 68000's, DMA, and Memory Management hardware. Ideal for disk intensive operating systems like Unix[™] and Pick.

And a Pinnacle LX expansion chassis allowing nine 68000 processors to network 56 users.

A micro's gotta do what a micro's gotta do.

And starting at under \$4000 Pinnacle's just the fastest there is.

PINNACLE
The accessible peak of performance

US DISTRIBUTORS **Pinnacle Systems Inc.** 10410 Markinson Road, Dallas, Texas 75238. Tel. (214) 340-4941. Telex 88-8442

ELECTRONIC MANUFACTURING/SERVICE **Lamtech Electronics Corporation**, 620 Easy Street, Garland, Texas. Tel. (214) 272-3504

INTERNATIONAL SYSTEMS GROUP **ISG Pinnacle**, Dallas, Texas. Tel. (214) 340-4941. (Distributor enquiries invited).

VERTICAL MARKET SYSTEMS **VMS Pinnacle**, Dallas, Texas. Tel. (214) 340-4941.

EUROPEAN DISTRIBUTORS **TDI Pinnacle Ltd**, 29 Alma Vale Road, Bristol BS8 2HL, England. Tel. (0272) 742796. Telex 444653.

UNIX is a Registered Trade Mark of Bell Labs. CP/M-68K is a Registered Trade Mark of Digital Research.

Inquiry 320

of it. Like the "Not ready error;" the only remedy is to reset. That BIOS needs work.

It's when you get past the d: error that the trouble really starts. The manual tells you to set your printer to no parity, 8 data bits, 1 stop bit, and full duplex. So far, so good. Now the instructions on data-transmission rate: "Set the same as your terminal."

That's ridiculous. Damned few printers run faster than 1200 bps—but a writer trying to use a computer talking to a terminal at 1200 bps might as well go back to a quill pen. Just for the hell of it, I tried to connect the Companion up to my NEC Spinwriter, using the Printer Optimizer as an interface since that runs at 9600 bps. I left the terminal set for 19,200; after all, the Companion figured out how to talk to the TeleVideo terminal, and maybe, just maybe, the manual meant to say that the data-transmission rate is set in the same way as with the terminal.

Nope. Actually, the result was weird: the Companion never did manage to talk to either the printer or the Optimizer, but attempting to make it do it would *lock up the terminal*. Locked it up good, too: not even Reset would get me out of that pickle. I had to disconnect the RS-232C line from the printer port, then turn both the Companion and the TeleVideo completely off, count to 20, and turn them back on again. No permanent harm was done, but I'd sure hate for that to have happened when I was first starting.

I suppose that if I were to muck about with the Companion and my printer I would, eventually, get them to talk to each other. There's nothing simple about setting up serial communications under the best of conditions. Even with a breakout box and a lot of luck you have to hold your mouth right.

On the other hand, the manual tells me that the Companion has two kinds of handshaking protocols, neither of which I normally use. My system is set up to do ETX/ACK, which my books tell me is pretty standard. We also use XON/XOFF protocol. According to the

(continued)

How Do I Choose the Right Personal Computer Monitor?



SOLVE PROGRAMMING PROBLEMS THE WAY YOU THINK. PURE AND SYMBOL.

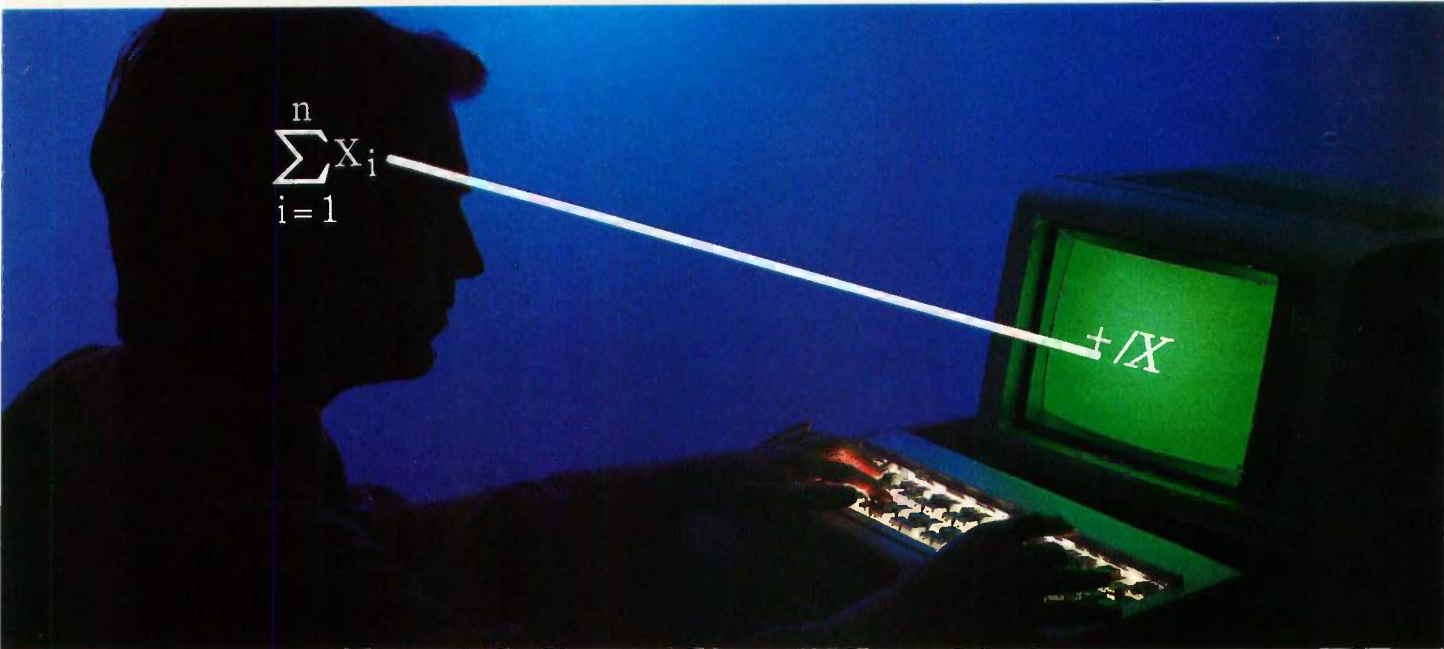

APL★PLUS®/PC IS THE ANSWER.

The shortest distance between two points is a straight line. But unfortunately, that's not the case in programming.

Most languages require you to go through an enormous number of steps before an idea becomes reality.

That's why the APL★PLUS/PC System is such a dramatic and exciting software tool for serious PC programmers and application developers.

Instead of requiring you to learn—and write—long-winded and complicated programs, APL is based on your instinctive ability to deal in symbols. And once you begin using APL's quick notations, you'll find it the ideal programming

environment for all your application needs.

The incredible shortcuts you'll get with APL not only make you more productive, but make programming enjoyable. Intricate calculations and modeling on PC's are a snap. You'll spend less time on drudgery, and more time creating.

Only with APL★PLUS/PC, do you get:

- full-screen editing
- a built-in terminal emulator
- communications
- graphics primitives
- and report formatting.

Writing time-consuming programs like sorting, matrix inversions, and string searching is eliminated. APL's concise notation

already provides these...and more.

No wonder a *PC Magazine* reviewer enthusiastically reacted to our APL★PLUS/PC System with "awe and delight."

So will you. The complete package price is \$595 and major credit cards are accepted.

Act now and we'll send you a free Convincer Kit. Contact your local dealer, or call **800-592-0050** (in Maryland, call **301-984-5123**) to order your system, or for more information about our other

APL PLUS★WARE™ products—from our UNIX™ version to our new streamlined Pocket APL™.

You'll see how symbol they are to use, the very first time you use them.

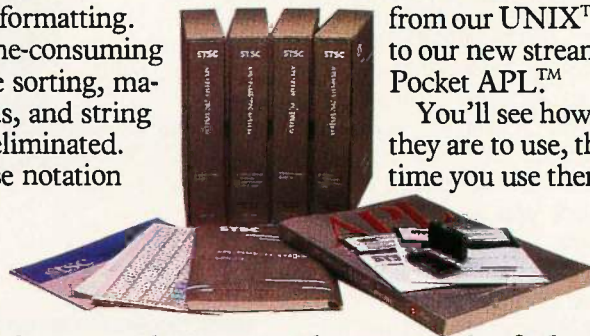

Problem-solving at the speed of thought.

STSC
A Contel Company

APL★PLUS/PC System requires 192K. A soft character set can be used for computers with IBM compatible graphics board. A character generator ROM or software is included for the IBM PC or selected compatibles.

PLUS★WARE and POCKET APL are trademarks of STSC, Inc. APL★PLUS is a registered service mark and trademark of STSC, Inc. UNIX is a trademark of AT&T Bell Laboratories.

manual, the Companion uses ENQ/ACK, which I've never heard of. The excellent little manual that comes with the Printer Optimizer knows about a dozen handshaking routines, including ETX/ACK, but not ENQ/ACK. There's nothing about it in the Spin-writer manual.

It's enough for me. If I had the BIOS source I might make another stab at it, but I don't.

SIGH...

In some ways the Companion falls between the cracks. It has some great features that might make it a good second machine for hobbyists and hackers, but there are also enough irritants to set a hacker's teeth on edge. Hackers don't need to have BDOS error messages removed, especially since the error trap doesn't allow the system to recover anyway. Given the BIOS source code (and the rest of the CP/M utilities such as SYSGEN and MOVCP/M), most of the problems should be fixable. You'd have to boot from a floppy rather than the ROM, but so what? But since there is no BIOS source, and no circuit diagrams, I don't think too many hackers will buy it.

On the other hand, the Companion has the potential to be a really great entry-level system, especially for writers who put a lot of importance on a good keyboard and screen. A beginner could shop around for just the right terminal. The Companion is inexpensive enough that you could buy a really good terminal, word-processing software, and a decent printer, and still have less invested than you'd spend on some of the all-up systems with a less aesthetic keyboard and display. Unfortunately, the manual wasn't written for beginners, and there are all those unexplained glitches. It badly needs an expanded, hand-holding manual if it's to be a beginner's machine.

That leaves me with a dilemma. For all its problems, I like this little machine. Partly it's aesthetics: I really would rather have this little machine and a good terminal than one of the

(continued)

Will It Work with My PC?

Before you can experience the full capabilities a high performance monitor offers, it has to work with your personal computer. That's why Princeton Graphic Systems makes high resolution monitors compatible with most popular brands of personal computers. IBM, Compaq, Corona, Apple and more. But we go one step further. By paying close attention to ergonomic detail, we make Princeton Graphic Systems monitors compatible with you, the computer system user...

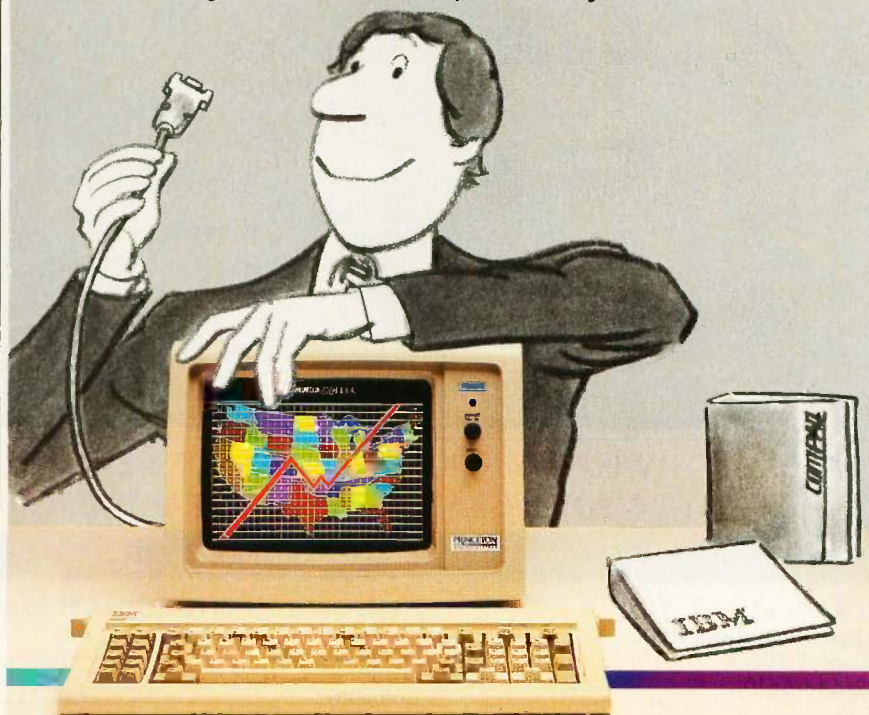

SAN FRANCISCO JULY 22-26



S I G G R A P H



The combined efforts of many disciplines – academia, industry, science and art – are brought together in one conference.

SIGGRAPH '85 PRESENTS THE STATE OF THE ART IN COMPUTER GRAPHICS.

- ◆ TECHNICAL PAPERS
– original research results, formally reviewed
- ◆ PANELS
– lively exchange with leaders in the field
- ◆ COURSES
– new topics and old favorites, introductory and advanced
- ◆ FILM AND VIDEO SHOW
– computer animation for the connoisseur
- ◆ ART SHOW
– the synergy of art and technology
- ◆ EXHIBITION
– the state of the art in hardware and software tools
- ◆ PLUS
– technical proceedings, birds-of-a-feather groups, continuous animation screenings and social events at the Exploratorium and the Academy of Science

All this, Silicon Valley and San Francisco too!
Register early for substantial savings and to ensure full participation.

TWELFTH ANNUAL CONFERENCE & EXHIBITION ON COMPUTER GRAPHICS AND INTERACTIVE TECHNIQUES.

SIGGRAPH '85
111 East Wacker Drive # 600
Chicago, IL 60601
(312) 644-6610

Inquiry 438

SIGGRAPH '85 is sponsored by the Association for Computing Machinery's Special Interest Group on Computer Graphics in cooperation with Eurographics and the IEEE Technical Committee on Computer Graphics.

Please send a copy of the SIGGRAPH '85 advance program to:

Name _____

Company _____

Address _____

City _____ State/Country _____ Zip _____

Telephone Number () _____

Members of ACM SIGGRAPH will automatically receive these materials in the mail in April and need NOT return this coupon. ◆◆◆◆◆

Does It Give Me A Bright, Sharp Image?

Take a close-up look at the display. Bright, crisp characters and sharp, colorful graphics mean you're getting a high-quality image. The kind of image that comes with every Princeton Graphic Systems' monitor. Because Princeton Graphic Systems combines flicker-free technology, a fine dot pitch, and a nonglare screen to give you an image that *PC World's* World Class Survey rates number 1 . . .



"luggable" computers with a small screen. It runs the TeleVideo at 19,200 bps just fine, so that it scrolls faster than most luggables can manage.

Except for the weird business with terminal lockup, I never got into any trouble that Reset wouldn't cure, and since Reset does *not* wipe out the RAM disk, the only thing to really be afraid of would be a power failure. According to the manual, the Companion has a whole bunch of terminal programs to let it work with the TRS-80 Model 100 (and therefore the NEC counterpart to the Model 100); and the Companion is small and light. That suggests a number of interesting possibilities, including carrying the Companion along with a lapboard when I go on trips.

The bottom line is that I can't really recommend the Companion to naive users. If you don't get confused easily; have patience and a sense of humor and won't get irritated when the machine hangs up; are reasonably careful; won't panic; and are willing to put in some time learning CP/M and general computer vagaries, that's another story. There are some good points about this machine. The right user would like it a lot.

What I really wish is that Companion Computers would (1) release the BIOS, (2) support a users group, and (3) then sell a lot of these little machines. A good users group hacking on that BIOS could turn this into a really dandy little machine that would not only be an entry-level computer for writers but a good second machine for hobbyists and everyone else. The potential is there.

I have since found that the BIOS source is available—but it's written in FORTH. For some hackers I suppose that's a feature.

MACMOUSE

One problem with mice—at least one of my problems—is that I can never find any clear space on my desk. The Macintosh sits near my desk—I confess I'm fond enough of it that I haven't packed it away—but it isn't my primary system. As a result, the space

(continued)

Circuit-Board-Design Without the Tedium

smARTWORK™ lets the design engineer create and revise printed-circuit-board artwork on the IBM Personal Computer.

Forget tape. Forget ruling. Forget waiting for a technician, draftsman, or the CAD department to get to your project. smARTWORK™ software turns your IBM Personal Computer into a professional, high-quality drafting tool. It gives you complete control over your circuit-board artwork — from start to finish.



smARTWORK™ transforms your IBM PC into a CAD system for printed-circuit-board artwork. Display modes include both single-layer black and white and dual-layer color.

What makes smARTWORK™ so smart is that it understands electrical connections. Conductor spacing is always correct, lines don't become too narrow, and connecting lines do not intersect other conductors. smARTWORK™ can automatically find and draw the shortest route between two conductors. Or you can specify the route.

smARTWORK™ is the only low-cost printed-circuit-board artwork editor with all these important advantages:

- Complete interactive control over placement and routing
- Quick correction and revision
- Production-quality 2X artwork from pen-and-ink plotter
- Prototype-quality 2X artwork from dot-matrix printer
- Easy to learn and operate, yet capable of sophisticated layouts
- Single-sided and double-sided printed-circuit boards up to 10 x 16 inches
- Multicolor or black-and-white display
- 32 user selectable color combinations; coincident points can be displayed in contrasting colors.
- Can use optional Microsoft Mouse as pointing device

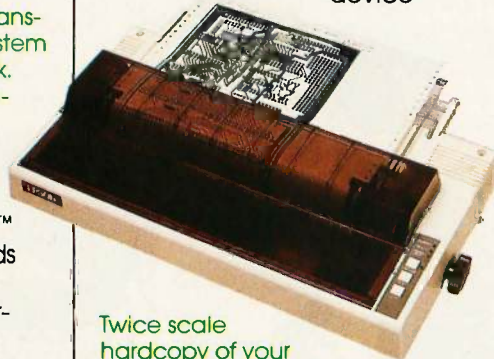

Twice scale hardcopy of your artwork is produced using the Epson dot-matrix printers or the Houston Instrument DMP-41 pen-and-ink plotter. Quick 1X check plot is also available from Epson printers.

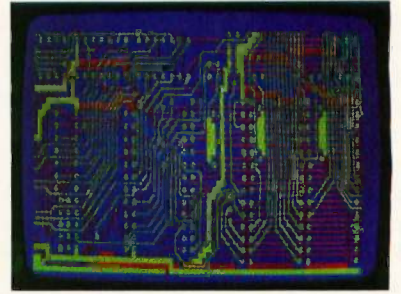

Dual-layer color display of a 2" by 4" section of a 10" by 16" circuit board

The Smart Buy

At \$895, smARTWORK™ is an exceptional value, particularly when compared to conventional engineering workstation costs.

Call or write us for more information on smARTWORK™. We'll be glad to tell you how smARTWORK™ helps us design our own circuit boards and what it can do for your business.

Send a purchase order, or major credit card number, and smARTWORK™ can be working for you next week.

System Requirements

- IBM PC or XT with 192K RAM, 2 disk drives and DOS Version 2.0
- IBM Color/Graphics Adapter with RGB color or b&w monitor
- Epson MX-80/MX-100 or FX-80/FX-100 dot-matrix printer
- Houston Instrument DMP-41 pen-and-ink plotter (optional)
- Microsoft Mouse (optional)



"smARTWORK" and "Wintek" are trademarks of Wintek Corporation.

around the Mac is soon filled with papers, software, coffee cups, staplers, letter openers, and general mess. I have trouble even *finding* the mouse, much less finding a place to use it.

Mouse Systems A+ optical mouse offers one solution to that problem: simply pull out the little etched mouse pad (if you can find it!) and put it on top of the mess. The optical mouse is a wee bit more precise than the mechanical mouse that comes with the Macintosh; I find I have better control. When I first set it up, the A+ mouse cord had a tendency to stick against the optical pad on the "up" strokes, but that seems to have cured itself.

The A+ has a slightly thinner cord, and you need a small screwdriver to permanently attach it to the Mac; it doesn't have the big screw-knobs that are standard on the plugs that Apple provides. I don't know that I'd have bothered to replace the mouse that came with the Mac if Mouse Systems hadn't sent me one, but I do prefer it enough that I haven't put the mechanical mouse back into action. It's purely aesthetics, though, and I'd be hard put to explain the preference.

The Mouse Systems A+ mouse also works with the Apple IIc and Lisa computers.

MTBASIC

This is one of those programs that I got fascinated with even though I can't think of anything I'd use it for. MTBASIC is a compiling, recursive, multitasking BASIC that runs under CP/M on a Z80. An IBM PC and PCjr version was supposed to be out in March.

Z80 programs that require a terminal are a bit of a problem here. It isn't that we don't *have* Z80 machines and terminals, but they aren't set up. Just at the moment I'm surrounded by: the Lilith; the Macintosh; Lucy Van Pelt, the fussybudget IBM PC; a Zenith Z-160; and the two permanent machines, Zeke II the Z80 and the CompuPro 8/16. Zeke II uses memory-mapped video. The 8/16 uses a terminal. For all my mutterings about the

(continued)

How About Dependability?

You rely on your personal computer system to help get your work done. That's why it's important to choose a monitor built for reliability. Princeton Graphic Systems monitors are built under the highest quality control standards, backed by a full one-year warranty and supported by a nationwide service network.* The result: monitors that perform when you need them, day in and day out . . .

*Bell & Howell, Xerox, MAI Sorbus Service and Princeton Graphic Systems.



Some of these expert systems are really very good.

TeleVideo 950 terminal, I went back to it in preference to the Qume, and I'm now ready to confess that I like the Telewidget. But while the 8/16 uses a terminal, it doesn't have a Z80 chip.

I had the Macrotech 80286/Z80 board in the 8/16 for a couple of months, but just now we're testing some new hardware and software; until that's done I'm using the standard CompuPro 8/16 processor. (Well, nearly standard; mine has Jim Hudson's piggyback 8087 support board.) Another alternative would be the Shirley (CompuPro 10), which has multiple Z80 processors, but until the new office construction is done she's in the back room. MTBASIC looked interesting enough that I tried getting it to run on the Companion, but that doesn't work either; there's something *very* odd about the Companion's BIOS.

Thus, a firsthand account of using MTBASIC will have to wait until the contractors finish building the new library, office, and workshop suite upstairs. When that's done I'll have room to keep several more test systems set up and running. Meanwhile, I know from other reports that MTBASIC does run, and that it's one of the more interesting language ideas. I still don't know what I'll *do* with it, but I expect anyone with hacker tendencies might be interested in it. A true multitasking BASIC (task control can be through hardware interrupt or through an automatically installed software timer built into MTBASIC) that supports windows and recursion has all sorts of potential. There are even built-in commands for saving and reloading windows, meaning that you can generate pop-up menus and that sort of thing.

Using MTBASIC is a bit like using CBASIC, but easier, because it's partly interactive. You can create a pro-

gram using your own editor. Since line numbers are needed, you can use the Microsoft BASIC editor, provided, of course, that you save the result as an ASCII (American Standard Code for Information Interchange) file. Programs can be merged simply by loading them; lines with the same line number will be overlaid. The whole program has to be in memory, which restricts its size a bit. Once there, you tell it to run and the program is first compiled at a rapid clip, then executed. When debugging is done, you can compile into a more or less stand-alone COM file.

There are some limits. There are no string arrays, and strings are handled more in the manner of Pascal than BASIC. Variable names can be seven characters long, but there can't be more than 255 variables in any given program. A lot of the BASIC statements we're used to don't exist. On the other hand, there are some low-level commands for handling hardware interrupts that don't exist in any other BASIC, and of course there is tasking: that is, you give the machine several tasks, and it works on them all more or less simultaneously. Since there's only one processor, obviously it can't *really* do more than one thing at a time; but it can work on one task for a while, then switch to another, and so forth, many hundreds of times a second. It can also be doing other things while waiting for input.

Given my immediate problem of putting together a Z80 with a terminal, I'll probably wait for the IBM PC version before I do a definitive report. On the other hand, MTBASIC would be useful for controlling dedicated machines; I've already thought of a Z80-based security/control system I might use it for. We'll see. Meanwhile, if you like playing about with unusual and different languages, you might look into MTBASIC.

EXPERT-EASE

The artificial-intelligence community has done a number of wonderful things, but most of its practical contributions are yet to come. One exception to that is expert systems. An ex-

pert system is a program that "understands" some limited subject field, such as particular kinds of cancers, missile-checkout procedures, and the like. Some of these expert systems are really very good. The best will ask questions, reach conclusions, and explain the reasoning behind them.

A recent article in the *Wall Street Journal* quotes one major research firm's prediction that expert-system software sales—already more than \$34 million in 1984—will continue to rise, becoming a mass market by the nineties. They also report on a program called Puff (Pulmonary Function), which assists a San Francisco lung specialist in diagnosis and prescription. My October 1983 column featured another medical program, Dr. Larry Weed's Problem-Knowledge Coupler.

There are not many micro-based expert systems because building the programs is not easy. Comes now Expert-Ease, which does that job.

Expert-Ease is a program that comes from Scotland. You sure can tell it, too. Not only is my copy decorated with a detail from Raeburn's painting "The Rev. Walker Skating on Duddingston Loch," but it also has, in huge red letters, the words "SAMPLE Not For Resale" stamped about 50 times randomly throughout the manual. The program is copy-protected and sells for 2000 bucks—plus \$50 for shipping and handling. The disclaimer specifically states that it's not fit for any particular purpose but contains trade secrets. My grandfather MacInnie would have been delighted.

Whether the program is worth that much depends on how badly you need an expert system. Expert-Ease is based on some advanced AI research done at the University of Edinburgh, and it does seem to work. The manual is short on theory, but it's certainly adequate to let you run the program. Apparently they expect anyone who has paid \$2000 for an expert-system generator to have a pretty good idea of what he wants to do with it.

(continued)

Meet The Princeton Graphics Systems Family.

The right monitor at the right price. Princeton Graphic Systems offers you a complete family of high performance personal computer monitors. Monitors that deliver the compatibility, resolution, and reliability you need for any application and any budget: from word processing to sophisticated business graphics.



HX-12. High resolution RGB monitor -690 x 240 lines noninterlaced - .31 mm dot pitch tube-Nonglare screen -**\$695**

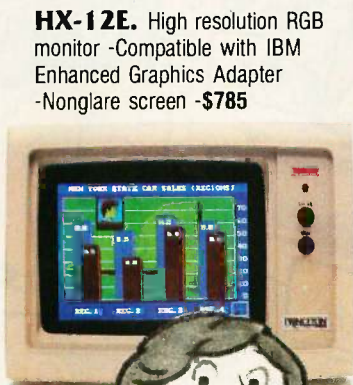

HX-12E. High resolution RGB monitor -Compatible with IBM Enhanced Graphics Adapter -Nonglare screen -**\$785**



MAX-12. Amber monochrome -720 x 350 lines -Enhanced to interface with IBM color or monochrome adapter card -Nonglare screen -Can display 16 shades of amber -**\$249**



HX-9/9E. Nine inch, high resolution RGB monitor -.28mm dot pitch tube - 9E compatible with IBM Enhanced Graphics Adapter -Nonglare screen -Green/amber switch -Apple/IBM colors - Etched dark glass screen -**\$650/\$750 (9E)**



SR-12P. PGS's top of the line RGB monitor - Analog input allows for the display of 4,096 possible colors - Compatible with IBM Professional Graphics Adapter - Nonglare screen -**\$999**



SR-12. Super-high resolution RGB monitor -690 x 480 lines noninterlaced -.31 mm dot pitch tube - Nonglare screen - Requires interface card -**\$799**

Princeton Graphic Systems. The only real choice.

For office or home use, Princeton Graphic Systems has a monitor that's right for you. Inquire at your local computer store about our complete line of high resolution color and monochrome monitors; monitors that live up to the Princeton Graphic Systems 'tradition of quality, performance, and value. **Princeton Graphic Systems**, 601 Ewing Street, Bldg. A, Princeton, N.J. 08540. (609) 683-1660 Telex: 821402PGSPRIN (800) 221-1490. Ext. 504



Princeton accessory product line. Undergraduate tilt/swivel monitor base, ColorView card, Green/Amber switch, RGB-80 card and Scan Doubler card.

PRINCETON
GRAPHIC SYSTEMS
AN INTELLIGENT SYSTEMS COMPANY

IBM Enhanced Graphics Adapter, and IBM Professional Graphics Adapter are trademarks of International Business Machines, Inc. Compaq is a trademark of Compaq Computer Corp. Corona is a trademark of Corona Data Systems, Inc. Apple is a trademark of Apple Computer Corp. PC World is a trademark of CW Communications Inc.



Finally A Video Board That Leaves The Confusion Behind.

On an IBM™ monochrome monitor (or equivalent), STB's Chauffeur displays color/graphics software in full-screen format and no software modifications are necessary.

Of course, we built the Chauffeur to work with the family of IBM PCs and compatibles. Our new video board is software compatible with the IBM Color/Graphics Adapter, as well as hardware and software compatible with the IBM Monochrome/Printer Adapter.

No More Confusion

No more mixing and matching hardware with software. The

Chauffeur converts graphics display into a format compatible with the IBM monochrome monitor.

For you, that means no more worries about preboot software. Best of all, you don't have to deal with those drivers anymore.

Follow The Leader

STB's Chauffeur is clearly the leader in video boards. It converts colors to a 16 level grey scale, and gives you a graphics display that fills a monochrome screen.

For graphics, the Chauffeur supports the same resolutions as the IBM Color/Graphics Adapter.

For text, our board produces a high quality monochrome character set.

STB's Chauffeur includes a parallel port, an optional clock/calendar and our exclusive PC Accelerator™, for print spooling and high speed disk emulation. You also get our one year warranty and an illustrated manual with thorough instructions.

Relax And Enjoy The View

Buy the Chauffeur now. Put it in your system and enjoy watching graphics on your monochrome monitor.

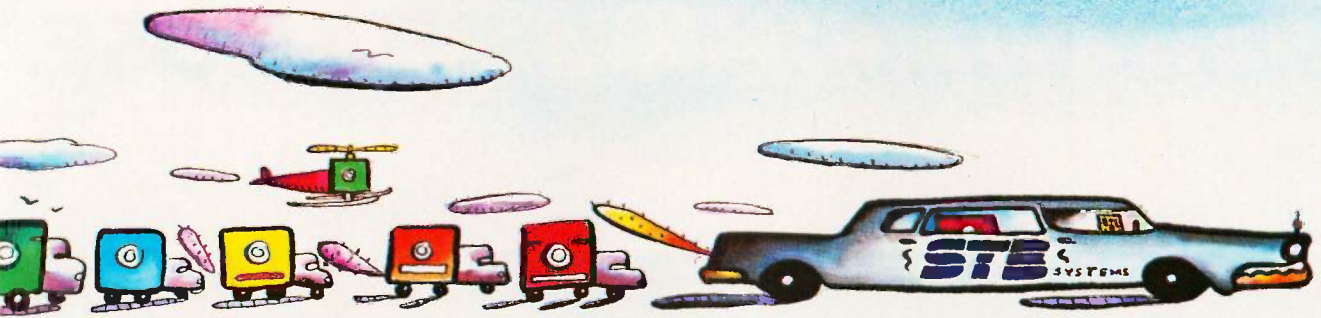

Avoid The Crazy Drivers In The Graphics Jam With STB's ChauffeurTM

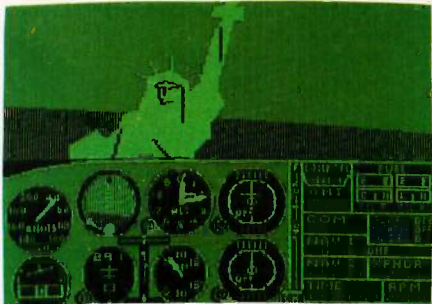

Flight SimulatorTM

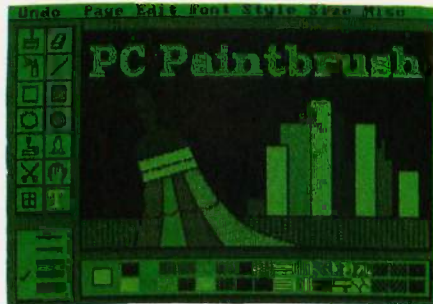

PC PaintbrushTM

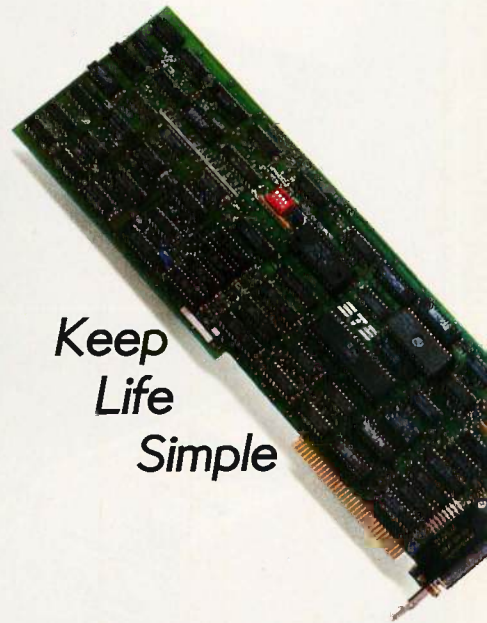

Keep
Life
Simple

Finally you can buy the most popular IBM color/graphics software with no worries about hardware compatibility. STB's Chauffeur video board produces monochrome display without preboot software or those crazy drivers.

Write For A Free Info Pack Today.

STB Systems, Inc., 601 North Glenville, Richardson, Texas 75081

Inquiry 446

STB
STB Systems, Inc.

from MicroComputer Accessories, Inc.

EVERY WHICH WAY BUT LOOSE.

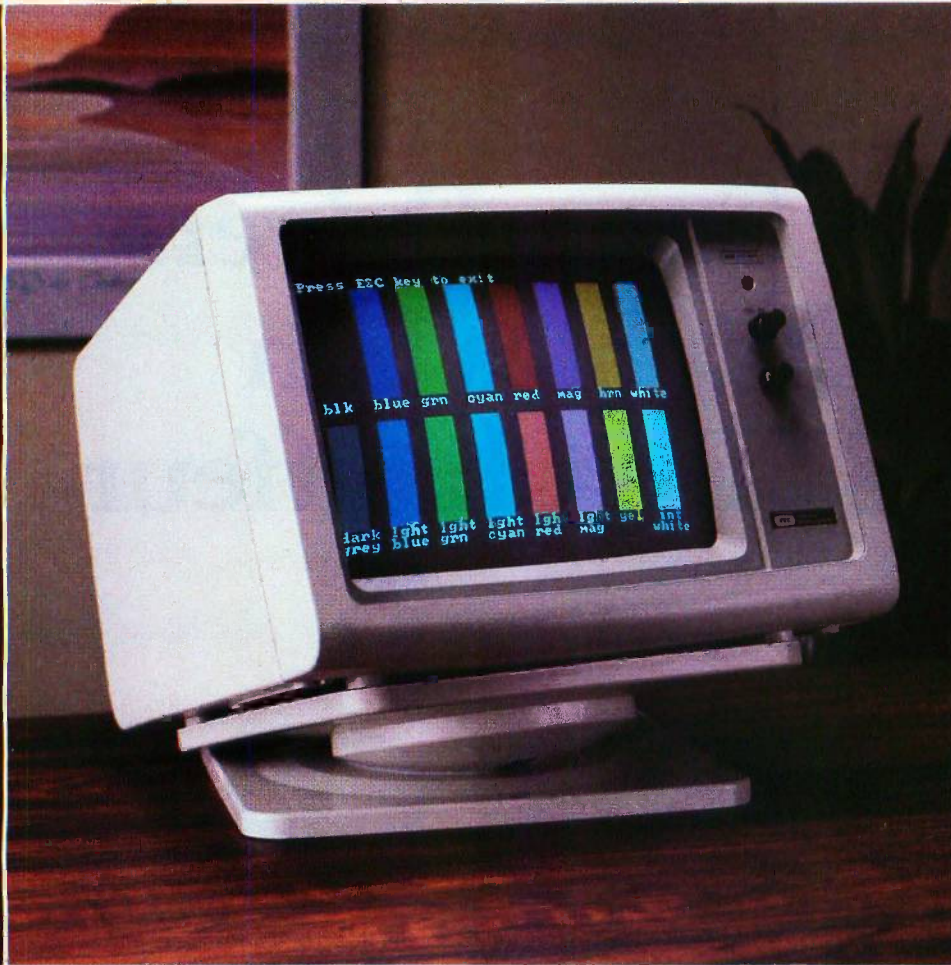

Our Tilt 'n Turn CRT stand lets you move your monitor any which way you want. It fits large CRT's with feet separation up to 12" x 12". The low silhouette design elevates your CRT for increased comfort. It's fully adjustable while in use, with a stable 25° tilt and 360° turn. Anti-skid feet. Cures neck pain, eye strain. Go ahead. It'll make your day.

MicroComputer Accessories, Inc.

5721 Buckingham Parkway
P.O. Box 3725
Culver City, California 90231
Telephone 213/641-1800

In Europe:
N.V. Microcomputer Accessories Europe S.A.
Rue de Florence 37
1050 Bruxelles, Belgique
Telephone 02/538.61.73

These and other fine products are available at Computerland, Businessland, IBM Product Centers and other computer/software retail locations. Inquiry 268 for Dealers. Inquiry 269 for End-Users.

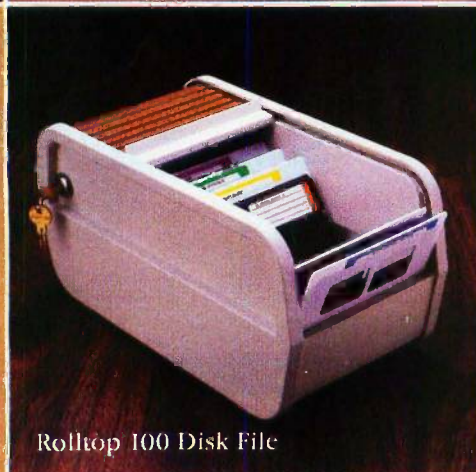

Rolltop 100 Disk File

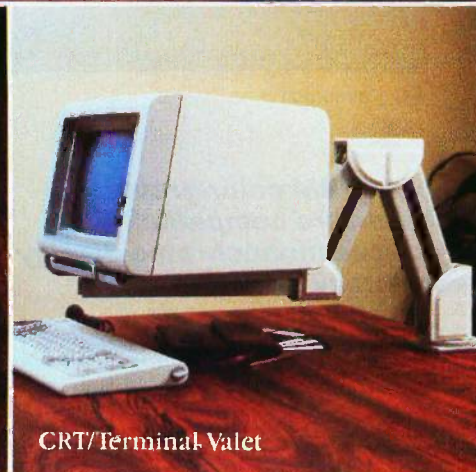

CRT/terminal Valet

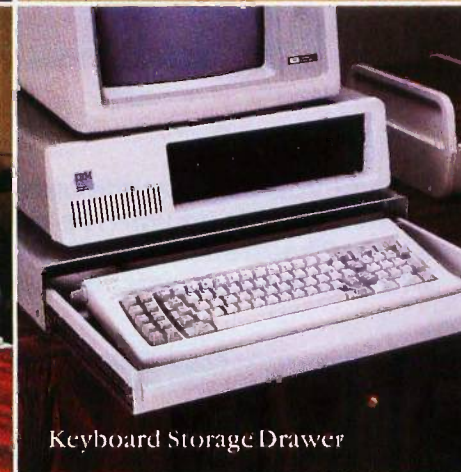

Keyboard Storage Drawer

It works this way. First, you figure out what criteria you want the system to use to reach decisions. Then you give the program a bunch of examples in a matrix where the columns are the criteria and the rows are cases. The final column in the matrix is the recommendation an expert would make in each case. For example, you could take one of those tables of data from BYTE that give all the attributes of a computer, or a printer, or whatever; add your requirements and recommendations; and generate an "expert" system that would in theory make the same recommendations you would. Now anyone could use it to enter data about a new machine and see what you would say about it.

You don't have to enter all the cases you know about. When you think you have enough cases, you tell the machine to go to work. It trundles for a while and comes up with a decision rule. There's no "explanation" as such, but the rule is tree-structured, and you can examine it to see what the machine has done. If there aren't enough cases, the program will tell you by making "null" recommendations in the rule tree. This shows where new examples are needed.

If there are contradictory examples, the program will tell you. Contradictions usually mean you don't have enough criteria to establish an actual rule.

So far, so good.

Unfortunately, the program doesn't know how to handle incomplete data or probabilities. It wants absolute certainty with no ambiguities. Worse, you can't *weight* the criteria. In fact, the program weights them for you according to their position in the matrix, with the left-hand criterion getting the greatest weight. New criteria (called attributes) can be inserted at any column position, so you can get the effect of weights by the placement of criteria. I tried to simulate probabilities, after a fashion, by adding an integer variable with a range of 0 to 100; but that didn't work well for me.

The manual is clear, and there are examples. The program is reasonably easy to understand but not so easy to

use because the editing capabilities are abysmal; the worst spreadsheet I know of has better editing functions. You can get the job done, but if it's a big job, you'll curse the program before you're done.

I'd think a Bayesian decision-analysis program, which asks for criteria and weights and includes probabilities, could be altered to produce something considerably more powerful than Expert-Ease. Several single-decision Bayesian-theory programs were published in computer magazines back in the seventies, and at least one was sold for less than \$100. Having said that, I confess that I'm not ready to sit down and write such a program. Expert-Ease does work, and if you need to generate an expert system from a large mass of cases and variables (up to 32 attributes, each with up to 32 values for logical variables, and a range of

-32,766 to +32,767 for integer values), I don't know of anything else that would do the job.

My copy of Expert-Ease came from Export Software International Ltd. of Edinburgh, but I understand that the program is marketed in the U.S. exclusively by Human Edge. This is the outfit that advertised the "expert" program called Mind Prober by promising, "We'll get you into her mind; the rest is up to you," until a number of magazines refused the advertisement. Human Edge also publishes Sales Edge, Negotiation Edge, Management Edge, and Communications Edge, all "expert-system" programs based on your responses to a series of questions very similar to the questions on a standard psychological test. The programs work fine, as programs, but I have serious reservations about the theory on which they're based; that's

(continued)

Now IBM AT Compatible

THE RAPID PACE DATA BASE.

The rapid pace of business today demands data storage solutions that can keep pace with the dynamics of today's computing solutions.

The Bernoulli Box™ does just that—by creating, expanding, storing and backing up data bases on handy 10-megabyte cartridges (5 megabytes on the single-drive Macintosh™ box). Its transfer rates and access times outperform hard disk devices. And when *rapid pace* means getting somewhere fast, your cartridge-contained data bases go with you.

The Bernoulli Box. Available for the IBM PC, XT, AT, most compatibles, the TI Pro and Apple's Macintosh.

For the dealer nearest you, call 1-800-556-1234 ext. 215. In California call 1-800-441-2345 ext. 215.

OMEGA™
 OMEGA CORPORATION
 1821 West 4000 South
 Roy, Utah 84067

THE BERNOLLI BOX™

A FEW NEAT THINGS YOU CAN DO WITH KODAK'S CAT-QUICK INSTANT SLIDE-MAKERS...



"Make your slides one by one, save on film and have some fun!"

"Correct mistakes, add new facts, give a show the punch it lacks."

"Take CRT data off the screen, edit freely in between."

"Mount your slides fast and clean—project bright hues on the screen."

"Meet tight deadlines, do a whole show, win new clients, hear 'bravo.'"

"Waste no money, waste no time, get results that are sublime."

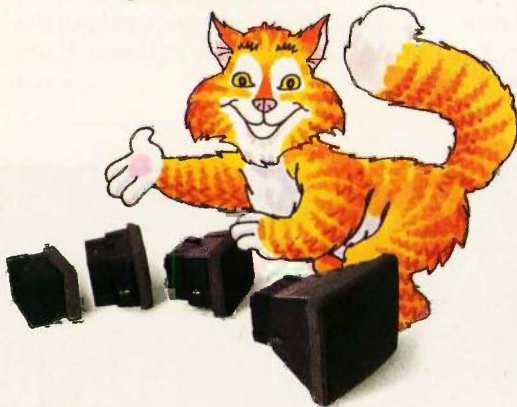

"If you can't do without these cat-quick instant slide-makers another minute, contact your dealer in Kodak audiovisual products, listed in the Yellow Pages under 'AV Equipment and Supplies.' Or, phone 1 800 44KODAK, Ext 293 (1 800 445-6325, Ext 293). Tell 'em Slide Cat sent you!"



The system includes KODAK INSTAGRAPHIC Copy Stand, KODAK INSTAGRAPHIC CRT Slide Imager and CRT Adapters, KODAK INSTAGRAPHIC Color Slide Film, and KODAK INSTAGRAPHIC Slide Mounter and Mounts.

© Eastman Kodak Company, 1985

a large enough subject that I'll get to it another time.

OMNITEL ENCORE AND CROSTALK

We have 1200-bps capability at last. Actually, I bought a U.S. Robotics 1200-bps modem nearly a year ago, but Alex took it to San Diego before I ever got it hooked up. He says it works fine, too. One day I'll get it back . . .

Anyway, we recently received an OmniTel Encore 1200B, which we installed in the Zenith Z-160. It went into that particular machine because the IBM PC has no open slots—I really should get an expansion box—and the Zenith Z-150 is still under Mrs. Pournelle's control. Installation was simple. The Encore can be addressed to ports COM3 or COM4 as well as the standard COM1 and COM2. This means that if you already have two serial ports, as the Zenith machines and the Columbia PC do, there's still no problem putting in an internal modem.

The Encore came with Crosstalk XVI, so that's what we used. Crosstalk is a perfectly adequate communications program. I prefer Mycroft Laboratories' MITE, because I find it easier to use; but I've been using MITE for years, too, so there's a familiarity factor there. I certainly didn't have any problems using Crosstalk, and I appreciated the terminal-emulation capability built into the program, since I was able to log onto the ARPANET (Advanced Research Projects Agency Network) without changing the initialization file that tells MIT I'm using a Telewidget terminal.

There isn't a lot you can say about a modem. The Encore was simple to install, the price looks good, and it has worked just fine nearly every night for the past two weeks. I'm sending to Mycroft for a MITE program geared up for it. The Encore is compatible with the Hayes Smartmodem—much more so than the U.S. Robotics modem, has a built-in speaker that lets you hear what's going on (phone tones, dial tones, busy signals, etc.), and works just fine with Crosstalk.

OmniTel also makes 300-bps integral modems for Apple and PCjr and both 300- and 1200-bps stand-alones.

SEMI-DISK

We've had the SemiDisk RAM disk in the Epson QX-10 for some time now. Works fine, but, alas, only under CP/M; it can't hook into Valdocs 1.8, which is the Epson system that really needs a RAM disk. In fooling around with the SemiDisk, we learned that its implementation takes up 3328 bytes of the temporary program area (TPA), which can be significant on a big assembly or load. However, all you have to do is type

```
SEMI-DISK R [cr]
```

and the memory is recovered. Getting the RAM disk implemented is just as simple.

The SemiDisk comes with instructions on how to use part of its mem-

ory as a printer buffer. Installation is simple, but you should read the manual a couple of times. They also have an automatic way to patch their COM file to include a whole bunch (about four pages!) of customization options you can install.

If you run an Epson QX-10 as a CP/M system, the SemiDisk will speed things up considerably.

Last-minute good news for Epson owners: SemiDisk now has software to let you use the RAM disk with Valdocs 1.9.

MUSIC . . .

Mrs. Pournelle teaches music, sings opera, and directs musicals at her school. She's thus very interested in music programs.

Tunesmith came about two hours ago. Alas. It's copy-protected. You can make backups, but you have to have

(continued)

Now IBM AT Compatible

THE BRIEFCASE DATA BASE.

Your business needs more data base versatility than you get from hard disk systems, versatility to help your people work more productively, wherever they are, or go. Your business needs The Bernoulli Box,™ a storage system that lets you build and backup individualized data bases—for payroll, accounting, marketing—on rugged, interchangeable 5- and 10-megabyte cartridges. It works more reliably, quickly, and flexibly than hard disk alternatives—without head crashes. And it works on the IBM PC, XT, AT, compatibles, the TI Pro and Apple's Macintosh.™

For the dealer nearest you, call 1-800-556-1234 ext. 215. In California call 1-800-441-2345 ext. 215.

OMEGA
 IOMEGA Corporation
 1821 West 4800 South
 Roy, Utah 84067

THE BERNOULLI BOX™

DATASAFE by AFTEK

THE HIGH PERFORMANCE

RANDOM ACCESS TAPE BACK-UP !

THE NEXT GENERATION OF TAPE DRIVES.

DATASAFE STAND ALONE UNIT

- C/W cable (chains off DB-37 connector on rear of computer)
- Has its own booster power supply
- Is easy to install

DATASAFE INTERNALLY MOUNTED UNIT

- Is daisy chained off the existing floppy controller
- Requires IBM plug compatible bus and internally selected 4 channel select floppy disk controller
- No additional slots needed

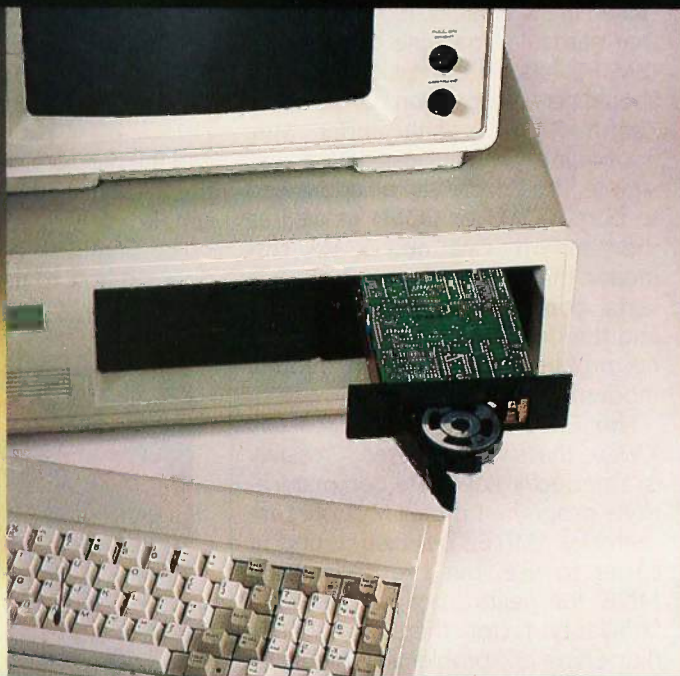
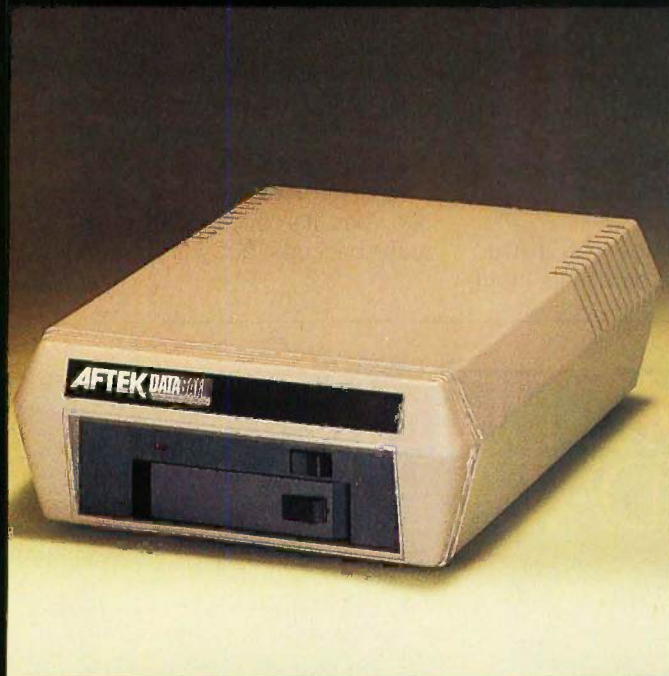

- For IBM XT's and compatibles
- Incorporates main frame micro reel technology
- Random access
- Use of PC DOS and MS DOS commands (tree, path, etc.)
- MTBF - 20,000 hrs.
- Reliable (150,000 load and unload failsafe tested by an independent laboratory)
- C/W software device drivers
- C/W cable
- Extremely fast back-ups
- 10 meg available only
- Priced less than **50% less** than the nearest rival
- **ONE YEAR WARRANTY**

See us at Canadian Government Stand
at Comdex, May 6-9
Atlanta, Georgia



The **DATASAFE** uses industry standard 1/4" tape on a self threading 2.2" spool

1050 Clinton St.
Buffalo, New York
14206

Tel.: (716) 694-5366 Telex: 916428

Inquiry 18

**AFTEK**
Business Machines Inc.

762 Gordon Baker Rd.
Willowdale, Ontario
Canada M2H 3B4
Tel.: (416) 497-0531 or toll free
1-800-268-5412 Telex: 06-986133

PRIME DEALER DISTRIBUTOR TERRITORIES AVAILABLE. OEM CALLS INVITED.

IBM IS THE ONLY REGISTERED TRADE MARK FOR INTERNATIONAL BUSINESS MACHINES

the original system disk to put into drive A.; not merely the first time you use the program in a session, but *every* time you want to play a tune. Naturally I didn't make any backups.

Doesn't seem to have harmed the disk to run off it. The program plays a passable rendition of "Malaguena," a pretty bad one (according to rock/jazz enthusiast John F. Carr) of "Foggy Mountain Breakdown." Every time I play a tune and want to hear another—there are about 18 on the disk, including "Clair de Lune," Fucik's "Entry of the Gladiators," etc.—I must (1) insert a disk with the Command files on it; (2) insert the original system disk.

I don't feel good enough to do that.

While the program is playing, it shows a display of the notes played. They are not, alas, in standard musical notation, but consist of strings of data statements (complete with the word "DATA" and the quotation marks) that the cursor runs through, resting briefly on each note (ABEF etc.) as it is played. There are also numbers and on the right side of the screen a standard musical notation shows one—and only one—note as it is played.

I can see how it would be a lot of fun, but I am determined not to get addicted to copy-protected programs. Alas.

FONTS!

Now one that is not copy-protected. Fontrix, which works only on PCs with a color monitor. Since Lucy Van Pelt, our fussy budget IBM PC, has only the high-resolution green screen, we can't tell if Fontrix will work with the Orchid Technology PCTurbo 186 board.

Fontrix works *fine* with the Z-150, which has a color screen. After you've bought Fontrix, you can get a whole mess of very nice fonts, from Arabic to Russian to a bunch of electronics symbols, for \$20 a disk. The program allows you to modify existing fonts or create, name, and save your own.

It's supposed to print, and there's a menu of printers, including the really high-resolution Toshiba. The printer connected to our Z-150 is an MPI Sprinter dot-matrix, not listed on the

Fontrix driver list; I'm sure the MPI emulates one of the many that *are* on there, but it's too late to call MPI tonight. More next time.

Meanwhile, Peter has had an hour to play with it and wants to get a copy for the Hewlett-Packard Touchscreen; connect that to the HP LaserJet printer and you'd have some *really* nice fonts, graphics, designs, and all kinds of stuff.

I think we're going to like it, but this is an early report.

WINDING DOWN

I've decided that if I have products of the year I should also have a folly of the year.

It was awfully close; in fact, a tie. The Chaos Manor Folly of the Year Award for 1984 is shared. Winner number one is W. Krag Brotby, chairman of the Vault Corporation, for his threat to market Killer Prolok, a copy-protection

scheme that will "create a variety of nasty effects" for people who use unauthorized copies. The effects would include planting software worms that would cause the computer to malfunction at random times and under random tasks.

Winner number two is Craig McClure, vice president of Defendisk of Denver, who also threatens programs that insert worms into your operating system. They wouldn't necessarily surface for quite a long time. Mr. McClure says, "Our booby traps will make Vietnam look like a birthday party."

I understand that whole teams of lawyers are anxiously awaiting the appearance of these products. I'm sure Defendisk and Vault will take lots of precautions to see that the original copies of software they protect won't hurt your system. What could go

(continued)

THE SAVING GRACE DATA BASE.

Businesses today need more than just more data capacity from mass storage devices. They need more data dynamics. And that means backup as well as primary storage.

The Bernoulli Box,™ with its removable storage system, delivers both. Not only can you create individual data bases on handy 10-megabyte cartridges (5 megabytes on the single-drive Macintosh™ box), you can backup files—in minutes, not hours. The compact cartridges are easily stored. And with the lowest available cost-per-megabyte, you not only save your data, but money and time as well.

The Bernoulli Box. Available for the IBM PC, XT, AT, most compatibles, the TI Pro and Apple's Macintosh.

For the dealer nearest you, call 1-800-556-1234 ext. 215. In California call 1-800-441-2345 ext. 215.

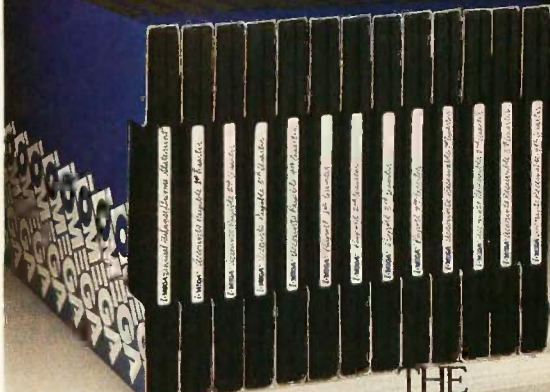

THE BERNOLLI BOX™



OMEGA CORPORATION
1821 West 4000 South
Roy, Utah 84067

ITEMS DISCUSSED

A+ MOUSE\$150 Mouse Systems Corporation 2336 H Walsh Ave. Santa Clara, CA 95051 (408) 988-0211	SIDEKICK\$49.95 Borland International 4807 Scotts Valley Dr. Scotts Valley, CA 95066 (408) 438-8400
COMPANION COMPUTER\$995 Companion Computers P.O. Drawer CC Apex, NC 27502 (919) 362-6655	SMARTLINE SMARTBOARD\$399 Wico 6400 Gross Point Rd. Niles, IL 60648 (312) 647-7500
ENCORE 1200B\$499 OmniTel 3090 Oakmead Village Dr. Santa Clara, CA 95051 (408) 986-8236	THINKTANK Apple II.....\$150 Macintosh.....\$145 IBM PC.....\$195 Living Videotext 2432 Charleston Rd. Mountain View, CA 94043 (415) 964-6300
EXPERT-EASE\$2050 Human Edge Software Corp. 2445 Faber Place Palo Alto, CA 94303 (415) 493-1593	TRACE86\$125 PROFESSIONAL BASIC\$99 Morgan Computing 10400 North Central Expressway Suite 210 Dallas, TX 75231 (214) 739-5895
FONTRIX Apple.....\$95 IBM.....\$155 Data Transforms Inc. 616 Washington St. Suite 106 Denver, CO 80203 (303) 832-1501	TUNESMITH\$49.95 Blackhawk Data Corp. 307 North Michigan Ave. Chicago, IL 60601 (312) 236-8476
LASERJET\$3495 Hewlett-Packard 19447 Pruneridge Ave. Cupertino, CA 95014 (800) 367-4777	TUTSIM demonstration disk.....\$29.95 IBM PC version.....\$495 Applied i 200 California Ave., #214 Palo Alto, CA 94306 (415) 325-4800
MTBASIC\$49.95 + \$3.50 Softaid Inc. postage & handling POB 2412 Columbia, MD 21045-1412 (301) 792-8096	TWEEK\$18 Topology POB 13038 Oakland, CA 94661 (707) 833-2348
PCTURBO 186 128K bytes.....\$1095 256K bytes.....\$1245 Orchid Technology 47790 Westinghouse Dr. Fremont, CA 94539 (415) 490-8586	UNIVERSE Atari.....\$89.95 Apple, IBM PC.....\$98.50 Omnitrend Software POB 3 West Simsbury, CT 06092 (203) 658-6917
SEMI DISK 512K bytes.....\$799 2 megabytes.....\$2499 SemiDisk Systems POB GG Beaverton, OR 97075 (503) 642-3100	

wrong? But just to be safe, I think I'll take the precaution of not using them at all.

The book of the month is *Pascal for BASIC Programmers* by Charles Seiter and Robert Weiss (Addison-Wesley Microbooks, 1984). I wish I'd had this one years ago. It's clearly written, well organized, and has good examples, and one of the best discussions of pointers I've seen anywhere. If you're into noncomputer reading, I recommend *In Search of Schrodinger's Cat* by British science writer John Gribbin (Bantam New Age, 1984). It's a layman's-level discourse on modern physics and quantum mechanics. The cat in question is in a sealed box, and it will be killed if a particular atom emits a particle of radiation, but will be alive otherwise. It turns out that until the box is opened there may be two cats, one alive and one dead.

Coming up is a look at the Hewlett-Packard Touchscreen and Thinkjet ink-sprayer printer. The Touchscreen is a nice computer all by itself; and used as a high-resolution terminal in connection with the CompuPro Shirley, it allows us to run SCADA, a professional-level computer-assisted-design program that rivals some of the best available on big minicomputers. More on that another time.

Meanwhile, Tony has my copy of the CompuPro PC Video Board that lets an 8/16 S-100 computer run IBM PC software, and they swear I'll have it Real Soon Now; the contractors have poured the foundations for the new office addition and partly filled up the moat where the grapefruit tree used to be; the software stack has grown another foot; and there seems to be no end to the marvels the computer revolution pours forth. I love it. ■

Jerry Pournelle welcomes readers' comments and opinions. Send a self-addressed, stamped envelope to Jerry Pournelle, c/o BYTE Publications, POB 372, Hancock, NH 03449. Please put your address on the letter as well as on the envelope. Due to the high volume of letters, Jerry cannot guarantee a personal reply.

every option you'll ever need.

You're looking at ULTRAFRAME™, a powerful 8/16 bit multiprocessor you can configure to handle any application.

It's the one system that can tackle your toughest jobs today with the capacity to grow up to 32 users or tasks — within the same chassis.

Get 5" & 8" Winchester drives from 10-120MB (formatted). Also, 14" models from 145MB to 1,160MB. And backup systems appropriate to any system you design.

Now run both MS-DOS and CP/M software.

Our system lets you network IBM PC's, compatibles or other popular PC's into a serious multiuser business system. Tie PC's into the speed of an

S-100 buss with inexpensive boards and a coaxial cable.

Each PC can tap network resources including hard disks (10-300MB) and system printers with spooling.

The PC's gain the proven network

management capabilities of TurboDOS™. Run MS-DOS™ and CP/M 86 software plus true multiuser accounting and data base applications.

The industry's longest warranty.

We've built the ULTRAFRAME to last — and backed it with a full three year warranty. Plus, we give a level of old-fashioned factory support you won't get from anyone else. And on-site maintenance is available nationwide through 45 service centers.

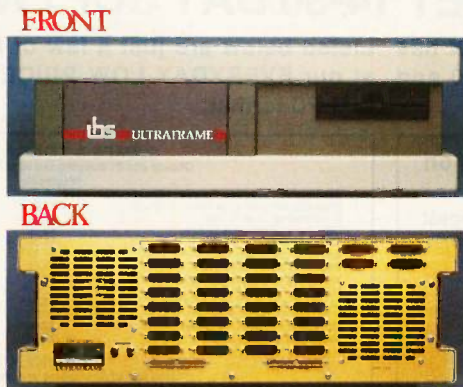

ULTRAFRAME™



INDEPENDENT BUSINESS SYSTEMS

Call collect (415) 443-3131 TWX: 910-386-6003 IBSNET
5915 Graham Court, Livermore, CA 94550

The multiuser system that also networks IBM PC's.

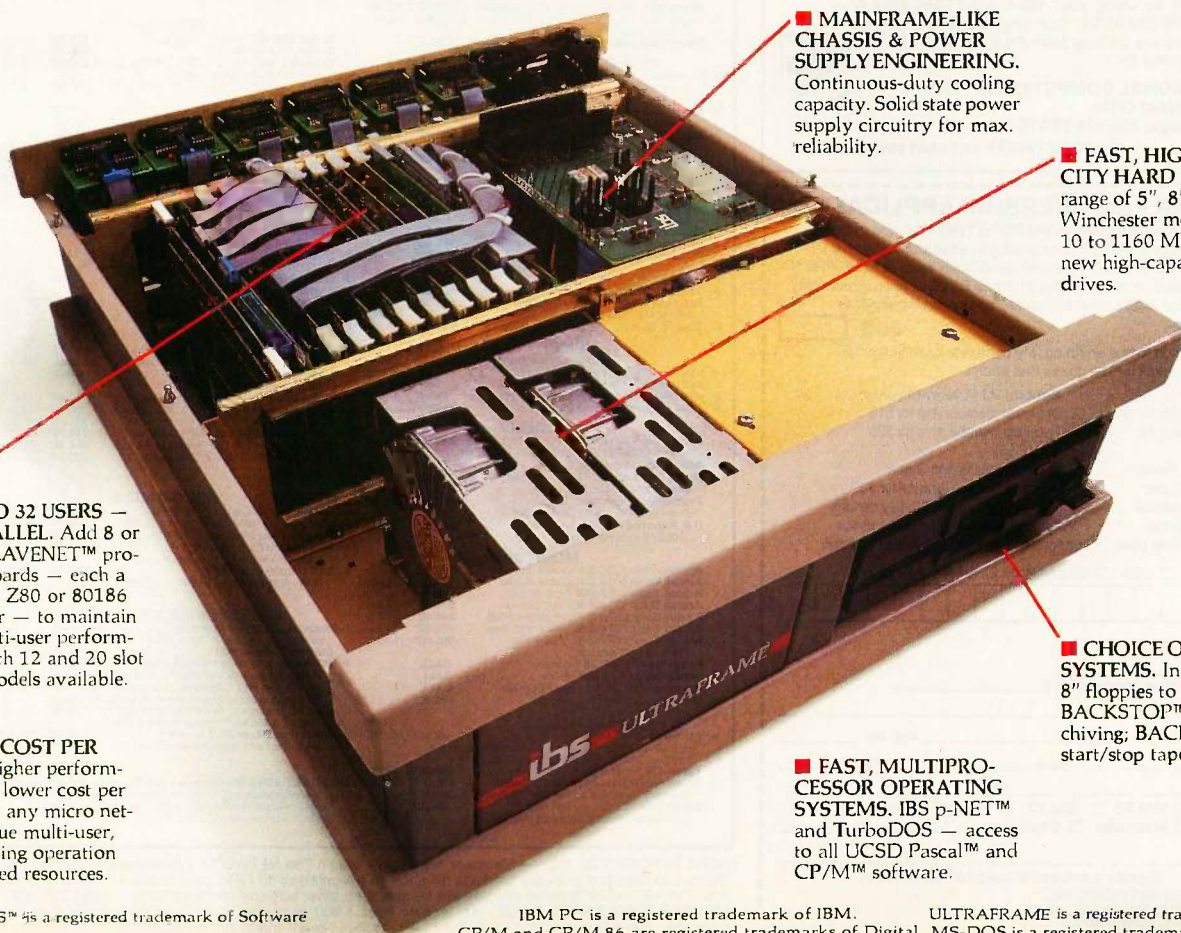

■ **MAINFRAME-LIKE CHASSIS & POWER SUPPLY ENGINEERING.** Continuous-duty cooling capacity. Solid state power supply circuitry for max. reliability.

■ **FAST, HIGH CAPACITY HARD DISKS.** Full range of 5", 8" and 14" Winchester models from 10 to 1160 MB, including new high-capacity 5" drives.

■ **UP TO 32 USERS — IN PARALLEL.** Add 8 or 16 bit SLAVENET™ processor boards — each a complete Z80 or 80186 computer — to maintain best, multi-user performance. Both 12 and 20 slot models available.

■ **LOW COST PER USER.** Higher performance and lower cost per user than any micro network. True multi-user, multitasking operation plus shared resources.

■ **FAST, MULTIPROCESSOR OPERATING SYSTEMS.** IBS p-NET™ and TurboDOS — access to all UCSD Pascal™ and CP/M™ software.

■ **CHOICE OF BACKUP SYSTEMS.** Integral 5" or 8" floppies to 1.2 MB. BACKSTOP™ video archiving; BACKSTOP II™ start/stop tape.

TurboDOS™ is a registered trademark of Software
2000.

IBM PC is a registered trademark of IBM.
CP/M and CP/M 86 are registered trademarks of Digital
Research.

ULTRAFRAME is a registered trademark of IBS, Inc.
MS-DOS is a registered trademark of Digital Research.

PC NETWORK

BUY HARDWARE AND SOFTWARE AT WHOLESALE + 8%, AND GET 14-30 DAY SOFTWARE RENTALS†...

In just the last few months, *The NETWORK* has saved its members more than \$24,000,000 and processed over 100,000 orders.

Listed below are just a few of the over 20,000 products available at our EVERYDAY LOW PRICES! All software below is priced in IBM-PC format.

The nation's largest corporations depend on PC NETWORK!

On our corporate roster are some of the nation's largest financial industrial and professional concerns including some of the most important names in the computer industry:

- | | |
|------------------------------|---------------------------------|
| AT&T | General Motors |
| Barclays Bank | Gillette |
| Bell & Howell | Hewlett Packard |
| Citibank | Hughes Aircraft |
| Columbia University | IBM |
| Data General | ITT |
| Exxon | Kodak |
| Farm Bureau Insurance | Multimate |
| Frontier Airlines | United Nations |
| General Mills | Yale University |
| General Electric | Veteran's Administration |

plus thousands of satisfied consulting firms, small businesses, user groups, municipalities, government agencies and value-wise individuals ACROSS THE NATION! Their buyers know that purchasing or renting from PC NETWORK saves them time, money and trouble. They also count on us for product evaluation, professional consultation and the broadest spectrum of products and brands around.

CALL TOLL FREE 1-800-621-S-A-V-E

In Illinois call (312) 280-0002

Your Membership Validation Number: **B355**

You can validate your membership number and, if you wish, place your first money-saving order over the phone by using your VISA, MASTERCARD or AMERICAN EXPRESS. Our knowledgeable service consultants are on duty Mon-Fri 8 AM to 7 PM, SAT 9 AM to 5 PM CST.

PERSONAL COMPUTER NETWORK
320 West Ohio
Chicago, Illinois 60610

Call now... Join the PC NETWORK and start saving today!

PC NETWORK • MEMBERSHIP APPLICATION

YES! Please enroll me as a member in the PC NETWORK™ and rush my catalog featuring thousands of computer products, all at just 8% above DEALER WHOLESALE PRICES. I will also periodically receive "THE PRINT-OUT", a special up-to-date on merchandise at prices BELOW even those in my wholesale catalog, and all the other exclusive, money-saving services available to Members.

355

I am under no obligation to buy anything. My complete satisfaction is guaranteed. Please check (✓) all boxes that apply:

- | | |
|--|---|
| <input type="checkbox"/> Basic Membership | <input type="checkbox"/> Special V.I.P. Membership* |
| <input type="checkbox"/> One-year membership for \$8 | <input type="checkbox"/> One-year membership for \$15 |
| <input type="checkbox"/> Two-year membership for \$15 (SAVE \$1) | <input type="checkbox"/> Two-year membership for \$25 (SAVE \$5) |
| <input type="checkbox"/> Business Software Rental Library for \$25 add'l. per year—with 14 day rentals | <input type="checkbox"/> BOTH Business and Game Software Rental Libraries for \$30 add'l per year—with 30 day rentals |
| <input type="checkbox"/> Games Software Rental Library for \$10 add'l per year | *VIP members receive advance notice on limited quantity merchandise specials |

Bill my credit card VISA MasterCard American Express

Account Number:

Exp. mo. year

Check or money order enclosed for \$

Name

Address Apt. No.

City State Zip

Telephone ()

My computer(s) is: IBM PC IBM-XT IBM-AT Apple II Macintosh Other

Signature
(Signature required to validate membership)

Copyright © 1984, PC NETWORK, INC.

344 BYTE • MAY 1985

GAMES & EDUCATIONAL SOFTWARE

(Please add \$1 shipping and handling for each title ordered from below.)

	Wholesale	Wholesale
Bluebush Chess (Your Toughest Opponent)	\$ 34.00*	\$ 15.50*
Bluechip Millionaire (Oil Baron or Tycoon)	34.00*	21.00*
Broderbund Lode Runner	19.75*	18.00*
CSB Goren-Bridge Made Easy	48.00*	24.00*
CSI Mastering the SAT	61.00*	16.97*
Epyx Temple of Apshe!	21.97*	24.97*
Innocent Zork 1 or Witness	21.50*	15.97*
Innocent Deadline or Suspended	27.00*	15.97*
Microsoft Flight Simulator	27.00*	15.97*
Mouse Systems PC Paint-Turn your PC into A Color Macintosh!	59.95*	15.97*
Orion JBird (Overt Look Alike)	22.00*	20.77*
Scarborough MasterType	27.00*	21.00*

BUSINESS SOFTWARE

(Please add \$2.50 shipping and handling for each title order from below.)

		CALL
ATI How to use Multimate	\$ 42.00*	\$230.00*
ATI How to use Microsoft Word	42.00*	275.00*
ATI How to use Lotus 1-2-3	42.00*	275.00*
Ashton-Tate dBase III	315.00*	205.00*
Ashton-Tate Framework	315.00*	105.00*
Ashton-Tate Friday	151.00*	CALL
Borland Side Kick (Protected)	26.00*	239.00*
Central Point Copy II PC	23.00*	90.00*
Conceptual Instruments Desk Organizer	157.00*	370.00* ea.
Digital Research PIM-85	33.00*	387.50*
Digital Research Logo	87.00*	74.97*
Digital Research PLII Compiler	399.00*	570.00*
Digital Research Concurrent CP/M—Windows	195.97*	325.00*
Funk Software Sideways	38.00*	215.00*
Harvard Harvard Project Manager	26.00*	135.00*
Howardsoft Tax Preparer 1985	177.00*	35.00*
Hayes Smartcom II—New V100 Emulator	68.00*	72.00*
Human Edge The Management Edge	145.00*	64.00*
Human Edge The Software Edge	1,952.52*	CALL
Human Edge Mind Prober	28.48*	72.00*
Lotus C Compiler	310.00*	440.00*
Lotus Development Lotus 1-2-3	265.00*	25.00*
Lotus Development Symphony		CALL
Microfilm Base 4000		230.00*
Microsoft C Compiler		275.00*
Microsoft Word—Latest Version 2.0		205.00*
Microsoft Multiplan		105.00*
Monogram Dollars & Sense		CALL
Multimate Multimate (Latest Version)		239.00*
Omnia The World Plus		90.00*
Open Systems P/O Sales A/R INV G/L A/P Team Mgr		370.00* ea.
Real World G/L A/P A/R P/R or Q/E/INV		387.50*
Roseart Prokey Version 3		74.97*
Ryan McFarland RM COBOL (Dev. System)		570.00*
Sigma Sigma III Word Processor		325.00*
Satellite Software WordPerfect		215.00*
Softart Fancy Fonts		135.00*
Softstyle SET-FX		35.00*
Software Publishing PFS: File		72.00*
Software Publishing PFS: Report		64.00*
Software Publishing PFS: Write		72.00*
Software Publishing PFS: Graph		72.00*
TCS Total Ledger		440.00*
Verbatim Desk Drive Analyzer		25.00*

HARDWARE

(Please add shipping and handling charges found in Italics next to prices.)

COMPLETE SYSTEMS		MULTIFUNCTION CARDS	
Apple Macintosh Base System	CALL	Apparat 256K Memory Board with 64K	\$ 81.00* (1.75)
Apple Apple IIc	CALL	Apparat Combo II w/ser/par/game	\$ 115.00* (2.48)
Apple Apple IIe	CALL	Apparat AT Ram Expansion card	136.00* (2.50)
Columbie Desktop & Portable Systems	CALL	ABT Six-Pack Plus with 64K	229.00* (2.50)
COMPAG Hard Disk Portable	2,735.00* (69.08)	ABT I/O Plus II	120.00* (2.50)
DATA General D/C One (Floppy/256K	1,999.00* (43.20)	ABT Advantage for AT	CALL
128K) Drive "The Real Portable"		EVEREX Magic Card 64K	160.00* (2.50)
Eagle Desktop PC and Spirit Portables	CALL	Full Six Packs features—Game Port included Extra Software	
IBM PC Base System 2DSDD/DCI/256K	1,495.02* (32.55)	ORCHID BLOSSOM W/64K	200.00* (2.50)
IBM PC Professional Hard Disk	1,962.52* (42.87)	Quadram Improved Quadboard w/OK	199.00* (2.50)
Compag All Models	CALL	Teacur Captain Multifunction Card OK	195.00* (2.50)
IBM PC/AT All Configs	CALL		
Sayno MBC 707 Color Portable IBM Clone	620.00* (13.39)		
2 Drives/Color Monitor/256K	1,775.00* (38.00)		
Texas Instruments Professional	CALL		

DISK DRIVES & CONTROLLERS

PC Network 10MB INTERNAL 1/2 Height	\$ 545.00* (12.00)
Autoboot Drive New lower price	
Drive by Fujitsu/Cogito/Shugart	
MMI 1/2 10MB Low rowner Winchester	616.00* (13.50)
Mounts Like Half Height Drive	
Mextor 140MB External Auto Booting	4,900.00* (106.00)
Drive with Controller for PC	
Mextor 140MB External Auto Booting	4,900.00* (106.00)
Drive for AT	
Maynard Floppy Disk Controller	92.00* (2.50)
Maynard WS-1 10MB Internal Hard Disk	770.00* (18.15)
Maynard WS-2 same as WS-1 but with	930.00* (20.30)
Standard Floppy Controller (uses 1 slot)	
Maynard Floppy Controller/Serial Port	145.00* (2.50)
Parasoft Half Height DSDC Drive Pair	190.00* (3.10)
PC Network Half Height Drive Pairs	145.00* (2.18)
Our Volume Lets us Import These Name Brand Drives Directly from the Source.	
Tandem TM 10MB Height DSDC Drive	102.00* (2.20)
Tallgrass 25MB External Hard Disk	2,445.00* (46.44)
with 60MB Tape Backup	
Teac FD 55-B Half Height DSDC Drive Pair	225.00* (5.29)

MEMORY CHIPS

64K Memory Upgrade Kits (9 chips)	\$ 15.21* (1.00)
1MB Random Access Memory	1.65* (1.00)
256K Dynamic Ram Chips (Each)	13.00* (1.00)
128K AT Mother Board Chips (Each)	16.00* (1.00)

MODEMS

Anchor Mark XII LOWEST PRICE 1200BPS	\$ 230.00* (5.00)
HAYES COMPATIBLE EXTERNAL MODEM!	
Anchor Voice Modem 300	47.00* (1.00)
Hayes Smartmodem 1200B with new	325.92* (2.50)
Smartcom II V100 Emulator	
Prometheus Promodem 1200	279.00* (6.00)
Extel 100% Hayes Compatible	
U.S. Robotics Password/Compact	240.00* (5.60)
1200BPS External	

MONITORS

Amdek Video 300G Composite Green	\$ 110.00* (3.00)
Amdek Video 300A Composite Amber	120.00* (3.00)
Amdek Video 310A High Res Amber	130.00* (3.00)
Amdek Color 300 (NEW!) Composite	215.00* (4.64)
Amdek Color 600 (NEW!) High Res RGB	395.00* (8.53)
Amdek Color 700 (NEW!) Ultra High Res	485.00* (9.83)
Amdek Color 710 (NEW!) 702 w/10hr	485.00* (10.48)
Glare/Long Phosphor	
Princeton FX-12 RGB Monitor	CALL
Princeton MAX-12 RGB Monitor	CALL
Princeton SR-12 Ultra High Res RGB	CALL
Quadram Quachrome II (NEW!) 640x200 RGB w/14" Screen	370.00* (8.21)
A Great looking/performing monochrome from the manufacturer of IBM's own color monitor.	
Samung 12" TTL IBM Type Amkor	89.50* (5.00)
Black Phosphor Mask/IBM Case	
Taxan 420 Super High Res RGB Monitor	380.00* (8.21)
Taxan 440 Highest Res RGB (720x400)	828.00* (11.34)
Currently Available Works With Peryst Bob Card	
Zenith ZVM-123 Green High Res	76.00* (2.50)

(Consumer Reports Rated Best Buy!)

VIDEO CARDS

Hercules Color Card w/Parallel Port	\$ 148.00* (3.20)
Hercules Monochrome Graphics Cards	273.00* (2.50)
Paradise New Modular Multisync Card	255.00* (2.50)
Parast Bob Card Ultra High Res Color Card with Mono Quality Text in Color	365.00* (2.50)
BTB Graphics Plus II (NEW!) (Simultaneous Mono Graphics & Color)	235.00* (5.00)

ACCESSORIES AND SUPPLIES

Brand Name DSDC Diskettes	\$ 14.00* (1.00)
Curves (simulated by Life) Not Generc	
Curtiss PC Pedestal II	32.50* (1.00)
PC Network Replacement 130 Watt IBM-PC Power Supply—Gives your PC (Old or New) the same capacity as an AT. Good for add in tape drives (without need for a piggyback unit) and large capacity disk drives.	185.00* (3.56)
BMA PC Document, Keyboard Templates for	9.99* (1.00)
Lotus/IBASE/Multimate and others (Each)	
WP Printer Paper 2500 Sheets	17.00* (10.00)
Microfilm Perfs (invisible when torn)	

*PC NETWORK Members pay just 8% above the wholesale price, plus shipping. All prices reflect a 3% cash discount. Minimum shipping \$2.50 per order. Personal checks please allow 10 working days to clear.

†RENT BEFORE YOU BUY—Members are eligible to join The NETWORK's Business and Game Software Rental Libraries and evaluate products for a full 14 (Regular) or 30 (VIP) days to see if it meets your needs. And The NETWORK's rental charges are far less than other software rental services—JUST 20% OF THE MEMBER WHOLESALE PRICE. We feature over 1,000 available titles in IBM/Apple/MAC and CP/M Formats. Hardware prices highlighted by ► reflect recent major price reductions.

COMPLETE IBM™ PC SYSTEMS

IBM PC BASE SYSTEM IBM PC w/256K

\$1,495.02* (32.55)

Floppy Drive Controller
2 Double Sided Double Density 320/360K Disk Drives
The Base System is your lowest cost starting point for configuring the exact system of your choice. Combine it with any of the monitors, video cards, multifunction cards and accessories listed in this ad, and prove the Network can't be beat as your system source.

IBM PC PROFESSIONAL HARD DISK SYSTEM IBM PC w/256K

\$1,962.52* (42.87)

Floppy Drive Controller
1 Double Sided Double Density 320/360K Disk Drive
w/ Half Height Disk Subsystem
Half Height 10MB Drive Allows Room
for Addition of Tape Backup in PC!
10 times faster than XT
Automatic Hard Disk Boot Feature.
This system increases productivity in any business or professional situation. The 10Mb hard disk eliminates cumbersome floppy disk changes, simplifies operations and dramatically speeds program execution time. The NETWORK's buying power provides you with better than X1 performance at a price lower than you'd expect to pay for a standard PC.

*PC Network Members pay just 8% above this wholesale price plus shipping. These prices have been prepared in February, 1985 and may have been changed with new product announcements. Call for latest prices.

CALL FOR
LATEST IBM
ANNOUNCEMENTS

CUSTOM
CONFIGURATIONS
WELCOME

COMPAQ™ HARD DISK SYSTEM (+)

PROFESSIONAL PORTABLE HARD DISK SYSTEM COMPAQ w/256K

\$2,735.00* (59.08)

Floppy Drive & Controller
Integral dual mode monitor
Shock Mounted 3" 10MB Auto Booting Hard Disk
PC Network goes the COMPAQ + one better building a newer technology. A height low power consumption hard disk into the standard COMPAQ. Mounted with a height floppy drive in the space of 1 Conventional full height unit, you have expansion available to add up to 2 additional hard disk, tape or floppy drives in your portable, just like the Desk Pro. All for about what you would pay for the standard 2 floppy portable.

FEATURED PRODUCTS!

- 64K MEMORY EXPANSION KITS** \$ 15.21*
Set of 9 chips. Guaranteed for Life.
- LOTUS 1-2-3** 265.00*
New Best Price!
- INTERNAL PC 10MB HARD DISK** from 545.00*
Low Power Automatic Boot works on standard PCs. Includes drive/controller cables, mounting hardware & instructions. Full one year warranty!
We use our clout with Brand Name suppliers like COGITO/MMI/Tandon/Fujitsu/Miniscribe/Shugart and others to bring you the best products at the Lowest Price in the Business! Call on the brand of your choice.
- 1/2 HEIGHT DS/DD DISK DRIVES** per pair from 145.00* (pr)
2 drives w/ mounting hardware & complete instructions.
Just like our hard disks featured above. The Network buy's direct and makes fantastic deals with manufacturers like MPI/Tandon/CDC/Shugart/Qume/TEAC and others to bring you fantastic prices and Name Brand drives for your PC/AT/XT or Jr/or Compatible. Yes, this price is for two drives!!
- OKidata NEW PERSONAL PRINTERS**
Microline 182/120CPS/IBM Graphics/LQ Mode & More! + More! 200.00*
Okimate Color 20 80CPS/100+ Colors/IBM Graphics/
LQ Mode + More! (Needs Interface) 109.00*
- TANDON TM100-2 OR CDC FULL HEIGHT DRIVE** 102.00*
- EVEREX MAGIC CARD/64K** 160.00*
Full six Pack Features - Game Port included Extra Software - Fantastic Price!!!
- AMDEK V310A IBM TTL AMBER** 130.00*
- STB GRAPHIX PLUS II** 235.00*
Both Mono and Color Card w/ printer port. Run either Monitor type or both at once!
Gives 16 Colors w/ Lotus
- HERCULES COLOR CARD w/Printer Port** 148.00*
- HAYES 1200B with new Smartcom II/VT100 Emulator** 325.92*
- BRAND NAME DISKETTES** 14.00*
DS/DD Box of 10. Guaranteed for Life. Not Generic.
*NETWORK members pay just 8% above these wholesale prices plus shipping

CALL TOLL FREE 1-800-621-S-A-V-E (orders and memberships only)

In Illinois call (312) 280-0002 validation code B355
IBM and COMPAQ are registered trademarks of IBM and COMPAQ corporations.

PC NETWORK

... WITH THESE 15 UNIQUE BENEFITS

- 1 COST + 8% PRICING**—The NETWORK purchases millions of dollars in merchandise each month. You benefit in receiving the lowest price available and all at just 8% above published dealer wholesale price.
- 2 OUR 600 PAGE WHOLESALE CATALOG**—Members receive our 600 page wholesale catalog containing over 20,000 hardware and software products for the IBM PC, APPLE and over 50 other popular computer systems. THE NETWORK'S CATALOG IS THE LARGEST SINGLE COMPILATION OF PERSONAL COMPUTER PRODUCTS AVAILABLE TODAY. NOW UPDATED QUARTERLY!
- 3 IN-STOCK INSURED FAST HOME DELIVERY**—The NETWORK maintains a giant multi-million dollar inventory of most popular products, allowing us to ship many orders from stock. Non-stock items are typically maintained in local warehouses just days away from The NETWORK and YOU. We pay all insurance expenses on your shipment. **EMERGENCY OVERNIGHT SERVICE IS AVAILABLE ON REQUEST.**
- 4 10 DAY RETURN POLICY**—If you are not satisfied, for any reason with any hardware component purchased from The NETWORK within 10 days of receipt, we will refund your entire purchase (less shipping) with no questions asked.
- 5 MEMBERSHIP SATISFACTION GUARANTEE**—If for any reason you are not satisfied with your membership within 30 days, we will refund your dues IN FULL.
- 6 EXPERIENCED CONSULTANTS**—The NETWORK hires consultants, not order takers, to aid you in product selection. Our consulting staff possesses in excess of 150 man years of personal computer product experience. We back our consultants with our money back guarantee: IF ANY PRODUCT RECOMMENDED BY OUR CONSULTING STAFF FAILS TO PERFORM AS PROMISED—WE WILL TAKE IT BACK AT OUR EXPENSE FOR A 100% REFUND.
- 7 FREE TECHNICAL SUPPORT**—The NETWORK supports every product it sells. Our qualified TECH-SUPPORT staff will help you assemble your system, interpret vendor documentation and get your software and hardware to work. WE WILL GIVE YOU ALL THE HELP YOU NEED, WHEN YOU NEED IT—FREE!
- 8 OPTIONAL BUSINESS RENTAL LIBRARY**—All members can join our BUSINESS RENTAL LIBRARY featuring over 1000 available titles for just \$25 PER YEAR above the base membership fee. This entitles you to rent business software AT JUST 20% OF THE DISCOUNT PRICE FOR A 14 DAY PERIOD. If you decide to keep the software, the entire rental fee is deducted from the purchase price. VIP MEMBERS GET A FULL 30 DAYS for just \$30 above the V.I.P. base fee. This also includes the game library privileges for a \$5 combination savings.
- 9 OPTIONAL GAME SOFTWARE RENTAL LIBRARY**—The Game Rental library is available to members for just \$10 PER YEAR and permits evaluation (or just enjoyment) of any game or educational software product as above.
- 10 SPECIAL SAVINGS BULLETINS—THE PRINTOUT**—Issued Quarterly at no charge to Network members only! The Printout contains all the New Product listings and price changes you need to keep your Catalog up to date. Also, we buy excess dealer inventories, and store bankruptcy closeouts, which we turn around and make available to our members at fantastic savings via THE PRINTOUT.
- 11 DISCOUNT BOOK LIBRARY**—Working with numerous publishers and distributors, The NETWORK has assembled a library of over 1000 computer related books and manuals at savings of up to 75% from the normal store price.
- 12 MEMBERSHIP REFERRAL BONUS**—Our most valuable source of new members is you! To date almost 40% of our members have been referred by word of mouth from other satisfied members. For those of you who refer new members, The NETWORK will credit a cash bonus to your account applicable to any future purchase.
- 13 CORPORATE ACCOUNT PROGRAM**—Almost 50% of The NETWORK's members are corporate buyers and users (see opposite page left). The NETWORK can establish open account status and assign designated account managers to expedite orders, and coordinate multiple location shipments.
- 14 QUANTITY DISCOUNTS**—For large corporations, clubs, and repeat or quantity buyers The NETWORK can extend additional single order discounts, when available to us from our manufacturers and distributors.
- 15 PRICE PROTECTION**—The PC industry is crazy!! Prices change not yearly or monthly or even weekly but often day by day! These changes are sometimes up but are mostly down!! THE NETWORK GUARANTEES THAT IN THE EVENT OF A PRODUCT PRICE REDUCTION, BETWEEN THE TIME YOU PLACE YOUR ORDER AND THE TIME THE PRODUCT SHIPS YOU WILL ONLY PAY THE LOWER AMOUNT!!

WordPerfect is just that.

PC World

At SSI, we face a monumental challenge; living up to the name we gave our word processing software. After all, with a name like WordPerfect, the product had better measure up. Obviously it's doing just that. For good reason.

Simplicity.

Most WordPerfect functions require only one keystroke, a simple press of a finger. And comprehensive, well-written documentation makes learning a breeze.

Speed.

With WordPerfect's document orientation, you never have to wait between pages of

text. No matter how fast you type, WordPerfect won't slow you down.

Features.

In addition to standard word processing functions, WordPerfect includes several comprehensive, useful features not found on many word processors. Like a 100,000-word phonetic dictionary; multi-page footnoting capability; table of contents and index generation; automatic outlining and paragraph numbering; and a network version of WordPerfect.

Get the word processor that's living up to its name. WordPerfect. For more information, see your dealer.

Or call or write:

SSI Software
288 West Center Street
Orem, Utah 84057
Information: (801) 224-4000
Order Desk: 1-800-321-4566,
Toll-free.



SSI Software
Reaching for perfection.

There is very little this program WordPerfect can't do.

InfoWorld

even a beginner can soon master WordPerfect's most difficult functions, such as

PC World

NEW SOFTWARE

Dear Jerry,

Enclosed is a complimentary copy of our new product, CLUBware Diskette #1. I am sending it to you for a couple of reasons.

First, I would like to thank you for your many humorous and useful insights into the microcomputer industry. I, as do many of my acquaintances, always open BYTE to your column first.

Second, I hope you will find both our CLUBware concept and the first product intriguing enough to write about.

This release of CLUBware is an attempt to unrust the IBM PC's BASIC. (Guess what newsletter we have been reading.) That is, Microsoft made some poor design decisions in implementing the screen I/O of its BASIC. It is understandable, if for no other reason than that it was under considerable time pressure from Big Blue. We have essentially reverse-engineered the product and can dynamically apply a fix that accelerates screen output.

At any rate, please take an opportunity to run CLUBware on some IBM PC BASIC applications. I think you will discover that even a poor little IBM PC can really shine.

JOE RAYHAWK

*Rayhawk Automation, N W, Inc.
11600 Southwest Barnes Rd.
Suite 230
Portland, OR 97225*

Great routines. If you put that good of a stuff on all your disks, you ought to get a lot of subscribers. Thanks.—Jerry

SCIENTIFIC COMPUTING

Dear Jerry,

After reading the letter by Steve Maas in the August 1984 BYTE, which is the second letter in recent months trying to convince you that FORTRAN is the one and only language for scientists and engineers, past, present, and future, I decided that I finally had to overcome my laziness and write an opposing letter. I too am a scientist, and I have worked for 24 years in research for one of the largest corporations. However, I am not a member of the Moral FORTRAN Majority but belong to the Immoral Pascal Minority because I had

the benefit of starting with ALGOL-60 as my first computer language, back in the early sixties on a Burroughs B-5500. Later, I too had to convert to FORTRAN, and still later I learned BASIC because these languages were all that were available on the computers I was using. When I finally graduated to a CompuPro microcomputer and had my own choice of languages, I ran, not walked, to get a Pascal compiler. Comparing these four languages, I know from experience that Pascal is by far the best choice for science and engineering, for all the well-known reasons that you already have pointed out.

I submit that the dominance of FORTRAN in science and engineering is by no means an indication that it is the best language, or even a good language, but came about only by historical development. The FORTRAN myth is based on a vicious cycle: In the IBM-dominated world of mainframe computers, all that was available to scientists and engineers was FORTRAN. Therefore, in the past, the universities taught them to program in FORTRAN. Therefore, large libraries of existing programs, all written in FORTRAN, were built up. Therefore, in order to avoid duplication, all scientists and engineers are using FORTRAN. FORTRAN forever! No progress possible!

Well, not all is lost yet! This vicious cycle is being broken now. The universities seem to be teaching mainly Pascal, and with the microcomputer revolution, Pascal is available to everybody. For the first time, individual programmers can make their own choice.

However, FORTRAN cannot be simply ignored: There is, after all, this large mass of existing programs and subroutines. Ways must be found to integrate FORTRAN modules into modern languages, such as Pascal, Modula-2, Ada, and C, so that FORTRAN can be used for existing programs. All new programs can, and should, be written in one of the modern languages. For this purpose, the design of Ada includes a language pragma, i.e., a compiler directive telling the Ada compiler to compile FORTRAN source code within an Ada program. The implementation of this pragma, however, seems to be in the future or, as you would express it, in the

Real Soon Now category. What is available right now are the "common back-end" compilers by Microsoft and, more recently, by Digital Research. These compilers are designed so that only the first pass is different for each language, while the second pass is the same for all languages supported. Thus, modules written in different languages can be linked together into one executable program.

All developers of Ada, Modula-2, Pascal, and C compilers should include a facility that allows you to link in compiled FORTRAN modules, following the example given by Microsoft. Most of these systems do provide for linking in assembly-language modules.

I was using Digital Research's Pascal MT+86, but I switched to Microsoft's MS-Pascal partially because of its interlinkability with MS-FORTRAN77 and partially because it allows using the full address space of the 8086. Both compilers are written in MS-Pascal, and both produce object modules that can be linked together by the MS-DOS linker. The main program can be either in Pascal or in FORTRAN. Both languages support separate compilation of modules. The Pascal part supports modules (like Pascal MT+86) as well as units (like UCSD Pascal). Procedures in the modules or units can be external and can be in FORTRAN or assembly language. Thus, I write the main program and all new work in Pascal and use the FORTRAN compiler for existing scientific subroutines that are made part of a Pascal unit as separately compiled external procedures. This works very well. The MS-FORTRAN77 compiler compiled a large FORTRAN IV program, ported from a mainframe, essentially without changes—no complaints at all!

In order to run MS-Pascal and MS-FORTRAN, I had to switch my CompuPro 8/16 system from CPM to MS-DOS, and I do not want to miss this opportunity to point out to you and all other CompuPro enthusiasts the availability of MS-DOS and, more recently, IBM PC-DOS on CompuPro systems from Computer House in San Rafael, California, under the trade names MS-PRO and PC-PRO. Both systems are simply wonderful, and I hope that you

will review them in your column when time and space permit. You can boot up either MS-DOS (MS-PRO) or PC-DOS (PC-PRO) on any standard CompuPro 8/16 system without losing your CP/M-80 or CP/M-86 capability.

Please keep up your support of Pascal, Modula-2, and Ada and tell all your letter writers from the scientific and engineering community that, yes, FORTRAN and

BASIC programs are difficult to read, difficult to debug, and difficult to maintain, and let them know that they don't know what they are missing if they do not try something that is new to them. After all, science is the search for new frontiers, which would also include computer programming.

GUNTHER E. MOLAU
Clayton, CA

Thank you for a very thoughtful letter. Your point is well made.

I hadn't known about MS-PRO and PC-PRO; the difficulty we've always had running PC-DOS is teaching the machine to talk to whatever terminal we had running at the time. Now, though, I have Concurrent DOS, which does have MS-DOS as well as allowing me to run CP/M 8/16, giving me the best of both worlds. I'll try to get MS-PRO and compare.

Best.—Jerry

MONITORS

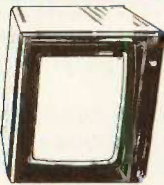

USI 20 MHz Hi Res., Best Buy, 1000 Lines Res. up to 132 Char. Display, 12" Amber Screen only 89

ZENITH DATA SYSTEMS

ZVM Series 122, 123, 124, 131, 135.

PANASONIC SPECIAL PURCHASE

Panasonic 13" color Monitor, RGB and Composite, IBM Compatible.



List \$449. Our Price 259

20 MHz with Sound Amp 12 Amber 125

New X-Iron Amber TTL IBM-Compat. 125

AMDEK Still the Leader

Color 1 & 1 + closeout. 199/209

Video 300/300A 135/145

Color 300/Color 600 239/450

Color 500/Color 700 380/520

ELECTROHOME

ECM1226 12 green 95

1302-1 33 color 195

1302-2 13 color RGB H R 330

COMPUTERS

800-822-1211

Service contracts available on everything we sell.

WE HAVE MORE THAN JUST THE BEST PRICE

We know you want more than just the best price. We have a fulltime staff of professionals whose only job is to evaluate the hardware and software systems we sell. The Whole Earth Software Catalog described us as providing "excellent technical support... low repair costs and a... good return policy." When you buy from us you get more than just the best price. When you buy from someone else...?

COMPUTERS

ZENITH DATA SYSTEMS

152 Desk Top PC, 320K Ram, 2-360K Drives, Serial & Parallel Ports, P3 Amber Hi Res 20 MHz Monitor Plus MS DOS/Wind/Multiphan 1,850

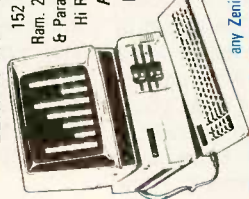

Personal Pearl database manager only \$100 with any Zenith System purchase.

POWER DEVICES

Datashield back-up power source 265

200 PC-200 watt 370

300XT-300 watt 370

Noise Filter, Brooks 6 Outlet - Surge Suppressor/ 54

Computer Power Inc. — 500 VA 1,320

Tripp Lite 425 VA 1000VA 390

DISCS & ACCESSORIES

NOBODY BEATS OUR PRICE ON DISKS!

AB's OWN 5 1/4" DISKETTES
Over 40% off our regular low priced 100 quality ds/dd diskettes packaged in an Amaray Media Mate 5 Only 180



DISK STORAGE

Mini Flip N File (50 5" disks) 17.45

Rolltop 100 (100 disk, 10 div.) 28.95

Mini Kas-ette/70 (for 5" disks) 1/2,25

10/2,05 ea

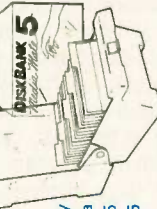

Amaray Media Mate 5 9.95

Innovative Concepts - fold out style for 5" disks

Flip N File 25 16.50

Flip N File/50 22.95

PLUS — "Head" disk cleaning kit w/2 disks 11.98

IBM drive analyzer (Verbatim) 22.50

U.S. CONTACTS

Dear Jerry,

I hope you will be able to help me. I represent a small group of French computer and data-network (not hackers, of course) enthusiasts.

We are looking for contacts with American fans, and we could give them access to a French electronic mailbox (free of charge!) on our national computerized data network (0208075040371 or 0208075040864).

PASCAL LAGADIC
Residence Cornouaille
28, Bd Bougainville
F.29110 Concarneau,
France

Anyone out there interested? Please keep me posted.—Jerry

WRITING AND EDITING

Dear Jerry,

I am half of an information-center support group responsible for microcomputers at a power company. The staff consists of two groups: mainframe support and microcomputer support. We provide a monthly newsletter to all corporate users of either mainframes or microcomputers. Presently, we are creating and editing this letter on our IBM mainframe using a full-screen editing product (ISPF). As you have said often, any form of word processing, even a very crude one, is better than a typewriter.

What would you recommend to streamline the writing and editing process? We have access to several IBM PCs and compatible computers. Some members of our group use various word-processing programs (WordStar, WordPerfect, EasyWriter), and I have convinced the rest that we could produce a better newsletter on a PC with less effort. To add to the problem, many of our users submit articles. They submit them in a printed format, but most are generated on some type of microcom-

puter. The articles could come off of non-compatible machines. Do you know a word-processing program that would allow all our writers to use any program they want and still make it fairly easy to bring it all together for formatting, spelling checking, indexing, etc.? I believe this would also be useful to the company's PC Club, which is open to members with any kind of computer. Our company has 5000 employees, so you can imagine the cross section of machines and programs we could be looking at.

Thanks for your time and keep up the great work!

KEVIN WANDTKE
Milwaukee, WI

My guess is that your common denominator is going to be WordStar. What you need is a series of filters that will turn foreign files into something that WordStar can eat.

Those are not difficult to come by. I wrote my own for the Z80 (in assembly language, yet; just use the "Copy" program example in DR's MAC document as a base and start adding features). It shouldn't be hard to write 8088 filters; use Turbo Pascal or Logitech's Modula-2. After you've done a couple of filters you'll find the rest are easy.

The filter should take text from one editorial format and write a new file with the text in WordStar format. From there it's easy.

Best.—Jerry

CP/M-80 AND 8-BIT MACHINES

Dear Jerry,

What is the future of CP/M-80 and the 8-bit machine? I have been following software developments very closely for the past eight months, and it appears that aside from KAMAS, Turbo Pascal, and the three C compilers covered in the June 1984 BYTE, there has not been a new software product introduced for CP/M-80 in two years. Even the latest public-domain software packages have 1982 dates in the copyright notices, NSW206 excluded, of course.

Is CP/M-80 on the way out, or is it alive and well, hiding behind an impenetrable barrier of high-hype 16-bit advertisements? What do you see CP/M-80 being used for in the future?

Finally, one more question: Has the supply of new CP/M-80 software dried up for good?

ALLEN STANBURY
Barrie, Ontario, Canada

Glad you asked. Some of the best bargains in computing are 8-bit CP/M machines, new or used.

Their advantages: they're plenty good enough for a lot of really interesting work. I managed my affairs for years with Ezekial, my friend who happened to be a Z80, and you can get a better machine than he was (sorry, old friend) for a lot

less than I paid for him.

There is a lot of software out there for 8-bit CP/M machines; particularly for those with a Z80 processor (which most now have). Most of that software is low-cost, and much of it is free or nearly so. You can even get ZCPR-3, which revamps the operating system into something a heck of a lot nicer than MS-DOS. There's

(continued)

ADDITIONAL BOARDS

Quadram Quadboard 225
 Quadlink/Quakad 512+ 479/255
 Quadcolor 1/chrome II 197/469

AST RESEARCH

Six Pack +/-/Mega + 245/295
 Combo +/-/O + 275/129

PARADISE

* 5 Pack Graphics 180/315
 Multi disp./RAM kit (9) 335/25

ETC.

COMMUNICATIONS

Everyone knows that phones and computers are coming together. While evaluating a data phone we were so impressed with a unit we wish to share it with you. Perfect for a small company. Great for you just need one for home. So many features... can't list them all. 2 lines/8 ext. intercom, no ksu, loop installation, PBX Compatible, etc. with door speakers and built in modem coming.

First phone 276
 Mark X Auto Dial/Auto Answer 119
 Anchor 1200 Baud Hayes Comp 190
 Hayes SmartModem 1200B 419
 Smartcomm II Software 489
 Hayes SmartModem 1200/300 489
 "Crosstalk" software 129
 Koala Pad (w/software) Call
 Koala Muppet Learning Keys Call
 4164 Chip Kit Memory for IBM 64K 24
 interface cables 6, 10, 12 ft. all popular connectors (Dealer inquiries invited) 19
 IBM Printer Special 19

PRINTERS

OKIDATA

82,83,84,92,93,2350 Call for current prices!
 EPSON

RX80/RX80FT 239/309
 FX80/FX100 369/569
 RX100/L01500 639/1,109
 JX80 Color Call

STAR

Gemini SG-10/SG-15 269/456
 SD-10/SD-15/SR-10 435/680/613
 S. interface Call

ASK ABOUT FREE PAPER WITH PRINTERS

PANASONIC

Panasonic KXP1080 239
 with IBM cable, Friction & tractor Software for IBM to change type size & style 239
 Reg. List 430 NDW 265

COMPUTERS

800-822-1211

In PA 215-822-7727
 CUSTOMER SERVICE
 215-822-7727

We support Apple, Macintosh, Commodore, IBM & compat.
 252 Bethlehem Pike, Colmar, PA 18915

MasterCard
 VISA
 American Express

Software Super-Hit Parade

BUSINESS

Lotus 123/Symphony IBM 290/489
 PFS Grady/Report C/A/I 79
 PFS Write/file/plan C/A/I Call
 Type Tutor III C/A/I 35
 dBase II/III IBM 325/460

ENTERTAINMENT

PHI BEATH PHILER C/A/I Call
 Mind Prober C/A/I 30
 Mad Spy vs. Spy C/A/I 25
 Your New Baby C/A/I 29
 Kermit's Story Maker C/A/I 23
 Think Tank C/A/I Call
 Bridge C64 Call
 Bank Street Writer C/A/I Call
 Lode Runner C/A/I Call

UTILITY

Slide Kick Call
 Norton Utilities Call
 Copy II PC IBM install Lotus dBase etc. on hard disk Call
 Print Shop C/A/I Call

EDUCATIONAL

SAT Math & English C/A/I Call
 Agent USA Call
 Math Diaster Davidson C/A/I 34
 Word Attack, Davidson C/A/I 34
 Story Machine, Spinnaker C/A/I 22
 Rocky Boots C/A/I Call
 Flight Simulator C/A/I Call
 Solo Flight C/A/I 26.50
 F-15 Strike Eagle C/A 26.50
 Hitchhikers guide to the galaxy Call
 Ultimate/Multiplan C/I 320/125
 Word with mouse/Chart 319/325
 Spot Light Software Arts I 120
 Get Organ. Elec. Arts I 79/135
 Word Star Propack 4 Prog. A/I 279
 VMM Pascal C64+/+Pet 95

We carry full software lines by Electronic Arts, Scholastic, Scarborough, PFS, Spinnaker and Batteries included.
 Others if you don't see Call

C - Commodore A - Apple I - IBM

AB SATISFACTION GUARANTEE

Every product sold by AB Computers is factory packed and comes with the manufacturer's warranty. However, if an item is defective when received, you may return it to us within 15 days for repair, adjustment or replacement at our option. Returns must be accompanied with copy of your receipt, letter detailing defect. Blank warranty card and original factory packing. To expedite handling, please include return number (50¢). No return on computer software (size ordered).

ORDERING INFORMATION: Orders by check, MasterCard or VISA. Personal checks take 15 days to clear, no ordering on unperfected checks or money orders. Add 3% shipping and handling on all orders (minimum \$2.00). Mail, APD/PPO Air may require additional charge. PA residents add 6% sales tax. All residents add 5%. All items subject to availability. Prices subject to change. Additional discounts available to qualified educational institutions. Requests for bid on volume requirements invited.

a lot more software that was published by companies that no longer support it and that has effectively fallen into the public domain: no one will give permission for swapping it, but no one cares much either. And, of course, most 8-bit machines come bundled with some really good programs.

Finally, when you do upgrade, you can go the 8/16 route; machines like the Z-100 and the CompuPro line immediately come to mind. These will run all your old familiar software. I'm writing this with an 8-bit text-editor program called WRITE that I prefer to anything else I've seen.

Disadvantages: you won't upgrade easily, and probably not at all. There's little new commercial software being written for 8-bit CP/M machines; that means you'll have to join user groups and scrounge about; and even so, as time passes you'll see more and more about the newest programs with fancy features that your 8-bit system just won't handle.

There's not a lot of support for either software or hardware. You'll have to learn a bit more of what you're doing. CP/M

takes a couple of days' study before you can do much with it and a couple of weeks' use before it becomes automatic. Most of the 8-bit software was written in times when computer users were expected to put some effort into learning about computers.

Should you get an 8-bit machine? Like most questions, the answer is "That depends." If you're one of those people who has to have the latest and best, no; but if you just want to get some jobs done while holding down costs, you'll think hard about 8-bit CP/M systems. They'll be around for years yet.—Jerry

MISCELLANEA

Dear Jerry,

I enjoy your observations on the industry, your user viewpoint, and the generally good advice on products and systems. I am now involved in the computerization of a law office for my father. Because of your column, I have looked at the Zenith Z-150 plus network (four workstations) and the CompuPro System 10.

Either system will be built around a 40-megabyte hard disk. The Zenith would run under Concurrent DOS. We have not made up our minds yet. My dad's office is less than 20 miles from the Heath factory that makes the units.

In the December volume of the ACM Sigplan Notices on Programming Languages, David V. Moffat of North Carolina State University wrote a paper on Modula-2. As you have been writing about how great a programming environment Modula-2 is, I wonder if you feel Mr. Moffat's concerns have any merit.

When you discuss text editors you have not mentioned WordPerfect by Satellite Software. Have you used this package?

I think that Borland should get a company-of-the-year award for its fine products. My System Engineer wife has gone exclusively to Turbo when programming in Pascal. Turbo is very popular with the computer science students at Old Dominion University.

ROBERT ADAMS
Norfolk, VA

(continued)

6 TIMES FASTER!

SuperFast Software Development Tools

INCREASE YOUR PROGRAMMING EFFICIENCY
with high-performance software development products from SLR Systems.
No other tools approach the speed or flexibility of the SLR Systems line.

"Z80ASM is an extraordinary product..."
Robert Blum, Sept. 84 DDJ

"...in two words, I'd say speed & flexibility"
Edward Joyce, Nov. 84 Microcomputing

ASSEMBLERS

- RMAC/M80 macros
- Nested INCLUDES & conditionals
- 16 char. labels on externals
- Built in cross-reference
- Optional case significance
- Phase/dephase
- Math on external words and bytes
- Define symbols from console
- Generate COM, HEX, SLR-REL, or Micro-soft-REL files
- Time & Date in listing
- Over 30 configure options

LINKERS

- Links SLR & M80 format files
- Output HEX or COM file
- Three separate address spaces
- Load map and SID/ZSID .SYM file

SLRNK+ includes:

- All tables overflow to disk
- HEX files do not fill unused space
- Intermodule cross-reference
- EIGHT separate address spaces
- Works with FORTRAN & BASIC
- Generate PRL & SPR files
- Supports manual overlays
- Full 64K output

Z80ASM -full Zilog Z80	\$125
NEW! Z80ASM+ -all tables virtual	\$195
NEW! SLRMAC -full Intel 8080, with Z80.LIB extensions internal	\$125
NEW! SLRMAC+ -all tables virtual	\$195

Z80 CPU, CP/M compatible, 32K TPA required.

Inquiry 358

"Z80ASM...a breath of fresh air..."
Computer Language, Feb. 85

C.O.D., Check or Money Order Accepted

For additional information contact SLR Systems
1-800-833-3061, in PA (412) 282-0864
1622 N. Main St., Butler, PA 16001 • Telex 559215

SLR Systems

TeleVideo is the multiuser system for companies who expect to grow.

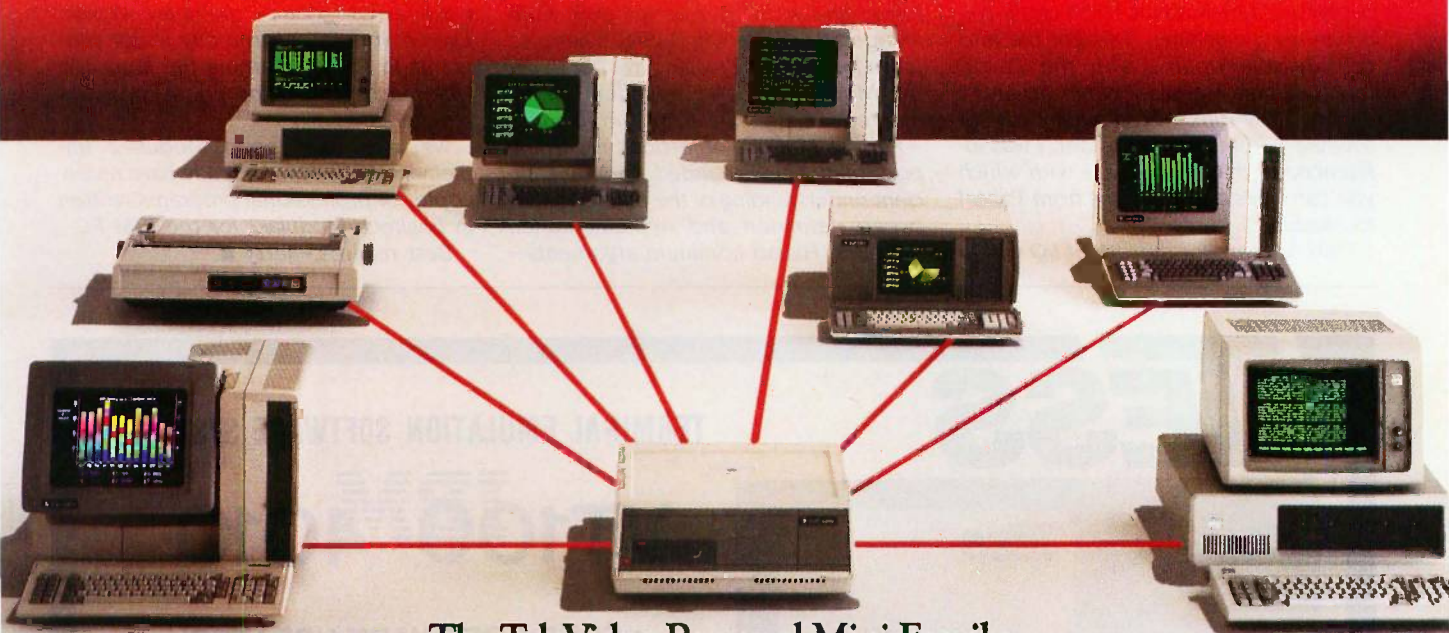

The TeleVideo Personal Mini Family

Growing companies need a computer system that will grow right along with them. Simply and economically.

A computer system that lets people communicate and share resources. Even work on the same file simultaneously.

The TeleVideo® Personal Mini™ Family is that system.

Runs PC, mini and multiuser software.

With the TeleVideo Personal Mini, users of IBM® or TeleVideo PCs, XTs, and portable computers can share data, as well as expensive peripherals, like printers and plotters.

The Personal Mini dramatically increases computing power. So it not

only runs PC software, but also hundreds of popular, fast mini-computer and multiuser programs. Without destroying your established PC environment.

And, unlike less advanced networks, the Personal Mini never sacrifices performance or speed regardless of how many workstations are on line.

Build on your original PC investment.

Even our system expansion costs are substantially less than what you'd pay to add new IBM PCs. And your original investment in hardware, software and personal computer education is never lost.

Your TeleVideo dealer has the Personal Mini. Arrange to see it today by calling toll free, 800-521-4897. In California, call 800-821-3774. Ask for operator 10.

The TeleVideo Personal Mini. The growing business computer.

Regional Sales Offices: Northwest (408) 971-0255, Southwest (714) 476-0244, Southcentral (214) 258-6776, Midwest (312) 397-5400, Southeast (404) 447-1231, Mid-Atlantic (703) 556-7764, Northeast (617) 890-3282, East (516) 496-4777, Rocky Mountain (714) 476-0244.



Systems
TeleVideo Systems, Inc.

IBM is a registered trademark of International Business Machines

Alas, I haven't seen WordPerfect.

Thank you for including Professor Moffat's paper on Modula-2. I can share some of his unhappiness about the lack of I/O within the Modula-2 language itself. I'd like it better if there were richer I/O functions built in, or, failing that, if there were a defined standard I/O library (set of I/O definition modules) every compiler publisher had to implement.

Of course, what Moffat does here is to reject Wirth's most basic philosophy of keeping compilers small and simple. Perhaps he's right. I don't think so.

In my early days with this column, I explicitly refused to examine languages *per se* and confined my attention to particular implementations that I could run on my own machines. This got me into considerable trouble with the Pascal lovers. When Modula-2 came around I changed my rule: I liked what I saw of Modula-2 from the first instant. I was influenced in that by the ease with which you can translate programs from Pascal to Modula-2.

I did not care for the lack of I/O within

Modula-2, but I was assured that there would be, with any implementation, a library of I/O procedures adaptable to the particular machines (and I/O devices!) the compiler would support. Alas, Moffat has a point: there seems to have been little standardization of the libraries. I expect that to change; if it doesn't, Modula-2 will not become the language of the future for microcomputers.

It may not anyway. In the three years since I gave Modula-2 my support, small computers have changed radically. They are faster, have more memory, and can access much larger files. As a result, we have got better and better versions of BASIC, with debugging tools and compilers; and while no one will ever write an operating system in BASIC, it has also taken longer than I would have bet to get the Modula-2 operating system implemented on anything I can run it on.

Part of Moffat's objections regarding portability seem founded on an insufficient understanding of the difference between definition and implementation modules. His *ad hominem* arguments—

the only Modula-2 enthusiasts are those who will somehow profit from its success—are untrue and not worth commenting on.

His final observation, that there is no "final" computer language, is probably true; but it fails to answer the question, "What should the user learn after BASIC?" For Moffat to tell us that SNOBOL and APL handle many problems perfectly is probably not much use to the general public.

For now, my advice to readers is to learn some BASIC, then get Borland's Turbo Pascal and a good introductory Pascal text. Follow that up by getting some books with Pascal source code and examine how good programs are written. Even if you never write any major programs in Pascal, learning the language will teach you a lot about program structure.

We also have good Modula-2 implementations now. I already have review copies of professional programs written in Logitech Modula-2 for the IBM PC.

Best regards.—Jerry ■

TESS

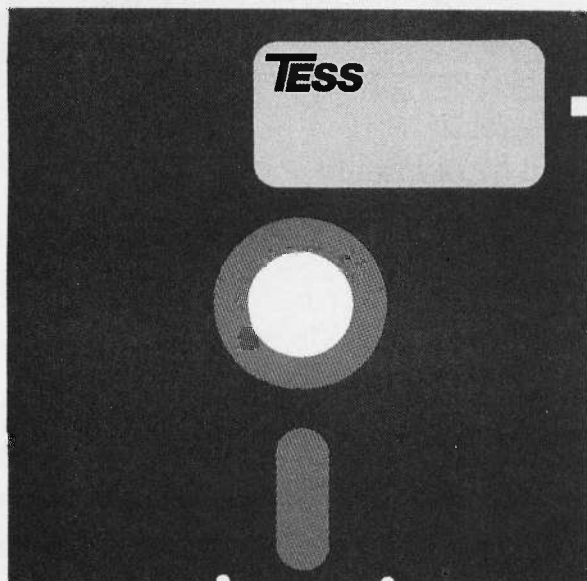

\$19500

Corporate discounts available. Price includes 12 month updating service.

TERMINAL EMULATION SOFTWARE SYSTEM

VT100-4010

• FREE SOFTWARE UPDATES

- Double height / double width, VT102 support
- ANSI / ISO color command support
- Convenient help screens
- ASCII file transfers
- IBM / EPSON graphics printer support
- HERCULES, HAYES and KEYTRONICS support
- Monitor mode for data stream debugging
- "Smart" key assignments
- Extensive setup support

Enhance through-put of your IBM PC, XT, AT or portable by using TESS®...the first Terminal Emulation Software System developed and optimized by a leading graphics terminal house. Unparalleled user productivity...2 to 10 times faster than other emulators...data buffering from host while doing local processing...and much more.

ORDER TESS® NOW...CALL 1-800-633-2252, Ext. 680

Satisfaction guaranteed or return within 30 days for full refund. Visa, Mastercard or C.O.D. accepted and we pay shipping.

ID SYSTEMS

CORPORATION

6175-W Shamrock Court • Dublin, Ohio 43017

Trademarks: VT100 is a trademark of Digital Equipment Corp.
4010 is a trademark of Tektronix Corp.

Make Any Computer Do Exactly What You Want With McGraw-Hill's

Contemporary Programming & Software Design Series



From Writing Your Own Programs to Modifying Existing Software, Here's the New, Easy, and Low Cost Way to Unlock the Secrets of Your Computer

Whether you use computers for business, for personal applications, or for fun, off-the-shelf programs will never do everything you want them to do for you. That's because they were written by programmers to satisfy what they perceived as the needs of the greatest number of potential users—often missing some or many of your specific needs.

That's why McGraw-Hill's new Contemporary Programming and Software Design Series teaches you how to create your own software . . . either from scratch or by making key modifications to existing programs.

There is nothing magical about it. You learn the process of building a computer program step-by-step with McGraw-Hill *Concept Modules* sent to you one at a time, once a month. Each of the ten modules in the Series takes you through an important step in the development of the structure and detailed logic of a program, including testing, debugging, and documentation.

Unique Interactive Hands-On Instruction

Each module includes an easy-to-understand guide PLUS a 5¼" floppy disk containing typical programs and interactive instruction that you can run on any IBM or IBM-compatible computer for hands-on experience.

In the first Module, for example, when your sample program (Declining Interest Loans) appears on your screen, you'll find errors on certain program lines. You'll also see that the program is only three-quarters completed.

Now comes the fun part. You'll discover how this program is built, and in the process you'll learn how to identify and correct errors. And by the end of Module 1, you'll actually have

completed this program yourself.

But there's more. Special graphics on your screen work in conjunction with the accompanying guide to amplify, illustrate, and deepen your understanding of software design principles.

Learn the Foundation of All Computer Languages

Although the Series teaches you programming procedures, it is not aimed at

any one language or machine. Why? Because 95% of the programming process is carried out using design techniques that are independent of a specific language or machine. Nevertheless, we include enough training in BASIC and machine language to get you started. You'll find that the whole process of learning new languages will be greatly accelerated once you complete the Series.

Create a Complete, Customized Family Financial Package As You Learn

The sample programs you work with throughout the Series are excellent learning tools. But they're more than that. By combining the sample programs onto one master disk, you'll create your own family financial package that will help you balance your budget, figure loan amortization, and much more. And — of course — you'll be able to further modify your financial package to fit your own specific needs!

15-Day No-Risk Trial

To order your first module without risk, send the postage-paid card today. Examine the first module for 15 days and see how the Series will help you make any computer do exactly what you want it to do!

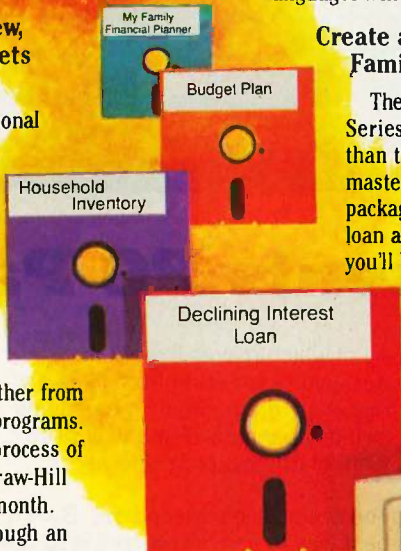

If someone has beaten you to the card, write to us for ordering information about the Contemporary Programming and Software Design Series.

McGraw-Hill Continuing Education Center

3939 Wisconsin Avenue
Washington, DC 20016

IBM is a registered trademark of International Business Machines, Inc.



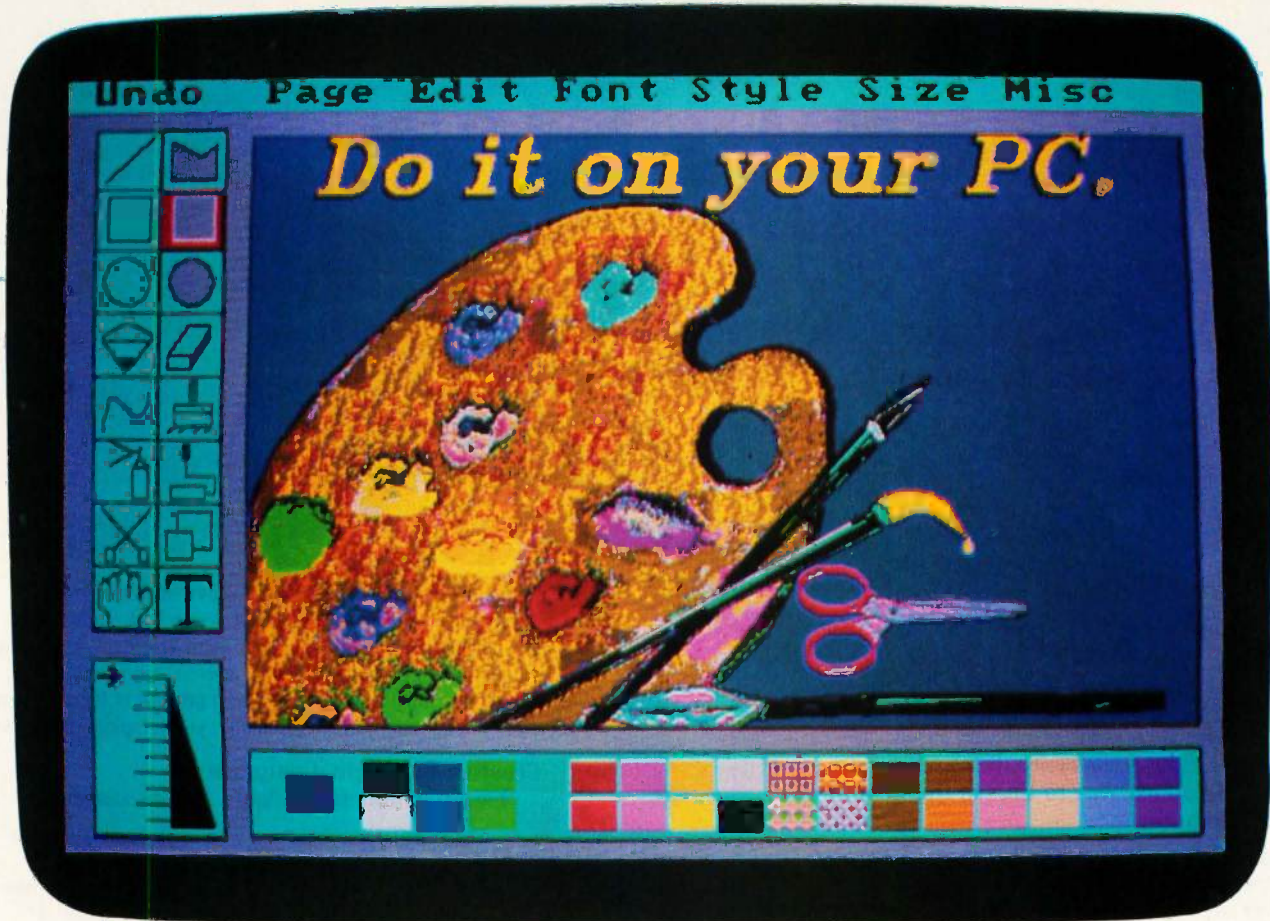

IMSI Presents PC Paintbrush™

With PC Paintbrush, you'll now be able to do things that you once only dreamed about.

Because, like your dreams, you'll be working with a palette of up to 256 vibrant colors and shades, depending on your color card.

And, as you'll notice, you'll also have drawing tools, drop-down menus, and a range of brush widths and shapes. Plus your choice of mouse or joystick.

In addition to freeform drawing, you'll be able to draw precise triangles, rectangles, boxes, circles and ellipses.

You'll be able to cut, paste, and move things around. Even enhance graphs, text, and images from other programs like Lotus 1-2-3, Microsoft Word, and SuperCalc 3.

But don't stop with painting. PC Paintbrush also gives you an electronic type shop to work with. Several fonts, from Olde English to Computer. Each in seven styles (boldface, italics, underline, etc.) and seven sizes.

All of which makes it great for designing everything from fliers and report covers to greeting cards and birthday banners. (For a wall-sized work of art, just print sideways.)

The possibilities are endless. But the best way to see for yourself is to see for yourself. Get a demonstration at your nearest computer store.

Then, draw your own conclusions.



INTERNATIONAL MICROCOMPUTER SOFTWARE, INC.
633 Fifth Avenue • San Rafael, CA 94901 • 415/454-7101

RUNS ON:	IBM PC/compatibles, and Corona PC, 192K RAM. IBM PCjr., and Mindset, 256K RAM. HP 150, 320K RAM. All require DOS 2.0 and up and 1 drive.
MICE:	Summagraphics, Mouse Systems, Microsoft.
JOYSTICKS:	Any IBM compatible.
GRAPHICS CARDS:	Amdek, Hercules, IBM, PCjr., Quadram, Scion, Tecmar, STB, Paradise.
MONITOR:	Color or black and white.
OUTPUT:	Printers: IBM/Epson graphics, Epson FX-80 and 100, MX 80 and 100, IDS Non-Color, IDS Prism Color, NEC 8023, C-Itoh 8510, Okidata 8X or 9X series, Radio Shack CGP-220, Xerox 1770, PrintaColor TC1040, Quadram Quadjet, Transtar Color, Diablo C150, Tektronix 4695, HP Thinkjet, Star Micronics, Epson JX-80, Data Products 8050, IBM Color printer. Plotters: HP 7475A and 7470A.

PC Paintbrush is a registered trademark of ZSOFT CORP.

Megabits and Gigaflops

New RAM chips and computers

BY WILLIAM M. RAIKE

For about a week, Japan was closed for business. But that's not as strange as it sounds; the week was January 1-7, and virtually all stores, restaurants, and other businesses here close for the New Year holidays. After a frantic few weeks of *bonenkai* (literally, "forget-the-year parties"), Tokyo's crowds vanish, with many people going off to visit relatives in rural areas.

After my customary New Year's Eve visit to a neighborhood shrine, listening to the drums heralding the new year and sipping sake from a traditional little square wooden box, there was plenty of peace and quiet for writing columns, and even time to get around to some long-delayed software chores.

Before the holidays, though, there were a number of computer-related developments in the news. In addition to announcements of a new supercomputer and of the test production of 1-megabit memory chips, both NEC and Fujitsu introduced new personal computers.

MEGABIT RAM CHIPS FROM IBM JAPAN

The latest round in the ongoing competition for large-scale memory chips was the start of IBM Japan Ltd.'s test production of 1-megabit dynamic RAM (random-access read/write memory) chips. Quantity production is still probably at least a year away; the entire output is destined for in-house consumption, with the chips to be installed in computers manufactured by IBM Japan. The plant, located in Shiga Prefecture in western Japan, has produced both 64K-bit and 256K-bit dynamic RAM chips for the past year or so.

NEW SUPERCOMPUTER

Fujitsu Ltd. is the second-largest manufacturer of personal computers in Japan (well behind NEC); however, the company is the largest manufacturer of mainframes. It now claims to be the fastest, too, after having just

announced a new supercomputer. The new behemoth is called the VP-400, and Fujitsu claims that it is capable of computing at the rate of 1 gigaflop (one billion floating-point operations) per second. Like the Hitachi S-810 supercomputer I talked about in *BYTE* Japan last month (see "The Fifth Generation in Japan," page 401), that is a peak rate, dependent on taking the greatest possible advantage of the pipeline structure of the hardware. The actual processing rate for the Hitachi machine can be as much as six times slower than the peak rate, depending both on the specific application and on how finely the software is tuned. Fujitsu is undoubtedly just as adept at playing the specifications game as Hitachi is. From the viewpoint of peak processing speeds it may look as if Japan's supercomputer manufacturers are in a position to compete with the U.S.'s Cray Research Corp., but unless their software (and documentation) improves soon, the impact of Japanese supercomputers outside Japan is unlikely to be economically substantial.

NO NEC-COMPATIBLE FROM IBM?

IBM Personal Computers (PCs) are downright rare in Japan, for reasons that include relative technical inferiority, inability to support the Japanese language, high prices, poor distribution, and high-priced maintenance. The JX computer introduced by IBM Japan late last year has not been enthusiastically accepted for some of the same reasons. In addition to the MSX standard for very low priced computers, there is a de facto standard in Japan for powerful, multi-purpose personal computers: it's the NEC 16-bit personal computer family, the PC-9801 series. In the 16-bit personal computer market here in Japan, the PC-9801E and PC-9801F command more than a 70 percent share of the market. (NEC's APC III, introduced last year in the U.S., is similar to the PC-9801F2 except for the floppy-disk capacity and the hardware features that

(continued)

William M. Raikes, who holds a Ph.D. in applied mathematics from Northwestern University, has taught operations research and computer science in Austin, Texas, and Monterey, California. He holds a patent on a voice scrambler and was formerly an officer of Cryptext Corporation in the United States. In 1980, he went to Japan looking for 64K-bit RAMs. He has been there ever since as a technical translator and software developer.

NEC has trumped its own ace with the PC-9801M2.

support the Japanese language.)

When new software or peripheral equipment is introduced in Japan, the versions for the PC-9801 are invariably the first to hit the market; if you go to a computer show, most of the software and peripherals vendors demonstrate their wares on a PC-9801F2. (The F2 designation indicates the model with two built-in floppy-disk drives. There are also F1 and F3 models; the F3 has one floppy disk and one 10-megabyte hard disk built in.)

So dominant is the position of this machine that I've only half-jokingly suggested that IBM Japan, instead of bringing out the JX, should have borrowed a trick from the IBM PC's imitators and introduced a machine of its own that was fully NEC PC-9801-compatible.

THE LATEST AND GREATEST NEC MACHINE

In the past month, NEC has apparently trumped its own ace by introducing the PC-9801M2. It's not really a new machine, but it represents several technical refinements over the F2 model, along with a substantial price reduction.

The two biggest differences are that the floppy-disk drives in the M2 hold 1 megabyte each instead of 640K bytes as in the F2, and the basic price (the list price is equivalent to about \$1650) now includes a standard 256K bytes of memory instead of the F2's 128K bytes. A mouse interface is included with the M2; it was optional in the F2. Since adding 128K bytes of memory to the F2 costs about \$160 and takes up one expansion slot, the extra memory on the main board of the M2 is a real advantage. And my own experience with the 1-megabyte disk drives in my Fujitsu computer has been very satisfying; it's a great relief

not having to swap disks or remember which program is in which drive during an edit-compile-debug cycle.

The central processing unit of the PC-9801M2 is an 8086-2 running at 8 MHz, although you can switch to a 5-MHz clock rate for compatibility with earlier versions of the PC-9801 computer. NEC offers an optional 8087-2 numeric coprocessor (there's a socket for it on the main board) that runs at 8 MHz, but the price for the chip is a hefty \$325.

Main memory is expandable to 640K bytes. That may seem like a lot, but I'm spoiled; my Fujitsu can handle up to a megabyte (it has 768K bytes installed now), and I use 512K bytes of that as a RAM disk. Fujitsu's version of the CP/M-86 operating system "knows" that drive M: is the RAM disk, so I normally load any necessary files onto drive M: when I boot up the computer; then I just forget about waiting for disk I/O (input/output). The trouble with NEC's limit of 640K bytes is that many programs need at least 256K bytes to run in. That leaves only 384K bytes free for a RAM disk, which is squeezing things a bit if you want to load something like Digital Research's C compiler and its associated linker and library files, in addition to an editor and various utilities.

In addition to the standard 96K bytes of ROM (read-only memory) containing the BASIC interpreter, the PC-9801M2 comes with a kanji ROM board with the 2965-character JIS (Japan Industrial Standard) No. 1 kanji-character set; the JIS No. 2 set of 3384 additional characters is available as an option for less than \$50. Japanese characters are displayed on the screen in a 16- by 16-dot font, with 40 characters per line. As is common with personal computers in Japan at this price level, the operating system supports the full Japanese language; the basic price does not include an operating system, but both Japanese-language CP/M-86 and MS-DOS are available as options for about \$40. You can also buy the PC-UX operating system, which is essentially a UNIX System III; it costs about \$1200 and requires at least 384K bytes of mem-

ory and a 10-megabyte hard disk. (The hard disk costs an extra \$1775.)

The rest of the PC-9801M2 is unchanged from the F2 version; 192K bytes of graphics video RAM is standard—graphics are in eight colors with 640- by 400-dot resolution. An 8-bit parallel printer interface is, of course, standard, as is an RS-232C serial interface and a calendar/clock with battery backup. There are three expansion slots.

NEC offers a wide selection of display monitors and printers. For example, there's a 14-inch high-resolution (640- by 400-dot) monochrome display that lists for about \$230, while a 14-inch high-resolution color display goes for about \$670. The PR-101 printer is a very high quality 24-pin dot-matrix printer that prints 80 characters per line and lists for about \$950 (it also prints beautiful kanji characters), while the new PR-201CL is a 24-pin dot-matrix printer that prints 136 characters per line in eight colors and lists for about \$1300. (The printers use conventional 8-bit parallel interfaces and print either alphanumeric or kana/kanji characters.)

FUJITSU'S BETA

You'd think that one FM-16 would be like another FM-16. It's not necessarily so. Fujitsu's new FM-16 β , known as the Beta, bears little resemblance to the FM-16s that's sold in the U.S. This new computer is Fujitsu's answer to the NEC PC-9801M2, and it's quite a machine. If I hadn't just bought my FM-11BS, I'd want to own the FM-16 β .

To begin with, the Beta uses Intel's 80186 microprocessor. The basic architecture of the 80186 is similar to the 8086, and it can run all 8086 software, but the 80186 has some features that make it quite a bit faster than the 8086. For example, the reduced number of instruction-execution cycles lets it perform integer multiplication and division about three times as fast as the 8086. From the hardware engineer's standpoint, the on-chip interrupt controller, timer, clock generator, and DMA (direct memory access) channel let

(continued)

HOW TO SOLVE THE PROBLEMS PCs CREATE IN TWO WORDS.



Back-Up™

It's all you have to say when one of your PCs goes down. We specialize in servicing business PCs. Particularly IBM-PCs. We also service your mixed brands of peripherals, too. Our service is fast, flexible and economical. We use a range of service options to design a program that's right for your company. Fixed fee. Per-call. And our unique flexible fee, which can save you up to 70% over traditional maintenance contracts.

But no matter which options you choose, Back-Up gives you centralized support. So calling one number brings service to your company's PCs. Anywhere across the country.

Back-Up is just one of the ways we're using proven technology to solve computer maintenance problems worldwide. Call **1-800-346-6789** (in Minnesota 612/292-2209). Outside the U.S., call your local Control Data office. Wherever you are. Whenever you need us.

 **CONTROL DATA**

the 80186 chip perform functions all by itself that otherwise would require additional chips. Finally, the 80186 offers some additional machine instructions, called stack-frame instructions, that could potentially improve the efficiency of programs written in high-level languages. This last advantage is largely an illusion, though; at this writing I don't know of any compilers that take advantage of this feature.

In addition to the 80186, the Beta incorporates an MBL68B09 coprocessor running at 2 MHz to manage the display, graphics functions, and keyboard, relieving the main processor of these burdens. All of the functions handled by the coprocessor are accessible from application programs via BIOS (basic input/output system) function calls.

You get as much standard RAM with this computer as with any other personal computer I know—half a mega-

byte (512K bytes). Main memory is expandable to a full megabyte, and additional 256K-byte RAM boards cost only about \$240 each. Since the machine has four expansion slots (three in the hard-disk version), expanding the system up to the maximum memory capacity doesn't use up all the slots, as is unfortunately the case with the NEC PC-9801M2. Kanji-character support is excellent; both the JIS No. 1 and No. 2 standard character sets are supported from standard ROM, giving a total of over 6800 characters in addition to the full alphanumeric and kana character sets. The standard operating system is Japanese-language CP/M-86, which offers full kanji support at the operating-system level. It also includes RAM-disk support; just as in my FM-11BS, you can reserve up to 512K bytes of main memory for use as a RAM disk. In addition to all the other memory,

you get 192K bytes of graphics video RAM. Custom LSIs are used to speed up graphics functions like drawing lines and circles, too. Besides the printer and RS-232C interfaces, the Beta includes mouse and light-pen interfaces. Finally, it gives you a calendar/clock with battery backup, a feature that's missing from my FM-11BS.

The Beta comes in two models: one includes two built-in 1-megabyte floppy-disk drives, while the other has one floppy-disk drive and one 10-megabyte hard disk. You can partition the hard disk between two different operating systems if you're so inclined (Japanese-language MS-DOS is available as an option), but I'd rather be drawn and quartered than run a computer under two operating systems.

For a new computer, especially in Japan, the Beta is well supported by software from independent vendors. In addition to all the CP/M-86 and MS-DOS public-domain software, over 350 major software packages are available from over 60 different co-operating vendors. They include business software, languages, utilities, English- and Japanese-language word processors, database managers, spreadsheets, communications programs, and graphics packages. A large percentage provide full Japanese-language interaction with the user. Unfortunately, the prices for the language processors imported from the U.S. (Japanese-language manuals are usually available) are very high, often double or triple the cost of the same software in the U.S. This situation is tantamount to an open invitation to piracy; I haven't yet been able to find out whether tariffs, greedy (but short-sighted) distributors, or some other factors are at the root of the problem.

Considering its power, the FM-16β is a bargain. The list price for the version with two floppy-disk drives is just under \$1700; the hard disk version goes for just under \$3000. In view of the stiff competition from the new NEC machine, discounts are prevalent; the typical 20 percent discount on computer equipment here in the Tokyo area is bound to extend to the FM-16β very soon. ■

INSTANT FINANCIAL PICTURE!

Corporate Financial Simulation Model on your IBM PC, XT or AT with Lotus 1-2-3, Multiplan, SuperCalc, VisiCalc or PeachCalc. Also available on most PC/M & all Apple systems. A \$6,000 value for \$295.



Bottomline V

A Financial Decision Support System - budgeting, planning, analysis, and five-year forecasting. Now used nationwide by Peat, Marwick, Mitchell & Co. ("Big 8" accounting firm).

Fill out this card and mail for complete details, or call 1-800-828-7257, CA only 1-800-523-7201, or 714-476-2842 for UPS COD delivery.

- Send more information
- My check for \$10 is enclosed. Please send me a (circle one) **black and white/color** Demo for my IBM PC.
- Please send me Bottomline V for _____ Spreadsheet on the _____ computer. My check for \$295 plus \$5 for shipping and handling is enclosed.

Name _____ Title _____
 Company _____ Phone _____
 Street _____
 City _____ State _____ Zip _____

Mail to: **ILAR Systems, Inc.** • 1300 Dove St., Suite 105 • Newport Beach, CA 92660
 Inquiry 195 for Dealers. Inquiry 196 for End-Users.

Gifford's Multiuser Concurrent DOS.™ The net that works!

Gifford has the network solution. It's simple, fast, secure, complete, and it works. Multiuser Concurrent DOS is based on Digital Research's Concurrent DOS, the only major microcomputer operating system specifically designed for networking.

Users can share disks and printers transparently, and can also take advantage of true multiuser features like file and record lockout. And Gifford has added a bundle of features that makes Multiuser Concurrent DOS easy to install and use. It lets you get right to work.

Our net is ARCNET.™

Multiuser Concurrent DOS utilizes Datapoint's ARCNET, the most popular network hardware in the industry. It's reliable, economical, and fast — so you can add users without overloading the network.

You can network up to 255 single and multiuser systems. You can connect single or multiuser Gifford or CompuPro® systems as well as IBM PC-XTs*. Dual processor Gifford and CompuPro systems can run thousands of 8 or 16 bit CP/M or MP/M applications. PC-XTs can run 16 bit CP/M and MP/M programs as well as most popular MS-DOS applications, such as Lotus 1-2-3.™

Gifford adds to your net worth.

Our enhancements of Concurrent DOS make it possible to get more and better work done in less time. Network-wide features include electronic mail, event calendar, inter-terminal communication, user time accounting and usage report generation, telecommunications, user expandable HELP facility,

reminder messages, message of the day, automatic startup and shut-down procedures, and easily prepared files for initializing terminals, printers, and network nodes.

Gifford's Virtual Terminals™ increase productivity

by offering full-screen concurrency; you can run up to four programs simultaneously from one physical terminal.

The safety net.

Multiple users can mean multiple security problems. Gifford's security enhancements include

login account names and encrypted passwords to control

access to the system. Users can be further restricted to specified

terminals, user areas, programs, or nodes on the network. You're also safe from excessive down time, since the modular network architecture gives you immunity from single point failure.



Gifford nets a big one: Simplicity.

If you've gone through the ordeal of typing as many as seven commands just to get on and off a network, Gifford has your number.

A single, menu-driven network command handles all your network options. Everything you need is right in

front of you. The net effect is simplicity — and sanity.

If you'd like to see how Gifford's Multiuser Concurrent DOS can solve your networking problems, or if you'd like to know about Gifford's selection of multiuser systems and software options, call (415) 895-0798.

Or write us at the address below.

We'll send you a free networking brochure and give you the name of the nearest dealer.

Multiuser Concurrent DOS is a trademark of Gifford Computer Systems. Concurrent DOS is a trademark of Digital Research, Inc. ARCNET is a trademark of Datapoint Corporation. IBM PC-XT is a registered trademark of IBM Corporation. CompuPro is a registered trademark of CompuPro Corporation. Lotus 1-2-3 is a trademark of Lotus Development Corp. Virtual Terminals is a trademark of Gifford Computer Systems.

GIFFORD
COMPUTER SYSTEMS

A subsidiary of Zitel Corporation

2446 Verha Court
San Leandro, CA 94577
(415) 895-0798 TELEX: 704521
Houston, TX (713) 680-1944

THE MULTIUSER COMPANY™

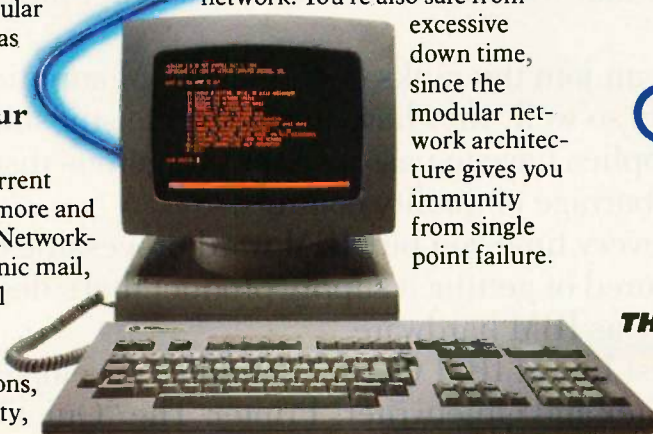
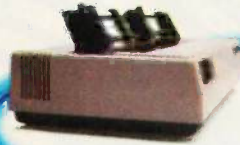



They've earned their stripes.

The supplies that wear the IBM stripes must first prove themselves worthy of the distinction.

Before they can join the ranks of all those IBM supplies that have gone on to serve IBM customers so well, they have to meet some stiff standards.

Our IBM supplies have to pass a series of rigorous inspections and battle their way through a barrage of quality controls.

This means every time you buy IBM word processing or data processing supplies, you're assured of getting a supply product that's designed with the same advanced technology as IBM hardware.

Take our latest line of IBM Quiet™ Supplies developed for the IBM Quietwriter® Typewriter and Quietwriter® Printer. The "Quiet" electronic fonts,



printheads and thermal-transfer ribbons were developed and engineered together with the hardware to work as a team. The result is a unique print technology that “paints” ink onto the page.

We’ve made it our business to make supplies that inspire confidence day after day. So, the next time you’re in the market for supplies, choose the ones that have earned the right to wear the IBM stripes.

More convenient ways to buy. To get the IBM supplies you need, contact an IBM supplies representative or visit an IBM Product Center or IBM supplies dealer. For the store location nearest you, or to place an order by phone, call IBM Direct 1 800 IBM-2468, Ext. 104.





Combine VISION with PC Graphics



**Captures
Anything You Can See.**

**IMIGIT adds icon-
selected Graphic
Functions, text, and
textures with a full
palette of vibrant colors.**

**Together You Enjoy
Unparalleled Economy
and Applications
Flexibility.**

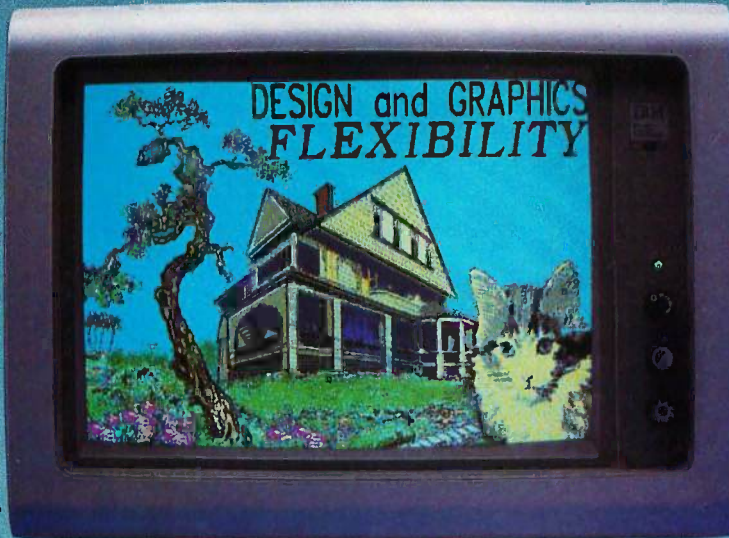

*The illustration incorpo-
rates line art, photos, text,
textures and color elements.
You can do the same with
this icon-driven, user-
friendly system.*

For \$695.00 you get the PC-EYE™ video digitizer board and IMIGIT™ graphics software. PC-EYE allows you to capture real-life images with an ordinary video camera or VCR and produce them on your personal computer. IMIGIT is an icon-oriented graphics software package which allows you to modify the camera image by adding text, patterns, colors, lines and shapes. By using cut and paste features with multiple video images, you can store images for later retrieval and print images from the screen.

You get this Exciting Tool for integrating video images with graphics created by other software packages like Lotus 1-2-3*; Graftalk*; CAD and business presentation packages. Imagine combining a real-life camera image, text and a pie chart generated by Lotus into one picture. It's really as easy as 1, 2, 3.

IMIGIT Supports . . .

High Resolution - up to 640 x 512 pixels with 16 colors or gray scale (64 with 6-bit PC-EYE). Flexibility - to support the most popular graphics cards and printers for convenient display and hardcopy output. Speed - less than 2/10 of a second to capture an image in the IBM-compatible 320 x 200 mode. All in all, a powerful but easy-to-use package that allows you to develop sophisticated and dramatic graphic presentations.



CHORUS is the Single Source for your graphics and imaging needs. Complete solutions in both hardware and software. Call us for other low cost/high performance imaging products such as Dr. Halo* and Halo* graphics software; video cameras and accessories; and graphic adapter cards. You can expect prompt delivery, technical support and complete OEM design assistance.

**CALL 1-800 OCHORUS or
603-424-2900.**

**PC-EYE and IMIGIT are trademarks of
Chorus Data Systems, Inc.**

*Dr. Halo and Halo are trademarks of Media Cybernetics, Inc.
Graftalk is a trademark of Redding Group, Inc.
Lotus 1-2-3 is a trademark of Lotus Development Corporation.

Inquiry 72

CHORUS

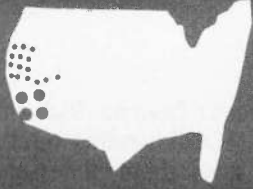

Homebrew Chips

MOSIS, two packages for the Mac, Turtle Talk, and Concurrent DOS-286

BY JOHN MARKOFF,
PHILLIP ROBINSON,
AND DONNA OSGOOD

Have you ever wanted to make your own VLSI (very large scale integration) chip? Do you think you have a foolproof design for an IBM PC AT compatible on a chip, but no one will take you seriously until you show them a working sample? Maybe you're in luck. The Syracuse AI coprocessor chip was actually fabricated through MOSIS (MOS Implementation System), a brokerage that connects chip and board designers with chip and board fabricators. MOSIS is an outgrowth of both the Arpanet and an idea from Xerox's Palo Alto Research Center (PARC). If you follow the MOSIS rules and can afford the prices, your chip could be sitting on your desk just a few months from today.

Before VLSI was more than a twinkle in anyone's eye, the defense department's ARPA (Advanced Research Projects Agency) set up ARPANET, a computer network that connected a number of universities and defense contractors. Later, ARPA changed to DARPA (Defense Advanced Research Projects Agency), but the network retained its original name.

In 1980, Xerox PARC offered to organize VLSI fabrication services for the ARPANET community. The PARC researchers knew that university engineering and computer science departments were getting shut out of much of the microelectronics revolution because they couldn't afford the equipment necessary to manufacture silicon chips. Even those universities that could afford some equipment could never keep up with the rapidly advancing state of the art. VLSI students and professors had been reduced to designing chips on paper and then seeing those designs languish in libraries.

At the same time, many chip manufacturers in Silicon Valley were fretting over their unused manufacturing capabilities. The best way to pay off millions of dollars of wafer-fabrication equipment is to run it as much as possible and the manufacturers had more idle machine time than they wanted.

While a single batch of wafers is too expensive for a university to buy, the engineers at Xerox PARC figured that if enough designs could be gathered together and made on a single wafer-fabrication run, the price per design would be affordable. Besides, while designers would be delighted to see their creations become hardware, the manufacturers would be thrilled to make some extra money with their equipment. Another advantage for the chip makers was that students would graduate with some hands-on chip-design experience.

So Xerox PARC invited the DARPA community to send in chip designs that Xerox would then organize into wafer runs. The first run was a bunch of student designs from a VLSI course taught by Lynn Conway in 1978 at MIT. The first masks were made by Micro Mask and the first run was fabricated at Hewlett-Packard's Deer Creek Road facility. The service was immediately successful and DARPA wanted to see it continue, but Xerox didn't want permanent responsibility. The Information Processing Techniques division of DARPA had a VLSI design research program and was an ARPANET node. DARPA let ISI (Information Sciences Institute) take over from Xerox and called the new service MOSIS. Although chip designs were initially only accepted from the DARPA community, other groups were gradually added to the fold. First the NSF (National Science Foundation), then any government organization with DARPA permission, and finally, practically anyone was permitted to submit VLSI designs.

MOSIS puts out a schedule of the wafer-fabrication runs for six months into the future. Those scheduled runs will be made even if too few designs show up to fill the wafers (the extra space will be devoted to test structures). That commitment assures designers that they can plan around fabrication dates and allows wafer-fabrication factories to schedule equipment time. However, demand has been so great that the

(continued)

BYTE West Coast is prepared monthly by BYTE's editors and staff in San Francisco and Palo Alto. Correspondence should be addressed to BYTE West Coast, BYTE Magazine, 425 Battery St., San Francisco, CA 94111.

wafers have always been full of actual chips.

You can choose from NMOS (negative-channel metal-oxide semiconductor) 3- or 4-micron, CMOS (complementary metal-oxide semiconductor) 3-micron, and CMOS-SOS (silicon-on-sapphire) 4-micron processes. A new, experimental CMOS 1.2-micron process should be in limited use by the spring of 1985. MOSIS will provide you with the design rules, process specifications, and device specifications for the process you choose.

MOSIS has masks made from your design and then gives the masks to any of 11 different Silicon Valley chip fabricators. The finished wafers are accepted on the basis of test-structure specifications. If those meet agreed-upon levels—indicating that the process was properly executed—the wafers are accepted, whether or not

the customers' chips actually work. MOSIS also extracts Spice (a low-level circuit-simulation language) parameters from each and every run so there is a database of actual device parameters from which designers can take cues.

While many chips are made on share-the-silicon wafer runs, some runs have only a few or even a single type of chip. Some MOSIS customers only need a few chips to verify a design. Others need more to stuff a prototype board or a prototype system. Finally, some customers need to get a small production run of the chips.

Chip fabricators used to be stuck with judging whether to take on a new, small customer. It was hard for them to gear up for a small run, but they didn't want to miss out on a small firm that might grow into a major account. Now, if a chip fabricator works with

MOSIS, it doesn't have to deal with small outfits: MOSIS handles that for them. "We save them time and money," says Dr. George Lewicki of ISI. Plus, the manufacturer doesn't have to worry about competition from MOSIS. According to Lewicki, "We are a broker, nothing more than a broker."

As Dr. Oldfield of the Syracuse SUM (Syracuse Unification Machine) team told us, "It's becoming easier for universities to think of building experimental systems. It's an interesting historical point. If you go back to the 1950s and 1960s, a number of universities built machines. But the complexity overwhelmed them. Now, thanks to these custom CAD [computer-aided design] aids, it's feasible, though still very difficult, for a university to think about designing a real system without having an army of technicians to put it together."

So you want to make some chips? How many? MOSIS will make two or more if you send them your design in either CIF (Caltech Intermediate Format) or Calma-GDS 2-stream format. In 4 to 12 weeks, the packaged chips will be delivered to you. The turn-around time depends on which process you choose and how well the economy is doing. Choose 4-micron NMOS and you'll get your chips sooner than if you choose 1.2-micron CMOS. Even so, if the chip fabricators have long production queues, you'll have to wait longer.

As for the price—your chips will probably cost less than you think. For the DARPA, NSF, and DOD (Department of Defense) communities, the service is free. DARPA pays the whole freight for those lucky customers. For the rest of us, MOSIS has a price schedule. Remember, however, that MOSIS is a nonprofit service. All you have to pay is your proportional share of the run's cost (there are about 900 chips in a run). Dr. Lewicki estimates that a batch of 20 chips would cost about \$5000. If your chip is so successful that you need "zillions," MOSIS encourages you to deal directly with the chip manufacturer.

MOSIS is an impressive example of

(continued)

INSIGHT™

EXPERT SYSTEMS

"INSIGHT is essentially the equivalent or better than any other tool available for the personal computer."

Paul Harmon, author of Expert Systems, Artificial Intelligence in Business

Turn your PC into an expert.

Give it Insight, or give it Insight 2. Both let you create knowledge base systems using any PC-compatible text editor.

Insight not only simplifies access to lots of information, it analyzes and offers solutions. For entry-level operators it's a perfect procedural training package to help build and implement knowledge base software.

Insight 2 is more than just an "expert." It's a knowledge base engineering tool with application capabilities. It can call up Pascal programs, read and write dBASE II® files, and its decision-making process can tie in directly to your existing databases. Run-only versions also can be developed and distributed.

Two unique packages from the same expert idea.

Insight™ (\$95) and Insight 2™ (\$485) run on the IBM® PC, DEC® Rainbow, and Victor® 9000.



**Level
Five
Research, Inc.**

4980 South A-1-A

Melbourne Beach, Florida 32951

(305) 729-9046

What's New at AMERICAN DESIGN COMPONENTS?

"The Source" of the
electro-mechanical components
for the hobbyist.

We warehouse
60,000 items at
American Design Components—expensive, often
hard-to-find components for
sale at a fraction of their
original cost!

You'll find every part you
need—either brand new, or
removed from equipment
(RFE) in excellent condition.
But quantities are limited.
Order from this ad, or visit
our retail showroom and find
exactly what you need from
the thousands of items on
display.
Open Mon.—Sat., 9-5.

THERE'S NO RISK.

With our full 90-day warranty,
any purchase can be returned for
any reason for full credit or refund.

N. 19" COLOR X-Y DISPLAY

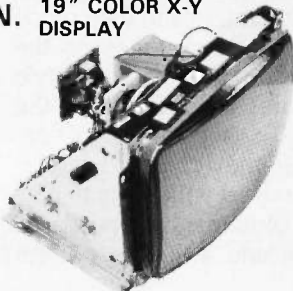

Originally designed for use in Atari coin-operated games. Contains a 19VLUP22 3-gun color tube, focus and brightness controls. Has electromagnetic deflection and solid state circuitry with three "Z" amp inputs (red, green, blue). Ideal for arcade replacement or, with the addition of external circuitry, for color graphics display. Manual included.

\$129.00 NEW

A. APPLE 2c DISC DRIVE

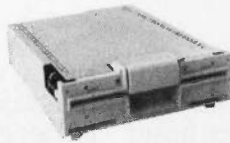

Original equipment drive,
compatible with Apple 2e, 2+
and 2C.

\$139.50 RFE

5 1/4" TANDON DISC DRIVES

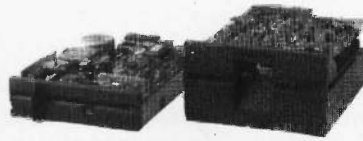

B.

1/2 Ht. 96 T.P.I.
TM55-4 DS/Quad

\$99.00

Full Ht.

C. TM100-1SS/DD \$ 99.50
D. TM100-2DS/DD 159.00
F. TM100-4DS/Quad 179.00
G. TM101-4DS/Quad 199.00

H. TIMEX 48 KEY KEYBOARD



Replace the membrane key-
board on your Timex/Sinclair
Z-81/1000 with this brand
new "big computer" key-
board from Texas Instru-
ments. Simple to install—
complete instructions and
schematic included.

\$5.95 NEW

J. 115 CFM MUFFIN FAN



Metal frame with 5 high-impact
plastic blades. For cooling Hi Fi,
electronic equipment, com-
puters, etc. Mounts for intake or
exhaust. 115 VAC, 60 Hz.,
Dim.: 4 1/8" x 1 1/2" D.

\$7.95 RFE

With adjustable speed control
\$10.95

K. AUDIO & VIDEO MODULATOR



Made for Texas Instruments.
Lets you use your TV set as a
monitor for video and audio
signals produced by home
computers, surveillance
cameras, video games, etc.
Complete with 8', 5-pin din
cord, hook-up diagram.

\$7.95 NEW

COMPUTER DISC DRIVE SWITCHING POWER SUPPLIES

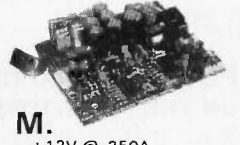

L.

+24V @ 2.2A
-12V @ .17A
+5V @ 3A
Dim.: 7 3/8" x 6 1/8"
INPUT: 115/230V, 50/60 Hz

\$19.95 NEW

M.

+12V @ .350A
+5V @ 1.2A
-5V @ .12A
Dim: 4 1/8" x 4 3/8"
Input: 115 VAC when used
with AC wall transformer
(supplied) \$6.95 NEW

O. HARD DISC DRIVE *20 Mb (formatted)

For IBM PC and compatibles.
Can be used for external or internal
applications.

Mfr. Discron #526

XT & AT

Power Requirements:

+12VDC +/-10% 1.3 amps (running)
3.3 amps (start up)

+5VDC +/-5% 1.5 amps (running)

\$599.00 NEW



Factory Warranty

P. NICAD BATTERY & CHARGER

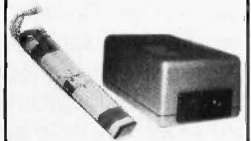

13.2 V @ 1.65 AH
Contains 11 C Cells.
Portable computer battery
back-up.

Mfr. GE #41B035BB00101
with 17 Volt Battery Charger.

\$29.95 (set)

PUMPS—COMPRESSORS—BLOWERS—MOTORS—POTENTIOMETERS—COUNTERS TIMERS—RELAYS—VOLTAGE REGULATORS—POWER SUPPLIES

STEPPING MOTORS

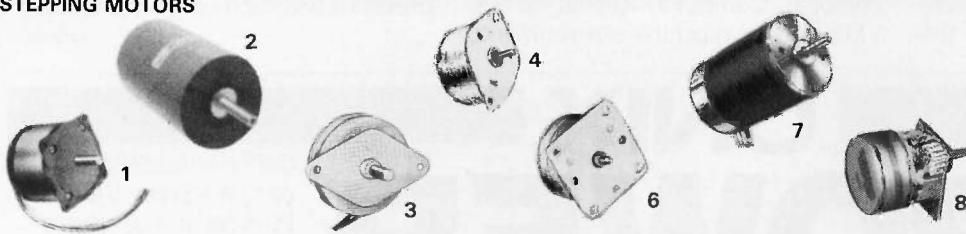

Step Angle	Voltage DC	Stall Torque oz/in	Type	Dimensions		Fig.	Manufacturer & Part No.	Price	
				1) Body	2) Shaft			Each	2 For
1	5	17*	PM	1) 1.875 x 1.75 x 1.0 H	2) .5 x .125	8	N.A. Phillips A82310-M2	\$ 9.95	\$14.95
1.8	1.3	200	PM	1) 2)		2	Sigma 20-4247TD-200F1.3	34.50	59.50
1.8	1.8	150	PM 4 Ø	1) 2 3/8 L x 2 3/8 dia.	2) 3/8 dia. x 1 L	1	Superior Electric M091-FD-6009	34.50	59.50
1.8	1.8	72	PM 2 Ø	1) 2 3/8 L x 2 3/8 dia.	2) 1/2 dia. x 3/4 L	1	Superior Electric M061-FF-6201B	19.95	37.50
7.5	5	13	P M	1) 1 1/2 L x 2 1/2 dia.	2) 5/16 L x 1/4 dia.	6	Airpax A82816	8.95	16.95
7.5	9	36	P M	1) 1 3/4 L x 2 3/4 dia.	2) 1/2 dia. x 1/2 L	6	N.A. Phillips B82916	9.95	17.95
7.5	12	13	P M	1) 1 L x 2 1/2 dia.	2) 1/2 dia. x 3/4 L**	3	N.A. Phillips A82733M2-3	9.95	17.95
7.5	12	16	P M	1) 1.97 L x 1.39 W x .68 H	2) .375 x .125	4	Airpax K82201-P2	5.95	9.95
15	28		VR	1) Size 15		7	Rapid Syn. 15R-01X	29.95	49.50
90	24		PM 4 Ø	1) Size 15		7	Rapid Syn. 15P-03X	34.50	59.50

* Calculated ** Shaft with 1/2 diameter *** 8 threads/inch † w/worm drive

Q. 24 VDC MUFFIN FAN



115 CFM, 11 Watt

Metal frame with 5 high-impact
plastic blades. For cooling Hi Fi,
electronic & computer
equipment. Mounts for intake
or exhaust.

Mfr. — Centaur CNDC24K4-601

\$14.95 RFE

For all phone orders, call
TOLL-FREE
(800) 524-0809
In New Jersey, call
(201) 939-2710



FREE CATALOG of
electro-mechanical
devices sent with
every order.

American Design Components 62 Joseph St., Moonachie, NJ 07074
(201) 939-2710

a new, information-age public utility. It brings together people with complementary needs. So what's keeping you? Get some time on a VAX (or a personal computer) with the right CAD tools, scrape together the \$5000, read "Introduction to VLSI Systems" by Carver Mead and Lynn Conway (Addison-Wesley, 1979), and join the VLSI age.

PC BOARD DRAFTING SYSTEM ON THE MACINTOSH

Now that a flood of mainstream Macintosh software has arrived, it is worth taking a look at some of the less-obvious programs being written to take advantage of the Macintosh graphics interface.

We recently visited the San Leandro factory of Douglas Electronics. If you've ever done any printed-circuit (PC) prototyping or breadboarding you may be familiar with Douglas. For 20 years they have supplied designers with circuit prototyping and interfacing products and manufactured custom PC boards. Douglas also manufactures the Ap'seed, a modular dedicated microcomputer system based on the Apple II.

At Wescon last year Douglas introduced a PC-board-design software package called QuikCircuit for the

128K-byte Macintosh. The new CAD package will make it possible for a designer to create a prototype board on the Macintosh, save it on a 3½-inch floppy disk, mail the disk to Douglas, and then receive a finished prototype board in return. Douglas president Chad Pennebaker estimated that the Macintosh design system will cut the time involved in the design cycle by half and yield a significant savings in board cost because Douglas will be able to manufacture directly from the floppy disk by using Macintoshes to drive their equipment. Currently, plans call for Bishop Graphics in Westlake Village, California, to market the CAD program and shortly other PC board houses around the country and internationally will also be able to manufacture directly from disk.

The design system makes extensive use of the Macintosh user interface and builds on many of the features found in generic drawing programs like MacPaint and MacDraw. Referred to by Douglas as a printed-circuit-board layout and manufacturing system, QuikCircuit allows the user to specify the type of PC board he or she wishes to design from a range of options including the Apple II, IBM Personal Computer, Digital Q-bus, VME (virtual machine environment),

and a variety of special Douglas breadboard designs. It is also possible to design your own custom board shape and edge connector.

After selecting the proper board outline, the designer can place pads and patterns anywhere on the board with the aid of a grid that constrains movement. A variety of common pads and patterns are available from a menu of options or it is possible to design custom options. A MacDraw-like feature permits specifying a common feature such as a RAM (random-access read/write memory) IC (integrated circuit) pattern and then quickly replicating it many times on the board. Many of the MacPaint-style editing features are included in the program, so it is possible to continuously alter the PC board layout. Edit commands let you select an item or a group of items, cut and paste, and they include a special pattern editor.

Once pads have been placed, the user selects a trace width and then routes the trace. All traces are automatically constrained to vertical, horizontal, or 45-degree placement. To go through the board and continue a trace on the other side, the user presses a keyboard command and the

(continued)

UNIX POWER

100,000 software developers can't be wrong.*

UNIX is the chosen operating system for more than 100,000 software developers because it has the power they need. But

developers aren't the only people who need computing power. Any business that wants multi-users to access the same files at the same time or wants to simultaneously run multi-task operations . . . needs UNIX. At Dynacomp, we offer UniPlus +[®] System V by Unisoft Corp. For \$1495. U.S. dollars you can run UNIX on the CompuPro[®] System 816/E™ . . . a powerful 68K S-100 bus computer system that maximizes its memory for multi-user/multi-task operations.

performance of UNIX, allowing an affordable operating system for program development, text preparation, and general office use.

If it's time for you to upgrade to UNIX, call your local Full Service CompuPro System Center in the United States or call Dynacomp in Canada for complete details.

UNIX is a trademark of Bell Laboratories, Inc. CompuPro is a registered trademark and System 816/E is a trademark of Viasyn Corp./CompuPro. UniPlus+ is a registered trademark of Unisoft Corp. AT&T is a registered trademark of AT&T Information Systems.

FROM

DYNACOMP
COMPUTER SYSTEMS LTD.

UniPlus + includes all the standard UNIX System V features PLUS performance enhancements found only in UniPlus +. These features increase the portability, flexibility, and per-

210 W. Broadway
Vancouver, B.C. V5Y 3W2
(604) 872-7737

46-6535 Mill Creek Dr.
Mississauga, Ont. L5N 2M2
(416) 826-8002

*AT&T estimates that there are more than 100,000 people currently developing software under UNIX. Dynacomp serves all of Canada and parts of Asia and the Pacific Rim. Call us for details and information on our full product line including Plexus, Macrotech and Ampro. Dealer inquiries invited.

introducing the world's first autonomous personal robot . . .

GEMINI

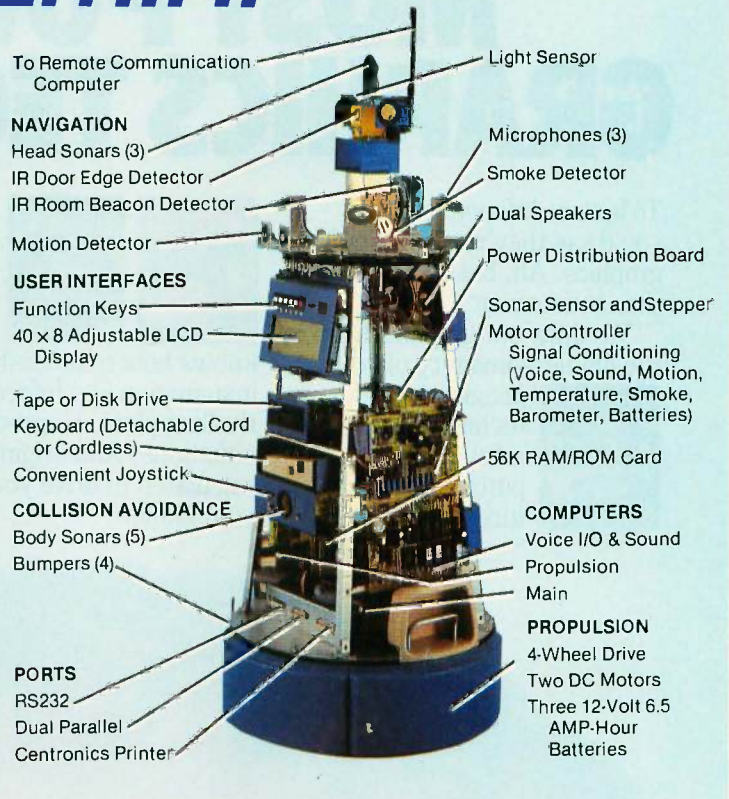

Your new robot will find its way around your home and office, perform preassigned tasks, charge its own batteries, talk to you and obey your spoken commands.

This remarkable life-sized robot is controlled by three on-board computers, an unprecedented 108K bytes of built-in software and a sophisticated array of electronic sensors all integrated together to give it life-imitating artificial intelligence.

You'll know the moment you power up GEMINI that you have a real robot. One that performs a self check of its hardware while verbally and visually informing you of the results. One that will keep itself alive while always monitoring its multiple inputs for your commands.

Ready made, easy-to-use software will allow you to demonstrate most functions of the robot with single keystrokes. Missions for the robot to accomplish at future times can be assigned by anyone. No programming experience required. Important missions, too, such as periodic reminders, wake-up calls, storytelling for the kids, remote control of appliances and more.

An enhanced floating-point BASIC language will give you complete control of the robot. Commands like SPEAK, GOHOME, MOVETO, RANGE, etc., provide you with a means to develop complex programs, fast. Machine language level programs provide you with many debugging tools that you would expect to find on a real robot.

A high-level voice command language provides voice access for up to three users. And the voice I/O and sound

computer can store up to 256 words or phrases, and dynamically update these as you converse with the robot. Highly accurate text-to-speech software and music programs with vocals are built-in.

GEMINI is ready for you now. Buy assembled or in modular, learn-as-you-go form. Either way, don't miss out on the chance to participate in the exciting new world of machine intelligence.



9104 Red Branch Road • Columbia, MD 21045
 (301) 730-1237
 CA (619) 746-5511 • Canada (613) 592-2830

- Please send details on GEMINI.
- Please send dealer information.
- Interested in Club Demonstration.

Mail to: **ARCTEC SYSTEMS, INC.**
 9104 Red Branch Road
 Columbia, MD 21045

Name _____

Address _____

City _____

State _____ Zip _____ Phone _____

ARCTEC SYSTEMS™ is a member of the ARCTEC GROUP, INC., United States and Canada.

WE UNLEASH THE WORLD'S MOST POWERFUL GRAPHICS TECHNOLOGY.

To look at Infocom stories, you'd say they're all prose. No graphics. Ah, but there's more than meets your eyes.

We draw our graphics from the limitless imagery of your imagination—a technology so powerful, it makes computer screen pictures look like



graffiti by comparison. And no one knows how to unleash your imagination like Infocom. With thrilling plots. Unpredictable situations. And original puzzles calculated to drive you out of your skull.

Step up to Infocom. All words. No graffiti. The secret reaches of your imagination are beckoning.

It's time to open your mind's eye.



INFOCOM™
INTERACTIVE FICTION SOFTWARE

Infocom's interactive fiction is available for a wide variety of personal computers.
Inquiry 203



board is flipped on the screen, letting the trace continue on the other side. This command places a special feed-through pad at that point. Traces on the current side of the board are displayed in black, while traces on the reverse side appear in a lighter gray shade. It is possible to select a variety of background grids ranging from 0.001 inch to 0.156 inch.

In addition to being able to flip the board from solder side to component side, it is possible to change the scale of the view, zooming in and out to focus on various portions or view the entire board. At any time it is also possible to view a special *x-y* locator in the bottom left corner of the screen. This locator can be zeroed.

Currently it is only possible to get hard copy from the Macintosh Image-writer printer. The quality is not high enough for many professional applications. Plans call for the develop-

ment of a driver for the program to enable the Macintosh to produce a finished-quality pen plot.

Pennebaker acknowledges that the Douglas Macintosh design system is missing some of the bells and whistles of the most sophisticated CAD tools but points out that the system costs only a fraction of the cheapest systems now available.

"This is a drawing program," he says. "It's actually electronic drafting." He contrasts this against systems where the designer enters information and then the computer routes traces automatically (but not in real time). Frequently a system like that will fall in the \$100,000 range, he adds.

When the program was first introduced at Wescon it was priced at just \$10, on the assumption that Douglas would make its profit from PC boards manufactured from disks that designers sent to the company. Now that

Bishop Graphics has taken over the commercial marketing, the price has risen to \$895. However, Martin Salvin, president of Bishop Graphics, said that his company plans on selling special Macintosh systems that include the Macintosh machine, Image-writer, and pen plotter for performing checkplots for "under \$5000." Bishop Graphics is also preparing to manufacture photoplotting and drilling systems that are compatible with QuikCircuit for PC board manufacturers. Salvin says they will cost about one-third of the price of equivalent commercial systems. In the future, plans call for a network of manufacturers around the country offering what Salvin says is the PC-board equivalent of "one-hour photo service" based around the QuikCircuit and the Macintosh design system.

One of the program's most unique

(continued)

This shape is worth saving.

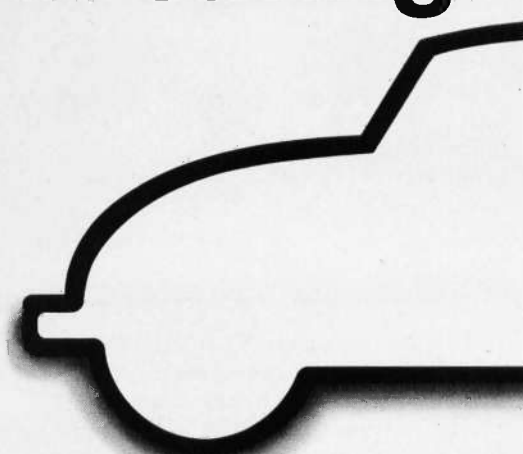

REASON 1: Because next month's Byte will fill you in on a lot of savings. It will offer all folks quality and dependability at reasonable prices: on the entire CompuPro® 816 family — our powerful multi-user systems. On our versatile 286 system based on Intel's 80286 microprocessor. Plus all the operating system support you need.

Don't miss next month's Byte insert with values all folks will appreciate!

VIASYN™
The CompuPro People

Where Computers Grow

3506 Breakwater Court, Hayward, CA 94545 • Call 800/VIASYN-1 • In CA, 415/786-0909

CompuPro is a registered trademark of Viasyn Corporation.

Now your IBM PC and AT can read

The OMNI-READER

The OMNI-READER is a revolutionary new Text Reader or Optical Character Reader (OCR).

It costs a fraction of the price of most computer systems. It reads the printed word and translates it into an electronic signal capable of being recognized and data loaded into most computers and word processors. The need for slow and tedious re-typing of already printed data is eliminated.

The quick brown fox has jumped from the OMNI-READER into your micro computer system and onto the screen with as little effort as it takes to read "The quick brown fox."

IBM

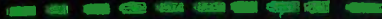

The OMNI-READER

The OMNI-READER is a revolutionary new Text Reader or Optical Character Reader (OCR).

It costs a fraction of the price of most computer systems. It reads the printed word and translates it into an electronic signal capable of being recognized and data loaded into most computers and word processors. The need for slow and tedious re-typing of already printed data is eliminated.

The quick brown fox has jumped from the OMNI-READER into your micro computer system and onto the screen with as little effort as it takes to read "The quick brown fox."



With the Oberon OMNI-READER™ — the first optical character reader designed and priced for small computers.

Now you can transfer material directly from the typed page to the screen of your computer, without ever touching the keyboard — using specially designed interface software that allows input directly into your spreadsheet, database and word processing applications program.

And because the OMNI-READER uses a standard RS232 serial port hookup, it interfaces easily with *your* computer.

The technology is revolutionary. But what is most revolutionary is the price — under \$500. IBM interface software, \$50.

Find out more about the Oberon OMNI-READER. Dial 800-2-OBBERON. In Texas, (214) 446-9567.

IBM is a registered trademark of International Business Machines.

Inquiry 298

OBBERON
INTERNATIONAL

features is the ability for the user to get an automatic price quote on the cost of a PC board from Douglas over the telephone, yet without a modem. It works like this: First the user calls up the PC board manufacturer, then the user places the mouthpiece of the telephone handset near the Macintosh speaker. When a special command is given, the program transmits information on the complexity of the board directly to the manufacturer's computer, which then estimates the cost. An employee can then give an accurate price quote to the designer in a few moments.

DESKTOP PUBLISHING WITH THE MACINTOSH

The introduction of the Apple LaserWriter laser printer has paved the way for "desktop publishing" on the Macintosh. According to Paul Brainerd, president of the Seattle-

based Aldus Corporation, the combination of relatively low cost laser printers and graphics-oriented personal computers will make it possible for small companies or corporate work groups to produce production-quality multipage documents without doing mechanical pasteup or resorting to outside typesetting and printing services.

In January, Apple announced the LaserWriter, and Aldus also introduced PageMaker for the 512K-byte Macintosh. PageMaker is a full-page composition software program for the Macintosh that allows the user to blend text and graphical documents on an "electronic layout board" displayed on the Macintosh. It is intended for professional publishing of small jobs such as newsletters, data sheets, price lists, training manuals, etc. Priced at \$495 and scheduled for release during the second quarter of

1985, the Aldus system will permit Macintosh users to integrate diverse documents from MacWrite, MacPaint, MacDraw, Microsoft Word, or virtually any program whose data can be stored in the Macintosh Clipboard, a special system buffer used for passing information between programs.

PageMaker is intended to serve the same market as electronic composition systems now being marketed by corporations like Interleaf and CompuGraphic. PageMaker is priced significantly lower than these systems, however. A complete system consisting of the newly introduced Macintosh XL (formerly the Lisa 2/10), PageMaker software, and the LaserWriter will be priced at approximately \$11,500.

Aldus is currently writing its own drivers to take advantage of the Postscript device-independent page-description language that Apple has

(continued)

This shape is worth saving.

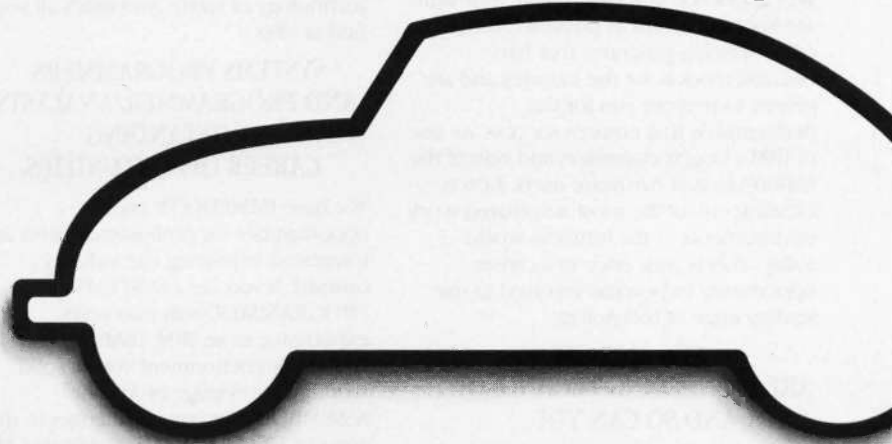

REASON 2: Because economy plus quality is the only way to go. Expect this combination in a long list of CPU boards. In quality boards that let you mix or match 8-bit and 16-bit software. Boards compatible with IEEE 696/S-100 specs, including DMA devices. Motherboards, too, along with strong enclosures. And there's a great choice of CPU support. All make next month's insert the most appetizing Byte of the year.

VIASYN™
The CompuPro People

Where Computers Grow

3506 Breakwater Court, Hayward, CA 94545 • Call 800/VIASYN-1 • In CA, 415/786-0909
CompuPro is a registered trademark of Viasyn Corporation.

Systems Programmers and Programmer/Analysts:
EDS Wants to Challenge Your Talents.

THE EDS AND GM ALLIANCE HAS CREATED A TECHNICAL ARENA THAT OTHER COMPANIES CAN ONLY ENVY.

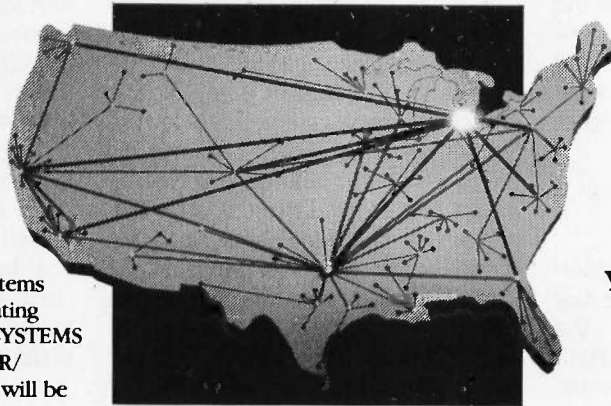

The alliance of Electronic Data Systems (EDS) and General Motors is creating major career opportunities. As a SYSTEMS PROGRAMMER or PROGRAMMER/ANALYST, your skills and abilities will be challenged.

EDS is offering you IMMEDIATE opportunities to enjoy hands-on experience with truly state-of-the-art hardware and software. This state-of-the-art experience will ensure that your skills are kept as current as possible. Also, EDS offers training programs that have become models for the industry and are geared to prepare you for the performance that ensures success. As one of IBM's largest customers and one of the nation's largest hardware users, EDS is creating one of the most automated work environments in the business world today. This is your once-in-a-career opportunity to become involved in the leading edge of technology.

**EDS AND GM
ARE PIONEERING TECHNOLOGY.
AND SO CAN YOU.**

EDS and GM are world-renowned leaders in technology. EDS ensures this leadership by continually upgrading our facilities with the most advanced hardware and software available. And since we employ components that accommodate change, our operating

systems are never limited by technology of the past. You benefit as a professional since you will never be hindered by out-of-date equipment. The best technology of tomorrow is built on the best technology of today. And that's all you find at EDS.

SYSTEMS PROGRAMMERS AND PROGRAMMER/ANALYSTS: OUTSTANDING CAREER OPPORTUNITIES.

We have IMMEDIATE career opportunities for professionals who are interested in moving the industry onward. If you are a SYSTEMS PROGRAMMER with two years experience in an IBM, IBM-compatible or DEC/VAX environment with a solid working knowledge of ALC or ASSEMBLER, we have challenges in the areas of VTAM, VM, IMS, IDMS, and MVS. If you are a Programmer/Analyst with two years experience in an IBM or IBM-compatible environment with a solid working knowledge of COBOL, PL/1 or ALC, EDS has the ideal environment to challenge your skills.

**YOUR CAREER GROWTH:
AT EDS, WE DON'T
TAKE YOUR TALENT
FOR GRANTED —
WE CHALLENGE IT,
WE RESPECT IT
AND WE NURTURE IT.**

EDS knows that new ideas and new technology are only as good as the people who create them. That's why developing the potential of our employees is a continuing priority. We believe our strength is enhanced when our employees develop new skills and accept greater responsibilities. Therefore, we have created an environment that lets you build your future by the knowledge and skills you acquire — not by rank or seniority. At EDS, you control your own future.

Act now, advance the industry while experiencing the technological challenges and advantages EDS can offer you. Send your resume in confidence to:

**ELECTRONIC DATA SYSTEMS
CORPORATION**
755 W. Big Beaver
Suite 310, Dept. 08-0585-03
Troy, MI 48084

EDS

Electronic Data Systems Corporation

An Equal Opportunity Employer.

placed in the half megabyte of ROM (read-only memory) in the Apple LaserWriter printer. Postscript was developed by Adobe Systems in Palo Alto, California, and has recently been adopted by a variety of hardware manufacturers and software publishers in the personal computer industry. Initially, PageMaker will work with the Imagewriter dot-matrix printer, the LaserWriter, and also with at least two commercially available typesetting machines, Allied and Mergenthaler Linotype. This will make it possible for users to proof and review pages on the LaserWriter and then get finished copy output from a commercial typesetter.

PageMaker uses the Macintosh user interface to present an image of an 8½-by-11-inch page surrounded by a layout board area for temporarily setting text and graphic elements while working on page design. The program

uses the Macintosh mouse for positioning elements of the page design. It is possible, for example, to open a window on the display, select headlines, text, or graphics stored in files on disk, and then position them on the page with accuracy. Each selected item is represented by a special icon. The cursor can be represented by a small paintbrush within a half-rectangle when a MacPaint document is selected, or it is represented by a text icon when a MacWrite file is selected. PageMaker permits the designer to set custom column guides and then "flow" text from a MacWrite document directly onto the page layout area. A special positioning indicator permits proper alignment of text at the bottom and top of each column, and the text flow can be continued in new columns or pages or interrupted for the insertion of graphics or charts. "Window shades" allow

the user to adjust each separate text block. A "+" sign indicates that the text continues. A "#" icon indicates the end of a document.

To aid in positioning on the screen, both the column guides and up to 10 adjustable rules have a "snap-to" feature that causes a text block or graphic that is moved close to a boundary to automatically align itself with that edge. For precise alignment PageMaker also permits the page to be displayed in five different scales. The largest scale is magnified 200 percent, while the greatest reduction permits the user to view the entire page. At most levels of magnification, text is easily visible. The user can also pop up a set of horizontal and vertical rulers that will display in inches, centimeters, or picas and points.

PageMaker will also provide limited text-editing tools to alter copy while

(continued)

This shape is worth saving.

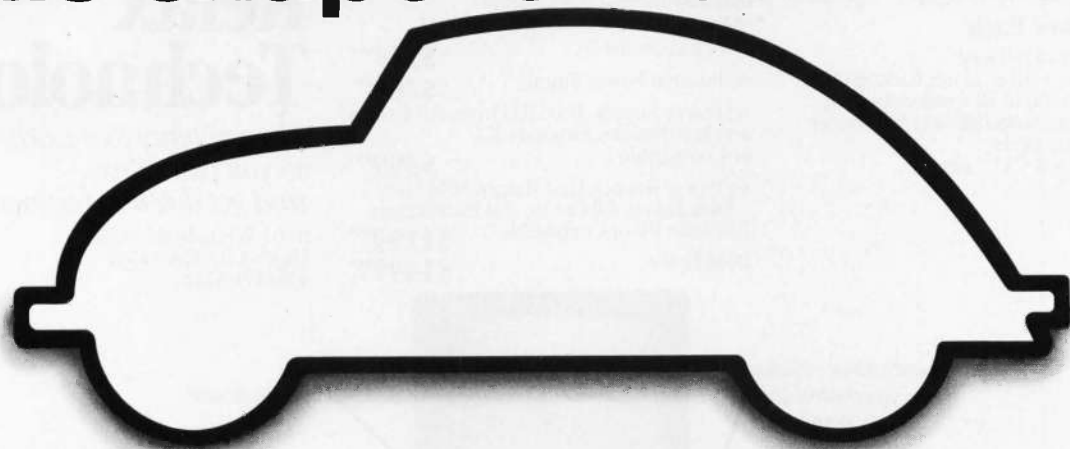

REASON 3: Because of the reliability that's built into our memory boards, disk controllers and interface boards. You'll see them all lined up with the best prices in memory. RAM boards in popular configurations. Disk controllers for floppies and Winchester. Plus, a drive that can increase operating speeds to 3500%! (Look for our MDRIVE[®]/H.) Everything you need to make your I/O super-productive. Count on next month's Byte insert to come through for you!

VIASYN™
The CompuPro People

Where Computers Grow

3506 Breakwater Court, Hayward, CA 94545 · Call 800/VIASYN-1 · In CA, 415/786-0909
CompuPro and MDRIVE are registered trademarks of Viasyn Corporation.

Take control of your computer.

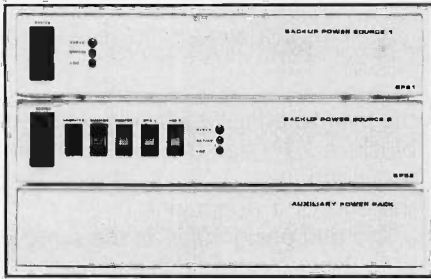

The Backups™

Backup power for peace of mind and memory.

Backup Power Source 1

- delivers up to 225 watts @ 120V.AC
- 40 minutes of power at 50% load
- visual and audible power interrupt alarm
- fast automatic switching
(Within 6 milliseconds of peak voltage detection)

- 2 Outlets
- AC surge suppressor
- 3 stage noise filter
- thermal output protection
- IEC power connector
- attractive metal enclosure
- 3¼" high, 16" wide, 11" deep

\$379⁹⁵ complete*

Backup Power Source 2

- All the features of Power Source 1 plus:
- 6 outlets controlled by front switches
 - switchable visual and audible alarm
 - 10 amp master switch circuit breaker
 - cross suppression between all 6 outlets
 - optional 2 hour auxiliary power pack

\$499⁹⁵ complete*

Auxiliary Power Pack

- 2 hours of power at full load
- plugs directly into either of our backup units
- includes 6 rechargeable 12V power cells
- backup units keep power cells at full charge
- heavy duty power cable
- 3¼" high, 16" wide, 11" deep

\$299⁹⁵ complete*

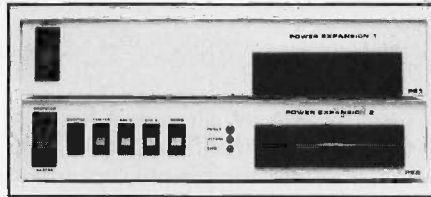

The Expanders™

Control power and expand with floppy or hard disks.

Power Expansion 1

- 1 stage noise filter
- AC surge suppression
- IEC power connector
- attractive metal enclosure
- 3¼" high, 16" wide, 11" deep
- optional internal power supply
- optional floppy and hard disk drives

Power Expansion 1 **\$149⁹⁵**

w/Internal Power Supply **\$219⁹⁵**

w/Power Supply, DS/DD Drive, All Cables and Instructions. Expands XT or Compatible **\$349⁹⁵**

w/Power Supply, Half Height 10M Hard Disk Drive, All Cables and Instructions. Expands PC or Compatible . . . **\$1149⁹⁵**

20M Drive **\$1449⁹⁵**

Power Expansion 2

- All the features of Power Expansion 1 plus:
- 6 outlets controlled by front switches
 - 10 amp master switch circuit breaker
 - LED ground and line indicators
 - 3 stage noise filter
 - cross suppression between all 6 outlets
 - optional internal power supply
 - optional floppy and hard disk drives

Power Expansion 2 **\$199⁹⁵**

w/Internal Power Supply **\$269⁹⁵**

w/Power Supply, DS/DD Drive, All Cables and Instructions. Expands XT or Compatible **\$399⁹⁵**

w/Power Supply, Half Height 10M Hard Disk Drive, All Cables and Instructions. Expands PC or Compatible . . . **\$1199⁹⁵**

20M Drive **\$1499⁹⁵**



The Controllers™

Control power, peripherals, spikes, and glitches.

Power Control 1

- 4 outlets control computer and 3 peripherals
- AC surge suppressor
- attractive metal enclosure
- 1¼" high, 16" wide, 10" deep

\$69⁹⁵ complete*

Power Control 2

- All the features of Power Control 1 plus:
- 10 amp master switch circuit breaker
 - 1 stage noise filter
 - IEC power connector

\$89⁹⁵ complete*

Power Control 3

- All the features of Power Control 1 & 2 plus:
- illuminated switches
 - 3 stage noise filter
 - cross suppression between all 4 outlets

\$129⁹⁵ complete*

**All prices suggested retail.*

Available at fine computer stores everywhere, or by mail or phone. MasterCard and Visa accepted. *Dealer inquiries invited.*

Relax Technology

The company that works so you can relax and get down to business.

3101 Whipple Rd. #25
Union City, CA 94587
415/471-6112

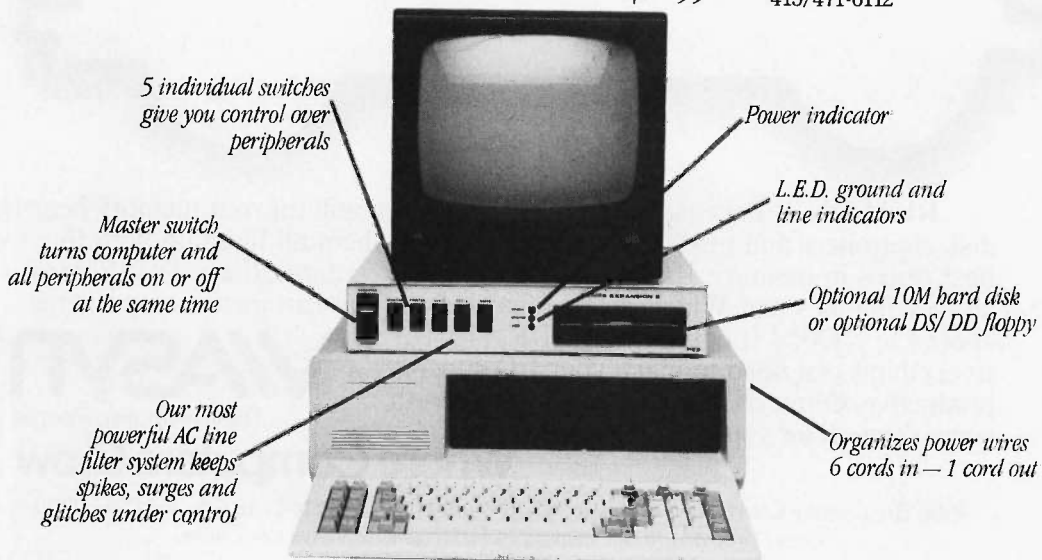

it is being "pasted up." A small movable toolbox window offers a text-editing cursor, a cropping tool, and box-, circle- and line-drawing functions. There is also a set of line and shade menus on the menu bar across the top of the display that permit the user to define and fill areas and shade behind text and graphics.

Icons in the lower left corner of the display represent up to 16 different pages and it is possible to alter the numbering scheme for even larger documents. Two special page icons permit the user to lay out page information that will appear on all pages, similar to running headers and footers, but more extensive.

Brainerd says that he expects to see the development of commercial electronic printing centers that can directly receive PageMaker files and return either finished laser-printer or typeset copy.

Aldus says that it also has plans to develop PageMaker for the IBM PC AT with the enhanced graphics display at some time in the future.

TURTLE TALK

From a teacher in Berkeley, California, we learned that Logo has become the language of the playground. A Logo version of "Simon Says" has evolved among the children in her school: One child calls commands and the others are the "turtles." As in other children's games, the rules are fluid and are passed from child to child, in a sort of playground folklore, without interference or coaching from adults. All right everybody, REPEAT 4 [FORWARD 10, RIGHT 90]!

CONCURRENT DOS-286 CHALLENGES UNIX

In January, Digital Research (of CP/M fame) unwrapped the latest product

in its Concurrent DOS line of multitasking operating systems. Concurrent DOS-286 is a multitasking, real-time, network-compatible operating system for single- or multiuser, 80286-microprocessor-based systems and is written in the C language. With that mouthful of attributes, Concurrent DOS is plainly in line to compete with the new microcomputer versions of UNIX. While ROM implementations of UNIX (see "The HP Integral Personal Computer" by Phillip Robinson, February BYTE, page 98) and new programs that allow UNIX to run PC-DOS programs (see BYTE West Coast, January, page 415) are moving that powerful minicomputer operating system down into the microcomputer world, Concurrent DOS-286 is moving microcomputers up into the world of multitasking and passwords.

Concurrent DOS-286 is not just a

(continued)

This shape is worth saving.

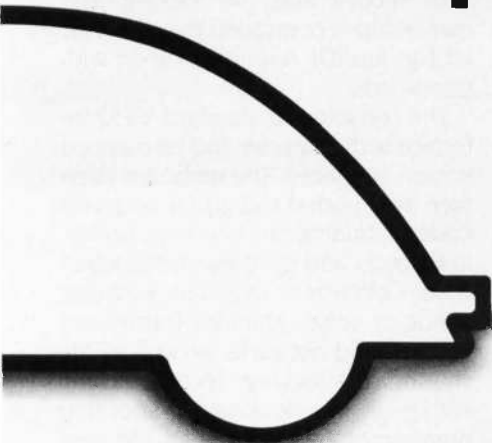

REASON 4: Because next month's Byte can make all smart folks satisfied owners. Owners of advanced communication boards. Operators of multi-tasking systems who profit from peripheral sharing and networking. And viewers of the sharpest PC Video Board that highlights spectacular values — from systems to full system support. Reasons enough to recall this shape and head for our insert, the minute you get next month's Byte.

VIASYNTM
The CompuPro People

Where Computers Grow

3506 Breakwater Court, Hayward, CA 94545 • Call 800/VIASYN-1 • In CA, 415/786-0909

CompuPro is a registered trademark of Viasyn Corporation.

revision of the earlier Concurrent operating systems; it has an entirely new architecture. Specifically, it is built around advanced hardware features of the Intel 80286 (also known as the iAPX286) microprocessor. Those features—descriptor tables, call gates, and protection levels (see "The 80286 Microprocessor" by Paul Wells, November 1984 BYTE, page 231)—allow speedy context switching as well as protection of files and programs.

COMPATIBILITY

Concurrent DOS-286 provides a migration path for PC-DOS or CP/M-86 users who need more power; it can run both CP/M and PC-DOS applications. Gary Gysin of Digital Research explained to us that "To start. . . our strategy is one of following what IBM does. So, if they come out with PC-DOS 2, PC-DOS 3, PC-DOS 3.1, whatever it is, our operating-system strategy is to embody whatever they're doing and at minimum to be compatible with [it]." An example of that strategy is Digital Research's new hierarchical file system: CP/M files have been left behind. The file system, all the system calls, and all of the

utilities are a superset of those in PC-DOS 3.0. Because of this change, if you want to run CP/M applications, you have to transfer them to PC-DOS disks (the native media of Concurrent DOS-286). Concurrent DOS is compatible with PC-DOS 3.0; with the PC-DOS front end it will run PC-DOS 1.1, 2.0, 2.1, and 3.0 applications.

Although more will be available in the future, the two most important front ends, one for CP/M-86 users and one for PC-DOS users, will be available immediately. This lets you run applications from those operating systems on Concurrent DOS-286. However, as Gysin further explained, "Theoretically, if we wanted to add some other front end to the operating system, be it UNIX, XENIX—whatever might become an industry-standard operating-system front end—then that possibility is there," because of the modular design of Concurrent DOS-286.

Cross-compilers and cross-assemblers for the VAX are not available, but the source code we're told can easily be moved to a VAX. All Digital Research languages will be available for Concurrent DOS-286. Also, if you

know CP/M, you may be interested to know that ED is gone. Digital Research had a funeral for the text editor that is now replaced by DR EDIX—a function-key-driven editor.

ARCHITECTURE

As shown in figure 1, Concurrent DOS-286 has three functional units and two primal interfaces. The functional units are termed *program*, *system*, and *physical* hardware. The system receives requests from the programs and translates them into instructions for the physical hardware. Optional front ends let the operating system run PC-DOS or CP/M applications. The *supervisor* portion of the system controls the flow of services to the underlying *resource managers*, which in turn control the actual physical peripherals.

Concurrent DOS-286 can run multiple applications using virtual consoles on each physical console, handle asynchronous events and software-interrupt handling, and deal with interprocess communications and synchronization. Storage depends on a hierarchical, shared-disk-file system with record and file locking. File ownership is controlled through user and group IDs requiring log-on with passwords.

The console is a standard VT52 interface with character and bit-mapped screen interfaces. The keyboard interface uses both standard 16- and 8-bit codes including function keys, numeric keypads, and multikeyed characters. Also, Concurrent DOS-286 supports windows, mice, graphics (raster and vector), and networks as well as file sharing, file locking, record locking within a file, locking a specified number of bytes within a file, and even overlapping locks.

Concurrent DOS-286 with floppy- and hard-disk drivers, character-mapped and bit-mapped consoles, and a printer driver requires about 160K bytes of RAM. The minimum suggested system configuration has 512K bytes of RAM. The operating system is ROMable.

The kernel is based on an event-driven dispatcher. Time slicing by a

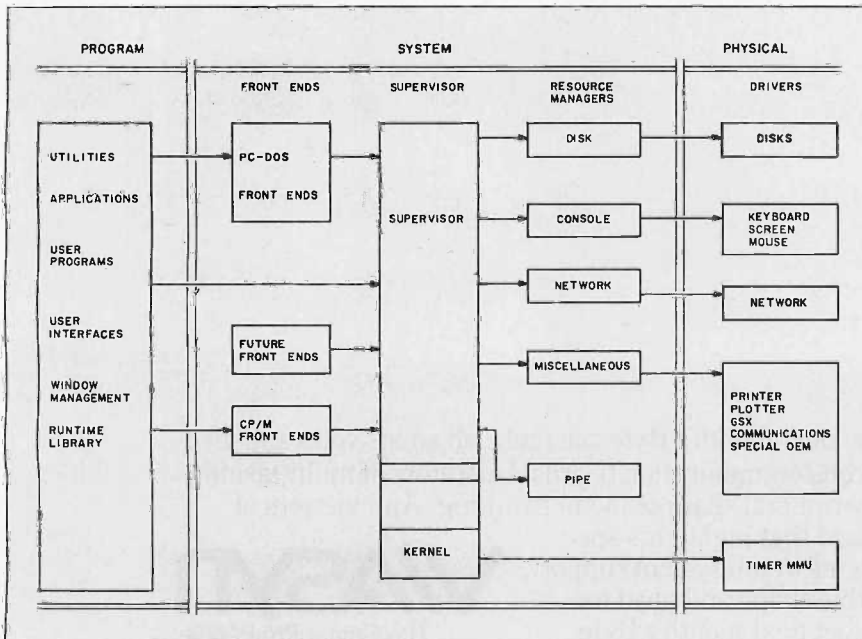

Figure 1: A diagram of the three functional units, program, system, and physical, and two primal interfaces of Concurrent DOS-286.

(continued)



Solutions

When corporate America needs a solution to information management, it turns to DATAEASE.

A major bank uses DATAEASE to link the record keeping of their trade officers worldwide. A leading insurance company uses it to provide their agents access to mainframe data from which they create their own micro information systems. Thousands of businesses, both large and small, use DATAEASE to solve their productivity needs.

DATAEASE, with its ideal combination of power and ease-of-use, allows you to gather, link, calculate and report information key to decision making; to interchange data with mainframes and other software; to create accounting, production, inventory and personnel reports all from one database. All without the need for programming skills.

Find your solution tomorrow. Ask your dealer for a DATAEASE demonstration. Or contact us directly by returning the coupon.

DATAEASE™

The Information Management Solution for Corporations Worldwide.



DATAEASE Demonstration Package

- Check one: IBM PC WANG TI
- Check attached for \$10. Send demonstration diskette, information and information package.
- Send information package only.

BYT 5/85

Name: _____ Title: _____

Phone: _____ Company: _____

Street: _____

City: _____ State: _____ Zip: _____

©Software Solutions, Inc., 305 Bic Drive, Milford, CT 06460

For information or the dealer nearest you call: **800-243-5123**

Scandinavia
West Soft A/S, Alesund, Norway; (47) 71-41141
South Africa
Dataflex, Craighill; 11724-6353

Switzerland, France
Softsource, S & A 1222 Vesenz, Switzerland; 022/430 80 00
United Kingdom
Sapphire Systems, Essex; 01-554-0582

Come see us at
COMDEX Booth 3802



Why your competitors want one of these.

They want the *Merlin*[™] Communications System from AT&T, because it can give the competitive edge to any small business.

The *Merlin* System's more than a telephone. It's a conference caller, an intercom, a speed-dialer. It lets you call your banker, call a meeting, screen a call or recall a call, with just one touch. In short, it helps you organize all your office communications.

So you can get down to business.

Plus the *Merlin* System is modular. Which means you can program any of its phones with any of its features. And you can expand the system as your small business grows.

One more thing: you can get the *Merlin* System from AT&T's unique Small Business Connection. They'll help you design the system that best suits your business.

No matter what calling you're in, get the edge by calling the Small Business Connection. **1 800 247-7000, Ext. 12. AT&T Information Systems. When you've got to be right.**

timer event occurs once per tick (16 to 20 milliseconds), and scheduling of equal-priority processes is based on a round-robin scheme. Process communication and synchronization are done through named *pipes* that pass messages from one process to another or synchronize processes by acting as semaphores. The 80286 chips have a protection mechanism based on address manipulations. On-chip calculations handle the translation of virtual and physical addresses. Certain segments of memory can be marked as exception areas for particular users or programs. Whenever a program tries to address an exception area, the central processor is interrupted, a trap is generated, and processing is forced to another routine.

STOPPING THE OPERATING SYSTEM BYPASS

Trapping is a vital element in Concurrent DOS-286's ability to handle poorly behaved programs. Programs that employ operating-system routines to handle the computer hardware are termed *well behaved*. Programs that bypass operating-system routines and make direct calls to hardware—for instance, to the screen—are *poorly behaved*. While bypassing the operating system sometimes improves a program's execution speed, it hurts program portability. A program written around the operating system works on any computer running that operating system. A program tailored to a specific computer by means of direct hardware calls only runs on that computer and its nearly identical copies—poorly behaved programs are the waterloo of clone-makers. Concurrent DOS-286, however, can trap the calls made directly to the *physical* hardware and route them to *virtual* hardware.

For example, Lotus 1-2-3 is a poorly behaved program that assumes it owns the entire computer display screen. Gysin pointed out that if you tried to run both Lotus 1-2-3 and WordStar concurrently on a system that couldn't trap hardware calls, "you'd have trash all over the screen." Lotus 1-2-3 wouldn't let WordStar have

a window. In Concurrent DOS-286, however, whenever a program tries to control the screen, the operating system traps the call and sends it to a window instead. The program thinks it is running on a full IBM Personal Computer, but instead it is running on a virtual console manager—a part of the Concurrent DOS-286 system. This is another advantage for computer companies that want to sell IBM-compatible personal computers. As Gysin tells competitors, "Go ahead and build whatever kind of screen you want, go ahead and build whatever kind of super-duper machine you can, we can still guarantee you we'll run PC-DOS applications, given that you've got a 286 chip."

The 80286 provides you with both compatibility and practical concurrency. All the fancy trapping could be done entirely by software, but it would take much longer than the

The 80286 provides both compatibility and concurrency.

hardware trapping. Trapping and re-routing signals could slow programs down to the point that they don't work properly. Because all of the trapping chores are handled within a single chip (the 80286), Concurrent DOS-286 doesn't have that problem. According to Gysin, Digital Research's quest to have applications run as fast under Concurrent DOS-286 as they do under PC-DOS has been successful. He claims, "We've gotten there, there's no difference."

Context switching—changing the active program by suspending one pro-

(continued)

IF POWER FAILS, DATASAVER® TAKES OVER!

PROTECTION - saves data during power failures.
 - saves hardware from overvoltage transients.

PORTABILITY - allows mobile or extended holdup time using auxiliary 12 volt battery.

FEATURES - internal battery provides 5 min. + operating time - AC line conditioning
 - audible and visual alarms, interrupt signal - compact, desktop styling
 - no installation required.

200 WATT - \$495 / 90 WATT - \$350
 For special applications and product information, call 805-541-4160.

Instant power order line
805-541-4161

CUESTA SYSTEMS, INC.
 3440 Roberto Court, San Luis Obispo, California 93401

INSTANT AC POWER



gram, saving the registers, restoring the registers, and then restarting another program—is now done in software. Digital Research estimates that each software context switch takes between 200 and 400 microseconds. Digital Research plans to take advantage of the 80286's on-chip context-switching hardware that can handle the switch in only 20 microseconds.

DYNAMIC DRIVERS

Another big change in Concurrent DOS-286 is that the device drivers are dynamic. In previous incarnations of CP/M and Concurrent DOS, all the drivers were in a single section of code called BIOS (basic input/output system) or XIOS (extended input/output system). You had to load the drivers into the operating system before starting up. Dynamic loading means that you can add or modify device drivers while the operating system is running.

USER INTERFACE

Digital Research is also presenting a new user interface for Concurrent

DOS-286 and Concurrent PC-DOS. It is essentially a menu system and a file manager that allows you to control all system utilities and all running applications with the function keys. "What we're trying to do is take away the A> prompt," says Gysin. But if you prefer the standard CP/M-style prompts, just press the Escape key to get back onto familiar ground.

TOPVIEW, GEM, AND GSX

What Digital Research calls "desktop primitives," which support such application environments as Microsoft Windows, Visi On, TopView, or "unannounced products from Digital Research" (Gysin's words), are built into Concurrent DOS-286. Gysin adds, "Whatever becomes standard, that is something that we'll map to our operating system. If some other bit-map graphics type of interface is the standard, then we'll also support that one." Digital Research's new GEM (Graphics Environment Manager) is a Macintosh-like interface that fits that bill.

Digital Research's GSX (Graphics System Extension) software is also supplied with Concurrent DOS-286.

This graphics operating system lets you write to a standard set of graphics calls so you don't need to know at programming time which specific peripherals you will have.

INTERNATIONAL FLAVORS

Concurrent DOS-286 has three features that should delight software engineers outside the United States: All the system messages are kept in a separate pool, the user tables have a *country* code, and the keyboard interface supports 16-bit character I/O (which is required for kanji, for example). Those design tidbits are understandable when you realize that 40 percent of Digital Research's business is done overseas.

SUMMARY

What's new with Concurrent DOS-286? The architecture has changed. Previous versions of Concurrent DOS provided support for PC-DOS 1.1 and CP/M-86 applications. Concurrent DOS-286 provides support for PC-DOS 1.1, 2.0, and 3.0 applications as well as memory protection, log-on and log-off, dynamic local device drivers, a hierarchical file system, completely modular design, pipes, I/O redirection, and an address-exception mechanism. In essence, Concurrent DOS-286 is intended to release you from needing IBM hardware or a clone to run IBM Personal Computer programs such as Lotus 1-2-3. Now, any system that can run Concurrent DOS-286 can run IBM Personal Computer programs.

How well does Concurrent DOS-286 work? We don't know. The descriptions in this article are based on discussion with Digital Research and Intel technical experts, not on a review of the operating system itself. When we do get into testing Concurrent DOS-286, our first consideration will probably be its use of memory. Although Concurrent DOS-286 is supposed to run as many programs concurrently as the hardware can handle, BYTE staff members have had problems with the voracious memory appetite of previous versions of Concurrent DOS. ■

COMPANIES MENTIONED

HEWLETT-PACKARD
3495 Deer Creek Rd.
Palo Alto, CA 94304

MOSIS
USC/ISI
Care of Kathy Fry
4676 Admiralty Way
Marina Del Rey, CA 90292
(213) 822-1511 ext. 230

APPLE COMPUTER
20525 Mariani Ave.
Cupertino, CA 95014
(800) 538-9696
in Canada, (800) 268-7796 or
(800) 268-7637

DOUGLAS ELECTRONICS
718 Marina Blvd.
San Leandro, CA 94577
(415) 483-8770

BISHOP GRAPHICS
5388 Sterling Center Dr.
Westlake Village, CA 91359
(818) 991-2600

ALDUS CORPORATION
616 1st Ave., Suite 400
Seattle, WA 98104
(206) 467-8165

ADOBE SYSTEMS
Embarcadero, Suite 100
Palo Alto, CA 94303
(415) 852-0271

DIGITAL RESEARCH
60 Garden Court
POB DRI
Monterey, CA 93942
(800) 772-3545
ext. 400 in California
(800) 227-1617
ext. 400 elsewhere

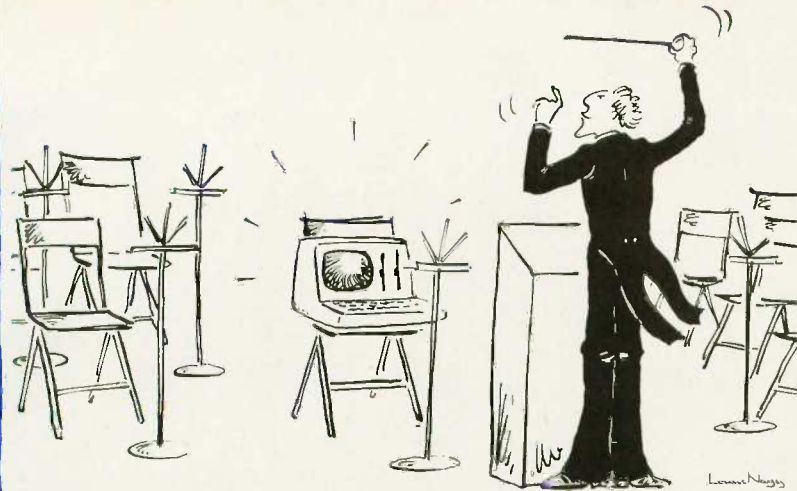

Would you hire an entire band when all you need is one instrument? Of course not.

So why use a whole orchestra of computers when all you need is one to develop software for virtually any type of micro-processor?

The secret? Avocet's family of cross-assemblers. With Avocet cross-assemblers you can develop software for practically every kind of processor — *without having to switch to another development system along the way!*

Cross-Assemblers to Beat the Band!

Development Tools That Work

Avocet cross-assemblers are fast, reliable and user-proven in over 4 years of actual use. Ask NASA, IBM, Xerox or the hundreds of other organizations that use them. Every time you see a new micro-processor-based product, there's a good chance it was developed with Avocet cross-assemblers.

Avocet cross-assemblers are easy to use. They run on almost any personal computer and process assembly language for the most popular microprocessor families.

Your Computer Can Be A Complete Development System

Avocet has the tools you need to enter and assemble your soft-ware and finally cast it in EPROM:

VEDIT Text Editor makes source code entry a snap. Full-screen editing plus a TECO-like command mode for advanced tasks. Easy installation - INSTALL program supports over 40 terminals and personal computers. Customizable keyboard layout. CP/M-80, CP/M-86, MSDOS, PC DOS. \$150

EPROM Programmers let you program, verify, compare, read, display EPROMS but cost less because they communicate through your personal computer or terminal. No personality modules! On-board intelligence provides menu-based setup for 34 different EPROMS, EEPROMS and MPUs (40-pin devices require socket adaptors). Self-contained unit with internal power supply, RS-232 interface, Textool ZIF socket. Driver software (sold separately) gives you access to all programmer features through your computer, lets you download cross-assembler output files, copy EPROM to disk.

Model 7228 Advanced Programmer — Supports all PROM types listed. Superfast "adaptive" programming algorithm programs 2764 in 1.1 minutes.

Model 7128 Standard Programmer — Lower-cost version of 7228. Supports all PROM types except "A" versions of 2764 and 27128. Standard programming algorithm programs 2764 in 6.8 minutes.

Avocet Cross-assembler	Target Microprocessor	CP/M-80	CP/M-86 IBM PC, MSDOS**
XASM04 <i>NEW</i>	6804	\$ 250.00	\$ 250.00
XASM05	6805	200.00	250.00
XASM09	6809	200.00	250.00
XASM18	1802/1805	200.00	250.00
XASM48	8048/8041	200.00	250.00
XASM51	8051	200.00	250.00
XASM65	6502/65C02	200.00	250.00
XASM68	6800/01, 6301	200.00	250.00
XASM75	NEC 7500	500.00	500.00
XASM85	8085	250.00	250.00
XASM400	COP400	300.00	300.00
XASMF8	F8/3870	300.00	300.00
XASMZ8	Z8	200.00	250.00
XASMZ80	Z80	250.00	250.00
XMAC682 <i>NEW</i>	68200	595.00	595.00
XMAC68K <i>NEW</i>	68000/68010	595.00	595.00

Model 7956 and 7956-SA Gang Programmers — Similar features to 7228, but program as many as 8 EPROMS at once. 7956-SA stand-alone version copies from a master EPROM. 7956 lab version has all features of stand-alone plus RS-232 interface.

EPROM: 2758, 2716, 2732, 2732A, 2764, 2764A, 27128, 27128A, 27256, 2508, 2516, 2532, 2564, 68764, 68766, 5133, 5143. **CMOS:** 27C16, 27C32, 27C64, MC6716. **EEPROM:** 5213, X2816A, 48016, I2816A, 5213H. **MPU (w/adaptor):** 8748, 8748H, 8749, 8749H, 8741, 8742, 8751, 8755.

7228	Advanced Programmer	\$ 599
7128	Standard Programmer	429
7956	Laboratory Gang Programmer	1099
7956-SA	Stand-Alone Gang Programmer	979
GDX	Driver Software	95
481	8748 Family Socket Adaptor	98
511	8751 Socket Adaptor	174
755	8755 Socket Adaptor	135
CABLE	RS-232 Cable (specify gender)	30

HEXTRAN Universal HEX File Converter — Convert assembler output to other formats for downloading to development systems and target boards. Also useful for examining object file, changing load addresses, extracting parts of files. Converts to and from Intel, Motorola, MOS, RCA, Fairchild, Tektronix, TI, Binary and HEX/ASCII Dump formats. For CP/M, CP/M-86, MSDOS, PC DOS. \$250

Ask about UNIX.

68000 CROSS-ASSEMBLER — With exhaustive field testing completed, our 68000 assembler is available for immediate shipment. XMAC68K supports Motorola standard assembly language for the 68000 and 68010. Macros, cross-reference, structured assembly statements, instruction optimization and more. Linker and librarian included. Comprehensive, well-written manual.

To find out more, call us toll-free.

1-800-448-8500

(in the U.S. Except Alaska and Hawaii)

VISA and MasterCard accepted. All popular disc formats now available — please specify. Prices do not include shipping and handling — call for exact quotes. OEM INQUIRIES INVITED.

*Trademark of Digital Research **Trademark of Microsoft



Sales and Development:
10 Summer Street
P.O. Box 490, Dept. 585-B
Rockport, Maine 04856
(207) 236-9055 Telex: 467210 AVOCET CI

Corporate Offices:
804 South State Street
Dover, Delaware 19901

A black and white advertisement. The background is a dark, textured wall with a grid pattern. On the left side, there is a blurred image of a city street at night with light trails from cars and streetlights. In the center, a man is silhouetted against a bright window. He is sitting on a ledge or desk, looking out. Above him is a large, white, oval-shaped thought bubble containing text. Three small circles lead from the man's head to the bubble.

**"LOTUS®, PC-DOS™, DISOSS™, XENIX®
... HOW DO YOU GET IT ALL
TO WORK TOGETHER?"**

© Lanier, 1985

Lotus is a registered trademark of Lotus Development Corporation. PC-DOS and DISOSS are trademarks of International Business Machines Corporation. XENIX is a registered trademark of Microsoft Corporation.

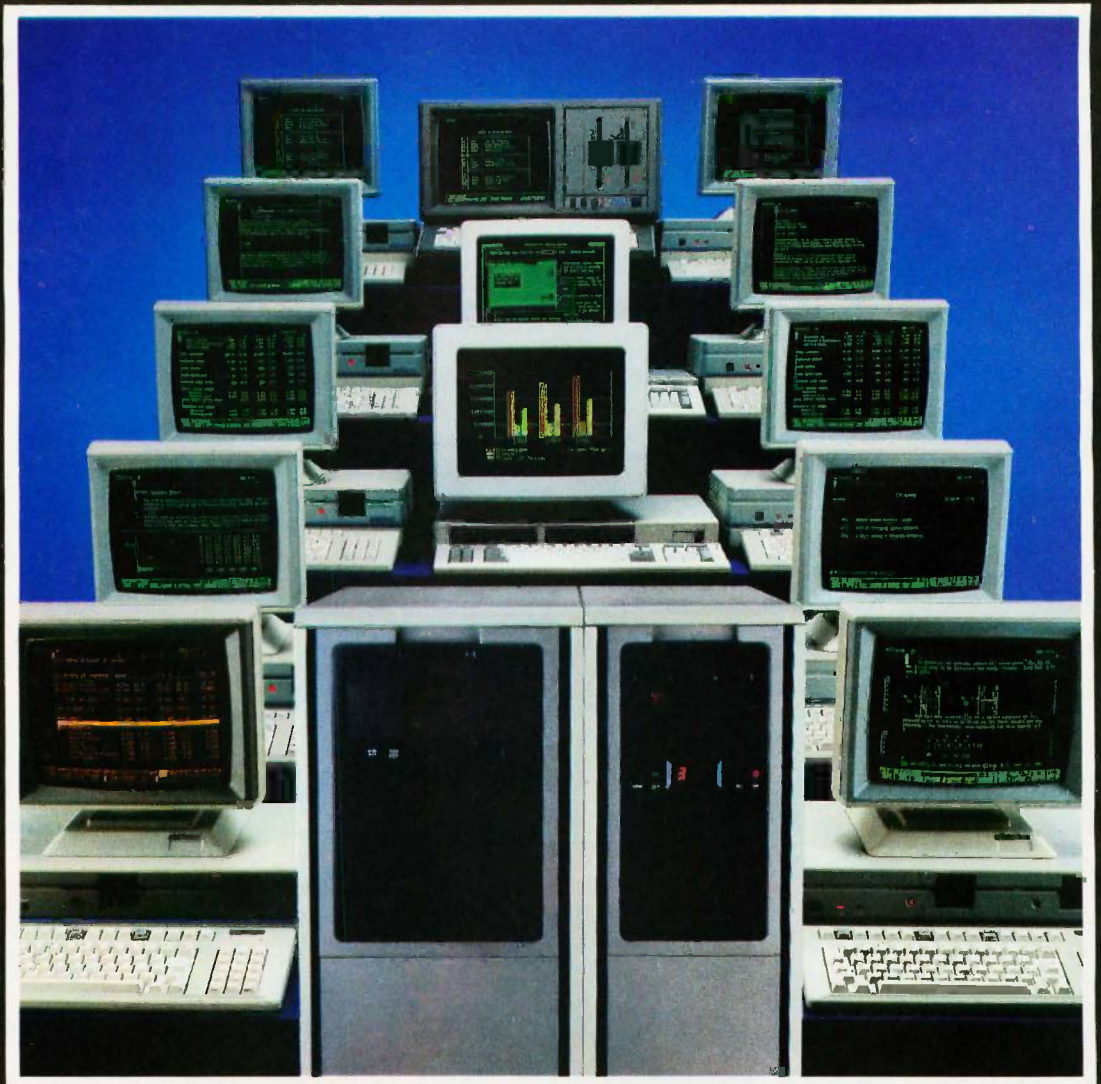

SEE LANIER.

For Concept III. The networking family of multifunctional integrated systems. Interconnects to IBM mainframes, remote data files, other vendors' equipment. A new Perspective on office automation that lets you add processing power as you grow.

Lanier customer training and service are second to none. And we're backed by Harris, a world leader in Information Technology. Call for a demonstration. 800-241-1706.*

Or send the coupon. Today.

**FOR YOUR INFORMATION,
WE'RE NOW PART OF HARRIS.**

*In Georgia, call 404-321-1244 collect.
Harris/Lanier, Electronic Office Systems Div.
SEE LANIER. For a new Perspective on office automation

LANIER, A HARRIS COMPANY

1700 Chantilly Drive, N.E., Atlanta, GA 30324

Name

Firm Title

Address

County Phone

City State Zip



May '85, Byte 475 H E5

from Lanier, please circle #232.

Engineering Excellence

CROSSTALK™

XVI



THE STATE OF THE ART IN
DATA COMMUNICATIONS
SOFTWARE

DESIGNED BY

MICROSTUF®

CROSSTALK IS A TRADEMARK OF
MICROSTUF, INC., ATLANTA, GEORGIA

CROSSTALK IS AVAILABLE FOR
MOST SMALL BUSINESS
COMPUTERS

DATE

2/16/84

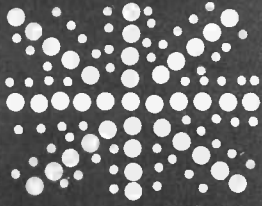

Parallel Processing

A look at the ALICE hardware and Hope language

BY DICK POUNTAIN

In the August 1984 BYTE U.K. (page 361), I mentioned a team at London's Imperial College that was working on a parallel-processing computer that would run fifth-generation functional languages. Since this month's theme is multiprocessing, this is a good time to make proper acquaintance with that machine—ALICE.

The name ALICE is an acronym that stands for Applicative Language Idealized Computing Engine. The machine uses a number of processors working in parallel to execute functional and logic languages like Hope, LISP, and Prolog efficiently. Such languages, which are of great importance to current computer science research, tend to be inefficient when run on conventional sequential computers, a fact that has prevented their widespread use and has already led to the development of custom hardware such as the LISP Machine (which uses a microcoded instruction set optimized for LISP).

ALICE is a modular design, with possible configurations ranging from a single-user workstation up to a multiuser mainframe. The first machine will be an experimental vehicle using 64 processors to test the principles involved. The performance goal is to have a single-user ALICE workstation run applicative languages at speeds comparable to that of Pascal on a VAX-11/750, and with a very favorable cost/performance ratio.

Performance may be increased simply by adding more processor modules. The processor elements will be INMOS Transputers, two of which together with 256K bytes of RAM (random-access read/write memory) make a unit, and two units are installed on a single-board module. The intention is that a future design phase will further integrate these processor/memory/network modules onto single VLSI (very large scale integration) chips, which should allow performance to be increased substantially. In 1983, INMOS published encouraging performance projections of a two-dimensional ar-

ray of Transputers. The projected price/performance ratio of the initial design is already claimed to be 30 times better than current mainframes and superminicomputers.

The ALICE team is headed by Dr. John Darlington and is funded by the U.K. Science and Engineering Research Council. The prototype machine should be nearing completion at about the time this article is published.

APPLICATIVE PROGRAMMING

I can't explain how ALICE works without first discussing what applicative languages are and how *they* work. In the December 1984 BYTE U.K. (page 355), I touched on the importance of declarative languages using the example of Prolog. In a nutshell, such languages try to replace the traditional programmer's activity of telling the computer what to do with the more productive activity of describing one's problem in a formal way that also happens to be an executable computer program. Prolog is representative of one family of declarative languages (*relational* or *logic* languages) in which predicate logic is the formalism used.

There is, however, another family called applicative or functional languages, of which LISP is a well-known, though not pure, example. In such languages, the only activity permitted is the definition, *application*, and combination of *functions* (hence the alternate names).

In particular, a strict applicative language does not allow the use of variables or assignment to variables, and the only control structure that is permitted is recursion. Many programmers' first thought will be that it's not possible to write programs without using variables; however, this is not so. It means that all data must be passed as arguments to functions or returned as results from functions, without being stored permanently; in other words, data is produced and consumed "on the fly." To con-

(continued)

Dick Pountain is a technical author and software consultant living in London, England. He can be contacted c/o BYTE, POB 372, Hancock, NH 03449.

pute the hypotenuse of a triangle from sides X and Y we would say

```
PRINT( SQRT( SUM( SQUARE(X),
  SQUARE(Y) ) ) );
```

rather than

```
Z := SQRT( X^2 + Y^2 );
PRINT Z ;
```

Those of you who know LISP will recognize that it tends in this direction, but most modern dialects allow assignment (using SET and SETQ) and iterative loops.

It's possible to get some of the flavor of functional programming by getting your Pascal compiler out and trying to write programs using only function (not procedure) declarations and using recursion instead of while ... do, repeat ... until, etc. You won't find it particularly useful though, for Pascal restricts the types of objects that can be passed to or

returned by a function.

Why bother with functional programming then, since it seems so restrictive? It turns out that purely applicative programs have some interesting properties. Because they don't use variables or assignment, they are free of side effects (the alteration of a program's environment by parts of the program). In a sense, applicative programs don't *do* anything, they merely return values. This makes it possible to *reason* about the correctness of such programs, and in particular, it opens up the possibility that we could use the computer to check programs for correctness, to modify them, and even to write them.

Since debugging and program maintenance now account for most of the time and money spent worldwide on computing, such developments would be of the greatest significance.

Of equal importance is the fact that

the absence of side effects renders each part of a functional program independent of every other and of the order in which they are evaluated, which means that these parts can be evaluated in parallel. Conventional procedural languages (like BASIC and Pascal) don't lend themselves to parallel processing; because routines typically depend on one another, most of the code ends up being devoted to making routines wait for the others or stopping them from fighting each other for resources.

Parallel processing is now widely held to be the way forward in computer performance; we can't just keep making faster sequential von Neumann machines forever, because we'll soon be running up against physical obstacles like the speed of light and the melting point of the conductors. Even from what puny infor-

(continued)

The biggest news in printers since Herr Gutenberg, and a lot less expensive.

Introducing the Sumicom 1120. At \$495 it's the least expensive letter-quality printer ever, with features you'd expect to cost hundreds more.

The 1120 is as fast as any letter-quality printer under \$900, and faster than most: 18 characters per second. It's universally standard, with Qume printwheels and ribbons and an 8-bit parallel Centronics interface; it works with IBM, Apple, Commodore and many other PCs.

The 1120 is quiet (only 60 dBA), features proportional spacing and takes paper up to 13 inches wide. Options include serial interface, forms tractor and cut sheet feeder. The dependability is standard: a 120-day warranty, a month longer than other manufacturers.

For fast delivery, call 800/556-1234, ext. 167 (California 800/441-2345, ext. 167). Letter quality, and many other qualities, all for \$495: give us a call.

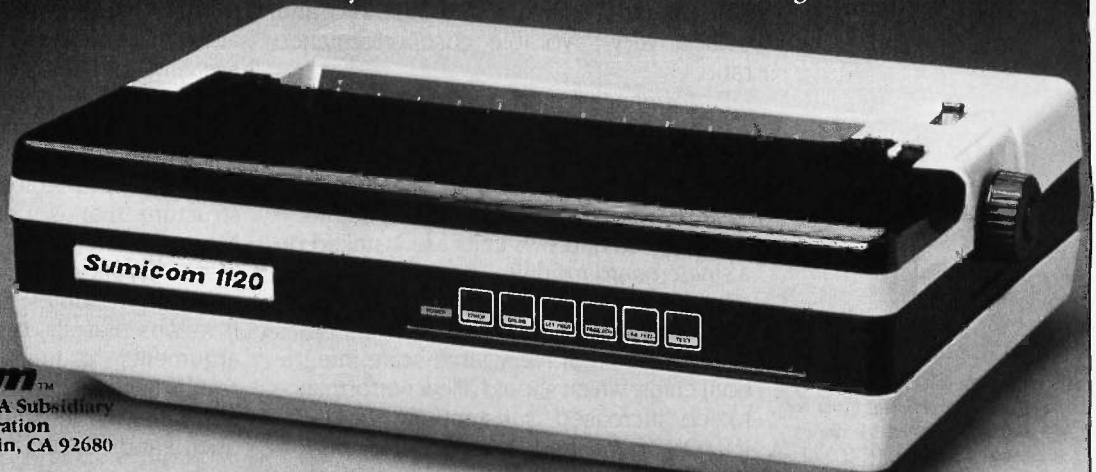

SumicomTM
SUMITRONICS INC., A Subsidiary
of Sumitomo Corporation
17862 E. 17th St., Tustin, CA 92680

SILICON SPECIALTIES

**ORDER
LINE
800-354-7330**

PRINTERS

Anadex	
9625B	\$1089
WP6000	\$2039
DP6500	\$2179
Brother	
DX-15XL	\$365
HR-25	\$649
HR-35	\$875
C-Itch	
A-10-30	\$469
F-10 Parallel or Serial	\$869
55 CPS Serial or Parallel	\$1035
8510 Parallel (Prowriter)	\$295
8510 SP	\$385
8510 SCP	\$465
8510 BPI	\$315
Citizen	
MSP-10	\$329
MSP-15	\$509
MSP-20	\$469
MSP-25	\$639
Comrex	
CR-2E	\$364
CR-4	\$ave
420	\$ave
Datasouth	
DS180	\$1089
DS220	\$1315
DS-PPH1	\$449
DS-PPH2	\$635
Diablo	
D-25	\$609
630 API	\$1484
630 ECS	\$1669
630 ECS/IBM	\$1669
D-36	\$ave
80 IF	\$2649
P12CQI	\$529
P32CQI	\$759
S32CQI	\$839
P38	\$1639
S38	\$1719
C150	\$999
Epson All Printer Models	\$ave
Inforunner	
Rileman w/Tractor	\$244
Rileman 15	\$499
Rileman Blue w/Tractor	\$299
Juki	
5500	\$ave
6100	\$ave
6300	\$ave
NEC	
2010, 2015, 2030	\$639
2050	\$654
3510, 3515, 3530	\$1215
3550	\$1359
8810, 8815, 8830	\$1665
8850	\$1779
P2, P3	\$ave
Okidata All Printer Models	\$ave
Panasonic	
1091	\$265
1092	\$349
1093	\$519
KXP3151	\$459
Siemens	
PT/88 InkJet	\$ave
PT/89 InkJet	\$ave
Star Micronics All Printer Models	\$ave
Silver Reed	
EXP400 Parallel	\$235
EXP500 Parallel or Serial	\$379
EXP550 Parallel or Serial	\$399
EXP770 Parallel or Serial	\$699
Toshiba P1340 Parallel or Serial	\$549
P351 Parallel or Serial	\$1165

Comrex	
CR-2E	\$364
CR-4	\$ave
420	\$ave
Datasouth	
DS180	\$1089
DS220	\$1315
DS-PPH1	\$449
DS-PPH2	\$635
Diablo	
D-25	\$609
630 API	\$1484
630 ECS	\$1669
630 ECS/IBM	\$1669
D-36	\$ave
80 IF	\$2649
P12CQI	\$529
P32CQI	\$759
S32CQI	\$839
P38	\$1639
S38	\$1719
C150	\$999
Epson All Printer Models	\$ave
Inforunner	
Rileman w/Tractor	\$244
Rileman 15	\$499
Rileman Blue w/Tractor	\$299
Juki	
5500	\$ave
6100	\$ave
6300	\$ave
NEC	
2010, 2015, 2030	\$639
2050	\$654
3510, 3515, 3530	\$1215
3550	\$1359
8810, 8815, 8830	\$1665
8850	\$1779
P2, P3	\$ave
Okidata All Printer Models	\$ave
Panasonic	
1091	\$265
1092	\$349
1093	\$519
KXP3151	\$459
Siemens	
PT/88 InkJet	\$ave
PT/89 InkJet	\$ave
Star Micronics All Printer Models	\$ave
Silver Reed	
EXP400 Parallel	\$235
EXP500 Parallel or Serial	\$379
EXP550 Parallel or Serial	\$399
EXP770 Parallel or Serial	\$699
Toshiba P1340 Parallel or Serial	\$549
P351 Parallel or Serial	\$1165

Comrex	
CR-2E	\$364
CR-4	\$ave
420	\$ave
Datasouth	
DS180	\$1089
DS220	\$1315
DS-PPH1	\$449
DS-PPH2	\$635
Diablo	
D-25	\$609
630 API	\$1484
630 ECS	\$1669
630 ECS/IBM	\$1669
D-36	\$ave
80 IF	\$2649
P12CQI	\$529
P32CQI	\$759
S32CQI	\$839
P38	\$1639
S38	\$1719
C150	\$999
Epson All Printer Models	\$ave
Inforunner	
Rileman w/Tractor	\$244
Rileman 15	\$499
Rileman Blue w/Tractor	\$299
Juki	
5500	\$ave
6100	\$ave
6300	\$ave
NEC	
2010, 2015, 2030	\$639
2050	\$654
3510, 3515, 3530	\$1215
3550	\$1359
8810, 8815, 8830	\$1665
8850	\$1779
P2, P3	\$ave
Okidata All Printer Models	\$ave
Panasonic	
1091	\$265
1092	\$349
1093	\$519
KXP3151	\$459
Siemens	
PT/88 InkJet	\$ave
PT/89 InkJet	\$ave
Star Micronics All Printer Models	\$ave
Silver Reed	
EXP400 Parallel	\$235
EXP500 Parallel or Serial	\$379
EXP550 Parallel or Serial	\$399
EXP770 Parallel or Serial	\$699
Toshiba P1340 Parallel or Serial	\$549
P351 Parallel or Serial	\$1165

Comrex	
CR-2E	\$364
CR-4	\$ave
420	\$ave
Datasouth	
DS180	\$1089
DS220	\$1315
DS-PPH1	\$449
DS-PPH2	\$635
Diablo	
D-25	\$609
630 API	\$1484
630 ECS	\$1669
630 ECS/IBM	\$1669
D-36	\$ave
80 IF	\$2649
P12CQI	\$529
P32CQI	\$759
S32CQI	\$839
P38	\$1639
S38	\$1719
C150	\$999
Epson All Printer Models	\$ave
Inforunner	
Rileman w/Tractor	\$244
Rileman 15	\$499
Rileman Blue w/Tractor	\$299
Juki	
5500	\$ave
6100	\$ave
6300	\$ave
NEC	
2010, 2015, 2030	\$639
2050	\$654
3510, 3515, 3530	\$1215
3550	\$1359
8810, 8815, 8830	\$1665
8850	\$1779
P2, P3	\$ave
Okidata All Printer Models	\$ave
Panasonic	
1091	\$265
1092	\$349
1093	\$519
KXP3151	\$459
Siemens	
PT/88 InkJet	\$ave
PT/89 InkJet	\$ave
Star Micronics All Printer Models	\$ave
Silver Reed	
EXP400 Parallel	\$235
EXP500 Parallel or Serial	\$379
EXP550 Parallel or Serial	\$399
EXP770 Parallel or Serial	\$699
Toshiba P1340 Parallel or Serial	\$549
P351 Parallel or Serial	\$1165

Comrex	
CR-2E	\$364
CR-4	\$ave
420	\$ave
Datasouth	
DS180	\$1089
DS220	\$1315
DS-PPH1	\$449
DS-PPH2	\$635
Diablo	
D-25	\$609
630 API	\$1484
630 ECS	\$1669
630 ECS/IBM	\$1669
D-36	\$ave
80 IF	\$2649
P12CQI	\$529
P32CQI	\$759
S32CQI	\$839
P38	\$1639
S38	\$1719
C150	\$999
Epson All Printer Models	\$ave
Inforunner	
Rileman w/Tractor	\$244
Rileman 15	\$499
Rileman Blue w/Tractor	\$299
Juki	
5500	\$ave
6100	\$ave
6300	\$ave
NEC	
2010, 2015, 2030	\$639
2050	\$654
3510, 3515, 3530	\$1215
3550	\$1359
8810, 8815, 8830	\$1665
8850	\$1779
P2, P3	\$ave
Okidata All Printer Models	\$ave
Panasonic	
1091	\$265
1092	\$349
1093	\$519
KXP3151	\$459
Siemens	
PT/88 InkJet	\$ave
PT/89 InkJet	\$ave
Star Micronics All Printer Models	\$ave
Silver Reed	
EXP400 Parallel	\$235
EXP500 Parallel or Serial	\$379
EXP550 Parallel or Serial	\$399
EXP770 Parallel or Serial	\$699
Toshiba P1340 Parallel or Serial	\$549
P351 Parallel or Serial	\$1165

Comrex	
CR-2E	\$364
CR-4	\$ave
420	\$ave
Datasouth	
DS180	\$1089
DS220	\$1315
DS-PPH1	\$449
DS-PPH2	\$635
Diablo	
D-25	\$609
630 API	\$1484
630 ECS	\$1669
630 ECS/IBM	\$1669
D-36	\$ave
80 IF	\$2649
P12CQI	\$529
P32CQI	\$759
S32CQI	\$839
P38	\$1639
S38	\$1719
C150	\$999
Epson All Printer Models	\$ave
Inforunner	
Rileman w/Tractor	\$244
Rileman 15	\$499
Rileman Blue w/Tractor	\$299
Juki	
5500	\$ave
6100	\$ave
6300	\$ave
NEC	
2010, 2015, 2030	\$639
2050	\$654
3510, 3515, 3530	\$1215
3550	\$1359
8810, 8815, 8830	\$1665
8850	\$1779
P2, P3	\$ave
Okidata All Printer Models	\$ave
Panasonic	
1091	\$265
1092	\$349
1093	\$519
KXP3151	\$459
Siemens	
PT/88 InkJet	\$ave
PT/89 InkJet	\$ave
Star Micronics All Printer Models	\$ave
Silver Reed	
EXP400 Parallel	\$235
EXP500 Parallel or Serial	\$379
EXP550 Parallel or Serial	\$399
EXP770 Parallel or Serial	\$699
Toshiba P1340 Parallel or Serial	\$549
P351 Parallel or Serial	\$1165

Comrex	
CR-2E	\$364
CR-4	\$ave
420	\$ave
Datasouth	
DS180	\$1089
DS220	\$1315
DS-PPH1	\$449
DS-PPH2	\$635
Diablo	
D-25	\$609
630 API	\$1484
630 ECS	\$1669
630 ECS/IBM	\$1669
D-36	\$ave
80 IF	\$2649
P12CQI	\$529
P32CQI	\$759
S32CQI	\$839
P38	\$1639
S38	\$1719
C150	\$999
Epson All Printer Models	\$ave
Inforunner	
Rileman w/Tractor	\$244
Rileman 15	\$499
Rileman Blue w/Tractor	\$299
Juki	
5500	\$ave
6100	\$ave
6300	\$ave
NEC	
2010, 2015, 2030	\$639
2050	\$654
3510, 3515, 3530	\$1215
3550	\$1359
8810, 8815, 8830	\$1665
8850	\$1779
P2, P3	\$ave
Okidata All Printer Models	\$ave
Panasonic	
1091	\$265
1092	\$349
1093	\$519
KXP3151	\$459
Siemens	
PT/88 InkJet	\$ave
PT/89 InkJet	\$ave
Star Micronics All Printer Models	\$ave
Silver Reed	
EXP400 Parallel	\$235
EXP500 Parallel or Serial	\$379
EXP550 Parallel or Serial	\$399
EXP770 Parallel or Serial	\$699
Toshiba P1340 Parallel or Serial	\$549
P351 Parallel or Serial	\$1165

Comrex	
CR-2E	\$364
CR-4	\$ave
420	\$ave
Datasouth	
DS180	\$1089
DS220	\$1315
DS-PPH1	\$449
DS-PPH2	\$635
Diablo	
D-25	\$609
630 API	\$1484
630 ECS	\$1669
630 ECS/IBM	\$1669
D-36	\$ave
80 IF	\$2649
P12CQI	\$529
P32CQI	\$759
S32CQI	\$839
P38	\$1639
S38	\$1719
C150	\$999
Epson All Printer Models	\$ave
Inforunner	
Rileman w/Tractor	\$244
Rileman 15	\$499
Rileman Blue w/Tractor	\$299
Juki	
5500	\$ave
6100	\$ave
6300	\$ave
NEC	

*Hope is a strongly typed,
pure, higher-order
applicative language.
It doesn't allow
assignment and is
side-effect-free.*

mation we have at present about the human brain, it seems clear that it couldn't achieve its staggering performance without its millions of neurons working in parallel.

HOPE

Let's now take a look at a particular functional language called Hope.

which will be run on ALICE. Hope is a strongly typed, pure, higher-order applicative language. All this means is that it has data "types" as in Pascal. The data types must be declared and are checked by the compiler; the language doesn't allow assignment and is side-effect-free; it allows functions to be passed as arguments to other functions or to be returned as results.

Hope was designed at Edinburgh University by Burstall, McQueen, and Sannella. Burstall also developed the language POP-2 (see the October 1984 BYTE U.K., page 381). McQueen now works at Bell Laboratories in the U.S. I should stress that Hope is a purely experimental language right now, and it lacks some of the features required for production programming.

Unlike LISP and Prolog, Hope source code looks quite familiar to

programmers with a knowledge of, for instance, Pascal. Some of this familiarity is illusory, however, as the symbols don't mean what you'd expect from experience of a procedural language. As an example, take the factorial program

```
dec fact : num -> num ;
--- fact( 0)      <= 1 ;
--- fact( succ( n)) <=
  ( succ( n) x fact( n)) ;
```

The first line declares a function called fact, which takes an argument of type num and returns a result of type num. The next two lines are equations that define the function's value for all possible cases (type num represents positive integers so the negative case doesn't arise). In the case that its argument is 0, then it returns the value 1. In any other case the factorial of one-more-than-n is

(continued)

Classy Chassis

3315
5" Floppy/Winchester
7 Cards \$417*

3310
5" Floppy/Winchester
4 Cards \$387*

3002T
5" Floppy/Winchester
10 Cards \$565*

3307
8" Floppy/5" Winchester
7 Cards \$494*

laser
3000

MAIN/FRAMES & DISC ENCLOSURES FROM \$100

LASER 3000 DISC/COVERS (not shown)

3916F
5" Floppy \$100*

3915
2 ea. 5" Winchester \$199*

* 1 piece; prices lower in quantity.

INTEGRAND

RESEARCH CORPORATION

(Disk drives not included)

8620 Roosevelt Ave./Visalia, CA 93291 209/651-1203

AMPRO
"Little Board"
MAIN/FRAMES
6 Models from **\$125***

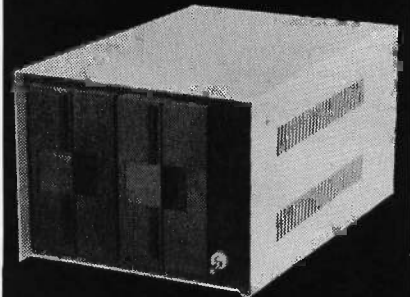

\$150 (1 piece*)

MODEL 2800
Includes power supply & fan

(Disk Drives and Little Board not included)
AMPRO & Little Board are TM AMPRO computers.

INTEGRAND

RESEARCH CORPORATION

8620 Roosevelt Ave./Visalia, CA 93291

209/651-1203

SAVE YOUR MEMORY

EDC IS FOR EVERYBODY!

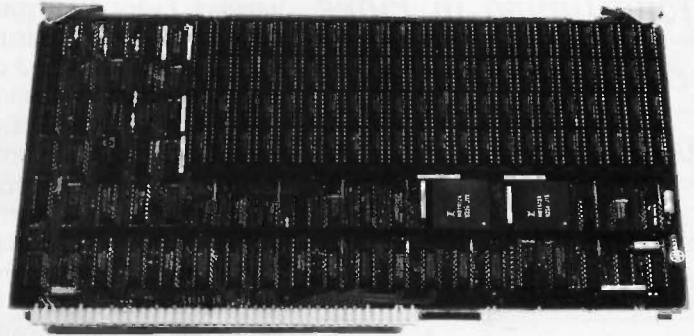
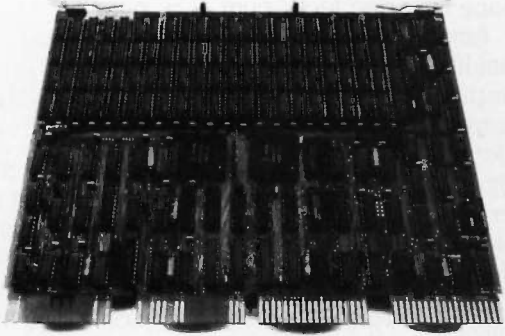

ERROR DETECTION AND CORRECTION MEMORY FOR QBUS and MULTIBUS

2MB ONLY \$1935

- Lowest Pricing
- Fastest Delivery



- Fastest Access
- 24 Hour Repair

Chrislin knows that faulty memory for a computer serving business or science is unacceptable. That is why, **ERROR DETECTION AND CORRECTION (EDC) ON A MEMORY IS NECESSARY.** EDC provides a computer system with unbeatable performance and reliability. Without EDC implemented, an error could occur in a matter of days. But with EDC implemented, the likelihood of an error would be a matter of years. And that's not all! Each board has a 5 year warranty, 24 hour repair, and each QBUS memory comes with a software support program for onsite repair or service. Add reliability to your computer memory and take a step forward by placing your order today.

Also try our QBUS compatible Systems and Subsystems.

"OFFERING QUALITY WITH AFFORDABLE PRICING"



Chrislin Industries, Inc.

31352 Via Colinas • Westlake Village, CA 91362

Telephone (818) 991-2254 • TWX 910-494-1253 CHRISLIN WKVG

AUTHORIZED DISTRIBUTORS: Mississauga, Canada—Transduction Ltd (416) 625-1907;

France—SNGA/Auctel (1)736.87.00, Peru—General Trading Corporation (51)-14-222506.

QBUS is a trademark of Digital Equipment Corporation

MULTIBUS is a trademark of Intel Corporation

Strong typing in Hope is called polymorphic typing and is of a different and more flexible sort than that in Pascal and Modula-2.

one-more-than-n times the factorial of n.

The function succ (for "successor"), which returns a number one more than its argument, is called a "constructor" function; in particular it is a constructor function for the positive

integers. Every data type in Hope is built by its own constructor function(s). When we write a constant like 3, we are, in fact, evaluating a function called 3 whose value is, not surprisingly, 3, but that 3 is shorthand for the expression succ(succ(succ(0))).

The identifier n doesn't refer to a variable in the traditional sense but is a formal parameter that refers to the argument passed to the function at run time and has meaning only for the duration of the function application.

Two other things are important to note. The <= symbol does *not* refer to anything being assigned to anything but means "is defined as," "could be replaced by," or "could be rewritten as." Such program lines, introduced by ---, are called "recursion equations." The second point is that the order is quite unimportant; I could as easily write

```
dec fact : num -> num ;
--- fact( succ( n)) <=
    (succ( n) x fact( n)) ;
--- fact( 0) <= 1 ;
```

with the same effect.

Strong typing in Hope is of a different, more flexible sort than that in Pascal and Modula-2. It's called "polymorphic" typing, which means that you can write functions that will work on any type, while still controlling the relation between argument and result type. This is accomplished by using type variables in place of actual types in the declaration. For example,

```
typevar any;
dec member : any X list (any)
    -> truval ;
--- member ( x, nil) <=
    false ;
--- member ( x, y::z) <=
    true if x = y else member ( x, z);
```

(continued)

CAD SYSTEM

2D, 3D — CALL
Plotters, Digitizers, Software

COMPUTERS

- IBM PC 64K 1 DR.....CALL
- IBM PC 256K 2½ HT DR.....\$1535
- IBM PC 256K 2½ HT DR + 10 MB.\$2275
- IBM PC 256K 2½ HT DR + 20 MB.\$2459
- SANYO COMPUTERS.....CALL
- IBM XT.....\$3395
- IBM AT (AVAILABLE).....CALL

SOFTWARE

ALL IBM SOFTWARE AVAILABLE..CALL

MONITORS

- PGS MAX 12/HX 12.....\$189/460
- QUIMAX MONO/COLOR.....\$165/450
- AMDEK 310A/600.....\$165/399
- POLO COLOR.....\$335
- SAMSUNG AMBER.....\$145

DISK DRIVES

- 10 MB INTERNAL.....\$695
- 20 MB INTERNAL.....\$995
- TEAC ½ HT 360 KB.....\$125

- IBM FULL HT 360 KB.....\$159
- 20 MB FOR AT.....\$1109
- TAPE BACKUPS.....CALL

HARDWARE

- HERCULES COLOR/MONO.....\$179/315
- 64K RAM/256K RAM.....\$20/99
- AST 6 PACK + 64 K.....\$249
- TECMAR GRAPHIC MASTER.....\$450
- AST ADVANTAGE.....\$450
- 8087/80287.....\$149/375
- SIGMA PRODUCTS.....CALL
- QUADRAM.....CALL
- PARADISE.....CALL

WILL SHIP C.O.D. WITHIN U.S.A.

DISKETTES

- VERBATIM DS/DD & SS/DD.\$21.95/14.95
- MAYELL DS/DD.....\$22.00

LEASING ARRANGED UP TO \$1 MILLION AT LOW RATES, CAN INTRODUCE YOUR NEW PRODUCTS TO MARKETS. UPGRADE YOUR PRESENT COMPUTERS WITH 10 MB PLUS HARD DRIVES. COMPANY P.O. WELCOME. MC/VISA + 3% CASH PRICES SUBJECT TO STOCK ON HAND. OPEN 7 DAYS.

PRINTERS

- CABLE.....\$17
- OKIDATA 92P/93P.....\$350/575
- EPSON (ALL PRINTERS).....very low
- BROTHER 15/25/35.....\$375/595/795
- STAR SG & SD SERIES.....CALL
- DTC 480Z 45 CPS.....\$1299
- NEC.....CALL
- TOSHIBA.....CALL
- DIABLO.....CALL
- PANASONIC.....CALL
- JUKI 6100/6300/2200.....CALL

MODEMS

- HAYES 1200/1200B.....\$450/359
- BIZCOMP.....\$349

Call us to check current prices
800-621-0854 x 905
800-272-0045 (Calif. only)
800-824-5257
Telex 5101000015 Comp.

ADVANCED COMPUTER SYSTEMS

Sunnyvale
Fremont
San Francisco
Walnut Creek
San Jose

665 Grape Ave.
39138 State St.
690 Market St.
1987 No. Main St.
N. 1st St.

(408) 732-6200
Town & Faire Center
(415) 397-1311
(415) 945-8011
(408) 293-7860

Viasyn's inspiration for the CompuPro 816 family.



Durability.

The Army battle tank is probably the epitome of ruggedness and reliability. It has to be. A lot depends on its survival under a variety of extreme conditions.

So it is with Viasyn's CompuPro 816 computer. A multi-user family with dependability that outlasts the competition, regardless of the field conditions. Not to mention superior cost-effectiveness, flexibility, a one- or two-year warranty, and expandability that lets you network up to 255 systems.

You can see the 816 in action at your local Full Service CompuPro® System Center. Call us toll-free for the location nearest you. And talk to trained specialists interested in understanding your needs, and providing the optimum system to satisfy them.

And find out how it can help your business win the war against unproductivity.

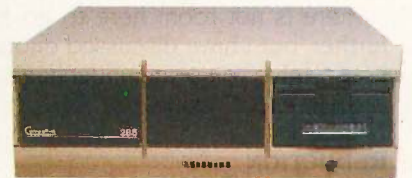

VIASYN™

The CompuPro People

Where Computers Grow

3506 Breakwater Court, Hayward, CA 94545 • Call 800/VIASYN-1 • In CA, 415/786-0909

CompuPro is a registered trademark of Viasyn Corporation.

yields a function that tests whether its first argument *x* is a member of the list that is its second argument. The type declaration says that *member* must receive as arguments an object of type *any*, and a list of the same type of objects, and it returns a result of type *truval* (the Hope equivalent of Boolean). For instance,

```
member(2,[1,2,3]);
true : truval
```

is the same as saying

```
member ('b','aardvark');
false : truval
```

and any will be replaced at run time by type *num* or type *char*, respectively (notice that strings are lists of *char*). The constructor function `::` is for lists (`y::z` means "the list whose head is *y* and tail is *z*") and is itself polymorphic, as is *nil*, the empty list constructor. You use `::` like an infix operator rather than a function `::(y,z)`—this privilege can be extended to any user-defined function in Hope.

There is much more to Hope than this brief glimpse. Unlike Pascal, it enables you to pass structured data types to functions and return them as results. Data types of any complexity can be defined by the user, and they can be made polymorphic. So you could define a type *tree(alpha)*—a binary tree of objects of arbitrary type—and then write functions that operate on such trees regardless of the type of objects they contain. It also supports proper mathematical sets in addition to lists.

There is not room here to go any further, but I have discussed enough here to give you some understanding of how ALICE works.

REDUCTION

You'll notice that in all the preceding examples the left-hand side of the equation is merely an application of the function being defined to some pattern describing a possible form of its arguments; for example, `member(x, y::z)` says "the first argument can be anything at all, but the second must be a list with at least one element." The equation's right-hand side

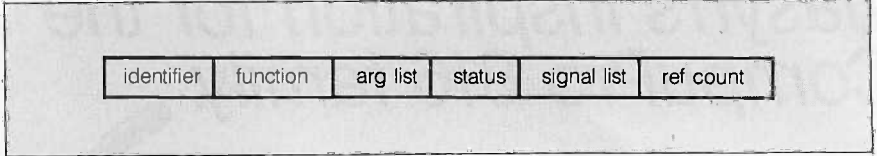

Figure 1: Packet structure.

describes an expression that can be substituted for a call of this sort (i.e., one whose actual arguments match the pattern).

The execution of a program proceeds by progressively rewriting expressions, using the appropriate recursion equation as a *rewrite rule*. Let's see how it works on `member('a','bat')`.

1. `member('a','bat')` doesn't match `member(x,nil)` because "bat" isn't *nil*. Try another.
2. `member('a','bat')` does match `member(x,y::z)` if *x* is 'a', *y* is 'b', and *z* is "at". The equation says we can therefore rewrite it as *true* if 'a' = 'b' (which it doesn't) or else as `member('a','at')`. Do the latter.

In this process we have successfully *reduced* `member('a','bat')` to the simpler `member('a','at')`. If you perform a second reduction of *this* expression, you'll end up with *true*, which can't be reduced any further because it doesn't involve the application of a *reducible function* that has rewrite rules. Constructor functions are the equivalent of constants in Hope and are not reducible—*true* is a constructor for type *truval*.

This process of reduction of expressions permits parallel evaluation because, in a side-effect-free language, subexpressions on the right-hand side of an equation can be evaluated (i.e., reduced) independently of one another.

THE ALICE IMPLEMENTATION

In ALICE, expressions are stored as *packets*, which are fixed-size blocks of data each divided into a number of fields. The overall structure of a packet is shown in figure 1.

A pool of these packets is maintained in RAM, and the processing agents sit around this pool fishing for

packets. A processor pulls a packet out of the pool and checks what function is referred to in its function field. If it is a reducible function, the processor will try to reduce it and then throw it back into the pool. As long as there is work for them to do, all the processors can operate at once.

Of course it isn't quite that simple. For one thing, reduction of a packet often creates several packets (the joke among the ALICE team is that it's called reduction because it makes things bigger). In fact, this is necessary to exploit parallel processing.

Let's see how `fact(3)` gets evaluated in terms of packets. (This is not exactly as ALICE would do it; I've simplified the schema in some details to increase clarity.) The reductions involved are

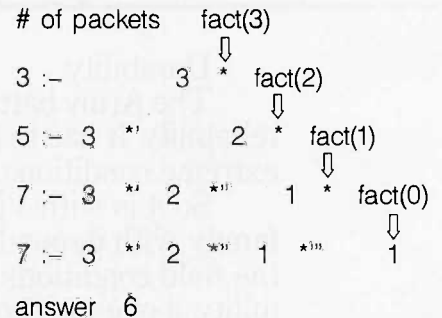

The packet representing `fact(3)` gets rewritten to contain `*` instead of `fact`, and it spawns two new packets whose identifiers are put on its argument list. These contain 3 and `fact(2)` and are created from two empty packets grabbed from the pool. There are now three packets. The one for `fact(2)` then is rewritten and spawns two more offspring, making five, and so on until seven packets exist.

The packets containing the integers 3, 2, and 1 are not reducible and the `*` packets can't be reduced further while one of their arguments is still

(continued)

Kimtron

MULTI-USER SOLUTION for IBM PC, XT, AT

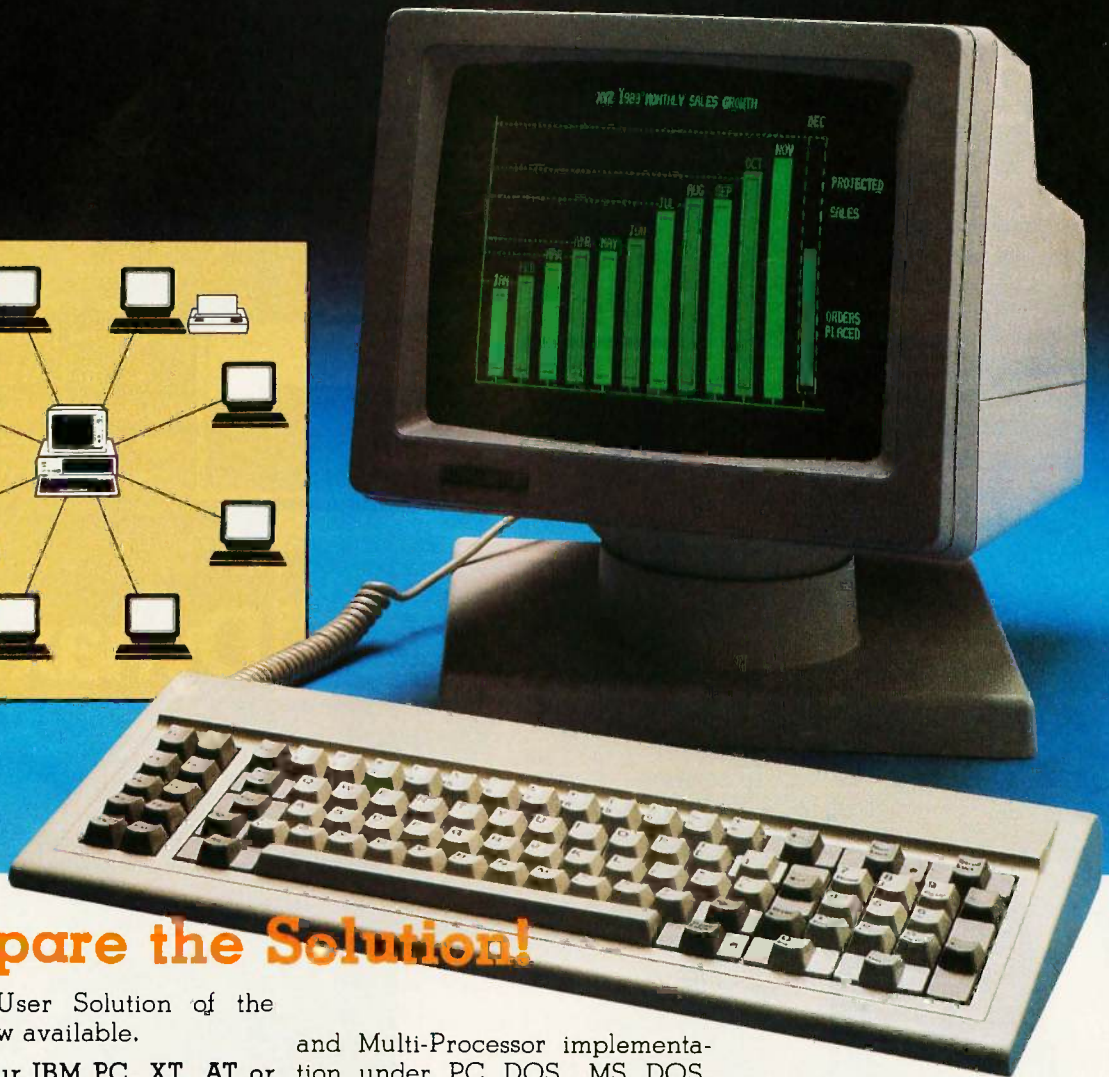
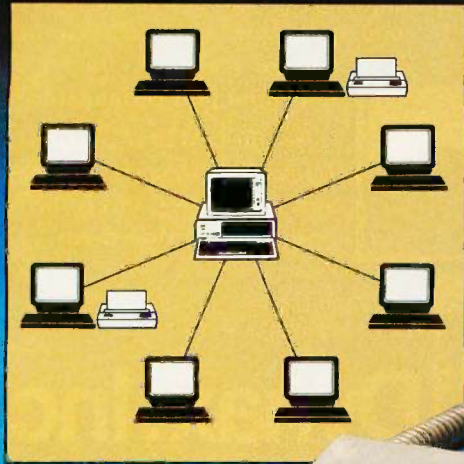

Compare the Solution!

The Multi-User Solution of the future is now available.

Convert your IBM PC, XT, AT or Compatibles to a true multi-user system while maintaining display, keyboard and software compatibility.

Since the KT-7/PC display is the same as your PC monochrome monitor, with its look-alike keyboard, operators will feel they're using an IBM PC and can also use the same software manual. Kimtron's multi-user solution includes file and record locking, shared data access, and communication between users. It is the intelligent alternative.

The KT-7/PC supports Time Sharing, Enhanced Time Sharing

and Multi-Processor implementation under PC DOS, MS DOS, UNIX, XENIX, CPM 86, Multilink, Concurrent PC DOS, and other compatible multi-user operating systems.

Kimtron's multi-user solution may be tailored for cost effectiveness; as low as \$1095 for an additional user, and for speeds more than ten times faster than LAN. You can add one or as many as 31 additional users per PC. Kimtron delivers the future now by allowing an ever-widening network of multi-user PC's.

The KT-7/PC may be complemented with one (or more) I/O Card, Memory Card, 8086 Speed

Enhancer Card, 80286 AT Card, 8088 Multi-Processor Card, 80186 Speed Enhancer Card, 68000 Card, and related software.

For more information about Kimtron's Multi-User Solution, or general video data terminals for other mini or micro multi-user systems, call your local computer dealers, distributors or Kimtron Corporation Today!

(408) 727-1510

See us at Comdex, Booth #4636



1705 Junction Court
Building #160
San Jose, CA 95112

Kimtron

NOTE: IBM PC, XT, AT, PC DOS, MS DOS, UNIX, XENIX, CPM 86, Multi-Link, Concurrent PC DOS are registered trademarks of IBM Corporation, Microsoft Corp., Bell Labs., Digital Research Inc., Software Link Inc. respectively.

FORTIS

DM20, The Heavy Duty Professional

At last, letter quality for the president, spreadsheets for accounting and graphs for marketing. All from one printer . . . the new technology DM20 dot matrix.

Refinement of the print head design reduced the diameter of the wire pins. This produced sharper and crisper characters in the letter quality mode. Both the letter and draft modes offer a number of type styles, all software selectable.

A unique set of front panel controls for setting characters per inch and line spacing helps place this multi-purpose printer above the competition.

DEAR CUSTOMER:

Research indicates
translates into a

This work-horse comes standard with both parallel and serial interfaces making it compatible with all popular computers. It emulates Epson* and IBM* printer control codes. A tractor for long print jobs is standard.

See the DM20 at your dealer. Look at the quality. One look and you'll agree, this is the one printer for all your needs.

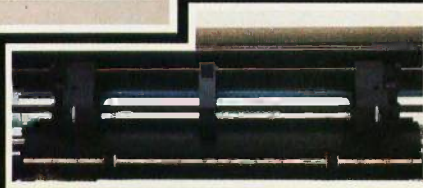
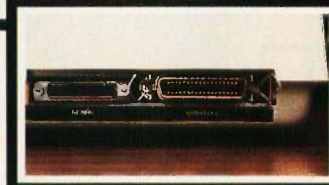

*Epson and IBM are registered trademarks of Epson Corporation and International Business Machines Corporation

Dynax, Inc.™



FORTIS

See us at Comdex, Booth #W5036

DYNAX, INC. OFFICES

■ HEADQUARTERS 6070 Rickenbacker Rd., Commerce, CA 90040 • (213) 727-1227
■ NEW JERSEY One Madison St., East Rutherford, NJ 07073 • (201) 471-0100
■ TEXAS 6012 Campus Circle, Suite 250, Irving, TX 75062 • (214) 257-1700

■ ILLINOIS 533 West Golf Rd., Arlington Heights, IL 60005 • (312) 228-0707
■ MASSACHUSETTS 400 W. Cummings Park, Suite 5300, Woburn, MA 01801 • (617) 933-8162
■ N. CALIFORNIA 1255 Oakmead Parkway, Sunnyvale, CA 94086 • (408) 730-1712

*ALICE's network
allows packet-pool
segments and any pair
of processing agents
to communicate and
operates at 200
megabits per second.*

not an integer. In this situation, the thwarted parent packet puts its name on the signal list of the offending offspring packet, which means "let me know as soon as you have a value," and goes to sleep. When the final fact(0) packet is rewritten to 1, these signals are sent out and all the * packets know their arguments are ready, at which point they flag themselves as being reducible and are snapped up by the next free processor.

This program doesn't exploit parallelism as well as it might, because at each generation there is only one immediately rewritable packet created, thus providing work for only one processor during the middle part of the evaluation.

The function factlist, which returns a list of the factorials of a list of numbers, will perform better.

```
dec factlist: list(num) - >
  list(num);
--- factlist(nil) <= nil;
--- factlist(x::y) <=
  fact(x)::factlist(y);
```

When this program is run, two rewritable packets are created (one for fact and one for factlist) at each generation

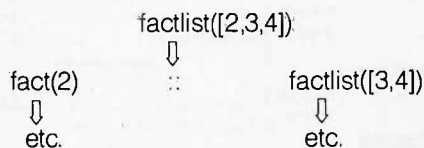

and these can be reduced in parallel.

in turn creating work for more processors. You'll see that the full benefit of parallelism is only obtained by writing programs with the maximum possible number of recursive sub-expressions.

There are other more complex considerations, which cannot be fully dealt with here, relating to this evaluation mechanism. Sometimes it's necessary that subexpressions on the right-hand side of an equation be evaluated sequentially. For instance, in the expression 0 if x = 0 else 1/x, a divide-by-zero error would occur if both parts were always evaluated, so the test must be done first. Similarly, during I/O (input/output), it's necessary to print things in sequence, not all at the same time.

ALICE provides an alternative mode of evaluation (which is flagged by the programmer in the source code) that suspends execution of a subexpression. This also makes "lazy evaluation" possible; data structures with an infinite number of elements can be defined, but only those elements that are needed are ever generated.

HARDWARE

ALICE is conceptually composed of just a packet pool and a gang of processors, but the real hardware is organized into four types of functional units; a number of processing agents and packet-pool segments, an inter-connection network, and a distribution system.

Processing agents and packet-pool segments are implemented by the same hardware unit consisting of two Transputers (see "The Transputer" by Paul Walker on page 219) and 256K bytes of RAM; the memory segments are therefore "intelligent." Two such units are mounted on a single board. Which role a unit will play is determined by Occam programs loaded into its Transputers at initialization.

The packet pool is thus not a contiguous memory block but is distributed throughout the system in discrete 256K-byte segments. This is preferable to the alternative that would require the RAM to be multiplexed as many times as there are

processors. Instead a network is used to allow the segments and processors to communicate.

Designing this network was one of the big challenges of the project, as its performance crucially affects system throughput. The final design is a delta network whose building block is a four-by-four crossbar switch, implemented as a custom chip in ECL (emitter-coupled logic). This network allows any pair of processing agents and packet-pool segments to communicate and operates at 200 megabits per second.

The distribution system is a multi-channel system bus upon which the identifiers of both processible and empty packets are circulated (as separate streams). Any processing agent can grab the next packet that comes along and start to process it, communicating over the network to find the packets containing its arguments and the rewrite rules. Once reduced, the packet is put back onto the bus (as are any newly created packets), to be picked up and processed further elsewhere.

Garbage collection is performed by reference counting; a field (ref count) in each packet records the number of other packets that refer to it. When this count falls to zero, the packet can be put on the "empty" stream. Garbage collection is thus happening all the time, concurrently with processing, and all through the system.

ALICE doesn't actually execute Hope directly but uses an "assembly language" called CTL (compiler target language).

Compilers have been written to compile Hope, Prolog, Parlog (parallel Prolog), and LISP into ALICE CTL. The ALICE hardware has a special mode that permits direct assignment to packets and, together with suspended evaluation for sequencing, this enables conventional procedural languages like Pascal to be supported if required. In this case, the multiple processors could be used (given a suitable operating system) to serve multiple users, as they would not otherwise provide any performance benefit. ■

COMPUTER MAIL ORDER

THE CMO ADVANTAGE

- ✓ THE BEST PRICES!
We will meet or beat any qualified price you find.
- ✓ Next day shipping on all in stock items.
- ✓ Free easy access order inquiry.
- ✓ Orders from outside Pennsylvania and Nevada save state sales tax.
- ✓ Free technical support with our factory trained technical staff.
- ✓ There is no limit and no deposit on C.O.D. orders.
- ✓ There's no extra charge for using your credit card. Your card is not charged until we ship.
- ✓ We accept purchase orders from qualified corporations. Subject to approval.
- ✓ Educational discounts available to qualified institutions.
- ✓ FREE CATALOG MEMBERSHIP.

ORDER LINE

1-800-233-8950
In PA 1-800-242-4215

CUSTOMER SERVICE AND TECH SUPPORT
1-717-327-1450

MAILING ADDRESS

EAST

Dept. A105, 477 E. Third St.
Williamsport, PA 17701

WEST

Dept. A105, P.O. Box 6689
Stateline, NV 8944



Inquiry 102

MEMBER DIRECT MARKETING ASSOCIATION

CREDIT CARDS



SHIPPING

Add 3%, minimum \$5.00 shipping and handling on all orders. Larger shipments may require additional charges.

All items subject to availability and price change.

Returned shipments may be subject to a restocking fee.

CANADIAN ORDERS

1-800-268-3974
Ontario/Quebec

1-800-268-4559
Other Provinces

1-416-828-0866
In Toronto

TELEX: 06-218960

2505 Dunwin Drive,
Mississauga, Ontario
Canada L5L1T1

All prices shown are for U.S.A. orders.
Call The Canadian Office for Canadian prices.

HOME COMPUTERS

APPLE

APPLE IIe.....	CALL
APPLE IIc.....	CALL
MacINTOSH.....	CALL
IIc LCD Display.....	CALL



65XE (64K).....	NEW CALL FOR PRICES
130XE (128K).....	
130ST (128K).....	
520ST (512K).....	

600XL & 800XL CALL WHILE SUPPLIES LAST

850 Interface.....	\$109.00
1010 Recorder.....	\$49.99
1020 Color Printer.....	\$79.99
1025 Dot Matrix Printer.....	\$199.99
1027 Letter Quality Printer.....	\$269.99
1030 Direct Connect Modem.....	\$69.99
1050 Disk Drive.....	\$179.99
Touch Tablet.....	\$64.99
7097 Atari Logo.....	\$74.99
4018 Pilot (Home).....	\$57.99
5049 VisiCalc.....	\$59.99
CX30 Paddles.....	\$11.99
CX40 Joystick.....	\$7.99
4011 Star Raiders.....	\$12.99
4022 PacMan.....	\$16.99

BOARDS FOR ATARI

Axlon 32K.....	\$39.99
Axlon 48K.....	\$69.99
Axlon 128K.....	\$269.99
Microbits 64K (600).....	\$109.00
Bit 3 Full View 80.....	\$239.00



NEW

Commodore 128, LCD..CALL

SX-64 Portable.....	\$499.00
Commodore Plus 4.....	\$199.00
CBM 64.....	\$149.00
C1541 Disk Drive.....	\$199.00
C1530 Datasette.....	\$39.99
M-801 Dot Matrix Printer.....	\$189.00
M-802 Dot Matrix/Serial.....	\$219.00
MCS 803 Dot Matrix.....	\$179.00
C1802 Color Monitor.....	\$199.00
C1660 Auto Modem.....	\$59.99
DPS 1101 Daisy Printer.....	\$339.00

Professional Software

Fleet System II w/Spell.....	\$59.99
------------------------------	---------



File (64).....	\$59.99
Report (64).....	\$59.99

Precision Software

Superbase 64.....	\$54.99
-------------------	---------



PaperClip w/Spell Pack.....	\$79.99
The Consultant DBMS.....	\$69.99
Bus Card II.....	\$139.00
80 Col Display.....	\$139.00

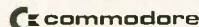

CBM 8032.....	\$639.00
CBM 4032.....	\$599.00
2031 LP Disk Drive.....	\$299.00
8050 Disk Drive.....	\$999.00
8250 Disk Drive.....	\$1249.00
4023 Printer.....	\$329.00
8023 Printer.....	\$589.00
6400 Printer.....	CALL
Z-RAM.....	\$299.00
Silicon Office.....	\$299.00

Professional Software

Word Pro 4 Plus/5 Plus each.....	\$239.00
Info Pro.....	\$179.00
Administrator.....	\$399.00
Power.....	\$69.99

PORTABLE COMPUTERS



41CV.....	\$189.99
41CX.....	\$249.99
HP 71B.....	\$419.99
HP 11C.....	\$62.99
HP 12C.....	\$89.99
HP 15C.....	\$89.99
HP 16C.....	\$89.99
HP 75D.....	\$999.99
HPIL Module.....	\$98.99
HPIL Cassette or Printer.....	\$359.99
Card Reader.....	\$143.99
Extended Function Module.....	\$63.99
Time Module.....	\$63.99

We stock the full line of HP calculator products

NEC

PC-8401.....	\$749.00
PC-8201 Portable Computer.....	\$299.00
PC-8231 Disk Drive.....	\$599.00
PC-8221A Thermal Printers.....	\$149.00
PC-8281A Data Recorder.....	\$99.99
PC-8201-06 8K RAM Chips.....	\$105.00

SHARP

PC-1350.....	\$159.99
PC-1261.....	\$159.99
PC-1260.....	\$109.99
PC-1500A.....	\$165.99
PC-1250A.....	\$88.99
CE-125 Printer/Cassette.....	\$128.99
CE-150 Color Printer Cassette.....	\$171.99
CE-161 16K RAM.....	\$134.99

DRIVES

HARD ALLOY

PC Stor.....	CALL
PC-Disc.....	CALL
PC QIC-Stor.....	CALL
PC Back-Up.....	CALL

EVEREX

Hard Drives.....	CALL
Tape Back Up.....	CALL



5 meg Removable/Internal.....	\$1399.00
10 meg Fixed/Internal.....	\$1249.00
15 meg 5 Removable/10 Fixed.....	\$2149.00
25 meg 5 Removable/20 Fixed.....	\$2499.00

MEGA™

10 meg Bernoulli Box.....	\$2149.00
20 meg Bernoulli Box.....	\$2799.00

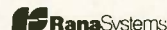

10 meg Internal.....	\$699.00
----------------------	----------



20, 30, 80 meg (PC).....	from \$2399.00
--------------------------	----------------

FLOPPY

INDUS

Apple GT.....	\$209.00
Atari GT.....	\$249.00
C-64 GT.....	\$259.00



A1.5 Apple.....	\$199.00
A2 Apple.....	\$199.00

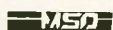

SD1 C-64 Single.....	\$269.00
SD2 C-64 Dual.....	\$469.00



Rana 1000 (Atari).....	\$199.00
Elite 1 (Apple).....	\$189.00



320K 5 1/4" (PC).....	\$129.00
-----------------------	----------

MODEMS

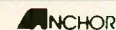

Volkmodem.....	\$59.99
Volkmodem XII.....	\$189.99
Mark II Serial.....	\$79.99
Mark VII (Auto Ans/Auto Dial).....	\$99.99
Mark XII (1200 Baud).....	\$259.00

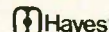

Smartmodem 300.....	\$199.00
Smartmodem 1200.....	\$389.00
Smartmodem 1200B.....	\$359.00
Smartmodem 2400.....	\$699.00
Micromodem IIe.....	\$249.00
Smart Com II.....	\$89.99
Chronograph.....	\$199.00



Reach 1200 Baud Half Card.....	\$399.00
--------------------------------	----------

micro MICROBITS

MPP-1000E AD/AA (Atari).....	\$109.00
MPP-1064 AD/AA (C-64).....	\$69.00



Smart Cat Plus.....	\$329.00
J-Cat.....	\$99.99
Smart Cat 103.....	\$179.00
Smart Cat 103/212.....	\$399.00
AutoCat.....	\$219.00
212 AutoCat.....	\$549.00
Apple Cat II.....	\$249.00
212 Apple Cat.....	\$449.00
Apple Cat 212 Upgrade.....	\$259.00
Macmodem 1200B.....	\$339.00

TELELEARNING

C64 300 Baud.....	\$49.99
-------------------	---------



ZT-1.....	\$339.00
ZT-10.....	\$309.00
ZT-11.....	\$369.00

DISKETTES

maxell.

5 1/4" MD-1.....	\$17.99
5 1/4" MD-2.....	\$23.99
8" FD-1.....	\$39.99
8" FD-2.....	\$49.99



5 1/4" SS/DD.....	\$21.99
5 1/4" DS/DD.....	\$29.99



5 1/4" Disk Head Cleaner.....	\$14.99
-------------------------------	---------

Dennison

Elephant 5 1/4" SS/SD.....	\$14.99
Elephant 5 1/4" SS/DD.....	\$16.99
Elephant 5 1/4" DS/DD.....	\$19.99
Elephant EMSP 5 1/4".....	\$24.99

DISK HOLDERS

INNOVATIVE CONCEPTS

Flip-in-File 10.....	\$3.99
Flip-in-File 50.....	\$17.99
Flip-in-File 50 w/lock.....	\$24.99
Flip-in-File (400/800 ROM).....	\$17.99

AMARAY

50 Disk Tub.....	\$9.99
------------------	--------

GRAPHICS

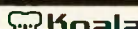

Atari.....	\$39.99
C-64.....	\$59.99
IBM.....	\$89.99
Apple/Franklin.....	\$79.99



Super Sketch Pad (C-64).....	\$39.99
Super Sketch Pad (Atari).....	\$39.99

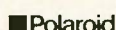

Palette.....	\$1399.00
--------------	-----------

CALL TOLL-FREE

MONITORS

AMDEK

300 Green.....	\$129.00
300 Amber.....	\$149.00
300 Color/Audio.....	\$259.00
310 Amber IBM-Plug.....	\$169.00
Color 500 Composite/RGB.....	\$389.00
Color 600 Hi-Res (640x240).....	\$439.00
Color 700 Hi-Res (720x240).....	\$499.00
Color 710 Long Phosphor.....	\$579.00

BMC

9191U Color.....	\$199.00
------------------	----------

NAP

12" Amber.....	\$69.99
12" Amber/Green TTL.....(ea.)	\$119.00

NEC

JB 1260 Green.....	\$99.99
JB 1201 Green.....	\$139.00
JB 1205 Amber.....	\$139.00
JB 1215 Color.....	\$229.00
JC 1216 RGB.....	\$379.00
JC 1460 Color.....	\$269.00
JC 1410 RGB.....	\$669.00

PRIN PRINCETON CS

MAX-12 Amber.....	\$189.00
HX-12 RGB.....	\$469.00
SR-12 RGB.....	\$629.00

Sakata

SC-100 Color.....	\$249.00
SG-1000 Green.....	\$129.00
SA-1000 Amber.....	\$139.00

TAXAN

115 12" Green Mono.....	\$99.99
116 12" Amber Mono.....	\$99.99
121 Green TTL.....	\$139.00
122 Amber TTL.....	\$149.00
210 Color RGB.....	\$239.00
400 Med-Res RGB.....	\$319.00
415 Hi-Res RGB.....	\$399.00
420 Hi-Res RGB (IBM).....	\$429.00
440 Ultra Hi-Res RGB.....	\$589.00

QUADRAM

8400 Quadchrome.....	\$479.00
8410 Quadchrome II.....	\$469.00
8420 Amberchrome.....	\$179.00

ZENITH

ZVM 122 Amber.....	\$89.99
ZVM 123 Green.....	\$89.99
ZVM 124 IBM Amber.....	\$149.00
ZVM 131 Color.....	\$299.00
ZVM 133 RGB.....	\$429.00
ZVM 135 RGB/Color.....	\$459.00
ZVM 136 RGB/Color.....	\$629.00

ZENITH

ZVM 122 Amber.....	\$89.99
ZVM 123 Green.....	\$89.99
ZVM 124 IBM Amber.....	\$149.00
ZVM 131 Color.....	\$299.00
ZVM 133 RGB.....	\$429.00
ZVM 135 RGB/Color.....	\$459.00
ZVM 136 RGB/Color.....	\$629.00

INTERFACES

PRACTICAL PERIPHERALS

Graphcard.....	\$79.99
Serial Card.....	\$99.99
Microbuffer II +.....	\$169.00
Microbuffer 32K.....	\$189.00

QUADRAM

Microfazer.....	from \$139.00
Efazer (Epson).....	from \$79.99

Orange Mikro

Grappler CD (C64).....	\$99.99
Grappler + (Apple).....	\$109.00
Grappler 16K + (Apple).....	\$189.00

DIGITAL DEVICES

Ape Face (Atari).....	\$49.99
Uprint (Atari).....	\$59.99
Uprint (C-64).....	\$59.99
Printer Buffer P-16.....	\$79.99

mpe MICROBITS

MB1150 Parallel (Atari).....	\$79.99
MPP-1150 Parallel (Atari).....	\$69.99
MP-1150XL (Atari 1200XL).....	\$69.99
MicroStuffer 64K Print Buffer.....	\$109.00

PRINTERS

AXIOM

AT-100 Atari Interface Printer.....	\$159.00
AT-550 Atari Dual Mode.....	\$259.00
GP-100 Parallel Interface.....	\$189.00
GP-700 Atari Color Printer.....	\$489.00
GP-550 Parallel Printer.....	\$269.00

BMC

BX-80 Dot Matrix.....	\$229.00
-----------------------	----------

CITIZEN

MSP-10 (80 col).....	\$349.00
MSP-15 (132 col).....	\$539.00
MSP-20 (80 col).....	\$569.00
MSP-25 (132 col).....	\$729.00

C. ITOH

Prowriter 7500.....	\$219.00
Prowriter 8510P.....	\$299.00
Prowriter 1550P.....	\$469.00
Son of Starwriter A10P.....	\$459.00
Hot Dot Matrix.....	\$459.00
F10-40P Starwriter.....	\$899.00
F10-55 Printmaster.....	\$1049.00

COMREX

ComWriterII Letter Quality.....	\$399.00
---------------------------------	----------

DIABLO

620 Letter Quality.....	\$749.00
630 API Letter Quality.....	\$1549.00

easywriter

2000.....	\$899.00
-----------	----------

EPSON

RX-80, FX-80+, LX-80, JX-80.....	CALL
FX-100+, RX-100, LQ1500.....	CALL
Homewriter 10.....	CALL

JUKI

6100.....	\$399.00
6300.....	\$749.00

MANNESMANN TALLY

Spirit 80.....	\$239.00
160L.....	\$539.00
180L.....	\$699.00

NEC

8027 Transportable.....	\$319.00
2010/15/30/50.....	\$699.00
3510/15/30.....	\$1299.00
3550 IBM.....	\$1369.00
8810/15/30.....	\$1699.00
8850 IBM.....	\$1749.00

OKIDATA

82, 83, 84, 92, 93, 182, 2350, 2410, Okimate-20.....	CALL
Okimate (Specify C64 or Atari).....	\$199.00

OLYMPIA

Needlepoint Dot Matrix.....	\$339.00
Compact RO.....	\$399.00
Compact 2.....	\$439.00

Panasonic

KX1090.....	\$199.00
KX1091.....	\$279.00
KX1092.....	\$409.00
KX1093.....	\$599.00

QUADRAM

Quadjet.....	\$749.00
--------------	----------

SILVER-REED

400 Letter Quality.....	\$279.00
500 Letter Quality.....	\$329.00
550 Letter Quality.....	\$429.00
770 Letter Quality.....	\$779.00

STAR

SG10 (120 cps).....	\$239.00
SG15 (120 cps).....	\$399.00
SD10 (160 cps).....	\$359.00
SD15 (160 cps).....	\$479.00
SR10 (200 cps).....	\$499.00
SR15 (200 cps).....	\$639.00
PowerType Letter Quality.....	\$319.00

TOSHIBA

1340 (80 column).....	\$599.00
1351 (132 column).....	\$1259.00

PC COMPATIBLES

ZENITH

PC-150 Desktop.....	CALL
PC-160 Portable.....	CALL

COLUMBIA DATA PRODUCTS, INC.

2220 Dual Portable.....	\$1999.00
4220 Dual Desktop.....	\$1999.00

SANYO

MBC 550-2 Single Drive.....	\$749.00
MBC 555-2 Dual Drive.....	\$1099.00
MBC 775 Portable.....	CALL

AT&T

Safari.....	CALL
6300.....	CALL

corona

PPC22 Dual Portable.....	\$1599.00
PPCXTA 10 meg Portable.....	\$2799.00
PC40022 Dual Desktop.....	\$2199.00

NEC

PC-8800 8/16 Bit.....	\$1299.00
-----------------------	-----------

SOFTWARE FOR IBM

Lotus

Symphony.....	\$429.00
1-2-3.....	\$299.00

Hayes

Please (Data Base).....	\$199.00
-------------------------	----------

PeachPack (GUAP/AR)

PeachPack (GUAP/AR).....	\$199.00
--------------------------	----------

MicroPro

WordStar 2000.....	\$239.00
WordStar 2000 +.....	\$299.00

MICRORIM

R:Base 4000.....	\$249.00
Clout 2.0.....	\$129.00

MultiMate

Multi Mate.....	\$249.00
-----------------	----------

MICROSTUF

Crosstalk.....	\$89.99
----------------	---------

MICROSOFT

Flight Simulator.....	\$39.99
MultiPlan.....	\$129.00

ASHTON-TATE

Framework.....	\$349.00
dBASE II.....	\$299.00
dBASE III.....	\$369.00

Professional Software

PC Plus/The Boss.....	\$249.00
-----------------------	----------

synapse

File Manager.....	\$49.99
-------------------	---------

ELECTRONIC ARTS*

Get Organized.....	\$69.99
Cut -n- Paste.....	\$39.99
Music Construction.....	\$29.99
One -on- One.....	\$29.99
Financial Cookbook.....	\$34.99

ALPHA

Electronic Desk.....	\$199.00
----------------------	----------

BORLAND INTERNATIONAL

Turbo Pascal.....	\$39.99
Sidekick.....	\$39.99

SPI

Open Access.....	\$379.00
------------------	----------

Harvard Software Inc.

Harvard Project Manager.....	\$209.00
Total Project Manager.....	\$269.00

pfs: IBM/APPLE

Access (NEW).....	\$79.99
Write.....	\$79.99
Graph.....	\$79.99
Report.....	\$74.99
File.....	\$79.99
Plan.....	\$79.99
Proof.....	\$59.99
Mac Software.....	CALL

Human Edge™

Communication Edge.....	\$119.00
Management Edge.....	\$149.00
Negotiation Edge.....	\$179.00
Sales Edge.....	\$149.00

IBM



IBM PC SYSTEMS
Configured to your specifications.
Call for Best Price!

MULTIFUNCTION CARDS

AMDEK

MAI.....	\$249.00
----------	----------

AST

Six Pack Plus.....	\$239.00
Mega Plus II.....	\$269.00
I/O Plus II.....	\$139.00
Memory MBII.....	\$249.00
Advantage-AT.....	\$399.00
Preview Monograph.....	\$299.00
Graph Pak Mono/64K.....	\$599.00
MonoGraph Plus.....	\$399.00
5251/11.....	CALL
5251.....	\$579.00
3780.....	\$639.00
BSC.....	\$499.00

dec

IRMA 3270.....	\$899.00
IRMA Print.....	\$999.00

EAGLE

Color.....	\$199.00
------------	----------

EVEREX

Color Card (Graphics Edge).....	\$299.00
Magic Card.....	\$199.00

HERCULES

Graphics.....	\$319.00
Color.....	\$169.00

IBEA Associates

IDEAmax - ZPR, 64K, C, S, P.....	\$229.00
IDEAmini - YPR, C, S, P.....	\$189.00
IDEAminimax - MPR 128K.....	\$229.00
IDEAshare Software.....	\$219.00
IDES 5251.....	\$649.00

PARADISE

Modular Graphics Card.....	\$279.00
Multi Display Card.....	\$299.00
Five Pack C, S.....	\$169.00

PLANTRONICS

Color Plus.....	\$369.00
-----------------	----------

TEGAAR

Captain - 64.....	\$239.00
Captain Jr. 128K.....	\$339.00
Graphics Master.....	\$469.00

QUADRAM

Quadboard II.....	\$229.00
Expanded Quadboard.....	\$239.00
Quad 512 +.....	\$249.00
Quad 2 Meg.....	\$879.00
Memory Board.....	\$229.00
Quad Jr Exp. Chassis.....	\$539.00
Quad Jr Exp. Memory.....	\$219.00
QuadMem Jr.....	\$229.00
Chronograph.....	\$89.99
Parallel Card.....	\$69.99
Quadcolor I.....	\$219.00
Quadgraph.....	\$379.00

ACCESSORIES

KEYBOARDS

Keytronics Keyboards 5150, 5151, 5151 Jr, 5149 Jr.....	CALL
--	------

MEMORY CHIPS

4164 RAM Chips.....(ea.)	\$2.99
--------------------------	--------

COMPUTER MAIL ORDER

1-800-233-8950

TOLL FREE ORDERS ONLY! **800-631-0962**
 (INSIDE CALIFORNIA) **800-521-6162**

Customer Service **HOTLINE**
 (408) 559-6555

GUARANTEED the LOWEST!

OUR PRICE GUARANTEE - It's Simple! We'll beat any ad in this magazine - same terms - call TOLL FREE for details!

DCC DISCOUNT COMPUTER CENTERS
 OUR CUSTOMER SATISFACTION GUARANTEE: If for any reason your DCC purchase fails to meet manufacturers specifications within 30 days of purchase, please return it to us for a full refund or exchange of your choice! Sorry, software excluded due to copyright laws.

EPSON all models!
 RX/FX and LQ1500 also NEW JX80 (7 colors)
PRINTER SALE!!!
 models 82/83/84 and 92/93!! also 2410 (350 cps!)
OKIDATA

IBM PC \$1650 2 drvs 256K
 or 2 drives/256K, 10 mg hard disk
\$2295
IBM XT \$3395
 10 mg. hard disk
 256K, 1-360Kb drive only

HR-15 XL \$359
BROTHER
 LETTER QUALITY
 • High Speed 36 cps
 • 7K Buffer
HR-35

COMPUTERS

IBM PC & XT See special above!!!
 PC with 1 drive/64K 1395
 PC with 2 drives/256K 1650
 XT with 10 mg HD/128K 3350
 XT with 2 drives/10MG 3475
 Call for details - Compatible brand portables and desktops

PRINTERS

****DOT MATRIX****
 EPSON RX 80 100 cps 235
 RX 80 FT 100 cps 279
 RX 100 100 cps, 132 col 399
 FX 80 or JX 80 best price
 FX 100 160 cps, 132 col in
 LQ 1500 200 cps NEW! magazine
 OKIDATA 82A/83/84 Save
 92P All
 93P Models
 2410 Drastically Reduced!!
 GEMINI 10-X 239
 15-X 349
 DELTA 10 or 15 Special
 RADIX 10 or 15 \$Call

IBM SOFTWARE

****SPREADSHEET****
 FRAMEWORK Monthly Special 355
 FRIDAY 195
 SUPERCALC 3 228
 COGITO 10 MG H.D. W/CONTRL 665
 ATARI INDUS GT 349

IBM - BOARDS

HERCULES GRAPHICS 305
 HERCULES COLOR New! 165
 AST SIX PAK W/64K 249
 MEGAPLUS 259
 STB GRAPHX PLUS 309
 EVEREX GRAPHIC EDGE 379
 H.D. CONTROLLER 299
 MAGIC CARD 199
 QUADRAM QUADBOARD W/64K 269
 QUADLINK 449
 IBM MONOCHROME 249
 COLOR GRAPHICS 219
 PLANTRONICS COLOR PLUS 375
 TECMAR GRAPHICS MASTER 475
 PARADISE COLOR 279

APPLE - BOARDS

ORANGE MICRO GRAPPLER + 113
 BUFFERED w 64K 168
 MICROMAX GRAPHMAX 99
 VIEWMAX 80 139
 VIEWMAX 80E W/64K 189
 MAC DISKETTES 48
 IIC PRINTER INTERFACE 59
 SUPER COOLING FAN 49

MONITORS

IBM MONOCHROME 249
 COLOR 569
 AMDEK 300G 135
 300A 145
 310A 165
 COLOR 600 419
 COLOR 710 NEW 515
 TAXAN 12" Green 114
 12" Amber 117
 420 RGB 439
 PRINCETON HX-12 459
 SR-12 649
 MAX-12 168
 ZENITH 122 - 12" G 93
 12" A 93
 124 MONO - IBM 169
 135 RGB/COMP 475
 POLO 16 COLOR RGB!! 350

MODEMS

HAYES 300 195
 1200 459
 1200B IBM INTERNAL 389
 MICROMODEM II E 209
 ANCHOR MARK XII 244

IBM ACCESSORIES

64K RAM CHIPS 200ns 35
 150ns 35
 IBM KEYBOARDS 159
 KEYTRONICS 5151 NEW! 179
 5150 159
 MICRO-SOFT MOUSE 129
 MOUSE SYSTEM-MOUSE 124
 KOALA PAD 85
 JOYSTICKS - KRAFT/HAYES 45

ACCESSORIES

PRINTER RIBBONS all makes Low!!!
 64K RAM chips SALE 35
 VERBATIM SS/DD diskettes 21
 DS/DD diskettes 27
 DYSAN SS/DD diskettes 26
 DS/DD diskettes 34
 DISK MINDER-PLEXI (75) 19
 DISK MINDER W/KEY (100) 24
 SURGE PROTECTOR Compugard 59
 PTI POWER BACK-UP 200 w 275
 300 w 355
 FINGERPRINTS - EPSON all models 48
 MONI-BASE Monitor Stands 10
 COMPUTER PAPER all makes Low!!!
 PRINTER STANDS Plexiglass 29/39
 SURGE PROTECTORS \$Call

DRIVES

IBM 360 KB 219
 TANDON 100-2 360KB 165
 APPLE DRIVES Sale 135

WORDSTAR

All new-easy to use
 "Windows"
 Footnotes
 Spell Checker
 Much, much more
\$259

MOUSE

mouse systems' w/PC PAINT **\$124**
\$129 micro-soft

ATARI/C-64

ACCESSORIES low, low CALL!!
 C-64 CARD/CO + G 79
 ATARI MP1150 94
 APE FACE 69
 GRAPPLER CD COMMODORE 99

HERCULES

Color graphics card **\$165**
\$309 Mono graphics card

AST \$229
SIX PAK PLUS
 w/64K RAM **\$249**

10 MG 1/2 HI Internal \$665
HARD DISK
 ****SPECIAL****
 w/controller card and cables!!
\$1099 20 MG 1/2 HI Internal

WORDSTAR 2000
\$259

MOUSE \$129 micro-soft

HERCULES \$309

DCC DISCOUNT COMPUTER CENTERS

an established mail order/retail distribution network

BUYER FRIENDLY TERMS! DELIVERY We ship immediately! Most orders delivered within 5 days! Add 3% (15^{min}) for UPS shipping, handling, insurance. Calif. residents add 6.5% sales tax. 2nd day UPS available at extra charge. PAYMENT Visa, M/C, cashiers checks, money orders, personal checks accepted. (Allow 10 business days for personal company checks to clear). WE NEVER CHARGE EXTRA FOR CREDIT CARDS! C.O.D.'s welcome (20% p/p deposit) with cash, certified check or money order. WARRANTY All items shipped are new, include FACTORY WARRANTY and are GUARANTEED TO WORK. DCC is an AUTHORIZED DEALER and SERVICE CENTER for most major brands. RETURNS Must be accompanied by RMA number (supplied by DEALER) and may be subject to a 20% restocking fee. Prices and availability subject to change without notice. All items limited to stock on hand. MAIL ORDER PRICES NOT VALID AT RETAIL OUTLETS DUE TO REGIONAL PRICING RESTRICTIONS. Minimum order *50⁰⁰.

1707 S. BASCOM AVE • CAMPBELL, CA 95008 • (408) 559-6555
 1243 W. EL CAMINO • SUNNYVALE, CA 94087 • (415) 965-4494
 1341 FULTON AVE • SACRAMENTO, CA 95825 • (916) 971-3503

FREE - VISA/MC!



VISIT OUR DISCOUNT SHOWROOMS!

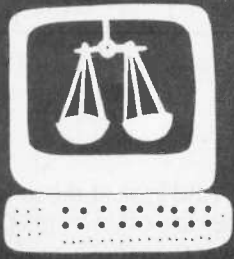

The Sale of Computer Products

A self-help guide for buyers and sellers

BY ROBERT GREENE
STERNE AND
PERRY J. SAIDMAN

In this column we will discuss the legal aspects of buying and selling computer products, an important concern because each stage of the distribution network is involved. We'll deal with computer products—microcomputers of all types, off-the-shelf software packages, printers, floppy disks, computer furniture, and the like—but not services—customization of software, service calls, and so on—since services are treated somewhat differently. We hope you find this a concise self-help guide to be retained and consulted when buying or selling computer products.

We'll examine both pre-sale activities and the sale itself. We'll attempt to present as balanced a view as possible, one that is neither pro-buyer nor pro-seller. However, the subject is, by nature, very buyer-oriented, since sellers in many respects have forced the marketplace to be seller-biased. For clarity we will cast you, the reader, in the role of buyer.

The buyer being discussed is the individual person or business buying for personal or business use. The seller can be in the business of selling computer products—a local store, a mail-order house, a hardware manufacturer, or software publisher—or an individual or business selling computer products on a one-shot basis. This second group is growing exponentially as older products are being supplanted.

THE LAW OF COMPUTER SALES

The legal aspects of computer sales involve a hybrid of federal and state laws. One part is in the form of statutory rules as interpreted by actual court cases. And another part is *judge-made* laws that have evolved over the centuries and trace their ancestry back to England. When you apply this patchwork quilt of legal rules to a given sales situation, you must examine the facts carefully, since it is not uncommon for a single fact to radically alter the end result.

The primary source of federal law is the Federal Trade Commission's (FTC) Rules and

Regulations relating to mail-order sales and to warranties. At the state level, it is Article 2 of the Uniform Commercial Code (UCC) that makes up the bulk of sales law. In certain states, additional laws govern deceptive trade practices. In each state, judge-made laws control those areas not addressed by federal law, the UCC, or the deceptive trade practice laws (if present).

THE BUYER'S RESPONSIBILITIES

As a buyer, your first rule is to check out the product you intend to buy and the various sellers from whom you could buy it. Buyer advocates stress that much pain and aggravation can be avoided if you observe this simple rule.

Take the time to read reputable and in-depth reviews of the product, preferably from a nonpartisan journal. Some buyer advocates recommend that you avoid products that have just been released unless you have the wherewithal to deal with the product shakedown risks.

Find a way to use the product—examine the manual, try to run some functions, and determine if it will operate in its intended environment. You should try to talk to a person currently using the product; reputable sellers will put you in touch with such users.

Check out possible sellers. Price and product availability usually are not the only factors to be considered. Local stores are attractive, since they offer the advantages of product inspection and evaluation, support, and service as well as off-the-shelf delivery. But you should determine whether the product requires support or service. Obviously, a printer does and a floppy disk does not. If support and/or service are important, then you should evaluate the local store's capability to provide them. How well established is the store? What kind of staff does it have and how experienced are they? What reputation do the store and staff have? Do they stand behind the products they sell? Local stores constantly complain

(continued)

Robert Greene Sterne and Perry J. Saidman are attorneys with Saidman, Sterne, Kessler, & Goldstein in Washington, DC. They are also contributing editors for BYTE. They can be contacted c/o BYTE, POB 372, Hancock, NH 03449.

to us that they do all the pre-sale work for mail-order houses, hardware manufacturer, and software publishers who get the sale due to their lower pre-sale overhead. If you intend to use the computer products in a business context where downtime is costly, you should be sensitive to this. You should try to determine if the

local store will be loyal to you if you are loyal to it. As a buyer, you should remember the time-tested adage of being penny-wise and pound-foolish.

Mail-order houses are the real wild cards in the seller's game. As a buyer, you should take a minute to look at magazine advertising. Any computer product imaginable can be purchased

by mail order. And look at those low, low prices. They are often from 10 to 40 percent lower than those available from other sellers. But the support and service are not available, according to many buyer advocates and some seller attorneys. And even more importantly, you should be aware that there is a significantly higher risk that you may get a late delivery or *no delivery at all*.

Mail-order houses argue that they are the force that keeps the marketplace truly competitive, resulting in the amazing gains in the performance/price curve that the microcomputer industry has enjoyed in its 10-year life span. Without them, they argue, the local stores would conspire with manufacturers and publishers and artificially raise prices in the name of support and service. Apple Computer has been on the receiving end of such allegations in the lawsuits spawned by Apple's termination of dealers engaged in so-called *transshipping*—sales through the mail or by phone by sellers who provide little or no pre- or post-sale support or service.

Hardware manufacturers and software publishers make up the third group of regular sellers. They will be glad to talk to you about selling you their products. You should call them up, ask to talk to their sales departments, and get price and delivery quotes. Dealing with the manufacturers offers several advantages. Often they are the ultimate sources of support and service. In other words, the local stores are really fronting for them. You also stand a greater chance of getting the latest version of a product directly from the manufacturer. This is particularly true with small manufacturers and publishers who may not have the dealer network that warrants using a local store. Larger manufacturers may operate company stores in your local area.

Suppose you are about to buy or sell a computer product and the person you are negotiating with is not yet 18 years old. As any experienced seller knows, this is one of the danger points in the law of computer sales.

(continued)



How Do You Measure A C Compiler?

CODE SPEED & SIZE

The Lattice C Compiler "generates code that is quite compact and fast running." *Peter Norton, PC Magazine*

CONSISTENT RELIABILITY

"The Lattice Compiler has performed reliably and predictably." *R. Phraner, Byte Magazine*

COMPILE TIME

"Lattice is a real performer!" *Houston, Brodrick, Kent, Byte Magazine*

THIRD-PARTY LIBRARIES

More than 40 library products are currently available for Lattice

UNIX V COMPATIBILITY

The Lattice Library is UNIX V-compatible

DEBUGGER SUPPORT

The Lattice C-SPRITE Debugger is now available

DOCUMENTATION

Lattice "is thorough and excellent." *D. Clapp, PC Magazine*

UPDATE POLICIES

Lattice provides free bugfix updates for 90 days

COOPERATING PRODUCTS

New LMK Utility, dBC Library, CVUE Screen Text Editor, CURSES Screen Library and GSS Graphics are available from Lattice

VENDOR REPUTATION

Lattice is used in more commercial products than any other C Compiler. No run-time license is required.

ALL MEMORY MODELS

Lattice C has 7 memory models available to allow the best solution for the task at hand

AVAILABILITY OF CROSS COMPILERS

SATISFACTION GUARANTEED!

Ask About Our "Trade Up To Lattice C" Policy



LATTICE®

Lattice®, Inc.
P.O. Box 3072
Glen Ellyn, IL 60138
(312) 858-7950
TWX 910-291-2190

International Sales Offices

Belgium: Softshop. Phone: (32) 53-664875.
England: Round Hills. Phone: (0672) 54675.
Japan: Lifeboat Japan. Phone: (03) 293-2311.

UNIX is a trademark of AT&T Bell Laboratories

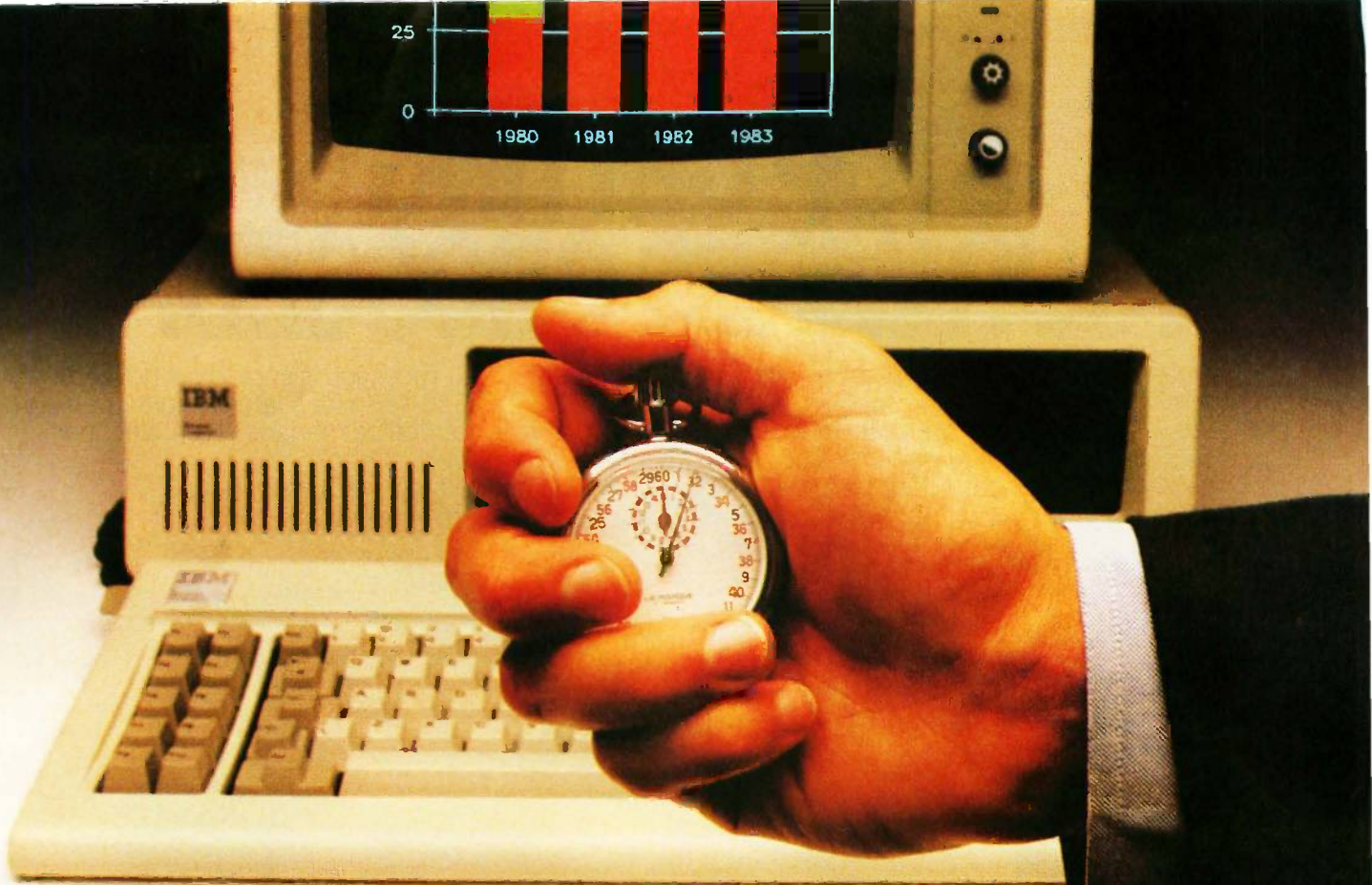

Double your IBM PC's processing speed for under \$650.

AT speed for your IBM PC, with QuadSprint by Quadram.

Quadram introduces a rapid advancement in IBM PC performance. QuadSprint. The innovative expansion board that doubles the processing speed of your personal computer. Just plug the totally transparent QuadSprint into your system and watch **all** your PC programs (Lotus 1-2-3, dBASE III, Wordstar, and more*) run faster and more efficiently than ever before... without special commands or interface software.

But best of all, you can pick up QuadSprint without running up a huge bill. At less than \$650, QuadSprint is about half the price of other accelerator (turbo) cards and turns your PC into a machine that's virtually as fast as the new PC AT.

So make your own rapid advancement. To the Quadram dealer closest to you. And see how to double the processing speed of your IBM PC. With QuadSprint by Quadram.

QUAD*Sprint*[™]

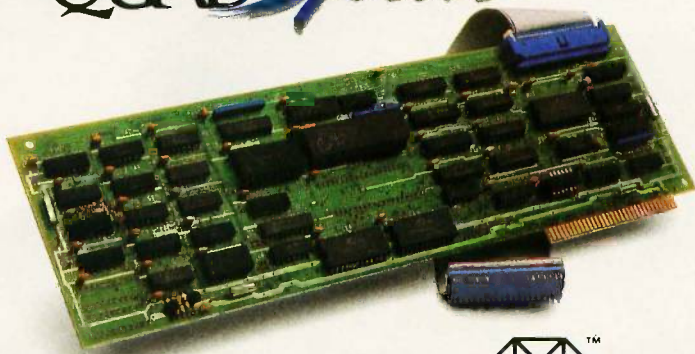

QUADRAM[™]
An Intelligent Systems Company

4355 International Blvd./Norcross, Ga. 30093
(404) 923-6666/TWX 810-766-4915 (QUADRAM NCRS)

Inquiry 335

STOP GETTING YOUR WIRES CROSSED.

One mix up, and a whole project can get thrown off. Which can mean costly delays. With Post-it[™] Notes, you can put important notes or directions right where they'll be seen. The unique, repositionable adhesive means they'll stay put. Then come off as easily as they went on. And the bright

color means your message is sure to get noticed. Call 1-800-328-1684 for a free sample. Then get more from your office manager, local stationer or art supply dealer. With Post-it Notes, you'll never have problems making connections.

Post-it[™]
Note Pad



BILL,
DIDN'T JIM TELL
YOU TO CHANGE
THIS WIRING?
SEE ME
IMMEDIATELY!
JOHN

Commercial Office Supply Division. "Post-it" is a registered trademark of 3M.

3M

Inquiry 2

And with the rapidly expanding used-product market, there is a significant possibility that you may find yourself buying a product from a minor. The rule here is that you should *always* make sure that an adult (a person 18 years or older) signs the written sales contract for the minor. The reason is that a minor is not allowed by law to contract. In effect, a minor could buy or sell a computer product and then void the sale and get his money or product back even though he has made full use of the money or product for a considerable period of time. This rule traces its lineage back to the days when the law sought to protect minors from unscrupulous adults and from themselves. Minors today seldom repudiate their deals, but when big-ticket product purchases are involved, it's prudent to be on the safe side and make sure an adult signs the sales agreement.

THE SALES AGREEMENT

Whether you are the buyer or the seller, you should always use a written sales agreement—a must if the transaction is for more than \$500. And you should always get the other party to sign it or initial it. Sometimes, one party to a sale of over \$500 will try to get the other party to sign the agreement but will try not to sign it himself. A section of the UCC says that a contract for more than \$500 must be in writing and signed by the party that is on the *receiving* end of an enforcement action. Thus, if one party does not sign, that party can enforce the contract against the other party but can prevent it from being enforced against himself.

A sales agreement can be as simple as an itemized note or sales slip or as elaborate as the multisheet printed form with carbon paper that has become commonplace. If you are a buyer, it is imperative to get everything in writing to be able to prove those items that have been agreed upon. On the other hand, if you are the seller, only put in writing that which you intend to provide and nothing more. The reason for this is that the UCC explicitly states that all

discussions that lead up to a written contract are deemed to be contained in the written contract, unless otherwise stated. Most printed agreements, however, contain an integration or entire-agreement clause. This clause is part of the boldface, capitalized verbiage usually found on the front of a form contract near the price or near

where the buyer's signature goes. This clause states in effect that the paper being signed is the entire agreement, understanding, and representation between the buyer and seller and *supersedes all* previous discussions, promises, and understandings. In other words, if it's not in the written

(continued)

You already own a computer that can talk. Now let it.

Now you can upgrade almost any personal computer and make it more powerful than ever, by giving it the power of speech.

The Votrax Personal Speech System is the least expensive sophisticated voice synthesizer available today. The PSS's text-to-speech vocabulary is virtually unlimited, and you can define an exception word table and customize your translations. So the PSS can say just about anything!

It's a speech and sound specialist.

The PSS can also mix speech and sound effects or speech and music. It contains its own speaker, a programmable master clock, 256 programmable frequencies, a programmable speech rate for a more natural rhythm, and 16 programmable amplitude levels for incredible control of word emphasis. You can control the volume. Plus, it doesn't use any of your computer's valuable memory.

It's computer friendly.

The PSS is unbelievably easy to use. It doesn't need an interface card for most computers. It comes with standard serial and parallel ports. Speech, music, and sound effects are as simple as printing out a document.

What do you do with a talking computer?

There are countless practical applications. Businesses may want the PSS for spoken transmission of information, narration of displays, and product demonstrations. It makes verification of data input possible for the blind. It can be part of a burglar alarm system. Children can use the PSS as a study aid. And it helps games come alive, speaking while you play.

Whatever your computer can do, the PSS can help it do it better, at a cost that makes it all worthwhile: only \$395.* Call (313) 583-9884 to hear an actual voice demonstration of the PSS.

*Suggested retail price

There's also the Type 'N Talk.

If you want a less sophisticated unit and want to spend a little less, consider the Votrax Type 'N Talk (TNT). Its vocabulary is also limited only by what you can type. It doesn't use any computer memory, it's compatible with most computers, and it's only \$249.* Just plug it in to your own speaker and go!

For more information about the Personal Speech System or the Type 'N Talk, see your local computer retailer, call toll-free or write:



1394 Rankin
Troy, Michigan 48063
1-800-521-1350
(In Michigan, call collect
313-588-0341)

GIVE YOUR
COMPUTER
THE POWER OF
SPEECH.



The seller should let you read and understand the boilerplate before you sign the contract.

contract, it's not part of the deal. If you are the buyer, you cannot always trust the salesperson to adequately document the deal, so take these simple precautions. It is perfectly reasonable to require that the salesperson let you read and understand the boilerplate of the contract and to have all of the particulars of your deal

entered on the contract *before* you sign it, pay any money, or take possession of the computer products. If a printed form contract is used, make sure all deletions and additions are initialed and dated by the seller in the margin beside the change on all of the copies. Also make sure that the contract is signed by an agent of the seller who has the authority to sign contracts.

Prudent sellers should pay great attention to making sure they have legally strong, well-drafted, and plain-English standard contracts and that their sales personnel are diligent in completing them and having them executed in each computer-product sale. This cannot be overemphasized. In the event of a dispute with a disgruntled buyer, a seller, particularly if selling is the seller's regular business, will be at a great disadvantage if he doesn't have such a written agreement. Furthermore, if a buyer tries to cheat the seller out of money owed, the buyer must have a written contract. And if a seller should be unfortunate and become involved in a defective-computer lawsuit where the buyer may quite legitimately claim consequential and punitive damages in the millions of dollars, a written contract can be the seller's main shield against such liability.

Buyers often tell us that sellers will not change their standard contracts. This is a negotiation as much as a legal issue. If a seller will not document the terms of your deal—the computer products involved, price, delivery date, the name and address of the buyer and seller, any special terms, and the like—then you should probably find a different seller. However, if boilerplate language is the problem, then the issue is much more difficult. Many sellers just won't deviate from their standard agreement, particularly on single-system deals, because they are afraid that if they give in to one, they will have to give in to all future buyers. One way to get around this impasse may be to create a side letter that specifically incorporates the standard agreement but states that the modifications con-

(continued)

GIVE YOUR PC THE GIFT OF SIGHT.



Once installed, our electronic digitizing scanner allows you to capture images in high resolution. These can then be manipulated, stored, retrieved, and even printed.

But what's truly amazing is the range of applications for the Datacopy 700. Such as generating complex documents including text, drawings and pictures.

Until now, your PC was telling only half the story. Because no matter how you look at it, words and numbers are simply that: words and numbers.

But the Datacopy 700 changes all that. **TURN YOUR WORD PROCESSOR INTO AN IMAGE PROCESSOR.**

This remarkable peripheral enables you to combine photos, diagrams, even 3-D objects with word processing, data base, CAD and communications applications using standard software.

All you need to get the picture is an IBM XT, AT, or compatible. Our friendly, yet powerful, Word Image Processing System™ software is included in your purchase.



Technical manuals. Catalogs. Personnel or document files. Or what ever you decide.

The result is a visionary achievement: the power to give words and numbers far more meaning. To publish information, not just data. And to extend the possibilities of your PC. All for a surprisingly low cost.

For more details, call toll-free 1-800-821-2898 or in California 415-965-7900.

Or write to Datacopy Corporation, 1215

Terra Bella Avenue,
Mountain View,
CA 94043. Telex:
701994 DATA-
COPY UD.



DATACOPY
The Eye of the Computer

In the quiet city of Metropolis, SuperSoft Software is turning ordinary business people into

COMPUTER SUPERHEROES

ScratchPad Plus

When faced with the perilous threat of data overflow, this Spreadsheet will NEVER let you run Out Of Memory

ScratchPad Plus is the no-nonsense financial planning spreadsheet suitable for every business Superhero.

- HANDLE HUGE SPREADSHEETS—192K memory is all you'll ever need, it runs in much less. Use up to 9,999 rows or columns. Fill up to 25,000 cells simultaneously. Never see "Out of Memory" again.
- CONSOLIDATE LIKE CRAZY—Take as many spreadsheets as you would like and consolidate them into one. Get totals or averages of all entries.
- ENTER DATA WITH BLINDING SPEED—Enter columns and rows of data with only one hand.
- LEAP TALL PROJECTS IN A SINGLE BOUND—Automatic pagination, format options, data transfer capabilities, windowing, built-in functions, formula display, precise error reporting, and help screens are just some of the time-saving features of ScratchPad Plus.

ScratchPad Plus
(for all PC DOS, MS DOS, CP/M-86,
and CP/M-80 systems): \$195
Demo available: \$19.95

Stats-graph

Create Super Graphs Without Graphics Hardware

Bring excitement and immediacy to your reports and presentations. Create PIE GRAPHS, SCATTER PLOTS, and BAR CHARTS that can be output to any screen, printer, or text file. No matter what kind of system you have—color or black and white, graphics or no graphics, printer or no printer—Stats-graph will create great looking graphs. You can also produce statistics such as regression analysis and standard deviation. And Stats-graph works alone or with ScratchPad Plus, PDB, or any other program which outputs DIF files.

Stats-graph
(for all PC DOS, MS DOS, CP/M-86,
and CP/M-80 systems): \$195
Demo available: \$19.95

Inquiry 383

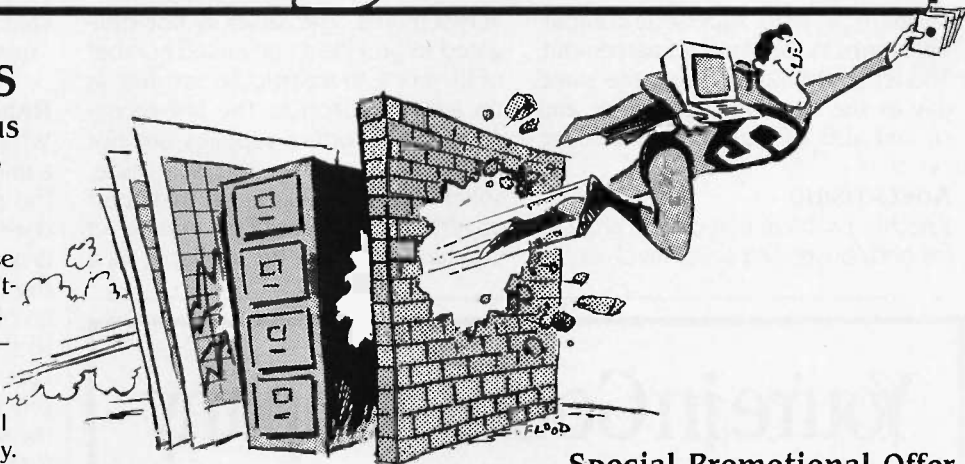

PDB

The Superhero's Business Filing System

When up against a villainous quagmire of disorganized data, Superhero PDB puts you in control. File it, sort it, search it, format it, enter it, delete it, reorganize it, merge it, convert it, subdivide it, print it, report it...

PDB is the high-powered business filing system that even the INCREDIBLE HULK would find easy to use. Get PDB, PDQ.

PDB (for PC DOS and selected MS DOS systems): \$195

Diagnostics II

Take care of your microcomputer before it takes care of you.

Protect yourself from time-robbing system failure. Pinpoint costly hardware problems before they cause serious trouble.

NCR, XEROX, MORROW DESIGNS, and SONY all use this software to take care of their systems. Diagnostics II is the finest set of system diagnostics available for microcomputers. It thoroughly checks memory, CPU, terminal, printer, and disk drives—isolating many problems to the chip level. It checks both standard and non-standard components, including non-IBM add-ons. So get a copy of Diagnostics II for yourself—and keep your system in great shape.

Diagnostics II
(for all PC DOS, MS DOS, CP/M-86,
and CP/M-80 systems): \$125

Special Promotional Offer

Mention this ad when ordering from SuperSoft and get the following outstanding discounts on any of these products.

BUY ONE PRODUCT, GET \$25 OFF—BUY TWO PRODUCTS, GET \$60 OFF—BUY ANY THREE, GET \$100 OFF—BUY ALL FOUR AND GET \$150 OFF

This offer is available for a limited time only.

HOW TO ORDER

CALL
800-
762-
6629

(in Illinois call
217-359-2112)



or SEND YOUR CHECK OR CREDIT CARD INFORMATION TO THE ADDRESS BELOW. Add \$3 shipping U.S., \$6 Canada, \$20 all other areas. Please specify your computer and operating system. (C.O.D. orders also accepted)

SuperSoft

SuperSoft, Inc. P.O. Box 1628,
Champaign, IL 61820
Telex: 270365 SUP ACI CHM

MAY 1985 • BYTE 405

tained in the letter supersede comparable terms in the standard agreement. The letter should be dated the same day as the standard agreement and should also be signed by the seller.

ADVERTISING

Another problem that causes anguish for both buyer and seller involves ad-

vertisements. The seller is not obligated to provide an unlimited number of buyers with a particular product at an advertised price. The law recognizes that product supplies are not limitless. To be on the safe side, sellers should make sure that their advertisements specify the number of products that will be available at a

sale price or state minimally that "quantities are limited."

RAIN CHECKS

What happens when the seller issues a rain check to the buyer? Must he sell the product to the buyer at a later date? Seller lawyers argue that there is no obligation under state law, since the rain check is considered merely an offer, revocable by the seller prior to the actual purchase. Buyer advocates disagree but have little legal precedent on which to rely. To be on the safe side, buyer advocates suggest that you either purchase the products in full and await delivery or put down a partial payment and get a written rain check. The partial payment turns that written rain check into a binding contract.

MAIL ORDER

Many buyers are scared of dealing with mail-order houses. They are afraid of being burned. Buyer advocates suggest the following strategy to minimize this. First, always deal with a seller whose business is located out of state to avoid paying sales tax. Second, call the seller, negotiate the terms mentioned below, and follow up with a letter documenting the oral agreement. One important term is the exact description of the product being purchased (model or version number, etc.). Another is the price, including handling and shipping. Make sure the product is shipped "FOB your address" (so risk of loss only passes to you upon delivery). If the seller insists on "FOB shipping point," make sure he gets sufficient insurance. Specify the delivery date required and include the magic words "time is of the essence." Also state that the seller is not to deviate from the terms in the letter without your prior written permission. Third, always keep a copy of your letter along with your notes and all correspondence received from the seller.

The FTC has rules requiring a mail-order seller, after receiving a complete sales order, to deliver the product either within the time specified in

You're in Good Company When You Program in BetterBASIC



All of these companies rely on BetterBASIC to write their software programs. They have found that BetterBASIC combines the features they need from BASIC, Pascal, C and Forth in one familiar environment. Some of these features include the following.

640K Now you can use the full memory of your PC to develop large programs.

STRUCTURED Create well organized programs using procedures and functions that are easily identified and understood and completely reusable in future programs.

MODULAR Use procedures and functions grouped together to form "library modules."

INTERACTIVE BetterBASIC acts like an interpreter, responding to the users' commands in an immediate mode. However, each statement is actually compiled as it is entered.

EXTENSIBLE Create your own BetterBASIC modules which contain BetterBASIC extensions (ideal for OEMs).

COMPILED Each line of the program is compiled as it is entered

into the computer's memory rather than interpreted at runtime. The optional Runtime System generates EXE files.

BetterBASIC Runs on IBM PC, IBM PC/XT and compatibles.

CALL 1-800-225-5800 Order Better BASIC now, or write Summit Software Technology, Inc.™, P.O. Box 99, Babson Park, Wellesley, MA 02157. Prices are listed below.

BetterBASIC: \$199 Runtime System: \$250
8087 Math Module: \$99

Still not convinced? Order the BetterBASIC sample disk which includes a demo, a tutorial, compatibility issues, 50 lines of BetterBASIC and more. Only \$10.

MasterCard, VISA, P.O. Checks, Money Order, C.O.D. accepted.

BetterBASIC is a registered trademark of Summit Software Technology, Inc.

IBM PC and IBM PC/XT are registered trademarks of International Business Machines Corp. Tandy is a registered trademark of Tandy Corp. Illustrated above are registered trademarks of the following companies: Mobil Oil Corp.; A T & T; General Electric Co.; Westinghouse Electric Corp.; TRW, Inc.



ALSO AVAILABLE FOR THE TANDY 2000, 1200 AND 1000

(continued)

Now Showing In Black And White

if you own an IBM-PC or PC work-alike, Roland's new MB-142 monitor lets you show off your text and graphics in today's hottest colors—black and white. That's right! The MB-142 gives you black characters on a paper-white background—just like people have been reading for centuries. You can also have white characters on a black background with just the touch of a button.

Both of these black and white display formats are easier on the eyes and less fatiguing than the green or amber phosphor used in standard monochrome monitors. The MB-142's large 14-inch screen, combined with its ultra-high 720 x 350 resolution, can display characters that are larger and more legible than what you can get with ordinary monochrome monitors. Another great plus is that the MB-142 plugs directly into the monochrome board of your IBM or compatible—just like your present monochrome monitor, with nothing more to buy.

Because of the MB-142's advanced electronic circuitry, you even have the ability to mix graphics and text on the same display when using graphics and text boards from leading manufacturers such as Persyst, STB, Paradise, Hercules, AST and many others. What makes it all possible? The same sophisticated technology used in color monitors.

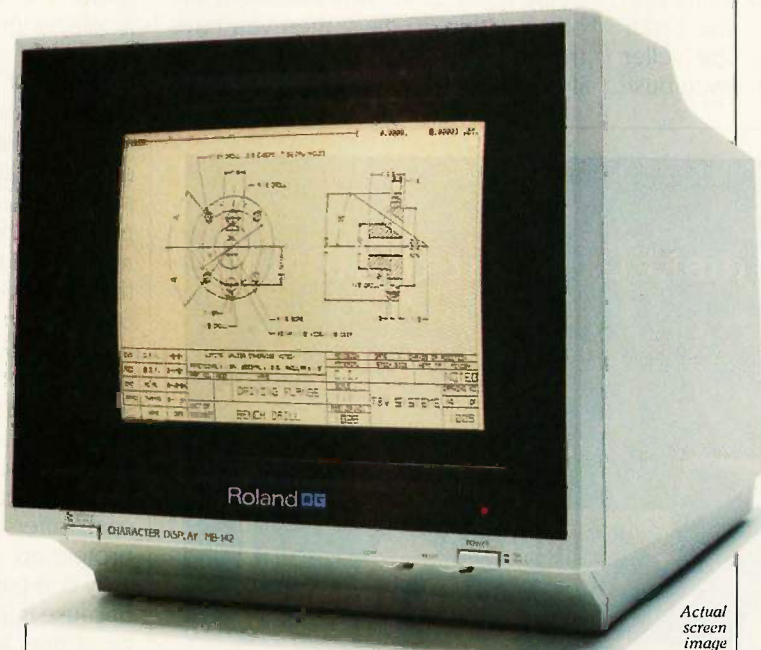

Actual screen image

MODEL
MB-142

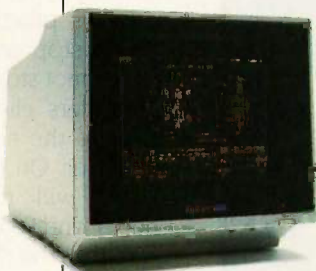

Push a button for instant reverse screen



the MB-142 supports all the winning cards



for business, black and white makes more sense than green and black

the big difference is that the MB-142 monitor does the job for significantly less money. The MB-142 is designed to interface economically, too. Imagine seeing your favorite business graphics or CAD/CAM packages, such as Lotus 1-2-3, Energraphics, Chart-Master, AutoCAD, CADDraft and VersaCAD, in ultra-high resolution black and white. Also, take full advantage of your program's windowing capability using the large 14-inch screen.

Take a good look at the differences that set the MB-142 apart from the rest. No other monochrome monitor gives you the fatigue-free black and white viewing, text and graphics capabilities and easy interface. Naturally enough, the MB-142 is from Roland DG—the new computer peripherals company that's pointing the way to the future. Look for this and other Roland products at fine computer dealers everywhere.

For more information, contact: Roland DG, 7200 Dominion Circle, Los Angeles, CA 90040. (213) 685-5141.

The software programs listed are trademarks of the following companies: AutoCAD, AUTODESK, Inc.; CADDraft, Personal CAD Systems, Inc.; Chart-Master, Decision Resources, Inc.; Energraphics, Enertronic Research, Inc.; Lotus 1-2-3, Lotus Development Corp.; VersaCAD, T&W Systems, Inc.

Roland DG

the advertisement or within 30 days if no time is specified. The FTC rule is superseded when you specify a delivery date. But what happens if the delivery date is missed? First, if the delivery date was specified along with "time is of the essence," the order becomes null and void. The seller must make a refund within seven busi-

ness days (or within one billing cycle for a credit card) after the contract cancellation. If you did not specify a delivery date, then the FTC rule requires that the seller notify you of the delay. If the seller says shipment will occur within 30 days, then you have the option to cancel and get a refund. If you fail to respond to the seller's

notice, the new delivery date takes effect. However, if the seller says shipment will occur in *more* than 30 days, you are off the hook automatically unless you agree otherwise. Furthermore, the seller must refund your money within the 30-day period.

FORMS OF PAYMENT

Buyer advocates argue that the payment mechanism is one of the most effective ways for guaranteeing that a seller delivers the desired computer product. They rank payment mechanisms from most to least attractive for the buyer as follows: credit card; cash on delivery (COD) (without deposit and with payment by personal check); personal check; other instruments, such as certified or cashiers' checks or postal or private money orders; wire transfer; and, as a last resort, cold hard cash. In descending order, each offers you less in control and protection.

By comparison, a seller prefers cash because it is immediate payment with no strings attached. A wire transfer, where your bank electronically sends the money to the seller's bank account, is practically cash since you cannot stop payment. Because you also cannot stop payment on certified or cashiers' checks or money orders, they are the next most attractive to the seller. On the other hand, many sellers will not accept personal checks, and those that do typically require that the check clear—two weeks is common—before the product is shipped. This is because sellers fear that you could stop payment on a personal check or might have insufficient funds to cover it. In a COD transaction, you pay for the product when it is delivered. When United Parcel Service (UPS) is the carrier, the seller can specify the mode of payment, such as cash or certified check as opposed to personal check.

Credit cards are attractive to sellers since the credit-card company is on the hook unless you (the buyer) successfully protest some aspect of the transaction. Furthermore, some marketing people believe that through

(continued)

Change your diskette to fit the IBM PC



THE FILE CONNECTION 8" DISKETTE SYSTEM FOR THE IBM PC

Our "FILE CONNECTION" programs provide 8" diskette file exchange between the IBM PC and most Micro-Mini-Main Frame computer systems.

Our "WORD CONNECTION" programs provide 8" diskette text document exchange between the IBM PC and many word processing systems.

Our "DISPLAYWRITER CONNECTION" programs transform documents from Textpack, Wordstar, Multimate, etc. to the new DisplayWrite 2 format.

In addition to our hardware and program products, we also provide a conversion service for customer supplied diskettes. Please contact us for information about the hundreds of 5 1/4" and 8" diskette formats and systems which we currently support.

FLAGSTAFF ENGINEERING / P.O. Box 1970 / Flagstaff, AZ 86002
Telephone 602-774-5188 / Telex 705609 FLAG-ENG-UD

What every Apple owner
should know about

WORD JUGGLER.™



If you own an Apple IIe or IIc—or you're planning to buy one—here are a few things you should know about Quark's Word Juggler word processor.

First of all, Word Juggler is the only word processor that gives you a powerful spelling checker *and* a built-in telecommunications feature. So you can create a document—check it for spelling errors—and then send it via electronic mail. All with just one program.

Plus, Word Juggler is the most easy-to-use, professional word processor you can buy for your Apple. Even complicated "cut-and-paste" tasks can be accomplished with just a few keystrokes.

There's nothing to memorize, either. Because Word Juggler comes with replacement keycaps—and a special keyboard template—which identify principal editing and formatting commands. So you can focus your efforts on using the program, not learning it.

Fact is, no other word processor for your Apple IIe or IIc gives you this unique combination of power, functionality and ease of use. And if all these advantages aren't compelling enough, check the price. Suggested retail is only \$189.

So visit your favorite dealer today. Ask for a complete demonstration—and for a copy of our brochure, "What Every Apple Owner Should Know About Word Juggler." If you don't have a favorite dealer, but would like one, just call 1 (800) 543-7711. We'll fix you up.

Quark™
INCORPORATED

Inquiry 338

Quark and Word Juggler are trademarks of Quark Incorporated. Apple is a registered trademark of Apple Computer, Inc.

Ask about our specially-priced educational version.

Copyright 1985. Quark Incorporated

Photography by Barbara Kasten

2525 West Evans, Suite 220
Denver CO 80219

The Micromint Collection



TERM-MITE ST SMART TERMINAL BOARD

TERM-MITE is a completely self-contained video display controller.



All you need to build a Smart Video Terminal equivalent to the types advertised for \$1000 or more is a Term-Mite ST circuit board, scanned or parallel keyboard, video monitor and power supply.

- Uses brand new Nat'l Semi NS405 Terminal Processor
- 24 lines by 80 characters, 25th reverse-video status.
- Upper & lowercase. Line (block) graphics.
- Selectable data rate, parity & display options.
- Reverse video, half intensity, double height & width, underline, blinking and/or blank character.
- Separate sync or composite video output. Self Test.

TERM-MITE ST Video Display Terminal Board
BCC22 Assembled & Tested \$284.
BCC23 Complete Kit \$244.

MPX-16 MICROCOMPUTER IBM PC COMPATIBLE



As featured on the cover of BYTE Magazine. Also featured in *Giardia's Circuit Cellar* November, December 1982 & January 1983

The Computer with a Split Personality

- Use it as an IBM PC look alike that directly boots PC DOS 2.0 and accepts all expansion boards designed for the IBM PC.
- Use it as a powerful 8088 single board computer for all your OEM applications. Just add serial terminal, disk drive and power supply. Directly boots CP/M-86.

Buy the MPX-16 in the form that best meets your needs or budget. As a bare board, as a wave soldered board that contains all components less ICs, as an assembled and tested circuit board or as a complete system.

- Directly boots PC DOS 2.0 and CP/M-86.
- Most IBM PC software executes with no modifications.
- IBM PC bus compatible +9 expansion slots.
- Intel 8088 16-bit microprocessor.
- Optional Intel 8087 math coprocessor.
- 256K bytes on board memory.
- Up to one megabyte of system memory.
- Up to 64K bytes of system ROM/EPROM.
- 2 RS-232C Serial & 3 Parallel I/O ports.
- Disk controller for 5 1/4" or 8" drives.
- Sixteen levels of vectored interrupts.

MPX-16 Circuit Board Assembled w/64K RAM \$1,200.
OEM 100 quantity price 840.
MPX-16 Circuit Board Assembled w/256K RAM 1,400.
MPX-16 Sem-Kit (Wave soldered circuit board w/all components) Less ICs 595.
Complete Kit of ICs w/256K RAM 595.
MPX-16 Unpopulated (bare) PC Board 300.
CP/M-86 Operating System + Manuals 80.
MPX-16 Switching Power Supply 300.
MPX-16 Technical Reference Manual 50.
MPX-16 Metal Enclosure with Fan 225.
Tendon TM 100-2 Double Sided/Density Drive 300.
IBM/PC Keyboard Interface Adapter 100.

Shipping and handling additional on MPX-16 orders.

IBM PC is a trademark of International Business Machines Inc.
CP/M-86 is a trademark of Digital Research Inc.
Z8 is a trademark of Zilog Inc.

Z8 COMPUTER SYSTEM

BASIC System Controller



The Z8 Basic System Controller is an updated version of our popular BCC01. The price has been reduced and features added. The entire computer is 4" by 4" and includes a tiny BASIC interpreter, up to 6K bytes of RAM and EPROM, one RS-232C serial port with switchable baud rates and two parallel ports. BASIC or machine language programming is accomplished simply by connecting a CRT terminal. Programs can be transferred to 2732 EPROMs with an optional EPROM programmer for auto start applications. Additional Z8 peripheral boards include memory expansion, serial and parallel I/O, real time clock, an A/D Converter and an EPROM programmer.

- Uses Zilog Z8 single chip microprocessor.
- Data and address buses available for complete peripheral expansion
- Can be battery operated.
- Cross assemblers for various computers.

New
BCC11 Assembled & Tested \$149. Low Price

FORTH Language Version

With the new Z8 with on board 4K FORTH you can program high speed control functions in a few simple high level language commands. Perfect for data reduction, process control and high speed control applications.

BCC20 Z8 FORTH Microprocessor chip \$150.
BCC21 Z8 FORTH System Controller
(This board is a BCC11 with a BCC20 installed)
Assembled & Tested 280.

Memory, I/O Expansion, Cassette Interface

- 8K bytes of additional RAM or EPROM.
- Three additional 8 bit parallel ports.
- Cassette interface - 300 baud K.C. Standard.
- Software real time clock.
- BCC33 w/OK RAM Assembled & Tested \$150.
- BCC34 w/6K RAM Assembled & Tested \$180.

Eprom Programmer

- Transfer BASIC or Assembly Language application programs from RAM in 2716 or 2732 EPROM.
- Comes with programming & utility routines on EPROM
- Requires Z8 I/O Expansion Board for operation.
- BCC07 Assembled & Tested \$145.

Analog to Digital Converter

- Uses Analog Devices 7581 IC, 8-channel 8-bit.
- Adds process control capability to the Z8 system
- Over 1,000 conversions per channel per second.
- Monitors 8 analog signals in one of two 10v Ranges.
- BCC13 Assembled & Tested \$140.

Serial Expansion Board

- Adds additional RS-232C and opto-isolated 20 ma. current loop serial port to the Z8 System.
- Runs at 75 to 19,200 baud in all protocols.
- Comes with listings of sample serial I/O routines.
- BCC08 Assembled & Tested \$160.

16K Memory Expansion Board

- Add up to 16K of additional memory, RAM or EPROM, to your Z8 System Controller in any multiple.
- Accepts 2016, 6116, 2716, or 2732 memory types.
- Four 16K cards may be installed on the Z8 System bringing the total memory to 64K.
- BCC14 Assembled & Tested w/4K RAM \$120.

Cross Assemblers

From Micro Resources
IBM PC, APPLE, 6502 Systems 5 1/4",
CP/M 2.2 8" \$75.
From Allen Ashley
TRS-80 Model I, III, Northstar 5 1/4",
CP/M 2.2 8" 150.

Five Slot Mother Board

- Expand your Z8 BASIC System with minimum effort.
- Contains five slots complete w/44 pin connectors.
- M802 Assembled & Tested \$69.

Triple Voltage Power Supplies

+5V @ 300 ma +/- 12V @ 25 ma.
UPS01 Assembled & Tested \$35.
UPS02 Complete Kit 27.
+5V @ 1 Amp. +12V @ .5 Amp. -12V @ 50 ma.
UPS03 Assembled & Tested 60.
UPS04 Complete Kit 50.

SPEECH PRODUCTS

Lis' ner 1000 Voice Recognition Board



Uses the new, high performance SP1000 voice recognition chip.

The LIS'NER 1000 provides voice input capability for your computer. The unit functions in the same manner as your keyboard, serving as a data entry device for application programs or the normal operation of the computer.

The LIS'NER 1000 recognition system works by analyzing human speech and extracting the most important features. These impressions of words are compacted into "templates" which can be stored and later compared to someone talking to the recognition unit. The LIS'NER 1000 supports a 64 word vocabulary in speaker dependent, discrete utterance mode. The recognition accuracy is greater than 98%. Each unit comes with a professional quality head-band style electret microphone to assure accuracy, software on diskette and a user's manual.

The APPLE II LIS'NER board has provision for an SSI 263 phonetic speech synthesizer chip with text-to-speech algorithm. This addition provides all the features described for the Sweet Talker II as well as speech recognition.

APPLE II LIS'NER 1000 with SP1000 recognition/synthesis components only
VR01 Assembled & Tested \$189.
VR02 Complete Kit \$149.
APPLE II LIS'NER 1000 with SP1000 recognition/synthesis components and SSI 263 phonetic synthesizer chip with text to speech algorithm.
VR03 Assembled and Tested \$259.
VR04 Complete Kit \$219.
COMMODORE 64 LIS'NER 1000 with SP1000 recognition/synthesis components
VR10 Assembled & Tested \$149.
VR11 Complete Kit \$119.

Sweet Talker II Text-to-Speech Synthesizer

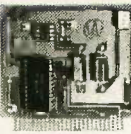

SWEET TALKER II, a 3rd generation speech synthesizer, is based on the SSI 263. SWEET TALKER II directly drives a speaker to provide music, sound effects and continuous speech of unlimited vocabulary at data rates as low as 50-70 bps.

- SSI 263-based Apple II compatible speech synthesis board
- Comes with text-to-speech algorithm on disk (DOS 3.3)
- Appropriate control inputs for mapping with several buses
- On-board 1 watt amplifier with volume control
- Measures 3" x 3 1/2"
- Operates on +5 and +12v
- ST22 SWEET TALKER II Apple II compatible speech synthesizer with text-to-speech algorithm on disk \$104.

Microvox Text-to-Speech Synthesizer

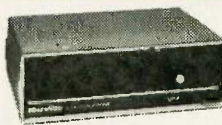

Microvox is a professional voice quality text-to-speech synthesizer that is easily interfaced to any computer, modem, RS-232C serial or parallel output device and provides speech of unbelievable clarity.

- Unlimited vocabulary.
- 64 program/male inflection levels.
- 8K text-to-speech algorithm.
- Full ASCII character set recognition and echo.
- RS-232C and parallel input.
- 1000 Character buffer, 3000 optional.
- Adjustable baud rates (75-9600).
- Spelling output mode.
- 7 octave music and sound effects.
- On board audio amplifier & power supply.
- X-On/X-Off handshaking.
- MV01 Assembled with 1K buffer \$349.
MV02 Complete Kit with 1K buffer \$269.
Add \$15.00 for 3K buffer option.

Speech Synthesizer IC's

The SC-01A Speech Synthesizer is a completely self-contained solid state device that phonetically synthesizes continuous speech of unlimited vocabulary.
SC01A Quantity 1-99 \$32.
100+ \$24.
1000+ call

The Silicon Systems SSI 263 Speech Synthesizer Chip is a third generation speech synthesizer chip that produces even more intelligible speech than did older devices. The SSI 263 has improved intonation, inflection and filtration.
SSI 263 Quantity 1-9 \$42. ea.
10-99 \$34. ea.
100 \$30. ea.

The Micromint is stocking thousands of SP1000 voice recognition chips. Call us for a quote.

MICRO D-CAM DIGITAL TV CAMERA



- Give your computer the dimension of sight.
- Interprets, enhances and stores images.
 - 256 x 128 digital image sensor.
 - Plug-in boards for the IBM-PC, APPLE II or e.
 - Software includes utilities for auto exposure, multi-level greyscale, screen dump and image enhancement.
 - Includes interface card, 4 foot extension cable camera assembly, manual, and software on diskette.
 - OC01 IBM PC Assembled & Tested \$299.
 - DC02 IBM PC Complete Kit \$264.
 - DC03 APPLE II Assembled & Tested \$299.
 - OC04 APPLE II Complete Kit \$264.

ULTRASONIC RANGING SYSTEM

The Micromint Sonar Ranging Experimenter's Kit is an updated and higher functioning version of the Polaroid SX-70 Camera sonar ranging circuit used in the original Polaroid Ultrasonic Ranging System Designer's Kit. There are similar performance characteristics but this unit requires far less support circuitry and interface hardware.

The Sonar Ranging Experimenter's Kit includes one SSI2827 ranging module, one Polaroid 50 KHz electrostatic transducer, and user's manual with data sheets.
T101 Sonar Ranging Experimenters Kit \$60.

300 BAUD ANSWER/ORIGINATE MODEM KIT

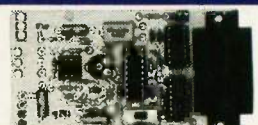

Micromint's latest 300 Baud Modem Kit is crystal controlled, uses the TI TMS99532 IC, contains just 25 parts and requires no calibration or adjustments. Use with acoustic coupler or in direct connect mode.
MD04 Complete Kit as shown \$60.
MD05 Transformer for Direct Connect Mode \$9.
AC01 Acoustic Coupler Kit \$20.

MICROMINT INC. 561 Willow Avenue,
Cedarhurst, NY 11616
To Order: Call Toll Free 1-800-645-3479
For Information Call: 1-516-374-6793
Call: Monday-Friday, 9-5 PM



credit-card transactions, larger sales occur because you can withhold payment—a buyer advantage—if you feel a delivered product is defective or does not meet your intended purpose. If you dispute the transaction, the credit-card company withholds that money from the seller. Regardless of whether you ultimately prevail, the cash-flow loss hurts the seller.

TAKING DELIVERY

Typically, you receive computer products in sealed containers. This effectively prevents you from inspecting the products at the store or before the deliveryman leaves. Because some sales agreements say that you have accepted the products merely by taking possession of them, buyer advocates warn that you should make sure such language is stricken from any sales agreement in order to allow reasonable inspection prior to accep-

tion. Where a written contract does not contain such language or there is no written contract, you are allowed a reasonable amount of time to perform a reasonable inspection before accepting the products. This includes, for example, operating hardware or running software to demonstrate that it fulfills the terms of the agreement.

Where the terms are not fulfilled, you have the right to reject the products. Buyer advocates caution that such rejection should be done as soon as possible by telephoning the seller and following up with an explanatory letter. Buyer advocates also recommend that the goods be returned, especially when they have been purchased by credit card. Sellers are protected from unreasonable buyer rejection where you accept the products knowing that they do not conform to your agreement, where you don't inspect them within a rea-

sonable amount of time, or where you use the products beyond the acceptance period or modify them. When you have accepted the products, you can only revoke your acceptance where the product defect was difficult or impossible to discover through reasonable inspection or short-term use.

A PRACTICAL APPLICATION

Let's apply all these rules to a typical situation as if we had an expert system for the law of computer sales. Doc is a computer hobbyist who plays the stock market. After careful research, he decides to buy a new computer system from a mail-order house. Doc orders by phone and pays by certified check to get immediate shipment. Five weeks go by and he has neither heard nor received anything. Doc calls and is told by the

(continued)

Come visit us in our Long Island Showroom
226 Sherwood Ave.
Farmingdale, NY 11735

Computer Channel

Se Habla Español
1-800-331-3341
Cable: COMSYSTEC NEWYORK
Telex: CSTNY 429418

OUR SPECIALTY: IBM COMPATIBLE PRODUCTS, GRAPHICS, DATABASE, 68000 UNIX, EXPORT

IBM PC II ADD-ONS

IBM AT BOARDS, DRIVES, ETC.
AT COMPATIBLES

BUSSBOARDS—MULTIFUNCTIONS
ALL IN ONE SLOT AS A to D,
D to A, I/O, RAM, CLOCK, FLOPPY-
HD, MONITOR, INTERFACES

MORE RELIABLE DRIVE FOR PC
360K, 1.2MB, 1.6MB ALL FROM
ONE DRIVE.
BETTER THAN IBM!!

COMPUTERS

Zenith, IBM, Sanyo, Apple,
Cromemco, Dual, Dec

Prices subject to change. American Express, Visa/Mastercard add 3%. F.O.B. point of shipment. 20% restocking fee for returned merchandise. Personal checks take 3 weeks to clear. COD on certified check only. N.Y. residents add sales tax. Manufacturers' warranty only. International customers, please confirm price before order. Accept P.O. from Fortune 500, schools and gov't.

Computer Channel
226 Sherwood Ave.
Farmingdale, NY 11735

TELEX: 429418
CSTNY

For information CALL (516) 420-0142
To order CALL 1-800-331-3341

AN AFFORDABLE CAD SYSTEM FOR ENGINEERS & DESIGNERS

```

graph TD
    SW[SOFTWARE AUTOCAD] --- CPU[COMPUTER ZENITH ZF151-52 320K RAM]
    ZVM[ZENITH ZVM 135] --- CPU
    CPU --- PRN[PRINTER EPSON FX-80]
    CPU --- PLO[PLOTTER DMP-40]
    CPU --- DIG[DIGITIZER DT-114]
            
```

\$5,800.00

Package with IBM PC/XT also available

SYSTEM CONFIGURATION

We assemble systems at special prices, including software, special operating systems, shells etc. Call us for business systems, CAD systems, networking, LANS, graphics, mainframe links, interfacing, application integration.

PLEASE ASK US FOR QUOTES!

FORTUNE 1500 COMPANIES—LET US SOLVE YOUR SYSTEM NEEDS!

NEW UNDER \$4000 COMPLETE CASH REGISTER—COMPUTER—POINT OF SALE—COMBINATION SYSTEM—CALL!

ALSO — SYSTEMS FOR MULTI-USER ACCOUNTING, LEGAL, MEDICAL, DENTAL, PHARMACY, CHIROPRACTIC, WHOLE-SALERS, RETAILERS, WAREHOUSES, BUSINESS, DATABASES, COMMUNICATION, NETWORKS

PRINTERS

EPSON, OKIDATA

EPSON LQ1500	24 wire, excellent	
Hewlett Packard	ThinkJet	\$450
	LaserJet	3,300
Toshiba P1340	80 col., 160 cps	799
Dataproduct	8010 180 cps	545

Letter Quality

Star Power Type	18 cps parallel/serial	375
NEC 2050	20 cps for IBM PC	760
3550	35 cps for IBM PC	1,520
CItoh F-10	50 cps	1,350
Juki 6104	18 cps	459
Qume 11/40	w/IBM interface	1,420
Diablo 630	ECS/IBM ext. char. set	2,100
Dynax HR35	33 cps	910
Comrex Comwriter III		740
Transtar 315	graphic, color	479

TERMINALS

Zenith	Z29	CALL
	Z49	880
ESPRIT	6310 14"	580
EXEC 10/102	emul. VT102	850
QUME 102	14"	499
	103	875
211GX	emul. VT100	1,050
VISUAL 55	emul. TEK4010	760
	102	920
550	14" emul. VT102	2,050
WYSE 50	emul. TEK 4010	559
	14" 80/132 col.	625
75	ANSI X3.64	625

Inquiry 94

MAY 1985 • BYTE 411

seller that the computer is out of stock for the "foreseeable future" and that the price has gone up. Reluctantly, Doc pays the higher price and receives the machine six weeks later. The machine arrives four days before he goes on a one-month vacation. When Doc returns, he unpacks the machine, only to discover that it does not work. What should he have done differently?

First, Doc should have called several sellers and negotiated not only the best price but the most favorable payment and delivery terms. He should have paid by credit card and sent a confirmatory letter setting forth all the terms of the deal. The letter should have explicitly stated the magic phrase "time is of the essence." After not hearing from the seller for two weeks, Doc should have called to confirm that shipment had taken place. Having learned that it had not, Doc

had the option of canceling or demanding immediate shipment. In either case, he should have confirmed his decision in writing. If he had foolishly waited more than 30 days, he could have canceled under the FTC mail-order rule.

Second, Doc did not have to pay the higher price since the seller cashed his original check implying acceptance of the order for that price. Had he paid by credit card, he could have protested the change in price from the original agreement. Unfortunately, Doc accepted the computer by failing to inspect it within a reasonable time after receipt. He cannot revoke his acceptance since the defect was obvious. His vacation does not serve as a valid excuse for his failure to inspect the product, which he should have inspected *immediately* upon receipt. Then he could have rejected the defective goods and demanded

a working replacement. Such rejection should have been made immediately by telephone and followed up in writing. The defective computer should then have been returned. If the seller did not provide a working replacement within a reasonable amount of time, Doc could demand that the credit-card company issue him a credit, thereby canceling the transaction.

IN CONCLUSION

This column has addressed the rights and responsibilities of both buyers and sellers of computer products. Most buyers and sellers are honest and most transactions go smoothly. The law of computer sales, however, must provide a set of rules that operate when transactions don't go smoothly. We will deal with the legal ramifications of an unsatisfactory transaction in a future column. ■

ACCESS THIS DATABASE FOR FREE

No sign-up charges. No connect charges. No long distance calling charges. And it's the handiest, most useful database you'll ever dial up. Need a particular product or service? This base can take you through all fifty states on a search for the best available. Let your fingers do the talking (on your keyboard of course). Sign on through our toll-free numbers today.

The following phone #s are for computer use only:

(Ohio) (800) 223-5541 (24 hrs.)
(National) (800) 231-3158 (24 hrs.)

For more information, etc., call our voice line: (216) 327-1623 (9 AM - 5 PM EST) Mon.-Fri.

Or write:



TelCor America

P.O. Box 40206 Cleveland, Ohio 44140

The TelCor America Classified Directory - USE IT LIKE THE YELLOW PAGES... ONLY BETTER.

HARMONY VIDEO & COMPUTERS

2357 CONEY ISLAND AVE., BROOKLYN, NY 11223
800-VIDEO84 OR 800-441-1144 OR 718-627-1000



COMMODORE 64
\$149.95
APPLE 2E w/DRIVE
\$819.95

APPLE 2C
\$889.95
STAR SG 10
\$210.95

"PRINTER SPECIALS"

Brother HR15 XL	349	Juki 6100 Telewriter	353	Panasonic KXP 1092	379
Brother HR 35	777	Juki 6300	629	Panasonic KXP 1093	532
Brother Keyboard	129	Mannesman Spirit 80	178	Panasonic KXP 3151	437
Citizen MSP 10	314	Mannesman 160L	459	PowerType	278
Citizen MSP 15	479	Mannesman 180L	629	QuadJet	720
Corona Laser	2468	NEC 2050	629	Riteman Blue +	195
Daisywriter	735	NEC 3550	1218	Star SG10	211
Diablo 620 A PI	659	NEC 7730	1629	Star SG15	352
Dynax DX 15 XL	342	NEC 8850	1679	Star SD10	352
Epson RX 80 FT +	285	NEC 03 rev. p2	839	Star SD15	431
Epson RX 80	219	Okidata 92	349	Star SR10	461
Epson RX 100	374	Okidata 93	564	Star SR15	571
Epson FX 80	369	Okimate 10	127	Star SB10	678
Epson JX80	546	Olympic Compact 2	349	Silver Reed Exp 550	369
Epson FX 100 +	583	Olympic 304	304	Silver Reed Exp 500	263
Epson LO 1500	998	Panasonic KXP 1091	252	Silver Reed Exp 770	659
HP Laser Jet	2678	Panasonic KXP 1090	169	Toshiba 1340	518
				Toshiba 1350	1112

WOW! WOW! WOW!

IBM		APPLE		MONITORS	
PC w/Drive	CALL	2E w/Disk Drive	819	Amdek 300 Green	114
PC XT	CALL	Macintosh	1365	Amdek 300 Amber	121
PC Portable w/Drive	CALL	Apple 2C	887	Color 300	221
AST Six Pack	209	Imagewriter	473	Color 500	324
Tailgrass 20 Meg	2274	Add. Drives	from 224	Color 600	384
Quad Board	221	Modem 12	429	Color 700	441
Keytronics	129			Color 710	509
Hercules Color	142	ATARI		Taxan 210	199
Hercules Monochrome	294	800 XL	96	Princeton HX12	419
Paradise Graphics	252	1027 Printer	224	Taxan 122A	139
Paradise Multi Display	273	1050 Drive	148	Taxan 420	394
STB Graphics + 2	246	Indus. Drive	234		
Quad Board	221	1025 Printer	156		
Tecmar Graphics	439	Rana 1000	167	SANYO	
Tecmar Captain	169	Koala Pad	44	550 D.S	645
Persyst Color Card	148	Printer IIF	49	555 D.S	947
Persyst Monocard	162			CRT 70	509
Bernouli Box	1953	MODEMS		MBC 775	1799
10 Meg Drive	659	Hayes 1200	378		
Joystick	34	Hayes 1200B	314	COMMODORE	
Tandon 100-2	119	Hayes 300	179	Commodore 64	149
		Micromodem 2E	206	1541 Disk Drive	177
		Access 123	359	1702 Monitor	169
		Novation J-cat	89	MPS 802	188
ZENITH				Indus. Drive	258
Zenith PC 2150	1619				
Zenith PC 15152	2057				
Zenith PC 161-52	2204				

800-441-1144

Items reflect cash discount. For your protection we check for stolen credit cards.

MICROWAY'S 8087 RUNS 1-2-3™!

MicroWay is the world's leading retailer of 8087s and high performance PC upgrades. We stock a complete selection of 8087s that run at 5 and 8mhz. All of our coprocessors are shipped with a diagnostic disk and the best warranty in the business - 180 days! We also offer daughterboards for socketless computers such as the NEC PC and PCjr, and a board which increases the clock speed of the 80287 in the PC AT. Our new NUMBER SMASHER™ includes 512K ram. It will run the IBM PC at clock speeds up to 9.5mhz and achieves a throughput of .1 megaflops

with 87BASIC/INLINE, Intel Fortran, or Microsoft Fortran. Software reviewers consistently cite MicroWay software as the best in the industry! Our customers frequently write to thank us for recommending the correct software and hardware to meet their specific needs. They also thank us for our same day shipping! In addition to our own products which support the 8087 and 80287, we stock the largest supply of specialized software available anywhere. For information call us at

617-746-7341

FASTBREAK™

MicroWay's daughterboard turns on your 8087 during 1-2-3™ execution and extends DOS functionality. Recalculations run up to 33 times faster. Includes an 8087 chip. When used with the NUMBER SMASHER™ it can provide a total increase in 1-2-3™ execution speed of up to 80 to 1.

FASTBREAK™ 5mhz..... \$339
FASTBREAK™ 8mhz..... \$479
FASTBREAK™
 for **NUMBER SMASHER**..... \$239
FASTBREAK™ BOX Option..... \$60

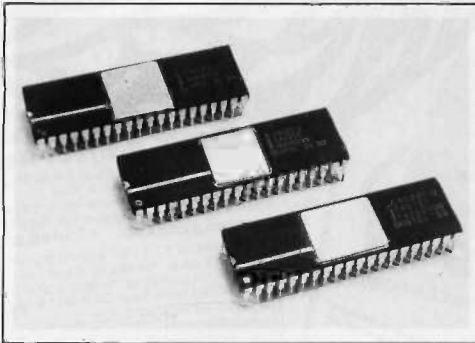

MicroWay™ 8087 Support

For the IBM PC, PC XT, PC AT and Compatibles.

87FFT™ performs Forward and Inverse FFTs on real and complex arrays which occupy up to 512K bytes of RAM. Also does convolutions, auto correlations, hamming, complex vector multiplication, and complex to radial conversions. Callable from MS Fortran or 87BASIC/INLINE..... \$150

87FFT-2™ performs two-dimensional FFTs. Ideal for image processing. Requires 87FFT...\$75

MATRIXPAK™ manages a **MEGABYTE!** Written in assembly language, our runtime package accurately manipulates large matrices at very fast speeds. Includes matrix inversion and the solution of simultaneous linear equations. Callable from MS Fortran 3.2, 87MACRO, 87BASIC/INLINE, and RTOS..... each \$150

GRAPHICS PACKAGES
 Energraphics (stand alone)..... 295
 Grafmatic for MS Fortran or Pascal..... 125
 Plotmatic for Grafmatic..... 125
 Halo for Basic, C or Fortran..... each 150

OTHER TOOLS
 Alpha Software ESP..... 500
 Borland Sidekick, Toolbox, or Graphics SuperKey..... 70
 COSMOS Revelation..... 850
 smARTWORK..... 895
 SPSS/PC..... 695

MAYNSTREAM..... 1695

DFixer
 A disk utility which thoroughly checks PC or AT hard disks for bad sectors and updates the MS DOS file allocation table accordingly..... \$149

87DEBUG™ - a professional debugger with 8087 support, a sophisticated screen-oriented macro command processor, and trace features which include the ability to skip tracing through branches to calls and software and hardware interrupts. Breakpoints can be set in code or on guarded addresses in RAM..... \$150

HARDSCOPE™ includes a version of 87DEBUG which interfaces a Breaker Box which makes it possible to reset your PC and break program execution independent of DOS... 249

87BASIC/INLINE™ converts the output of the IBM Basic Compiler into optimized 8087 inline code which executes up to seven times faster than 87BASIC. Supports separately compiled inline subroutines which are located in their own segments and can contain up to 64K bytes of code. This allows programs greater than 128K! Requires the IBM Basic Compiler and Macro Assembler. Includes 87BASIC..... \$200

87BASIC™ includes patches to the IBM Basic Compiler and both runtime libraries for USER TRANSPARENT 8087 support. Provides super fast performance for all numeric operations including trigonometrics, transcendental, addition, subtraction, multiplication, and division.... \$150

87MACRO™ - our complete 8087 software development package. It contains a "Pre-processor," source code for a set of 8087 macros, and an object library of numeric functions including transcendental, trigonometrics, hyperbolics, encoding, decoding and conversions. For the IBM Macro Assembler, Version 1.0 or 2.0..... \$150

OBJ→ASM™ - a multipass object module translator and disassembler. Produces assembly language listings which include public symbols, external symbols, and labels commented with cross references. Ideal for understanding and patching object modules and libraries for which source is not available..... \$200

RTOS - REAL TIME OPERATING SYSTEM
 RTOS is a multi-user, multi-tasking real time operating system. It includes a configured version of Intel's iRMX-86, LINK-86, LOC-86, LIB-86, OH-86, and MicroWay's 87DEBUG. Runs on the IBM-PC, XT, PC-AT and COMPAQ..... \$400

INTEL COMPILERS¹
 FORTRAN-86..... 750
 PASCAL-86..... 750
 PL/M-86..... 500
 87C (LATTICE/MICROWAY)..... 750
 ASM-86..... 200

¹Requires RTOS or iRMX-86. All Intel compiler names and iRMX-86 TM Intel Corp.

HARDWARE AND LANGUAGES

8087 5mhz..... \$129
 Including DIAGNOSTICS and 180-day warranty For IBM PC and compatibles.

8087-2 8mhz..... \$275
 For Wang, AT&T, DeskPro, NEC, Leading Edge

80287-3 5mhz..... \$275
 For the IBM PC AT

64K RAM Set..... \$15

256K RAM Set..... \$89

128K RAM Set PC AT... \$169

NUMBER SMASHER™..... 1590
 9.5mhz 8087 coprocessor board with 512K

FORTRAN and UTILITIES
 Microsoft Fortran 3.2..... 229
 IBM Professional Fortran..... 545
 Intel Fortran-86¹..... 750
 FORLIB+..... 65
 STRINGS and THINGS..... 65

C and UTILITIES
 Lattice C..... 299
 Microsoft C V 3.0..... CALL
 C86..... 299
 C TOOLS..... 85
 C Trigs and Trans..... 150

BASIC and UTILITIES
 IBM Basic Compiler..... 270
 87BASIC/INLINE..... 200
 Summit BetterBASIC™..... 175
 Summit 8087 Module..... 87

MACRO ASSEMBLERS
 IBM Assembler with Librarian..... 155
 87MACRO..... 150
 Microsoft Assembler V 3.0..... 125

PASCAL
 Microsoft Pascal 3.2..... 199
 Borland Turbo Pascal..... 45
 Turbo with 8087 Support..... 85

APL
 STSC APL★PLUS/PC..... 475
 Pocket APL..... 85

FASTBREAK and NUMBER SMASHER are trademarks of MicroWay, Inc. Lotus and 1-2-3 are trademarks of Lotus Development Corporation.

MicroWay P.O. Box 79
 Kingston, Mass.
 02364 USA
 (617) 746-7341

**You Can
Talk To Us!**

RECTIFIER DIODES

Type No.	Cat No.	Price Ea.	Price 10up	PIV mA	USE
IN4004	Z-3204	.10	.08	400	1 General Purpose
IN4007	Z-3207	.13	.10	1000	1 General Purpose

ZENER DIODES
 1 WATT Zener diodes Cat Z-3575/43 20¢ ea 10 up .15¢ ea.
 4 1/2 digit 10mm Liquid Crystal Display Cat Z-4475.
 \$9.95 ea 10 up \$9.00 ea

4x28 Optic Coupler - LED and photo diode in DIP package Cat Z-4804 .80¢ ea 10 up .70¢ ea

LIGHT EMITTING DIODES

Type No.	Colour	Size	Cat No.	Price Ea.	Price 10up
TL4211	Red	3mm	Z-4077	.20	.15
TL4231	Green	3mm	Z-4079	.25	.20
TL4251	Yellow	3mm	Z-4081	.30	.25
TL4291	Orange	3mm	Z-4083	.30	.25
TL4213	Red	5mm	Z-4085	.20	.18
TL4233	Green	5mm	Z-4089	.30	.25
TL4253	Yellow	5mm	Z-4091	.30	.25
TL4293	Orange	2mm x 5mm	Z-4093	.30	.25
TL3215S	Red	2mm x 5mm	Z-4095	.30	.25
TL3235S	Green	2mm x 5mm	Z-4095	.30	.25

LINEAR IC'S

Type No.	Cat No.	Description	Price Ea.	Price 10up
TL555CP	Z-6144	CMOS timer	.70	.60
NE/DS555	Z-6145	Universal timer	.35	.30
NE556	Z-6146	Dual timer	.80	.70

General purpose linear operational amp uA741 Cat Z-6382 .40¢ ea 10 up .35¢ ea

DYNAMIC RAMS (memory chips)

Type No.	Description	Cat No.	Price Ea.	Price 10up
4116	16K x 1 dynamic RAM	Z-9310	1.00	.90
4164	64K x 1 dynamic RAM	Z-9312	7.95	6.95

"XIDEX" Quality Diskettes
 Don't risk the loss of your valuable computer data by using "economy" floppy disks. The Xidex range has a better disk substrate, finer particles in the coating, ultra smooth polishing, tighter tolerances and an extra 18 critical tests.
 Cat X-3512 Single sided box of 10 \$39.95
 double density soft sector 10 up \$29.95 ea
 Cat X-3514 Double sided box of 10 \$49.95 ea
 d/density soft sector 10 up \$39.95 ea
 Don't be hoodwinked into "cheap" disks

HOT OFF THE PRESS!!
6502 Machine and Assembly Language Programming
 by Mike Smith

It's a unique self-teaching concept that simplifies and clarifies machine operation. Plus, you'll gain new insight into BASIC programming procedures. HIGHLIGHTS - Using RATS - Software Tools - From Intro to the Registers - The Flags - Machine Memory to Machine Language - Mastering Mathematics - Turning BASIC into Machine Code - UnBASIC Instructions - Making Improvements. Cat B-2372 Rec. retail \$12.45

Handbook of Advanced Robotics
 Edward L. Safford, Jr. 480 pages, 242 illustrations. The complete book of robotics, from commercial applications to how-to's for building a hobby robot. Gives an insight into modern robotic applications in home, hobby, and commercial environments. Cat B-1800 Rec. retail \$15.95

Making Money with your Microcomputer
 Robert J. Traister and Rich Ingram. 160 pages, 62 illustrations. 33 practical ideas for using an ordinary personal computer to make extra income from part-time home business. Cat B-2371 Rec. retail \$7.95

Computer Graphics with 28 ready-to-run programs
 David Chance. 280 pages, 58 illustrations. Here's the computer graphics guide for beginners... and a super source of new game patterns for any home computerist, regardless of experience! Cat B-2352 Rec. retail \$9.95

EXPLOSIVE SAVINGS
VOLTAGE REGULATORS

Type No.	Description	Cat No.	Price Ea.
7805	3 terminal 5 volt 1A positive regulator	Z-6545	90¢ each
7812	3 terminal 12 V. 1A positive regulator	Z-6552	each
7815	3 terminal 15V 1A positive regulator	Z-6554	10 or more
7905	3 terminal 5V 1A negative regulator	Z-6555	.80¢ each
7912	3 terminal 12V 1A negative regulator	Z-6556	
7915	3 terminal 15V 1A negative regulator	Z-6557	

COMPUTER CONNECTORS

- 9 pin plug - solder tail P-2684 \$1.25 10 up \$1.10 ea
- 9 pin jack - solder tail P-2685 \$1.75 10 up \$1.60 ea
- 9 pin hood P-2686 .90¢ 10 up .75¢ ea
- 15 pin plug - solder tail P-2687 \$1.80 10 up \$1.45 ea
- 15 pin jack - solder tail P-2688 \$2.20 10 up \$2.00 ea
- 15 pin hood P-2689 \$1.00 10 up .85¢ ea
- 25 pin plug - solder tail P-2690 \$1.85 10 up \$1.80 ea
- 25 pin jack - solder tail P-2691 \$2.60 10 up \$2.40 ea
- 25 pin hood! P-2692 \$1.25 10 up .95¢ ea

Centronics Connectors
 36 pin 'D' type plug - solder tail P-2680 \$2.95 10 up \$2.50 ea
 36 way 'D' type jack - solder tail P-2681 \$5.95 10 up \$5.50 ea

IDC - NO SOLDERING
 25 pin 'D' type plug P-2693 \$5.49 10 up \$4.80 ea
 25 pin 'D' type jack P-2694 \$5.95 10 up \$5.40 ea

IDC FLAT RIBBON CABLE

26 way	Cat W-2750	.46¢/ft
34 way	Cat W-2752	.60¢/ft
40 way	Cat W-2754	.72¢/ft
50 way	Cat W-2756	.89¢/ft

BOOMING BARGAINS

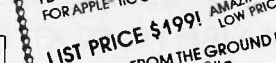

GAMMA™
 FD 100C FLOPPY DISK DRIVE FOR APPLE® IIC COMPUTERS
 LIST PRICE \$199! AMAZINGLY LOW PRICE \$129

- DESIGNED FROM THE GROUND UP TO PROVIDE FULL COMPATIBILITY WITH THE NEW APPLE® IIC FEATURES:
- Low cost
 - Precise band positioner
 - Track 00 sensor design eliminate recalibrate noise
 - Reliable data read/write
 - 12 msec track to track access time
 - 160K bytes storage capacity

HIGH PERFORMANCE WITH A LOW PRICE
 Design innovation and use of advanced state-of-the-art technology make the GAMMA FD 100C more reliable and more durable while actually allowing it to be sold at a lower price. Once you've compared specifications however, the question will not be so much why the GAMMA costs so little, but rather why the others cost so much. Cat X-7505

Technical Specifications:
 • Media: Standard 5.25" single sided floppy diskette
 • Density: 48 tpi • Tracks/Diskette: 40 • Sectors/Track: 16 • Bytes/Sector: 256 • Capacity: 160K bytes • Disk Rotation Speed: 300 rpm • Track to Track Access Time: less than 12 msec

APPLE® is a registered trademark of Apple Computer Inc. GAMMA™ is a registered trademark of Video Technology Ltd

EXPLOSIVE SAVINGS
3c/ft Speaker Cable
 Light duty, fig 8 cable ideal for hi-fi speaker connections or with intercoms. Cat W-2010 325' roll \$4.95

75 Ohm Coaxial Cable
 Low loss coax ideal for color installations. Cat W-2080 66' or 325' roll for only \$14.95

50 Ohm Coaxial Cable
 Used for all types of transmitter to antenna applications. Ultra low loss with stranded center conductor. For use up to 500MHz. Cat W-2090

EXPLOSIVE SAVINGS
BAYONET HOLDER (SAG)
 Chassis or panel mounting fuse holder, accepts standard 3AG fuse. 1/2" mounting hole required. Cat S-4206 75¢ ea 10 for \$4

EXPLOSIVE SAVINGS
Solder Sucker
 A rugged all metal construction solder sucker complete with Teflon tip and a nozzle sweeper as well. Light thumb release mechanism for the removal of solder from the board. Don't pay twice the price - a top quality import from Dick Smith. Spare Teflon Tip to suit Cat T-2565 \$1.95

DICK SMITH BLASTS SILICON

WITH ...

- DEDICATED SERVICE BY ENTHUSIASTS
- UNBEATABLE VALUE
- THOUSANDS OF INNOVATIVE PRODUCTS

PRICES BLASTED

Project Boards
 MINI - 80 x 60 x 8mm one piece board with 58 groups of 5 connected terminals and 4 bus lines of 25 connected terminals. Alpha-numerically coded and also has self adhesive pad on base. Cat P-4614 \$4.95
 SHATTERING BARGAINS 10 up \$4.50 ea
 GIANT - A massive 175 x 67 x 8mm board which can be split into 3 parts. Similar to above board but has 128 groups of 5 connected terminals plus 8 bus lines of 25 connected terminals. Cat P-4615 \$9.95 10 up \$8.95 ea
 Regular price will be \$16.95

Testclips & Leads
 16 piece Universal Meter Lead Set
 This set is suitable for any multimeter. You get a pair of red and black leads with 14 interchangeable probes and plugs. Truly versatile. Cat W-4526 \$9.95

RESISTORS & CAPACITORS
 Please forgive us - we only had a couple of pages to cram in just a fraction of our range. When you order, just ask for a comprehensive list of resistors and capacitors.

PRICES BLASTED
Solder Sucker
 Cat T-2560 \$9.95

SPECIAL INVASION PRICES
EXPLOSIVE SAVINGS
Hook up wire
 Flexible, light duty, PVC insulated wire that is ideal for the hobbyist. Huge range of colors. Cat No. Color Cat No. Color
 W-2220 Red W-2224 Yellow W-2228 Blue
 W-2222 Black W-2225 Green W-2229 Grey
 W-2223 Brown W-2226 Dk Blue W-2230 Cream
 W-2223 Orange W-2227 Purple W-2231 White
 325' roll for only 3.95

Inquiry 128

BE THE FIRST TO KNOW!!

By simply filling in the coupon and either mailing it to our mail order center or dropping it into our new showroom in Redwood City, YOU have the chance to WIN A TRIP TO THE LAND DOWNUNDA FOR TWO FLYING QANTAS. In addition to this we will automatically create your own personal file which opens the doors to great benefits such as special mail order only offers, priority on your mail orders and receive details on our latest products. HURRY - DON'T MISS OUT!

Name

City

State

Zip

MAIL TO: Dick Smith Electronics, Inc.
 P.O. Box 2249 Redwood City CA 94063

*Void where prohibited by law



Statpro Professionals.

People who want to spend their time analyzing results, not just crunching numbers.

Statpro™ data analysis software was specifically created to give professionals of all kinds the analytical tools they need on the job.

It's for corporate planners and marketing specialists, engineers and lab technicians, scientists and educators. In fact, Statpro is for every professional who does data analysis but can't afford to waste time.

Mainframe statistics on your PC.

As a practical tool for professionals, Statpro was specially designed for the personal computer. It's not a scaled-down mainframe program or one of those packages that can only handle a few basic analyses. Instead, it brings a full repertoire of statistical techniques to your IBM PC or PC/XT. From basic descriptive statistics and linear regressions to unequal size ANOVA and discriminant function analysis.

And despite its impressive power, Statpro is easy to use. You just respond to simple menus and screen prompts with single keystrokes. No programmers,



Single keystrokes are all it takes to put Statpro to work.

complex commands or long lines come between you and the job.

A powerful database.

Because you'll want to set up your analyses according to your needs, we've equipped Statpro with a remarkably flexible database. You can range check, verify data entries and keep track of missing data. Analyze any subset of your data-

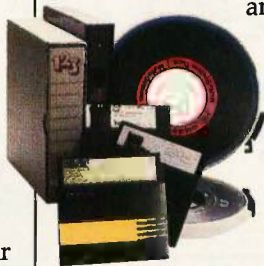

Statpro exchanges data with many popular programs.

base. Transform variables according to virtually any formula. And add, edit, delete, sort or move data wherever you want.

Chances are you'll also be using data from other sources. So Statpro is designed to allow you to easily exchange information with other popular programs and file formats, such as 1-2-3,™ dBase II,™ ASCII, DIF™ and SYLK.™

Lots of graphics.

Nothing makes complex data clearer and easier to present than pictures. So Statpro lets you create graphics and charts in the best format for each job, from pie charts, scatter and regression plots to bar, box and

multivariate vector plots. What's more, Statpro graphics can be customized—with scaling, labels and colors—to emphasize important aspects of your analyses.

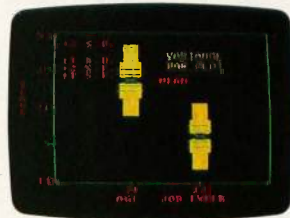

Colorful graphics make complex data easy to understand.

Call for a demo. Statpro Professionals get more

done, faster. But don't take our word for it. Call and ask about our demonstration package, or order Statpro for only \$795.

Don't wait! Become a Statpro Professional today.

800-322-2208

In Massachusetts, call (617) 423-0420.

Call us for the dealer nearest you.

Wadsworth Professional Software

Statpro is a trademark of Wadsworth Professional Software, Inc. dBase II is a registered trademark of Ashton-Tate. DIF is a trademark of Software Arts, Inc. 1-2-3 is a trademark of Lotus Development Corporation. SYLK is a trademark of Microsoft Corp.





M·A·T·H·E·M·A·T·I·C·A·L R·E·C·R·E·A·T·I·O·N·S

An Exercise in BASIC Bitwise Logic Operation

The game of
Nim is used
to teach the
use of the
logical AND,
OR, and NOT

BY ROBERT T. KUROSAKA

The April artificial intelligence (AI) theme got me thinking about Nim, one of the first strategy games that programmers tried to teach computers to play. Nim is one of the oldest two-person games and is believed to have originated in China. Objects such as matches or coins are placed in rows before the two players, who take turns removing objects until none remain. The winner is the player who takes the last object. The rules are simple: You must not skip a turn, and you may take as many objects from any one row as you wish, up to, and including, the entire row. The number of rows is arbitrary (but less than three is trivial), and the number of objects in a row is up to you (but letting all rows have the same number is also trivial).

Some strategies become obvious within the first few games. If you can reduce the board to an even number of equal rows, you will win. If your opponent faces a board like the one shown in table 1, he or she cannot win if you simply echo his or her move in the other row. Other winning patterns become apparent: the 1-2-3 and 1-4-5. In table 2, you have just created the 1-2-3 pattern. No matter how your opponent plays, you can make two equal rows. If he takes one from row one, you take one from row three; if he takes one from row two, you take all of row three, and so on.

In the 1-4-5 pattern, no matter how your opponent plays, you can always make two equal rows or the 1-2-3 pattern. Similarly, with a 1-6-7 pattern, you can make two equal rows, the 1-4-5 pattern, or the 1-2-3 pattern on your move.

It is tempting to think that the 1-7-8 must also be a winning pattern. But your opponent will take two objects from the last row, leaving you to face a 1-7-6 pattern.

With more rows and objects, the winning patterns become far too numerous to learn. Instead, of course, we prefer to learn the winning strategy.

The elegant strategy was first proved in 1901 by Charles Leonard Bouton, then as-

sociate professor of mathematics at Harvard University. He also gave the game its present name, "Nim."

Every position can be considered to be "safe" or "unsafe" to the player facing it on his turn. If you can create a safe position and continue to do so, you will win. Every unsafe position can be made safe by a single move. Every safe position will be made unsafe by *any* move. Therefore, once you make a safe position, your opponent cannot help but make it unsafe with his move; you can make it safe with your next move, and so on.

BINARY ANALYSIS

The analysis of the patterns is as follows: The number of objects in the rows are written in binary notation and stacked vertically, as if preparing for addition. Reading down the columns, if every column has an *even* number of 1s, the position is safe. We will denote an even-parity column with a 0, and an odd-parity column with a 1.

This procedure is simpler than it sounds. Consider the number 13. The largest power of two contained in 13 is 8: think "one 8." The remaining 5 contains one 4, no 2s, and one 1 (don't forget 2 to the 0 power). Hence, $13 = 8 + 4 + 0 + 1$, or in binary, 1101.

Now consider table 3, where the pattern is 13-12-4. The numbers have been converted to binary and stacked. Reading down the columns, the first (leftmost) column has an even number of 8s, so its parity designation is 0, and so on. The column-parity pattern is 0101. For a safe position, all column-parities must be even. That is, a safe position will have a column-parity value of 0000. Thus, the table 3 position is unsafe, and may be made safe by one move. How do we find this move?

Find the leftmost odd-parity column. In our example, it is the 4's column. We must remove one of the 4s to make that column even parity. We have three choices of 4s. If we remove the 4 from the first row, we must

(continued)

Robert T. Kurosaka teaches mathematics in the Massachusetts State College system. He invites your correspondence to BYTE, POB 372, Hancock, NH 03449.

also remove the 1 from its last column to make the last column of even parity. The move would be "row 1, take 5." The resulting board is shown in table 4. All the column parities are even: the position is safe.

Alternatively, we could choose to remove the 4 from the second row in the table 3 position. In that case, we would have to replace 1 in order to make the last column even parity. The move would be "row 2, take 3" and the resulting board would be that of table 5. Once again, the position is safe.

To familiarize yourself with the strategy, play solitaire fashion, making small random moves for your oppo-

nent and using precise binary analysis for your own moves.

Now, it may appear that the analysis used in playing from row 1 was different than the analysis used when we played from row 2. In the first case, we only *removed* column bits and in the second we had to *replace* some column bits. Actually, we can perform both operations with one procedure. Here's how. Take row 1 and the column-parity number in table 3 and create a new number by comparing the parity of the row 1 number and the column-parity number. That is, write a 1 for the 8's column because there is an odd parity between the 13 and the column-parity number in that column.

BASIC has three

kinds of bitwise

logical operators:

AND, OR, and NOT.

Write 0s for all the other columns because they have even parity. The resulting number is 1000, or 8 in base ten. Notice that this is the number we wanted to end up with in row 1 to make the position safe. Try the same procedure with the 12 in row 2 and the column-parity number of table 3. You end up with 1001, or 9. This is the number we should leave in row 2 if we play there.

What we have done with the row and column-parity number is a kind of bitwise logic operation known as an *exclusive-OR* (XOR to assembly-language programmers). An exclusive-OR operates on two arguments and returns a 0 for each column in which both binary representations have the same value (either both 0s or both 1s) and returns a 1 for each column in which one number has a 1 and the other number has a 0. Unfortunately, BASIC does not have an exclusive-OR operation in it.

However, BASIC does have three kinds of bitwise logical operators. The first is NOT, which operates on a single argument and returns a 1 for each column that contains a 0 and returns a 0 for each column that contains a 1. Try having your computer PRINT NOT a bunch of numbers. You will find that -1 is NOT 0. Why? Computers use a kind of binary representation called two's complement. For the sake of simplicity, assume that your computer uses one byte to represent a number. Zero would be stored as 00000000. NOT 0 is then 11111111. This is called the one's complement of 0 and looks like 255. However, computers need to be able to represent negative numbers as well as positive numbers. So any integer that has a 1 in the most significant bit

(continued)

TABLE 1	
row 1:	////
row 2:	////

TABLE 2	
row 1:	1
row 2:	//
row 3:	///

TABLE 3	
row 1:	////////
row 2:	////////
row 3:	////
column-parities	= 0 1 0 1

	8	4	2	1
13 =	1	1	0	1
12 =	1	1	0	0
4 =	0	1	0	0

TABLE 4	
row 1:	////////
row 2:	////////
row 3:	////
column-parities	= 0 0 0 0

	8	4	2	1
8 =	1	0	0	0
12 =	1	1	0	0
4 =	0	1	0	0

TABLE 5	
row 1:	////////
row 2:	////////
row 3:	////
column-parities	= 0 0 0 0

	8	4	2	1
13 =	1	1	0	1
9 =	1	0	0	1
4 =	0	1	0	0



**Genicom would like to get personal with you.
On a professional level, of course.**



Personal computers have become a valuable asset in business. The problem is that most personal computer systems are originally sold with "personal printers"...printers built for home use, not for heavier business work.

These "personal printers" are too slow for many business needs. They can tie-up your computer for extended periods of time...time you could be using to do other work.

Another problem is durability. In business, you need a printer that can produce high volume output over a long duty cycle. The common "personal printer" will often just quit under such continuous operation.

That's why Genicom has created the 3014, 3024, 3304 and 3404...professional printers built for personal computers.

Price/performance matched for small business systems, the Genicom 3000 PC printers are designed to increase productivity and maximize the value of your personal computer.

The 3000 PC printers provide 160-400 cps draft, 80-200 cps memo, and 32-100 cps NLQ printing...performance for both high productivity and high quality printing.

The 3014/3024 models print 132 columns. The 3304 and 3404

models give you a full 136 column width, and offer color printing as well.

Each printer is easy to use, lightweight, functionally styled and attractive. And you can choose options from pedestals and paper racks to document inserters, sheet feeders and 8K character buffer expansion, plus more.

Genicom 3000 PC printers feature switch selectable hardware, dual connectors and dual parallel or serial interfaces. Plus the 3014 and 3024 emulate popular protocols for both Epson MX with GRAFTRAX-PLUS™ and Okidata Microline 84 Step 2™, while the 3304 and 3404 emulate popular protocols for Epson MX with GRAFTRAX-PLUS™. So your current system is most likely already capable of working with these Genicom printers without modification.

Most important, the Genicom 3000 PC printers are quality-built, highly durable printers designed for rapid, continuous duty cycle printing. So take some personal advice. Get a Genicom professional printer for your personal computer today.

Genicom Corporation, One General Electric Drive, Dept. C421, Waynesboro, VA 22980. In Virginia, call 1-703-949-1170.

GENICOM

The New Printer Company.

For the solution to your printing needs call

TOLL FREE 1-800-437-7468

In Virginia, call 1-703-949-1170.

Epson MX with GRAFTRAX-PLUS is a trademark of Epson America, Inc.
Okidata Microline 84 Step 2 is a trademark of Okidata Corporation

**See Us At
Comdex/Spring
Booth #3124**

A computer uses the same circuitry to add and subtract.

(MSB) is defined to be a negative number. The MSB simply represents the sign of the number. So why isn't $1111111 = -127$ then? It is cheaper to make a computer that uses the same circuitry to add and subtract than one that requires a different set of circuits for each operation. You can use addition to subtract if you take the one's complement of a number you want to subtract, add 1 to it (it is now called the two's complement), and add it to the number you wanted to take the original number from. Let's go through the steps to subtract 1 from 2. First, change 00000001 into its one's complement: 11111110. Now add 1: 11111111. Now add it to 2 (00000010). You get 00000001, carry the 1. Throw away the carry, and $2 - 1$ is 1. As you experiment with NOT, you will discover that NOT 1 is -2, NOT 2 is -3, etc.

The second BASIC logic operator is OR. OR operates on two arguments and returns a 1 if there is a 1 in the corresponding column of one or both of the arguments, and a 0 if both arguments have a 0 in that column. Try experimenting with PRINT argument__1 OR argument__2 until you are comfortable with this operation.

The final operation we will discuss is AND. AND operates on two arguments and, reasonably enough, returns a 1 just in case both the arguments have a 1 in the corresponding column. In any other case, it returns a 0 for that column. Again, familiarize yourself with this operation using PRINT argument__1 AND argument__2.

So what good do these operations do us? We need an exclusive-OR operator. We can make an exclusive-OR out of NOT, OR, and AND in the following way (assume that our two numerical arguments are stored in variables A and B):

Listing 1: The Nim program.

```

10 *****
20 **                               NIM                               **
30 **                               BY BOB KUROSACA                       **
40 *****
50 CLS
60 DEFINT A-Z:VICTORY$="NO"
70 REM DEFINE INITIAL BOARD CONDITIONS
80 INPUT "ENTER THE NUMBER OF ROWS (3 <= ROWS <= 18)";ROWS
90 IF ROWS<3 OR ROWS>18 THEN PRINT "MUST BE BETWEEN 3 AND
    18":GOTO 80
100 DIM ROW(ROWS)
110 FOR I=1 TO ROWS
120   PRINT "ENTER NUMBER OF OBJECTS (1 TO 59) IN ROW ";I
130   INPUT ROW(I)
140   IF ROW(I)<1 OR ROW(I)>59 THEN PRINT "NUMBER MUST BE
    BETWEEN 1 AND 59":GOTO 120
150 NEXT I
160 GOSUB 540:REM DRAW THE BOARD
170 INPUT "ENTER 1 TO MOVE FIRST, 2 TO MOVE SECOND";MOVE
180 IF MOVE<1 OR MOVE>2 THEN 170
190 ON MOVE GOTO 210,340
200 REM
210 REM PLAYER'S MOVE SEQUENCE
220 REM
230 PLAYER$="YOU"
240 INPUT "ROW";ROW
250 IF ROW<1 OR ROW>ROWS THEN PRINT "INVALID ROW":GOTO 230
260 INPUT "REMOVE";REMOVE
270 IF REMOVE>ROW(ROW) OR REMOVE<1 THEN PRINT "INVALID":GOTO
    240
280 ROW(ROW)=ROW(ROW)-REMOVE
290 GOSUB 540:REM REDRAW BOARD
300 IF VICTORY$="YES" THEN 500
310 REM PAUSE LONG ENOUGH TO SEE THE BOARD
320 FOR I=1 TO 5000:NEXT
330 REM
340 REM COMPUTER'S MOVE SEQUENCE
350 REM
360 PLAYER$="I"
370 REM DETERMINE PARITY OF THE BOARD
380 PARITY=ROW(1)
390 FOR I=2 TO ROWS
400   PARITY=(PARITY OR ROW(I)) AND (NOT(PARITY AND ROW(I)))
410 NEXT I
420 REM CHOOSE MOVE-SELECTION ROUTINE DEPENDING ON BOARD
    SAFETY
430 IF PARITY=0 THEN GOSUB 690 ELSE GOSUB 790
440 REM DRAW THE NEW BOARD
450 GOSUB 540
460 REM ANNOUNCE COMPUTER MOVE
470 PRINT "I HAVE REMOVED ";REMOVE;" PIECES FROM ROW ";ROW
480 REM LOOP FOR NEXT MOVE SEQUENCE
490 IF VICTORY$="NO" THEN 210
500 END
510 REM END OF MAIN PROCEDURE
520 REM BEGINNING OF SUBROUTINES
530 REM
540 REM BOARD-DRAWING ROUTINE
550 REM
560 CLS

```

```

570 STATUS=0 'HOW MANY ROWS ARE EMPTY?
580 FOR I=1 TO ROWS
590 PRINT "ROW ";I;"("";ROW(I);")";TAB(20);
600 IF ROW(I)=0 THEN STATUS=STATUS+1:GOTO 640
610 FOR J=1 TO ROW(I)
620 PRINT "'";
630 NEXT J
640 PRINT
650 NEXT I
660 IF STATUS=ROWS THEN PRINT PLAYER$;" WON":VICTORY$="YES"
670 RETURN
680 REM
690 REM NO GOOD MOVES ROUTINE
700 REM
710 REMOVE=0:ROW=0
720 WHILE REMOVE=0
730 ROW=ROW+1
740 IF ROW(ROW)>0 THEN REMOVE=1
750 WEND
760 ROW(ROW)=ROW(ROW)-REMOVE
770 RETURN
780 REM
790 REM FIND THE GOOD MOVE ROUTINE
800 REM
810 REMOVE=0:ROW=0
820 WHILE REMOVE=0
830 ROW=ROW+1
840 RETAIN=(ROW(ROW) OR PARITY) AND (NOT(ROW(ROW) AND PARITY))
850 IF RETAIN<ROW(ROW) THEN REMOVE=ROW(ROW)-RETAIN
860 WEND
870 ROW(ROW)=ROW(ROW)-REMOVE
880 RETURN
    
```

TABLE 6

		8 4 2 1
row 1:	////////	12 = 1 1 0 0
row 2:	////////	12 = 1 1 0 0
row 3:	//	2 = 0 0 1 0
	column-parities =	0 0 1 0

$A \text{ XOR } B = \text{def } (A \text{ OR } B) \text{ AND } (\text{NOT}(A \text{ AND } B))$.

In simple language, what this says is that A exclusive-OR B is by definition the same as A or B (there is a 1 in the appropriate column of A, or B, or both) except that XOR isn't true for the both A and B case. More formally, A XOR B is true if and only if A OR B is true and A AND B is false.

Notice that we can make use of the exclusive-OR for determining the parity of the Nim board as well as for

plotting our best move. Successive applications of the XOR with the parity results for preceding rows will end up producing the parity of the entire board. Lines 380 to 410 of listing 1 show this procedure. [Editor's note: The listing is available for downloading via *BYTE-net Listings*. The telephone number is (603) 924-9820.]

Our procedure for implementing our strategy has one flaw. Consider table 6. If we XOR the 12 in row 1 with the parity value, we find that the number we want to leave in row 1 is

14. While that would make the board safe, it would also violate the rules of the game. The only sound move that makes the board in table 6 safe is to remove row 3. Thus, we must check to see that the value returned by the operation is a number less than the original number of objects in the row. The full unflawed strategy for a position that can be made safe is contained in the subroutine starting at line 790 of the listing. If we can't make the board safe, we just remove one object from the first row we can and hope that the opponent makes a mistake. (The subroutine beginning at line 690 includes everything but our hopes.)

Before leaving the program, look at line 320. Why is it there? After the player enters his move, the new board is redrawn and then the computer moves. Bitwise logic is what computers were born to do, so the computer will find the best move and redraw the position including its new move at approximately the rate that your computer can redraw a screen. You won't have time to see what the board looks like after your move if you don't slow the computer down. It's very irritating to people to be beaten by a machine that doesn't even appear to pause and think about the clever traps that they have devised. So I like to add a pause to make people feel better.

Now that you know the winning strategy to Nim, you might like to experiment with variations on the game. For example, you might limit the number of objects that can be removed from a row. What would be the optimal strategy for a game like that in table 3 if you could remove only 1 or 2 objects per turn? Alternatively, you might consider a three-person game. Would the ternary (base-3) number system hold the key to optimal strategy for the three-person game? Is there a winning strategy at all with a three-person game? I'd enjoy hearing your answers to any of these questions. Write me c/o BYTE, POB 372, Hancock, NH 03449. If I get some particularly clever responses, I'll report on them in a future column. ■

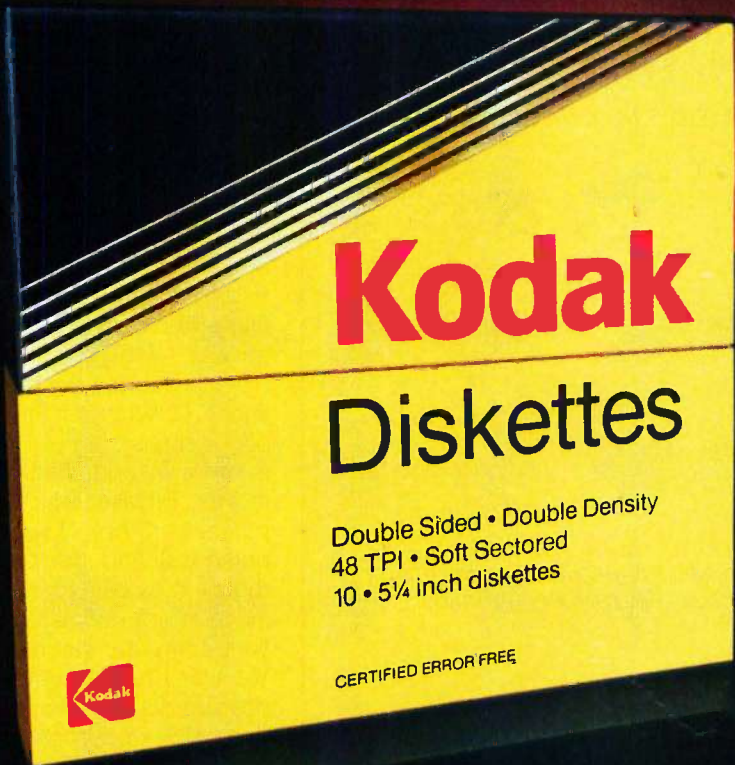

Double Sided • Double Density
48 TPI • Soft Sectored
10 • 5 1/4 inch diskettes

CERTIFIED ERROR FREE



Kodak
Diskette
Double Sided • Double Density
48 TPI • Soft Sectored

A NEW LEGEND BEGINS.

INTRODUCING NEW KODAK DISKETTES.

For as long as anyone can remember, the world has trusted Kodak film to capture its memories. Now the world can trust legendary Kodak quality to capture its computer data.

Introducing Kodak diskettes. And the beginning of a new legend.

We know you expect nothing less than extraordinary performance from a Kodak product. We didn't disappoint you.

These remarkable new diskettes are so thoroughly tested, they're certified error-free.

Every Kodak diskette has a highly burnished head surface for optimum read-write accuracy. And every standard diskette is made to

withstand 4½ million passes before significant wear occurs.

With accuracy and durability like that, we can offer this no-questions-asked replacement policy:

This KODAK Diskette will be free from manufacturing defects, or we will replace it.

Kodak diskettes for home and business PC use are available in standard 8- and 5¼-inch formats, high-density 5¼-inch diskettes, and 3½-inch micro diskettes in our HD 600 Series.

New Kodak diskettes. Because the only thing that can follow a legend is another legend.



KODAK.
The name says it all.



Conducted by Steve Ciarcia

A WORD FROM STEVE

Dear Circuit Cellar Project Builders,

In my November 1984 article on the Lis'ner 1000 voice-recognition board, I offered the software separately to Circuit Cellar project builders for \$17 through March 1, 1985. Requests have poured in throughout the offering period, but the majority of foreign mail has just started to arrive. To give everyone time to properly evaluate the project and respond, I am extending the availability of the software through August 1, 1985.

Thanks for your support.—Steve

MULTITASKING TIMEX

Dear Steve,

I'm one of them hackers, and I wonder if I can get a superhacker to consider a little problem of mine and point me in the right direction.

I have completed building a system using a Timex 1000 circuit board. I'd like to experiment with adding another Timex 1000 board to create a multitasking system. Any ideas you can offer I'll appreciate.

BILL JONES
Panama City, FL

A multitasking system usually contains system resources such as input and output devices that are used by all master and slave processors. Therefore, you will need some method of preventing more than one processor from accessing the same system resources at the same time.

There are several ways of avoiding this type of system clash. Two of the more common methods are to use an interrupt-driven system and to use a technique called temporary master access (TMA).

In an interrupt-driven system, an interrupt is initiated by a slave processor to the master processor when it requests use of the system resources. When the request is received by the master processor, it enters an interrupt mode and allows the slave processor the use of the system resources, depending on the priority of the requesting processor relative to any other processors making

simultaneous requests. When the interrupt request is completed, the control of the system's resources is again returned to the master processor.

In a TMA system, the slave processor requests use of the system resources by sending a signal to a temporary master access control (TMAC) circuit. Again, depending on the priority of the request, the TMAC circuit will take control of the system resources from the master processor and allocate them to the requesting processor. The difference between a TMA system and an interrupt-driven system is that, during the TMA operation, the TMAC circuit becomes the system resource master.

These techniques are covered in detail in a book called Interfacing to S-100 IEEE 696 Microcomputers by Sol Libes and Mark Garetz. If you intend to build a master/slave-type system, you should be familiar with the concepts offered in this book.—Steve

SPEEDY RAM DISK

Dear Steve,

I enjoy your columns in BYTE, especially your responses to readers' questions. Your responses certainly educate. I hope my own inquiry can provoke a response of similar general utility.

A few months ago I purchased a Morrow MD-3, with which I am contented. The problem is that the thing is slow. For instance, it takes several minutes to back up two 20K-byte files using the public-domain "squeeze" utility. I'd like to install a RAM disk in my Morrow to speed it up, but I don't know how. Can it be done easily, perhaps as a Circuit Cellar project?

CHANDOS BROWN
Cambridge, MA

A RAM disk will speed up your operation considerably when you are saving and recalling data from the RAM disk. However, it will not increase your speed when you finally save or back up your data to the physical disk since the same software that you are presently using will still have to be used for that operation. Several minutes to back up two 20K-byte files does seem a little long,

and it may be the "squeeze" utility that is causing the time increase.

I do agree that a RAM disk is a valuable feature. I use the RAM-disk feature available in my Trump Card (May and June 1984) for most of my word processing.

Building a low-cost RAM disk would be a good Circuit Cellar project, and I will keep it in mind. However, the problems with this kind of project are twofold. The first is the software. The software would by necessity be specific to a particular operating system, for example, CP/M 3.0, MS-DOS, etc., which would limit the appeal of such a project to some extent. The second problem is that a RAM disk has a lot of RAM on it. With today's prices, 256K bytes of RAM and the associated DIP sockets will cost about \$150. Add to that the prices of the other components and a circuit board, and the low-cost RAM disk soon becomes a medium-cost RAM disk.—Steve

Z8 VALVE CONTROL

Dear Steve,

I am attempting to interface a computer to some solenoid switching valves. Would the Z8 System Controller be a good interface? I want to connect the Z8's serial port to the computer and its parallel port to the valves. The Z8 will decide which of 40 valves, up to 7, are to be actuated according to the commands of the computer, so that while the controller is acting upon the valves, the computer can do something else. The controller's program should run about 16K bytes. Does the Z8 have the memory to handle a program this size?

JEFF SCHNEIDER
San Francisco, CA

The Z8 System Controller would be an excellent choice for an application such as you described. A Z8 BASIC System Controller and a Z8 Memory I/O Expansion Board would give you five 8-bit ports that could control the 40 valves that you mention. The two boards would also give you up to 14K bytes of memory space for your program. If you

(continued)

DATASOUTH WHEELS OUT YOUR NEW CORPORATE IMAGE

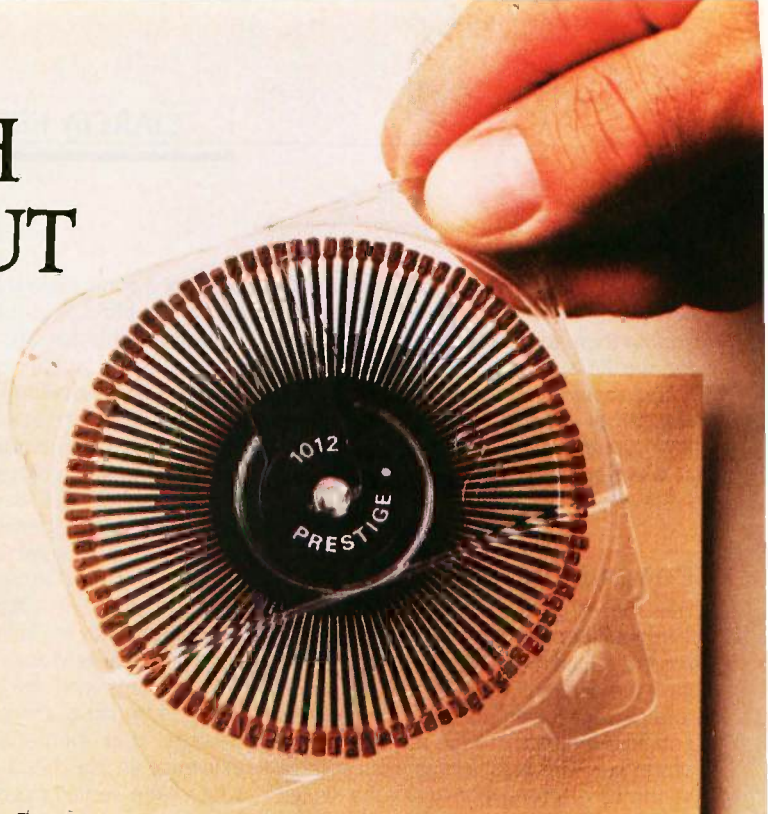

Dear Businessperson:

A good daisywheel printer should work like a pin-stripe suit for your letterhead.

That's why you need a new DaisyWheel 36 from Datasouth. It is, literally, a very impressive machine.

The DaisyWheel 36 is quick, with a top speed of 36 cps. It's more capable than any other daisywheel in its class, with superscripts, subscripts, **boldfacing**, underlining, text reprinting, **red** & black color printing and proportional spacing, among other impressive features. And with its Diablo 630 compatibility, your DaisyWheel 36 will get along with just about any computer in your office.

Your secretary will get along with your DaisyWheel 36 too--thanks to its sheet and tractor feed options, cartridge ribbon, and a whole garden of distinctive daisywheel type faces, each with its own protective cassette.

Best of all, the DaisyWheel 36 comes from a company with a most impressive name: Datasouth--the name that means high performance.

So wheel over to your Datasouth Dealer and run some of your best letterhead through a new DaisyWheel 36, the high performance daisywheel from Datasouth.

By the way, the DaisyWheel 36 lists for just **\$995**

Which is a pretty good price for the best image around.

Eventually yours,

DaisyWheel 36



datasouth

H I G H P E R F O R M A N C E P R I N T E R S

Datasouth Computer Corporation
Box 240947 · Charlotte, NC 28224
704/523-8500 · Telex 6843018 DASOU UW

Inquiry 125

CALL TOLL FREE:
1-800-222-4528

still need additional capability, more I/O boards could be added to the system by adding them to the motherboard offered for the Z8 system.

You should also read my article in the December 1984 BYTE, "Build the Power I/O System," which describes methods of connecting peripherals in the real world.
—Steve

POWER MONITOR

Dear Steve,

In your September 1984 Circuit Cellar project, "Build the AC Power Monitor," you have the differential amplifier IC1a hooked to a current-sensing resistor, Rs, which is connected directly to the hot side of the power line. This results in an input voltage to the IC of more than 100 volts, which exceeds the IC's input-voltage rating. How were you able to keep this IC from self-destructing—or is there something I don't understand? I would think it would be preferable to have the current-sensing resistor on the return or neutral side of the load. Your answer will be appreciated.

LAWRENCE SWANSON
Colorado Springs, CO

The differential amplifier shown in figure 1 of that article measures the voltage difference developed across Rs when current is flowing in the AC line. This voltage difference is the product of the current in the AC line times the value of Rs. The large AC voltage on the line is not detected by the differential amplifier because the ground systems of the AC line and the differential amplifier are isolated from each other by the 120-V-to-12.6-V power-supply transformer.

By using the isolation transformer, the measuring circuit and the AC line don't know electrically that each other exists. All the measuring circuit "knows" is that a voltage is applied between the input terminals of the differential amplifier and only this voltage difference is amplified in the circuit.—Steve

AIDS FOR THE BLIND

Dear Steve,

I have noted with interest your suggestion, mentioned in the October 1984 BYTE, of using acoustic ranging as an aid to the blind. Having had a personal experience with this type of electronic aid, I feel I must comment.

In the middle sixties I had a blind friend. During a trip to England in 1967 I became

aware of a commercially available acoustic aid for the blind. A group of us ultimately purchased this for my friend, financed from a bloated laboratory coffee fund that we periodically dumped for good causes. The manufacturer was a British firm, Ultra Electronics, if I remember correctly. The acoustic transmitter/receiver was housed in a flashlight-like case powered by nickel-cadmium batteries, and the output was an audio signal via an earpiece. Frequency varied with distance, enabling the user to "see" with his ears. The experiment with my friend failed for some very practical reasons.

In working with my friend, I learned many surprising things about simple devices that perhaps explains their existence in the blind community. The white cane serves many more functions than I ever imagined. It senses distance from an object. It is useful in following a line, i.e., a hallway, a curb, or the border between a sidewalk and grass. It senses texture. It senses steps and other dangerous forms of surface texture. It warns other people of the blind person's presence.

While the acoustic device could sense distance quite accurately in some situations, the nature of the surface returning the signal tended to muddy the interpretation. Soft things, drapery walls, and people were difficult to interpret. Hard surfaces could be "seen" quite accurately.

Slant-range measurement (perhaps interpretation is a better word) was difficult. The device could be used to follow a line, the demarcation between sidewalk and grass boulevard, for example, but the return was substantially different if this was a concrete/snow demarcation. Patchy snow was exceedingly difficult to deal with.

The device just didn't see steps: another slant-range problem.

It was hard to see people, and they couldn't be aware of his problem since he was only carrying a "flashlight" in the daytime. Embarrassing collisions resulted.

After a diligent learning effort, my friend abandoned the electronic aid for his cane. He did not lack interest or ingenuity. He was in his third year of an electrical engineering education when blinded, and he later developed his own test instrumentation to enable him to advance into better and better jobs with a nationally known instrumentation company. The last I heard of him, he was working in the computer field with a municipal government. I believe it would

have been difficult to find a more ideal subject for such an experiment.

In all fairness to the manufacturer, my friend did not take the training course that was required of all purchasers of the device. Because this was a British firm the travel cost was prohibitive, and I managed to twist one of the devices away from them with tears and wringing of the hands. The training course may have made a difference, but I doubt it; the difficulties are quite fundamental when given a bit of thought. My friend thought the device could have been of some assistance if it could have been incorporated into the cane. The cane, however, remained the primary system.

Finally, the blind are not really a big market, and most firms are not interested in helping with these types of products. Any serious development involves a high degree of altruism and must depend on the bright Ciarcias of the world.

RICHARD J. REILLY
St. Paul, MN

ASSEMBLED WHIMSI-BELL

Dear Steve,

I liked your July 1984 article about the Whimsi-Bell. I work in an office that could use such a device, and although I could build your design, I wonder if there isn't another such product on the market that's already built?

ERIC VANDERVEER
Los Alamos, NM

The only unit comparable to my Whimsi-Bell is made by Heath. The company sells a kit that performs a similar function but with only four tunes to choose from. It isn't offered in assembled form either. I haven't seen any assembled units advertised. However, I still believe that other products must be available.

The Whimsi-Bell is an easy-to-assemble kit that represents a low-cost solution to your problem.—Steve ■

.....
: Over the years I have presented many :
: different projects in BYTE. I know many of :
: you have built them and are making use of :
: them in many ways. :
: I am interested in hearing from any of you :
: telling me what you've done with these projects :
: or how you may have been influenced by the :
: basic ideas. Write me at Circuit Cellar :
: Feedback, POB 582, Glastonbury, CT :
: 06033, and fill me in on your applications. :
: All letters and photographs become the property :
: of Steve Ciarcia and cannot be returned. :
:.....

For IBM-PC Add-On Users

In A Pinch? Give QIC The Inch Measure Us By The Standards We Set!

We Set The Standard
On Price!

**QIC-01 Internal Hard Disk
Subsystem**

~~\$699~~
Call



The price of our QIC-01 10 MB internal hard disk is too low to list, but we can whisper it to you when you call. Comes complete with controller, cables, drive, easy instructions. Fits inside your floppy slot. Compatible with DOS 2.0, 2.1, and 3.0 without any patches. 20 MB half-height, ~~\$950~~ (call) ... 40 MB full-height, ~~\$1,599~~ (call) ... 20 MB Drive for the PC AT, ~~\$350~~ (call). These are all priced so low you won't believe it!

We set The Standard
In Quality!

**QIC-03 300/1200 Baud
Modems**

Our modems are fully Hayes compatible with features such as low heat dissipation, low power consumption, software volume control for the speaker, and large-scale-integration "Modem on a chip" for high reliability. It also comes with communications software which lets you emulate VT100 or IBM 3101. Both external and internal models are available.



~~\$395~~

We Set The Standard
On Performance!

QIC-02 Floppy Tape Drive

~~\$595~~



How's **this** for Performance? It backs up your 10 MB disk in only 5 minutes and performs both image and file-by-file back-up. This half-height drive will fit inside your floppy disk and connect to your floppy controller. (No need for an additional controller card.) ... All for a truly amazing low price.

We Set The Standard
On Innovation!

**QIC-04 Half-Height Floppy
Disk Drive**

~~\$129~~

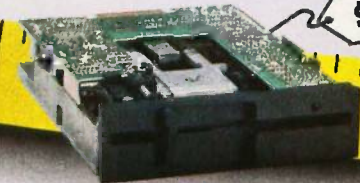

Presenting the QIC-04, the quietest drive on the market. It draws the least amount of current, is compatible with your PC's floppy controller card, and is double-sided, double-density. Also compatible with IBM AT.

We Set The Standard
On Reliability!

QIC-05 Five-Function Card

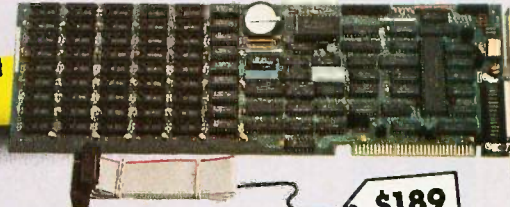

~~\$189~~

It gives you more than just added memory. It gives you **reliable** memory expansion (up to 384K), a serial port, a parallel port, a game port, and a battery back-up clock calendar. Includes RAM disk, print spooler, and clock utilities. (The 64K RAM set is only \$27.)

**...And
We Guarantee Satisfaction!**

No Risk All our products are guaranteed for one year. And remember, if for any reason, you are not completely satisfied within 30 days, you can return it for a full refund.

**Call Us Today!
(408) 942-8086**

"We Set The Standards"

QIC RESEARCH
INCORPORATED

Inquiry 333 489 Valley Way
Milpitas, Ca 95035

IBM PC/XT Compatibility AT Performance OEM Price

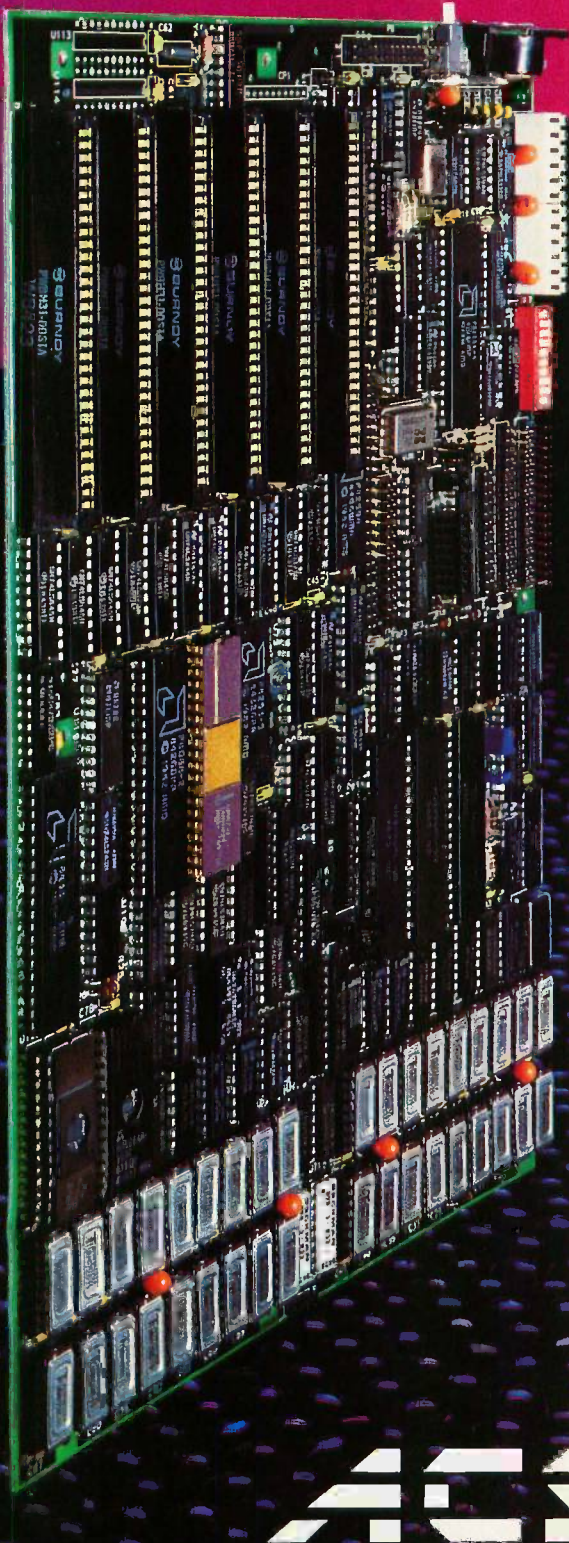

High Speed

4.7 or 8 MHz

8088-2 Processor
With 8087-2 Option

Highly Compatible

IBM PC/XT Form, Fit & Function

Highly Integrated

Built-In Disk Controllers

- Up To 4 Floppies
- SASI Hard Disk Interface

1 Megabyte On-Board Memory

Parallel Port

2 Serial Ports

Time of Day Clock

54K User Definable ROM

SEIZE CONTROL OF YOUR HARDWARE DESTINY

The switchable 4.7 or 8 MHz speed of the ACS-1000 SuperComputer coupled with the optional 8087-2 number cruncher provide AT-like performance without sacrificing PC/XT compatibility ... or price!

If your company is using board level microcomputers as a part of your own product, you can increase profits and improve reliability by using the ACS-1000 single board SuperComputer.

The ACS-1000 is compatible with both software and hardware designed for the IBM PC/XT. It even has the same mounting holes and the same power supply connections. The difference is that the ACS-1000 offers a much higher level of integration and—costs less than \$500 in OEM quantities.

Disk controllers, I/O ports and extensive memory are already built-in, simplifying production and freeing the 6 expansion slots to take on the specialized work of your process control, CAD/CAM or office automation applications.

There's even a special port for a low cost piggyback modem.

A 128K evaluation board is available to qualified OEM's for \$595. Power supplies, packaging, keyboards and other system support available on request. To order, call or write:

ACS International, Inc.
2105 Luna Rd. Suite 330
Carrollton, Texas 75006

214-247-5151

In Canada:
Soltech Industries
9274 194th St.
Surrey, B.C. V2T4W2

604-888-2606

**ADVANCED COMPUTER SOLUTIONS
INTERNATIONAL, INC.**

$$0.8660254 \approx \sqrt{3}/2$$

BY DAN SANDBERG

*An algorithm
that converts decimals to fractions*

IF YOU NEEDED the solution of $11/17 + 13/19 - 139/323 - 37/15 + 47/21$ in fractional form, finding the lowest common denominator might be difficult. Instead, you can plug the decimal equivalent, 0.672357364, into the following program and obtain a solution of 7601/11305.

The program can help you factor $133133/1101373$ to $11/91$ or verify that $\sin 60^\circ = \sqrt{3}/2$.

Listing 1, which returns a fraction for every decimal input, uses a short algorithm. First, the program inverts the decimal to obtain a number greater than 1. The routine saves the integer and again inverts the decimal remainder. So it continues, until the algorithm finds a denominator that supports an integer numerator.

To find the denominator, the program uses the algorithm $x_n \times a_{n-1} + a_{n-2} = a_n$, where n equals the number of inversions and x_n equals the saved integers. Figure 1 uses 0.5625 as an example. Using listing 1, you will obtain exact fractions only if the total number of digits in the fraction is less than the number of digits in the computer's precision. For example, if the calculating precision is 12 digits, the computer can construct a fraction like

135791/97531. But if the numerator or denominator contained one more digit, the computer would generate, unless you increased the calculating precision, only an almost exact solution. Try running the program in single and double precision.

If you want fractions printed in mixed form, add

```
35 IF INT(A)>0 THEN PRINT
INT(A);" + ";C*(A - INT(A));"/";C
```

Listing 2 is shorter and faster, but it may require higher calculating precision. It never returns an inexact (even if close) fraction; it returns an error if you input insufficient precision.

Like listing 1, the program inverts the incoming number with a special algorithm until it finds the denominator. If the fraction is too difficult (i.e., requiring greater precision), an overflow error will occur. If you enter too few decimal digits, the program, which does not round $A*B$ to an integer, will warn you by writing a decimal numerator that is close to an integer. With a precision of 12 digits, 0.333333333333 will generate the answer $1/3$. However, 0.3333333333 will yield $0.9999999999/3$. On the other hand, 0.333 gives the answer

$333/1000$, a useful feature for those needing precise fractions. Others might round $A*B$ to the nearest integer. The constant, 0.00001, in line 110 is suitable for 12-digit calculating precision. Try constants like 0.0001 and 0.000001 to produce the best possible conversion capability.

For mixed output, you can add

```
130 PRINT INT(A);" + ";(A -
INT(A))*B;"/";B
```

Listing 3 detects constants like π , $\sqrt{2}$, and $\sqrt{3}$; enter the $\sin 60^\circ$ (0.8660254) and get $\sqrt{3}/2$. The program divides and multiplies the incoming decimals by the constants, one at a time, and uses a slightly modified version of listing 2 as a subroutine to determine whether the constants form part of the fraction. The decimal equivalent of $\arctan(-1)$, -0.7853983 , gives the answer $-\pi/4$. $\arcsin -1$ returns $-\pi/2$. You need not struggle with tables.

Note that the program always places the square root in the numerator. Therefore, $1/\sqrt{3}$ will appear as

(continued)

Dan Sandberg (Täppgatan 32, S-151 33 Södertälje, Sweden) is a medical student at the Karolinska Institute in Stockholm.

American Semiconductor

Computers, Components, Hardware and Software

4164-Hit. 1.37

41256-Fuji 5.99

New! Disk Drives Full Heights

DSDD.... 89.

I.B.M.-P.C. 1350

P.C.-10mb Half Height Winchester 729

A.T.-20mb Winchester 887

8087 129

AST-8 Pack+ 289

D BASE / EVEREX / HAYES
HERCULES / EPSON / OKIDATA

800-237-5758

Sales Ext. 261

Vendor Line Visa M.C.
813-848-3183 Add 3%

Inquiry 463

Call For DEALER'S ADVANTAGE

Add-on Products for IBM PC®

10 Mb Hard Disk Kit (with controller)	\$550.00
20 Mb Hard Disk Kit (with controller)	\$650.00
Floppy Controller Card	\$50.00
Hard Disk Controller Card	\$170.00
Color Graphics Card (RGB and NTSC Comp.)	\$395.00
Monochrome Graphics Card	\$100.00
Memory Card With 256K	\$150.00

MINIMUM OF TEN BOARDS

® IBM is a registered trademark of International Business Machines, Inc.

CRANE Associates, Inc

3928 S. Sepulveda Blvd., Ste. 12
Culver City, CA 90230
(213) 390-9840

Inquiry 465

CBASIC CB80-86

New Development Utilities

Writing complex code with data input and verification? MicroScreen does all data input and verification with a single line of code, reducing your development time and costs by up to 50%. Masked input provides the utmost in flexibility. Manual and doc. incl.

- Many O/S's & Terms supported.
- Highly transportable code.
- Easy to use.

-Current programs easily convertible.

-No accidental program exits.

-Free utility software:

Screen & Menu makers

MicroScreen Tutorial

Rush \$69.95 + \$2.50 S&H (CK. or M.O.) for this introductory offer to:



MicroScope

147 St. Joseph Blvd
Lodi, NJ 07844
(201) 473-5482
Dealer inquiries welcome.

Inquiry 464

$$0.8660254 \approx \sqrt{3}/2$$

N	Decimal	Inversion	Integer(X)	Remainder
1	0.5625	1/0.5625	1	0.7777
2	0.7777	1/0.7777	1	0.2857
3	0.2857	1/0.2857	3	0.5
4	0.5	1/0.5	2	0

The following equation determines the denominator:

$$\begin{array}{rclclcl}
 X_n & * & a_{n-1} & + & a_{n-2} & = & a_n \\
 n=0 & 1 & * & 1 & + & 0 & = & 1 \\
 n=1 & 1 & * & 1 & + & 1 & = & 2 \\
 n=2 & 3 & * & 2 & + & 1 & = & 7 \\
 n=3 & 2 & * & 7 & + & 2 & = & 16
 \end{array}$$

Once we know the denominator, the numerator is simple to find, since $N = Q * D$. Here, $N = 0.5625 * 16 = 9$. Therefore, 0.5625 equals 9/16. (Note that, in the first equation, a_{n-1} and a_{n-2} are always set to 1 and 0 respectively.)

Figure 1: An illustration of the algorithm in listing 1. The entry, 0.5625, is inverted. The routine saves the integer, 1, and inverts the result, 0.7777. Continuing the routine produces four integers: 1, 1, 3, and 2. The expression $C = \text{INT}(E) * C + B$ in line 30 of listing 1 searches, as in the figure, for a denominator that supports an integer numerator.

Listing 1: This short program returns a fraction for every decimal input. Figure 1 helps to explain the algorithm.

```

10 INPUT A:B=0:C=1:
   D=ABS(A-INT(A))
20 IF D=0 THEN 40
30 E=1/D:F=C:C=INT(E)*C+B:B=F:
   D=E-INT(E):IF A*C > INT(A*C)
   THEN 30
40 PRINT A*C;"":C:GOTO 10
    
```

Listing 2: A shorter and faster version of listing 1, which returns only exact fractions. You can adjust the constant in line 110 for different conversion capabilities.

```

100 INPUT A: C=ABS(A):B=1
110 B=B/C:C=(1/C)-INT(1/C):IF
   C>0.00001 THEN 110
120 B=INT(B): PRINT A*B;"":B:
   GOTO 100
    
```

Listing 3: This program uses a slightly modified version of listing 2 as a subroutine to determine whether constants like π and $\sqrt{2}$ form part of the fraction.

```

10 K$="":L$="":INPUT H:A=H:GOSUB 100
20 K$="sqr 2":A=H/SQR(2):GOSUB 100
30 K$="sqr 3":A=H/SQR(3):GOSUB 100
40 K$="sqr 5":A=H/SQR(5):GOSUB 100
45 PI=3.141592653589793#
50 K$="PI": A=H/PI:GOSUB 100
60 K$="PI exp 2":A=H/PI/PI:GOSUB 100
70 K$="":L$="PI":A=H*PI:GOSUB 100
80 L$="PI exp 2":A=H*PI*PI:GOSUB 100
100 C=ABS(A):B=1
110 B=B/C:C=(1/C)-INT(1/C):IF B>10000 THEN RETURN
120 IF C>0.00001 THEN 110
130 B=INT(B): PRINT A*B;K$;"":B;L$:END
    
```

SQR 3/3. To eliminate this, simply add

```

125 B=INT(B):IF SQR(B)= H/A
THEN L$=K$:K$="":A=A*B:B=1
    
```

I am sure that the third listing will be a useful subroutine for a variety of tasks. You could easily add other constants for the program to search. ■

**THE FOOL PROOF
XT/PC
TAPE BACKUP**

THE WORLD OF PC UPGRADES

MT10	10 Mbyte Micro Tape Backup "add it to your XT"	\$695
XT01	Micro Tape Backup and 1/2 High Floppy "add it to your XT"	\$895
IS10	10 Mbyte Hard Disk with Controller	\$795
IS10R	10 Mbyte Removable Hard Disk/Controller	\$1295
IS20	20 Mbyte Hard Disk with Controller	\$1095
IS33	33 Mbyte Hard Disk/Controller & Power Supply	\$1995
ISPS	Power Supply "Internal" (140 watts)	\$295
CC01	Floppy/Hard Disk/Controller Card (1.6 Meg Floppy Compatible)	\$465
	when included in any of above Hard Disk Systems add	\$185

NOTE: The above pricing is for Internal units. External units are available. **Micro Design International** has been serving the Computer Industry for over 8 years and all our products carry a one year warranty with a 30-day money back guarantee.

**MAGNETIC MEMORY
PRODUCTS FOR THE
IBM XT/PC AND
COMPATIBLES. . .**

FROM

\$695

FREE

WITH THE
PURCHASE
OF ANY
HARD DISK

COMMAND

ASSIST \$49.95

(DOS manual on disk)
...as reviewed in P.C. Week

AND

CACHE

ASSIST \$49.95

(For faster disk access)

**TO ORDER CALL COLLECT
(305) 677-8333**

MasterCard/Visa/Check/or Money Order

Micro Design International Inc.

6566 University Blvd., Winter Park, Florida 32792

(305) 677-8333

Inquiry 264



See what you think.



Inspiration is fleeting, so just let your thoughts flow. The flexible format makes it easy to rearrange them later into headings and a basic outline.



Use as many headings and as much text as you need to develop the outline fully. ThinkTank's processing power can move whole sections of text with a single keystroke — something no word processor can do.



When you want to scope the Big Picture, a simple command drops out everything but the main headings. Subheads and detailed text are stored for recall later.

Go ahead.

Put your two cents worth onto ThinkTank™. And watch it grow into a million-dollar idea.

Because ThinkTank is the first software designed to process ideas on the IBM PC, XT and compatibles, the Apple II family and Macintosh.

ThinkTank's flexible outline format lets you clearly see your idea from all angles. So you can sharpen up an inspired thought, weed out a weak one, set priorities, weigh alternatives.

It's like a spreadsheet for ideas.

While all this structuring helps your brain-child take shape, it won't inhibit the natural flow of creative juices. Because entering an idea onto ThinkTank is as easy as scribbling it on a cocktail napkin. All you need is simple English.

Just let your thoughts flow — from "pie in the sky" concepts to the "nuts and bolts" details. And build more professional proposals, marketing plans, legal briefs, case reports, engineering specifications, research notes, action items, hot lists and to-do lists.

Call 1-800-556-1234 Ext. 213 (in Calif., 1-800-441-2345 Ext. 213) for the store nearest you. And see what's really on your mind.



The First Idea Processor.

"ThinkTank" and "The First Idea Processor" are trademarks of Living Videotext, Inc. © Copyright 1984, Living Videotext, Inc., 2432 Charleston Road, Mountain View, CA 94043, (415) 964-6300.

COMPUTING PI

BY DAVID J. CRAWFORD

Using infinite series to compute mathematical functions

THE ANCIENT GREEKS, who had an almost religious obsession with geometry, were well aware that the ratio of the circumference of a circle to its diameter is a constant. However, they had little success in measuring the value of the constant, which we now symbolize with the lowercase Greek letter " π " (pi). Even Archimedes, regarded as one of the three greatest mathematicians of all time, could do no better than estimate π somewhere between $3\frac{1}{2}$ and $3\frac{1}{4}$. There were two reasons for this.

First, the numbering system of the Greeks did not allow easy arithmetic computations. Second, and most important, they had no algebraic method to compute π ; instead, they summed the perimeter of a many-sided polygon.

In fact, mathematicians had no method for approximating the decimal value of π and other irrational numbers until the arrival of calculus in the late seventeenth century. The new tool was the *infinite series*, especially the technique now known as Taylor series expansion.

Like many other calculus operations named after individuals, full credit for discovery of the Taylor series should

not belong to one person. In 1712, Brook Taylor (1685–1731), a mathematician at Cambridge, generalized the series and put it on a sound theoretical footing. Even before his birth, however, other mathematicians had discovered the "magical" properties of the infinite series.

By 1671, the Scottish mathematician James Gregory knew that the function arctangent x (meaning "the angle whose tangent is x ") equaled the sum of the series

$$x - \frac{1}{3}(x^3) + \frac{1}{5}(x^5) - \frac{1}{7}(x^7) + \dots$$

for values of x between -1 and $+1$. This series, actually derived using a geometric rather than a Taylor series, provided a method for computing π because arctangent 1 equals $\frac{\pi}{4}$ in the radian measure of angles used in the calculus. Therefore, 4 times arctangent 1 is the exact value of π and is expressed as the series

$$\frac{\pi}{4} = \frac{1}{1} - \frac{1}{3} + \frac{1}{5} - \frac{1}{7} + \frac{1}{9} - \dots$$

Listing 1 sums the terms in this series. [Editor's note: The listings for the programs in this article are available for downloading via BYTEnet Listings. The telephone number is (603) 924-9820.]

Line 190 declares the variables as

double-precision. Line 210 prints a heading for each set of 10 terms. Lines 220–230 add another term to the sum. Lines 240–270 print a line of formatted output. Lines 280–300 update the variables in preparation for computing the next term in the series. Line 310 jumps back to do the next term. The program will run indefinitely.

Table 1 presents the output of listing 1 for the first 10 terms of the series.

The cumulative sum in the right-hand column is alternately greater than and less than the actual value of π . As more terms are added, the sum will continue to oscillate back and forth, but closer and closer to the true value of π .

Mathematicians have referred to this series as an elegant method for computing π because it is a clear and very simple formulation; however, a mathematician would be the first to admit that in practical terms the

(continued)

David J. Crawford (7025 Garden Grove Ave., Reseda, CA 91335) is completing a B.S. in applied mathematics and works as a consultant in the Computer Center at California State University, Northridge. His other interests include electronics and hiking.

method is virtually useless. To illustrate the impracticality of the series, it is only necessary to let the program run for a few minutes. Table 2 presents the output after 1000 terms.

The total is beginning to look more like π , but we have added 1000 terms without resolving the third decimal place. Considering the amount of number crunching that has been done, this is not a satisfactory result.

John Machin found the answer to the problem in 1706. Another Scotsman and one of Taylor's instructors at Cambridge, Machin was able to show through the use of trigonometric identities that "arc-

tangent 1" is exactly equal to "4 arctangent $\frac{1}{5}$ - arctangent $\frac{1}{239}$." This rather bizarre-looking equality has considerable significance because, when computed as an infinite series, it will converge much more rapidly. The infinite series for computing π raises x to higher and higher powers. In listing 1, $x=1$ and remains equal to 1 when raised to higher powers. If, however, x is a fraction of 1, as it is in Machin's identity, higher powers of x will become smaller and smaller, speeding the convergence.

To use the new identity to compute π , we again multiply by 4 and expand two different series. First, we compute

the sum of the series for "16 arctangent $\frac{1}{5}$ " as follows:

$$16(\frac{1}{5}) - \frac{1}{3}(\frac{1}{5})^3 + \frac{1}{5}(\frac{1}{5})^5 - \dots$$

Then we calculate "4 arctangent $\frac{1}{239}$ " with the series

$$4(\frac{1}{239}) - \frac{1}{3}(\frac{1}{239})^3 + \frac{1}{5}(\frac{1}{239})^5 - \dots$$

and subtract the second sum from the first. The result will again equal π but will require much less computation.

To see just how quickly these new series converge, we use listing 2, which incorporates the first program as a subroutine for summing a given number of terms of the arctangent series.

Line 190 declares the variables as double-precision. Line 200 sets up the parameters for the first call of the arctangent-series subroutine in line 210. Line 220 temporarily stores the returned sum. Line 230 sets up the second subroutine call in line 240. Lines 250-260 print the final answer. Table 3 is the complete output of the program.

Note how quickly the magnitude of the denominators in the second column increases for both series. The result, given in the lower right-hand corner of the output, is the value of π correct to 15 decimal places. The advantages of this method are obvious; it required only 12 terms of the first series and 4 of the second.

There is no point in adding any more terms to either series because for both the last term has an absolute value less than 10^{-16} ; the first 15 decimal places would not subsequently change. In fact, adding only a few more terms to the second series might cause an overflow error because most microcomputer programming languages are not equipped to handle numbers whose base-10 exponents exceed + or -39.

The value of π computed above is the most accurate that Microsoft BASIC can derive in its double-precision mode. More accuracy would require special routines to handle decimal numbers with more than 16 significant figures. Of course, this has already been done. One of the first

(continued)

Listing 1: Summing the series 4 times arctangent 1.

```

100 REM *****
110 REM *
120 REM *          PI1.BAS
130 REM *
140 REM *****
150 REM
160 REM THIS PROGRAM COMPUTES PI USING THE INFINITE-SERIES EXPANSION
170 REM OF 4 ARCTANGENT 1.
180 REM
190 DEFDBL A-D,P
200 A=4 : B=1 : C=1 : E=1 : PI=0
210 IF RIGHTS$(STR$(E),1)="1" THEN PRINT "TERM #","RATIO",
    "DECIMAL", "PI TOTAL"
220 D=C*A/B
230 PI=PI+D
240 PRINT E,
250 IF SGN(C)=1 THEN PRINT "+ "; ELSE PRINT "- ";
260 PRINT STR$(A);"/";STR$(B),
270 PRINT TAB(29);D;TAB(56);PI
280 C=-C
290 B=B+2
300 E=E+1
310 GOTO 210
    
```

Table 1: The first 10 terms derived from listing 1.

Term #	Ratio	Decimal	Pi Total
1	+ 4 / 1	4	4
2	- 4 / 3	-1.3333333333333333	2.666666666666667
3	+ 4 / 5	0.8	3.466666666666667
4	- 4 / 7	-0.5714285714285714	2.895238095238095
5	+ 4 / 9	0.4444444444444444	3.33968253968254
6	- 4 / 11	-0.3636363636363636	2.976046176046176
7	+ 4 / 13	0.3076923076923077	3.283738483738484
8	- 4 / 15	-0.2666666666666667	3.017071817071817
9	+ 4 / 17	0.2352941176470588	3.252365934718876
10	- 4 / 19	-0.2105263157894737	3.041839618929402

Now! Tek quality and expert advice are just a free phone call away!

The industry standard in CRT performance. Crisp, easy-to-read, bright CRT; 14kV accelerating potential, provides high writing rate and small spot size. Full size 8x10 cm display for measurement accuracy.

Display controls are flexible and easy to use. Separate intensity controls reduce blooming in alternate sweep mode. Focus tracking minimizes control adjustment and BEAM FIND eliminates confusion.

Vertical system provides measurement assurance. Flat transient response and high accuracy ensures true reproduction of your signals. Fast risetime and high bandwidth is well suited for a variety of measurement.

Perform delayed sweep measurements accurately and easily. Both sweeps can be displayed alternately making differential measurements easy and accurate (1%). An interlocking SEC/DIV control simplifies set-up.

Stable hands-off triggering. P-P AUTO detects signal peaks, then sets the trigger level for you. Display asynchronous signals using VERT MODE triggering. Independent TV field and line selection.

Front panel laid out by function for ease of use. Color coding aids the user in operation. Functions and modes are placed logically. All nomenclature is clearly labeled, and protected behind a scratchless Lexan surface.



1-800-426-2200

Our direct order line gets you the industry's leading price/performance portables... and fast answers from experts!

The 60 MHz single time base delay 2213A, the 60 MHz dual time base 2215A and the 100 MHz dual time base 2235 offer unprecedented reliability and affordability, plus the industry's first 3-year warranty* on labor and parts, CRT included.

The cost: just \$1275 for the 2213A, \$1525 for the 2215A, \$1750 for the 2235.† Even at these low prices, there's no scrimping on performance. You

have the bandwidth for digital and analog circuits. The sensitivity for low signal measurements. The sweep speeds for fast logic families. And delayed sweep for fast, accurate timing measurements. All scopes are UL Listed and CSA approved.

You can order, or obtain literature, through the Tek National Marketing Center. Technical personnel, expert in scope applications, will answer your questions and expedite delivery. Direct orders include comprehensive 3-year warranty*, operator's

manual, two 10X probes, 15-day return policy and worldwide service backup.

Order toll free: 1-800-426-2200, Ask for Rick.

In Oregon, call collect: (503) 627-9000. Or write Tektronix, Inc. P.O. Box 1700 Beaverton, OR 97075

Tektronix®
COMMITTED TO EXCELLENCE

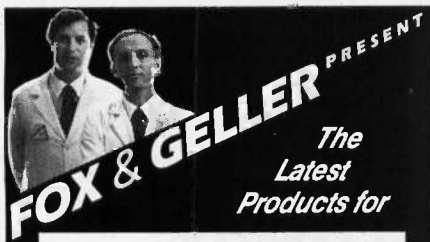

dBASE



NEW

QUICKREPORT™

dBASE Report Generator

- Prints *any kind* of report or form
- Up to **6 databases** per report!!
- Incredibly easy to use
- No programming required

QUICKCODE III™

dBASE Program Generator

- Create CMD files *automatically*
- Data entry screens
- Data input error checking
- Computed fields & totals
- Link up to 8 databases!

Why write programs yourself?
Let QUICKCODE III do it!

dGRAPH III™

dBASE Graphics System

- Pie, line, bar charts
- Printer, plotter, or CRT
- Many automatic features

dUTIL III™

dBASE Program Utility

- Finds program errors
- Improves code
- Saves time

—Versions available for dBASE II—

**INFORMATION
HOTLINE**

800-221-0156

FOX & GELLER

Fox & Geller, Inc. 604 Market St., Elmwood Park, N.J. 07407

dBASE II and dBASE III are trademarks of Ashton-Tate.
QUICKCODE and QUICKCODE III are trademarks of Fox & Geller, Inc.

COMPUTING PI

tasks given to digital computers at the dawn of the computer age was to calculate the value of π to an absurd number of decimal places. In 1949, at the Army Ballistic Research Center in Aberdeen, Maryland, the original

ENIAC, a vacuum-tube computer, computed π to 2037 decimal places. Over the next 20 years, the accuracy increased many times, until in Paris in 1967, a Control Data 6600 calculated

(continued)

Table 2: Later output from listing 1.

Term #	Ratio	Decimal	Pi Total
1001	+ 4 / 2001	1.999000499750125D-03	3.142591654339554
1002	- 4 / 2003	- 1.99700449326011D-03	3.140594649846294
1003	+ 4 / 2005	1.99501246882793D-03	3.142589662315122
1004	- 4 / 2007	- 1.993024414549078D-03	3.140596637900573
1005	+ 4 / 2009	1.991040318566451D-03	3.14258767821914
1006	- 4 / 2011	- 1.989060169070114D-03	3.14059861805007
1007	+ 4 / 2013	1.987083954297069D-03	3.142585702004367
1008	- 4 / 2015	- 1.985111662531017D-03	3.140600590341836
1009	+ 4 / 2017	1.983143282102132D-03	3.142583733623938
1010	- 4 / 2019	- 1.981178801386825D-03	3.140602554822551

Listing 2: Summing Machin's series.

```

100 REM *****
110 REM *
120 REM *          PI2.BAS
130 REM *
140 REM *****
150 REM
160 REM THIS PROGRAM COMPUTES PI USING THE INFINITE-SERIES EXPANSION
170 REM OF "16 ARCTANGENT 1/5 - 4 ARCTANGENT 1/239."
180 REM
190 DEFDBL B-G,P
200 A=12 : B=16 : C=5
210 GOSUB 280
220 P1=P
230 A=4 : B=4 : C=239
240 GOSUB 280
250 PRINT "16 ARCTAN 1/5 - 4 ARCTAN 1/239 = PI"
260 PRINT P1,P,P1-P
270 STOP
280 REM *** THIS SUBROUTINE SUMS "A" TERMS OF THE INFINITE SERIES
290 REM FOR "B" TIMES THE ANGLE WHOSE TANGENT IS (1/"C")
300 REM AND RETURNS THE SUM AS "P."
310 PRINT "INFINITE SERIES FOR";B;"ARCTAN( 1 /";C;" )"
320 PRINT "TERM #";TAB(10);"RATIO";TAB(38);"DECIMAL";TAB(61);
"SUBTOTAL"
330 D=1 : E=1 : F=C : P=0
340 FOR X=1 TO A
350 G=E*F
360 P=P+D*B/G
370 PRINT X,TAB(8)
380 IF SGN(D)=1 THEN PRINT "+ "; ELSE PRINT "- ";
390 PRINT STR$(B);"/";STR$(G);TAB(37);D*B/G;TAB(60);P
400 F=F*C*C
410 E=E+2
420 D=-D
430 NEXT X
440 PRINT : RETURN
    
```

Make Stat Magic

Now for the IBM PC/AT*
with hard disk

Statistics, reports and plots happen magically with SPSS/PC™—the Statistical Package for IBM PC/XTs.*

SPSS/PC is the most comprehensive statistical package for performing simple or complex tasks, regardless of data size. It maintains feature and language compatibility with mainframe SPSS; while optimizing for the PC environment.

Statistics range from simple descriptive to complex multivariate, including Multiple Regression, ANOVA, Factor and Cluster analysis. Loglinear and nonparametric procedures are also included.

Simple facilities allow transfer of files between

SPSS/PC and programs like Lotus 1-2-3, dBase II and SAS. A complete Report Writer, Plotting facilities and a Communications program for mainframes round out a fully integrated product.

For more information, contact our Marketing Department without further ado. And see what a little stat magic can do for you.

SPSS Inc., 444 N. Michigan Avenue,
Chicago, IL 60611, 312/329-3500.

In Europe: SPSS Benelux B.V.,
P.O. Box 115, 4200 AC Gorinchem,
The Netherlands, Phone: +31183036711
TWX: 21019.

VISA, MasterCard and
American Express
accepted.



SPSS inc. PRODUCTIVITY RAISED TO THE HIGHEST POWER™

*SPSS/PC runs on the IBM PC/XT or AT with 320K memory and a hard disk. An 8087 co-processor is recommended. Contact SPSS Inc. for other compatible computers.
IBM PC/XT and AT are trademarks of International Business Machines Corporation. dBase II is a trademark of Ashton-Tate. 1-2-3 is a trademark of Lotus Development Corporation.
SAS is a registered trademark of SAS Institute, Inc. SPSS and SPSS/PC are trademarks of SPSS Inc. for its proprietary computer software. ©Copyright 1985, SPSS Inc.

Table 3: The complete output of listing 2.

Infinite series for 16 arctan(1 / 5)

Term #	Ratio	Decimal	Subtotal
1	+ 16 / 5	3.2	3.2
2	- 16 / 375	-0.04266666666666667	3.157333333333333
3	+ 16 / 15625	0.001024	3.158357333333333
4	- 16 / 546875	-2.925714285714286D-05	3.158328076190476
5	+ 16 / 17578125	9.102222222222222D-07	3.158328986412699
6	- 16 / 537109375	-2.978909090909091D-08	3.158328956623608
7	+ 16 / 15869140625	1.008246153846154D-09	3.158328957631854
8	- 16 / 457763671875	-3.495253333333333D-11	3.158328957596901
9	+ 16 / 12969970703125	1.233618823529412D-12	3.158328957598135
10	- 16 / 362396240234375	-4.415056842105263D-14	3.158328957598091
11	+ 16 / 1.001358032226563D + 16	1.597830095238095D-15	3.158328957598092
12	- 16 / 2.741813659667969D + 17	-5.835553391304348D-17	3.158328957598092

Infinite series for 4 arctan(1 / 239)

Term #	Ratio	Decimal	Subtotal
1	+ 4 / 239	0.01673640167364017	0.01673640167364017
2	- 4 / 40955757	-9.766636714833522D-08	0.01673630400727302
3	+ 4 / 3899056325995	1.025889257698589D-12	0.01673630400829891
4	- 4 / 3.118051949560246D + 17	-1.282852263113878D-17	0.0167363040082989

16 arctan 1/5 - 4 arctan 1/239 = pi
 3.158328957598092 0.0167363040082989 3.141592653589793

π to a half-million decimal places!
 We should not underestimate the importance of infinite series to computer science. Novice computer users often imagine that computers, for trigonometric and exponential functions, contain immense lookup tables like those found in the appendixes of mathematics textbooks. Obviously, this is not the case; the storage space required for such tables is prohibitive.

When a computer or hand calculator requires the sine of a given angle, it calculates the value on the spot with a method similar to the Taylor series. Mathematical tricks that allow more rapid convergence of infinite series, like the one just demonstrated, are absolutely necessary to reduce computation time. Indeed, without employing special techniques, the series for finding the logarithm of a number

will converge slowly—if at all.
 And for those who fear that 15 decimal places of π are not enough for their purposes, consider the following: if you had a circle the size of the earth's equator and you knew its diameter with the same degree of accuracy, you could use this value of π to calculate the circumference to within a few hundredths of a micron! ■

GRAPHS WITHOUT GRAPHICS?

Disk Drives 11.9%

Printers 25.4%

Software 15.9%

Modems 27.0%

Computers 19.8%

SALES IN 1983

No need for color monitor or graphics board.
 Make graphs on dot matrix printers.
 Easy to Use. No Programming.
 CP/M 2.2, 3, 80, or 86, MS-DOS or PC-DOS.
 Excellent Manual. Most disk formats.

DataPlotter™
 Line Graphs & Scatterplots . . . \$69
 Bar Graphs & Pie Charts \$69
 Both for \$99
(Prices include manual)
 Add \$3 shipping,
 \$8 outside US and Canada.

Specify type of Printer.

Lark Software™
 131 N. Leverett Rd.
 Leverett, MA 01054 (413) 773-8687 Visa, M/C

DISPLACEMENT

THEORETICAL

EMPIRICAL

MILLISECONDS

Finally, business computer software for the hard-nosed.

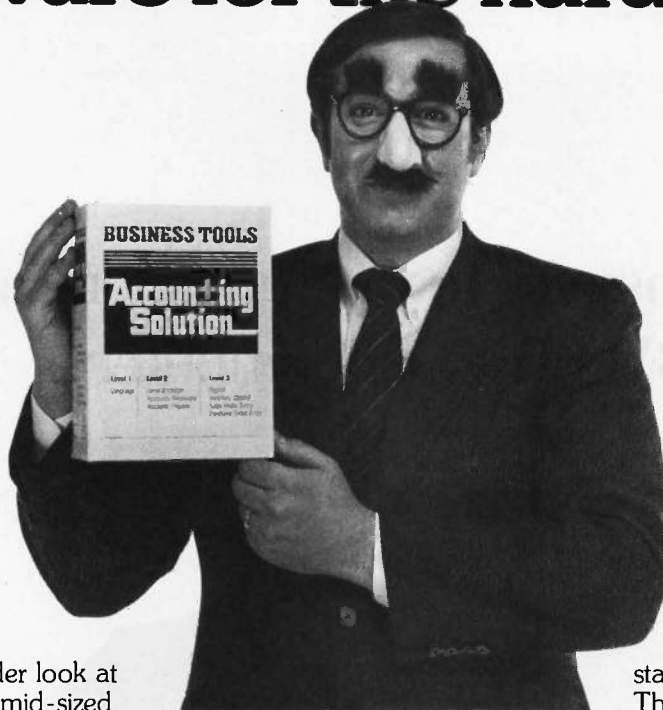

No one takes a harder look at software than small to mid-sized businesses.

So take a long, hard look at The Accounting Solution™, a new, totally integrated software package from Business Tools, Inc.™

You'll find its breakthrough features are designed to pay off where it counts—on the bottom line.

Hard-nosed economy, \$99.*

Contrary to popular opinion, you don't need a small business loan to buy quality software. Not if you're buying The Accounting Solution. For \$99, you get a language/data base manager with more hard-nose capabilities and speed than any program available at any price; \$249 buys the language plus accounts receivable/payable and general ledger; \$399 gets you all the above plus inventory control, sales order entry, purchase order entry and payroll. Even more good news for the budget minded—source code is included with applications.

Easy for any hard-nose.

The Accounting Solution is easy

enough for the novice hard-nose to use within minutes of receiving the package. Yet it's also sophisticated, offering unlimited flexibility and opportunity to the hot-shot hard-nose. And it's designed to run on CP/M-80, MP/M-80, IBM PC and compatibles.**

Multi hard-nose capability.

The Accounting Solution never

stands in the way of progress. Thanks to multi-user capability, two or more hard-noses can use the same application at the same time.

Hard-nosed flexibility.

With The Accounting Solution, it's easy to change your mind because the source code is so simple to modify. Ready to grow? Great. You can change hardware without spending a dime on new software.

Take it from hard-nose Phil Mickelson.

Phil created The Sensible Solution™, a highly respected software package. Now he's offering the next step, another breakthrough: The Accounting Solution. It's simple. Sophisticated. Affordable. And backed by Phil's reputation and personal service. If you're looking for hard-nosed value and quality, you'll agree, The Accounting Solution is the only solution.



Write or call:

Business Tools, Inc.
4038-B 128th Avenue SE
Bellevue, WA 98006

1-800-648-6258

Washington State:
(206) 644-2015

Dealer inquiries welcome.

**Suggested retail price.

**CP/M-80 and MP/M-80 are registered trademarks of Digital Research, Inc.; IBM PC is a registered trademark of International Business Machines Corporation; The Sensible Solution trademark rights are claimed by O'Hanlon Computer Systems.

Simple answers to your questions about IBM Personal Computers.



If you're personally interested in personal computers, but want to know more, these definitions, descriptions and details should help.

"Just what is a personal computer, and how can I use it?"

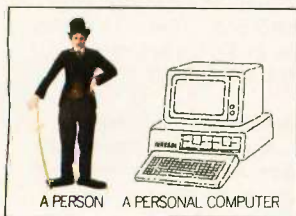

An IBM Personal Computer is a computer designed for a person. It's a tool to help accomplish just about anything a person needs to do with information. It can help you start a small enterprise at home just as surely as it can help a corporate planner solve complex problems.

"Suppose I've never had my hands on a computer. How 'easy' will it be?"

As with any new tool, you'll want to get comfortable with your IBM Personal Computer before getting down to work. The nice thing is that the computer is on your side, interacting with you as you learn. Then you're running programs and feeling good with the results. It becomes clear that you've made a good investment, and you'll probably be telling your friends why they should get one.



"Are IBM Personal Computers simple or sophisticated?"



Both. Our systems have many advanced design features; they are there to make your computer simple to operate and to help make you more productive. As with a well-designed car, the computer is designed around you, the user.

"What kind of software programs do you have to help me?"

Perhaps the world's largest and most up-to-date library of business programs has been written specifically for the IBM PC family. And among the best

of this software is IBM's Personal Computer Software.

A great deal of it is compatible from one system to another or from office to home. You might be interested in help with your writing, filing, graphing, planning or reporting. And if you want to get all your ducks in a row, line them up with the IBM Assistant Series.

You can work with each program individually, or together as a team. There is also software to help you with accounting, inventory and payroll—practically anything, including communications packages to connect you to a company mainframe or outside information services.



"How expensive are they? And what if my needs change?"

With all the quality, power and performance built into IBM Personal Computers (including their extraordinary expansion capabilities), you'll find they're surprisingly affordable.

But the value doesn't end there, because if your needs change you can always expand or upgrade within the IBM PC family. It's a very extensive, very compatible family of products that can help you protect your initial investment.



"If I want a demonstration, where do I go and who will show it to me?"

Go to any Authorized IBM Personal Computer Dealer or IBM Product Center, or contact your IBM marketing representative. All have received special training and you should find them quite helpful.

Ask to see the software programs that interest you most, and get your hands on the system yourself. Then you'll begin to see what this tool for modern times can do for you.

For a store near you, call 1-800-447-4700, Dept. HC. In Alaska or Hawaii, 1-800-447-0890.

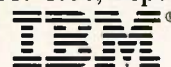
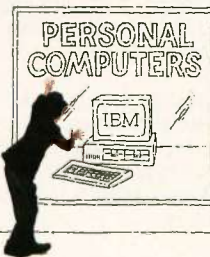

B.O.O.K.S R.E.C.E.I.V.E.D

THE ABC'S OF 1-2-3, Chris Gilbert and Laurie Williams. Berkeley, CA: Sybex, 1985; 242 pages, 17.5 by 22.5 cm, softcover, ISBN 0-89588-168-3, \$14.95.

ADA: LANGUAGE, COMPILERS AND BIBLIOGRAPHY, M. W. Rogers, ed. New York: Cambridge University Press, 1984; 300 pages, 15.5 by 23 cm, hardcover, ISBN 0-521-26464-2, \$17.95.

ANALOG INTEGRATED CIRCUITS, Sidney Soclof, Englewood Cliffs, NJ: Prentice-Hall, 1985; 526 pages, 18.5 by 24 cm, hardcover, ISBN 0-13-032772-7, \$39.95.

APPLE ACCESS: USERS' GUIDE TO APPLE COMPUTER-RELATED PERIODICAL LITERATURE, VOLUME 1, Michael McAfee, ed. Petaluma, CA: Stony Point Publications, 1985; 256 pages, 18 by 23 cm, softcover, ISBN 0-931293-01-04, \$19.95.

THE APPLE COMPUTER CLUBS' ACTIVITIES HANDBOOK, Samuel K. Miller and Michael E. Caley. Englewood Cliffs, NJ: Prentice-Hall, 1984; 205 pages, 21.5 by 27.5 cm, softcover, ISBN 0-13-039454-8, \$14.95.

APPLE LOGO: A COMPLETE ILLUSTRATED HANDBOOK, Drew Berentes. Blue Ridge Summit, PA: Tab Books, 1984; 390 pages, 13 by 21 cm, softcover, ISBN 0-8306-1751-5, \$13.95.

ATARI XL USER'S HANDBOOK, staff of Weber Systems. Cleveland, OH: Weber Systems, 1984; 352 pages, 15 by 22.5 cm, softcover, ISBN 0-938862-08-1, \$14.95.

THE BANK STREET WRITER BOOK, Don Beil. Reston, VA: Reston Publishing, 1985; 266 pages, 21.5 by 28 cm, spiral-bound, ISBN 0-8359-0361-3, \$19.95.

BASIC ADVENTURE AND STRATEGY GAME DESIGN FOR THE TRS-80, Jim Menick. New York: Facts on

File Publications, 1984; 272 pages, 15 by 23 cm, softcover, ISBN 0-87196-977-7, \$9.95.

BASIC & FORTH IN PARALLEL, S. J. Wainwright. London: Bernard Babani Ltd., 1984; 119 pages, 11 by 17.5 cm, softcover, ISBN 0-85934-113-5, £1.95.

BASIC IN ACTION, Stanislav Dvořák and Anthony Musset. Stoneham, MA: Butterworth Publishers, 1984; 304 pages, 15.5 by 23.5 cm, softcover, ISBN 0-408-01395-8, \$29.95.

BASICALLY KAYPRO: PROGRAMMING THE 2, 4 AND 10, Joseph K. Rensin and Larry Joel Goldstein. Bowie, MD: Brady Communications, 1985; 288 pages, 17.5 by 23.5 cm, softcover, ISBN 0-89303-360-X, \$16.95.

BOWKER'S 1985 COMPLETE SOURCEBOOK OF PERSONAL COMPUTING, R. R. Bowker. New York: R. R. Bowker Co., 1985; 2020 pages, 15 by 22.5 cm, softcover, ISBN 0-8352-1931-3, \$19.95.

BRAIN GAMES FOR KIDS & ADULTS USING THE APPLE II/IIe/IIc, John W. Stephenson and Robert L. Randell. Bowie, MD: Brady Communications, 1985; 254 pages, 17.5 by 23 cm, softcover, ISBN 0-89303-362-6, \$13.95.

BUSINESS AND HOME APPLICATIONS FOR THE MACINTOSH: USING MICROSOFT BASIC, Stan Schatt. Bowie, MD: Brady Communications, 1985; 224 pages, 17.5 by 23.5 cm, softcover, ISBN 0-89303-403-7, \$14.95.

BUSINESS MINI/MICRO SOFTWARE DIRECTORY, Information Sources Inc. New York: R. R. Bowker Co., 1984; 824 pages, 21.5 by 28 cm, softcover, ISBN 0-8352-1970-4, \$75.

BUSINESS PROGRAMMING ON YOUR BBC MICRO, Peter Jackson. North Pomfret, VT: David & Charles Inc., 1985; 158 pages, 15.5 by 23.5 cm, softcover, ISBN 0-9465-7620-3, \$14.95.

BUSINESS PROGRAMMING ON YOUR COMMODORE, Peter Jackson. North Pomfret, VT: David & Charles Inc., 1985; 158 pages, 15.5 by 23.5 cm, softcover, ISBN 0-9465-7619-X, \$14.95.

CHARLES BABBAGE: PIONEER OF THE COMPUTER, Anthony Hyman. Princeton, NJ: Princeton University Press, 1982; 306 pages, 15 by 23.5 cm, softcover, ISBN 0-691-02377-8, \$9.95.

COBOL WITH AN EMPHASIS ON STRUCTURED PROGRAM DESIGN, D. F. Galletta. Englewood Cliffs, NJ: Prentice-Hall, 1985; 368 pages, 21 by 28 cm, softcover, ISBN 0-13-139858-X, \$21.95.

THE COMMODORE DISK AND PRINTER HANDBOOK, David Bridges and Helen Naylor. North Pomfret, VT: David & Charles Inc., 1984; 212 pages, 15.5 by 23 cm, softcover, ISBN 0-9465-7623-8, \$14.95.

COMMODORE LOGO, Harold Bailey, Kathleen Brautigam, and Trudy Doran. Bowie, MD: Brady Communications, 1984; 320 pages, 17.5 by 23.5 cm, softcover, ISBN 0-89303-376-6, \$14.95.

COMMODORE 64: TUTOR FOR HOME AND SCHOOL, Julie Knott and Dave Prochnow. Glenview, IL: Scott, Foresman and Co., 1985; 220 pages, 19.5 by 23.5 cm, softcover, ISBN 0-673-18074-3, \$15.95.

COMMUNICATING WITH DATABASES IN NATURAL LANGUAGE,

Mark Wallace. New York: John Wiley & Sons, 1984; 172 pages, 17 by 24.5 cm, hardcover, ISBN 0-470-20105-3, \$29.95

COMPAQ PORTABLE COMPUTER: USE, APPLICATIONS, AND BASIC, William Arnold. New York: Holt, Rinehart and Winston, 1984; 240 pages, 17 by 23 cm, softcover, ISBN 0-03-064119-5, \$18.45.

THE COMPLETE GUIDE FOR THE COMMODORE 64, Spencer Bateson. North Pomfret, VT: David & Charles Inc., 1984; 334 pages, 13.5 by 21.5 cm, softcover, ISBN 0-9465-7621-1, \$18.95.

THE COMPUTER FREELANCER'S HANDBOOK, Ardy Friedberg. New York: New American Library, 1984; 160 pages, 15 by 22.5 cm, softcover, ISBN 0-452-25562-7, \$10.95.

COMPUTER PROGRAMMING FOR THE COMPLETE IDIOT, Donald McCunn. San Francisco, CA: Design Enterprises of San Francisco, 1984; 208 pages, 21 by 27.5 cm, softcover, ISBN 0-932538-14-2, \$10.95.

COMPUTER PROGRAMMING IN FORTRAN THE EASY WAY, Lawrence S. Leff and Arlene Podos. Woodbury, NY: Barron's Educational Series, 1985; 326 pages, 19.5 by 27.5 cm, softcover, ISBN 0-8120-2800-7, \$7.95.

CP/M SOFTWARE DIRECTORY, Xerox Corporation. New York: R. R. Bowker Co., 1984; 768 pages, 21.5 by 28 cm, softcover, ISBN 0-8352-1973-9, \$24.95.

CREATIVE COMPUTER GRAPHICS, Annabel Jankel and Rocky Morton. New York: Cambridge University Press, 1984; 150 pages, 30 by 30.5 cm, softcover, ISBN 0-521-26251-8, \$29.95.

DATABASE AND FILE MANAGEMENT SYSTEMS FOR THE MICRO-

.....
THIS IS A LIST of books received at BYTE Publications. It is not meant to be exhaustive; its purpose is to acquaint BYTE readers with recently published titles in computer science and related fields. We regret that we cannot review all the books we receive; instead, this list is meant to be a monthly acknowledgment of these books and the publishers who sent them.

(continued)

See us at Booth #B218
COMDEX Spring '85
May 6-9, 1985
Georgia World Congress Center,
Atlanta, Georgia

We've Put a Local Area Network on a Disk

Corporate Information Sharing. It's been described as the key to increasing a company's productivity. It's also why large networks of PC's are becoming more and more common in the workplace...In spite of the fact that they're costly, difficult to install, and incompatible with much existing software.

Finally, there's a solution to this corporate dilemma. Its name is LANLink™

A Software-Driven LAN That Uses Standard, RS-232 Ports. A major breakthrough in local area networks, LANLink™ uses your computers' existing serial ports and runs under PC-DOS.

Because all of the intelligence the network requires is on the server and satellite diskettes, expensive network interface boards aren't required:

A Powerful Network That's Cost-Conscious. If you've been pricing board-driven LAN's, you already know that they can cost over \$1,000 per workstation.

LANLink™ is different.

Boasting a data transfer rate in excess of 100,000 BPS, LANLink™ is compatible with a wide range of programs. And because special boards aren't required, installation costs are one-third that of a traditional network.

A Network Designed the Way Business Works. With LANLink™ you're able to customize your network along departmental lines using a data-sharing hierarchy and password-protected access.

Get Started With LANLink™ TODAY. Call The Software Link TODAY for complete details and the authorized dealer nearest you. The LANLink™ Starter Kit, priced at \$595 (U.S.), comes complete with network software for both a server and a satellite computer. For a limited time, 50 feet of RS-232 cable will be included free of charge.

LANLink™ is immediately available and comes with a money-back guarantee. VISA, Mastercard, American Express accepted.

LANLink™



THE SOFTWARE LINK, INC.

Developers of MultiLink™ and MultiLink Advanced™

8601 Dunwoody Place, Suite 336, Atlanta, GA USA 30338 Telex 4996147 SWLINK

CALL: 404/998-0700

Distributor Inquiries Invited

MultiLink, MultiLink Advanced & LANLink are trademarks of The Software Link, Inc. PC-DOS is a trademark of IBM Corp.

Inquiry 366

WIRED?



WIRELESS FILE TRANSFER.

The Best of 1984

EDITOR'S CHOICE AWARD

APPLE TURNOVER™

A "wireless file transfer" package for the IBM PC* to Apple II and back, and back again. Apple Turnover is a firmware board which fits into any slot in the IBM PC* or compatible, and software running under MS-DOS*. No modems, no serial links, no hassles, no problems. APPLE TURNOVER™ will format Apple CP/M* and Apple DOS 3.3 disks. Leave your IBM and Apple computers where they are. Simply bring your Apple disk to work and transfer your file to a PC-DOS disk. Allows for modifications to text and data files. It's a simple, inexpensive, fast high performance alternative to complicated serial links and modems.

XENO-COPY PLUS™ (NO LONGER COPY PROTECTED)

A "wireless file transfer" software program for your IBM PC and most PC look-a-likes. XENO-COPY PLUS™ formats, writes to and copies from over 100 different disk formats including 40 and 80 track 5 1/4 inch CP/M disk formats, as well as TurboDOS, TRS-DOS, p-System and NEC-DOS formats. An uncomplicated and inexpensive way to transfer text and data files. Also, allows for modifications to text and data files. XENO-COPY PLUS™ can be upgraded to XENO-DISK™ for the price difference.

XENO-DISK™ (NO LONGER COPY PROTECTED)

The high performance model of XENO-COPY PLUS™, XENO-DISK™ also formats, writes to, and copies from over 100 different disk formats including 40 and 80 track 5 1/4" disks. XENO-DISK™ contains a powerful table driven text translator, "Text-Trans." For low volume disk production, XENO-DISK™ includes a track-by-track disk duplicator (which is faster than file by file duplication). Gives you the option to input disk format parameters which allows you to utilize uncommon disk formats.

80Mate™

Simulates CP/M-80 in your MS-DOS computers. After programs have been transferred onto PC/MS DOS* disks with XENO-COPY PLUS™, XENO-DISK™, or APPLE TURNOVER™, 80Mate™ lets you simulate most CP/M* 80 systems on your MS-DOS* computer. Includes all internal CP/M* commands and many available functions. 80Mate™ includes a terminal emulator for 7 predefined terminals including APPLE CP/M*! You can also input parameters for other terminals that need to be emulated.

See your dealer or
Call for information:
(213) 938-0857

Vertex
systems, inc.
Innovation in microcomputer products

6022 W. Pico Blvd., Los Angeles, CA 90035

APPLE TURNOVER, XENO-COPY PLUS, XENO-DISK and 80Mate are registered trademarks of Vertex Systems, Inc. • IBM PC & PC-DOS are registered trademarks of International Business Machines Corporation. • TurboDOS is a trademark of Software 2000, Inc. TRS-DOS is a registered trademark of Tandy-Radio Shack. • p-System is a trademark of Softech Microsystems, Inc. • APPLE is a registered trademark of Apple Computers, Inc. • CP/M is a registered trademark of Digital Research, Inc. • MS-DOS is a registered trademark of Microsoft Corp.

BOOKS RECEIVED

COMPUTER, Nelson T. Dinerstein. Glenview, IL: Scott, Foresman and Co., 1985; 128 pages, 19 by 23 cm, softcover, ISBN 0-673-18088-3, \$15.95.

DATABASES: ROLE AND STRUCTURE, P. M. Stocker, P. M. D. Gray, and M. P. Atkinson, eds. New York: Cambridge University Press, 1984; 416 pages, 15.5 by 23.5 cm, hardcover, ISBN 0-521-25430-2, \$39.50.

DBASE II & DBASE III: AN INTRODUCTION FOR INFORMATION SERVICES, Roger C. Palmer. Studio City, CA: Pacific Information, 1984; 102 pages, 21.5 by 28 cm, softcover, ISBN 0-913203-09-2, \$25.

DIAGRAMMING TECHNIQUES FOR ANALYSTS AND PROGRAMMERS, James Martin and Carma McClure. Englewood Cliffs, NJ: Prentice-Hall, 1985; 414 pages, 18 by 24.5 cm, hardcover, ISBN 0-13-208794-4, \$40.

DIGITAL AND MICROPROCESSOR ENGINEERING, S. J. Cahill. New York: John Wiley & Sons, 1984; 514 pages, 15 by 22.5 cm, softcover, ISBN 0-470-27301-1, \$34.95.

ELECTRONICS THE EASY WAY, Rex Miller. Woodbury, NY: Barron's Educational Series, 1984; 336 pages, 19.5 by 27.5 cm, softcover, ISBN 0-8120-2709-4, \$8.95.

ELECTRONICS READY REFERENCE MANUAL, E. Pasahow. New York: McGraw-Hill, 1985; 588 pages, 10.5 by 14.5 cm, hardcover, ISBN 0-07-048723-5, \$24.50.

THE ENDLESS APPLE, Charles Rubin. Bellevue, WA: Microsoft Press, 1984; 286 pages, 19 by 23.5 cm, softcover, ISBN 0-914845-27-6, \$15.95.

EPSON PRINTER USER'S HANDBOOK, the staff of Weber Systems. New York: Ballantine Books, 1984; 310 pages, 14 by 22 cm, softcover, ISBN 0-345-31842-0, \$9.95.

THE EVERYONE CAN BUILD A ROBOT BOOK, Kendra Bonnett, Gene Oldfield, and the editors of *DIGIT Magazine*. New York: Simon & Schuster, 1984; 86 pages, 19 by 23.5 cm, softcover, ISBN 0-671-53059-3, \$8.95.

EXPANDING YOUR IBM PC, Bil. Alvernaz. Bowie, MD: Brady Communications, 1985; 254 pages, 18 by 23.5 cm, softcover, ISBN 0-89303-445-2, \$16.95.

EXPERT SYSTEMS, Richard Forsyth, ed. New York: Chapman and Hall, 1984; 248 pages, 15 by 23.5 pages, softcover, ISBN 0-412-26280-0, \$19.95.

EXPLORING CAREERS AS A COMPUTER TECHNICIAN, Jean W. Spencer. New York: Rosen Publishing Group, 1985; 128 pages, 14.5 by 22 cm, hardcover, ISBN 0-8239-0626-4, \$8.97.

FANCY PROGRAMMING IN IBM PC BASIC, Gabriel Cuellar. Reston, VA: Reston Publishing, 1984; 278 pages, 15 by 22.5 cm, softcover, ISBN 0-8359-1860-2, \$19.95.

THE FIFTH GENERATION, ARTIFICIAL INTELLIGENCE AND JAPAN'S COMPUTER CHALLENGE TO THE WORLD, Edward A. Feigenbaum and Pamela McCorduck. New York: New American Library, 1984; 354 pages, 10.5 by 18 cm, softcover, ISBN 0-451-13153-3, \$3.95.

FINANCIAL PLANNING SOFTWARE TOOL KIT, Robert T. LeClair. Glenview, IL: Scott, Foresman and Co., 1985; 80 pages, 19 by 23 cm, spiral-bound, ISBN 0-673-15974-4, \$44.95. Includes floppy disk.

FUNDAMENTALS OF HUMAN-COMPUTER INTERACTION, Andrew Monk, ed. Orlando, FL: Academic Press, 1984; 312 pages, 16 by 23.5, hardcover, ISBN 0-12-504580-8, \$26.50.

FUNDAMENTALS OF ROBOTICS, Larry Heath. Reston, VA: Reston Publishing, 1985; 432 pages, 18 by 24 cm, hardcover, ISBN 0-8359-2189-1, \$32.95.

GETTING WHAT YOU WANT FROM THE TRS-80 MODEL 100, E. Paul Cone. New York: Harper & Row, 1984; 256 pages, 18.5 by 23 cm, softcover, ISBN 0-06-669022-6, \$14.95.

THE GRAPHIC MACINTOSH BOOK, Richard Maran. Toronto, Ontario: Holt, Rinehart & Winston of Canada Ltd., 1984;

(continued)



Faster than a speeding bullet.

NOTHING CAN STAND UP TO SAFT'S NEW SUPER PROTECTION SYSTEM (SPS).

Pull a fast one on the high cost of protecting your computer's memory against sudden voltage drops or power outages. Get the fastest-switching power protection unit on the market today. Get the SAFT SPS-1000VA.

The SPS-1000VA can do everything a full UPS System can do... except cost a lot of money. When the line drops to 108 volts, the new SAFT unit leaps into action in 1 millisecond or less. But the cost is only about 60% of the UPS price.

All computers, including the IBM[®] XT and AT networks, are right for the powerful benefits of the SPS-1000VA. It provides clean sine wave power, which is both voltage regulated and current limited.

Best of all, the SPS-1000VA is made by SAFT, the hottest name in the battery business. So are the 200VA and 400VA Standby Power Systems. To prove how extraordinary these systems really are, each comes with a 2-year warranty.

For complete information on the truly super SPS-1000VA, and 200VA and 400VA, call SAFT at 602-894-6864. Or write SAFT Electronic Systems Division, 2414 W. 14th St., Tempe, Arizona 85281.

SAFT

MORE POWER TO YOU.

Inquiry 352

NOVA PC/XT

THE TOP OF THE LINE IBM COMPATIBLE SUMMER SPECIALS

COMPUTER SYSTEM:

NOVA basic system 64K entry model
(Expandable to 256K) \$645
Includes: 1 drive controller, 1 64K mother board, 1 hitec keyboard, 1 130W power supply.

NOVA PC 256K system \$1295
Includes: 1 hitec keyboard, 1 130W power supply, 2 360KB floppy drives, 1 Ast 6 pack compatible multifunction board, 1 color graphic card, 4-drive controller.

NOVA XT 256K system \$1935
Includes: 1 hitec keyboard, 1 130W power supply, 2 360KB floppy drives, 4-drive controller, 1 10MB hard disk drive, 1 DTC hard disk controller card, 1 Ast 6 pack compatible multifunction board, 1 color graphic card.

NOVA PC/XT BARE BOARD w/MANUAL \$79.00

DISK DRIVE:

SHUGART SA455 1/4 drive \$90.00
Teac 55B 1/2 floppy drive \$115.00
Miniscribe 10MB h.d. w/controller card and CABLE \$650.00
Miniscribe 20MB Hard Disk Drive \$695.00
Miniscribe 30MB-60MB hard disk for AT (30ms seeking time, close loop) CALL

UPGRADE KITS FOR IBM/AT:

IBM/AT compatible CASE \$165.00
IBM/AT compatible POWER SUPPLY (195W) \$225.00
IBM/AT compatible KEYBOARD CALL
#4128 pigiback ram \$22.00



HARDWARE:

The best quality 130W power supply (110/220) same dimension as IBM \$130.00
Multifunction card \$195.00
Case for PC/XT \$90.00
Hitec Keyboard \$130.00
Color graphic card \$150.00
Hercules compatible monochrome card \$185.00
Floppy disk controller card with cable \$100.00
STREAM TAPE:
Irwin 10MB stream tape for backup (Use standard floppy controller) \$625.00

MONITOR:

Amdek 300 color monitor \$245.00
Amdek 310A \$143.00
Amdek RGB 600 color monitor \$445.00
Amdek RGB 700 color monitor \$495.00
Amdek 710 double scan \$545.00

DEALER INQUIRIES WELCOME. — NOVA PC/XT KITS AVAILABLE

COMPUTRADE COMPANY (in Koll Commercial Center)

780 Trimble Road, Suite 605, San Jose, CA 95131

Tel. (408) 946-2442, Telex: 171605

Hours: Mon-Fri 9:00 a.m.-6:00 p.m.

a message to our subscribers

From time to time we make the **BYTE** subscriber list available to other companies who wish to send our subscribers material about their products. We take great care to screen these companies, choosing only those who are reputable, and whose products, services, or information we feel would be of interest to you. Direct mail is an efficient medium for presenting the latest personal computer goods and services to our subscribers.

Many **BYTE** subscribers appreciate this controlled use of our mailing list, and look forward to finding information of interest to them in the mail. Used are our subscribers' names and addresses only (no other information we may have is ever given).

While we believe the distribution of this information is of benefit to our subscribers, we firmly respect the wishes of any subscriber who does not want to receive such promotional literature. Should you wish to restrict the use of your name, simply send your request to the following address.

BYTE Publications Inc.

Attn: Circulation Department,

70 Main St., Peterborough, NH 03458

BOOKS RECEIVED

48 pages, 21.5 by 28 cm, softcover, ISBN 0-03-928875-7, \$9.95.

THE GRAPHIC PC-DOS Book, Richard Maran. Toronto, Ontario: Holt, Rinehart & Winston of Canada Ltd., 1984; 30 pages, 21.5 by 28 cm, softcover, ISBN 0-03-928876-5, \$9.95.

A GUIDE TO APPLE WRITER II/IIe, John A. Allen and Alex Ayres. Reston, VA: Reston Publishing, 1984; 352 pages, 15 by 23 cm, softcover, ISBN 0-8359-2613-3, \$18.95.

HACKERS: HEROES OF THE COMPUTER REVOLUTION, Steven Levy. Garden City, NY: Anchor Press/Doubleday, 1984; 480 pages, 14.5 by 21.5 cm, hardcover, ISBN 0-385-19195-2, \$17.95.

HERE COME THE CLONES! Melody Newrock. New York: McGraw-Hill, 1984; 206 pages, 15 by 23 cm, softcover, ISBN 0-07-046458-8, \$18.95.

A HOBBYIST'S GUIDE TO COMPUTER EXPERIMENTATION, John D. Lenk. Englewood Cliffs, NJ: Prentice-Hall, 1985; 304 pages, 15.5 by 23.5 cm, hardcover, ISBN 0-13-392473-4, \$25.95.

HOME ACCOUNTANT PLUS, Leslie Lauderdale. Reston, VA: Reston Publishing, 1985; 192 pages, 17.5 by 23.5 cm, softcover, ISBN 0-8359-2846-2, \$16.95.

HOW TO BUILD PROGRAMS ON YOUR COMMODORE 64, Lou Goldstein. Bowie, MD: Brady Communications, 1985; 256 pages, 17.5 by 23.5 cm, softcover, ISBN 0-89303-522-X, \$13.95.

HOW TO EXCEL ON YOUR ATARI 600XL AND 800XL, Timothy O. Knight. New York: McGraw-Hill, 1985; 144 pages, 14 by 20.5 cm, spiral-bound, ISBN 0-07-035104-X, \$9.95.

HOW TO MAKE MONEY WITH YOUR MICRO, Herman Holtz. New York: John Wiley & Sons, 1984; 336 pages, 15 by 22.5 cm, softcover, ISBN 0-471-88455-3, \$14.95.

HOW TO MULTIPLY MATRICES FASTER, Victor Pan. Lecture Notes in Computer Science

#179. New York: Springer-Verlag, 1984; 224 pages, 16.5 by 24 cm, softcover, ISBN 0-387-13866-8, \$11.

HOW TO START AND RUN YOUR OWN WORD-PROCESSING BUSINESS, Gary S. Belkin. New York: John Wiley & Sons, 1984; 216 pages, 13.5 by 21 cm, softcover, ISBN 0-471-88396-4, \$9.95.

HUMAN FACTORS AND INTERACTIVE COMPUTER SYSTEMS, Yannis Vassiliou, ed. Norwood, NJ: Ablex Publishing Corp., 1984; 304 pages, 15.5 by 23.5 cm, hardcover, ISBN 0-89391-182-8, \$35.

IBM PC GRAPHICS, John Clark Craig and Jeff Bretz. Blue Ridge Summit, PA: Tab Books, 1984; 268 pages, 18.5 by 23.5 cm, softcover, ISBN 0-8306-1860-0, \$13.95.

THE IBM PCjr FOR STUDENTS: USER'S HANDBOOK, staff of Weber Systems. Cleveland, OH: Weber Systems, 1984; 564 pages, 15 by 23 cm, softcover, ISBN 0-938862-25-1, \$17.95.

THE INDIVIDUAL INVESTOR'S MICROCOMPUTER RESOURCE GUIDE, Norm Nicholson. Chicago, IL: Investment Information Services Press, 1984; 204 pages, 15.5 by 22.5 cm, softcover, ISBN 0-930369-01-7, \$11.95.

INFORMATION PAYOFF: THE TRANSFORMATION OF WORK IN THE ELECTRONIC AGE, Paul A. Strassmann. New York: The Free Press, 1985; 320 pages, 16 by 24 cm, hardcover, ISBN 0-02-931720-7, \$20.75.

INTERACTIVE FORTRAN 77, Ian Chivers and Malcolm Clark. New York: John Wiley & Sons, 1984; 232 pages, 17 by 24.5 cm, hardcover, ISBN 0-470-20101-0, \$29.95.

INTRODUCTION TO INTEGRATED-CIRCUIT LAYOUT, Brian Spinks. Englewood Cliffs, NJ: Prentice-Hall, 1985; 190 pages, 21 by 28 cm, softcover, ISBN 0-13-485400-4, \$19.95.

AN INTRODUCTION TO PROGRAMMING THE SINCLAIR QL, R. A. and J. W. Penfold. London: Bernard Babani Ltd., 1984; 112

(continued)

MULTI-USER REQUEST:

THE DBMS THAT MAKES GREAT MINDS THINK ALIKE.

Now there's multi-user software to go with your multi-user hardware—including the new IBM PC/AT®.

Now there's reQuest.

reQuest is the database management system that can support just one PC, or an entire Local Area Network.

It gives your top managers the individual computing power to build high-performance applications. Plus the networking power to share their thoughts with your company's other great minds.

No executive is an island.
Think of the possibilities:

When everyone shares the same database, decision-making becomes more consistent, company-wide.

Sales can keep in touch with Production.

Property can compare notes with Finance.

Reports will be more accurate.

Strategies will be more cohesive.

And you'll finally realize the full potential of your executive PCs.

Proven, guaranteed performance.

reQuest has been proven in hundreds of major government and business applications.

It works with a wide variety of hardware, including IBM PC® and PC compatibles, Burroughs, A. B. Dick, NCR, Hewlett-Packard, and many others.

It has the capacity to download information from your mainframe, process it, and send it back. And the versatility to serve as the foundation for dozens of popular programs, including LOTUS 1-2-3™, Multiplan®, and WordStar®.

Yet, its menu-driven format is so easy that even the most computer-shy managers can quickly build and operate their own applications. And reQuest is backed by full money-back satisfaction guarantee.

Request reQuest, today.

Call or write now for a free brochure or our \$9.95 sample diskette:
1-800-321-DBMS.

You'll see how much more your company can do when you connect with reQuest.

reQuest®

POWER TO SHARE

System Automation Software, Inc.
8555 Sixteenth Street, Silver Spring, MD 20910
301-565-9400

Inquiry 385

Trademark Acknowledgements:
IBM, PC, and PC/AT: International Business Machines Corp.,
A. B. Dick: A. B. Dick Company, Burroughs: Burroughs Corporation,
Hewlett-Packard: Hewlett-Packard Co., NCR: NCR Corp.,
Lotus and 1-2-3: Lotus Development Corp., Multiplan: Microsoft Corp.,
WordStar: Micropro Corp. reQuest is a trademark of System Automation Corporation.

© 1984 System Automation Software, Inc.

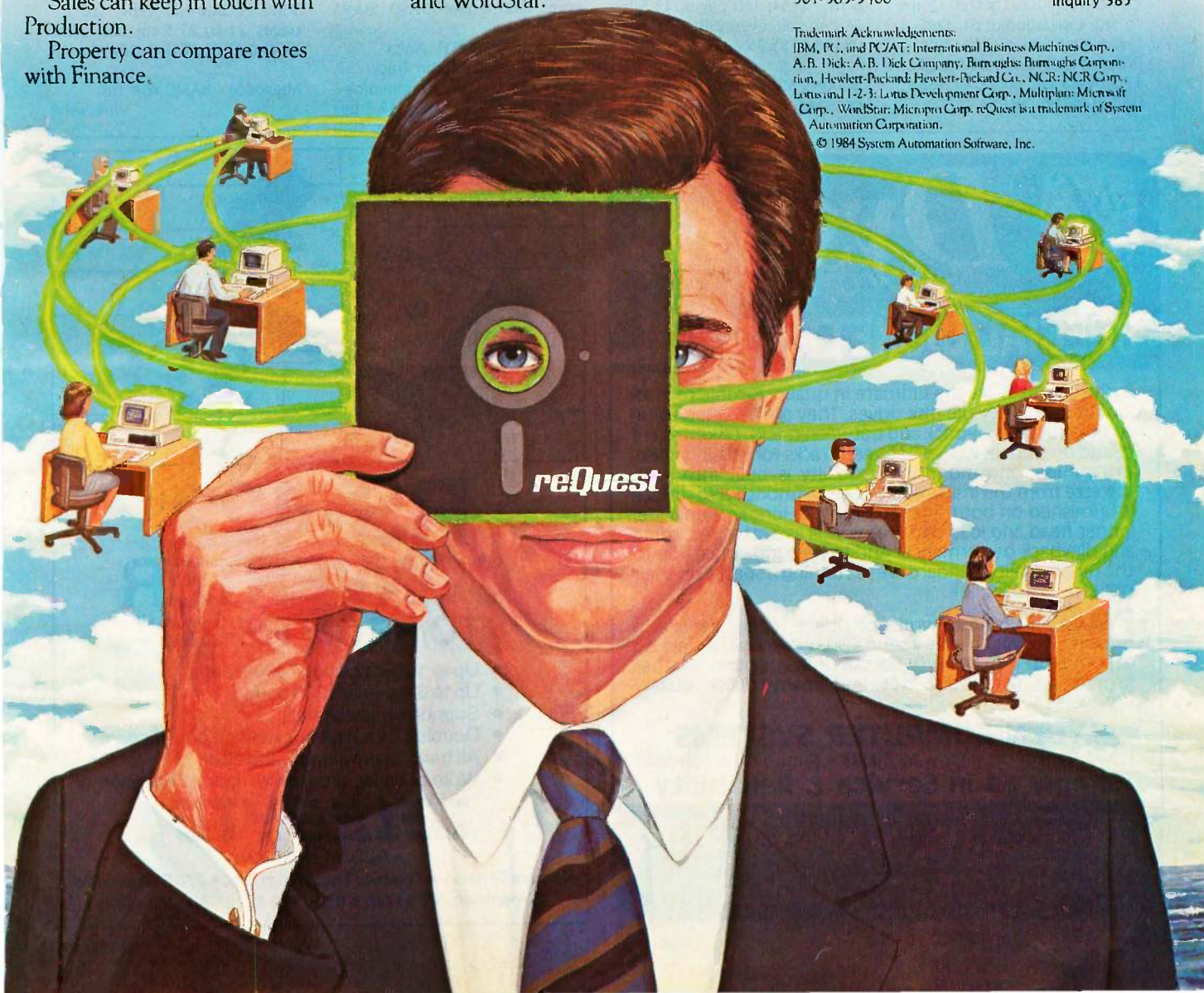

BOOKS RECEIVED

pages, 11 by 17.5 cm, softcover, ISBN 0-85934-125-9, £1.95.

AN INTRODUCTION TO 6502 MACHINE CODE, R. A. and J. W. Penfold. London: Bernard Babani Ltd., 1984; 112 pages, 11 by 17.5 cm, softcover, ISBN 0-85934-122-4, £1.95.

AN INTRODUCTION TO Z80 MACHINE CODE, R. A. and J. W. Penfold. London: Bernard Babani Ltd., 1984; 144 pages, 11 by 17.5 cm, softcover, ISBN 0-85934-127-5, £2.25.

KEN USTON'S ILLUSTRATED GUIDE TO THE APPLE IIe, Ken Uston. Englewood Cliffs, NJ: Prentice-Hall, 1984; 288 pages, 17.5 by 23 cm, softcover, ISBN 0-13-514688-7, \$9.95.

KEN USTON'S ILLUSTRATED GUIDE TO THE COMMODORE 64, Ken Uston. Englewood Cliffs, NJ: Prentice-Hall, 1984; 272 pages, 17.5 by 23 cm, softcover, ISBN 0-13-514621-6, \$9.95.

KEYBOARD CHALLENGE WITH COMMODORE 64, David D. Busch. Bowie, MD: Brady Communications, 1985; 204 pages, 17.5 by 23.5 cm, softcover, ISBN 0-89303-601-3, \$12.95.

LOCAL AREA NETWORKS, James Harry Green. Glenview, IL: Scott, Foresman and Co., 1985; 288 pages, 16 by 23.5 cm, softcover, ISBN 0-673-18065-4, \$17.95.

MAGIC WRITING, John Stratton with Dorothy Stratton. New York: New American Library, 1984; 368 pages, 13.5 by 20 cm, softcover, ISBN 0-452-25563-5, \$12.95.

MAKING MONEY WITH YOUR HOME COMPUTER, Dana K. Cassell. New York: Dodd, Mead & Co., 1984; 160 pages, 13.5 by 21 cm, softcover, ISBN 0-396-08448-6, \$5.95.

MAKING MUSIC WITH MICROPROCESSORS, Bonaventura Antony

Paturzo. Blue Ridge Summit, PA: Tab Books, 1984; 294 pages, 13 by 21 cm, softcover, ISBN 0-8306-1729-9, \$11.95.

MANAGER'S GUIDE TO SMALL COMPUTERS, Charles W. Bradley. New York: Holt, Rinehart and Winston, 1984; 366 pages, 17.5 by 23, softcover, ISBN 0-03-059538-X, \$20.45.

THE MASTER HANDBOOK OF HIGH-LEVEL MICROCOMPUTER LANGUAGES, Charles F. Taylor. Blue Ridge Summit, PA: Tab Books, 1984; 366 pages, 18.5 by 23.5 cm, softcover, ISBN 0-8306-1733-7, \$15.50.

MASTERING THE 8088 MICROPROCESSOR, L. V. Dao. Blue Ridge Summit, PA: Tab Books, 1984; 336 pages, 13 by 21 cm, softcover, ISBN 0-8306-1888-0, \$15.95.

MASTERING FORTH, Anita Anderson and Martin Tracy. Bowie, MD: Brady Communications, 1984; 224 pages, 17.5 by

23.5 cm, softcover, ISBN 0-89303-660-9, \$19.95.

MASTERING SYMPHONY, Douglas Cobb. Berkeley, CA: Sybex, 1984; 800 pages, 17.5 by 23 cm, softcover, ISBN 0-89588-244-2, \$24.95.

MICRO INTERFACING CIRCUITS, BOOK 2, R. A. Penfold. London: Bernard Babani Ltd., 1984; 96 pages, 11 by 17 cm, softcover, ISBN 0-85934-106-2, £2.25.

MICROCOMPUTER ASSEMBLY LANGUAGE PROGRAMMING, Gary Elfring. New York: Van Nostrand Reinhold, 1984; 314 pages, 15.5 by 22.5 cm, hardcover, ISBN 0-442-22261-0, \$29.95.

MICROCOMPUTER BUYER'S GUIDE, 3rd ed., Tony Webster. New York: McGraw-Hill, 1984; 360 pages, 21 by 27.5 cm, softcover, ISBN 0-07-068963-6, \$19.95.

MICROSOFT BASIC FOR THE

(continued)



Dysan

CORPORATION

SPECIAL DISKETTE OFFER

Dysan diskettes are the ultimate in quality flexible recording media for flexible disk drives. They are certified to be 100% error free on-track and between tracks. Diskettes are tested on-track as well as between tracks for missing pulse, extra pulse, and modulation. Quality is built into each diskette from the inside out. The ultra smooth disc surface is burnished on both sides to promote longer media life, longer head and load pad life, as well as better recording and playback performance. And to help introduce you to the Dysan quality standard we're running a special on their diskette product line.

PLUS! If you call, write, or utilize reader service in response to this ad—we'll send you our full-range catalog of computer supplies with Special Offers good for further savings on Dysan diskettes and many other quality products.

LYBEN COMPUTER SYSTEMS

1250-E RanKin Dr. • Troy, MI 48083 • Phone (313) 589-3440

Simply #1 in Service & Reliability

**Dysan. The Finest Quality
Diskettes Available.**



RS-422 CONVERTER TO/FROM RS-232

- Up to 100 kilobaud at 4000 feet
- Up to 3 miles at 1200 baud
- Supports eight signals
- Doubles as a high speed short haul modem
- All handshake signals and clock
- Write or call to order or for more information

TELEBYTE

A PUBLIC COMPANY

Remark Division • Telebyte Technology, Inc. • 270 E. Pulaski Rd.
Greenlawn, NY 11740 • (516) 423-3232 800-835-3298

With NRI training at home, you can...

Move up to a high paying career servicing computers



And you can start by actually building NRI's 16-bit IBM-compatible computer.

You can create your own bright, high paying future as an NRI trained computer service technician. The biggest growth in jobs between now and 1995, according to Department of Labor predictions, will occur in computer service and repair, where demand for trained technicians will double. There is still plenty of room for you to get in on the action—if you get the proper training now.

Total computer systems training, only from NRI

To learn how to work on computers, you have to get inside one. And only NRI takes you inside a computer, with total systems training that gives you hands-on experience with computers, peripherals, and software. As part of your training, you'll build a Sanyo MBC-550-2, which experts have hailed as the "most intriguing" of all the new IBM-compatibles. The Sanyo even surpasses the IBM PC in computing speed and graphics quality.

Even if you've never had any previous training in electronics, you can succeed with NRI training. You'll start with the basics, rapidly building on the fundamentals of electronics until you master advanced concepts like digital logic, microprocessor design and computer memory. You'll probe into electronic circuits, using the exclusive

NRI Discovery Lab® and professional Digital Multimeter, that you keep.

You'll assemble Sanyo's intelligent keyboard, install the power supply and disk drive, and attach the high resolution monitor—all the while performing hands-on experiments and demonstrations that reinforce your skills.

Learn to service today's computers

As you complete your Sanyo, you grasp the "secrets" that qualify you for a new career. You'll learn to program in BASIC and machine language. You'll use utility programs to check out the operation of the Sanyo's 8088 microprocessor (the same chip used in the IBM PC). And you also get over \$1,000 worth of software, including WordStar and CalcStar.

Most importantly, you'll understand the principles common to all computers. Only a person who fully understands all the fundamentals can hope to be able to tackle all computers. NRI makes sure that you'll gain the knowledge and skills to maintain, troubleshoot and service computers.

Learn at home in spare time

With NRI training, you'll learn at home on your own time. That means your preparation for a new career or part-time job doesn't have to interfere

with your current job. You'll learn at your own pace, in the comfort and convenience of your own home. No classroom pressures, no rigid night school schedules. You're always backed up by the NRI staff and your instructor, who will answer questions, give you guidance and be available for special help if you need it.

Let others worry about computers taking their jobs. With NRI training, you'll soon have computers making good paying jobs for you.

Send for Free NRI Catalog

Send the post-paid reply card today for NRI's 100-page catalog, with all the facts about computer training plus career training in Robotics, Data Communications, TV/Video Servicing and many other fields. If some other ambitious person beat you to the card, write to NRI at the address below.

NRI SCHOOLS

McGraw-Hill Continuing Education Center
3939 Wisconsin Avenue, NW
Washington, DC 20016

We'll Give You Tomorrow.



IBM is a Registered Trademark of International Business Machines Corporation.

TOGETHER, STOPPING YOU.



RUN-TIME VERSION AVAILABLE

THERE'S NO

KnowledgeMan™ and You. The possibilities are endless.

To succeed in business, you need a partner that's fast, flexible, intelligent and easy to work with. A partner that can help turn your big ideas into well-conceived reality. One that gives you the support you need to make critical decisions confidently.

No partner can give you more of what you need than KnowledgeMan, the knowledge management software from MDBS.

A powerful partner.

KnowledgeMan helps you manage more knowledge, in more ways, than ordinary software. It can help you make better decisions on just about everything from production scheduling to financial planning to market

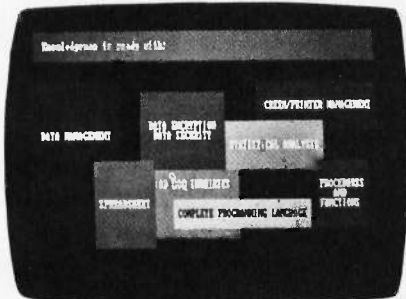

forecasting. KnowledgeMan and its optional components offer data management, spreadsheet analysis, statistical analysis, text processing, forms management, business graphics, programming and more.

The key to KnowledgeMan's versatility is its exclusive synergistic integration, allowing you to accomplish your computing needs within one program. Unlike other software, there's no need to exit one function before entering another. The result: different kinds of processing can be intermingled. Quickly and easily.

A partner that speaks your language.

For all of its power and sophistication, KnowledgeMan is remarkably simple to understand. Even a beginner can start putting KnowledgeMan to work in minutes. With a single query, you can obtain related data from unlimited multiple tables. You can even teach KnowledgeMan to understand your own jargon.

A partner that helps you along.

The on-line HELP facility allows you to draw on 6800 lines of helpful information organized into 380 screens. If you have a problem or question, KnowledgeMan allows you to access the pertinent HELP screen immediately. Each screen is carefully designed to provide a quick reference guide to KnowledgeMan commands.

A partner that gives you room to grow.

Ordinary software packages can be frustratingly easy to outgrow. Not KnowledgeMan. Each KnowledgeMan component has more power than you'll probably ever need — far more than conventional integrated programs. With KnowledgeMan, you don't sacrifice capability, capacity or convenience. So with KnowledgeMan, you spend your time solving problems — not trying to overcome software limitations.

A partner that protects your interests.

KnowledgeMan offers sophisticated security features. Unauthorized access to data is next to impossible, thanks to password checking, thousands of access code combinations and data encryption.

So your secrets are safe with KnowledgeMan.

A partner you can build on.

To add yet another dimension to KnowledgeMan's capabilities, you can get fully-integrated options like K-Graph, an extensive business graphics facility that



lets you plot information in a variety of colorful graphs, charts and diagrams. For text processing, the K-Text option lets you incorporate data into written documents quickly and easily. Or, create highly-polished, full-color customized forms with K-Paint, our forms painting option. To short-cut the keyboard, put the K-Mouse option to work.

A partner you should get to know better.

To see KnowledgeMan in action, visit your dealer. Or contact Micro Data Base Systems, Inc., P.O. Box 248, Lafayette, IN 47902, (317) 463-2581, Telex: 209147 ISE UR.

It may be the beginning of a long, successful partnership.

Current version is 1.07 as of 9/10/84. KnowledgeMan, K-Graph, K-Paint, K-Text, and K-Mouse are trademarks of Micro Data Base Systems, Inc. MDBS is a registered trademark of Micro Data Base Systems, Inc.

**KNOWLEDGE
man**
The Knowledge Management Software
from MDBS

Fifth Conference on

Microcomputers in Education and Training DEVELOPMENT OF EFFECTIVE INTERACTIVE INSTRUCTION MATERIALS

Pentagon Quality Inn
Arlington, Virginia
June 19-21, 1985

Presentations cover:

Creative Development

Computer-based Authoring Systems
Videodisc Creative Systems
Design for Interactivity
CD-ROM Potential
(Compact Disc/Read Only Memory)

Technological Implementation

Effectiveness Criteria
Implementation Capability
Generic Programs

Pre-conference tutorials are scheduled for June 18.

For further information contact:

Society for Applied Learning Technology
50 Culpeper St., Dept. B
Warrenton, VA 22186 (703) 347-0055

BOOKS RECEIVED

MACINTOSH, Larry Joel Goldstein and David I. Schneider. Bowie, MD: Brady Communications, 1985; 576 pages. 17.5 by 23.5 cm. softcover. ISBN 0-89303-662-5. \$19.95.

MICROSOFT WORD MADE EASY. Paul Hoffman. Berkeley, CA: Osborne/McGraw-Hill, 1985; 258 pages. 18.5 by 23.5 cm. softcover. ISBN 0-88134-144-4. \$14.95.

THE MIND AND THE MACHINE. Steve Torrance, ed. New York: John Wiley & Sons, 1984; 220 pages. 17 by 25 cm. hardcover. ISBN 0-470-20104-5. \$29.95.

MORE FROM YOUR MICRO. Charles Platt. New York: Avon Books, 1985; 192 pages. 10.5 by 17.5 cm. softcover. ISBN 0-380-89529-3. \$2.50.

MY PERSONAL COMPUTER AND OTHER FAMILY CRISES. Ben Ross Schneider Jr. New York: Macmillan Publishing, 1985; 254 pages. 14.5 by 22 cm. hardcover. ISBN 0-02-949610-1. \$15.95.

1985 COMPUTER BUYING GUIDE, the editors of *Consumer Guide*. New York: New American Library, 1984; 384 pages. 10.5 by 17.5 cm. softcover. ISBN 0-451-13244-0. \$4.50.

OFFICE TECHNOLOGY FOR THE NONTECHNICAL MANAGER, Phyllis J. Peck and Gilbert J. Konkell. Stamford, CT: Office Publications, 1984; 226 pages. 15 by 23 cm. softcover. ISBN 0-911054-07-3. \$13.95.

100 PROGRAMS FOR THE COM-MODORE 64, John Gordon and Ian McLean. Englewood Cliffs, NJ: Prentice-Hall, 1984; 352 pages. 14.5 by 23 cm. softcover. ISBN 0-13-634650-2. \$14.95.

OWNING YOUR HOME COMPUTER. Robert L. Perry. New York: Dodd, Mead & Co., 1984; 256 pages. 21.5 by 28 cm. softcover. ISBN 0-396-08250-5. \$13.95.

PASCAL PROGRAMMING FOR THE IBM PC AND XT. W. M. Fuori, L. Gioia, S. Gaughran, L. Aufiero, and M. Fuori. Reston, VA: Reston Publishing, 1985; 270 pages. 17.5 by 23.5 cm. softcover. ISBN 0-8359-54354-8. \$19.95.

PC PROGRAMMING TECHNIQUES. A. C. Elliott. Bowie, MD: Brady Communications, 1985; 174 pages. 17.5 by 23.5 cm. softcover. ISBN 0-89303-755-9. \$14.95.

PERSONAL COMPUTERS AND THE DISABLED. Peter A. McWilliams. Garden City, NY: Quantum/Doubleday, 1984; 416 pages. 15 by 23 cm. softcover. ISBN 0-385-19685-7. \$9.95.

PERSONAL GRAPHICS. Michael P. Barnett and Graham K. Barnett. Boston, MA: Little, Brown and Co., 1984; 332 pages. 21 by 27.5 cm. softcover. ISBN 0-316-08220-1. \$14.50.

THE PHYSICS DISK. Sheridan Simon. Englewood Cliffs, NJ: Prentice-Hall, 1985; 82 pages. 17.5 by 23.5 cm. spiral-bound. ISBN 0-13-672387-X. \$29.95. Includes floppy disk.

THE POWER OF: PROFESSIONAL TAX PLANNING USING LOTUS 1-2-3. Mitchell H. Jacobs and Robert B. Rice. Englewood Cliffs, NJ: Prentice-Hall, 1984; 224 pages. 21 by 27.5 cm. softcover. ISBN 0-13-688276-5. \$29.95.

THE POWER OF: PROFESSIONAL TAX PLANNING USING MULTI-PLAN. Mitchell H. Jacobs and Robert B. Rice. Englewood Cliffs, NJ: Prentice-Hall, 1984; 218 pages. 21 by 27.5 cm. softcover. ISBN 0-13-688250-1. \$29.95.

A PRACTICAL GUIDE TO COMPUTER COMMUNICATIONS AND NETWORKING, 2nd ed., Richard Deasington. New York: John Wiley & Sons, 1984; 126 pages. 17 by 24 cm. softcover. ISBN 0-470-20078-2. \$24.95.

A PRACTICAL GUIDE TO MACHINE LANGUAGE PROGRAMMING ON THE TIMEX/SINCLAIR 1500 AND 1000 (AND ZX81). David B. Wood. Lexington, MA: Sirius-Ware, 1985; 252 pages. 15 by 23 cm. softcover. ISBN 0-926848-00-3. \$14.95.

PROCEDURAL ELEMENTS FOR COMPUTER GRAPHICS. David F. Rogers. New York: McGraw-Hill, 1985; 448 pages. 16.5 by 23.5 cm. softcover. ISBN 0-07-053534-5. \$24.95.

PRODOS QUICK AND SIMPLE FOR THE APPLE II FAMILY. John G.

(continued)

BOOTH
B-322

COMDEX
Spring '85

BEFORE YOU BUY CABLE ASSEMBLIES,

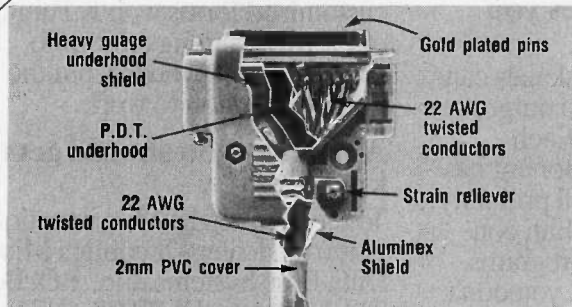

CHECK UNDER THE HOOD!

DATA SPEC™ cable assemblies are the very best. Each cable is fully shielded to exceed FCC EMI/RFI emission requirements. The unique P.D.T. technique, introduced by DATA SPEC™ and employed beneath the hood shield, insures maximum integrity under the most adverse conditions. DATA SPEC™ has interface cables for all your requirements: Printers, Modems, Monitors, Disk Drives, and much more. And all DATA SPEC™ cable assemblies carry a lifetime warranty. Insist on DATA SPEC™ cables in the bright orange package. Available at better computer dealers everywhere. For more information, call or write:

DATA SPEC™

A Division of Alliance Research Corporation

20120 Plummer Street • Chatsworth, CA 91311 • (818) 993-1202

Copyright © 1984 by Alliance Research Corporation

Patent PND.

Inquiry 439 for Dealers.
Inquiry 440 for End-Users.

Mirrored Hardware

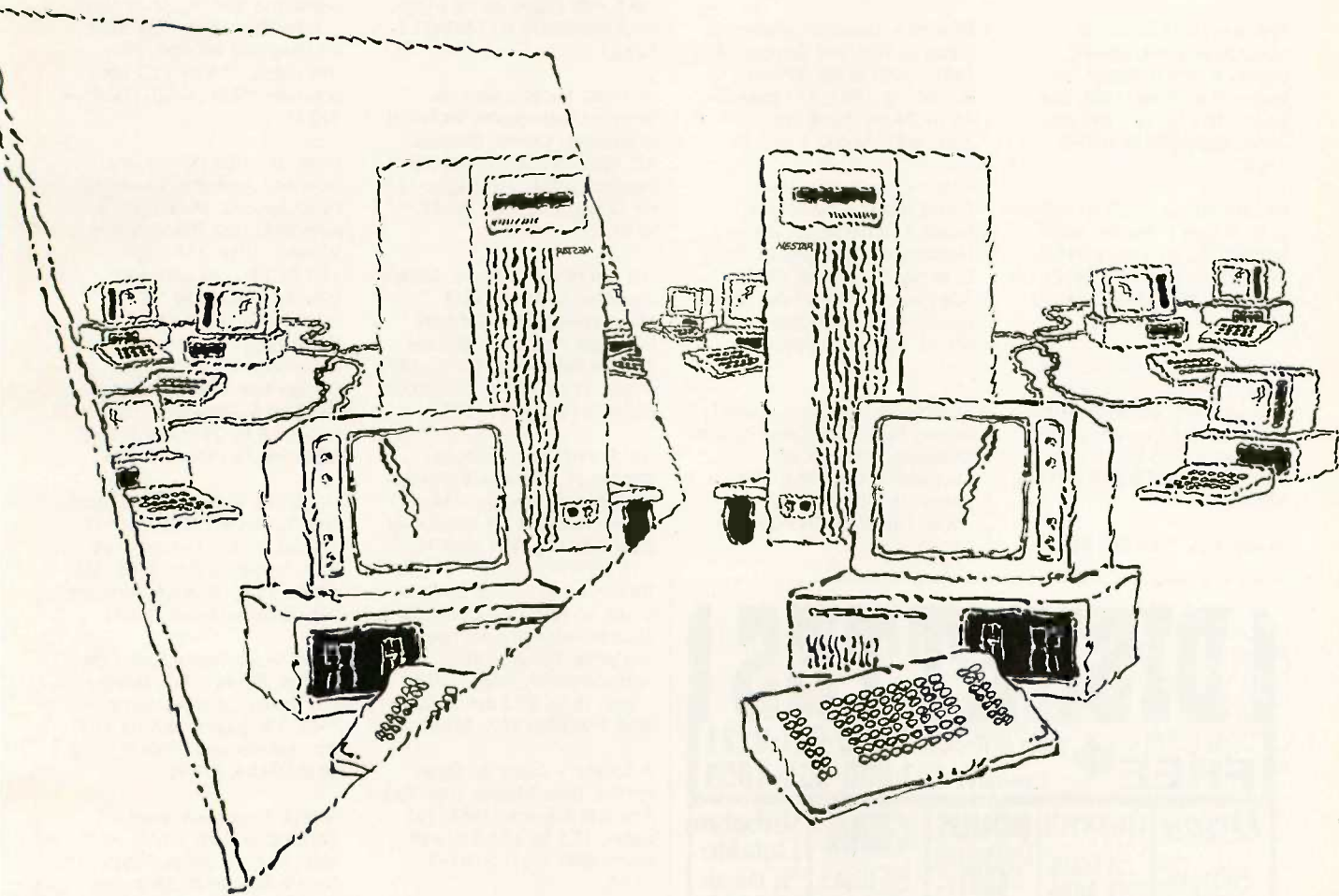

Unmatched System Reliability

A mirrored image of your data. Just what you need to assure yourself of reliable data reliably transmitted and reliably received. NESTAR's engineers ensure the reliability of your system—and your data—by designing into its products such features as tape backup for hard disk files, automatic check-sums on transmitted data, full duplexing, and mirroring of file servers.

Banks trade and transfer billions of dollars every day. They demand a network that stores, transfers, and retrieves data reliably. Banks trade and transfer their billions of dollars every day over NESTAR networks.

Call or write for your copy of:

"Executive Briefing"

2585 East Bayshore Road,
Palo Alto, CA 94303 • (415) 493-2223



Local Area Networks For Large Organizations

NESTAR™



BOOKS RECEIVED

Burdick and Peter B. Weiser. Glenview, IL: Scott, Foresman and Co., 1985; 256 pages, 19 by 23 cm, softcover, ISBN 0-673-18077-8, \$19.95.

PROGRAMMER'S GUIDE TO MS-DOS FOR THE IBM PC. Dennis N. Jump. Reston, VA: Reston Publishing, 1984; 266 pages, 17.5 by 23.5 cm, softcover, ISBN 0-8359-5655-5, \$16.95.

PROGRAMMING HALO GRAPHICS IN C. Robert J. Traister. Englewood Cliffs, NJ: Prentice-Hall, 1985; 192 pages, 17.5 by 23 cm, softcover, ISBN 0-13-729310-0, \$17.95.

PROGRAMMING LANGUAGES: A GRAND TOUR, 2nd ed., Ellis Horowitz, ed. Rockville, MD: Computer Science Press, 1985; 768 pages, 22.5 by 28.5 cm, hardcover, ISBN 0-88175-073-5, \$39.95.

READY, RUN, FUN: IBM PC EDI-

TION. Joan Targ and Jeff Levin-sky. Englewood Cliffs, NJ: Prentice-Hall, 1985; 208 pages, 21.5 by 28 cm, softcover, ISBN 0-13-762220-1, \$14.95.

ROBOTICS. James W. Masterson, Elmer C. Poe, and Stephen W. Fardo. Reston, VA: Reston Publishing, 1985; 272 pages, 18 by 24 cm, hardcover, ISBN 0-8359-6692-5, \$27.95.

RUNNING YOUR BEST RACE: PROGRAMS FOR IMPROVING SPEED AND DISTANCE. Joe Henderson. Dubuque, IA: Wm. C. Brown Publishers, 1984; 208 pages, 19 by 23 cm, spiral-bound, ISBN 0-697-00459-7, \$18.95. Includes floppy disk.

SILICON VALLEY GUIDE. Daniel Remer, Paul Remer, and Robert Dunaway. Bellevue, WA: Microsoft Press, 1984; 320 pages, 18.5 by 23.5 cm, softcover, ISBN 0-914845-09-8, \$19.95.

16-BIT MICROPROCESSORS: ARCHITECTURE, SOFTWARE, AND INTERFACE TECHNIQUES. Walter A. Triebel and Avtar Singh. Englewood Cliffs, NJ: Prentice-Hall, 1985; 400 pages, 18 by 24 cm, hardcover, ISBN 0-13-811407-2, \$29.95.

16/32-BIT MICROCOMPUTER SYSTEM COMPONENTS. Technical Information Center. Phoenix, AZ: Motorola Semiconductor Products, 1984; 230 pages, 17.5 by 23 cm, softcover, DL127, \$2.05.

THE SOFTWARE CATALOG: MICROCOMPUTERS, Winter 1985. Menu/International Software Database. New York: Elsevier Science Publishing, 1985; 1688 pages, 21 by 27.5 cm, softcover, ISBN 0-444-00883-7, \$75.

THE SOFTWARE HANDBOOK. Dimitris N. Chorafas. Princeton, NJ: Petrocelli Books, 1984; 472 pages, 16 by 24 cm, hardcover, ISBN 0-89433-248-1, \$49.95.

THINKING SMALL: THE BUYER'S GUIDE TO PORTABLE COMPUTERS. Charles Rubin and Michael McCarthy. Reading, MA: Addison-Wesley, 1984; 302 pages, 16 by 23.5 cm, softcover, ISBN 0-201-05793-X, \$12.95.

A TOURIST'S GUIDE TO COMPUTERS. Dave Morice. New York: Simon & Schuster, 1984; 192 pages, 15.5 by 23.5 cm, softcover, ISBN 0-671-50200-X, \$7.95.

THE UNDER \$800 COMPUTER BUYER'S GUIDE. Anthony T. Easton and Tony Seton. Reading, MA: Addison-Wesley, 1984; 272 pages, 16 by 23 cm, softcover, ISBN 0-201-04191-X, \$12.95.

USER FRIENDLY GUIDE TO LAP PORTABLES. Sam Redman and Michael Stanford. New York: McGraw-Hill, 1985; 270 pages, 15 by 22.5 cm, softcover, ISBN 0-07-051388-0, \$16.95.

USING COMPUTERS TO LEARN ... ABOUT COMPUTERS. J. L. Lawrence. Princeton, NJ: Petrocelli Books, 1984; 292 pages, 17.5 by 25 cm, softcover, ISBN 0-89433-254-6, \$24.95.

USING THE EAGLE PC AND 1600 SERIES. Kenniston W. Lord Jr.

New York: Van Nostrand Reinhold, 1984; 352 pages, 15 by 22.8 cm, softcover, ISBN 0-442-26035-0, \$16.95.

USING THE IBM PC: MULTIMATE. C. J. Puotinen. New York: Holt, Rinehart and Winston, 1984; 350 pages, 17.5 by 23.3 cm, softcover, ISBN 0-03-071411-7, \$20.45.

USING THE IBM PC: ORGANIZATION AND ASSEMBLY LANGUAGE PROGRAMMING. Mark Franklin. New York: Holt, Rinehart and Winston, 1984; 384 pages, 17.5 by 23.3 cm, softcover, ISBN 0-03-062862-8, \$20.45.

USING LOTUS 1-2-3 TO SOLVE YOUR BUSINESS PROBLEMS. George Gershefski. Totowa, NJ: Rowman & Allanheld, 1984; 160 pages, 18 by 25 cm, softcover, ISBN 0-8476-7346-4, \$19.95.

USING THE WANG FOR BUSINESS: THE TECHNICIAN'S PERSPECTIVE, VOLUME 1. Bert Dumpé. New York: Harper & Row, 1984; 368 pages, 21 by 27.8 cm, softcover, ISBN 0-06-041801-X, \$22.95.

WANG WORD PROCESSING COMPANION. Debra I. Tait. Bowie, MD: Brady Communications, 1985; 256 pages, 18.5 by 23.5 cm, spiral-bound, ISBN 0-89303-945-4, \$17.95.

WHOLE EARTH SOFTWARE CATALOG. Stewart Brand, ed. New York: Quantum Press/Doubleday, 1984; 208 pages, 21 by 27.5 cm, softcover, ISBN 0-385-19166-9, \$17.50.

THE WORD PROCESSOR BUYER'S SURVIVAL MANUAL. Ralph Roberts. Blue Ridge Summit, PA: Tab Books, 1984; 320 pages, 13 by 21 cm, softcover, ISBN 0-8306-1642-X, \$10.95.

WORDSTAR WITH STYLE ON THE DEC RAINBOW. Roger B. White Jr. Reston, VA: Reston Publishing, 1984; 252 pages, 15.5 by 23 cm, spiral-bound, ISBN 0-8359-8808-2, \$18.95.

YOUR TI PROFESSIONAL COMPUTER: USE, APPLICATIONS, AND BASIC. Thomas W. Madron and C. Neal Tate. New York: Holt, Rinehart and Winston, 1984; 222 pages, 17.5 by 23.5 cm, softcover, ISBN 0-03-071921-6, \$18.45. ■

DISKETTES

CALL TOLL FREE → West of Rockies **1-800-621-6221**
Central & East **1-800-654-4058**

<p>Dysan CORPORATION</p> <p>5 1/4" Disks S-SIDE 1695 D-DEN. 2195</p> <p>D-SIDE 2895 96TPI</p> <p>D-SIDE 3895 96TPI</p> <p>HIGH DEN. 5195</p> <p>8" Disks S-SIDE 2195 S-DEN. 2395</p> <p>D-SIDE 2795 D-DEN.</p>	<p>maxell</p> <p>5 1/4" Disks S-SIDE 1495 D-DEN. 1995</p> <p>D-SIDE 2495 96TPI</p> <p>D-SIDE 3095 96TPI</p> <p>HIGH DEN. 3995</p> <p>3 1/2" Disks S-SIDE 2895</p> <p>D-SIDE 4295</p> <p>8" Disks S-SIDE 2595 D-DEN. 2895</p>	<p>BONUS Disks-10 pk \$9.95 per box</p> <p>Verbatim Kits 495 Refills 895</p> <p>Media Mate 895 ea. +299 Shipping</p> <p>100 Disk Bulk Pack 89.00 SS DD</p> <p>112.00 DS DD</p>	<p>3M</p> <p>5 1/4" Disks S-SIDE 1495 D-DEN. 1995</p> <p>D-SIDE 2495 96TPI</p> <p>D-SIDE 3095 96TPI</p> <p>3 1/2" Disks S-SIDE 2895</p> <p>8" Disks S-SIDE 1995 S-DEN. 2495</p> <p>D-SIDE 2895 D-DEN.</p>	<p>Verbatim Datalife</p> <p>5 1/4" Datalife S-SIDE 1495 D-DEN. 1995</p> <p>D-SIDE 2495 96TPI</p> <p>D-SIDE 3095 96TPI</p> <p>3 1/2" Datalife S-SIDE 2795</p> <p>8" Datalife S-SIDE 1995 S-DEN. 2295</p> <p>D-SIDE 2695 D-DEN.</p>
---	--	---	---	---

the **Diskette Connection**™

VISA MasterCard

1-800-621-6221 PO. Box 1213 Boulder City, NV. 89005

1-800-654-4058 PO. Box 1674 Bethany, OK. 73008

TERMS: Minimum 20 disks or \$35⁰⁰ — VISA or MasterCard accepted
COD orders add 299 for special handling. **SHIPPING:** 3 1/2" & 5 1/4" Diskettes; Add 399 for every 100 Diskettes or any fraction thereof. 8" Diskettes; Add 499 for every 100 Diskettes or any fraction thereof. We ship UPS; orders requiring other delivery methods add shipping, plus 2% of total order.

COMPUTER HUT™

COMPARE
OUR
SERVICE & PRICE!

SPECIAL OF THE MONTH

IBM-PC, XT & AT
CALL FOR
PRICE

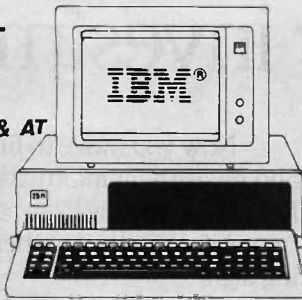

COMPAQ CALL

DISK DRIVES

Tandon TM100-2 DS/DD	\$159
MATSUSHITA JA 551	\$139
TEAC FD-55B Slimline	\$139

HARD DISKS/TAPE

MAYNARD	
WS1	\$849
WS2	\$1049
IOMEGA	
Bernoulli Box 20 Meg	\$2695
EVEREX, SYSGEN	CALL

ME MAYNARD ELECTRONICS

Floppy Disk Controller	\$129
FDC w/Par. Port or Ser Port	\$179/189

ADD-ON BOARDS

QUADRAM	
Quadboard 64K exp. to 384K	\$269
Quadcolor I & II	CALL
Quad 512+ 64K	\$239
AST RESEARCH	
SixPak Plus 64K	\$269
MegaPlus II 64K	\$279
I/OPlus II	\$129
Advantage	CALL
MICROLOG	
Baby Blue II 64K	\$489
TECMAR	
Graphics Master	\$489
MAESTRO	CALL
HERCULES	
Hi Res Mono Graphics	\$335
Color Graphics w/Par Port	\$189
PARADISE	
Modular Graphics	\$285
5-PACK	CALL

MODEMS

Hayes	
Smartmodem 1200	\$429
Smartmodem 1200B	\$389
Smartmodem 2400	\$649
BIZCOMP	
PC Intellimodem	\$359
NOVATION	CALL
SmartCat	\$349

PRINTERS

EPSON	
FX-80+	FX-100+
RX-80	RX-100
JX-80	LQ-1500
LX80	
brother	
HR-15 XL	\$399
HR 35	\$839
DYNAX/FORTS	
DX-15 Par	\$399
DM40 NLQ	CALL
C-ITOH	
PROWRITER	CALL
STARWRITER F-10P	\$995
OKIDATA	
182P	
84P	84S
92P	92S
93P	93S
NEC	
Spinwriter 2050	\$699
3550	\$1449
8850	\$1949
Pinwriter P2	\$589
P3	\$795
TOSHIBA	
P1351	\$1299
P1340	\$649
DAISYWRITER	
2000 w/48K Buffer	\$849
DATAPRODUCTS	
	CALL

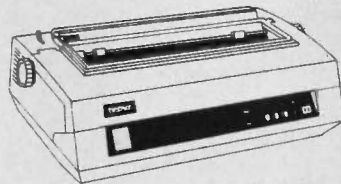

ASK ABOUT OUR
TRAINING & REPAIR
SERVICES.

MONITORS

AMDEK	
Video 300G	\$135
300A	\$145
Video 310A	\$179
PGS	
HX12 Hi Res RGB monitor	BEST
MAX-12 Hi Res Mono.	PRICES
SR-12 Super Hi Res RGB	



SOFTWARE

WORDPROCESSING	
MS Word	\$239
Multimate	\$269
Volkswriter Deluxe	\$159
PFS: Write	\$89
PFS: Proof	\$69
WordPerfect	\$269
WordStar	CALL
DATABASE/INTEGRATED	
dBase III	CALL
Quickcode III	\$179
RBase 4000	\$279
Clout 2.0	\$169
LOTUS 1-2-3 & Symphony	CALL
Framework	CALL
UTILITIES/COMPILERS	
Crosstalk	\$109
Smartcom II	\$109
Sideways	\$49
Norton Utilities	\$59
Sidekick	\$45
Turbo Pascal	\$45
LIFEBOAT Lattice C	\$299
MS Basic	\$259
MS Fortran	\$239
BUSINESS	
MICROSOFT Project	\$159
Chart	\$159
STAR Acct. Partner I & II	CALL
BPI SYSTEMS	
PFS: File	\$89
PFS: Graph	\$89
PFS: Plan	\$89
Multiplan	\$139
OTHER	
Mastertype	\$35
Typing Tutor III	\$39
Math Blaster	\$39
Flight Simulator	\$39
Managing your money	\$135

AND LOTS MORE

ANY PRODUCT NOT
LISTED? CALL

EAST COAST

COMPUTER HUT OF NEW ENGLAND INC.

101 Elm St. Nashua, NH 03060

(603) 889-0666

For Orders Only — (800) 525 5012

CANADA

MICROCONTEXT AUTHORIZED DEALER

4847 Ave Du Parc
Montreal Que H2V4E7.

(514) 279-4595

MID-WEST

COMPUTER HUT INC.

524 S. Hunter
Wichita, Kansas 67207

(316) 681-2111

For Orders Only — (800) 572 3333

All products usually in stock for immediate shipment and carry full manufacturers' warranty. Price subject to change — this ad prepared two months in advance. You get the lowest price. We honor personal checks — allow 10 days to clear. COD up to \$300 add 2%. Visa, MasterCard add 2%. For shipping & insurance add 2% or \$6.00 min. for small items and \$12. min. for monitors, printers, etc. We accept company checks and P.O.'s from Fortune 1000 Companies.

IBM is a trademark of IBM Corp.

Return authorization and order status call information line

Inquiry 98

45

When it comes to your investment

Flipping a coin is a harmless way to help you make simple decisions: "Heads we go to the movies, tails we play Scrabble.®"

But being flip with your investments could have harmful—even drastic—results.

Like having no coins left to flip.

Now, with a little help from your personal computer and Dow Jones Investment Software, you can start making more informed decisions—instead of playing hunches.

Whatever type of investor you are, Dow Jones can help you stay ahead of the odds.

Oil Stocks: To Buy or Not?

You're working out at the gym. The guy straining his biceps gives you a tip: "Oil stocks. They're undervalued right now."

Buy or not? How do you find out?

The Dow Jones Investor's Workshop™ can help. First you connect to Dow Jones News/Retrieval®, the #1 online resource for business and financial information. At the touch of a few keys, you can construct price and volume charts on the oil stocks that interest you. Two stocks are lower than they've been all year.

Now you move to financial and investment information. Analysts estimate low P/E ratios for two of the stocks. Another interesting sign.

In News/Retrieval's exclusive up-to-date file of The Wall Street Journal stories, you find that one of the companies *has just acquired* substantial interest in a highly profitable plastics manufacturer—a good move. You decide to buy.

Your Portfolio and Your Taxes.

The market says it's a good time to sell your high technology stocks. But is it the right time from the point of view of your taxes?

The Dow Jones Market Manager PLUS™ can help. Using News/Retrieval to update your portfolio throughout the year, the program tracks by tax lot your security transactions. Now, it's easy to calculate whether your profits from a sell will be taxed as income or capital gains. And what that will mean to your entire investment portfolio.

It's clear. If you wait two weeks to sell, you'll save 20% on taxes.

Dow Jones offers a comprehensive line of Investment Software that gives you the information and analytical tools you need to make smart investment decisions.

	Portfolio Management	Technical Analysis	Fundamental Analysis
Investor's Workshop™	●	●	
Market Manager PLUS™	●		
Market Analyzer™		●	
Market Microscope™			●

You can select the software program designed to meet your investment needs—whether you're a private investor or a sophisticated professional.

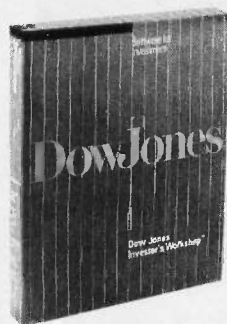

**Dow Jones Software.
For informed decisions.**



decisions, 50-50 isn't good enough.

**Dow Jones
Investment Software:
Helping You Make
Informed Decisions.**

The Investor's Workshop and the Market Manager PLUS are from Dow Jones, publisher of Barron's and The Wall Street Journal, the standard in reliable and timely business and financial information.

So instead of playing your hunches or flipping coins, invest in Dow Jones Software. It could be the best investment you make this year.

To obtain a free brochure and information on where you can conveniently purchase Dow Jones Investment Software, fill out the coupon or call:

1-800-345-8500

Extension 240

(Alaska, Hawaii and foreign call 1-215-789-7008 ext. 240)

Fill out this coupon and mail to:
A. Callahan, Dow Jones and Company,
P.O. Box 300, Princeton, N.J. 08540

Please send me a free brochure on
Dow Jones Investment Software

Please call me between _____ and _____
with more information

Name _____

Company _____

Address _____

City _____

State _____ Zip _____

Phone _____

Dow Jones™
Software

BBE



"Heads I buy. Tails I sell."

Dow Jones Software, Investor's Workshop, Market Manager PLUS, Market Analyzer and Market Microscope are trademarks of Dow Jones & Company, Inc. Dow Jones News/Retrieval is a registered trademark of Dow Jones & Company, Inc. Scrabble is a registered trademark of Selchow & Righter Company. Copyright © 1985 Dow Jones & Company, Inc. All Rights Reserved.

(continued from page 32)

tempt to maintain their prices with more promotion and advertising?

Economic theory says that when excess profits are being made (excess profits being profits higher than would be expected given the risk of the investment), then new competitors will enter the market to grab some of these high profits. This new competition will push prices down. As a hot new market with only a few suppliers changes into one with a much larger number of suppliers and a much wider customer base (a classic free market), the pricing should change to reflect the new realities. Unfortunately, a large number of companies were founded with the idea that these juicy profits would go on forever, that the products' pricing would never have to relate to the costs of production. These companies developed without understanding the organic nature of a free market, that they themselves were the new entrants whose role was to bring prices down to mature market levels.

I don't believe that the software market has approached anything like its potential sales levels, but this won't change until prices come down. The recent integrated packages (Symphony, Framework, Enable) have all aimed themselves at the corporate market. They figure that their products are the perfect productivity packages for a personal computer, except that prices would have to be lowered to appeal to the private owner. Would Borland's SideKick, elegant piece of work that it is, have nearly the impact if it was \$199? I'd rather have a car without a radio than a PC without SideKick, but part of its success is its utility-class price.

When we see prices for the full-featured integrated packages come down to the \$300 to \$400 range, the market will react with the same excitement created by those breakthrough spreadsheets. VisiCalc and Lotus 1-2-3.

ZAVE SHAPIRO
Winnipeg, Manitoba, Canada

SIGN-LANGUAGE SOFTWARE WANTED

I would greatly appreciate the assistance of BYTE readers in my research project. I am attempting to identify public-domain and proprietary microcomputer software packages that teach sign language. I am defining sign language as any system of hand gestures used for communicating with the hearing-impaired. If you have such information, please contact me at POB 19142, Washington, DC 20036, or

leave a message at (202) 475-4939 and I will return your call. All responses will be acknowledged.

ELLEN L. BOUWKAMP
Washington, DC

TOWARD A LESS STRUCTURED APPROACH

So much hype has been published about the wonders of structured programming, and so much of the criticism of it has been from petulant programming wizards worried about being accountable to their supervisors, that a more dispassionate voice is called for. Every benefit has its cost, and structuring is no exception.

A key problem of the structured approach is strikingly illustrated by the index in Niklaus Wirth's book, *Programming in Modula-2*, reviewed by David D. Clark in the August 1984 BYTE. Consider for a moment two programs to print an index whose entries are in the array INDEX of dimension N, an even number (I'll use vanilla BASIC here to reach the widest audience; granted, both programs could be improved in many ways by applying structured techniques in another language, but it's the difference between the programs that's important here):

```
10 FOR I = 1 TO N STEP 2: LPRINT
  INDEX(I); TAB(40); INDEX(I + 1) ;
  NEXT I
```

and:

```
10 PL = 60; FOR I = 1 TO N STEP 2:
  IF (I + PL <= N) LPRINT INDEX(I);
  TAB(40); INDEX(I + PL);
  ELSE LPRINT INDEX(I)
```

```
20 NEXT I
```

By every structured standard, the first program wins: It has fewer lines, fewer statements, fewer variables, it's easier to read and understand at a glance, etc. There's only one problem. The first program produces the sort of index that's in Wirth's book: the second entry opposite the first, the third back under the first, the fourth under the second, and so on. It's a royal pain to use.

Thus one of the costs of structure is insensitivity to the end user. Structured programmers typically take the condescending attitude that users are ill-served by programs that have bugs; therefore, they shouldn't quibble about inconveniences they may have to put up with to get bug-free programs. This attitude may pass in the academic world, but the software

market today demands programs (and documentation) that are bug-free AND convenient to use.

The best the structure gurus have to offer here is pious exhortations to keep the user in mind, the equivalent of saying, "Hey! Let's be careful out there!" This is a cop-out. This is like the attitude of the computer pioneers who regard program bugs as character flaws; their approach to debugging it to sniff that, with proper conscientiousness, there would be no bugs. This is just the attitude that structured techniques are touted as rebutting. With so much of the programmer's mind focused on the mechanics of structured programming, concentration on how the final product will look to the user is bound to suffer, and kludges like Wirth's index must be expected.

Don't misunderstand me. Structured programming is a fine thing in a production-type environment, when the programmers thoroughly understand the system they're working with (what it can't do, and how to make it do what it can do) and the programs they're trying to write (because they're writing their zillionth database application, process-control routine, etc.). But when programmers are exploring new systems and developing new kinds of programs, they need the flexibility of a less structured approach. Debugging can come later.

ERWIN S. STRAUSS
Fairfax, VA

BARGAIN COMPUTING IN JAPAN

After living in Japan for over a year, I picked up some recent issues of BYTE and was surprised by the current state of the art in personal computers being sold in the United States. It seems that many advertisers in the U.S. offer systems that just do not come close to what we can get here in Tokyo. I was taken aback by this, because I thought that, if in anything, American technology was leading in the personal computer field.

For example, a few weeks ago I purchased a Fujitsu FM-16 Beta, which is not available in the United States. This computer's standard features include:

Hardware

512K bytes of main RAM (expandable to 1 megabyte), two 5¼-inch 1-megabyte floppies, DMA access, 192K bytes of video RAM, 52K bytes of ROM, 80186 16-/16-bit main microprocessor, MBL68B09E (8-bit) subprocessor (2

(continued)

Lycó Computer Marketing & Consultants



SAVE ON THESE PRINTERS IN STOCK



AXION	
GP 550 AT (Atari)	249
GP 550 CO (C-64)	249
GP 550 PC (IBM)	239
GP 550 AP (Apple)	279
GP 700 AT (Atari)	459
GP 700 AP (Apple)	459
Elite 5CD (C-64)	329

BLUE CHIPS	
M12010	\$275
M12010 C-64	\$275

C. ITOH	
Prowriter 8510 AP	279
8510 BC2	389
8510 BP1	319
8510 SP	379
8510 SR	429
8510 SCP	459
8510 SCR	479
7500 AP	205
7500 AP	495
1550 P	449
1550 BCD	489
A-10-20-P	459
F 10 40 PU or RDU	888
F10 SSPU or RDU	1069

CARDCO	
LQ1	369
LQ3	279

CITIZEN	
MSP-10	329
MSP-15	499
MSP-20	479
MSP-25	649

COMREX	
CR-II-EC Comriter IIE Parallel	359
CR-II-ES Comriter II E Parallel	379
CR-IV-C Comriter IV Parallel	689
CR-IV-S Comriter IV Serial	689

Corona	
LP300 Laser Printer	2699
200361 Toner Cartridge	89

DIGITAL DEVICES	
16K printer buffer	99 75
32K printer buffer	119 75
64K printer buffer	169 95

EPSON	
RX-80	225
RX-80 FT	279
FX100	579
JX 80	529
LQ 1500 P	1088
LQ 1500 S	1149
HI-80 Color Plotter	399

JUKI	
Juki 6100	379
RS 232 Serial Board	55
Tractor	119
Sheet Feeder	209
Juki 6300	769

LEGEND	
880	219
1080	239
1200	249

★ **PRINTER** ★
INTERFACING
Available

MANNESMANN TALLY	
Spirit 80	255
MTL-160L	549
MTL-180L	739

NEC	
NEC 8025	\$.699
NEC 8027	\$.359

OKIDATA	
Okimate 10	179
82A	295
84	645
92	340
93	565
92 Imagewriter	425
92 IBM Version	349

OLIVETTI	
DY 250 Parallel	739
DY 250 Serial	729
DY 450 Parallel	1099
DY 450 Serial	1079

PANASONIC	
1090	189
1091	259
1092	395
1093	589
3151	459

Smith Corona	
Fastextl 80	189 00
D100	219 00
D200	399 00
D300	519 00
L1000	339 00

STARMICRONICS	
SG-10	219
SG-15	379
SD-10	339
SD-15	445
SR-10	489
SR-15	585
Powertype	309
Gemini 10X	CALL
Gemini 15X	CALL
SB-10	CALL

MONITORS

AMDEK	
300 Green	125
300 Amber	139
310 Amber IBM	155
Color 300 Audio	245
Color 500 Composite	369
Color 600	429
Color 700	495
Color 710	569

GORILLA	
12" Green	78
2" Amber	84

NEC	
JB-1260 Green	95
JB-1201 Green	135
JC 1215 Color	235
JC 1216 RGB	375
JC1450 Color	265
JB-1205 Amber	139

PANASONIC	
DT 1300 RG1 composite	329

PRINCETON GRAPHICS	
MAX-12 Amber	189
HX-12 RGB	475
SR-12 RGB	599

SAKATA	
SC-100 Color	219
STS1 Stand	29
SG 1000 Green	99
SA 1000 Amber	109

TAXAN	
210 Color RBG	249
115 Green	119
115 Amber	125
400 Color RGB	275
410 Color RGB	339
420 Color IBM	429
121 Green IBM	139
122 Amber IBM	145

X-TRON	
Comcolor I Composite Green	199

ZENITH	
ZVM 122A Amber	84
ZVM 123G Green	75
ZVM 124 Amber IBM	125
ZVM 131 Color	275
ZVM 133 RGB	389
ZVM 135 Composite	449
ZVM 136 Hi Res Color	589

MODEMS

MICROBITS	
MPP 1000 E (Atari)	99.00
MPP 1064 (C-64)	69.95

HAYES	
Smartmodem 300	189
Smartmodem 1200	459
Smartmodem 1200B	389
Micromodem IIE	249
Micromodem 100	289
Chronograph	179
Smart Com II	75

TELE LEARNING	
CM-250 (C-64)	65.00
AP-250 (Apple)	109.95
IB-250 (IBM)	109.95

CARDCO MOD-1 (C-64)	CALL
NESTRIDGE (C-64)	CALL
MITEY MO (C-64)	CALL
1660 AUTO MODEM (C-64)	85
COMPUSERVE	23.95

DISK DRIVES

INDUS		MSD	
GT ATARI	\$219.00	SD1 DRIVE	\$229.00
GT COMMODORE	\$249.00	SD2 DRIVE	\$469.00

DISKETTES

MAXELL	
5 1/4" MD-1	16.99
5 1/4" MD-2	23.75
(Box 10)	

SKC (Box 10)	
5 1/4" SKC-SSSD	10.99
5 1/4" SKC-SSDD	13.99
5 1/4" SKC-DSDD	15.99

ELEPHANT (Box 10)	
5 1/4" SSSD	13.99
5 1/4" SSDD	15.99
5 1/4" DSDD	19.99

IBM-PC COMPATIBLE

CORONA		Zenith		*LOTUS	
PPC 22A		Z-150	Call	Lotus 1-2-3	309.00
Portable 256K-Amber	1F99			Symphony	439.00
PPC 22G					
Portable 256-K-Green	1699				
PPCXTA					
Portable 256K-10Meg	2899				
CORI 28K 128K RAM	1599				

*MICROPROSE	
Wordstar 2000	299.00
Wordstar 2000+	375.00

TOLL FREE 1-800-233-8760

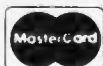

CALL TOLL FREE

800-233-8760

Customer Service 1-717-327-1825 Jersey Shore PA 17740

TO ORDER

or send order to

Lycó Computer
P O Box 5088



RISK FREE POLICY

In-stock item shipped within 24 hours of order. No deposit on C.O.D. orders. Free shipping on prepaid cash orders within the Continental U.S. PA residents add sales tax. APO, FPO, and international orders add \$5.00 plus 3% for priority mail service. Advertised prices show 4% discount for cash, add 4% for Master Card or Visa. Personal checks require 4 weeks clearance before shipping. All items subject to change without notice.

For your protection, we check for stolen credit cards.

MHz) (for graphics and I/O support) full 102-key keyboard with everything, 640 by 400 (by 4) graphics (partitionable to different pages), 80 by 25 roman character lines (16 by 16 dots/character), Japanese character ROM, RS-232C (transmission rate, etc., software-controllable), all cables, connectors, and interfaces for printer, mouse, light pen, and voice synthesizer

Software

Japanese Foreign Language Extension (Japanese writing ability), Graphics Extension (GSX, Digital Research), Terminal software, CP/M-86, FBASIC86 V2.0 (with graphics support: windows, viewports, etc., mouse, light pen, and voice-synthesizer functions, etc.)

All for only about \$1200, which is what I paid at Akihabara, the big electronics neighborhood in Tokyo.

It seems, from looking at recent issues of BYTE, that the current 16-bit American systems usually come with only about 128K bytes or 256K bytes of RAM and that minifloppies are way behind the commonly used dual 1-megabyte floppies that are built in to current computers here in Japan. And the prices! It seems that for these substandard systems you have to pay more than twice what you pay here, \$2500 to \$3000 or more! Why is that?

Anyway, to complete my system, I bought an RGB high-resolution monitor and a Kanji printer (24 x 24 dot) and the entire system, everything, came to less than \$2000! Can they beat that in the U.S. yet?

I am now happily running my system, using the included FBASIC and assembler as well as Optimizing C and the very nice screen editor that comes with Turbo Pascal (it seems to handle the Japanese conversions very nicely).

By the way, I spent the last year here working for the Toyo Links Corporation of Tokyo, a computer-graphics company. We created a computer-graphics movie for the Fujitsu Pavilion at the Science and Technology World's Fair (Expo '85), which opens this March. The film is quite exciting: completely computer-generated and projected on a specially-built Omnimax dome, in stereo.

I hope that many American readers of BYTE can visit the fair, which will run for six months, and drop by the pavilion. If anybody would like more information about the fair or movie, drop me a line and I will be glad to pass your name and address onto the fair committee and you'll get some literature from Japan. I would

also welcome hearing from people who just want to write and talk about computers here in Japan and elsewhere.

DOUG LERNER

Ota Ku Nishi Kamata 8-24-6-302

Tokyo, 144, Japan

LANGUAGE CONSIDERATIONS

The entertaining and informative dispute among champions and critics of rival computer programming languages should consider the following:

1. *Language size.* To compare languages without considering their sizes, which may vary by one or two orders of magnitude, is disinformative.

2. *External size constraints.* Today's 8K-byte to 16K-byte BASICs are constrained by the allotted ROM room, not by the nature of the language itself. A 64K BASIC interpreter is the obvious and natural size for a microprocessor, which, like the 6509/6510 or 8088/8086, organizes a memory in 64K pages. Will a language that sounds great compared to an 8K Procrustean BASIC still sound great compared to a 64K full-page BASIC?

3. *Factional interests.* Interpretation vs. compilation represents the real power struggle between do-it-yourself computer users and the caste of professional priests and scribes (systems programmers and applications programmers) attempting to insinuate itself between the computer and its end users. Logo versus BASIC versus Pascal represents the power struggle among elementary, secondary, and higher education. There's always the simple bias of salesmen "pushing" their own wares and "knocking the competition." Important personal, social, economical, and political fortunes ride on the outcomes of language competitions, and it would be hopelessly naive to imagine otherwise.

4. *Personal sentiments.* Some language criticism reveals more of the critic than of the language criticized. Scratch a critic of line numbers, find an unconfessed mathophobe. FORTH's arcane magic attracts a personality radically different from those attracted to Pascal and Modula-2. Sentiments should be addressed explicitly, not glossed over by coats of pseudorational, pseudotechnical varnish.

5. *Language essentials.* Features that can be optionally added to or deleted from a language don't distinguish it from other languages. Logo's supposedly distinctive "turtle graphics" and some of Pascal's supposedly distinctive "powerful structured-programming constructs" have been absorbed by some BASICs. APL's matrix

operators could be added to Modula-2, C's advanced assembly-language commands could be added to COBOL, and whitewall tires could be added to any car without effecting any fundamental change. So what are the essential differences among languages that merit discussion? Do any exist? I don't know.

But I do know that some purported feature advantages are mythical. Pascal fans argue that invoking *procedures* by semi-descriptive names like ERRMSG, for display an error message, and FIXERR, for fix the error condition, enable you to scan a listing and grasp its flow. But to grasp a BASIC line like

```
500 IF X=0 THEN GOSUB 2500:
      GOTO 5720
```

you've got to look up lines 2500 and 5720. Surprise! Microsoft BASIC on the Commodore PCs I recently checked has an undocumented feature that gives the best of both approaches. You can write:

```
500 IF X=0 THEN GOSUB 2500
      ERRMSG: GOTO 5720 FIXERR
```

While scanning the program you can ignore the line numbers and grab the semi-descriptive names. But when you do want to find ERRMSG and FIXERR, the line numbers tell you exactly where to look in a long listing. Will this revelation cause wholesale defections from the Pascal camp? I doubt it, though I'm sure it will provoke some giggling among BASIC fans. More generally, I do hope that future critiques and comparisons of languages will shed more light on the five general issues I've mentioned.

J. G. KROL
Anaheim, CA

FUBAR AGAIN

As one of the 10 million Americans overseas during World War II, I can surely recall FUBAR and its friends ("The Origin of 'FOO.BAR,'" February, page 420).

There were three of them: SNAFU, TARFU, and FUBAR. All fared well because there was a nonvulgar word, "fouled," that could be substituted for the original. SNAFU means Situation Normal—All Fouled Up, TARFU means Things Are Really Fouled Up, and FUBAR means Fouled Up Beyond All Recognition, as you indicated.

These three survived, I believe, partly because they showed a slight ring of culture and restraint, even in the otherwise unbearable military.

NOEL J. THOMPSON
Warren, OR ■

DISK DRIVES

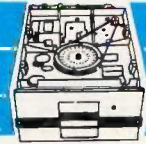

We Will Beat ALL Competitor's Pricing

Teac 55B

- ★ 360K Half Height
- ★ 1 Year Warranty

\$95

Tandon TM100-2

- ★ 360K Full Height
- ★ The "IBM" Drive

\$119

MPI B-52

- ★ 360K Full Height
- ★ PC Compatible

\$80

10 Meg Hard Disk

- ★ For IBM
- ★ W/Hard Disk Controller

\$675

YE Data

- ★ YD 580
- ★ 360K, AT Drive

\$225

Shugart SA455

- ★ Full PC Compatible
- ★ 360K Dbl. Side/Dbl. Den.

\$89

Apple Compatible Drives

	QUANTITY		
	1	2	10
Micro Sci			
A-2 or A-20 Full HT Controller	\$170	\$170	\$160
	65	60	50
Rana Systems			
Elite I	\$195	\$195	\$190
Elite II, Dbl. Head	335	330	325
Elite III, Quad Density	380	380	375
Controller Controls 4 Drives	75	75	70
CCU Half Height			
FD525A Slimline w/cable	\$140	\$135	\$130
FD525C for IIc	169	169	169
CCU Full Height			
FD555A w/cable	\$160	\$150	\$140
Hard Disk			
10 Meg w/controller	\$675	\$675	\$650

**CCU
YOUR LARGEST
DISK DRIVE
SUPPLIER**

5 1/4" Disk Drives

	QUANTITY		
	1	2	10
Teac			
FD55A, 160K	\$100	\$100	\$100
FD55B, 360K	95	95	95
FD55F, Quad Density	159	150	140
All Teac's are Half Heights			
Tandon			
TM100-1, 160K	\$150	\$140	\$130
TM100-2, 360K	119	119	119
TM101-4, Quad Density	280	270	260
TM65-2, 360K 1/2 Height	195	190	185
MPI			
B-52, 360K PC Compatible	\$ 80	\$ 80	\$ 80
Shugart			
SA400, 160K	\$190	\$180	\$170
SA455, 360K 1/2 Height	89	89	89
SA465, Quad Den. 1/2 Height	200	190	180
Mitsubishi			
4851, 1/2 Height	\$159	\$149	\$139
4853, Quad Den. 1/2 Height	169	159	140
Control Data Corp.			
CDC 9409, 360K	\$190	\$180	\$170

8" Disk Drives

	QUANTITY		
	1	2	10
Siemens			
FDD-100-8	\$129	\$120	\$111
FDD-200-8	180	170	160
Shugart			
801R, Sgl./Dbl.	\$160	\$150	\$140
851R, Dbl./Dbl.	480	470	460
Tandon			
TM848-1E, Sgl./Dbl. 1/2 Ht.	\$270	\$265	\$260
TM848-2E, Dbl./Dbl. 1/2 Ht.	370	360	350
Mitsubishi			
M2894-63, Dbl./Dbl.	\$400	\$390	\$380
M2896-63, Dbl./Dbl. 1/2 Ht.	400	390	380
5 1/4" & 8" Power Supply & Cabinets			
	QUANTITY		
	1	2	10
JMR 5 1/4"			
Single Cabinet w/pwr	\$ 70	\$ 60	\$ 50
Dual Thinline Cab w/pwr	80	70	60
Dual Cabinet & Power	80	70	60
All have 6 month Warranty			
JMR 8"			
Sgl. Cabinet w/pwr & fan	\$220	\$210	\$200
Dual w/pwr for 2 thinlines	230	220	210
Dual w/pwr & fan	270	260	250

**CALL TOLL FREE
(800) 847-1718**

**Computer
Components
Unlimited**
A California Corporation

Inquiry 82

RETAIL STORES:
11976 Aviation Blvd.
Inglewood, CA 90304

16129 Hawthorne Blvd., Suite E
Lawndale, CA 90260

MAIL ORDER:
P.O. Box 1936
Hawthorne, CA 90250

**Customer Service & Technical
(213) 618-0487**

**Sales Desk
(800) 847-1718**
Outside California

(213) 618-0477
Inside California

PRINTERS

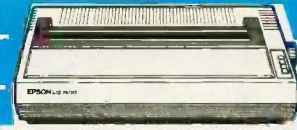

We Will Beat ALL Competitor's Pricing

Epson LX-80

- ★ 100 cps ★ Friction Feed
- ★ Letter Quality Mode
- ★ IBM & Apple Roms ★ 91 lb

\$275

PRINTERS

Epson

LX-80
RX-80 (120 cps)
RX-80FT
RX-100+
FX-80+
FX-100+
LQ1500
JX-80

Save
At Least
\$150

We Will
Beat ALL Pricing

We are an Authorized Dealer

Okidata	
OKI 182	\$ 229
OKI 83A	535
OKI 84P	669
OKI 84S	749
OKI 92P	349
OKI 93P	585

Call for other Models
FREE Plug 'n Play Roms w/92 & 93

JUKI	
6100, 18 cps Ltr. Quality	\$ 398
6300, 40 cps "New" w/3K Buffer Letter Quality	795

Brother Dist. by Dynax	
HR15XL, 12 cps	\$ 389
HR25, 25 cps	625
HR35, 36 cps	835

Panasonic	
1091, 120 cps w/ tractor	\$ 289

C. ITOH	
8510AP	\$ 305
F10, 40 cps	919
Printmaster F1055pu	1050

Toshiba	
P1351, 192 cps	\$1219

PRINTER INTERFACES

Fourth Dimension

Card & Cable	\$ 45
--------------	-------

Microtek

Dumpling GX (Grappler Compatible)	\$ 75
Dumpling GX exp to 64K	145
Dumpling GX 16K w/ 16K exp to 64K	160
for each additional 16K	10

Okidata Options

Tractor for 82 & 92	\$ 55
Serial Interface	85

Orange Micro

Grappler +	\$ 84
Grappler + w/16K	174

Star or Epson

Epson Serial interface	\$ 119
Star Serial Interface w/2K buffer	55

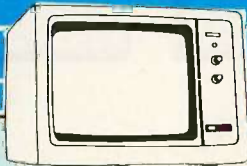

BMC 9191

- ★ Color Composite
- ★ 13" works w/Apple & IBM

\$165

MONITORS

MONITORS

Amdek

300G, Hi-Res Green	\$ 125
300A, Hi-Res Amber	134
310A, Monochrome Amber	158
300 Hi-Res Color Comp.	275
500 RGB Composite	399
DVM Board for Apple RGB	119

Taxan

425 Color RGB	\$ 389
440 Ultra Hi-Res	539

Princeton Graphics

MAX12, Monochrome Amber	\$ 169
HX12, RGB Color	449
SR-12 w/ Doubler Board	775

IBM

Monochrome Green	\$ 219
Color Hi-Res	559

Zenith

ZVM122	\$ 95
ZVM123	95

BMC

12AUW	\$ 59
9191	165



MODEMS

Express by Anchor

- ★ 1200 Baud/RS 232
- ★ Stand alone
- ★ Hayes 1200 Compatible

\$269

MODEMS

Hayes

Micro Modem IIE	\$ 229
300 Baud	195
1200B Internal	355
1200	385
2400 Baud	635

Anchor Automation

Mark For TI	\$ 59
Mark VI 300 Baud IBM	79
Mark XII, 1200 Baud	219
Mark X, 300 Baud Stand alone	149
Express 1200 Baud	269

Prometheus

Promodem	\$ 329
Pro 1200A Apple Int w/sw	329
Pro 1200B IBM Int w/sw	299
Pro Mac w/ cable & sw	329
No. C Cable	12
Alpha Disp.	89
Options Proc.	89

U.S. Robotics

Password	\$ 239
----------	--------

Computer
Components
Unlimited
A California Corporation

Inquiry 83



No Surcharge for Credit Cards
All Prices Reflect a Cash,
Pre-Paid Discount
This Ad Supersedes All Others

Customer Service & Technical
(213) 618-0487

Sales Desk
(800) 847-1718
Outside California

(213) 618-0477
Inside California

SYSTEMS

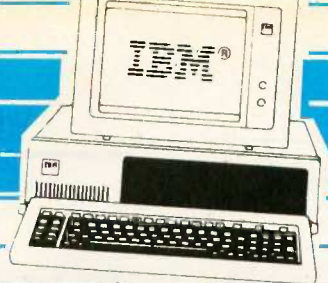

IBM PC System
 ★ 256K Memory
 ★ Two 360K Disk Drives
**Call (800) 847-1718
 For Lowest Quote**

Compaq
 ★ Two Drives
 ★ 256K Portable
\$1995

IBM PC System
 ★ 256K, Two 360K Drives
 ★ Cir. Graphics Card
 ★ Hi-Res Green Monitor
 ★ Epson LX-80 Printer / cable & Letter Quality
\$2242

Apple	
IIe CPU	\$ 790
Macintosh	1895
IIc Portable	899
Compaq	
Portable (PC Compatible) 2, 360K Drives 256K of Memory	\$1975
Compaq + w/10 Meg	3700
Deskpro 1	1675
Deskpro 2	2250
Deskpro 3	3900
Deskpro 4	Call

Sanyo	
MBC 550-2	\$ 799
MBC 555-2	1089
Optional Serial Port	69
Optional 360K Drive	159
Kaypro	
Kaypro II	Call
Kaypro 4	Call
Kaypro 10	Call
Kaypro IIX	Call

IBM	
PC 256K, No Drives	\$1250
PC 256K, 1 Drive	1399
PC 256K, 2 Drives	1599
XT w/10 Meg, 256K	3495
Additional Memory 64K	12
AT Standard Config.	Call
AT w/20 meg	Call
Tava	
PC Compatible w/ Monitor	\$1100

IBM & APPLE ACCY'S

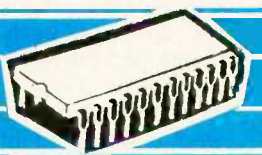

**We Will Not Be Beat
 On 64K Upgrade Prices**
 ★ Nine 4164, 200ns
 ★ 1 Year Warranty
\$11

Flip Tub
 ★ 5 1/4" Disk Holder
 ★ Holds 60 Disks
 ★ Smoked Plexiglass
2 for \$10

64K Upgrade	
64K of Memory	\$ 11
AT Upgrade	
Upgrade 200 ns	\$ 99
PC Products	
PC Peacock Color Card w/Par. Port	\$ 175
Ports	
Parallel	\$ 79
Serial	79
CCU	
Color Graphics Card	\$ 139
5 1/4" DISKETTES	
CCU	
Sgl/Dbl reinforced hub	\$ 16 100 for 140
Dbl/Dbl reinforced hub	19 100 for 170
Not Hub Packed	
Dysan	
Sgl/Dbl	\$33 100 for 300
Dbl/Dbl	39 100 for 370
Verbatim	
Sgl/Dbl	\$26 100 for 240
Dbl/Dbl	36 100 for 340
8" DISKETTES	
Dysan	
Sgl/Sgl	\$34 100 for 320
Dbl/Dbl	53 100 for 480
Verbatim	
Sgl/Sgl	\$30 100 for 280
Dbl/Dbl	40 100 for 360
DISK ACCESSORIES	
Verbatim	
8" or 5 1/4" Head Cleaning Kit	\$ 9
Flip Tub	
5 1/4" Holds 70 disks, plexiglass	\$ 17

APPLE EXTRAS	
ALS	
Z Engine	\$ 119
CPM 3.0 Card	240
CCU	
RF Modulator	\$ 9
Fan w/Surge	34
CCU	
16K Mem. Card 1 yr war	\$ 45
Kraft	
Joystick	\$ 44
Macro	
Joystick	\$ 29
Micro Max	
Viewmax 80, 80 col. card	\$ 135
Viewmax 80E (F for IIE) 64K	120
Micro Soft	
Mouse	\$ 139
Premium Soft Card IIE	369
Multiplan	149
Soft Card (Z80) w/64K	279
Micro Tek	
Serial Interface	\$ 89

IBM EXTRAS	
Ast Research	
Six Pack + "NEW"	\$ 269
Mega +	265
Add on Ports	49
Hercules	
Color Card	\$ 185
Graphics Card	325
Hard Disk	
10 Meg. External w/power supply	\$1195
IBM	
Monochrome Adapter	\$ 219
Color Card	225
Paradise Systems	
Multi-display Card	\$ 329
New Modular Card	299
Module A	88
Module B	240
5 Pack Multifunction	275
Quadram	
Quad Color Card	\$ 199
Quadlink	349

RETAIL STORES:
 11976 Aviation Blvd.
 Inglewood, CA 90304
 16129 Hawthorne Blvd., Suite E
 Lawndale, CA 90260

MAIL ORDER:
 P.O. Box 1936
 Hawthorne, CA 90250

Retail Hours:
 10 a.m. - 6 p.m. Mon.-Fri.
 10 a.m. - 3 p.m. Sat.

All merchandise new. We accept MC, Visa, Wire Transfer, COD Call, Certified Check, P.O.'s from qualified firms, APO accepted. Shipping: Minimum \$4.50 first 5 pounds. Tax: California Res. Only add 6 1/2% sales tax. All returns subject to 15% restocking charge. Advertised prices for Mail Order only. Retail prices slightly higher.
 Prices Subject to Change.

Customer Service Hours:
 10 a.m. - 4 p.m. Mon.-Fri.
 John Aurentz
 (213) 618-0487

Mail Order Hours:
 8 a.m. - 6 p.m. Mon.-Fri.
 10 a.m. - 3 p.m. Sat.
 (800) 847-1718 (213) 618-0477
 (Outside California) (Inside California)

NEW SYSTEMS

Total Talk PC Aids Visually Impaired

Maryland Computer Services' Total Talk PC is a talking computer based on Hewlett-Packard's HP 150. The system includes a speech-synthesis board, voice-generation firmware, software, and a speech-control pad that turns any group of characters into a spoken word.

With Total Talk PC, a blind or visually impaired user can hear data entered through the keyboard or appearing on the screen. The user can control pitch, volume, and the rate of speech (from 45 to 720 words per minute). The user can also choose to listen to information either a single word, a sentence, or a paragraph at a time. Another feature is user-definition of words that don't follow standard rules of pronunciation, such as abbreviations and mnemonics.

The Search String and Programmable Key functions let the user locate a word or phrase and combine several routinely used keystrokes into one key. The Enunciator Key announces functions before the system performs them.

Also, more than 50 speech functions are built into the Total Talk PC and controlled through its modified numeric keypad. The system connects to most computers from micros to mainframes. It uses MS-DOS and includes a built-in Talking Information Manager for keeping track of addresses, phone numbers, and dates.

Total Talk PC is available in two versions. The standard configuration has dual 3½-inch double-sided double-density disk drives



The Total Talk PC system based on the HP 150, along with some optional peripherals.

and sells for \$7995.95. The second model uses a 15-megabyte Winchester hard-disk drive and costs \$10,995.95. Contact Maryland Computer Services, 2010 Rock Spring Rd., Forest Hill, MD 21050, (301) 879-3366.

Inquiry **615**.

The TERI 16-bit Microcomputer

The TERI is an integrated unit that contains a CRT, 80-cps dot-matrix printer, two double-sided double-density disk drives, clock and calendar, modem, and Telex capabilities. The screen collapses into the main unit to form a low profile, and the footprint is slightly larger than that of a typewriter. A remote unit is also available.

The TERI uses Intel's 8086 chip and is IBM software-compatible. The basic system contains those features mentioned above, a case in three color choices, 192K bytes of memory expandable to 768K bytes, an 80-character 12-inch built-in

screen, graphics capabilities in color and monochrome, a remote CRT hookup, five expansion slots, an RS-232C port, a security-card activator, and such software as MS-DOS. Some available options are a color monitor, hard-disk drive, and remote monitor with keyboard.

The system's basic unit is selling at \$3600. Contact Israel Strategic Computers Ltd., 19 Nachon St., Yemin Moshe, Jerusalem, Israel, tel: 02 247-681/243-368; Telex 35770 COIN IL TER. Inquiry **616**.

Expert 32 Multiprocessor Computer

Elite Computer Systems' Expert 32 is a 32-bit multiprocessor computer that supports four true 32-bit processor card sets. However, the system is designed to support more

processors, with quantity dependent on application. The E82/CPU2 processor card is based on the 32032 processor from National Semiconductor. It includes the floating-point processor, memory-management unit, real-time clock/calendar, and 32K bytes of cache memory.

The system has a 16-slot double-width VME bus backplane and comes standard with a processor board set. Other features include 512K bytes of main memory expandable to 16 megabytes; a peripheral-interface card with DMA SCSI disk interface, 4 intelligent RS-232C serial channels expandable to 20; a Centronics-compatible parallel printer interface; a 500-watt power supply; and 5¼-inch cartridge hard-disk drives with 5 megabytes of removable storage and 5 megabytes of fixed storage. You can expand the Expert 32 to accommodate up to 140 megabytes of storage.

The Expert 32 uses ECS PVS, a portable virtual-storage operating system that supports real-time and

(continued)

COMPUTER WAREHOUSE

CALL TOLL FREE **1-800-528-1054**

PRINTERS

Anadex	
9625B	\$1089
WP6000	\$2039
DP6500	\$2179
Brother	
DX-15XL	\$365
HR-25	\$649
HR-35	\$875
C-Itoh	
A-10-30	\$469
F-10 Parallel or Serial	\$869
55 CPS Serial or Parallel	\$1035
8510 Parallel (Prowriter)	\$295
8510 SP	\$385
8510 SCP	\$465
8510 BPI	\$315
Citizen	
MSP-10	\$329
MSP-15	\$509
MSP-20	\$469
MSP-25	\$639
Comrex	
CR-2E	\$364
CR-4	Call
420	Call
Datasouth	
DS180	\$1089
DS220	\$1315
DS-PP#1	\$449
DS-PP#2	\$635
Diablo	
D-25	\$609
630 API	\$1484
630 ECS	\$1669
630 ECS/IBM	\$1669
D-36	Call
80 IF	\$2649
P12CQ1	\$529
P32CQ1	\$759
S32CQ1	\$839
P38	\$1639
S38	\$1719
C150	\$999
Epson All Printer Models	Call
Inforunner	
Riteman w/Tractor	\$244
Riteman 15	\$499
Riteman Blue w/Tractor	\$299
Juki	
5500	Call
6100	Call
6300	Call
NEC	
2010, 2015, 2030	\$639
2050	\$654
3510, 3515, 3530	\$1215
3550	\$1359
8810, 8815, 8830	\$1665
8850	\$1779
P2, P3	Call
Okidata All Printer Models	Call
Panasonic	
1091	\$265
1092	\$349
1093	\$519
KXP3151	\$459
Siemens	
PT/88 InkJet	Call
PT/89 InkJet	Call
Star Micronics All Printer Models	Call
Silver Reed	
EXP400 Parallel	\$235
EXP500 Parallel or Serial	\$379
EXP550 Parallel or Serial	\$399
EXP770 Parallel or Serial	\$699
Toshiba P1340 Parallel or Serial	\$549
P351 Parallel or Serial	\$1165

BOARDS

AST Six Pack Plus	\$259
Hercules Color Card	\$145
Graphic Card	\$295
Paradise Modular Graphic 06-1	\$259
Five Pak	\$159
Quadram Quadboard EX Ok	\$219
E-Ram 80	\$89
Quadlink	\$329
Tec Mar	
Graphics Master	\$449
128K Dynamic Memory	\$225
256K Dynamic Memory	\$299
Captain 128K	\$299
Captain 256K	\$399

*** YOUR WYSE CHOICES ***

WYSEpc

IBM-COMPATIBLE PERSONAL COMPUTER

- Dual Drive**
 - 256K • MS DOS
 - GW Basic
 - Single Drive - 10 Megabyte**
 - 256K • MS DOS
 - GW Basic
- Wy-500 Green Monitor • Wy-600 Color Monitor
• Wyse 50 • Wyse 75

SAVE UP TO 30%

VIDEO TERMINALS

Altos Smart II	\$769
Qume	
QVT 102 Green	\$449
QVT 102 Amber	\$469
Televideo	
800	\$1225
800A	\$979
910	\$425
910+	\$559
921	\$449
922	\$755
924	\$639
925	\$699
925E	\$599
Wyse 50	Call
75	\$565
Wyse 85	Call
Zenith z-22	\$469
Z-29	\$599
Z-49	Call

KEYBOARDS

Keytronics S151	\$179
5151 Jr.	\$179

MODEMS

Anchor Automation	
Anchor Express	Call
Mark XII	\$239
Hayes Smartmodem 300 Baud	\$189
Smartmodem 1200 Baud	\$379
Smartmodem 1200B (IBM)	\$359
Smartmodem 2400 Baud	Call
Micromodem IIE (Apple)	\$219
Novation Smart Cat Plus	\$315
Prometheus All Models	Call
Racal-Vadic All Models	Call
US Robotics Password 1200	\$209

COMPUTERS

NEC	
PC-8201 Computer	\$315
PC-8201A-90 Battery Pack	\$15
PC-8206A 32K Ram	\$215
PC-8271A-01 AC Adapter	\$16
PC-8271A-02 AC Adapter	\$16
PC-8281A Recorder	\$89
Sanyo MBC-775 Portable	Call
MBC-550 System	Call
MBC-555 System	Call
MBC-550-2 System	Call
MBC-555-2 System	Call
MBC-885	Call
Televideo	
803	\$1915
804	\$3429
1605D	\$1909
1605C	\$2299
1605H	\$3459
1605CH	\$3549
TPC-1	\$795
TPC-2 Single Drive	\$1509
TPC-2 Dual Drive	\$1749
Wyse	
Wyse pc Dual	Call
Wyse pc 10 Meg	Call
Zenith	
Z-150 Single Drive	Save 25%
Z-150 Dual Drive	Save 25%
Z-150 W/10 Megabyte	Save 25%
Z-160 Single Drive	Save 25%
Z-160 Dual Drive	Save 25%

PLOTTERS

Enter Sweet-P600	\$780
Epson HI-80	Call

DISKETTES

Maxell MD-1 (Qty 100)	\$149
MD-2 (Qty 100)	\$189

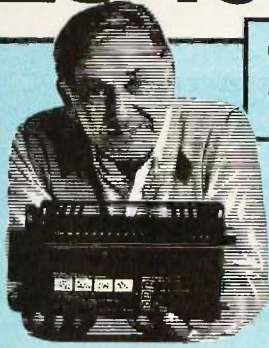

Canon PC PERSONAL COPIERS



Canon PC-10
Compact. Convenient. Personal. With the exclusive Canon cartridge copying system for easy maintenance. **\$519**



Canon PC-25
Reduction and enlargement comes to Personal Cartridge copying. Make copies up to legal size from originals as big as 10" x 14"! **\$979**



Canon PC-20
Compact, yet efficient for any business. With the exclusive Canon cartridge copying system. Plus automatic paper feeding. Make 8 copies a minute. **\$749**

MONITORS

Amdek All Monitors	Call
Princeton Graphic HX-12	\$479
Sanyo CRT-36	\$149
Taxan	
121 Green	\$125
122 Amber	\$134
420 RGB	\$399
425 RGB/Green	\$410
Zenith	
ZVM-122 Amber	\$95
ZVM-123 Green	\$89
ZVM-124	\$129
ZVM-130	Call
ZVM-133 Color/RGB	\$410
ZVM-135 Color/RGB W/Audio	\$459
ZVM136	\$575

DISK DRIVES

Alpha Omega Turbo 10	\$689
Turbo 20	\$1019
Turbo 30	\$1379
Haba Habadisk for Macintosh	\$329
lomega Bernoulli Box for IBM	
10 Megabyte	\$1799
20 Megabyte	\$2499
20 Megabyte Plus	\$2660
5 Megabyte for Macintosh	\$1459
Rana Elite I	\$179
Elite II	\$339
Elite III	\$405
Elite 10H/Apple	\$1080
Controller (W/Drive Only)	\$69
1000 W/DOS for Atari	\$175
Tallgrass TG-3020	\$2289
TG-3135	\$3689
TG-4060	\$1469
Controller	\$119

Order Processing & Order Line: 1-800-528-1054
Other Information: 602-954-6109

2222 E. Indian School Rd.
Phoenix, Arizona 85016

COMPUTER WAREHOUSE

Store Hours: Mon-Fri 10-5:30 Saturday 9-1
Order Line Hours: Mon-Fri 8:30-5:30 Saturday 9-1



Prices reflect 3% to 5% cash discount. Product shipped in factory cartons with manufacturer's warranty. Please add \$3.00 per order for UPS shipping. Prices & availability subject to change without notice. Send cashier's check or money order... all other checks will delay shipping two weeks.

NEW SYSTEMS

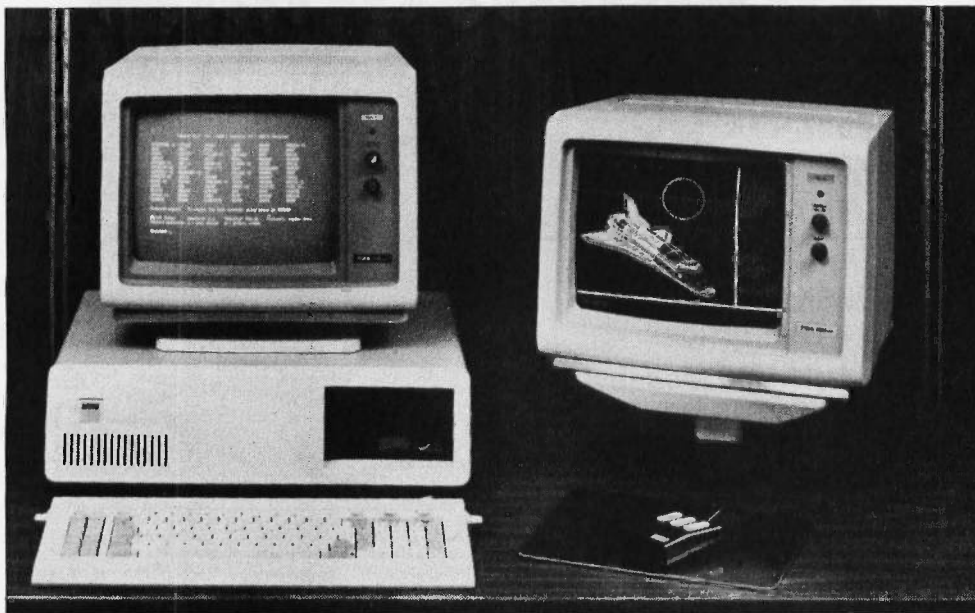

MNC International's MCAD workstations for computer-aided design.

multiple-processor environments. ECS PVS also supplies demand-paged virtual memory, multiuser and multitasking operation, mountable file systems, and dynamically installed device drivers. UNIX will soon be supported on the Expert 32. Elite provides additional software support with compilers for FORTRAN, Pascal, C, Modula-2, LISP, and SMPL.

Quantity-one prices for the Expert 32 start at \$17,700. Additional E82/CPU2 processor sets are \$3850. Contact Elite Computer Systems, 4129 May St., Wichita, KS 67209, (316) 942-6619. Inquiry 617.

Multifunction CAD Workstations

MNC International created the MCAD family of workstations specifically for computer-

aided design. The workstations are based on MNC's IBM PC-compatible computers and come complete with hardware and software.

The first three available models, MCAD 1000, MCAD 2000, and MCAD 3000, integrate the AutoCAD 2 software with three levels of hardware. All members of the MCAD family use an IBM PC-compatible processor and an 8087 coprocessor.

MCAD 1000 comes standard with a 10-megabyte hard-disk drive and 256K bytes of RAM. The monochrome graphics adapter provides 720-by-348-dot resolution. AutoCAD 2 basic design software and an integral mouse come with the package.

MCAD 2000 has the same processor configuration as MCAD 1000 but uses two monitors: a monochrome display functions as the system console, and the graphics design console is a

medium-resolution color display. This display combined with an Artist II graphics adapter from Control Systems gives you up to 16 simultaneous colors with a 640-by-400-dot resolution. Control is through the keyboard or an optical mouse.

The top-of-the-line MCAD 3000 also uses two monitors, including a high-resolution color-graphics monitor that supplies 1024-by-768-dot resolution with 16 simultaneous colors. MCAD 3000 disk memory is 22 megabytes, half of which is a removable cartridge. It comes standard with 512K bytes of RAM.

Options include plotters, printers, extended memory to 640K bytes, and software extensions. Several Tektronix emulation packages are also available.

Prices for the packages include software. MCAD 1000 is \$4850, MCAD 2000 is \$6995, and MCAD 3000 is \$11,995. IBM PC owners can purchase add-on kits to make their systems equivalent to any MCAD model. Contact MNC International, 2817 Anthony Lane S, Minneapolis, MN 55418, (612) 788-1099. Inquiry 618.

Spirit 68 32-bit Microcomputer System

Spirit 68 from First Computer Corporation is a 32-bit system that runs with UNIX System V. Spirit 68 can handle up to 12 users and addresses up to 4 megabytes of parity MOS memory while offering full processor functionality. The system also supports local-area networks and remote communications.

The basic Spirit 68 contains 40 megabytes of on-line disk storage that comprises a 20-megabyte removable disk cartridge and 20 megabytes of fixed storage. It also has a 22-bit addressing capability.

The system is available in two styles: a clamshell, pedestal-type cabinet that opens along the full length of the unit and a standard rack-mount version. Both styles accept three models of field-installable expansion modules that increase disk storage with 40 megabytes of combination fixed/removable storage and either 72 or 142 megabytes of fixed storage.

Basic Spirit 68 system pricing ranges from \$16,200 to \$19,500. Contact First Computer Corp., 645 Blackhawk Dr., Westmont, IL 60559, (312) 920-1050. Inquiry 619.

(continued)

It doesn't take much to make your programs run up to 20 times faster.

If you've been writing programs for your Commodore 64, Apple IIe or Apple IIc in BASIC you can take a giant step forward in speed of execution and in programming productivity for just \$49.95.

You can get program performance that you only thought possible from machine language programs. While still using a powerful, understandable high-level language. A language that's similar to Pascal, but much easier to learn and use.

You can create programs with our advanced, full-screen editor—much like you would on a word processor, and it even locates your compilation errors.

And when you compile your programs, you have a fast one-pass compiler, a recursive descent compiler that can compile a 100-line source program in 10 seconds or less.

PROMAL™ also gives you an elegant operating system "Executive" which includes powerful file, program and memory management commands and even I/O redirection.

You get all of that with PROMAL—improved programming productivity, faster compile and run time and power that you may never have thought possible.

PROMAL—for the beginning or advanced programmer.

Whether you are just beginning to write or are an experienced programmer, you can be more productive with PROMAL (PROgrammer's Micro Application Language). It's easier to learn than Pascal, C or Forth. It provides you with a full range of powerful structured statements like IF-ELSE, WHILE, REPEAT, FOR and CHOOSE. And, because indentation is part of the language's syntax, it helps you write programs neatly and logically. There are no line numbers to worry about, and since comments don't take up memory space, you can document your programs completely.

COMMODORE 64 BENCHMARK

(Sieve of Eratosthenes)

	PROMAL	BASIC	COMAL	FORTH	PASCAL
Execution Time (secs.)	30	630	490	51	55
Object Code Size (bytes)	128	255	329	181	415
Program Load Time (secs.)	3.2	3.8	6.3	11.2	23.5
Compile Time (secs.)	8.5	—	—	3.9	108

PROMAL—a language especially for small systems.

Unlike languages developed for larger systems and squeezed into small systems environments, PROMAL was conceived and developed specifically for the small system. With PROMAL there's finally a language created for the environment in which you work.

Speed up your programs and step up your programming productivity.

You get all of that speed and productivity—with the PROMAL PM-200 "End-User" system (220 pages of

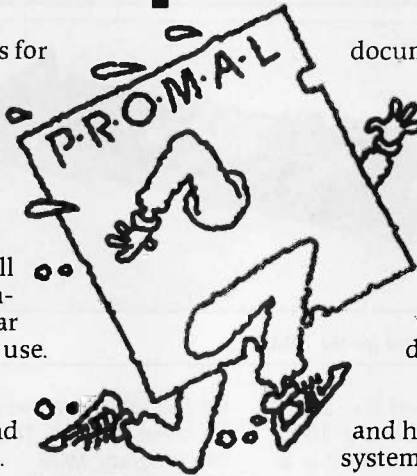

documentation and PROMAL system diskette including sample programs) for just \$49.95. There's a 15-day, no-risk moneyback guarantee. And the entire \$49.95 may be credited against later purchase of the "Developer's Version."

The "Developer's Version"—all the components of the "End User" system plus the "run time" object module generation capability, additional documentation and an unlimited right to sell or distribute PROMAL applications—is only \$99.95.

Or—for only \$10.00 plus \$2.50 postage and handling you can get the PM-100 demo system. It includes a 32-page manual and all the

\$49.95 to be exact.

capabilities of the PM-200 except the ability to print or save

files to disk. It's a very inexpensive way to explore the wonders of PROMAL.

Our Guarantee: Try PROMAL for 15 days. If you are not completely satisfied, return it to us undamaged and we'll refund your money. No questions asked. Dealer inquiries invited.

For quicker response on credit card orders, call Toll Free:

1-800-762-7874

In NC: 919-787-7703.



Systems Management Associates
3700 Computer Drive, Dept. PB-3
Raleigh, North Carolina 27609

Order Form

Please send me my copy of PROMAL

My system is (check one): Commodore 64 Apple IIe Apple IIc
PROMAL Package Desired (check one):

- PM-200 (for systems listed above) \$49.95 plus \$5.00 for shipping and handling at a total cost of \$54.95. Satisfaction Guaranteed.
- PM-300 Developer's Version \$99.95 plus \$5.00 for shipping and handling for a total cost of \$104.95. Satisfaction Guaranteed.
- PM-100 demo diskette \$10.00 for the diskette plus \$2.50 for postage and handling for a total cost of \$12.50. (Non-refundable.)
- My check is enclosed. Please charge my purchase to my Visa Mastercard

Card Number _____

Expiration Date _____

Signature _____

Name _____

Address _____

City, State, Zip _____

North Carolina Residents add 4-1/2% sales tax.
Foreign orders add \$15.00 additional shipping and handling.

A D D - I N S

**Model 256DIS
EPROM Programmer**

The Model 256DIS is a single EPROM programmer from Softalk, a subsidiary of Dynatec International. It can program any EPROM from a 2716 to a 27512, including "A" version and CMOS EPROMs. This programmer does not require additional modules or adapters.

Softalk's Model 256DIS programs one EPROM at a time. You can enter data from the programmer's own keyboard or from a development system through a standard RS-232C port. The programmer can also load from a master PROM into its 64K bytes of memory for programming a copy. The system uses a two-digit device code to set up the appropriate pin configuration and algorithms for the device being programmed.

The Model 256DIS costs \$895. Contact Softalk Inc., 3594 West 1820 S, Salt Lake City, UT 84104, (800) 722-7425; in Utah, (801) 973-9500. Inquiry 620.

The Apple in Color

An RGB color module for the Apple IIc is available from Telemax. The Peacock Model CM2C is an outboard module that comes with two cables and connectors. One short cable plugs into the 15-pin video output connector at the rear of the IIc. The other 3-foot cable plugs into your RGB monitor.

With the Peacock, you can select text and background colors from 14 color combinations. The Peacock Model CM2C sells for \$199.

Another Telemax product, the Kaleidoscope II, is an RGB color board for the

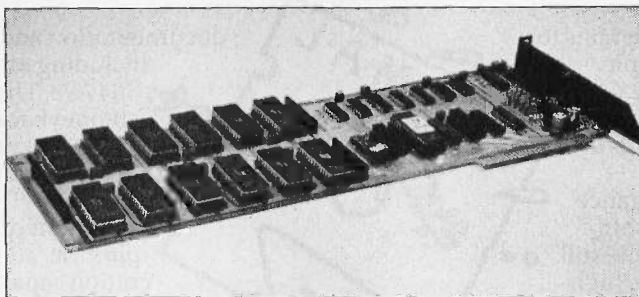

ROMDISK PC card for the IBM PC.

Apple II, IIe, and II+, and the Franklin ACE 100, 1000, and 1200. The board has a two-page memory operating system for programming both foreground and background colors. You can set each line of text to one of eight foreground and background colors.

The Kaleidoscope II plugs into slot 7. It lets you use your 80-column card or any other card that provides 80 columns and extended memory in slot 0 of the Apple IIe. For the Apple II+ and II and the Franklin series, you can use the Model VSP-80 switchplate option to interface 80-column boards to the Kaleidoscope II.

Apple versions of the Kaleidoscope II sell for \$199; Franklin models are \$219. The VSP-80 is \$30, and the monitor connector is \$15. Contact Telemax Inc., 780 Lorraine Dr., POB 339, Warrington, PA 18976, (215) 343-3000. Inquiry 621.

**Universal
Programmer**

Logical Devices' PROMPRO-XP is a 16-bit MOS EPROM programmer that will support software

for the IBM PC as well as for other systems. This unit can program MOS EEPROMs, MOS EPROMs, CMOS EPROMs, bipolar PROMs, programmable logic devices, and microprocessors with on-board EPROMs.

PROMPRO-XP has a base system that handles I/O, internal memory, control, and power functions. It can program MOS or CMOS EEPROMs and EPROMs without the aid of plug-in adapters. Adapters are available to handle devices with widely different technologies, such as bipolar PROMs and programmable logic devices.

This universal programmer directs I/O communications through a serial RS-232C port or a detachable keypad with an alphanumeric display. It can send data to a printer or be remotely operated.

You can organize a 512K-byte internal RAM buffer in 64K-byte by 8 or 32K-byte by 16 arrays so that two EPROMs with different data can be programmed simultaneously. An In-Circuit-Emulation option lets you download a 16-bit file in memory and run a 68000 or 8086 program from the PROMPRO-XP's memory. Other features include a built-in eraser, range command, and complete self-diagnosis.

The PROMPRO-XP base unit is \$1995; bipolar and PAL adapters are \$495 each. Contact Logical Devices Inc., 1321 Northwest 65th Place, Fort Lauderdale, FL 33309, (800) 331-7766; in Florida, (305) 974-0975. Inquiry 622.

**ROMDISK PC
Accessory Card**

ROMDISK PC for the IBM PC and compatibles consists of a ROM and circuitry that emulates a write-protected disk and disk-drive controller. This full-size card fits into an accessory slot inside the microcomputer case.

ROMDISK PC works with PC-DOS, MS-DOS, and equivalent DOSes. A utility program copies a user-selected DOS, programs, or program files from disk into the ROM, thus converting the software to firmware. You can use DOS commands to auto-boot or selectively load software into RAM from ROMDISK PC.

The microcomputer's power supply supports ROMDISK PC. You can erase the EPROMs with an ultraviolet eraser without removing them from the printed-circuit board, then load new programs into ROM. Data-access time is 100 microseconds; program characteristics and the DOS determine overall speed improvements.

ROMDISK PC-0, a half-size board with 180K bytes of storage, sells for \$599. ROMDISK PC-1, a full-size board with 180K bytes of storage upgradable to 360K bytes, is also \$599. ROMDISK PC-2 is a full-size

(continued)

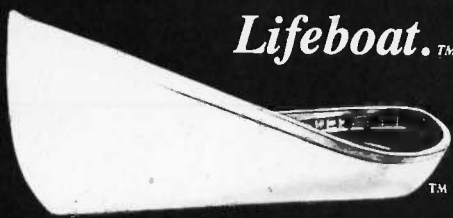

*C is the language.
Lifeboat™ is the source.*

TM

Productivity Tools from the Leading Publisher of C Programs.

The Lattice® C Compiler

The cornerstone of a program is its compiler; it can make the difference between a good program and a great one. The Lattice C compiler features:

- Full compatibility with Kernighan and Ritchie's standards
- Four memory model options for control and versatility
- Automatic sensing and use of the 8087 math chip
- Choose from the widest selection of add-on options
- Renowned for speed and code quality
- Superior quality documentation

"Lattice C produces remarkable code...the documentation sets such a high standard that others don't even come close...in the top category for its quick compilation and execution time and consistent reliability."

Ralph A. Phraner, *Byte Magazine*

Lattice Library source code also available.

Language Utilities

Pfix 86/Pfix 86 Plus — dynamic and symbolic debuggers respectively, these provide multiple-window debugging with breakpointing capability.

Plink 86 — a two-pass overlay linkage editor that helps solve memory problems.

Text Management Utilities — includes GREP (searches files for patterns), DIFF (differential text file comparator), and more.

LMK (UNIX "make") — automates the construction of large multi-module products.

Curses — lets you write programs with full screen output transportable among all UNIX, XENIX and PC-DOS systems without changing your source code.

BASTOC — translates MBASIC or CBASIC source code directly to Lattice C source code.

C Cross Reference Generator — examines your

C source modules and produces a listing of each symbol and where it is referenced.

Editors

Pmate — a customizable full screen text editor featuring its own powerful macro command language.

ES/P for C — C program entry with automatic syntax checking and formatting.

VEDIT — an easy-to-use word processor for use with V-PRINT.

V-PRINT — a print formatting companion for VEDIT.

CVUE — a full-screen editor that offers an easy way to use command structure.

EMACS — a full screen multi window text editor.

Fast/C — speeds up the cycle of edit-compile-debug-edit-recompile.

Graphics and Screen Design

HALO — one of the industry's standard graphics development packages. Over 150 graphics commands including line, arc, box, circle and ellipse primitives. The **10 Fontpack** is also available.

Panel — a screen formatter and data entry aid.

Lattice Window — a library of subroutines allowing design of windows.

Functions

C-Food Smorgasbord — a tasty selection of utility functions for Lattice C programmers; includes a binary coded decimal arithmetic package, level 0 I/O functions, a Terminal Independence Package, and more.

Float-87 — supports the 8087 math chip to boost the speed of floating-point calculations.

The Greenleaf Functions — a comprehensive library of over 200 routines.

The Greenleaf Comm Library — an easy-to-

use asynchronous communications library.

C Power Packs — sets of functions useful for a wide variety of applications.

BASIC C — This library is a simple bridge from IBM BASIC to C.

Database Record Managers

Phact — a database record manager library of C language functions, used in the creation and manipulation of large and small databases.

Btrieve — a sophisticated file management system designed for developing applications under PC-DOS. Data can be instantly retrieved by key value.

FABS — a Fast Access Btree Structure function library designed for rapid, keyed access to data files using multipath structures.

Autosort — a fast sort/merge utility.

Lattice dB-C ISAM — a library of C functions that enables you to create and access dBase format database files.

Cross-Compilers

For programmers active in both micro and mini environments we provide advanced cross-compilers which product Intel 8086 object modules. All were developed to be as functional — and reliable — as the native compilers. They are available for the following systems:

VAX/VMS, VAX/UNIX, 68K/UNIX-S, 68K/UNIX-L

Also, we have available:

Z80 Cross-Compiler for MS- and PC-DOS — produces Z80 object modules in the Microsoft relocatable format.

New Products

Run/C — finally, a C interpreter for all levels of C Programmers.

C Sprite — a symbolic debugger with breakpoint capability.

Call LIFEBOAT: 1-800-847-7078. In NY, 1-212-860-0300.

YES! Please rush me the latest FREE Lifeboat™ catalog of C products.

Name _____ Title _____

Company Name _____ Business Phone _____

Address _____

Please check one of the following categories:

Dealer/Distributor End User Other _____

Return Coupon to: Lifeboat™ Associates
1651 Third Avenue, New York, NY 10128

© 1985 Lifeboat Associates

BY

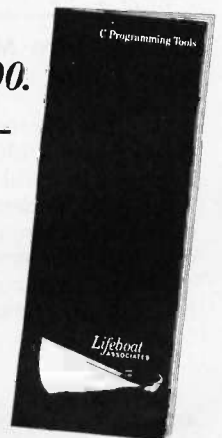

Inquiry 241

ADD-INS

board with 360K bytes of storage and costs \$999. Contact Curtis Inc., 22 Red Fox Rd., St. Paul, MN 55110, (612) 484-5064. Inquiry **623**.

512K-byte Memory Upgrade for the Mac

Micro Conversions has developed an upgrade kit for converting a 128K-byte Macintosh to 512K bytes. Installation does not require adding wires or drilling holes—only basic soldering. The kit includes a tool to

open the Macintosh's case, miniature flush cutters, an integrated-circuit insertion tool, stainless steel electronic-assembly tweezers, an X-Acto knife, and three rolls of desoldering braid. Parts for the upgrade include a multiplexer chip, seventeen 256K-byte RAM chips, 16-pin low-profile sockets for all chips to be installed, a miniature printed-circuit board assembly, and resistors and capacitor required for the new multiplexer chip.

The price of the 512K-byte upgrade kit is \$350. You can

also have the kit installed by Micro Conversions for a total cost of \$399. Contact Micro Conversions, 3606 Knoll Crest Dr., Arlington, TX 76014, (817) 465-5758. Inquiry **624**.

The Macintosh 512Kit

Three versions of the 512Kit from Levco Enterprises let you upgrade your 128K-byte Macintosh to 512K bytes. Kit I contains complete installation instructions, a printed-circuit board,

a pair of 2.2k-ohm resistors, a single 0.1-microfarad capacitor, a seven-position pin strip, and a 74AS253 integrated circuit. Kit II also has sixteen 16-pin gold-plated sockets for the memory chips. Kit III includes all of the above plus seventeen 256K-bit DRAMs.

The 512Kit prices are \$49.95 for Kit I, \$59.95 for Kit II, and \$298.95 for Kit III. A fully installed upgrade costs \$399.95. Contact Levco Enterprises, 4954 Sun Valley Rd., Del Mar, CA 92014, (619) 755-7827. Inquiry **625**.

PERIPHERALS

Hard-Disk Storage for the PC AT

PS20 Plus is a plug-in 20-megabyte hard-disk drive for the IBM PC AT. It works directly with the AT's controller board to provide the same capabilities as the extended AT.

If you need more storage, you can add a Perstor Expansion System for up to four additional hard-disk drives.

PS20 Plus sells for \$1295; Perstor Expansion Systems start at \$2000. Contact Systems and Software Inc., 7825 East Redfield Rd., Scottsdale, AZ 85260, (602) 948-7313. Inquiry **626**.



PS20 Plus for the IBM PC AT.

lets you follow the progress of a call.

Included in its \$200 list price are communications software for the Commodore 64 and one hour on CompuServe. A 300-bps version is offered for about \$70. Commodore plans a version of the 1200-bps modem with an RS-232C interface.

The Commodore 1571 disk drive works with the Commodore 128 as well as Commodore's 64, Plus/4, and LCD computers. It features LCD compatibility with the older 1541 drive and enhanced

disk capacity and speed. In its CP/M mode, it stores 410K bytes of data and transfers data at 3500 cps. Data-transfer rates under C64 and C128 control are 300 and 1500 cps, respectively. It will also read and write other CP/M-formatted disks.

The Commodore 1571 disk drive will cost approximately \$300. Contact Commodore International Ltd., 1200 Wilson Dr., West Chester, PA 19380, (215) 431-9100. Inquiry **627**.

IBM PC AT Line of Hard Disks

Genoa Systems has a line of hard-disk products for the IBM PC AT that includes 20- and 32-megabyte drives. These drives work with the existing PC AT controller and power supply. Both systems are compatible with all PC AT operating systems.

You can install one or two of the drives in your computer. They function with any network that works with the PC AT.

The drives cost \$1795 for 20 megabytes and \$2295 for 32 megabytes. Contact Genoa Systems Corp., 73 East Trimble Rd., San Jose, CA 95131, (408) 945-9720. Inquiry **628**.

Commodore Modem Disk Drive

Commodore recently announced a 1200-bps modem and a disk drive.

The 1670 Modem/1200, a compact modem, uses many of the same commands as the Hayes Smartmodem and has an internal speaker that

Removable-Cartridge Winchester for IBM PC AT

Interface's removable-cartridge Winchester disk subsystem provides data storage, data security, and multiuse of a single PC AT. You can remove the disk

(continued)

SOME FLOPPY DISKS WILL GIVE YOU A BYTE YOU'LL NEVER FORGET.



You'll find them lurking in stores wherever floppy disks are sold. Those evil denizens of computer drives that are eagerly waiting to devour your valuable information, bit by bit. What they can do to you and your business is too painful to print.

At TDK, we grimace at that thought. Which is why we took great pains to develop an absolutely flawless disk. One that is made with such technical superiority that it meets or exceeds the most rigid industry standards.

Whether you choose our 8-inch, 5.25-inch standard, 5.25-inch High Density or 3.5-inch No-Risk Disks, you'll be assured of consistent error-free performance, through years of extended usage. And although you'll probably never need it, it's nice to know that all our disks are covered by a lifetime replacement warranty.

It's also nice to know that our disks share both the technology and dedication to quality that have made TDK the world's largest manufacturer of magnetic media—including our higher-performance audio and video recording tapes. The fact that millions of people rely on our products is a true testament to our 50 year heritage in the industry.

So, the next time you enter the cluttered jungle of floppy disks, don't pick up something hazardous to your company's health. Avoid a bad byte. Use the TDK No-Risk Disk.

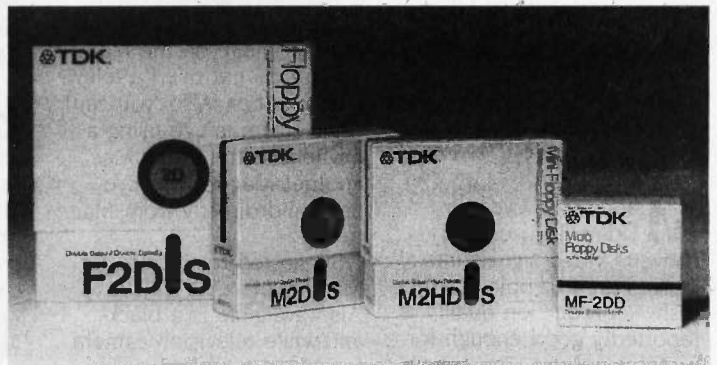

THE NO-RISK™ DISK. TDK®

PERIPHERALS



Mac Private Eye video digitizer.

cartridge when you finish working to help decrease the incidence of damaged or erased data.

The cartridge drive fits into the B slot on the IBM PC AT. It has 10½ megabytes of formatted storage per cartridge. Track-to-track access time is 22.5 milliseconds and an average access time, including head-settling time, is 98 milliseconds. The drive has a 5-megabit-per-second data-transfer rate.

The removable cartridge for the PC AT, model I²ATDMA10, sells for \$1695. A PC version, model I²DMA10, is \$2295. Contact Interface Inc., 21101 Osborne St., Canoga Park, CA 91304, (818) 341-7914. Inquiry 629.

Mac Private Eye Video Digitizer

Mac Private Eye is a video digitizer that converts video signals into images on an Apple Macintosh. Reproduction quality is reportedly good enough for professional use. The system accepts images from any standard NTSC video source, such as a black-and-white or

color television camera, television monitor, or video-cassette recorder.

The subject does not have to be stationary because Mac Private Eye works with moving video images. It captures a complete video frame in real time. Each video frame is converted into a 512- by 512-pixel image that you can see on the Macintosh with a movable window.

You can also manipulate images with MacPaint and store them in MacPaint files. The digitizer uses a random dot-pattern generator that creates images with continuous shades of gray.

You can make television camera adjustments by viewing the image on the Mac, so you do not need a television monitor. Also, you can transfer the image using a modem to the user's Mac, another Mac Private Eye user, and directly from Mac to Mac.

Suggested retail price for Mac Private Eye is \$595. Also available is a black-and-white television camera for \$225 or both units for \$799. Contact I/O Video Inc., 222 Third St., Cambridge, MA 02142, (617) 547-4141. Inquiry 630.

SOFTWARE • APPLE

Speed Up the 512K Macintosh

TurboCharger quickens floppy-disk access on the 512K-byte Macintosh by keeping critical areas of disk in RAM. According to Nevins Microsystems, disk performance is often doubled or tripled, with reported peak performance more than 500 percent faster. (The company cited a test using pfs:File to search a database of 1325 forms. With TurboCharger, the test took 11 seconds; without TurboCharger, it took 60.5 seconds.)

Once installed on a Mac start-up disk, TurboCharger works automatically. The program analyzes disk usage, buffering critical areas of disk in RAM. As little as 32K bytes of RAM can be used for buffering.

TurboCharger works with copy-protected software and can be used with almost every package written for the Mac, including MacWrite and MacPaint, Multiplan, Word, and Jazz. The price is \$95. Contact Nevins Microsystems Inc., 210 Fifth Ave., New York, NY 10010, (212) 563-1910. Inquiry 631.

Ensemble: Integrated Software for the Macintosh

Hayden Software's Ensemble is an integrated software package that runs on Apple's Macintosh. This package contains word-processing, spreadsheet, graphics, and list-management applications, and it will work on either a 128K- or a 512K-byte Macintosh.

Ensemble lets you use the

Macintosh's mouse and pull-down menus when using the word processor or when entering data into the spreadsheet. The word processor is said to be functionally similar to MacWrite. You can generate 10 types of graphs, including bar, pie, and line charts, from spreadsheet data, and you can use the list manager to merge addresses and letters.

Ensemble is available for \$299.95. Contact Hayden Software Co. Inc., 600 Suffolk St., Lowell, MA 01854, (617) 937-0200. Inquiry 632.

Applesoft Screen Routines

Magic Screen, a set of Applesoft screen-handling routines, consists of a screen-generator program for designing screens and a screen processor that contains a set of input and output routines. These routines can be called with ampersand (&) statements in an Applesoft BASIC program to handle full-screen data entry, reports, menus, and help screens.

With the screen generator, you can specify the protected and unprotected fields along with the attributes for data-entry fields. A data field can be defined as numeric, alphanumeric, or as a question field.

The screen processor, which becomes part of the Applesoft program, contains 18 screen routines, including & WINDOW, & MOVE, and & WAIT.

Magic Screen retails for \$30 and can be copied. Contact Graphware Inc., POB 373, Middletown, OH 45042, (513) 424-6733. Inquiry 633.

(continued)

NORTHROP

Annapolis

Where 21st Century Technology thrives in an 18th Century Setting

Annapolis, Maryland, is a place of history in America's proud past. Today it is also a place of the future. The newest element of Northrop Defense Systems Division will move to the **ANNAPOLIS SCIENCE CENTER** this summer. Defense Security Systems offers the kind of challenges, environment, and commitment to excellence that you can build a future on. Career professionals are offered a work environment that includes:

- A new VAX 11/780 computer facility with IBM PC systems
- \$1,000,000 digital/analog signal analysis laboratory
- An advanced systems engineering laboratory
- Microprocessor-based development system
- Comprehensive U.S./foreign technical library

Every assignment represents a KEY POSITION in our organization for professionals with BS or equivalent, MS/PhD desirable who are experienced in one of the following disciplines:

Systems Engineering

Experience in design/implementation of hardware/software systems in support of signal data collection and processing efforts. SYSTEMS ENGINEERING MANAGER, PROJECT MANAGER, and TEAM LEADER positions available.

Signal Science

Experience with IR&D studies in signal technologies, high speed digital signal processing, acousto-optics, advanced antennas, and modern modulation techniques preferred. Performance of predictive foreign capabilities analysis and deliverable systems development will be required.

Digital Engineering

Background in digital communications circuit design/analysis; hardware/software development; hardware testing; assembly language programming and microprocessor design. TEAM LEADER positions available.

Software Systems Analysis

Experience in defining user/system requirements and software development. Knowledge of VAX 11/780 systems and FORTRAN language helpful. TEAM LEADER positions available.

Software Engineering

Experience/technical mastery of key software development areas (structured systems design/modular programming, algorithms analysis, microprocessor software development, data base management).

Other positions also available:

- DIGITAL/ANALOG SIGNAL ANALYSTS
- INTELLIGENCE ANALYSTS
- OPERATIONS RESEARCH ANALYSTS

For immediate consideration, send resume to: Ms. Joyce Hicks, Professional Employment Dept. 012. NORTHROP CORPORATION, Defense Systems Division, Defense Security Systems, 1901 N. Beauregard Street, Ste. 208, Alexandria, VA 22311.

New Annapolis Address: 177 Admiral Cochrane Drive, Annapolis, MD 21401. Equal opportunity employer M/F/V/H. U.S. Citizenship Required.

NORTHROP

Defense Systems Division
Electronics Systems Group

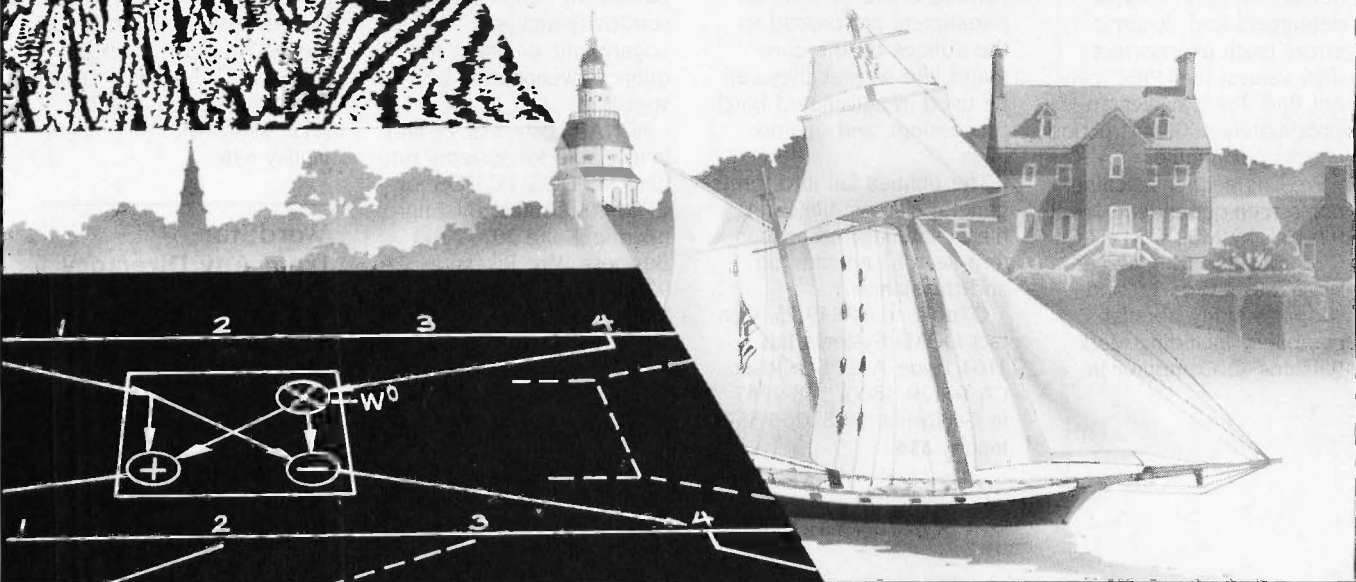
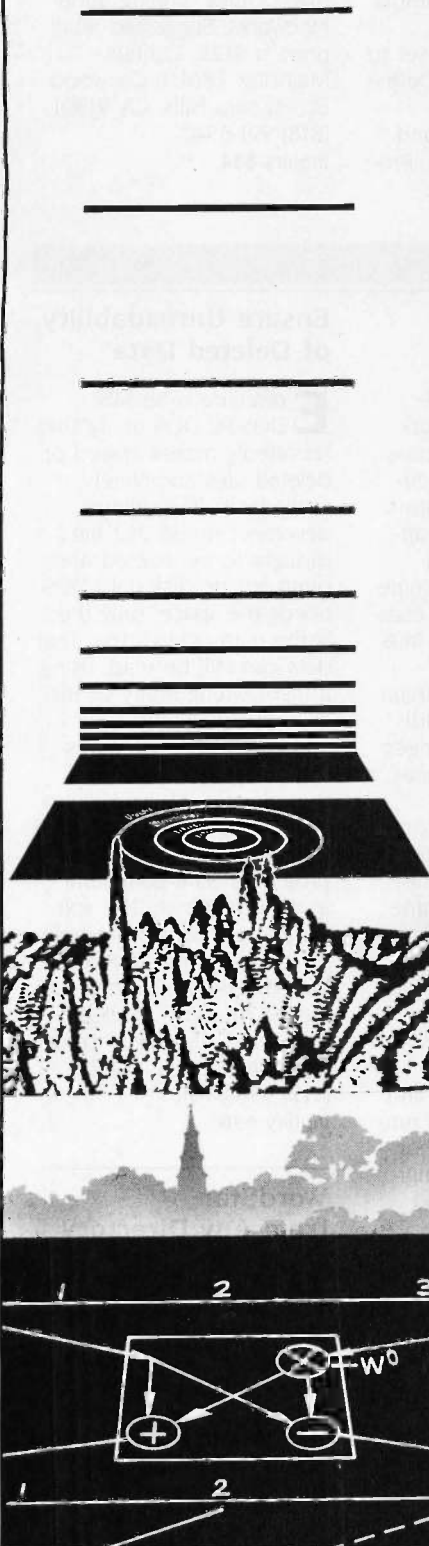

SOFTWARE • APPLE

Graphic Communications

A communications package for the Macintosh, Telescope features an integrated communications directory, intelligent macros, universal terminal emulation, error-checking file transfer, and unattended message

service. But according to the vendor, the package's most innovative feature is its graphics capability.

Telescope uses character-coded messages to produce graphics shapes as well as text of various sizes and styles. You can send messages by electronic mail or place them on any infor-

mation utility. Business uses include transmission of charts and graphs. You can also create and send simple animated messages.

The program can be set to emulate any terminal. Definitions for TTY, VT52, VT100/VT102, Teleray, and TeleVideo are provided. Protocol selections include

ASCII and XMODEM at 300, 1200, or 2400 bps.

Telescope works with any Mac or Lisa running under MacWorks. Suggested retail price is \$125. Contact Mainstay, 28611B Canwood St., Agoura Hills, CA 91301, (818) 991-6540. Inquiry **634**.

SOFTWARE • CP/M / MS-DOS

Program Analyzer for C

A superset of the UNIX LINT utility, Pre-C is designed to increase programmer productivity by quickly identifying program statement errors, including interface inconsistencies that require cross-file checking. The developer claims that a single execution of Pre-C spots many errors difficult to isolate when tracing a program with a debugger.

Producing a collection of diagnostic messages, the analyzer is said to identify incorrect subroutine calls and other problems up to 100 times faster than a programmer using a debugger. Pre-C can complement a debugging tool, because debuggers find dynamic errors (such as incorrect data values) that Pre-C can't find. Pre-C makes approximately 1000 instruction checks per minute.

Pre-C is neither machine- nor screen-dependent. It will run on any MS-DOS or PC-DOS machine running versions 2.0, 2.1, or 3.0 and supports many popular C compilers, including Mark Williams' C, Computer In-

novations' C86, and Lattice C. The price is \$395. Contact Phoenix Computer Products Corp., 1416 Providence Highway, Norwood, MA 02062, (617) 762-5030. Inquiry **635**.

UNIX-like Tools for MS-DOS

A collection of 19 tools adapted from UNIX, QTools is intended to provide a concise way to specify complex file manipulations, formats, and views. The toolbox operates under MS-DOS or PC-DOS on IBM PCs and compatibles.

QTools supports I/O redirection and pipes, wild cards, environment variables, command-line options (all parameters are passed to the utilities on the command line so that they can be used in automated batch processing), and on-line help.

The utilities fall into three general classes: file listing; file maintenance; and pattern search, substitution, and translation.

QTools costs \$49.95. Contact QCAD Systems Inc., 1164 Hyde Ave., San Jose, CA 95129, (800) 538-9787; in California, (408) 255-5574. Inquiry **636**.

Electronic-Circuit Analysis

A CNAP is a general-purpose, AC network analysis program for active and passive electronic circuits consisting of resistors, capacitors, inductors, transistors, and operational amplifiers. You can examine circuits with up to 200 components and 30 nodes in a single pass.

The program has a circuit editor that supports addition, deletion, and changes of components, tolerances, and node connections. ACNAP automatically computes the magnitude and phase at any node in the circuit and includes Monte Carlo, worst-case, noise equivalent bandwidth, and sensitivity analyses. Logarithmic or linear frequency sweeps may be specified.

ACNAP costs \$72.95 and is available for systems running MS-DOS, PC-DOS, or CP/M-80. Contact BV Engineering, Suite 207, 2200 Business Way, Riverside, CA 92501, (714) 781-0252. Inquiry **637**.

Ensure Unreadability of Deleted Data

Erasesure is an MS-DOS/PC-DOS utility that reportedly makes erased or deleted files completely unreadable. The utility's developer noted that files thought to be deleted are often left on disk until DOS needs the space; only then is the data overwritten. That data can still be read, using a disk-reading utility or the DOS utility Debug.

Erasesure first prepares the data for removal and then deletes it according to DOS conventions. Instead of Delete or Erase, you use the program's Sure command and the filename. The software is not copy-protected, so it can be transferred to hard-disk systems. Erasesure costs \$30 and is available from MPPi Ltd., 2200 Lehigh Ave., Glenview, IL 60025, (312) 998-8401. Inquiry **638**.

WordStar from Any Directory

Hard-disk WordStar users can run from any directory or subdirectory, including the floppy-disk drive, with a utility called Smart-Path. Until now, the vendor said, hard-disk users had to keep multiple copies of the

SOFTWARE • CP/M/MS-DOS

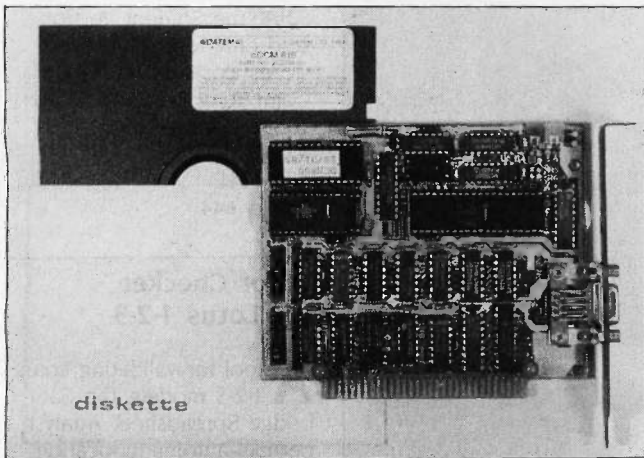

Datem's dDCM810 Bitbus support package.

word processor on disk because WordStar didn't recognize directories or subdirectories.

With SmartPath, you can run any program that uses overlays from any directory. With only one copy of WordStar on the hard disk, you can group letters, documents, and programs into separate directories.

SmartPath is priced at \$29.95 and runs under PC-DOS 2.0, 2.1, 3.0, and 3.1. Contact Software Research Technologies Inc., Suite 211, 3757 Wilshire Blvd., Los Angeles, CA 90010, (213) 384-4120. Inquiry 639.

Support for the Bitbus

Datem's dDCM810 package provides applications programmers with a high-level interface between MS-DOS computers and the

Bitbus distributed control network. The software runs on any IBM PC-compatible machine equipped with a Datem dDCM800 Bitbus interface adapter.

Facilities within the support package include message packet management, named device interfaces, full message protocol, and user-specified flow control. Datem offers utilities to let you manipulate the RAM-resident dDCM810 operating environment. The software provides an interface for users who want to develop real-time, hierarchical distributed control systems for data acquisition, process control, and robotics.

In addition to user-specified flow control, dDCM810 manages the routing of sporadic response messages. The software also provides automatic response-connection generation when operating the host PC as a slave node.

The application support package costs \$415 (U.S. currency). Contact Datem Ltd., 148 Colonnade Rd., Nepean, Ontario K2E 7R4, Canada. (613) 225-5919. Inquiry 640.

SOFTWARE • IBM PC

Volkswriter for Scientists

A word-processing package for scientists and academics, Volkswriter Scientific features more than 400 bit-mapped science and math characters, Roman and Greek alphabets, and multiple type styles and sizes. According to Lifetree Software, the package heightens the quality of dot-matrix output because it drives each pin rather than using the native character set of the printer.

The program offers user-definable and recallable composite symbols and macros, five text levels for each line, on-screen tutorials, and nine help menus. It's a page-oriented word processor with hyphenation and underlining as you edit.

Lifetree stresses that Volkswriter Scientific, priced at \$495, is not an upgrade of Volkswriter Deluxe. The program runs on the IBM PC and close compatibles, including the Compaq, Corona, Chameleon, and Hyperion, and requires 256K bytes, two disk drives, a color monitor, and color-graphics adapter. Contact Lifetree Software, 411 Pacific St., Monterey, CA 93940, (408) 373-4718. Inquiry 642.

FORTH for XENIX and UNIX

Ubiquitous Systems has introduced a FORTH-language software-development system tailored specifically for XENIX and UNIX. u4th is a portable, standard FORTH that is source-transportable to any

other environment that has a standard C compiler with a UNIX-compatible library. u4th's features include access to UNIX system calls, the capability to incorporate new primitives written in C, the capability to compile high-level FORTH words into the load image, a direct-threaded interpreter, and an object-oriented extension word set. The system is largely compliant, the vendor said, with the FORTH-83 standard (word size of 32 bits may be used where applicable, and lowercase characters are standard).

The object-oriented FORTH extensions provide a set of system-building tools suitable for AI research and other complex tasks, yet they can drop into "normal" FORTH when necessary. u4th has several object classes, including memory managers, lists, and tagged data objects.

The price of u4th for the IBM PC XT and PC AT is \$395. Contact Ubiquitous Systems Inc., 13333 Bel-Red Rd. NE, Bellevue, WA 98005, (206) 641-8030. Inquiry 641.

TelePaint Includes Paint Software, Can Enhance Any Graph

LC/Telegraphics' TelePaint software lets you capture, edit, enlarge, and enhance graphs generated by such programs as Lotus 1-2-3. With TelePaint, you can reposition charts, add new text or graphics, and change, add, or highlight colors and patterns. Added text can use any of 16 fonts and can range from simple labels and captions to full paragraphs. Entire graphs or parts of graphs can be stored to disk or printed in color or black and white.

(continued)

SOFTWARE • IBM PC

You can use TelePaint as a standard paint program, similar to Apple's MacPaint for the Macintosh. It's fully mouse-driven and uses pull-down and pop-up menus. TelePaint runs on the IBM PC, XT, AT, and compatibles. It requires 256K bytes of RAM, one double-sided disk drive, an IBM color-display adapter, and a Microsoft-compatible mouse.

TelePaint is available for \$149. Contact LCS/Telegraphics, 261 Vassar St., Cambridge, MA 02139, (617) 547-4738. Inquiry 646.

Program Development from Mainframe to Microcomputer

You can off-load program-development work done on a mainframe computer to an IBM PC with VS COBOL Workbench. Designed to provide uninterrupted development, testing, and maintenance of programs downloaded to a PC, the Workbench supports many features of COBOL as implemented in IBM's OS/VS COBOL and VS COBOL II. OS/VS COBOL and VS COBOL II syntax can be used separately or coexist in a single program. You can convert OS/VS COBOL programs to VS COBOL II using flags that report errors in code compiled from one syntax to the other.

Support of CALLS and EXEC statements enables you to edit, debug, and test applications that use IBM host interfaces such as IMS/VS, CICS/VS, DL/I, and SQL/DS. A Session Controller facility records keystrokes of testing and debugging sessions.

The syntax-check compo-



STATA statistical program for the IBM PC.

nent examines the COBOL source code and generates executable intermediate code. It also flags code that is not ANSI-74 standard.

VS COBOL Workbench, which costs \$4000, supports the IBM PC, PC XT, PC AT, and Portable PC. Contact Micro Focus Inc., 2465 East Bayshore Rd., Palo Alto, CA 94303, (415) 856-4161. Inquiry 643.

Statistics and Data Analysis

STATA, a program designed to help you manage, display, and analyze data, has features in

common with spreadsheet, database-management, and statistical packages. The program lets you ask "what if" questions. Like a database manager, STATA enables you to create complex data sets, transform them, and locate pieces of information. The package can calculate the standard univariate statistics, correlations and covariances, and chi-square tests for independence in two-way tables.

STATA runs on an IBM PC, PC XT, or PC AT with at least 256K bytes of RAM and one double-sided disk drive. The package will use, but does not require, the 8087 math coprocessor. The Professional System costs

\$395; the Student Version, sold only to college bookstores, costs \$30. Contact Computing Resource Center, 10801 National Blvd., Los Angeles, CA 90064, (213) 470-4341. Inquiry 644.

Error Checker for Lotus 1-2-3

A tool for validating Lotus 1-2-3 models, the Cambridge Spreadsheet Analyst permits automatic location of all circular reference errors. This CIRC feature reportedly eliminates hours spent tracking down interlocking formulas.

A complete package for spotting errors and scrutinizing a model's logic, the Analyst will scan a worksheet for more than a dozen conditions likely to indicate problems. Two interactive features let you examine the assumptions behind a 1-2-3 model. The cross-reference function shows where and how a given cell, range, or 1-2-3 function is used. The interactive probe capability lets you explore the cells that affect a formula.

The Analyst works directly with 1-2-3 spreadsheet files and, where possible, reflects the command conventions of the Lotus software. A help screen is available at every decision point.

The Cambridge Spreadsheet Analyst costs \$95, runs on the PC family, and requires at least 192K bytes of RAM, two disk drives, and PC-DOS 1.1 or higher. Contact The Cambridge Software Collaborative, 56 Garden St., Cambridge, MA 02138, (800) 343-0663 ext. 4200; in Massachusetts, (800) 322-1238 ext. 4200. Inquiry 645.

WHERE DO NEW PRODUCT ITEMS COME FROM?

The new products listed in this section of BYTE are chosen from the thousands of press releases, letters, and telephone calls we receive each month from manufacturers, distributors, designers, and readers. The basic criteria for selection for publication are: (a) does a product match our readers' interests? and (b) is it new or is it simply a reintroduction of an old item? Because of the volume of submissions we must sort through every month, the items we publish are based on vendors' statements and are not individually verified. If you want your product to be considered for publication (at no charge), send full information about it, including its price and an address and telephone number where a reader can get further information, to New Products Editor, BYTE, POB 372, Hancock, NH 03449.

Contact us for other low prices on hardware and software.
Next Day Air Extra

FREE SHIPPING. NO SURCHARGE FOR OR .

Call for latest prices.

COMPAQ®

256K, 1/360K drive,
10 Meg Internal

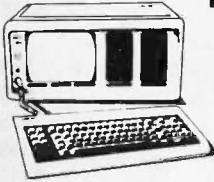

\$2695

Functional equivalent
to a Compaq Plus™

Now using 3 1/2" shock-mounted Winchester drives.

The same as used in the Compaq Plus.™

Also available with 2 half-height drives and 10 MEG HD—\$3195.

Or upgrade your Compaq to a Compaq Plus™ equivalent with
our 3 1/2" shock-mounted Winchester disk kit. Includes Hard
Disk, Controller, Cables, Manual, Software, and Mounting
Hardware. One year warranty.

\$695

COMPAQ®

It simply works better: **DESKPRO™**

Functional equivalent to
Compaq Deskpro™
Model 4.

\$3895

Includes Monitor

**640K, One 360K Drive,
One 10 Meg Internal Hard Drive,
Tape Backup Unit.**

Compaq is a registered trademark and Compaq Plus and Compaq Deskpro are trademarks of Compaq Computer Corporation.



XT™ POWER 135W



Solve your power problem.
Fully XT™ compatible. **\$119**
One Year Warranty.
Directly Replaces Power Supply in PC™.

AT™ PRODUCTS

Fully compatible w/IBM PC AT™
Disk Controller, DOS 3.0 or 3.1
128K RAM SET FOR PC AT™

\$149

20 MEG Internal Hard Disk **\$795** 33 MEG Internal Hard Disk **\$1195**

These are high-performance disk drives, well-suited for the AT™.

INTEL 8087 \$99

IRWIN™
MAGNETICS



TAPE BACKUP SYSTEM

\$595

- Half Height
- Low Power
- Uses Floppy Controller Card
- 10-35 Meg Formatted Capacity
- Used in Compaq Deskpro™

10, 20, 33 AND 42 MEG INTERNAL AND EXTERNAL HARD DISK SYSTEMS

With Hard Disk by



Half-Height
10 Meg Internal

\$549

	20 MEG	33 MEG	42 MEG
Brand of Hard Disk	Microscience	Rodime	Rodime
Internal	\$695	\$1395	\$1595
External	\$895	\$1495	\$1695



Externals mounted with independent power supply and fan. Fully DOS 2.1 or 3.0 compatible. Both Internals and Externals boot from Hard Disk. 33 and 42 Meg Internal Disks include extender power supply. The system comes complete and ready to install with the Hard Disk, Controller, Cables, Manual, Software, and Mounting Hardware. One Year Warranty.

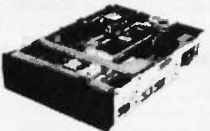

MITSUBISHI

(Japan's Best)
Half-Height, DS/DD

\$99

Tandon
1 1/4" 100 J Full Height, DS/DD
Control Data
w/ 1/2" High, DS/DD

\$129

TEAC
1 1/4" 100 J Full Height, DS/DD

\$99

PANASONIC
1 1/4" 100 J Full Height, DS/DD

\$99

64K RAM \$16

Quantities of 1-49 sets \$16 per set.

Set of 9 chips, 200 or 150 Nanoseconds

Quantities of 50-149 sets \$14 per set.

Quantities of 150 sets or more \$12 per set.

256K RAM \$69

Set of 9 chips

HARDWARE

Persyst Time Spectrum
w/OK—\$189 w/384K—\$285

AST SixPak Plus w/384K.....\$329
AST SixPak w/64K.....\$249
Hercules Color Card.....\$175
Hercules Graphics Card w/Parallel.....\$349
Paradise Modular Graphics Card.....\$295
Paradise Module A Parallel Port.....\$ 69
Paradise Module B64-256K/Clock.....\$209

Persyst Monochrome Card w/Parallel.....\$175
PGS UX-12.....\$179
PGS MAX-12.....\$179
Epson.....CALL
Juki G100.....\$399
OKidata 92/93/84.....\$369/\$569/\$719
TI 855.....\$719
Hayes Smartmodem 1200.....\$349
Hayes Smartmodem 1200B.....\$369
Keytronic 5151 Keyboard.....\$189

Framework or dBase III—\$349

Copy II PC.....\$24
Copywrite.....CALL
Disk Explorer.....CALL
Zero Disk.....CALL
Prokey 3.0.....\$79
Sideways.....\$39
Thinktank.....\$119

SOFTWARE

BORLAND™
INTERNATIONAL

Superkey

Turbo Toolbox

Sidekick

Non-Copy Protected Sidekick

Turbo Tutor

Turbo Pascal 2.0 or 3.0

Borland Gift Pack

Turbo Pascal w/8087 2.0 or 3.0 Borland Gift Pack w/8087

CALL FOR PRICES!

(Our prices are so low, they made us
take them out of the ad.)

Norton Utilities— Version 3.0, Dec. '84 Release —\$59

Wordstar 2000.....\$269
Wordstar 2000+.....\$319
Crosstalk XVI.....\$119
Multimate.....\$269
Lotus 1-2-3.....\$309
Lotus Symphony.....\$429

Terms: Due to our low prices and assurance that all our hardware is new, unused product, all sales are final. Call technical support for return authorization number on all monetary returns. Any unauthorized returns subject to a 10% restocking fee. Prepaid checks, money orders, VISA, MasterCard, American Express, or approved company purchase orders are accepted. No surcharge for VISA or MasterCard. 3% surcharge for American Express.

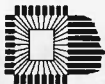

PC'S LIMITED



OUTSIDE TEXAS, ORDERS ONLY, CALL 1-800-IBM-5150

7801 N. Lamar, #E-200, Austin, Texas 78752

All calls for technical support and inside Texas,

call (512) 452-0323.

Telex No. 9103808386 PC LTD

Ad number 405



SUNTRONICS CO., INC.

12621 Crenshaw Blvd., Hawthorne, CA 90250

1-800-421-5775 (Order Only)
 (213) 644-1140 (CA Order & Info.)
 STORE HOURS
 Mon.-Fri. 9 a.m. to 6 p.m.
 Sat. 10 a.m. to 5 p.m.

TERMS: VISA, MASTERCARD, C.O.D. (Cash or Certified Check Required) Check (Allow 2-3 Weeks for Clearing)
 Shipping & H.C \$3.00 for 3 Lbs. plus \$0c for each add'l lb.
 Calif. residents add Calif. Sales Tax \$10.00 Minimum Order.
 IBM and Apple are registered trade marks of IBM & Apple.



XT Compatible Products

CPU Board (w/128K)	\$350.00
Computer Cabinet	\$69.00
83 Key Full-Function Keyboard	\$85.00
Monochrome Graphic Card (w/parallel printer port)	\$190.00
130 Watt Power Supply	\$125.00
135 Watt Power Supply	\$129.00
150 Watt Power Supply	\$135.00
Color Graphic Card	\$139.00
FDD Controller Card	\$85.00
Parallel Printer Card	\$59.00
ASYNC & RS232 Card	\$75.00
360KB DSDD (Slimline) Disk Drive	\$109.00
IBM Parallel Cable	\$19.00
IBM Prototype Board	\$9.00
Apparat EPROM Blaster	\$129.00
MicroLog Z-80B Baby Blue II Co-Processor, Multi-Function (Run CP/M Software, Require 64K RAM)	\$499.00
IBM Up-Grade Kit (4164-150NS)	14.50 per kit
10MB Hard Disk (w/Controller)	\$675.00
IBM PC Mouse	\$147.00
Quad Board II	\$249.00
Quad 512 (w/64K RAM)	\$259.00
Koala Graphics Table (w/Software)	\$105.00
Keyboard Extension Cable	\$9.00
Multi-Function (381K w 64K RAM 1 Serial & Parallel) Clock Calendar	\$179.00



Apple Compatible Products

Sun Z80 Card (w/o Software APPLE II & II+ only)	\$49.00
Sun 80 Column Card (w/Soft Switch)	\$85.00
Power Supply (5 Amp)	\$59.95
Cooling Fan	\$42.00
Floppy Disk Controller	\$42.00
16K RAM Card	\$49.00
128K RAM Card	\$159.00
Parallel Printer Card	\$49.00
Serial Printer Card	\$89.00
RS232 Card for Modem	\$99.00
EPROM Programmer (2716, 32, 64)	\$75.00
Apple Disk Drive (Full height)	\$159.00
Apparat EPROM Blaster	\$119.00
Grappier	\$75.00

SPECIAL SALE ITEMS

S-100 Single Board Computer (Z80A)	Kit \$99.00 B/B \$49.00
S-100 Universal Floppy Disk Controller	Kit \$125.00 B/B \$49.00
S-100 Clock Calendar Kit	\$89.00 B/B \$42.00
S-100 64K Static Memory Board (w/o RAM)	Kit \$89.00 B/B \$49.00
S-100 Prototype Board (Sun-721)	\$9.95
12" Amber TTL Hi-Res Monitor (20mHz)	\$135.00
12" Green TTL Hi-Res Monitor (20mHz)	\$129.00
12" Green Composite Hi-Res Monitor (22mHz)	\$99.00
SKC DS/DD 5 1/4" Diskette	\$14.95 per 10



IBM PC, 256 K, One Half Height 320 K Disk Drive DS/DD, Persyst Color Card, Taxan Green Monitor, DOS 2.1 PLUS a 10MB Hard Disk Sub System all for:

\$2690.00

IBM PC, 256 K, Two Half Height Drives DS/DD, Persyst Color Card, Taxan Green Monitor, DOS 2.1, 130 Watt Power Supply PLUS a 10MB Hard Disk Sub System all for:

\$2980.00

IBM PC, 256 K, Two Half Height Drives DS/DD, Persyst Color Card, Taxan Green Monitor, DOS 2.1, 130 Watt Power Supply, 10MB Hard Disk Sub System, PLUS 10MB Tape Back Up System all for:

\$3579.00

IBM PC, 256 K, Two Half Height Drives DS/DD, Persyst Color Card, Taxan Green Monitor, DOS 2.1, 130 Watt Power Supply, 20MB Hard Disk Sub System all for:

\$3380.00

IBM PC, 256 K, Two Half Height Drives DS/DD, Persyst Color Card, Taxan Green Monitor, DOS 2.1, 130 Watt Power Supply, 20MB Hard Disk Sub System PLUS 10MB Tape Back Up System all for:

\$3979.00

(We configure and test the system for you at no extra cost.)

SOMEBODY Has To Have The Lowest Prices!

MONITORS

AMDEK 300	\$135.00
PGS HX-12	\$475.00
PGS MAX-12	\$190.00
PGS SR-12	\$625.00
TAXAN GREEN COMPOSITE	\$125.00
TAXAN AMBER COMPOSITE	\$135.00
TAXAN GREEN W/TTL PLUS	\$149.00
TAXAN AMBER W/TTL PLUS	\$159.00
IBM MONOCHROME DISPLAY	\$260.00
IBM COLOR DISPLAY	\$590.00

PRINTERS

EPSON FX 80	\$425.00
EPSON FX 100	\$625.00
EPSON RX 80	\$245.00
EPSON RX 80FT	\$295.00
OKIDATA 82A	\$299.00
OKIDATA 83A	\$569.00
OKIDATA 92P	\$399.00
OKIDATA 93P	\$625.00
OKIDATA 84P	\$759.00
OKIDATA 2410P	\$1959.00
TOSHIBA P1351	\$1295.00
NEC SPINWRITER 3550	\$1595.00
NEC PINWRITER 80 COL	\$699.00
NEC PINWRITER 136 COL	\$899.00
BROTHER HR-25	\$699.00
BROTHER HR-35	\$925.00
(Accessories on NEC & OKIDATA printers available)	

DRIVES

TANDON TM-100-2	\$179.00
SLIMLINE - TOSHIBA	\$155.00
SLIMLINE - TEAC 55B	\$155.00

MULTIFUNCTION BOARDS

AST I/O+1 SER & 1 PAR	\$179.00
AST SIX PACK 64K, 1 SER & 1 PAR	\$269.00
QUADBOARD 64K	\$269.00
IBM COLOR GRAPHIC ADAPTER	\$225.00

IBM MONO PRINTER ADAPTER	\$230.00
PERSYST COLOR ADAPTER	\$190.00
PERSYST MONO PRINTER ADAPTER	\$210.00
HERCULES GRAPHIC ADAPTER	\$349.00
HERCULES COLOR CARD	\$210.00
STB GRAPHIX PLUS II	\$375.00

MODEMS

HAYES SMART MODEM 1200	\$469.00
HAYES SMART MODEM 300	\$209.00
HAYES 1200B PLUG IN CARD	\$429.00
QUBIE PC 212A/1200 INT	\$275.00
QUBIE PC 212E/1200 EXT	\$299.00

HARD DISKS

10MB SUB SYSTEM INT	\$850.00
10MB SUB SYSTEM EXT	\$1025.00
10MB TAPE BACK UP	\$599.00

GENERAL

CONTROL DATA DISKETTES	\$25.00/box
KEYTRONIC KB5151	\$189.00
PARALLEL CABLES	\$25.00
64K RAM UPGRADE KIT	\$50.00
128K RAM UPGRADE KIT (For AT)	\$199.00
IBM PC POWER SUPPLY (Original)	63.5 Watts \$89.00
IBM KEYBOARD FOR PC (Original)	\$109.00



(714) 838-7530

2640 Walnut Avenue, Unit K,
 Tustin, California 92680

(Prices & availability subject to change without notice—
 IBM is a registered trademark of IBM Corporation.)



Now, the lowest prices ever on

3M Scotch[®] DISKETTES

LIFETIME WARRANTY!

\$149^{ea.} 5 1/4" SSDD Qty. 50 **\$199**^{ea.} 5 1/4" DSDD Qty. 50

5 1/4" SSDD-96TPI → \$2.29 ea. 5 1/4" DSDD-96TPI → \$2.85 ea.
SOFT SECTOR ONLY! MINIMUM ORDER: 20 DISKETTES
ADD 3% FOR ORDERS UNDER \$50! **FREE!** FLIP 'N FILE 15 w/10 DISKETTES. (Eff. Thru 5/30/85)

These are factory-fresh 3M diskettes packed in boxes of 10 with Tyvek sleeves, reinforced hubs, identification labels and write-protect tabs.

3.5" MICRO-DISKETTES—SS-135 TPI → \$2.89 ea.

LIFETIME WARRANTY ON ALL 3M SCOTCH DISKETTES!

HOURS: 8AM-5PM Central Time, Monday-Friday

WE WILL BEAT ANY NATIONALLY ADVERTISED PRICE ON THE SAME PRODUCTS AND QUANTITIES!

DISK WORLD!, Inc.

Suite 4806 • 30 East Huron Street • Chicago, Illinois 60611

DISK WORLD!

Authorized Distributor
Information Processing
Products



FANTASTIC LOW PRICES ON



BASF QUALIMETRIC DISKETTES!



LIFETIME WARRANTY!

\$129^{ea.} 5 1/4" SSDD Qty. 20 **\$149**^{ea.} 5 1/4" DSDD Qty. 20

5 1/4" SSDD-96TPI → \$1.46 ea. 5 1/4" DSDD-96TPI → \$1.75 ea.

PACKED IN CARDBOARD CASES!

BASF QUALIMETRIC DISKETTES have a LIFETIME WARRANTY with Tyvek sleeves, reinforced hubs, user identification labels and write-protect tabs.

SOFT SECTOR ONLY! MINIMUM ORDER: 20 DISKETTES

BASF 3.5" MICRO-FLOPPIES BASF 5 1/4" HIGH DENSITY FOR IBM PC-AT

SSDD-135 TPI → \$2.50 ea. DSDD-HD → \$4.91 ea.

FOR ORDERS ONLY: INFORMATION & INQUIRIES:

1-800-621-6827 **1-312-944-2788**

(In Illinois: 1-312-944-2788) HOURS: 8AM-5PM Central Time, Monday-Friday

WE WILL BEAT ANY NATIONALLY ADVERTISED PRICE ON THE SAME PRODUCTS AND QUANTITIES!

DISK WORLD!

Authorized Reseller
Information Processing
Media



Incredible value!

Nashua Diskettes

LIFETIME WARRANTY!

\$105^{ea.} 5 1/4" SSDD Qty. 50 **\$115**^{ea.} 5 1/4" DSDD Qty. 50

These are poly-bagged diskettes packaged with Tyvek sleeves, reinforced hubs, user identification labels and write-protect tabs. NASHUA Corporation is a half-billion dollar corporation and a recognized leader in magnetic media.

SOFT SECTOR ONLY! Sold in multiples of 50 only!

FOR ORDERS ONLY: INFORMATION & INQUIRIES:

1-800-621-6827 **1-312-944-2788**

(In Illinois: 1-312-944-2788) HOURS: 8AM-5PM Central Time, Monday-Friday

WE WILL BEAT ANY NATIONALLY ADVERTISED PRICE ON THE SAME PRODUCTS AND QUANTITIES!

DISK WORLD!, Inc.

Suite 4806 • 30 East Huron Street • Chicago, Illinois 60611

DISK WORLD!

Authorized Distributor
NASHUA
MAGNETIC
MEDIA

BETTER MODEMS AT LOWER PRICES!

...and get 24-hour shipping on your DISK WORLD! orders

1200/300 Baud Avatex Modem 300 Baud Avatex Modem

\$189.95 ea. **\$59.95** ea.

Avatex Modems have everything. They're inexpensive, Hayes-compatible, Auto Dial, Auto Answer and high quality (backed by a one-year warranty).

Best of all, our combination includes a One-Year FREE subscription to MCI MAIL and special communications software for placing TOLL-FREE orders with DISK WORLD!

Orders received via MCI MAIL are shipped within 24-hours (subject to product availability).

(Cables are not included.)

FOR ORDERS ONLY: INFORMATION & INQUIRIES:

1-800-621-6827 **1-312-944-2788**

(In Illinois: 1-312-944-2788) HOURS: 8AM-5PM Central Time, Monday-Friday

WE WILL BEAT ANY NATIONALLY ADVERTISED PRICE ON THE SAME PRODUCTS AND QUANTITIES!

DISK WORLD!, Inc.

Suite 4806 • 30 East Huron Street • Chicago, Illinois 60611

DISK WORLD!

Authorized Distributor

AVATEX
MODEMS

DISK WORLD! Ordering & Shipping Instructions

Shipping: 5 1/4" & 3.5" DISKETTES—Add \$3.00 per each 100 or fewer diskettes. Other Items: Add shipping charges as shown in addition to other shipping charges. Payment: VISA and MASTER-CARD accepted. COD Orders: Add additional \$3.00 Special Handling charge. APO, FPO, AK, HI & PR Orders: Include shipping charges as shown and additional 5% of total order amount to cover PAL and insurance. Taxes: Illinois residents only, add 8% sales tax.

Prices subject to change without notice.

This ad supercedes all other ads.

Not responsible for typographical errors.

MINIMUM TOTAL ORDER: \$35.00

FOR ORDERS ONLY: INFORMATION & INQUIRIES:

1-800-621-6827 **1-312-944-2788**

(In Illinois: 1-312-944-2788) HOURS: 8AM-5PM Central Time, Monday-Friday

WE WILL BEAT ANY NATIONALLY ADVERTISED PRICE ON THE SAME PRODUCTS AND QUANTITIES!

DISK WORLD!, Inc.

Suite 4806 • 30 East Huron Street • Chicago, Illinois 60611

DISK WORLD!

ATHANA DISKETTES

The great unknown!

99¢^{ea.} 5 1/4" SSDD Qty. 50 **\$109**^{ea.} 5 1/4" DSDD Qty. 50

You've used these diskettes hundreds of times...as copy-protected originals on some of the most popular software packages. They're packed in poly-bags of 25 with Tyvek sleeves, reinforced hubs, user identification labels and write-protect tabs.

LIFETIME WARRANTY!

SOFT SECTOR ONLY! Sold in multiples of 50 only.

FOR ORDERS ONLY: INFORMATION & INQUIRIES:

1-800-621-6827 **1-312-944-2788**

(In Illinois: 1-312-944-2788) HOURS: 8AM-5PM Central Time, Monday-Friday

WE WILL BEAT ANY NATIONALLY ADVERTISED PRICE ON THE SAME PRODUCTS AND QUANTITIES!

DISK WORLD!, Inc.

Suite 4806 • 30 East Huron Street • Chicago, Illinois 60611

DISK WORLD!

Authorized Distributor
ATHANA
MAGNETIC
MEDIA

DISKETTE STORAGE CASES

AMARAY MEDIA-MATE 50: A REVOLUTION IN DISKETTE STORAGE



Every once in a while, someone takes the simple and makes it elegant! This unit holds 50 5 1/4" diskettes, has grooves for easy stacking, inside nipples to keep diskettes from slipping and several other features. We like it!

\$10.95 ea. Shpng. + \$2.00

DISKETTE 70 STORAGE: STILL A GREAT BUY.

Dust-free storage for 70 5 1/4" diskettes. Six dividers included. An excellent value.

\$11.95 Shpng. + \$3.00



DISK CADDIES **\$1.65** ea.

The original flip-up holder for 10 5 1/4" diskettes. Beige or grey only.

FOR ORDERS ONLY: INFORMATION & INQUIRIES:

1-800-621-6827 **1-312-944-2788**

(In Illinois: 1-312-944-2788) HOURS: 8AM-5PM Central Time, Monday-Friday

WE WILL BEAT ANY NATIONALLY ADVERTISED PRICE ON THE SAME PRODUCTS AND QUANTITIES!

DISK WORLD!, Inc.

Suite 4806 • 30 East Huron Street • Chicago, Illinois 60611

DISK WORLD!

The value leader in
Computer supplies
And accessories.

PRINTER RIBBONS:

at extraordinary prices!

Brand new ribbons, manufactured to Original Equipment Manufacturer's specifications, in housings. (Not re-linked or pools only.)

LIFETIME WARRANTY!

Epson MX-70/80 ... **\$3.58** ea. + 25¢ Shpng.

Epson MX-100 ... **\$4.95** ea. + 25¢ Shpng.

Okidata Micro83 ... **\$1.48** ea. + 25¢ Shpng.

Okidata Micro84 ... **\$3.66** ea. + 25¢ Shpng.

FOR ORDERS ONLY: INFORMATION & INQUIRIES:

1-800-621-6827 **1-312-944-2788**

(In Illinois: 1-312-944-2788) HOURS: 8AM-5PM Central Time, Monday-Friday

WE WILL BEAT ANY NATIONALLY ADVERTISED PRICE ON THE SAME PRODUCTS AND QUANTITIES!

DISK WORLD!, Inc.

Suite 4806 • 30 East Huron Street • Chicago, Illinois 60611

DISK WORLD!

Nail down great prices on MEMOREX diskettes!

LIFETIME WARRANTY!

\$128^{ea.} 5 1/4" SSDD Qty. 20 **\$170**^{ea.} 5 1/4" DSDD Qty. 20

MEMOREX DISKETTES come with heavy, lintless paper sleeves, reinforced hubs, write-protect tabs and user ID labels.

3.5" MICRO-FLOPPIES SOFT SECTOR ONLY! 5 1/4" DSDD-HD FOR IBM PC-AT

SSDD-135TPI MINIMUM ORDER: 20 DISKETTES \$3.89 ea.

INFORMATION & INQUIRIES:

1-312-944-2788

HOURS: 8AM-5PM Central Time, Monday-Friday

WE WILL BEAT ANY NATIONALLY ADVERTISED PRICE ON THE SAME PRODUCTS AND QUANTITIES!

DISK WORLD!, Inc.

Suite 4806 • 30 East Huron Street • Chicago, Illinois 60611

DISK WORLD!

THE CLASSIC

BYTE T-SHIRT

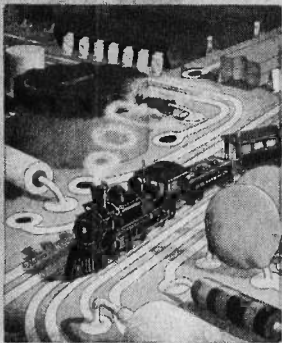

“COMPUTER ENGINEERING” – July 1977 Byte Cover

One of the truly classic Byte covers —and boy, does it look great on a T-shirt! The vivid colors really jump out. But don't mistake this for one of those rubbery patches that crack and peel off after a few washings. This is true four-color process: the inks are silk-screened into the fabric of the shirt, resulting in a beautiful, full-color image that lasts.

You'll also appreciate the shirt itself: a real heavyweight made of 50% cotton, 50% polyester. You'll enjoy cotton comfort in a tough shirt that keeps its crisp, fresh look through many washings—with almost no shrinking! The price for each Byte Classic T-Shirt is only \$9.50 (\$8.50 each for 3 or more). Your order will be shipped within a week.

Please send me the following T-shirt(s) at \$9.50 each, or \$8.50 each for 3 or more. I have included \$2.00 for shipping and handling.

Qty.	Size	Amount
_____	Adult—Extra Large	\$ _____
_____	Adult—Large	\$ _____
_____	Adult—Medium	\$ _____
_____	Adult—Small	\$ _____
_____	Child—(sizes 10-12)	\$ _____
	Shipping and Handling	\$2.00
	(Overseas add \$3.00)	\$ _____
TOTAL		\$ _____

I have enclosed check or money order.
 VISA MasterCard Send Dealer Info.
 Card #: _____
 Exp. Date: _____
Ship my T-Shirt(s) to:
 Name: _____
 (Business): _____
 Address: _____
 City: _____
 State: _____ Zip: _____

Mail this coupon to:

Robert Tinney Graphics
 1864 North Pamela Dr.
 Baton Rouge, Louisiana
 70815

For VISA or MasterCard Orders
 or for more information
Call 1-504-272-7266

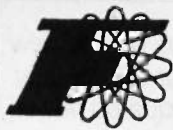

FORTRON CORPORATION

3797 YALE WAY, FREMONT, CA 94538

Power Supply Professional
INFORMATION & CALIF. RES. [415] 490-8171

ORDER TOLL FREE: [800] 821-9771

FC 135-40 Features:

Quality That You Can Trust

140 W.(max) Power Switcher

#FC 135-40



- Full Replacement to your regular IBM® PC 65 W. Power Supply
- 4 Disk Drives Connectors
- Built-in High Air Flow High Quality Cooling Fan
- (UL) File #E82453
- Schematics included
- One year Warranty
- +5V/15A, +12V/4.2-8.5A (peak)
-12V/1A, -5V/1A. (max. outputs)
- 110-230 VAC Convertible

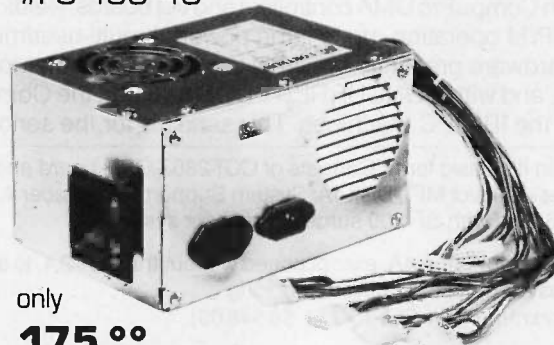

only

175.00

[Assembled & Fully Tested in USA]

IDEAL FOR:

- Upgrade IBM® PC
- OEM Manufacturer
- Do it yourself an IBM® PCXT Compatible

Please do not confuse this high quality product with the cheap imported units sold by others because of same outlook.

Dealers/OEMs are Invited

For "Build Your Own Computer" and OEM's Convenience, we also carry:

FC 427 Keyboard

- For IBM® PC or its compatible products
- 20 Million Time Life Cycle
- Light on Num and Caps Lock Keys

109.00



FC 630A-2 Cabinet

- IBM identical
- Use FORTRON FC 135-40 power supply
- 7 & 8 slots rear panels, good for 0.75" or 1" apart slot connectors.

99.00



HSC 130-40 130 Watt Switching Power Supply

- Good For Faraday, DTC Mega-board, Colby Computer and Other Compatible Level CPU boards
- Backside On-Off Switch
- Use Cabinet FC-630
- 110-230 VAC Convertible

169.00



FC-330 Hard Disk Controller

- Up to 2 Hard Disk Drives
- Fully Buffered I/O Bus
- Built-in ECC
- Accepts 5 to 20 MB Hard Disk

239.00



FC-630 Cabinet

- On-off switch to be on back side
- Use FORTRON HSC-130-40 power supply
- Good for Faraday and other compatible level CPU boards.

99.00

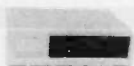

Monochrome/Graphic/Printer Card CT-6040

- 80 x 25 Text Mode (Default)
- 720 x 348 Graphic Mode
- Can Run Lotus 1-2-3
- 64K Graphic Display Memory
- 18 KHz Monitor and Printer Interface

229.00



NEW

Color/Graphic/Printer Card CT-6020

- RGB Color Port and Parallel Port For Printer
- Light Pen Interface
- Graphic Mode:
320 Dots x 200 Lines Color
640 Dots x 200 Lines B/W
- Text Mode:
40 Columns x 25 Rows Color / B/W
80 Columns x 25 Rows Color / B/W

199.00



FC-730 Multifunction Card, Expandable to 384K

- From 64 to 384K
- 1 RS-232C, 1 Centronics Printer Ports

199.00
(64K on Card)



FC-830 512K RAM Card

- From 64K to 512K
- Boundary and Total Memory

169.00
(64K on Board)



FC-930 RS232C/Parallel Printer Port Card

Fully IBM Compatible
99.00



FC-940 RS232C/Clock Calendar Card

- One RS-232C Port, One Clock Calendar, Battery Back-up

99.00



64K DRAM
19.00/9 pcs.
2764 EPROM
4.95/pcs.

8237A-5
8284A
8284C
MC1489
74LS245

6.50
2.90
1.50
0.29
0.65

Check with us for PC/AT Power Supply

SALES TERMS

1. Shipping & Handling charge \$6.00 minimum. Check with us for actual charges
2. CA add 6.5% tax
3. Restocking charge 15%
4. RMA # is required for all return merchandise
5. Prices subject to change without notice

CCT-4 SYSTEM SERIES

The latest CCT implementation of the new generation Intel 16-Bit Processor technology. This means extreme speed, unequalled power, and the ultimate in reliability, and of course, the innovators at CCT behind it.

This series in the CCT line exploits the speed and power of the Intel 80286 and Zilog Z-80H (8MHz), on the 286Z CPU board. This combination, along with CompuPro DMA controllers and I/O boards, yields a dramatic improvement in system throughput speeds, from basic CP/M operation, up to large powerful multi-user/multi-tasking machines. The CCT-4 represents the most advanced hardware presently available in a microcomputer to run the thousands of CP/M type software programs on the market, and with CONCURRENT DOS 8-16 and the CompuPro PC Graphics board (when available), all software written for the IBM PC machines. This series is for the serious business/scientific user.

CCT-4A State-of-the-art power in it's basic form. Consists of CCT-286Z CPU board and CCT-M256 (256K), along with CompuPro: Enclosure 2 Desk (21 slot MF), Disk 1A, System Support 1, Interfacer 4, the CCT-2.4 floppy drive system, and CP/M 80 and CP/M 86, and with SF-200 surge suppressor system. **\$5,599.00**

CCT-4B Single-user/hard disk power. As the 4A, except priced without the CCT-2.4, to add in your choice of CCT hard/floppy combination drive subsystem, at the published pricing. **\$4,499.00**
 (Example: CCT-4B Mainframe with CCT-10/1 = \$6,548.00) Plus cost of selected drive subsystem

CCT-4C Multi-user/hard disk power. As the 4B, with the CCT-M512 (512K static RAM board) instead of M256; Interfacer 3 instead of Interfacer 4; SF-400 instead of SF-200, plus Concur. DOS 8-16 O.S. (6 user system) **\$6,199.00**
 (Example: CCT-4C Mainframe with CCT-40/1 = \$9,248.00) Plus cost of selected drive subsystem

NEW RAM BOARD

Limited Time Offer - FREE Supercalc 86 with any CCT-4

The above systems include all necessary cabling, assembly, testing, minimum 20 hour burn-in, and the CCT unconditional 12 month direct warranty.

CCT-M512 CCT introduces it's 512K static RAM board. IEEE Standard 12MHz. 512K in one slot! **Introductory Price: \$1,899**
CCT-M256 256K version of M512 upgradeable to full 512K. Perfect 256K RAM board for any CompuPro system \$ **979**

CUSTOM COMPUTER TECHNOLOGY / BOX 4160 / SEDONA, ARIZONA 86340
TOLL FREE ORDERING: 800-222-8686 / For technical support / service: 602-282-6299

WAVE MATE BRINGS MUSCLE TO YOUR IBM PC/XT WITH IT'S 80286 MOTHERBOARD

BULLET-286 makes the XT perform with greater power and speed than the IBM PC/AT

It's the new **BULLET-286** motherboard for the IBM PC/XT marketplace. This advanced-technology product utilizes the Intel microprocessor 80286 while maintaining both hardware and software compatibility with the IBM PC/XT. By simply replacing the existing XT board with our new **BULLET-286**, you get greater power and speed than the IBM PC-AT. Thus, existing PC/XT users can preserve their investment in hardware and software while moving a quantum leap beyond PC-AT performance.

The **BULLET-286** contains a 6 megahertz no wait state 80286 microprocessor in place of the XT's 4.77 MHz 8088. There is an 80287 math co-processor option, 8 IBM expansion slots, and enhanced ROM BIOS. The **BULLET-286** is equipped with 256K bytes of

memory, expandable to 1 megabyte on-board.

The **BULLET-286** is compatible with the IBM PC/XT to a degree far beyond the IBM PC-AT product. Application programs and operating systems (PC-DOS, CP/M, UCSD Pascal, Pick, Oasis, Unix-derivatives) available for the XT, can run without incompatibilities on the **BULLET-286**.

You can order now. The **BULLET-286** is available with 256K RAM, with options to 1 full megabyte. Prices start at \$1,995.

Quantity discounts available. OEM and dealer inquiries welcome.

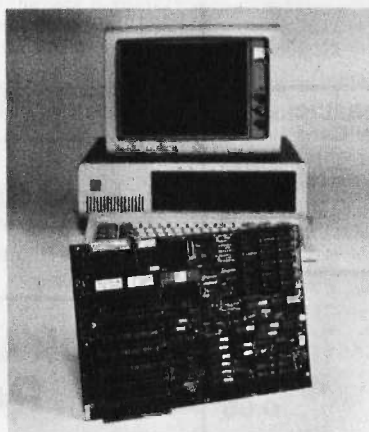

APOLLO MARKETING

(a division of Cal. Digital)
 22048 Sherman Way #316
 Canoga Park, CA 91303
 Tel: (818) 883-8390 Telex: 194369
 In Europe call: Brussels 649-1070
 Telex 61828

**TOLL-FREE
ORDERING:
800-222-8686**

CCT[®] CUSTOM COMPUTER TECHNOLOGY

**FOR TECHNICAL SUPPORT/
SERVICE / IN ARIZONA:
602-282-6299**

1 CCT PLAZA — P.O. BOX 4160 — SEDONA, ARIZONA 86340

Purchase your Hardware and Software directly from an OEM / Systems Integrator. Take advantage of our buying power! We stock a full line of Board Level Components, Software and Peripherals. Call for your needs. We'll give you the Lowest Prices, and the Technical Support and Know-How we are quickly becoming well-known for. Satisfied Customers Nationwide. The Nation's Custom Systems House for Business, Education and Science. Call for a system quote. CCT implements tomorrow's technology today!

• FOREMOST QUALITY • ADVANCED SUPPORT • REASONABLE COST •

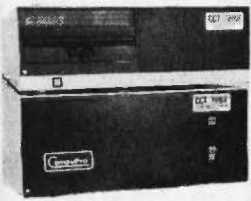

80286 NOW!

□ **CCT-286Z** is our model designation for the **MI-286** dual processor board from **Macrotech**. It features the super high speed combination of Z-80H and 80286, with provision for the 80287 math chip. Directly replaces 8085/88 and 8086 CPUs running CP/M, MP/M Concurrent DOS, and MS-DOS, at throughput increases of 3X to 5X!

SPECIAL PRICE - \$995
80287 Option - Installed - \$395

**SEE THE CCT-4 SERIES
USING THIS BOARD
DETAILED ON THE FACING PAGE**

NEW—TRUE IBM PC INTERFACE ULTRA HI-RES GRAPHICS!

CCT S-100/PC is a break-through for the Science/Business user. Mini-enclosure accepts PC & compatible boards and directly connects to your S-100 system, running PC-DOS or Concurrent DOS. Hercules™ Graphics System—Coming this May!

!! THE BEST OF BOTH WORLDS !!

LIBERTY TERMINALS • Superior Reliability •

110-14" GREEN-80/132 Column . . . \$499
110-14" AMBER . . . \$519
200-14" GREEN-80/132 Super Deluxe \$569
200-14" AMBER . . . \$589

OKIDATA PRINTERS - Top Quality

82 - 80 Col. . . \$329 **83 - 132 Col. . . \$619**
92 - 80 Col. . . \$429 **93 - 132 Col. . . \$659**
84 - 132 Col/200cps—Top of the Line . . \$799
For Serial Interfaces — Add . . . \$100

TOSHIBA P351 - 288 CPS/24 PIN - \$1499

DIABLO — Letter Quality Series
Model 620 . . \$969 **Model 630 . . \$1799**

WE HAVE ALL SOFTWARE—CALL

\$ PRICE REDUCTION \$ INDUSTRIAL GRADE SUPERIOR QUALITY **CCT DISK DRIVE SYSTEMS** ROLLS ROYCES OF THE INDUSTRY S-100 HARD DISK SUBSYSTEMS

Professionally engineered ST-506 type systems for the business market S-100 Computer user. Includes industry top quality drives, CompuPro Disk 3 DMA controller, all cabling, A&T, formatted, burned-in. Provisions for up to two hard disks in each system. We include operating system update. CP/M 80, CP/M 86, CP/M 8-16, MP/M 8-16, CP/M 68K. (1/1 Systems are CCT innovated hard/floppy combinations, with Mitsubishi DSDD 8" drive.) 12 month warranty.

CCT-10 (11 + MEG)	\$1499	CCT-10/1	\$2049
CCT-20 (22 + MEG)	\$2019	CCT-20/1	\$2569
CCT-40 (36 + MEG)	\$2499	CCT-40/1	\$3049
CCT-60 (58 + MEG) (New)	\$3699	CCT-60/1	\$4249
CCT-90 (87 + MEG) (New)	\$4909	CCT-90/1	\$5459
CCT-125 (123 + MEG) (New)	\$6099	CCT-125/1	\$6649

NEW 10 MEG REMOVABLE CARTRIDGE DRIVE SYSTEM for hard disk back-up — DMA using Disk 3 controller. Super fast/Ultra reliable — Available April

FLOPPY SYSTEMS

CCT-2.4 • Dual 8" DSDD
Mitsubishi 2.4 Megabyte in Extra Heavy horizontal enclosure, removable filter air system, all cabling, A&T, Burned in. The fastest system available: **\$1229**

CCT-5 • 5 1/4" DSDD
IBM Compatible Tandon 320K. Extra Heavy Cabinet accommodates two drives, hard or floppy. All cabling, A&T, Burned-in. Perfect for our PC-DOS Package **\$399**

CCT-8/5 • FULL IBM COMPATIBILITY
One Mitsubishi 8" DSDD (1.2 Meg)/One 5-1/4" DSDD (360K) IBM Drive
Both 3ms step rate — For Concurrent DOS and PC DOS **\$1029**

★ SUPER PRICES ★ COMPUPRO COMPONENTS ★ IN STOCK ★

CPU-Z - \$229 • Disk 1A - \$399 • Disk 1A w/CP/M - \$499 • CPU 8086/10 - \$349 • SPU-Z - ?
CPU 8085/88 - \$229 • CPU 8086 - \$559/10Mhz - \$599 • CPU 68K - \$519/10Mhz - \$639
PC Graphics - \$399 • Disk 3 - \$459 • RAM 22 (256K) - \$1179 • RAM 23/64K - \$309/128K - \$599

NEW — M-Drive/H - 512K - \$599 / 2 Meg - \$2099

Enclosure 2 Desk - \$649/Rack - \$699 • Interfacer 3 - \$499 • Interfacer 4 - \$349 • System Support 1 - \$329
Concurrent DOS 8-16 (CCTCMX) - \$309 • CP/M 80 (CCTHMX) - \$125 • CP/M 86 (CCTTMX) - \$175
CP/M 8-16 (CCTTMX) - \$199 • CP/M 68K (CCTCX) - \$279 • Operating System Updates/Remakes - \$30

16 Bit Upgrade Kit: CP/M 86, RAM 23, System Support 1, Cable \$759 □ CP/M 8-16 - Kit - \$783

CCT-1 — ENTRY LEVEL S-100 BUSINESS SYSTEM

- Enclosure 2-Desk-21 Slot Mainframe •
- CPU 8085/88 - 6Mhz 8085/8Mhz 8088 •
- Disk 1A - DMA Floppy Disk Controller •
- RAM 23 - 64K Static RAM - 12Mhz •
- Interfacer 4 - 3 Serial/2 Parallel I/O •
- CCT-2.4-Dual 8" Mitsubishi DSDD Drive System - 2.4 Megabytes •
- CP/M 80 - 2.2 HMX - CCT Modified •
- All Cabling, Complete CCT Assembly, Testing, and Minimum 20 Hour Burn-in •

**SPECIAL PRICE
\$3,375**

RUNS ALL STANDARD 8" CP/M SOFTWARE - INCLUDES OUR EXCLUSIVE 12 MONTH DIRECT WARRANTY

Prices & availability subject to change. All products new, and carry full manufacturer's warranties. Call for catalog. Free technical help to anyone. All products we sell are CCT individually tested and set up for your system - Plug-In & Go! Arizona residents add sales tax **CCT[®]** Trademark — Custom Computer Technology; **MS-DOS[®]** Trademark — Microsoft; **IBM[®]** Trademark — International Business Machines; **CompuPro[®]** Trademark — W.J. Godbout; **CP/M[®]** **MP/M[®]** Trademarks — Digital Research; **HERCULES[™]** Trademark — Hercules Computer Technology

LOOK NO FURTHER

WE'LL BEAT ANY PRICE IN THIS MAGAZINE OR ANY OTHER

64K RAM SET OF 9 \$1700	27128 \$780	41256-150 \$900	27256 \$4995	27C64 \$925
2764-200 \$400	2732-200 \$350	8087-3 \$17500	6264LP-15 \$1150	6116P-3 \$275

8000	8257P-5 270	LINEAR	CA3082 150	74490 230	74S570 270	4516 110	74HC00
8031AH 750	8259AC-2 270	LM312H 160			74S571 270		74HC85 125
8035 275	8274 750	LM318CN 145	7400	74S00		74LS00	74HC154 225
8039 300	8284A 295	LM319N 110	7443 58	74S124 250	CMOS	74LS145 105	74HC166 295
8085AP 340	8288 810	MCC1330 150	7444 62	74S132 115	4034 175	74LS147 220	74HC299 450
8086P 1015	8755 1200	MCC1349 170	7489 195	74S133 40	4035 76	74LS148 117	
8088 1000	8748 1100	MCC1350 105	7497 247	74S134 135	4094 270	74LS154 185	
8155 270	8749 1350	MCC1358 150	74100 158	74S135 135	4098 225	74LS166 170	74HCT00
8216 119		MCC1372 615	74142 285	74S251 85	4099 175	74LS181 190	74HCT85 135
8237A5 810	Z-80	CA3023 245	74143 445	74S253 85	4507 115	74LS189 800	74HCT154 270
8251A 270	Z80BCPU 405	CA3059 260	74144 265	74S280 175	4508 175	74LS348 225	74HCT166 270
8253C 270	Z80BCTC 475	CA3060 260	74390 130	74S287 170	4514 115	74LS364 170	74HCT299 475
8255A 270	Z80B-PIU 475	CA3081 150	74393 122	74S288 170	4515 160	74LS674 800	

INTERACTIVE COMPONENTS

4401 Atlantic Ave. #219 Long Beach, California 90807 • 213-423-6644 • TELEX 592022

CALL COLLECT!!!

\$100.00 Min. Order—U.S. Funds. California residents add 6½%. Shipping—5% plus \$1.50 Insurance. Visa, MC, M.O., Cashier Checks, Preapproved Company Checks. We reserve right to substitute manufacturers. We are not responsible for typographical errors.

HIGH REL ★ SWITCHING POWER SUPPLIES ★ LOW COST

ITEM	FOR	+5V	-5V	+12V	+12V	-12V	+24V	+8V	±16V	W x D x H in.	TERMINALS	PRICE
SW40W	TERM. & 2 ALPS DRIVES	2.5A	-	2/2.5A pk.	-	.3A	-	-	-	6.3 x 3.9 x 1.9	MOLEX 5051	\$ 54.95
SW70W	APPLE III*, IBM PC-I, II*	7A	.3A	2.5/3.5A pk.	-	.3A	-	-	-	9.6 x 4 x 2.4	MOLEX 126-P1	64.95
SW80W	PC WITH SOFT DRIVES	8A	.3A	3/4A pk.	-	.3A	-	-	-	7.4 x 4.5 x 2.3	MOLEX 2139	74.95
SW138	IBM PC-XT* P/S RPLCMNT.	15A	1.0A	4/6A pk.	-	1.0A	-	-	-	9.5 x 5.6 x 4.6	MOLEX, AMP.	129.95
SW150	PC WITH HARD DRIVES	12A	.3A	4/5A pk.	2.5A	.5A	-	-	-	10.4 x 5 x 2.5	TERM. BLOCK	139.95

SPECS. OF ABOVE SWITCHERS: 117/220 VAC SELECTABLE, INPUT 90-132 VAC/180-275 VAC, EFFIC. 75% TYPICAL, LINE REGUL. 0.3%, LOAD REGUL. 1% ON +5V, 5% ON OTHER VOLTAGES, 6.2 OVP SETTING ON +5V, OVERLOAD & SHORT CIRCUIT PROTECT, LOW OUTPUT RIPPLE & NOISE, 1% MAX, 50,000 HRS. MTBF RELIABILITY, UL, FCC & VDE SAFETY & NOISE STANDARDS.

S3	FOR S-100, 10 SLOTS	5A	1A	*	-	-	5/7A pk.	12A	3A	10 x 6 x 5	SOLDER POST	\$105.95
S4	FOR S-100, 6 SLOTS	4A	1A	*	-	-	4/5A pk.	8A	2.5A	8.4 x 5 x 4.8	SOLDER POST	89.95
R1	2 FLOPPY DRIVES	3A	.5A	*	-	-	3/4A pk.	-	-	8 x 4 x 3.4	SOLDER POST	44.95
R1A	APPLE II PC*	3A	.5A	3/4A pk.	-	.5A	-	-	-	8 x 4 x 3.4	SOLDER POST	46.95
C64	COMPATIBLE TO COMMODORE C64 (OR C+4)* POWER SUPPLY: +5V/1.7A, 9 VAC/1A & 117 VAC IN, POTTED, U/L & CSA.											19.95

*: +24V CAN BE CHANGED TO +12V BY FACTORY, PLEASE SPECIFY WHEN YOU ORDER.

THE ABOVE 5 LINEAR P/S ARE WITH 3% LOAD REGUL., OVP ON +5V, FUSED: INPUT & OUTPUTS.

OEM WELCOME

C64

UNINTERRUPTIBLE A.C. POWER SUPPLY: UPS-90W @ \$330.00 & UPS-200W @ \$475.00 EA.

SAVES YOU FROM LOSING DATA DURING A.C. POWER LINE FAILURES OR TRANSIENT OVER VOLTAGES CAUSED BY OFFICE EQUIPMENT, HOME APPLIANCES, LIGHTNING, ETC. SPECS: CUT-IN VOLTAGE, 102V; TRANSFER BACK TO LINE, 106V; BATTERY BACKUP IN 4 MS TYPICAL, OUTPUT VOLTAGE 102-132V STEPPED SINE WAVEFORM, BATTERY OPERATING PERIOD; 5 MIN. AT FULL LOAD & 15 MIN. AT HALF LOAD, EXTERNAL 12V BATTERY TERMINALS, ALARM ALERT, FULL PROTECTIONS ONE-YEAR WARRANTY. UPS-90W IDEAL FOR APPLE'S PC WITH MONITOR; UPS 200W IDEAL FOR IBM PC/XT/AT WITH MONITOR.

SHIPPING \$16.00 EA.
SIZE: 4H x 6W x 9L



UPS-90W

UPS-200W

SHIPPING:

FOR EA. POWER SUPPLY: \$6.00 IN CALIF.; \$8.00 IN OTHER STATES; \$18.00 IN CANADA. FOR EA. TRANSFORMER: \$6.00 IN ALL STATES; \$12.00 IN CANADA. CALIF. RESIDENTS ADD 6.5% SALES TAX.

MAILING ADDRESS:
P.O. BOX 4296
TORRANCE, CA 90510
TELEX: 182558



SUNNY INTERNATIONAL
IN BUSINESS SINCE 1975
(213) 328-2425, MON-FRI 8:30-5:30



SHIPPING ADDRESS:
22129 1/2 S. VERMONT AVE.
TORRANCE, CA 90502

Buy your PC products direct.

Buy direct from PROGRESSIVE MICRO DISTRIBUTORS and you'll discover that low prices together with a knowledgeable sales staff can make a surprising difference.

You'll be shocked by the lucrative prices PROGRESSIVE MICRO DISTRIBUTORS can offer on one of the largest selections of PC products anywhere. But you won't be surprised by our limitless supply of expert advice, support, service and information. After all, you expect these services from your computer supplier.

But did you expect same day insured shipping, complete product warranties (some up to 5 years), and no surcharge on most credit cards? All this combined with over 25,000 square feet of computerized warehouse space assures you prompt and efficient service.

Look Us Over and Compare.

Send for PROGRESSIVE MICRO DISTRIBUTORS Free catalog. You'll find that our catalog prices are discounted even lower than our advertised prices in national magazines. Once you start receiving our FREE catalog, you'll be entitled to free product literature and reviews by prominent industry sources at your request, as well as our monthly PRICE HOT LIST.

MAIL in your coupon **TODAY** to start receiving PROGRESSIVE MICRO DISTRIBUTORS monthly PRICE HOT LIST immediately. **ORDER TODAY** if you're ready to cash in on the savings right away. Call **TOLL FREE 1-800-446-7995** for a quote on any of the thousands of PC products you need.

PROGRESSIVE MICRO DISTRIBUTORS

BY5

- Please send me your FREE catalog.
- Please send your monthly PRICE HOT LIST.
- Please send me information on the following:

I am a new-user experienced-user
 business-user home-user

Name _____

Address _____

City _____ State _____ Zip _____

Please clip and mail to:

7000 Peachtree Industrial Boulevard, Norcross, GA 30071

PROGRESSIVE MICRO DISTRIBUTORS

BY5

- Please send me your FREE catalog.
- Please send your monthly PRICE HOT LIST.
- Please send me information on the following:

I am a new-user experienced-user
 business-user home-user

Name _____

Address _____

City _____ State _____ Zip _____

Please clip and mail to:

7000 Peachtree Industrial Boulevard, Norcross, GA 30071

ADVANCED COMPUTER PRODUCTS, INC.

64K
UPGRADE
\$24.95

SINCE 1976 **1985 CATALOG** \$5.00

AT RAM \$22.95
256K RAM 15.95
64K RAM SET 24.95

APPLE COMPATIBLE PERIPHERALS

- ALS CPN 3.0 PLUS CARD \$200.00
- CODEX 16K RAM CARD SALE 39.95
- CODEX PRINTER CARD W/CABLE 48.95
- CODEX 10 COL EXT 84K CARD 98.95
- IS PKASIO 10 (10) 138.95
- KENNINGTON SYSTEM SAVER 69.95
- KENNINGTON CP SAVER 49.95
- KRAFT JOYSTICK 39.95
- MOT SPEED DEMON 249.95
- MICROSOFT 2.00 SOFTCARD 247.95
- GRAPPLER LZR 99.95
- BUFFERED GRAPPLER \$189.95
- GRAPPLER SUPER SERIAL SALE \$118.95
- VIDEO 7 RGB I/O 189.95
- APPLE II DISK CONTROLLER 49.95
- APPLE IIe KEYBOARD 49.95
- APPLE IIe POWER SUPPLY 49.95
- APPROX I/O BEFO. CARD 49.95
- APPLE IIe COOLING FAN SYSTEM 49.95
- STREET ECHO II SPEECH SYSTEM 99.95
- TITAN ACCELERATOR II CARD 449.95
- WIZARD 80 COLUMN CARD SALE 99.95

FARADAY IBM PC'S

CPU board w/486 MS DOS Compatible
\$289.95

ROCKWELL AIM

8502 Single Board Computer
\$249.00

IBM PC HARDWARE

- AST 'COMBOPLUS' 64K \$199.00
- SIGMA 'MAXIMIZER' 64K 249.95
- SIGMA DISK CONTROLLER 169.95
- RAM DISK CONTROLLER 249.95
- 10 MB INTERNAL HARD DISK 685.00
- 10 MB EXTERNAL HARD DISK 685.00
- 15 MB INTERNAL HARD DISK 849.00
- 15 MB EXTERNAL HARD DISK 1049.00
- 80 WATT BOOSTER SUPPLY 149.95
- 130 WATT IBM SUPPLY 159.95
- PC COMPATIBLE KEYBOARD 129.00
- IBM PC CHASSIS 199.95
- QUADRONIC 'COLORPLUS' 399.95
- 10 MB INT. TAP STREAMER 1150.00
- PERMIST MONO CARD 199.00
- PARADISE MONO/CARD 409.95
- HERCULES MONO CARD 399.00

INTERSL STD-BUS BOARDS

- ISB3100 280 CPU 518T 569.95
- ISB3100 280 Univ. CPU 900 89.95
- ISB3110 8085 CPU 200 79.95
- ISB3218 10K CMOS RAM 610 99.95
- ISB3218 16K Static RAM 610 99.95
- ISB3220 16K CMOS RAM 750 119.95
- ISB3300 280 Pin I/O (main) 210 49.95
- ISB3321 Universal Bus 300 119.95
- ISB3340 Opto Plans Input 300 119.95
- ISB3400 Floppy Controller 215 79.95
- ISB3410 SASI (DMA) W/Int. 255 99.95
- ISB3500 Trac. 240 99.95
- ISB3510 Opto-In Input 270 116.95
- ISB3520 SPST Relay 150 69.95
- ISB3521 DPT Relay 150 99.95
- ISB3600 Arithmetic 375 149.95
- ISB3810 EPROM Programmer 260 79.95
- ISB3700 Syncl/Asyncl 245 69.95
- ISB3711 Univ. Syncl/Asyncl 315 99.95
- ISB3830 12 Bit AD 720 289.95

MONITORS

- AMDEK 3000 (GREEN) \$139.95
- AMDEK 300A (AMBER) 149.95
- AMDEK 310A (IBM AMBER) 189.95
- AMDEK 310A (IBM AMBER) 249.95
- AMDEK 310A (IBM AMBER) 289.95
- AMDEK 310A (IBM AMBER) 349.95
- AMDEK 310A (IBM AMBER) 389.95
- AMDEK 310A (IBM AMBER) 449.95
- AMDEK 310A (IBM AMBER) 489.95
- AMDEK 310A (IBM AMBER) 549.95
- AMDEK 310A (IBM AMBER) 589.95
- AMDEK 310A (IBM AMBER) 649.95
- AMDEK 310A (IBM AMBER) 689.95
- AMDEK 310A (IBM AMBER) 749.95
- AMDEK 310A (IBM AMBER) 789.95
- AMDEK 310A (IBM AMBER) 849.95
- AMDEK 310A (IBM AMBER) 889.95
- AMDEK 310A (IBM AMBER) 949.95
- AMDEK 310A (IBM AMBER) 989.95
- AMDEK 310A (IBM AMBER) 1049.95
- AMDEK 310A (IBM AMBER) 1089.95
- AMDEK 310A (IBM AMBER) 1149.95
- AMDEK 310A (IBM AMBER) 1189.95
- AMDEK 310A (IBM AMBER) 1249.95
- AMDEK 310A (IBM AMBER) 1289.95
- AMDEK 310A (IBM AMBER) 1349.95
- AMDEK 310A (IBM AMBER) 1389.95
- AMDEK 310A (IBM AMBER) 1449.95
- AMDEK 310A (IBM AMBER) 1489.95
- AMDEK 310A (IBM AMBER) 1549.95
- AMDEK 310A (IBM AMBER) 1589.95
- AMDEK 310A (IBM AMBER) 1649.95
- AMDEK 310A (IBM AMBER) 1689.95
- AMDEK 310A (IBM AMBER) 1749.95
- AMDEK 310A (IBM AMBER) 1789.95
- AMDEK 310A (IBM AMBER) 1849.95
- AMDEK 310A (IBM AMBER) 1889.95
- AMDEK 310A (IBM AMBER) 1949.95
- AMDEK 310A (IBM AMBER) 1989.95
- AMDEK 310A (IBM AMBER) 2049.95
- AMDEK 310A (IBM AMBER) 2089.95
- AMDEK 310A (IBM AMBER) 2149.95
- AMDEK 310A (IBM AMBER) 2189.95
- AMDEK 310A (IBM AMBER) 2249.95
- AMDEK 310A (IBM AMBER) 2289.95
- AMDEK 310A (IBM AMBER) 2349.95
- AMDEK 310A (IBM AMBER) 2389.95
- AMDEK 310A (IBM AMBER) 2449.95
- AMDEK 310A (IBM AMBER) 2489.95
- AMDEK 310A (IBM AMBER) 2549.95
- AMDEK 310A (IBM AMBER) 2589.95
- AMDEK 310A (IBM AMBER) 2649.95
- AMDEK 310A (IBM AMBER) 2689.95
- AMDEK 310A (IBM AMBER) 2749.95
- AMDEK 310A (IBM AMBER) 2789.95
- AMDEK 310A (IBM AMBER) 2849.95
- AMDEK 310A (IBM AMBER) 2889.95
- AMDEK 310A (IBM AMBER) 2949.95
- AMDEK 310A (IBM AMBER) 2989.95
- AMDEK 310A (IBM AMBER) 3049.95
- AMDEK 310A (IBM AMBER) 3089.95
- AMDEK 310A (IBM AMBER) 3149.95
- AMDEK 310A (IBM AMBER) 3189.95
- AMDEK 310A (IBM AMBER) 3249.95
- AMDEK 310A (IBM AMBER) 3289.95
- AMDEK 310A (IBM AMBER) 3349.95
- AMDEK 310A (IBM AMBER) 3389.95
- AMDEK 310A (IBM AMBER) 3449.95
- AMDEK 310A (IBM AMBER) 3489.95
- AMDEK 310A (IBM AMBER) 3549.95
- AMDEK 310A (IBM AMBER) 3589.95
- AMDEK 310A (IBM AMBER) 3649.95
- AMDEK 310A (IBM AMBER) 3689.95
- AMDEK 310A (IBM AMBER) 3749.95
- AMDEK 310A (IBM AMBER) 3789.95
- AMDEK 310A (IBM AMBER) 3849.95
- AMDEK 310A (IBM AMBER) 3889.95
- AMDEK 310A (IBM AMBER) 3949.95
- AMDEK 310A (IBM AMBER) 3989.95
- AMDEK 310A (IBM AMBER) 4049.95
- AMDEK 310A (IBM AMBER) 4089.95
- AMDEK 310A (IBM AMBER) 4149.95
- AMDEK 310A (IBM AMBER) 4189.95
- AMDEK 310A (IBM AMBER) 4249.95
- AMDEK 310A (IBM AMBER) 4289.95
- AMDEK 310A (IBM AMBER) 4349.95
- AMDEK 310A (IBM AMBER) 4389.95
- AMDEK 310A (IBM AMBER) 4449.95
- AMDEK 310A (IBM AMBER) 4489.95
- AMDEK 310A (IBM AMBER) 4549.95
- AMDEK 310A (IBM AMBER) 4589.95
- AMDEK 310A (IBM AMBER) 4649.95
- AMDEK 310A (IBM AMBER) 4689.95
- AMDEK 310A (IBM AMBER) 4749.95
- AMDEK 310A (IBM AMBER) 4789.95
- AMDEK 310A (IBM AMBER) 4849.95
- AMDEK 310A (IBM AMBER) 4889.95
- AMDEK 310A (IBM AMBER) 4949.95
- AMDEK 310A (IBM AMBER) 4989.95
- AMDEK 310A (IBM AMBER) 5049.95
- AMDEK 310A (IBM AMBER) 5089.95
- AMDEK 310A (IBM AMBER) 5149.95
- AMDEK 310A (IBM AMBER) 5189.95
- AMDEK 310A (IBM AMBER) 5249.95
- AMDEK 310A (IBM AMBER) 5289.95
- AMDEK 310A (IBM AMBER) 5349.95
- AMDEK 310A (IBM AMBER) 5389.95
- AMDEK 310A (IBM AMBER) 5449.95
- AMDEK 310A (IBM AMBER) 5489.95
- AMDEK 310A (IBM AMBER) 5549.95
- AMDEK 310A (IBM AMBER) 5589.95
- AMDEK 310A (IBM AMBER) 5649.95
- AMDEK 310A (IBM AMBER) 5689.95
- AMDEK 310A (IBM AMBER) 5749.95
- AMDEK 310A (IBM AMBER) 5789.95
- AMDEK 310A (IBM AMBER) 5849.95
- AMDEK 310A (IBM AMBER) 5889.95
- AMDEK 310A (IBM AMBER) 5949.95
- AMDEK 310A (IBM AMBER) 5989.95
- AMDEK 310A (IBM AMBER) 6049.95
- AMDEK 310A (IBM AMBER) 6089.95
- AMDEK 310A (IBM AMBER) 6149.95
- AMDEK 310A (IBM AMBER) 6189.95
- AMDEK 310A (IBM AMBER) 6249.95
- AMDEK 310A (IBM AMBER) 6289.95
- AMDEK 310A (IBM AMBER) 6349.95
- AMDEK 310A (IBM AMBER) 6389.95
- AMDEK 310A (IBM AMBER) 6449.95
- AMDEK 310A (IBM AMBER) 6489.95
- AMDEK 310A (IBM AMBER) 6549.95
- AMDEK 310A (IBM AMBER) 6589.95
- AMDEK 310A (IBM AMBER) 6649.95
- AMDEK 310A (IBM AMBER) 6689.95
- AMDEK 310A (IBM AMBER) 6749.95
- AMDEK 310A (IBM AMBER) 6789.95
- AMDEK 310A (IBM AMBER) 6849.95
- AMDEK 310A (IBM AMBER) 6889.95
- AMDEK 310A (IBM AMBER) 6949.95
- AMDEK 310A (IBM AMBER) 6989.95
- AMDEK 310A (IBM AMBER) 7049.95
- AMDEK 310A (IBM AMBER) 7089.95
- AMDEK 310A (IBM AMBER) 7149.95
- AMDEK 310A (IBM AMBER) 7189.95
- AMDEK 310A (IBM AMBER) 7249.95
- AMDEK 310A (IBM AMBER) 7289.95
- AMDEK 310A (IBM AMBER) 7349.95
- AMDEK 310A (IBM AMBER) 7389.95
- AMDEK 310A (IBM AMBER) 7449.95
- AMDEK 310A (IBM AMBER) 7489.95
- AMDEK 310A (IBM AMBER) 7549.95
- AMDEK 310A (IBM AMBER) 7589.95
- AMDEK 310A (IBM AMBER) 7649.95
- AMDEK 310A (IBM AMBER) 7689.95
- AMDEK 310A (IBM AMBER) 7749.95
- AMDEK 310A (IBM AMBER) 7789.95
- AMDEK 310A (IBM AMBER) 7849.95
- AMDEK 310A (IBM AMBER) 7889.95
- AMDEK 310A (IBM AMBER) 7949.95
- AMDEK 310A (IBM AMBER) 7989.95
- AMDEK 310A (IBM AMBER) 8049.95
- AMDEK 310A (IBM AMBER) 8089.95
- AMDEK 310A (IBM AMBER) 8149.95
- AMDEK 310A (IBM AMBER) 8189.95
- AMDEK 310A (IBM AMBER) 8249.95
- AMDEK 310A (IBM AMBER) 8289.95
- AMDEK 310A (IBM AMBER) 8349.95
- AMDEK 310A (IBM AMBER) 8389.95
- AMDEK 310A (IBM AMBER) 8449.95
- AMDEK 310A (IBM AMBER) 8489.95
- AMDEK 310A (IBM AMBER) 8549.95
- AMDEK 310A (IBM AMBER) 8589.95
- AMDEK 310A (IBM AMBER) 8649.95
- AMDEK 310A (IBM AMBER) 8689.95
- AMDEK 310A (IBM AMBER) 8749.95
- AMDEK 310A (IBM AMBER) 8789.95
- AMDEK 310A (IBM AMBER) 8849.95
- AMDEK 310A (IBM AMBER) 8889.95
- AMDEK 310A (IBM AMBER) 8949.95
- AMDEK 310A (IBM AMBER) 8989.95
- AMDEK 310A (IBM AMBER) 9049.95
- AMDEK 310A (IBM AMBER) 9089.95
- AMDEK 310A (IBM AMBER) 9149.95
- AMDEK 310A (IBM AMBER) 9189.95
- AMDEK 310A (IBM AMBER) 9249.95
- AMDEK 310A (IBM AMBER) 9289.95
- AMDEK 310A (IBM AMBER) 9349.95
- AMDEK 310A (IBM AMBER) 9389.95
- AMDEK 310A (IBM AMBER) 9449.95
- AMDEK 310A (IBM AMBER) 9489.95
- AMDEK 310A (IBM AMBER) 9549.95
- AMDEK 310A (IBM AMBER) 9589.95
- AMDEK 310A (IBM AMBER) 9649.95
- AMDEK 310A (IBM AMBER) 9689.95
- AMDEK 310A (IBM AMBER) 9749.95
- AMDEK 310A (IBM AMBER) 9789.95
- AMDEK 310A (IBM AMBER) 9849.95
- AMDEK 310A (IBM AMBER) 9889.95
- AMDEK 310A (IBM AMBER) 9949.95
- AMDEK 310A (IBM AMBER) 9989.95
- AMDEK 310A (IBM AMBER) 10049.95
- AMDEK 310A (IBM AMBER) 10089.95
- AMDEK 310A (IBM AMBER) 10149.95
- AMDEK 310A (IBM AMBER) 10189.95
- AMDEK 310A (IBM AMBER) 10249.95
- AMDEK 310A (IBM AMBER) 10289.95
- AMDEK 310A (IBM AMBER) 10349.95
- AMDEK 310A (IBM AMBER) 10389.95
- AMDEK 310A (IBM AMBER) 10449.95
- AMDEK 310A (IBM AMBER) 10489.95
- AMDEK 310A (IBM AMBER) 10549.95
- AMDEK 310A (IBM AMBER) 10589.95
- AMDEK 310A (IBM AMBER) 10649.95
- AMDEK 310A (IBM AMBER) 10689.95
- AMDEK 310A (IBM AMBER) 10749.95
- AMDEK 310A (IBM AMBER) 10789.95
- AMDEK 310A (IBM AMBER) 10849.95
- AMDEK 310A (IBM AMBER) 10889.95
- AMDEK 310A (IBM AMBER) 10949.95
- AMDEK 310A (IBM AMBER) 10989.95
- AMDEK 310A (IBM AMBER) 11049.95
- AMDEK 310A (IBM AMBER) 11089.95
- AMDEK 310A (IBM AMBER) 11149.95
- AMDEK 310A (IBM AMBER) 11189.95
- AMDEK 310A (IBM AMBER) 11249.95
- AMDEK 310A (IBM AMBER) 11289.95
- AMDEK 310A (IBM AMBER) 11349.95
- AMDEK 310A (IBM AMBER) 11389.95
- AMDEK 310A (IBM AMBER) 11449.95
- AMDEK 310A (IBM AMBER) 11489.95
- AMDEK 310A (IBM AMBER) 11549.95
- AMDEK 310A (IBM AMBER) 11589.95
- AMDEK 310A (IBM AMBER) 11649.95
- AMDEK 310A (IBM AMBER) 11689.95
- AMDEK 310A (IBM AMBER) 11749.95
- AMDEK 310A (IBM AMBER) 11789.95
- AMDEK 310A (IBM AMBER) 11849.95
- AMDEK 310A (IBM AMBER) 11889.95
- AMDEK 310A (IBM AMBER) 11949.95
- AMDEK 310A (IBM AMBER) 11989.95
- AMDEK 310A (IBM AMBER) 12049.95
- AMDEK 310A (IBM AMBER) 12089.95
- AMDEK 310A (IBM AMBER) 12149.95
- AMDEK 310A (IBM AMBER) 12189.95
- AMDEK 310A (IBM AMBER) 12249.95
- AMDEK 310A (IBM AMBER) 12289.95
- AMDEK 310A (IBM AMBER) 12349.95
- AMDEK 310A (IBM AMBER) 12389.95
- AMDEK 310A (IBM AMBER) 12449.95
- AMDEK 310A (IBM AMBER) 12489.95
- AMDEK 310A (IBM AMBER) 12549.95
- AMDEK 310A (IBM AMBER) 12589.95
- AMDEK 310A (IBM AMBER) 12649.95
- AMDEK 310A (IBM AMBER) 12689.95
- AMDEK 310A (IBM AMBER) 12749.95
- AMDEK 310A (IBM AMBER) 12789.95
- AMDEK 310A (IBM AMBER) 12849.95
- AMDEK 310A (IBM AMBER) 12889.95
- AMDEK 310A (IBM AMBER) 12949.95
- AMDEK 310A (IBM AMBER) 12989.95
- AMDEK 310A (IBM AMBER) 13049.95
- AMDEK 310A (IBM AMBER) 13089.95
- AMDEK 310A (IBM AMBER) 13149.95
- AMDEK 310A (IBM AMBER) 13189.95
- AMDEK 310A (IBM AMBER) 13249.95
- AMDEK 310A (IBM AMBER) 13289.95
- AMDEK 310A (IBM AMBER) 13349.95
- AMDEK 310A (IBM AMBER) 13389.95
- AMDEK 310A (IBM AMBER) 13449.95
- AMDEK 310A (IBM AMBER) 13489.95
- AMDEK 310A (IBM AMBER) 13549.95
- AMDEK 310A (IBM AMBER) 13589.95
- AMDEK 310A (IBM AMBER) 13649.95
- AMDEK 310A (IBM AMBER) 13689.95
- AMDEK 310A (IBM AMBER) 13749.95
- AMDEK 310A (IBM AMBER) 13789.95
- AMDEK 310A (IBM AMBER) 13849.95
- AMDEK 310A (IBM AMBER) 13889.95
- AMDEK 310A (IBM AMBER) 13949.95
- AMDEK 310A (IBM AMBER) 13989.95
- AMDEK 310A (IBM AMBER) 14049.95
- AMDEK 310A (IBM AMBER) 14089.95
- AMDEK 310A (IBM AMBER) 14149.95
- AMDEK 310A (IBM AMBER) 14189.95
- AMDEK 310A (IBM AMBER) 14249.95
- AMDEK 310A (IBM AMBER) 14289.95
- AMDEK 310A (IBM AMBER) 14349.95
- AMDEK 310A (IBM AMBER) 14389.95
- AMDEK 310A (IBM AMBER) 14449.95
- AMDEK 310A (IBM AMBER) 14489.95
- AMDEK 310A (IBM AMBER) 14549.95
- AMDEK 310A (IBM AMBER) 14589.95
- AMDEK 310A (IBM AMBER) 14649.95
- AMDEK 310A (IBM AMBER) 14689.95
- AMDEK 310A (IBM AMBER) 14749.95
- AMDEK 310A (IBM AMBER) 14789.95
- AMDEK 310A (IBM AMBER) 14849.95
- AMDEK 310A (IBM AMBER) 14889.95
- AMDEK 310A (IBM AMBER) 14949.95
- AMDEK 310A (IBM AMBER) 14989.95
- AMDEK 310A (IBM AMBER) 15049.95
- AMDEK 310A (IBM AMBER) 15089.95
- AMDEK 310A (IBM AMBER) 15149.95
- AMDEK 310A (IBM AMBER) 15189.95
- AMDEK 310A (IBM AMBER) 15249.95
- AMDEK 310A (IBM AMBER) 15289.95
- AMDEK 310A (IBM AMBER) 15349.95
- AMDEK 310A (IBM AMBER) 15389.95
- AMDEK 310A (IBM AMBER) 15449.95
- AMDEK 310A (IBM AMBER) 15489.95
- AMDEK 310A (IBM AMBER) 15549.95
- AMDEK 310A (IBM AMBER) 15589.95
- AMDEK 310A (IBM AMBER) 15649.95
- AMDEK 310A (IBM AMBER) 15689.95
- AMDEK 310A (IBM AMBER) 15749.95
- AMDEK 310A (IBM AMBER) 15789.95
- AMDEK 310A (IBM AMBER) 15849.95
- AMDEK 310A (IBM AMBER) 15889.95
- AMDEK 310A (IBM AMBER) 15949.95
- AMDEK 310A (IBM AMBER) 15989.95
- AMDEK 310A (IBM AMBER) 16049.95
- AMDEK 310A (IBM AMBER) 16089.95
- AMDEK 310A (IBM AMBER) 16149.95
- AMDEK 310A (IBM AMBER) 16189.95
- AMDEK 310A (IBM AMBER) 16249.95
- AMDEK 310A (IBM AMBER) 16289.95
- AMDEK 310A (IBM AMBER) 16349.95
- AMDEK 310A (IBM AMBER) 16389.95
- AMDEK 310A (IBM AMBER) 16449.95
- AMDEK 310A (IBM AMBER) 16489.95
- AMDEK 310A (IBM AMBER) 16549.95
- AMDEK 310A (IBM AMBER) 16589.95
- AMDEK 310A (IBM AMBER) 16649.95
- AMDEK 310A (IBM AMBER) 16689.95
- AMDEK 310A (IBM AMBER) 16749.95
- AMDEK 310A (IBM AMBER) 16789.95
- AMDEK 310A (IBM AMBER) 16849.95
- AMDEK 310A (IBM AMBER) 16889.95
- AMDEK 310A (IBM AMBER) 16949.95
- AMDEK 310A (IBM AMBER) 16989.95
- AMDEK 310A (IBM AMBER) 17049.95
- AMDEK 310A (IBM AMBER) 17089.95
- AMDEK 310A (IBM AMBER) 17149.95
- AMDEK 310A (IBM AMBER) 17189.95
- AMDEK 310A (IBM AMBER) 17249.95
- AMDEK 310A (IBM AMBER) 17289.95
- AMDEK 310A (IBM AMBER) 17349.95
- AMDEK 310A (IBM AMBER) 17389.95
- AMDEK 310A (IBM AMBER) 17449.95
- AMDEK 310A (IBM AMBER) 17489.95
- AMDEK 310A (IBM AMBER) 17549.95
- AMDEK 310A (IBM AMBER) 17589.95
- AMDEK 310A (IBM AMBER) 17649.95
- AMDEK 310A (IBM AMBER) 17689.95
- AMDEK 310A (IBM AMBER) 17749.95
- AMDEK 310A (IBM AMBER) 17789.95
- AMDEK 310A (IBM AMBER) 17849.95
- AMDEK 310A (IBM AMBER) 17889.95
- AMDEK 310A (IBM AMBER) 17949.95
- AMDEK 310A (IBM AMBER) 17989.95
- AMDEK 310A (IBM AMBER) 18049.95
- AMDEK 310A (IBM AMBER) 18089.95
- AMDEK 310A (IBM AMBER) 18149.95
- AMDEK 310A (IBM AMBER) 18189.95
- AMDEK 310A (IBM AMBER) 18249.95
- AMDEK 310A (IBM AMBER) 18289.95
- AMDEK 310A (IBM AMBER) 18349.95
- AMDEK 310A (IBM AMBER) 18389.95
- AMDEK 310A (IBM AMBER) 18449.95
- AMDEK 310A (IBM AMBER) 18489.95
- AMDEK 310A (IBM AMBER) 18549.95
- AMDEK 310A (IBM AMBER) 18589.95
- AMDEK 310A (IBM AMBER) 18649.95
- AMDEK 310A (IBM AMBER) 18689.95
- AMDEK 310A (IBM AMBER) 18749.95
- AMDEK 310A (IBM AMBER) 18789.95

What the world really needs is a 99 cent Double Sided, Double Density Diskette with a LIFETIME WARRANTY!

And DISK WORLD! has it.

Introducing Super Star Diskettes: the high quality diskette with the lowest price and the best LIFETIME WARRANTY!

In the course of selling more than a million diskettes every month, we've learned something: higher prices don't necessarily mean higher quality.

In fact, we've found that a good diskette manufacturer simply manufactures a good diskette...no matter what they charge for it. (By way of example, consider that none of the brands that we carry has a return rate of greater than 1/1,000th of 1 percent!)

In other words, when people buy a more expensive diskette, they aren't necessarily buying higher quality.

The extra money might be going toward flashier advertising, snazzier packaging or simply higher profits.

But the extra money in a higher price isn't buying better quality.

All of the good manufacturers put out a good diskette. Period.

How to cut diskette prices ...without cutting quality.

Now this discovery posed a dilemma: how to cut the price of diskettes without lowering the quality.

There are about 85 companies claiming to be "diskette" manufacturers.

Trouble is, most of them aren't manufacturers. Rather they are fabricators or marketers, taking other company's components, possibly doing one or more steps of the processing themselves and pasting their labels on the finished product.

The new Eastman Kodak diskettes, for example, are one of these. So are IBM 5 1/4" diskettes. Same for DYSAN, Polaroid and many, many other familiar diskette brand names. Each of these diskettes is manufactured in whole or in part by another company!

So, we decided to act just like the big guys. That's how we would cut diskette prices...without lowering the quality.

We would go out and find smaller companies to manufacture a diskette to our specifications...specifications which are higher than most...and simply create our own "name brand" diskette.

Name brand diskettes that offered high quality at low prices.



Super Star diskettes are sold in multiples of 50 only. Diskettes are shipped with white Tyvec sleeves, reinforced hubs, user ID labels and write-protect tabs.

Boy, did we get lucky. Our Super Star Diskettes are the same ones you've been using for years...without knowing it.

In our search for the low priced, high quality diskette of our dreams, we found something even more interesting.

We found that there are several manufacturers who don't give a hoot about the consumer market for their diskettes. They don't spend millions of dollars in advertising trying to get you, the computer user, to use their diskettes.

Instead, they concentrate their efforts on turning out the highest quality diskettes they can...because they sell them to the software publishers, computer manufacturers and other folks who (in turn) put their name on them...and sell them for much higher prices to you!

After all, when a software publisher or computer manufacturer or diskette marketer puts their name on a diskette, they want it to work time after time, everytime. (Especially software publishers who have the nasty habit of copy-protecting their originals!)

Super Star Diskettes. You already know how good they are. Now you can buy them...cheap.

Well, that's the story.

Super Star diskettes don't roll off the boat from Pago-Pago or emerge from a basement plant just east of Nowhere.

Super Star diskettes have been around for years...and you've used them for years as copy-protected software originals, unprotected originals. Sometimes, depending on which computer you own, the system master may have been on a Super Star diskette. And maybe more than once, you've bought a box or two or more of Super Star diskettes without knowing it. They just had some "big" company's name on them.

Super Star Diskettes are good. So good that a lot of major software publishers, computer manufacturers and other diskette marketers buy them in the tens or hundreds of thousands.

We buy them in the millions.

And then we sell them to you.

Cheap.

**When every little bit counts,
it's Super Star Diskettes.**

You've used them a hundred times...under different names.

Now, you can buy the real McCoy, the same diskette that major software publishers, computer manufacturers and diskette marketers buy...and call their own.

We simply charge less.

Super Special!

Order 50 Super Star Diskettes and we'll be happy to sell you an Amaray Media-Mate 50 for only \$8.75, shipping included...a lot less than the suggested retail price of \$15.95.



Regular DISK WORLD! price: \$10.95 ea.
+ \$2.00 Shpng.

DISKETTE STORAGE CASES

PERFECTDATA DIAL 'N FILE

Terrific! Holds 10 5 1/4" diskettes. Just flip the lever and they all slide up for easy access and identification. Grey with smoked plastic front.

\$2.75 Ea. + .35 Shpng.



DISK CADDIES

The original flip-up holder for 10 5 1/4" diskettes. Beige or Grey only.

\$1.65 ea. + .20 Shpng.



DISKETTE 70 STORAGE

Dust-free storage for 70 5 1/4" diskettes. Six dividers included. An excellent value.

\$11.95 ea. + \$3.00 Shpng.

HOURS:

Human: 8AM-6PM Central Time, Monday through Friday
Answering Machine: 6PM-8AM, All Times
MCI MAIL: 24 hours a day.

HOW TO ORDER:

ORDERS ONLY:
1-800-621-6827
(In Illinois: 1-312-944-2788)
INQUIRIES:
1-312-944-2788

FOR FASTEST SERVICE, USE NO-COST MCI MAIL: Our address is DISK WORLD. It's a FREE MCI MAIL letter. No charge to you. (Situation permitting, we'll ship these orders in 24 hours or less.)

SHIPPING: 5 1/4" & 3 1/2" DISKETTES—Add \$3.00 per each 100 or fewer diskettes. OTHER ITEMS: Add shipping charges as shown in addition to other shipping charges. PAYMENT: VISA, MASTERCARD and Prepaid orders accepted. COD ORDERS: Add additional \$3.00 special handling charge. APO, FPO, AK, HI & PR ORDERS: Include shipping charges as shown and additional 5% of total order amount to cover PAL and insurance. We ship only to United States addresses, except for those listed above. TAXES: Illinois residents, add 8% sales tax.

MINIMUM ORDER: \$35.00 or 20 diskettes.

The Super Star LIFETIME WARRANTY!

Super Star Diskettes are unconditionally warranted against defects in original material and workmanship so long as owned by the original purchaser. Returns are simple: just send the defective diskettes with proof of purchase, postage-paid by you with a short explanation of the problem, and we'll send you the replacements. (Incidentally, coffee stained diskettes and diskettes with staples "driven through them don't qualify as "defective".)

WE WILL MEET OR BEAT ANY NATIONALLY
ADVERTISED PRICE
ON THE SAME PRODUCTS AND QUANTITIES
SUBJECT TO THE SAME TERMS AND CONDITIONS.

DISK WORLD!, Inc.

Suite 4806
30 East Huron Street
Chicago, Illinois 60611

BASF DISKETTES

BASF Diskettes at competitive price. Call TOLL FREE (800) 235-4137 for prices and information. Visa and Master Card accepted.

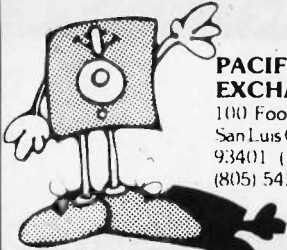

PACIFIC EXCHANGES
100 Foothill Blvd
San Luis Obispo, CA
93401 (In Cal call
(805) 543-1037)

Inquiry 310

INVENTORY REDUCTION

COLOR TERMINALS INTECOLOR 2405

- 8 COLORS THIN LINE GRAPHICS
- ANSI 3.64 PROTOCOL
- PROGRAMMABLE FUNCTION KEYS

NEW IN CARTONS WITH MANUALS
LIST \$1695 NOW \$995

Includes Installation Instructions
For Use With Wordstar® & Newword®

INTEX/MICROVOX TEXT-TO-SPEECH
SYNTHESIZER LIST \$349
NOW \$299

THE COMPUTER GROUP
12156 LACKLAND ROAD
ST. LOUIS, MO. 63146

Inquiry 97

DATAMASTER™

One-of-A-kind Data Management Program

Developed Especially for You.



\$175.00

- STOP thinking about any other programs
- STOP worrying about custom programming
- START saving time and money
- START being your own MASTER

California (800) 423-0320

Outside (800) 482-DATA

C.D.A. INTERNATIONAL SOFTWARE CORP.
(818) 986-3233 Telex: 215666

Inquiry 67

PC/XT USERS!

- COGTREE Utilities by Cogitate \$129.95
- LYNC by Norton-Lamber... \$199.95
- DATAFLEX by Data Access...Varies
- RMICOBOL by Ryan/McFarland.....Varies
- Universe by Omnitrend....\$ 98.50
- Blue MacI by Cogitate.....\$599.00
- CadPower+ by Trilix.....\$995.00
- Softext Teaching Aids.....\$ 95.00
- PrintSet by Cogitate.....\$ 79.95
- CogITAPE by Cogitate.....CALL!!
- Anti-Static Products.....Varies
- Uninterruptible Power Backups.....Varies
- TeleVideo Software.....CALL!!

COGITATE

"A Higher Form of Software"
24000 Telegraph Road
Southfield, MI 48034
(313) 352-2345/Telex 3865581

VISA/MASTERCARD ACCEPTED
Dealer Inquiries Welcomed

Inquiry 77

NEW BUS FOR DATA ACQUISITION & CONTROL

Now available for IBM PC, XT, AT & Apple II.

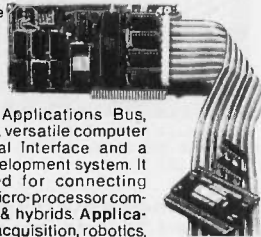

The Local Applications Bus, LAB 40, is a versatile computer to peripheral interface and a product development system. It is optimized for connecting directly to micro-processor compatible I.C.s & hybrids. Applications: data acquisition, robotics, instrumentation, control, conventional peripherals. Capabilities: access up to 64 sixteen bit ports, 8 interrupts, DMA speeds, more. Presently available Applications modules include 8 & 12 bit high speed A/D w/programmable gain. Prices for the LAB 40 developers kit (circuit, software & manual) start at \$200.

Computer Continuum

75 Southgate Ave., Suite 6
Daly City, CA 94015 (415) 755-1978

Inquiry 77

16 USERS ON YOUR I.B.M. P.C.

TURBOSLAVE - P.C.

- 8 MHZ Z-80H
- 128K RAM
- 2 RS-232 PORTS
- MULTIPROCESSOR ARCHITECTURE
- P.C. COMPATIBLE
- FASTEST CPM COPROCESSOR
- 16 TURBOSLAVES PER P.C.
- CPM-80 COMPATIBLE
- TRUE MULTI-USER
- LOW COST - \$495. RETAIL

TURBOSLAVE P.C. TURNS YOUR I.B.M. INTO A MULTI-USER MULTI-PROCESSOR SUPER MICRO. ONE TURBOSLAVE CAN BE USED AS A SIMPLE CPM COPROCESSOR. BY ADDING THE TURBODOS OPERATING SYSTEM, UP TO 16 TURBOSLAVE P.C.'S CAN BE ADDED, EACH SUPPORTING ONE USER ON A STANDARD TERMINAL. ALL CPM 2.2 PROGRAMS AND MOST MULTI-USER MPM APPLICATIONS CAN BE RUN UNDER TURBODOS. TRUE RECORD LOCKING AND PRINT-SPOOLING ARE FULLY SUPPORTED.



EARTH COMPUTERS

"Building Blocks For The Super Micro"

TELEX: 9109976120 EARTH FV
P.O. BOX 8067 • FOUNTAIN VALLEY, CA 92728
CALL: (714) 964-5784

★ FULL LINE OF S-100 TURBODOS PRODUCTS AVAILABLE ★

REGISTERED TRADEMARKS: Z-80H, ZILOG INC.; TURBODOS, SOFTWARE 2000, INC.

Inquiry 146

TW TAPE WORLD

1-800-245-6000



maxell.
It's Worth It

Dysan
Dysan Products

MD-1	5 1/4" SSDD	1.59	104/1D	5 1/4" SSDD	1.89
MD-2	5 1/4" DSDD	2.19	104/2D	5 1/4" DSDD	2.69
FD-1	8" SSDD	2.69	3740/1D	8" SSDD	2.69
FD-2	8" DSDD	3.29	3740/2D	8" DSDD	3.29
MF-1	3 1/2" MICRO	2.99			
MD2-HD	5 1/4" DSHD	4.99			
BASF					
5 1/4" SSDD		1.34			
5 1/4" DSDD		1.54			
VERBATIM					
5 1/4" SSDD		1.69			
5 1/4" DSDD		2.39			
	5 1/4" SSDD				1.69
	5 1/4" DSDD				1.99
MEMOREX					
	5 1/4" SSDD				1.49
	5 1/4" DSDD				1.99
SCOTCH					
	5 1/4" SSDD				1.59
	5 1/4" DSDD				2.19
ELEPHANT					

WE WILL BEAT ANY PRICE BY 3%

Factory Sealed. Shipping 3.75 any size order.
Pre-paid, COD, or credit card. COD add 1.95
SCHOOLS & GOVT. ON PO.

Also, TDK, and Maxell audio and video cassettes.
220 SPRING ST. BOX 361 BUTLER, PA 16001
412-283-8621 M-Fri. 8:30-5:00

Inquiry 387

IBM® PC/XT/AT Compatible

PC PIPELINE

- *4164-120/150/200 129
- *128K-150/200 for AT 995
- *256K-150 599
- *Teac half-height for AT 119.00
- *20 Mb Hard disk for AT 695.00
- 8087-3 119.00
- Apple Drives — half heights 124.00
- *Tandon/CDC full height drives 109.00
- *CDC/Teac half height drives 109.00
- *Micro Science 20 Mb kit for PC/XT 839.00
- *10 Mb Hard Disk System 649.00
- *20-100 Mb Hard Disk Drives Lowest Prices/Call
- *Everex Magic Card 0-384 expansion 179.00
- *Everex Magic Card w/384K RAM populated 259.00
- *Everex Graphic Edge Color Cards 339.00
- *Drive Installation Kits Call

Add \$3.95 shipping to all orders • Prices subject to change • PO's on approval • C.O.D. OK • All new, no surplus, no seconds.
QUANTITY DISCOUNTS • Corporate accounts invited
3310 West Main St., Tampa, FL 33607
In FL and for info, call 813-875-0299



TELEX 330690
FAX LINE: 813-876-7194

Inquiry 316

Super Tools by Paragon Courseware

Tools for Turbo Pascal™ on the IBM™ PC

Window Management = menus, help files...
• Unlimited windows • Window overlay & recall
• Cursor save & jump • Access all colors & chars
• Window Compiler/Librarian manages window files

Graphics Drawing = HiRes plotting power!
• Ellipses, polygons, etc. • Region fill and clear

String Formula Evaluator = easy calculation
• 22 functions with nesting and implicit multiplication
• Won't bomb on overflow or division by zero

System Check and Control = max flexibility!
• Time & date access • Get disk types & room
• Get & set default drive • I/O information

All this for only \$39.95... Incredible!

You get 321K of source code on a double-sided disk and a 35 page manual. For single-sided drives add \$2. Works with DOS 2.0, Turbo 2.0.

* Please include \$2 for postage and handling (\$4 if outside of USA). Californians add 6% MC/VISA

Paragon Courseware

4954 Sun Valley Road
Del Mar, CA 92014

(619) 481-1477

Super Tools is a trademark of Paragon Courseware
Turbo Pascal is a trademark of Borland International
IBM is a trademark of the IBM Corporation

Inquiry 315

★ **PRICE WAR** ★ **CALL US LAST** WITH YOUR BEST QUOTES ★

PRINTERS

EPSON FX-80 + ... \$399 FX-100 + ... \$599
 LQ-1500 Parallel ... \$1099 Serial ... \$1199
 JX-80 160 cps, dot-matrix/7 color graphics ... \$569
 HI-80 4 Pen Plotter ... \$469
 LX-80 draft (100 cps) & NLQ modes ... \$299

OKIDATA 92P/92-IBM ... \$359
 93-P/93-IBM ... \$569 84-P/84-IBM ... \$679
 OKIMATE 20-IBM Parallel with Plug & Print ... \$219
 182-IBM Parallel Personal Printer ... \$239
 92 Tractor ... \$70 84 Sheet Feeder ... \$390

TOSHIBA 1340P (80 column) ... \$599
TOSHIBA 1351P (132 column) ... \$1169
 Tractor ... \$170 Font Disk for 1351 ... \$50

JUKI 6100 (18 cps), 13" wide ... \$379
JUKI 6300 (40 cps), 16" wide ... \$699
 Tractor 6100/6300 ... \$130/\$140

BROTHER HR-15 XL (20 CPS) ... \$359
 HR-15 Tractor/Keyboard/Sheet Fdr ... \$110/\$160/\$190
 HR-25 (23 CPS) ... \$589 HR-35 (36 CPS) ... \$789
 Tractor/Sheet Feeder for HR-25/35 ... \$120/\$200
 M-1009 Dot Matrix - 9 pin, 50 cps ... \$199
 2024L LQ/Graphics - 24 pin, 160/80 cps ... \$999
 2024L Cutsheet Feeders - Narrow ... \$220 Wide ... \$290

C. ITOH 8510-BPI ... \$319 8510-SEP ... \$389
 8510-SCEP ... \$449 1550-EP ... \$439
 1550-P ... \$449 1550-SEP ... \$539
 Y10-20-P ... \$429 A10-30-P ... \$479
 F-10-40-P ... \$869 F-10-55-P ... \$1069

QUME LETTERPRO 20P - 20 cps ... \$429
 20P Tractor/Sheet Feeder ... \$140/\$380
SPRINT 1140 + ... \$1299 **SPRINT** 1155 + ... \$1499
INTERFACE MODULES Centronics/Serial/IBM Par ... \$80
SPRINT Tractor/Sheet Feeder ... \$210/\$690

PANASONIC KX-P1090 ... \$229
 KX-P1091 ... \$279 KX-P1092 ... \$419 KX-P1093 ... \$649

STAR MICRONICS NEW 10" & 15" MODELS
 SG-10/15 120 CPS ... \$249/\$409
 SD-10/15 160 CPS ... \$369/\$489
 SR-10/15 200 CPS ... \$529/\$649

NECP-2 ... \$649 P-3 ... \$899
NEW ELF 360 (19 CPS) ... \$449
 2050 ... \$669 3550 ... \$1299 8850 ... \$1699
 Spinwriter Tractor/Sheet Feeder ... \$190/\$790

DIABLO 630 ECS/IBM ... \$1799 630 API ... \$1599
 Advantage D-25 ... \$549 620 API ... \$729

DATA PRODUCTS Makers of IBM color printer
 SPG 8051 (Same as IBM Color Printer) ... \$1399
 SPG 8071 (Same as 8051 at twice the speed) ... \$1799

DISPLAY CARDS

EVEREX Graphics Edge ... Best Price Ever

AST Monograph Plus w/clock, Par & Ser Ports ... \$399

PERSYST BoB Board ... \$449
 Short-Port Color ... \$169 Mini-Mono ... CALL
 Color Combo: Multifunction & Color Adapter ... from \$349
 Mono Combo: Multifunction & Mono Adapter ... from \$349

MYLEX Chairman ... \$439

PARADISE Modular Brd ... \$269 Modules ... CALL

INTELLIGENT B-450 Mono/Color/printer ... \$249

TECMAR Graphics Master w/PC Paintbrush ... \$459

HERCULES MonoGraphics ... \$299 Color ... \$159

GENOA Spectrum ... CALL

IBM Color Card ... \$229 Generic ... \$129

QUADRAM QuadColor I or II ... \$199 Both ... \$390

EXCLUSIVELY FOR IBM PC

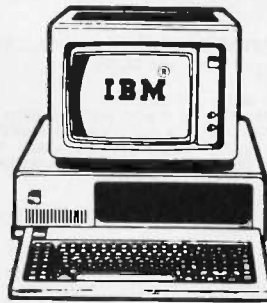

CALL FOR LATEST SYSTEM PRICES

FLOPPY/HARD DISKS

TEAC Half Ht FD 55B - DSDD ... \$109
 (Warranted for IBM PC only) 10 + ... \$105

TANDON 100-2 Full Ht - DSDD ... \$119

IBM Full Ht - DSDD ... \$159

HARD DISKS/BACKUP for IBM PC

10 MB HD Int ... \$599 10 MB HD Ext ... \$799
 20 MB HD Int ... \$999 20 MB HD Ext ... \$1199
 10 MB Tape Backup ... \$599 Larger Backup ... CALL

TALL GRASS NEW PC/T FORMAT DRIVES/BACKUP
 25 MB w/60 MB ... \$2799 35 MB w/45 MB ... \$3599
 50 MB w/60 MB ... \$4399 80 MB w/60 MB ... \$5999
 Controller ... \$140 Cartridge(60 MB) ... \$35

QUBIE 10/20 MB Internal or External ... CALL
 All Qubie Hard Drives include 1 Dir software

MAYNARD 10MB/WS-1\$899 10MB/WS-2\$1069
 20MB/WS-1 ... \$1149 20MB/WS-2 ... \$1319
 30MB/WS-1 ... \$1899 30MB/WS-2 ... \$2079
 Gemini WS-1 ... \$1029 Gemini WS-2 ... \$1169

The "Gemini" includes 10MB Hard Disk & Half Ht. floppy
 MaynStream - System 27 \$1299 Cartridge 450 \$35
 MaynStream System 60 ... \$1349 Cartridge 600 ... \$50

EVEREX 10MB Int ... \$649 20 MB Int ... \$999
EXCEL 4500-PC Internal 45MB Tape Backup ... \$949
EXCEL 4500 External 45MB Tape Backup ... \$999

IRWIN MAGNETICS
 10 MB Internal Tape Backup ... \$569
 10 MB External Tape Backup ... CALL

★ **SUPER SPECIALS** ★

\$1000 + SINGLE ORDER ENTITLES YOU TO THESE SPECIAL PRICES

EPSON FX-80 + ... \$389 FX-100 + ... \$579

OKIDATA 92P/93P/84P ... \$349/\$559/\$669

BROTHER HR-15/25/35 ... \$349/\$569/\$769

PGS HX-12 ... \$439

HAYES 1200B w/sft ... \$349 1200 Ext ... \$379

PROMETHEUS PROMODEM 1200 Ext ... \$279

NOVATION SmartCat w/sft - Int or Ext ... \$359

ANCHOR Signalman MK XII ... \$219

TECMAR Graphics Master w/PC Paintbrush ... \$449

HERCULES MonoGraphics ... \$289 Color ... \$149

COMPANY POLICY: Min order \$100. Prices & availability subject to change. We ship UPS only. Shipping/handling charges vary. COD requires cashiers check. All returns must be authorized in 10 days & are subject to 20% restocking fee (Min. \$50). Defective merchandise covered under appropriate warranty. Non-defective items returned as defective subject to 10% service charge (Min. \$50). No refunds, only Compunail credit issued. Not responsible for hardware or software compatibility of any product. Call for return authorization # for repairs/returns. No open acct. PO's or foreign orders. For advance payment (personal/company checks take 3 weeks to clear) or PICKUP: Please call first for work order #.



NO SURCHARGE ON COD, VISA or MC

AMEX 5%

MODEMS

MICROCOM ERA-2 Int. w/sft ... \$339

HAYES 1200 B Internal w/software ... \$359

1200 Standalone w/o software ... \$389

NEW 2400 Baud Ext ... CALL

POPCOM C-100/X-100 ... Special Low Prices

PROMETHEUS PROMODEM 1200 Ext ... \$289

PROMODEM 1200 B Internal w/software ... \$259

NOVATION SmartCat w/sft - Int or Ext ... \$369

ANCHOR Signalman MK XII ... \$229

Ven-Tel Half Card w/Crosstalk XVI ... \$359

1200 Plus External w/o software ... \$329

MONITORS

PGS MAX-12E ... CALL HX-12 ... \$449

SR-12 ... \$599 HX-12E ... CALL

TAXAN COMPOSIT 115 Green/116 Amber ... \$139

MONO 121 Green/122 Amber (1000x360) ... \$159

COLOR 411 (510x260) ... \$349 425 (640x262) ... \$449

COLOR 440 (720x400) ... \$549 W/Persvst BoB Brd ... \$969

SAKATA SG 1000 Green Composit ... \$119

COLOR MONITORS ... CALL

AMDEK 300G/300A/310A (M) ... \$139/\$149/CALL

COLOR 600 (640x240) ... \$429 710 (720x480) ... \$539

QUADRAM AMBERCHROME (720x350) ... CALL

QUADCHROME II (640x240) Color Graphics & Text ... \$429

SAMSUNG Mono-Green/Amber ... \$129

ROLAND MB-142 14" Mono B/W ... CALL

MULTI-FUNCTION CARDS

AST SIXPAK w/64k ... \$249 Exp to 384k ... \$379

QUADBOARD O-k ... \$219 Exp to 384k ... \$369

ORCHID Blossom O-k ... \$189 Exp to 384k ... \$339

BT 6 PLUS w/64k ... \$219 Exp to 384k ... \$349

IDS B-512 O-k ... \$199 Exp to 512k ... \$389

P/S/G/ Ports, Clock/Cal, disk emulation & Sockets for 512k

PARADISE S-Pack O-k ... \$159 Exp to 384k ... \$309

TECMAR Captain O-k ... \$199 Exp to 384k ... \$349

TALLTREE JRAM O-k ... \$129 Exp to 512k ... \$319

MISC. ADD ONS

64K RAM Set \$20 10+ Sets \$18 50+ ... \$17

8087-3 Math Chip for IBM PC ... CALL

ORCHID Pcturbo 186 (128k to 640k) ... Best Prices

QUADRAM QUADsprint ... \$499

CABLE Parallel, 6 ft ... \$20 Parallel, 10 ft. ... \$25

Keyboard Extension, 6 ft. ... \$10 Serial, 6 ft. ... \$25

MAXELL MD-1 SSDD Box ... \$20 10+ Boxes ... \$17

(10 per box) MD-2 DSDD Box ... \$25 10+ Boxes ... \$22

IBM Floppy Controller ... \$119 Generic ... \$79

IBM's original PC Keyboard ... CALL

QUBIE Keyboard 5150 ... \$119 5151 ... \$149

KEYTRONIC Deluxe Keyboard KB 5151 ... \$159

QUADRAM Microfazer 8k to 384k ... CALL

COMPUTER ACCESSORIES P2 (5) ... \$109

POWER DIRECTOR P22 (4) ... \$79 P12 (6) ... \$149

KENSINGTON Master Piece (5 Outlets) ... \$109

PC Keyboard Storage Drawer ... \$89

STANDBY PWR SUPPLY w/surge protection

200 Watts ... \$299 300 Watts ... \$399 800 Watts ... \$799

KOALA Touch Tablet w/software ... \$89

EPD Surge Protectors ... CALL

CURTIS Surge Protectors & Accessories ... CALL

TILT/SWIVEL Monitor Pedestal ... \$30

COMPU **805-987-7015**

406-C CONSTITUTION AVE., CAMARILLO, CA 93010

WHEN ORDERING PLEASE REFER TO AD #B797

VT102/TEK 4010

For the IBM PC, XT, AT, AT, PCjr, and Compatibles

PC102 precisely emulates DEC VT102, 101, 100, and VT52 terminals.

PC4010 includes all PC102 features plus Tektronix 4010 graphics.

A few reasons why thousands of customers - including GE, Dow, Raytheon, Westinghouse, and Stanford University - prefer our products:

- Complete keyboard and screen emulation w/line graphics (optional 132-columns)
- ANSI color, local printer, bidirectional file transfer support
- Guaranteed compatibility with all DEC applications including EDT, WORD-11, ALL-IN-ONE, DEC-CALC, UNIX v1
- New DOS shell key, ten programmable softkeys, plus full DOS 2.X-3.X path names
- Written in 'C' and ASM: up to 38.4 KB

30-DAY money back guarantee!
CALL TODAY!

PC102-JR	\$89.00	\$69.00
PC102	\$139.00	\$89.00
For PC-XT/AT ONLY		
PC4010	\$179.00	\$139.00

Prepaid C.O.D., Mastercard, VISA

gms
6440 Flying Cloud Dr.
Suite 205
Minneapolis, MN 55344 (612) 944-0593

GENERAL MICRO SYSTEMS

TERMINAL EMULATION SALES

Inquiry 174

dBASE II USERS

INCREASE DEVELOPMENT PRODUCTIVITY AND PROCESSING THROUGHPUT WITH

dTOOLKIT

CONTAINING MANY dBASE III FACILITIES... and MORE

- **dLIBRARY - OBJECT CODE ROUTINES:** ARRAYS, EXTRA 256 MEMORY VARIABLES, dBASE III DATE FACILITIES, AMOUNT IN WORDS, DOS TYPE, SOUND EX CODES, CHECK DIGITS, RANDOM NUMBERS, SORT, TOLOWER, CAPITALIZE, ISALPHA, ENCRYPTION, COMPRESSION... and MANY MORE.
- **dBASIC - FUNCTIONS:** PROCESS dBASE II DATA AND INDEX FILES USING CB80R OR CB86 COMPILED BASIC.
- **dFIX - UTILITY:** FIX CORRUPTED DATA FILES.
- **dCRYPT - UTILITY:** ENCRYPT AND DECRYPT DATA FILES.
- **dMENU - dBASE RUNTIME MENU SYSTEM:** MAINTENANCE ROUTINES, MENU HIERARCHY, SECURITY.

ORDERING DETAILS:

02ISOFT, P.O. BOX 2360, ROSEVILLE, CA 95746
\$90 or \$20 DEMO DISK

CP/M-80, CP/M-86, MS-DOS, PC-DOS, 8" or 5" IBM FORMAT
CHECKS, MONEY ORDERS, TAX: 6% (CALIF. ONLY)

Inquiry 307

SAVE (Same Day Shipping)

DISKETTES

LIFETIME WARRANTY

\$1.00 ea. Soft Sector 5 1/4" SS/DD

\$1.35 ea. Soft Sector 5 1/4" DS/DD

PLUS MANY OTHER TOP NAME BRAND DISKETTES

- **DYSAN**
- **MAXELL**
- **BASF**
- **3M**
- **NASHUA**
- **Free Catalogue:**

Our Satisfaction money-back guarantee...

- Certified 100% error free
- Non-metallic write protect tab
- Reinforced hub rings
- Tyvec Sleeve
- Plus Packaged in a hard library case (optional)

(CORPORATE ACCOUNTS WELCOME)
HOURS: 8 AM - 5 PM Mountain Time Monday-Friday
For Order Only: Information & Inquiries:
1-800-621-8385 Ext. 148 1-303-758-6134

SOFTWARE PLUS

3095-D South Peoria Street
Aurora, CO 80014

Inquiry 367

SUPERCOPY FOR IBM PC

Powerful utility copier, it allows making of backups of any diskette for IBM PC and compatibles.

Very compact, it replaces the Diskcopy without virtually losing any space. Its menu offers easy access to functions such as protection against copies from a diskette; analysis diagnosis; parameter modification and erasing of the target diskette.

Available in English, French and Spanish with instructions included in the diskette.

Frequently updated, its price is \$30 each or \$15 for orders of ten or more. This product is provided for the purpose of enabling you to make archival copies only.

Send check or money order to:

Yetiware
P.O. Box 1368
New York, NY 10025
212-222-6682

IBM PC is a trademark of IBM Corporation.
WE WANT DEALERS.

Inquiry 425

ICs PROMPT DELIVERY!!!

SAME DAY SHIPPING (USUALLY)

OUTSIDE OKLAHOMA: NO SALES TAX

INCREASE XT MOTHERBOARD TO 640 Kbytes
CONSUME NO EXPANSION SLOTS! \$123.85

DYNAMIC RAM			
256K	256Kx1	150 ns	\$ 5.77
64K	64Kx1	120 ns	2.30
64K	64Kx1	150 ns	1.69
64K	64Kx1	200 ns	1.87
EPROM			
27C256	32Kx8	250 ns	\$21.25
27256	32Kx8	250 ns	\$18.75
27128	16Kx8	250 ns	9.37
27C64	8Kx8	200 ns	8.75
2764	8Kx8	250 ns	3.97
2732A	4Kx8	250 ns	4.69
2716	2Kx8	450 ns	3.21
STATIC RAM			
6264LP-15	8Kx8	150 ns	\$10.50
6116LP-3	2Kx8	150 ns	2.67

QUANTITY ONE PRICES SHOWN

OPEN 6 1/2 DAYS: WE CAN SHIP VIA FED-EX ON SAT.
MasterCard/VISA or UPS CASH COD
Factory New, Prime Parts
MICROPROCESSORS UNLIMITED
24,000 S. Peoria Ave., BEGGS, OK, 74421 (918) 267-4961

Prices shown above are for March 26, 1985
Please call for current prices. Prices subject to change. Please expect higher or lower prices on some parts due to supply & demand and our changing costs. Shipping & insurance extra. Cash discount prices shown. Orders received by 6 PM CST can usually be delivered to you by the next morning, via Federal Express Standard Air @ \$8.00; Priority 1 @ \$11.50!

Inquiry 271

IN STOCK



MODEMS

All modems listed are Hayes compatible with Free Communications Software

RACAL-VADIC	MAXWELL
300PC 300, PC Internal w/soft	\$ 219
300 V 300, RS232C External	\$ 219
1200 PC 300/1200, PC Internal w/soft	\$ 337
1200 V 300/1200, RS232C External	\$ 369
2400 V 2400 Baud, RS232C External	\$ 519
George Communications Software	\$ 79
HAYES 1200 SMARTMODEM External	\$ 399
2400	\$ 645
U.S. ROBOTICS Passport	\$ 235
PROMETHEUS Promodem 1200	\$ 334

DIRECT CONNECT DEVICES

651 Chorro Ste. 6, San Luis Obispo, CA 93401

CALL FOR FREE CATALOG   CALL TO ORDER (805) 543-8308

PO/COD/Visa MC/Check - Many Items Not Listed.

Inquiry 131

maxell

PERSONAL COMPUTER PRODUCTS

The floppy disks that meet or exceed every standard of quality.

MD1-D 5 1/4" SINGLE SIDE DOUBLE DENSITY SOFT SECTOR \$1.59

MD2-D 5 1/4" DOUBLE SIDE DOUBLE DENSITY SOFT SECTOR \$2.09

SOLD IN BOXES OF TEN ONLY

tremendous selection of software books, accessories and supplies
UP TO 50% OFF!

Software for IBM PC

dBase III	349	Multimate	269
Framework	349	Symphony	419
Home Acct. Plus	89	Wordstar 2000	279
w/Ultralife	149	Wordstar Pro Pac	249

ABOVE SOFTWARE AVAILABLE IN OTHER FORMATS. CALL FOR AVAILABILITY AND PRICES.
Minimum shipping and handling \$2.00. California residents add 6% sales tax.
Prices subject to change without notice. Write for our free catalog.

ABC data products

3311 ADAMS AVE. SAN DIEGO, CA 92116
619-283-5488 800-854-1555

Inquiry 8

I.B.M. Compatible

Case	\$ 65.00
Motherboard (256 K RAM space, RAM not included)	280.00
Color Graphic Adapter	150.00
Floppy Disk Driver Controller Card	75.00
Plotter (4 colors)	495.00
Computer (2 DD Driver Color Graphic Adapter, 256 K RAM, Case, Keyboard and 135 W Power Supply)	1,500.00
Keyboard	100.00

APPLE Compatible

Z 80 Card	40.00
80 Column Card	50.00
I.C. Tester	125.00

Prom 8200 Programmer (Fast Universal Type
Eprom & Prom Programmer)
For Eprom: 2716-27512; 2516-25512; (No Adapter Needed)
For Prom: 63xx, 745xx, 145xx, 185xx, 245xx, 285xx, 825xx, 875xx,
Include RS232 Interface

CALL NOW (312) 280-7610
Telex 280208 HFFMNT CGP
DIST. WANTED
HOFFMAN INT'L
600 N McClurg CT. STE. 309A
Chicago, Illinois 60611

Inquiry 189

TRIFOX

PRODUCTIVITY TOOLS

FOR IBM PC or Compatible

Encrypt	Global Replace
Hexdump	Compress
Scan	Batch Builder
DIFF	and many more

\$24.95 plus \$5 Shipping & Handling
MONEY BACK GUARANTEE

14081 749-1331

TRIFOX, INC

505 W. Olive, #300, Sunnyvale, CA 94086

Inquiry 401

Sav-On Computers 800-345-7100

ORDERS INSIDE CALIF — 213-675-2115

CUSTOMER SERVICE & TECHNICAL HELP — 213-675-2382

WE HAVE THE LOWEST PRICES IN BYTE — WE HAVE MOST ITEMS IN STOCK AND WE WILL BEAT ANY ADVERTISED PRICE ON THE SAME TERMS!

DISK DRIVES TEAC 55B ½ HIGH DRIVE \$109.00 55A 169.00 55F CALL	DISK DRIVES TANDON 100-2 FULL HEIGHT FOR PC \$109.00 101-4 CALL	DISK DRIVES MPI FULL HEIGHT FOR PC \$89.00 ½ HIGH CALL	DISK DRIVES MICRO SCI A2 FOR APPLE \$179.00 OTHERS CALL	DISK DRIVES RANA DRIVE CONTROLLER \$85.00 RANA DRIVES CALL
DISK DRIVES IBM CONTROLLER HANDLES 4 DRIVES \$69.00 MANY MORE CALL	DISK DRIVES OTHER DRIVES AVAILABLE CALL	IBM MEMORY 64K \$15.95 128K \$30.00 DEALERS CALL	IBM IBM PC CALL FOR BEST PRICE	IBM IBM XT \$3195.00 w/10 MEG HD
IBM IBM PORTABLE \$2195.00 W / 2 DR & 256K	IBM IBM TO PRINTER \$19.95 OTHER CABLES AVAILABLE CALL	IBM IBM MONO CARD \$219.00 CALL FOR MONITORS NOT LISTED BELOW	IBM WE WILL BEAT ANY IBM PRICE CALL!	COMPUTERS COMPAQ DESK PRO 2 \$2379.00 WITH MONITOR
COMPUTERS SANYO 555-2 W/MON. & SOFTWARE \$1099.00 SANYO PARTS AVAIL.	COMPUTERS COMPAQ PORT. 2 DRIVES & 256K \$2095.00 WOW	COMPUTERS APPLE PRO SYSTEM \$1349.00 WHILE THEY LAST	COMPUTERS APPLE MAC 1 DRIVE & 256K \$2095.00 FATMAC AVAILABLE	COMPUTERS CALL FOR OTHER CPU's
MODEMS HAYES 1200B INTERNAL W/S.W. \$345.00 ALL HAYES AVAILABLE	MODEMS ANCHOR MARK XII \$219.00 ALL ANCHOR AVAILABLE	MODEMS VOLKS MODEM \$199.00 WHILE THEY LAST	SOFTWARE LOTUS 1-2-3 \$299.00 WHILE THEY LAST	SOFTWARE SYMPHONY \$409.00 WHILE THEY LAST
PRINTERS OKIDATA FOR IBM \$345.00	PRINTERS JUKI 6100 (18cps) \$379.00	PRINTERS EPSON FX80T \$379.00	PRINTERS GEMINI SG AVAILABLE CALL	PRINTERS BROTHER HR15XL \$389.00
HARD DISK CAL PEK 10 MEG HARD DRIVE W/CONTROLLER 120 DAY WARRANTY \$729.00	MONITORS AMDEK 310A MONOCHROME \$165.00	MONITORS PRINCETON HX12 \$439.00	COLOR CARD HERCULES W/PARALLEL PORT \$179.00	EXPANSION CARD DATA PLUS 256K EXP CARD FOR PC / COMPATIBLES \$169.00

FINANCING AVAILABLE—with approved credit

DEALERS: Open Accounts available, call for applications

TERMS: We accept VISA, MASTERCARD, COD's, and Wire Transfers. UPS, Federal Express and Emery shipping available. California residents please add 6½% sales tax to order. Prices are subject to change without notice. Not responsible for typographical errors.

Sav-On Computers, Inc.

12595 Crenshaw Blvd., Hawthorne, CA 90250

OPEN: 7:30am till 6:00pm Monday-Friday and 9:00am till 2:00pm Saturday

MAY 1985 • BYTE 491

**Your I.C. Connection
(213) 516-7018**

DYNAMIC RAMS	
4164-150NS	2.45
STATIC RAMS	
2016P-1 (100NS)	4.45
6116P-3 (150NS)	3.75
EPROMS	
2716-450NS	3.00
2532-450NS	4.50

**MANY OTHERS IN STOCK
CALL FOR SPECIAL PRICES**

- Low, low prices
- Top Quality Parts
- Wide Selection
- Fast Delivery



INTERNATIONAL (U.S.A.)
A DIVISION OF HAN YANG TRADING COMPANY, INC.

13760 Grammercy Place
Gardena, CA 90249

TLX: 664747 HYEXIM FAX: (213) 217-0363

Inquiry 163

DISK DRIVES

Half Height
IBM Compatible

**ONE YEAR
WARRANTY**

40 tr. DS/DD \$115.00
80 tr. DS/DD \$139.00
1.2 meg. floppy CALL

Enclosures and mounting kits
Special bracketed pair pricing

IN STOCK * 2 DAY SHIP



ALLIED MICRO DEVICES

2809 Boardwalk, Ann Arbor, MI 48104
(313) 996-1282:TX 2907707 AMEL

*Manufactured by SANYO

Inquiry 20

**SAVE TIME AND MONEY WITH
LOW COST PI-SWITCH BOXES.**

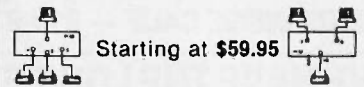

Starting at \$59.95

•Quickly shares your computer among multiple terminals, printers, modems, etc. with just a flick of the wrist.

•Compact black & beige aluminum enclosure features a high quality rotary switch with rear mounted connectors.

•Serial RS-232 Models have fem. 25-Pin Conn. (Lines 1-7 & 20)

PI-02-S switches 2 to 1 \$59.95

PI-03-S switches 3 to 1 79.95

PI-05-S switches 5 to 1 109.95

•Parallel models have fem. 36-Pin cent. conn.

PI-02-P switches 2 to 1 94.95

PI-04-P switches 4 to 1 154.95

•Dealers, schools & custom inquiries welcome.

•One Year Warrantee. COD, VISA, M/C.

•Shipping UPS \$2.00/ea. AIR \$4.00/ea.



7301 NW 41 St.
MIAMI, FL 33166
(305) 592-6092

Inquiry 350

Vertical Mkt.

Over 135,000
GAS STATIONS
Need Specialized
Bookkeeping Software

**STATION
MASTER**

Complete integrated system with quick, easy data entry to automatically create daily accounting. Reports shift check-out, TBA, profit & margins. Has full inventory control, AR, Payroll, P/L, many other features. MS DOS & CP/M versions, fully working demo available.



**Small Business
Computer Systems, Inc.**

313 Llewellyn Rd., Ambler, PA 19002 215-542-9639

Inquiry 359

wabash®

When it comes to
Flexible Disks, nobody
does it better than
Wabash.

MasterCard, Visa Accepted
Call Free: (800) 235-4137



**PACIFIC
EXCHANGES**
100 Foothill Blvd.
San Luis Obispo, CA
93401 (In Cal. call
(805) 543-1037)

Inquiry 310

**3M Diskettes
Lifetime Warranty**

Think you're getting the best price on 3M Diskettes?

You're right . . . BUT ONLY IF
You're buying from
NORTH HILLS CORP.

We will beat any nationally advertised price* or give you a 15 disk library case FREE!

Call us last—TOLL FREE—for our best shot every time.

1-800-328-3472

Formatted and hard sectored disks in stock.

Dealer inquiries invited. COD's and charge cards accepted. All orders shipped from stock within 24 hours. Why wait 10 days to be shipped?



North Hills Corporation

3564 Rolling View Dr.
White Bear Lake, MN 55110

MN Call Collect 1 612 770 0485

*verifiable; same product, same quantities

Inquiry 296



NEW!

SafeSkin

KEYBOARD PROTECTOR

Remains in place during keyboard use. Prevents damage from liquid spills, dust, ashes, etc. Fits like a second skin, excellent feel. Homerow and numeric locators. Available for: IBM-PC, Apple IIe, Radio Shack Model 100, Commodore 64. Send \$29.95, check or M.O., Visa & MC include exp. date. Specify computer type. Dealer inquires invited. Free brochure available.

MERRITT Computer Products, Inc.
2925 LBJ, #180 / Dallas, Texas 75234
(214) 942-1142

Inquiry 259

JUST IN TIME

EXSEL INC.

**30 - 60% SAVINGS
on**

**Computers
Word Processors
Peripherals**

EXSEL INC.

OFFICE EQUIPMENT BROKERS

800-624-2001 NY (716) 325-5530

Inquiry 162

**HARD DISK BOOT
+
DATA SECURITY**

*FiXT ends
boot hassles,
stops data
thieves—*

**DATAMAC, DAVONG,
GREAT LAKES, IOMEGA,
XEBEC, ZOBEX, others.**

*No-Slot Installation for
IBM PC, COMPAQ, COLUMBIA
\$70 - \$95 + tax/shpg*



**GOLDEN BOW
SYSTEMS**

Box 3039

San Diego

CA 92103

619/298-9349

Inquiry 178

KRUEGER
Technology, Inc.
offers you an
attractive
alternative
on the purchase
of guaranteed ICs.

COMPARE OUR PRICES!

100% GUARANTEED ICs

EXTRA
SPECIAL
FEATURE

4164 DRAM
9 for 13.95

41256 DRAM
8.95 each net

GROUP SPECIALS

74 Series

74XX	.25
741XX	.35
742XX	.49
743XX	.49

74LS Series

74LSXX	.25
74LS1XX	.35
74LS2XX	.49
74LS3XX	.49

74S Series

74SXX	.35
74S1XX	.45
74S2XX	.59
74S3XX	.59

OUR POLICY

Delivery: Orders normally shipped within 2 business days. Add \$3 for UPS ground-5# & under. Add \$4 for UPS blue (air). 2# & under, for each additional air pound add \$1. Arizona residents add 6% sales tax.

Payment: Visa, MC, cashiers check, certified check, money order, personal check accepted. (Allow 10 days for personal checks to clear.) No surcharge on credit card orders. CODs welcome with cash, certified check, cashiers check or money order. Add \$3 COD handling charge.

Pricing: Minimum order \$20. 30% discount on orders over \$500. Prices subject to change without notice. All items limited to stock on hand.

COMPARE 2764 200NS 3.95

EPROMS

1702	2K	2.63
2708	8K	2.37
68708	8K	7.50
2716 300-450NS	16K	2.63
2716 500-650NS	16K	1.88
2532, 2732 200NS	32K	4.20
2532, 2732 250NS	32K	3.75
2763	64K	3.20
68766 (24 PIN)	64K	11.86
2564, 2764 300NS	64K	3.95
27128 250NS	128K	7.45
27128 300NS	128K	6.95
27128 450NS	128K	5.95

COMPARE TMS4416 1.75

DYNAMIC RAMS

4164 150NS	64K	9/13.95
4164 150NS	64K	1.75
TMS4416	64K	1.75
4164 250NS	64K	1.25
2620	64K	1.75
4332	32K	3.00
2118	16K	1.50
4116 150NS	16K	.89
4116 200NS	16K	.59
4116 250NS	16K	.39
4027	4K	.45

COMPARE 6264P-12 14.40

STATIC RAMS

10415	1Kx1	6.26
2115	1Kx1	1.13
2125	1Kx1	1.50
93415	1Kx1	3.38
93425	1Kx1	3.38
2510	1Kx1	3.38
2511	1Kx1	3.38
2148	1Kx4	3.92
2149	1Kx4	3.92
10474	1Kx4	3.00
2114 200NS	1Kx4	.70
2114 450NS	1Kx4	.50
4801 70NS	1Kx8	3.38
4118 250NS	1Kx8	2.93
6116 200NS	2Kx8	3.68
6116 250NS	2Kx8	2.93
10470	4Kx1	10.44
2141	4Kx1	1.05
2147	4Kx1	3.38
TMS4044 200NS	4Kx1	1.05
TMS4044 300NS	4Kx1	.90
1420	4Kx4	4.50
2168	4Kx4	4.50
2167	16Kx1	4.50

"L" Series slightly higher.

NOTE: This is just a sampling of our 6 million IC Inventory.

COMPARE 6810 .75

6500/6800 MICROPROCESSORS

6502	1.50
6503	1.50
6504	2.75
6512	1.25
6522	2.75
6532	3.75
6545	8.00
6800	1.75
6802	3.25
6803	7.50
6809	5.00
6810	.75
6820	1.50
6821	1.25
6844	10.50
6850	1.50
6852	2.25
6860	3.25
6875	2.75

COMPARE 8080A 1.95

8000 Series

8031	9.00	8243	5.00
8035	3.75	8251	3.25
8039	3.75	8253	3.50
8080A	2.25	8253-5	4.00
8085	3.75	8255	3.25
8085A2	7.50	8255-5	3.75
8086	12.00	8257	3.50
8088	11.25	8257-5	4.00
8155	2.85	8259	3.50
8741	12.00	8259-5	4.00
8748	12.00	8272	12.50
8202	13.50	8274	12.00
8205	2.25	8276	17.50
8212	1.00	8279	4.00
8214	2.25	8279-5	5.00
8216	1.00	8284	4.00
8224	1.50	8286	4.50
8226	1.25	8287	4.50
8228	2.25	8288	10.00
8237	6.75	8289	18.00
8237-5	7.50	8292	5.00
8238	3.00		

COMPARE TMS9918 22.50

MISCELLANEOUS

TMS9901	1.50	TMS9900	3.00
TMS9904	1.50	9602	1.10
TMS9914	3.00	96L02	2.25
TMS9980	13.26	96L502	3.75

COMPARE Z80CPU 1.13

Z80 Series

2.5 MHZ		4.0 MHZ (Z80 A)	
CPU	1.13	CPU	1.88
CTC	1.13	CTC	1.88
DART	3.00	DART	4.50
DMA	3.00	DMA	4.50
PIO	1.13	PIO	1.88
SIO (Any)	3.00	SIO (Any)	4.50

COMPARE ADC0809 2.48

DATA ACQUISITION

DAC0800	9.90
DAC0806	1.14
DAC0808	1.44
ADC0809	2.48

COMPARE D765 11.25

FLOPPY DISK CONTROLLERS

D765	11.25	8877	11.25
1791	11.25	8272	12.00
1793	11.25	2143	5.25
8876	11.25	9216	5.25

COMPARE 6845 5.00

CRT CONTROLLERS

CRT5027	5.00
CRT5037	10.00
6845	5.00
46505	5.00

COMPARE AY5-1013A 2.00

UARTS

AY5-1013A	2.00	1482	4.50
AY3-1015A	3.00	2350	4.50
TR1402	2.00	2651	4.50
TR1602	2.25	6402	3.50
TR1863	2.25	7201	10.50
TR1472	4.50		

KRUEGER Technology, Inc.

2219 South 48th Street • Tempe, AZ 85282

800-245-2235

In Arizona 602-438-1570

HOURS: 8 a.m.-5 p.m.
(MOUNTAIN TIME)
Monday Thru Friday



PRINTER RIBBONS

	PRICE	PER RIBBON	PER DOZEN
ANADEX 9500		10.50	109.80
APPLE DMP		5.50	58.80
BROTHER HR-15/25 MS		5.95	68.40
C. ITOH PROWRITER		5.50	58.80
COMMODORE MPS-801		8.00	90.00
EPSON MX-FX 70/80		5.00	48.00
EPSON MX-FX 100		6.95	75.00
EPSON LQ-1500		9.75	111.00
GEMINI 10-10X-15-15X		2.50	23.40
IBM/IDS 4-COLOR		15.75	180.00
IDS MICROPRISM-480		5.75	58.80
NEC - 3500 M/S Non Flip		6.25	69.00
NEC - 3500 NYLON		9.00	96.00
NEC - 8023A		5.50	58.80
OKIDATA 80/82/83/92		2.50	23.40
RADIO SHACK DMP-2100		7.50	87.00
RADIO SHACK LP VI & VIII		7.50	58.80
RITEMAN		8.50	96.00
SILVER REED EX 550 M/S		8.50	90.00
SILVER REED EX 550 NYLON		6.95	75.00
TALLY SPIRIT - 80 M/S		7.50	84.00
TALLY - MT-160		8.00	90.00
TALLY - MT-180		8.50	96.00
TOSHIBA - 1350/1351		7.50	87.00

Add \$3.00 Ship. & Hand. — To Order Call

Toll Free 1-800-742-1122

In MI (313) 569-3218 or Write for our Catalog

DWIGHT COMPANY, INC.

15565 Northland Drive - West Tower
Southfield, Michigan 48075-6496

DATA ACQUISITION and control for ANY computer



The Model 1232 communicates via RS-232, and has 8 analog inputs (± 4 VDC; 12 bits), 8 digital inputs and outputs, and a 2000 point buffer. Suitable for field data logging or lab use, the 1232 costs only \$690. The 8-bit system (0-5 VDC) is \$490. Detailed manual, \$6. Phone our applications engineer at 617-899-8629 or write:

★★ **STARBUCK** DATA COMPANY ★★

225 Crescent St., Waltham, MA 02154

CONVERSE WITH YOUR COMPUTER

AT LAST! A FULL IMPLEMENTATION of the original ELIZA program is now available to run on your microcomputer!

Created at MIT in 1966, ELIZA has become the world's most celebrated artificial intelligence demonstration program. ELIZA is a non-directive psychotherapist who analyzes each statement as you type it in and then responds with her own comment or question—and her remarks are often amazingly appropriate!

Designed to run on a large mainframe, ELIZA has never before been available to personal computer users except in greatly stepped down versions lacking the sophistication which made the original program so fascinating.

Now our new microcomputer version possessing the FULL power and range of expression of the original is being offered at the introductory price of only \$25. And if you want to find out how she does it (or teach her to do more), we will include the complete SOURCE PROGRAM for only \$20 additional.

Order your copy of ELIZA today and you'll never again wonder how to respond when you hear someone say, "Okay, let's see what this computer of yours can actually do!"

ELIZA IS AVAILABLE IN THE FOLLOWING FORMATS:

- 1 5 1/4 inch disk for the 48K Apple II, II Plus, IIe or IIc \$25 for Protected Version—\$45 for Applesoft Source Version
- 2 5 1/4 inch disk for the 64K IBM Personal Computer \$25 for Protected Version—\$45 for IBM Disk BASIC Source Version
- 3 5 1/4 inch disk or tape cassette for the Commodore 64 (specify which) \$25 for Protected Version—\$45 for C-64 BASIC Source Version
- 4 Standard 8 inch single density disk for all CP/M based computers \$25 for ELIZA.COM—\$45 with Microsoft BASIC-80 Source
- 5 1/2 inch disk for most CP/M based computers (specify computer) \$25 for ELIZA.COM—\$45 with Microsoft BASIC-80 Source

Please add \$2.00 shipping and handling to all orders (California residents please add 6% sales tax)

ARTIFICIAL INTELLIGENCE RESEARCH GROUP

921 North La Jolla Avenue, Dept. B

Los Angeles, CA 90046

(213) 656-7368 (213) 654-2214

MC, VISA and checks accepted



Inquiry 141



Sure it's insured?

SAFEWARE Insurance provides full replacement of hardware, media and purchased software. As little as \$35/yr covers:

- Fire • Theft • Power Surges
- Earthquake • Water Damage • Auto Accident

For information or immediate coverage call:

1-800-848-3469

In Ohio call (614) 262-0559

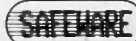

SAFEWARE, THE INSURANCE AGENCY INC.

Inquiry 351

BLUE BOOK

Prices shown for thousands of computers, software, and peripherals.

Each listing includes suggested list, avg. retail, wholesale, and used prices for all the geographical regions of the United States.

Send \$12.95 + \$.50 postage to:

NCDA

National Computer Dealers Association

5420 Hwy. 6 North

Houston, Texas 77084

Inquiry 88

Centech PREMIUM COLOR DISKETTES LOWEST PRICE EVER

TIMELESS WARRANTY

SSDD

\$165 ea.

DSDD

\$215 ea.

5-1/4" QTY. 20

~~\$230~~

96 TPI

~~\$290~~

*Discounts Starting At Quantity 50 & Above

DEFINITELY COLOR-CODED DISKETTES ARE THE MOST EFFECTIVE METHOD FOR ORGANIZING YOUR DISKETTE FILES. Available in Red, Blue, Green, Yellow, Orange and many other colors. 100% error-free and backed by TIMELESS WARRANTY. Factory fresh and boxed in 10's with Tyvek sleeves, reinforced hubs, write-protect tabs and labels.

SHIPPING: Add \$3.00 per 100 diskettes or fraction thereof. Same day dispatch. VISA and Mastercard accepted. COD orders only add \$3.00 handling charges. Utah residents add 5 1/2% sales tax.

WE WILL BETTER ANY PRICE ON THE SAME PRODUCT AND QUANTITIES ADVERTISED NATIONALLY.

TOLL FREE ORDER LINE ONLY:

1-800-233-2477

INFORMATION AND INQUIRIES:

1-801-942-6717

HOURS 9AM-8PM, M-F (MT. STATE TIME)



Computer Affairs, inc. 2028 E. FT. UNION BLVD., #105
SALT LAKE CITY, UTAH 84121
CALL: 1-800-AFFAIRS

Inquiry 92

Serial Parallel

NEW!



Convert What You Have
To What You Want!

- RS232 Serial
- 8 Baud Rates
- Latched Outputs
- Centronics Parallel
- Handshake Signals
- Compact 3 1/2 x 4 1/4 x 1 1/4

No longer will your peripheral choices be limited by the type of port you have available! Our new High Performance 700 Series Converters provide the missing link. Based on the latest in CMOS technology, these units feature full baud rate selection to 19.2K, with handshake signals to maximize transfer efficiency. Detailed documentation allows simplified installation. Order the Model 770 (Ser/Par) or Model 775 (Par/Ser) Today!

Buffer Products
Coming Soon!



only \$89.95

Connector Option \$10.00
CA Residents 6% tax
UPS Shipping \$3.00

2734C Johnson Dr.
Post Office Box 3717
Ventura, California 93008

CALL (805) 658-7466 or 658-7467

For FAST Delivery

maxell DISKS

LIFETIME WARRANTY

Think you're getting the best price on Maxell Diskettes? You're right . . . BUT ONLY IF . . .

You're buying from
NORTH HILLS CORP.

We will beat any nationally advertised price* or give you a 15 disk library case FREE!

Call us last—TOLL FREE—for our best shot every time.

1-800-328-3472

Formatted and hard sectored disks in stock.

Dealer inquiries invited. COD's and charge cards accepted. All orders shipped from stock within 24 hours. Why wait 10 days to be shipped?



North Hills Corporation

3564 Rolling View Dr.

White Bear Lake, MN 55110

MN Call Collect 1-612-770-0485

*verillable; same product, same quantities

Inquiry 297

DATA ACQUISITION TO GO INTERFACE FOR ANY COMPUTER



Connects via RS-232. Built-in BASIC. Stand alone capability. Expandable. Battery Option. Basic system: 16 ch. 12 bit A/D, 2 ch. D/A, 32 bit Digital I/O. Expansion boards available. Direct Bus units for many computers.

SPECIALISTS IN PORTABLE APPLICATIONS

(201) 299-1615

P.O. Box 246, Morris Plains, NJ 07950

ELEXOR

Inquiry 153

Inquiry 154

Flower Specials

We Cater to IBM™ Dealers
* Hardware * Software
* Training Tapes *
Call for our Catalog now!

Terms: We accept Visa, M/C, Pre-Pay by Check or Money Order. COD's are accepted by Telephone & Mail. COD Terms are: Cashier's Check for first time orders over \$100.00. Fax: 714/897-3383 Tlx: 887841 XORDATA HTBH

TEAM New Hayes SmartModem Compatible! TEAM
Finally a price breakthrough on a Hayes compatible, external 300/1200 baud modem. This low price is without driver software, but if you need it add \$25.00. Call for a 26 page catalog of our special deals. Look in this spot every month for Hot, New items sure to catch your interest.



- Runs the popular Hayes communications software
- FCC approved for direct RJ-11 connection
- All cables & power supply included for this one low price. MOD-8100-00

\$279.00

IBM PC-XT SELECTRIC KEYBOARDS
Our volume purchase of these excellent Selectric type keyboards will bring the features you have been wanting down to a price you can't resist. So many features you'll love it!!

- Single key reset
- Separate numeric keypad
- Separate "Arrow" keypad
- Dimple marked "5", F, & J keys

KEY-1051-00 Selectric **\$129.00**
KEY-1050-00 Standard **89.00**



ADD-ON POWER SUPPLY
Power Supply with Fan and Power Filter. Uses 140 watts, runs Hard Disk & Tape Back-Up. IBM Replacement type for Hard Disk.

New High Velocity Fan!
New Low Price!
POW-1040-00 **\$99.00**



IBM STYLE MOTHERBOARD
Micro Products announces a powerful new IBM XT type motherboard. 4 layers for superior reliability & speed. Turbo mode allows 75% higher thru-put by increasing system clock to 7.0MHz under software control. Designed to use new 256K RAM chips or 64K chips. 640K memory expansion does not require use of valuable card slots. Many outstanding features combined with our new 7 PAK Multifunction board make previously expensive options standard features at a LOW LOW Cost.

BOA-8068-00 Supplied with OK **\$349.00**



SUPER 12 PAK MULTI-FUNCTION
This one is really loaded! Features: One Parallel Port, One RS232-C Serial Port, One Game Port, Real-Time Clock/Calendar with Battery Back-up, Expandable to 384K of Parity-checked Memory, Supplied OK Memory, all cables, PrintSpooler and RAM Disk Software.

BOA-6335-00 **\$199.95**
*Additional (9) 64K Memory Chips
KIT-8000-00 **\$ 15.00**



Do it Yourself!
Think of this System as a "Do it Yourself" System. Start by choosing 8 Slots. Some of the standard Features: • 64K RAM expandable to 256K • 4 DMA Channels • Runs MS-DOS™ and CP/M-86™ software not included! • Multi-function Keyboard & Cable Hard Disk Ready Power Supply • And MORE!

YS-8000-00 **Only \$525*1695**



OEM's 1245-Single \$1495 Complete System! XPC Turbo!

NEW Features!

- RAM Disk
- Game Port
- 640K cpcty
- PrintSpooler
- Turbo mode!

4.77MHz to 7.00MHz!
■ Ser, Par
■ Clock

***OEM Qty 12 +**



Add-On H.D. & Tape

10 Meg H.D. Complete System! \$1995.00*

20 Meg Color Complete System! \$2550.00*

40 Meg w/Tape Complete System! \$3035.00*

Software

- XWORD
- XBASIC
- XBASE
- XCALC
- XCOM

10 Megabyte Irwin on the top, your choice of Hard Disk on the bottom. Super appearance! Requires one slot in your PC for SASI Interface and an extension connector on the floppy card. Everything else is supplied by us.

10 Meg \$1295	40 Meg \$1995
20 Meg \$1395	105 Meg \$4395
26 Meg \$1595	140 Meg \$4995



This is OUR Junior!
This "Driveless" workstation for low-cost Networking. Features: • 4-slot IBM™ compatible Motherboard • 128K Standard Memory • 8088, 8087 Math Co-processor • Optional Floppy Drive with Controllers.

YS-8100-00 **\$475*1675**

Full System w/Keyboard, Mono Monitor, Video Display Card, 128K RAM 1 Drive **SYS-8725-00 \$895*1950**



Check These Standard Features:

- Full-Size, Feather-Touch, Capacitance Keyboard, 10 Function Keys, Calculator-Type Numeric Keypad
- Parallel & Serial I/O • Real Time Clock • Game Port • 2.Slimline 5 1/4" DS/DD 48 TPI 360K Drives
- 8 IBM expansion slots • RAM Disk • Print Spooler • 4 DMA & 3 Timer channels
- Full 640K capacity on-board • 8088 16-bit CPU • Monochrome Video Card
- Up to 32K of EPROM (full 8K supplied) • Supports PC-DOS • MS-DOS • CP/M-86
- Power Supply Hard-Disk-Ready, no need to add-on additional power
- High resolution 12" Monitor, Green Screen, 22 MHz bandwidth

Add-On Hard Disk
Two ways to go. The Internal system is cheaper because it does not need a P/S & Chassis. The same P/S & Chassis can be used for a 10 Meg Tape Back-up on your XT!

10 Megabyte \$595 int/*895 ext	40 Megabyte \$1295 int/*1595 ext
20 Megabyte \$795 int/*1095 ext	105 Megabyte \$3795 int/*3995 ext
26 Megabyte \$995 int/*1295 ext	140 Megabyte \$4395 int/*4695 ext



Add-On 10 Meg Tape
If your IBM-XT needs a little help in the Back-up category, you won't be able to beat this price! Cables, software and everything!

SUB-8300-00 **\$495*1695**



Not enough room here - Call for Catalog

MITS MultiMedia Interactive Training Systems

INTERACTIVE Video or Audio Tape Training! That's Right!

Learn at home - at your own pace - Lotus 1-2-3™ Framework™ WordStar™ IBM-PC DOS™ dBase II™ Symphony™ SuperCalc™ BusinessMaster™

At last! An inexpensive, convenient means of learning how to use a Computer and Software. With his System you sit comfortably in front of your Computer, watch a demonstration, and then, the tape system (Audio or Video) actually INTERACTS with you! Telling you what keys to strike, waiting for you to do the exercises at your own rate. As much practice time as You want. A pace that you set. Some classes 10 hours in length! Fantastic detail and tips! Call us for more information and practical demonstrations. Nothing like it anywhere else!

We follow are a registered Trademarks and their Companies: 1-2-3, Symphony - Lotus Development Company, MS-DOS, PC-DOS, Flight Simulator - MicroSoft, dBase II - Ashton-Tate, WordStar - MicroPro International Corp., SuperCalc - Sorcim, Inc., VisiCalc - VisiCorp, Inc., CP/M-86 - Digital Research Inc., IBM, IBM-PC, IBM-PC XT - International Business Machines.

POWER BACK-UP
Protect your Data Datasheet! Is a battery operated Power Generator which instantly supplies even, uninterrupted AC Power to a Microprocessor in the event of a Power Drop or Outage. Also provides Surge Protection, which filters and eliminates voltage spikes (surges) above 140 VAC.

200 watts POW-2000-00 **\$299.00**
300 watts POW-2050-00 **\$399.00**



INTERNATIONAL ORDERS
Micro Products is ready to serve your needs in several countries. Each Office has Sales Literature, Local Pricing, Inventory and Technical Service available to support your needs. There are no problems with U.S. Export Forms.

HEAD OFFICE
Darryl R. Green
15392 Assembly Lane, Unit A
Huntington Beach, CA 92649
Phone: 714/898-0840
Telex: 887841 XORDATA HTBH

AMSTERDAM OFFICE
Cynthia Clark
Building 70, 4th Floor
1117 ZH Schiphol-East
Amsterdam, The Netherlands
Phone: (020) 45 26 50
Telex: 18306

AUSTRALIAN OFFICE
8 Irwin Street, Bellevue
W. Australia 6056
Phone: 274-3701

TAIPEI OFFICE
William Wang
Suite 605, Worldwide House
685 Min Sheng E. Rd.
Taipei, Taiwan, R.O.C.
Tel: (02) 712-8877 Tlx: 21405

MARACAIBO OFFICE
Jim Stevens
Av. 3F Esq. Calle 81
Centro Com. Maelga - Local #5
Maracaibo, Venezuela 4001-A
Phone: 061-913328
Telex: 62344 PEMIN

CANADIAN OFFICE
-- PENDING --

PROM LASER
This is the One! Our PROM Burner allows reading, storing-to-disk, recalling, and burning. Hi-speed algorithms burns 2764 in 45 seconds! Also handles 2716, 2732, 27128, 27256. Features: Zero insertion force sockets; On-board Voltage Generator; No Interference with normal computer operations.

BOA-8640-00 **\$199.00**



MISCELLANEOUS \$\$\$ SAVERS

7 PAK Multifunction Floppy, RTC, 2 Serial, 1 Parallel, Game, RAM Disk
BOA-8250-00 **\$189.00**

64K Memory Chips (9) NEC for IBM KIT-8000-00 **\$ 15.00**

256K DRAM Memory Chips (9) = 256K KIT-9000-00 **\$ 81.00**

Add-On Memory, (up to 512K) supplied OK BOA-6350-00 **\$ 99.00**

Floppy Controller, Controls up to four drives, 5 1/4" 4896 TPI
BOA-6100-00 **\$ 95.00**

Monochrome Graphics Card, (Hercules type) (1-2-3 compatible) 720h x 348v
BOA-6150-00 **\$175.00**

Color Graphics Card, 320 x 200 Res. Color, 640 x 200 Monochrome
BOA-8200-00 **\$145.00**

Clock Calendar Board, fits in "short slot" w/battery Back-up
BOA-6375-00 **\$ 55.00**

Hard Disk Controller, standard ST506 interface for DOS 1.1 & 2.0
BOA-8050-00 **\$245.00**

300 / 1200 Baud Modem Internal w/PC Talk III Communications Software
BOA-8725-00 **\$239.00**

Monochrome Monitor, 22MHz bandwidth, composite input or TTL
MON-1725-00 Green/Com **\$ 99.00** MON-1700-00 Amber/Com **\$104.00**
MON-1775-00 Green/TTL **\$104.00** MON-1750-00 Amber/TTL **\$109.00**

NEC PRINTERS

2050	\$ 655
3550	\$1315
8850	\$1685
2010/15/30	\$ 625
3510/15/30	\$1185
8810/15/30	\$1625
Elf 360,370.....	\$ 399
Pinwriter P-2.....	\$ 490
(w/Interface & Tractor)	
Pinwriter P-3.....	\$ 690
(w/Interface & Tractor)	

Terms: PREPAID — FREE FREIGHT!!

QUALITY PRINTERS
8415 Cement City Rd.
Brooklyn, Michigan 49230
Phone: 517-592-3749

Inquiry 336

ZENITH/Heath Users

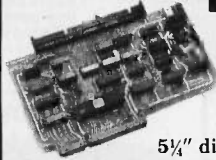

Double Your
5 1/4" disk storage
capacity without adding a drive.

Get twice as much from your H88 or H89 microcomputer. Our FDC-880H floppy disk controller, in conjunction with your 5 1/4" drives, for example, expands memory capacity from 256 bytes to 512 bytes per sector.

And it handles single and double-sided, single and double-density, 8" and 5 1/4" drives — simultaneously.



C. D. R. Systems Inc.

Controlled Data Recording Systems Inc.
7210 Clairmont Mesa Blvd., San Diego, CA 92111
(619) 560-1272

Inquiry 68

\$99 SINGLE BOARD COMPUTER / CONTROLLER



MODEL MCG-85 FEATURES

- | | |
|------------------------|------------------------|
| 8085A CPU | - Automatic Baud Rate |
| 2K System Monitor ROM | - 5 Interrupts |
| 256 Bytes of RAM | - 14 Bit Counter/Timer |
| RS232 Port | - Onboard Prototyping |
| Parallel & Serial I/O | - 6.144 MHz Crystal |
| * Two 8 Bit Prog Ports | - Onboard Expansion |
| * One 6 Bit Prog Port | * 4K ROM &/or |
| 4 1/2 x 6 1/2 PCB | * 4K RAM or CMOS RAM |

STOCK. \$99 KIT. \$135 ASSEMBLED & TESTED.
A/D, Parallel I/O, Memory & Mother Cards Avail.
STD Product Line also available.

Visa, M.C., Amex & COD. Add \$5.00 Shipping.

CUSTOM DESIGNS & DEVELOPMENT
OUR SPECIALTY

SYNALTA SYSTEMS

31-14 Broadway
Astoria, New York 11106
(718) 728-6700

Inquiry 384

FoxBASE™ Interpreter/Compiler

- dBASE II® source compatible
- Runs 3-20 times faster than dBASE II
- 8087 coprocessor support†
- 14 digit precision
- Up to 48 fields per record
- Full type-ahead capabilities
- Provides compact object code and program security
- Twice as many memory variables as dBASE II

FOX SOFTWARE INC.

13330 Bishop Road, P.O. Box 269
Bowling Green, OH 43402
419-354-3981



Inquiry 171

VT100 or D200 on your PC, jr, XT, AT or compatible

ZSTEMpc-VT100 Smart Terminal Emulator
132-col. by windowing-no addtl. hardware
Double High/Double Wide Characters
Full VT100 line graphics. Smooth scrolling
2-way file transfers incl. XMODEM
Full keyboard softkeys/MACROS
Speeds to 38.4KB. High Throughput
ZSTEMpc-VT100 \$150. ZSTEMpc-D200 \$125.
30 day money back guarantee. MC/VISA.

ZSTEM Communications Division
KEA SYSTEMS LTD.
#412-2150 W. Broadway
Vancouver, B.C. CANADA V6K 4L9
Support (604) 732-7411
Orders (800) 663-8702

Inquiry 426

controls up
to 4 motors
from any CRT,
terminal or
computer



STEPPING MOTOR CONTROLLER

- powerful 5 amps/ winding
 - RS232 interface
 - Standard Version with BASIC \$985
 - 16K BASIC with Battery Backup \$1335
 - CNC VERSION \$1950
 - Stepping Motor Tips Cookbook \$8
 - CNC Manual \$12
 - acceleration deceleration
 - 1-4 axis moves
- CENTROID (814) 237-4535
Box 739, State College, PA 16804

Inquiry 69

DOUBLE THE OPTION CAPACITY OF YOUR IBM PERSONAL COMPUTER.

PC-XTRA

- DIRECT EXTENSION OF IBM PC BUS
- NO SOFTWARE CHANGES
- NO HARDWARE MODIFICATION
- STYLING CONSISTENT WITH IBM

Add all these special options that you've been wanting without worrying about filling your plug-in and back panel space



DEALER INQUIRIES INVITED.

\$549.00* F.O.B. SANTA ANA
*CALIFORNIA RESIDENTS ADD 6% SALES TAX

P C HORIZONS, INC.

1701 E. Edinger, Ste. A6, Santa Ana, CA 92680
(714) 953-5396

Inquiry 308

The Statistician

CPM IBM-PC
TRS-DOS XENIX

- Multiple Regression
- Stepwise
- Ridge
- All Subsets
- Backward Elimination
- Time Series Analysis
- Descriptive Statistics
- Transformations
- Survey Research
- Nonparametrics
- X-Y Plots
- ANOVA
- Random Samples
- Data Base
- Search & sort
- Hypothesis tests

Please call TOLL FREE
1-800-334-0854 (Ext. 814)



for more information
or write:
Quant Systems
Box 628
Charleston, SC 29402
VISA/MC Accepted

Inquiry 337

Maxell Floppy Disks

The Mini-Disks
with maximum quality.



Dealer inquiries
invited. C.O.D.'s
accepted. Call
FREE (800) 235-4137.

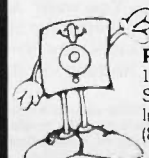

PACIFIC EXCHANGES
100 Foothill Blvd., San Luis
San Luis Obispo, CA 93401
In Cal. call (800) 592-5935 or
(805) 543-1037

Inquiry 310



SINCE 1977

Computer Discount Products

Monthly Mail-Order Listing For Apple, IBM & Macintosh Users

Retail Showrooms In California:
San Jose • San Mateo • San Francisco

WE PAY SHIPPING*
Get The Details Below!!

INFOCOM

Apple, IBM & Macintosh	
CUTTHROATS/ENCHANTER	ea25.99
DEADLINE/SUSPECT	ea29.99
INFIDEL/SORCERER	ea28.99
HITCHHIKER/SEASTALKER	ea26.99
WITNESS/ZORK I	ea27.99
ZORK II/ZORK III	ea29.99

MOCKINGBOARD

Sound Board	79.99
Speech Chips	79.99
Sound AND Speech Ite	145.99
Sound AND Speech Iic	145.99

ENTERTAINMENT

Ap	BEAGLE I.O. Silver - NEW!	SCALL
Ap	DECATHLON	23.99
Ap	SIR TECH Knight of Diamond	34.99
Ap	WIZPLUS	23.99
IBM	GATO	29.99
IBM	MASTERTYPE	32.99
IBM	SIR TECH Wizardry	44.99
Ap/IBM	CHAMP, LODERUNNER	24.99
Ap/IBM	ELECTRONIC ARTS Archon	29.99
Ap/IBM	Music/Pinball Const.	ea29.99
Ap/IBM	One On One/Sky Fox	ea29.99
Ap/IBM	FLIGHT SIMULATOR	35.99
Ap/IBM	SARGON III	31.99
Ap/IBM	TRILLIUM Amazon/Rama	ea27.99
Ap/IBM	Fahrenheit 451/Shadow	ea27.99
Ap/IBM	WINDHAM Below The Root	18.99
Ap/IBM	Swiss Family Robinson	18.99

APPLICATION Home & Business

Ap	ASCII Express	99.99
Ap	CONTINENTAL Hm. Acct	44.99
Ap	Home Accountant MAC	75.99
Ap	Tax Advantage	39.99
Ap	MONOGRAM Dollars/Sense Ite	69.99
Ap	Forecast	49.99
Ap	PFS Rept. File, Graph, Write	ea79.99
IBM	ASCII Express Pro	139.99
IBM	ASHTON-TATE dBase II	289.99
IBM	dBase III	389.99
IBM	Framework	389.99
IBM	CONTINENTAL FCM	71.99
IBM	Home Accountant +	84.99
IBM	Tax Advantage	45.99
IBM	CROSSTALK	105.99
IBM	LOTUS 1-2-3	299.99
IBM	MICROPRO TeImerge	119.99
IBM	MONOGRAM Dollars & Sense	109.99
IBM	PFS Rept. File, Graph, Write	ea89.99
Ap/IBM	MICRO COOKBOOK	32.99
Ap/IBM	MICROSOFT MULTIPLAN	169.99

WORD PROCESSING

Ap	BANK STREET Write/Spell	ea43.99
Ap	KENSINGTON Format II	99.99
Ap	MICROPRO Wordstar	189.99
Ap	Wordstar Pro w/CP-M	265.99
Ap	SENSIBLE SPELLER	79.99
Ap	SIERRA Screenwriter II	89.99
IBM	BANK STREET Writer	49.99
IBM	LIFETREE Volkswriter Deluxe	159.99
IBM	MICROSOFT Word w/Mouse	289.99
IBM	MICROPRO Wordstar 2000	259.99
IBM	Wordstar 2000 Plus	325.99

MODEMS

HAYES 300 Baud	209.99
1200 Baud	474.99
1200B for IBM	359.99
Micromodem Ite	239.99
NOVATION Applecat II 300 Bd.	198.99
Expansion Module	29.99
J Cat	104.99

HARDWARE

Ap	CDP 16K Ram Card	39.99	IBM	KENSINGTON PC Saver	29.99
Ap	Parallel Interface w/Cable	39.99	IBM	KOALA Touch Pad	89.99
Ap	DAN PAYMAR Lower Case 1	25.99	IBM	PLANTRONICS Color+ Board	375.99
Ap	Lower Case 2, Rev 7	19.99	IBM	QUADRAM 512 + 64K	229.99
Ap	EXTENDED 80 Col. Card-Ite	129.99	IBM	E Ram 80	129.99
Ap	JOYSTICK Kraft or TG	39.99	IBM	Microfazer 8K-All Config.	139.99
Ap	KENSINGTON System Saver	65.00	IBM	Quadboard I or II-No K	219.99
Ap	KOALA Touch Pad	75.99	IBM	Quadcolor I	195.99
Ap	MICRO-SCI A-2 Drive	195.99	IBM	Quadcolor Upgrade to II	199.99
Ap	ORANGE MICRO Grappier+	99.99	IBM	TEAC 1/2 Height Drive #55B	159.99
Ap	Buffered Grappier	159.99		VIDEO 7	
Ap	THUNDERCLOCK	109.99	Ap	RGB 80/64 Ite	189.99
Ap	TITAN Accelerator Ite	219.99	Ap	Slot 7 RGB Card II +/e	109.99
Ap	Neptune 64K	199.99	Ap	RGB Adapter Ite	149.99
IBM	AST Six Pack Plus 64K	245.99	Ap	Mapper Connector	39.99

UTILITIES & ENHANCEMENTS

Ap	BEAGLE D/Code - NEW!	29.99
Ap	Beagle Graphics	35.99
Ap	Dos Boss	15.99
Ap	Fat Cat	21.99
Ap	GPLE	29.99
Ap	Triple Dump	27.99
Ap	BRODERBUND Dazzle Draw	44.99
Ap	Graphics Library	19.99
Ap	Print Shop	31.99
Ap	COPY II + Program	25.99
Ap	EASTSIDE Wildcard II	111.99
Ap	FONTRIX	49.99
Ap	FINGERPRINT For Epson*	44.99
Ap	MERLIN	44.99
Ap	PENGUIN Complete Graphics	49.99
IBM	Graphics Magician	37.99
IBM	COPY II Program	25.99
IBM	FONTRIX	99.99
IBM	GET ORGANIZED	149.99
IBM	NORTON UTILITIES	55.99
IBM	SIDEKICK	35.99
IBM	SIDEWAYS	44.99
Ap/IBM	TURBO PASCAL	35.99
Ap/IBM	Toolbox	29.99
Ap/IBM	Tutor	29.99

MAXELL 5 1/4 SS 10/100	19.99/189.
MEMOREX 3 1/2 SS 10/100	34.99/339.
MEMOREX 5 1/4 SS 10/100	18.99/179.
FLIP-FILE Holds 50-5 1/4	14.99
MEDIA MATE Holds 30-3 1/2	11.99

MACINTOSH

BRODERBUND Loderunner	27.99
COPY II MAC	24.99
HOME ACCOUNTANT	63.99
MAC FUN	32.99
MAC VEGAS	34.99
MAC VISION	399.99
MEDIA MATE Holds 30-3 1/2*	9.99
MEMOREX 3 1/2" Diskettes	34.99
MICROSOFT Basic	94.99
Chart	74.99
File/Multiplan	ea129.99
MONOGRAM Dollars & Sense	94.99
Forecast	59.99
PFS File/Report	ea79.99
INFOCOM FOR MAC! - See Separate Box!	

EDUCATIONAL

DLM

Ap	Alien Addition/Minus Mission	ea21.99
Ap	Alligator Mix/ Dragon Mix	ea21.99
Ap	Division/Multiplication	ea21.99

LEARNING COMPANY

Ap	Bumble Games/Plot	ea25.99
Ap	Gertrudes Puzzle/Secret	ea27.99
Ap	Rockys Boot/Robot Odyssey	ea31.99
Ap/IBM	Addition Magician/Word Spinner	27.99
Ap/IBM	Magic Spell/Number Stamp.	ea25.99
Ap/IBM	Mopdown Hotel/Reader Rabbit	ea25.99

PEACHTREE ALGEBRA I-IV	ea25.99
ALGEBRA V & VI	ea32.99

SPINNAKER

Ap	Grandmas House/Kidwriter	ea19.99
Ap	Kids On Keys	19.99
Ap	Sum Ducks/Trains	ea24.99
Ap/IBM	Facemaker/Fraction Fever	ea19.99
Ap/IBM	Diddle Diddle/Kindercomp	ea19.99
Ap/IBM	Presidents Choice	25.99
Ap/IBM	Snooper Troops I or II	ea28.99

COLLEGE BOUND

Ap	BARONS SAT	59.99
Ap	CBS Mastering SAT	94.99
Ap	PEACHTREE SAT/PSAT	ea34.99
CROSSWORD MAGIC	39.99	

APPLE PRE-BOOTS

Apple Writer	14.99
Apple Writer for Ultraterm	23.99
Visicalc	39.99
Expansion	66.99
Visicalc for Ultraterm	54.99

VIDEX-Apple

ENHANCER II	99.99
FUNCTION STRIP	31.99
HARDSWITCH	14.99
PSIO	145.99
SOFTSWITCH	25.99
ULTRATERM	239.99
VIDEOTERM w/Softsw.	179.99

Printers & Monitors

EPSON FX80	499.99
RX 80	329.99
PRINCETON HX-12 RGB	459.99
Max-12 Amber	179.99
TAXAN #116 12" Amb-Ap	129.99
#122 12" Amber-IBM	159.99
#420 RGB Color-IBM	389.99
OKIDATA 92 w/Plug 'n Play	459.99
USI P14-Amb	99.99

Computer Discount Products

860 So. Winchester Bl., San Jose, CA 95128

(408) 985-0400 FROM 8AM PST

U.S. Mail - \$10 Minimum Chg. • Hardware Shipping - \$CALL

Purchase Order Prices Differ - Call First • Prices Subject To Change • Software Sales Final

PLEASE ALLOW TIME FOR PERSONAL CHECKS TO CLEAR

We reserve the right to charge for freight on orders less than \$100

Inquiry 96

ORDER B-5

***ALL SOFTWARE SHIPPED
FREIGHT-FREE
No Charge for Credit Cards
Guaranteed Fair Pricing**

BIG DISCOUNTS ON LITTLE BOARDS™ & ACCESSORIES

- **AMPRO LITTLE BOARD™**—64K, 280a CPU, CTC, DART, 1 parallel port, 5 1/4 controller supports four 48tpi and/or 96tpi drives w/CP/M 2.2 and ZCPR3 (A & T) \$329
- **SYSTEM SUPPORT PKG**—Manuals, source code schematics, connectors & cables \$99
- **SCSI PLUS**—DMA Hard disk interface \$99
- **TEAC 55B DSDD** 48tpi 1/2 ht drive \$159
- **TEAC 55F DSDD** 96tpi 1/2 ht drive \$189
- **INTEGRAND** Custom two drive cabinet with 5 amp power supply & power cables \$179
- **TERM-MATE**—Cabinet for 2 1/2 ht + LITTLE BOARD w/all cables & supply \$229
- **AMPRO SERIES 100** complete systems SCALL

VISA & MASTER CHARGE. Personal Checks. Please allow 2 weeks. Shipped via UPS. Prices F.O.B. Prairie View, IL. For additional information write or call: DISKS PLUS • 15945 West Pope Blvd. • Prairie View, IL 60069 • (312) 537-7888

DISKS PLUS
DIVISION OF SOLARONICS INC.

DUST COVERS

For Personal Computers and Small Business Systems, Peripherals, Game Units - Protective, Long-Lasting Vinyl Resists Both Dust and Liquids.

- CHOICE OF COLORS -

- | | |
|-----------|-------------------|
| Amdek | Franklin Ace |
| Apple | IBM |
| Atari | Kaypro |
| BMC | Okidata |
| Columbia | Rana Systems |
| Commodore | Star Micronics |
| Corona | Televideo |
| Eagle | Texas Instruments |
| Epson | PLUS OTHERS |

GROUP/VOLUME DISCOUNTS AVAILABLE

FOR FREE BROCHURE WRITE:

ENCHANTED FOREST
P.O. Box 5261, Newport Beach, CA 92662
(118 Onyx)

Dealer Inquiries Invited

PAL, EPROM PROGRAMMERS & UV ERASERS FROM \$49.95

LOGICAL DEVICES INC.

*Where Reliability and
Customer Support
is of utmost Importance*

SEE OUR AD ON PAGE 240

LOGICAL

ORDER TOLL FREE
1-800-EEL-PROM
(1-800-331-7766)

Inquiry 133

Inquiry 246

OK-WRITER T.M.

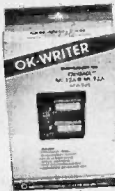

LETTER QUALITY

Enhancement for
OKidata ML82A/83A
Dot Matrix Printers

- Easy to install
- Plug-in module
- Letter Quality: 30 cps
- Draft Quality: 120 cps
- 10, 12, 17 cpi
- Full dot addressable graphics
- Front panel access to all features
- Proportional spacing, bold, double width, underlining, self-test, etc.
- Serial and parallel interfaces retained
- HELP mode; Diagnostic HEX dump
- And many other features

RAINBOW TECHNOLOGIES, INC.

17971-E Skypark Circle, Irvine, CA 92714
(714) 261-0228 Telex 386078
UK Distributor: X-DATA (0753) 72331

Inquiry 341

MARYMAC INDUSTRIES INC.

800-231-3680

Radio Shack TRS-80's Epson Printers

People you Trust to give you the very best!

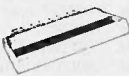

- Lowest Discount Prices
- Reliable Service
- Quality Products

"World's largest volume TRS-80 dealer."

22511 Katy Fwy., Katy (Houston) Texas 77450
(713) 392-0747 Telex 774132

Inquiry 254

IBM™/APPLE™/COMMODORE™ BARECOM™ MODEM

ADD-ON MODEM FOR
PERSONAL COMPUTER

- BELL 103 AND/OR 212 COMPATIBLE
- CCITT V.21 AND/OR V.23 COMPATIBLE
- AUTO DIAL/ANSWER/DISCONNECTION SOFTWARE
- FREE OF CHARGE COMMUNICATION SOFTWARE

DEALERS AND DISTRIBUTOR INVITED.
OEM DESIGN/MANUFACTURE
WELCOMED

COMPOWER TECHNOLOGY CORP.
Made in Taiwan, but not Copied.

P.O. BOX 58144 TAIPEI, TAIWAN, R.O.C.
TELEX: 20370 COMPOWER
TEL: (02) 3937976, 3213060

Inquiry 87

PC EXPANSIONS

Qume 142A	\$189
Teac FD55B	\$129
Tandon TM100-2	\$129
Tandon TM101-4	\$239
CDC 9409	\$129
Maynard Disk Controller	\$114
Sandstar Series	\$call
Internal 10MB HD systems WS1	\$769
WS2	\$929
MaynStream tape backup	\$1229
Quadboard (64K)	\$254
Quadboard (384K)	\$349
Quadcolor I	\$199
AST SixPakPlus (64K)	\$259
SixPakPlus (384K)	\$354
MegaPlus (64K)	\$269
Advantage	\$419
I/O Plus	\$129
PCnet - starter kit	\$809
HERCULES graphics board	\$339
Color Card with PP	\$169
HAYES Modems 300	\$199
Smartmodem 1200	\$429
Smartmodem 1200B	\$389
Set of 9 chips (64K)	\$19
256K chips (each)	\$6
8087 chip	\$139
Verbatim Datallife disks (20)	\$49

VLM Computer Electronics
10 Park Place • Morristown, NJ 07960
(201) 267-3268 Visa, MC, Check or COD

Inquiry 414

FLOWCHARTER

EasyFlow-PLUS is a program that helps you to produce neat, accurate flowcharts. You describe the chart using simple flowchart description commands; EasyFlow-PLUS then produces a complete flowchart for output to the printer or a disk file.

- automatic line routing • automatic text centering within shapes • charts up to 16 shapes wide by 16 shapes high • organization charts • standard flowcharting shapes included • user defined shapes easily added • wide charts can be printed in strips • text blocks can be placed anywhere in the chart • arbitrary lines can be drawn anywhere in the chart • fast: 12 seconds typical • 140 page manual • works with all printers • minimum memory MSDOS/PCDOS 128K; CP/M/80 (requires 280) 64K

\$89.95 + \$2.00 s&h. Check, VISA or M.O.

HavenTree Software Limited
P.O. Box 1093-A
Thousand Island Park, NY 13692
(613) 542-7270 Extension 80

AFFORDABLE M-68000 COMPUTER SYSTEM



M68KCPU	6-10 MHz CPU, 20K static RAM, 16K EPROM, on board monitor, two RS-232 serial ports, 16-bit parallel port, 5 timer/counters expansion bus	\$ 99.95
	Complete Kit	\$595.00
MD512K	128-512K static RAM, floppy disk controller & hard disk interface Bare board	\$ 99.95
	Complete Kit (128K)	\$725.00
M68KE	Enclosure with power supply, fan, filter, 4 slot card cage	\$249.00
M68KASM	M68000 Macro Cross Assembler for CP/M80, IBM PC, TRS-80 and Apple II computers	\$199.00
	UPS shipping & handling	\$ 4.00
	COD orders add	\$ 3.00
	Foreign orders add	\$200.00
	California residents add 6.5% tax	

EMS Educational Microcomputer Systems
P.O. Box 16115 • Irvine, CA 92713
(714) 854-8545

Inquiry 151

COASTLINE COMPUTERS



CALL COLLECT-FREE
213-329-4828
213-324-8087

1956 W. 153 St., Gardena, CA 90247

WHY GO OFFSHORE WHEN YOU CAN SAVE MORE ON THE COASTLINE!

IBM PC

- 2 55B Teac 1/2 High Drives
- 256K, BMC 13" Amb Mon.
- Monitor Interface

\$1729

IBM

EXECUTIVE SYSTEM

- IBM PC w/256K
- 2 Half High Drives
- 8087-3 Math Coprocessor
- Monochrome Monitor
- Mono Card w/Par Port
- DOS 2.1 Operating System
- Okidata 92P Dot Matrix Printer (160cps)

\$2399

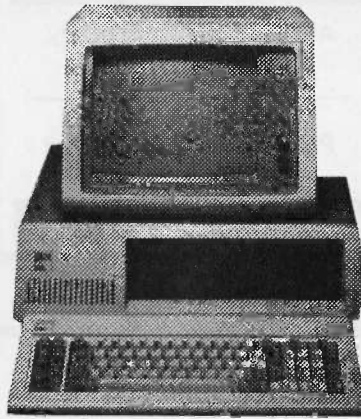

IBM PC

The Great Deal! Coastline Color Sys

- 2 Drives 256K Memory
- Color Card w/Par. Port
- HX12 Color Monitor

\$2395

IBM PC

- 2 Full Height MPI Drives
- Keyboard & Dr Controller
- 256K Memory

\$1549

IBM PRO

EXECUTIVE SYSTEM

- IBM PC w/256K
- 2 360K 1/2 High Dr w/Cont
- 10 Meg Internal Hard Disk
- Monochrome Monitor
- Mono Card w/Par Port
- DOS 2.1 Operating System
- Juki 6100 Letter Quality Printer (18cps)

\$3495

CALL FOR DAILY SPECIALS!!!

<p>INTEL Math Coprocessor 8087-3 (FOR IBM PC AND COMPATIBLES) \$119.00 Call for 8087 for IBM AT</p>	<p>AST SIXPAC + Comes with 384K Expandable Clock Calendar, Par/Ser Port Plus Software \$359.00</p>	<p>IBM Memory Upgrade For IBM & Compatibles 9 - 4164 64K Upgrade \$19.95 128K Upgrade \$40.95</p>
<p>IBM CABLE Computer to Par Printer 6 Foot Long \$14.50</p>	<p>BMC 13" Amber Monitor \$89.00</p>	<p>IBM DOS 2.1 IBM PC & XT Operating System \$54.99</p>
<p>QUANTITY ORDERS Call for Bigger Discounts Corporate & School Accts Call for Information Dealer Programs Avail - P.O.s Expedited</p>	<p>HERCULES GRAPHICS CARD Monochrome w/Par Port For IBM & Compatibles \$319.00</p>	<p>Other Product Lines Available from Coastline Amdek • Princeton Graphics • Techmar • Teac Hercules • Compaq • Tandon • NEC • Intel Okidata • Quadram • Hayes • Alpha Omega Anchor • Bizzcomp • Juki • Epson • Plus More!</p>
<p>CAL DEK 10 Meg INTERNAL HARD DISK For PC or Compatible Comes w/Drive Controller \$695.00 (120 day warranty)</p>	<p>OKIDATA 92P With Plug and Play \$339.00</p>	<p>CALL FOR NEW PRICING ON . . STAR MICRONIC GEMINI'S</p>

Mail Orders To: 1956 W. 153 St., Gardena, CA 90247. Terms: Visa, Mastercard, COD;s and Wire Transfers. No surcharge for credit cards. UPS, Federal and Emery shipping available. Calif. residents add 6 1/2% sales tax. Prices subject to change without notice. Not responsible for typos.

ZENITH data systems

Z-150 PC THE MOST COMPATIBLE PC
W/MSDOS 2.1 MS-WORD, MS-MULTIPLAN
320K RAM DUAL 5 1/4" DS DD DRIVES \$1,929
Z-150 PC W/106Mb H.D. \$2,450
Z-160 PC PORTABLE W/GOLD 9"
SCREEN, 320K RAM, DUAL 5 1/4" DSDD DRV
10Mb HARD DISK & ALL SOFTWARE \$2,849

KONAN™

SMC-200 DUAL DRV. SMD I/F CTRL BD. \$500
DGC-100 CTRL BD./5 1/4" H.D., ST-506 I/F \$325

5 1/4" HARD DISK SUBSYSTEMS

W/CONTROLLER, ALL CABLES,
CABINET, P/S, FAN AND
SOFTWARE DRIVERS

COMPUPRO
IBM-PC

RODIME

27M b
90mSEC \$1,525 \$1,295

QUANTUM

42M b
45mSEC \$1,995 \$1,795

MICROPOLIS

52M b
30mSEC \$2,350 \$2,095

Maxtor

85M b
30mSEC \$2,995 \$2,725

Maxtor

105M b
30mSEC \$3,695 \$3,695

Maxtor

140M b
30mSEC \$4,395 \$4,495

RODIME

DOUBLE-SHOCK MOUNT
12M b IN-SIDER \$639

CALL FOR IBM-PC/AT SUBSYSTEMS

CompuPro

WE STOCK, SUPPORT, AND AGGRESSIVELY
SELL ALL COMPUPRO PRODUCTS. CALL OUR
EXPERT SALES DEPT. FOR EXCEPTIONAL VALUES
AMONG THESE ARE:

SYSTEM 816/C H40 W/ 5 1/4" & 8" FLYP \$7,777
SYSTEM 816/10-H40 \$5,595
CPU286 CSC W/80287 CO-PROCESSOR \$1,449
CPU32016 WITH MMU \$699
HUDSON 8087 PIGGY-BACK FOR 8085/88 \$435
RAM22 A&T 256K STATIC RAM \$939
RAM23 A&T 128K STATIC RAM \$479
MDRIVE/H-512K \$525
MDRIVE/H-2Mb \$1,839
FUJITSU 2302B 23.2Mb 8" ADD-ON H.D. \$1,995
DISK 2 8" H.D. CTRL. SET FOR ABOVE \$495

MORROW

PIVOT PORT. W/DUAL 5 1/4" DRVS., BATT.,
640K, MODEM, MSDOS, NEWWORD CALL
MD3 W/TERMINAL & BROTHER HR15XL \$1,645
MD2 WITH MDT 70 AND
HR-10 PRINTER \$1,449
MD5 W/ TERMINAL & BROTHER HR15-XL \$2,025
MD11 W/ TERM. & BROTHER HR35-XL \$2,979

Vectrix

THE COMPUTER GRAPHICS COMPANY

TODAY'S 672X480 HI-RES GRAPHICS SOLUTION
FOR YOUR MICRO COMPUTER W/9 BIT PLANES,
512 COLORS/PIXEL FROM PALETTE OF
16,800,000 COLORS, 384K GRAPHICS RAM.
STAND-ALONE RS232 VX384A \$3,395
VX/PC 2 BOARD SET WITH 4096
COLOR PALETTE \$2,195
VXMA 13" HI-RES COLOR MONITOR \$1,395
IBM-PC INTERFACE CABLE \$150
VX/PC PAINT PROGRAM \$400
STANDARD PAINT PROGRAM \$725

ProModem 1200 from... PROMETHEUS

PRO MODEM 1200 HAYES COMPAT.
WITH BUILT-IN POWER SUPPLY \$298
1200A APPLE CARD MODEM \$297
1200B IBM-PC CARD MODEM W/ MITE \$265
1200 M MAC MODEM W/CABLE & MITE \$365
CO-PROCESSOR \$79
ALPHANUMERIC DISPLAY \$79
U.S. ROBOTICS, INC.
PASSWORD 1200 AUTO ANS./DIAL \$249
S-100 BD. 300/1200 MODEM "NEW" \$295
IBM PERSONAL MODEM W/ TELPAC \$289
IBM PERSONAL MULTIFUNC. MODEM 64K \$465
TELPAC FOR MSDOS \$59
COURIER 2400 \$525

SOFTWARE

8" SS SD OR AS SPECIFIED
SOFTWARE IS NOT RETURNABLE
BDS "C" COMPILER-8 BIT \$99
COMPUTER INNOVATIONS C88 "C" \$299
COMPUVIEW VEDIT-88 = \$158 MS-DOS= \$120
DATAFLEX MULTI-USER DATA BASE CALL
NEW WORD WORD PROCESSOR WITH
30 DAY MONEY BACK GUARANTEE \$169
LATTICE C (CP/M86 & MS/PC-DOS) \$299
LOTUS 1-2-3 \$299
MicroPro CLOSE-OUT 60% OFF
EXISTING INVENTORY
STARSOFT'S ACCOUNTING PARTNER
CP/M80 8" \$239
dBASE II 8" CP/M 80&86 \$295

DIGITAL RESEARCH

CALL FOR SUPER LOW PRICES
ON LATEST VERSIONS

"C" LANGUAGE COMPILER-86 \$229

TERMINALS

LIBERTY TERMINALS CALL
WYSE-50 14" 132 COLUMN \$499

MONITORS

AMDEK 710 HI-RES RGB COLOR \$595
PRINCETON GRAPHICS HX-12 \$449
TATUNG CM-1322 13" RGB-TTL
640X400 \$395 \$395
TAXAN RGB VISION 420 \$439
ZENITH ZVM 122A AMBER NON-GLARE \$89
ZENITH ZVM 123A GREEN NON-GLARE \$89
ZENITH ZVM-136 13" RGB 640 X 480 LONG
PERSIST. PHOSPHORS FOR INTERLACE \$595

PRINTERS

BROTHER DAISYWHEEL
HR-15XL SER. OR PAR. 17 CPS \$365
HR-25 SER. OR PAR. 23 CPS \$625
HR-35 SER. OR PAR. 36 CPS \$849
BROTHER DOT MATRIX
2024L 24 PIN HEAD, GRAPHICS \$935
BROTHER M1009 50 CPS 6LBS. \$195
EPSON ALL MODELS & ACCESSORIES CALL
OKIDATA ALL MODELS & ACCESSORIES CALL

DRIVES

WE SERVICE FLOPPY DRIVES
5 1/4" OR 8" \$45 + PARTS + SHIPPING

MITSUBISHI ELECTRONICS

4851 1/2 HT 5 1/4" 48TPI \$125
4853 1/2 HT 5 1/4" 96TPI \$139
M2894 STD 8" DSDD \$369
M2896 1/2 HI 8" DSDD \$389
SANYO 5 1/4" 1/2 HT FLYP. \$109

Amcodyne

THIS IS THE FINEST HARD DISK
SYSTEM YOU CAN BUY!
IT'S SPEED (35mSEC AVG. ACCESS) AND
EFFICIENCY (BACK-UP 20Mb IN 10 MIN.)
ARE SUPERB FOR MULTI-USER AND/OR
NETWORKING CONFIGURATIONS.
ARAPAHOE 7110 SUBSYSTEM W/
CONTROLLER, CAB., P/S, FAN, CABLES,
SOFTWARE DRIVERS, 8" 25Mb FIXED
AND 25Mb REMOVABLE
TURBODOS, COMPUPRO CONCURRENT DOS
& CP/M816, AND MSDOS FOR
IBM-PC, ETC. SUPPORTED \$4,795

wangtek PC-36 60Mb TAPE BACK-UP FOR IBM-PC 5Mb/MIN.

PC-INTERNAL SUBSYSTEM \$1,525
PC-EXTERNAL SUBSYSTEM \$1,595

IBM PC W/256K, FLYP &
10Mb H.D. \$2,330

9 CHIPS/SET:
64K RAM 4164-150 NS \$16.95
256K RAMS @ 150nS \$79.00
8087-3 MATH CO-PROCES. \$139
MUSCLE-150XT IBM-PC 150 WATT
REPLACEMENT P/S W/ ALL CABLES \$125

STB™

SUPER RES 400 UP TO 64K DISPLAY
BUFFER DUAL PORTED, 640 X 400,
25KHz, UP TO 16 COLORS \$409
GRAPHIX PLUS II RGB/MONO
COMP. OR TTL \$269
RIO PLUS II 384K 2S, P, G PORTS \$369
SUPER I/O II W/ALL CABLES
S, P & G PORTS \$149
QUARTER BYTE 256K FOR SHORT SLOT \$229
SUPER RIO 256K W/ S, P, G PORTS \$349
BIG BYTE 384K MEMORY BOARD \$269
GRANDE BYTE 2.5Mb FOR IBM-AT \$1,419
RIO GRANDE 1.5Mb, 2S, P, G PORTS \$1,065

TECMAR

DYNAMIC MEMORY 64K \$139
GRAPHICS MASTER - HIGH RES. COLOR \$459
LAB MASTER W/ TM40PGL
AND LABPAC SOFTWARE \$1,149

ADVANCED DIGITAL CORPORATION

PC-SLAVE/16-256K 8MHz
2 SERIAL PORTS - TURN YOUR
PC INTO A HIGH SPEED MULTI-USER
MACHINE W/ TODAY'S TECHNOLOGY \$750
SUPER SIX 128-6MHz \$695
SUPER SLAVE 128-6MHz \$525
SUPER 186/256K MSTR/SLAVE-4 USERS \$1,295
CP/M 3.0 \$300
TURBODOS VER. 1.4 8 BIT MULTI-USER \$450

Intercontinental Micro Systems

CPZ 48006 6MHz MASTER \$739
256K MB MEMORY BOARD \$709
CPZ-186 256K \$1,275
CPS-16 256K 8MHz 8088 SLV \$989
CPS-B4D 64K RAM SLAVE 4MHz \$389
CPS-B6A 128K RAM SLAVE 6MHz \$629
MUTD-E Z80 MULTI-TURBODOS \$556
TURBODOS CONFIG. "I" Z80 OR 80186 MASTER,
Z80 OR 8086 SLAVES & PC NETWORK \$939



FULL DEALER SUPPORT
VISIT OUR SHOWROOM
Hrs. 8:30AM - 5:00PM M-F

All merchandise new. We accept MC, Visa, Wires, COD (\$5 min. fee) with
Cashiers Check/MO, P.O.'s from qualified firms. APO accepted. Shipping;
minimum \$4, first 3 Lbs. Tax: AZ Res. Only add 6% sales tax. All returns
subject to 20% restocking fee. Advertised prices for Mail Order Only. Retail
prices slightly higher. Prices subject to change.

Inquiry 434 for Dealers. Inquiry 435 for End-Users.

Q. Business Systems Consulting? A. Masterbyte.

MASTERBYTE COMPUTERS OF NEW YORK, INC.
Ste. 815, 19 W. 34 St., N.Y. NY 10001 • (212) 760-0341
SERVING BUSINESSES SINCE 1984

BUILD YOUR IDEAS WITH TUTSIM™



Design a real system model by simulation! TUTSIM allows you the power to model, conduct experiments, evaluate strategies and much more.

TUTSIM models:

- Control and Servo Systems
- Robotics
- Fluid Dynamics
- Batch Chemical Processes
- Biological Processes
- Thermodynamics

Write or call for more information.
For the IBM PC's and other micros.
Short form \$29.95

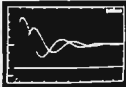

Applied i

200 California Ave., #214
Palo Alto, CA 94306
(415) 325-4800

Inquiry 35

8086
8088
AMX
280
280
6809

Real-Time Multitasking Executive

- ROMable (< 3K)
- No royalties
- Source code Included
- Language interfaces
- Low Interrupt overhead
- Inter-task messages

Options:

- C, Pascal, PL/M, Fortran Interfaces
- CP/M-80 BIOS interface
- IBM PC DOS interface
- Extended memory (> 64K)
- Configuration Builder Utility
- Resource Manager
- Buffer Manager
- Integer Math Library
- Real-Time C Library

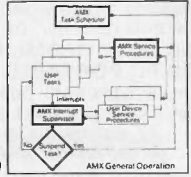

AMX, AMX86, Real-Time C are TM of KADAK Products Ltd.
280 is TM of Zilog Corp.
CP/M-80 is TM of Digital Research Corp.
IBM, PC DOS are TM of IBM Corp.

KADAK Products Ltd.

208-1847 W. Broadway
Vancouver, B.C., Canada
V6J 1Y5
Telephone: (604) 734-2796
Telex: 04-55670

AMX (for 8080) \$800 U.S.
(for 8086) \$950 U.S.
(for 8088) \$950 U.S.
Manual only \$ 75 U.S.
(specify processor)

Inquiry 225

LOW COST UNIVERSAL E(P)ROM PROGRAMMER



- SUPPORTS: (EPROMS) 2516 THRU 64, 2716 THRU 512, 27C16 THRU 128, 68F32 THRU 66 (EPROMS) 52813 THRU 33, 2816A THRU 64A (MICROS) 8741 THRU 49H
- NO PERSONALITY MODULES, ONBOARD POWER SUPPLY
- RS232C INTERFACE, XON-XOFF, RTS, CTS, DTR
- ACCEPTS KEYBOARD ENTRY WITH LINE EDITING
- ACCEPTS ASCII, INTEL, AND MOTOROLA FORMATS
- USER FRIENDLY MONITOR FOR I/O DEBUGGING
- FAST PROGRAMMING SUPPORTED: 2764 UNDER 3 MIN.
- LOW/HIGH BYTE PROGRAMMING FOR 16 BIT DATA PATH
- BYTE, BLOCK, OR CHIP ERASE (EPROMS ONLY)
- LIST IN INTEL OR MOTOROLA HEX FORMAT
- VERIFY PROGRAM AND VERIFY BLANK COMMANDS

- 1409-01: 4K FIRMWARE, PCB, XFORMER, DOC \$30.00
- 1409-02: 1409-01 + FULL SET OF PARTS \$200.00
- 1409-03: ASSEMBLED AND TESTED UNIT \$300.00
- 1409-11: 8K FIRMWARE, PCB, XFORMER, DOC \$125.00
- 1409-12: 1409-11 + FULL SET OF PARTS \$250.00
- 1409-13: ASSEMBLED AND TESTED UNIT \$350.00
- COMMUNICATION DRIVERS FOR MOST PC'S \$35.00

B&C MICROSYSTEMS
6322 MOJAVE DR., SAN JOSE, CA 95120
Tel. (408) 997-7685, TWX 4995363

Inquiry 255

**5 Year
Warranty**
**SAVE 50% ON
Verbatim Datalife
Diskettes**

SPECIAL DISKETTE OFFER

Verbatim Datalife Disks have 6 data-shielding improvements for greater disk durability and longer data life.

PLUS! If you call, write, or utilize reader service in response to this ad—we'll send you our full-range catalog of computer supplies with Special Offers good for further savings on Verbatim diskettes and many other quality products.

Call or write for our discount catalog.

LYBEN COMPUTER SYSTEMS
1250-E Rankin Dr., Troy, MI 48063
Phone: (313) 589-3440

**DATALIFE • THE NAME IS THE PROMISE
THE WARRANTY IS THE PROOF**

Inquiry 248

Get the Proportional Printing Program which Really Works!

Get type-set quality true proportional spaced printing from unmodified WordStar and NewWord document files. PropStar prints on most daisy-wheel printers with ps type-wheels including Diablo, Gume, NEC, Brother, Juki, S-R, C.Itoh and many others.

PropStar is a stand-alone program, not a patch to your w.p. program, it maintains correct letter spacing, never crowds capitals (even on short lines), gives higher quality print than modified WordStar. PropStar supports most of the common WordStar and NewWord print enhancements. No installation patching required. For CP/M-80 systems on 8" and 5-1/4" media, also for MS-DOS systems on 5-1/4" PC media. Only \$ 49.95, Visa & M/C o.k. Specify computer and printer. Dealers wanted.

**CIVIL
COMPUTING
CORPORATION**

2111 Research Drive, Suite 1
Livermore, California 94550

(415) 455-8086

Inquiry 75

Cables EIA RS 232-C

Quality cables with immediate delivery and low prices.

Send for
Catalog

Conductor	Price
1-4	11.50 + .15/ft.
5-7	12.00 + .22/ft.
8-12	13.00 + .30/ft.
13-16	14.00 + .40/ft.
17-25	16.00 + .50/ft.

Specify Male or female connectors, length of cable and pins to be connected. Extended Distance, Cantronic (Parallel), Coaxial (RG59U, 62A/U), Dual Wang, Twin-axial, Ribbon, IBM, DEC Compatible cables and AB Switches also available.

We supply connector parts, bulk cable, tools and hardware (wall plates), for those who prefer to build their own cables.

Communication Cable Company

PO Box 600-L, Wayne, PA 19087
215-964-9404

Inquiry 81

Osborne

As available only! Very limited quantity.

Important: Always call to check availa- bility before ordering.	To fix yourself, or for parts. Complete, but known not working.	Guaranteed for 30 days. May be new or refurb., depending on avail. Exch/ Repair	Outright
Main Board OS-1	\$49	\$79	\$159
Main Board Exec.	\$159	\$139	\$299
Battery Pack, 40 Watt	—	—	\$49
Double Density Kit **	—	—	\$79
** Includes board, cable, documentation & disk			
5" CRT (Grn/White)	\$9.95	\$19	\$29
7" CRT (Amber)	\$19	\$49	\$99
15" CRT, no case	—	—	\$85
Drive Analog Card	\$9.95	\$29	\$59
Drive Mechanism	—	\$25	\$59
Power Supply	\$4.95	\$24	\$29
Keyboard (No enclos.)	\$19	—	\$99

Shipping charged on all orders

Computer Parts Mart 415-493-5930
3200 Park Blvd * Palo Alto * CA 94306

Inquiry 103

28 PIN PROM BLASTER WITH LIFETIME WARRANTY*

Plugs into your
IBM PC, XT or PPC and
programs most 28 pin
EPROMS. Includes the
following features:



* Menu Driven • Edit function for the data buffer • Moves systems memory into data buffer • Performs a check sum • Reads EPROM into data buffer. Will program the following EPROMS: 2764 • 27128 • 27256 • 2764A • 27128A

OTHER APPARAT ADD-ONS: 24 Pin Prom Blaster, AT 3Mb Combo Card, 512K RAM Card, 384K RAM/Clock, Hard Disk Subsystem, Add-on Disk Drive, Clock/Calendar, 256K RAM Card, Parallel/Serail Card for PPC, 128/384K Short Slot RAM Card for the PPC and more.

Apparat, Inc.
ADD ON AND ON AND ON AND ON AND ON

4401 So. Tamarac Parkway / Denver, CO 80237 / 303/741-1778

ORDERING AND DEALER INFORMATION
800/525-7674

Stores in Denver & Chicago / *On all cards sold after June 1, 1984

Inquiry 33

IBM PC™ Compatible Hard Disk Subsystems

As Low As:

\$599



Internal		External
\$599* BQPRIPCSUB10I	10Mbyte	\$799* BQPRIPCSUB10X
\$999* BQPRIPCSUB20I	20Mbyte	\$1199 BQPRIPCSUB20X
\$1595 BQPRIPCSUB33I	33Mbyte†	\$1795 BQPRIPCSUB33X

*Half-height drive Shipping charges: Internal \$5.00 / External: \$9.00
† High-speed drive. 30ms access and high-speed are perfect for networking systems!

100MHz Dual Trace Dual Time-Base

BK PRECISION

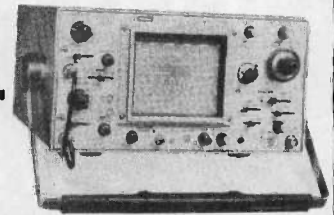

PRICE BREAK THROUGH!

PROBES INCLUDED!

\$995

BQBKP1580
List Price: \$1595.00

NOW OPEN - SAN JOSE (408) 946-7010

VIDEO MONITORS

MODEMS

IBM-PC™ COMPATIBLE MONITORS

TAXAN 12" green screen for IBM 18lbs.	BOYAX121	\$ 159
TAXAN 12" amber screen for IBM 18lbs.	BOYAX122	\$ 169
TAXAN 12" color RGB w/cable 28lbs.	BOYAXRGB420	\$ 469

GENERAL USE

SANYO 12MHz 12" Amber 18 lbs.	BOSYODM2212	\$ 79
SANYO 18MHz 12" Green 24 lbs.	BOSYODM112CX	\$ 129
SANYO 18MHz 12" Amber 24 lbs.	BOSYODM212CX	\$ 139
TAXAN 18MHz 12" Green 18 lbs.	BOTAX115	\$ 139
TAXAN 18MHz 12" Amber 18 lbs.	BOTAX116	\$ 139
SANYO 13" RGB color 7MHz 30 lbs.	BOSYODM7500	\$ 379
TAXAN 12" RGB color 6MHz 50 lbs.	BOTAX220	\$ 319

STD CARDS (2 lbs. each)

Super RIO (64K)	BOSTBSRID	\$ 319
Super IO II	BOSTBSIO	\$ 199
RIO PLUS II (64K)	BOSTBSRIPLS	\$ 289
Graphic PLUS II	BOSTBSGRPLS2	\$ 219
QUARTER BYTE	BOSTBSQB	\$ 395
GRAND BYTE	BOSTBSGB128	\$ 299
RIO GRANDE	BOSTBSRG8128	\$ 449

Description	Part No.	Price
HAYES		
2400 bps Smartmodem 4 lbs.	B00CH2400	\$ 595
1200 Baud Smartmodem 4 lbs.	B00CH0400P	\$ 429
1200 Baud for IBM-PC™ w/software	B00CH1200B	\$ 429
300 Baud Smartmodem	B00CH0200P	\$ 249
Micromodem II for Apple	B00CH70100A	\$ 249
PROMETHEUS		
ProModem 1200 baud auto dial/ans 4 lbs.	BPPRPM1200	\$ 299
ProModem IBM-PC™ card w/software	BPPRPM1200B	\$ 289
ProModem Apple II card w/software	BPPRPM1200A	\$ 349
ProModem for Macintosh w/cable & software	BPPRPM1200M	\$ 399
Alpha/num display for ProModem	BQPRMDISPLAY	\$ 79
Options processor for ProModem	BQPRMDPTPRO	\$ 79
64K Memory Exp. for options processor	BQBPDRMEXPE4	\$ 19

DISK DRIVES 8" DRIVES

SIEMENS Single side dbl/density 18lbs.	BOSIEFD1008	\$ 125
2 to 5 Drives \$110 each / 6 or more Drives \$99 each		
WORLD DISK DRIVES Double side	B0WDD2008P	\$ 219
dbl/density 18 lbs.		
2 to 5 Drives \$199 each		
6 or more Drives \$189 each		
MITSUBISHI dbl side, dbl dens 18lbs	BQMTM2894638	\$ 375
TANDON 1/2 height sgl side, dbl dens 9lbs	BQNTDM4818E	\$ 319
TANDON 1/2 height dbl side, dbl dens 9lbs	BQNTDM4821E	\$ 389

5 1/4" DRIVES

SHUGART 40trk 1/2 height, dbl side 3lbs	BOSHUSA455	\$ 99
SHUGART 40 trk 1/2-ht dbl side 3lbs	BOSHUSA465	\$ 99
TANDON 100-2 40trk full height, dbl side 4lbs	BQNTDM1002	\$ 149

5 1/4" HARD DISK

SHUGART SA712 12 Mbyte	BOSHUGA712	\$ 399*
SHUGART SA604 5Mbyte	BOSHUG604	\$ 99
Seagate ST225 1/2 high 25Mbyte 5lbs	B0SEAST225	\$ 695
Seagate ST225 Formatted for IBM PC	B0SEAST225F	\$ 749
QUANTUM 42Mbyte Hard disk 9lbs	BQNTM0540	\$1395

64K & 256K Memory Expansion Sets

64K Expansion Contains 9 64K x 1 150ns RAMS	BQPD8BMMEM9	\$18.00
256K Expansion Contains 36 64K x 1 150ns RAMS	BQPD8BMMEM36	\$59.95
256K Expansion Contains 9 256K x 1 RAMS	BQPD8BMMEM9	\$79.00

PRINTERS & BUFFERS

Description	Part no.	Price
OKIDATA		
824 w/tractor feed 25 lbs.	BOOKIDAT82AT	\$ 349
83A w/tractor feed 35 lbs.	BOOKIDAT83AT	\$ 689
84A - parallel 35 lbs.	BOOKIDAT84AP	\$ 895
84A - serial 35 lbs.	BOOKIDAT84AS	\$ 979
92A - parallel 25 lbs.	BOOKIDAT92AP	\$ 469
92A - serial 25 lbs.	BOOKIDAT92AS	\$ 610
93A - parallel 35 lbs.	BOOKIDAT93AP	\$ 699
93A - serial 35 lbs.	BOOKIDAT93AS	\$ 925

MANNESMANN TALLY

MT160L 80 col. 21 lbs.	BOTALMT160L	\$ 575
MT180L 132 col. 28 lbs.	BOTALMT180L	\$ 799

PRACTICAL PERIPHERALS

64K Microbuffer (serial) 2lbs	BOPRPM1564	\$ 249
64K Microbuffer (parallel) 2lbs	BOPRPM1P64	\$ 249
Microbuffer II+ for Apple (ser & par) 2lbs	BOPRPM2P.1516	\$ 159

EPSON & STAR IN STOCK!
Call For Our LOWEST PRICE!

5" Double Sided Double Density Diskettes Nashua Diskettes

\$1.20 EACH In Packs of 50
BQ5DS50 (\$1.20 X 50 = \$60.00/pack)
(Sh. wt. 1 lb. per pack)

\$1.00 EACH In Boxes of 250
BQ50S250 (\$1.00 X 250 = \$250.00/box)
(Sh. wt. 8 lbs. per box)

95¢ EACH In Cartons of 1000
BQ5DS1000 (\$.99 X 1000 = \$99.00/carton) (Sh. wt. 30 lbs.)

Diskettes are packaged with Tyvek sleeves, reinforced hubs, labels and write protect tabs.
To receive these low-low prices, you must order in exact multiples shown here.

S-100 CPU BOARDS

Shipping weight on all S-100 boards 2lbs. each

Description	Part no.	Price
CompuPro 8085/08 dual processor	BOGBTA041	\$ 259
CompuPro CPU-Z 8MHz	BOGBTA537	\$ 249
CompuPro 8085/86 8MHz	BOGBTA044	\$ 249
CompuPro CPU-8086 10MHz	BOGBTA041	\$ 375
CompuPro CPU-80286	BOGBTA048	\$ 895
CompuPro CPU-286 w/80287 chip	BOGBTA048	\$1195
CompuPro CPU-68K 10MHz	BOGBTA340	\$ 695
CompuPro CPU-68K w/Mem Mgr 10MHz	BOGBTA341	\$ 395
SDS SBC-300 4MHz	BOSDS38095	\$ 799
SDS SBC-300 6MHz	BOSDS38092	\$ 599
ADVANCED DIGITAL SuperSix w/happy controller, 128K RAM	BOADCSP6128	\$ 699
ADVANCED DIGITAL 4MHz SBC, 5 1/4" floppy controller, 64K RAM	BOADCBC15	\$ 595
ADVANCED DIGITAL 4MHz SBC, 8" floppy controller, 64K RAM	BOADCBC18	\$ 695

S-100 RAM BOARDS

CompuPro RAM23 / 24K	BOGBTA316	\$ 349
CompuPro RAM 23 / 128K	BOGBTA319	\$ 499
SDS ExpandedRAM III/696	BOSDS38097	\$ 599
SDS ExpandedRAM IV	BOSDS38088	\$ 825
MACROTECH 1 Megabyte	BQMACMAXM	\$2195
CompuPro RAM 22 / 256K	BOGBTA070	\$1099

S-100 RAM DISK BOARDS

CompuPro M-Driver™ 512K	BOGBTA072	\$ 699
SDS RAM disk 256K	BOSDS38082	\$ 649

S-100 I/O BOARDS

Vector Interlacer II	BOVCT800GF2B	\$ 259
CompuPro Interlacer 3	BOGBTA078	\$ 449
CompuPro Interlacer 4	BOGBTA080	\$ 329
CompuPro System Support 1	BOGBTA103	\$ 329
SDS 4 port Async. serial	BOSDS38096	\$ 449
SDS 8 port Async. serial	BOSDS38093	\$ 529
SDS 8 port 4-Async. 4-sync	BOSDS38094	\$ 649
CompuPro PC Video S-100 Card	BOGBTA356	\$ 475

S-100 CONTROLLER BOARDS

FOR FLOPPY DISKS

CompuPro DISK1A DMA	BOGBTA084	\$ 449
---------------------	-----------	--------

FOR HARD DISK

CompuPro DISK3 Seagate ST500 series	BOGBTA087	\$ 549
ADVANCED DIGITAL Seagate 500	BOADCHDC10015	\$ 399

DISK DRIVE ENCLOSURES

8" ENCLOSURES

ParaDynamics dual desktop 35lbs	BQPDN2200R	\$ 479
ParaDynamics dual rack mount 35lbs	BQPDN2200R	\$ 499
JMR Dual desktop 30lbs.	BOJMR2C	\$ 229

5 1/4" ENCLOSURES

JMR Single 5lbs	BOJMR1C5	\$ 59
JMR Dual full height 9lbs	BOJMR2C5	\$ 89
JMR Dual full height w/internal data cable 9lbs	BOJMR2C5C	\$ 99
JMR Dual half height vert. mount 7lbs	BOJMR2V5	\$ 65
JMR Single hard disk enclosure 15lbs.	BOJMRHDC51	\$ 199
JMR Dual hard disk enclosure 20lbs	BOJMRHDC52	\$ 299

Surge Suppressor Noise Filter



\$29.95

BQWBDRG115S List: \$49.95
(Sh. wt. 2 lbs.)



PRIORITY ONE ELECTRONICS

9161 Deering Ave., Chatsworth, CA 91311-5887



Inquiry 326

ORDER TOLL FREE (800) 423-5922, Local: (818) 709-5111

MINIMUM PREPAID ORDER \$25.00. Terms U.S. VISA, MC, BAC, Check, Money Order, U.S. Funds ONLY. CA residents add 6 1/2% Sales Tax. Include MINIMUM SHIPPING & HANDLING of \$3.00 for the first 3 lbs., plus 40¢ for each additional pound (20¢ if within California) PLUS 25¢ per \$100.00 value of your order for insurance. Orders over 70 lbs. sent freight collect. Just in case, include your phone number. Prices subject to change without notice. We will do our best to maintain prices through May, 1985. Credit card orders will be charged appropriate freight. We are not responsible for typographical errors.

ORDER TOLL FREE (800) 423-5922 (NOW IN CALIFORNIA, TOO!)

I*U*CO™ is the best thing to happen to personal computing since the invention of the personal computer!

I*U*CO is an idea whose time has come.

I*U*CO is the International Union of Computer Owners, an organization designed to protect the interests of personal computer owners and users against those who would take their money...and then deliver less than they promised.

Here's an overview of some of the vital services I*U*CO provides:

1. Access to the lowest priced, reputable vendor for nearly every computer related need; and,
2. Protection from the rip-off artists, vaporware specialists, false advertisers and other creepy, crawly creatures who have been attracted to the computer industry by the scent of your money; and,
3. Constantly updated information on software, hardware and peripheral releases, upgrades, bug reports, bug fixes, reviews, letters to the editor and other data individually tailored to your needs through the exclusive I*U*CO COMPUTER REGISTRY™; and,
4. Finally, a chance to get even with those characters out there who promised a lot, took your money...and then delivered less than they promised.

**I*U*CO™:
a lynch mob
with a purpose.**

Every computer owner has been ripped off at least once.

Or maybe a dozen times or more might be a more appropriate number.

In any event, we've all been victimized by the computer industry.

And It wasn't accidental.

Today's computer industry is filled with hysteresis, rip-off artists, vaporware specialists and others whose sole function in life is to part you from your money by delivering a little less than you bargained for...or by charging you more than you would otherwise have to pay.

The rip-off might have been a computer that wasn't quite as "compatible" as advertised. Or it could have been a well-known computer that was to be delivered at the same time that "hundreds" of programs would be available with it...if you consider the same time to be a year-and-a-half later.

Or the rip-off might be in the form of measures taken by certain manufacturers and software publishers to limit sales of their products through "authorized" dealers only.

This is, of course, designed (they say) to get you better service.

But it's also a neat way to keep prices

artificially high by restricting competitive forces in the market place.

The number of ways you're being ripped off grow everyday, as greed becomes the major motivating factor in the computer marketplace.

Possibly, you've been had by a software manufacturer who continuously upgrades their software...charging you a pretty penny for the elimination of bugs which shouldn't have been there in the first place!

In a few cases, it's nothing more complex than a vendor who takes your money and simply takes their time in delivering.

If they ever get around to delivering at all.

In any event, the computer industry just isn't the friendly place it used to be, when everyone was trying to help each other learn about their machines.

Today's computer market has been an invitation to be ripped off.

**Until now, that is.
I*U*CO**

means protection.

I*U*CO™ subscribes to some very ancient wisdom: there's strength in numbers.

Labor unions learned the lesson a long time ago.

The individual worker had no clout.

But when the workers organized, they got a lot of power.

Even automobile owners learned the lesson a long time ago. Back when the early drive got tired of dirt roads, they organized the American Automobile Association...and that's part of the reason the United States is laced with an incomparable highway and street system today.

Needless to say, the computer industry knows the value of organization as well.

Computer manufacturers, software publishers and others eager to get as much as they can from you have formed various associations to achieve such lofty goals: making sure that they can't be held responsible when their products don't work to prevent you from copying the software you "licensed" from them...so they can sell you a back-up disk.

In short, everyone seems to have learned the benefits of getting organized and gaining power.

Except the personal computer owner a user.

And that's why there has to be an I*U*CO

I*U*CO™ is designed to be what every collective organization is: a means to protect the special interests of its own members!

And, in this case, the members are the firms...the people who own and use personal computers.

The people who until now have been overlooked.

**First of all,
I*U*CO™**

means low prices.

The first benefit an I*U*CO™ member gets is the opportunity to save money. Lots of it.

While certain manufacturers of software, peripherals and hardware are trying hard to rack down on what they call the "grey market" (thus keeping prices higher than they should be), I*U*CO™ will maintain a database of every mail-order advertisement that appears in the major national computer magazines. A similar database will also be set up for selected major retail markets, so you can take advantage of special sales and

When you want the lowest price on something, just (electronically) mail your shopping list to I*U*CO™.

Within a day, you'll get the three lowest and most recently quoted prices...and, quite possibly, special prices that haven't been advertised anywhere!

I*U*CO™ protects you.

Of course, buying by mail or from a supplier you don't know can get you more than low prices.

You can get you problems in delivery, service and general dissatisfaction with the product you bought.

So, along with the low price quotations, you also get I*U*CO™ member evaluations of the product and the vendor and a bibliography of reviews, letters to the editor, articles and other information that just might convince you not to spend the money in the first place.

(Remember, most sellers are pretty restrictive about returns, particularly software returns.)

So, as an I*U*CO™ member, you get:

1. The lowest possible prices.
2. An assessment of both the product and the vendor.
3. Information on the actual use value of the product. (An awful lot of products sound better in their advertising than they are in reality. That's why so few companies offer a money-back guaranty.)

**Continuing protection
from I*U*CO™:**

the Computer Registry™.

As an I*U*CO™ member, you can also become part of our exclusive Computer Registry™.

You simply register the appropriate information about all the hardware, software and peripherals you own with I*U*CO™.

Then, as updates are announced, bugs discovered or fixed and so on, you automatically get this information as part of a customized and individualized monthly bulletin.

No more finding out a year after the fact that you're still using Version 1.00 and everyone else has Version 9.4! Or, you might find out that the problem you thought was yours alone is actually widespread.

(As a personal note, you'll find that this I*U*CO™ service is invaluable.)

In the past few weeks, I found out that a) the ROMS in my Anadex printer have been upgraded, b) there's at least one undocumented bug in running MacPaint with the 512K upgrade, c) the ROMS in my IOMEGA Bernoulli Box were upgraded, and d) [best of all] MicroPro knew of a bug in Infostar 1.6 which they didn't tell anyone about for 18 months!

In none of these instances did the manufacturer tell the consumer.

As an I*U*CO™ member, you could get this information on a customized and individualized basis, each and every month for every piece of hardware, software and peripheral equipment you own or acquire.

**I*U*CO™:
the Iron fist.**

The best part of I*U*CO™ has been saved for last.

Yes, I*U*CO™ will help you get the lowest prices on everything you want to buy for your computer.

And I*U*CO™ will give you solid information on the integrity of products and vendors.

Finally, if you choose to become a part of I*U*CO's™ exclusive Computer Registry™, you can also stay current with the products you own or acquire.

**But with I*U*CO™,
you also get power!**

But, more importantly, your membership in I*U*CO™ gives you the power of belonging to a community...a community of personal computer owners and users who need to protect their rights.

For instance, a group of software publishers managed to get the Louisiana legislature to pass a law "legalizing" the non-warranties they provide with their software. (You know, "this software is sold without any guaranty that it will work." Just pay your money and take your chances.)

I*U*CO™

will fight for you!

I*U*CO™ will fight that kind of nonsense by lobbying against it, organizing PAC's and, in general, by doing what every other special interest group does: fight for its own special needs and interests.

As one person, there is little you can do when you're ripped off by a vendor. The powers that be...such as the FTC...don't pay much attention to one person.

But when a special group like I*U*CO™ has a lot of members which can be translated into publicity and political pressure, you'd be surprised what can be done.

There's a lot more to the I*U*CO™ story.

More than we can afford to tell here.

Complete information costs only \$ 1.00.

So, fill in the coupon below.

Free! A guide to your legal rights as a personal computer owner!

Send a dollar for more information on I*U*CO™ membership and we'll include FREE a guide to your legal rights (and obligations) as a personal computer owner.

This synopsis, written by an attorney who also happens to be an electrical engineer will give you helpful information on questions such as using copy programs for making your own backup copies, how to complain effectively and other issues which affect you as a personal computer owner.

It's a slim volume, to be sure, because unless you're both rich and tough, you're going to learn that you haven't got all that many rights.

International Union of Computer Owners, Inc.
30 East Huron Street
Chicago, Illinois 60611

YES, I'm tired of being ripped off. Enclosed is \$ 1.00. Please send information on I*U*CO™. I understand that I am under no obligation to enroll as a member.

Please print all information!

Name _____
Company _____
Address _____
City _____ State _____ ZIP _____
Make of computer: _____

DoKay

COMPUTER PRODUCTS, Inc.

ORDER TOLL FREE

(800) 538-8800

(CALIFORNIA RESIDENTS)

(800) 848-8008



STATIC RAMS

2101	256 x 4 (450ns)	1.90
5101	256 x 4 (450ns) (cmos)	3.90
2102-1	1024 x 1 (450ns)	.79
2102L-1	1024 x 1 (450ns) (LP)	.89
2102L-2	1024 x 1 (250ns) (LP)	1.29
2111	256 x 4 (450ns)	2.29
2112	256 x 4 (450ns)	2.29
2114	1024 x 4 (450ns)	.99
2114-25	1024 x 4 (250ns)	1.10
2114L-4	1024 x 4 (450ns) (LP)	1.20
2114L-3	1024 x 4 (300ns) (LP)	1.30
2114L-2	1024 x 4 (200ns) (LP)	1.40
2147	4096 x 1 (55ns)	3.95
TMS4044-4	4096 x 1 (450ns)	2.95
TMS4044-3	4096 x 1 (300ns)	3.45
TMS4044-2	4096 x 1 (200ns)	3.95
MK4118	1024 x 8 (250ns)	8.95
TMM2016-20	2048 x 8 (200ns)	3.95
TMM2016-15	2048 x 8 (150ns)	4.45
TMM2016-10	2048 x 8 (100ns)	5.95
HMS1116-4	2048 x 8 (200ns) (cmos)	4.40
HMS1116-3	2048 x 8 (150ns) (cmos)	4.90
HMS1116-2	2048 x 8 (120ns) (cmos)	5.30
HMS1116LP-4	2048 x 8 (200ns) (cmos) (LP)	4.90
HMS1116LP-3	2048 x 8 (150ns) (cmos) (LP)	5.30
HMS1116LP-2	2048 x 8 (120ns) (cmos) (LP)	7.90
Z-8132	4096 x 8 (300ns) (Qstat)	29.95
HMS264LP-15	8192 x 8 (150ns) (cmos)	19.95
HMS264LP-15	8192 x 8 (150ns) (cmos) (LP)	22.95
HMS264LP-12	8192 x 8 (120ns) (cmos) (LP)	24.95

LP = Low Power Qstat = Quasi-Static

DYNAMIC RAMS

TMS4027	4096 x 1 (250ns)	1.45
UPD411	4096 x 1 (300ns)	1.95
MMS280	4096 x 1 (300ns)	1.95
MK4108	8192 x 1 (200ns)	.49
MMS288	8192 x 1 (250ns)	.49
4118-20	16384 x 1 (200ns)	.79
4116-15	16384 x 1 (150ns)	.99
4116-12	16384 x 1 (120ns)	1.49
2118	16384 x 1 (150ns) (5v)	3.95
4184-25	8536 x 1 (250ns) (5v)	2.00
4164-20	8536 x 1 (200ns) (5v)	2.22
4184-15	8536 x 1 (150ns) (5v)	2.90
41256-20	262144 x 1 (200ns)	12.95
41256-15	262144 x 1 (150ns)	15.95

5v = Single 5 Volt Supply

EPROMS

1702	256 x 8 (1µs)	3.95
2708	1024 x 8 (450ns)	2.49
2768	1024 x 8 (450ns)	5.90
2716	2048 x 8 (450ns) (5v)	2.95
2716-1	2048 x 8 (350ns) (5v)	3.95
TMS2516	2048 x 8 (450ns) (5v)	3.95
TMS2716	2048 x 8 (450ns) (5v)	6.95
TMS2532	4096 x 8 (450ns) (5v)	3.95
2732	4096 x 8 (450ns) (5v)	3.95
2732 A-4	4096 x 8 (450ns) (21v)	3.95
2732 A-36	4096 x 8 (350ns) (21v)	3.95
2732 A	4096 x 8 (250ns) (5v)	5.95
2732 A-2	4096 x 8 (200ns) (21v)	6.95
2764	8192 x 8 (450ns) (5v)	4.95
2764-25	8192 x 8 (250ns) (5v)	5.95
2764-20	8192 x 8 (200ns) (5v)	9.95
TMS2564	8192 x 8 (450ns) (5v)	9.95
MCM66764	8192 x 8 (450ns) (5v) (24-pin)	17.95
MCM66768	8192 x 8 (350ns) (5v) (24-pin)	19.95
27128-45	16384 x 8 (250ns) (5v)	14.95
27128-30	16384 x 8 (300ns) (5v)	16.95
27128-25	16384 x 8 (300ns) (5v)	16.95
27256-25	32768 x 8 (250ns) (14v)	79.95

5v = Single 5 Volt Supply

74LS00

74LS00	.23	74LS125	.48	74LS280	.58
74LS01	.24	74LS125	.48	74LS285	.54
74LS02	.24	74LS125	.58	74LS293	1.45
74LS03	.24	74LS133	.58	74LS276	3.30
74LS04	.23	74LS135	.38	74LS279	.48
74LS05	.24	74LS137	.98	74LS280	1.95
74LS08	.27	74LS138	.54	74LS283	.68
74LS09	.28	74LS138	.54	74LS290	.88
74LS10	.24	74LS145	1.15	74LS293	.88
74LS11	.34	74LS147	2.45	74LS295	.98
74LS12	.34	74LS148	1.30	74LS298	.88
74LS13	.44	74LS151	.64	74LS299	1.70
74LS14	.58	74LS153	.54	74LS323	3.45
74LS15	.34	74LS154	1.85	74LS324	1.70
74LS20	.24	74LS155	.68	74LS352	1.25
74LS21	.28	74LS155	.88	74LS353	1.25
74LS22	.24	74LS157	.84	74LS353	1.30
74LS26	.28	74LS159	.58	74LS354	1.90
74LS27	.28	74LS160	.68	74LS355	.48
74LS28	.34	74LS161	.64	74LS355	.48
74LS30	.24	74LS162	.88	74LS397	.44
74LS32	.28	74LS163	.64	74LS398	.44
74LS33	.54	74LS164	.68	74LS373	1.35
74LS37	.34	74LS165	.94	74LS374	1.35
74LS38	.34	74LS166	1.90	74LS377	1.35
74LS40	.24	74LS168	1.70	74LS378	1.13
74LS42	.48	74LS169	1.70	74LS378	1.30
74LS47	.74	74LS170	1.45	74LS385	1.85
74LS48	.74	74LS173	.88	74LS388	.44
74LS49	.74	74LS174	.54	74LS390	1.15
74LS51	.24	74LS175	.54	74LS393	1.15
74LS54	.28	74LS181	2.10	74LS395	1.15
74LS55	.28	74LS188	8.90	74LS399	1.45
74LS63	1.20	74LS190	.88	74LS424	2.90
74LS73	.38	74LS191	.88	74LS447	.38
74LS74	.34	74LS192	.78	74LS490	1.90
74LS75	.38	74LS193	.78	74LS524	3.95
74LS78	.38	74LS194	.68	74LS540	2.15
74LS78	.48	74LS195	.68	74LS545	2.15
74LS83	.58	74LS198	.78	74LS588	1.85
74LS85	.88	74LS197	.78	74LS589	1.85
74LS88	.38	74LS221	.94	74LS870	1.45
74LS90	.54	74LS240	.94	74LS874	9.80
74LS91	.68	74LS241	.94	74LS902	3.15
74LS92	.54	74LS242	.94	74LS903	3.15
74LS93	.54	74LS243	.94	74LS904	3.15
74LS95	.74	74LS244	1.25	74LS985	3.15
74LS98	.88	74LS245	1.45	74LS988	2.35
74LS107	.38	74LS247	.74	74LS989	3.15
74LS109	.38	74LS248	.98	74LS793	23.95
74LS112	.38	74LS249	.98	81LS95	1.45
74LS113	.38	74LS251	.58	81LS98	1.45
74LS114	.38	74LS253	.58	81LS97	1.45
74LS122	.44	74LS257	.58	81LS98	1.45
74LS123	.78	74LS258	.58	25LS2521	2.75
74LS124	2.85	74LS259	2.70	25LS2589	4.20

CRT CONTROLLERS

6845	11.95	6275	28.95
6845	18.95	7220	38.95
HD46505ap	11.95	CRT6027	18.95
6847	10.95	CRT6037	28.95
MC1372	6.90	TMS9018A	36.95
68047	23.95	DP8350	48.95

DISC CONTROLLERS

1771	14.95	2797	54.95
1791	21.95	6843	33.95
1793	25.95	8272	18.95
1795	21.95	UP0785	18.95
1797	21.95	M88676	23.95
2791	49.95	M88877	25.95
2793	49.95	1691	6.95
2795	54.95	2143	6.95

UV ERASERS

QUV-T8/1 \$49.95
ECONOMY Model

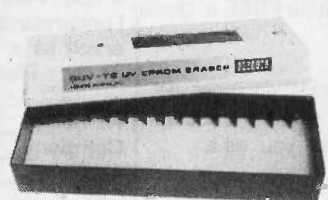

- Erases 15 EPROMS in 20 minutes
- Plastic Enclosure

6500

1 MHz	2 MHz		
65022	4.90	6502A	6.90
6504	6.90	6520A	5.90
6505	8.90	6522A	9.90
6507	9.90	6528A	10.90
6520	4.30	6545A	12.90
6522	4.90	6551A	10.90
6532	9.90		
6545	9.90		
6551	9.90	6502B	7.90

1 MHz

6600	2.90	68B00	9.90
6602	7.90	68B02	11.90
6603	17.90	68B09	11.90
6608	12.90	68B09E	11.90
6609E	8.90	68B10	6.90
6609	8.90	68B21	5.90
6610	2.90	68B40	18.90
6620	4.30	68B45	18.90
6821	2.90	68B50	6.90
6828	13.90	68000-8	34.90
6840	11.90	68047	23.90
6843	33.90	68488	18.90
6844	24.90	68652	14.90
6845	11.90	68681	6.90
6847	10.90	68764	17.95
6850	2.90	68766	19.95
6852	6.90		
6860	7.90		
6862	10.90		
6875	6.90		
6880	1.90		
6883	21.90		

8000

8031	14.90	8253	6.90
8035	5.90	8253-5	7.90
8039	5.90	8255	4.45
INS-8000	16.90	8255-5	4.90
INS-8073	29.90	8257	7.90
8080A	3.90	8257-5	8.90
8085	4.90	8259	5.90
8085A-2	11.90	8259-5	8.90
8086	24.90	8271	69.90
8087-3 (5 MHz)	169.90	8272	19.99
8087-2 (8 MHz)	279.90	8274	28.99
8089	19.90	8275	28.90
8099	59.90	8279	8.90
		8279-5	7.80
		8282	6.45
		8283	6.45
		8284	4.90
		8286	6.45
		8287	6.45
		8288	12.90
		8289	44.90
		8292	12.90

8100

8131	2.90	8300	2.90
8155	6.90	8304	1.90
8155-2	7.90	8307	2.90
8158	6.90	8310	2.90
8185	28.90	8310	3.90
8185-2	38.90	8311	3.90

8200

8202	23.90	8303	2.90
8203	38.90	8304	1.90
8205	2.90	8307	2.90
8212	1.75	8310	2.90
8214	3.75	8311	3.90
8216	1.75		
8224	2.20		
8225	1.75		
8228	3.45		
8237	12.90		
8237-5	14.90		
8238	4.45		
8243	4.45		
8250	9.90		
8251	3.90		
8251A	4.45		

8300

8700

8711	28.90
8748	19.90
8749	28.90
8755	23.90

80000

80188-8	99.90
80188	89.90

2 MHz

Z80-CPU	1.95	Z80A-810/0	9.95
Z80-CTC	1.95	Z80A-810/1	9.95
Z80-DART	8.95	Z80A-810/2	9.95
Z80-DMA	7.95	Z80A-810/9	9.95
Z80-PIO	1.95		
Z80-810/0	8.95		
Z80-810/1	8.95		
Z80-810/2	8.95		
Z80-810/9	8.95		

4 MHz

Z80A-CPU	2.45</
----------	--------

ROBOT KITS! PIPER-MOUSE



Controlled by sound sensor and 1-channel electronic circuit. Use the whistle in this kit and Piper-Mouse follows your commands, turning left or right, stopping and starting. Uses 2 AA and 1 9V battery (not included).

MV-915 \$44.95
RIBBON CABLE

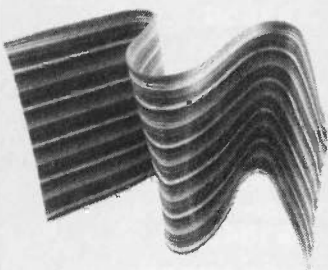

CONTACTS	SINGLE COLOR		COLOR CODED	
	1'	10'	1'	10''
10	.46	4.30	.78	7.20
16	.50	4.70	.96	8.70
20	.60	5.60	1.15	10.90
25	.70	6.50	1.22	11.50
28	.70	6.50	1.27	11.50
34	.93	8.50	1.55	14.40
40	1.27	11.50	1.82	18.70
50	1.28	12.00	2.40	21.90

RESISTORS

1/4 WATT 5% CARBON FILM
ALL STANDARD VALUES
FROM 1 OHM - 10 MEG OHM

50 PCS 1.25
100 PCS 2.00
1,000 PCS 15.00



**Checkmate
Technology,
Inc.**

**APPLE IIe Special
Extended 80-Col.
VIDEO CARD**

\$69.95

★ 64K to 128K ★
MULTIVIEW 80/160 249.00

90-160 columns with any monitor!

- Screens: 80x24, 80x32, 80x48, 96x24, 132x24, 132x30, 160x24
- On-screen **BOLD** and **Underline**
- Reverse scrolling
- Easy-to-read **Wide-angle** mode.
- Apple II and IIe compatible
- Prompt lines
- Upper & lowercase letters



APPLE & IBM ACCESSORIES

80 Column Apple II+ ... 149.95
80 Column Apple IIe ... 119.95
Z80 Apple II+ 89.00
Z80 Apple IIe 89.00
16K Card 39.95
Cooling Fan 38.95
Power Supply 74.95
Joystick 29.95
RF Modulator 13.95
Disk Drive 169.95
Controller Card 59.95
Paddles 7.95



VIEWMAX-80 149.95

80-Column card for Apple II series

- Video Soft Switch
- Inverse Video
- VIDEX's Videoterm compatible



VIEWMAX-80e 119.95

80-Column extended video card for Apple IIe

- 64K RAM, expandable to 128K
- Double High-resolution circuit
- Compatible with Pascal & CP/M



PRINTMAX 59.95

Parallel printer card, Apple II series

- Centronics compatible
- Variable print widths
- Up to 5000 characters/second

**APPLE & IBM Compatible
DISK DRIVES**

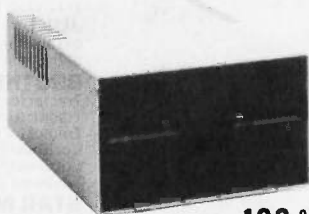

169.95

- Shugart mechanism, made in U.S.A.
- Directly replaces Apple Disk II
- Fully compatible with Apple Controller or other Apple compatible controllers.
- One Year Warranty

FULL or 1/2-Height

16K RAM Card - Apple II+
• 2-Year Warranty



Assembled & Tested **39.95**

**APPLE or IBM JOYSTICK
\$29.95**

Compatible for either:
APPLE II and APPLE IIe
OR
IBM-PC, JR., & IBM-XT
MULTIFUNCTION CARD



- 64K to 384K RAM
- Parallel Port
- Serial Port
- Clock Calendar
- Software Included
- 1-Year Warranty

\$249.95

MEMORY CARD



- Expandable to 512K
- Fully compatible with IBM software
- Fully compatible w/IBM diagnostic utilities
- Serial Port Available
- 1-Year Warranty

\$199.95

**MEMORY
EXPANSION KIT**



**4164 200ns
9 for \$19.98**

DISKETTES

5 1/4"

**ATHANA: (SOFT SECTOR
w/HUB RING)**
25 per package

SS/DD 29.75 or 1.19 ea.
DS/DD 34.75 or 1.39 ea.

**LIFETIME WARRANTY
ON ALL ATHANA DISKETTES**

**NO LABEL: (SOFT SECTOR
w/HUB RING)**
25 per package

SS/DD 24.75 or .99 ea.
DS/DD 29.75 or 1.19 ea.

**2-YEAR WARRANTY
ON ALL BULK DISKETTES**

ROBOT KITS! PEPPY



2-way sensor detects noise or solid objects in its path. When front sensor contacts an obstacle or hears a loud noise (hand-clap), Peppy automatically turns to the left.

Uses 2 AA and 1 9V battery (not included).
MV-916 \$24.95

**Reg. Power Supply
Model 4A/PS (99/4)
3 DC Outputs:**

12V @ .4A, +5V @ 1.1A
-5V @ .2A Highly Filtered

6.95

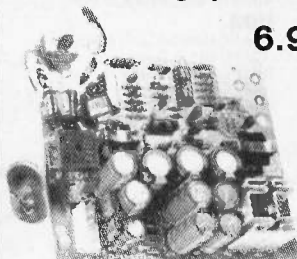

KEYBOARD (99/4)

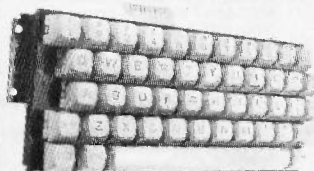

48 keys 4" x 10" 6.95

TERMS: Minimum order \$10.00
For shipping and handling, include \$2.50 for UPS ground or \$3.50 for UPS Blue (air). For each additional air pound, add \$1 for UPS Blue shipping and handling. California residents must include 6% sales tax. Bay area and LA residents include 6 1/2% sales tax. Prices are subject to change without notice. We are not responsible for typographical errors. We reserve the right to limit quantities and to substitute manufacturers. All merchandise subject to prior sale.

CALL for VOLUME Quotes

HOURS: Mon. - Fri. 7:30 to 5:00
Saturdays 10:00 to 3:00

VISIT OUR RETAIL STORE
2100 De La Cruz Blvd
Santa Clara, CA 95050
(408) 988-0697

**ALL MERCHANDISE IS
100% GUARANTEED**

Telex: 756440

Do Kay

COMPUTER CONNECTION
TOLL FREE ORDER LINE

SPRING CLEANING

Call Toll Free Now!

PERSONAL SYSTEMS

APPLE

Apple Professional System incl: Apple IIE, 128K, Tilt Monitor, Duo Disk, 80 col. card	\$1375
Mac 128K w/Drive, Mac Write, Mac Paint and mageWriter	2425
Fal Mac 512K, same as above	2995
Apple IIc	989
Apple IIc w/Monitor & Stand	1059

IBM

IBM PC Bare w/Cont. & 64K	\$1345*
IBM PC 64K, 1 Drive	1475*
IBM PC 64K, 2 Drives	1575*
IBM PC 128K, 1 Drive	1495*
IBM PC 256K, 2 Drives	1599*
IBM XT, 10 Meg, Floppy & 128K	3295*
IBM AT Base	Call
IBM AT Enhanced	Call

*Call For Current IBM Prices

KAYPRO

Kaypro II	Call
Kaypro IIX	For
Kaypro 4	Current
Kaypro 4/88	Price
Kaypro 10	And
Kaypro 16	Stock

SANYO

MBC 550-2 w/1 320K Drive & sftwr.	\$ 895
MBC 555-2 w/2 320K Drives & more software	1065
Serial Port for Sanyo	79
Sanyo Video Board	165

TAVA

TAVA PC1 Par. & 1 Ser. Ports, 128K, 2-320K Drives, Color Card & Monitor	\$1499
TAVA XT same as above incl. 10 meg Hd Disk	\$2495

COMPAQ

256K, w/2 - 320K Drives	\$1945
Desk Top Model 1	1650
Desk Top Model 2	1999
Desk Top Model 3	3795
Desk Top Model 4	4995

SOFTWARE

LOTUS DEVELOPMENT CORP.

Lolus 1-2-3	\$ 289
Symphony	434

ASHTON TATE

D Base II	\$ 329
D Base III	389

PRINTER SWITCHBOX

SRS-2 Serial	\$ 65
SRS-4 Serial	89
SCN-2 Parallel	79
SCN-4 Parallel	98

Run 2 to 4 Printers off 1 Computer

**20% to 40%
OFF LIST
ALWAYS**

PRINTERS

OKIDATA

ML182A, Replaces 82A "New"	\$ 279
ML83A, 15" Para. & Ser.	539
ML92P, 160 cps, Corr. Quality	349
ML92 IBM Graphics Comp.	349
ML92S, 160 cps, Corr. Quality	465
ML92 Apple Mac, 2K Graphics	475
ML93P, 160 cps, Corr. Quality	579
ML93 IBM Graphics Comp.	579
ML93S, 160 cps, Corr. Quality	659
ML84P, 200 cps	679
ML84 IBM Graphics Comp.	679
ML84S, 200 cps	779
Okimate 20	139
Interface Module for OKI 20	79

RITEMAN

Riteman Plus 120 cps w/Tractor	\$ 257
Riteman Blue Plus 140 cps IBM	342
Riteman II 160 cps, 8K mem. w/Trac	369
Riteman 15, 160 cps, 15" carr.	549

GUME

Letterpro 20P Prop. Spc. Enh.Prnt	\$ 399
Sprint 1140 + , 2K, 40 cps, 132 col. width	1229

STAR MICRONICS

SG10F1, 120 cps, corr. qual.	\$ 239
SG15F1, 120 cps, corr. qual.	399
SD10F1, 160 cps, corr. qual.	359
SD15F1, 160 cps, corr. qual.	475
SR10F1, 200 cps, corr. qual.	499
SR15F1, 200 cps, corr. qual.	629
SB10 Draft, 144 cps, NLQ 60 cps	795
Powerlype, 18 cps Bi-Di	359

C. ITOH

Prowriter 8510 AP, 120 cps, Parallel	\$ 299
Prowriter 8510 BC2, 120 cps, Serial	399
Prowriter 8510 SP, 180 cps, Parallel	399
8510 BPI (IBM Compatible), 120 cps	335
Prowriter II 1550 P, 15" 120 cps, Parallel	445
Prowriter II 1550BCD, 15" 120 cps, Serial	499
1550 EP (IBM Compatible), 120 cps	445
1550 SP, 180 cps	549
Starwriter F10-40PU, 40 cps	869
Starwriter A10, 205P, 29 cps	499
Printmaster F10-55PU, 55 cps	1069

BROTHER

HR25, 25 cps	\$ 629
HR35, 36 cps	839

DYNAX

DX15XL By Brother, 20 cps	\$ 379
---------------------------	--------

JUKI

6100, L.Q. 18 cps w/proportional spc.	\$ 389
6300, 40 cps	689

TOSHIBA

P1351 Dot Matrix, 192 cps, letter quality 100 cps, does graphics. 3 in 1 printer	\$1195
P1340 same as above but 10" carr.	585

PANASONIC

1091 w/Tractor, 120 cps, 1 yr. war.	\$ 269
1092, 10" carr., 180 cps	439
1093, 15" carr. 160 cps	669

LEGEND

880, 80 cps, FT & Graphics	\$ 229
1080, 120 cps, FT & Graphics	275

CLEARANCE

**COMPAQ
Desktop 1
RGB Comp. & Para.
\$1650**

**APPLE
Professional System
\$1375**

**IBM PC
2 Drives, 256K
Color Card w/Para.
\$1845**

**ORANGE MICRO
Grappler +
\$89**

**PARADISE 5 PACK
\$175**

**INTEL 8087
\$115**

PRINTER ACCESSORIES

ORANGE MICRO
Grappler + \$ 85
Buffered Grappler + , 16K exp. 64K 159

TOSHIBA
Bi-Directional Tractor \$ 149
Font Disk for Down loading P1351 48

MICROTEK
Dumping GX (same as Grappler +) \$ 69
Dumping GX w/16K buffer 145
Dumping GX w/32K buffer 12
Additional Buffering 16K 16

FOURTH DIMENSION
Par. Card & Cable for Apple \$ 45

OKIDATA
Plug and Play for IBM \$ 49
Okigraph I for 82A 49
Okigraph I for 83A 49
Tractor for 82A & 92 49

JUKI
Bi-Directional Tractor, 6100/6300 \$ 145
Serial Interface 65

BROTHER
Tractor for DX-15 \$ 99
Tractor for HR25 129
Tractor for HR35 129
Cut Sheet Feeder for DX15 175
Cut Sheet Feeder for HR25/35 199
Keyboard for DX15 165

STAR MICRONICS
Graphstar, Apple Interface \$ 69
Universal Atari 79
Universal Commodore 59
Serial Interface Card 59

CABLES
IBM PC to Parallel Printer \$ 18
Serial Cable 18
Cent. to Cent. M/M or M/F 18

**IF YOU SEE IT ADVERTISED FOR LESS,
CALL COMPUTER CONNECTION FIRST
FOR LOWEST QUOTE!**

**GIVE US A CHANCE TO BEAT THE
COMPETITION'S ADVERTISED PRICE.**



**NO SURCHARGE
FOR CREDIT CARDS**



We accept VISA, MasterCard, COD (w/deposit).
Certified Checks or Wire Transfers. Minimum
Shipping Charge \$4.00. Some items subject to
back order. California Res. add 6 1/2% Sales Tax.
All returns are subject to a 15% restocking
charge and must be authorized by store manager
within 10 days. Prices subject to change without
notice. This Ad supersedes all others.

COMPUTER CONNECTION

CLEARANCE SALE

(800) 732-0304

SPECIALS

PRINTER BOX
A-B Para/Serial
\$79 / \$65

STAR MICRONICS
SG-10Ft
\$239

PARADISE
5 Pack, Serial,
Clock, Cal. 0-384K
\$175

PANASONIC
KXP 1091
\$269

TOSHIBA P351
\$1295

MPI FOR IBM
\$75

TEAC 55B
\$97

APPLE & FRANKLIN ACCESSORIES

ACCESSORIES

Kensington System Saver \$ 69
Fan for Apple II & IIE w/surge 45

APPLE

Super Serial Card \$ 139
Cont. Card w/Pro Dos 80
Monitor II 159
80 Col. Card 65

ASTAR

RF Modulator \$ 17

MICRO-SCI

64K, 80 Col. Card \$ 85

ADVANCED LOGIC SYSTEMS

Z Engine 2.2 \$ 115
CPM/3.0 245

MICROMAX

Viewmax 80e, 128K extended 80 col. card
for Apple IIE \$ 124
Viewmax 80, 80 Col. Card for Apple II & II+ 139

DISKETTES

PC DISKETTES

Sgl./Dbl. (Box of 10) \$ 16
Dbl./Dbl. (Box of 10) 18

COMPUTER CONNECTION

Sgl./Dbl. (Box of 10) \$ 14
Dbl./Dbl. (Box of 10) 16
Sgl./Dbl. w/Disk Container (10) 20
Dbl./Dbl. w/Disk Container (10) 22
Bulk 50 & Up — Sgl./Dbl. 1.25 ea.
Bulk 50 & Up — Dbl./Dbl. 1.35 ea.

All Diskettes come w/5 Year Warranty

IBM PC ACCESSORIES

IBM

IBM Mono Card w/Printer Port \$ 245
IBM Mono Monitor 225
IBM Dos 2.1 59
IBM Dos 3.0 69
IBM Tech Ref. for PC 85

AST RESEARCH

Six Pak + w/64K \$ 255
Mega Plus II 265
Monograph + 329

PARADISE

Modular GraphicsCard \$ 265
Module A Paralell or Serial 75
Module B 189
5 Pack 175

PC PEACOCK

Color Graphics Card w/Par. Printer Port, Compat.
w/All IBM Software, 2 yr. war. \$ 199

64K MEMORY UPGRADE

64K (9 chips) 200 ns, 90 day war. \$ 16

QUADRAM

Quad Color 1 Board \$ 199
Exp. Quadboard w/64K & Game Port 249
Quadlink 3000 Run Apple sftwr on IBM 359

VUTEK

Vutek - CPS Board, RGB & Composite w/Par. & Ser.
Ports, 2 Yr. War. \$ 239
Color Card (Herc. comp.) 175
Monographic Card (Herc. comp.) 275

TECHMAR

Graphics Master \$ 459

PERSYST BOARD

Bob Hi-Res Display Adp. \$ 375

KEYTRONICS

KB5151 \$ 185

HERCULES

Monochrome Graphics Card \$ 345
Color Card w/Printer Port 185

ORCHID

Blossom, like Six Pak + w/Network capabilities \$ 245

DATA PLUS

384K Mem. Board w/OK \$ 115
XT Short Card, 384K Mem. 183
Multiplus, same as Six Pak 199

MICROTEK

Monochrome Text Card Par & Ser \$ 185
Color Graphics Card 165

MODEMS

ANCHOR

Mark XII \$ 225
Volsmodem XII, 5 yr. warranty 185
Express 1200 Call

HAYES MICRO

300 Baud Smart Modem \$ 205
1200 Baud Smart Modem 399
1200 B for IBM PC 379
2400 Baud Modem 645
Micro Modem IIE 259
Chronograph 189

BIZCOMP

Intelli Modem ST \$ 299
Intelli Modem XL w/Voice 339
Intelli Modem XT Short Modem 369

COMPUTER CONNECTION
TOLL FREE ORDER LINE

DISK DRIVES

TANDON

TM100-2 for IBM PC \$ 119

TALL GRASS TECHNOLOGIES

25 Meg. HD w/Integral 55 Meg. Tape Backup \$2795

ALPHA OMEGA

10 Meg HD for IBM 13 Month Warranty \$ 699

TEAC

55B Double Sided 360K \$ 97

Quad Density 169

IBM

IBM Logo Disk Drive \$ 160

MPI

B-52 for IBM \$ 75

Drives For Apple & Franklin

RANA SYSTEMS

Elite I \$ 199
Elite II 339
Elite III 389
Controller add 85

MICRO-SCI

A-2 \$ 174
A.5C for IIC w/cable 185
A.5 1/2 height for IIE 199
Controller Add 59

DISPLAY MONITORS

QUADRAM

Amber chrome IBM compatible \$ 175

AMDEK

V300G \$ 129
V300A 139
V310A for IBM PC 159
Color 300 249
Color 600 415
Color 710 545

TAXAN

Composite #115, Green \$ 120
Composite #116, Amber 125
IBM Green Monochrome #121 139
IBM Amber Monochrome #122 145
RGB IBM w/Cable #420 389
RGB Super Hi-Res. #415 393
RGB Super Hi-Res. #440 529
RGB/Comp. Med. Res. #220 245

PRINCETON GRAPHICS

HX-12 for use with IBM PC \$ 455
Max 12 Amber for IBM 175
SR 12 Super Hi-Res 595
Scan Doubler 185

ACCESSORIES

8087 Math Chip \$ 115

COMPUSERVE

Starter Kit Includes: Infoplex, Electronic Conferencing, Professional Forums and Much More \$ 39
Executive 55

MOST ORDERS SHIPPED SAME DAY

MAIL ORDER & WAREHOUSE:

17121 South Central, Unit L
Carson, California 90746

CUSTOMER SERVICE:

(213) 635-5065

Mon.-Fri. 9 a.m. to 3 p.m.

ORDER LINE (800) 732-0304

(Outside California)

(213) 635-2809

(Inside California)

Mon.-Fri. 7 a.m. to 6 p.m.
Saturday 11 a.m. to 3 p.m.

Inquiry 95

COMPUTER CONNECTION

NEW!!

MEGA-CASE™

NEW!!

**IDEAL FOR OEM MANUFACTURERS, UNIVERSITIES,
RESEARCH LABS ETC.**

THE ULTIMATE PC COMPATIBLE ENCLOSURE

**IDEAL FOR MEGA-BOARD™ XT OR ANY IBM-PC PC-XT
COMPATIBLE BOARDS**

**OEM AND DEALER
QUANTITY DISCOUNTS AVAILABLE**

EASY ACCESS!!
FLIP-TOP-CASE™
OPENS FOR EASY
ACCESS TO INSIDE!!

**EXCLUSIVE
FLIP-TOP-CASE™**
Overcomes Problems
With PC Case

Bus Expansion Slot
Allows External
Access To PC Bus

POWER SUPPLY

Blank Label Inset
For Your Company Or
University Name Here

Mounts Standard
Half or Full Height
Floppy Disk
or Hard Disk Drives

Rugged Heavy Gauge Steel Construction

**ONLY
\$99⁹⁵**
COMPLETE

ADVANCED KEYBOARD

- FEATURES:**
- Horizontal Return Key
 - Caps Lock and Num. Lock Indicators
 - Enter Key for Numeric Keypad

Full PC Compatibility



**ONLY
\$149⁹⁵**

Fully Assembled and Tested with One Year
Limited Warranty

DTC™ DISPLAY
TELECOMMUNICATIONS
CORPORATION

4100 SPRING VALLEY ROAD
SUITE 400
DALLAS, TX 75234
(214) 991-1644

TERMS: We accept cash, checks,
money orders, or purchase orders from
qualified firms and institutions. Prices
and availability subject to change without
notice. Shipping and handling charges
extra.

MEGA-BOARD™-XT

#1 CHOICE OF MAJOR OEM MANUFACTURERS, UNIVERSITIES, RESEARCH LABS ETC. A THOROUGHLY FIELD PROVEN DESIGN. HIGH VOLUME PRODUCTION ENGINEERED.

- **FULL IBM PC-XT* COMPATIBILITY!**
- **FULL MEGA-BYTE RAM CAPACITY ON MOTHERBOARD!**

THOUSANDS SOLD WORLD WIDE!

DEALERS AND OEM MANUFACTURERS QUANTITY DISCOUNTS AVAILABLE

Eight Compatible I/O Interface Connectors
(Full PC compatible)
(compatible with all IBM-PC* plug-in cards)

Special J1 Interface
(Allows horizontal mounting of compatible expansion cards for easy bus expansion and custom configuring) (Board has 62 pin gold plated compatible connector)

Extended ROM Capability
(Runs all compatible PC ROMS) (Jumper programmable to accommodate all popular 8K, 16K, 32K and 64K ROM chips and NEW EE ROMS! VPP power pin available for EP ROM burning!) (External VPP voltage required)

Full Mega-Byte Ram Capacity! On board!
(With parity)
 256K Bytes using 64K chips
 1 Mega Bytes using 256K chips

Standard Keyboard Interface
(Full PC compatible)

Hardware Reset
(Overcomes reset flaw in PC)

Power Connector
(Full IBM* pinout compatible)

8088 Processor
(Same as PC)

8087 Numeric Processor
(Same as PC)

Peripheral Support Circuits
(Same as PC)

Configuration Switches
(Same as PC)

Speaker/Audio Port
(Same as PC)

Wire Wrap Area
To facilitate special custom applications!

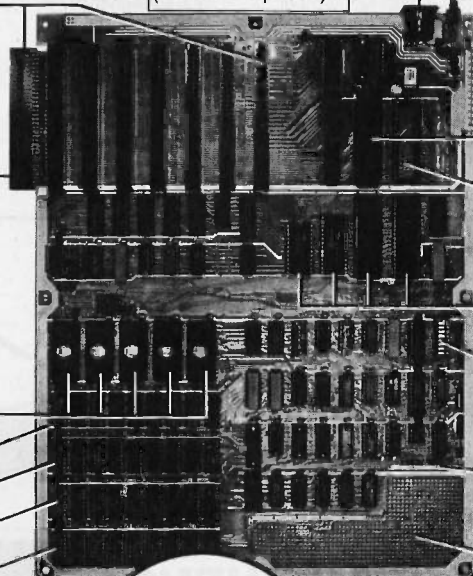

ONLY!
\$409.95

Mega-Board™ Triple-tested, fully socketed and assembled with IC's.

Includes highest quality PC board with gold plating, silk screen, solder mask

Board Size 10.5 inch X 13.5 inch

- MEGA-BOARD™ — XT
- BARE BOARD KIT \$ 99.95
- ASSEMBLED AND TESTED SOCKET KIT (LESS IC'S) (FULLY SOCKETED) \$199.95
- ASSEMBLED AND TESTED — COMPLETE (INCLUDES USERS MANUAL AND MEGA-BIOS ROM) \$499.95
- USERS MANUAL WITH THEORY OF OPERATION, SCHEMATICS, BLOCK DIAGRAM, APPLICATION NOTES \$ 19.95
- MEGA-BIOS™ ROM (2764) FULLY XT COMPATIBLE, MS-DOS, PC DOS \$ 29.95
- HARD TO GET PARTS CALL

FREE OFFER

FREE! Displaytel™ Exclusive. Our Commitment to Microcomputer Education!
FREE Intel 8088 Data Book with each Mega-Board™ Order!

ORDER NOW!!! Fast, friendly service

CALL 214-991-1644

100% **SATISFACTION GUARANTEE**

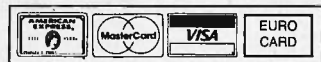

Immediate shipment! Most instock items shipped same or next day!

10 Day money back guarantee if not completely satisfied!

DTC™ DISPLAY TELECOMMUNICATIONS CORPORATION

4100 SPRING VALLEY ROAD SUITE 400 DALLAS, TX 75234 (214) 991-1644

TERMS: We accept cash, checks, money orders, or purchase orders from qualified firms and institutions. Prices and availability subject to change without notice. Shipping and handling charges extra.

* IBM and IBM PC are trademarks of International Business Machines

California Digital

17700 Figueroa Street • Carson, California 90248

NEC RGB COLOR \$259 MONITOR



The NEC JC-1401D is a 13" medium/high resolution RGB monitor suitable for use with the Sanyo MBC-550/555 or the IBM/PC. The monitor features a resolution of 400 dots by 240 lines. Colors available are Red, Green, Blue, Yellow, Cyan, Magenta, Black and White. These monitors are currently being used in applications far more critical than microcomputers.

The NEC monitor carries the Litton-Monroe label and was originally scheduled for use in their "Office of the Future" equipment. A change in Monroe's marketing strategy has made these units excess inventory which were sold to California Digital. We are offering these prime "new" RGB monitors at a fraction of their original cost. Sanyo compatible NEC-1401/5; IBM/PC Computer compatible NEC-1401/PC

COMPUTER PLOTTER

\$219

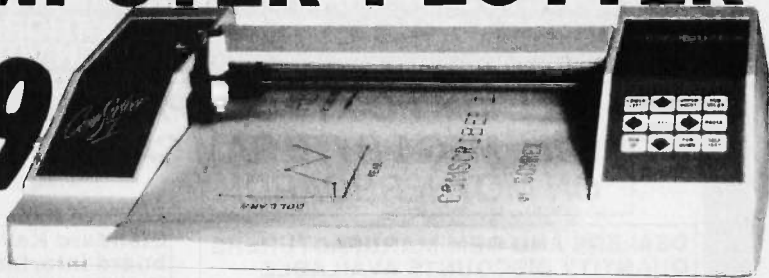

The Comrex Comscriber I is the ideal solution to make short work of translating financial and numeric data into a graphic presentation.

Many ready to run programs such as Lotus 1-2-3, Visi-on and Apple business graphics already support this plotter.

The Comscriber I features programmable paper sizes up to 8 1/2" by 120 inches, 6 inch per second plot speed and 0.004" step size.

Easy to implement Centronics interface allows the Comscriber I immediate use with the printer port of

most personal computers.

The Comscriber I is manufactured for Comrex by the Enter Computer Corporation. The plotter is marketed by Heath Kit and also sold under Enters own "Sweet P" Label. This is your opportunity to purchase a graphic plotter which was originally priced at \$795 for only \$219.

Also available is a support package which includes demonstration software, interface cable, amulicolor pen assortment and a variety of paper and transparency material.

MONITORS

BMC 12A green phosphor, 15 MHz, composite video
BMC 12" high resolution, 20MHz
Amitek 300A 12" green phosphor
Amitek 300A 12" amber phosphor, hi-resolution
Amitek 310A designed for IBM/PC, amber
Zenith ZVM122 Amber Phosphor 12" 40/80 column switch
Zenith ZVM123 green phosphor 12" 40/80 column switch
Toshiba 1011 green phosphor 18 MHz, composite video
NEC JB1260 commercial grade composite
Contrax 9" open frame requires horiz sync & 12v. supply.

BMC-12A 78.95
BMC-9191 119.00
AMK-300G 128.95
AMK-300A 138.95
AMK-310A 158.95
ZTH-122 89.95
ZTH-123 89.95
NEC-JB1261 159.00
NEC-JB1260 119.00
CON-BW9 59.00

COLOR

NEC JC1401D Medium/High 13" RGB
BMC AU9191U Color composite video with sound
BMC-9191M RGB designed for use with the IBM computer.
NEC JC1203DM, RGB color monitor
NEC JC1215 color composite.
Zenith ZVM135 RGB & composite suitable for IBM PC
Amitek Color I, 12" composite video
Amitek Color II - 13" RGB, hi resolution
Amitek Color III - 13" RGB, medium resolution
Princeton HK-12 RGB IBM/PC composite

NEC-1401/X 259.00
BMC-9191 236.95
BMC-9191M 272.00
NEC-1203 699.00
NEC-1215 399.00
BMC-9191M 272.00
AMK-100 299.00
AMK-200 419.95
AMK-300 359.95
PRN-HX12 478.95

1200 BAUD MODEM

The Team 212A offers all the features of the Hayes Smart Modem 1200 for a fraction of the price. Now is your opportunity to purchase a 1200 baud modem at the price of a 300 baud modem. California Digital is so confident of your complete satisfaction that we will allow the return the Team 212A and apply the full credit towards the purchase of any other 1200 baud modem. TEM-SM1200

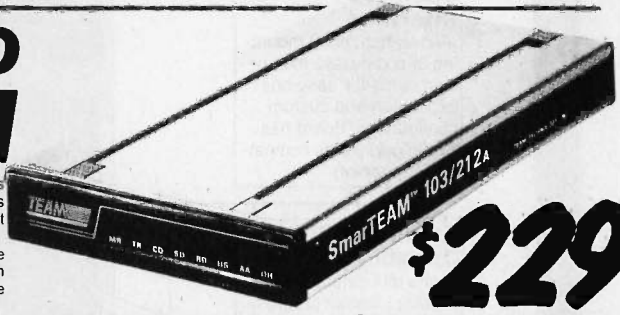

\$229

PRINTERS

MATRIX PRINTERS

Star Gemini-10X 120 char/sec.
Star Gemini-15X, 100 char./sec. 15" paper.
Star Gemini Delta 10, 160 Char/sec.
Amtek P1351, 132 char/sec. letter quality
Oxidata 82A serial & parallel 9 1/2" paper
Oxidata 92A parallel interface, 160 char./sec.
Oxidata 83A & parallel 15" paper
Oxidata 84A & parallel 15" paper
Epson RX-80 10" 120 Char/sec.
Epson RX-80FT Inclin & tractor
Epson FX80FT, 10" 160 char./sec with graphitraz
Epson FX100FT 15" 160 char./sec with graphitraz
Epson LX100, 15" correspondence quality
Epson JMB Color printer
Prowriter 8510 parallel 9 1/2" paper
Prowriter II, parallel 15" paper, graphics
Dataproducts B-800-3, band printer 500 LPM.
Princeton P300 high speed printer 300 lines per minute.
Printronic P600 ultra high speed 600 lines per minute.

STR-G10X 219.00
STR-G15X 365.00
STR-D10 359.00
TOS-1351 1455.00
OKI-82A 299.00
OKI-92A 379.00
OKI-83A 349.00
OKI-84A 329.00
EPS-RX80 239.00
EPS-RX80FT 279.00
EPS-FX80 399.00
EPS-FX100 569.00
EPS-LX100 1079.00
Epson JMB 579.00
PRO-8510P 329.00
PRO-2P 559.00
DPS-8600 695.00
PTX-P300 3995.00
PTX-P600 5795.00

WORD PROCESSING PRINTERS

Stawriter F10 parallel, 40 char/sec.
NEC8810 55 char/second, serial interface
NEC8830 55 char/sec, parallel interface
NEC3550, popular printer designed for the IBM/PC
NEC2050 designed for IBM/PC 20 char/sec, paral.
Silver Reed EXP500, 14 char/sec, parallel interface
Silver Reed EXP550 17 Char/sec parallel interface.
Diablo 60 40 char/sec, serial
Diablo 820, proportional spacing, horiz. & vert. tab. 20 cps
Juki 6100, 10 char./sec.
Juki 8300, 40 char./sec.
Comrex CR2, 5k buffer, proportional spacing, paral.

PRO-F10P 499.00
NEC-8810 1659.00
NEC-8830 1659.00
NEC-3550 1599.00
NEC-2050 689.00
SRD-EXP500 319.00
SRD-EXP550 429.00
DBL-830 1569.00
DBL-820 769.00
JUK-610 399.00
JUK-8300 699.00
CRX-CR2P 395.00

PROMETHEUS ProModem 1200



\$319

The Prometheus ProModem 1200 is best value that we have seen in a 300/1200 baud modem. This Hayes compatible modem features completely unattended operation, auto answer/auto dial and even includes "redial number when busy". Internal diagnostics make the ProModem 1200 an easy modem to install. Help commands, real time clock and internal speaker add to the ease of use of this unit.

An optional processor accessory allows battery back up, extra memory space for storing additional phone numbers, messages received, and can act as a transfer buffer when exchanging programs.

The Alphametric display option allows messages saved to be displayed when they were received, diagnostic test results, numbers in the directory, as well as modem status.

MODEMS

Team 1200 Hayes Compatible
CTS 212AH 1200 baud, auto dial
Terminal software for CTS 212AH
Prometheus 1200 super features
Prometheus 1200B internal PC
Signalman Mark 12, 1200 baud, Hayes compatible
Signalman Mark 1, direct connect with terminal cable
Hayes Smart Modem 1200 baud, auto answer, auto dial
Hayes 1200B for use with the IBM/PC, 1200 baud
Hayes Smartmodem, 300 baud only, auto answer, auto dial
Hayes Micromodem II, 103 Apple direct connect
Hayes Chronograph, time & date
U.S. Robotics 212A 300/1200 baud, auto dial/anwser.
Penny 300/1200 industrial quality
Universal Data 103/P, line power, answer & originate
Universal Data 202, 1200 baud, half duplex only
Universal Data 212LP, full 1200 baud duplex, line power
Navation J'Cat, direct connect, auto answer

TEM-SM1200 229.00
CTS-212AH 299.00
CTS-212SFT 35.00
PRM-P1200 319.00
PRM-P1200B 279.00
SGL-MK12 229.00
SGL-MK1 75.00
HVS-212AD 429.00
HVS-1200B 399.00
HVS-103AD 229.00
HVS-MM2 279.00
HVS-CHR232 199.00
USR-212A 439.00
PEN-12AD 495.00
UDS-103LP 169.00
UDS-202LP 219.00
UDS-212LP 359.00
NOV-JCAT 115.00



EAGLE \$895

The Eagle IIE/2 Computer features a 12" non-glare green phosphor CRT, typewriter style keyboard with separate numeric cluster. This unit provides two 5 1/4" drives for a combined storage capacity of 780 K/Byte. The computer contains a 4MHz Z-80A, DMA disk interface, two RS-232C serial ports, Centronics printer interface, along with an auxiliary parallel port.

Software included consists of ULTRACALC electronic spread sheet, SPELLINDER word processor, CBASIC2, CP/M 2.2, and an exclusive Eagle menu driven utility package. These units are all "factory new" and are being offered far below their suggested price of \$2495. This is your opportunity to purchase a complete CP/M system for only \$895.

Return of a Smash Hit Sellout DRAGON \$99



Compatible with most Radio Shack Color Computer software. The world famous Dragon computer is now available in the United States. Manufactured by the Tano Corp. under license of the British Broadcasting Company. The Dragon comes complete with 64K Byte of memory, serial modem port along with a Centronics printer interface. This unique microcomputer features Motorola's advanced 6809E microprocessor and comes standard with Microsoft Color Basic, data base manager, and a complete word processing package. The computer outputs color composite video along with R.F. video that allows the unit to be used in conjunction with any color television. This is the ideal low cost computer to be used with any dial up information system such as the Source, Western Union's EasyLink or any other time share service.

TERMINALS

Freedom 100, split screen, detachable keyboard
Qume 102 green phosphor terminal
Amtek Dialogue 125 green screen
Amtek Dialogue 175 amber screen, two page, func. keys
Wys5 50, 14" green phosphor
Wys5 300, Eight color display, split screen.
Zenith 29 terminal, VT52 compatible, detach. kb keyboard.
Televideo 910 Plus, block mode
Televideo 925, detachable keyboard, 22 function keys
Televideo 950, graphic char. split screen, 22 func.
Televideo 970, 14" green, 432 column, European

LIB-F100 495.00
QUM-102 339.00
APX-D125G 495.00
APX-D175A 719.00
WYS-50 595.00
WYS-300 1159.00
WYS-300 1159.00
ZTH-229 765.00
TVI-910P 575.00
TVI-925 755.00
TVI-950 850.00
TVI-970 1085.00

TOLL FREE ORDER LINE
(800) 421-5041

TECHNICAL & CALIFORNIA
(213) 217-0500

California Digital

17700 Figueroa Street • Carson, California 90248

C.I.TOH F10 STARWRITER

\$499
LETTER QUALITY PRINTER

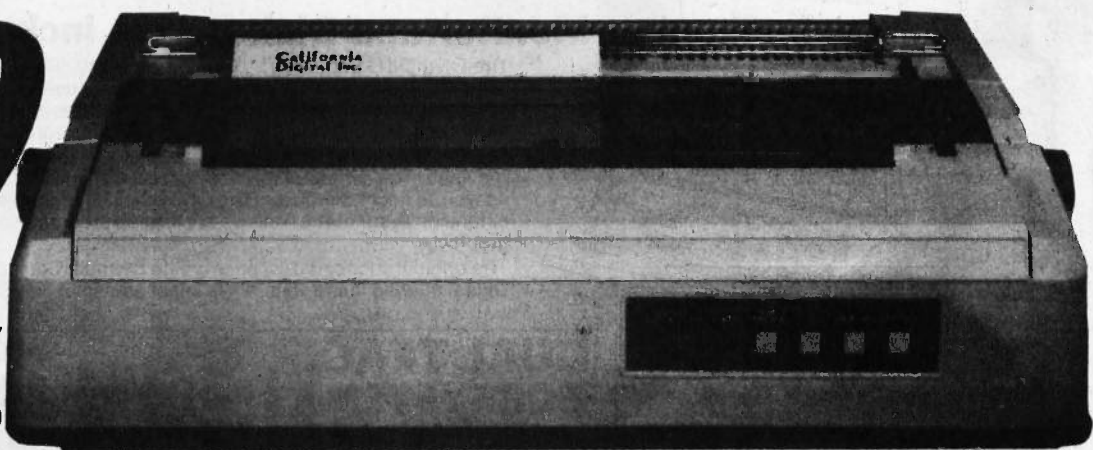

C. Itoh's STARWRITER F-10 is the answer for the perfect daisy wheel printer. The F-10 produces letter quality printing at 40 characters per second. Auto installs with Wordstar and Perfect Writer. Features extensive built-in word processing functions that allow easy adaptability and reduced software complexity. Industry standard Centronics interface provides instant compatibility with all computers equipped with a parallel printer port. The Starwriter F-10 ac-

cepts paper up to 15 inches in width.

These printers were originally priced to sell at over \$1400. Through a special arrangement California Digital has purchased these units from a major computer manufacturer and is offering these printers at a fraction of their original cost.

Options available include tractor feed, buffered memory and an assortment of printer cables for a variety of computers.

10 MEGABYTE WINCHESTER SPECIAL

California Digital has recently purchased several thousand 10 Megabyte Winchester disk drives. The manufacturer has asked us not to advertise their name. Please telephone for details

\$319



\$119

Your Choice

TEAC 55B 55F 48TPI-96TPI

One Two Ten

Five Inch Double Sided Drives

TEAC FD55B half height	119	115	109
TEAC FD55F 96 TPI, half ht.	119	115	109
CONTROL DATA 9409 PC	169	159	155
SHUGART SA455 Half Height	119	115	109
SHUGART SA465 1/2 Ht. 96TPI	119	115	109
TANDON 100-2 full height	149	145	139
TANDON 101-4 96TPI full ht.	299	289	279
MITSUBISHI 4851 half height	139	135	129
MITSUBISHI 4853 96/TPI 1/2 Ht.	155	149	139
MITSUBISHI 4854 8" elec.	295	285	275
QUME 142 half height	219	205	199

Eight Inch Single Sided Drives

SHUGART 801R	159	159	154
SIEMENS FDD 100-8	119	115	109
TANDON 848E-1 Half Height	369	359	349

Eight Inch Double Sided Drives

SHUGART SA851R	495	485	475
QUME 842 "QUME TRACK 8"	319	319	313
TANDON 848E-2 Half Height	459	447	435
REMEX RFD-4000	219	219	209
MITSUBISHI M2896-63 1/2 Ht.	459	449	409

Shugart 604 WINCHESTER

\$99



These 6.7 Megabyte drives are new units recently released by the Shugart division of Xerox. The Shugart 604 is fully 506 industry compatible. Each drive is tested before shipment and is supplied with a 90 day warranty. SHU-604

Five Inch Winchester Hard Disk Drives

FUJITSU M2235AS 27 Meg.	899	859
RODIME RO-208 53 Meg.	1589	1493
MAXTOR XT10140 140 Meg.	3895	3785
SHUGART 712 13 Meg. 1/2 Ht	495	465
SHUGART 604 6.7 Meg.	99	89
TANDON 502 10 Meg.	419	395
TANDON 503 19 Meg.	695	675
SEAGATE 225 25 Meg.	695	625

MEMORY



DYNAMIC MEMORY		1-31	32+	100+
4164 150ns. 64K 128 refresh	ICM-4164150	2.29	1.99	1.35
41256 150ns. 256K	ICM-41256150	8.95	8.50	7.25
41118 450ns. 16K	ICM-41118150	1.75	1.65	1.45
41118 200ns. 16K	ICM-41118200	1.75	1.65	1.45
4128 for IBM/AT	ICM-4128150	8.95	8.75	8.35
DP8409 dynamic controller	ICT-8409	39.00	35.00	29.00
STATIC MEMORY				
21L02 200ns. 1K static	ICM-21L02200	1.49	1.29	1.15
21L02 450ns. 1K static	ICM-21L02450	1.29	1.15	.99
2112 450ns. 2K static	ICM-2112450	2.99	2.85	2.75
2114 300ns. 1K x 4	ICM-2114300	1.95	1.85	1.75
4044TMS 450ns. 4K x 1	ICM-4044450	3.49	3.25	2.99
5257 300ns. 4K x 1	ICM-5257300	2.50	2.25	1.99
6116 P4 200ns. 2K x 8	ICM-6116200	3.95	3.85	3.70
6116 P3 150ns. 2K x 8	ICM-6116150	4.55	4.35	4.15
EPROMS				
2708 450ns. 1K x 8	ICE-2708	4.95	4.75	4.55
2716 450ns. 2K x 8	ICE-2716	4.50	4.25	3.97
2716TMS 450ns. Tri-voltage	ICE-2716TMS	7.95	7.65	7.25
2732 450ns. 4K x 8	ICE-2732	4.50	3.75	3.55
2764 350ns. 8K x 8	ICE-2764	5.95	5.75	6.25
27128 350ns. 16K x 8	ICE-27128	7.95	7.35	6.95

Shipping: First five pounds \$3.00, each additional pound \$.50. Foreign orders: 10% shipping, excess will be refunded. California residents add 6 1/2% sales tax. • COD's discouraged. Open accounts extended to state supported educational institutions and companies with a strong "Dun & Bradstreet" rating.



California Digital

17700 Figueroa Street • Carson, California 90248

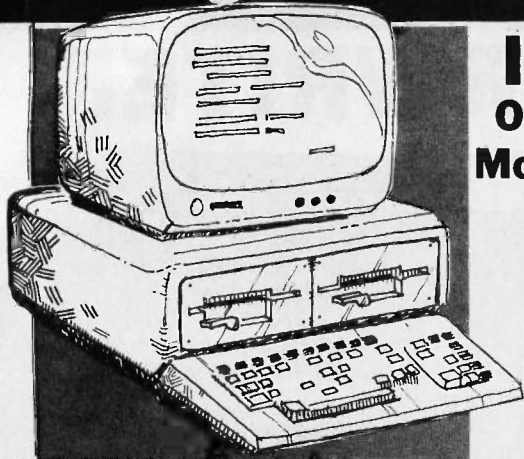

IBM COMPATIBLE OPERATES MS/DOS & CPM86 Monitor and Disk Drives included. \$995

The Olympia Computer is a current technology, IBM/PC compatible computer complete with two quad density disk drives, 128K/byte of user memory (expandable to 512K) and a 12 inch high resolution monitor. This unit features a 8086 CPU, a true 16 bit microprocessor, built in RS-232 serial port and a Centronics parallel printer port.

The Olympia includes a dual operating system and both MS/DOS 2.1 and CP/M 86 are provided. The computer will also support Concurrent CP/M. And will operate Lotus 1-2-3 as well as Flight Simulator. The Olympia uses Digital Research's GSX/86 graphics extension system which allows application programs to use the full capabilities of screen graphics.

The original suggested list price on the Olympia Computer was \$3,595 but California Digital offering these units, while supplies last, at only \$995.

WINCHESTER SUBSYSTEM For IBM/PC \$519



The California Digital Winchester subsystem provides over 10 megabytes of memory for only \$519. This low cost external hard disk systems is supplied with controller card and operating software. Everything you need to install this Winchester on your IBM/PC is included with the subsystem kit. And at only \$519, this is by far the best value that has ever been offered in a hard disk system.

DUAL TEAC SUBSYSTEM \$289



The dual Teac 55F subsystem features two 96 track per inch 5 1/4" double sided disk drives. Also supplied with in the subsystem is 50 watt power supply and a four foot shielded signal cable.

BAR CODE READER For IBM/PC \$589

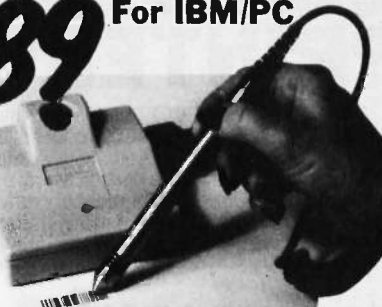

The DataLogic bar code reader plugs directly between the keyboard and the mainframe of your IBM/PC. All instructions are supplied in firmware built into the reader device. By the flip of a dip switch this bar code reader is capable of reading eight different formats of code including UPC, 2/5 and many more. Bar code is suitable for inventory control, freight and invoice records, personal records and other application limited only by imagination. Other DataLogic bar code readers are designed for the Apple II and RS-232 serial terminals. Please phone for list of other bar code products available.

ANCHOR AUTOMATION MODEM



The Anchor Automation Mark VI is direct connect modem that plus into any slot of your IBM/PC. This modem supports auto answer and auto dial capabilities. Other features include telephone number storage, send / receive text files, single key-stroke dialing along with many other functions provided on disk. The Mark VI was originally priced at over \$300.

\$89

TELETYPE MODEL 40 \$595



The Teletype Model 40 printer is continuous heavy duty communication equipment that have recently come off lease from a Cado Computer customer. It is seldom that California Digital becomes involved in the marketing of reconditioned equipment but we felt that this printer represented such an exceptional value that we had to offer this equipment to our customers.

The full character chain printer is capable of printing text in excess of 300 lines per minute. This printer, long used in high speed mini-computer applications, will provide the small business user with good quality multi-part printouts at speeds that can not be attained by dot matrix printers.

This unit also has a four channel vertical forms feed controller that allows for quick change of various form lengths. The Teletype Model 40 printer has a proprietary serial Teletype SSI interface and DIP switches are provided for setting baud rates to 9600. An optional RS-232 serial interface is available please phone for details.

DIGIGRAPHICS MULTIFUNCTION \$179

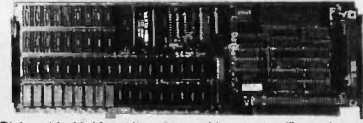

The Digigraphic 384M multifunction card is a work-a-like to the over priced AST Sixpack Plus but at a much more attractive price. Memory is expandible to 384K/byte, battery backed up clock/calendar, fully programmable RS-232 communication port, centronics parallel port, and game port as standard equipment making this card an outstanding value. Software is also provided for clock/calendar functions, RAM-Disk up to 360K, print spooler for up to 3 printers, as well as diagnostic memory tests. \$179.00 no memory DGC-384/0; \$219.00 64K/byte memory DGC-384/64.

FREE Plastic library case supplied with all diskettes purchased from California Digital.

	Soft Sector Ten Sector Sixteen	Each box	10 Boxes	100 Boxes
FIVE INCH DOUBLE SIDED DOUBLE DENSITY				
CAL DIGITAL	CAL-551 CAL-561 N/A	19.95	18.75	17.85
SCOTCH	MMM-745/0 MMM-745/10 MMM-745/16	29.95	27.95	24.75
VERBATIM	VRB-350/01 VRB-350/10 VRB-350/16	29.95	27.95	23.75
MAXELL / HD	MXL-MD2/96 N/A	CALL		
DYSAN	DYS-104/2D DYS-107/2D DYS-105/2D	42.50	40.50	35.50
DYSAN / 96	DYS-204/2D N/A	49.95	47.95	45.75

Other diskettes available include 3 1/2" and all 8" formats. Please phone for prices.

western union EasyLink

EasyLink gives any personal computer access to over 1.5 million Western Unions World Wide terminals. With EasyLink service you can send Telexes, Telegrams and Mailgrams from your own computer. Through the use of the "Mailbox" messages can be received even when your computer is turned off, and "picked up" at your convenience. Joining the World of Western Union's EasyLink is FREE of charge and there is no monthly service fee. Sending a domestic Telex is about \$1.75 and a Mailgram has an average cost of \$2.50. Western Union does require a minimum usage of \$25 per month. Call California Digital to receive your EasyLink subscriber number.

CONNECTORS

RIBBON CONNECTORS		"D" TYPE catalog	
DB25P male	CND-25P	5.65	5.25
DB25S female	CND-25S	5.95	5.59
37-30360 male	CNC-36P	7.95	6.75
37-30360 female	CNC-36S	7.95	6.75
20 pin edge	CNI-DE20	4.35	3.30
20 pin socket	CNI-DE20	2.75	1.85
26 pin edge	CNI-DE26	4.95	3.50
26 pin socket	CNI-DE26	3.50	2.40
34 pin edge	CNI-DE34	4.95	4.50
34 pin socket	CNI-DE34	4.50	3.95
50 pin edge	CNI-DE50	6.95	5.60
50 pin socket	CNI-DE50	4.95	4.60
AMPHENOL / CENTRONICS TYPE			
57-30360 36P	CNC-36P	7.95	6.35
IEEE488, C dor	CND-24P	7.95	6.35
DE9P male	CND-9P	1.60	1.40
DE9S female	CND-9S	2.25	2.00
DE hood	CND-9H	1.50	1.35
DA15P male	CND-15P	2.35	2.10
DA15S female	CND-15S	3.25	3.10
DA15 hood	CND-15H	1.80	1.35
DB25P male	CND-25P	1.85	1.75
DB25S female	CND-25S	2.95	2.55
DB25 hood	CND-25H	1.35	1.15
DC37S male	CND-37P	4.20	3.95
DC37S female	CND-37S	5.95	5.75
DC37 hood	CND-37H	2.25	1.95
DD50P male	CND-50P	5.50	5.10
DD50 hood	CND-50H	2.80	2.40
Hardware 2/set	CND-2HS	.89	.69



Shipping: First five pounds \$3.00, each additional pound \$.50. Foreign orders: 10% shipping, excess will be refunded. California residents add 6 1/2% sales tax. • COD's discouraged. Open accounts extended to state supported educational institutions and companies with a strong "Dun & Bradstreet" rating.

TOLL FREE ORDER LINE
(800) 421-5041
TECHNICAL & CALIFORNIA
(213) 217-0500

Hyperon Software

Specializing in innovative programming tools.

- Complete documentation and C-source provided (presently DOS only).
- Reasonable prices.
- High quality and good performance.

Products currently available:

C Preprocessor. Features include variables and expressions, loops, and full macros. Price — \$39.95
 General purpose editor. Line oriented commands with a screen oriented submode. Command window. Price — \$29.95

Order from:

HYPERON SOFTWARE
 P.O. Box 3349
 Costa Mesa, CA 92628

Enclose check or money order. California residents add 6%
 2532 Orange Ave. Costa Mesa, CA

Inquiry 193

DISKS

AS LOW AS **77¢** SS/DD BULK

Highest quality disks, complete with labels and sleeves. *Guaranteed 100% error free.* Full one year replacement warranty! Call for volume pricing and private labeling.

#UD1D SS/DD +SLEEVE & LABEL 100/\$8.80 500/\$420
 #UD1N SS/DD NO SLEEVE/LABEL 100/\$8.2 1000/\$770
 #UD2D DS/DD +SLEEVE & LABEL 100/\$12.90
 #UD2N DS/DD NO SLEEVE/LABEL 100/\$119

RFS	ICS	2114	2716	2732	2764	60	99	3.00	3.50	4116	4164-150	8255	8748	.34	1.88	3.50	18.50
-----	-----	------	------	------	------	----	----	------	------	------	----------	------	------	-----	------	------	-------

Pay by MC/Visa/Amex, COD, or send check with order. We charge standard UPS/Postal shipping, with no handling charge. In the USA, we ship only to a street address, not a PO Box or RFD. Please include your day phone number. Minimum order \$17. Money-back 30 day guarantee!

WORLDWIDE FREE (800)343-0472 IN MASS (617)UNI-TECH*

UNITTECH 208 HURLEY ST. CAMBRIDGE, MA 02141
 Send for FREE CATALOG listing 1000's of items!

Inquiry 404

NEW Monitor Mover Gives Back the Desk



\$159.⁹⁵

- Models to fit most CRT's
- Rotates 360° on base
- Adjustable height
- Support tray swivels and tilts
- Holds up to 50 lbs
- Clamp, screw and wall mountings

Lintek ■■■■■

P.O. Box 8056
 Grand Rapids, MI 49508
 (616) 241-4040

Inquiry 242

Macintosh™



512K
Includes drive.

\$1995

Call for prices on other Macintosh products.

PC'S LIMITED

OUTSIDE TEXAS, ORDERS ONLY, CALL 1-800-426-5150.
 7801 N. Lamar, #E-200, Austin, Texas 78752.

All calls inside Texas and all non-order inquiries, call (512) 453-0322.

MasterCard VISA
 Texas No. 9102808286 PC LTD
 Macintosh is a trademark licensed to Apple Computer, Inc. No surcharge on 115A or MasterCard. 3% surcharge on American Express.

Inquiry 318

NEW LOW-COST EPROM PROGRAMMER



Programs MOS EPROMs and EEPROMs to 256k for only \$1,450 (U.S. list price). Full-stroke keyboard • Large alpha display • Full editing • Intelligent algorithms • RS 232C • Remote control.

Call (800) 547-4000, Dept. 123** for more information.

**In Oregon 1-503-684-3000.

DATA I/O

10525 Willows Road N.E., P.O. Box 97046
 Redmond, WA 98073-9746

Inquiry 404



NEW

Paper Catcher

Stacks printed pages neatly on top of your computer printer!

- Rests on top of most Epson and Okidata 80 col. and similar printers
- Saves space
- Eliminates paper stacking problems
- Low \$49.95 suggested retail price

See Paper Catcher at a dealer near you, or contact:

Buddy Products
 1350 S. Leavitt Street
 Chicago, IL 60608
 (312) 733-6400

Inquiry 452

DISKS \$1.00

SSDD

DSDD - \$1.39

IBM PREFORMATTED (360K) \$1.55

QUALITY MEDIA • ANY QUANTITY
 LIFETIME REPLACEMENT
 GUARANTEE
 HUB RINGS • TYVEC ENVELOPES

Because we buy in huge volume to supply software manufacturers, our prices can't be beat.



BLACKSHIP
 COMPUTER SUPPLY

PO Box 883362 • San Francisco, CA 94188
 (415) 550-0512

Add \$3.00 shipping and handling (CA residents add 6.5%) VISA/MC/COD

Inquiry 52

Guard Your RS-232 Ports Against Costly Damage Caused By Lightning • Voltage Peaks

RS-232 SURGE PROTECTOR

Only \$34.95

Model 232SP



Suppresses voltage above 26 volts without affecting normal RS-232 voltage levels. Protects pins 2, 3, & 7. ORDER NOW! Only \$34.95. All cash orders postpaid (IL res. add 6% sales tax). MC, Visa accepted. FREE: New illustrated catalog of RS-232 Interface and Monitoring Equipment. Phone: (815)-434-0846.

B & B electronics
 MANUFACTURING COMPANY
 P.O. Box 1008B, OTTAWA, IL 61350

Inquiry 47

NOW C HERE! CROSS SOFTWARE for the NS32000

Also Available for IBM PC

INCLUDES:

- * Cross Assembler *
- * Cross Linker *
- * Debugger *
- * N.S. ISE Support *
- * Librarian *
- * Pascal Cross Compiler *
- * C Cross Compiler *

U.S. prices start at \$500

SOLUTIONWARE

1283 Mt. View-Alviso Rd.

Suite B

Sunnyvale, Calif. 94089

408/745-7818 • TLX 4994264

Inquiry 370

FREE CATALOG!

To Get Yours, Just Circle Reader Service #215 On Page 529.

BETTER THAN TALLGRASS!!! 45 Megabyte Streaming Tape System

Includes 45 MB half-high streaming tape drive, 45 MB tape cartridge, controller, cables, and software. Just plug-in and run!

- IBM PC, XT, AT compatible
- Fast 2.2 minutes per 10 MB
- Unique flexible software allows choice of file-by-file or complete mirror-image back-up & retrieval
- 6 different file selection parameters
- Automatic error checking & correction
- Full one year factory warranty

	JADE
Internal 45 MB for XT	\$1395
Internal 45 MB for PC	\$1145.95
External 45 MB system	\$1195.95
Extra 45 MB tape cartridge	\$50.45.95

New! from JADE IBM Multifunction Card

Up to 384K, parallel printer port, RS-232 serial port, serial cable, clock/calendar, RAM disk/spooler and diagnostic software package.

	JADE
0K	\$349
64K	\$449
256K	\$549
384K	\$649

AST for IBM PC

	JADE
Six Pak Plus 64K	\$395
Six Pak Plus 256K	\$695
Six Pak Plus 384K	\$945
Mega Plus 64K	\$395
Mega Plus 256K	\$665
Mega Plus 512K	\$1095
I/O Plus	\$119.95
Preview	\$399

64K RAM Upgrade Kits for Your IBM PC

High speed RAM upgrade kit with FREE! parity (error detection) and one year warranty. We ship thousands of these kits to satisfied customers every week.

	JADE
128K RAM Chip Kit for AT	\$359
256K RAM Chip Kit	\$88.95

GET YOUR IBM PC-AT THE AST Advantage

- Up to 3 Megabytes of RAM
- Uses standard 64K or 256K chips
- Has PAL for split-addressing
- Low power, IBM-AT high speed bus
- One parallel & one serial port
- 2nd serial or game port optional

	JADE
128K, 1 serial, 1 parallel	\$595
512K, 1 serial, 1 parallel	\$1395
1.5 MB, 1 serial, 1 parallel	\$2195
3.0 MB, 1 serial, 1 parallel	\$4145

New Products to Expand Your PCjr.

AST 512K jrCombo w/128K	\$395	\$299.95
512K Multifunc. Card w/OK	\$295	\$229.95
External 360KB Disk Drive	\$499	\$369.95
Parallel Printer Port	\$120	\$94.95
8087 Co-Processor Card	\$199	\$149.95
Light Pen System	\$299	\$229.95
Simultaneous Disk/Keyboard	\$59	\$44.95
AST-PCnet IIjr LAN	\$495	\$399.95
TECMAR CAPTAINjr. w/128K	\$499	\$349.95
TECMAR GRAPHICS MASTER	\$699	\$499.95

JADE 1200 BAUD MODEM

Hayes Smartmodem compatible, 1200 BAUD modem at a fraction of the price. FCC approved.

JADE 1200 BAUD MODEM	\$399	\$229.95
----------------------	-------	----------

10 Megabyte Hard Disk for Your IBM PC \$689.95

Plug-n-run, ready to go, complete with controller card, data cable, and mounting hardware, totally PC/XT compatible, faster than XT, handles 4 different operating systems, streamer tape back-up available. External model includes cabinet & power supply. Full one year manufacturers warranty.

	JADE
10 MEGABYTE Internal	\$1350
10 MEGABYTE External	\$1585
15 MEGABYTE Internal	\$1765
15 MEGABYTE External	\$1897
20 MEGABYTE Internal	\$1800
20 MEGABYTE External	\$2060
33 MEGABYTE Internal	\$3298
33 MEGABYTE External	\$3388
10 MEGABYTE Half-High Tape	\$1000
20 MB Disk with 10 MB Tape	\$2980

KEYTRONICS Keyboards

	JADE
5150	\$209
5151	\$199.95

Hayes Smartmodem 2400 BAUD IN STOCK!

(At press time we had 100 Smartmodem 2400's in stock and more on their way to us.)

SAVE \$21000

List Price \$895 Sale Price \$679.95

HAYES Smartmodems

Sophisticated direct-connect auto-answer/auto dial modem, touch tone or pulse dialing RS232 interface programmable

	JADE
HAYES Smartmodem 2400	\$679.95
HAYES Smartmodem 1200	\$469.95
HAYES 1200B w/o Smartcom II	\$539
HAYES 1200B for IBM PC	\$399.95
HAYES Smartmodem 300	\$289
HAYES Chronograph	\$249
HAYES Micromodem 100	\$399
HAYES Micromodem IIc	\$299
HAYES Smartmodem Ilic	\$399
HAYES PLEASE Software	\$395
HAYES Smartcom II	\$149

PROMODEMS from PROMETHEUS

	JADE
1200B ProModem for IBM PC	\$399
1200 RS-232 ProModem	\$495
1200A ProModem for Apple	\$449
1200 ProModem for Macintosh	\$495
Alpha/num Display Option	\$99
Options Processor	\$79.95
64K Mem Expansion for Above	\$99

	LIST	JADE
PC MOUSE with Pop-ups	\$195	\$139.95
PC MOUSE with Paint	\$220	\$159.95
FIELD MOUSE (male or female)	\$175	\$129.95
PC PAINT Software	\$99	\$69.95
MOUSE WINDOW Software	\$150	\$109.95
POP-UP MENU Software	\$50	\$39.95

QUADRAM for IBM PC

	LIST	JADE
Quadboard No RAM	\$269	\$234.95
Quadboard 64K	\$395	\$275.95
Quadboard 128K	\$495	\$319.95
Quadboard 256K	\$595	\$399.95
Quadboard 384K	\$795	\$469.95
Quadlink	\$680	\$449.95
Quad 512 Plus 64K	\$325	\$239.95
Quad 512 Plus 256K	\$550	\$359.95
Quad 512 Plus 512K	\$895	\$549.95
Quadcolor I	\$295	\$209.95
Quadcolor II	\$275	\$209.95
Quad 2 MEG w/512K	\$1195	\$995.95
Quad 2 MEG w/1 MByte	\$1995	\$1695.95

20 MEGABYTE TAPE

Low power, half-height tape drive that uses standard audio/data cassettes. Unique flexible software choice of file-by-file or complete mirror-image backup and retrieval. IBM PC, XT, AT compatible.

20 MB Cassette Back-up	\$995	\$649.95
------------------------	-------	----------

TEAC \$999.95

55B

360K

Disk Drive for IBM PC

Double-sided, double density

	LIST	JADE
TANDON 100-2	\$299	\$129.95
TEAC 55B	\$249	\$99.95
CDC 1/2 Height	\$279	\$139.95
CDC Full Height	\$299	\$149.95

SHUGART 8" Disk Drives

SHUGART SA 801A SS/DD (Limited Supply)	
LIST \$502	\$399.95 ea. 2 for \$389.95 ea.
SHUGART SA-851R DS/DD	
LIST \$605	\$459.95 ea. 2 for \$454.95 ea.

	LIST	JADE
Mouse with Word	\$495	\$319.95
Microsoft Word	\$249	\$339.95
Mouse a la carte	\$199	\$129.95

BERNOULLI BOXES from IOMEGA

5, 10, or 20 Megabyte removable cartridge mass storage system with flexibility not available with hard disks and speed unmatched by floppy disk drives.

	LIST	JADE
5 Mbyte system Macintosh	\$1895	\$1695.95
10 Mbyte system IBM PC	\$2695	\$2289.95
20 Mbyte system IBM PC	\$3895	\$2989.95
Extra 10 Mbyte Cartridge	\$100	\$79.95

High-Resolution Monitors

	LIST	JADE
Amdex 300G	\$179	\$139.95
Amdex 300A	\$199	\$149.95
Amdex 310A	\$230	\$179.95
Amdex Color 300	\$349	\$269.95
Amdex Color 500	\$525	\$399.95
Amdex Color 600	\$650	\$449.95
Amdex Color 710	\$799	\$589.95
PGS MAX-12	\$269	\$189.95
PGS HX-12 640x240	\$699	\$469.95
PGS SR-12 720x480	\$799	\$629.95
PGS Scan-Doubler	\$299	\$199.95
14 inch Quadchrome II	\$599	\$499.95
Taxan 440 Ultra Hi-res RGB	\$799	\$599.95
Taxan 210 RGB/Composite	\$349	\$289.95
Taxan TV Tuner for RGB Monitor	\$99	\$89.95

PERSYST Boards

	LIST	JADE
Mono display adapter	\$225	\$189.95
Mono display adapter w/parallel	\$250	\$199.95
BoB Hi-res display adapter	\$595	\$469.95
Time Spectrum SB 384 w/64K	\$395	\$299.95

High Speed 8087 APU

LIST PRICE \$293	SALE PRICE \$179.95
------------------	---------------------

These industrial quality ISO-BARS look like a standard multi-outlet power strip but contain surge suppression circuitry and built-in noise filters plus a 15 amp circuit breaker.

	LIST	JADE
4 Receptacle Iso-Bar	\$89	\$59.95
8 Receptacle Iso-Bar	\$99	\$69.95

UNINTERRUPTIBLE POWER SUPPLY

Emergency back-up power to save your computer system and your valuable data. A must for every computer system

	LIST	JADE
200 Watt UPS	\$359	\$279.95
425 Watt UPS	\$539	\$459.95
1000 Watt UPS	\$1179	\$995.95

	LIST	JADE
Full Height Disk Drive	\$299	\$139.95
Half Height Disk Drive	\$249	\$149.95
Disk Drive for Apple IIc	\$249	\$159.95
Dual Disk Controller	\$100	\$79.95
CP/M 3.0 Card with 64K	\$399	\$269.95
ALS Z Engine	\$299	\$145.95
16K RAM Card	\$99	\$39.95
Best 80 Column Card	\$219	\$139.95
Printer Card & Cable	\$109	\$49.95
Fan with Surge Protection	\$99	\$59.95
Koala Pad	\$125	\$89.95
Grappler Plus	\$175	\$99.95
64K Buffered Grappler+ w/16K	\$275	\$149.95
10 Megabyte Hard Disk	\$1495	\$995.95

IBM PC \$1695

JADE XPC \$1295

256K of RAM, Two 360K Disk Drives, & Disk Controller

JADE XPC

- ▶ 256K of RAM Expands to 640K on Main Board
- ▶ 140 Watt Power Supply
- ▶ 4.77 or 7 MHz Clock
- ▶ 8 Expansion Slots
- ▶ Deluxe Keyboard
- ▶ 90 Day Warranty

IBM PC

- ▶ 256K of RAM Maximum on Main Board
- ▶ 63 Watt Power Supply
- ▶ 4.77 MHz Clock
- ▶ 5 Expansion Slots
- ▶ IBM Keyboard
- ▶ 90 Day Warranty

OPTION #3

- 256K Expands to 640K
- 10 Megabyte Hard Disk
- One 360K Drive
- 130 Watts of Power
- Multifunction Card
- Hercules Card
- Amdex 300

OPTION #2

- 256K of RAM
- Two 360K Drives
- Hercules Card
- PGS HX-12 Monitor

OPTION #1

- 256K of RAM
- Two 360K Drives
- Hercules Card
- Amdex 300

IBM PC \$2995
JADE XPC \$2695

IBM PC \$2395
JADE XPC \$2095

IBM PC \$1995
JADE XPC \$1695

Place Orders Toll Free!

Continental U.S.A. Inside California Los Angeles Area
(800) 421-5500 (800) 262-1710 (213) 973-7707

JADE

Computer Products

4901 West Rosecrans Ave. Hawthorne, California 90250

NEW! EPSON LX-80

EPSON P501 45 cps Thermal
EPSON LX-80 100 cps, NLQ
EPSON JX-100FT+ 100 cps
EPSON JX-80+ 160 cps, Color
EPSON FX-80FT+ 160 cps
EPSON FX-100FT+ 160 cps
EPSON LQ-1500 200 cps, NLQ
EPSON HI-80 4 Pen Plotter
EPSON/COMREX 420 cps
2K Serial Board for RX/FX
NLQ Board for RX/FX
Letter/Writer NLQ Kit for FX
LX-80 Tractor
FX-80 Tractor
LQ-1500 Tractor
LQ-1500 Sheet Feeder

Save up to 40% on
Call for Low Price

	\$2,495	\$1,995.95
	\$149	\$99.95
	\$219	\$179.95
	\$75	\$59.95
	\$59	\$29.95
	\$59	\$39.95
	\$89	\$49.95
	\$499	\$399.95

NEW! OKIDATA PRINTER MICROLINE

192

160 CPS, Near Letter Quality, & Graphics

OKIMATE 20 Color printer	LIST \$150	JADE \$139.95
PLUG-N-PRINT for OKI 20	75	69.95
OKI 182 120 cps, graphics	\$299	\$259.95
OKI 192 160 cps, graphics	\$499	\$389.95
OKI 193 160 cps, 15" paper	\$699	\$549.95
OKI 92 160 cps, graphics	\$599	\$359.95
OKI 93 160 cps, 15" paper	\$995	\$599.95
OKI 84 200 cps, parallel	\$1,399	\$799.95
OKI 84 200 cps, serial	\$1,499	\$949.95
Tractor for OKI 192	50	44.95
Tractor for OKI 92	89	54.95
2K Serial Board for 192/193	99	69.95
2K Serial Board for 92/93	\$120	\$99.95
Extra Ribbon	59	44.95

Ultra-Violet EPROM Erasers

Spectronics with out Timer	LIST 99	JADE \$69.95
Spectronics with Timer	139	\$94.95

A-B Printer Switch

Fully bi-directional switch allows your computer to run either of two printers, or allows two computers to share one printer, standard parallel switch box.

Printer Switch	LIST \$149	JADE \$99.95
Extra Cable	50	\$29.95

Continental U.S.

800-421-5500

Inside California.

800-262-1710

For Technical Inquires
or Customer Service call:
213-973-7707



MANUFACTURED BY G. ITOH

STARWRITER F-10

40 CPS LETTER QUALITY DAISYWHEEL

\$499.95

LIST PRICE \$1199
QUANTITY LIMITED

The LITTLE BOARD with FREE! CP/M 2.2

Miniature single board CP/M computer designed to mount directly on top of a 5 1/4" floppy disk drive (7.75" x 5.75"). Contains Z80A, CPU, 64K RAM, Boot EPROM, terminal port, modem port, parallel printer port, floppy disk controller, and CP/M 2.2 included FREE!

Little Board with CP/M	LIST \$400	JADE \$339.95
Support Package	59	\$48.95
Serial Cable	\$13	\$11.95
Diskless Monitor Eprom	30	\$24.95
SCSI/Plus I/O Adapter	99	\$89.95

QUADRAM MICROFAZER Buffers

Expandable to 64K (parallel) model expands to 512K)

8K Parallel in/Parallel out	\$169	\$139.95
32K Parallel in/Parallel out	\$225	\$164.95
128K Parallel in/Parallel out	\$445	\$269.95
8K Serial in/Parallel out	\$199	\$169.95
32K Serial in/Parallel out	\$260	\$199.95
8K Parallel in/Serial out	\$199	\$169.95
32K Parallel in/Serial out	\$260	\$199.95
8K Serial in/Serial out	\$199	\$169.95
32K Serial in/Serial out	\$260	\$199.95

PRACTICAL PERIPHERAL MICROBUFFERS

Stand alone Microbuffers for Printers & Modems

32K Parallel in/Parallel out	LIST \$299	JADE \$229.95
64K Parallel in/Parallel out	349	\$269.95
32K Serial in/Serial out	389	\$229.95
64K Serial in/Serial out	\$349	\$269.95
64K Add-on Board	\$179	\$149.95

C. ITOH Printers

C. Itoh's best-selling ProWriter and StarWriter printers are now available with parallel interfaces for Apple & IBM, or a serial interface for Apple IIc, Macintosh, Data General, etc. Full one year manufacturers warranty.

ProWriter 7500 FT 105 cps	LIST \$289	JADE \$209.95
ProWriter 8510 FT 120 cps	\$429	\$299.95
ProWriter II 1550 FT 120 cps	\$619	\$439.95
StarWriter Y10-20 20 cps	\$689	\$359.95
StarWriter A10-30 29 cps	\$689	\$479.95
StarWriter F10-40 40 cps	\$1,199	\$899.95
StarWriter F10-55 58 cps	\$1,449	\$1,089.95
StarWriter F10 Tractor	\$249	\$159.95
StarWriter A10 Tractor	\$199	\$139.95

Letter Quality Printers On Sale!

Diablo 630 40 CPS	LIST \$2340	JADE \$1569.95
Tractor for 630	\$250	\$219.95
Comrex CR-IIe 20 CPS	\$599	\$399.95
Tractor for CR-IIe	\$120	\$99.95
Keyboard for CR-IIe	\$199	\$179.95
Sheet Feeder for CR-IIe	\$259	\$199.95
Sheet 6100 18 CPS	\$599	\$399.95
Juki 6300 40 CPS	\$995	\$849.95
Tractor for 6100	\$149	\$124.95
NEC 3550 33 CPS	\$2250	\$1399.95
Tractor for 3550	\$265	\$229.95
Toshiba P1340 180 CPS, par.	\$995	\$649.95
Toshiba P1340 180 CPS, serial	995	\$649.95
Toshiba P1351 196 CPS	\$1,895	\$1,289.95
Tractor for P1351	\$195	\$174.95
Sheet Feeder for P1351	\$1,095	\$899.95

CITIZEN Printers

Best Near-Letter-Quality printers for under \$1000!!!

CITIZEN MSP-10 FT 160 cps	LIST \$499	JADE \$349.95
CITIZEN MSP-15 FT 160 cps	\$749	\$529.95
CITIZEN MSP-20 FT 200 cps	\$699	\$499.95
CITIZEN MSP-25 FT 200 cps	\$949	\$669.95
CITIZEN Serial Option	\$60	\$49.95

Printer Accessories

IBM PC style cable	LIST \$54	JADE \$19.95
Standard parallel cable	40	\$19.95
Dual Printer Switch Box	\$149	\$99.95
Apple Card & cable	\$109	\$49.95
RS-232C serial cable	30	\$24.95
Ribbons	as low as	\$4.95
Apple IIc cable	39	\$19.95

SUPER DISKETTE SPECIAL Perfect for IBM, Apple, Kaypro, etc.

Ultra-high quality diskettes from a premium U.S. manufacturer, certified to be absolutely error free for one full year. Buy a box of ten this month and we will include a plastic storage/library box FREE!

Single-sided, double-density	LIST \$34	JADE \$16.50
Double-sided, double-density	42	\$19.50
3 1/2" Single-sided for AT	69	\$49.50
3 1/2" Double-sided for Mac	69	\$39.50
Bulk Diskettes as low as	89	\$49.50
		90c

We accept cash, checks, credit cards, or purchase orders from qualified firms and institutions. Minimum prepaid order \$15.00 California residents add 6 1/2% tax. Export customers outside the US or Canada please add 10% to all prices. Prices and availability subject to change without notice. Shipping and handling charges via UPS Ground 50¢/lb. UPS Air \$1.00/lb. minimum charge \$3.00

JADE

Computer Products

APPLE IIC SERIAL PORT
STANDARD PRINTER CONNECTOR



MW-100 232-C SERIAL TO CENTRONICS PARALLEL PRINTER INTERFACE FOR ALL MAJOR CENTRONICS PRINTERS INTERFACES THE APPLE IIC, EPSON FX8, AND HX10 TO STANDARD PARALLEL PRINTERS \$99

MW-200 UNIVERSAL INPUT-OUTPUT BOARD BOARD FOR IBM PC 16 EIGHT BIT ANALOG INPUTS 14 HI VOLTAGE/CURRENT OUTPUTS BASIC DEMO PROGRAM INCLUDED 1 ANALOG OUTPUT -- PROTOTYPING AREA 10 PROGRAMMABLE DISCRETE INPUTS/OUTPUTS \$265



MW-201 UNIVERSAL SERIAL I/O BOARD WITH RS-232 INTERFACE 16 EIGHT BIT ANALOG INPUTS 14 HI VOLTAGE/CURRENT OUTPUTS ONE ANALOG OUTPUT APPLE-IBM-KAYPRO- COMPATIBLE TALKS TO ANY SERIAL RS-232 PORT MICROPROCESSOR CONTROLLED - 6511Q AUTO BAUD RATE SEEKING - AUTO DATA LOGGING \$385



Micro World Electronix, Inc.
3333 S. Wadsworth Blvd., #C105,
Lakewood, CO, 80126
(303) 987-9531 or 987-2671

Inquiry 267

Erases Most Eproms in 3 Minutes



ONLY \$34.95

Solid State 2-8 Min.
Timer Version \$54.95

For all 24 or 28 pin devices—2 at a time.

90 DAY WARRANTY SHIPPING & HANDLING \$2.50
DEALERS WELCOME AZ RESIDENTS ADD 6% TAX

WALLING CO.
4401 S. JUNIPER • TEMPE, AZ 85282 • (602) 838-1277

Inquiry 417

IN LESS THAN 3 MINUTES

Your IBM Model 50, 60, 65, 75, 85, 95 or WHEELWRITER Typewriter can be a computer printer or terminal using our interface modules:

Model 5060 RS232 Serial
Model 5060-CP Centronics Parallel

NEW

Both Versions can be easily installed and require NO modifications to the typewriter. A 2K buffer is standard, 8K optional.



CMC CALIFORNIA MICRO COMPUTER
9323 Warbler Ave., Fountain Valley, CA 92708
(714) 964-9301

Inquiry 310

Two Dollars SALE

Each book from this ad is two Dollars! Buy all 12 books for only \$19.95! Incredible savings - Mail your order today!

BOOKS FOR THE COMMODORE-64

The Great Book of Games 46 games, 134 pages
Order-No. 182 was \$ 9.95 now \$ 2.00

More on the Sixtyfour Machine Language Programs for the advanced user.
Order-No. 183 was \$ 9.95 now \$ 2.00

Machine Language Programming on the C-64
Order-No. 184 was \$ 12.95 now \$ 2.00

Commodore-64 Tune-up Hardware expansions, I/O programming, A/D conversion.
Order-No. 185 was \$ 12.95 now \$ 2.00

Small Business Programs for the C-64
Order-No. 186 was \$ 12.95 now \$ 2.00

28 Programs for the C-64
Order-No. 95 was \$ 9.95 now \$ 2.00

The programs from the books are also available on disk. Each disk is \$ 9.95.

ELCOMP PUBLISHING, INC.
2174 West Foothill Blvd., Unit E
Upland, CA 91786
Phone: (714) 955-4477, Tlx.: 29 81 81

SUPER BOOK FOR THE APPLE II

The APPLE in your Hand Advanced BASIC programs, introduction into machine language, FORTH, Tips & Tricks (220 pages).
Order-No. 178 was \$ 12.95 now \$ 2.00

GAMES FOR ATARI 800 XL

112 pages full of super games.
Order-No. 162 was \$ 7.95 now \$ 2.00

ATARI BASIC—Learning by Using
Order-No. 164 was \$ 7.95 now \$ 2.00

ATARI Machine Language Programming
Order-No. 169 was \$ 9.95 now \$ 2.00

Hackerbook for the ATARI
Order-No. 172 was \$ 9.95 now \$ 2.00

BASIC in 60 Minutes—a day
Order-No. 35 was \$ 7.95 now \$ 2.00

PAYMENT: Money Order, VISA, MC
CA residents add \$ 5.00 sales tax
Add \$ 2.00 per book for 8 1/2" (max.) \$ 10-1
Outside USA: add \$ 20.00 for shipping

Inquiry 454

EPROM PROGRAMMER



APPROTEK 1000 ONLY
\$249.95
COMPLETE WITH PERSONALITY MODULE

117 AC POWER-RS232
-6 BAUD RATES - HANDSHAKE TO HOST
ALLOWS READ, WRITE, VERIFY & COPY
Comes complete with CPM & BASIC Driver Program Listings for most small micros

Full 1 Year Warranty

Programs the following: 5 Volt 24 or 28 pin devices 27xx series through 27256, 25xx series, 68766 plus others
Specify Personality Module desired with order
Additional Personality Modules only \$15.00 ea

TO ORDER: CALL OR WRITE
APROPOS TECHNOLOGY
1071-A AVENIDA ACASO Add
CAMARILLO, CA 93010 \$4.00 Shipping-USA
(805) 482-3604 VISA or MC Add 3%

Inquiry 38

MEMOREX FLEXIBLE DISCS

WE WILL NOT BE UNDER-SOLD!! Call Free (800)235-4137 for prices and information. Dealer inquiries invited and C.O.D.'s accepted.



VISA

PACIFIC EXCHANGES
100 Foothill Blvd.
San Luis Obispo, CA 93401. In Cal. call (800)592-5935 or (805)543-1037

Inquiry 310

A WESOME TECHNOLOGY, INC.

Poor Man's TopView™
"MULTIPLE CHOICE" Provides:

- A) Screen switching under DOS
- B) Up to 8 programs in memory
- C) Efficient memory use - run 123 with WordStar in 256K
- D) Data transfer screen snapshot

✓E) All of the above available NOW

Multiple Choice is only \$64 and runs on IBM PC/XT/AT/clones

For information, Call (408) 646-1384

AWESOME TECHNOLOGY, INC.
177 Webster St. Ste. A-416
Monterey, CA 93940

Order Toll Free (VISA/MC)
Outside CA (800) 548-2255 Ext 803
Inside CA (800) 624-2644 Ext 803

TopView is a trademark of IBM Corporation

Inquiry 46

ROSE DATA SWITCHES



SHARE computers, printers, any parallel or serial device
ELIMINATE cable swapping
INEXPENSIVE way to network
COMPATIBLE with all computers.
Businesses, Schools, Homes

WE ALSO OFFER:
Data Buffers, Line Drivers, Modems, Protocol Converters, Parallel - Serial Converters, Cables, Computers, Printers, Disk Drives, and more.

AUTOMATIC - CARETAKER is ideal for a business or school to share a printer or modem among many computers. Operation is fully automatic with no software required.
Parallel or Serial 4 channels - \$295 8 channels - \$395

MANUAL - HARDSWITCH is operated with the flip of a switch. 2:2 and 2:4 models allow simultaneous communication.
Serial 1:2 - \$59 1:4 - \$ 99 2:2 - \$109 2:4 - \$169
Parallel 1:2 - \$99 1:4 - \$159 2:2 - \$189 2:4 - \$279
LED and spike protection on serial models add \$20.

CODE ACTIVATED - PORTER connects one computer to multiple peripherals. A software code selects the peripheral.
Parallel or Serial 4 channels - \$295 8 channels - \$395
Buffer option 64K - \$100 256K - \$250

REMOTE - TELEPATH connects multiple computers to multiple peripherals. A selector at each computer or terminal chooses up to 4 peripherals and displays busy status.
4:4 - \$495 4:8 - \$795 selector - \$39.

Give a Rose to your computer

ROSE ELECTRONICS (713) 240-7673
P.O. BOX 742571 MC & VISA Accepted
HOUSTON, TX 77274 Dealer Inquiries Invited
CALL US FOR ALL YOUR INTERFACE NEEDS

Inquiry 453

MetalCE-31



Powerful Real Time 8031 Emulator That Runs on your IBM PC

The MetalCE series of emulators provide full speed, real time, transparent in-circuit emulation capability for either the 8031, 8032 or 8344. Many unique features are provided including over 16,000 hardware breakpoints. MetalCE emulators simply connect to your IBM PC or compatible through an RS232C interface. Each MetalCE emulator includes an advanced menu driven host interface. Prices start at under \$1,500.00. A Demonstration Package is available for \$35.00. Call toll free for more information: 1-800-METAICE.

MetaLink Corp.
33 W. Boxelder Place
Chandler, AZ 85224
1-800-METAICE In AZ (602) 926-0797

Inquiry 260

4164 64K DYNAMIC 200ns 9/19.95

41256 256K DYNAMIC 200ns 8.95

STATIC RAMS

2101	256x4	(450ns)	1.95
5101	256x4	(450ns)(cmos)	3.95
2102-1	1024x4	(450ns)	.89
2102L-4	1024x1	(450ns)(LP)	.99
2102L-2	1024x1	(250ns)(LP)	1.45
2125	1024x1	(45ns)	2.95
2111	256x4	(450ns)	2.49
2111L	256x4	(450ns)(LP)	2.95
2112	256x4	(450ns)	2.99
2114	1024x4	(450ns)	8/10.95
2114-25	1024x1	(250ns)	8/12.95
2114L-4	1024x4	(450ns)(LP)	8/13.45
2114L-3	1024x4	(300ns)(LP)	8/13.95
2114L-2	1024x4	(200ns)(LP)	8/19.95
2114L-15	1024x4	(150ns)(LP)	8/19.95
TC5514	1024x4	(650ns)(cmos)	4.95
2141	1024x1	(200ns)	2.95
2147	4096x1	(55ns)	4.95
2148	1024x4	(70ns)	4.95
TMS4044-4	4096x1	(450ns)	3.49
TMS4044-3	4096x1	(300ns)	3.99
TMS4044-2	4096x1	(200ns)	4.49
TMS4014-2	4096x1	(200ns)(LP)	4.95
UPD410	1024x1	(100ns)	3.95
MK4118	1024x8	(250ns)	9.95
TMM2016-200	2048x8	(200ns)	3.25
TMM2016-150	2048x8	(150ns)	3.75
TMM2016-100	2048x8	(100ns)	4.75
HM6116-4	2048x8	(200ns)(cmos)	3.69
HM6116-3	2048x8	(150ns)(cmos)	3.95
HM6116-2	2048x8	(120ns)(cmos)	5.95
HM6116LP-4	2048x8	(200ns)(cmos)(LP)	3.95
HM6116LP-3	2048x8	(150ns)(cmos)(LP)	4.25
HM6116LP-2	2048x8	(120ns)(cmos)(LP)	6.95
TC5516	2048x8	(250ns)(cmos)	9.95
TMS4016	2048x8	(200ns)	6.95
Z-6132	4096x8	(300ns)(Qstat)	34.95
HM6264LP-15	8192x8	(150ns)(cmos)	10.25
HM6264LP-16	8192x8	(150ns)(cmos)(LP)	10.95
HM6264LP-12	8192x8	(120ns)(cmos)(LP)	12.95

LP-Low power

Qstat-Quasi-Static

DYNAMIC RAMS

TMS4027	4096x1	(250ns)	1.99
2107	4096x1	(200ns)	1.95
MM5280	4096x1	(300ns)	1.95
TMS4050	4096x1	(300ns)	1.95
UPD411	4096x1	(300ns)	1.95
TMS4060	4096x1	(300ns)	1.95
MK4108	8192x1	(200ns)	.49
MM5298	8192x1	(250ns)	.49
4116-300	16384x1	(300ns)	8/6.95
4116-250	16384x1	(250ns)	8/6.95
4116-200	16384x1	(200ns)	8/8.95
4116-150	16384x1	(150ns)	8/10.95
4116-120	16384x1	(120ns)	8/12.95
2118	16384x1	(150ns)(5v)	4.95
MK4332	32768x1	(200ns)	9.95
4164-200	65536x1	(200ns)(5v)	9/19.95
4164-150	65536x1	(150ns)(5v)	9/21.95
4164-120	65536x1	(120ns)(5v)	2.95
MCM6665	65536x1	(200ns)(5v)	4.95
TMS4164-20	65536x1	(200ns)(5v)	4.25
TMS4164-15	65536x1	(150ns)(5v)	4.95
4164-REFRESH	65536x1	(150ns)(5v)(REFRESH)	8.95
TMS4416-20	16384x4	(200ns)(5v)	9.95
TMS4416-15	16384x4	(150ns)(5v)	9.95
41256-200	262144x1	(150ns)(5v)	8.95
41256-150	262144x1	(150ns)(5v)	9.95

5v=Single 5 Volt Supply

REFRESH=Pin 1 Refresh

EPROMS

1702	256x8	(1us)	4.50
2708	1024x8	(450ns)	3.95
2758	1024x8	(450ns)(5V)	5.95
2716-6	2048x8	(650ns)	2.95
2716	2048x8	(450ns)(5V)	3.95
2716-1	2048x8	(350ns)(5V)	4.95
TMS2516	2048x8	(450ns)(5V)	4.95
TMS2716	2048x8	(450ns)	7.95
TMS2532	4096x8	(450ns)(5V)	4.95
2732	4096x8	(450ns)(5V)	4.25
2732A-4	4096x8	(450ns)(5V)(21V PGM)	4.95
2732A-35	4096x8	(350ns)(5V)(21V PGM)	4.95
2732A	4096x8	(250ns)(5V)(21V PGM)	6.95
2732A-2	4096x8	(200ns)(5V)(21V PGM)	10.95
2764	8192x8	(450ns)(5V)	4.95
2764-250	8192x8	(250ns)(5V)	5.25
2764-200	8192x8	(200ns)(5V)	8.95
TMS2564	8192x8	(450ns)(5V)	10.95
MCM68764	8192x8	(450ns)(5V)(24 pin)	24.95
27128-45	16384x8	(450ns)(5V)	9.95
27128-30	16384x8	(300ns)(5V)	10.95
27128	16384x8	(250ns)(5V)	11.95
27256	32768x8	(250ns)(5V)	29.95

5V=Single 5 Volt Supply 21V PGM=Program at 21 Volts

★★★★HIGH-TECH★★★★

8087-6 \$119.00

- * 4.87 MHz VERSION OF 8087 MATH COPROCESSOR
- * IBM-PC COMPATIBLE
- * RUNS TURBO PROGRAMS AS MUCH AS 100 TIMES FASTER THAN 8088 ALONE

★★★★SPOTLIGHT★★★★

**ORDER TOLL FREE
800-538-5000
800-662-6279
(CALIFORNIA RESIDENTS)**

CRYSTALS

32.768 KHz	1.95
1.0 MHz	3.95
1.8432	3.95
2.0	2.95
2.097152	2.95
2.4576	2.95
3.2768	2.95
3.579545	2.95
4.0	2.95
4.032	2.95
5.0	2.95
5.0688	2.95
5.185	2.95
5.7143	2.95
6.0	2.95
6.144	2.95
6.5536	2.95
8.0	2.95
10.0	2.95
10.738635	2.95
14.31818	2.95
15.0	2.95
16.0	2.95
17.430	2.95
18.0	2.95
18.432	2.95
20.0	2.95
22.1184	2.95
24.0	2.95
32.0	2.95

CRYSTAL OSCILLATORS

1.0MHz	7.95	8.0	7.95
1.8432	7.95	10.0	7.95
2.4576	7.95	15.0	7.95
2.5	7.95	16.0	7.95
5.0	7.95	18.432	7.95
5.0688	7.95	20.0	7.95
6.0	7.95	24.0	7.95
6.144	7.95		

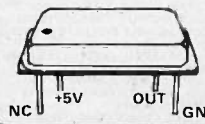

74LS00

74LS00	.24	74LS189	8.95
74LS01	.25	74LS190	.89
74LS02	.25	74LS191	.89
74LS03	.25	74LS192	.79
74LS04	.24	74LS193	.79
74LS05	.25	74LS194	.69
74LS08	.28	74LS195	.69
74LS09	.29	74LS196	.79
74LS10	.25	74LS197	.79
74LS11	.25	74LS221	.85
74LS12	.35	74LS240	.95
74LS13	.45	74LS241	.99
74LS14	.59	74LS242	.99
74LS15	.35	74LS243	.99
74LS20	.25	74LS244	1.29
74LS21	.25	74LS245	10.95
74LS22	.25	74LS246	.75
74LS26	.29	74LS248	.99
74LS27	.29	74LS249	.99
74LS28	.35	74LS251	.59
74LS30	.25	74LS253	.59
74LS32	.25	74LS257	.59
74LS33	.55	74LS258	.59
74LS37	.35	74LS259	2.75
74LS38	.35	74LS260	.59
74LS40	.25	74LS261	2.25
74LS42	.49	74LS266	.55
74LS47	.75	74LS273	1.49
74LS48	.75	74LS275	3.35
74LS49	.75	74LS279	.49
74LS51	.25	74LS280	1.98
74LS54	.29	74LS283	.69
74LS55	.29	74LS290	.89
74LS56	1.25	74LS293	.89
74LS73	.39	74LS295	.99
74LS74	.35	74LS298	.99
74LS75	.39	74LS299	1.75
74LS76	.39	74LS322	5.95
74LS78	.49	74LS323	3.50
74LS79	.49	74LS325	1.95
74LS85	.69	74LS348	2.50
74LS86	.39	74LS352	1.29
74LS90	.55	74LS353	1.29
74LS91	.89	74LS363	1.35
74LS92	.55	74LS364	1.95
74LS93	.55	74LS365	.49
74LS95	.75	74LS366	.49
74LS96	.89	74LS367	.45
74LS107	.39	74LS368	.45
74LS109	.39	74LS373	1.39
74LS112	.39	74LS374	1.39
74LS113	.39	74LS375	3.20
74LS114	.39	74LS377	1.39
74LS122	.45	74LS378	1.18
74LS123	.79	74LS379	1.35
74LS124	2.90	74LS385	3.90
74LS125	.49	74LS386	.45
74LS126	.49	74LS387	1.19
74LS132	.59	74LS393	1.19
74LS133	.59	74LS395	1.19
74LS136	.39	74LS396	1.89
74LS137	.99	74LS399	1.49
74LS138	.55	74LS424	3.95
74LS139	.75	74LS425	2.95
1691		74LS426	2.95
2143		74LS490	1.95
		74LS491	1.95
		74LS492	1.95
		74LS493	1.95
		74LS494	1.95
		74LS495	1.95
		74LS496	1.95
		74LS497	1.95
		74LS498	1.95
		74LS499	1.95
		74LS500	1.95
		74LS501	1.95
		74LS502	1.95
		74LS503	1.95
		74LS504	1.95
		74LS505	1.95
		74LS506	1.95
		74LS507	1.95
		74LS508	1.95
		74LS509	1.95
		74LS510	1.95
		74LS511	1.95
		74LS512	1.95
		74LS513	1.95
		74LS514	1.95
		74LS515	1.95
		74LS516	1.95
		74LS517	1.95
		74LS518	1.95
		74LS519	1.95
		74LS520	1.95
		74LS521	1.95
		74LS522	1.95
		74LS523	1.95
		74LS524	1.95
		74LS525	1.95
		74LS526	1.95
		74LS527	1.95
		74LS528	1.95
		74LS529	1.95
		74LS530	1.95
		74LS531	1.95
		74LS532	1.95
		74LS533	1.95
		74LS534	1.95
		74LS535	1.95
		74LS536	1.95
		74LS537	1.95
		74LS538	1.95
		74LS539	1.95
		74LS540	1.95
		74LS541	1.95
		74LS542	1.95
		74LS543	1.95
		74LS544	1.95
		74LS545	1.95
		74LS546	1.95
		74LS547	1.95
		74LS548	1.95
		74LS549	1.95
		74LS550	1.95
		74LS551	1.95
		74LS552	1.95
		74LS553	1.95
		74LS554	1.95
		74LS555	1.95
		74LS556	1.95
		74LS557	1.95
		74LS558	1.95
		74LS559	1.95
		74LS560	1.95
		74LS561	1.95
		74LS562	1.95
		74LS563	1.95
		74LS564	1.95
		74LS565	1.95
		74LS566	1.95
		74LS567	1.95
		74LS568	1.95
		74LS569	1.95
		74LS570	1.95
		74LS571	1.95
		74LS572	1.95
		74LS573	1.95
		74LS574	1.95
		74LS575	1.95
		74LS576	1.95
		74LS577	1.95
		74LS578	1.95
		74LS579	1.95
		74LS580	1.95
		74LS581	1.95
		74LS582	1.95
		74LS583	1.95

HM6264P-15 8Kx8 STATIC 150ns 10.25 SSI263 SPEECH SYNTHESIZER 39.95

74S00

74S00	.32	74S135	.89	74S244	2.20
74S02	.35	74S138	.85	74S251	.95
74S03	.35	74S139	.85	74S253	.95
74S04	.35	74S140	.85	74S257	.95
74S05	.35	74S151	.95	74S258	.95
74S08	.35	74S153	.95	74S260	.79
74S09	.40	74S157	.95	74S273	2.45
74S10	.35	74S158	.95	74S274	19.95
74S11	.35	74S161	1.95	74S275	19.95
74S15	.35	74S162	1.95	74S280	1.95
74S20	.35	74S163	1.95	74S283	3.29
74S22	.35	74S168	3.95	74S287	1.90
74S30	.35	74S169	3.95	74S288	1.90
74S32	.40	74S174	.95	74S289	6.98
74S37	.88	74S175	.95	74S299	7.35
74S38	.85	74S180	11.95	74S301	6.95
74S40	.35	74S181	3.95	74S373	2.45
74S51	.35	74S182	2.95	74S374	2.45
74S64	.40	74S185	16.95	74S381	7.95
74S65	.40	74S188	1.95	74S387	1.95
74S74	.50	74S189	6.95	74S399	2.95
74S85	1.99	74S194	1.49	74S412	2.98
74S86	.50	74S195	1.49	74S470	6.95
74S112	.50	74S196	1.49	74S471	.95
74S113	.50	74S197	1.49	74S472	4.95
74S114	.55	74S201	6.95	74S474	4.95
74S124	2.75	74S225	7.95	74S570	2.95
74S132	1.24	74S226	3.99	74S571	2.95
74S133	.45	74S245	2.20	74S572	2.95
74S134	.50	74S247	2.20	87S181	16.25
				87S185	16.95

CMOS

4000	.29	4531	.95
4001	.25	4532	1.95
4002	.25	4538	1.95
4006	.89	4539	1.95
4007	.29	4541	2.64
4008	.95	4543	1.19
4009	.39	4553	5.79
4010	.45	4555	.95
4011	.25	4556	.95
4012	.25	4558	2.45
4013	.38	4560	4.25
4014	.79	4569	3.49
4015	.39	4581	1.95
4016	.39	4582	1.95
4017	.69	4584	.75
4018	.79	4585	.75
4019	.39	4515	12.95
4020	.75	4702	12.95
4021	.79	4724	1.50
4022	.79	74C00	.35
4023	.29	74C02	.35
4024	.65	74C04	.35
4025	.29	74C08	.35
4026	1.65	74C10	.35
4027	.45	74C14	.59
4028	.69	74C20	.35
4029	.79	74C30	.35
4030	.39	74C32	.35
4034	1.95	74C42	1.29
4035	1.65	74C43	1.99
4040	.75	74C73	.65
4041	.75	74C74	.65
4042	.69	74C76	.80
4043	.85	74C83	1.95
4044	.79	74C85	1.95
4045	.85	74C87	1.95
4047	.95	74C89	4.50
4048	.69	74C90	1.19
4049	.35	74C93	1.75
4050	.35	74C95	.99
4051	.79	74C150	5.75
4052	1.59	74C151	2.25
4053	.79	74C154	3.25
4059	.89	74C157	1.75
4066	.39	74C160	1.19
4068	.39	74C161	1.19
4069	.29	74C162	1.19
4070	.25	74C163	1.19
4071	.29	74C164	1.39
4072	.29	74C165	2.00
4073	.29	74C173	.79
4075	.29	74C174	1.19
4076	.29	74C175	1.19
4077	.95	74C182	1.49
4078	.29	74C193	1.49
4081	.29	74C195	1.39
4082	.29	74C200	5.75
4085	.95	74C221	1.75
4086	.95	74C244	2.25
4087	.95	74C245	2.25
4094	2.99	74C374	2.45
4098	2.49	74C901	.39
4099	1.95	74C902	.85
14409	12.95	74C903	.85
14410	12.95	74C905	10.95
14411	11.95	74C906	.95
14412	12.95	74C907	1.00
14419	7.95	74C908	2.00
14433	14.95	74C909	2.75
14490	4.99	74C910	9.95
4502	.95	74C911	8.95
4503	.95	74C912	1.19
4507	1.25	74C914	1.95
4508	1.95	74C915	1.19
4510	.85	74C918	2.75
4511	.85	74C920	17.95
4512	.85	74C921	15.95
4513	.85	74C922	4.49
4515	1.79	74C923	4.95
4516	1.55	74C925	5.95
4518	.89	74C926	7.95
4519	.39	74C927	7.95
4520	.79	74C928	7.95
4521	4.59	74C929	15.95
4522	1.25	74C930	4.95
4526	1.25	80C95	.85
4527	1.95	80C96	.95
4528	1.19	80C97	.95
4529	2.95	80C98	1.20

HIGH SPEED CMOS

A new family of high speed CMOS logic featuring the speed of low power Schottky (8ns typical gate propagation delay), combined with the advantages of CMOS: very low power consumption, superior noise immunity, and improved output drive.

74HC00

74HC: Operate at CMOS logic levels and are ideal for new, all-CMOS designs.

74HC00	.59	74HC175	.99
74HC02	.59	74HC193	1.25
74HC04	.59	74HC194	1.04
74HC08	.59	74HC195	1.09
74HC10	.59	74HC238	1.35
74HC11	.59	74HC240	1.89
74HC14	.79	74HC241	1.89
74HC15	.85	74HC242	1.89
74HC27	.59	74HC243	1.89
74HC30	.59	74HC244	1.89
74HC32	.69	74HC245	1.89
74HC51	.59	74HC251	.85
74HC74	.75	74HC257	.85
74HC75	.85	74HC259	1.39
74HC85	1.35	74HC273	1.89
74HC86	.69	74HC299	4.99
74HC93	1.19	74HC367	.99
74HC125	1.19	74HC373	2.29
74HC132	1.19	74HC374	2.29
74HC138	.99	74HC393	1.39
74HC139	.99	74HC4017	1.99
74HC151	.89	74HC4020	1.39
74HC153	.89	74HC4024	1.59
74HC154	2.49	74HC4040	1.39
74HC157	.89	74HC4049	.89
74HC161	1.15	74HC4050	1.39
74HC164	1.25	74HC4060	1.29
74HC166	2.95	74HC4511	2.39
74HC174	.99	74HC4538	2.29

74HC00

74HC: Direct, drop-in replacements for LS TTL and can be intermixed with 74LS in the same circuit.

74HC00	.69	74HC175	1.09
74HC02	.69	74HC193	1.39
74HC04	.69	74HC194	1.19
74HC08	.69	74HC195	1.29
74HC10	.69	74HC238	1.49
74HC11	.69	74HC240	2.19
74HC14	.89	74HC241	2.19
74HC15	.89	74HC242	2.19
74HC27	.69	74HC243	2.19
74HC30	.69	74HC244	2.19
74HC32	.79	74HC245	2.19
74HC51	.69	74HC251	1.09
74HC74	.85	74HC257	.99
74HC75	.95	74HC259	1.59
74HC85	1.49	74HC273	2.09
74HC86	.79	74HC299	5.25
74HC93	1.09	74HC367	1.09
74HC125	1.29	74HC373	2.49
74HC132	1.29	74HC374	2.49
74HC138	1.15	74HC393	1.59
74HC139	1.15	74HC4017	2.19
74HC151	1.05	74HC4020	1.59
74HC153	1.05	74HC4024	1.79
74HC154	2.99	74HC4040	1.59
74HC157	.99	74HC4049	.99
74HC161	1.39	74HC4050	.99
74HC164	1.39	74HC4060	1.49
74HC166	3.05	74HC4511	2.69
74HC174	1.09	74HC4538	2.59

VOLTAGE REGULATORS

TO-220 CASE PACKAGE

7805T	.75	7905T	.85
7808T	.75	7908T	.85
7812T	.75	7912T	.85
7815T	.75	7915T	.85
7824T	.75	7924T	.85

TO-3 CASE PACKAGE

7805K	1.39	7905K	1.49
7812K	1.39	7912K	1.49
7815K	1.39	7915K	1.49
7824K	1.39	7924K	1.49

TO-92 CASE PACKAGE

78L05	.69	79L05	.79
78L12	.69	79L12	.79
78L15	.69	79L15	.79

OTHER VOLTAGE REGS

78M05CS	5volt 1/2amp	TO-220	.35
LM323K	5volt 3amp	TO-3	4.95
LM338K	Adj. 5amp	TO-3	3.95
78H05K	5volt 5amp	TO-3	9.95
78H12K	12volt 5amp	TO-3	9.95
78P05K	5volt 10amp	TO-3	14.95
UA78540	Fairchild	DIP	1.95

7400

7400	.19	7483	.50	74172	5.95
7401	.19	7485	.59	74173	.75
7402	.19	7486	.35	74174	.89
7403	.19	7489	2.15	74175	.89
7404	.19	7490	.35	74176	.89
7405	.25	7491	.40	74177	.75
7406	.29	7492	.50	74178	1.15
7407	.29	7493	.35	74179	1.75
7408	.24	7494	.65	74180	.75
7409	.19	7495	.55	74181	2.25
7410	.19	7496	.70	74182	.75
7411	.24	7497	2.15	74183	2.45
7412	.30	74100	1.75	74184	2.00
7413	.35	74105	1.14	74189	2.99
7414	.49	74107	.30	74190	1.15
7416	.25	74109	.45	74191	1.15
7417	.25	74110	.45	74192	.79
7420	.19	74111	.55	74193	.79
7421	.35	74116	1.55	74194	.85
7422	.35	74120	1.20	74195	.85
7423	.29	74121	.29	74196	.79
7425	.29	74122	.45	74197	.75
7426	.29	74123	.49	74198	1.35
7427	.29	74124	.49	74199	1.35
7428	.45	74126	.45	74221	1.35
7430	.19	74128	.55	74246	1.35
7431	.29	74132	.55	74247	1.25
7433	.45	74136	.50	74248	1.85
7437	.29	74141	.65	74249	1.95
7438	.29	74142	.65	74251	.75
7439	.79	74143	4.95	74259	2.25
7440	.19	74144	2.95	74265	1.35
7442	.49	74145	.60	74273	1.95
7443	.65	74147	1.75	74276	1.25
7444	.65	74148	1.20	74278	3.11
7445	.69	74150	1.35	74279	1.95
7446	.69	74151	.55	74283	2.00
7447	.69	74152	.65	74284	3.75
7448	.69	74153	.55	74285	3.75
7450	.19	74154	1.25	74290	.95
7451	.25	74155	.75	74293	.85
7452	.25	74156	.75	74298	.85
7453	.23	74157	.65	74301	.85
7454	.23	74157	.55	74351	2.25
7460	.23	74159	1.65	74365	.65
7470	.35	74160	.85	74366	.65
7472	.29	74161	.69	74367	.65
7473	.34	74162	.85	74368	.65
7474	.34	74163	.85	74376	2.20
7475	.45	74164	.85	74390	1.75
7476	.35	74165	.85	74393	1.35
7480	.59	74166	1.00	74425	3.15
7481	1.10	74167	2.96	74426	.85
7482	.95	74170	1.65	74429	

DB25S RS232 FEMALE SOLDER CUP 2.25

DB25P RS232 MALE SOLDER CUP 1.90

BARGAIN HUNTERS CORNER SPECIAL PURCHASE!

TAXAN RGB VISION III \$299.95

**SUPER HI-RES RGB MONITOR
ORIGINALLY MADE FOR ACORN COMPUTER**

- * 12" SCREEN * 18 MHz BANDWIDTH
- * 640 x 262 PIXELS * 25 LINES x 80 COL.
- * .38mm DOT PITCH WITH BLACK MATRIX
FOR A SHARP IMAGE AND HIGH CONTRAST.

NO C.O.D. ORDERS PLEASE!

ACCESSORIES

COLOR DISPLAY ADAPTOR FOR IBM PC/XT \$129.00
RGB CABLE FOR IBM \$16.95

SPECIALS ENDS 6/30/85

HARD TO FIND

"SNAPABLE" HEADERS

Can easily be snapped apart to make any size header, all with .1" centers

1x40	STRAIGHT LEAD	.99
1x40	RIGHT ANGLE	1.49
2x40	STRAIGHT LEAD	2.49
2x40	RIGHT ANGLE	2.99

SHORTING BLOCKS

SPACED AT .1" CENTERS
IDEAL FOR DISK DRIVES
OR ANY .1" HEADER



5/1.00

DIP SWITCHES

4 POSITION	.85
5 POSITION	.90
6 POSITION	.90
7 POSITION	.95
8 POSITION	.95
10 POSITION	1.29

36 PIN CENTRONICS

IDCEN36	RIBBON CABLE MALE	8.95
IDCEN36/F	RIBBON CABLE FEMALE	8.95
CEN36	SOLDER CUP MALE	7.95

RF MODULATOR (ASTEC UM1082)

QUANTITIES LIMITED

- * PRESET TO CHANNEL 3
- * USE TO BUILD TV-COMPUTER INTERFACE
- * +5 VOLT OPERATION

\$6.95

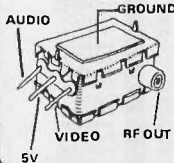

EMI FILTER

- * MAJOR MANUFACTURER
- * LOW COST
- * FITS LC-HP BELOW

\$4.95



LINE CORDS

LC-2	2 CONDUCTOR	6 ft	.39
LC-3	3 CONDUCTOR	6 ft	.99
LC-HP	3 CONDUCTOR WITH STANDARD FEMALE SOCKET	6 ft	1.49
LC-CIR	CIGARETTE LIGHTER PLUG WITH 6 FOOT CORD		2.95

MUFFIN FANS

4.68" SQUARE	14.95
3" SQUARE	14.95

RESISTORS

1/4 WATT 5% CARBON FILM ALL STANDARD VALUES FROM 1 OHM TO 10 MEG OHM	
50 PIECES SAME VALUE	.025
100 PIECES SAME VALUE	.02
1000 PIECES SAME VALUE	.015

BYPASS CAPS

.01 µf DISC	100/\$6.00
.01 µf MONOLITHIC	100/\$12.00
.1 µf DISC	100/\$8.00
.1 µf MONOLITHIC	100/\$15.00

DIODES

1N751	5.1 VOLT ZENER	.25
1N769	12.0 VOLT ZENER	.25
1N4148	(1N914) SWITCHING	25/1.00
1N4001	50PIV 1A BRIDGE	12/1.00
1N4004	400PIV RECTIFIER	10/1.00
1N5402	200PIV 3A	.25
KBPO2	200PIV 1.5A BRIDGE	.45
KBPO4	400PIV 1.5A BRIDGE	.55
MDA801	50PIV 12A BRIDGE	1.39
MDA980-1	50PIV 12A BRIDGE	1.95
MDA980-2	100PIV 12A BRIDGE	2.25
VM48	DIP-BRIDGE	.35

CAPACITORS

TANTALUM				
1.0 µf	15V .40	.47 µf	35V .50	
6.8	15V .70	1.0	35V .45	
10	15V .80	2.2	35V .65	
22	15V 1.35	4.7	35V .85	
.22	35V .40	10	35V 1.00	

DISC				
10 µf	50V .05	560	50V .05	
22	50V .05	680	50V .05	
25	50V .05	820	50V .05	
27	50V .05	.001 µf	50V .05	
33	50V .05	.0015	50V .05	
47	50V .05	.0022	50V .05	
56	50V .05	.005	50V .05	
68	50V .05	.01	50V .07	
82	50V .05	.02	50V .07	
100	50V .05	.05	50V .07	
220	50V .05	.1	12V .10	

MONOLITHIC

.01 µf	50V .14	.1 µf	50V .18
.047 µf	50V .15	.47 µf	50V .25

ELECTROLYTIC

RADIAL		AXIAL	
1 µf	25V .14	1 µf	50V .14
2.2	35V .15	4.7	16V .14
4.7	50V .15	10	16V .14
10	50V .15	10	50V .16
47	35V .18	22	16V .14
100	16V .18	47	50V .20
220	35V .20	100	15V .20
470	25V .30	100	35V .25
2200	16V .60	220	25V .30
		330	15V .40

COMPUTER GRADE

44,000 µf 30V	3.95	500	16V .42
		1000	16V .60
		2200	16V .70
		6000	16V .85

LED DISPLAYS

HP5082-7760	CC	.43"	1.29
MAN-72	CA	.3"	.99
MAN-74	CC	.3"	.99
FND-357(359)	CC	.375"	1.25
FND-500(503)	CC	.5"	1.49
FND-507(510)	CA	.5"	1.49
TIL-311 4x7 HEX W/LOGIC	.270"		9.95

DIP CONNECTORS

DESCRIPTION	ORDER BY	CONTACTS								
		8	14	16	18	20	22	24	28	40
HIGH RELIABILITY TOOLED ST IC SOCKETS	AUGATxxST	.99	.99	.99	1.69	1.89	1.89	1.99	2.49	2.99
HIGH RELIABILITY TOOLED WW IC SOCKETS	AUGATxxWW	1.30	1.80	2.10	2.40	2.50	2.90	3.15	3.70	5.40
COMPONENT CARRIES (DIP HEADERS)	ICCxx	.49	.59	.69	.99	.99	.99	.99	1.09	1.49
RIBBON CABLE DIP PLUGS (IDC)	IDPxx	---	.95	.95	---	---	---	1.75	---	2.95

FOR ORDERING INSTRUCTIONS SEE IDC CONNECTORS BELOW

D-SUBMINIATURE

DESCRIPTION	ORDER BY	CONTACTS					
		9	15	25	37	50	
SOLDER CUP	MALE	DBxxP	1.19	1.59	1.90	2.85	4.25
	FEMALE	DBxxS	1.50	1.85	2.25	3.90	5.25
RIGHT ANGLE	MALE	DBxxPR	1.65	2.20	3.00	4.83	---
	FEMALE	DBxxSR	2.18	3.03	3.00	6.19	---
PC SOLDER	MALE	DBxxPWW	1.69	2.56	3.89	5.60	---
	FEMALE	DBxxSww	2.76	4.27	6.84	9.95	---
WIRE WRAP	MALE	IDBxxP	2.95	3.90	4.75	6.95	---
	FEMALE	IDBxxS	3.25	4.29	5.25	7.95	---
IDC RIBBON CABLE	MALE	IDBxxP	---	---	---	---	---
	FEMALE	IDBxxS	---	---	---	---	---
HOODS	BLACK	HOOD-B	---	---	---	---	---
	GREY	HOOD-xx	.89	.99	.99	1.09	1.19

MOUNTING HARDWARE-\$1.00

FOR ORDERING INSTRUCTIONS SEE IDC CONNECTORS BELOW



IDB375

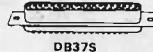

DB375

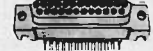

DB25SR

TEXT TOOL ZERO INSERTION FORCE SOCKETS AND RECEPTACLES



SCREWDRIVER CLAMP

ECONO ZIF

LEVER CLAMP

ZIF SOCKET

WW RECEPTACLES

ZIF RECEPTACLE

TYPE	CONTACTS				
	14	16	24	28	40
ECONO ZIF	---	4.95	6.75	7.75	9.95
ZIF SOCKET	4.95	4.95	5.95	6.95	9.95
ZIF RECEPTACLE	8.25	8.75	9.75	10.50	12.75

IDC CONNECTORS

DESCRIPTION	ORDER BY	CONTACTS					
		10	20	26	34	40	50
SOLDER HEADER	IDHxxS	.82	1.29	1.68	2.20	2.58	3.24
RIGHT ANGLE SOLDER HEADER	IDHxxSR	.85	1.35	1.76	2.31	2.72	3.39
WW HEADER	IDHxxW	1.86	2.98	3.84	4.50	5.28	6.63
RIGHT ANGLE WW HEADER	IDHxxWR	2.05	3.28	4.22	4.45	4.80	7.30
RIBBON HEADER SOCKET	IDSxx	---	.99	1.39	1.59	1.99	2.25
RIBBON HEADER	IDMxx	---	5.50	6.25	7.00	7.50	8.50
RIBBON EDGE CARD	IDExx	1.75	2.25	2.65	2.75	3.80	3.95

ORDERING INSTRUCTIONS: INSERT THE NUMBER OF CONTACTS IN THE POSITION MARKED "xx" OF THE "ORDER BY" PART NUMBER LISTED. EXAMPLE: A 10 PIN RIGHT ANGLE HOLDER STYLE WOULD BE IDH10SR



IDH20W

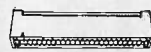

IDES0

RIBBON CABLE

CONTACTS	SINGLE COLOR		COLOR CODED	
	1'	10'	1'	10'
10	.18	1.60	.83	7.30
16	.28	2.50	1.00	8.80
20	.36	3.20	1.25	11.00
25	.45	4.00	1.32	11.60
26	.46	4.10	1.32	11.60
34	.61	5.40	1.65	14.50
40	.72	6.40	1.92	16.80
50	.89	7.50	2.50	22.00

RETAIL STORE - 1256 S. BASCOM AVENUE
HOURS: M-W-F, 9-5 TU-TH, 9-9 SAT, 10-3

PLEASE USE YOUR CUSTOMER NUMBER WHEN ORDERING

TERMS: Minimum order \$10.00. For shipping and handling include \$2.50 for UPS Ground and \$3.50 for UPS Air. Orders over 1 lb. and foreign orders may require additional shipping charges - please contact our sales department for the amount. CA. residents must include 6% sales tax, Bay Area and LA residents include 6 1/2%. All merchandise is warranted for 90 days unless otherwise stated. Prices are subject to change without notice. We are not responsible for typographical errors. We reserve the right to limit quantities and to substitute manufacturer. All merchandise subject to prior sale.

JDR Microdevices

1224 S. Bascom Avenue, San Jose, CA 95128
800-538-5000 • 800-662-6279 (CA) • (408) 995-5430
FAX (408) 275-8415 • Telex 171-110

IBM PC PROTOTYPE CARD WITH DECODING CIRCUITRY \$29.95

WIRE WRAP PROTOTYPE CARDS

FR-4 EPOXY GLASS LAMINATE WITH GOLD-PLATED EDGE-CARD FINGERS



IBM-PR2

IBM

BOTH CARDS HAVE SILK SCREENED LEGENDS AND INCLUDES MOUNTING BRACKET

IBM-PR1 WITH +5V AND GROUND PLANE . . . \$27.95
IBM-PR2 AS ABOVE WITH DECODING LAYOUT \$29.95

S-100

P100-1 BARE - NO FOIL PADS . . . \$15.15
P100-2 HORIZONTAL BUS . . . \$21.80
P100-3 VERTICAL BUS . . . \$21.80
P100-4 SINGLE FOIL PADS PER HOLE . . . \$22.75

APPLE

P500-1 BARE - NO FOIL PADS . . . \$15.15
P500-3 HORIZONTAL BUS . . . \$22.75
P500-4 SINGLE FOIL PADS PER HOLE . . . \$21.80
7060-45 FOR APPLE IIe AUX SLOT . . . \$30.00

GENERAL PURPOSE

22/44 PIN EDGE-CARD (156" SPACING)
P441-1 BARE - NO FOIL PADS 4.5" x 6.0" . . . \$9.45
P441-3 VERTICAL BUS 4.5" x 6.0" . . . \$13.95
P441-4 SINGLE FOIL PADS 4.5" x 6.0" . . . \$14.20
P442-1 BARE - NO FOIL PADS 4.5" x 9.0" . . . \$10.40
P442-3 VERTICAL BUS 4.5" x 9.0" . . . \$14.20
P442-4 SINGLE FOIL PADS 4.5" x 9.0" . . . \$13.50
36/72 PIN EDGE-CARD (1" SPACING)
P721-1 BARE - NO FOIL PADS 4.5" x 6.0" . . . \$9.45
P721-3 VERTICAL BUS 4.5" x 6.0" . . . \$13.25
P721-4 SINGLE FOIL PADS 4.5" x 6.0" . . . \$14.20
P722-1 BARE - NO FOIL PADS 4.5" x 9.0" . . . \$10.40
P722-3 VERTICAL BUS 4.5" x 9.0" . . . \$14.20
P722-4 SINGLE FOIL PADS 4.5" x 9.0" . . . \$15.15

BARE GLASS BOARDS

NO EDGE-CARD FINGERS OR FOIL
P25x45 2.5" x 4.5" \$2.40
P45x65 4.5" x 6.5" \$4.70
P45x85 4.5" x 8.5" \$6.20
P45x170 4.5" x 17.0" \$11.35
P85x170 8.5" x 17.0" \$18.95

EXTENDER CARDS

IBM \$45.00
APPLE \$45.00
MULTIBUS \$86.00

WIRE WRAP WIRE PRECUT AND STRIPPED

Note: 1 inch of insulation is stripped on each end. A 3.5" wire has only 1.5" of insulation.

LENGTH (INCHES)	QUANTITY		
	100	500	1000
2.5	1.60	4.70	8.20
3	1.60	4.70	8.20
3.5	1.65	5.00	8.90
4	1.75	5.40	9.60
4.5	1.80	5.75	10.30
5	1.85	6.10	11.00
5.5	1.90	6.50	11.75
6	2.00	6.85	12.50
6.5	2.30	7.80	14.30
7	2.40	8.20	15.05
7.5	2.50	8.55	15.85
8	2.60	8.95	16.60
8.5	2.65	9.30	17.40
9	2.70	9.80	18.15
9.5	2.80	10.00	18.95
10	2.90	10.50	19.70

PRECUT ASSORTMENT IN ASSORTED COLORS \$27.50

100ea: 5.5", 6", 6.5", 7"
250ea: 2.5", 4.5", 5"
500ea: .3", 3.5", 4"

SPOOLS

100 feet \$4.30 250 feet \$7.25
500 feet \$13.25 1000 feet \$21.95
Please specify color:
Blue, Black, Yellow or Red

RECHARGEABLE BATTERIES NI-CAD CHARGER PACKAGE

PRICE INCLUDES CHARGER (WALL PLUG), BATTERIES, & MODULAR BATTERY HOLDER
AAA CELLS QTY. 2 \$11.71
AA CELLS QTY. 2 \$11.71
C CELLS QTY. 2 \$13.21
D CELLS QTY. 2 \$13.21
9 VOLT QTY. 1 \$13.21

BATTERIES ONLY

AAA CELLS PKG. 2 \$6.07 pr.
AA CELLS PKG. 1 \$3.03 ea.
C CELLS PKG. 1 \$3.78 ea.
D CELLS PKG. 1 \$3.78 ea.
9 VOLT PKG. 1 \$7.57 ea.

DISK DRIVES TANDON

TM 100-1 5 1/4" (FOR IBM) SS/DD \$139.95
TM 100-2 5 1/4" (FOR IBM) DS/DD \$159.95

MPI

MPI-B52 5 1/4" (FOR IBM) DS/DD \$109.95

TEAC

FD-55B 1/2 HEIGHT DS/DD \$119.95
FD-55F 1/2 HEIGHT DS/QUAD \$139.95

SHUGART

SA 400L 5 1/4" (40 TRACK) SS/DD \$199.95
SA 460 5 1/4" (80 TRACK) DS/QUAD \$199.95

8" DISK DRIVES

FD100-8 BY SIEMENS, SHUGART 801 EQUIV. SS/DD \$129.00
FD200-8 BY SIEMENS, SHUGART 851 EQUIV. DS/DD \$180.00

JFORMAT-2 \$49.95

SUPPORT FOR QUAD DENSITY DRIVES FROM TALL TREE SYSTEMS

PLEASE INCLUDE SUFFICIENT AMOUNT FOR SHIPPING ON ABOVE ITEMS



TEAC FD-55B

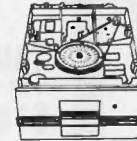

TANDON TM 100-2

DISK DRIVE CABINETS

CABINET #1 \$29.95
• Fits one full height 5 1/4" disk drive
• Color matches Apple

CABINET #2 \$79.00
• Fits one full height 5 1/4" disk drive
• Complete with power supply, switch, line cord, fuse and standard power connector
• Please specify Grey or Tan

CABINET #3 \$89.95
• Fits two half height 5 1/4" disk drives
• Complete with power supply, switch, line cord, fuse and standard power connectors

8" DISK DRIVE CABINETS ALSO AVAILABLE-PLEASE CALL

PLEASE INCLUDE SUFFICIENT AMOUNT FOR SHIPPING ON ABOVE ITEMS

SWITCHING POWER SUPPLIES

PS-IBM \$159.95

• FOR IBM PC-XT COMPATIBLE
• 130 WATTS
• +5V @ 15A, -12V @ 4.2A
• -5V @ .5A, -12V @ .5A
• ONE YEAR WARRANTY



PS-A \$49.95

• USE TO POWER APPLE TYPE SYSTEMS
• +5V @ 4A, -12V @ 2.5A
• -5V @ .5A, -12V @ .5A
• APPLE POWER CONNECTOR



PS-3 \$39.95

• AS USED IN APPLE III
• +5V @ 4A, -12V @ 2.5A
• -5V @ .5A, -12V @ .30A,
• 15.5" x 4.5" x 2", .884 LBS.



PS-ASTEC \$19.95

• CAN POWER TWO 5 1/4" FDDs
• +5V @ 2.5A, -12V @ 2A
• -12V @ .1A
• +5V @ 5A IF -12V IS NOT USED
• 6.3" x 4.0" x 1.9"



OK INDUSTRIES

EX-1 IC EXTRACTION TOOL

• ONE PIECE METAL CONSTRUCTION
• EASILY EXTRACTS 8-24 PIN DEVICES
• LOW COST \$2.19



EX-1

EX-2 IC EXTRACTION TOOL

• EXTRACTS 24-40 PIN DEVICES
• HEAVY DUTY METAL CONSTRUCTION
• GROUND LUGS FOR MOS EXTRACTIONS
• EASY ONE HAND OPERATION \$12.74

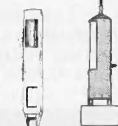

INS-1416 INS-2428

IC INSERTION TOOLS

INS-1416 for 14-16 pin IC's \$5.15
MDS-1416 for 14-16 pin IC's \$10.92
MOS-2428 for 24-28 pin IC's \$10.92
MOS-40 for 40 pin IC's \$12.43
MOS series insertion tools have metal construction and include grounding lug for CMOS applications.

BW-630 WIRE WRAP GUN

• BATTERY POWERED-USES 2 NI-CAD C CELLS (NOT INCLUDED)
• POSITIVE INDEXING
• ANTI-OVERWRAP DEVICE \$41.55

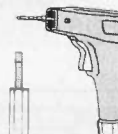

BW-630

WSU-30 WIRE WRAP TOOLS

• WRAPS, STRIPS, AND UNWRAPS
• WSU-30M WRAPS AN EXTRA TURN OF INSULATION

WSU-30 \$8.84 / WSU-30M \$10.14

WIRE WRAP TERMINALS

WWT-1 SLOTTED 25 / \$7.06
WWT-2 SINGLE SIDED 25 / \$4.25
WWT-3 IC SOCKET 25 / \$7.06
WWT-4 DOUBLE SIDED 25 / \$2.80
INS-1 INSERTION TOOL \$3.64



WSU-30/30M

WIRE DISPENSER

• WITH 50' ROLL OF WIRE
• BUILT IN PLUNGER CUTS WIRE
• BUILT IN STRIPPER STRIPES 1"
• REFILLABLE

WD-30 \$6.50 WD-30TRI \$9.50

Specify Blue, White, Yellow or Red With 50' of each: Red, Blue and White



SOCKET-WRAP I.D.TM

• SLIPS OVER WIRE WRAP PINS
• IDENTIFIES PIN NUMBERS ON WRAP SIDE OF BOARD
• CAN WRITE ON PLASTIC, SUCH AS IC #

PINS	PART#	PCK. OF	PRICE
8	IDWRAP 08	10	1.95
14	IDWRAP 14	10	1.95
16	IDWRAP 16	10	1.95
18	IDWRAP 18	5	1.95
20	IDWRAP 20	5	1.95
22	IDWRAP 22	5	1.95
24	IDWRAP 24	5	1.95
28	IDWRAP 28	5	1.95
40	IDWRAP 40	5	1.95

PLEASE ORDER BY NUMBER OF PACKAGES (PCK. OF)

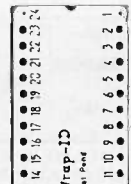

Wrap-I.D. Pin Pack

TRANSFORMERS FRAME STYLE

12.6V AC 2 AMP 4.95
12.6V AC CT 2 AMP 5.95
12.6V AC CT 4 AMP 7.95
12.6V AC CT 8 AMP 10.95
25.2V AC CT 2 AMP 7.95

PLUG CASE STYLE

12V AC 250ma 3.95
12V AC 500ma 4.95
12V AC 1 AMP 5.95
12V AC 2 AMP 6.95

DC ADAPTER

6, 9, 12V DC SELECTABLE WITH UNIVERSAL ADAPTER 8.95

MICROCOMPUTER HARDWARE HANDBOOK

FROM ELCOMP \$14.95

Over 800 pages of manufacturer's data sheets on the most commonly used IC's

• TTL - 74, 74LS & 74F
• CMOS
• Voltage regulators
• Memory - RAM, ROM, EPROM
• CPU's - 6800, 6500, Z80, 8080, 8085 & 8086/8
• MPU Support & Interfaces, 6800, 6500, Z80, 8200, etc.



ORDER TOLL FREE
800-538-5000
800-662-6279
(CALIFORNIA RESIDENTS)



20 MHz DUAL TRACE OSCILLOSCOPE

UNSURPASSED QUALITY AT AN UNBEATABLE PRICE

• BAND WIDTH - DC: DC TO 20MHz (-3db)
AC: 10Hz TO 20MHz (-3db)
• SWEEP TIME - 2 μSEC TO .5 SEC / DIV ON 20 RANGES
• VERT. / HORZ. DEFLECTION: 5mV TO 20V / DIV ON 20 RANGES
• COMPLETE MANUAL AND HIGH QUALITY HOOK-ON PROBES INCLUDED
• INPUT IMPEDANCE: 1 MEG OHM
• TV VIDEO SYNC FILTER
• X, Y AND Z AXIS OPERATION
• 110 / 220 VOLT 50 / 60Hz OPERATION
• COMPONENT TESTER
• LP CONSUMPTION - 19 WATTS
• BUILT IN CALIBRATOR
• AUTOMATIC OR TRIGGERED TIMEBASE

\$399.95
WITH PROBES

FULL ONE YEAR WARRANTY

MULTIMETER PEN

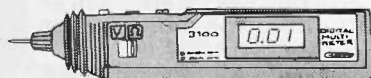

AUTO RANGING, POLARITY & DECIMAL!

• LARGE 3 1/2" DIGIT DISPLAY
• DATA HOLD SWITCH FREEZES READING
• FAST, AUDIBLE CONTINUITY TEST
• LOW BATTERY INDICATOR
• OVERLOAD PROTECTION
• ONLY 1 1/2" x 6 1/4" x 3/4"
• DC VOLTS: 1mV-500V
• AC VOLTS: 1mV-500V
• 1 OHM-20 MEG OHMS
• WEIGHS ONLY 2.3 OUNCES
• LOW PARTS COUNT-CUSTOM 80 PIN LSI INSURES RELIABILITY
• INCLUDES MANUAL, BATTERIES, SOFT CASE, 2 PROBE TIPS, AND ALLIGATOR CLIP

ONLY \$49.95

TEAC-FD55B DS/DD 1/2 HT. **119.95**
FOR IBM PC

MPI-B52 DS/DD FULL HT. **109.95**
FOR IBM PC

EPROM PROGRAMMER
FOR APPLE COMPUTERS

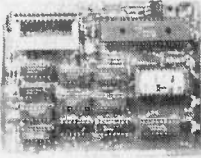

RP525
\$79.95



- * LOW COST!
- * DUPLICATE OR BURN ANY STANDARD 27xx SERIES EPROM
- * EASY TO USE MENU-DRIVEN SOFTWARE INCLUDED
- * MENU SELECTION FOR 2716, 2732, 2732A, 2764 & 27128
- * HIGH SPEED WRITE ALGORITHM
- * LED INDICATORS FOR ACTIVITY
- * NO EXTERNAL POWER SUPPLY REQUIRED

DISK DRIVES FOR IBM

TEAC
FD55B
\$119.95

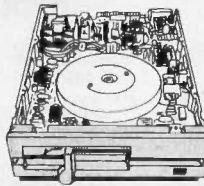

TANDON
TM100-2
\$159.95

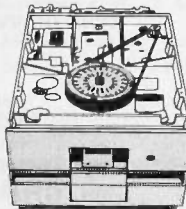

MPI
MODEL B52
\$109.95

IBM ACCESSORIES

- MAXIMIZER** SIGMA MULTIFUNCTION CARD **\$259.95**
- HAYES SMARTMODEM** 1200B FOR IBM **\$419.95**
- PRINTER CABLE** PARALLEL 6' SHIELDED CABLE **\$19.95**
- KRAFT JOYSTICK** **\$39.95**

DISKETTE FILE

\$8.95 IF PURCHASED WITH 50 DISKETTES OR MORE

\$9.95 IF PURCHASED ALONE

HOLDS 70 5 1/4" DISKETTES, WITH ROOM TO SPARE

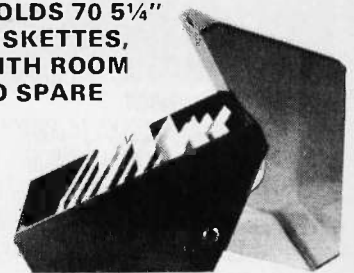

16K RAM CARD \$39.95

- BARE PC CARD AND INSTRUCTIONS \$9.95
- * 2 YEAR WARRANTY
- * EXPAND YOUR 48K APPLE TO 64K
- * USE IN PLACE OF APPLE LANGUAGE CARD

DISK DRIVES

FOR APPLE COMPUTERS

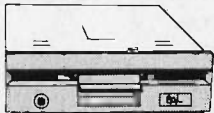

BAL-525
\$139.95

- * 1/2 HEIGHT-ALPS MECHANISM
- * 100% APPLE COMPATIBLE
- * FULL 1 YEAR WARRANTY

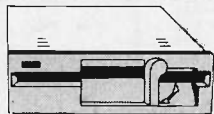

BAL-500
\$169.95

- * TEAC MECHANISM- DIRECT DRIVE
- * 100% APPLE COMPATIBLE- 35 TRACK
- * 40 TRACK WHEN USED WITH OPTIONAL CONTROLLER

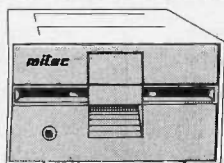

MITAC
AD-1
\$179.95

- * FULL HEIGHT SHUGART MECHANISM
- * DIRECT REPLACEMENT FOR APPLE DISK II

DISK DRIVE ACCESSORIES

- DISK CONTROLLER CARD** \$49.95
 - APPLE IIc ADAPTOR CABLE** \$19.95
- NOW FOR APPLE IIc

BMC MONITOR STAND

MODEL PA-900

TILTS AND SWIVELS TO PROVIDE OPTIMUM VIEWING ANGLE, REDUCES OPERATOR FATIGUE



FACTORY SPECIAL \$14.95

NASHUA DISKETTES

5 1/4" SOFT SECTOR

DS/DD WITH HUB RINGS

BULK PACKAGED IN FACTORY SEALED BAGS OF 50. INCLUDES DISKETTE SLEEVES AND WRITE PROTECT TABS. IDEAL FOR SCHOOLS, CLUBS, AND USERS GROUPS. THIS IS A SPECIAL PURCHASE, SO QUANTITIES ARE LIMITED. THERE IS A 5 YEAR WARRANTY.

\$1.39ea. \$1.49ea. \$1.59ea.
QTY 250 QTY 100 QTY 50

NASHUA DISKETTES WERE JUDGED TO HAVE THE HIGHEST POLISH AND RECORDED AMPLITUDE OF ANY DISKETTES TESTED. (SEE "COMPARING FLOPPY DISKS", BYTE 9 '84)

VERBATIM DATALIFE DISKETTES

- SS/DD SOFT SECTOR \$29.95
- SS/DD 10 SECTOR HARD \$29.95
- DS/DD SOFT SECTOR \$34.95

ORDER TOLL FREE

800-538-5000

800-662-6279 (CA)

BMC BX-80 PRINTER

80 CPS DOT MATRIX PRINTER

- * BI-DIRECTIONAL
 - * SUPERB GRAPHICS
 - * CENTRONICS INTERFACE
- \$199.95**

CLOSE-OUT SPECIAL. QUANTITIES LIMITED

APPLE ACCESSORIES

- VIEWMAX-80** \$159.95
- VIEWMAX-80e** \$129.95
- GRAPHMAX** \$129.95
- THUNDERCLOCK** \$129.95
- KRAFT JOYSTICK** \$39.95
- POWER SUPPLY** \$49.95

IBM COMPATIBLE POWER SUPPLIES

130 WATT
\$159.95

XT COMPATIBLE

- * +5V @ 15A, +12 @ 4.2A
- * -5 @ .5A, -12 @ .5A
- * UPGRADE YOUR PC, POWERS HARD DISK
- * POWER CABLES FOR 4 FDDs
- * ONE YEAR WARRANTY
- * SWITCH ON SIDE (FITS IBM CASE)



100 WATT
\$99.95

- * SWITCH ON REAR
- * FOR USE IN OTHER IBM TYPE MACHINES
- * AVAILABLE IN 100W OR 130W VERSIONS
- * 90 DAY WARRANTY



130 WATT MODEL

\$129.95

JDR Microdevices

1224 S. Bascom Avenue, San Jose, CA 95128

800-538-5000 • 800-662-6279 (CA) • (408) 995-5430

FAX (408) 275-8415 • Telex 171-110

RETAIL STORE - 1256 S. BASCOM AVENUE
HOURS: M-W-F, 9-5 TU-TH, 9-9 SAT, 10-3

PLEASE USE YOUR CUSTOMER NUMBER WHEN ORDERING

TERMS: Minimum order \$10.00. For shipping and handling include \$2.50 for UPS Ground and \$3.50 for UPS Air. Orders over 1 lb. and foreign orders may require additional shipping charges - please contact our sales department for the amount. CA. residents must include 6% sales tax. Bay Area and LA residents include 6 1/2%. All merchandise is warranted for 90 days unless otherwise stated. Prices are subject to change without notice. We are not responsible for typographical errors. We reserve the right to limit quantities and to substitute manufacturer. All merchandise subject to prior sale.

© Copyright 1985 JDR Microdevices

APPLE IS A TRADEMARK OF APPLE COMPUTER CO.

U·N·C·L·A·S·S·I·F·I·E·D A·D·S

WANTED: United Cerebral Palsy seeks tax-deductible donation of six IBM PCs with printers for vocational training program. UCP, Suite 204, 1904 Franklin St., Oakland, CA 94612. (415) 832-7430.

WANTED: Nonprofit agency needs donation of microcomputer and printer to help low-income veterans, youth, handicapped individuals, ex-offenders, and unemployment recipients attain training and employment. Will pay shipping. Bill Slovick, Project J.O.V.E. Inc., Suite 2K, 2725 Congress St., San Diego, CA 92110. (619) 238-3826.

WANTED: Small nonprofit YMCA seeks tax-deductible donation of computer system with disk drives and printer. Need word-processing capabilities, network-information management, inventory, and office management. Will pay shipping. Joy Jackson, Kosciusko Community YMCA, 1401 East Smith St., Warsaw, IN 45680. (219) 269-9622.

WANTED: Private educational organization seeks tax-deductible donation of any disk-based microcomputer with printer for educational and administrative purposes. Will pay shipping. Duane D. Hartman, Lord's Mission, POB 1005, Whitefish, MT 59937. (406) 721-2347.

WANTED: Nonprofit educational institution welcomes tax-deductible contributions of computer equipment for classroom instruction, especially Apple, TRS-80, and IBM-compatible. R. M. Edwards, California Lutheran University, 60 West Olsen Rd., Thousand Oaks, CA 91360. (805) 492-2411, ext. 464.

WANTED: Missionary seeks donation of IBM PC or Compaq with word-processing capabilities for aid to Bible translators. Will issue tax-deductible receipt. Reverend Steve Hopkins, Evangel Bible Translators, 39 Maple St., Centerville, OH 45459.

WANTED: Psychology lab needs a reliable terminal and S-100 bus interface cards. Instructor will pay shipping and provide letter for tax purposes. Barry W. Godolphin, PhD, Psychology Department, Sonoma State University, Rohnert Park, CA 94928.

WANTED: Nonprofit club needs microcomputers, even used, such as C-64, Apple, TRS-80, or IBM PC, plus peripherals and public-domain programs. M. Peleg, Mofet-Club, POB 3252, Haifa 31032, Israel.

WANTED: Contact with Altair user group or individuals for mutual support. Walter Gordon, 10 Bonnie Brook Dr., Shelton, CT 06484.

WANTED: Contacts worldwide for exchange of Ideas and individual or public-domain software for Apple IIe. J. Paulino Ferreira, Apartado 37, Cortegaça, 3882 Ovar Codex, Portugal.

TRADE: Want to trade a copy of Tannenbaum & Augenstein's *Data Structures Using Pascal* for the PL/I version of the same book. R. C. Pierce, 404 Summit Dr., Corte Madera, CA 94925.

FOR SALE: Victor 9000 hard-disk system with quad-density floppy drive, monitor, 18 months old: \$2200 or best offer. American Philosophical Association, University of Delaware, Newark, DE 19716. (302) 451-1112.

FOR SALE: HP CRT, model 1332A hi-res 7-inch flat-face electrostatic XYZ CRT. HP 1984 price \$2730; clean and working with manual: \$200 plus shipping. Mating camera with Polaroid back: \$60 plus shipping. Mark Goldstein, POB 825, Tempe, AZ 85281. (602) 437-1767.

FOR SALE: Apple I, number 37 of the first 175 manufactured. Historical value, excellent condition. runs. Keyboard, cassette interface, power supply. Full 8K memory. Make an offer. John Victor, 24 Sawmill Lane, Greenwich, CT 06830. (203) 869-4479.

FOR SALE: NEC APC H03 computer reset button: \$15. Howard D. Roney, 4840 Andrea Dr. NW, Salem, OR 97304.

FOR SALE: Commodore color monitor, model 1702: \$160 or trade for hi-res amber monitor plus \$60. MPI 5¼-inch DS/DD 40-track drive, model B-52 with case and power supply: \$160 or trade for bare half-height 5¼-inch DS/DD 40-track drive. Evan Americh, 1366 Marie Court, Santa Maria, CA 93454. (805) 922-0102.

FOR SALE: IBM PC XT 768K, 20 megabytes, AST Six-Pack, Tecmar 1st Mate, Hercules, Plantronics, 8087, Z80, 1200B, second hard disk and floppy, IBM mono and color monitors, game I/O, mouse, Okidata 93, HP 7475A, Qume 11440, 64K buffer, and more: \$6750. Bert Baker, 724W 1720N #109, Provo, UT

84604. (801) 377-7343.

WANTED: Public-domain software for IBM PC on astrology and cosmogram construction. Hanspeter Gräub, POB 141, 4125 Riehen, Switzerland.

FOR TRADE: IBM PC public-domain software. Send name and address. Marc David Seidel, 149 Carol St., Danbury, CT 06810. (203) 798-1375.

FOR SALE: Commodore 64, modem, datasette recorder, phone. All about one year old, original packages, reasonable. David Haaland, POB 1704, Minot, ND 58702. (701) 852-5463.

FOR SALE: Hayes Smartmodem 1200B, like new. Does not conform to Spanish standards; asking \$325. F. Tusell, Avenida Tòlosa, 95, 2B, 20009 San Sebastian, Spain.

FOR SALE: Morrow S-100 system: MPZ-80, 64K static RAM, DJ2D/B, two DS/DD 8-inch drives, 5-megabyte Winchester, HD/CMDA, Multi I/O board, ADM-20 terminal, and more. Best offer. May part out. Dave Edick, 15938 Gramercy, San Leandro, CA 94578.

FOR SALE: Complete BYTE issues in excellent condition: 1975 (4 issues): \$15; 1976 to 1978 for \$30/year; 1979 for \$35. Complete *Kilobaud*, 1977 to 1978: \$25/year; 1979 for \$30. Postage included. Sold in annual blocks only. Ricky Peterson, 206 Pine Valley Dr., Warner Robins, GA 31093. (912) 922-1196.

FOR SALE: S-100 boards with documentation. 8080 CPU: \$35; Vector Graphic 16K static RAM: \$60; Ithaca Audio 8K static RAM: \$30; Micro Applications 4K static RAM: \$15; Ithaca Audio 16K ROM: \$75; solid-state music video interface VBI-B: \$30; and others. Neil Schmidt, 2201 San Miguel Dr., Walnut Creek, CA 94596. (415) 939-5342.

FOR SALE: IBM PC with 128K, 360K disk, IBM 10-megabyte hard disk, 130-watt power supply, monochrome and printer adapter, Key Tronic 5150 keyboard. Asking 60 percent of current IBM price. Will sell hard disk and adapter card separately. Joe Gunter, RR2, Box 823, Lot 125, Pompano Beach, FL 33067. (305) 421-6301, days 7-11 p.m.

FOR SALE: Three Shugart 850 1.2-megabyte 8-inch floppy drives. Brand new, double-sided: \$150 each. Ray Turner, 3026 Reece Way, San Jose, CA 95133. (408) 745-1440, ext. 270.

FOR SALE: Logic analyzer. Paratronics 100A/10. Displays truth table on oscilloscope. 3 bytes by 16 words deep. Intensified trigger word 8 to 24 bits wide. 8-MHz data-collection rate. 200-page manual. \$300 plus UPS. Perfect for micro development, test, repair. Ron Dalpiaz, 308 High St., POB 573, Tuscarawas, OH 44682. (614) 922-9446 after 7 p.m.

WANTED: BYTE issue volume 5, number 11, November 1980. Will pay top dollar. Call collect. James Baldwin, (812) 422-3348.

FOR SALE: Lear Siegler ADM 3A+ monitor, hardly used: \$250 firm for quick sale; you pay shipping. Patrick Gleeson, 3470 19th St., San Francisco, CA 94110. (415) 864-1967.

FOR SALE: Hewlett-Packard 86B, 12-inch monitor, dual 3¼-inch drives, RS-232C interface, two 128K memory modules, modem, ROMs, cables, and more. Retail \$6598; asking \$3300. Also printer (82906A) and plotter (7475A). Retail \$2890; asking \$1450. Shannon W. Davis, POB 813, Corvallis, OR 97339. (503) 758-1432.

FOR SALE: Two Radio Shack Modem IIs, 300 bps, auto-dial/auto-answer, direct connect, programmable, good condition, complete with manual. \$125 each (retail \$200). Gary Turkel, 141 Lafayette Ave., Suffern, NY 10901. (914) 357-5183.

.....
UNCLASSIFIED ADS MUST be noncommercial, from readers who have computer equipment to buy, sell, or trade on a one-time basis. All requests for donated computer equipment must be from nonprofit organizations. Programs to be exchanged must be written by the individual or be in the public domain. Ads must be typed double-spaced, contain 50 words or less, and include full name and address. This is a free service; ads are printed as space permits. BYTE reserves the right to reject any unclassified ad that does not meet these criteria. When you submit your ad (BYTE, Unclassified Ads, POB 372, Hancock, NH 03449), allow at least four months for it to appear.

FOR SALE: Shugart SA460, SA800-2, 5¼-inch power supply and case, and Atari 850 interface. Excellent condition or new. Best offer. Lee Fischman, 1332 East 100th St., Brooklyn, NY 11236. (718) 251-2321.

FOR SALE: S-100 complete board set from Vector Graphic including CPU, disk controller, I/O board, 64K RAM, PROM/ROM board, Flashwriter 80-column board, and two extra boards: \$1199. A. Tan, 5749 South Nepal Way, Aurora, CO 80015.

WANTED: Architecture student seeks used graphics computer terminal (at least 1024 by 1024 addressable points) with memory, light pen, manuals, and RS-232C or RS-422 interface. Massimo Stefani, via Lazzaretto II, 20124 Milano, Italy.

WANTED: I would like to know how to convert educational programs from C-64 to IBM PC. G. Sawabini Jr., POB 524, Dearborn, MI 48121.

FOR SALE: Remex 8-inch DS/DD drives, two units: \$150 each or trade for S-50 bus equipment. J. W. Wilson, 400 North Pierce St., Lansdale, PA 19446. (215) 855-0102.

WANTED: *Nibble* Magazine, volume 3, number 2 and volume 3, number 1. Also volume 2, number 7 and earlier issues if the price is right. Send prices to Michael Ching, 2118 Kula St., Honolulu, HI 96817.

WANTED: Inexpensive, bare S-100 mainframe and 8-inch floppy-disk enclosures. Dale Kashuba, S-7 C-10 RR#1, Vernon, British Columbia V1T 6L4 Canada.

FOR SALE: Two Tandon TM 100-1 SS/DD IBM PC disk drives. Excellent condition. \$175 each new; will sell for \$125 each, \$200 for both. Will pay shipping. Mike Molohon, 305 Judy Lane 186, Copperas Cove, TX 76522. (817) 547-5579.

FOR SALE: 64K North Star Horizon-2, FPB-A board, extra 16K IMS static RAM board, Matrox ALT-256 video board, full documentation plus books on CP/M and Z80 assembly language. Make an offer. R. A. Jacobson, 9 Shadewood Lane, Hilton Head Island, SC 29928.

TRADE: Computer Learning Center public-domain software for the Apple II for your CLC disks. Send SASE for list. Dale Flatow, 7684 South Logan Ave., Oak Creek, WI 53154.

WANTED: Hardware, parts, accessories, information for the Exidy Sorcerer computer. Particularly need disk controller, BASIC compiler, EPROM burner, utilities, cassette-to-disk converter, etc. Gary Pewitt, 3039 West 4375 S, Roy, UT 84067.

WANTED: IBM PC, two floppy drives, graphics paper plotter, 256K, etc., to design double-sided layout PC boards, CAD system. Steven Abratti, M.O.S. Inc., 90 East 212th St., Cleveland, OH 44123.

FOR SALE: Texas Instruments 99/4A technical reference manual: \$20. Two Teac SS/DD half-height disk drives from Sanyo MCB 555: \$75 each. All in excellent condition. Michael J. Vargo, 2999 Lutheran Rd., Gilbertsville, PA 19525.

FOR SALE: VT-100 terminal with AVO, Sierra Data Sciences Z80 single-board computer, two Qume DS/DD DataTrak 8-inch disk drives, Q.T. 12-slot S-100 mainframe with power has room for drives. Any reasonable offer accepted. Mark Fowler, 2740 San Carlos Lane, Costa Mesa, CA 92626. (714) 754-1708.

FOR SALE: IBM-compatible board for TRS-80 Model III/4 with 128K RAM, RS-232C serial I/O port, Centronics parallel port, power supply, and enclosure: \$500. 8088 microprocessor: \$20. 8031 microprocessor: \$40. Tandon TM 100-1, 160K disk drive: \$100. Other equipment available. Dave Engelbert, 1625 Lake Dr., Haslett, MI 48840. (517) 339-1771.

WANTED: Correspondence with other computerists in English or Italian. Magnaterra Alessandro, Via Tomba I, 47040 Santarcangelo di Romagna, Forlì, Italy.

FOR SALE: Apple Lisa 2/10, 10 megabytes: \$4500. IBM PC Portable, two disk drives: \$1950. Apple IIc: \$800. Apple IIe, one drive, and monitor: \$900. Osborne I single density: \$350. Atari 800XL, disk drive, and printer: \$600. Apple II+ : \$800. Betty Weber, POB 413, Gates Mills, OH 44040. (216) 729-2808.

WANTED: Used EPROM eraser for 2716s, etc. Andrew F. Siska, 331 South Grant, Westmont, IL 60559. (312) 960-2176, evenings.

WANTED: Engineering student needs Xerox 820 CPU board or Heath H-8, any condition. Curtis L. Martin, POB 341, Fayette City, PA 15438. (412) 326-8759.

B·O·M·B

BYTE'S ONGOING MONITOR BOX

ARTICLE#	PAGE	ARTICLE	AUTHOR(S)
1	48	Ask BYTE	Ciarcia
2	98	The AT&T UNIX PC	Williams
3	108	Ciarcia's Circuit Cellar: Build the Home Run Control System, Part 2: The Hardware	Ciarcia
4	128	Set Extensions with Apple Pascal	Schumer
5	143	Build a Talking Clock Speech Synthesizer	Piette
6	152	Methods: A Preliminary Look	Webster, Yonkman
7	155	Smalltalk-PC	Macie
8	160	The Smalltalk Programming Language	Anderson, Fishman
9	171	Multiprocessing: An Overview	Krajewski
10	185	Extending Microprocessor Architectures	Beals
11	201	Applying Data Flow in the Real World	Paseman
12	219	The Transputer	Walker
13	239	Data-Movement Primitives	Roskos, Hsieh
14	260	The Compaq Deskpro	Grady
15	270	IBM PC AT	Finger
16	279	True BASIC	Vose
17	291	The GTX-100 Modem	Haas
18	307	Computing at Chaos Manor: In Search of the Perfect Product	Pournelle
19	355	BYTE Japan: Megabits and Gigaflops	Raie
20	363	BYTE West Coast: Homebrew Chips	Markoff, Robinson, Osgood
21	385	BYTE U.K.: Parallel Processing	Pountain
22	399	Computers and Law: The Sale of Computer Products	Sterne, Saidman
23	417	Mathematical Recreations: An Exercise in BASIC Bitwise Logic Operation	Kurosaka
24	429	Programming Insight: $0.8660254 \approx \sqrt{3}/2$	Sandberg
25	433	Programming Insight: Computing Pi	Crawford

THE FEBRUARY SEVEN

"Build a Serial EPROM Programmer," an essential hacker's tool designed in Ciarcia's Circuit Cellar, won the blue ribbon in February. In second place is Phillip Robinson's Product Preview on "The HP Integral Personal Computer," a system that makes UNIX portable. And "Troubles" didn't prevent Jerry Pournelle's column, Computing at Chaos Manor, from placing third. "Copying Mass-Marketed Software," the subject and debut of Computers and Law, won fourth place. Robert Greene Sterne and Perry J. Saidman will coauthor this new column scheduled to appear quarterly. The discussion with James H. Wilkinson on the design process of Turing's Universal machine placed fifth. That interview, entitled "The Birth of a Computer," was conducted by John C. Nash.

Because the first five articles are written by BYTE technical or contributing editors, the articles that placed next in line are eligible for the prize money. Eric Aubanel and Keith Oldham's "Fourier Smoothing Without the Fast Fourier Transform" won sixth place; these coauthors will split the \$100 bonus. In seventh place and the winner of the \$50 bonus is Jeffrey Star for his "Introduction to Image Processing." Hearty congratulations to all.

BYTE ADVERTISING SALES STAFF:

J. Peter Huestis, Advertising Sales Manager, 70 Main Street, Peterborough, NH 03458, tel. (603) 924-9281

NEW ENGLAND
ME, NH, VT, MA, RI
Paul McPherson Jr. (617) 262-1160
McGraw-Hill Publications
575 Boylston Street
Boston, MA 02116

ATLANTIC
NY, NJ, CT, NJ (NORTH)
Dick McGurk (212) 512-3588
Leah Goldman (212) 512-2096
McGraw-Hill Publications
1221 Avenue of the Americas—
39th Floor
New York, NY 10020

EAST
PA (EAST), NJ (SOUTH),
MD, VA, W.VA., DE, D.C.
Daniel Ferro (215) 496-3833
McGraw-Hill Publications
Three Parkway
Philadelphia, PA 19102

SOUTHEAST
NC, SC, GA, FL, AL, TN
Maggie M. Dorvee (404) 252-0626
McGraw-Hill Publications
4170 Ashford-Dunwoody Road—
Suite 420
Atlanta, GA 30319

MIDWEST
IL, MO, KS, IA, ND, SD, MN, WI, NB, IN
Bob Denmead (312) 751-3740
McGraw-Hill Publications
Blair Building
645 North Michigan Ave.
Chicago, IL 60611

GREAT LAKES, OHIO REGION
MI, OH, PA (ALLEGHENY), KY,
EASTERN CANADA
Mike Kisseberth (313) 352-9760
McGraw-Hill Publications
4000 Town Center—Suite 770
Southfield, MI 48075

SOUTHWEST, ROCKY MOUNTAIN
UT, CO, WY, OK, TX, AR, MS, LA
Dennis Riley (214) 458-2400
McGraw-Hill Publications
Prestonwood Tower—Suite 907
5151 Beltline
Dallas, TX 75240

SOUTH PACIFIC
SOUTHERN CA, AZ, NM, LAS VEGAS,
Jack Anderson (714) 557-6292
McGraw-Hill Publications
3001 Red Hill Ave.
Building #1—Suite 222
Costa Mesa, CA 92626
Karen Niles (213) 480-5243, 487-1160,
McGraw-Hill Publications
3333 Wilshire Boulevard #407
Los Angeles, CA 90010

NORTH PACIFIC
HI, WA, OR, ID, MT, NORTHERN CA,
NV (except LAS VEGAS), W. CANADA
David Jern (415) 362-4600
McGraw-Hill Publications
425 Battery Street
San Francisco, CA 94111

Bill McAfee (415) 964-0624
McGraw-Hill Publications
1000 Elwell Court—Suite 225
Palo Alto, CA 94303
**WEST COAST SURPLUS
AND RETAIL ACCOUNTS**
Tom Harvey (805) 964-8577
3463 State Street—Suite 256
Santa Barbara, CA 93105

Post Card Mailings
National
Bradley Browne (603) 924-6166
BYTE Publications
70 Main Street
Peterborough, NH 03458

International Advertising Sales Representatives:

Mr. Hans Csokor,
Publimedia
Reisnerstrasse 61
A-1037 Vienna, Austria
222 75 76 84

Mrs. Gurit Cepner
McGraw-Hill Publishing Co.
PO Box 2156
Bat Yam, 59121 Israel
3 866 501 321 39

Mr. Fritz Krusebecker
McGraw-Hill Publishing Co.
Liebigstrasse 19
D-6000 Frankfurt/Main 1
West Germany
69 72 01 81

Mrs. Maria Sarmiento
Pedro Teixeira 8, Off. 320
Iberia Mart I
Madrid 4, Spain
1 45 52 891

Mr. Andrew Karnig
Andrew Karnig & Associates
Finnbodavagen
S-131 31 Nacka, Sweden
8-44 0005

Mr. Jean Christian Acis
McGraw-Hill Publishing Co.
17 rue Georges Bizet
F 75116 Paris
France
1 720 33 42

Mrs. Arthur Scheffer
McGraw-Hill Publishing Co.
34 Dover St.
London W1X 3RA
England 01 493 1451

Mr. Savio Pesavento
McGraw-Hill Publishing Co.
Via Flavio Baracchini 1
20123 Milan, Italy
011 86 90 656

Seavex Ltd.
400 Orchard Road, #10-01
Singapore 0923
Republic of Singapore
Tel: 734-9790
Telex: RS35539 SEAVEX

Seavex Ltd.
503 Wilson House
19-27 Wyndham St.
Central, Hong Kong
Tel: 5-260149
Telex: 60904 SEVEX HX

Hiro Morita
McGraw-Hill Publishing Co.
Overseas Corp.
Room 1528
Kasumigaseki Bldg
3-2-5 Kasumigaseki,
Chiyoda-Ku
Tokyo 100, Japan
3 581 9811

R·E·A·D·E·R S·E·R·V·I·C·E

Inquiry No.	Page No.	Inquiry No.	Page No.	Inquiry No.	Page No.	Inquiry No.	Page No.
437	2500 AD SOFTWARE.....236, 237	73	CHRISLIN IND. INC.....389	153	ELEXOR INC.....494	448	LARK SOFTWARE.....438
2	3-M COMMERCIAL OFFICE SUPPLY DIV.....402	74	CITIZEN AMERICA.....268, 269	*	ELLIS COMPUTING INC.....221	234	LATTICE, INC.....400
3	800 SOFTWARE.....243	75	CIVIL COMPUTING CORP.....502	*	ENCHANTED FOREST.....498	235	LAWSON LABS, INC.....500
4	A.S.T. RESEARCH.....19	76	COASTLINE COMPUTER.....499	155	ENTER COMPUTER.....289	236	LEADING EDGE PROD.....49
5	A.S.T. RESEARCH.....19	77	COGITATE.....488	156	ENTER COMPUTER.....289	237	LEADING EDGE PROD.....71
6	AB COMPUTERS.....348, 349	78	COMARK INC.....176	159	ERICSSON COMPUTER CO. 36, 37	238	LEVEL 5 RESEARCH.....364
7	AB COMPUTERS.....348, 349	80	COMMTEK ELECTRIC INC.....30	161	EVEREX SYSTEMS.....64	239	LIFEBOAT ASSOCIATES.....18
8	ABC DATA PRODUCTS.....490	81	COMMUNICATION CABLE CO.....502	163	EXIM INTERNATIONAL.....492	241	LIFEBOAT ASSOCIATES.....469
438	ACM SIGGRAPH '85.....328	82	COMP. COMPNTS. UNLTD.....461	165	EXPRESS BUSINESS SOFTWARE.....52	242	LINTEK INC.....515
9	ACS INT'L. INC.....428	83	COMP. COMPNTS. UNLTD.....462, 463	162	EXSEL INC.....492	243	LIVING VIDEOTEX.....432
10	ACTION COMPUTER.....145	*	COMPAQ COMPUTER CORP.....88, 89	166	FACIT AB.....319	245	LOGICAL DEVICES.....240
11	ACTION COMPUTER.....145	84	COMPETITIVE EDGE.....66	167	FLAGSTAFF ENGINEERING.....408	246	LOGICAL DEVICES.....498
12	ADDMASTER CORP.....500	87	COMPPOWER TECH. CORP.....498	168	FLAGSTAFF ENGINEERING.....408	247	LOMAS DATA PRODUCTS.....197
13	ADV. BUSINESS COMP. SYS.....298	*	COMPUMAIL.....489	169	FORTRON, INC.....481	248	LYBEN COMP. SYS.....502
14	ADV. COMP. PROD.....486	89	COMPUSERVE.....35	170	FORTRON, INC.....481	249	LYBEN COMP. SYS.....448
15	ADV. COMPUTER SYSTEMS.....390	90	COMPUSERVE.....215	451	FOX AND GELLER.....436	250	LYCO COMPUTER.....459
18	AFTEK BUSN.MACHINES.....340	91	COMPUTATIONAL SYS. INC.....232	171	FOX SOFTWARE INC.....496	251	MANAGEMENT INFO SOURCE.....138
*	ALF PRODUCTS, INC.....60	92	COMPUTER AFFAIRS INC.....494	172	FRIENDLY COMPUTER.....165	252	MANX SOFTWARE SYS.....53
19	ALL ELECTRONICS CORP.....84	93	COMPUTER AFFAIRS INC.....294	173	FUNK SOFTWARE.....258	253	MARK WILLIAMS CO.....75
20	ALLIED MICRO DEVICES.....492	94	COMPUTER CHANNEL.....411	174	GENERAL MICRO SYSTEMS.....490	254	MARYAMK INDUSTRIES INC.....498
21	ALLOY COMPUTER PROD.....248	*	COMPUTER CHRONICLES.....315	175	GENERAL TECHNOLOGY.....205	255	MASTERBYTE COMP. OF N.Y.....502
22	AMARAY CORP.....241	95	COMPUTER CONNECT, INC.....508, 509	444	GENICOM CORP.....419	256	MAXELL DATA PRODUCTS.....7
23	AMBER SYSTEMS.....323	*	COMPUTER CONTINUUM.....488	176	GIFFORD COMP. SYS.....359	257	MAYNARD ELECTRONIX.....15
24	AMDEK CORP.....8	96	COMPUTER DISCOUNT PROD.....497	177	GOLD HILL COMPUTERS.....170	*	MCGRAW-HILL CEC.....353
26	AMERICAN DESIGN COMPNTS.....365	97	COMPUTER GROUP, THE.....488	178	GOLDEN BOW SYSTEMS.....492	258	MEGATEL COMPUTER TECH.....86
27	AMERICAN RESEARCH.....226	98	COMPUTER HUT OF N.E.....455	179	GRAPHIC COMMUNICATIONS 562, 63	259	MERRITT COMP. PRODUCTS.....492
28	AMERICAN RESEARCH.....226	99	COMPUTER INNOVATIONS.....320	180	GTEK INC.....85	260	METALINK CORP.....519
463	AMERICAN SEMICONDUCTOR.....430	101	COMPUTER INNOVATIONS.....310	181	H&E COMPUTRONICS.....137	261	MFI ENTERPRISES INC.....91
29	AMPERE INC.....150	102	COMPUTER MAIL ORDER.....396, 397	182	HAMMER COMPUTER SYSTEMS 80, 81	262	MICRAY ELECTRONIX.....246
30	AMPRO COMPUTERS INC.....230	103	COMPUTER PARTS MART.....502	183	HANZON DATA INC.....248	263	MICRO DATA BASE SYS.....450, 451
31	ANTHRO CORP.....199	*	COMPUTER WAREHOUSE.....465	184	HARMONY VIDEO & COMP.....78	264	MICRO DESIGN INT'L.....431
32	APOLLO MARKETING.....482	105	COMPUTERBANC.....74	185	HARMONY VIDEO & COMP.....412	265	MICRO MART, INC.....72, 73
33	APPARAT INC.....502	107	COMPUTRADE.....446	232	HARRIS/LANIER EOS DIV. 382, 383	266	MICRO PRODUCTS, INC.....495
*	APPLE COMPUTER INC.....CII, 1	441	CONROY-LAPOINTE.....166, 167	*	HAVENTREE SOFTWARE LTD.....498	267	MICRO WORLD ELECTRONIX.....519
34	APPLIED DATA SYSTEMS.....139	442	CONROY-LAPOINTE.....166, 167	187	HERCULES COMPUTER TECH.....25	268	MICROCOMPUTER ACCESSORIES.....336
35	APPLIED I.....502	443	CONROY-LAPOINTE.....166, 167	188	HERCULES COMPUTER TECH.....179	269	MICROCOMPUTER ACCESSORIES.....336
36	APPLIED SOFTWARE TECH.....251	109	CONTROL DATA.....147	189	HOFFMAN INT'L.....490	270	MICROGRAFX.....135
37	APRICOT INC.....12, 13	110	CONTROL DATA MICRO SERV.....357	*	HOLIDAY INNS, INC.....312, 313	*	MICROMINT INC.....410
38	APROPOS TECHNOLOGY.....519	111	CORVUS SYS. INC.....231	190	HOOLEON COMPANY.....165	271	MICROPROCESSORS UNLTD.....490
39	ARCTEC SYSTEMS.....367	465	CRANE ASSOC., INC.....430	191	HOOLEON COMPANY.....165	464	MICROSCOPE.....430
40	ARTIFICIAL INT'L. RESRCH.GRP.....494	112	CROMEMCO.....5	192	HOUSTON INSTR/BAUSCH&LOMB 304	272	MICROSHOP.....178
41	ASHTON-TATE.....94, 95	113	CUESTA SYSTEMS.....379	193	HYPERON SOFTWARE.....515	*	MICROSOFT CORP.....126, 127
42	AT&T GENERAL BUSN. SYS.....378	117	CUSTOM COMP. TECH.....173	194	I.B.C.....195	*	MICROSOFT CORP.....283
43	AUGAT PACKAGED PROD.....69	118	CUSTOM COMP. TECH.....482	195	I.B.C.....195	*	MICROSOFT CORP.....285
145	AVATEX MODEMS.....216, 217	119	CUSTOM COMP. TECH.....483	196	I.D.SYSTEMS.....352	*	MICROSOFT CORP.....287
44	AVOCET.....381	120	DATA BANK.....78	197	IBM CORP.....440, 441	*	MICROSOFT CORP. PRESS.....306
45	AWARD SOFTWARE, INC.....212	121	DATA EXCHANGE.....500	198	IBM NDD SYS. SUPP.....360, 361	274	MICROSTUF, INC.....384
46	AWESOME TECHNOLOGY, INC.....519	*	DATA I/O INC.....515	200	ILAR SYSTEMS, INC.....358	275	MICROTIME.....92
47	B&B ELECTRONICS.....515	439	DATA SPEC.....452	201	ILAR SYSTEMS, INC.....358	276	MICROWAY.....218
*	B&C MICROSYSTEMS.....502	440	DATA SPEC.....452	202	IMSI.....354	277	MICROWAY.....413
48	BASF SYSTEMS.....133	123	DATA TRANSLATION INC.....233	*	INDEPENDENT BUSN.SYS INC.....343	278	MIDWEST MICRO-PERIPHERALS.....34
49	BAY TECHNICAL ASSOC.....23	124	DATACOPY CORP.....404	203	INFOCOM.....368	279	MINORITY HI-TECH INDUSTRIES.....281
50	BEST POWER TECHNOLOGY.....69	125	DATASOUTH COMP. CORP.....425	207	INOVIOM CORP.....242	279	MOTEL COMPUTERS LTD.....500
*	BEST WESTERN INT'L.....138	126	DAYNA COMM.....148, 149	205	INTEGRAND.....388	280	MOUNTAIN VIEW PRESS.....77
51	BIBLE RESEARCH SYSTEMS.....132	127	DELUXE COMP. FORMS.....70	206	INTERACTIVE COMPONENTS.....484	281	MTI SYSTEMS CORP.....146
52	BLACKSHIP COMP. SUPPLIES.....515	128	DICK SMITH ELECTRONICS 414, 415	207	INTERCONTN. MICRO SYS.....4	282	MULTI-TECH SYSTEMS.....234
53	BLAISE COMPUTING INC.....244	129	DIGITAL PRODUCTS INC.....146	208	INTERCONTN. MICRO SYS.....4	286	NANTUCKET.....184
455	BORLAND INT'L.....41	130	DIGITAL RESEARCH COMP.....76	209	INTERFACE INC.....247	287	NANTUCKET.....184
456	BORLAND INT'L.....41	131	DIRECT-CONNECT DEVICES.....490	210	INTERFACE INC.....247	288	NAT'L. PUBLIC DOMAIN SFTW.....86
457	BORLAND INT'L.....43	*	DISCOUNT COMPUTER CENTERS 398	211	INTERFACE TECH. CORP.....238	289	NATIONAL INSTRUMENTS.....125
458	BORLAND INT'L.....43	132	DISKETTE CONNECTION.....454	429	INTERNATIONAL UNION OF COMPUTER OWNERS INC 504, 505	88	NCDA.....494
459	BORLAND INT'L.....45	133	DISKS PLUS.....498	212	IOMEGA.....337	290	NEC HOME INFORMATION SYS. CIII
460	BORLAND INT'L.....45	134	DISK WORLD!, INC.....479	213	IOMEGA.....339	291	NESTAR SYSTEMS INC.....453
461	BORLAND INT'L.....46, 47	135	DISK WORLD!, INC.....487	214	IOMEGA.....341	292	NEW GENERATION SYS.....250
462	BORLAND INT'L.....46, 47	137	DISPLAY TELECOMMNTNS 510, 511	215	JADE COMP. PROD.....516, 517	293	NEWSNET INC.....55
452	BUDDY PRODUCTS.....515	139	DOKAY COMP. PROD. INC. 506, 507	216	JADE COMP. PROD.....518	294	NICOLET PARATRONS.....30
58	BUSINESS TOOLS INC.....439	140	DOW JONES SOFTWARE.....456, 457	217	JAMECO ELECTRONICS.....228, 229	295	NIGHTOWL SOFTWARE.....253
*	BYTE PUBLINC.....446	141	DWIGHT CO., INC.....494	218	JDR MICRODEVICES INC. 520, 521	296	NORTH HILLS CORP.....492
59	BYTEK COMP. SYS. CORP.....66	143	DYNACOMP COMPUTER SYS.....366	219	JDR MICRODEVICES INC. 522, 523	297	NORTH HILLS CORP.....494
*	C WARE.....292	144	DYNAX, INC.....394	220	JDR MICRODEVICES INC.....524	*	NORTHROP.....473
60	C ITOH DIGITAL PRODUCTS.....38	146	EARTH COMPUTERS.....488	221	JEDEN.....278	298	NRI SCHOOLS ELECTR. DIV.....449
61	C ITOH DIGITAL PRODUCTS.....38	147	EARTH COMPUTERS.....500	222	JOHN WILEY & SONS.....252	298	OBERON INTERNATIONAL.....370
*	CALIF. DIGITAL.....512, 513	148	EASTMAN KODAK CO.....338	225	KADAK PRODUCTS.....502	300	OLDEN.....181
*	CALIF. DIGITAL.....514	149	EASTMAN KODAK CO.....422, 423	226	KIMTRON CORP.....393	104	OPUS COMP PROD.....16
*	CALIF. MICRO COMPUTER.....519	150	ECOSOFT.....54	227	KRUEGER TECHNOLOGY INC.....493	301	ORCHID TECHNOLOGY.....131
62	CALIF. MICRO HOUSE.....136	151	EDUCATIONAL MICROCOMP.....498	227	L-COM INC.....318	302	ORCHID TECHNOLOGY.....321
63	CANON U.S.A.....28, 29	454	ELCOMP.....519	228	LABORATORY MICROSYS.....132	303	ORION INSTRUMENTS.....198
64	CAPITAL EQUIPMENT CORP.....280	152	ELECTRONIC DATA SYS.....372			304	ORYX SYSTEMS.....254, 255
65	CAPITAL MICRO.....192					305	ORYX SYSTEMS.....254, 255
67	CDA INT'L SOFTWARE.....488					306	ORYX SYSTEMS.....254, 255
68	CDR SYSTEMS.....496					307	OZISOFT.....490
69	CENTROID CORP.....496					308	PC. HORIZONS, INC.....496
71	CHIPS 'N DIPS.....500					309	PC NETWORK.....344, 345
72	CHORUS DATA SYSTEMS.....362					310	PACIFIC EXCHANGES.....488, 492, 496, 519
						311	PACIFIC PAYROLL SYSTEMS.....92

TO GET FURTHER information on the products advertised in BYTE, either pick up your touch-tone telephone and use TIPS (if you are a subscriber), or fill out the reader service card. Either way full instructions are provided following this reader service index which is provided as an additional service by the publisher, who assumes no liability for errors or omissions. *Correspond directly with company.

ONLY PINWRITER DOT MATRIX PRINTERS CAN SAY ALL THIS.



Pinwriter printers are available in black & white and color models

And to make things even easier, Pinwriter printers work with the most popular PCs and software packages.

All the controls at your fingertips.

The Pinwriter is also much easier to use than any other dot matrix printer.

Press a button and you can change typefaces. Or speeds. Even spacing and pitch selection. And that's a refresh-

I CAN PRINT PICA HIGH SPEED.
OR PICA CORRESPONDENCE QUALITY
OR PICA NEAR LETTER QUALITY
OR ELITE CORRESPONDENCE QUALITY
OR ELITE NEAR LETTER QUALITY
OR PROPORTIONALLY SPACED CORRESPONDENCE
OR PROPORTIONALLY SPACED NEAR LETTER QUALITY
OR CONDENSED
OR ANY PROGRAMMABLE TYPEFACE

The Pinwriter prints in 8 different typefaces at the touch of a button.

ing change. Of course, you can do it through your software, too.

See your dealer for a quote.

For all this versatility, you might expect to pay a bundle for a

Pinwriter printer. Not so. Pinwriter prices are also easy to handle.

For more information, call 1-800-343-4418 (in MA call 617-264-8635). And find out why more and more PC owners are saying, "NEC and me!"

NEC AND ME

NEC Information Systems, Inc.

1414 Massachusetts Ave.
Department 1610
Boxborough, MA 01719

Inquiry 290

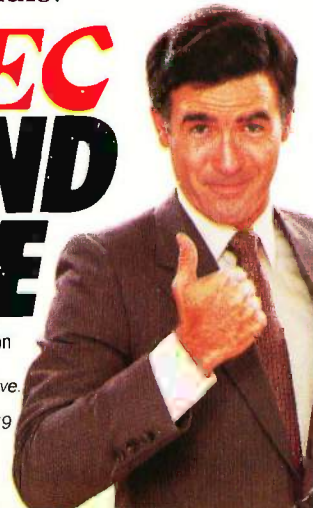

The reason most people buy a dot matrix printer is for versatility.

And that's exactly why you should buy an NEC Pinwriter™ printer.

Pinwriters are the final word in versatility.

The Pinwriter lets you do more than any other dot matrix printer. Three different speeds cover all your needs—300, 900 or 1800 words per minute.

Pinwriter printers also let you create

unbelievably clear graphics. In black and white. Or in seven crisp colors.

But that's not all. Every Pinwriter gives you a choice of 8 different type styles. Plus, you can choose from a wide range of easy-to-use NEC forms handlers.

With Pinwriter, you can change spacing, type pitch, and speed with one finger

Pinwriter is a trademark of NEC Corp.



A STAR IS BORN

Out of Radio Shack's Famed Model 100 Evolves the Advanced Technology Tandy 200

Our new Advanced Technology Tandy 200 portable computer does what no other computer could.

It takes our amazing Model 100 one step further.

Get Much More Power



A new 40-character by 16-line flip-up screen gives

the Tandy 200 improved text and graphics. The 24K memory (expandable to 72K) is great for data

storage and other big jobs, and the built-in Multiplan software makes the Tandy 200 a portable spreadsheet analysis tool.

Five other "instant-on" programs include an improved version of the Model 100 word processor, a telecommunications program, a personal calendar and a telephone and appointment file. You can even write your own programs in BASIC. And the Tandy 200's tone-dialing feature lets you use long-distance phone services.

See It Today

Get a hands-on demonstration of the Tandy 200 (26-3860, \$999) at any Radio Shack Computer Center or participating Radio Shack store or dealer.

Radio Shack[®]
The Technology Store[™]

A DIVISION OF TANDY CORPORATION

Prices apply at Radio Shack Computer Centers and at participating stores and dealers.

Inquiry 340

