

BYTE[®]

MARCH 1982 Vol. 7, No. 3
\$2.95 in USA/\$3.50 in Canada
A McGraw-Hill Publication

the small systems journal

Printers



A new small computer that won't limit you tomorrow

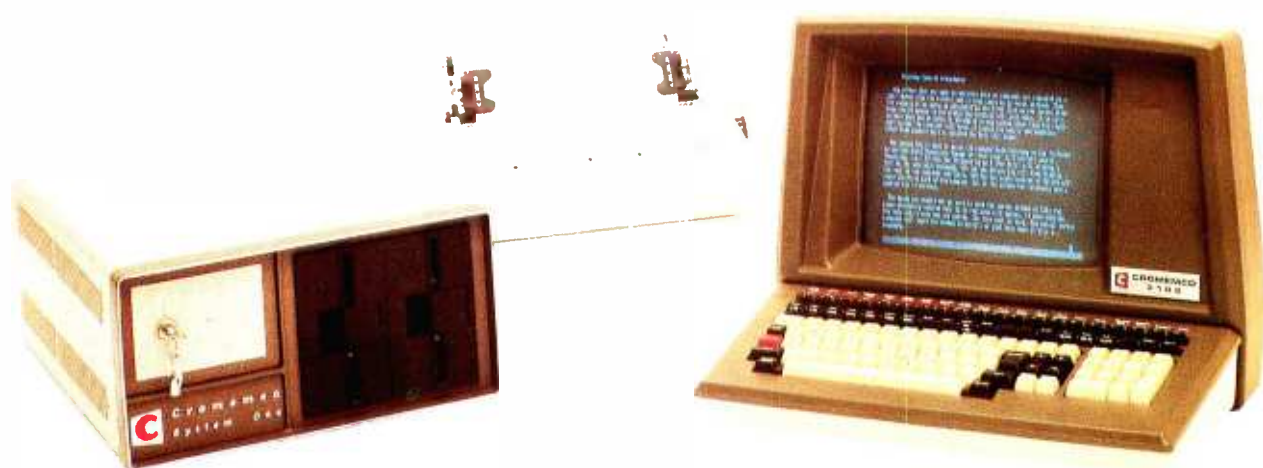

New Cromemco System One shown with our
high-capability terminal and printer.

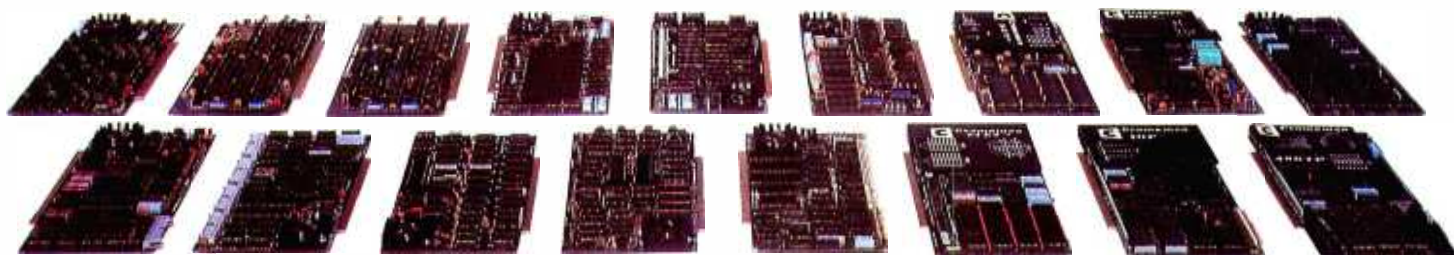

Expandability

Here's a low-priced computer that won't run out of memory capacity or expandability halfway through your project.

Typically, computer usage tends to grow, requiring more capability, more memory, more storage. Without a lot of capability and expandability, your computer can be obsolete from the start.

The new System One is a real building-block machine. It has capability and expandability by the carload.

Look at these features:

- **Z80-A processor**
- **64K of RAM**
- **780K of disk storage**
- **CRT and printer interfaces**
- **Eight S-100 card slots, allowing expansion with**
 - color graphics
 - additional memory
 - additional interfaces for telecommunications, data acquisition, etc.
- **Small size**

GENEROUS DISK STORAGE

The 780K of disk storage in the System One Model CS-1 is much greater than what is typically available in small computers. But here, too, you have a choice since a second version, Model CS-1H, has a 5" Winchester drive that gives you 5 megabytes of disk storage.

MULTI-USER, MULTI-TASKING CAPABILITY

Believe it or not, this new computer even offers multi-user capability when used with our advanced CROMIX* operating system option. Not only does this outstanding O/S support multiple users on this computer but does so with powerful features like multi-

ple directories, file protection and record level lock. CROMIX lets you run multiple jobs as well.

In addition to our highly-acclaimed CROMIX, there is our CDOS*. This is an enhanced CP/M† type system designed for single-user applications. CP/M and a wealth of CP/M-compatible software are also available for the new System One through third-party vendors.

COLOR GRAPHICS/WORD PROCESSING

This small computer even gives you the option of outstanding high-resolution color graphics with our Model SDI interface and two-port RAM cards.

Then there's our tremendously wide range of Cromemco software including packages for word processing, business, and much more, all usable with the new System One.

ANTI-OBSOLESCENCE/LOW-PRICED

As you can see, the new One offers you a lot of performance. It's obviously designed with anti-obsolence in mind.

What's more, it's priced at only \$3,995. That's considerably less than many machines with much less capability. And it's not that much more than many machines that have little or nothing in the way of expandability.

Physically, the One is small — 7" high. And it's all-metal in construction. It's only 14 1/8" wide, ideal for desk top use. A rack mount-option is also available.

CONTACT YOUR REP NOW

Get all the details on this important building-block computer. Get in touch with your Cromemco rep now. He'll show you how the new System One can grow with your task.

*CROMIX and CDOS are trademarks of Cromemco Inc.

†CP/M is a trademark of Digital Research



CromemcoTM
i n c o r p o r a t e d

280 BERNARDO AVE., MOUNTAIN VIEW, CA 94040 • (415) 964-7400
Tomorrow's computers today

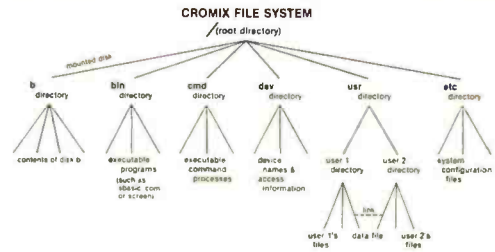

CROMIX* — Cromemco's outstanding UNIX†-like operating system

CROMIX is just the kind of major development you've come to expect from Cromemco. After all, we're already well-known for the most respected software in the microcomputer field.

And now we've come up with the industry's first UNIX-lookalike for microcomputers. It's a tried and proven operating system. It's available on both 5" and 8" diskettes for Cromemco systems with 128K or more of memory.

Here are just some of the features you get in this powerful Cromemco system:

- Multi-user and multi-tasking capability
- Hierarchical directories
- Completely compatible file, device, and interprocess I/O
- Extensive subsystem support

FILE SYSTEM

One of the important features of our CROMIX is its file system comprised of hierarchical directories. It's a tree structure of three types of files: data files,

*CROMIX is a trademark of Cromemco, Inc.
†UNIX is a trademark of Bell Telephone Laboratories

directories, and device files. File, device, and interprocess I/O are compatible among these file types (input and output may be redirected interchangeably from and to any source or destination).

The tree structure allows different directories to be maintained for different users or functions with no chance of conflict.

PROTECTED FILES

Because of the hierarchical structure of the file system, CROMIX maintains separate ownership of every file and directory. All files can thus be protected from access by other users of the system. In fact, each file is protected by **four separate access privileges** in each of the three user categories.

TREMENDOUS ADDRESS SPACE, FAST ACCESS

The flexible file system and generalized disk structure of CROMIX give a disk address space in excess of one gigabyte per volume — file size is limited only by available disk capacity.

Speed of access to disk files has also been optimized. Average access speeds far surpass any yet implemented on microcomputers.

'C' COMPILER AVAILABLE, TOO

Cromemco offers a wide range of languages that operate under CROMIX. These include a high-level command process language and extensive sub-system support such as COBOL, FORTRAN IV, RATFOR, LISP, and 32K and 16K BASICs.

There is even our highly-acclaimed 'C' compiler which allows a programmer fingertip access to CROMIX system calls.

THE STANDARD O-S FOR THE FUTURE

The power and breadth of its features make CROMIX the standard for the next generation of microcomputer operating systems.

And yet it is available for a surprisingly low \$595.

The thing to do is to get all this capability working for you now. Get in touch with your Cromemco rep today.



Cromemco™
i n c o r p o r a t e d

280 BERNARDO AVE., MOUNTAIN VIEW, CA 94040 • (415) 964-7400
Tomorrow's computers today

Features

- 40** **Four New Products from Radio Shack** by Chris Morgan / New developments from Radio Shack include some surprises.
- 50** **Use Voiceprints to Analyze Speech** by Steve Ciarcia / The first step in designing a speech-recognition system is analyzing the spectral content of speech.
- 80** **The Atari Tutorial, Part 7: Sound** by Bob Fraser / The Atari 400 and 800 computers can generate a variety of noises.
- 100** **Build a Half-year Clock for the Color Computer** by William Barden Jr. / The inexpensive and accurate half-year clock can be easily interfaced to a Radio Shack Color Computer.
- 126** **The Input/Output Primer, Part 2: Interrupts and Direct Memory Access** by Steve Leibson / Second in a series that explains the way in which computers talk with the world.
- 142** **A BASIC Plotting Subroutine, Sophisticated Plotting with Your MX-80** by Lawrence J. Bregoli / Simple software routines let the Epson MX-80 emulate sophisticated plotters.
- 158** **Modify Your Paper Tiger for Different Paper Thicknesses** by R. P. Sarna / A simple modification increases the versatility of your printer.
- 198** **Custom and Standardized Forms for the Microcomputer User** by Philip Lemmons / A number of companies stand ready to help you with various stock, custom, or standardized forms.
- 218** **The Fill Forms System, CP/M Programs to Cut Down on Paperwork** by Bill Roch / Use your computer to fill in standardized forms.
- 248** **Lowercase Descenders for the Epson MX-70** by Bruce Piggott / Get true lowercase descenders and program your own special characters.
- 278** **BYTE Printer Directory** by Curtis P. Feigel / A listing of printer manufacturers and their products.
- 456** **The Computer Toolbox** by Mark Bernstein / The modularity of FORTH gives laboratory computers portability and flexibility.
- 466** **Skip Sequential: A New File Structure for Microcomputers** by Jack Purdum / An interesting technique for North Star and Microsoft BASICs combines the speed of random-access disk files with the space-saving advantages of sequential-access files.

Reviews

- 26** Commodore 4022 Printer by Joseph Holmes
- 44** Integral Data Systems' Prism Printer by Ed Umlor
- 68** BYTE's Arcade: Apple Panic by Gregg Williams; Missile Command by Stanley J. Wszola; Dino Wars by George Stewart
- 172** Graphics II by Selanar, High Resolution Hard Copy from a DECwriter by Daniel Macero, Daniel Holmes, Thomas Banks, and Lloyd Burgess
- 206** Base 2 Printer by Walter Jeffries
- 262** Text Editing with Compuview's VEDIT by H. Bradford Thompson
- 316** Four Implementations of Pascal by Thomas H. Woteki and Paul A. Sand
- 358** Microsoft's BASIC Compiler for the TRS-80 by Mahlon G. Kelly
- 372** LDOS—Disk Operating System for the TRS-80 by Tim Daneliuk
- 384** COBOL for the TRS-80 Models III/III by Rowland Archer Jr.
- 414** John Bell Engineering's Apple II Parallel Interface Board by Ned W. Rhodes

Nucleus

- 6** Editorial: The Microprocessor's Tenth Birthday
- 14** Letters
- 162, 300, 310, 473** Programming Quickies: BASIC Formatted Printing; An Underline Filter for Matrix Printers; A Shape-Drawing Program for Diablo Printers; Finding Words That Sound Alike, The Soundex Algorithm
- 166, 256, 272** System Notes: Epson MX-80 Print-Control Program for the Apple II; Add a Full-sized Keyboard to Sinclair's ZX80; Add a Cassette Interface to Your VIC-20
- 240** Product Description: Tele-VIC, Commodore Breaks the \$100 Price Barrier for Modems
- 432** Books Received
- 434, 441** BYTE's Bugs
- 436** BYTELINES
- 440** Clubs and Newsletters
- 441** Software Received
- 442** Ask BYTE
- 448** Event Queue
- 454** BYTE's Bits
- 475** What's New?
- 526** Unclassified Ads
- 526** BOMB, BOMB Results
- 527** Reader Service

BYTE

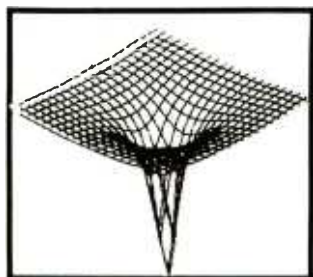

Page 40

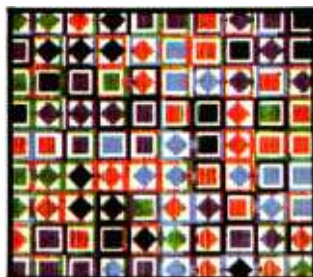

Page 44



Page 50



Page 68



Editor in Chief
Christopher Morgan

Managing Editor
Mark Haas

Technical Editors
Gregg Williams, Senior Editor;
Richard S. Shuford; Curtis P. Feigel;
George Stewart; Arthur Little;
Stanley Wszola; Steve Ciarcia; Mark Dahmke;
Philip Lemmons; Allan Lundell, Consulting
Editors; Jon Swanson, Drafting Editor

Copy Editors
Beverly Cronin, Chief; Faith Hanson;
Warren Williamson; Anthony J. Lockwood;
Ann Graves; Linda M. Evers; Hilary Selby Polk;
Elizabeth Kempner

Assistants
Faith Ferry; Debe Wheeler;
Karen A. Cilley; Susan Ferber;
Marie Hennessy

Production
Nancy Estle, Director; David R. Anderson,
Assoc. Director; Jonathan M. Graves, Creative
Consultant; Patrice Scribner; Damian
Henriques; Jan Muller; Linda J. Sweeney;
Sherry McCarthy, Chief Typographer;
Debi Fredericks; Donna Sweeney;
Valerie Horn

Advertising
Thomas Harvey, Director; Marion Carlson;
Rob Hannings; Deborah Porter;
Vicki Reynolds; Cathy A. R. Drew;
Jacqueline Earnshaw, Reader Service
Coordinator; Wai Chiu Li, Advertising/
Production Coordinator

Circulation
Gregory Spitzfaden, Manager;
Andrew Jackson, Asst. Manager;
Agnes E. Perry; Barbara Varnum;
Louise Menegus; Pinky Krulis;
James Bingham, Dealer Sales;
Deborah J. Cadwell, Asst.
Kathleen Reckhart

Controller's Office
Daniel Rodrigues, Controller;
Mary E. Fluhr, Acct. & D/P Mgr.; Karen
Burgess; Jeanne Cilley; Linda Fluhr;
Vicki Bennett

Traffic
N. Scott Gagnon; Scott Jackson,
Mary McRae

Publishers
Virginia Londoner; Gordon R. Williamson;
John E. Hayes, Associate Publisher;
Cheryl A. Hurd; Michele P. Verville, Publisher's
Assistants;

Officers of McGraw-Hill Publications Company: Paul F. McPherson, President; Executive Vice Presidents: Daniel A. McMillan, III, Gene W. Simpson; Senior Vice President-Editorial: Ralph R. Schulz; Vice Presidents: Kemp Anderson, Business Systems Development; Harry L. Brown, Special Markets; Robert B. Doll, Circulation; James E. Hackett, Controller; Eric B. Herr, Planning and Development; H. John Sveger, Jr., Marketing.

Officers of the Corporation: Harold W. McGraw Jr., Chairman and Chief Executive Officer; Joseph L. Dionne, President and Chief Operating Officer; Robert N. Landes, Senior Vice President and Secretary; Ralph J. Webb, Treasurer.



In This Issue

Hard copy was once considered a luxury by computer hobbyists, but now the ability to record program listings and text on paper is seen as almost a necessity. And though you're not likely to find a printer like the one Robert Tinney pictured on this month's cover, you're sure to find one from the many available that will fit your needs. For a rundown on what's around, see Curtis Feigel's printer directory. For a look at a new approach to printers, see Ed Umlor's review of the Prism Printer. We've also included a report on custom and standardized forms: where to get them and how to use them. And we have an article on programming your computer to fill in forms.

The Atari Tutorial continues with Part 7: Sound; William Barden Jr. discusses building a half-year clock for the Color Computer in the fourth article in his series on Radio Shack computers; in Part 2 of the "Input/Output Primer" Steve Leibson discusses interrupts and direct memory access; and Steve Ciarcia writes about using voiceprints to analyze speech. Don't miss our quarterly games feature, "BYTE's Arcade," plus our regular items and reviews.

BYTE is published monthly by BYTE Publications Inc. 70 Main St. Peterborough NH 03458, phone (603) 924-9281, a wholly-owned subsidiary of McGraw-Hill, Inc. Address subscriptions, change of address, USPS Form 3579, and fulfillment questions to BYTE Subscriptions, POB 590, Martinsville NJ 08836. Second class postage paid at Waseca, Minnesota 56093 - USPS Publication No. 528890 (ISSN 0360-5280). Canadian second class registration number 9321. Subscriptions are \$19 for one year, \$34 for two years, and \$49 for three years in the USA and its possessions. In Canada and Mexico, \$21 for one year, \$38 for two years, \$55 for three years, \$43 for one year air delivery to Europe, \$35 surface delivery elsewhere. Air delivery to selected areas at additional rates upon request. Single copy price is \$2.95 in the USA and its possessions, \$3.50 in Canada and Mexico, \$4.50 in Europe, and \$5.00 elsewhere. Foreign subscriptions and sales should be remitted in United States funds drawn on a US bank. Printed in United States of America.

Address all editorial correspondence to the editor at BYTE, POB 372, Hancock NH 03449. Unacceptable manuscripts will be returned if accompanied by sufficient first class postage. Not responsible for lost manuscripts or photos. Opinions expressed by the authors are not necessarily those of BYTE. Entire contents copyright © 1982 by BYTE Publications Inc. All rights reserved. Where necessary, permission is granted by the copyright owner for libraries and others registered with the Copyright Clearance Center (CCC) to photocopy any article herein for the base fee of \$1.00 per copy of the article or item plus 25 cents per page. Payment should be sent directly to the CCC, 21 Congress St, Salem MA 01970. Copying done for other than personal or internal reference use without the permission of McGraw-Hill is prohibited. Requests for special permission or bulk orders should be addressed to the publisher.

BYTE® is available in microform from University Microfilms International, 300 N Zeeb Rd, Dept PR, Ann Arbor MI 48106 USA or 18 Bedford Row, Dept PR, London WC1R 4EJ England.



Subscription WATS Line: (800) 258-5485

Office hours: Mon-Thur 8:30 AM - 4:30 PM, Friday 8:30 AM - Noon, Eastern Time

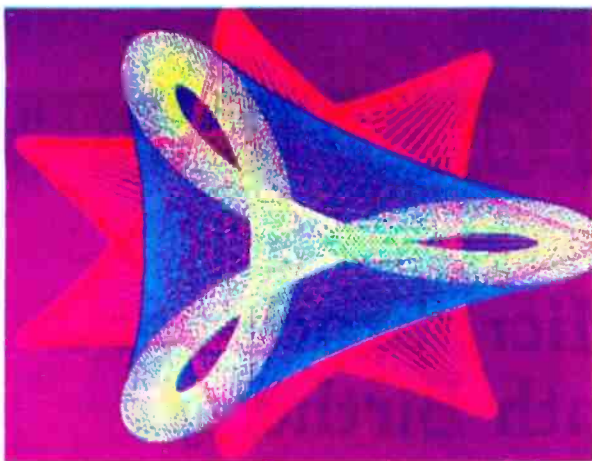

"...stands well above other S-100 graphics displays in its price and performance range."

BYTE, Product Review



"... better monochromatic display ..."

ELECTRONIC DESIGN, 1981 Technology Forecast

MICROANGELO

HIGH RESOLUTION GRAPHICS SINGLE BOARD COMPUTER
512 x 480 resolution black and white and vivid color displays

RS-170 composite or direct drive output

Local or external sync generation

4 Mhz Z80 microprocessor

60 hertz real-time clock

8 level interrupt tie-in

IEEE S100 bus compatible

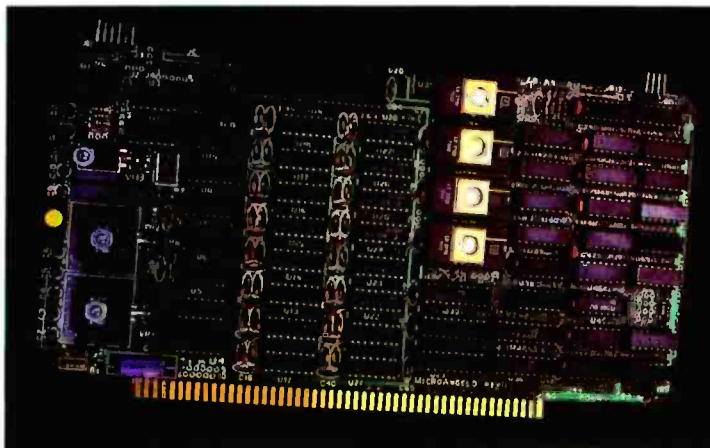

Light pen interface

Time multiplexed refresh

4K resident Screenware™ Pak I operating system

32K RAM isolated from host address space

High speed communications over parallel bus ports

Screenware™ Pak I

A 4K byte operating system resident in PROM on MicroAngelo™. Pak I emulates an 85 character by 40 line graphics terminal and provides over 40 graphics commands. Provisions exist for user defined character sets and directly callable user extensions to Screenware™ Pak I.

Screenware™ Pak II

An optional software superset of Pak I which adds circle generation, polygon flood, programmable split screen for separate graphics and terminal I/O, relative coordinates, faster vector and character plotting, a macro facility, full UCSD Pascal compatibility, and more.

And now... COLOR!!

The new MicroAngelo™ Palette board treats from 2 to 8 MicroAngelos as "bit planes" at a full 512 x 480 resolution. Up to 256 colors may be chosen from 16.8 million through the programmable color lookup table. Overlays, bit plane precedence, fade-in, fade-out, gray levels, blinking bit plane, and a highly visual color editor are standard.

Ask about our multibus and RS-232 versions.

SCION

Circle 347 on inquiry card.

12310 Pinecrest Road • Reston, VA 22091 • (703) 476-6100 • TWX: 710-833-0684

THINK AHEAD



THINK CP/M-86™

MILESTONE-86™—\$395. Manual alone — \$30.
 "Critical path" network analysis program for scheduling manpower, dollars and time to maximize productivity. Interactive project management program that runs under CP/M-86. MILESTONE can be used to track paper flow, build a computer, check a department's performance, or build a bridge. MILESTONE can be used by executives, engineers, managers, and small businessmen.

- Produce PERT chart in minutes.
 - Find critical tasks that can't be delayed.
 - Investigate tradeoffs between manpower, dollars and time
 - Give plans to others using a printed project schedule.
 - Change details and immediately see results on the screen
 - Balance time, manpower and costs.
- Formats: 8, IDW, IPC.

PLAN80™ for 8086 — \$495. Manual alone — \$30.
 A financial modeling system that's easy to use yet powerful enough to replace your timesharing applications. Lets you calculate IRR and depreciation as well as trig functions effortlessly. You write a PLAN80 model just the way you would write a letter using any editor or word processing program. PLAN80 results can be incorporated into any report that requires a financial model. It can tackle any numeric problem that can be defined on a worksheet. You'll remember how you created the model because calculations are defined using real English — not matrix coordinates. At any oint in the PLAN80 model you may display or print the results on your screen, printer or disk. Save all or part of the results for use by other models, or play "what if?" by inputting new values interactively.
 Formats: 8, IDW, IPC

DATEBOOK-86™—\$295. Manual alone—\$30.
 Schedule appointments for up to 27 different doctors, lawyers, rooms etc. Three appointment schedules are displayed on the screen at a time. File structure allows for appointments for up to one year in advance. Searches for openings that fit time of day, day of week and/or day of year constraints. Appointments made, modified or cancelled easily. Copies of day's appointments can be printed easily.
 Formats: 8, IDW, IPC

MORE SOFTWARE	PRODUCT/MANUAL ALONE	
CBASIC/86	\$325	\$25
PASCAL/M-86	\$495	\$25
Pascal: SORT-86	\$195	\$20
TEXTWRITER-86	\$125	\$30
FIELD COMPANION-86	\$295	\$30
PERSONAL DATEBOOK	\$150	\$30

FORMAT CODES: 8 (8" single density IBM soft-sector) IDW (IBM Display Writer with CP/M-86) IPC (IBM Personal Computer with CP/M-86)

TRADEMARKS: CP/M-86, CBASIC/86 - Digital Research. Milestone, Datebook, Personal Datebook, Textwriter - Organic Software. Pascal/M - Sorcom. Pascal SORT, Field Companion - Technical Software

SOFTWARE
 SOFTWARE
DIGITAL MARKETING
 DIGITAL MARKETING™

2670 Cherry Lane, Walnut Creek, CA 94596
 (415) 938-2880, Telex 17-1852 (DIGMKTG WNCN)
 Dealer Inquiries Invited

Editorial

The Microprocessor's Tenth Birthday

by Chris Morgan, Editor in Chief

"... Intel introduces an integrated CPU complete with a 4-bit parallel adder, sixteen 4-bit registers, an accumulator, and a push-down stack on one chip. It's one of a family of four new ICs which comprise the MCS-4 microcomputer system—the first system to bring you the power and flexibility of a dedicated general-purpose computer at low cost in as few as two dual in-line packages . . ."

—from the first microprocessor advertisement in the November 15, 1971 issue of *Electronic News*

It's hard to believe, but the microprocessor celebrated its tenth birthday this past November. The event slipped by with little comment from the technical press. We nearly missed it ourselves in the rush to keep up to date in an industry that refuses to slow down and wait for anyone. Nevertheless, it's staggering to realize that ten years have gone by since the calculating powers of the computer were first squeezed onto a small square of silicon. The first microcomputer was actually a family of four integrated circuits known collectively as the "MCS-4 system." It consisted of the 4004 CPU (central processing unit) that featured a set of 45 instructions, the 4001 ROM, the 4002 RAM, and the 4003 shift register.

Ironically, it was a Japanese calculator company called Busicom (now out of business) that spurred the creation of the microprocessor. As Ted Hoff Jr., inventor of the 4004, put it, "The development came as all good ideas do. I looked at a customer's proposed design and said, 'There ought to be a better way.'"

The "better way" came about in 1971 when Busicom contracted the newly formed Intel company to develop a family of integrated circuits that Busicom could use in a proposed line of programmable calculators. The Japanese company had already designed the calculator with about a dozen proposed MOS chips, and it wanted Intel to complete the design. Intel had only two designers at the time, though, and probably would have been hard pressed to design the chips quickly enough if it had not been for Hoff's inspiration. It was all related to Hoff's admiration for the architecture of DEC's PDP-8, a mini-



Ted Hoff Jr., inventor of the 4004.

PERCOM

YOU GET MORE OUT OF PERCOM DISK SYSTEMS.

EXPECT IT!

TRS-80* Model III computer, available now. Watch for IBM PC, Apple II, Atari, and H/Z-89 versions. Prices start at under \$3000, including software. Also available with 5 or 15-Mbyte drives.

At Percom, our business is making disk storage systems for microcomputers — something we've been doing right, since 1977.

From the design of rock-solid drive controller circuitry to quality controls that include 100% life testing of every drive shipped, you can expect to get more out of Percom Disk Systems.

And Percom provides you with comprehensive after-sales service from our wholly owned, fully independent customer service center.

WINCHESTER 10-MEGABYTE DISK STORAGE SYSTEMS

Enormous storage capacity plus high speed. Percom 5¼ inch hard disk systems are 40 times faster than single-density floppy mini-disks, 20 times faster than double-density units.

Systems include a smart, four-drive controller featuring state-of-the-art data encoding and separation, adaptable industry-standard disk interfacing. Plug-in-compatible version for



Coming soon! Ten megabyte removable-disk cartridge drive.

FLOPPY MINI-DISK STORAGE SYSTEMS

40 or 80-track drives, single or dual-head, floppy or non-floppy — all double-density rated. Available in 1, 2 and 3-drive add-on units, 1 and 2-drive internal units, with full documentation and software support. Add-on drives from \$399, complete systems from \$459.95.

To learn more about quality Percom disk storage systems, mail the coupon today. Or, call toll-free 1-800-527-1222. Ask for booklet "D".

YES ... I'd like to know more about Percom disk systems. Please rush me booklet "D".

Send to: PERCOM DATA COMPANY, INC. Dept BD1
11220 Pagemill Road, Dallas TX 75243

name _____

street _____

city _____

state _____

zip _____

phone number _____

I'm interested in floppy disk storage for my...

TRS-80 Mdl III Mdl I IBM PC
 H/Z-89 H-8 AIM/KIM/SYM System-50

I'm interested in hard disk storage for my...

IBM PC TRS-80 Mdl III Apple II Atari H/Z-89

Other computer? _____

(floppy disk or hard disk?)

PERCOM

THE DRIVE PEOPLE

11220 Pagemill Road • Dallas TX • 75243 • (214) 340-7081

PRICES AND SPECIFICATIONS SUBJECT TO CHANGE WITHOUT NOTICE.

*TRS-80 is a trademark of Tandy Radio Shack Corporation which has no relationship to Percom Data Company, Inc.

© 1981 Percom Data Company, Inc.

PROFESSIONAL PASCAL

Pascal/Z

NEW 4.0

SYMBOLIC DEBUGGER

This fourth generation version of our reliable, Z-80 native code compiler adds the two features professionals ask for:

- ◆ **SWAT™**—an interactive symbolic Pascal debugger that allows easy error detection.
- ◆ **Overlays**—that allow larger programs to run in limited memory.

A compiler for Professional programmers

Pascal/Z is a true Pascal. It closely follows the Jensen and Wirth standard with a minimum of extensions designed to aid the serious program developer in producing extremely compact, bug-free code that runs FAST.

Pascal/Z generates Z-80 native code that is ROMable and Re-entrant. Permits separate compilation, direct file access, external routines and includes a relocating macro assembler and Microsoft compatible linker. And code written for Pascal/Z is fully compatible with I-PAS 8000, our new native code Pascal compiler for Z-8000, to guarantee graceful migration to 16 bit operation.

Get "The FACTS about Pascal"

Confused about which Pascal to buy? Pseudo-code... Native code... M, MT or Z? Compare the **unbiased** benchmarks in our new booklet. **Don't buy a Pascal compiler until you've read it.**

Call us for a free copy:

800-847-2088

(outside NYS)

or **607-257-0190**

And ask your local full-service computer dealer about our Pascal/Z demo package.



InterSystems™

Ithaca Intersystems Inc.

Micros for bigger ideas.

Ithaca Intersystems Inc.

1650 Hanshaw Rd • Ithaca, NY 14850 • TWX 510 255-4346

U.K. Distributor:

Ithaca Intersystems (U.K.) Ltd.

Editorial

computer he had been using for some time. "The PDP-8 was a nice machine: simple, yet it could do a lot. I looked at the PDP-8, I looked at the proposed Busicom, and I wondered why the calculator should be so much more complex." Busicom was initially uninterested in the proposed microprocessor. Nevertheless, Hoff's supervisors encouraged him to continue with the design, and Busicom finally relented.

As it turned out, the final configuration of the 4004 in the Busicom calculator was "pretty exotic," as 4004 design team member Stan Mazor describes it. "Shima Masutashi [another member of the 4004 design team who was later to design the 8080] and I worked on the design of the calculator. He wrote a 19-byte interpreter in MCS-4 machine code for the calculator. It performed the relatively trivial task of fetching the next pseudo-byte and jumping to a subroutine. I laughed when I realized that what we had inside the desk calculator was a computer programmed as an interpreter emulating a pseudo-language."

Intel didn't realize at first what it had. An article in a recent issue of Intel's house magazine, *Solutions*, points out that "Intel's own board of directors could not agree on whether to proceed with the sale of the 4004. Their resistance was underscored by the company's marketing department which, based on the belief that microprocessors would only be sold as minicomputer replacements, initially estimated the entire worldwide market at only a few thousand units per year." Today, as we all know, Intel's initial sales estimate was off by several orders of magnitude.

Situations like this are not uncommon in the technical world. A similar situation occurred at the Philadelphia Centennial Exposition of 1876. In a small pavilion at the fair, Alexander Graham Bell exhibited his newly invented telephone to a moderate number of politely interested people. Down the midway, though, thousands lined up to view the real technological hit of the show: the Corliss Steam Engine. I'll refrain from saying which of these two gadgets ultimately became a household item. But I will say that I don't have a princess model Corliss Steam Engine in my den.

Of course the microprocessor ultimately "made it" too, and it continues to affect our lives every day. The personal computer simply would not exist today without the microprocessor. In fact, it created a revolution. In his book *Promise of Power*, Carl Stokes said, "When you start dealing with change you are talking about interfering with those who are in possession of something." This concept doesn't apply to the microprocessor revolution, though, because microprocessors do not deny anything to anyone. Instead, they offer everyone a new tabula rasa. Not even the mainframe computer companies really suffered when the microprocessor appeared: they simply regrouped and continued marching (although it took some of them a long time to do it, and some of them haven't started yet).

Clogged memory? Sluggish program execution? Constricted throughput?

Introducing

**the fastest Micro-relief for
these common business maladies—**

ITHACA 525



Ithaca 525, the new, *fast* single- or multi-user S-100 system is *the fastest* Micro for typical disk-intensive business and commercial programs, with throughput increases of over 500% over 64K systems.

Ithaca 525 combines a 6 MHz Z-80B[®] CPU with Cache BIOS[™]/XIOS[™] cache memory under the CP/M[®] -MP/MI[™] operating systems for execution speeds unmatched by *any* other Micro.

Ithaca 525 includes DMA control for up to 4 floppy drives and up to 4 Winchester. 256K RAM with parity is expandable to 1 Mbyte.

Ithaca 525 offers features and performance *unmatched* at the price. And if you act *now*, during our introductory period, the price is even *more* attractive.

If you suffer from any of the common Micro-computer maladies, for *fast* relief and a personal introduction to the Ithaca 525*, call one of our Regional Sales Managers toll free (Outside NYS):

800-847-2088

In New York State call: (607) 257-0190.

business

Micros for bigger ideas.

InterSystems[™]
Ithaca Intersystems Inc.

Ithaca Intersystems Inc.
1650 Hanshaw Rd. P.O. Box 91
Ithaca, New York 14850
TWX 510 255 4346



*Systems are available in both 5 1/4" and 8" versions.

Circle 199 on Inquiry card.

Ithaca 525, Cache BIOS and Cache XIOS are trademarks of Ithaca Intersystems Inc. Z-80B is a trademark of Zilog, Inc. CP/M and MP/MI are trademarks of Digital Research.

JOHN STARKWEATHER'S

NEW NEVADA
PILOT

\$149.95

DISKETTE AND MANUAL

For all CP/M systems. Works with Apple (softcard needed), TRS-80, North Star, Superbrain, Micropolis, Vector and many other microcomputers. Needs 32K RAM, one disk drive and CRT or video display and keyboard.

- PILOT for Programmed, Inquiry, Learning Or Teaching.
- An excellent interactive language for education and office automation.
- Perfect companion for BASIC, COBOL and PASCAL to solve training and documentation problems.
- John Starkweather, Ph.D., creator of PILOT, wrote this version to meet all PILOT-73 standards and added many new features.
- New features include full screen text editor, commands to drive optional equipment such as VTR's & voice response units.
- Currently used in many college and progressive high schools.
- Use for interactive applications—data entry, programmed instruction and testing.

NEW NEVADA
EDIT

\$119.95

DISKETTE AND MANUAL

For all CP/M-based systems. Requires 32K RAM, one disk drive and CRT or video display and keyboard.

- A character oriented full screen video display text editor designed specifically for program preparation.
- Write program in COBOL, FORTRAN, BASIC or similar languages.
- Features include single key commands for cursor control, scrolling, block moves, search and replace, tab setting and multiple file insertions.

NEVADA
COBOL



\$199.95

DISKETTE AND MANUAL

For all CP/M or MP/M operating systems. Requires 32K RAM and one disk drive.

- Edition II of Nevada COBOL is based on ANSI-74 Standards.
- With 48K RAM, you can compile and execute up to 4000 statements.
- COPY statement for library handling.
- CALL...USING...CANCEL
- PERFORM...THRU...TIMES...UNTIL...paragraph or section names.
- IF...NEXT SENTENCE...ELSE...NEXT SENTENCE AND/OR <=> NOT.
- GO TO...DEPENDING ON...
- Interactive ACCEPT/DISPLAY...
- RELATIVE (random) access files
- Sequential files both fixed and variable length.
- INSPECT...TALLYING...REPLACING.



ELLIS COMPUTING
SOFTWARE TECHNOLOGY

600 41st Avenue, Dept. B
San Francisco, CA 94121
U.S.A.

COD's WELCOME



(415) 751-1522

CP/M, MP/M and TRS-80 are registered TM's of Digital Research and Tandy Corporation.

Editorial



Smith-Corona's new letter-quality printer, the TP-1.

We congratulate Intel on the tenth anniversary of the fortuitous invention that made personal computing possible, and we look forward to the day in 1992 when we can examine the second decade of the microprocessor.

* * * * *

An \$895 Daisy-Wheel Printer

This month's theme is printers, and the most exciting news in the fast-changing printer market is undoubtedly Smith-Corona's new \$895 (suggested retail) letter-quality printer, the TP-1. It features a plastic daisy wheel plus either an RS-232C serial interface or a Centronics-style parallel interface. Maximum speed of the TP-1 is between 14 and 15 characters per second, but the average speed is closer to 12 characters per second.

Smith-Corona makes no apologies for the fact that the TP-1 is a bare-bones system, and even though it lacks such niceties as proportional spacing, double-striking capability, and bidirectional printing, it's still a bargain. Price-wise, its closest competitor is in the \$1500 range. The American-made unit accepts letter or legal-sized paper, and, in a new version, will soon be able to handle fanfold paper. The TP-1 has some competition in the form of add-on boards that convert the Olivetti Praxis typewriter into a letter-quality printer. They're manufactured by Vertical Data Systems Inc., Mississauga, Ontario, Canada (Converter TP35); Williams Laboratories, Ithaca, New York (Bytewriter); and Systemed Corporation, Mountain City, Tennessee (Typrinter). We plan to review these units as soon as possible, for they herald the beginning of a new age of affordable word-processing computer systems. ■

Acknowledgments

Thanks to Donna Shuster and Intel for permission to reprint quotes and comments from the article "Tenth Anniversary of the Microprocessor" in the November/December 1981 issue of Solutions.

S-100 Fast-Aid.

Including 3 new boards for system design relief.

The MB64.

An economical, high-performance 64K static RAM memory.

Just what the doctor ordered. A new 64K static RAM configured as two 32K blocks that's fast (in excess of 6MHz), reliable and economical. The MB64 supports IEEE 696/S-100 24-bit extended addressing for up to 16MB of RAM. Bank switching permits compatibility with popular multi-user computer systems (such as CROMIX*). Up to 8K can be replaced with 2716 EPROMs. The MB64 offers low power consumption (typically less than 600 milliamps). And a provision for optional battery backup.

(The MB64 is priced at less than \$850.)

*CROMIX is a trademark of Cromemco, Inc.

The IO8.

An I/O board featuring eight serial interfaces, individually programmable baud rates, and an interrupt clock.

Give your system fast-aid—including easier testing and speedier diagnosis—with SSM's new IO8. This board features eight asynchronous serial RS-232 I/O ports with LED data transfer indicators. Individually programmable I/O port baud rates (110-19,200) meet all your specific configuration requirements. A timer (50/60 Hz) supports real-time or multi-user applications.

And all our Fast-Aid boards offer:

- Card ejectors for painless card removal.
- LEDs for easy troubleshooting and monitoring.
- IEEE 696/S-100 compatibility.

The IO5.

A two-serial/three-parallel I/O board with programmable timer.

The perfect remedy for fast system integration, more precise diagnosis, and far healthier system operation. The IO5 features two RS-232 asynchronous serial interfaces for maximum peripheral compatibility. The board supports a variety of devices with high-speed serial data transmission (110-19,200 baud). Three parallel ports, providing a total of 32 bits, support various I/O configurations: a 16-bit software programmable bi-directional interface, and two 8-bit interfaces. One 8-bit interface supports direct connection to Centronics-compatible printers. The other provides 8 bits of parallel input for such devices as keyboards. The IO5 also offers a software-programmable timer for real-time or multi-user applications.

For more details about these new boards, or any of SSM's S-100 compatible boards (including various CPU, EPROM, video and development boards), just call your local dealer or SSM today.



SSM Microcomputer Products, Inc.
2190 Paragon Drive
San Jose, CA 95131
(408) 946-7400 Telex: 171171
TWX: 910-338-2077
Circle 357 on Inquiry card.

The disk drive that puts more byte into your Apple.

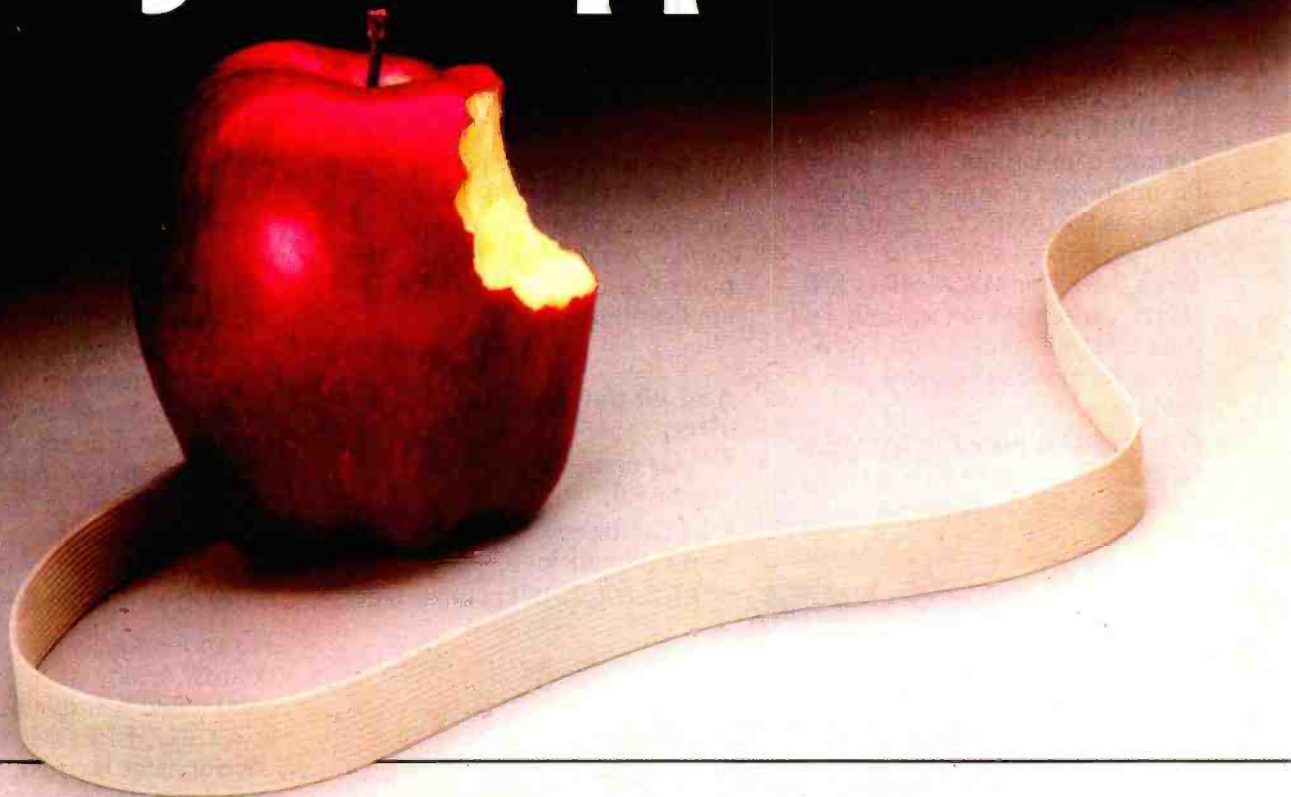

Introducing the first totally compatible Floppy Disk Drive.

Rana Systems has designed a totally compatible disk drive for Apple, that's better than Apple's. A high density, high capacity disk drive and controller that offers a myriad of features Apple never thought of. Unique advantages that get the maximum efficiency out of your existing Apple II® hardware and software.

At Rana, we knew you wanted more storage, so we went right to the core of the problem. Even our most economical model is designed to give you 15% more storage capacity than Apple's. Our top-of-the-line unit gives

you 4 times the capacity of Apple's comparable unit. Even our design is far more dramatic than theirs. With lines that actually complement the sleek Apple II computer.

We're a step ahead of Apple because we have a faster step.

Holding more information is even more valuable when you can get it faster. The Rana System track positioning mechanism is engineered to access three to four times faster track to track, with greater accuracy than Apple's. Our disk drive offers safeguards like a stall provision to protect spin motor burnout,

Apple II is a registered trademark of Apple Computer Inc.



an advanced write protect feature that keeps your information where you put it, and an energy saving device that "powers down" when your disk drive is taking a break.

We even took a bite out of Apple's price.

Our most popular model is 25% more economical per byte than Apple's, providing you with maximum performance, superior cost efficiency, and totally compatible styling. It also comes with a free diskette containing all the optional software and supports you'll need to enhance the capacity and performance. And it's all backed up with an efficient service

support system, and a full 90 day warranty.

The Rana System Floppy Disk Drive. Just plug it into your Apple and all those delicious extra bytes will be yours.

Rana Systems™



Circle 222 on Inquiry card.

20620 South Leapwood Avenue, Carson, CA 90746 213-538-2353.
For dealer information call toll free: 1-800-421-2207.
In California only call: 1-800-262-1221. Source Number TCT-654.
See our booth at the West Coast Computer Faire Show.

Apple's Decision Questioned

We use Apple computers for commercial machine-language program development and buy Apple IIs at frequent intervals, either as a service to our customers or in order to expand our office.

I have recently spoken to a mail-order distributor of Apples who told me that as of December 4, 1981, Apple was no longer wholesaling to mail-order houses. I could not believe this, so I called CALL-A.P.P.L.E. It's true, I was told.

I am outraged. How can Apple, with new, large, clever, powerful competitors just beginning to breathe down its neck, remove the only way for small, intelligent users to buy Apples inexpensively?

Apple is, in effect, forcing us to buy from retail stores, which are usually overpriced. Their personnel are insulting in their inexperience and knowledgeable only about the latest space games. We can not afford their arbitrary \$700 markup on the Apple II. Our software systems, while cost-effective with mail-order firms' prices, are not with the retail stores' prices.

Apple will have to decide just who its friends are—the retailer who sits on his duff selling other people's ideas or the software innovator who takes a piece of hardware and makes it usable by the masses. While Apple may be trying to help out its dealers, it seems to have decided to do this at the expense of its serious customers—the people on whose success its own ultimate success depends.

Apple has succeeded so far because it provides a product which we (and others) can program without too much trouble and which our customers can afford. This new attitude of demanding that we submit to retailers' ridiculous prices will compel many to reconsider which personal computer we will use to develop our systems. I hope Apple discovers its error before its competitors profit too much from it.

Dennis Gerald Pratt
666 North Dearborn, Apt 3F
Chicago, IL 60610

Yes, it is true. Apple Computer Inc. has given its dealers an ultimatum: either cease all mail and phone order sales, or your authorized dealership will be terminated effective December 4, 1981. This

was delivered in a "Notice of Dealer Agreement Modification" dated November 2, 1981, and dealers had until November 20, 1981, to sign and return the "modification." Otherwise, Apple threatened to pull the plug, so to speak.

Apple is attempting to justify this move by stating: "We believe that our ability to maintain a leadership position in competition with the corporate giants now entering the personal computer field depends in large measure on the willingness of our dealers to satisfy the end user with their familiarity with Apple products and their commitment to passing on this knowledge and support." Accordingly, Apple has added subparagraph 3 (g)(iv) to its Authorized Dealer Sales Agreement: "Dealer and Apple recognize that because of the special, technical nature of Apple Products, customers purchasing them can be properly served only if they have the benefit of pre- and post-sale education, orientation and support, specifically including in-person contact with the selling dealer, in order that each customer's needs may be properly served and the features, benefits, operation and applications of the Apple Products being purchased may be demonstrated and fully explained by knowledgeable sales personnel." It then goes on to specifically prohibit mail and telephone order sales of Apple products under penalty of losing the dealership.

Apple concluded its modification notice with the following paragraph:

"Apple personal computer products demand innovative and creative marketing. We are willing to work with all who are willing to meet that challenge. Those who are unwilling to expend the effort have no place in our future plans." . . . MH

Is Microfiche the Answer?

This letter is in response to the letter of Lew Merrick (October 1981 BYTE, page 10) regarding the storage bulk of advertising material in BYTE back issues.

The separation of advertising material into a separate removable section is undesirable because it would reduce the exposure of the advertising, reduce the value of the advertising, and ultimately degrade the quality of BYTE by reducing revenues.

An alternative is to convert to microfiche files at some loss of convenience but

great savings in space. BYTE is now available from University Microfilms, Ann Arbor, Michigan, but you must be very patient with them because (1) back issues are available only in one-year blocks, (2) back issues are not produced until well into the following year, and (3) orders are not filled promptly.

My suggestion is that BYTE offer a microfiche subscription option, just as is now done with the IEEE journals. The microfiche might actually be cheaper to produce and ship than the paper edition.

A microfiche viewer can be used for many purposes and occupies about as much space as three years of BYTE. The space needed to store the fiche is negligible.

Back issues of BYTE are well worth preserving, as they enable me, after a session on my modest micro, to ponder what little was available only five years ago and to speculate what the future holds. The advertisements in a five-year-old BYTE issue contain some very interesting material.

Richard Schwartz
Electrical Engineer
Star Fleet Engineering
1328 North Santa Anita Ave
Arcadia, CA 91006

More on the WAI

Regarding Dr. S. S. Reddi's "Where Am I?" instruction (Technical Forum, November 1981 BYTE, page 413), I would like to point out that Motorola's 6809 has such an instruction. The simplest form is:

TFR PC,X

The instruction transfers the value in PC (program counter) to register X. (The value transferred is the location of the next instruction.) The 6809 also allows:

LEAX n,PC

which adds "n" (8 or 16 bits) to PC and puts the result in register X. (LEA = Load Effective Address) This instruction, which may also be written:

LEAX label,PCR

can compute the address of any label (location) within the program without using an absolute address (PCR means use

**Your
computer.**

Compute.

Compute.

Compute.

Compute.

Compute.

Dump...

Compute.

Compute.

Compute.

Compute.

Compute.

**Your
printer.**

...Print.

Print.

Print.

Print.

Print.

Print.

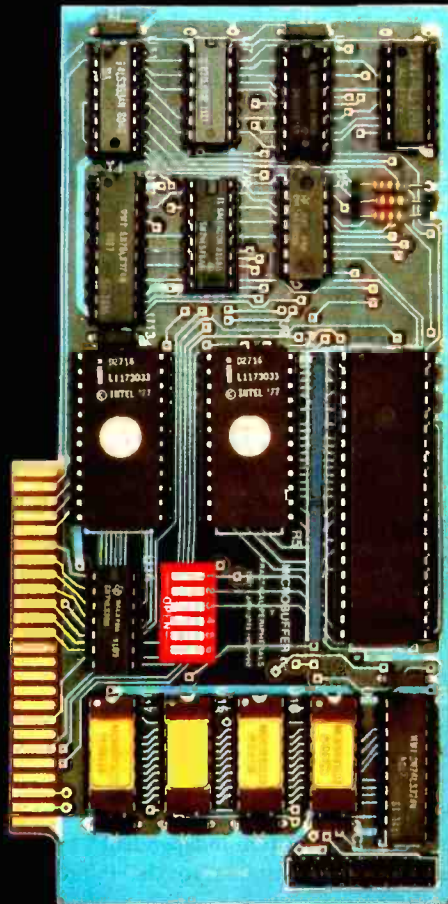

New Microbuffer II lets you use your printer without tying up your computer.

Time. As an important resource it shouldn't be wasted. One such waste is in printing, where your computer must wait for your printer. Now there's a way to eliminate this waste.

Introducing the Microbuffer II™, a buffered parallel printer interface for the Apple II® computer with 16K characters of memory (user expandable to 32K). It accepts data as fast as your computer can send it, allowing you to use your computer while the Microbuffer II is in control of your printing.

The Microbuffer II, compatible

with Applesoft, CP/M® and Pascal, comes with complete print formatting features as well as advanced graphics dump routines for most popular graphics printers.

The Snapshot™ option permits you to dump the text screen or graphics picture to the printer while any program is

running — without interruption.

The 16K Microbuffer II is available for \$259. And the 32K version, for \$299. The Snapshot option is \$69.

So why waste time while your computer waits for your printer? Ask your computer dealer for the Microbuffer II or call us for the name of a dealer near you.

Microbuffer II and Snapshot are trademarks of Practical Peripherals, Inc.

CP/M is a registered trademark of Digital Research, Inc. Apple II is a registered trademark of Apple Computer, Inc.

PRACTICAL PERIPHERALS, Inc.
31245 La Baya Drive
Westlake Village, California 91362
(213) 991-8200

Circle 316 on Inquiry card.

MICROBUFFER II

MI

PC-relative addressing). In these examples, the destination register could be Y, U, or S, instead of X, if desired. The destination for the TFR instruction could also be register D, which is accumulators A and B treated as one 16-bit register.

I question the usefulness of a WAI (Where Am I) instruction by itself, however. Apparently, Dr. Reddi would like to get the value of the 6502's program counter and then use this value to set up a table of addresses in page zero of memory, to be used with page zero indirect addressing (or, I shudder, to modify addresses within his program, such as jump and subroutine addresses). Adding a WAI instruction to the 6502 would help, slightly, with this rather clumsy method of making programs relocatable.

Much more is needed to make programs easily relocatable. The ideal situation would be to have code that runs at any address with no changes required. This is called position-independent code. The 6809 has the necessary instructions for such code. In addition to the LEAX (and LEAY, etc.) mentioned above, its instruction set includes branches (jumps), both conditional and unconditional, and subroutine calls with relative addressing. The relative address can be either 8 or 16 bits long, the latter allowing relative addressing anywhere within the 6809's address space. (Subroutine calls and unconditional jumps are also available with absolute addressing.) The presence of these instructions allows writing programs that can be run at any address with no changes (and with no need to set up a table of addresses or to modify the code at run time).

The WAI instruction by itself solves only a small part of the problem of being able to have position-independent code, code that will run unchanged at any address. Perhaps this is one reason it is not present in most computers. Most (or all) computers that have a WAI instruction, such as the 6809, PDP-11, 68000, and IBM 370, are also capable of position-independent code. I suspect that the 8086, Z-8000, and VAX 11/780 are also in this category.

Another reason for the absence of WAI in most microcomputers is that most 8-bit microprocessors were intended for use in dedicated controllers where there is no need for position independence or a WAI instruction.

One may note that the 6800 has a WAI instruction, namely:

	BSR	NEXT
NEXT	EQU	\$

This use of BSR (branch to subroutine), which uses relative addressing, pushes the address of the next instruction onto the stack, where it can be easily retrieved. (This is not to be confused with the 6800 instruction whose mnemonic is WAI. This WAI means "wait for interrupt.")

Jim Howell
5472 Playa Del Rey
San Jose, CA 95123

The "Where Am I?" instruction is indeed useful. That is probably why it was included in the design of the Motorola 6809 as the Load Effective Address, or LEA, instruction, and its use is not restricted to finding the current PC contents.

The LEA instruction loads the effective address of its operand into the specified 16-bit register, which may be either stack, either index, or the double accumulator. The operand must use the indexed addressing mode, which includes PC-relative. "Where am I?" could be coded:

HERE LEAX HERE,PCR

Assuming that you want HERE to be in the X register.

Other uses for the LEA instruction are addressing position-independent tables and adding constants to the indexable registers.

I recently read an article comparing the 6502 and the 6809 in which the author complained that he wasn't able to find much use for the LEA instruction. This caused some amusement among my friends. A close examination of some of my own code reveals that the LEA instruction is one of the most heavily used. I would venture the opinion that position-independent code would be much more difficult to write without it.

Howard Lee Harkness
Word's Worth
POB 28954
Dallas, TX 75228

Architecture Controversy

It was nice to see your article on higher-level machine-language constructs, "Should the DO Loop Become an Assembly-Language Construct?" by Glenn L. Williams (October 1981 BYTE, page 413). I would like to add a couple of comments to Mr. Williams's remarks.

Since Mr. Williams was including mini-computers in his article (he references the

PDP-11 and VAX 11/780) he might also have included a reference to the HP3000 instructions MTBA, MTBX, TBA, and TBX. These four instructions each perform a variation of Mr. Williams's NXT function. All the instructions use a loop variable, a limit value, and a step value. TBA and MTBA use a variable address on the stack while TBX and MTBX use the index register for the loop variable. In all cases, the limit and step values are on the stack. MTBA and MTBX modify the variable by the step value, which may be any integer, positive or negative, and compare the result to the limit value. Positive step values cause a check to see if the limit has been exceeded, and negative step values cause the check to see if the result is less than the limit. TBA and TBX do not modify the variable but check only for the limit being exceeded. These allow compilers to implement more complex counting-loop structures than can be accomplished by adding or subtracting a step size. Also, functions similar to Mr. Williams's SRCH function are performed by SCU (SCan Until memory byte matches test byte or terminal byte) and SCW (SCan While memory byte matches test byte or until terminal byte is found) on character strings.

With the growing acceptance of modular, structured programming it has long been my feeling that high-level constructs should be imposed at the machine-instruction level. The only real need for assembly language these days is to utilize the machine architecture not available at the high-level-language level to produce quick, short code. Implementing high-level functions in machine language and providing optimizing compilers should just about eliminate any need for assembly language. Code produced would be very short and quick, because a single complex machine instruction should run faster than the many simpler instructions put together needed to accomplish the same function. I would like to see both micro- and minicomputer processors developed with instructions to implement WHILE, IF . . . THEN . . . ELSE, CASE, DO . . . UNTIL, and other high-level constructs at the machine-instruction level.

Let's all keep pushing for advances in architecture to keep up with advances in software. And thanks, BYTE, for being among the leaders in this respect.

David B. Mears
757 Cornell Dr.
Santa Clara, CA 95051

QUME

SPRINT 9



STANDARD OPERATOR CONTROL PANEL.

Switch selection of interface parameters and forms handling allows simple OEM system integration.

Automatic proportional spacing, without decreasing system throughput, sets the new standard for print quality.

To cut service costs and reduce adjustments, the exclusive Kevlar® belt is stronger and lighter than steel, with virtually no stretch.

For the highest accuracy in the history of daisywheel printing, our Microdrive™ carriage drive mechanism has no cables or pulleys.

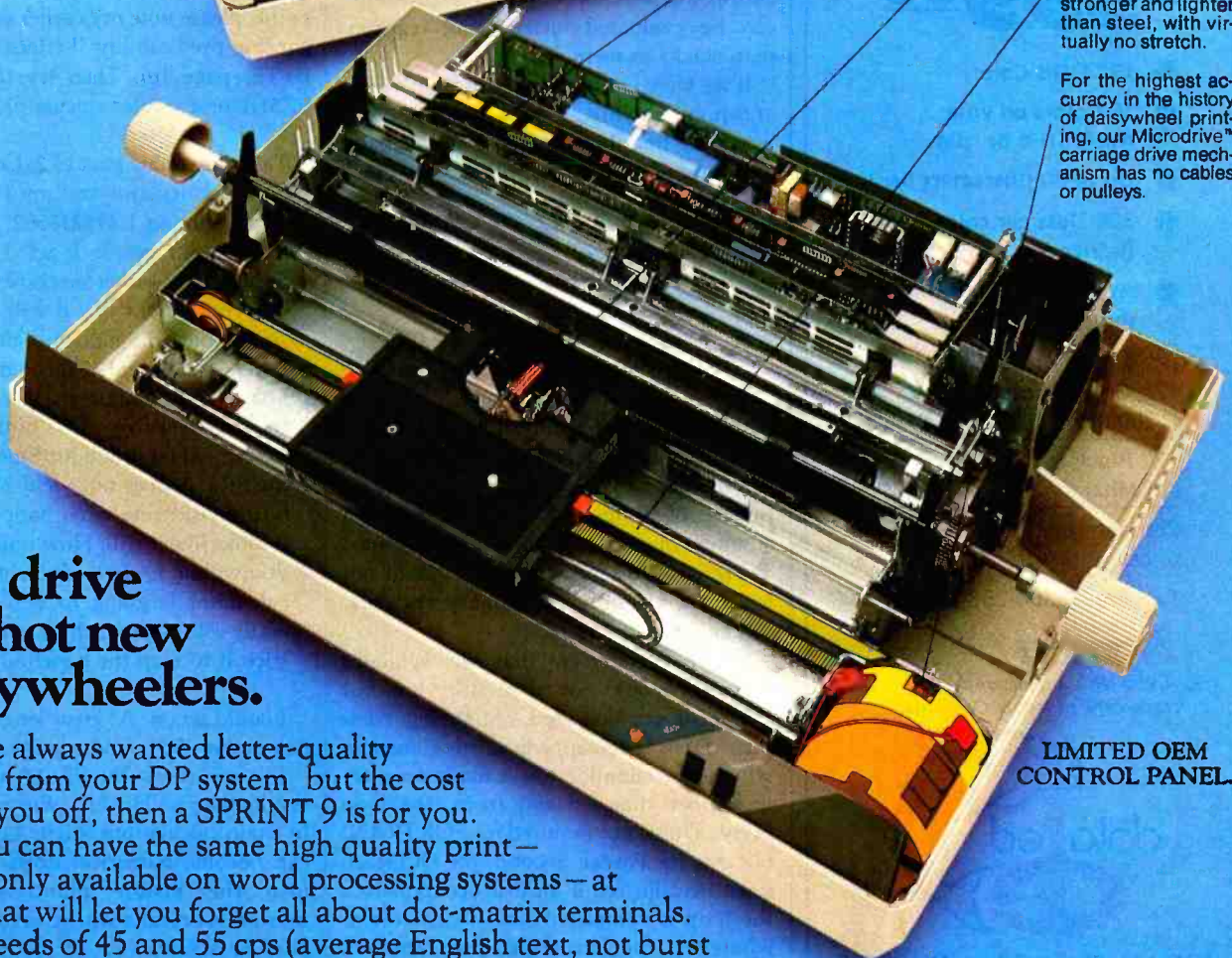

LIMITED OEM CONTROL PANEL.

Test drive our hot new daisywheelers.

If you've always wanted letter-quality printing from your DP system but the cost has put you off, then a SPRINT 9 is for you. Now you can have the same high quality print—usually only available on word processing systems—at prices that will let you forget all about dot-matrix terminals. With speeds of 45 and 55 cps (average English text, not burst rate), the reliable high performance of SPRINT 9 terminals leaves the crowd behind. Prove it to yourself with a test drive. Call or write Qume at (408) 942-4000. 2350 Qume Drive, San Jose, California 95131.

Qume
A Subsidiary of ITT

Circle 331 on Inquiry card.

Compliment
your
Apple III®
or IBM...



simply
\$599⁰⁰

- ✱ 13" RGB Color.
- ✱ 16 Colors on your Apple III® or IBM.
- ✱ Up to 80 Characters per line.
- ✱ 360 Dots per color. (horizontal resolution)
- ✱ Available for immediate shipment.

Other models available:

12" Green Phosphor
(1200 lines resolution) \$179.00

12" Black & White
(15 Mhz) \$139.00

Contact your local dealer
or call us direct.

Toll Free 1-800-258-6370



® Apple III is a registered
trademark of Apple Computer.

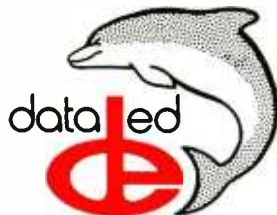

18 Bridge Street, Salem, NH 03079
Tel. (603) 893-2047
TWX: 710-366-0502

Letters

Glenn Williams is undoubtedly correct when he says that the instruction sets of microprocessors can be improved. For various reasons, however, I do not agree with his specific proposals.

It will always be necessary to write programs in assembly language, but if the "software crisis" can be solved at all it will only be by the efficient implementation of high-level languages. Processor designers have clearly realized this, but unfortunately their attempts at providing "features" that are supposed to help the compiler writer are often misguided. Consider, for example, two of the features mentioned by Mr. Williams: stack and condition registers.

There are two principal reasons for using stacks in the implementation of a high-level language. One is to save and restore environments when procedures are called, and the other is to provide fast temporary storage during expression evaluation. Typical PUSH and POP instructions do not help in either case: to save and restore an environment we need an appropriate addressing mechanism, and expressions can be evaluated faster using registers than stacks in memory.

If we were interested only in simple test-and-jump coding, condition registers would be fine, but in high-level language programming this is not always the case. The Pascal statements

```
finished := eof OR (lines > maximum)
```

and

```
total := total + width * length
```

have the same structure. On a processor with condition registers, however, the first is coded by means of an elaborate sequence of jumps, while the second is a simple sequence of arithmetic operations. There is no reason why tests should not leave their results in ordinary registers, like other instructions.

The DO statement that Mr. Williams proposes would not be used by any but the most sophisticated optimizing compiler. First, it is inappropriate for loops in which a termination test is made on entry to, rather than on exit from, the loop body. This is not required for FORTRAN, but it is for Pascal. Second, the DO stack must be adjusted if an exit occurs before the loop is completed, and that is often, whatever the structured-programming zealots say. Third, a special addressing mode is required so that the code within the loop can access the DO index, because

the DO index lives in the DO stack.

The real requirements have been accurately summarized by Professor William Wulf ("Compilers and Computer Architecture," *Computer*, July 1981): the compiler writer wants well-designed primitive instructions, not solutions to problems. A small set of efficient, useful instructions is better than a vast number of "clever" instructions that do the right thing in special circumstances but require elaborate analysis in the general case.

Peter Grogono
Metonymy Productions
4125 Beaconsfield Ave.
Montreal, Quebec
H4A 2H4 Canada

SR51A vs. HP-41C Calculations Continued

I thank Mr. Kitchen (Letters, October 1981 BYTE, page 20) for another opportunity to discuss accuracy in Hewlett-Packard calculators. I fear he missed the point; please note my earlier statement regarding predicability (Letters, April 1981 BYTE, page 16). Then try this with an SR51A or a similar calculator:

1. Take the square root of 2. On both your SR51A calculator and my HP-41C, the display shows 1.414213562. Square this result. You get 2; I get 1.999999999. Subtract 2. Neither machine yields zero, but yours looks like it will, unless you "chisel out" the hidden digits first.
2. Enter 1.414213562 through the keyboard, then square it. If your display reads 2, feel free to be outraged: your machine does funny arithmetic. Indeed, the SR51A does not yield 2 as a result, but, considering what happened in (1), it looks like it will. How much work are you willing to do to discover how your calculator is going to behave? If it is really a 13-digit machine, why must you trick it to reap the benefits?

I could go on. At great length. And not just about SR51s and square roots.

In some cases, the SR51A yields better results than an HP-41C. *But which cases?* In chain calculations, digits 11, 12, and 13 can become numerical noise that creeps into the visible mantissa, causing mysterious results whose origins are very hard to isolate.

Hewlett-Packard calculators exhibit more deterministic behavior. Accurate internal software that discards guard

Has your microprocessor become a major problem?



Mountain Computer introduces — rapid, low cost data entry.

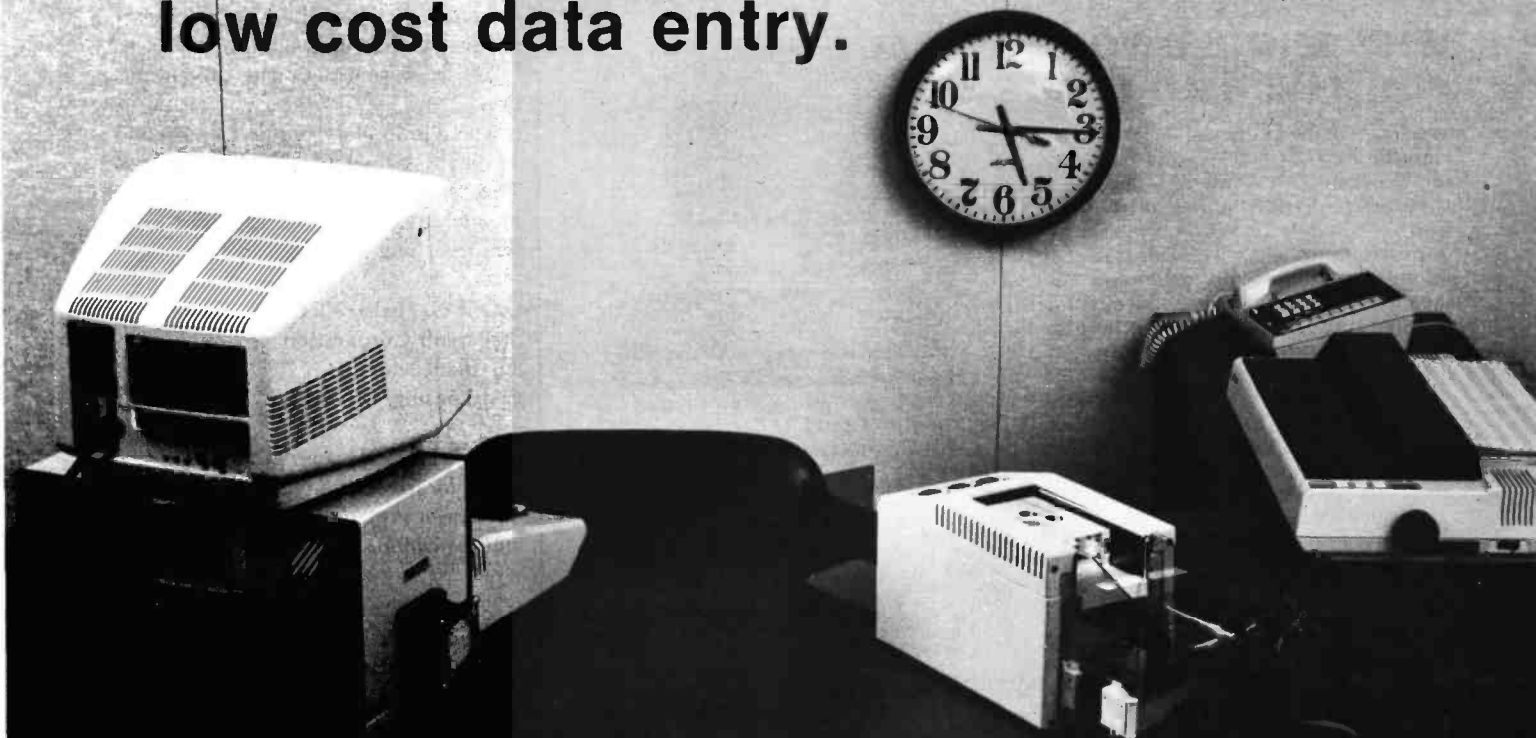

Mountain™ Computer
INCORPORATED

300 El Pueblo, Scotts Valley, CA 95066
TWX: 910 598-4504 | 408|438-6650

Circle 267 on Inquiry card.

Model 1100A Intelligent Card Reader

Ideal applications include time reporting, job costing, inventory control, market surveys etc. . . .

Contact us or see your computer dealer today!

897 N.W. Grant Ave. • Corvallis, Oregon 97330 • 503/758-0521

THE DAWN OF A NEW ERA FOR APPLE II: THE ENHANCER II

Introducing the Enhancer II: a new Standard which is improving the relationship between Humans and Apples. The Enhancer II can help your Apple II's keyboard become more sociable by remembering words or phrases which can be entered into the Apple by the mere touch of a key. Life can become even easier because the Enhancer II can remember what you typed while your Apple was busy talking to your disc (or doing other things). Naturally, it knows the difference between upper and lower case letters and what shift keys are supposed to do. It even knows to auto repeat any key held down. The Enhancer II replaces the encoder board making installation simple.

Suggested retail price: \$149.00.



VIDEOTERM

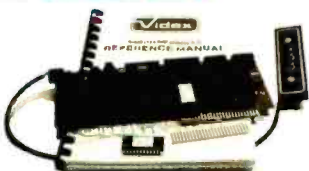

The time tested Videoterm 80 column card:

- 80 characters x 24 lines
 - True decenders
 - 7 x 9 character resolution
 - Low power consumption
 - Compatible with most word processors
 - Softcard and CP/M compatible
 - Modem compatible
 - Most popular character set of any 80 column card
 - Alternate character fonts available
- Suggested retail price \$345.00

SOFT VIDEO SWITCH

The Soft Video Switch is an automatic version of the popular Switch-plate. It knows whether it should display 40 or 80 columns or Apple graphics. It does the tedious work of switching video-out signals so you don't have to. The Soft Video Switch can be controlled by software. Any Videoterm with Firmware 2.0 or greater may be used with the Soft Video Switch. The single wire shift mod is also supported. Package price is \$35.00.



KEYBOARD AND DISPLAY ENHANCER



The original Keyboard and Display Enhancer is still available for Revision 0-6 Apples (on which the new Enhancer II will not fit). These Apples have memory select sockets at chip locations D1, E1 & F1. The Keyboard and Display Enhancer allows entry and display of upper & lower case letters with fully functional shift keys. It does NOT have user definable keys nor a type ahead buffer. The price is \$129.00.

ACCESSORIES:

Videoterm Utilities Disc \$37.00 (includes)

- Font Editor
- Pascal Mid-Res Graphics
- Applesoft Read Screen Utility
- Top & Bottom Scrolling
- Pascal Vidpatch
- Graphics Template

Character Set EPROMs \$29.00 ea

- Half Intensity
- Inverse
- German
- Katakana (Japanese)
- Line Drawing Graphics (Expanded)
- Spanish
- French
- Math & Greek Symbols
- Super & Subscript

Dvorak EPROM (Enhancer) \$29.00
Lower Case Chip \$29.00

day I got my magazine I also got a long-distance call asking if I was Dave Bower and if I owned a TRS-80 and if I had written to BYTE magazine. The caller then answered my question. The next day I got a letter answering the question. There's nothing strange about getting a letter, except that you didn't print my address, and neither did the person sending the letter! And it continued like that for the next couple of months—letters and phone calls from all over the United States. And just when I thought it was over I got a package from Steve Ciarcia containing the letters he had received!

So, needless to say, I got my question answered. And I got a lot more too. I think every person that contacted me also shared more hints and/or information or whatever. So even though they all called or wrote me about the same thing, not one exchange was a waste of time.

I just wanted to let you know what kind of readers you have and that I think Steve has a pretty good column, and a well-read one too.

Dave Bower
741 Lake Edward Dr., Apt. 104
Virginia Beach, VA 23462

Closing the Net

Harry Saal's article on local networks ("Local-Area Networks, Possibilities for Personal Computers," October 1981 BYTE, page 92) did injustice to your readers with its narrow scope and omissions. Specifically:

1. Datapoint's local coaxial network-based ARC system was introduced and installed in 1977.
2. About 2000 ARCs are installed and in commercial service worldwide—more than all other networks, prototype or otherwise, combined. (I have heard no argument to estimates that Datapoint has a 95 percent market share of installed local networks.)
3. Tandy uses the local network portion of ARC, ARCNET, for its TRS-80 Model II personal computer network, announced in September—a step of major significance.
4. Three companies now use ARCNET—Datapoint, Inforex, and Tandy.
5. The only deliverable chip-based local network interface is manufactured by Datapoint.

Considering these omissions, I'm skeptical that the article was well researched.

Gerard Cullen
Vice-President Marketing
International Operations
Datapoint Corporation
9725 Datapoint Dr.
San Antonio, TX 78284

Harry J. Saal replies:

My article was not intended as a complete survey of local-area network products. Datapoint's offerings in the high-speed, serial, coax network were indeed quite early; it is unfortunate that Datapoint has not provided any in-depth technical information in the published literature by which its system can be evaluated for comparative study. In September 1981, several months after my article was completed, Datapoint announced its relationship with Tandy, a very exciting recent development.

Let me assure Mr. Cullen that there are substantially more than 100 installed, non-ARC local networks worldwide; hence the 95 percent market share claim is false. ■

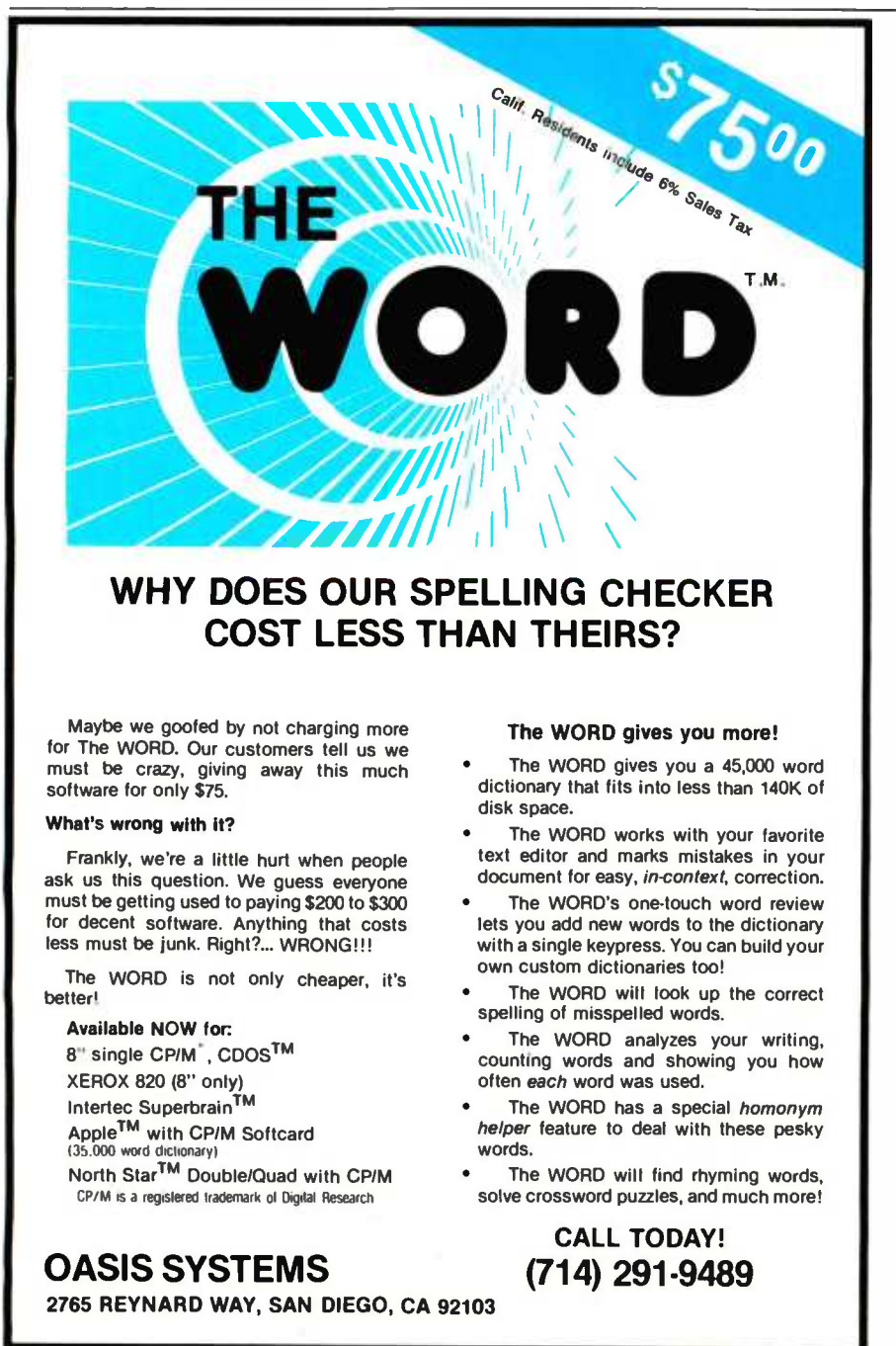

\$7500

THE
WORD™

WHY DOES OUR SPELLING CHECKER
COST LESS THAN THEIRS?

Maybe we goofed by not charging more for The WORD. Our customers tell us we must be crazy, giving away this much software for only \$75.

What's wrong with it?

Frankly, we're a little hurt when people ask us this question. We guess everyone must be getting used to paying \$200 to \$300 for decent software. Anything that costs less must be junk. Right?... WRONG!!!

The WORD is not only cheaper, it's better!

Available NOW for:
8" single CP/M*, CDOS™
XEROX 820 (8" only)
Intertec Superbrain™
Apple™ with CP/M Softcard
(35,000 word dictionary)
North Star™ Double/Quad with CP/M
CP/M is a registered trademark of Digital Research

The WORD gives you more!

- The WORD gives you a 45,000 word dictionary that fits into less than 140K of disk space.
- The WORD works with your favorite text editor and marks mistakes in your document for easy, *in-context*, correction.
- The WORD's one-touch word review lets you add new words to the dictionary with a single keypress. You can build your own custom dictionaries too!
- The WORD will look up the correct spelling of misspelled words.
- The WORD analyzes your writing, counting words and showing you how often *each* word was used.
- The WORD has a special *homonym helper* feature to deal with these pesky words.
- The WORD will find rhyming words, solve crossword puzzles, and much more!

CALL TODAY!
(714) 291-9489

OASIS SYSTEMS
2765 REYNARD WAY, SAN DIEGO, CA 92103

The Context Connector™ Converts Any Data Directly Into VisiCalc™ Without Re-typing.

If you're one of the thousands of VisiCalc users who enter data from another computer into your VisiCalc models, the Context Connector can save you hours of work.

The Connector automatically converts text files from any computer into VisiCalc format. So you can easily move numbers from any file directly into selected VisiCalc cells.

Load Data From Your Company Computer.

The Connector lets you convert data from your company computer directly into VisiCalc models. So you can compare actual results to VisiCalc projections. The Connector will also consolidate different VisiCalc models, an invaluable tool for 3.2 version owners.

Analyze Stock and Commodities Prices.

The Connector converts data from timesharing services like Dow Jones into VisiCalc cells. So you can manipulate error free numbers instead of spending valuable time on typing.

Convert Data From Any Timesharing System.

The Connector will convert data from any time-sharing system into your VisiCalc models. Information from DRI, Dow Jones, The Source, Chase Econometrics, Dialog and other leading data bases can be processed by the Connector. The Connector has its own editor to let you review and edit figures prior to converting into VisiCalc.

The Connector Also Transmits and Receives Electronic Mail.

The Context Connector also serves as a basic communications program. The Connector has an auto-dial feature to automatically call other

computers. Once on-line, the Connector can transmit standard DOS text files to any computer. The Connector can transmit and receive complete VisiCalc models. Another useful function is "save to disk" which allows you to save your electronic mail on disk for future reference.

Specifications.

The Connector is designed to work with the Apple II, 48K of RAM and at least one disk drive. The Connector supports both 13 and 16 sector disk versions of VisiCalc. It also works with the Apple III in emulation mode.

For data transmission, the Connector supports the D.C. Hayes Micromodem, Apple communications card or the SSM/AIO card.

Available at Your Local Computer Store.

The Connector is available at most personal computer stores. For the name of your nearest dealer, please call or write Context Management Systems. Retailers, the Connector is available from Softsel Distributors or from Context Management Systems.

Free Demo Disk

Send us a blank 5¼" disk and a self addressed stamped mailer and we'll return your disk with a copy of the Connector demonstration program which explains how you can use the Connector. Or if you prefer, send a check for \$4.00 made out to Context and we'll send you a new Maxell MD-1 5¼" disk containing our demo program. Once you've seen our demo, you can delete the program and use the demo disk as you would any new blank diskette. It's a risk free way of seeing the Connector demonstrated on your Apple.

CONTEXT MANAGEMENT SYSTEMS
Management Software For Personal Computers
23864 Hawthorne Blvd., Suite 101
Torrance, California 90505
(213) 378-8277

©1982 Context Management Systems

VisiCalc™ is a trademark of Personal Software, Inc. • Apple™ is a trademark of Apple Computer, Inc.

Circle 110 on Inquiry card.

CP/M-86™ The Standard in the 16-Bit World

The Growth Market & Proven Tools

The 16-bit world answers universal demands for greater performance, more address space and increased resources. This market's unprecedented growth fuels a profit-driven supply curve for software and hardware, where compatibility reigns. Our upward compatible CP/M® based family of 16-bit products, plus our commitment to our customers' success eases and speeds your entry, your conversion, to the 16-bit world of opportunities — the Digital Research world.

Single user solution: CP/M-86 features efficiency and power. For over a year, its dramatic user acceptance has generated impressive quantities of code. While others are just entering the market, Digital Research's CP/M-86 is already offering a broad array of languages and applications. This simplifies your conversion to 16-bit systems.

For concurrent single user applications, MP/M-86™ performs simultaneous, multiple operations such as communications, printing, computation, etc. It features compact, time-tested modular code. And it's available today.

In multiple computer environments, MP/M-86 lets you sell your same programs into this market segment. You solve multi-user needs with a field proven product, not a "newcomer." Increased sales of multi-user products mean more profit potential for you.

Expand to network: CP/NET-86™ interconnects multiple 16 or 8-bit systems. It allows you to expand your product's capabilities.

High level languages (over 20 languages) under CP/M-86, handily support your 16-bit applications. Our XLT86™ utility speeds conversion to 16-bit code by reducing R&D time. It makes program development and maintenance easier.

Documentation in a comprehensive set of manuals clarify your use of CP/M-86, MP/M-86 and XLT86.



Over 2 Million CP/M-86 Units

Software Writer Benefits

2,800,000 CP/M-86 based systems by 1986. This market projection identifies the type and scope of your future sales.

Independent Software Vendor (ISV) benefits from Digital Research can make you more profitable. Here's a glimpse. Call for the complete repertoire of sales and development aids.

16-bit laboratory for your use features many different 16-bit machines. This one stop development reduces the conversion time of your application or language. First to call means first to enjoy this resource, and first to start sales rolling.

ISV selling aid: Descriptive listings of your products in our ISV Compatible Software Catalog have worldwide exposure.

IBM Display Writers and Personal Computers running CP/M-86 guarantee a large installed base for your 16-bit products.



Apple/Tandy software writers:

Personal and professional computer applications increasingly require 16-bit resources. Our established "how-to" aids simplify and speed your conversion to 16-bit applications. Just let us help.

The Standard Is Digital Research

We are the most experienced microcomputer software company in the industry. Over 300,000 microcomputers use our operating systems. Over 400 OEMs and 500 independent software vendors use our products. Hundreds of 8-bit applications now run under our 16-bit products. Across the board, we set the standard. And these people help us set it, with languages under CP/M-86 or MP/M-86:

The Code Works
Computer Innovations
Compuview Products, Inc.
Digital Research
Microfocus, Inc.
Micropro Int'l Corp.
Microsoft
Midwest Micro-Tek, Inc.
Ryan-McFarland Corp.
The Soft Warehouse
Sorcim Corp.
Stackworks
Supersoft Associates
Thomas W. Yonkman
Vanguard Systems Corp.

OEM Strategy

New sales. New markets. New applications become realities when you convert to 16-bits. New demand curves. New and larger profit centers are yours with our 16-bit products. To immediately capture increased market share, make a priority call to our marketing group for our 16-bit product briefs, OEM price list and contract information.

C compiler
C compiler
VEDIT, screen editor
CBASIC-86, PASCAL MT
CIS COBOL
WORDMASTER, WORDSTAR
BASIC, FORTRAN, COBOL, PASCAL
BASIC-compiler
RM/COBOL
LISP compiler, MuMATH
PASCAL/M, TRANS-86
FORTH
C compiler
LISP/86
APL/V86

Turn Opportunity into Success.

Stop following the competition. Help lead the field. Today. We provide the capability, and we have the desire, to accelerate your profitability. There's no other software product on the market today that can help make you more successful than Digital Research's CP/M-86. And there's no other company. We stand ready. It's your move.

Call (408) 649-3896, or write: Digital Research, P.O. Box 579, Pacific Grove, CA 93950. Europe: Vector, Int'l., Leuven, Belgium, 32(16)202496. Far East: Microsoft Assoc., Tokyo, Japan, 03-403-2120.

Circle 132 on Inquiry card.

16 BIT LAB

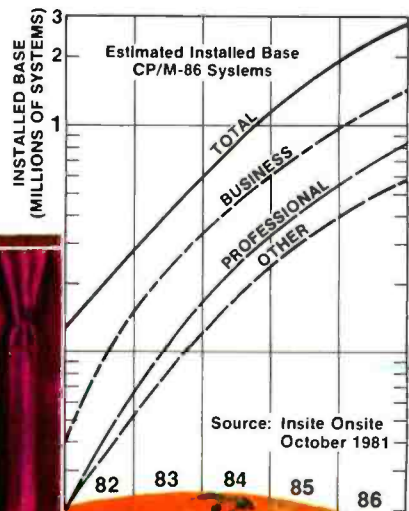

DIGITAL RESEARCH™

CP/M is a registered trademark of Digital Research. CP/M-86, MP/M-86, CP/NET-86, XLT86 and PASCAL MT are trademarks of Digital Research. ©Copyright 1981 Digital Research.

Commodore 4022 Printer

Joseph Holmes
13049 Broadway Terrace
Oakland, CA 94611

Some marriages are made in heaven—others are made in Japan. Commodore Business Machines has joined Epson to produce a fine, low-

cost printer that combines the hardware features of the Epson MX-80 with the upgraded operating system of the Commodore CBM 2022

printer. Latest in a series of new products from Commodore, the CBM 4022 will handle most printing jobs where the 8½- by 11-inch paper size and dot-matrix output are acceptable.

The 4022 is totally compatible with all Commodore 2000, 4000, and 8000 series computers. The printer requires no special interface other than a cable. The 4022 prints the entire CBM/PET character set (256 characters), which means that listings and graphics programs come out just as they were entered (see figure 1). It is controlled by an internal micro-processor, which gives the 4022 versatile line-spacing and formatting capabilities. You can design your own business forms; you can even design and print special characters. The 4022 has both a replaceable line cord and an external, easily replaceable fuse.

In order to detail the other features of the CBM 4022, I will compare it to its cousin, the MX-80, and to its father, the CBM 2022.

CBM 4022 Versus Epson MX-80

Many of the 4022's features overlap those of the MX-80. Both have a self-diagnostic print test and lowercase descenders (one-dot descenders with the 4022 and two-dot descenders with the MX-80). Line spacing defaults to 1/6 inch (six lines per inch) in the 4022 and to either 1/8, 1/6, or 7/72

At a Glance

Name

Commodore Business Machines Dot-Matrix Printer Model CBM 4022

Use

General (listings, reports, business forms, graphics, draft-quality word processing, etc.)

Manufacturer

Commodore Business Machines and Epson
3330 Scott Blvd.
Santa Clara, CA 95051

Dimensions

10.7 by 37.3 by 33 cm (4¼ by 14¾ by 13 inches); the weight is 6.6 kg (14.6 pounds)

Price

\$795

Additional Hardware Needed

Cable (CBM to IEEE-488 or IEEE-488 to IEEE-488)

Features

Disposable heavy-duty 8-wire jeweled print head, cartridge ribbon, 80-column width capability, 5 by 8 dot-matrix characters (6 by 8 for graphics), true lowercase descenders, maximum print speed of 80 lines/minute for 20 columns (40 lines/minute for 40 columns), programmable line spacing, user-designed characters, paging with variable lines/page, enhanced (widened) characters, two character sets, and built-in error messages

Documentation

Commodore User's Manual, 45-page paperback (supplied with printer); Osborne/McGraw-Hill PET/CBM Personal Computer Guide, 2nd edition, 501-page paperback (supplied with computer)

Audience

Programmers, businesspeople, engineers, educators, students, writers, hobbyists, or others with Commodore 2000, 4000, or 8000 series microcomputers.



META TECHNOLOGIES

26111 Brush Avenue, Euclid Ohio 44132
CALL TOLL FREE 1-800-321-3552 TO ORDER
IN OHIO, call (216) 289-7500 (COLLECT)



1001 THINGS TO DO WITH YOUR PERSONAL COMPUTER

BY MARK SAWUSCH

333 pages \$10.95

333 pages, written in simple terms, of "what-to-do" and "how-to-do-it". Suitable not only for microcomputers, but for programmable calculators as well. Includes program listings, formulas, a glossary of computer terms and more! Definitely a MUST BUY!

"TRS-80™ DISK AND OTHER MYSTERIES"

by Harvard C. Pennington

132 pages written in PLAIN ENGLISH packed with HOW TO information with details, examples and in-depth explanations. Recover lost files and directories, remove file protection, make BASIC programs unlistable. How to use SUPERZAP, recover from DOS errors and MORE!

TRS-80™ DISK \$19.95

"OTHER MYSTERIES" VOLUME II

by James Farvour

Call now and place your order for this new book, "MICROSOFT™ BASIC DECODED & OTHER MYSTERIES for the TRS-80™", from IJG, Inc. A primer for cassette and disk BASIC on the TRS-80™, the information provided applies to similar MICROSOFT™ BASIC interpreters. MICROSOFT™ BASIC DECODED . \$24.95

"OTHER MYSTERIES" VOLUME III

by Dennis Kitz

THE CUSTOM TRS-80™ \$28.95
CALL FOR AVAILABILITY

"OTHER MYSTERIES" VOLUME IV

"BASIC FASTER AND BETTER"

If you program in BASIC, you want this book! Time-tested and proven, the techniques and routines can be used in thousands of ways to make your programs smaller, faster, and look truly professional.

BASIC FASTER & BETTER \$24.95

EPSON PRINTERS

MX-80, MX-80FT, MX-100

NEW LOWER PRICES!

EXTRA-LONG 10 ft. RIBBON CABLE \$24⁹⁵

CONNECTS EPSON PRINTER & TRS-80 MICROCOMPUTER

40-TRACK, SINGLE/DOUBLE-DENSITY, FAST ACCESS, 5 1/4-inch TANDON DISK DRIVES \$289⁹⁵ complete

FOR MODEL I and MODEL III

Includes Case, Power Supply and External Drive Connector

DISK DRIVE EXTENDER CABLE \$9⁹⁵

for VISTA, MICROPOLIS, MTI, PERTEC, SHUGART, PERCOM & OTHERS

PARAGON MAGNETICS™ PLAIN JANET™ DISKETTES \$19⁹⁵ box of 10

These are factory fresh, absolutely first quality (no seconds!) mini-floppies. They are complete with envelopes, labels and write-protect tabs in a shrink-wrapped box.

Box of 10 Diskettes \$19.95

PARAGON magnetics™ Gold

Introducing MTC's premium generic diskette. Single-Sided, Soft-Sectored, DOUBLE-DENSITY, 5 1/4-inch diskettes with reinforcing HUB-RINGS. Individually 100% ERROR-FREE certified. Invest in GOLD!

PARAGON MAGNETICS GOLD \$23.95

VERBATIM'S PREMIUM DISKETTES DATALIFE™

Seven data-shielding improvements mean greater durability and longer data life. These individually, 100% error-free certified diskettes feature thicker oxide coating, longer-lasting lubricant, improved liner, superior polishing and more! Meets or exceeds IBM, Shugart, ANSI, ECMA and ISO standards.

VERBATIM DATALIFE™ DISKETTES

5 1/4-inch (box of 10)
MD525-01 \$26.95

8-inch FLOPPIES

Double-Density, FD34-8000 . \$43.95

'RINGS' & THINGS

HUB RING KIT for 5 1/4" disks. . . . \$10.95
HUB RING KIT for 8" disks. \$12.95
REFILLS (50 Hub Rings) \$ 5.95
CLEANING KIT for 5 1/4" drives . . . \$24.95
5 1/4-inch diskette case \$3.50
8-inch diskette case \$3.95
5 1/4-inch File Box for 50 diskettes \$24.95
8-inch File Box for 50 diskettes \$29.95

TRS-80 is a trademark of the Radio Shack Division of Tandy Corporation. DATALIFE is a trademark of VERBATIM. PLAIN JANE, PARAGON MAGNETICS, are trademarks of MTC.
© 1981 by Meta Technologies Corporation

MOST ORDERS SHIPPED WITHIN ONE BUSINESS DAY
Products damaged in transit will be exchanged.

PRICES IN EFFECT March 1, 1982 THRU March 31, 1982
Prices, Specifications, and Offerings subject to change without notice.
8203

WE ACCEPT
• VISA
• MASTER CHARGE
• CHECKS
• MONEY ORDERS
• C.O.D.

• Add \$3.00 for shipping & handling
• \$3.00 EXTRA for C.O.D.
• Ohio residents add 6.5% sales tax.

Systems Group System 2800 computers. They're making people stand up and take notice.

But then Systems Group products have always appealed to those who appreciate sensible value, high performance, unmatched reliability and prompt, courteous service.

Through the years, Systems Group product acceptance in Z80 CPU, disk controller, I/O and memory boards have been the result of some very purposeful and carefully thought out engineering. Not to mention strict industrial quality production standards.

That same effort has made System Group's new family of expandable System 2800 computers what they are today.

Fast, reliable and powerful.

System 2800 computer systems are designed for a single user with 64K of memory or for up to as many as six separate users with additional add-in memory. They can easily expand as your organization's needs grow.

You can handle up to 8000 customers and 24,000 inventory items in our lowest cost dual floppy model and much, much more in our 40M byte hard disk models. And you can connect up to 12 terminals or printers and other add-on Systems Group floppy, tape and hard disk single or dual drive subsystems.

Select CP/M¹, MP/M¹ or OASIS¹ operating systems to run all your word processing and

accounting programs. No matter what size organization you control, controlling will be easier from now on.



See the System 2800 from Systems Group, they're what computers should have been in the first place.

[†] registered trademark of Digital Research
^{††} registered trademark of Phase One Systems

Dealer Inquiries Invited

For dealers only, circle 371.
All other inquiries, circle 372.

Systems Group

A Division of MEASUREMENT systems & controls
incorporated

1601 Orangewood Avenue
Orange, California 92668, (714) 633-4460
TWX/TELEX 910 593 1350 SYSTEMGRP ORGE

Be Permanently Impressed.

The Expandable Computer Family from Systems Group.



1981

Today's Requirements
Dual floppy single or multi-user system



1983

Tomorrow's Requirements
10M byte hard disk and floppy drive,
single or multi-user system



1985

Your Future Requirements
40M byte hard disk and 20M byte tape
back-up, single or multi-user system

4022 has one print mode and one type size giving 10 cpi or 80 characters per 8-inch line. Characters can be widened, however, for special effects.

- The character matrix of the MX-80 is 9 by 9 dots, whereas that of the CBM 4022 is 6 by 8 dots (5 by 8 for nongraphic characters). This allows two-dot lowercase descenders for the MX-80 versus one-dot descenders for the CBM 4022.

- The MX-80 has four indicator lights: Power On, Printer Ready, Paper Out, and On Line. The four switches on the MX-80 are Power On/Off, On Line, Form Feed, and Line Feed. In addition, a warning buzzer responds to paper-out and error conditions. The CBM 4022 has one indicator light (Power On), which also flashes for paper out, and two switches: an On/Off switch and a Paper Advance button that takes you to top-of-form or feeds continuously if held down.

- The MX-80 lists for \$645; the CBM 4022 lists for \$795. Since no addi-

tional interface board is needed to connect to PET/CBM computers, you could come out ahead with the 4022.

CBM 4022 Versus CBM 2022

How does the CBM 4022 stack up against its predecessor, the CBM 2022? Physically, they are quite different. The 4022 is lighter and far more compact. It is also much quieter—a plus for the families of nighttime programmers! The 4022 has true lowercase descenders; the 2022 does not.

Both printers share a slightly annoying bug. When in the lowercase mode, the *backslash*, the *left arrow* and *up arrow*, and the *left and right brackets* must be shifted to achieve their normally unshifted appearance. For their shifted versions, or graphics, you must type them unshifted. I have learned to live with this. The earlier model's paper advance couldn't find the top-of-form, but it was useful for advancing the

paper short distances without turning the knob. The new model makes it more difficult to back up the paper without crinkling precious hard copy.

Both CBM printers have formatting and other features that are controlled by a system of *secondary addresses (sa)*. These features are activated by opening *files (channels)* to one or more of the secondary addresses and then printing to the appropriate file. The earlier model 2022 had these seven secondary addresses:

- sa 0: Print exactly as received
- sa 1: Print according to an established format
- sa 2: Establish format field
- sa 3: Set number of lines per page
- sa 4: Activate error messages
- sa 5: Design custom character
- sa 6: Set spacing between lines

The later model 2022 added an eighth secondary address (*sa 7*) that switched the entire PET/CBM character set from uppercase/shifted

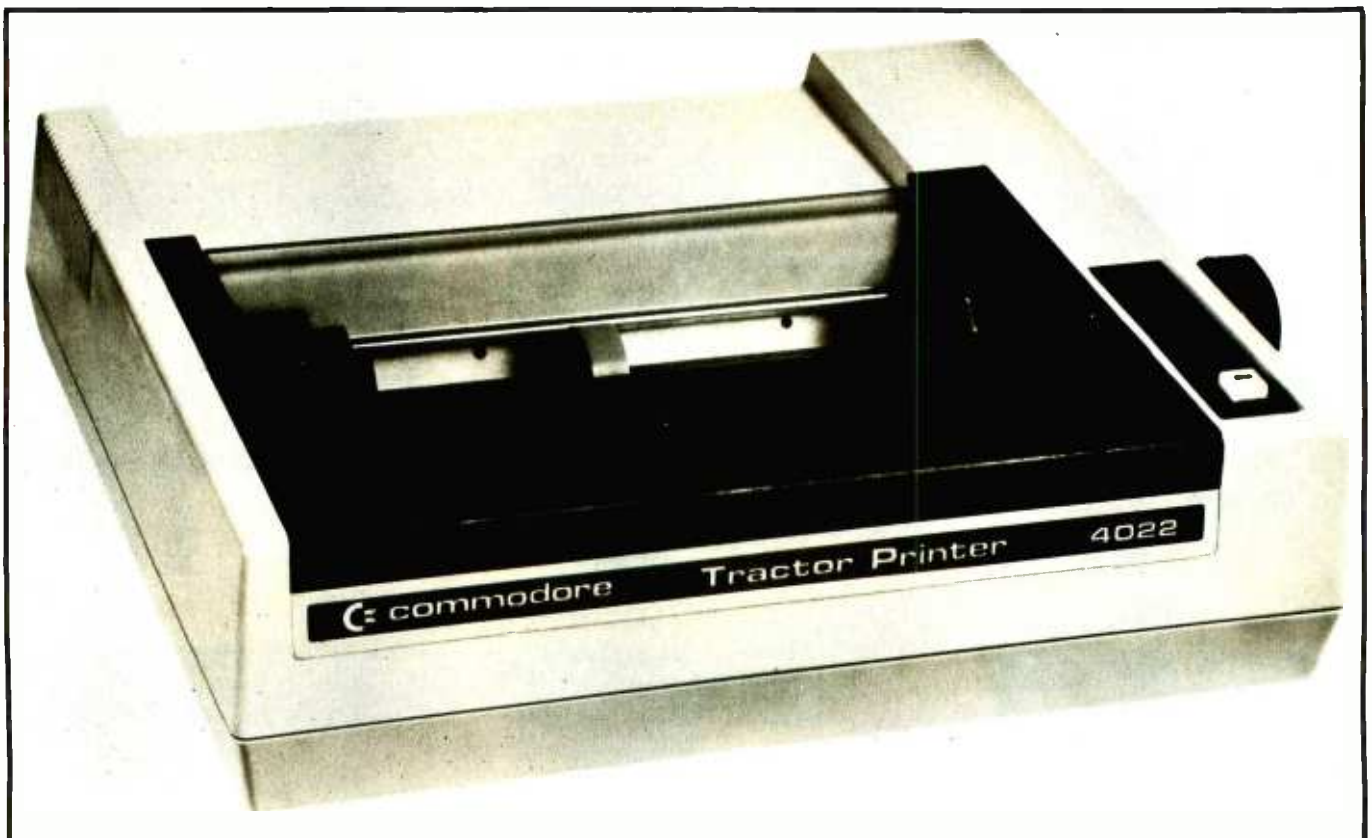

Photo 1: Manufactured in Japan by Epson, the new CBM 4022 combines the hardware features of the MX-80 with the upgraded operating system of the CBM 2022 printer.



A simple fact:

The considerable benefits of a personal computer like the Osborne 1® are often intangible, often exciting, and always expanding.

The value of the Osborne 1 is clear and simple:

\$1795. Complete.

\$1795 includes this hardware:

- Z80A™ CPU with 64K RAM
- Dual floppy disk drives with 100K bytes storage each
- 5" CRT
- Business keyboard with numeric keypad and cursor keys
- RS-232C Interface
- IEEE 488 Interface
- Weather-resistant, portable housing
- Operates on European and American voltages

\$1795 includes this software:

- CP/M® Operating System
- WORDSTAR® word processing with MAILMERGE
- SUPERCALC™ electronic spreadsheet
- CBASIC®
- MBASIC®



OSBORNE

Call (415) 887-8080 for the name of your nearest authorized OSBORNE 1 computer retailer.

Trademarks: Z80A: Zilog Corporation
SUPERCALC: Sorcim Corporation
Registered Trademarks:
OSBORNE 1: Osborne Computer Corporation
CP/M: Digital Research MBASIC: Microsoft
CBASIC: Compiler Systems, Inc.
WORDSTAR, MAILMERGE: MicroPro International

GARBAGE PROBLEM?

Memory Loss • Errors • Crashes • Reboots



Take out the garbage

with **QUIET LINE 6**
SPIKE, SURGE AND NOISE SUPPRESSOR

- Six protected receptacles
- Load rating of 15 amps
- Broad band RFI suppression
- Maximum transient current of 6000 amps (8X20µs)

only **\$39⁹⁵** PLUS \$1.75 FOR SHIPPING

PROTECTS COMPUTERS, TELEVISION, PERIPHERALS, VIDEO GAMES, VCR'S AND OTHER ELECTRONIC DEVICES. SUPPRESSES DAMAGING POWERLINE TRANSIENTS AND RF INTERFERENCE.

BWJ TECHNOLOGY, INC. BOX 6214 ARLINGTON, TX 76011 DEPT. B (817) 277-2726

CHECK, MONEY ORDER, VISA, MASTER CHARGE • TEXAS RESIDENTS ADD 5%

graphics to lowercase/shifted uppercase. However, this upgrade had one nasty bug. Often, when another secondary address was accessed, the character set would switch inexplicably to lowercase. The only remedy for this was to reset the printer by turning it off and then on again. The CBM 4022 has overcome this problem with the addition of three more secondary addresses: numbers 8, 9, and 10—for a total of 11. Secondary address 8 switches the printer back to uppercase mode. Secondary address 9 closes the channel to *sa 4*, the error channel, and *sa 10* resets the printer so that only *sa 0* (the default channel) is left open. These new addresses allow much better and more reliable direct keyboard and software control of printer functions. The last four secondary addresses for the CBM 4022 are:

- sa 7: Switch to lowercase
- sa 8: Reset to uppercase
- sa 9: Turn off error channel
- sa 10: Reset everything

Let's look at some of the 4022's features in more detail. If a file (channel) has been opened to *sa 1*, all printing will be in a format that was previously established. This format was set up by opening file *sa 2* and then assigning a format field (or image string) to a string variable, then printing that string variable to the file open to *sa 2*. The format field that governs output layout is similar to the image fields used in the PRINT USING command found in some versions of BASIC.

Here are a sample PRINT statement, a format field, and the formatted printout. (The values of the variables used are A\$ = "OK", A = 37, B = 86, C = 8.27, D = 1.28, E = 1.25, F = 26.51, G = -3, H = -3.) The PRINT statement is:

```
PRINT#1,"A$CHR$(29)CHR$(160)
CHR$(29),A,B,C,D,E,F,G,H"
```

The format field for this PRINT statement is:

```
AAAA AAA ZZZZ R| 9999R|
99.99 ZZ.99 $99.99 $$$99 S99 99-
```

DUAL 68000

... Hard Power from the Soft Support of **UNIX®**

A new and powerful computer has been born... the System 83. The versatile UNIX® operating system pilots the System 83's raw power through a myriad of software such as "C", FORTRAN, PASCAL, BASIC, COBOL, and even Networking. Step into a bold new frontier with more power than you ever dreamed possible.

- UNIX V7 configured by UNISOFT**
- Full IEEE 696/S-100 Compatibility
- MC68000 8MHz Processor
- 32-Bit Data Operations with 32-Bit Internal Registers
- 16-Bit Data Transfer Operations
- Memory Management Allows Concurrent Use of Mapped and Non-mapped Address space
- 16 Mb of Main Memory Directly Addressable
- 7 Vectored Interrupt Levels
- 256 Kb of RAM with Parity Per Board Slot

* UNIX is a trademark of Bell Laboratories and is supported on the DUAL System 83 by UNISOFT
**UNISOFT is a trademark of UNISOFT Corporation of Berkeley, CA.

DUAL SYSTEMS
system reliability/system integrity
720 Channing Way • Berkeley • CA 94710 • (415) 549-3854 • Telex: 172029 SPX

Tired of writing (and rewriting) customized and friendly error free code?

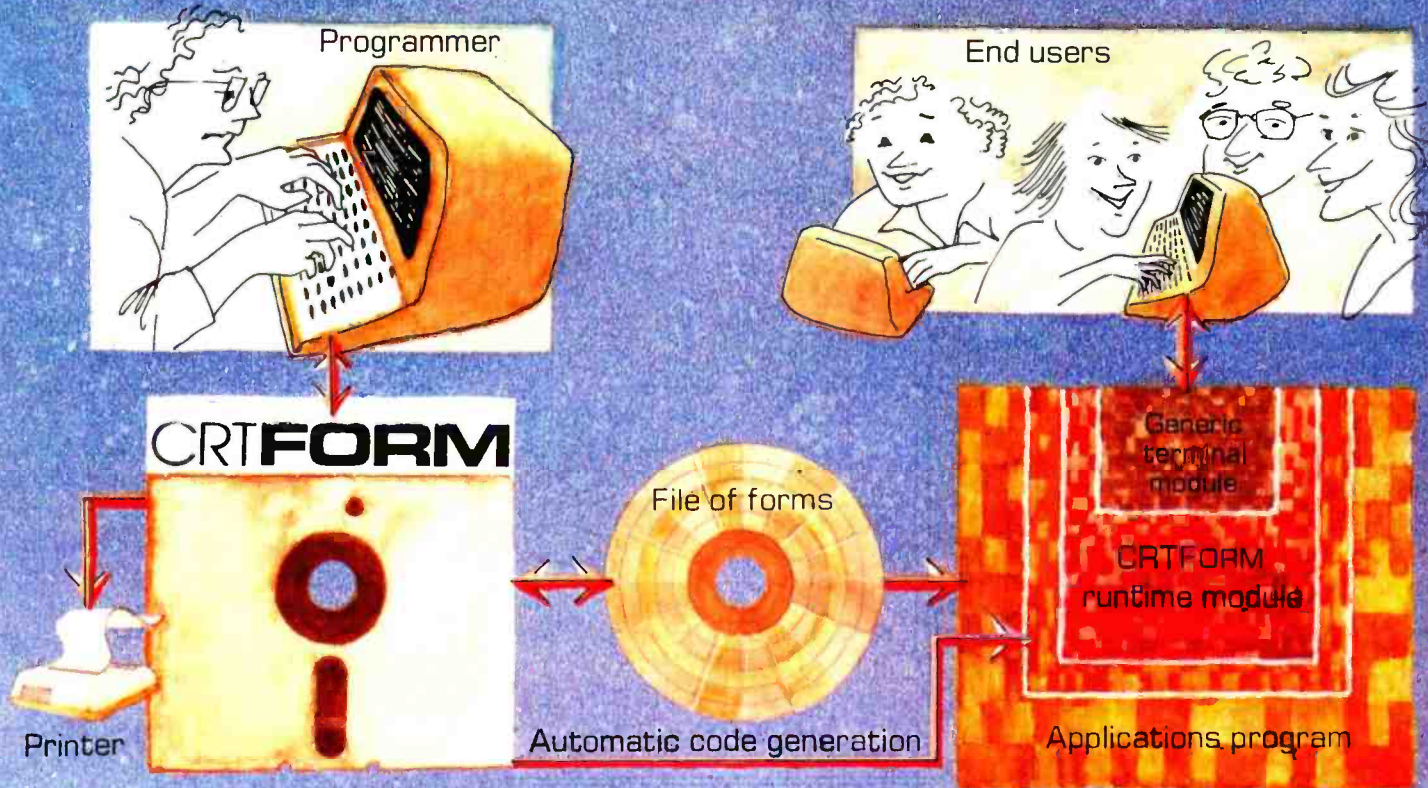

CRTForm™ is a programmer productivity tool that saves time.

CRTFORM produces a friendly bug free interface between end users and the applications programmer.

CRTFORM makes sure that end users enter information correctly, and gives error messages (in plain English) if they don't. It guarantees that programmers will receive correct information without having to write hundreds of lines of error checking code.

CRTFORM allows you to modify program input specifications without requiring expensive and time consuming changes in applications code. It even generates a source code skeleton (Pascal, BASIC, COBOL, FORTRAN, PL/I, and Ada) to interface the programmers' application code to the CRTFORM runtime module.

The CRTFORM package consists of:

- A forms manager that manipulates random access files of input specification forms.
- An editor that creates and modifies the specifications forms.
- A print utility that produces hard copy of forms and their specifications.
- A code generator that writes source code skeletons for ease of program interfacing.
- A terminal-independent runtime module in the machine language of your host processor.

CRTFORM is available under the CP/M, UCSD, and Apple Pascal operating systems. Please call or write for further information on OEM licensing arrangements, or for the name of your nearest CRTFORM dealer.

PROGRAMS THAT WRITE PROGRAMS
STATCOM
CORPORATION

5766 BALCONES SUITE 202
AUSTIN, TEXAS 78731
PHONE 512/451-0221

Circle 360 on Inquiry card.

CRTFORM and Statcom are trademarks of Statcom Corporation - Registered trademark as follows: CPM-Digital Research; UCSD-U.C. San Diego; Apple-Apple Inc.

www.americanradiohistory.com

TWO TO REMEMBER

256 Kb Dynamic Memory...

Available now from Dual Systems: DMEM/256 memory boards. Put the most density of memory ever available on your IEEE/S-100 bus. Get industrial-grade quality with this ruggedly built board; it's been burned in for 168 hours.

- FULL 256 Kb on a single board.
- TWO INDEPENDENTLY ADDRESSABLE 128 Kb BLOCKS.
- RUNS IN 8 MHz System.
- RUNS AT 4 MHz BUS SPEED (no wait states).
- RUNS IN 8 OR 16-BIT systems with 8 or 16-bit wide data paths.
- EXTENDED 24-BIT ADDRESSING
- PARITY ERROR DETECTION—generates either interrupt or bus error signals on error.
- DMEM/256KP (Parity) \$1345

Static Non-Volatile Memory

The Dual Systems CMEM memory boards combine high speed CMOS memories with new 3-10 year lithium batteries to give you the nonvolatility of an EPROM board while retaining the instant writability of a high-speed read/write RAM.

- RUNS AT 6 MHz (no wait states).
- 8 OR 16-BIT with 8 or 16-bit wide data paths.
- EXTENDED 24-BIT ADDRESSING and bank select.
- CMEM/32K \$895
- CMEM/16K \$795
- CMEM/8K \$695

OEM and Dealer pricing is available. Sales representatives in most metropolitan areas.



system reliability/system integrity

DUAL SYSTEMS

720 Channing Way, Berkeley, CA 94710
(415) 549-3854/3890 · Telex: 172029 SPX

```
LOOSER  +++| | | | |
LINE     +++| | | | |
SPACING  +++| | | | |
3 LINES PER INCH
```

```
TIGHTER +++| | | | |
LINE     +++| | | | |
SPACING  +++| | | | |
8 LINES PER INCH
```

```
NORMAL  +++| | | | |
LINE     +++| | | | |
SPACING  +++| | | | |
6 LINES PER INCH
```

Figure 2: Three examples of the line spacing available with the CBM 4022.

The formatted printout is:

```
OK  0037 | 86| 8.27 01.28 $ 1.25
      $26.51 - 3 3-
```

The CHR\$(29) in the PRINT statement is a string delimiter that assigns spaces to the right of a string equal to the number of spaces in the format field to the right of the alpha (string) field. The As represent characters in a left-justified alpha field and are *right padded* with blanks, if necessary. The CHR\$(160) prints the first character of the next alpha field as a blank and then right pads the rest of the alpha field with blanks. Otherwise, CHR\$(160) will add an extra space, as well as convert unshifted leading spaces in a string to shifted spaces. A shifted space in a string will be accepted as a space for formatting.

The other symbols are numeric. The 9s are digits in a right-justified field and are *left padded*, if necessary, with blanks. Zs act like 9s, except blanks are left padded with zeros. A single \$ next to a 9 or Z gives a fixed dollar sign, whereas using all \$s up to the decimal gives a floating dollar sign. S prints the sign of a number to its left (-12, +15); the - sign prints the sign of the number to its right: a blank if positive, and a - if negative. Literals such as vertical bars

can be embedded in the format field. These embedded literals are useful in creating special forms as a part of the printout.

When paging is turned on by printing CHR\$(147) to a file open to *sa 0*, the paper is advanced six spaces after 60 lines have been printed. The number of lines per page can be changed from the default number 66 by first turning on the paging feature, opening a file to *sa 3*, and then printing the number of lines to that file (e.g., PRINT#3,33—which would be correct for 8½- by 5½-inch paper). After 27 lines have been printed (six less than the 33 set by *sa 3* in this example), the paper automatically advances six spaces: three spaces before and three spaces after the perforations—if you have planned correctly. When paging is turned off by printing CHR\$(19) to a file open to *sa 0*, a top-of-form function is performed. It is a good idea to do this if you are not certain that all set lines have been printed.

Additional Features

Six diagnostic error messages can be accessed by opening a file to *sa 4*:

- *PE:L* Lines per page out of range
- *PE:C* Bad command (invalid secondary address)
- *PE:M* Data-format mismatch
- *PE:E* Exponent error
- *PE:F* Bad format
- *PE:T* Terminator error (change of *sa* before carriage return or other terminator detected)

This error channel can be turned off by opening a file to *sa 9*, printing to that file, and then closing the file.

The *User's Manual* gives a method for designing custom characters that should be changed to the following: Fill in a 6 by 8 matrix with dots where you like. Each row in this matrix is assigned a value that is a power of two from 1 (bottom row) to 128 (top row). The dot values are added for each of the six columns, assigned a CHR\$ value, and then printed to a file open to *sa 5*. This character can be printed as CHR\$(254).

Opening a file to *sa 6* allows you to change the normal spacing of 6 lines

INTELLIGENT PRINTER INTERFACE

Free Your Computer from the Mundane Task of Printing

Imagine being able to use your computer seconds after beginning an extensive printout.

Visualize your printout with page breaks, page numbering and titles, margins of your choice, indented carryover lines, on any size paper!

Appreciate the time and money you will save by not waiting on your printer.

SooperSpooler, a buffered printer interface, maintains control over your printer while you go on using your computer for more productive activities. Eliminate waiting while your printer pecks through a long document. SooperSpooler accepts information from your computer at up to 2500 characters per second and feeds it to your printer as fast as it can handle it—without using any of your computers memory or time! As soon as SooperSpooler has stored your document in its buffer, control of your computer is returned to you.

SooperSpooler features include:

- 16K Memory—Will handle most of your printing jobs (expandable, see options)
- Buffer Status Readout—Lets you know just how much data is stored
- Space Compression—Makes the best use of memory on columnar documents
- Pagination—Eliminates printout on page perforations
- Page Stops—For single sheet printouts
- Headers and Page Numbering—Give your listing a professional look
- Indentation on Carryover Lines—Easy to find the beginning of a line
- Self Test Routine—You instantly know that all is well
- All Features Software Controllable—Your program can take over
- Plugs into Most Computer Systems—Standard cables available
- **\$349.00!**—16K parallel I/O unit

Options:

- Serial Board—\$95.00—Gives you the option of any combination of serial or parallel input or output. Can also be used for modem transmission.
- Memory Expansion—\$159.00—Additional 46K for a total of 62K
- Cables—Available per your application.

TM
SooperSpooler by Compulink
—The missing link that gives your microcomputer mainframe printing.

COMPULINK CORPORATION

1840 Industrial Circle, Dept. A
Longmont, CO 80501
(303) 651-2014
Order line: 800-525-6705

Dealer inquiries welcome

Circle 86 on Inquiry card.



We accept
• VISA
• MasterCard

• Checks
• Money Orders
• COD

Add \$3.00 per order for postage and handling
COD add \$3.00
Colorado residents add sales tax

Prices and Specifications Subject to Change
Without Notice

Toughest Boards in Town... IEEE 696/S-100

NON-STOP CLOCK

Keeps time with power off. Our industrial clock utilizes a new lithium battery for 3-8 years use. Easiest clock to program you'll ever see. Runs in all S-100 systems.

- Year, date, hrs, mins, secs.
- Uses new LSI CMOS chip.
- Vectored interrupts.
- CLK-24 \$250

A/D CONVERTER

IEEE696/S-100 AIM-12 industrial standard module designed for industrial analog-to-digital use.

- Runs in all S-100 systems.
- 32-channel, 16-differential 12-bit resolution/accuracy. 25-microsecond conversions.
- Instrumentation amplifier.
- BASIC program provided.
- AIM-12...\$695 AIM-12B w/1-1000 gain transducer amplifier.

D/A CONVERTER

AOM-12 IEEE696/S-100 industrial level digital-to-analog (D/A) converter.

- 12-bit $\pm 1/2$ L.S.B. accuracy over full 0-70°C temperature range.
- Outputs 0-10, ± 5 , or ± 10 volts.
- Short circuit protection, all outputs.
- Switch-programmable for multiple boards.
- AOM-12, \$575

VIC 4-20

Standard output for industrial control 4-20 mA D/A converter. Used in conjunction with the D/A board. VIC4-20, \$445.

DUAL 77 Data Acquisition and Control System-

A Z-80 based system built to industrial standards; designed for severe environments. BASIC language makes programming easy. Access to hundreds of sensors. Expandability to meet your increased needs. Nonvolatile memory. Power interruption recovery with automatic restart. DUAL 77 includes AOM-12, AIM-12, CLK-24, 64Kb (2-CMEM/32K), 2-SIO ports (SIO-2) and twin 8" 1 Mb drives with cp/m, BASIC and choice of video or printer terminal: \$12,495. DUAL 77A basic controller only without drives, software and terminal: \$6,310.



system reliability/system integrity
DUAL SYSTEMS

720 Channing Way, Berkeley, CA 94710
(415) 549-3854/3890 · Telex: 172029 SPX

Function	CHR\$ Value	Keystrokes
Enhance On	CHR\$(1)	none
Enhance Off	CHR\$(129)	none
Paging On	CHR\$(147)	CLR/HOME (shifted)
Paging Off (Reset)	CHR\$(19)	CLR/HOME
Reverse Field On	CHR\$(18)	OFF/RVS
Reverse Field Off	CHR\$(146)	OFF/RVS (shifted)
Carriage Return	CHR\$(13)	RETURN
Carriage Return (no feed)	CHR\$(141)	none
Line Feed	CHR\$(10)	none
Uppercase	CHR\$(145)	CURSOR UP *
Lowercase	CHR\$(17)	CURSOR DOWN *
Skip Space	CHR\$(29)	CURSOR RIGHT
Insert Leading Blanks	CHR\$(160)	SPACE (shifted)
Quote	CHR\$(34)	Quote (") **

* These functions are reversed if sa 7 is in effect.

** This can be a forced quote within a PRINT statement. Also, an odd number of quotes allows control characters to be printed in their graphics form.

Table 1: Control characters sent through secondary addresses 0 and 1.

per inch (see figure 2). To do so, you must choose a divisor for 216 that will give a quotient that is the number of lines per inch that you want (default = 36 for 6 lines per inch): 18 yields 12 lines per inch and is nice for graphics that normally get too stretched out vertically when printed; 24 yields 9 lines per inch, but some graphics with this spacing are still too stretched out. If you want normally spaced text and somewhat compressed graphics, you can leave an extra space between text lines in your program and then change your spacing to 12 lines per inch. The *User's Manual* needs a revision on line spacing. The values given on page 31 are incorrect; they are left over from the model 2022. To correct them, change the 144 to 216, and change the divisors accordingly. You can use any divisor from 1 to 127. Dividing 216 by 1 will, of course, give a quotient of 216—the number of lines per inch (1/216, or 0.0046, inch spacing). Dividing 216 by 127 will give a quotient of 216/127, or approximately 1.7 lines per inch (127/216, or 0.5880, inch spacing).

The CBM 4022 and 2022 both have a set of special control characters. Their functions and equivalent keystrokes are listed in table 1.

To get more information on the use of these controls plus the other features of the CBM 4022, consult either the Commodore *User's Manual* or the appropriate sections of the *Per-*

sonal Computer Guide, 2nd edition, published by Osborne/McGraw-Hill.

Conclusions

The CBM 4022, manufactured by Epson for Commodore, is the dot-matrix printer of choice for users of PET/CBM computers because of the Commodore specificity of its operating system. It compares well with its cousin, the Epson MX-80.

This printer is an improvement over the earlier CBM 2022 because it has true lowercase descenders; is quieter; has an inexpensive, disposable print head; uses a cartridge ribbon; and has overcome some serious bugs with the addition of three new control channels (secondary addresses).

The CBM 4022 features control characters, secondary address channels, the full CBM 256-character set with graphics, and user-designed characters. Although the CBM 4022 still has a minor bug or two, its weakest point is the inaccurate user's manual.

The \$795 list price is reasonable, considering that a simple cable is the only extra expense.

I have used both the CBM 2022 and the new CBM 4022 printers during the last year. Although most of my time has been spent with the earlier model, I am very pleased with the upgraded version as it has worked well for me. I enthusiastically endorse the Commodore CBM 4022 printer. ■

GRAPHICS FOR CP/M[®] COMPUTERS

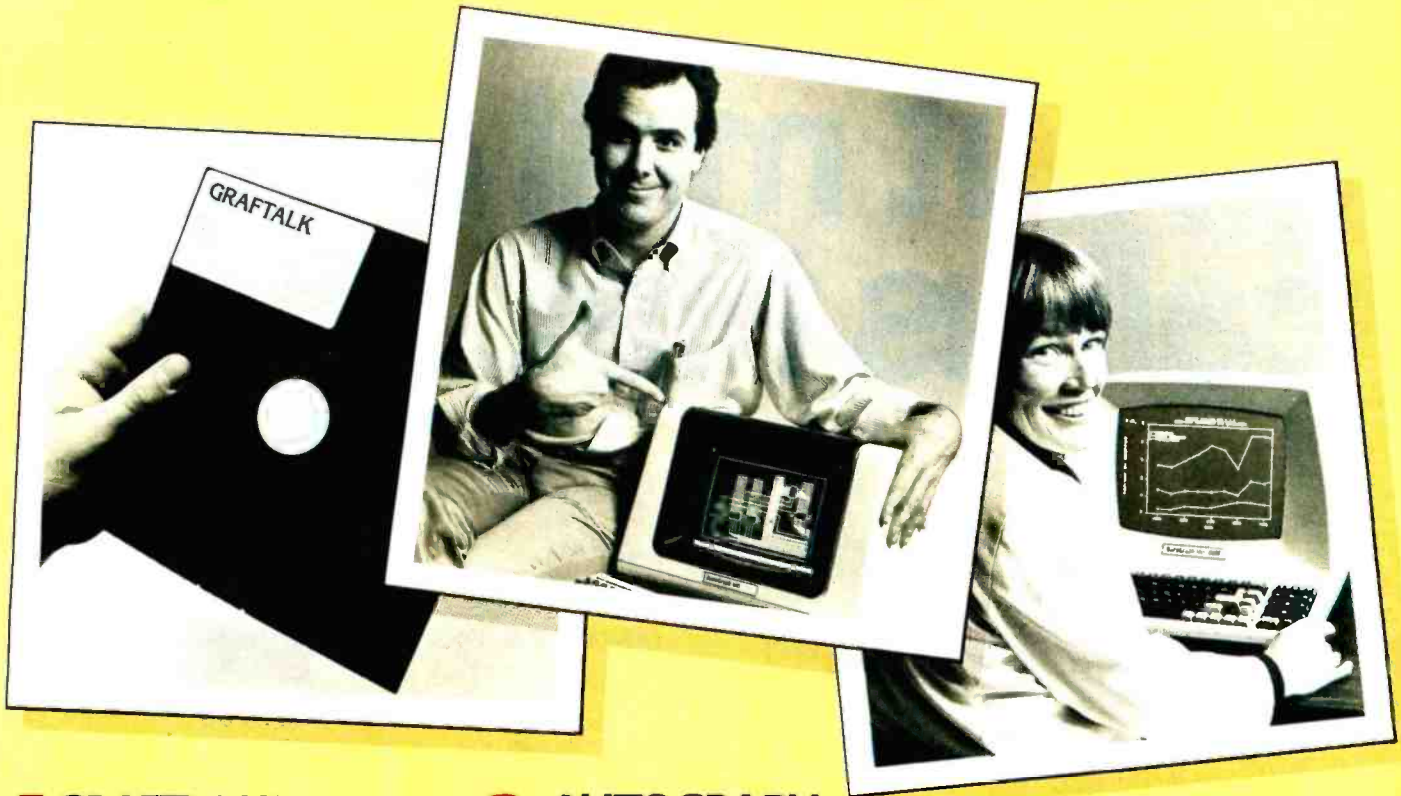

1 GRAFTALK[®]
The first graphics software for CP/M systems, GRAFTALK reduces data to pictures, giving you the ability to look at information that would otherwise be a boring text file.

GRAFTALK is friendly and easy to use. Great for first-time users. But that doesn't mean GRAFTALK lacks capability.

Bar charts. Pie charts. Line plots. Symbol plots. Composite plots. Text. Color. Advanced graphics, over 100 powerful commands, and sophisticated "tuning" features.

You name it, you can picture it.

Available from:

Lifeboat Associates

(212) 860 0300

Trademarks: CP/M: Digital Research
GRAFTALK: Redding Group, Inc.

Circle 120 on Inquiry card.

2 AUTOGRAPH
Terminals and printers for graphics and alphanumerics, from DATATYPE.

The AUTOGRAPH terminal is based on the popular TeleVideo series. So you get all the terminal you need for your CP/M system's alphanumeric requirements.

We've added the logic necessary to make the terminal fully compatible with GRAFTALK. (With ISSCO's Tell-A-Graf and Tektronix graphics software, too.) And you can combine a graphic display with alphanumeric information. (We can even supply retrofits for your TeleVideo terminals.)

The AUTOGRAPH dot matrix printer is quiet, reliable, and fast. (You get up to 200 characters per second at only 54dba.)

The 7 x 9 dot print head will also produce draft-quality and correspon-

dence-quality letter characters. In the graphics mode you get a true hard copy of the graphics you create on your AUTOGRAPH terminal using GRAFTALK.

3 RESULTS
You can now put graphics to work to communicate your business information. Quickly, easily, and affordably. Your local AUTOGRAPH distributor can provide a demonstration of GRAFTALK and the AUTOGRAPH series.

Call or write DATA TYPE for more information and the name of your local AUTOGRAPH distributor.



DATA TYPE
2615 Miller Avenue
Mountain View, CA 94040
(415) 949-1053
Telex 172042

If you have second thoughts about mail order, call us first.

If mail-order shopping hasn't been everything you hoped for, look into Alpha Byte.

Our incredible low prices, our guarantee of satisfaction, our expertise — all as near as your phone.

All you have to do is call. A state-of-the-art microcomputer expert is standing by to answer your questions, offer advice, or take your order.

The rest is up to us. At Alpha Byte, orders are processed right now! Quickly and efficiently. In-stock merchandise is usually shipped within 24 hours. Sooner than you think, there'll be a surprise at your doorstep.

We make mail order quite painless and pleasant. Even fun. Call (213) 706-0333 and let us put

a little sunshine into your shopping.

16K RAM KITS . . . 13.95

Set of 8 NEC 4116 200 ns Guaranteed one full year

DISKETTES

ALPHA DISKS . . . 21.95

Single sided, certified Double Density 40 Tracks, with Hub-ring Box of 10 Guaranteed one full year

VERBATIM DATALIFE

MD 525-01 10, 16	26 50
MD 550-01 10, 16	44 50
MD 557-01 10, 16	54 95
MD 577-01, 10, 16	34 80
FD 32 or 34-9000	36 00
FD 32 or 34-8000	44 95
FD 34-4001	48 60

ATARI COMPUTERS

ATARI 800	699 00
ATARI 400 (16K)	329 00
ATARI 810 DISK DRIVE	449 00
ATARI 850 INTERFACE	449 00
ATARI 410 PROGRAM RECORDER	60 00
EPSON CABLE	35 00
MEMORY MODULE (16K)	89 95
JOYSTICK CONTROLLERS	10 00
PADDLE CONTROLLERS	19 95
STAR RAIDERS	35 00
MISSILE COMMAND	35 00
ASTERIODS	35 00

INTEC PERIPHERALS RAM MODULES

48K FOR ATARI 400	279 00
32K FOR ATARI 800	135 00

DISKETTE STORAGE

5 1/4" PLASTIC LIBRARY CASE	2 50
8" PLASTIC LIBRARY CASE	3 50
PLASTIC STORAGE BINDER w/ Inserts	9 95
PROTECTOR 5 1/4" (50 Disk Capacity)	23 95
PROTECTOR 8" (50 Disk Capacity)	29 95

NEC PERSONAL COMPUTERS

PC-8001A CPU	899 00
PC-8012A I/O	559 00
PC-8033A DISK I/O	125 00
PC-8031A DUAL DISK	899 00

ALTOS COMPUTER SYSTEMS

Call Alpha Byte for our low Altos prices

PRINTERS

ANADEX DP 9500	1295 00
ANADEX DP 9501	1295 00
C-I/OH 25 CPS PARALLEL	1440 00
C-I/OH 25 CPS SERIAL	1495 00
C-I/OH 45 CPS PARALLEL	1770 00
C-I/OH 40 CPS SERIAL	1870 00
EPSON MX-80	\$CALL
EPSON MX-80 F/T	\$CALL
EPSON MX-100 GRAPHIC	\$CALL
EPSON GRAFTRAX	90 00
IDS-445G PAPER TIGER	779 00
IDS-460G PAPER TIGER	945 00
IDS-560G PAPER TIGER	1195 00
NEC SPINWRITER 3510 S RO	2095 00
NEC SPINWRITER 3530 P RO	2095 00
NEC SPINWRITER 7710 S RO	2545 00
NEC SPINWRITER 7730 P RO	2545 00
NEC SPINWRITER 7700 O SELLUM	2795 00
NEC SPINWRITER 3500 SELLUM	2295 00
OKIDATA MICROLINE 80	389 00
OKIDATA MICROLINE 82A	569 00
OKIDATA MICROLINE 83A	799 00

OKIDATA MICROLINE 84	1199 00
OUME 9/45	2149 00
MALIBU 200 DUAL MODE	2695 00

CORVUS

FOR S-100, APPLE OR TRS-80 MOD I, III

Controller, Case/P.S., Operating System, A & T	
5 MEGABYTES	3245 00
10 MEGABYTES	4645 00
20 MEGABYTES	5545 00
MIRROR BACK-UP	725 00

APPLE HARDWARE

VERSA WRITER DIGITIZER	259 00
ABT APPLE KEYPAD	119 00
MICROSOFT Z-80 SOFTWARE	299 00
MICROSOFT RAMCARD	159 00
VIDEX 80 x 24 VIDED CARD	299 00
VIDEX KEYBOARD ENHANCER II	129 00
VIDEX ENHANCER REV D-6	99 00
VIDEX SDFT SWITCH	29 00
M & R SUPERTERM 80 x 24 VIDEO BD	315 00
NEC 12" GREEN MONITOR	199 00
NEC 13" COLOR MONITOR	399 00
SANYO 12" MONITOR (B & W)	249 00
SANYO 12" MONITOR (GREEN)	269 00
SANYO 13" COLOR MONITOR	469 00
SSM AIO BOARD (INTERFACE) A & T	165 00
SSM AIO BOARD (INTERFACE) KIT	135 00
ZENITH 13" HI RES GREEN MON	139 00
APPLE FAN	44 95
T/G JOYSTICK	54 95
T/G PADDLE	34 95
VERSA E-Z PORT	21 95
MICRO SCI A40 W/CONTROLLER	479 00
MICRO SCI A40 W/O CONTROLLER	409 00
MICRO SCI A70 W/CONTROLLER	629 00
MICRO SCI A70 W/O CONTROLLER	549 00
THE MILL-PASCAL SPEED UP	329 00
PROMETHEUS VERSACARD	229 00
SUPERCLOCK II	129 00

MOUNTAIN HARDWARE

CPS MULTIFUNCTION BOARD	199 00
SUPERTALKER SD200	259 00
ROMPLUS W/ KEYBOARD FILTER	179 00
ROMPLUS W/O KEYBOARD FILTER	130 00
KEYBOARD FILTER ROM	49 00
COPYROM	49 00
MUSIC SYSTEM	369 00
ROMWRITER	149 00
APPLE CLOCK	252 00
A/D + D/A	299 00
EXPANSION CHASSIS	625 00

CALIF. COMPUTER SYSTEMS

S-100 BOARDS

2200A MAINFRAME	459 00
2065C 64K DYNAMIC RAM	539 00
2422 FLOPPY DISK CONT & CP/M*	359 00
2710 FOUR SERIAL I/O	279 00
2718 TWO SERIAL/TWO PARALLEL I/O	269 00
2720 FOUR PARALLEL I/O	199 00
2810 Z-80 CPU	259 00

APPLE BOARDS

7710A ASYNCHRONOUS S INTERFACE	149 00
7712A SYNCHRONOUS S INTERFACE	159 00
7424A CALENDAR CLOCK	99 00
7728A CENTRONICS INTERFACE	105 00

VISTA COMPUTER CO.

APPLE 80 COLUMN CARD	329 00
APPLE 8" DISK DRIVE CONTROLLER	549 00

MODEMS

NOVATION CAT ACOUSTIC MODEM	145 00
NOVATION D-CAT DIRECT CONNECT	165 00
NOVATION AUTO-CAT AUTO ANS	219 00
NOVATION APPLE-CAT	349 00
UDS 103 LP DIRECT CONNECT	175 00
UDS 103 JLP AUTO ANS	209 00
HAYES MICROMODEM II (APPLE)	299 00
HAYES 100 MODEM (S-100)	325 00
HAYES SMART MODEM (RS-232)	249 00
HAYES CHRONOGRAPH	225 00
LEXICON LX-11 MODEM	109 00

TERMINALS

TELEVIDEO 910	639 00
TELEVIDEO 912C	745 00
TELEVIDEO 920C	830 00
TELEVIDEO 950C	995 00
ZENITH Z-19	799 00

TRS-80 MOD I HARDWARE

PERCOM DATA SEPARATOR	27 00
PERCOM DOUBLER II	159 00
TANDON 80 TRACK DISK DRIVE	429 00
TANDON 40 TRACK DISK DRIVE	289 00
LNW DOUBLER W/ DOSPLUS 3.30	159 00
M00 III DRIVE KIT	649 00

MORROW DESIGNS

FLOPPY DISK SYSTEMS

Controller P.S., Microsoft Basic, CP/M*	
A & T	
DISCUS 2D (Single Drive - 500K)	869 00
DISCUS 2D (Dual Drive - 1 MEG)	1499 00
DISCUS 2 + 2 (Single Drive - 1 MEG)	1099 00
DISCUS 2 + 2 (Dual Drive - 2 MEG)	1999 00

HARD DISK SYSTEMS

Controller, P.S., Microsoft Basic, CP/M*	
A & T	
DISCUS M10 (10 Megabytes)	3099 00
DISCUS M26 (26 Megabytes)	3749 00

ISOLATORS

ISO-1 3-SOCKET	53 95
ISO-2 6-SOCKET	53 95

BARE DRIVES

TANDON 5 1/4 INCH	
100-1 SINGLE HEAD 40 TRK	219 00
100-2 DUAL HEAD 40 TRK	299 00
100-3 SINGLE HEAD 80 TRK	299 00
100-4 DUAL HEAD 80 TRK	429 00

TANDON THINLINE 8 INCH

848-1 SINGLE SIDE	459 00
848-2 DUAL SIDE	549 00

MICRO PRO

APPLE CP/M*

WORDSTAR*	249 00
SUPERSORT*	145 00
MAILMERGE*	90 00
DATASCOPE*	215 00
SPELLSTAR*	169 00
CALCSTAR*	239 00

CP/M*

WORDSTAR	310 00
SUPERSORT	195 00
MAILMERGE	110 00
DATASCOPE	245 00
SPELLSTAR	195 00
CALCSTAR	169 00

MICROSOFT

APPLE

FORTRAN*	165 00
BASIC COMPILER*	315 00
COBOL*	595 00
Z-80 SOFTCARD	299 00
RAMCARD	159 00
TYPING TUTOR	17 95
OLYMPIC DECATHLON	24 95
TASC APPLESOFT COMPILER	159 00

CP/M*

BASIC 80	299 00
BASIC COMPILER	319 00
FORTRAN 80	369 00
COBOL 80	595 00

APPLE SOFTWARE

MAGIC WINDOW	79 00
APPLE PIE	99 00
QB MASTER (NEW)	179 00
PFS PERSONAL FILING SYSTEM	79 00
PFS REPORT	79 00
Z-TERM*	89 95
ASCII EXPRESS	63 95
HAYDEN APPLESOFT COMPILER	149 00
EASY WRITER-PRO	199 00
EXPEDITER II APPLESOFT COMPILER	73 95
A-STAT COMP STATISTICS PKG	119 00
SUPER TEXT II	129 00

CONTINENTAL SOFTWARE

G/L	199 00
A/R	199 00
A/P	199 00
PAYROLL	199 00
PROPERTY MGMT	199 00
THE HOME ACCOUNTANT	59 95

PERSONAL SOFTWARE

DESKTOP PLAN II	159 00
VISIPLOT	159 00
VISITREND/VISIPLOT	199 00
VISIDEX	159 00
VISITERM	129 00
VISICALC 3.3	159 00
VISIFILES	199 00

CP/M® SOFTWARE

THE WORD-SPELL CHECK	75 00
d BASE II	599 00
SUPER CALC	229 00
SPELLGUARD	239 00
P & T CP/M* MOD II TRS-80	175 00
COMM TERMINAL PROG	82 50
C BASIC 2	115 00
PASCAL Z	349 00
PASCAL MT +	439 00
PASCAL/M	205 00
SYSTEMS PLUS -	
G/L, A/R, A/P, P/R	1799 00
CONDOR I	579 00
CONDOR II	849 00

TRS-80 GAMES

TEMPLE OF APSHAI	34 95
HELLFIRE WARRIOR	34 95
STAR WARRIOR	34 95
RESCUE AT RIGEL	24 95
CRUSH, CRUMBLE AND CHOMP	24 95
INVADERS FROM SPACE	17 95
PINBALL	17 95
STAR TREK 3.5	17 95

MISSILE ATTACK	18 95
STAR FIGHTER	24 95

TRS-80 SOFTWARE

NEWDOOS/80 2.0 MOD I	139 00
LAZY WRITER MOD I	165 00
PROSOFT NEWSSCRIPT MOD I, III	99 00
SPECIAL DELIVERY MOD I, III	119 00
X-TRA SPECIAL DELIVERY MOD I, III	199 00
TRACKCESS MOD I	24 95
OMNITERM SMART TERM MOD I, III	89 95
MICROSOFT BASIC COMP FOR MOD I	165 00
LOOS 5.1	159 00

APPLE GAMES

PERSONAL SOFTWARE

CHECKER KING	21 95
GAMMON GAMBLER	21 95
BRIDGE PARTNER	21 95
MONTY PLAYS MONOPOLY	29 95
ZORK I	32 95
ZORK II	32 95
MONTY PLAYS SCRABBLE	34 95

BRODERBUND

GALAXY WARS	20 95
ALIEN RAIN (AKA GALAXIAN)	20 95
ALIEN TYPHOON	20 95
APPLE PANIC	24 95
MIDNIGHT MAGIC	29 95
SPACE QUARKS	24 95

AUTOMATED SIMULATIONS

INVASION ORION	20 95
STAR WARRIOR	32 95
TUES MORNING QUARTERBACK	25 95
CRUSH, CRUMBLE AND CHOMP	24 95
THE DRAGON'S EYE	20 95

MUSE SOFTWARE

ROBOT WARS	32 95
THREE MILE ISLAND	32 95
A B M	20 95
GLOBAL WAR	20 95
CASTLE WOLFENSTEIN	24 95

ON-LINE SYSTEMS

WIZARD AND PRINCES	29 95
MISSILE DEFENSE	25 95
SABOTAGE	20 95
SOFT PORN ADVENTURE	24 95
THRESHOLD	31 95
JAW BREAKER	24 95
CROSSFIRE	16 45
TIME ZONE	69 95

LISA 2.5	59 95
SUPERSCRIBE II	99 95

SIRIUS SOFTWARE

SPACE EGGS	24 95
GORGON	32 95
SNEAKERS	24 95
EPOCK	29 95
BEER RUN	24 95
HADRON	29 95

EDU-WARE

PERCEPTION PKG	19 95
COMPU-READ	24 95
STORY TELLER	18 95
COMPU-MATH ARITHMETIC	39 95
COMPU-MATH FRACTIONS	34 95
COMPU-MATH DECIMALS	34 95
COMPU-SPELL (REQ DATA DISK)	24 95
COMPU SPELL DATA DISKS 1-4, ea	17 95

MORE GREAT APPLE GAMES

COMPUTER QUARTERBACK	32 95
TORPEDO FIRE	49 95
THE SHATTERED ALLIANCE	49 95
POOL 1.5	29 95
ULTIMA	33 95
RASTER BLASTER	24 95
FLIGHT SIMULATOR	27 95
INTERNATIONAL GRAND PRIX	25 95
SARGON II	28 95
SHUFFLE BOARD	29 95
FIREBIRD	24 95
SNACK ATTACK	24 95
THIEF	24 95
ROACH HOTEL	29 95
JABBERTALKY	24 95

SUPPLIES

AVERY TABULABLES

1,000 3 1/2 x 15/16	8 49
3,000 3 1/2 x 15/16	14 95
5,000 3 1/2 x 15/16	19 95

FAN FOLD PAPER

(Prices F.O.B. S.P.)

9 1/2 x 11 18lb WHITE 3,000 ct	29 00
14 7/8 x 11 18lb WHITE 3,000 ct	39 00

CP/M is a reg. trademark of Digital Research

*Requires Z-80 Softcard

To order or for information, call:
(213) 706-0333

To use our 24-hour modem order line, call: (213) 883-8976.

We built a reputation on our prices and your satisfaction.

We guarantee everything for 30 days. If anything is wrong, return the item and we'll make it right. And, of course, we'll pay the shipping charges.

We accept Visa and Master Card on all orders: COD up to \$300.00.

Add \$2.00 for standard UPS shipping and handling on orders under 50 lbs. delivered in continental U.S. Call for shipping charges over 50 lbs. Foreign, FPO and APO orders, add 15% for shipping. Californians add 6% sales tax.

Prices quoted are for stock on hand and subject to change without notice.

Send for our hot new catalog.

**Alpha
Byte
COMPUTER
PRODUCTS**

31245 LA BAYA DRIVE, WESTLAKE VILLAGE, CALIFORNIA 91362

This catalog is a "must". Its unique 3-ring binder format lets you keep it up-to-the-minute current. We will provide you with additions or changes, as necessary, on a regular basis.

Four New Products from Radio Shack

by Chris Morgan

It was Christmas all over again on January 19 at Radio Shack in Fort Worth, Texas, where a quartet of major new products was unveiled during a day-long session. Some of the announcements were expected. Others were surprises.

The TRS-80 Model 16: Two Computers in One

The most significant announcement was for the new TRS-80 Model 16 computer, which contains a Motorola M68000 processor (see photo 1). Externally, the unit looks like

the TRS-80 Model II (in fact, the case is virtually identical to the Model II's), but the front bezel has been redesigned to accommodate either one or two slim-line 8-inch drives. Two of these drives fit into the same amount of space as a single, standard-width drive. The big surprise is that Model II owners will be able to convert their machines to Model 16s by adding two printed-circuit boards that together cost \$1499. But there's one limitation: the maximum RAM (random-access read/write memory) on the upgraded Model II system is

256K bytes, whereas the Model 16 allows the user up to 512K bytes of RAM on board.

The Model 16's most important feature is its built-in Z80 coprocessor with 64K bytes of its own memory that allows the user to run all existing Model II software. Radio Shack's simple but clever idea is to free up the 68000 processor by using the Z80 for disk and I/O routines. This has to be one of the most elegant answers to the question of 8- and 16-bit compatibility. The operating system (Radio Shack's own design) boots up like the Model II, but automatically enters the 16-bit mode. A simple keyboard message from the user switches the system to the Z80 mode.

Floppy Disks and Hard Disks

The slim-line floppy-disk drives are double sided and double density, with slightly more than one megabyte capacity each (formatted). Normally, a user would get only one floppy-disk drive for operating the Model 16 with a Radio Shack 8-megabyte hard-disk unit. Such a configuration (with the maximum 512K bytes of RAM) costs \$11,191—a bargain. By comparison, the least-expensive configuration, featuring 128K bytes of RAM and one disk drive (no hard disk), costs \$4999. This certainly gives the IBM Personal Computer some competition. (It should be kept in mind that the Model 16 lacks some of the IBM's features, such as color graphics.)

The announcement of the TRS-80 Model 16 gives the 68000 processor a firm footing in the 16-bit sweepstakes. (Can Apple be far behind with its 68000 design?) It's safe to say that the 16-bit era is underway.



Photo 1: Radio Shack enters the 16-bit market with the Model 16. While cosmetically very similar to the Model II, the Model 16 contains a Motorola 68000 processor and can address up to 512K bytes of memory. Two slim-line 8-inch floppy-disk drives can be installed in the same space occupied by one standard-width drive. When used in conjunction with Radio Shack's 8-megabyte Winchester hard-disk drive, one drive is sufficient. The Model 16 also contains a Z80 processor. Though normally used for disk I/O, the Z80 is employed in a Model II emulation mode and addresses its own 64K-byte memory. Upon booting up, the Model 16 automatically enters the 16-bit mode. A few simple commands place the machine in Model II emulation mode.

An Updated Pocket Computer

The PC-2 Pocket Computer is an improved version of the current TRS-80 Pocket Computer, now known as the PC-1. Like the PC-1, the PC-2, shown in photo 2, is manufactured for Radio Shack by Sharp, in Japan, and features a built-in real-time quartz clock; a 7-by-156 dot-matrix liquid-crystal display; an 8-bit processor operating at 1.3 MHz; a new extended BASIC package with two-dimensional arrays, built-in arithmetic functions, and variable-length character strings; a four-color printer-plotter/dual-cassette interface (more about this later); and a 60-pin I/O con-



Photo 3: Though cosmetically similar to the Model III, the DT-1 video terminal uses the same monitor section as the Model II. Communication is through an RS-232C port, and both serial and parallel printer ports are provided. Transmission rates of from 75 to 19,200 bps are supported, all through keyboard commands.

Photo 4: The DT-1 video terminal achieves new heights in configurable systems. Not only does the DT-1 have built-in provisions for emulating four popular terminals, it can also be programmed from the keyboard to emulate most other terminals with similar capabilities. Emulation and transmission parameters are stored in an EEPROM, which means, in effect, that the DT-1 programs itself. Parameters can be changed on a more temporary basis as well, without being programmed into the EEPROM.

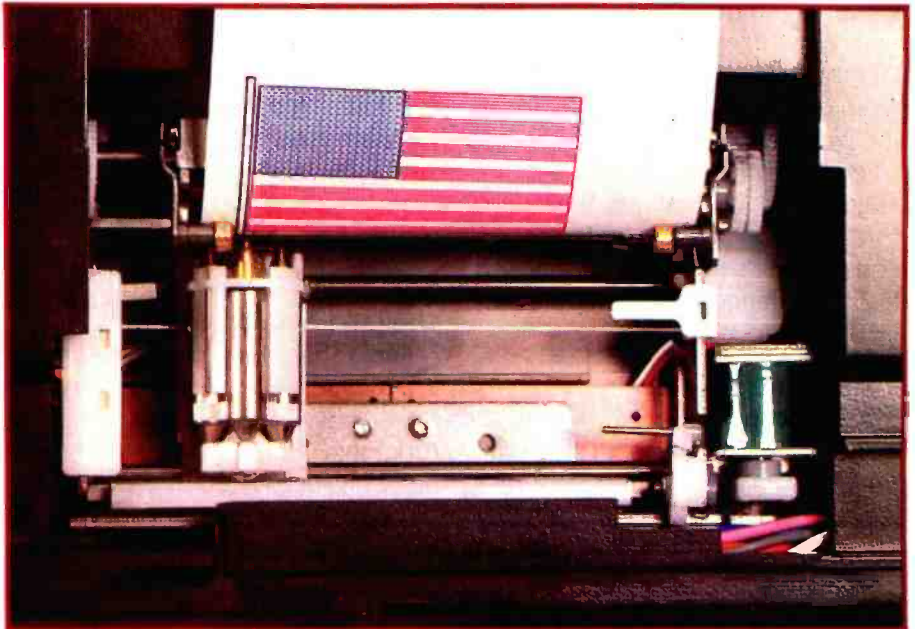

Photo 2: The PC-2 Pocket Computer from Radio Shack features an optional four-color PC-2 Printer/Plotter. The PC-2 contains 2.6K bytes of RAM and 16K bytes of ROM. Provision for a plug-in module allows an additional 16K bytes of RAM, ROM, or both. A 4K-byte RAM module is available for \$69.95. PC-2 peripherals are intelligent and contain additional RAM and ROM. The Printer/Plotter can produce nine sizes of characters and plot graphs and charts with a resolution of 0.2 millimeter.



necter that brings address data, interrupts, timing, and control signals to the outside world.

The basic PC-2, which retails for \$279.95, contains 16K bytes of ROM (read-only memory) and 2.6K bytes of RAM. There is provision for one additional plug-in module which may be RAM, ROM, or a combination of both. A 4K-byte RAM module is available for \$69.95, and an 8K-byte RAM will be introduced in the near future. The 8K-byte RAM is expected to cost almost as much as two 4K-byte modules. A 16K-byte RAM module is planned, but its introduction will depend on how quickly the price of 16K-byte CMOS RAMs drops.

Peripherals for the PC-2 will be intelligent and will contain their own RAM and ROM which will further extend the unit's memory capacity. An RS-232C interface plus software will also be introduced.

A Miniature Four-Color Printer/Plotter

The PC-2 Printer/Plotter is impressive. Packed into the unit's

minuscule chassis is a four-color plotter that "draws" letter-quality characters in nine different sizes on standard 2½-inch adding-machine tape and creates four-color graphs and charts (see figures 1 and 2). A small circular barrel holds the four miniature solenoid-selectable pens.

The PC-2 Printer/Plotter is not a toy; it is capable of plotting with a resolution of 0.2 millimeter! It features a simple, yet sophisticated paper-drive system that anchors one side of the paper tape with a small nubbed wheel. This arrangement allows the plotter to move the paper tape back and forth repeatedly by as much as 10 centimeters as it creates an image. In the character mode, the printer's average speed is 12 characters per second (see photo 2).

The DT-1 Video Terminal

Radio Shack has done some unique things with its new terminal entry, the DT-1, shown in photos 3 and 4. For a suggested retail price of \$699, you not only get an 80-by-24 character

display, serial-communication port, and both serial- and parallel-printer ports—you also get the built-in capability of emulating a number of other terminals, including the Televideo 910, Lear Siegler ADM-5, ADDS 25, and Hazeltine 1410. This is accomplished by simple commands from the keyboard; no DIP switches to set. All emulation parameters as well as transmission protocols such as word length and data rate are then stored in an EEPROM (electrically erasable programmable read-only memory). Thus, the DT-1 actually reprograms itself. Even when power is turned off, the DT-1 retains its emulation and transmission parameters.

As if that weren't enough, you have the ability to change any or all of the emulation and transmission parameters, which allows you to emulate a number of other terminals in addition to those that are built in. The cursor is programmable from the keyboard and may be either a steady or blinking block or underline. The video attributes include normal, reverse, invisible, blink, underline, and half intensity. Data rates from 75 to 19,200 bps are available. The black-and-white monitor section of the DT-1 is identical to that of the Model II computer.

High-Resolution BASIC Graphics Package for the Model II

A \$499 high-resolution BASIC graphics package that allows the user to create black-and-white graphics with a resolution of 640 by 240 pixels is now available for the TRS-80 Model II (see photos 5 and 6). The price includes a plug-in printed-circuit board with 32K bytes of on-board memory. Because the high-resolution graphics are generated from a separate memory, both text and graphics can be overlaid on the screen and each can be cleared separately.

The accompanying BASIC package features the same commands as the high-resolution BASIC for the TRS-80 Color Computer, except that only black and white can be chosen. Radio

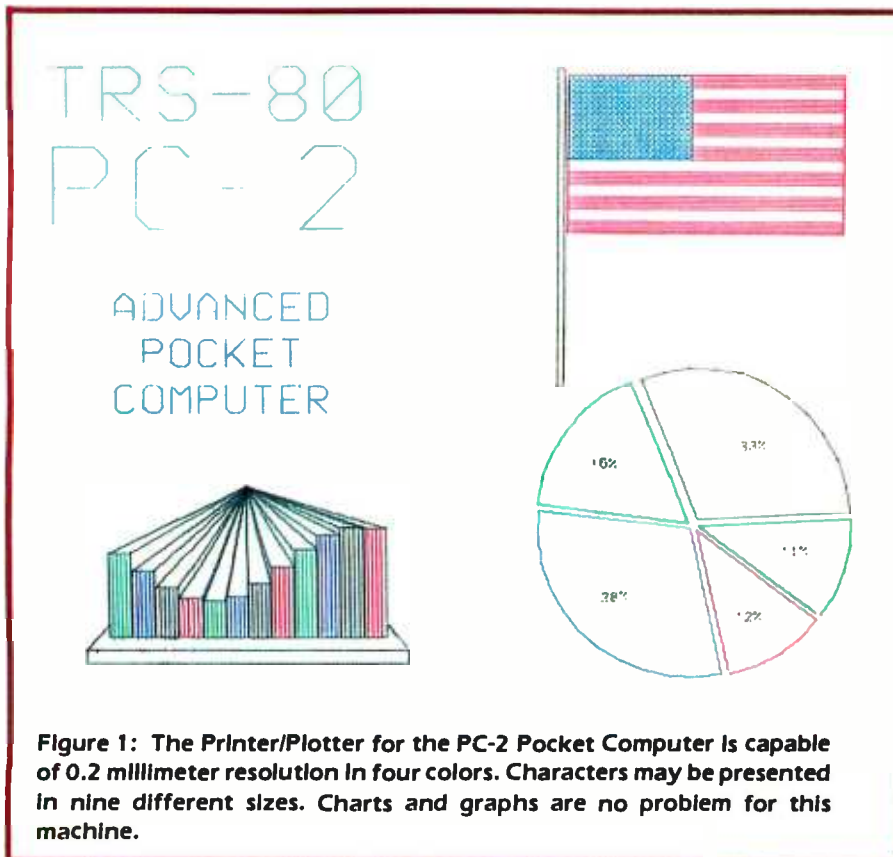

Shack is including a library of commands that allow you to pass parameters from COBOL, FORTRAN, or assembly-language programs—a nice touch.

Yet to come is a printer dump routine that lets the user dump the screen to the Radio Shack Lineprinter VIII. Note: In order to use the high-resolution BASIC graphics package, your Model II must have the latest CPU (central processor unit) board, because the original Model II CPU board has a different set of wait states than the graphics board requires.

Radio Shack will retrofit any Model II with the latest CPU board if you bring your computer to a Radio Shack computer center. The upgrade, if needed, is included in the cost of installing the graphics package.

Final Thoughts

These four new products from Radio Shack indicate both a continuing commitment from the company to the furthering of the state of the art, and reaffirmation of the company's refreshing entrepreneurial approach to new computer products. ■

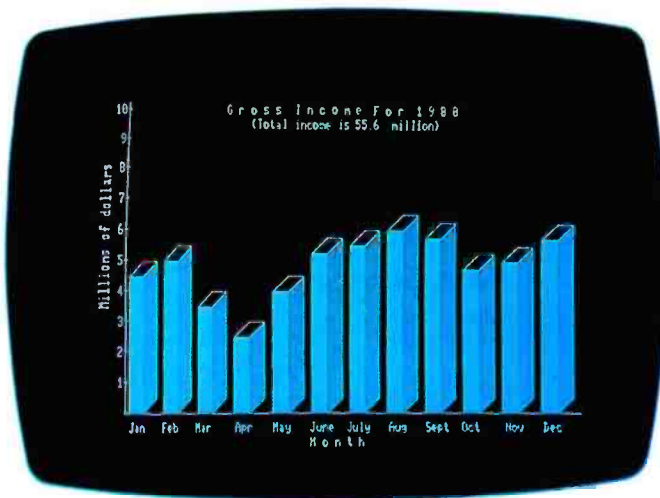

Photo 5: A bar graph produced with the Model II high-resolution graphics package. Both text and graphics can be mixed on the screen and selectively erased.

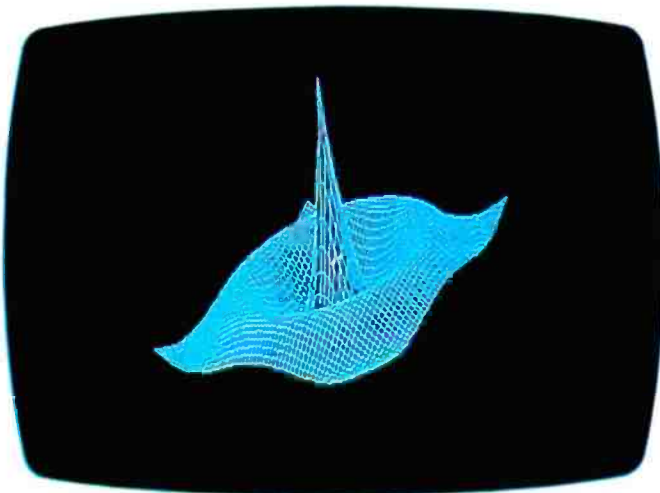
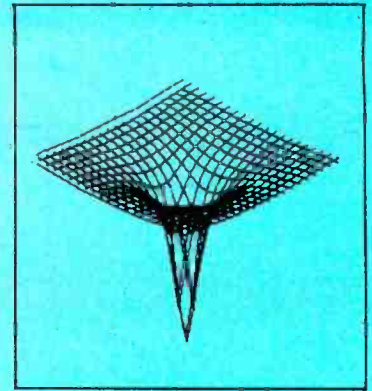

Photo 6: Another example of what is possible using the Model II high-resolution graphics package.



```

RANDOM : CLEAR
: DIM A$(1)*56.
DEGREE .WAIT 0
10: K=0: RESTORE 50
: FOR I=1 TO 10
: READ A$(1).
PRINT A$(1)
15: FOR J=1 TO 60: A
$=INKEY$ : IF A
$<>" "LET J=60
20: NEXT J
22: IF A$="" THEN 3
5
25: FOR J=1 TO 10:
IF MID$( "1234
ABCDEF", J, 1)=A
$LET K=J. J=12
30: NEXT J
31: IF KCLS : ON K
GOSUB 100, 2000
, 600, 800, 300, 4
00, 500, 700, 900
, 1000: GOTO 5
35: NEXT I: IF RND
(25)>2 THEN 10
40: K=RND (10). IF
K<>8 THEN 31
45: GOTO 10
50: DATA "1 - LCD
display & grap
hics", "2 - Fea
tures Banner",
"3 - Clock", "4
- Beeper"
55: DATA "A - 3-D
Bar Chart", "B
- Pie Chart",
" C - 2-D User B

```

Figure 2: Mixing text and graphics is easy with Radio Shack's new Printer/Plotter. Also shown is a partial BASIC listing.

Integral Data Systems' Prism Printer

Ed Umlor
E & G Umlor Enterprises
4 South Street
Milford, NH 03055

Integral Data Systems (IDS) has introduced an innovative printer called the Prism, whose modular design uses add-on options which let you upgrade the machine as needed.

The basic 80-column Prism is available for \$899 and yields correspondence-quality print using an overlapping 24 by 9 dot matrix. Printing bidirectionally at 110 characters per second (cps) (up to 150 cps for proportionally spaced characters) the Prism printer is capable of 10, 12, or 16.8 character-per-inch densities, plus double-width characters.

Selectable standard features on the basic printer include automatic text justification, programmable horizontal and vertical tabbing, reverse paper feed, and "fine positioning" of characters to 1/120 inch. Up to four different 96-character sets can reside within the printer at the same time, although the basic unit is provided with only one 96-character set.

The Prism is microprocessor controlled, with true logic-seeking capability. It comes with a standard RS-232C serial interface as well as a Centronics-compatible parallel interface. Serial transmission rates from 110 to 9600 bits per second (bps) are switch selectable.

Six upgrade kits can be added to the printer at any time making it one of the faster printers in its price category. (As a comparison, an 80-cps printer drops to about 60 cps in enhanced mode and 40 cps in double-strike mode.) The Prism does not have a double-strike mode, although it is capable of providing it with the proper software. You can do reverse linefeeds.

External Controls

A slot on the top left side of the printer exposes the self-test switch and the power-up configuration switches—a

At a Glance

Name

Prism Printer

Use

Dot-matrix printer

Manufacturer

Integral Data Systems
Milford, NH 03055
(603) 673-9100

Dimensions

80-column: 9.1 by 15.75 by 12.4 inches (23.1 by 40 by 31.5 cm)
132-column: 9.1 by 21.6 by 12.4 inches (23.1 by 54.9 by 31.5 cm)

Features

80 and 132-column models, 24 × 9 dot matrix, bidirectional printing at 110 to 150 cps, true logic seeking, automatic text justification, programmable horizontal and vertical tabbing, 96-character ASCII set, up to four character sets coresident, microprocessor controlled, RS-232C and Centronics-compatible interfaces.

Options

Cut Sheet Feeder, Dot Plot, Prism Color, Sprint Module, additional character sets, cassette for fully automatic sheet feed.

Price

80-column, basic unit, \$899; 132-column, basic unit, \$1299; Options available now: Cut Sheet Feeder, \$149; Dot Plot, \$99; Prism Color, \$399; Sprint Mode, \$99. To come: Additional fonts, \$99; cassette for automatic sheet feed, \$399. **Note:** Until April 1, 1982 only—Special Option Package: Cut Sheet Feeder, Dot Plot, and Sprint Mode, \$297.

Warranty

90-day limited

very nice touch in the design of the printer. Unlike most printers, you do not have to remove the cover or fumble with the unit to change the power-up parameters. Three switches located under this slot provide self-test on/off (a

A Closer Look

The Prism printer gave me several pleasant surprises. The early IDS Paper Tigers were some of the loudest printers I had encountered. When IDS engineers designed the 560—and now the Prism—they acoustically insulated the case and lowered the noise level to less than 63 dBA, a level suitable for most office environments. (By the way, the case for the Prism is identical to the one used on the 560.)

The print quality in the normal mode is excellent. Most other printers require an enhanced mode (move over ½ dot and strike again) or double-strike mode (reprint entire line) to achieve the same character quality. Furthermore, the Prism produces this type at 110 to 150 cps, and may be used in any combination. Cut Sheet Feeder, Dot Plot graphics, Prism Color, and Sprint Module upgrades are available now; special character sets and a cassette for fully automatic sheet feed will be available in the near future.

Control Line Form Length			
S3-1	S3-2	S3-2	Length (inches)
Off	Off	Off	3
Off	Off	On	4
Off	On	Off	3.5
Off	On	On	7
On	Off	Off	12
On	Off	On	11
On	On	Off	8.5
On	On	On	14
Control Line Serial Data Rate			
S3-4	S3-5	bits per second	
Off	Off	2400	
Off	On	300	
On	Off	9600	
On	On	1200	
Selecting Parity			
S3-6	S3-7	Parity	
Off	Off	No parity, transmit space	
Off	On	No parity, transmit mark	
On	Off	Even parity	
On	On	Odd parity	

Table 1: DIP switch 3, located on the top left-hand side of the printer and accessible through a slot located there, controls form length, data rate for the RS-232C interface, and the parity. Although the switch sets the default values upon power-up, they can be overridden by software commands.

toggle switch); print-parameter controls (DIP switch S4), and form-length and serial-interface-parameter controls (DIP switch S3). The self-test switch is nonactive with the lever to the left and active (only in the off-line mode) when the lever is to the right. S4-1 and S4-2 set the character density and characters per inch (cpi), OFF-OFF sets the 5-cpi mode (double-width mode), OFF-ON sets the 16.8-cpi mode (condensed mode on most other printers). S4-3 selects 6 lpi (lines per inch) when OFF or 8 lpi when ON. S4-4 controls the automatic boundary skip (so the printer skips over the perforations on fan-fold paper) of one inch. When OFF, S4-4 disables the skip; when S4-4 is ON the skip is enabled. S4-5 is the switch TRS-80 users will be interested in. ON enables the auto linefeed on carriage return and OFF disables the auto linefeed. S4-6 controls the default setting of the Sprint Mode and is not used in the basic Prism. S4-7 controls the expanded functions (IDS's name for software control). Once again, ON enables and OFF disables software control. The functions of DIP switch 3 are shown in table 1.

On the right side of the top of the printer are two switches and a marker plate with several indicator lights. The left switch is a three-position switch labeled FS/OFL/ONL (Forms Set/Off line/On Line). The right switch is a spring-loaded, center return (off position), two-position switch labeled FF/LF (Form Feed/Line Feed). The indicators are for fault, on line, and power on.

Software Control

Many software commands are available with the basic unit. Here is a complete rundown. A line feed, Ctrl-J or CHR\$(10), causes the paper/form to advance one line vertically. A form feed, Ctrl-L or CHR\$(12), feeds the paper/form vertically to the next top of form. A carriage return, Ctrl-M or CHR\$(13), causes the carriage to return without a linefeed (unless S4-5 is set to auto linefeed) after printing data in the buffer. These three controls will operate regardless of S4-7's position.

Now let's take the rest by the numbers:

- Ctrl-A or CHR\$(1): set expanded mode (double wide).
- Ctrl-B or CHR\$(2): reset expanded mode.
- Ctrl-D or CHR\$(4): set justify mode on (left and right margins are even).
- Ctrl-E or CHR\$(5): reset justify mode.
- Ctrl-F or CHR\$(6): set printer to fixed character space.
- Ctrl-I or CHR\$(9): tab to next set horizontal tab.
- Ctrl-K or CHR\$(11): tab to next set vertical tab.
- Ctrl-N or CHR\$(14): do two line feeds (double space vertical).
- Ctrl-P or CHR\$(16): print characters proportionally spaced.
- Ctrl-Q or CHR\$(17): reset the deselect mode.
- Ctrl-R or CHR\$(18): line feed without carriage return (S4-5's position makes no difference).

Ctrl-S or CHR\$(19): deselect printer (causes it to ignore data from computer).

Ctrl-T or CHR\$(20): do two line feeds without carriage return.

Ctrl-Y or CHR\$(25): do three line feeds without carriage return.

Ctrl-Left bracket or CHR\$(27): cause the printer to enter/exit the programming mode (This is called the escape code ESC).

Ctrl-Right bracket or CHR\$(29): set printer to 10 cpi.

Ctrl-Uparrow or CHR\$(30): set printer to 12 cpi.

Ctrl-Underscore or CHR\$(31): set printer to 16.8 cpi.

ESC F or CHR\$(27)+"F": program horizontal tabs in increments of 1/120 inch (1 inch = 120, 2 inches = 240, . . . etc). CHR\$(27);"F,120,240,600,\$" will set tabs at 1 inch, 2 inch, 5 inch points. You can set up to 8 tab points.

ESC B or CHR\$(27)+"B": set vertical tab 1 in increments of 1/48 inch. CHR\$(27);"B,24" will set a 1/2-inch vertical tab with only one point allowed. This is ADV-1 and defaults to 8 or 6 as S4-3 is positioned.

ESC C or CHR\$(27)+"C": same as ESC B but with a default value of 8, which is a 6-1pi subscript value.

ESC D or CHR\$(27)+"D": same as ESC B but with a default value of -8, which is a 6-1pi superscript value.

ESC E or CHR\$(27)+"E": same as ESC F but for vertical tabs (1/48-inch increments) and up to 8 values can be set.

ESC G or CHR\$(27)+"G": set the absolute head position from the home position in 1/120-inch increments.

ESC H or CHR\$(27)+"H": set absolute head position from top of form.

ESC J or CHR\$(27)+"J": set margins—two values are required, left margin first, then the right margin (1/120 inch).

ESC L or CHR\$(27)+"L": set vertical form length—two values are required, form length first and then the printable space within that length. This instruction works within the form-length switch settings (1/48 inch).

ESC P or CHR\$(27)+"P": sets the intercharacter spacing in increments of 1/24 character width.

In all the above instructions, a "\$" is required as the last character to terminate the instruction. Tabs may be cleared by setting a single tab to 0: CHR\$(27);"E,0,\$" clears the vertical tabs and CHR\$(27);"F,0,\$" clears the horizontal tabs. (I have deliberately not put the PRINT statement in these examples due to the variety of forms it can take. With the Apple computer you open the printer port and then use PRINT statements. With the TRS-80 you have to use LPRINT statements.)

Options

The \$149 Cut-Sheet option (what I call letterhead) adds friction feed to the Prism printer. Most printers that have a friction option force you to feed the paper from the top and manually advance it to the position where you want

Fig. 1A

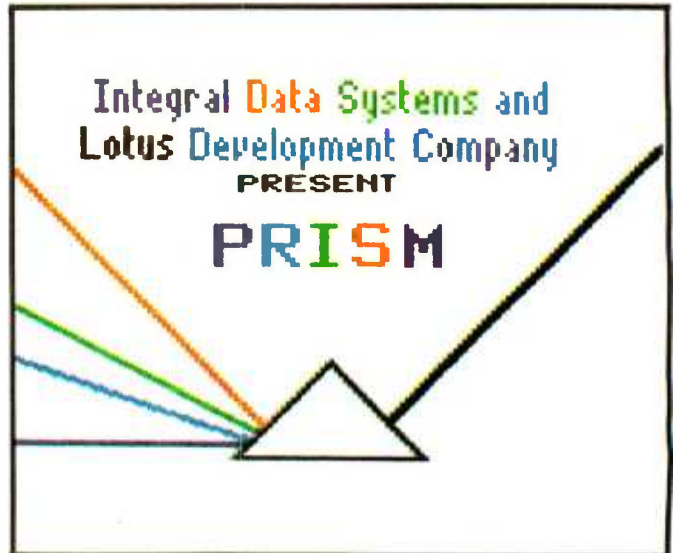

Fig. 1B

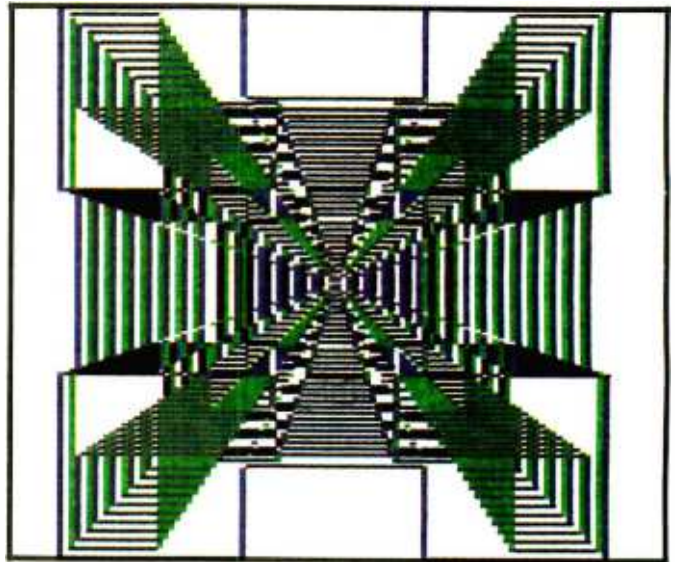
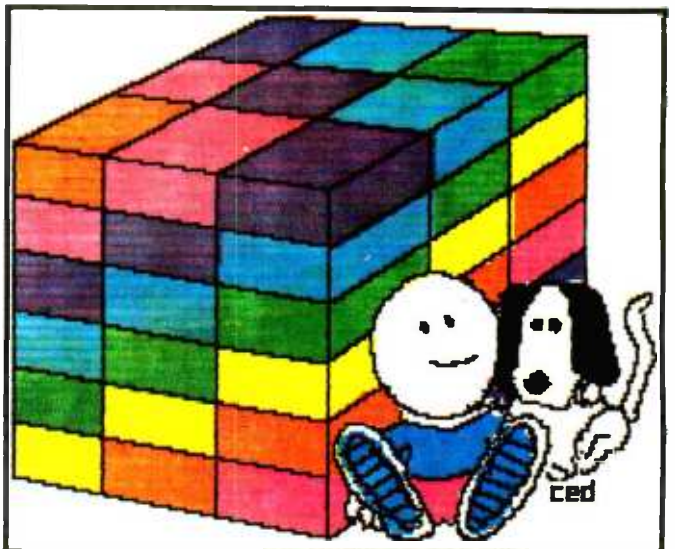

Fig. 1C



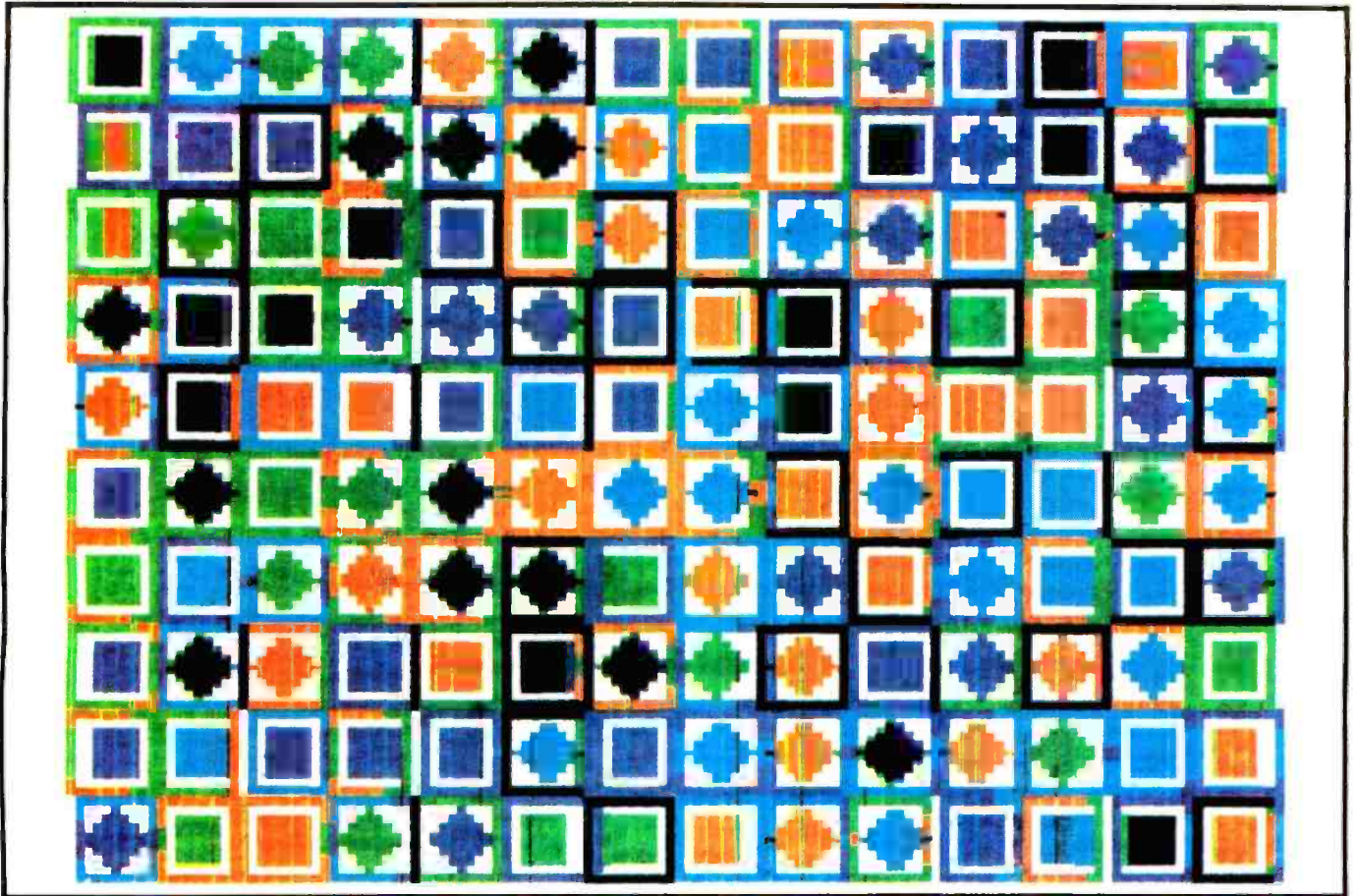

Figure 1: Four examples of color graphics. These were produced on a 132-column Prism printer with the Dot Plot and Prism Color options and the process-color ribbon. Graphics are dot addressable.

to start printing. If you are good at it, you won't have to square up your sheet. It is also very difficult trying to print to the bottom of the page with other friction-feed printers. The Prism's Cut Sheet option shows the same care in design as the rest of the unit. You can feed the paper from either the back or front of the printer. A photo sensor detects the paper being inserted. After a one-half- to one-second delay, the pinch rollers start to revolve, and if you have inserted the paper correctly it will feed and position the sheet to the first printable line on the paper. You might have to manually line feed past your letterhead, or you can handle that with your word-processing software. You will have to adjust the tractors on the printer to allow the paper to feed through them with the pins just to the outside of the paper. IDS has placed a set of pinch rollers into the tractors that are driven by the normal tractor-feed mechanism and continue to feed the paper after the bottom pinch rollers have been passed. With the out-of-paper sensor located at the print head level, this allows the printer to print clearly and evenly right to the last line on the page. A simple form feed will eject the letter completely from the printer. Very nice indeed for the office that does a lot of letters on standard letterhead bond.

Dot Plot is a \$99 dot-addressable graphics option package. The density is 84 by 84 dots per inch (dpi) for single-pass raster and 168 by 168 dpi for a four-pass raster. This option adds more control codes for you to play with. To enter the graphics mode you set switch S4-5 to ON and send a Ctrl-C (CHR\$(3)). You can also select unidirectional (default) or bidirectional graphics by sending Ctrl-L or Ctrl-V, respectively. To exit you use a Ctrl-C + Ctrl-B (CHR\$(3);CHR\$(2);). In the graphics mode you have to be careful to always end your BASIC instruction line with a semicolon to prevent the automatic generation of carriage returns and linefeeds, as these would be printed as graphic characters and mess up your picture. Seven wires of the print head are used in the graphics mode and are bit controlled. Bit 0 controls the top wire and bit 6 controls the bottom wire. Bit 7 is ignored. You also have vertical and horizontal control if you use the previously given codes prefixed by CHR\$(3).

Prism Color is a \$399 color-capability option that adds color designator control codes to your instruction set. The printer that I reviewed did not have this option, so my assumptions are based on the color ribbons that I saw. You will have a choice of three ribbons: black plus process colors for mixing, black plus primary colors, and

INTRODUCING AFFORDABLE COLOR The INTEGRAL DATA PRISM™ Printer

The PRISM COLOR PRINTER prints four basic colors :

COLOR #4=BLACK
COLOR #2=MAGENTA

COLOR #3=CYAN
COLOR #1=YELLOW

AND CAN MIX COLORS :

MIX #1+#2, ORANGE
MIX #2+#3, VIOLET

MIX #1+#3, GREEN
MIX #2+#4, BROWN

Versatile Printing Capabilities

- Correspondence quality print in a 24x9 matrix cell
- Six software selectable character sizes
- Auto sheet feed mechanism
- Adjustable tractor feed, 5.0 to 14.75 inches
- Programmable horizontal and vertical tabbing
- 6 or 8 lines/inch spacing
- 110-150 cps in correspondence quality
- 200 cps Sprint Mode in draft matrix quality

Microprocessor Driven Controller

- State-of-the-art technology
- Versatile features with programmable capabilities
- User defineable function codes

Ease of Operation

- Switch selectable baud rates
- Auto line feed capability
- Hardware/software selectable forms length
- Fault/Paper-out indicator light

Ready Serviceability

- Simple mechanisms for easy service
- Modular design provides for low MTTR
- Built-in diagnostics and Self-test mode

Interfaces for All Configurations

- Parallel (Centronics compatible)
- RS-232c (up to 9600 bd) with Xon/Xoff protocol
- 115/230 volts, 50/60 Hz power, switch selectable

DotPlot Graphics Capability

- High resolution raster graphics
- 84x84 dots/inch
- Includes 1500 byte character buffer
- Long-life cartridge ribbon system

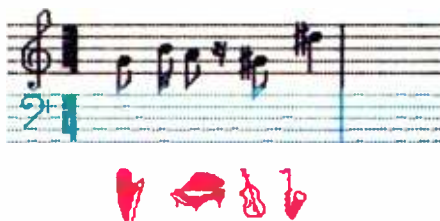

INTEGRAL DATA SYSTEMS
Milford, N.H. 03055
(603) 673-9100

Figure 2: Combining color with text. Color adds a new dimension to reports, manuscripts, and other documents. Combined with Dot Plot graphics, the possibilities are endless.

Use Voiceprints to Analyze Speech

Steve Ciarcia
POB 582
Glastonbury, CT 06033

Do you ever talk to your computer? I do. But it doesn't understand a word I say. That's just as well right now, because I talk to it mostly in moments of hardware-induced frustration.

Of course, the computer talks to me. If you've read my June and September 1981 Circuit Cellar articles, you know that my computers can talk using two different methods of voice synthesis. At present, a computer can synthesize speech much more easily than it can recognize speech.

Professional speech-recognition systems currently on the market can cost up to \$100,000. Budget-priced systems for personal computers are available for about \$500, but of course, they don't perform as well.

My mail has been full of requests from readers for a speech-recognition circuit. Most correspondents point out that such a project is a natural follow-up to the two articles on voice synthesis. Unfortunately, designing a cost-effective voice-input speech-rec-

ognition system is a major project; it not only requires a complete understanding of the techniques involved but also necessitates skills in the design of filter networks and intricate data-comparison algorithms.

The basic concept of speech recognition is rather simple: have a computer digitize the analog voice waveform of each spoken word and compare it to a stored reference vocabulary. A basic block diagram is shown in figure 1.

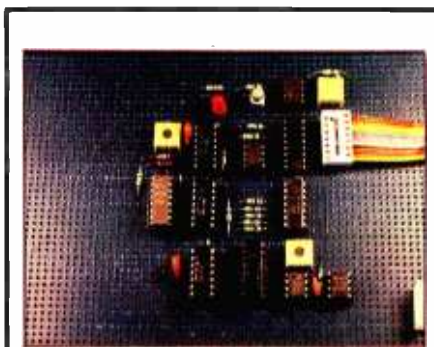

Photo 1: The sample and scanning circuit of figure 5b, constructed on a breadboard.

First, the analog voice input is amplified, then it is digitized to form a *word template*. This template formatting can be done by various techniques that include bandpass filters, A/D (analog-to-digital) converters, zero-crossing detectors, or fast Fourier analyzers. The result, whatever the technique, is a digital representation of the word spoken into the microphone. In an inexpensive speech-recognition system, this word template might be 10 bytes long, whereas in a \$100,000 system the template may have 10K bytes of data per word.

The input word template is then processed by a computer and compared to a series of templates stored in memory. The stored templates constitute the machine's vocabulary. A spoken word is deemed to be recognized when there is an exact or reasonably close match with one of the stored templates.

In practical speech-recognition systems, the size of the word template must be traded off against the amount of available memory or storage and the computing power of the processor. With a small template, the

words are not very well defined, and there is a considerable possibility that the computer will confuse two different words. On the other hand, large templates, which more precisely define the words, take considerably more time for comparison as well as more storage space.

To achieve reasonably fast recognition with large templates, the computer must digest information at prodigious speed. In professional speech-recognition systems, a typical processor might perform 1 million 16-bit by 16-bit multiplications per second. Creating such a number cruncher is expensive.

To build a speech-recognition system on a low budget, using a microprocessor, we must make some compromise either in the time allotted for the computer to recognize a word or in the precision with which words are defined in the templates. There must be some amount of storage between 10K and 10 bytes that defines a word sufficiently well for our low-cost speech-recognition system to recognize it within a tolerable duration.

Preliminary Research

This article doesn't tell you how to build a speech-recognition system.

We aren't ready for that yet. Instead, it describes a scheme to analyze the audible content of speech so that we can more accurately define a suitable template size.

A definition of just how much data is required can be determined only by carefully examining the spectral content of speech and analyzing the differences between the words we want to have the computer recognize. Just what is the audible difference between the numbers "six" and "eight"? Is there a unique set of data points that allows them to be easily differentiated?

In essence, the information we are looking for is a kind of fingerprint for speech, a *voiceprint*. (It may also be called a *spectrogram*.) By visually comparing the spectral voiceprints of words, we can perhaps come to understand details of definitive templates and the workings of comparison algorithms.

We may find that in a limited-vocabulary speech-recognition system the spectral differences between the words in the selected recognizable set may be so distinct that the template resolution can be reduced to perhaps less than 100 bytes. It is also possible that such an examination will demonstrate that a monumental effort must be exerted to distinguish between two words such as "seem" and "seen."

I hope to eventually write about a voice-response speech-recognition system. Such a project seems to lie

within the scope of a Circuit Cellar article. For the present, however, I am still researching certain information about the significant differences between words, seeking to answer such questions as: Must data on amplitude as well as frequency be recorded? Must the input word be digitized in real time? Can the stored template data be compressed in some way? What frequencies are important and which can be ignored? Is there much variation between different utterances of the same word?

This month's hardware project, a spectral voiceprint display, should help answer some of these questions.

What Are Voiceprints?

When you speak, the sound that comes out of your mouth is composed of various frequencies blended together to create the tonal quality that is unique to your voice. If you attach a microphone to the input of an oscilloscope and speak into it, you can watch the frequency and amplitude changes. The bandwidth of meaningful sounds for most voices is about 4 kHz. (Not coincidentally, this is the passband of a voice-grade telephone line.)

Another method of looking at the various frequencies present in voices is to produce a graph of speech waveforms showing frequency as a function of time. An example of this is shown in figure 2 on page 52. As the word "eight" is spoken, the majority of the energy is between 1 and 4 kHz

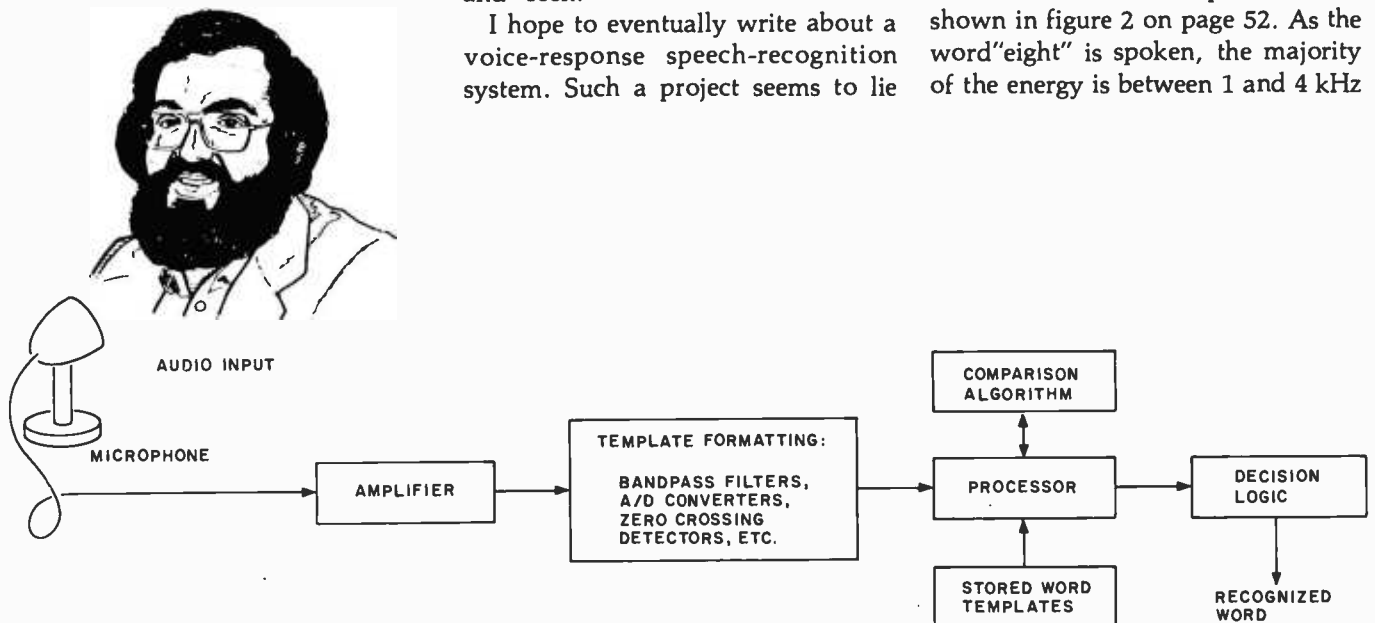

Figure 1: Block diagram of a computer speech-recognition system using word templates.

for the first 0.15 seconds, then a silent period is interrupted after another 0.15 seconds by a quick burst of energy at about 4 kHz. The first waveform group is the "eigh", and the final burst is the "t". A plot of the amplitude also provides significant information.

This sort of voiceprint or spectrogram shows a record of frequency and amplitude versus time.

Producing the graph shown in figure 2 requires an x,y plotter and a real-time spectrum analyzer. This equipment is costly and not generally available to the average experimenter, but with a little ingenuity we can obtain similar results with some simple bandpass filters and an oscilloscope.

Economy Voiceprint Display

The laboratory spectrum analyzer typically used to produce voiceprints often contains either a scanning filter or FFT (fast-Fourier-transform) processor. Such equipment has extremely high resolution (as well as cost) and allows the operator to resolve frequencies separated by only a few hertz (Hz). This is much more resolution than is required for our applica-

tion, and a more cost-effective real-time spectrum analyzer can be substituted.

Figure 3 is a block diagram of the hardware I used to record voiceprints. It consists of an eight-octave bandpass filter connected to a microphone and some timing circuitry. The outputs of the circuit are connected to the x-axis, y-axis, and blanking (z-axis) inputs of an oscilloscope. The result is a three-dimensional view of the spoken word. The x axis represents time, the y axis represents frequency, and the z axis (brightness) represents amplitude.

The plot thus produced looks somewhat different from the spectrogram in figure 2, but it is equally representative of spectral content. The eight filter sections cover eight octaves from 31 Hz to 4 kHz. Concentrations of energy in the eight octaves appear as eight bands across the display.

For example, if there are any frequencies present around 1 kHz, the 1-kHz band on the display is illuminated, appearing as a stripe across the oscilloscope screen. The amplitude of these frequencies governs the intensity of the stripe. If

this approximately 1-kHz signal is weak, the pattern will be dim; if it is strong, the pattern will be bright.

Figure 4 is an example of the kind of display produced by my interface circuit. This is approximately how the word "eight" appears when spoken. You'll note the grouping of energies corresponding to "eigh" and "t" as before. (There is also a shift in frequencies due to the fact that this display was produced by a different

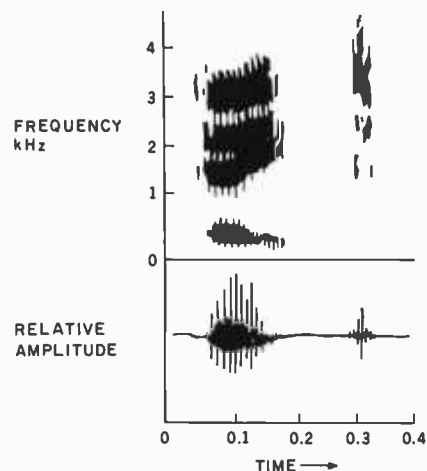

Figure 2: A conventional voiceprint, or spectrogram, of a man saying the word "eight." Frequency is plotted as a function of time.

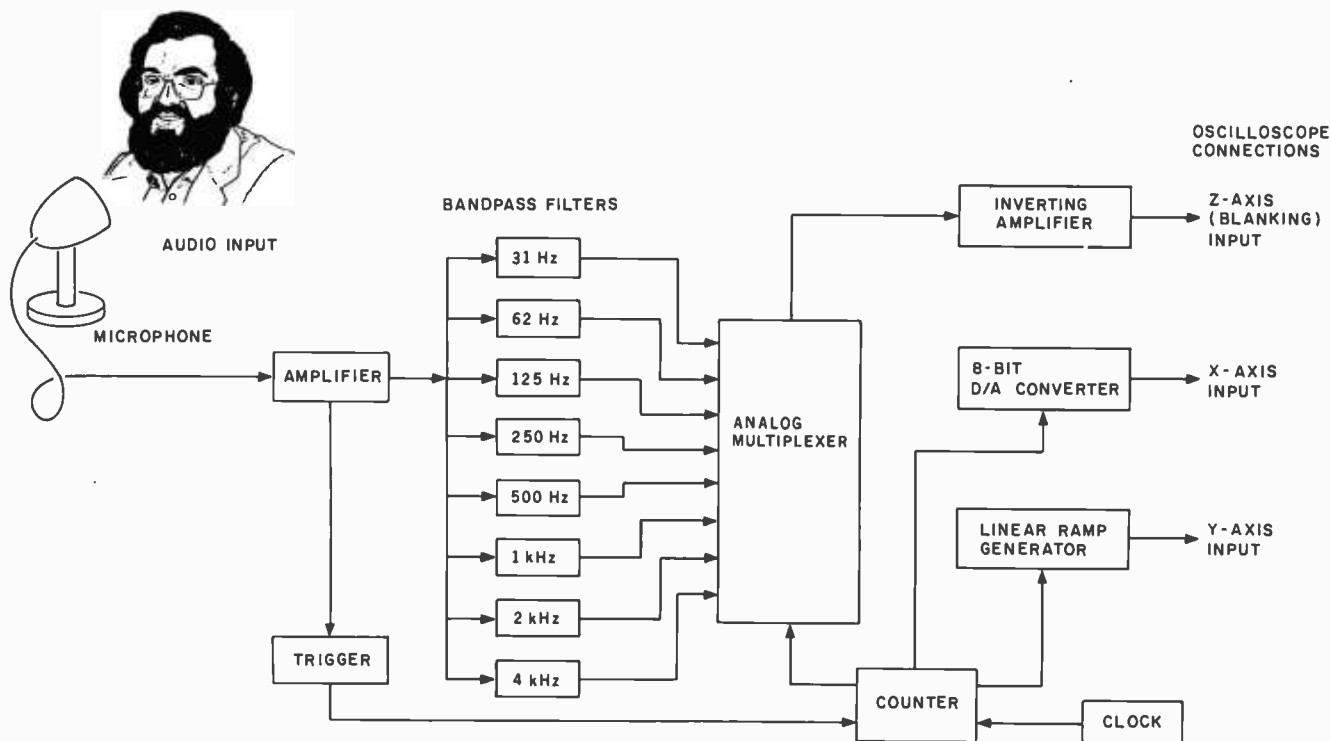

Figure 3: Block diagram of the Circuit Cellar voiceprint-recording system.

person speaking.) While unlike the ink-drawn spectrogram, it is equally detailed and unique.

On an 8- by 10-cm (centimeter) oscilloscope display, each frequency band occupies 1 cm on the vertical (y) axis. Time is recorded on the horizontal (x) axis where 1 cm corresponds to 0.05 seconds (all screen photos accompanying this article have these values). A complete word sample therefore represents sounds occurring during a one-half-second interval, consisting of 128 samples at each frequency. Changing the clock rate of the circuit can increase or decrease the scan time.

The scans appear as vertical lines on the screen. A full half-second sample consists of 128 vertical filter scans. Each vertical scan is divided evenly into eight sections corresponding to the eight filters. The bottom is 31 Hz, and the top is 4 kHz. The intensity of each segment of the scan line is determined by the output voltage of the particular filter: the more positive the output, the brighter the segment. If there is no output from a filter section during a segment interval, that portion of the segment will not be illuminated (it will be blanked). As configured, a half-second sample period scans the filters every 3.9 ms (milliseconds).

How the Display Circuit Works

Figure 5 is a schematic diagram of the voiceprint-display system. It is basically divided into two sections: amplifier and filters (figure 5a on page 56) and the sample and scanning logic (figure 5b on page 58). A prototype of the sample and scanning logic is shown in photo 1 on page 50. The ribbon cable leads off to the amplifier and filter board.

Integrated circuit IC1 is a two-stage microphone preamplifier (you could substitute a much simpler circuit; this just happens to be the one I used) feeding output into IC2b, which has a sensitivity adjustment potentiometer and an additional stage of amplification. IC2a is an average level indicator. While each filter responds only to its preset frequency passband, this portion of the circuit passes all

frequencies and produces a DC voltage output proportional to the average volume level. This output is fed to the voltage comparator IC9, which switches when the average input level is above a certain amplitude, thus triggering the sample period when pronunciation of the word begins.

Integrated circuits IC3 through IC6 are configured as eight separate band-pass amplifiers with center frequencies at 31 Hz, 62 Hz, 125 Hz, 250 Hz, 500 Hz, 1 kHz, 2 kHz, and 4 kHz. The filters are not particularly sharp, possessing a frequency rolloff of about 8 dB (decibels) per octave. The output stage of each filter contains an integrator that converts the pass frequencies into an average DC level.

The timing network appears more complicated than it is. For a half-second word sample the clock rate is set for 4096 Hz and is divided down through an 11-bit counter configured from IC14 and IC15. The reset lines of the counters are controlled by the trigger-level comparator IC9 and an RS (set-reset) flip-flop formed from IC7, sections c and d. When the circuit triggers, the reset line on the counters is raised to a logic 1, and they begin to count. After 2048 clock cycles, the flip-flop is reset and the scanning is stopped. A timing

diagram is shown in figure 6 on page 60.

The 3 least significant bits of the counter control the address lines of an 8-channel analog multiplexer, IC16. The eight inputs of the multiplexer are the eight outputs from the filters, and the output of the multiplexer goes to the oscilloscope. When the multiplexer address is binary 000, the 31-Hz filter output is channeled through it to the scope blanking input, where it controls the oscilloscope-beam intensity. Similarly, binary 111 addresses the 4-kHz filter. (While this eight-cycle scan occurs every eight clock periods, it is displayed only at alternating scans.) The other 8 bits of the 11-bit counter set the 256 positions of the x axis (128 displayed and 128 blanked positions).

(The output level of the multiplexer should be set for the blanking range of your particular oscilloscope. This can be either a positive or negative voltage. My oscilloscope, a Tektronix model 2215, requires a negative blanking voltage, so I added IC10 as an inverting amplifier.)

Since an oscilloscope is an analog device, the digital counter outputs must be converted to analog voltages. Two different methods are employed in this circuit. The 8 most significant bits of the 11-bit counter drive an

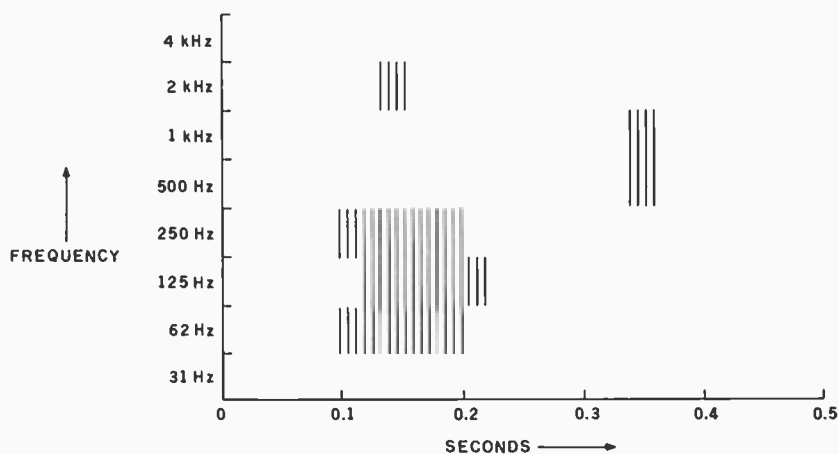
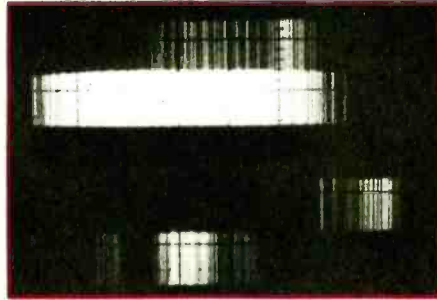

Figure 4: Typical display produced by the Circuit Cellar voiceprint system, of the word "eight." Although dissimilar in appearance to the conventionally plotted spectrogram of figure 2, it contains the same kind of information, along with indications of amplitude through modulation of the intensity of the scanning beam.

Photo 2:

Voiceprints, or spectrograms, of various words being pronounced by a Micromouth voice synthesizer, as recorded by the circuit of figures 5a and 5b attached to a Tektronix model 2215 oscilloscope. Eight frequency bands are defined in the vertical y axis, while the horizontal x axis gauges time elapsed during the sounding of the word. The amplitude of energy in the various frequency bands is indicated by the brightness of the oscilloscope trace.

a. on



b. off

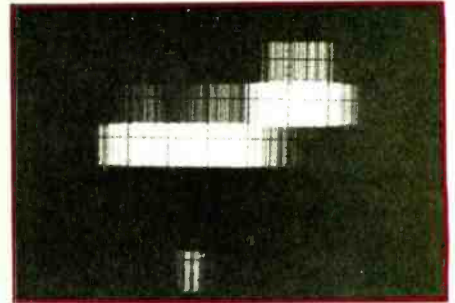

c. error

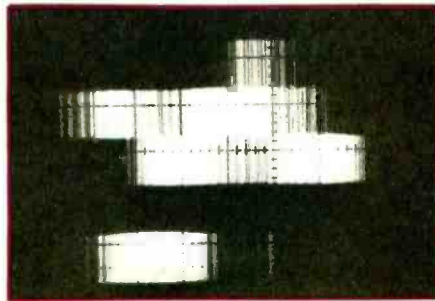

d. ready

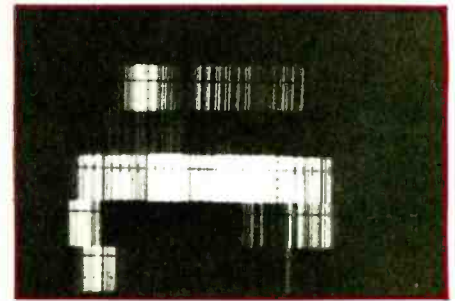

e. stop

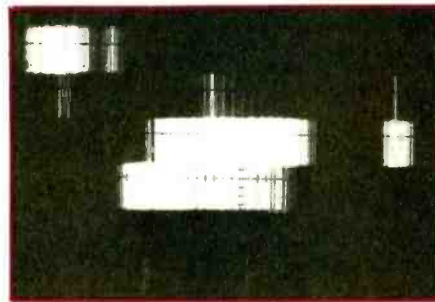

f. start

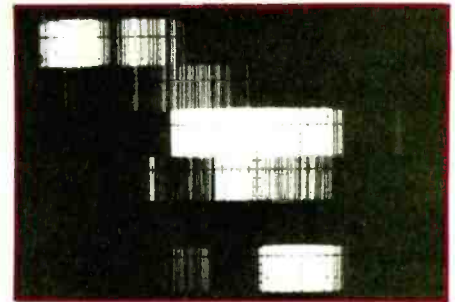

g. zero

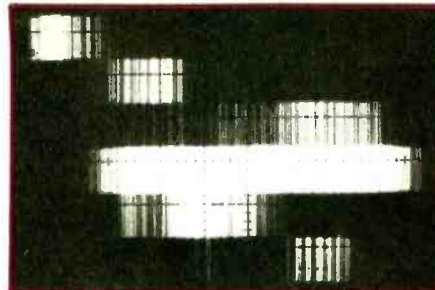

h. one

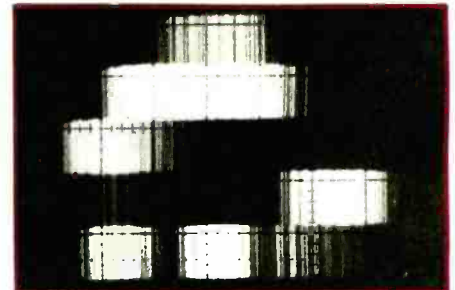

i. two

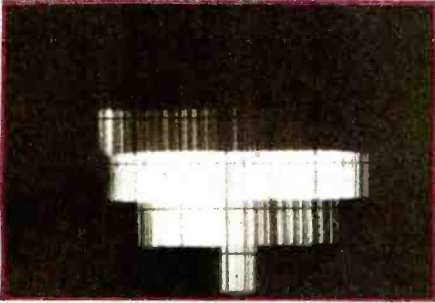

j. three

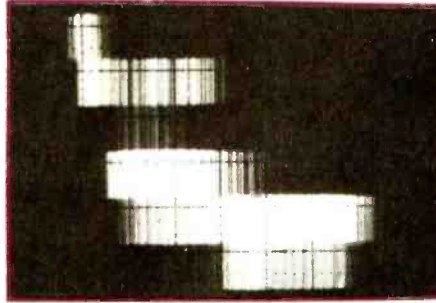

k. four

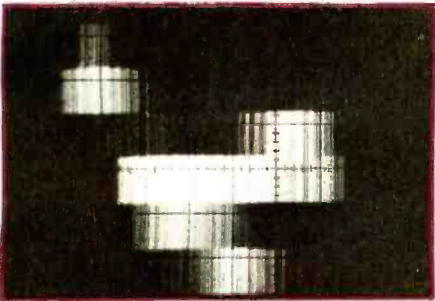

l. five

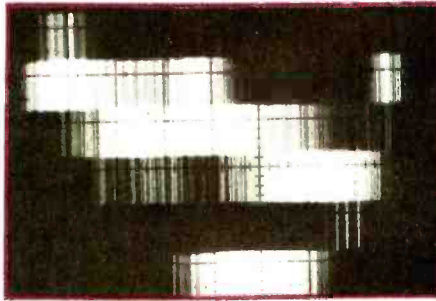

m. six

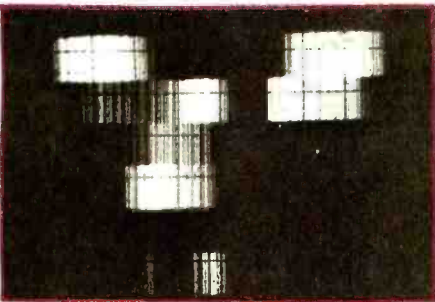

n. seven

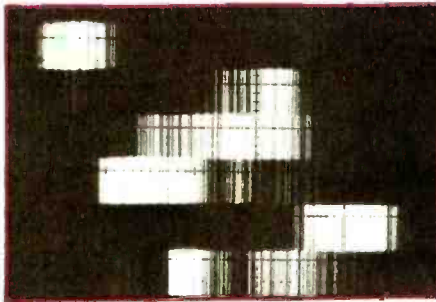

o. eight

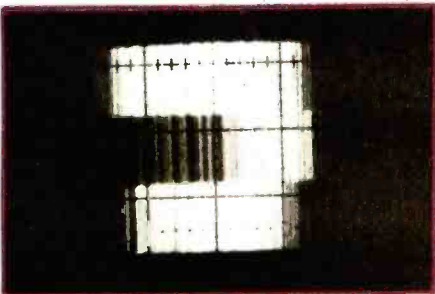

p. nine

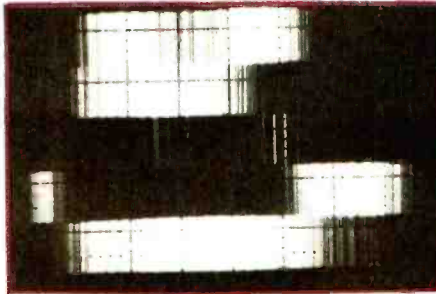

R-2R-ladder D/A (digital-to-analog) converter, which I discussed in my January Circuit Cellar article. With a count of 0, the output is 0 V (volts); with a count of 255, the output is +5 V. Therefore, each step is 19.5 mV (millivolts).

With a clock rate of 4096 Hz, the D/A converter increases its output voltage by an increment of 19.5 mV every 2 ms. With the scope set for *x,y*-vector display mode, the *x*-axis scope trace proceeds from the bottom left corner (0 V) to the bottom right corner (+5 V), taking half a second.

Initially I used a 3-bit D/A converter to increment the position of the *y*-axis beam. However, the 60-MHz bandwidth of the Tektronix scope was sufficient to cause each vertical scan to appear as eight dots rather than eight line segments. The scope was too fast. This was remedied by using a ramp-function generator configured from IC11 and IC17. IC11 is a positive-going integrator, and IC17 is a shorting switch connected across the integrating capacitor.

When the switch is closed, the output of IC11 is 0 V. This is the case during the odd-numbered scans, when the Q4 output of IC14 is high. On even scans the switch is open, and the capacitor is allowed to charge. As configured it charges linearly at a rate determined by the slope-adjustment potentiometer. This potentiometer should be set so that the output of IC11 (pin 6) goes from 0 V to 12 V during the 2-ms half period of the Q4 output. The clock rate affects this time period, so the slope will have to be readjusted if the clock frequency is changed.

Recording Voiceprints

After connecting the voiceprint-generating system to the scope, you can begin to experiment. Speak a word into the microphone. The beam will be triggered, and the trace will move from left to right across the screen. Slowly increase the input-sensitivity potentiometer until the background noise saturates the display. All filters will have some output, and the screen will be completely unblanked. Slowly back off

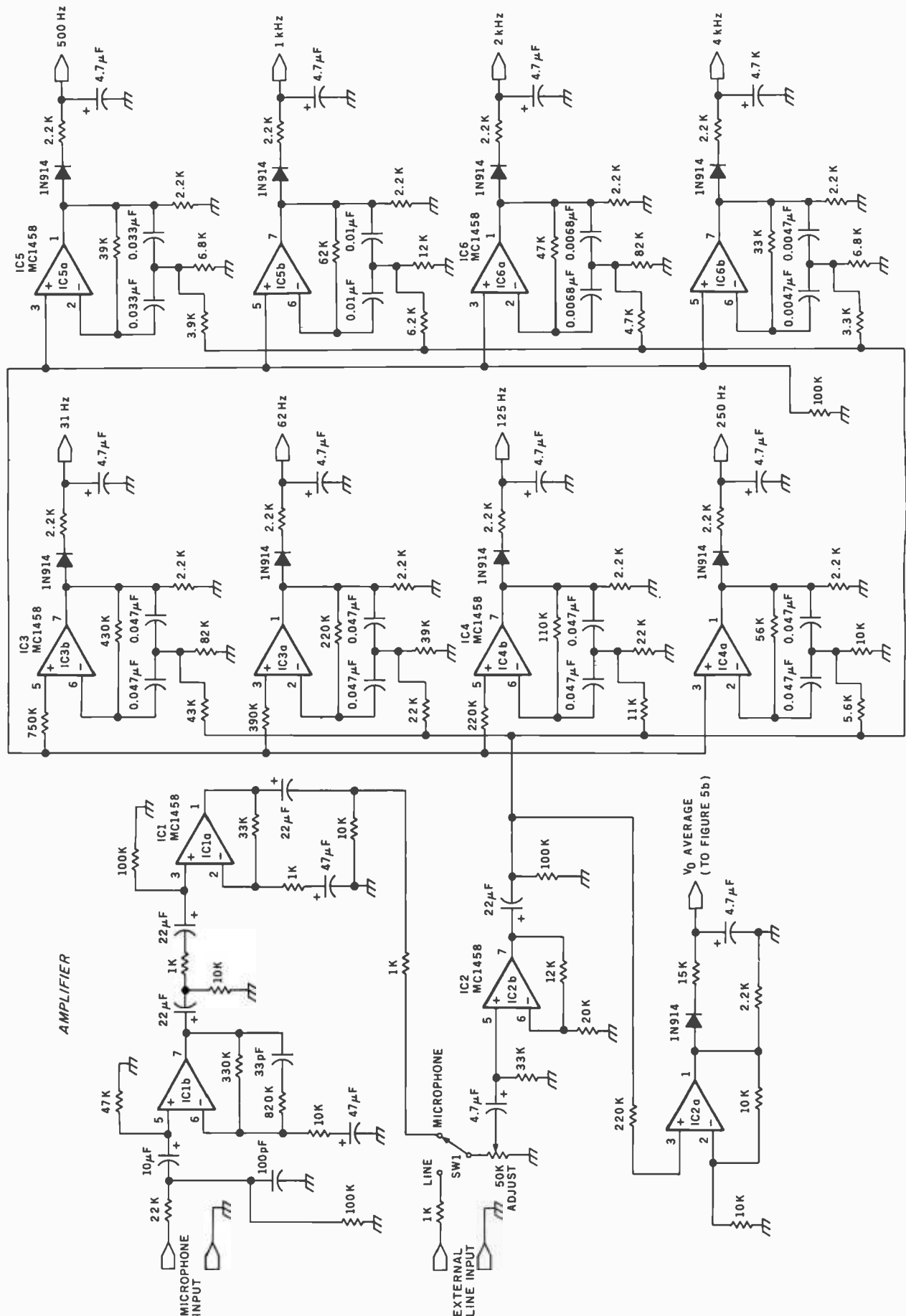

Figure 5a: Section of the schematic diagram of the spectral voiceprint circuit, showing the amplifier and bandpass-filter components. Eight passbands are selected by the filter stages, with the output sent to the scanning and display section of figure 5b.

FRIENDLINESS.

Informative HP manuals, helpful error messages, and automatic syntax checking make BASIC language programming easy.

EXPANDABILITY.

Just plug in the HP interface bus (HP-IB) and add up to 14 peripherals without disassembly.

FULL-SCREEN EDITING.

Edit the easy way – without retyping entire statements. Insert, change, or delete characters at the touch of a key.

12-DIGIT ACCURACY.

(Not just 9!) Thanks to BCD math capability.

HP SOFTWARE.

Powerful, time-saving solutions to your everyday problems.

PORTABILITY.

Keyboard, CRT, printer and storage – all in a 20-lb. package. So you'll have computing power wherever you need it... office, lab, field, or home.

INTEGRATED GRAPHICS.

Analyze a better way – with graphics. Document your results with hard-copy plots.



Hewlett-Packard put it all together.

The HP-85 personal computing system.

Leave it to Hewlett-Packard to put a lot of power in a little package. Plus flexibility, portability, and all the other features you'd expect to find in a personal, professional, integrated computing system.

Turn it on and the HP-85 is ready to go. You're off and running using HP software or creating your own programming solutions. There's no bootstrapping. And since the operating system and powerful BASIC language exist in ROM, they use almost none of the available RAM.

If you've been looking for a friendly, integrated

computer with power and dependability, look at the HP-85.

We put it all together for you!

For further information, phone toll-free, 800-547-3400, Dept. 276K, except Alaska/Hawaii. In Oregon, call 758-1010. Or, write Hewlett-Packard, Corvallis, OR 97330, Dept. 276K.

611/22

When performance must be measured by results.



HEWLETT PACKARD

New from HIPLØT™

multi-pen plotting for as little as \$1480*.



FCC class B tested.
UL listed.

the Houston way

The new HIPLØT DMP Series 6-pen option makes high performance multi-pen plotting affordable. It's available on the DMP 2, 3, and 4 models in the HIPLØT family so you can enjoy the advantages of multi-colored plots on 8½" × 11" (DIN A4) surfaces. Of course, you also get the standard HIPLØT range of capabilities such as intelligence, controls, interfaces and resolutions. There's a model for virtually every plotting application.



Big Performance in a Small Plotter
Since its introduction, the HIPLØT DMP Series has been recognized as the innovative plotter

line which made low-cost, high performance digital plotting a reality.

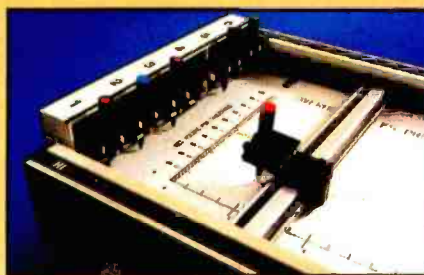

Now, with our new 6-pen option, there's an exciting new dimension in the DMP Series' versatility. Imagine two standard models with RS-232-C and parallel interfaces, four intelligent models with RS-232-C or Centronics® compatible interfaces, a choice of controls, resolutions, and pen speeds. Add to this the ability to plot with 6-pens on paper, vellum or mylar (ideal for overhead projectors) and you have the ultimate plotter price/performance combination — the perfect choice for the user or OEM.

8-Pen Models Also Available

If you need a little more capability, take a look at our new 8-pen option. It's available on the DMP 5, 6, and 7 so you can have 8-pen multi-colored plots on 11" × 17" (DIN-A3) surfaces.

Why wait? Let us send you complete information on this breakthrough in affordable, multi-pen plotting. Contact Houston Instrument, P.O. Box 15720, Austin, Texas 78761. (512) 835-0900. For rush literature requests, outside Texas, call toll free 1-800-531-5205. For technical information ask for operator #5. In Europe contact Houston Instrument, Rochesterlaan 6, 8240 Gistel, Belgium. Phone 059/27-74-45.

INSTRUMENTS & SYSTEMS DIVISION

Together...we'll create tomorrow.

BAUSCH & LOMB 

Circle 179 for literature.
Circle 180 to have representative call.

TM Trademark of Houston Instrument.
* U.S. Suggested retail prices.
Centronics® registered trademark of
Centronics Data Computer Corp.

PROOF READER™

The Aspen Software Company Spelling Checker



GRAMMATIK™

Beyond Spelling Checking

THE ONLY COMPLETE PROOFREADING PACKAGE

FOR ALL CP/M, MS-DOS, AND TRS-80 WORD PROCESSORS

We'll match Proofreader with any other spelling checker on the market. It has a big 38,000 word expandable dictionary, and can check even your largest documents in under four minutes. Proofreader looks up every word, and does not use less accurate root word analysis like some others. Full interactive correction is standard on CP/M and TRS-80 Model II systems, and is a low cost option for the TRS-80 Model I/III.

Spelling checking alone is not enough! No one else has anything like Grammatik! It analyzes your document for common typos, punctuation errors, misused phrases, and poor writing style. Grammatik is receiving rave reviews from both critics and users. Bob Loudon in *InfoWorld* (12/7/81): "Grammatik is a surprisingly fast and easy tool for analyzing writing style and punctuation. If you are currently doing original writing on a word processor, you should consider this product." Eric Balkan in *The Computer Consultant*: "I'm impressed with the imagination that went into this product." A user: "Thanks for making my life easier!"

Grammatik and Proofreader are compatible with all CP/M, MS-DOS (including IBM PC), and TRS-80 word processors.

Current CP/M formats:

standard 8", NorthStar, Omikron TRS-80.

Please call or write for details of minimum system sizes, and availability of additional disk and operating system formats. Shipping costs included.

Please specify your system configuration when ordering. Dealer inquiries invited.

MS-DOS versions scheduled for March 1982 release.

	Proofreader	Grammatik
CP/M, MS-DOS	\$129.00	\$149.00
TRS-80 Model II	\$99.00	\$99.00
TRS-80 Mod. I/III	\$54.00	\$59.00
(Model I/III interactive correction option - \$30.00)		

Trademarks: CP/M: Digital Research; TRS-80: Tandy Corp.; Proofreader, Grammatik: Aspen Software Co.



P.O. Box 339-B, Tijeras, NM 87059
(505) 281-1634

the gain until the display appears to respond as you speak a word. Continue this adjustment until the display looks like the sample photos.

In bright ambient light the display will appear as a single vertical line moving across the screen. If you darken the room, the persistence of the phosphor screen will allow you to see the entire voiceprint.

To record the voiceprint for posterity you will need a camera. In a darkened room, simply set the camera on a tripod, open the shutter manually, allow one sample to scan on the screen, and then close the shutter. This is essentially the technique I used to produce the sample voiceprint photos that accompany this article. Unfortunately, since the Tektronix 2215 has no reticule illumination, no scale is reproduced in the photos. Keep in mind that there are eight vertical filter bands and that the x axis is half a second.

Examples of my own voiceprints wouldn't be especially helpful to you in trying to align your voiceprint system, so I have provided examples that can potentially be duplicated and compared. All the voiceprint photos here were produced using the output of a Micromouth voice synthesizer. The Micromouth, which I described in my June 1981 article, uses a National Semiconductor Digitalker speech-synthesis chip set. It has a limited vocabulary which is extremely intelligible and eminently reproducible. If you have a Micromouth, simply connect it up

and compare your results to the various prints of words and numbers shown here.

Experimental Results

What can we learn from studying the results of our simple testing? First of all, the voiceprints of speech synthesizers and people are very different. While the words sound much the same to the ear, the frequency content is rather different. This difference should not bother a computer speech-recognition system so long as the word templates are set to recognize either synthesized or natural voices. But because of its repeatable speech, the synthesizer might provide a good way to initially test a speech-recognition system.

In general, there seem to be considerable spectral differences between the words in the minimum useful vocabulary I chose as examples. Because of the great differences, a speech-recognition system could use minimally precise template data to differentiate between these words.

Consider how a computer could store these voiceprints as word templates. An A/D converter could be used to read the filter values. Storing the output values from 128 scans of eight filters requires 1024 (1K) bytes for each word, assuming the use of an 8-bit A/D converter. The amount of memory required can be reduced by eliminating the dead air time at the beginning of words and between the sounds contained within a word.

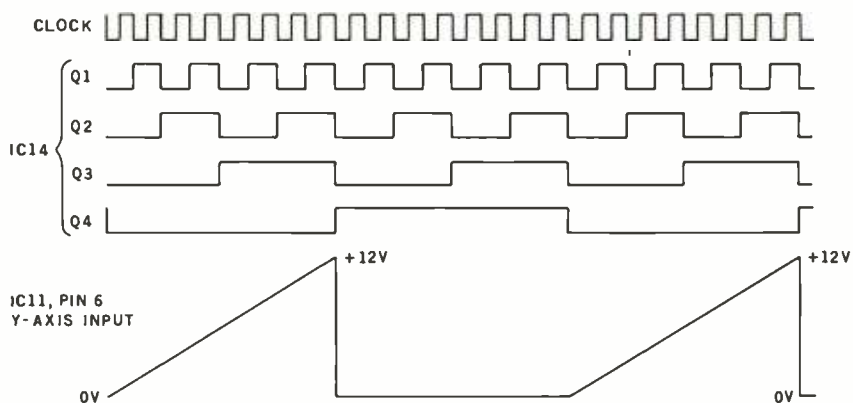

Figure 6: Timing diagram of the voiceprint-recording system.

MICRO-SCI IS IN THE GAME FOR ALL THE APPLES...

μ-SCI

μ-SCI



...WITH A FULL HOUSE OF 5 1/4" DRIVES

Micro-Sci has three disk drives and two controllers so you can configure your Apple II™ or Apple II Plus™ system to fit your individual budget and performance requirements.

THE FIRST ACE — A2

The new A2 is the price/compatibility substitute for the Disk II,™ intended as the second drive on an existing controller, or as a full A2 subsystem. The A2 drive or A2 subsystem is an ideal choice when the drives will be primarily used for entertainment or prepackaged software programs.

THE SECOND ACE — A40

The A40 is a price/performance alternative to the Disk II. With 40 tracks, you get an additional 20K bytes, and faster track-to-track access. The A40 is intended for use in dedicated DOS, CP/M and Pascal applications, and as a companion drive for the A70. The A40 is Micro-Sci's most cost-effective

disk subsystem for the Apple IIs.

THE THIRD ACE — A70

The A70 is the price/capacity alternative. At over a quarter million bytes per drive, the A70 has the capacity of two Disk IIs or on eight-inch floppy, but costs only slightly more than a single Disk II. One A70 supports a DOS file as large as 270K, a CP/M file up to 254K, and 560 blocks in Pascal.

THE PAIR — MICRO-SCI'S CONTROLLERS

The A2 comes with a unique new controller. This controller supports any combination of A2s or Disk IIs, you have complete flexibility.

The A40 and A70 share a common controller. Mix A40s and A70s in any fashion, one A40 with one A70, two A40s or two A70s — all on the same controller.

You can have a Disk II or A2 controller with

Disk II or A2 drives and still add an A40 or A70 subsystem. That's full system-level compatibility.

THE FAT HAND

Versatility, reliability, capability are assured when choosing Micro-Sci. Pick the drive, pick the controller, pick the capacity and function. Whatever your need, DOS 3.2, 3.3, Pascal, CP/M, games or pre-packaged software, Micro-Sci has the drive. Start wherever you choose with the knowledge that you can expand without concern. All Micro-Sci products are backed by a full 120-day warranty (parts and labor).

Our complete line of Apple compatible products makes us the dealer's choice. We're always looking for good dealers.

International dealer inquiries:
International Markets Co., Telex: 69-6191.
TELEX CO LSA

μ-SCI

MICRO-SCI

17742 IRVINE BOULEVARD • SUITE 205 • TUSTIN, CALIFORNIA 92680 • 714/731-9461 • TELEX: 910-346-6739

MICRO-SCI IS A DIVISION OF STANDUN CONTROLS, INC.

***APPLE II, APPLE II PLUS **DISK II ©APPLE, APPLE II AND DISK II ARE REGISTERED TRADEMARKS OF APPLE COMPUTERS, CUPERTINO, CALIFORNIA

www.americanradiohistory.com

Announcing 23 new Microboard products.

Now there are over 70
Microboard problem-solvers
from "Old Reliable"

The first color Microboard Computer
Development System.

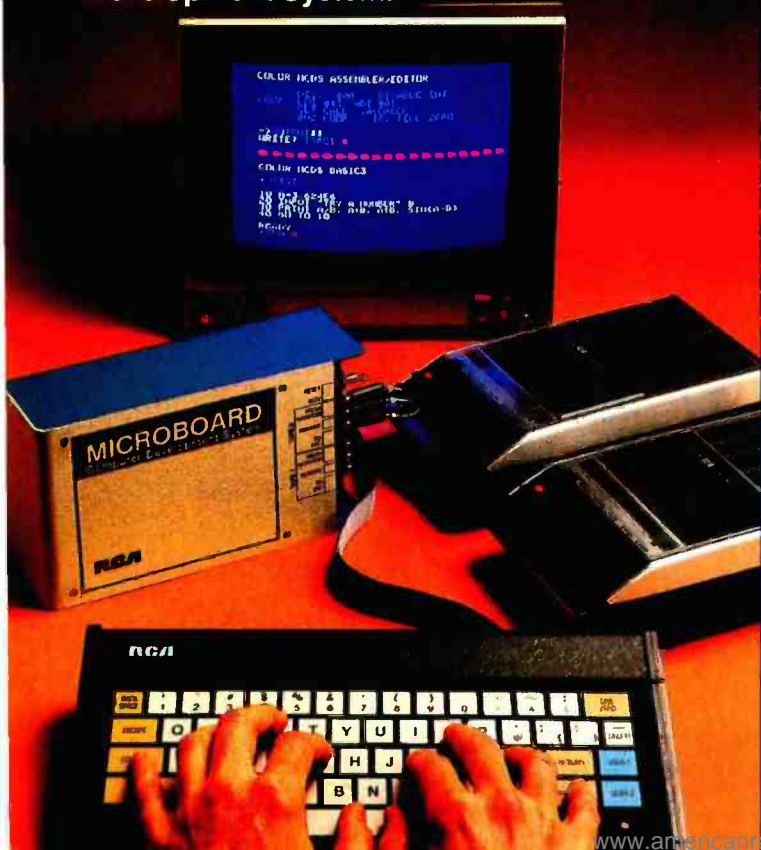

New Opto 22* I/O interface Microboard.

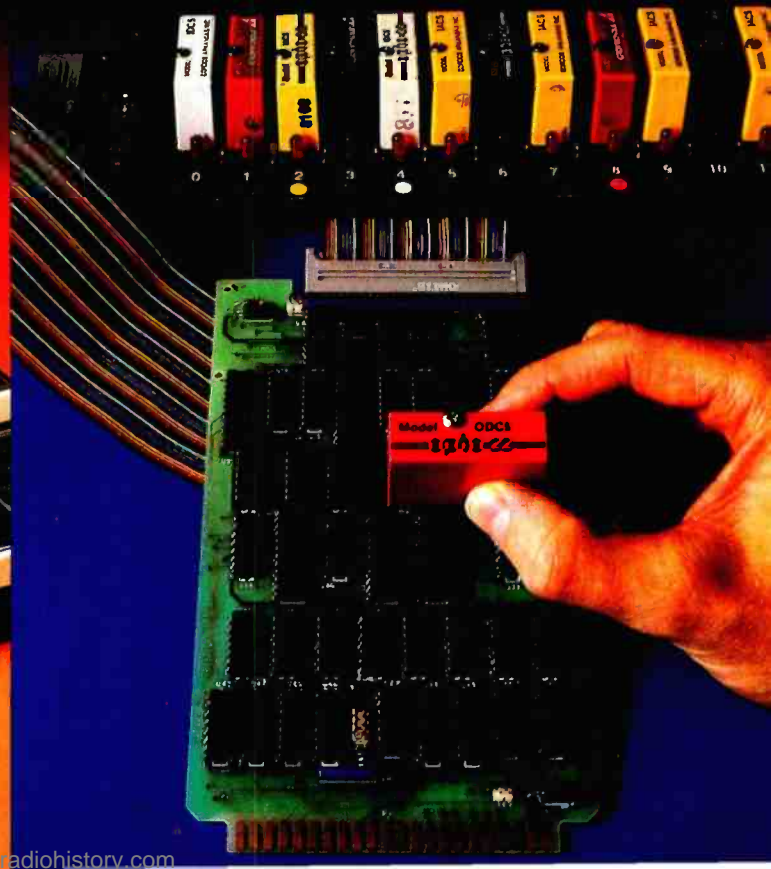

These new products will help you to use the power of board-level computers to solve many more of your application problems.

Color development system.

The first color development system for 1802-series microprocessors. Ideal for developing your own 1802 microprocessor, Microboard, or color video applications.

Software development and screen editing made easy by colors that distinguish your inputs from computer responses. Unique cursor, prompt, and background color identify Monitor and Program Development modes. Expandable with any RCA memory or I/O Microboard. Firmware includes floating-point BASIC3, ROM-based assembler/editor, and monitor.

The CDP18S695V1 comes complete with color monitor, full keyboard and promprogrammer for only \$1499.** Other models as low as \$499** at that price the system is an ideal BASIC language controller.

New I/O interface.

Opto 22* module interface Microboard CDP18S662 provides 24 bi-directional parallel I/O lines. Solves your power problems by interfacing directly with industry-standard optically isolated plug-in modules and racks.

Unique circuit design enables you to select the direction of each signal line. No Microboard changes or programming required.

Innovative built-in interrupt structure can be programmed to generate an interrupt in response to a change in one or more signal lines.

Five new Microboard computers.

Based on the new 1805 microprocessors with built-in counter/timers. The new counter/timer features include real-time event counter, pulse-duration timer and program decrement counter.

And these new microprocessors have 22 additional powerful instructions, including one-instruction call and return, and 4 instructions to load and store 16-bit words.

We've put these features of the 1805 to work for you on five new Microboards. Each is a complete computer system, with read-write memory, parallel and serial I/O ports (available on 4 of the 5), power-on reset, expansion interface and ROM sockets.

Ideal for solving your 1805 or 1806 microprocessor prototyping needs, or for systems requiring timers and counters.

Industrial chassis series.

Designed to stand up to tough industrial environments. Seven sizes, from 4 to 25 slots. Built-in Universal Backplane accepts all Microboards.

Mounting methods almost unlimited: 19" rack, NEMA enclosure, backwall mounting and even desk-top models.

Every industrial packaging problem known to us was carefully considered,

resulting in a really useful small, compact, front access, protected family.

Two initial optional modules make these chassis even more versatile: A self-contained, plug-in power supply that will accept 110-volt or 220-volt AC input to provide all logic and analog supplies needed for Microboard cards.

And a Microboard I/O module card which mounts into a 4-slot segment of the chassis, and holds up to 8 industry-standard optically isolated power modules in any mix of AC or DC input or output signals. Complete with mating 4-slot cover with barrier strips for power connections.

These new products are part of our ongoing commitment (39 new products in 1981) to develop and produce the devices you need to put the flexibility and power of board-level computers to work solving your problems.

And of course, our Microboards give you the bonus of CMOS low power and -40°C to +85°C operating temperature range at no additional cost.

For more information, contact any RCA Solid State sales office, representative or distributor.

Or call (800) 526-3862.

Circle 338 on Inquiry card.

RCA

*Trademark of Opto 22. **Optional U.S. distributor resale. RCA Solid State headquarters: Somerville, NJ. Brussels. Sao Paulo. Hong Kong.

Five new Microboard computers with 1805 microprocessors and counter/timers.

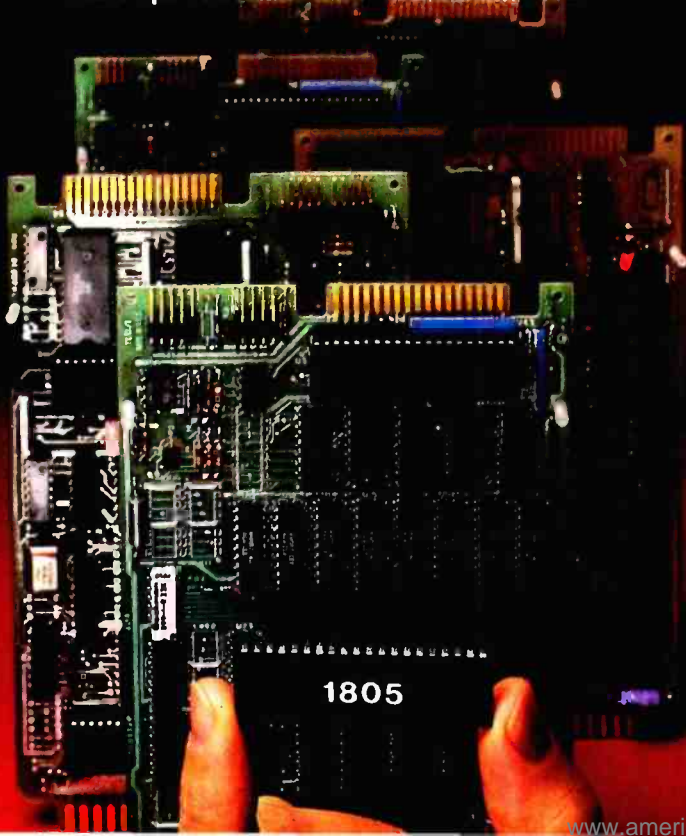

Rugged, versatile family of 16 industrial chassis and signal-conditioning Microboards.



DISCOUNT LINE

1-800-528-8960

GUARANTEED LOW PRICES

ADDS

Viewpoint — \$545

ALDOS

ACS 8000-15 — \$4150

ANADEX

9500 — \$1225 9501 — \$1225

ATARI

400 16K — \$349 800 16K — \$740

CENTRONICS

730 — \$600 737 — \$750

DATASOUTH

DS120 — \$595 DS180 — \$1269

DIABLO

630 — \$2095 1640 — \$2575

DISKETTES

Scotch — \$2.50 Dysan — \$3.50

EPSON

MX80 — \$449 MX100 — \$739

HAZELTINE

1500 — \$995 Esprit — \$675

INTERFACES

SSM-AIO — \$160 CPS-CARD — \$199

NORTHSTAR

HR64DD — \$2875 HR64QD — \$3150

LOBO

Apple Drive/Card — \$390/\$90
TRS80 Drive/Interface — \$390/\$90
Apple DD Drive — \$2740

MODEMS

HAYS-MICROMODEM — \$285

Novation-Cat — \$155

Penril - 300/1200 (212A) — \$795

MONITORS

Teco-BW — \$99 Teco Green — \$120

Sanyo-Green — \$249 Color — \$425

Amdek-Green — \$159 Color — \$350

MPI

88G — \$575 99G — \$675

NEC

7710 — \$2475 7720 — \$2875

SOROC

120 — \$729 135 — \$799

SOFTWARE

All Major Brands — \$CALL

TELEVIDEO

912 — \$669 950 — \$920

TI

810 — \$1240 820 — \$1795

OKIDATA

M80 — \$329 SL125 — \$3150

M82A — \$469 SL250 — \$4200

M83A — \$739 M84 — \$1099

APPLE EXTRAS

Memory-16K 200ns — \$19.95

Game Paddle Extension — \$14.95

Prototyping P.C. Board — \$19.95

CIOTH

25CPS-P — \$1320 45CPS-P — \$1699

ZENITH

Z19 — \$749 Z89 — \$2095

Arizona 1-602-246-1783

EXPOTEK CORPORATION

2231R W. Shangri La Rd.
Phoenix, AZ 85029

Perhaps storing the output amplitude of the filters is unnecessary, and a simple threshold detector would be sufficient. A logic 1 could indicate that there is some spectral content in that frequency range while a logic 0 indicates none. The eight instantaneous filter outputs could then be stored in a single byte rather than eight. This translates into a memory requirement of 128 bytes per sample period. This presumes that information about the frequency content of speech with respect to time is more important than information about the amplitude of the energy in the different frequency bands. I think it will depend a lot upon the vocabulary chosen.

Finally, I saw little activity in either the 31-Hz or the 4-kHz band in speech both from my own voice and from the Micromouth. This may be a limitation of the hardware, but I think it would be safe to eliminate these passbands from any voice-response system. In my experience, the three frequency ranges that seem to always contain the most energy are about 60 Hz to 200 Hz, 200 Hz to 500 Hz, and 1 kHz to 2 kHz. I am at present unwilling to design a speech-recognition system with only three sampling passbands, but I'm still gathering data.

In Conclusion

I haven't yet decided how I will configure my speech-recognition system. I have only one major design criterion so far: because writing comprehensive software algorithms isn't among my greatest pleasures in life, I will attempt to do as much in hardware as I can.

Perhaps if I stall long enough a few inexpensive integrated circuits that can do it all will emerge from Silicon Valley. I have heard promising reports on a few such products. I know of the intense interest many of my readers have in the subject, and I intend to build a speech-recognition system as soon as I can make it cost-effective.

I hope that this article has at least helped you understand some of the first steps in speech recognition. If

you are talented in software, you may have been inspired with an idea that will make the process easy. But at any rate, I hope to have helped allay any suspicions that computerized voice response is a black art.

Next Month:

New technological developments have made infrared light a convenient medium for remote-control or data transmission. We'll explore how to use it. ■

References

1. *Analog-to-Digital Conversion Handbook*. Norwood, MA: Analog Devices Inc., 1976.
2. Ciarcia, Steve. "Analog Interfacing in the Real World," *BYTE*, January 1982, page 72.
3. Ciarcia, Steve. "Build a Low-Cost Speech-Synthesizer Interface," *BYTE*, June 1981, page 46.
4. Ciarcia, Steve. "Build an Unlimited-Vocabulary Speech Synthesizer," *BYTE*, September 1981, page 38.
5. *Digital-to-Analog Converter Handbook*. Billerica, MA: Hybrid Systems Corporation, 1970.
6. Doddington, George R. and Thomas B. Schalk. "Speech Recognition: Turning Theory to Practice," *IEEE Spectrum*, September 1981, page 26.
7. Levinson, Stephen E. and Mark Y. Liberman. "Speech Recognition by Computer," *Scientific American*, April 1981, page 64.
8. Wiggins, Richard H. and George R. Doddington. "Speech Recognition Spurred by Speech-Synthesis Success," *Electronic Design*, July 9, 1981, page 107.

Editor's Note: Steve often refers to previous *Circuit Cellar* articles as reference material for each month's current article. Most of these past articles are available in reprint books from *BYTE Books*, 70 Main St., Peterborough, NH 03458. Ciarcia's *Circuit Cellar*, Volume I, covers articles that appeared in *BYTE* from September 1977 through November 1978. Ciarcia's *Circuit Cellar*, Volume II, contains articles from December 1978 through June 1980. Ciarcia's *Circuit Cellar*, Volume III, contains the articles that were published from July 1980 through December 1981.

To receive a complete list of Ciarcia's *Circuit Cellar* project kits available from the Micromint, circle 100 on the reader-service inquiry card at the back of the magazine.

The Performance Leader Model 925



Non-Glare Green Screen

Tilt and Swivel

Protected Fields

8 x 10 Character Resolution

Visual Attributes

Code Compatible with 912/920 and 910/950 TeleVideo Products

RS232C Printer Port

25th Status/User Line

Time of Day Character Sets (Spanish, German, French, English)

Now you can have it all with TeleVideo's new 925. Code compatible with our 910 and 950 terminals, the 925, with its 6502 microprocessor-based control board can emulate our 912/920 models while operating at speeds up to 19.2K baud. This allows you to grow within the TeleVideo family of terminals, from the conversational to the smart.

The 925, a modular designed unit that uses the same power supply, monitor, and keyboard as the rest of TeleVideo's family, has built-in *proven* reliability and quality from beginning to end. TeleVideo's P31 non-glare, tiltable, green screen and detached selectric style keyboard make the 925 a comfortable, low stress terminal to use.

They offer you options; we give you standard features like RS232C printer port, X-on/X-off control, 22 function keys, user line, 25th status line with setup mode, local duplex edit modes, and many more.

Nationwide service is available from General Electric Company Instrumentation and Communication Equipment Service Centers.

Contact TeleVideo today for information on the Performance Leader, the 925!



TeleVideo®

TeleVideo Systems, Inc.

1170 Morse Avenue, Sunnyvale, CA 94086
408/745-7760; 800/538-8725 (toll-free outside California)

The Value Leaders

CALIFORNIA Santa Ana (714) 557-6095 • Sunnyvale (408) 745-7760 • MASSACHUSETTS Boston (617) 668-6891
NEW YORK / NEW JERSEY Morris Plains (201) 267-8805 • TEXAS Dallas (214) 980-9978
ILLINOIS Bloomingdale (312) 351-9350 • GEORGIA Atlanta (404) 255-9338
EUROPE London 44-9905-6464

BYTE

TOLL-FREE
SUBSCRIPTION
LINE

**800
258-5485**

New Hampshire Residents Dial 924-9281

The Quickest Way To

- Order a Subscription
- Renew a Subscription
- Inquire about a Subscription
- Give a Friend a Gift Subscription
- Change or Correct an Address

We are waiting
to help you.

Call us between:
8:30-4:00 Mon.- Fri.
(Eastern Time)

1-800-258-5485

BYTE the small systems journal

CompuView

New ! CP/M-86 For IBM Personal Computer

The first available CP/M-86 for the IBM Personal Computer has the capabilities you need, including serial and parallel printer support, a 'smart' screen driver which can emulate most popular CRT terminals, 193K disk capacity and the facility to read/write the common XEROX 820 disk format. Innovative features include built in horizontal scrolling and screen line editing which lets you extensively edit or re-enter your typed lines to CP/M and application programs. (Available March 15, 1982)

CompuView CP/M-86 for IBM Personal Computer. . . \$325
VEDIT-86 with above purchase. \$100

8086 Software

- VEDIT full screen editor for CP/M-86, SCP 86-DOS and IBM Personal Computer. Disk and Manual \$195
- CP/M-86 BIOS for popular S-100 disk controllers and SCP 8086 computer. Source Code \$90

V-COM Disassembler

Finally a Z-80 disassembler for CP/M which produces easy to read code, a cross reference table and handles INTEL and ZILOG mnemonics. V-COM is exceptionally fast and produces an .ASM file directly from a .COM file. V-COM can accept two user created information files. One contains assignments of labels to 8 and 16 bit values; the second specifies the location of tables and ASCII strings. The resulting .ASM file will then contain labels and proper storage allocation for tables and strings. Each information file may contain nested 'INCLUDE' to other files. Each package includes a 30 page manual, sample program files and variations of V-COM compatible with the TDL, MAC and two types of ZILOG assemblers. \$80

PIICEON 24x80 S100 Video Board

The PIICEON V-100 offers memory mapped speed, but being I/O mapped, uses no memory space nor bank select. Lower case descenders, hardware scrolling and other features. Fully assembled with 1 year warranty by PIICEON the company known for reliability.

PIICEON with software driver. \$470
PIICEON board only. \$450

Software

An Industry Standard for CP/M & 8086



Uniquely User Oriented

VEDIT is user oriented to make your editing for program development and word processing as fast and easy as possible. The customization (installation) process makes VEDIT the only editing package that allows you to determine your own keyboard layout and use any available cursor and function keys. Just think of the difference it makes in your ease of learning and usage to type cursor and function keys instead of memorizing obscure control characters. This customization is menu driven, extends to much more and takes only a few minutes.

Unequaled Hardware Support

The CRT version directly supports over 35 terminals (including ANSI standard) in its installation menu and utilizes 'smart' terminal features such as line insert/delete, reverse scroll, status line and reverse video. Function keys on terminals like the Televideo 920/950, Heath H19, and IBM 3101 are all supported. The memory mapped version is extremely flexible, supports bank select such as on the SSM VB3 and screen sizes up to 70 X 200.

Sophisticated Full Screen Editing

VEDIT gives you true 'what you see is what you get' full screen editing with an extensive set of features for creating and editing standard text files of up to one diskette in length. Very large files are effortlessly handled by VEDIT's ability to edit up to 47K of a file entirely in memory without performing any slow and annoying disk accessing. And you can handle multiple files, insert a specified line range of another file anywhere in the text and even change diskettes.

User Oriented Features

You get the features you expect, like searching, a scratchpad buffer for moving and rearranging sections of text, complete file handling on multiple drives and flexible macros. For ease of use VEDIT has features you won't find elsewhere, like automatic indenting for use with structured languages such as Pascal and PL/I. You are less likely to make a mistake with VEDIT, but if you do, one key will 'Undo' the changes you just made to a screen line. And if you run out of disk space with VEDIT, you can easily recover by deleting old files or even inserting another diskette. It is therefore no surprise that VEDIT is the industry standard for program development editing.

Word Processing

VEDIT is suitable for simple stand-alone word processing, or it may be used in conjunction with a text processor. Its features include word wrap, adjustable left margin, reformatting of paragraphs, word oriented cursor movement and deleting, and imbedding of printer control characters. VEDIT can print any portion of your file and display the cursor's line and column positions.

Now for
IBM
Personal Computer
XEROX 820

Ordering

Please specify your micro-computer, video board or the CRT terminal version, the 8080, Z80 or 8086 code version and disk format.

VEDIT - Disk and manual
For 8080 or Z80 \$145
For CP/M-86 or IBM MDOS . \$195
Manual only \$15

VISA and MASTER CARD Welcome.

Apple II Softcard • TRS-80 II and I
SuperBrain • Heath H8/H89 • Altos
NorthStar • Vector • MP/M • IBM

1955 Pauline Blvd., Suite 200
Ann Arbor, Michigan 48103
(313) 996-1299

CompuView

PRODUCTS, INC.

CP/M and MP/M are registered trademarks of Digital Research, Inc. Apple II is a registered trademark of Apple Computer, Inc. Softcard is a trademark of Microsoft. TRS-80 is a trademark of Tandy Corporation.

BYTES ARCADE

Apple Panic

Gregg Williams
Senior Editor

Personality—it's a major factor in distinguishing arcade best-sellers from the ones that lie around gathering dust in a corner. In coin-operated arcade games, it is not the only factor in determining success—anything with enough color, sound, and action will attract an adequate following. However, personality is a greater factor in microcomputer-based arcade games because they have fewer distracting frills. Of the many games I've seen in the past six months, Apple Panic has far more personality than any of several equally well-done games for the Apple II or II Plus microcomputers. Additionally, Apple Panic is an original game. It is not just a simplified copy of a coin-operated game. As a game that's available *only* for microcomputers, you can show it off to coin-op game snobs.

Like many successful arcade games, Apple Panic has a simple but eccentric premise. Your player is trapped in a world of walkways and ladders. The objective is to keep your player alive as long as possible. Of course, no arcade game is complete without a merci-

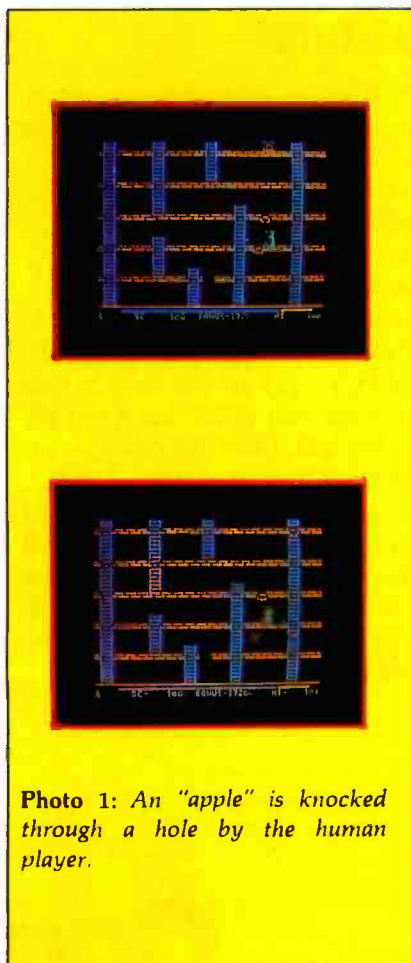

Photo 1: An "apple" is knocked through a hole by the human player.

less enemy, and Apple Panic is no exception. Your enemies are a number of flattened "apples" (similar to Terrapin Turtle robots) that roam the walkways and ladders. They aren't terribly bright, but what they lack in intelligence they make up for in number. How do you fight back? By digging a hole in the walkway, waiting until an apple drops into it, and then knocking it through the hole to smash on the walkway below.

You control your player's movement by using the "I," "J," "K," and "M" keys. To dig a hole, hit the "A" key while your player is moving. (For some reason, your player does not always dig a hole when you want it to. Although this is probably the result of simplifying the game's algorithm to a manageable size, I look on it as a chance to develop my expertise in the game.)

Once an apple falls into the hole and sticks there, you have several seconds to return to that hole and knock the apple through by hitting the "S" key; if you line up two or more holes well enough for the apple to drop through all of them,

you get bonus points that increase with each extra hole used. When an apple falls through a hole, the walkway is mysteriously repaired; see photos 1a and 1b. (You didn't expect this to be easy, did you?) In addition, if you don't get to a stuck apple in time, the dumb but industrious critter pulls itself out of the hole and repairs the walkway.

Although the apples are slow, they don't waste any opportunities. If they get close enough, they pounce on and eat your player. The screen is then redrawn with a different arrangement of ladders and apples, and you start over. On successive screens, you usually get more apples on the screen. If you get good enough, two new predators, the Green Butterfly and the Mask of Death, appear; the latter appears only if you are *very* good. You get more points for killing them, but they are more difficult to kill. The Butterfly must drop through two holes

before it is eliminated; if it drops from one hole to the walkway immediately below, it continues walking as if nothing had happened. (You get an extra player life when you kill a Butterfly.) The Mask of Death is even more difficult to kill; it must fall through *three* holes before it is destroyed.

One final note on the mechanics of the game: your player can fall through a hole without injury. This is sometimes useful as an escape route because the apples can't follow.

Strategy

Timing is very important in this game. It takes a certain amount of time to dig a hole or knock an apple through a hole. If you underestimate the amount of time needed when an apple is nearby, it may get you before you get it.

Another element of your strategy is the placement of holes with respect to ladders. On one hand, you like to have a hole between you and every apple. On the other hand, if an apple falls into a hole on the other side of the screen, those same holes may prevent you from getting to the trapped apple in time. After hastily digging a hole, you may find that it is now impossible to get to an entire section of the screen. Also, the strategy of going to the end of a walkway, digging a hole between you and the center of the screen, and waiting for an apple to come after you usually doesn't work—the apples aren't smart enough to sense you unless you are nearby.

Conclusions

Apple Panic is an interesting, playful game. It is interesting to note that, like Pac-Man (a game similar in spirit), it uses engulfment as the main form of destruction. This is very different from the majority of games, which have objects shooting projectiles at each other.

Apple Panic makes good use of both graphics and sound. When walking, the player does not flicker (as it would with less skillful animation). Nearly constant sound effects keep the ear entertained without assaulting it.

Even when played by a novice, this game usually lasts longer than most other arcade-style games. Although the apples will eventually overwhelm you, split-second reflexes are not as important here as they are in other games. A normal game of Apple Panic lasts from five to fifteen minutes; it lasts longer as you get better. Therefore, while still being entertaining and engaging, Apple Panic will not leave you a nervous wreck when the game is over. (Well, less of one, anyway.)

I do have a criticism, however. This game does not have the features that allow you to indefinitely pause while you turn the sound effects off. Granted, one game can't have everything, but these easily implemented features are becoming more common on Apple games. Game designers should take note.

Apple Panic is a copy-protected disk that boots directly on either 13- or 16-sector Apple computers. Broderbund Software pledges to replace the disk free of charge if it fails to boot and to replace it for a minimal charge if the disk is ever physically damaged. This is another policy that should be encouraged. It takes away many of the objections about copy-protected disks for programs of this nature.

It should be reemphasized that Apple Panic is an original game, not a copy of an arcade game. If the current trend away from microcomputer games adapted from coin-operated arcade games continues, the work of authors and companies that produce high-quality original games will become more important. ■

At a Glance

Name

Apple Panic

Type

Arcade-style game

Manufacturer

Broderbund Software
2 Vista Wood Way
San Rafael, CA 94901

Price

\$29.95

Author

Ben Serki

Format

5¼-inch floppy disk

Language

6502 machine code

Computer

Apple II or II Plus with one disk drive (13 or 16 sectors) and 48K bytes of memory

Documentation

One-page instruction leaflet

Audience

Arcade enthusiasts of all ages

Missile Command

Stanley J. Wszola
 Technical Editor

As your left thumb stabs at the firing button, your right hand spasmodically tries to control the cursor. You see flashes of light, hear bursts of sound, and finally it's over. You've done it, racked up your best score ever playing Missile Command. Have you ever wondered why Missile Command is such a popular game? Despite the claims of Atari that its

development was a long process, there are other reasons for its success. In this review, I'd like to touch lightly upon some of these reasons.

If you have never pumped a quarter into a video arcade game, or don't own an Atari 400 or 800 microcomputer, I'll briefly describe the game. The Missile Command game for the Atari 400 and 800 is an

adaptation of the commercial arcade game. You become the commander of a missile base with armaments consisting of ABMs (antiballistic missiles). You must preserve your six cities and missile base from nuclear attack by destroying the incoming enemy missiles and bombs.

The enemy is armed with ICBMs (intercontinental ballistic missiles), MIRVs (multiple independently targeted reentry vehicle ICBMs), killer

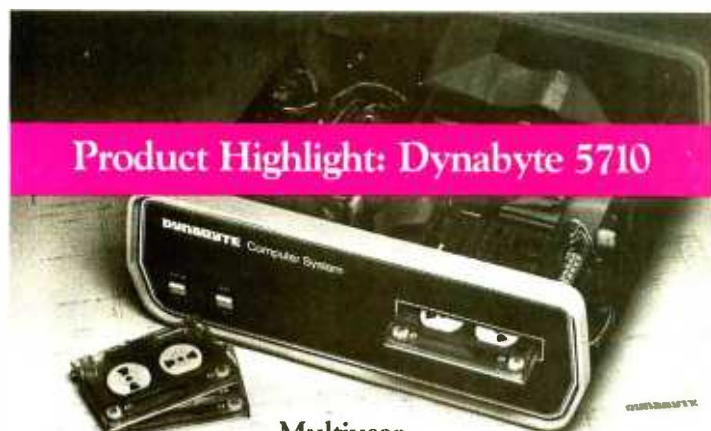

Product Highlight: Dynabyte 5710

Multiuser microcomputers—up to 19MB Winchester/Tape from \$8,995*

For performance

Enhanced CP/M-MP/M or OASIS multiuser operating system for the speed of a mini with the ease of a micro—supports up to 8 terminals and 16 printers.

For Winchester/Tape performance, you just can't buy a better multiuser microcomputer than the Dynabyte 5710. Take our 5 1/4" Winchester disk drive. Either 12MB or 19MB capacity with a removable 17MB Cartridge tape drive.

Packaged in a single, compact, table-top box.

See for yourself

All Dynabytes are backed by Dynabyte's engineering expertise and reputation for high quality. We'd like to tell you more. Call now! 800-538-3939. In California, 408-263-1221 or write Dynabyte, 521 Cottonwood Dr., Milpitas, California 95035.



*5710-A2-64K, 12MB Winchester 17MB Cartridge Tape—\$8,995 (list)
 5710-B2-64K, 19MB Winchester 17MB Cartridge Tape—\$10,450 (list)

CP/M; MP/M—trademarks of Digital Research, Inc. OASIS—trademark of Phase One Systems, Inc.

At a Glance

Name

Missile Command

Type

Arcade-type game

Manufacturer

Atari Inc.
 1265 Borregas Ave.
 Sunnyvale, CA 94086
 (408) 745-2213

Price

\$39.95

Format

Plug-in ROM cartridge

Language

6502 machine language

Computer

Atari 400 or 800 with 8K bytes of RAM and joysticks

Documentation

18-page booklet

Audience

Any Atari computer owner who enjoys a good game

WICAT 68000 MULTI-USER SYSTEM 150

STANDARD EQUIPMENT

68000 Processor
256KB RAM
10MB Winchester
5 1/4" Floppy Disk Backup
5 RS-232 C Serial Interfaces
Parallel Port
Multibus™
WICAT Operating System
Choice of One Language

HARDWARE OPTIONS

Graphics CRT
Up to 1.5MB RAM
Communications: Auto Answer
and Auto Dial (1200 Baud)
Local Networking
Videodisc Interface

SOFTWARE OPTIONS

UNIX™ V/7
CP/M™ Emulator

LANGUAGE SUPPORT

PASCAL
C
FORTRAN
BASIC
APL*
COBOL
ADA™
LISP
Assembler



WICATsystems

P.O. Box 539 1875 South State Street Orem, Utah 84057 (801) 224-6400

Call or write WICAT Systems for additional information.

*UNIX is a trademark of Bell Labs. Multibus is a trademark of INTEL.

ADA is a trademark of the United States Dept. of Defense

CP/M is a trademark of Digital Research

APL is a product of the Computer Company

satellites that drop missiles, bombers, and smart missiles that can evade your ABMs and home in on their targets.

The enemy attacks come in waves. Each wave lasts from 30 to 45 seconds. The waves become increasingly more difficult as the game progresses, with the sixth wave introducing you to the smart missiles.

You are provided with 30 ABMs per wave. These are launched against targets by using the joystick to control a cursor on the screen. When a missile, bomber, or satellite appears, you position the cursor over or near the target and press the fire control button. Your missile base launches an ABM toward a detonation mark left by the cursor on the screen. The resulting atomic fireball, complete with the simulated sound of a nuclear explosion, will destroy the incoming missile or other target. That is, if your aim was true, if you allowed for a moving target, if you hadn't already used all your ABMs, and if the target wasn't smart enough to get out of your way (smart missiles).

The game allows you to select one or two players. The computer automatically keeps score and remembers the highest score while the game is continuing. You have the option of skipping the easier waves of



Photo 1: *Missile Command, one of the most popular coin-operated arcade games, is now available in a cartridge for the Atari 400 and 800 microcomputers. The trackball of the coin-operated version has been replaced by an Atari joystick. Also, you have only one missile base (not three), but the sights, sounds, and action of the original game are still there.*

enemy attacks. For example, you can practice shooting down nothing but smart missiles.

The object of all this nuclear mayhem is to accumulate points. Points are scored for every enemy weapon destroyed and for every city and ABM left at the end of each wave.

Every two waves, a wave point multiplier increases the value of each point by as much as six times. Every time you earn 10,000 points, you get another city to replace one that was previously vaporized.

Why Is It Successful?

Though none of the editors on the BYTE staff advocate nuclear war, we all agree that Missile Command is a good game. Yet we agree for different reasons, and therein lies the reason for the game's success.

Some people enjoy the competitiveness of trying to better another person's score. Others enjoy the interaction between human and computer. And some enjoy the lights, noise, and the satisfaction of symbolically blowing things up. My enjoyment stems mostly from not having to pump quarters into the computer.

The Critics

There are those who object to the overt violence implicit in the game. After all, the destruction of cities is a very violent activity. A friend of mine once said that games of this type only encourage the acceptance of warfare as a viable solution to problems that could be settled peaceably. I asked if he ever played chess.

The **HOME BRAIN™** is a dedicated microcomputer system in a stand-alone package. **HOME BRAIN'S™** I/O potential exceeds 300 channels.

ACHIEVE TOTAL HOME CONTROL

- Energy Management
- Home Security
- Lighting Control
- Safety Monitoring
- Appliance Control

THE HOME BRAIN™ IS

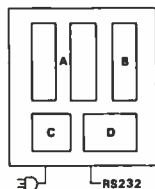

- A** - 32 Channels Buffered Input
- B** - 8 Relay Output
- C** - Uninterruptable Power Supply
- D** - CPU, Communications, 256 Channel AC Wireless Control

the First Total Home Control Computer

- Communicate with the **HOME BRAIN™** using your personal computer RS232 Interface
 - **HOME BRAIN™** controls your home using your define logic sequences
 - Logic diagrams, timers, counters, alarm clocks, calendars, are directly implemented by the **HOME BRAIN™** microprocessor
 - **HOME BRAIN™** logs controlled operating times for the month
- The **HOME BRAIN™** operates totally independent of your personal computer. Crashing your computer will not crash **HOME BRAIN™** leaving your home delenseless.

EVALUATE THE HOME BRAIN™

Order Now By Calling Toll-Free
1-800-228-2028



Lines Open 8 AM To 6 PM C.S.T.

Just give us your Name, Shipping, Address and Visa or MasterCard number and we will charge the \$750.00 purchase price, plus \$20.00 shipping (N.J. residents add 5% sales tax) to your account. Or, **SEND*** your **CHECK*** or **MONEY ORDER*** to:

HYPERTeK, INC
30-4 FARM ROAD
SOMERVILLE, NEW JERSEY 08876

*Sending your check will qualify you for an INTRODUCTORY REBATE of 10%.
Allow 6-8 weeks for delivery.

The revolutionary Discovery multiprocessor is the only system that allows the total integration of powerful 16 bit 8086 processors with the more standard Z-80 user processors. The DISCOVERY system may be configured in any 8 bit/16 bit combination, or as a totally exclusive 16 bit system only to provide the ultimate in performance and flexibility in advanced micro systems.

Ultimate performance. The dpc-186 is the most sophisticated single board microcomputer available today offering more power and faster processing time through the 8086 CPU for bigger, more complex programs. Memory starts at 128 K (compared to the Z-80's 64 K), and is expandable to 1 megabyte. And the dpc-186 is fully compatible with the standard DISCOVERY multiprocessor system permitting efficient upgrading as future needs develop, without sacrificing any of your extensive hardware and software investment.

World's best multiprocessor system. The DISCOVERY system provides separate processors and memory for each of its 16 users. It offers full CP/M™ and CP/M-86™ compatibility, interprocessor communication, and shared and private files. Each user can take advantage of shared peripherals and cross submitting of tasks between processors. The system is controlled by a unique, two board dpc-280 service processor and dpc/os distributed processing operating system.

By the board or by the system. The DISCOVERY multiprocessor is ready for immediate delivery as a complete system, as processor boards, and everything in between. It offers exclusive technology in multiprocessing, yet is fully compatible with existing standards including CP/M and S-100. It is quite simply unmatched in performance, capabilities and offers a far greater degree of flexibility. DISCOVERY—offering a whole new world of possibilities.

For the first time, 8 and 16 bit processor intermixing.



Action Computer Enterprises, Inc.



The Multiprocessing Company
55 West Del Mar Boulevard, Pasadena, CA 91105 USA
(213) 793-2440, TWX 910-588-1201

Circle 7 on inquiry card.

Dealer and OEM inquiries invited.

*CP/M is a registered TM of Digital Research, Inc.

When he said yes, I then asked if he thought his aggressive activities on the chessboard affected his actions in real life. A very spirited discussion then ensued, with neither of us convincing the other to change his views.

Whether the designers of Missile Command intended to or not, they have presented a game that reflects contemporary society. The game takes the threat of nuclear warfare and, simplifying the concept to the extreme, reduces that threat to a man-

ageable human level. Whether this familiarity with nuclear warfare is good or not, I don't know. However, it doesn't seem to have affected the popularity of the game.

Conclusion

Missile Command is a great success, and Atari should be congratulated on producing such a high-quality product. However, it is only a temporary success. Programmers are constantly working on newer, better

games. My advice to them is to carefully examine the current successes and determine why they work. Then, taking their own original games, incorporate those ideas in their own programs.

With the advent of new microcomputers and with the foundations for software development already well established, the potential for creative programming is greater than ever. I am excitedly awaiting what's coming next. ■

Dino Wars

George Stewart
Technical Editor

If any computer game deserves the title "action game," this one does. Dino Wars is a two-player game in which each player controls a ferocious dinosaur that attempts to bite the other player's dinosaur until it cries uncle. Although there is no gore and the losing dinosaur always survives, the combat between the two creatures seems vicious at times.

The battle takes place on a desert plain decorated with several clumps of cactus. However, this is not your ordinary cactus. If a dinosaur mistakenly runs into one, the creature falls over and loses five units of fighting energy. Perhaps it's fossilized.

Although the terrain is much larger than the field of view displayed on the screen, it is not infinite. If a dinosaur exits to either the left or the right, it eventually reemerges on the opposite side of the screen. Even if not visible on the screen, battles can rage in full force and dinosaurs can trip over unseen cacti.

The dinosaurs are chunky creatures (low-resolution is the term used outside of the prehistoric epoch) modeled after *Tyrannosaurus rex*. One is purple, the other blue. (An alternate color set is available for variety.) Although not the most graceful of animals, they can swing their tails menacingly, open their jaws to bite, and swagger around the screen in any direction.

The game is three-dimensional. As a dinosaur recedes into the background, it becomes smaller, eventually shrinking to the size of a dot. As it advances, its size increases to a stage where it consumes much of the screen.

Joysticks are used to control the combatants. Although these joysticks permit 360 degrees of apparent control, the dinosaurs can actually move in only six directions. As a result, they appear to hop from one stance to another.

The object of the game is to bite the

At a Glance

Name

Dino Wars

Type

Animated dinosaur combat game

Manufacturer

Radio Shack
1800 One Tandy Center
Fort Worth, TX 76102

Price

\$39.95

Author

Robert Kilgus

Format

Plug-in ROM cartridge

Computer

TRS-80 Color Computer with two joystick controllers; 16K bytes of RAM recommended for best results

Audience

Game fans age 6 and up

BMC's best seller newly available with superb functional versatility

VIDEO DISPLAY

12 Inch
80 ch x 25 line
80 ch x 20 line
40 ch x 25 line Selectable by Programming
40 ch x 20 line
Color (8 colors)/Green
Smooth Scrolling

• FUNCTION KEY

Programmable
10 Keys

• FLOPPY DISC

5 inch x 2 deck, 280 KB/deck
Dual sided — Double density

• SUPER FUNCTION KEY

Programmable
10 Keys

• PRINTER

Dot Impact
80 ch/sec.
80 ch/line, 40 ch/line
Graphic Mode
Alphabets (capital/small), Numerics,
Katakana
Various Symbols, Hiragana, Kanji
Roll Paper/Sprocket Paper
3 Copies

Dimensions: 510W x 683D x 505H mm (Color)
510W x 608D x 505H mm (Green)

Input Voltage: AC 117V/220V ±10% 50/60Hz

Option: Light pen Rom Cartridge



 **BMC USA INC.**

20610 Manhattan Pl.
Suite 112, Torrance CA, 90501 USA
Tele: 213-320-9880, Telex: 182379 bmcimg

other dinosaur while it is vulnerable, i.e., while it has its back turned or is recovering from a nasty fall over a cactus (the Marquis of Queensberry rules don't apply in this primitive world). After sustaining an effective bite, a dinosaur falls to the ground with a resounding crash.

When two experienced players control the dinosaurs, the battle resembles an awkward ballet, with the dinosaurs constantly circling each other while vying for a shot at each other's weak point. When beginners play, the action is more likely to resemble a pastoral scene in which the two dinosaurs wander around aimlessly, occasionally engaging one another with little effect and separating again.

To make a dinosaur bite, you press the joystick button. The dinosaur issues an awesome roar as it closes its jaws on air, cactus, or the opposing dinosaur. Generating this sound is one of the more satisfying aspects of the game.

Both dinosaurs start out with 100 units of energy. Each time a dinosaur is successfully bitten in a clinch, it

loses 20 points; if bitten while recovering from a cactus fall, 10 points; falling over a cactus costs five points. The game ends when one of the dinosaurs loses all its points.

A prerequisite to enjoying this game at length is a sense of the ridiculous. Without that, you are apt to become frustrated by some of its limitations. For example, while either dinosaur is roaring, all action on the screen halts because the Color Computer's microprocessor is totally preoccupied with the task of generating the sound (a hardware limitation).

Here are bite-by-bite reports from two noteworthy dino wars.

In the first battle, one player was an expert, the other a beginner. This quite typical case corresponds to computer owner and friend. The expert player used a sneak-attack strategy: his dinosaur stayed just off-screen until the beginner's dinosaur presented a vulnerable back. Then the expert's dinosaur lunged into view, bit effectively, and retreated again. Five such attacks were enough to send the beginner's dinosaur into squeaking submission (a defeated

dinosaur always runs off yelping toward the horizon).

In the second battle, two jaded players searched for a nonviolent use of the game. The cactus provided an answer. A dinosaur can become hopelessly entangled in a cactus; each time it gets up, it immediately falls down again, losing five points each time. Accordingly, the object of this absurd battle was to be the first to expend all one's energy in mortal combat with a cactus.

Dino Wars is primarily a novelty, but a good one. It allows two players to work off all sorts of aggressions toward each other and plant life. However, it is not a game you can grow with; it doesn't take long to "peak out." It is not an intellectual game like Adventure, nor does it get your adrenaline going as does a fast-paced game of Star Raiders. Compared to one of these, you might say Dino Wars is *prehistoric*. ■

MEMORY EXPANSION MODULE FOR IBM PERSONAL COMPUTER

- Directly expands memory to 256K Bytes. Replaces three 64K Byte cards. (larger configurations available)
- Each card aged at high temperature and voltage margined; less than 350 mA of +5v; one year warranty.
- Available at participating COMPUTERLAND stores: contact factory for further information.
- Intermedia Systems: 10 year old company; also produces CAD and Medical Graphic Display systems for Hewlett-Packard computers.

STAINLESS
STEEL
BRACKET

\$995
EACH

CARD GUIDE INCLUDED

EXTENDED FOOT FOR
VERTICAL STABILITY

 **intermedia systems**

10601 S. De Anza Blvd. ■ Cupertino, CA 95014
(408) 996-0900

FULL WIDTH CARD FOR HORIZONTAL STABILITY

One of the great masters?

Although the Datasouth DS180 matrix printer may not exactly rate as a work of art, our customers have a very high opinion of its value. Over the past year, we have shipped thousands of DS180 printers to customers throughout the world. Many of our sales now come in the form of repeat business—a strong testimonial to the acceptance of a product.

The success of the DS180 in a very competitive market did not happen by accident; rather through our sensitivity to the needs of the industry. This sensitivity we carry through research and development, production and quality control and finally to after sales support and service.

Recently we introduced new enhancements to make the DS180 printer even more versatile. Dot addressable raster scan graphics produces output of computer generated charts, maps and graphs at a resolution of 75 x 72 dots per inch. Variable horizontal pitch selection allows printing at 10, 12 or 16.5 characters per inch plus double wide printing at 5, 6 or 8.25 characters per inch. The expanded 2K FIFO print buffer handles a full CRT screen dump at up to 9600 baud without delaying the host system. We also offer transparent mode for isolating communications problems, and for APL users, the dual ASCII/APL character set option.

Check our list of features and we think you will agree that the DS180 offers the most complete performance package in matrix printers.

DS180 PRINTER STANDARD FEATURES

- Microprocessor Control
- 180 CPS Print Speed
- Bidirectional Logic Seeking
- 1000 Character Buffer (Expandable)
- 9x7 Dot Matrix
- Expanded Characters
- Adjustable Printhead 1-6 Copies
- 96 ASCII Character Set
- Cartridge Ribbon
- 132 Column Print Width
- Tractor Feed (Front or Bottom)
- Non-Volatile Format Retention
- Top of Form
- Horizontal Tabs

- Vertical Tabs
- Perforation Skip Over
- Auto Line Feed
- 6 S.L.P.I.
- Auto End of Line Carriage Return
- 5 IPS Paper Skew
- Parallel and Serial Interfaces
- 110-9600 Baud Communications
- Terminal Status Indicators
- Audio Alarm
- Self Test
- X on, X off
- Paper Out Detection

OPTIONAL FEATURES

- Compressed Print - 10, 12, 16.5 cpi
- High Resolution Dot-Addressable Graphics
- 2k Expanded Print Buffer
- APL, ASCII Character Set

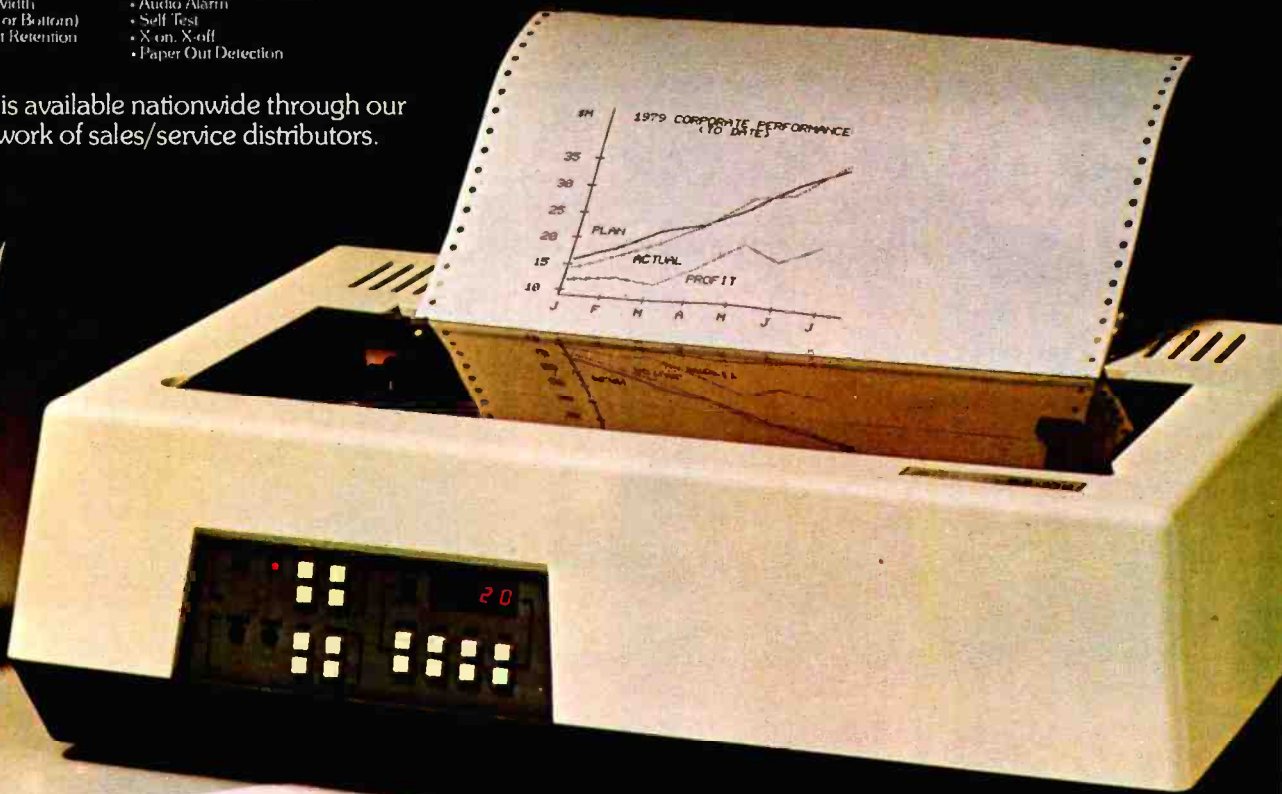

The DS180 is available nationwide through our network of sales/service distributors.



Circle 122 on Inquiry card.

datasouth
computer corporation
P.O. Box 240947 • Charlotte, NC 28224 • 704/523-8500

Performance.

Quality.

Reliability.

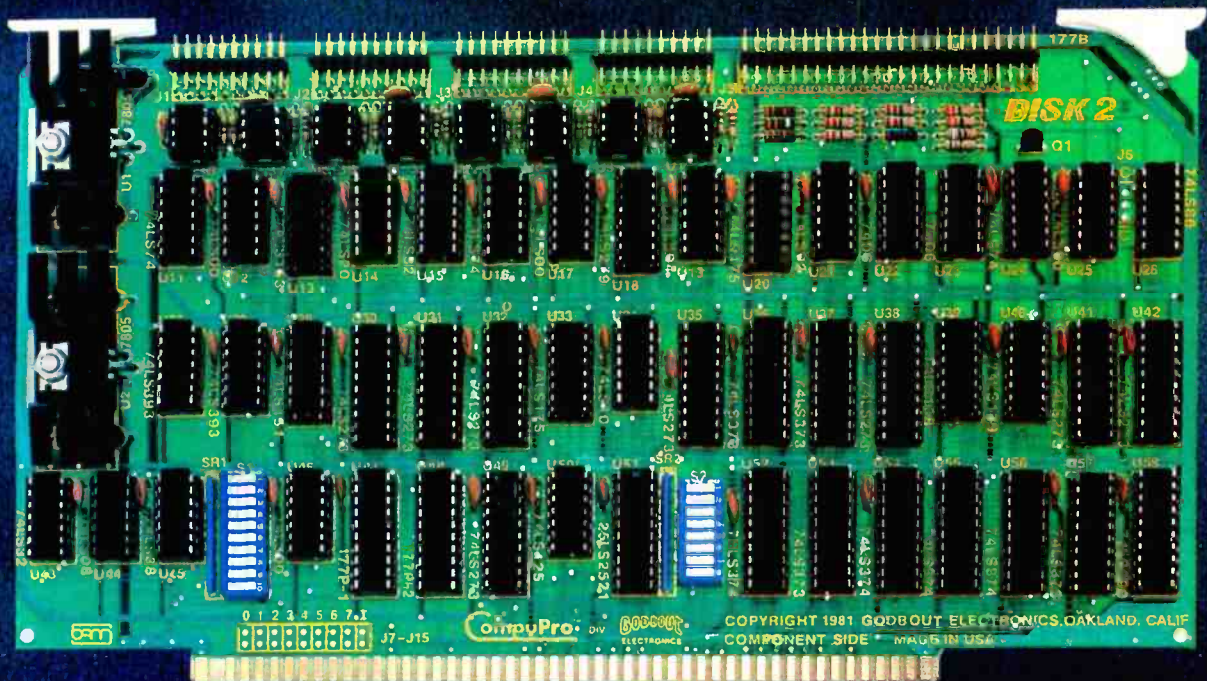

For more information on these products and other business, industrial, and scientific computing solutions, contact your nearest CompuPro systems center.

New!

**Disk 2 DMA Hard Disk Controller
8086/87 Co-Processor**



CompuPro is a division of Godbout Electronics, Oakland Airport, CA 94614-0355 415-562-0636

The Atari Tutorial

Part 7: Sound

Bob Fraser
1639 Martin Ave.
Sunnyvale, CA 94087

The Atari 400 and 800 home computers have extensive hardware sound capabilities. Four independently controllable sound channels are able to play simultaneously. Each channel has a frequency register determining the note and a control register regulating the volume and the noise content. Several options allow you to insert high-pass filters, choose clock bases, set alternate modes of operation, and modify polynomial counters. This article will explain these options; next month, part 8 will show how to call these options from both BASIC and 6502 machine language.

Definitions

For the purposes of this discussion, a few terms and conventions need to be clarified:

1 Hz (hertz)	is 1 pulse per second
1 kHz (kilohertz)	is 1000 pulses per second
1 MHz (megahertz)	is 1,000,000 pulses per second

A *pulse* is a sudden voltage rise followed somewhat later by a sudden voltage drop. If a pulse is sent to a

television speaker, it will be heard as a single pop.

A *wave*, as used here, is a continuous series of pulses. Different types of waves exist, each of which is distinguished by the shape of the in-

The smaller poly counters repeat often enough to create droning sounds that rise and fall quickly.

dividual pulses. Waves created by the Atari computer are square. Brass instruments typically produce triangular waves, and a human voice produces sine waves.

A *shift register* is like a memory location (in that it holds binary data) that, when so instructed, shifts all its bits to the right by one position (i.e., bit 5 will get whatever was in bit 4, bit 4 will get whatever was in bit 3, and so on). Thus, the rightmost bit is pushed out, and the leftmost bit assumes the value on its input wire (see figure 1).

"AUDFn" is read "any of the audio frequency registers, AUDF1 through AUDF4." Their addresses are, respectively, hexadecimal D200, D202,

D204, and D206 (decimal 53760, 53762, 53764, and 53766).

"AUDCn" is read "any of the audio control registers, AUDC1 through AUDC4." Their addresses are, respectively, hexadecimal D201, D203, D205, and D207 (decimal 53761, 53763, 53765, and 53767).

For the purposes of this discussion, *frequency* is a measure of the number of pulses in a given amount of time; that is, a note with a frequency of 100 Hz means that in one second exactly 100 pulses will occur. The more frequent (hence, "frequency") the pulses of a note, the higher the note. For example, a singer vocalizes at a high frequency (5 kHz), and a cow moos at a low frequency (100 Hz). The words "frequency," "note," "tone," and "pitch" are used interchangeably.

Noise and *distortion* are also used interchangeably, although their meanings are not the same. Noise is a more accurate description of the function performed by the Atari computer.

All examples are in BASIC unless

This article appears in slightly different form in De Re Atari, published by Atari Inc., and is reproduced with its express permission.

Amdetek

From picture perfect.

To letter perfect.



Amdetek
Color-I
FCC/UL approved



Amdetek
Video-300

At Amdetek, we make monitors for people who demand state-of-the-art color. And for people who know that crisp, clear text display is an art in itself.

Our versatile Color-I 13" video monitor features standard NTSC composite input, front-mounted controls and a built-in speaker with audio circuit. Our popular Video-300 12" Green Phosphor monitor has an easy-to-read, non-glare screen, 18 MHZ band width and 80 x 24 character display.

Both offer easy portability, with lightweight cabinetry and molded-in handles. And both are fully

compatible with most computer and word processing systems. So compare our performance with other monitors. Then compare prices. For quality and value, you'll choose Amdetek.

NEW THIS FALL: our advanced high resolution Color-II monitor with interface board for Apple II compatibility. Color-II features RGB, TTL input and 560(H) x 260(V) resolution for crisp 80 x 24 character display and exceptionally sharp color graphics. Ask your dealer about an Amdetek Color-II, Color-I, or Video-300 monitor today.

AMDEK

2420 E. Oakton Street, Suite "E," Arlington Heights, Illinois 60005 (312) 364-1180 TLX: 25-4786

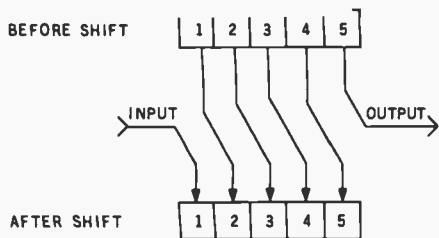

Figure 1: Operation of a shift register. Here, all bits are shifted one bit to the right. As the rightmost bit is lost, some external value fills the leftmost bit.

otherwise stated. Type the examples *exactly as they appear*. If there are no line numbers, don't use any; if several statements are on the same line, type them as such.

Sound Hardware

Sound is generated in the Atari computer by the POKEY chip, a custom integrated circuit designed especially for the Atari 400 and 800; POKEY also handles the serial I/O bus and the keyboard. The POKEY chip must be initialized before it will work properly. Initialization is required after any serial bus operation (cassette, disk drive, printer, or RS-232C read/write). To initialize POKEY in BASIC, execute a null sound statement; that is, SOUND 0,0,0,0. In machine language, store a 0 at AUDCTL (hexadecimal D208 = decimal 53768) and a 3 at hexadecimal 232 (decimal 562); this is the shadow location for the SKCTL register at hexadecimal D20F (decimal 53775).

The Audio Frequency Registers

Each of the four audio channels has a corresponding frequency register that controls the note played by the computer. The frequency register contains the number *N* used in a divide-by-*N* circuit. This is not a division in the mathematical sense, but something much simpler: for every *N*

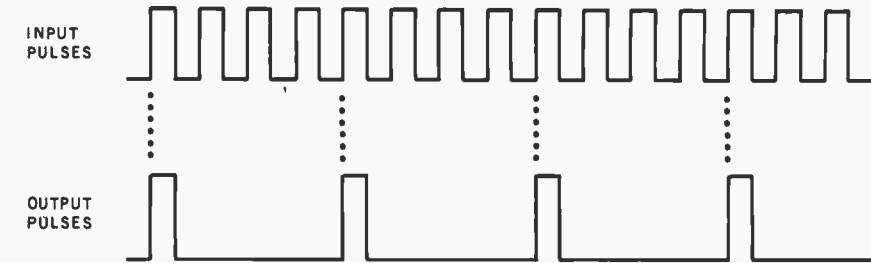

Figure 2: An example of a divide-by-4 process. The circuitry for this process allows only every fourth pulse to pass through.

pulses coming in, one pulse goes out. For example, figure 2 shows a divide-by-4 function.

As *N* gets larger, output pulses become less frequent, making a lower frequency note.

The Audio Control Registers

Each channel also has a corresponding control register. These registers allow the volume and distortion content of each channel to be set. The bit assignment for AUDC*n* is given in table 1.

Volume

The volume control for each audio channel is straightforward. The lower 4 bits of the audio-control register (AUDC*n*) contain a 4-bit number that specifies the volume of the sound. A zero in these bits means zero volume; a fifteen means as loud as possible. The sum of the volumes of the four channels should not exceed thirty-two because this forces overmodulation of the audio output. The sound produced tends to actually lose volume and assume a buzzing quality.

Distortion

Table 1 also shows that each channel has three distortion-control bits in its audio-control register. Distortion is used to create special sound effects any time a pure tone is undesirable.

The computer's use of distortion offers great versatility and control. It is easy to synthesize an almost endless variety of sounds, from rumbles, rattles, and squawks to clicks, whispers, and mood-setting background tempos.

Distortion, as used here, is not equivalent to the standard interpretation. For example, *intermodulation distortion* and *harmonic distortion* are quality criteria specified for high-fidelity stereo systems. These types of distortion refer to waveform degeneration, where the shape of the wave is slightly changed due to error in the electronic circuitry. The computer's distortion does not alter waves (they are always square), but rather deletes selected pulses from the waveform. This technique is not adequately characterized by the word "distortion." A more descriptive and appropriate term for these distortion methods is "noise."

Before you can fully grasp what we

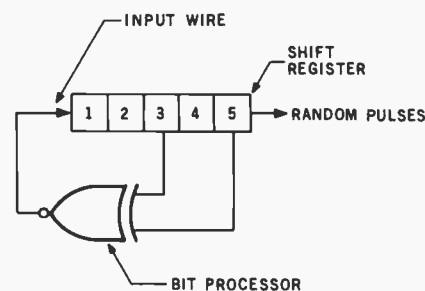

Figure 3: An example of a poly counter. By letting the new leftmost bit be determined by some algorithm (here, an exclusive NOR of bits 3 and 5), a poly counter can produce a semirandom stream of bits. The pattern of the bits will eventually repeat, but the length of the pattern depends on the width in bits of the poly counter.

AUDC <i>n</i>	7	6	5	4	3	2	1	0
Bit Number								
Use	distortion			volume-only bit	volume			

Table 1: Bit usage in the AUDC*n* registers (AUDC1 through AUDC4).

The IBM Personal Computer

Personal, Professional, Technical — or somewhere in between ...
PC-MATE™ makes the IBM Personal Computer a perfect match

PC-MATE™ from TECMAR is the first and only complete expansion series available for the IBM Personal Computer. There are currently more than twenty PC-MATE™ expansion options available, and new products are continuously added to the list.

When you want more from your IBM Personal Computer, look to PC-MATE™.

You can create a SUPER PERSONAL COMPUTER with household lights and appliance control, voice output, and give it more memory than any ordinary personal can handle.

Or make it a PROFITABLE PROFESSIONAL SYSTEM with expansion space and a Winchester disk to handle more business accounts. Increase memory up to

the system limit and process those accounts faster. Add flexible I/O interfaces and put yourself on line to outside information sources.

As an INTELLIGENT LABORATORY TOOL with interfaces to IEEE 488 instrumentation, analog signals, stepper motors and video signals, your IBM Personal Computer becomes the perfect workbench assistant.

Hardware, Software, Accessories — PC-MATE™ provides the highest quality and the greatest possible range of functionality for the IBM user.

Ask your local computer store for more information on the PC-MATE™ series from TECMAR, or call for the name of your nearest authorized PC-MATE™ dealer.

PC-MATE™ EXPANSION OPTIONS

Personal Computer Expansion Chassis (see photo)
192K and 256K Dynamic Memory with Parity
Winchester Disk Drive and Controller
Parallel Medium Speed Input/Output Interface
Serial Medium Speed Input/Output Interface
Parallel High Speed Input/Output Interface
Serial High Speed Input/Output Interface
Analog to Digital Converter - 8, 12, 14, 16 Bit
Dust Cover Set for IBM PC and Peripherals
High Speed Static Memory (RAM/ROM)
Digital to Analog Converter - 8 and 12 Bit
Multi-System Printer Sharing Facility
CMOS Memory with Battery Backup
System Clock with Battery Backup
Electrically Erasable EPROM
BSR X-10 Device Controller
Stepping Motor Controller
Video Image Digitizer
IEEE 488 Interface
Prototyping Board
Music Synthesizer
Voice Synthesizer
Extender Board

One Year Warranty

Additional products are already under development, so if we don't have what you need, chances are good that we soon will.



Tecmar Inc. PERSONAL COMPUTER PRODUCTS DIVISION
23600 Mercantile Rd., Cleveland, OH 44122 (216) 464-7410

NOW THAT YOU'VE FIRST GENERATION TAKE A LOOK



Welcome to a tour of the biggest Apple. The Apple® III Personal Computer — the most powerful machine in its class.

Because it's the only personal computer that lets you add up to 256K RAM, hang on a full complement of peripherals, and still have four expansion slots left for future growth. (Unlike some micros which become woefully "slot-bound" when upgraded to maximum memory.)

Because it's the only machine now using 64K RAM chips to keep 256K tidy on a single board.

And because it's the only machine that gives you the help of SOS.

THE MOST SOPHISTICATED OS.

SOS is the Apple III's Sophisticated Operating System, an elegant software interface that frees you from most system control tasks. It features a hierarchical file system, device- and user-level interrupt capabilities, a device-independent file system and memory management capability.

Since all Apple III languages use SOS, they share a common disk format. So Apple III programs can merge and communicate — a Pascal application program can directly access a BASIC text file, for example.

Xerox 820	Hewlett-Packard 125—Model 10	IBM Personal Computer	Apple III
<i>Standard Memory</i>			
64K	64K	64K	128K
<i>Maximum Memory when fully configured*</i>			
64K	64K	192K	256K
<i>Expandability</i>			
No expansion slots	No expansion slots	No extra expansion slots in fully configured* 192K system	4 extra expansion slots in fully configured 256K system*
<i>Diskette Storage (per drive)</i>			
92K	256K	160K	140K
<i>Mass Storage (per drive)</i>			
—	1.16 megabyte Floppy Disk	—	5 megabyte Hard Disk
<i>Display Graphics Capability</i>			
High resolution B/W	High resolution B/W	High resolution B/W or 4-color (color requires additional card)	High resolution B/W or 16-color
<i>Software Available</i>			
Word Processing Super Calc®	Word Processing VisiCalc® 125 Business Graphics Communications	Word Processing VisiCalc® Communications	Word Processing VisiCalc® III Business Graphics Communications Apple II software library CP/M® library (available Spring, 1982)
—	—	—	—
CP/M® library	CP/M® library	CP/M® 86 programs	—

*"Fully configured" means system includes, at minimum, monitor, printer, 2-disk drives and RS-232 communicator. NOTE: Chart based on manufacturer's information available as of December, 1981.

WE'VE SEEN THEIR GENERATION AT OUR THIRD.



SOS allocates system resources to make the most of dynamic memory, simplifies programming with standard device and file interfaces for all languages, and speeds software development by reducing program size and complexity.

OUR NEW PROFILE.

ProFile™ is Apple's new personal mass storage system — a quick, quiet 5MB hard disk ideal for software development or any mass storage application. Shown above twixt monitor and console, it comes with everything you need to get up and running, including interface card and driver software.

The III's standard built-in drive is a 140-K floppy that can be daisy-chained with three additional drives through a back panel connector. Which leaves you plenty of expansion slots for things like our new Universal Parallel Interface Card or our OEM Prototyping Card.

CHANGE KEYS.

The 128-character ASCII-encoded keyboard happens to be fully-programmable. So you can (with SOS) do neat things like remap it into

DVORK. Or create armies of special function keys. Or teach your Apple to write Chinese.

Its own languages already include Business BASIC, UCSD Pascal™ Assembly and, soon, a powerful new COBOL—and, in emulation mode, most languages available for Apple II.

Look up from the keyboard and you'll see our standard Monitor III green phosphor display (80 char. x 24 lines, u/l). It can show you some of the highest resolution graphics available — 560 x 192 in 16 gray scales. Or choose a color monitor, and you could be seeing 16-color graphics in high 280 x 192 resolution.

HIT LIST.

We have a new edition of that monster hit, VisiCalc® with more modeling space than any other version. Plus AppleWriter III, a powerful new word processing package. Plus a new Business Graphics package. Plus a new Mail List Manager.

Plus a Pascal Utility Library that lets you take full advantage of all UCSD Pascal features.

Plus Access III — sophisticated smart terminal software to access mainframes with asynchronous communications up to 9600 bps.

Plus Apple II emulation to access that vast software library.

Plus, soon, a CP/M® card to access that other vast library.

Even with all this, the Apple III's potential remains essentially untapped.

So we're offering improved documentation, new programmer's aids, expert hotline counseling and an open channel to the industry leader in software publishing. Us.

See your Apple dealer for more information and, perhaps, a little comparison shopping.

We're sure you'll find that between our third generation and their first, there's quite a gap.

The personal computer.



For the authorized dealer nearest you, call (800) 538-9696. In California, call (800) 662-9238. Or write: Apple Computer Inc., 10260 Bandleway Dr., Cupertino, CA 95014. VisiCalc is a registered trademark of Personal Software, Inc. UCSD Pascal is a trademark of the Regents of the University of California. CP/M is a registered trademark of Digital Research, Inc. Apple is a registered trademark.

Circle 29 on inquiry card.

mean by distortion, you must understand *polynomial counters* (also called *poly counters*). Poly counters are employed in the Atari computer as a source of random pulses used in noise generation. The Atari computer's poly counters utilize a shift register working at 1.79 MHz. The shift register's contents are shuffled and fed back into the input; this produces a semirandom sequence of bits at the output of the shift register.

For example, in figure 3, the old value of bit 5 will be pushed out of the shift register to become the next output pulse, and bit 1 will become a function of bits 3 and 5.

The bit processor gets values from certain bits in the shift register (in figure 3, bits 3 and 5) and processes them in a way irrelevant to this discussion. It yields a value that becomes bit 1 of the poly counter's shift register.

These poly counters are not truly random because they repeat their bit sequence after a certain span of time. As you might suspect, their repetition rate depends upon the number of bits in the poly counter; in other words, the longer ones require many cycles before they repeat, while the shorter ones repeat more often.

On the Atari computer, distortion is achieved by using random pulses from these poly counters in a *selection circuit*. This circuit is actually a digital comparator, but the term "selection circuit" is more descriptive. The only pulses making it through the selection circuit to the output are those coinciding with a random pulse. Various pulses from the input are thereby eliminated in a random fashion. Figure 4 illustrates this selection method. A dotted line connects pulses that coincide.

The net effect is this: some pulses from the frequency-divider circuit are deleted. Obviously, if some of the pulses are deleted, the note will sound different. This is how distortion is in-

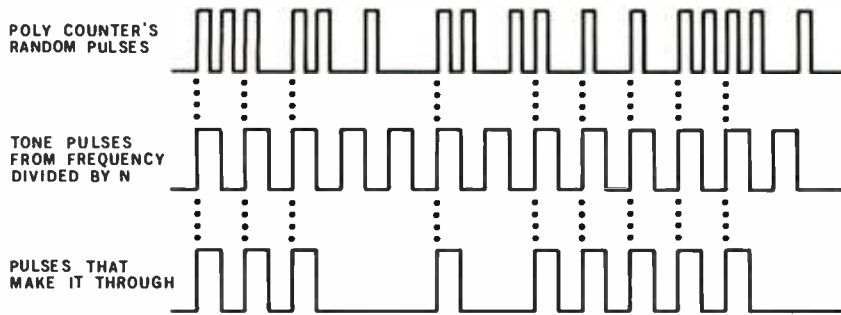
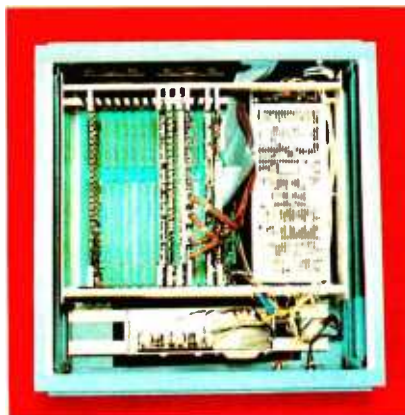

Figure 4: Using the output of a poly counter to create a noisy tone. The resulting sound of the output pulse train is considerably modified by using the poly counter output to select pulses from a pure square-wave input.

OPTIONS

1. **Processor**
 - Z8001 • 68000
2. **Disk Controllers**
 - Floppy disk controller
 - Winchester disk controller
3. **Memory**
 - Memory boards from 32K to 512K
 - Either processor can address up to 16 Megabytes
4. **I/O**
 - Standard serial I/O board with 8 RS-232 I/O ports
 - Intelligent I/O board with 8 ports, 16K dual port buffer memory, and an 8-bit I/O processor on board
 - Parallel I/O board with 80 bits of parallel I/O
5. **15 slot mother board**
6. **Heavy duty power supply**
 - + 5 volts at 40 amps
 - +/- 12 volts at 3.5 amps each
7. **Meets IEEE Multibus Standard**

16 Bit Systems Z8000 or 68000



COMPUTEX

MICROCOMPUTER SYSTEMS

5710 Drexel Avenue
Chicago, Illinois 60637

312 684-3183

TYPICAL SYSTEMS

System 3 (Z8001 based) \$7053

Includes: • Z8001 processor with memory management • 256K RAM • 8 serial I/O ports • Floppy disk controller • ZMOS multiuser operating system • Dual 8 inch double density floppy disk drives • Case and power supply

System 4 (68000) based \$7099

Includes: • 68000 processor (8mhz) • 256K RAM • 2 serial and 4 parallel I/O ports • Floppy disk controller • Dual 8 inch double density floppy disk drives • Operating system • Case and power supply

WINCHESTER DISK SUBSYSTEMS

1. 20 Meg 8 inch drive with dual case, power supply, and electronic module \$3398
2. 20 Meg add-on 8 inch drive \$1898
3. 60 Meg 8 inch drive with dual case, power supply, and electronic module \$5898
4. 60 Meg add-on 8 inch drive \$3598



THE ULTIMATE IN COMPUTER CHESS - THE MATE

THE MATE FOR YOUR MICRO

PMK Associates, one of the world's largest dealers of computer chess systems, is pleased to introduce an extraordinary new product for the computer chess enthusiast. The Mate is a strategy game peripheral for your Apple II*, TRS-80† or PET‡ (TRS-80 and PET versions not available until June '82).

It comes complete with the strongest chess program, by far, ever available for a microcomputer (requires 32K), plus a true, magnetic sensor chessboard with magnetic pieces. All you do is move the pieces. The Mate senses your move, enters it into the computer, shows the move on its high-resolution graphic display and responds by lighting two LEDs. There are no distracting codes to type in during a game, and no need to apply pressure on the squares of the board.

UNPRECEDENTED FLEXIBILITY

Developed by Applied Concepts, Inc., whose \$600 MCT chess computer was ranked number one in playing strength in *Chess Life's* January '82 issue, The Mate also incorporates a wide variety of features: 9 levels of play, opening library of over 6,000 moves, computer thinks on opponent's time, Best/Randomize move selection, move suggestions, audio On/Off, move erasing, change sides dur-

ing game, reverse board, watch replay of finished game, printout entire game. And for hobbyists who want to write their own chess programs, full documentation of the interface software is provided.



As ACI continues to develop new, stronger chess programs your system can be easily upgraded. And additional programs for checkers, Reversi and other strategy games will soon be available. The Mate comes complete with sensory board, magnetic chess pieces, plug-in computer interface card, interconnecting cable, game program on cassette or disk and operation/programming manual for just **\$269.95.**

FREE BONUS BOOK

Each unit is covered by our 15-day home trial, money-back guarantee. And

we will promptly exchange any defective unit still under the manufacturer's 90 day warranty. We maintain a large inventory, and most orders are shipped within 48 hours of receipt. Order before August '82 and we will include, free of charge, the chess classic *Bobby Fischer Teaches Chess* developed in cooperation with Xerox Learning Systems.

There is no game for your micro more stimulating than chess, and in computer chess there is nothing more powerful than The Mate.

To order, mail your check to: PMK Associates, PO Box 598, East Brunswick, NJ 08816 (please include \$5.00 for shipping; NJ residents please add 5% sales tax; include \$10.00 extra for disk format). Customers in Alaska, Hawaii and foreign countries please contact us for shipping charges. For fastest service, credit card holders may use our 24 hour Toll Free order number -

1-800-835-2248
ask for Carol

Please call (201)246-7680 for technical questions and further information.

DEALER INQUIRIES INVITED

**PALMER,
MCBRIDE
KINCAID
ASSOCIATES**

COMPUTER AND
ELECTRONIC PRODUCTS
FOR THE HOME

P.O. BOX 598
EAST BRUNSWICK
NEW JERSEY 08816

(201) 246-7680
24 HOURS A DAY

* Apple II TM of Apple Computer, Inc.

† TRS-80 TM of Tandy Corp.

‡ PET TM of Commodore Business Machines

Circle 315 on Inquiry card.

troduced into a sound channel.

Because poly counters repeat their bit sequences, their output pattern of pulses is cyclic. And since the selection circuit uses this output pattern to delete pulses from the original note, the distorted note will contain the same repetitious pattern. This allows the hardware to create noises such as drones, motors, and other sounds having repetitive patterns.

The Atari computer is equipped with three poly counters of different lengths, which can be combined in many ways to produce interesting sound effects. The smaller poly counters (4 and 5 bits long) repeat often enough to create droning sounds that rise and fall quickly; the larger poly counter (17 bits long) takes so long to repeat that no pattern to the distortion can be readily discerned. This 17-bit poly counter can be used to generate explosions, steam, and any sound where random crackling and popping is desired. It is even irregular enough to generate *white noise* (an audio term meaning a hissing sound).

Each audio channel offers six distinct combinations of the three poly counters, which are listed in table 2. These upper AUDC_n bits control three switches in the audio circuit as shown in figure 5. This diagram will help you understand why table 2 is structured as it is.

Each combination of the poly counters offers a unique sound. Furthermore, the distorted sounds can sound quite different at different frequencies. For this reason, some trial and error is necessary to find a combination of distortion and frequency that produces the desired sound effect. Table 3 gives you some rough guidelines with which you can begin your experimentation.

Volume-only Sound

Bit 4 of AUDC_n specifies the volume-only mode. When this bit is set, the volume value in AUDC_n bits 0 through 3 is sent directly to the television speaker; it is not modulated with the frequency specified in the AUDF_n registers.

To fully understand the use of this

mode of operation, you must understand how a speaker works and what happens to the television speaker when it receives a pulse. Any speaker has a cone that moves in and out. The cone's position at any time is directly proportional to the voltage it is receiving from the computer at that

time. If the voltage sent is zero, the speaker is in the resting position. Whenever the cone changes position, it moves air that is detected by your ear as sound.

From our definition of a pulse, you know that it consists of a rising voltage followed by a falling voltage.

AUDC _n Bit			Type of Distortion Carried Out
7	6	5	
0	0	0	Divide clock by frequency, select using 5-bit then 17-bit poly counter, then divide by 2
0	X	1	Divide clock by frequency, select using 5-bit poly counter, then divide by 2
0	1	0	Divide clock by frequency, select using 5-bit then 4-bit poly counter, then divide by 2
1	0	0	Divide clock by frequency, select using 17-bit poly counter, then divide by 2
1	X	1	Divide clock by frequency, then divide by 2 (no poly counters used)
1	1	0	Divide clock by frequency, select using 4-bit poly counter, then divide by 2

Table 2: Types of distortion available from the Atari 400/800. See table 1 for the usage of other bits in each AUDC_n register. An "X" in the second column of the table represents a bit that can be either 0 or 1.

AUDC _n Bit			Examples of Resulting Sound			
7	6	5	Low frequencies	Middle frequencies	High frequencies	
0	0	0	Geiger counter	raging fire	rushing air	steam
0	X	1	machine gun	auto at idle	electric motor	power transformer
0	1	0	calm fire	laboring auto	auto with a "miss"	
1	0	0	building crashing in	radio interference	waterfall	
1	X	1	pure musical tones			
1	1	0	airplane	lawn mower	electric razor	

Table 3: Types of sounds available from the six types of distortion available from each AUDC_n register. An "X" in the second column of the table represents a bit that can be either 0 or 1.

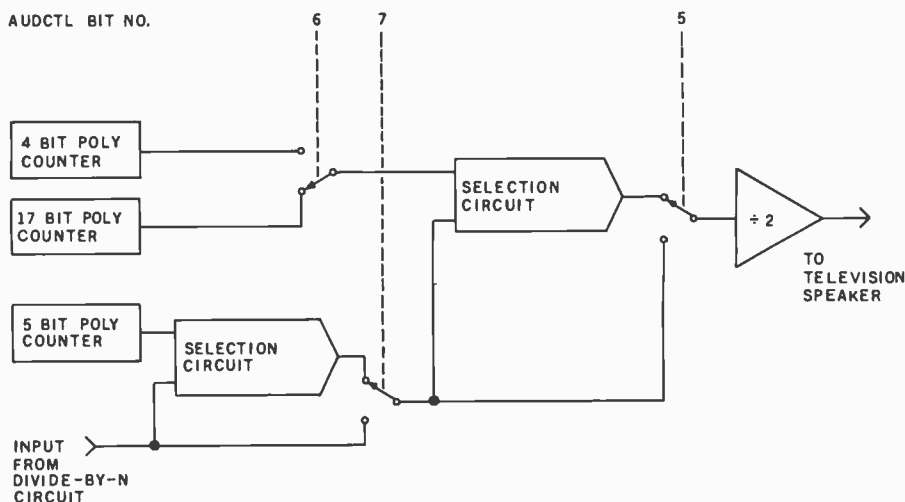

Figure 5: A schematic representation of the effects of bits 5 through 7 of the AUDCTL register on the sound sent to the television speaker.



“WHAT IF...”

Seldom is your first solution to a problem the only one, or the one that's necessarily best to use.

That's why our VisiCalc® program is #1 in the business: the most widely-used business program ever for the personal computer.

It's a powerful “electronic worksheet” that takes the work out of working with numbers. Whether you are working with investments, cash flow, inventory, estimates, budgets, plans—nearly anything numerical, the VisiCalc program will help you work better, smarter, faster.

In just seconds, the VisiCalc program can calculate and display the answers to involved problems you could have spent hours doing by hand.

Its speed and versatility makes it easy for you to explore more alternatives. You can ask “What if?”... just change any number in your problem and instantly, the VisiCalc program recalculates all the numbers and displays the new results. So you can

readily analyze the impact of decisions before you make them.

While the VisiCalc program does a lot by itself, it can do even more for you when used with the other Visi™ programs. That's because they're all inter-related, just like your needs and tasks, to give you a fully integrated solution. For example, automatically bring in data stored in our VisiFile™ program—such as customer or inventory information—for calculation and analysis with your VisiCalc program.

In addition, our series includes the VisiTrend/Plot,™ VisiSchedule,™ VisiDex,™ VisiTerm,™ VisiPlot,™ and Desktop/PLAN™ programs.

Ask your retail computer store salesperson for a demonstration of the VisiCalc program. Discover how easy it is to take the work out of working with numbers.

VISICALC® FROM
VISICORP®
PERSONAL SOFTWARE™

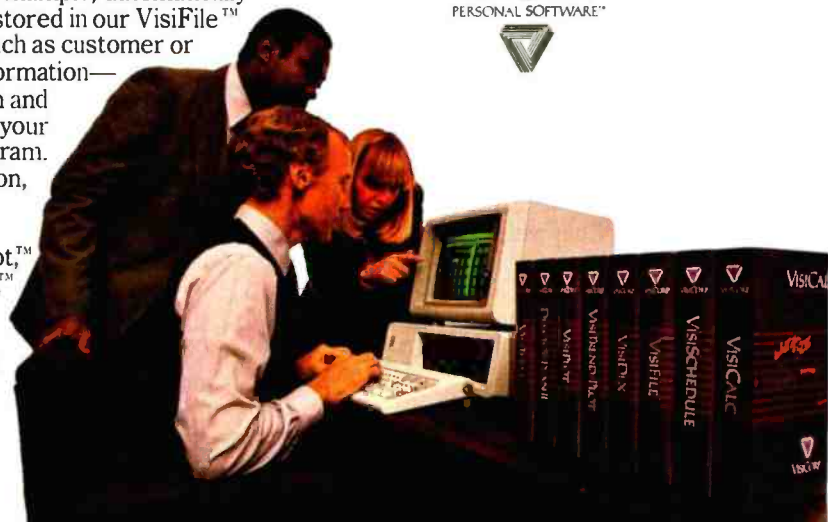

If you sent the speaker a pulse, it would push out with the rising voltage and pull back with the falling voltage, resulting in a wave of air that can be detected by your ear as a pop. The following statements produce such a pop on the television speaker by sending a single pulse:

POKE 53761,31:POKE 53761,16

A stream of pulses (or wave) would set the speaker into constant motion, and a continuous buzz or note would be heard. The faster the pulses are

sent, the higher the note. This is how the computer generates sound on the television speaker.

It is essential to note that in the volume-only mode the volume sent does not drop back to zero automatically, but remains constant until the program changes it. The program should modulate the volume often enough to create a noise. Now try the following two statements, listening carefully after each:

POKE 53761,31
POKE 53761,31

The first time you heard a pop, as expected. The speaker pushed out and moved air. But the second time you didn't because the speaker cone was already in the extended position; an identical extension command did nothing to the speaker. Since it moved no air, you heard nothing. Now try this:

POKE 53761,16
POKE 53761,16

As before, you heard a pop the first time as the speaker moved back to its resting position, and you heard nothing the second time because the speaker was already in the resting position.

Thus, the volume-only bit gives the program complete control over the position of the speaker at any time. Although the examples given above are only binary examples (either on or off), you are by no means limited to this type of speaker modulation. You can set the speaker to any of 16 distinct positions.

For example, a simple triangle wave (similar to the waveform produced by brass instruments) could be generated by sending a volume of 8 followed by 9, 10, 11, 10, 9, 8, 7, 6, 5, 6, 7, and back to 8, then repeating this sequence over and over very rapidly. By changing the volume quickly enough, virtually any waveform can be created. It is feasible, for example, to perform voice synthesis using this technique. However, this requires the use of assembly language. There is more discussion of this bit in part 8 of this series.

AUDCTL

In addition to the independent channel-control bytes (AUDC*n*), an option byte (AUDCTL) affects all four channels. Each bit in AUDCTL is assigned a specific function, as shown in table 4. AUDCTL is at location D208 hexadecimal, 53768 decimal.

Clocking

Before proceeding with the explanations of the AUDCTL options, a

More Modem. Less Moola.



LEX-11
Acoustically Coupled
Modem

Our new LEX-11 was designed for the professional. Yet its economical \$175 price tag makes it affordable for small businesses and personal use, as well.

The LEX-11 can be operated with a home or office terminal to communicate with a computer or to communicate between computers. And it works in geographic areas where other modems fall short.

It has a receive sensitivity of -47 dBm (compared to our competitor's -45 dBm). It has a transmit filter which greatly enhances its performance. It weighs only 24 ounces. And its battery power option enables you to use it anywhere.

If you're looking for a versatile, high-performance acoustical modem, look into the LEX-11.

For information, mail this coupon or call us toll-free at **800-327-8913**. In Florida, call (305) 792-4400.

I want to know more about the LEX-11. Please contact me with details.

Name _____

Title _____

Company _____

Street _____

City _____

State/Zip _____

LEXICON
Corporation of Miami

1541 N.W. 65th Avenue
Ft. Lauderdale, FL 33313 B3/82

Mindful Machines

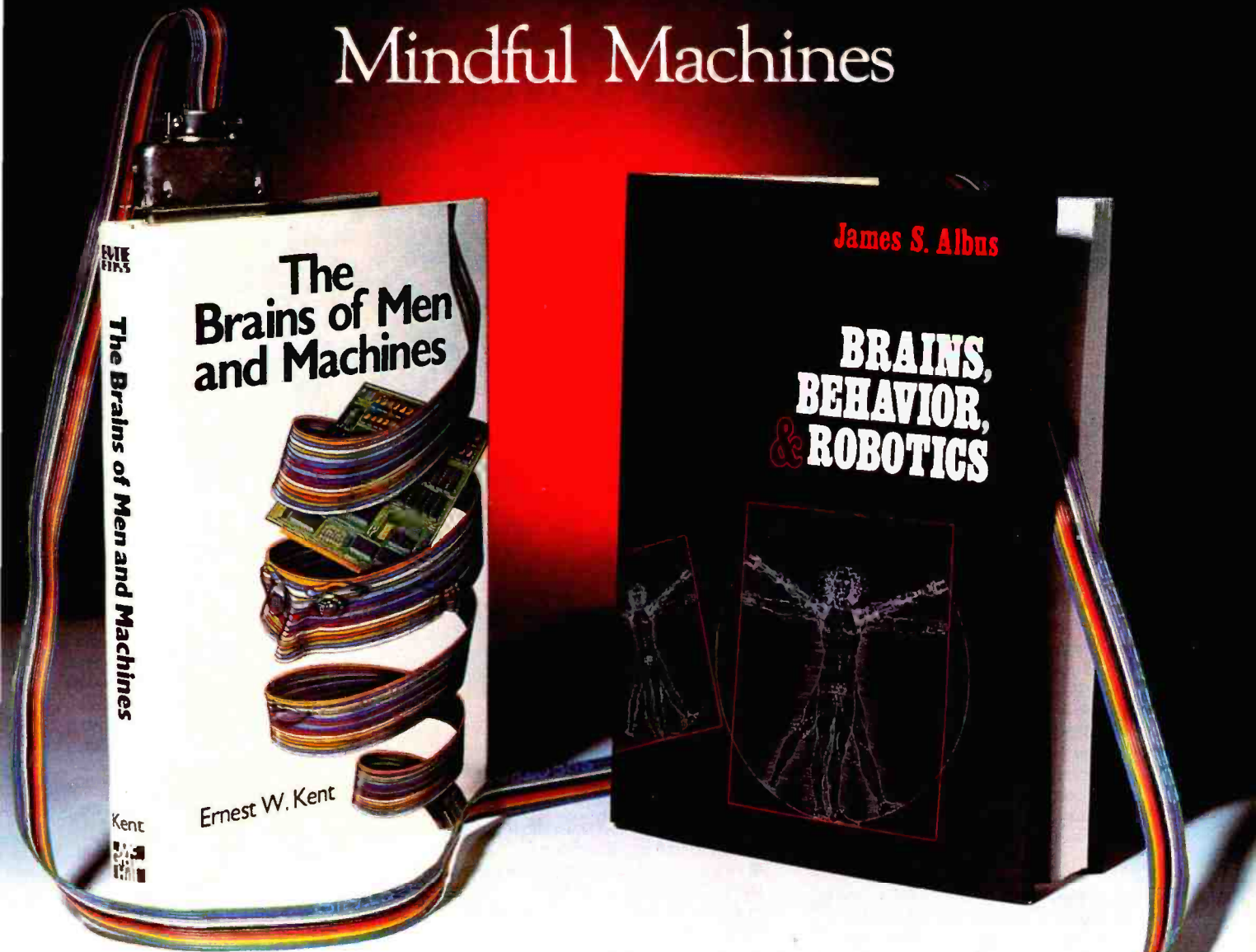

On the leading edge of the current technological revolution, these two books are written by modern thinkers who, like the Renaissance sages of an earlier time, venture across the boundaries of traditional disciplines to create vivid, detailed studies of humanity's quest for self-contained thinking machines.

In *Brains, Behavior, and Robotics*, Dr. James Albus demonstrates through an analysis of the processing hierarchies of the human brain that in our own heads we find the best model for an artificial intelligence computer. He goes on to survey the state of the art of robotics and concludes by portraying the social and economic impact of the coming "robot revolution." Dr. Ernest W. Kent writes in *The Brains of Men and Machines* of the complex relationship between humans and machines. Drawing on the latest research in physiological psychology, he predicts that the more intelligent our machines become, the more they will resemble their creators in methods of processing information, storing data, solving problems, and even in their very circuitry.

Complete with extensive bibliographies, both *The Brains of Men and Machines* and *Brains, Behavior, and Robotics* will fascinate the layman and challenge the professional.

Circle 56 on Inquiry card.



Please send _____ **Brains, Behavior, and Robotics \$16.95**
 _____ **Brains of Men and Machines \$15.95**

Name _____ Check Enclosed _____

Address _____ Bill Visa/
 _____ Master Card # _____

City _____ State _____ Zip _____ Expiration Date _____

BYTE Books 70 Main Street Peterborough, N.H. 03458 Please add .75 per book to cover shipping cost.



Call Toll-Free 800/258-5420



The \$99⁹⁵ personal computer.

ZX81

Introducing the ZX81 kit

If you really want to save money, and you enjoy building electronic kits, you can order the ZX81 in kit form for the incredible price of just \$99.95* It's the same, full-featured computer, only you put it together yourself. We'll send complete, easy-to-follow instructions on how you can assemble your ZX81 in just a few hours. All you have to supply is the soldering iron.

How to order

Sinclair Research is the world's largest manufacturer of personal computers.

The ZX81 represents the latest technology in microelectronics, and it picks up right where the ZX80 left off. Thousands are selling every week.

We urge you to place your order for the new ZX81 today. The sooner you order, the sooner you can start enjoying your own computer.

To order, simply call our toll free number, and use your MasterCard or VISA.

To order by mail, please use the coupon. And send your check or money order. We regret that we cannot accept purchase orders or C.O.D.'s.

CALL 800-543-3000. Ask for operator #509. In Ohio call 800-582-1364. In Canada call 513-729-4300. Ask for operator #509. Phones open 24 hours a day, 7 days a week. Have your MasterCard or VISA ready.

These numbers are for orders only. For information, you must write to Sinclair Research Ltd., 2 Sinclair Plaza, Nashua, NH 03061.

sinclair

AD CODE	PRICE†	QTY.	AMOUNT
0 3BY			
ZX81	\$149.95		
ZX81 Kit	99.95		
8K BASIC chip (for ZX80)	39.95		
16K Memory Module (for ZX81 or ZX80)	99.95		
Shipping and Handling	4.95		\$4.95
TOTAL			

MAIL TO: Sinclair Research Ltd., One Sinclair Plaza, Nashua, NH 03061.

NAME _____

ADDRESS _____

CITY/STATE/ZIP _____

†U.S. Dollars

AUDCTL Bit	Function Performed If Bit Set
0	Switches the main clock base from 64 kHz to 15 kHz
1	Inserts high-pass filter into channel 2, clocked by channel 4 (only frequencies higher than that of channel 4 are passed by the filter)
2	Inserts high-pass filter into channel 1, clocked by channel 3 (only frequencies higher than that of channel 3 are passed by the filter)
3	Joins channel 4 to channel 3 to give 16-bit resolution
4	Joins channel 2 to channel 1 to give 16-bit resolution
5	Clocks channel 3 with 1.79 MHz
6	Clocks channel 1 with 1.79 MHz
7	Makes the 17-bit poly counter into a 9-bit poly counter

Table 4: Modifications to the sound-generation registers available by manipulation of the bits in register AUDCTL (location D208 hexadecimal, 53768 decimal). Bit 7 is the most significant bit in the register.

new concept must be explained: clocking. In general, a clock is a train of pulses used to synchronize the millions of internal operations occurring every second in any computer. The central clock pulses continuously, each pulse telling the circuitry to perform another step in its operations. You may remember that a divide-by-*N* frequency divider outputs one pulse for every *N*th input

pulse. You also may have wondered where the input pulses come from. One main input clock runs at 1.79 MHz; it can provide the input pulses. Also, several secondary clocks can be used as input clocks. The AUDCTL register allows you to select the clock used as the input to the divide-by-*N* circuit. If you select a different input clock, the output from the frequency divider will change drastically.

For example, imagine that you are using the 15-kHz clock, with the frequency register set to divide by 8. The rate of output pulses from the divide-by-*N* circuit would be about 2 kHz. But if you changed the selection of clocks to get the 64-kHz clock and did not change the frequency register, what would happen? The divide-by-*N* would still be putting out one pulse for every eighth input pulse, but the input rate would be 64 kHz. The result is an output frequency (from the divide-by-*N*) of 8 kHz. Thus, you can see that relocking changes the frequency independent of the frequency register and on a larger scale.

The formula for the output frequency (from the divide-by-*N*) is quite simple:

$$\text{Output frequency} = \frac{\text{Clock}}{N}$$

Setting bit 0 of the AUDCTL register switches from the 64-kHz clock to the 15-kHz clock. Note that if this bit is set, every sound channel clocked with the 64-kHz clock will instead use the 15-kHz clock. Similarly, by setting bits 5 or 6, you can clock channels 3 or 1, respectively, with 1.79 MHz. This will produce a much higher note, as demonstrated by the following example:

```
SOUND 0,255,10,8
POKE 53768,64
```

The SOUND statement causes channel 1 to give a low tone, and the POKE sets AUDCTL bit 6 to 1, causing the pitch generated by channel 1 to jump to a much higher note.

16-Bit Frequency Options

The 8 bits of resolution in the frequency-control registers normally provide more than adequate resolution for the task of selecting any desired frequency. There are, however, situations in which 8 bits are inadequate. Consider what happens when you execute the following statements:

```
FOR I=255 TO 0 STEP -1:
SOUND 0,I,10,8:NEXT I
```

Initially, the sound rises smoothly,

ATTENTION GOVERNMENT D P USERS AND PURCHASERS

We represent many fine micro products and manufacturers on the U.S. Government's GSA Schedule, including

**Apple, Cromemco, Micropolis, NorthStar,
Osborne and Seequa Computers**

Purchasing from the Schedule will save you the time consumed by the bid process. Products shipped throughout the United States and world-wide. Visit or write any of our stores for more information or to receive our catalogue of products represented.

**Computers,
Etc.....
the dependable store**

257 West Street, Annapolis, MD 21401 – (301) 268-6505
13A Allegheny Avenue, Towson, MD 21204 – (301) 296-0520
9330 Georgia Avenue, Silver Spring, MD 20910 – (301) 588-3748
6671 Backlick Road, Springfield, VA 22150 – (703) 644-5500
Plaza 38, 2442 Route 38, Cherry Hill, NJ 08002 – (609) 779-0023

Callers outside metropolitan areas served by our stores

Please call (301) 268-5801

Career Opportunities Available * An Equal Opportunity Employer

SANYO MONITORS

When you're ready to stop playing around.

Maybe your home TV was OK as a display when all you were concerned with was blasting Klingons.

But if you spend more than a couple of hours in front of your TV screen, you'll start to pay the price in eyestrain. Maybe even headaches.

It's not worth it. Not when you can get a Sanyo data monitor that's specifically designed for long-term, day-in, day-out use.

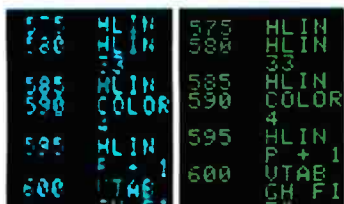

Compare display quality of a typical home TV (left) with a Sanyo professional monitor (right).

Sanyo monitors have been the industry standard for as long as there's been a personal computer industry—in fact they're recommended by computer dealers and manufacturers alike. That's because when you buy a Sanyo, you're not just getting a stripped-down TV set. You're getting a truly professional display system.

Sanyo offers a complete selection of monitors for any application. You can choose from

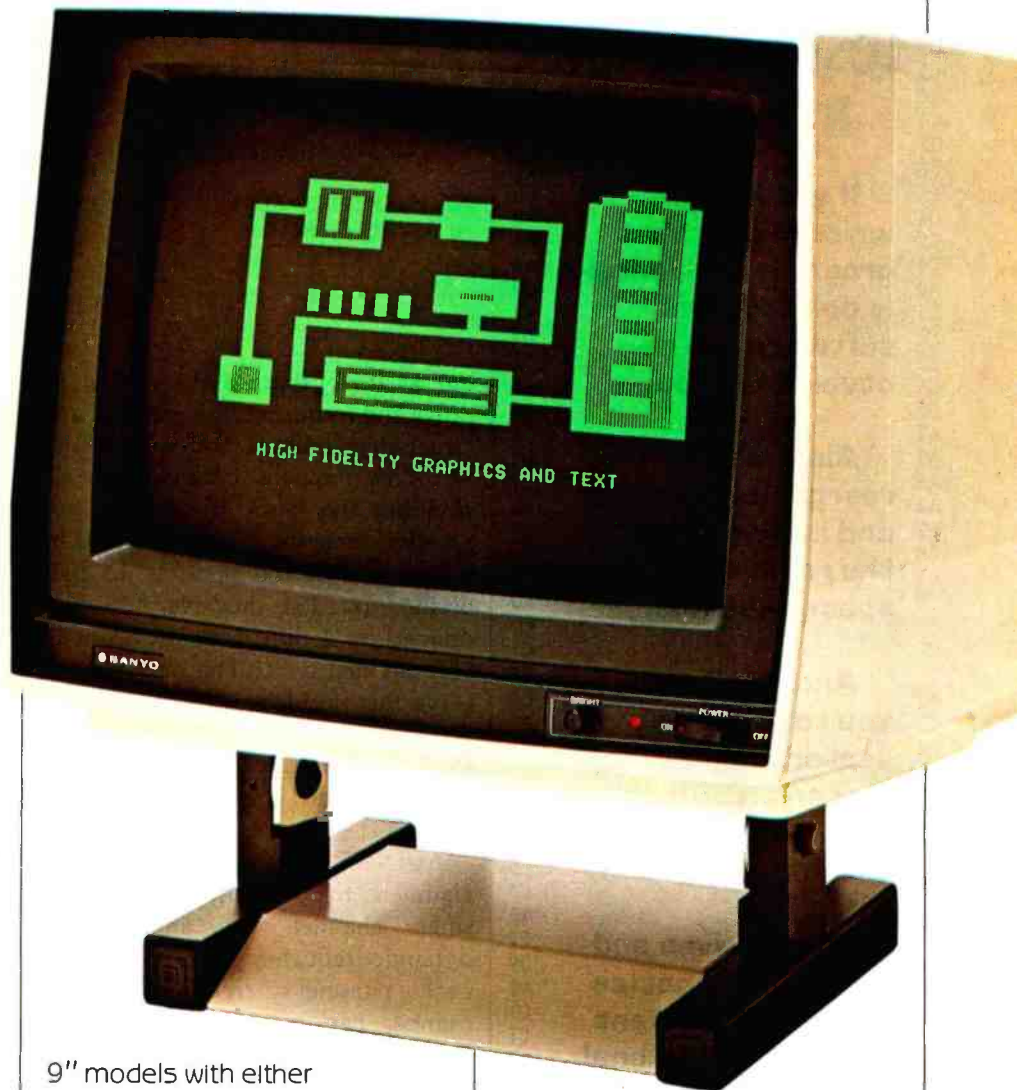

9" models with either white or easy-on-the-eyes green phosphors. Or a sleek new 12" model with a special anti-reflec-

tive screen (green or white), and an optional desk stand with adjustable tilt. If color graphics are your thing, check our 13" full-color models—one with TV-compatible video input, and a new ultra-high resolution RGB model for computers like the IBM, NEC and Apple III.

Visit your computer dealer and find out how much better things look on a real, professional monitor from Sanyo.

Anything less is just playing around.

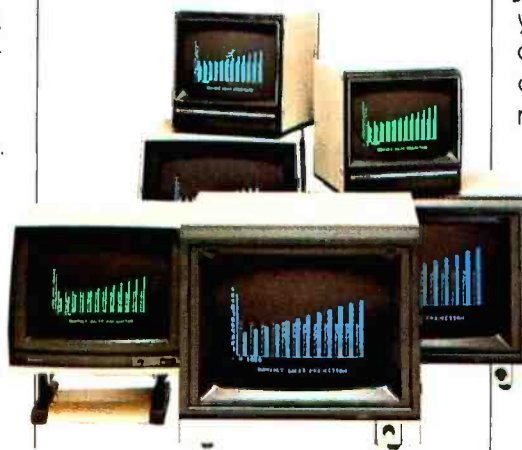

Communications Products Division

Sanyo Electric Inc., 1200 W. Artesia Blvd., Compton, CA 90220 (213) 537-5830

A0C4C9D3CBA0D5D4C9CCC9D4D9A0A4B5B0A0

**Disk Utility
for Apple DOS 3.3**

**LOST PROGRAM
RECOVERY**

**If you haven't
written over that
program accidental-
ly deleted, this
software can re-
cover it for you.**

**Also, it can
reorganize your disk
and inform you of
the remaining
space available.**

**And, it allows
you to patch any
sector: display in
Hex and ASCII on
standard Apple
screen.**

**Menu driven and
easy for the novice
while still efficient
for the professional.
Compatible with
M & R Superterm.**

**For more information or
to place your order call:
(208) 263-1213**

Cost: \$50

We pay first class postage and insurance. You may use VISA or Master Card.

TO ORDER: Send us your check, money order or credit card number and expiration date. Certified checks avoid clearance delay.

**ANSWER Corporation
502A North Second Ave.
Sandpoint, Idaho 83864**

A0A0C2D9A0CAC5D2D2D9A0D4C9C6C6D4A0A0

Listing 1: A program that uses a 16-bit divide-by-N register. When used with game paddles in port 1, this program produces a sound with a frequency that can be varied by paddles 1 and 2. Paddle 1 changes the sound in large steps; paddle 2 changes the sound between two adjacent large steps.

```

10 SOUND 0,0,0,0.: REM          Initialize sound
20 POKE 53768,80: REM          Clock channel 1 with 1.79 MHz, clock
                                channel 2 with channel 1
30 POKE 53761,160:POKE 53763, 168: REM  Turn off channel 1, turn on channel 2
                                        (pure tones)
40 POKE 53760,PADDLE(0):POKE 53762,PADDLE(1)
50 GOTO 40: REM                Set paddles to put frequencies in
                                        frequency registers
    
```

but as it approaches the end of its range the frequency takes larger and larger steps that are noticeably clumsy. This happens because you are dividing the clock by smaller and smaller numbers: 15 kHz divided by 255 is almost the same as 15 kHz divided by 254; however, 15 kHz divided by 2 differs greatly from 15 kHz divided by 1. The only way to solve this problem is to use a larger number that allows you to specify frequency with greater precision. The means to do this are built into POKEY.

AUDCTL bits 3 and 4 allow two channels to be joined, creating a single channel with an extended dynamic-frequency range. Normally, each channel's frequency-divider number can range from 0 to 255 (which results from 8 bits of divide-by-N capability). Joining two channels allows a frequency range of 0 to 65535 (16 bits of divide-by-N capability). In this mode, it is possible to reduce the output frequency to less than 1 Hz. The program in listing 1 uses two channels in the 16-bit mode and two paddles as the frequency inputs. Insert a set of paddles into port 1, then type in and run listing 1. The right paddle tunes the sound coarsely; the left paddle finely tunes the sound between the coarse increments.

This program first sets bits 4 and 6 of AUDCTL; this tells the Atari computer to clock channel 1 with 1.79 MHz and join channel 2 to channel 1. Once this happens, the 8-bit frequency registers of both channels are assumed to represent a single 16-bit number N that is used to divide the input clock. Next, the volume of

channel 1 is set to 0. Since channel 1 no longer has its own direct output, its volume setting is meaningless to us and we zero it. The channel 1 frequency register is used as the fine-tuning or low byte in the sound generation; the channel 2 frequency register is the coarse-tuning or high byte. For example, poking a 1 into the channel 1 frequency register makes the pair of registers divide by 1. Poking a 1 into the channel 2 frequency register makes the pair divide by 256. Poking a 1 into both frequency registers makes the pair divide by 257.

Bit 3 of AUDCTL can be used to join channel 4 to channel 3 in the same way.

The following instructions demonstrate some interesting aspects of 16-bit sound (try poking other numbers into the last four locations):

```

SOUND 0,0,0,0
POKE 53768,24
POKE 53761,168
POKE 53763,168
POKE 53765,168
POKE 53767,168
POKE 53760,240
POKE 53764,252
POKE 53762,28
POKE 53766,49
    
```

High-Pass Filters

AUDCTL bits 1 and 2 control high-pass filters in channels 2 and 1, respectively. A high-pass filter allows only higher frequencies to pass through. In the case of these high-pass filters, high frequencies are defined as anything higher than the output of another channel selected by

VIC-20

The Friendly Computer

\$299.95



- Full Computer Keyboard
- 16 Colors/4 Sound Generators
- 66 Graphics Characters
- Memory Expansion to 32K RAM
- Includes Microsoft™/PET® BASIC
- Connects to TV or Monitor
- Recreation, Education & Personal Computing Programs
- Peripheral Equipment: Joystick, Paddles, Disk Drive, Printer, Cassette unit
- Telephone Modem for Communicating with outside Information Sources
- 4 Programmable Function Keys

For more information on the VIC-20's exciting
Space Games, Personal Software, and Programming capabilities,
visit your Commodore Dealer, or write:

VIC-20, Commodore Business Machines, 681 Moore Road, King of Prussia, PA 19406

 **commodore**
COMPUTER

www.americanradiohistory.com

the AUDCTL bit combination. For example, if channel 3 is playing a cow's moo and AUDCTL bit 2 is set, only sounds with frequencies higher than the moo will be heard on channel 1 (anything lower than the "moooo" will be filtered out). See figure 6.

The filter is programmable in real time because the filtering channel can be changed on the fly. This opens a large field of possibilities to the pro-

grammer. The filters are generally used to create special effects. Try the following statements:

```
SOUND 0,0,0,0
POKE 53768,4
POKE 53761,168:POKE 53765,168
POKE 53760,254:POKE 53764,127
```

9-Bit Polynomial Conversion

Bit 7 of AUDCTL, when set, turns the 17-bit poly counter into a 9-bit

poly counter. The shorter the poly counter, the more often its distortion pattern repeats, or the more discernible is the pattern in the distortion. Therefore, changing the 17-bit poly counter into a 9-bit poly counter makes the noise pattern more repetitious and more discernible. Try the following demonstration of the 9-bit poly-counter option, listening carefully when the POKE is executed:

```
SOUND 0,80,8,8
POKE 53768,128
```

The first statement activates the 17-bit poly counter; the second changes the counter to a 9-bit poly counter.

Next Month

Now that we know about the various registers that control the sound-generating capabilities of the Atari 400/800, we will look at several BASIC and machine-language techniques to use sound within a program. ■

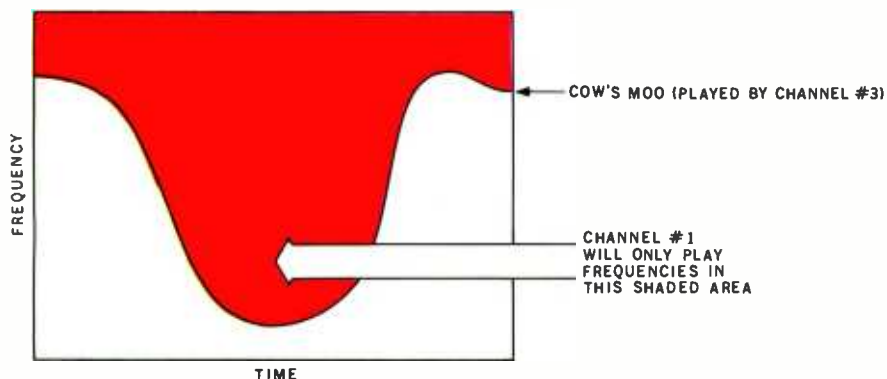
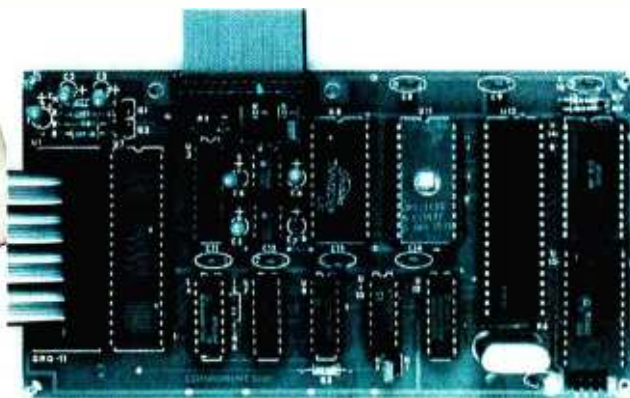

Figure 6: High-pass filtering in the Atari 400/800. At any given instant, the only frequencies in channel 1 that are passed by the filter are those greater than the frequency being played in channel 3.

DATAFACE GRQ SERIES INTERFACE

URNS YOUR ELECTRONIC TYPEWRITER INTO A PRINTER/TYPEWRITER



The Dataface GRQ-11 Interface expands your Olympia ES Series electronic typewriter into a letter press quality printer for your personal or business computer. And, you still have a fully featured electronic typewriter—two machines in one.

The GRQ Series Interface features:

1. Standard EIA RS-232-C Serial Interface and Parallel (Centronics compatible).
2. Standard asynchronous ASC11 code, 7 bit data; 1 start bit; accommodates 1 or 2 stop bits automatically; accommodates odd, even or absence of parity bit.
3. Fifty thru 9600 Baud data rate options.
4. Two K buffer; supports X-on, X-off protocol as well as RTS signals.

5. Circuit board is installed inside typewriter back panel along side logic board. The connection between boards accomplished by 40 pin jumper cable using existing socket. No soldering required. Power is provided to the GRQ thru two pins of the 40 lead cable. Installation in 10 minutes.

GRQ-10 — CALL FOR SPECIAL WHOLESALE PRICE. SUGGESTED RETAIL \$349.50.

DATAFACE INC.

2372 A WALSH AVE., SANTA CLARA, CA 95050
(408) 727-6704

SuperSoft's

Ada*

for CP/M

Ada*, the language of the '80s, is here now. Required by the Department of Defense for all programming, Ada is a highly structured, sophisticated language, well suited to both applications and systems programming.

SuperSoft Ada is a native code, fully recursive, two pass compiler which generates ".COM" files. While currently a subset, SuperSoft Ada supports most features of the standard Ada language such as:

pragma	arrays	case
loop	for	while
procedure	characters	integers
strings	float	disk I/O
console I/O	printer I/O	

Ada is a state-of-the-art language designed for the demanding contemporary user/programmer. Because it is required by the Department of Defense, Ada is certain to become a dominant language soon. Begin learning and using Ada now with SuperSoft Ada.

Ada Compiler (requires 48K CP/M) \$250.00
Manual & documentation: \$ 20.00

Available from fine dealers everywhere, or directly from:

SUPERSOFT, INC.
P.O. BOX 1628
CHAMPAIGN, IL 61820
217-359-2112 Telex: 270365
Technical Hot Line:
217-359-2691

U.K. and Europe:
DIGITAL DEVICES
134 LONDON ROAD
SOUTHBOROUGH, KENT
TUNBRIDGE WELLS
TN4, OPL
ENGLAND
Tel.: Tunbridge Wells (0892)37977/9
Telex. 95582

Japan:
ASR CORPORATION INTERNATIONAL
3-23-8 NISHI-SHIMBASHI, MINATO-KU
TOKYO 105
JAPAN
Tel: 03-437-5371
Telex: 0242-2723

SuperSoft.....First in Software Technology

The following is required by the Department of Defense for copyright protection:

"This compiler is presently an incomplete implementation of the Ada programming language. It is intended that this compiler will be further developed to enable implementation of the complete Ada programming language, and then to be submitted to the Ada Joint Program Office for validation."

*Ada is a trademark of the Department of Defense. (Ada Joint Program Office).

*CP/M is a registered trademark of Digital Research.

Circle 365 on Inquiry card.

www.americanradiohistory.com

Build a Half-year Clock for the Color Computer

Fourth in a Series

William Barden Jr.
28122 Orsola
Mission Viejo, CA 92692

The ideal clock for a computer system, to my mind, would be an inexpensive, compact, accurate unit with a self-contained power supply that could be easily interfaced to the computer system. This article describes a clock for the Radio Shack Color Computer; it meets all of my goals at the expense of some software complexity.

The half-year clock (HYC) described here can provide the time with a resolution of ± 10 seconds or better over a six-month period. Powered by a self-contained 9-volt (V) battery, it can be disconnected from the Color Computer at any time, set aside, plugged in later, and will continue reporting the time. It is a compact unit measuring 14 by 9 by 3.8 cm (5½ by 3½ by 1½ inches).

The HYC uses seven integrated circuits (ICs) plus some discrete components. The project is built using wire-wrapping techniques. If you've never tried wire-wrapping, fear not: I'll provide detailed tips for easy construction.

Since the HYC communicates with the Color Computer via the serial interface of the computer, I'll start with a description of that interface.

Color Computer Serial Interface

The complete serial interface of the Color Computer is shown in figure 1. The four lines of the serial interface go to a 4-pin DIN plug on the rear of the system. These four lines are a subset of the 25 lines normally used in other computer systems, such as the Radio Shack Models I and III. The Color Computer uses asynchronous

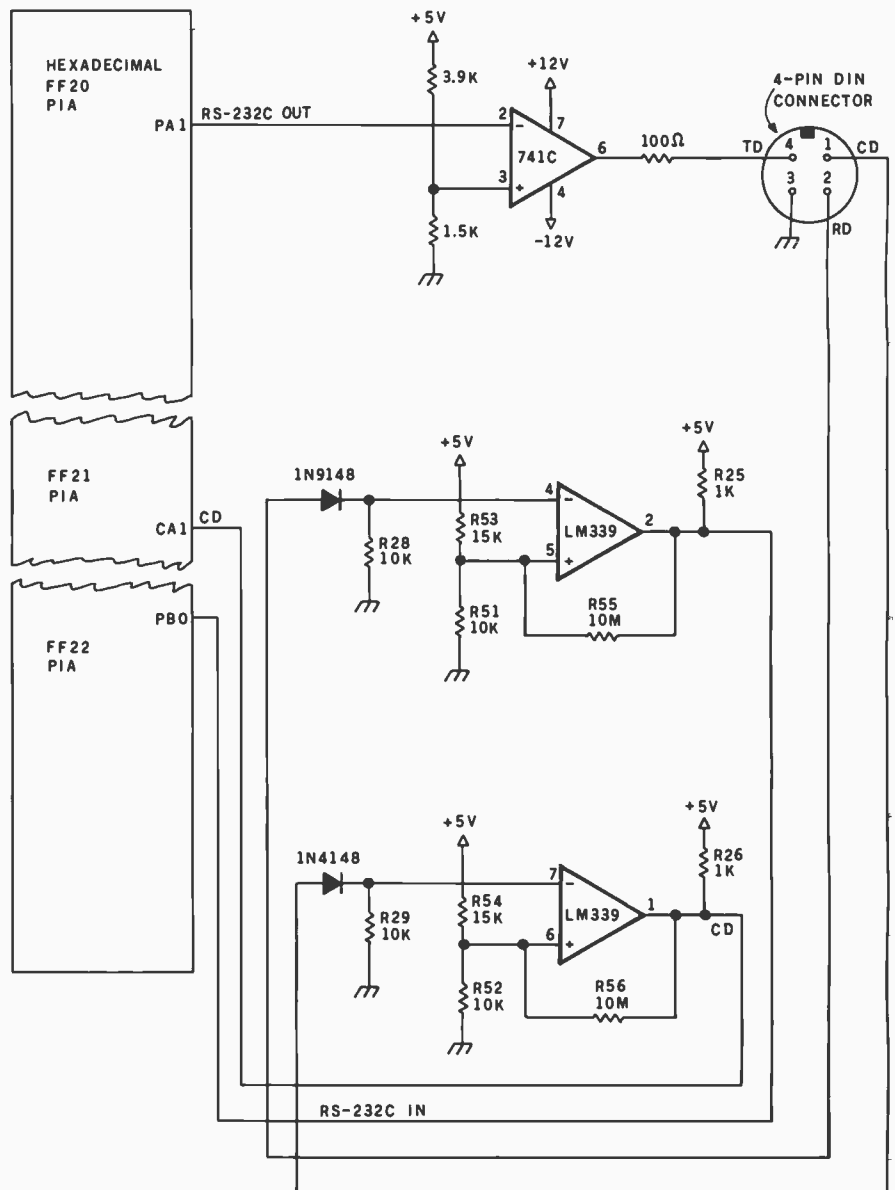

Figure 1: The Color Computer RS-232C interface consists of two comparators and one op amp used as a comparator. The TD signal is generated from software by output to PIA (peripheral interface adapter) address FF20 hexadecimal. The RD is read into PIA address FF22 hexadecimal. The CD signal is not normally used and is an "edge trigger" signal generating a PIA interrupt.

Announcing the Printing Breakthrough of the Century: Smith-Corona® TP-1™ Text Printer



• **Low Cost Daisy Wheel Printer**

\$845⁰⁰

- Microprocessor Electronics
- Serial or Parallel Interface
- Simple, Reliable Mechanism

ACT NOW: Limited Supply, Low, Low Cost

Smith Corona, one of the largest manufacturers of small printers in the world, gives a whole new perspective to printing with their electronic text printer—TP-1. The TP-1 is a microprocessor controlled, high quality **daisy wheel printer**. It produces perfectly formed, executive quality printouts at the speed of 120 words per minute. Typewriter quality printing at dot matrix prices.

Simple, durable and dependable, TP-1 may be used with word processing systems, microcomputers and most small business systems. Compact and attractively



Additional daisy print wheels \$4.95



Additional ribbons \$2.95

styled, the TP-1 blends well with any setting.

Now, all your letters, documents forms and reports can have the crisp, professional look you demand—for business or personal use—at an affordable price. TP-1, the electronic text printer.

Don't delay. Order your TP-1 TODAY at the low price of **\$845**.

Micro Printer Marketing offers same day shipping, nationwide service and invites dealer inquiries. Catalogues available. No shipping charges on pre-paid orders.

**Micro™
Printer
Marketing**

Circle 245 on inquiry card.

Call Micro-Printer Marketing

CALL TOLL FREE **1-800-523-9859** MasterCard and Visa Accepted

In PA Call Collect **215 / 433-3366**



Data sent in asynchronous RS-232C format typically consist of a start bit, 8 bits of data, and one or two stop bits. The bits are evenly spaced with no inherent clock.

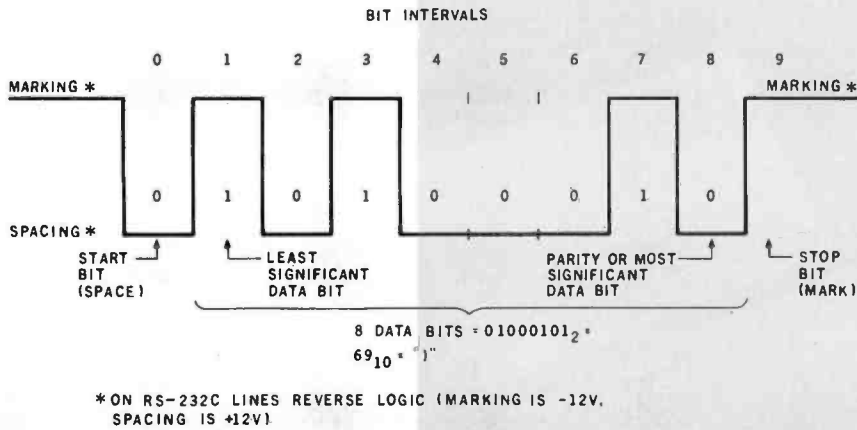

Asynchronous Communication

The EIA standard RS-232C defines the format for data communication. Therefore, serial communication is often called "RS-232C" or "RS-232" communication. A system channel designed for data communication is known as a serial or RS-232 port.

The standard format for asynchronous communication is shown above. In this example, 8 bits make up the actual data word. The data are asynchronous, that is, they are sent at unpredictable times, rather than at regularly spaced intervals. A good example of an asynchronous datum is a character transmitted from a keyboard to a communications system such as The Source or Compuserve. The host system does not know when to expect the next character—it may occur within 1/10 second or 10 seconds. Each character must be detected and handled as an independent "event."

The computer system or device receiving an asynchronous character can read either a logic 1 or logic 0 on the receive data (RD) line. Initially, the RD line is at logical 1, called "mark." The receiving system or device expects this high condition to exist initially. To signal the start of a data word, the transmitting system sends a start bit by bringing the RD line to a logical 0,

called a "space," for a duration known as a "bit time." The length of the bit time depends on the data-transmission rate and may vary from about 9 milliseconds to 0.1 millisecond.

The receiving system or device detects the start bit, delays 1/2 bit time, and gets set to receive the rest of the data word at evenly spaced intervals of one bit time. The start bit is followed by eight data bits (one of which may be a parity bit) and one or two stop bits that are always at logic 1 (mark). The stop bits ensure that the RD line will be marking prior to transmission of the next data word.

The bit rate is the data-transmission rate of all data measured in bits per second (bps). Three hundred bps is typical for the Color Computer. Each character at this bit rate typically is made up of one start bit, eight data bits, and one stop bit, for a total of 10 bits. Thus, 300 bps yields 30 characters per second. The bit time is 1/300 second, or 3.33 milliseconds.

The standard logic levels for RS-232C communication are voltages above 3 V (logic 0) and below -3 V (logic 1). In the Color Computer, the voltages used are 12 V for logic 0 and -12 V for logic 1.

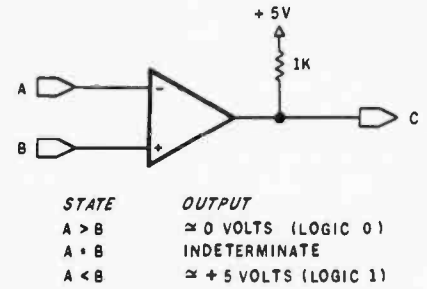

Figure 2: A comparator contrasts two input signals in relation to each other. If the "+" (plus) input is greater than the "-" (minus) input, a logical 1 is generated at the output; if the "+" input is less than the "-" input, a logical 0 is produced.

serial communication, which requires only three lines; the fourth line is available for special purposes. See the text box for background information on serial communication.

Interface operation. The Color Computer's serial interface is made up of one comparator (actually an operational amplifier) for controlling the transmit data (TD) line and two comparators for checking the receive data (RD) and carrier detect (CD) lines.

A comparator accepts two input voltages. If the "+" (plus) input voltage is higher than the "-" (minus) input, the comparator outputs a logic 1; if the "+" input voltage is lower than the "-" input, the comparator outputs a logic 0 (see figure 2).

In the following descriptions, I'll be referring to a few "memory" addresses in the Color Computer that function as I/O lines—part of the peripheral interface adapter (PIA).

TD line. The 741C operational amplifier compares the "-" input from bit 1 of port address FF20 hexadecimal with the "+" input from the voltage divider R23/R24. The "+" input is a constant +1.38 V. A logic 1 on port FF20 hexadecimal bit 1 will generate -12 V on the TD line; a logic 0 will generate +12 V on the TD line.

RD and CD lines. The two LM339 comparators have serial data as their input. Both have the same configuration. One is connected to the RS232IN line of port FF22 hexadecimal bit 0. The second is con-

"Dad, can I use the IBM computer tonight?"

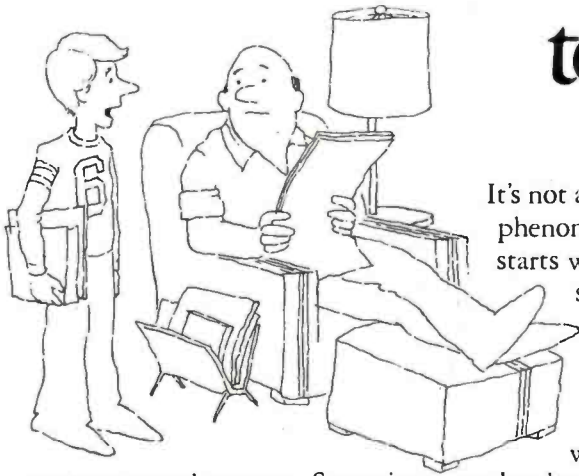

It's not an unusual phenomenon. It starts when your son asks to borrow a tie. Or when your daughter wants to

use your metal racquet. Sometimes you let them. Often you don't. But when they start asking to use your IBM Personal Computer, it's better to say yes.

Because learning about computers is a subject your kids can study and enjoy at home.

It's also a fact that the IBM Personal Computer can be as useful in your home as it is in your office. To help plan the family budget, for instance. Or to compute anything from interest paid to calories consumed. You can even tap directly into the Dow Jones data bank with your telephone and an inexpensive adapter.

But as surely as an IBM Personal Computer can help you, it can also help your children. Because just by playing games or drawing

colorful graphics, your son or daughter will discover what makes a computer tick — and what it can do. They can take the same word processing program you use to create business reports to write and edit book reports (and learn how to type in the process). Your kids might even get so "computer smart," they'll start writing their own programs in BASIC or Pascal.

Ultimately, an IBM Personal Computer can be one of the best investments you make in your family's future. And one of the least expensive. Starting at less than \$1,600* there's a system that, with the addition of one simple device, hooks up to your home TV and uses your audio cassette recorder.

To introduce your family to the IBM Personal Computer, visit any ComputerLand® store or Sears Business Systems Center. Or see it all at one of our IBM Product Centers. (The IBM National Accounts Division will serve business customers who want to purchase in quantity.)

And remember. When your kids ask to use your IBM Personal Computer, let them. But just make sure you can get it back. After all, your son's still wearing that tie.



The IBM Personal Computer and me.

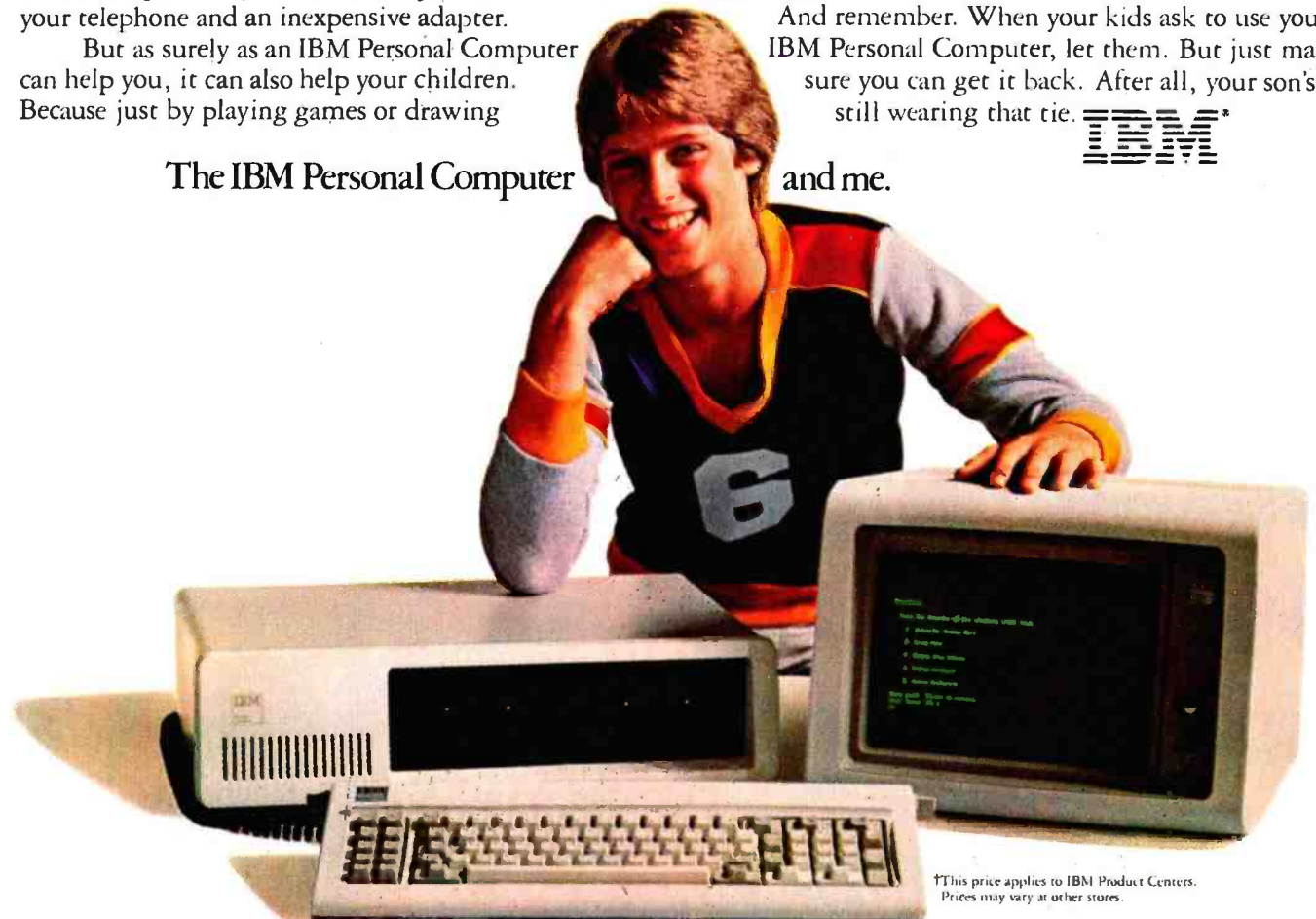

*This price applies to IBM Product Centers. Prices may vary at other stores.

For the IBM Personal Computer dealer nearest you, call (800) 447-4700. In Illinois, (800) 322-4400. In Alaska or Hawaii, (800) 447-0890.

Circle 182 on Inquiry card.

www.americanradiohistory.com

**ALL MATTER
IS MODULAR.**

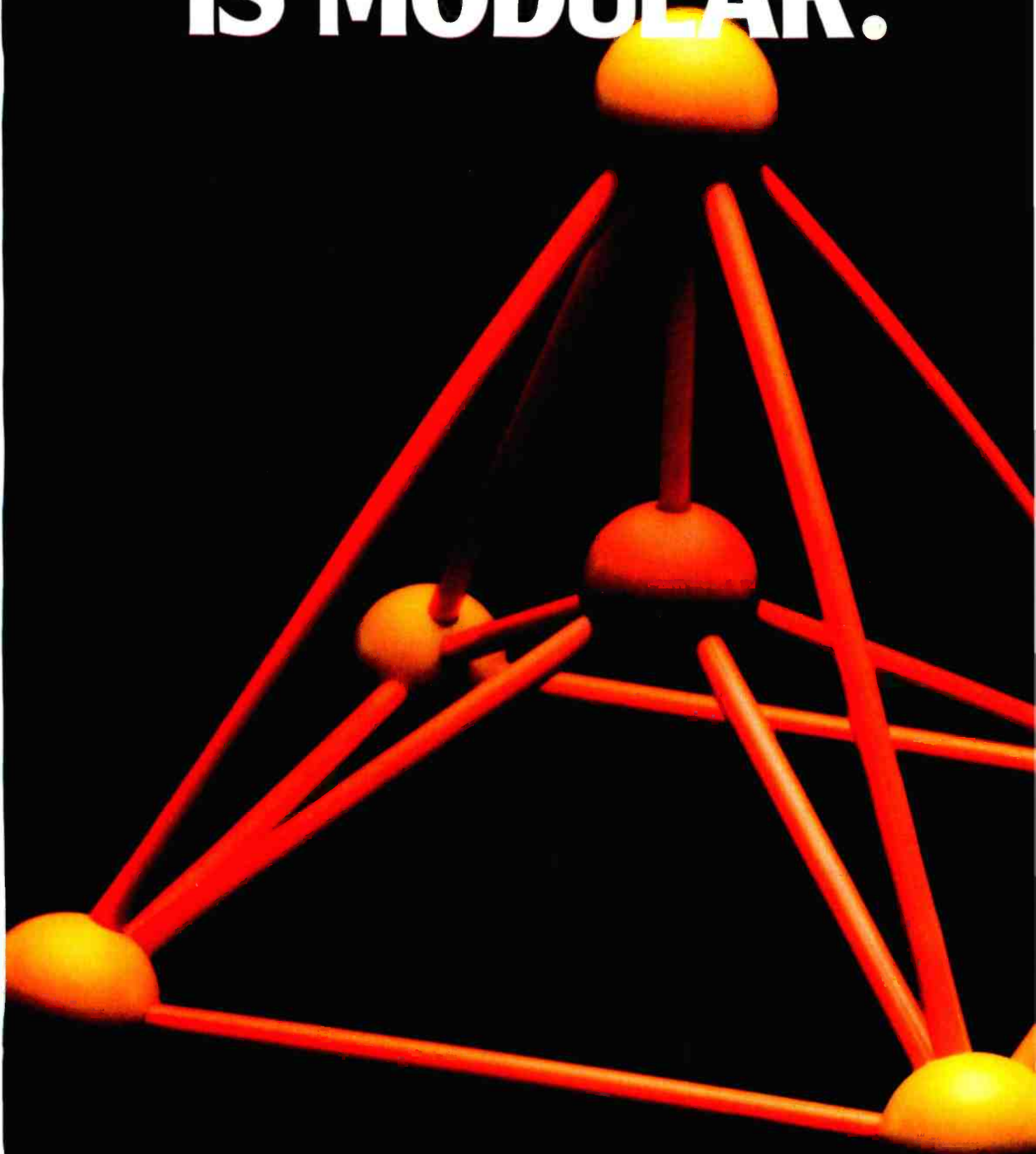

YOUR PRINTER SHOULD BE, TOO.



Introducing the Prism Printer™ from Integral Data Systems.

The Prism Printer is the first truly modular, field-upgradable dot matrix printer. Now your printer can be as flexible as the rest of your system.

No other printer offers you as much (or as little) as you need. Start with the basic printer which features text-quality printing; then add the performance

modules you need—when you need them. Getting into word processing? Add the automatic cut sheet feeder. Handling lots of data? Install the high speed Sprint Mode™. Want to get the big picture? Add the Dot Plot™ graphic option. And for communicating information and ideas faster, nothing is more effective than Prism Color™ for high quality, multi-color output.

And that's just the beginning. Additional Prism option modules will soon be available to help your evolving system meet its true potential. You'll never pay too much or get too little again.

If you're an Apple, IBM, or other professional micro-computer user, Prism Printer is the key to your total system solution. At last, the chemistry is right between you and your printer. The Prism Printer from Integral Data Systems.

For more information, and the name of your nearest Integral Data Systems Dealer, call toll free (800) 258-1386. In New Hampshire, Alaska and Hawaii, call (603) 673-9100.



Integral Data Systems, Inc.

A Whole New Spectrum of Imaging Ideas

Milford, NH 03055

Telex 95 3032

Circle 190 on inquiry card.

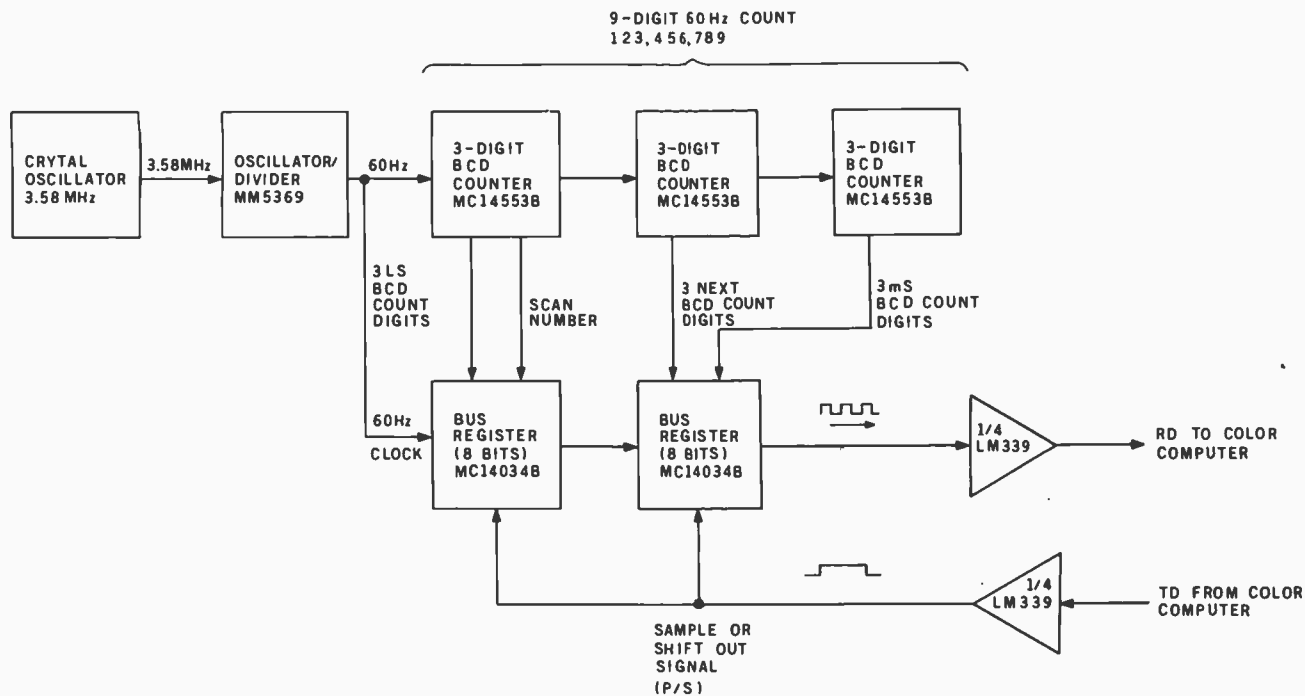

Figure 3: The half-year clock consists of a crystal oscillator, a divider producing 60-Hz pulses, a 9-digit BCD counter, a parallel/serial register, and comparator output to the Color Computer.

nected to the CD line of port FF21 hexadecimal. The CD line generates an interrupt and is not used in this project.

The "+" input of the RS232IN comparator is biased at +2 V by the R54/R52 voltage divider. The "-" input is connected via a diode to the RD line. If the RD line is at 2.6 V (+2-V bias plus about 0.6 V for the diode), the output of the comparator is a logic 0, or about 0 V. If the RD line is less than 2.6 V, the diode will not conduct, and the output of the comparator is a logic 1, or about +5 V. In short, the RS232IN signal follows the serial data on the RD line and can be tested by reading FF22 hexadecimal bit 0.

The third line used in serial communication is ground, which is connected to pin 3 of the DIN connector.

HYC Design

A block diagram of the HYC is shown in figure 3. It interfaces to the Color Computer via the RD, TD, and ground lines of the serial port. The clock count is sent via the RD line after a prompt by the Color Computer from the TD line.

At the heart of the HYC are three BCD (binary-coded decimal) counter

chips. Each chip accumulates a three-decimal digit count of 0 to 999. Together, the three chips accumulate a count of up to 999,999,999.

The input to the three counters is a 60-hertz (Hz) signal from the oscillator/divider chip. This chip takes a 3.58-megahertz (MHz) signal from a "color burst" crystal and divides it down to 60-Hz signals.

At any given time, the count in the counter chips represents the number of 60-Hz pulses received. The maximum count of 999,999,999 represents 16,666,666 seconds—about 192 days.

The two "universal bus register" chips load 16 bits from the counters upon command from the Color Computer. The bits are then shifted out to the RD line at a rate of one every $\frac{1}{60}$ second. It requires three transfers (48 bits total) to transmit the current time to the Color Computer. (Of course, the Color Computer has to decode it into a usable form.) The detailed logic diagram of the HYC is shown in figure 4.

Counters. The counters are Motorola MC14553B ICs. Each chip increments its count by one each time a 60-Hz pulse is received from the CLK input. To output its count, each

chip presents one digit at a time over the Q3 through Q0 outputs. Q3 through Q0 represent a BCD digit of 0000 through 1001. For example, if the count in one of the MC14553B chips was "678," the outputs on Q3 through Q0 would be, in sequence, 0110, 0111, and 1000.

The chips are outputting their counts continually. The scan rate, the rate at which the three digits appear, is controlled by an external capacitor connected to C1A and C1B. A 1.0-microfarad (μ F) capacitor generates a scan rate of about 3 Hz, or a new BCD digit every 333 milliseconds (ms). The scan frequency has no relation to the 60-Hz clock frequency. This scan frequency is applied to all three counters simultaneously so that the BCD digits of all sets of Q3 through Q0 change at the same time.

The DS3 to DS1 outputs indicate which BCD digit is being displayed on the Q3 through Q0 outputs. If DS3=0, the most significant digit is being output; if DS2=0, the next digit is being output; and if DS1=0, the least significant digit is being output.

To read the current count requires three reads of Q3 through Q0: at DS1 time, DS2 time, and DS3 time. When

BETA COMPUTER DEVICES

AVAILABLE NOW ... SYSTEM 2800 FROM SYSTEMS GROUP

FEATURES

- IEEE S-100 Bus Compatible Systems, Z80A Based
- Two 8-Inch Drives: Single or Double Sided, Double Density Floppy Disk Drives or 10MB Winchester Hard Disk Drive
- 20MB Winchester and Tape Backup
- 8-Slot Shielded and Terminated Motherboard
- System Software Selection includes CP/M*, MP/M* or OASIS**
- Single-User or Multi-User Systems, Expandable to 6 Users
- Table Top or Rack Mountable
- Two Switched AC Outlets on Rear Panel
- One Year Warranty on Entire System



Model 2812/14/24

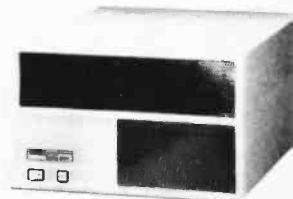

Model 2819/29

2812 CP/M, 2 Single Sided Floppies.....	\$3,995.00
2814 CP/M, 2 Double Sided Floppies.....	4,395.00
2819 CP/M, 1 10 MB Winchester & 1 Double Sided Floppy.....	6,995.00
2824 MP/M, 2 Double Sided Floppies....	5,195.00
2829 MP/M, 1 10 MB Winchester & 1 Doubled Sided Floppy....	7,695.00

S-100 PRODUCTS

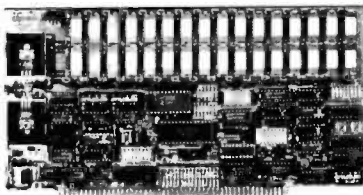

QUALITY RAM FROM SYSTEMS GROUP

- Z-80 4MHZ operation with no wait states
 - IEEE compatible timing - 200 NS 4116's
 - Factory assembled, tested & burned in
- | | |
|---------------------------------------|-----------|
| DMB6400 64K (Bank Select, shown)..... | \$ 599.00 |
| DM6400 64K | 519.00 |
| DM4800 48K | 489.00 |
| DM3200 32K | 459.00 |

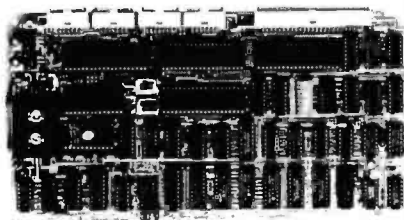

CONFIGURE A COMPLETE S-100 SYSTEM WITH 2nd GENERATION* PRODUCTS FROM SYSTEMS GROUP.

- CPC 2810 (shown) Z-80A processor board (4MHZ) with 4 serial & 2 parallel ports.....\$379.00
- CPC2813 - same as CPC2810 but 2 serial ports only.....\$349.00
- FDC2801/8 - 8" floppy disk controller board, up to 4 single/double sided drives, single or double density.....\$379.00
- I/O-2804 - 4 channel serial I/O..... 329.00
- CRA-100 - Cromix* adaptor board.. \$57.00

CALL US FOR OUR MOST CURRENT PRICES!

*2nd Generation is a trademark of Measurement Systems and Controls, Inc. Cromix is a trademark of Cromemco, Inc. CP/M and MP/M are trademarks of Digital Research. OASIS is a trademark of Phase One Systems.

PAPER TIGER PRINTERS

IDS 460G 9x9 Dot Matrix Printer.....	\$ 899.00
IDS 560G Wide Carriage Printer.....	1,149.00

TERMINALS

ADDS Viewpoint.....	\$599.00
TeleVideo 910C.....	599.00
TeleVideo 912C.....	699.00
TeleVideo 920C.....	749.00
TeleVideo 950C.....	979.00

8" DISK DRIVES

Shugart 801R.....	\$ 425.00
NEC FD1160 (double sided).....	525.00

DYNAMIC RAMS

4116 (200ns).....set of 8.....	\$24.00
4164 (64K x 1).....	18.00

wabash®

8" or 5 1/4" flexible diskettes certified 100% error free with manufacturer's 5-year limited warranty on all 8" media. Soft-sectored in boxes of 10. 5 1/4" available in 10-sector.

(Add \$3.00 for plastic library cases)

8" single sided, single density.....	\$28.00
8" single sided, double density.....	36.00
8" double sided, double density.....	46.00
5 1/4" single sided, single density.....	28.00
5 1/4" single sided, double density.....	29.00

TERMS: Minimum order \$15.00. Minimum shipping and handling \$3.00. Calif. residents add 6% sales tax. Cash, checks, Mastercard, Visa and purchase orders from qualified firms are accepted. (Please allow two weeks for personal checks to clear before shipment.) Product availability and pricing subject to change without notice.

INTERNATIONAL ORDERS: Add 15% to purchase price for all orders. Minimum shipping charge is \$20.00. Orders with insufficient funds will be delayed. Excess funds will be returned with your order. All prices are U.S. only.

6502 PRODUCTS

6502 DM

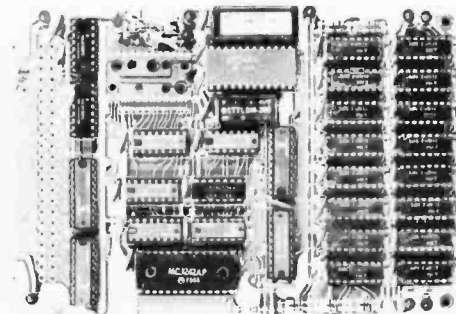

BETA 32K BYTE EXPANDABLE RAM FOR 6502 AND 6800 SYSTEMS

AIM 65 KIM SYM PET S44-BUS

- Plug compatible with the AIM-65/SYM expansion connector by using a right angle connector (supplied).
 - Memory board edge connector plugs into the 6800 S44 bus.
 - Connects to PET using an adaptor cable.
 - Uses +5V only, supplied from the host computer.
 - Full documentation. Assembled and tested boards are guaranteed for one full year. Purchase price is fully refundable if board is returned undamaged within 14 days.
- | | |
|--|----------|
| Assembled with 32K RAM..... | \$349.00 |
| & Tested with 16K RAM..... | 319.00 |
| KIT with all parts except RAM..... | 179.00 |
| Bare board, manual & 6 hard-to-get parts. 119.00 | |
| PET interface kit. Connects the 32K RAM board to a 4K or 8K PET..... | \$ 59.00 |

AIM Professional Enclosure...\$189.00

**BETA
COMPUTER DEVICES**
1230 W. COLLINS AVE.
ORANGE, CA 92668
(714) 633-7280



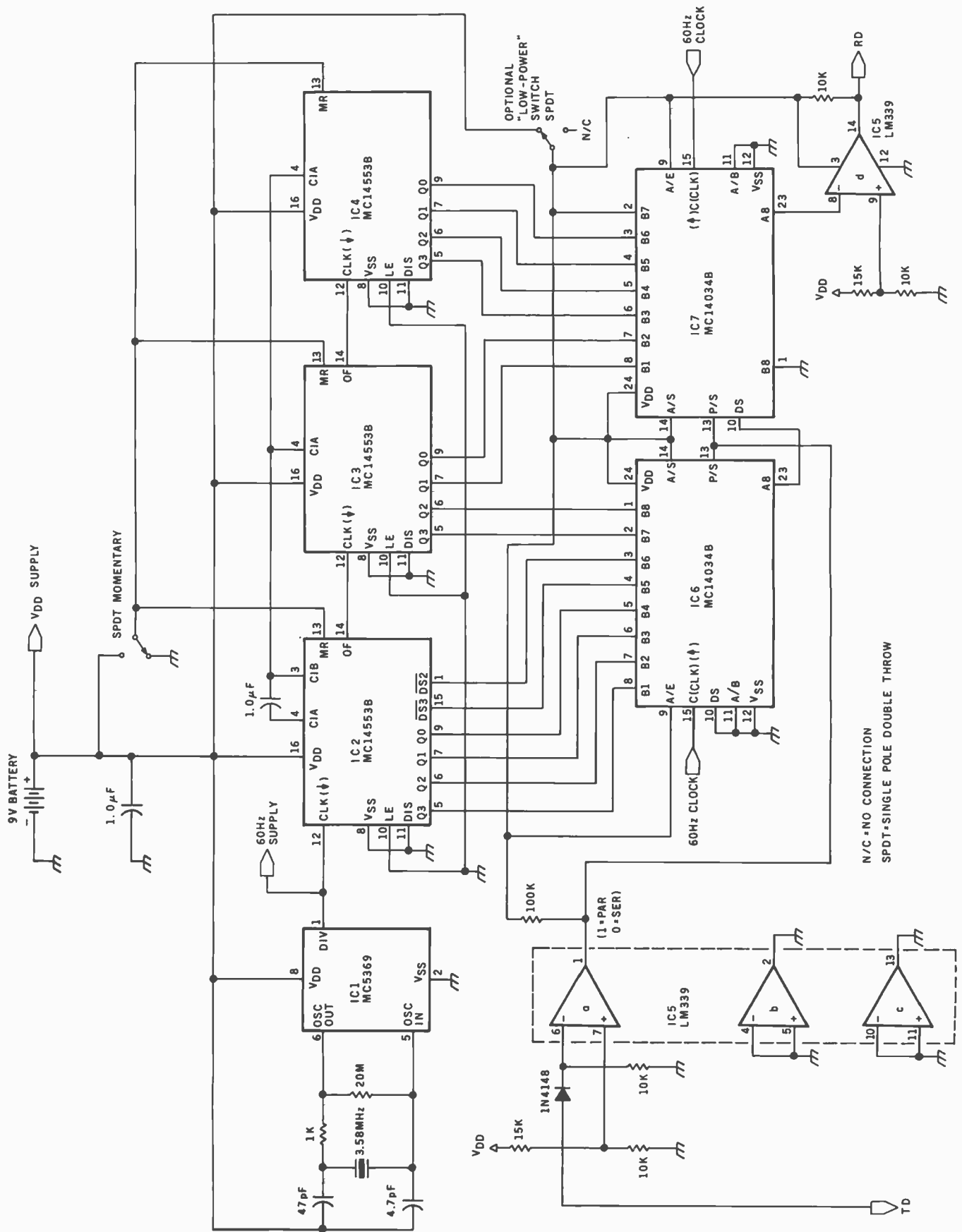

Figure 4: The half-year clock uses seven integrated circuits, most of which are CMOS devices. The counter information is multiplexed and the count data are brought into the Color Computer in three segments of 2 bytes each.



GO

APPLICATIONS

PROGRAM GENERATORS

DATABASES

CUSTOM PROGRAMMING

CONFUSED?

Are You confused from the many new software products becoming available?

Are you searching for the answer to your software problems?

Now your search has ended! You've discovered CONQUEST – A fully relational database system which allows for the generation of complete multifile turn-key applications.

This one easy-to-use tool will enable you to solve a myriad of business, professional, and personal information management problems at a fraction of the cost of custom programming. Ask for a demonstration of CONQUEST at your local computer store.



\$325
Complete



Available now for
Apple II
Corvus
Compatible

CONQUEST™

* Conquest formerly Request

USA UNITED
SOFTWARE
OF
AMERICA

750 3RD Avenue,
New York NY 10017

(212) 682-0347 Telex 640055

the outputs are shuffled around in the proper order, the nine digits represent the current count.

The OF signal is the "carry" output to the next counter. This appears on the thousandth count when the counter recycles to 000. The disable (DIS) and latch enable (LE) lines are not used in this application configuration. MR, "master reset," is used to zero the counters when a momentary switch is pulsed.

Bus registers. The bus-register chips are Motorola MC14034B ICs. They contain two 8-bit registers and can operate in a number of different modes, depending upon the configuration of the A/E, P/S, A/B, and A/S inputs. The two modes being used here are "synchronous parallel data input" and "synchronous serial data input."

In the first mode, parallel data are strobed in by the clock input. In our circuit, 14 bits of data from the counter chips are strobed in. Twelve of these bits are the current BCD

digits from each counter chip. Two of the bits are the DS3 and DS2 scan signals. (The third scan signal, DS1, is not needed, since we can infer that it is active when DS3 and DS2 are inactive.)

Setting the P/S signal to logic 1 selects the parallel data input mode. The 14 lines are continuously strobed in on the rising edge of every C (CLK) input. Since the clock runs at 60 Hz, the 14 lines are recorded 60 times per second.

When signal P/S is a logic 0, the bus registers are in the serial data input mode. This is something of a misnomer because this mode not only shifts in new data, but also shifts out previously recorded data; in this case, the 14 bits recorded earlier. The 14 "old" bits are shifted out at a 60-Hz rate. To allow synchronization of the serial bit stream, a leading 0 and 1 are prefixed to every 14-bit group.

RS-232 interface. The Color Computer's RD line is driven by the least significant bit of the HYC's lower-

order bus register. The output is about 0 V if the data bit is a 1, or about +5 V if the data bit is a 0. The "bit time" of this output is $\frac{1}{60}$ second, or about 16.66 ms. This RD output goes into the RS232IN bit of port FF22 hexadecimal.

The Color Computer's TD line drives the HYC's mode-select signal P/S. The level at the P/S pin changes from 0 V to close to +9 V for a positive or negative input, respectively. The P/S signal is logically equivalent to the status of the RS232OUT bit in port FF20 hexadecimal.

CMOS circuitry. All chips except the LM339s are CMOS (complementary metal-oxide semiconductor). CMOS is characterized by low power consumption. The HYC requires less than 4 milliamperes (mA) of current. The optional power switch shown in figure 4 lets you extend battery life when the HYC is not connected to the system or when the Color Computer is not in use. It shuts off power to all

DUAL

THERMOMETER

For Apple II*
COMPLETE WITH SOFTWARE

- Display temperature, maximum, minimum and difference.
- Sound alarm for over/under temperature.
- Store data on disk or printer automatically.
- Display time with on-board timer.
- Up to 7 boards with 14 probes in one Apple*.
- -55°C to 125°C range, 0.4° accuracy over most of range.
- Requires 48K Apple* with Applesoft* and disk.

\$260.00

If your dealer doesn't have it, call or write us at dept. A

Strawberry Tree Computers
949 Cascade Drive
Sunnyvale, Ca. 94087
(408) 736-3083

*TM of Apple Computer, Inc.

DEC LSI-11 Components

Dependable service
at discount prices
Domestic
and Export

**Mini
Computer Suppliers, Inc.**
25 Chatham Rd., Summit, N.J. 07901
Since 1973
(201) 277-6150 Telex 13-6476

©Mini Computer Suppliers, Inc.
1979



CHANGING THE LAMPS IN THEIR OFFICES SAVED \$2,000 A YEAR.

While lighting energy costs kept going up, Carroll County Bank's costs started going down when they changed to General Electric Watt-Miser® II fluorescent lamps in the office and customer areas of their six banks. In fact, they not only realized a slight increase in light levels, they also enjoyed a 27-month payback period.

Isn't it about time you realized how much you can save by changing to GE energy-saving lamps? Call your GE lamp distributor or sales representative to find out. Or call 800-321-7170. (In Ohio: 800-362-2750.)

**WE BRING
GOOD THINGS
TO LIFE.**

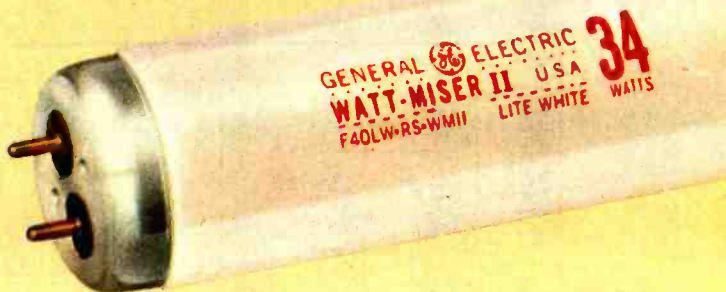

This lamp saves 7 watts and \$8.40*

Replace standard fluorescent lamps in existing fixtures with Watt-Miser II lamps, and save enough energy costs to pay for them in no time at all.

*Savings for lamps and ballast at 6¢/KWH.

GENERAL  ELECTRIC

Integrated Circuits

- IC1 Motorola MM5369 oscillator/divider
- IC2-IC3 Motorola BCD counter
- IC5 LM339 comparator
- IC6-IC7 Motorola MC14034B universal bus register*

Resistors

- 1 1 K Ω , 1/4 W, 10%
- 4 10 K Ω , 1/4 W, 10%
- 2 15 K Ω , 1/4 W, 10%
- 1 100 K Ω , 1/4 W, 10%
- 1 20 M Ω (use two 10 M Ω), 1/4 W, 10%

Capacitors

- 1 4.7-pF disk
- 1 47-pF disk
- 2 1.0- μ F electrolytic, 25 V

Miscellaneous

- 1 3.58-MHz crystal
- 1 SPDT momentary switch, miniature
- 1 SPST or SPDT switch, miniature (optional)
- 1 1N4000 series diode (not critical)
- 1 4-pin male DIN connector*
- 1 9-V battery, alkaline
- 1 8-pin wire-wrap socket
- 1 14-pin wire-wrap socket
- 3 16-pin wire-wrap sockets
- 2 24-pin wire-wrap sockets*
- 1 prototype board
- 1 case
- 1 ribbon cable, 3- or 4-conductor wire-wrap wire, solder, #14 wire, battery connectors

Table 1: Parts list for the half-year clock. All parts, except those starred, are available from Radio Shack.

components not involved in maintaining the half-year count.

A typical alkaline battery has a capacity of about 0.5 ampere-hours, making the HYC functional for about 250 hours of continuous use in the low-power mode, or about 125 hours of continuous use without the optional power switch. This 5/10-day life can be extended by paralleling a number of 9-V batteries or by using a larger battery, such as the NEDA 1603 size, which will not fit in the case used here, but which will last a good deal longer—over 1000 hours in the low-power mode.

CMOS operates on a power supply of from 3 to 18 V. The voltage of the supply can be degraded quite far before the HYC will stop operating. The limiting factor is the RD output, which must swing from 0 to at least +2.6 V for proper comparator operation in the Color Computer.

Construction of the HYC

All the parts in the HYC are easy to obtain. The 3.58-MHz crystal, oscillator/divider, counter chips, and LM339 are stocked by Radio Shack. The bus-register chips are available from any well-stocked parts supplier (see the ads in any issue of BYTE). The cost of all parts should be under \$20. See the parts list in table 1.

The HYC is housed in a project case (Radio Shack 270-219 or equivalent). This plastic case has a built-in compartment large enough to hold a 9-V battery.

A 7- by 9.5-cm (2 $\frac{3}{4}$ - by 3 $\frac{3}{4}$ -inch) grid board is used to hold the components. Two #14 bus wires run down the center of the board. One is used for the V_{DD} bus (+9 V); the other is ground (see figure 5).

The board has printed-circuit pads on one side. Mount the IC sockets, resistors, capacitors, and crystal on the side of the board without the foil. Solder two diagonally opposing pins of the IC sockets. Leave the resistor, capacitor, and crystal leads uncut for wire-wrapping.

Wire-wrap the IC pins according to table 2. All detailed connections are shown, but obvious power-supply connections are not indicated. I

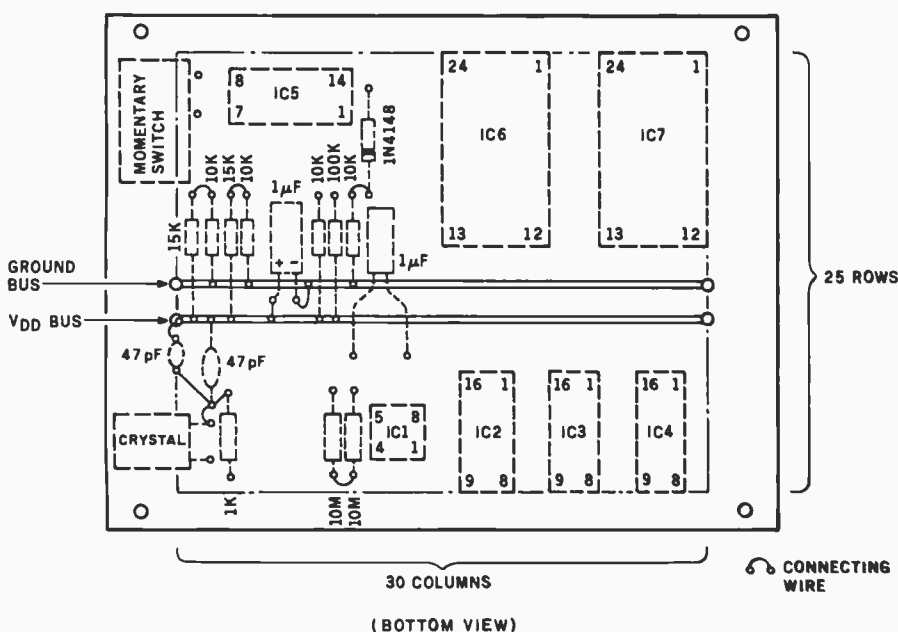

Figure 5: A 7- by 9.5-cm (2 $\frac{3}{4}$ - by 3 $\frac{3}{4}$ -inch) grid board holds seven wire-wrap sockets, eighteen discrete components, and two bus lines to facilitate wiring.

CASH FLOW PROBLEMS?



IT'S NICE TO KNOW SOMEONE WHO HAS THE SOLUTION.



MicroAge is your Solution Store . . . that means at MicroAge Computer Stores we have a wide selection of time-saving computerized business systems designed specifically to solve the daily cash flow problems every businessman faces.

MicroAge has computerized business systems that quickly and affordably allow you to regain control of your critical accounts receivable . . . at last making it possible for you to carry out effective collection procedures on a consistent basis. MicroAge has accounts receivable program packages to automatically display and update account information; prepare trial balance including a balance-due and delinquency aging

report, and take care of dozens of other tasks that eat into your time and profit!

Computerized business systems from the MicroAge Computer Store are available in the \$5,000 to \$15,000 range, to suit the individual budget of your small business or professional practice. MicroAge backs up every system with personalized service, warranty service and repair, installation, systems consulting, even customer training. Visit the MicroAge Computer Store in your area soon with your business problems, and let us help you with the solution.

MicroAge.
COMPUTER STORE

"The Solution Store" SM

VISIT THE STORE IN YOUR AREA:

El Paso, Texas
(915) 591-3349

Rockville, Maryland
(301) 762-7585

Tucson, Arizona
(602) 790-8959

Albuquerque, New Mexico
(505) 883-0955

Pleasant Hill, California
(415) 680-1489

Aurora, Colorado
(303) 696-6950

Rochester, New York
(716) 244-9000

Hurst, Texas
(817) 284-3413

Salina, Kansas
(913) 823-7596

Oiland Park, Illinois
(312) 349-8080

Millwaukee, Wisconsin
(414) 257-1100

Mountain View, California
(415) 964-7063

Scottsdale, Arizona
(602) 941-8794

Anchorage, Alaska
(907) 279-6688

San Diego, California
(714) 278-0623

Richardson, Texas
(214) 234-5955

Minneapolis, Minnesota
(612) 338-1777

Omaha, Nebraska
(402) 339-7441

Phoenix, Arizona
(602) 265-0065

Columbus, Ohio
(614) 868-1550

Indianapolis, Indiana
(317) 849-5161

Portland, Oregon
(503) 256-4713

Norwalk, Connecticut
(203) 846-0851

St. Louis, Missouri
(314) 567-7644

Oklahoma City, Oklahoma
(405) 728-1837

Houston, Texas
(713) 440-7547

W. Palm Beach, Florida
(305) 683-5779

Toronto, Canada
(416) 487-5551

Houston, Texas
(713) 270-9647

Wilmington, Delaware
(302) 368-3672

Allentown, Pennsylvania
(215) 434-4301

FOR FRANCHISE OPPORTUNITY INFORMATION CALL (602) 968-3168

recommend buying precut wire in lengths of 1, 2, and 3 inches. It is inexpensive and will cut the wire-wrap time in half.

The V_{DD} and ground leads can be connected directly to the two buses. No power switch is used. The three leads to the serial port can be made from three-conductor ribbon cable routed into the battery compartment of the case and between the compartment cover (see figure 6). The opposite end of the ribbon cable con-

nnects to the 4-pin male DIN plug (see figure 7).

Testing the Hardware

After you've assembled the board, test the interconnections, referring to table 2 and figure 4. Invariably, there will be one or two miswires. (I once wired 10 chips in mirror-image fashion—pin 1 to 24, 2 to 23, etc.; you should be in better shape than this!)

Use two common straight pins, clip

leads, and an ohmmeter or continuity tester to check all connections before installing the ICs in their sockets. When you're confident that all the connections are proper, plug in the ICs. CMOS is not as intolerant of static electricity as it once was, but avoid handling the chips more than necessary.

Plug in the 9-V battery, and you should be in operation. If you have an oscilloscope, check between pin 3 of IC4 and ground. The scan clock

MM5369 (IC1)	IC4-13 to IC3-13
IC1-1 to IC2-12	IC4-16 to V_{DD}
IC1-2 to GND	
IC1-5 to 20 M Ω /XTAL	LM339 (IC5)
IC1-6 to 20 M Ω /1 k Ω	IC5-1 to 100 k Ω
IC1-8 to V_{DD}	IC5-1 to IC6-13
	IC5-2 to GND
Oscillator	IC5-3 to V_{DD}
20 M Ω /IC1-6 to 1 k Ω	IC5-4 to IC5-2
20 M Ω /IC1-5 to XTAL	IC5-5 to IC5-2
MC14553B (IC2)	IC5-6 to 10 k Ω /diode (-)
IC2-1 to IC6-3	IC5-7 to 10 k Ω /15 k Ω
IC2-3 to 0.47 μ F	IC5-8 to IC7-23
IC2-4 to 0.47 μ F	IC5-9 to 10 k Ω /15 k Ω
IC2-5 to IC6-8	IC5-10 to IC5-13
IC2-6 to IC6-7	IC5-11 to IC5-13
IC2-7 to IC6-6	IC5-12 to GND
IC2-8 to GND	IC5-13 to GND
IC2-9 to IC6-5	IC5-14 to 10 k Ω /TD
IC2-10 to IC2-11	RS-232 Cable
IC2-11 to IC2-8	Diode (+) to RD
IC2-12 to IC6-15	TD to 10 k Ω /IC5-14
IC2-13 to SPDT center or to IC2-11	GND to GND
IC2-14 to IC3-12	MC14034B (IC6)
IC2-15 to IC6-4	IC6-9 to IC6-24
IC2-16 to V_{DD}	IC6-10 to IC6-11
MC14553B (IC3)	IC6-11 to IC6-12
IC3-4 to IC2-3	IC6-12 to GND
IC3-5 to IC6-2	IC6-13 to IC7-13
IC3-6 to IC6-1	IC6-14 to IC6-24
IC3-7 to IC7-8	IC6-23 to IC7-10
IC3-8 to GND	IC6-24 to V_{DD}
IC3-9 to IC7-7	
IC3-10 to IC2-10	MC14034B (IC7)
IC3-11 to IC3-8	IC7-1 to IC7-11
IC3-13 to IC2-13	IC7-2 to IC7-9
IC3-14 to IC4-12	IC7-9 to IC7-24
IC3-16 to IC2-16	IC7-11 to IC7-12
	IC7-12 to GND
MC14553B (IC4)	IC7-14 to IC7-24
IC4-4 to IC3-4	IC7-15 to IC6-15
IC4-5 to IC7-6	IC7-24 to V_{DD}
IC4-6 to IC7-5	
IC4-7 to IC7-4	Miscellaneous
IC4-8 to GND	SPDT-NC to GND
IC4-9 to IC7-3	SPDT-NO to V_{DD}
IC4-10 to IC3-10	GND bus to GND
IC4-11 to IC4-8	V_{DD} bus to +9 V

Table 2: Major component pin connections.

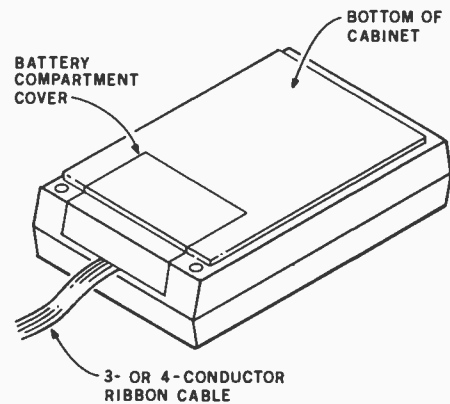

Figure 6: The ribbon cable can be brought out between the cover of the battery compartment and the project case.

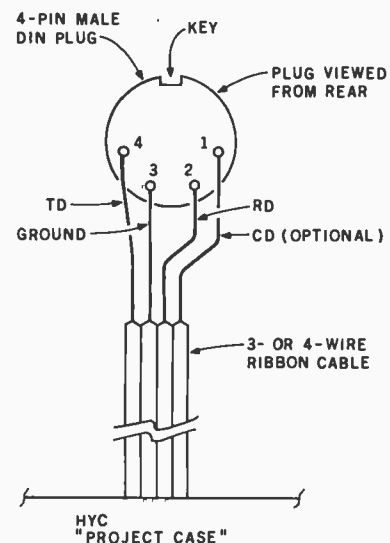
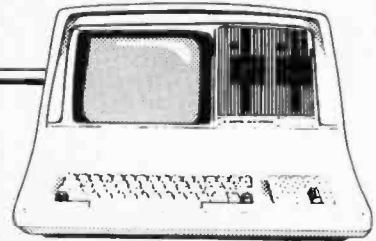

Figure 7: A 4-pin male DIN connector is used to link the half-year clock to the Color Computer's RS-232C jack on the rear of the computer.

From CMC International, world's largest Intertec distributor...



SUPERBRAIN and COMPUSTAR - YOUR CUSTOMERS WILL NEVER NEED ANOTHER SYSTEM!

CMC International is the largest distributor in the world of Intertec Data Systems products -the SuperBrain and CompuStar - Intertec's incredibly expandable microcomputers. No matter how small or large your customers are or become, we doubt that they'll ever outgrow these computers. Both SuperBrain and CompuStar offer the industry-standard CP/M disk operating system and 64K of dynamic RAM. Both are expandable to 10 megabytes of storage with the CompuStar disk storage system. CompuStars can be linked together to form a 255-user network.

Dealers benefit from the service and support offered through CMC. Like advertising co-op, software and hardware support, module replacement. And a toll-free line so you can call from anywhere in the continental United States.

The bottom line is profitability. Our dealers benefit with a combination of quality Intertec products and CMC International's pricing.

Contact us today. We deliver.



For Information Call (206)453-9777
To Order, Call Toll-free 1-800-426-2963

CMC INTERNATIONAL

A Division of Computer Marketing Corporation

11058 Main Street, Suite 220
Bellevue, Washington 98004

TELEX 152556 SEATAC

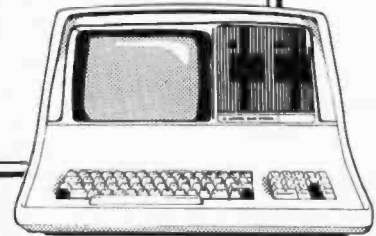
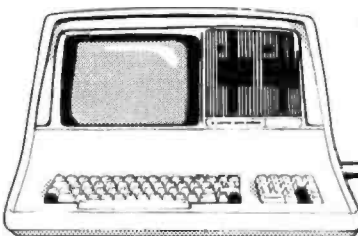

SuperBrain and CompuStar are registered trademarks
of Intertec Data Systems Corporation
CP/M is a registered trademark of Digital Research

PET Fun and Games

Selected **CURSOR** Programs

Ron Jeffries and
Glen Fisher

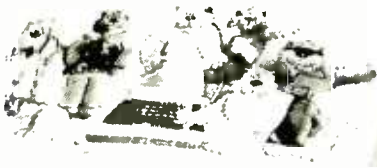

Byte-Sized Menagerie

Challenge friends or outwit the PET™ in games of action, risk, and chance. Practice your cunning. Sharpen your strategy. 31 games and puzzles which run on Commodore PET™ and CBM™ computers are presented along with complete game instructions and the BASIC programs needed to play. No knowledge of programming required. Includes games which make use of Commodore special graphics and CB2 sound capability. Perfect bound paperback, illustrated, 192 pages, \$10.00.

Osborne/McGraw-Hill
630 Bancroft Way,
Berkeley, CA 94710

Call Toll Free: 800-227-2895
in California (415) 548-2805
Dept. 4



PET™ Fun and Games \$10.00

Name _____

Address _____

City/State/Zip _____

Plus: .75/item 4th class \$1.50/

item UPS \$2.50/item Air Mail

\$10.00/item Overseas

(California residents add applicable tax.)

Total amount enclosed \$ _____

or charge my Visa Mastercharge

Card # _____

Expiration Date _____

Authorized Signature _____

PET AND CBM are trademarks of Commodore
Business Machines, Inc.
CURSOR is a trademark of The Code Works

should be operating at about 3 Hz. If it's slower than 3 Hz, try lower values than the 1- μ F capacitor connected between pins 3 and 4 of IC2. Also, check the oscillator/divider output. You should see a clean 60-Hz square wave.

HYC Software

The HYC, in keeping with the traditions of the Color Computer system, is largely software dependent. Listing 1 shows a 6809

assembly-language program that reads data from the HYC. It resides in the upper 256 bytes of RAM (in a 16K Color Computer system). Protect this area by a CLEAR 200,&H3EFF when running the program with BASIC. Key in the 97 bytes of the program or use POKEs and DATA statements in your BASIC program.

With the exception of 2 bytes, the program is relocatable. Change the second and third bytes of the second instruction (locations 3F05 to 3F06 hexadecimal in listing 1) if you

How the HYC Program Works

The Clock I/O Handler (listing 1) is divided into three parts: the DELAY subroutine, the INPUT subroutine, and the main loop CLOCK.

The DELAY subroutine delays in multiples of 0.8333 second. One 60-Hz pulse has a duration of 16.666 milliseconds. This subroutine can be conveniently used for delaying in multiples or submultiples of one 60-Hz bit time.

The INPUT subroutine makes a single read of 16 bits of data from the counters. The BSR instruction at INPUT calls INPUA, resulting in the code from INPUA through the RTS instruction being executed twice. Eight bits of data are read on each pass through the section of code.

The loop at INP010 reads in eight data bits from port FF22 hexadecimal. Bit 0 is shifted right into the carry condition code and then rotated into the byte pointed to by the user stack pointer. The byte is initially cleared to 0. At the end of the second pass through INPUA, 2 bytes of data have been stored in the user stack, representing one complete read of three digits.

The main loop at CLOCK performs consecutive calls of the INPUT subroutine until three samplings of DS1, DS2, and DS3 have been compiled in the 6 bytes of the buffer. First, a 1 is output to bit 1 of port FF20 hexadecimal, bringing the HYC's P/S signal to a 1 (parallel data input mode). A delay of 1.9 cycles is provided so that

the data can be clocked into the bus registers.

After the delay, the serial output is started by outputting a 0 to bit 1 of port FF20 hexadecimal, bringing P/S to a 0 (serial data input mode). Immediately after the output, the serial datum is checked by reading port FF22 hexadecimal bit 0. If the datum is a 1, the first clock occurred too close to the initialization of the process, and the process is repeated from CLK010. If the datum is a 0, a delay of 1/10 cycle is done and a test for 0 is done again; if the datum is not 0, the clock occurred within 1/10 cycle (close to the edge of a bit time), so the process is repeated.

If the first bit is a 0, the loop at CLK020 delays until the appearance of a 1. At this point, the second clock has just occurred. A delay of 1½ cycles is then done to position the next read in the middle of the third data bit time. The INPUT subroutine is then called to read in the next 16 bits. The last two of these are always zeros.

Now, the scan number of the first 16 bits is tested. If not equal to binary 11, or DS1, the process is repeated from CLK010. If equal to DS1, the user stack pointer is adjusted, the scan number is adjusted to 2, and another read from CLK010 is done to read the DS2 cycle. A third iteration reads the last cycle, DS3.

The short subroutine at GETSER gets the serial bit and tests it, changing the Z condition code to zero or nonzero.

relocate the program. These 2 bytes should hold the address of a 6-byte buffer.

A simple BASIC test program is shown in listing 2. This program defines the location of the program by the DEFUSR0 statement. (Change this statement if you have relocated the machine-language code.) The assembly-language program is entered by the USR0 call and returns with 6 bytes of the current clock count in locations 3FF0 through 3FF5 hexadecimal. These six locations rep-

resent the BCD digits and scan numbers as shown in figure 8. Sample outputs are shown in figure 9.

Text continued on page 122

Listing 2: This short BASIC program calls the clock I/O handler and displays the 6 bytes of data that were read.

```

100 DEFUSR0=&H3F00
110 A=USR0(0)
120 FOR I=&H3FF0 TO &H3FF5
130 PRINT PEEK(I),
140 NEXT I
150 PRINT:PRINT:GOTO 110
    
```

Listing 1: The clock I/O handler is a three-section, assembly-language program that reads in 6 bytes of the count into a buffer at location 3FF0 hexadecimal.

```

3F00          00100      ORG      $3F00
              00110      BUFFER  EQU    $3FF0
              00120      *****
              00130      * CLOCK I/O HANDLER. READS IN 3 CLOCK COUNTS *
              00140      *****
              00150      CLOCK   LDY    #3      SCAN #
3F00 108E 0003 00160      LDY    #BUFFER
3F04 CE 3FF0 00170      LDA    CLK010      2 TO A
3F07 86 02 00180      STA    $FF20      STROBE IN NEXT COUNT
3F09 B7 FF20 00190      LDA    #3E      1.3 CYCLE COUNT
3F0C 86 26 00200      BSR    DELAY      DELAY 1.3 60HZ CYCLES
3F0E 8D 47 00210      STA    $FF20      START SERIAL
3F10 B7 FF20 00220      BSR    GETSER    GET SERIAL IN
3F13 8D 25 00230      BNE    CLK010      GO IF INVALID
3F15 26 F0 00240      LDA    #2      DELAY COUNT
3F17 86 02 00250      BSR    DELAY      DELAY 1/10 CYCLE
3F19 8D 3C 00260      BSR    GETSER    GET SERIAL IN BIT
3F1B 8D 1D 00270      BNE    CLK010      GO IF INVALID
3F1D 26 E8 00280      BNE    CLK020      GET SERIAL IN BIT
3F1F 8D 19 00290      BSR    GETSER    GO IF 0
3F21 27 FC 00300      BEQ    CLK020      GO IF 0
3F23 86 1E 00310      LDA    #30      1+1/2 CYCLE COUNT
3F25 8D 30 00320      BSR    DELAY      DELAY 1+1/2 CYCLE
3F27 8D 17 00330      BSR    INPUT      READ CLOCK COUNT
3F29 33 5E 00340      LEAU   -2,U      RESET PNTR
3F2B 1F 20 00350      TFR    Y,D      SCN # NOW IN B
3F2D E8 41 00360      EORB   1,U      TEST SCN #
3F2F C4 03 00370      ANDB   #3      MASK OUT DIGIT
3F31 26 D4 00380      BNE    CLK010      GO IF NOT PROPER SCN #
3F33 33 42 00390      LEAU   2,U      POINT TO NEXT 2 BYTES
3F35 31 3F 00400      LEAY   -1,Y      DECREMENT SCN #
3F37 26 CE 00410      BNE    CLK010      GO IF NOT DONE
3F39 39 00420      RTS          RETURN
3F3A 86 FF22 00430      GETSER  LDA    $FF22      GET SERIAL BIT
3F3D 84 01 00440      ANDA   #1      TEST
3F3F 39 00450      RTS          RETURN
00460 *****
00470 * INPUT. INPUTS 14 BITS AND STORES IN TWO BYTES *
00480 * ENTRY: BUFFER ADDRESS IN U *
00490 * EXIT: 2 BYTES STORED IN BUFFER. U UPDATED *
00490 *****
3F40 8D 00 00500      INPUT   BSR    INP0A      GO TWICE
3F42 4F 00 00510      INP0A  CLRA   0 TO A
3F43 A7 C4 00520      STA    ,U      CLEAR BYTE
3F45 C6 08 00530      LDB    #8      FOR 8 BITS
3F47 B6 FF22 00540      INP010 LDA    $FF22      GET BIT
3F4A 44 00550      LSR    OUT TO C
3F4B 66 C4 00560      ROR    ,U      MERGE IN USER STACK
3F4D 86 14 00570      LDA    #20      1 CYCLE COUNT
3F4F 8D 06 00580      BSR    DELAY      DELAY 1 CYCLE
3F51 5A 00590      DECB   DECREMENT ITERATION COUNT
3F52 26 F3 00600      BNE    INP010      GO IF NOT 8
3F54 33 41 00610      LEAU   1,U      POINT TO NEXT STACK BYTE
3F56 39 00620      RTS          RETURN (AGAIN OR CLOCK)
00630 *****
00640 * DELAY. DELAYS IN MULTIPLES OF .03333 MS *
00650 * ENTRY: COUNT IN A *
00660 * EXIT: AFTER DELAY *
00670 *****
3F57 8E 005C 00680      DELAY  LDY    #92      FINAGLE FACTOR
3F5A 30 1F 00690      DEL010 LEAX   -1,X      DECREMENT X
3F5C 26 FC 00700      BNE    DEL010      GO IF NOT 0
3F5E 4A 00710      DECA   DECREMENT MAJOR COUNT
3F5F 26 F6 00720      BNE    DELAY      GO IF NOT 0
3F61 39 00730      RTS          RETURN
              00740      END
    
```



You Thumbed Through the Manual. Now Read the book

In 14 accelerated steps, *WordStar™ Made Easy* lets you build word processing skills which are applicable to any business office. Legal documents, sales reports, business letters, manuscripts—all can be generated quickly and easily without reference to complicated manuals. Applies to any version of *WordStar™*, including version 3.0. An appendix listing CP/M® commands and a detachable *WordStar™* Command Sheet are featured for handy reference. Spiral bound paper, 125 pages, \$7.95.

Osborne/McGraw-Hill
630 Bancroft Way,
Berkeley, CA 94710

Call Toll Free: 800-227-2895
in California (415) 548-2805
Dept. 4



WordStar Made Easy \$7.95

Name _____

Address _____

City/State/Zip _____

Plus: .75/item 4th class \$1.50/

item UPS \$2.50/item Air Mail

\$10.00/item Overseas

(California residents add applicable tax.)

Total amount enclosed \$ _____

or charge my Visa Mastercharge

Card # _____

Expiration Date _____

Authorized Signature _____

WordStar is a trademark of MicroPro International Corporation.
CP/M is a trademark of Digital Research Corp.



Here Comes the Revolution

With the price of the UNIX® system license cut by 90%, a whole new era in multi-user systems operation comes to programming.

Now, as the feasibility of incorporating UNIX® into your data management or buying UNIX® based products increases, THE book on the subject has been published by Osborne/McGraw-Hill.

Included are hands-on tutorials on the basic UNIX® system commands, chapters on related resources, definitions of basic system concepts... everything needed for immediate practical fluency, or evaluation of the system by potential users. \$15.99, paperback, 496 pages.

Osborne/McGraw-Hill
630 Bancroft Way, Berkeley, CA 94710

Call Toll Free: 800-227-2895
in California (415) 548-2805
Dept. 4



A User Guide to the UNIX® System \$15.99

Name _____

Address _____

City/State/Zip _____

Plus: .75/item 4th class \$1.50/

item UPS \$2.50/item Air Mail

\$10.00/item Overseas

(California residents add applicable tax.)

Total amount enclosed \$ _____

or charge my Visa Mastercharge

Card # _____

Expiration Date _____

Authorized Signature _____

UNIX is a trademark of Bell Laboratories

HEXADECIMAL LOCATION

3 FF 0	DIGIT D	DIGIT G	
3 FF 1	0 0	DIGIT A	1 1 ← SCAN NUMBER
3 FF 2	DIGIT E	DIGIT H	
3 FF 3	0 0	DIGIT B	1 0 ← SCAN NUMBER
3 FF 4	DIGIT F	DIGIT J	
3 FF 5	0 0	DIGIT C	0 1 ← SCAN NUMBER

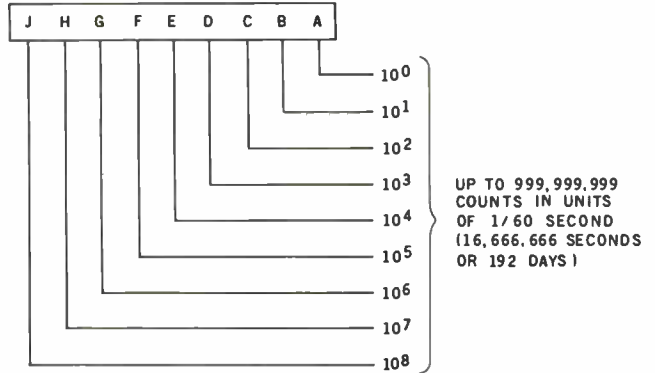

Figure 8: The 6 bytes of count data from the half-year clock contain nine BCD digits and three scan numbers. The order is based on the functional layout of the hardware and the data must be rearranged by the interface software.

COUNT = 000289457 • 4824* SECONDS

DECIMAL		1 0 0 1	0 0 0 0	
144	9,0	1 0 0 1	0 0 0 0	
31	7	0 0 0 1 1 1 1 1		← DS 1
128	8,0	1 0 0 0	0 0 0 0	
22	5	0 0 0 1 0 1 1 0		← DS 2
32	2,0	0 0 1 0	0 0 0 0	
17	4	0 0 0 1 0 0 0 1		← DS 3

SAMPLE 1

144	9,0	1 0 0 1	0 0 0 0	
23	5	0 0 0 1 0 1 1 1		← DS 1
128	8,0	1 0 0 0	0 0 0 0	
10	2	0 0 0 0 1 0 1 0		← DS 2
32	2,0	0 0 1 0	0 0 0 0	
21	5	0 0 0 1 0 1 0 1		← DS 3

SAMPLE 2

COUNT = 000289525 • 4825* SECONDS

Figure 9: These are typical data samples. Sample 1 represents a count of 000289457, or 4824.XX seconds. Sample 2 occurred after sample 1 and represents the next count of 000289525, or 4825.XX seconds.

Most small system users think all micro-computers are created equal. And they're right. If you want performance, convenience, styling, high technology and reliability (and who doesn't?) your micro usually has a price tag that looks more like a mini. It seems big performance always means big bucks. But not so with the SuperBrain!

Standard SuperBrain features include: twin double-density 5¼" drives which boast nearly 350,000 bytes of disk storage — expandable to 10 megabytes. A full 64K of dynamic RAM. A CP/M* Disk Operating System to insure compatibility to literally hundreds of application packages presently available. And, a 12" non-glare, 24 line by 80 column screen.

*Registered trademark of Digital Research, Inc.

You'll also get a full ASCII keyboard with an 18 key numeric pad and individual cursor control keys. Twin RS232C serial ports for fast and easy connection to a modem or printer. Dual Z80 processors which operate at 4 MHz to insure lightning-fast program execution. And the list goes on! Feature after feature after feature.

Better yet, the SuperBrain boasts modular design to make servicing a snap. A common screwdriver is about the only service tool you'll ever need. And with the money you'll save on purchasing and maintaining the SuperBrain, you could almost buy another one. For under \$3,500, it is truly one of the most remarkable microcomputers available anywhere.

Whether your application is small business, scientific, educational or just word processing, the SuperBrain is certainly an exciting solution to the small computer problem. And since you can easily expand it, you'll probably never outgrow it.

Call or write us today for a complimentary copy of our "SuperBrain Buyer's Guide." We'll show you how you can get big system performance without having to spend big bucks.

**INTERTEC
DATA
SYSTEMS**

2300 Broad River Rd. Columbia, SC 29210
(803) 798-9100 TWX: 810-666-2115

Circle 195 on inquiry card.

SUPERBRAIN

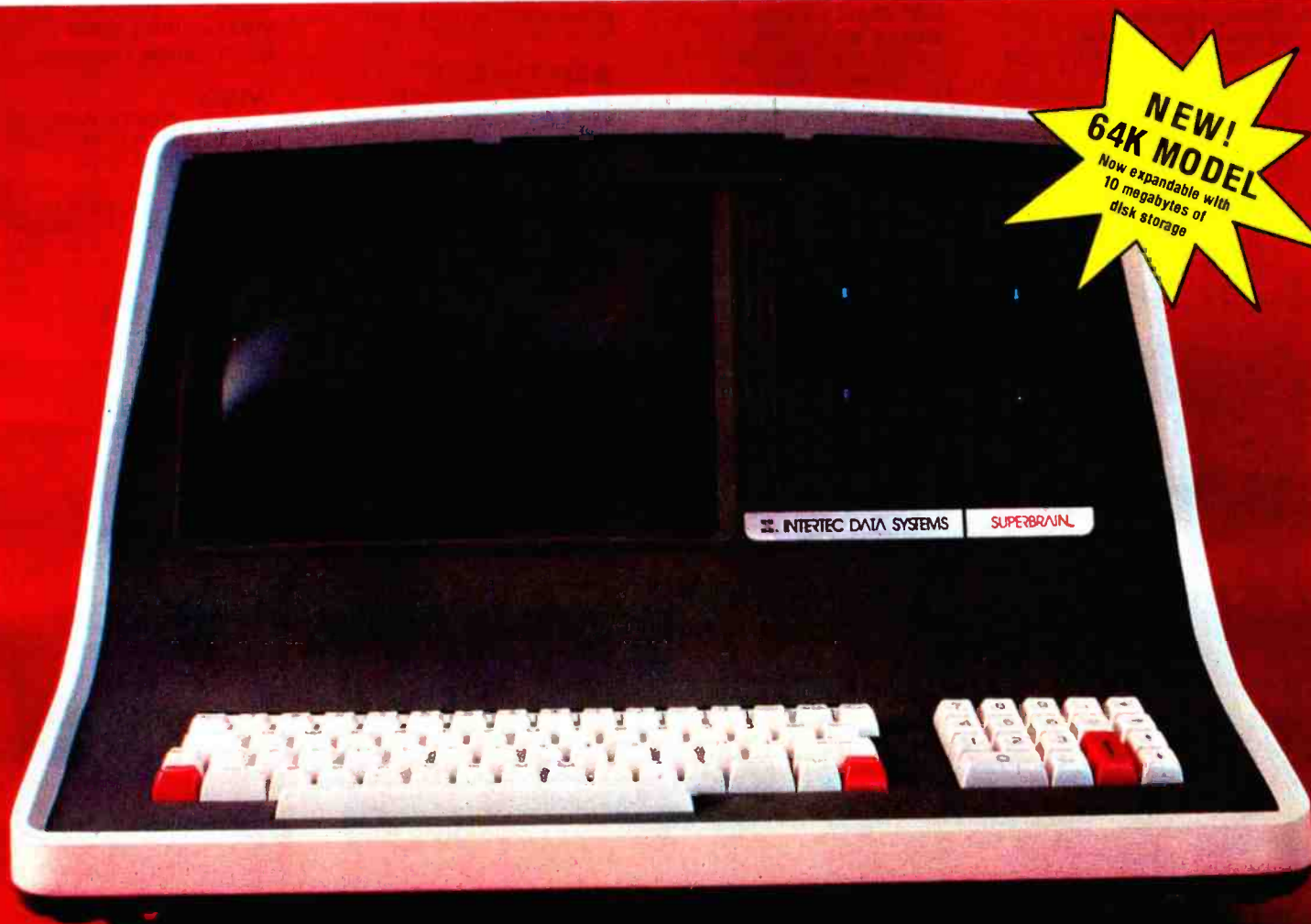

COMMODORE
 SUPERPET
 4032
 8032
 VIC 20

ROCKWELL
 RM 65
 AIM 65

DEC
 PERSONAL COMPUTER

WANG
 WANGWRITER

ACCESSORIES

**MOTOROLA 4116-2—MEM-
 ORY**—200 nano-second chips.

GILTRONIX RS-232 SWITCH—
 Up to 3 peripherals to one com-
 puter or vice versa. We have all
 other models.

MOUNTAIN COMPUTER
 Total product family in stock!
 CPS Multifunction Board—clock,
 calendar, serial and parallel inter-
 face on one card/Super Talker/
 The Music System/ RDM plus
 board with Keyboard filter/ RDM
 Writer/ Clock Calendar/ A to D
 and D to A Converter Clock/, and
 more.

CALCULATORS

**HP-41C AND HP-41CV CAL-
 CULATORS**—And we have all

the accessories!
Memory Modules
Magnetic Card Reader
Printer—Upper and lower case,
 high resolution plotting.
Applications Paccs

DISKETTES

DYSAN DISKETTES—5¼", 8",
 soft or hard sector, single or
 double density.

MEMOREX DISKETTES—All
 types including some with hub
 ring for Apple Drives.

NEW CORVUS DISKS

Winchester Disk in 5, 10, and 20
 megabyte.

APPLE INTERFACE—With disc
 operating system.

**CONSTELLATION DISK NET-
 WORK**—Up to 64 computers
 connect to a 5, 10, or 20 mega-
 byte Winchester.

OMNINET—Unlimited number of
 computers and peripherals con-
 nected by a two wire twisted
 pair.

MIRROR—Video backup inter-
 face system.

MODEMS

**NOVATION CAT
 NOVATION D-CAT
 HAYES SMARTMODEM**

MONITORS

SANYO MONITORS
 9" Sanyo green screen
 12" Sanyo B/W
 12" Sanyo green screen
 13" Sanyo Color

**NEC COLOR MONITOR/
 RECEIVER**—Composite video,
 VCR/VTR video loop in/out and
 television reception.

NEW
 NEW
 NEW

PRINTERS

NEC SPINWRITERS—We have
 all models RD thru KSR.

NEC 3500 Spinwriters—33
 cps, hardware word processing
 package, bi-directional 370,000
 character ribbon and much more.

NEC 7700 Spinwriter—55
 CPS, printer; pitch is 10, 12, and
 also new 15 and proportional
 spacing. Twin sheet feeder and
 word processing package.

**INTEGRAL DATA—
 IDS PRISM PRINTER**—Afford-
 able COLDR copy. True four color
 technology. Ship from stock!

IDS 560 Matrix Printer—
 14½ paper, 132 col. graphics.

IDS 445—Available with or with-
 out graphics.

IDS 460

CENTRONICS 739—The latest
 innovations from the industry
 leader and quiet too!

SOFTWARE

PERSONAL SOFTWARE
Visi-Pack—Includes Visi-Calc,
 Visiplot/Visitend, Visifile.
Visicalc—For HP, APPLE,
 COMMODORE and ATARI.

**Compumart has sold thou-
 sands of Commodores—we
 were their first dealer!**

Serious Apple Software—Dow
 Jones, Apple Fortran, Apple
 Plot, Apple Writer, Apple Pilot,
 Data-Plot, Datamover/Telepong,
 Apple Post Mailing System, DOS
 Tool Kit Utilities, DB Master
 Data Base Manager, and much
 more.

APPLE PASCAL

Games—Zork II, Apple
 Adventure, Microchess 2.0,
 Flight Simulator, Apple Bowl,
 Stellar Invaders, Gammon
 Gambler, Star-Raiders, ABM,
 Pool 1.5, call for more.

Word Processing—Magic Wand,
 Easy Writer, Apple Writer, Word-
 star, Word Pro 4, Wordcraft,
 Super Text II.

**VIDEO
 CONTROLLERS**

**VIDEX—VIDEO TERM
 M & R SUPER TERMINAL**

**WRITE:
 YOUR CHOICE OF FREE CAT-
 ALOGS WITH LETTERHEAD
 OR BUSINESS CARD**

**MICRO
 CATALOG**
 The most com-
 plete catalog of
 micro com-
 puters, periph-
 erals and
 accessories.

**DEC LSI/11
 CATALOG**
 Includes com-
 patibles from
 Control Data,
 C-ITOH and
 others.



HEWLETT-PACKARD
 HP-125
 HP-85 CAPRICORN
 HP-83 VIRGO

APPLE
 APPLE III
 APPLE II PLUS

XEROX
 820

ATARI
 800

Authorized Dealers For:

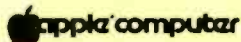

XEROX



- 10 Day Free Return — No Questions Asked
- Choose From Largest Product Line In Industry
- Immediate Shipment From \$ Multimillion Stock
- Expert Service
- Technically Knowledgeable Sales Staff
- Serving Industry And Education Since 1971

**NO ONE ELSE HAS IT ALL—
 Call Our Experts For Immediate Configuration Service**



COMPUMART/Customized Systems
 65 Bent Street, Dept. 103
 PO Box 568, Cambridge, MA 02139
TELEX: 921401 COMPUMART CAM
800-343-5504

In Mass call 617-491-2700
 if you prefer, call our Ann Arbor Michigan store
 (313) 994-6344



*FREE (See below)



PHONES: open EST Mon.-Thurs. 8:30-7:00, Fri. 8:30-6:00.
PURCHASE ORDERS: Accepted from Dun and Bradstreet rated companies—shipment contingent upon receipt of signed purchase order.

SALE PRICES: Valid for month of magazine date only—all prices subject to change without notice. **ANN ARBOR RETAIL STORE HOURS:** Tues.-Fri., 11:00-7:00, Sat. 10:00-5:00, closed Mon.
 • **FREE:** Diskettes 5 1/4", double sided, double density to the first 100 people who correctly identify all products and models on this page. Must use company letterhead; one entry per person.

LET US INTRODUCE YOU TO THE COMPUSTAR™ NETWORK.

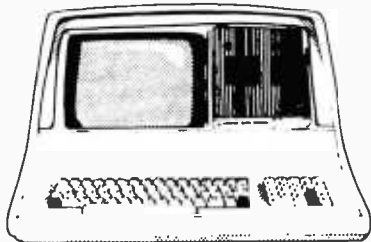

AGAIN



AND AGAIN



AND AGAIN

Each CompuStar unit offers the CP/M operating system, 64K of RAM and the ability to start as a floppy-based system and grow to 400 megabytes of hard disk storage. Up to 255 units can be linked together in one shared-disk system.

Just the system for the dealer or OEM who wants to make it big in the business market. The versatility and expandability of the CompuStar network lets you answer your clients' needs today and tomorrow. And our low price lets you offer a package they can afford to buy and you can afford to sell.

If networking is new to you, TriStar will give you a proper introduction. We've got software for CompuStar, including accounts payable, payroll, accounts receivable, word processing and database management. Plus we'll help you with your own software development, systems configuration, communications, hardware service, training, installation and any other needs that might pop up.

Because we're experts in networking and support, Intertec® (the manufacturer of CompuStar) has chosen us to distribute this incredible, expandable business system.

For more information on CompuStar and other Intertec products, call (609) 424-4700.

TRISTAR

2 Keystone Avenue
Cherry Hill, NJ 08003

CompuStar is the trademark of Intertec, Inc.

Listing 3: This BASIC program interfaces to the assembly-language clock driver. It converts the 6 bytes of clock data into a count of days, hours, minutes, and seconds, and checks for error conditions.

```

100 INPUT "TIME IN 60THS";T2
110 CLS
120 DEFUSR0=&H3F00
130 T0=-1
140 A=USR0<0>
150 A=INT<PEEK<&H3FF1>/4>
160 B=INT<PEEK<&H3FF3>/4>
170 C=INT<PEEK<&H3FF5>/4>
180 D=INT<PEEK<&H3FF0>/16>
190 E=INT<PEEK<&H3FF2>/16>
200 F=INT<PEEK<&H3FF4>/16>
210 G=(PEEK<&H3FF0> AND 15)
220 H=(PEEK<&H3FF2> AND 15)
230 J=(PEEK<&H3FF4> AND 15)
240 T1=(J*100000000+H*1000000+G*100000+F*10000+E*1000+D*100+C*10+B*10+A)
245 IF T0=-1 THEN T0=T1
250 IF T1<T0 THEN GOTO 140 ELSE IF T1-T0>999 THEN GOTO 140 ELSE T0=T1
260 T3=T1+T2: IF T3>999999999 THEN T3=T3-999999999
270 T3=INT<T3/60>
280 D=INT<T3/86400>:H=INT<(T3-D*86400)/3600>:M=INT<(T3-D*86400-H*3600)/60>:S=T3-D*86400-H*3600-M*60
290 PRINT @ 256, "DAY";D;"HOURS";M;"MINS";S;"SECS"
300 GOTO 140

```

Text continued from page 117:

A general-purpose BASIC driver is shown in listing 3. This program displays the actual number of days, hours, minutes, and seconds represented by the count in the HYC. This count can be held in a Color Computer BASIC variable, which allows nine decimal digits of precision.

A "bias" count can be input to the program before sampling the HYC. This bias may be positive or negative to adjust the current count to a previous starting point or to "trim" the time. The unit of bias is $\frac{1}{60}$ second. Thus, use a value of 60 for every second, 3600 for every minute, 216,000 for every hour, or 518,400 for every day. The momentary-contact RESET switch resets the entire count to 0.

The tests of the current count (T1) with the previous count (T0) require some explanation. In most cases, the sampling process reads count data in a "nonchanging" state. However, because the scan clock occurs at unpredictable times, the count may be sampled in the middle of a scan clock "edge," yielding invalid data. Because of this, T1 (current) is compared to T0 (old). If T1 is less than T0, T1 is invalid and another sample is made. If T1 is greater than T0 by 999 counts (16.65 seconds), T1 is considered invalid and another sample is made. The typical display generated by the program shows the time changing

every 2 seconds, with occasional lapses of up to 4 seconds.

Tests run over several days showed less than one (detected) invalid read per minute with a maximum delay of 5.5 seconds. No invalid times appeared.

If the HYC is to be called at random times, make three calls and test for ascending counts with a difference of less than 10 seconds or so. Using this method, the resulting time will be accurate to within 10 seconds of the counter time.

The crystal used should provide an excellent time base. It can be fine-tuned, however, by substituting a 5 to 50-picofarad (pF) "trimmer" capacitor in place of the 4.7-pF capacitor connected to the crystal.

In operation, the HYC can be disconnected from the system at any time (without turning off the Color Computer) and left running. It can be reconnected at any later time. (Stop the BASIC program above if this is done to prevent a hang-up caused by T1-T0 being greater than 999.)

If Rip van Winkle had owned a Color Computer, he would have loved the half-year clock. If you have nothing to do for the next 192 days, why not check this project out with your Color Computer to test its accuracy? Or count clock pulses instead of sheep: 999,998,767; 999,998,768; 999,998,769 (yawn) . . . ■

**\$1=1/3
of a business
phone call**



**\$1=6¼ actual
McGraw-Hill
readers***



**As your selling dollar buys less and less,
it pays more and more to advertise
in McGraw-Hill magazines.**



With inflation, we're an even better buy.

* One reader-noted impression in the average McGraw-Hill publication.

BRAINS-MAINFRAMES

SUPERBRAINS

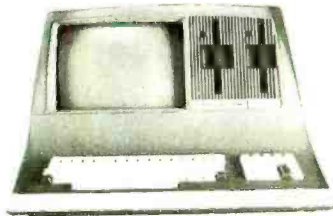

SUPERBRAIN QD 64K
List \$3995 only \$2949

ZENITH



Z-89 48K
LIST \$2895 ONLY \$2099
Z-90 64K DD 3195 ONLY \$2489

NORTH STARS

MINICOMPUTER
PERFORMANCE
GREEN PHOSPHOR
OPTIONS:
GRAPHICS + CP/M
LIST \$3999
ONLY \$2999

ADVANTAGE

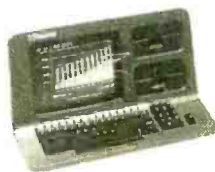

ZENITH MONITOR GREEN PHOSPHOR \$118
GREEN

TERMINALS Z-19 \$718
INTERTUBE III SUPER SMART \$710

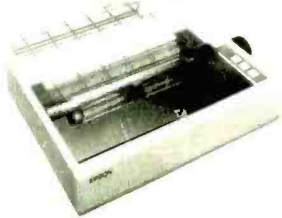

EPSON

MX70 GRAPHICS	299
MX80 FT	598
MX-80	474
MX-100	749

ANADEX 9501	\$1290
NEC LETTER QUAL FRICTION & TRACTOR	CALL
ZENITH PRINTER Z-25 LIST 1595 ONLY	\$1256
DIP-84 FT GRAPHICS	\$ 595
STARWRITER LETTER QUAL FT	\$1824
EPSON MX70 WITH GRAPHICS SALE!	
6 ONLY	\$ 299
QANTEX W/BUFFER	\$1299

	400	LIST 399	ONLY 340
	800	1080	799

WONDERFUL GAMES-EDUCATION
RCA-COSMAC VP-711 199
GAMES-BASIC-PROGRAMS-MUSIC
GUIDED SATELLITE TO SATURN

TARBELL's Empire I, II, & III have two 8" disk drives. The I is single sided, the II is double sided, and the Empire III has one of the floppies replaced by an 8-Megabyte Hard Disk. FREE BUSINESS SOFTWARE EMP 1 \$4888 **ONLY \$3666**

CALIFORNIA COMPUTER 2210A
\$2195 **ONLY \$1795** Z80, 64K, I/O, DMA Disk controller + CP/M.

Model 300-1A is the larger system: 2.4 Mb 8", Z80, 64K, and optional OASIS, CP/M, or MP/M operating system. LIST \$5695 **ONLY \$4995**

MORROW DESIGNS Decision 1
OPTIONAL UNIX FREE CP/M. Multi user & Multi processing, 4 to 6 Mhz Z80, and optional Floating Point Processor, or Hard Disk 26 M6. A very powerful system at a saving.
LIST \$1725 **ONLY \$1380.**

GODBOUT COMPUPRO Big 8:
6MHz Z80, DMA Disk Controller, 32K fast static RAM, Interfacer 1 I/O board, + CP/M. LIST \$1995 **ONLY \$1595**

Super Sixteen 8085/8088 is the fastest combo 8-16 CPU. LIST \$3495 **ONLY \$2795**

SYSTEMS GROUP System 2812
runs CP/M or OASIS. Supports single user & multi-user & multi task. Up to 5 megabytes with 8" drives optional 10-megabyte hard disk.
LIST \$5035 **ONLY \$3775**

AMERICAN SQUARE COMPUTERS is organizing a World-Wide FRANCHISE of Computer Stores. Be a WINNER! Join our SUCCESSFUL TEAM selling powerful Computers. Write or Phone us.

SEATTLE's 16 bit COMPUTER is here! 8 MHz 8086 CPU the fastest S-100 computer! 128K Static RAM, DD Disk Controller, 22-slot Main Frame, 86-DOS #2 128K LIST \$4185 **ONLY \$3349** #1 As above but 64K LIST \$3190 **ONLY \$2649**

WE SELL GOOD HARDWARE

square

WE SELL GOOD SOFTWARE

American



Computers

919-889-4577

KIVETT DR. JAMESTOWN N.C. 27282

919-883-1105

CP/M is a registered trademark of Digital Research, Inc.

Circle 20 on inquiry card.

www.americanradiohistory.com

LOWEST PRICE - BEST QUALITY

NORTH STAR



North Star Horizon 2

2-5½ Disk Drives
64K Double Den
Factory assem. & tested
Factory guaranteed
List \$4195

only **\$2875**

**POWERFUL NORTH STAR BASIC FREE
SUPERB FOR BUSINESS & SCIENCE**

FACTORY ASSEMBLED & TESTED	LIST	ONLY
HORIZON-2 32K-DOUBLE DEN	\$3695	\$2625
HORIZON-2-32K-QUAD DENSITY	\$3995	\$2799
HORIZON-2-64K-QUAD	\$4495	\$3150
HORIZON-1-64K-Q-HD5	\$6695	\$4685
HORIZON RAM ASSM	48K = \$679	64K = \$879
BIG SALE ON MULTI-USER TIME-SHARING		CALL
ENGLISH TO BASIC TRANSLATOR		\$ 99
NORTH STAR HARD DISK 18 Mb	\$5375	\$3923
NORTH STAR TIME SHARING MULTI-USER		CALL
ZBASIC 2 TO 5 TIMES FASTER!		\$350
SECRETARY WORD PROCESSOR		\$99
WORDSTAR WORD PROCESSOR		\$318
FLOATING POINT BOARD	\$399	\$319
OASIS MULTI-USER SOFTWARE	SAVE	CALL
CP/M FOR N* Extra features	\$230	\$220
MICRO MIKE SOFTWARE	SAVE	CALL
ECOSOFT ACCOUNTING \$355	MICROSTAT	\$265
UCSD PASCAL II.0	\$199	\$159
EXTRA PRECISION BASIC		\$50
NORTHWORD	\$399	\$299
MAILMANAGER	\$299	\$224
INFOMANAGER	\$499	\$374
GENERAL LEDGER	\$999	\$749
ACCOUNTS RECEIVABLE	\$599	\$449
ACCOUNTS PAYABLE	\$599	\$449
INVENTORY	\$999	\$749
ORDER ENTRY	\$999	\$749

InterSystems

ITHACA INTERSYSTEMS 2A

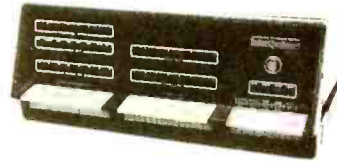

Z-80A CPU 4 MHz
64K Dynamic RAM
Front panel
V I/O—with interrupts
FDCII Disk Controller
20 slot motherboard

LIST \$3795 ONLY **\$2839**

PASCAL/Z + THE FASTEST PASCAL \$375

	LIST	ONLY
PASCAL SYSTEM 128K 2 DRIVES	\$7295	SAVE
CACHE BIOS SYSTEM 128K 2 DRIVES	\$6995	CALL
CP/M SYSTEM 64K 2 DRIVES	\$6295	SAVE
DPS-1 MAINFRAME WITH Z80A	\$1795	CALL
Z80 MACRO ASSEMBLER	\$125	SAVE
SPELL—PERFECT SPELLING	\$295	CALL
COMPARE—UTILITY SOFTWARE	\$295	SAVE
INTEREDIT—TEXT EDITOR	\$295	CALL

MORROW 8" DISK

DISCUS 20 + CP/M® 600K ONLY \$848
DISCUS 2 + 2 + CP/M⁺ 1.2 MEGA B. \$1099
ADD DRIVES 2D = \$599 2 + 2 = \$795
DISCUS 20-DUAL + CP/M® ONLY \$1388
FREE MICROSOFT BASIC FROM MORROW WITH
DISCUS SYSTEM OR HARD DISK



MORROW HARD DISK
26,000,000 BYTES!!
LIST \$4495 ONLY **\$3395**
CP/M⁺ IS INCLUDED!

AMERICAN SQUARE COMPUTERS is organizing a World-Wide FRANCHISE of Computer Stores. Be a WINNER! Join our SUCCESSFUL TEAM selling powerful Computers. Write or Phone us.

SAVE ON MEMORY AND PROGRAMS

SYSTEMS MEMORY 64K A&T	\$549	CORVUS HARD DISK	SAVE	ECOSOFT FULL ACCOUNTING	355	Which Computers are BEST?	FREE
SYSTEMS MEMORY 64K BANK	684	SSM VIDEO BRD V83 4Mhz	412	CAT NOVATION MODEM	169	INSURED SHIPPING AT LOW RATES	
MICROANGELO	985	SPECTRUM COLOR ASM	326	MEMORY MERCHANT 16K	159	CALL FOR LATEST PRICES, DETAILS	
ITHACA MEMORY 8/16 BIT 64K	845	EZ-CODER English to BASIC	99	WICAT 68000 16-BIT	CALL	WE BEAT ADVERTISED PRICES	

FACTORY GUARANTEES

square

EXPERT ADVICE

American Computers

919-889-4577

KIVETT DR. JAMESTOWN N.C. 27282

919-883-1105

CP/M is a registered trademark of Digital Research, Inc.

Circle 20 on inquiry card.

www.americanradiohistory.com

The Input/Output Primer

Part 2: Interrupts and Direct Memory Access

Steve Leibson
Auto-Trol Technological Corporation
12500 North Washington St.
POB 33815
Denver, CO 80233

Last month we left the computer waiting patiently for the printer to signal its readiness to receive another character. If you think it's wasteful to make a machine as expensive as a computer spend most of its time waiting on slower equipment, you are definitely thinking ahead. Later in this month's article, I'll explore a communication mechanism that lets the computer work on another task after transmitting a piece of information. This mechanism, known as the *inter-*

rupt, enables the computer to go about its business until the printer is ready for more data. First, though, you need to know how a computer selects a peripheral device to communicate with; you also need to know about *interfaces*—the hardware that connects computers and peripherals.

Creating subaddresses ensures that information of different kinds can be directed to the proper section of the device.

Picking and Choosing

In the first article of this series, I briefly discussed *peripheral address lines*. Computers, which generally have several peripheral devices attached, select a particular device in one of two ways. One method is to have a separate I/O connection for

every device connected. Selecting a particular device is merely a matter of sending information on the proper bus. This technique, however, rapidly creates a rat's nest of wires, something that's impractical to manufacture.

An I/O *bus* has a set of peripheral-address lines that the processor uses to specify a device. This greatly simplifies wiring the system and results in major cost savings, although it does limit the computer to communicating with one peripheral at a time. For most computer processors, though, one is the limit anyway.

Multiplexing Peripherals

Peripheral-address lines allow the I/O bus to be shared or *multiplexed* by many devices. Each device must have a unique address on the bus. Otherwise, conflicts will arise when two devices try to use information on the bus simultaneously. For instance, plotters are useful for graphing data but are terrible for listing programs.

This article is the second in Steve Leibson's six-part series, "The Input/Output Primer." The series will explain the way in which computers talk with the world. Upcoming articles will discuss parallel and HPIB (GPIB) interfaces; BCD and serial interfaces; character codes; and interrupts, buffers, grounds, and signal degradation. An I/O Glossary, which defines many terms used in these articles, appeared with the first installment (February 1982 BYTE, page 122). Figure and table numbers are continued from Part 1.

With the Hayes direct-connect Micromodem II,TM your Apple II can communicate by phone with the outside world. You can access information networks like The Source for a variety of business and personal applications, exchange programs with friends anywhere in North America, and even use your Apple II when you're away from your home or office.

Dependable. The Micromodem II is so dependable it comes with a two-year limited

warranty. That's another reason why it's the largest selling direct-connect modem for Apple II computers.



Programmable. Automatic dialing and answering? Of course! We include programs on disk that dial phone numbers for you, send messages while you're away, and much more!

Complete. You get everything you need to communicate with other Bell 103 compatible modems at 110 or 300 baud. The serial interface

is built-in, and we even include our FCC-approved MicrocouplerTM that plugs directly into any modular telephone jack in the U.S. — you don't even need the phone!

S-100, too. The Hayes Micromodem 100 gives S-100 microcomputers all the advantages of our Micromodem II!

Put the outside world *inside* your computer with a data communications system from Hayes. Available at computer stores nationwide — call or write for the location nearest you. And



Hayes

don't settle for anything less than Hayes.

The Hayes Micromodem II opens up your Apple II to the outside world.

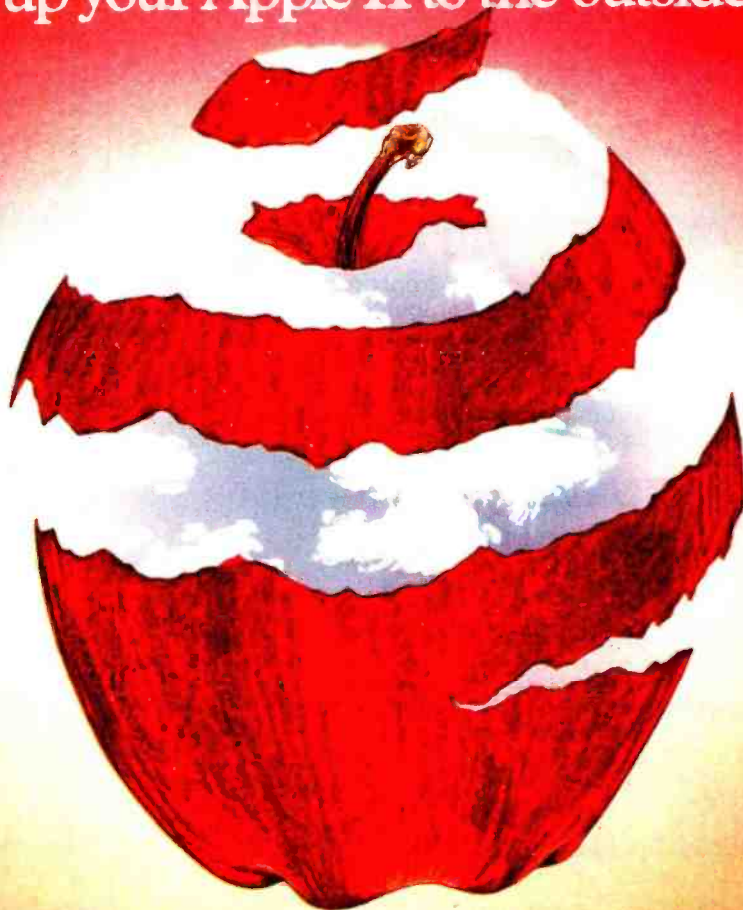

Hayes Microcomputer Products Inc. 5835 Peachtree Corners East, Norcross, Georgia 30092 (404) 449-8791

Micromodem II, Micromodem 100 and Microcoupler are trademarks of Hayes Microcomputer Products Inc.

¹TM Apple Computer Inc. Micromodem II can also be used with the Bell & Howell computer. © 1981 Hayes Microcomputer Products Inc.

Scopes, scopes and more scopes!

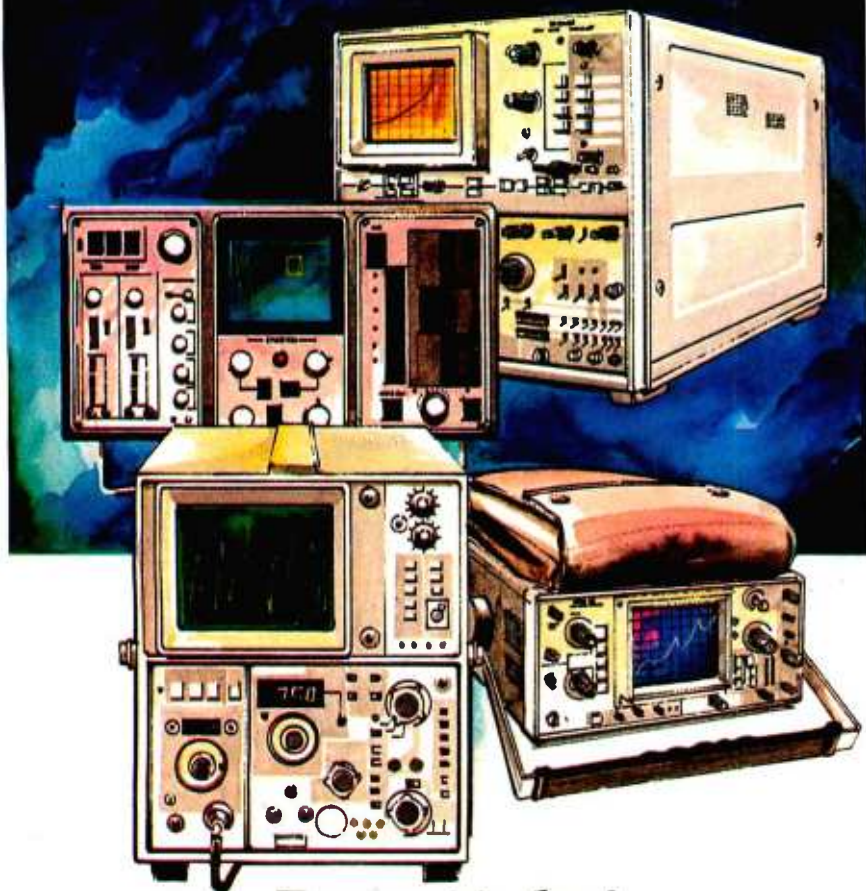

For rent today!

If you need any model of oscilloscope from Tektronix or Hewlett-Packard (or anyone else, for that matter), it's probably sitting on-the-shelf, right now, at Genstar REI . . . just waiting for you to rent it. Prices are from 30 days up (and darned competitive, too) at any of our convenient North American inventory centers. About the only kinds of scopes you can't rent from us today are John Thomas and tele. Call . . . now! GSA Contract #GS-04S-23560

GENSTAR

Rental Electronics, Inc.
(800) 227-8409

In California (213) 993-7368, (415) 968-8845 or (714) 879-0561

I'll be a monkey's uncle, REI! Send free details immediately!

- It sounds great. Tell me more! Call me at _____
- Send me your new Rental Catalog.
- I'd like a copy of your "like new" equipment for sale catalog, too.
- I'm particularly interested in the following equipment: _____

NAME _____ TITLE _____

ORGANIZATION _____

ADDRESS _____ MAIL STOP _____

CITY/STATE/ZIP _____

TELEPHONE _____

Please complete coupon and mail to: Genstar Rental Electronics, Inc., 19525 Business Center Drive, Northridge, CA 91324

© Genstar Rental Electronics, Inc. 1982

When the computer is accessing the disk storage device, everything will run more smoothly if the plotter ignores transactions on the I/O bus.

Clearly, each peripheral device must have its own unique address. It's more advantageous, however, for each device to have several unique addresses. Think of the peripheral device as an apartment building having a single, unique street address. Apartment One gets the local daily newspaper, which covers general information, while Apartment Two gets *The Wall Street Journal*, which reports on economic events. Each apartment gets information but of a different kind.

A peripheral device also requires information of different kinds. Not only do printers receive characters to print, but they also get control information such as line spacing, number of characters to print per line, type font, and other functions. Creating subaddresses within the peripheral device ensures that information of different kinds can be directed to the proper section of the device.

Peripheral address lines are split into a *select code* that specifies a particular peripheral and a *register code* that specifies the subaddress. (A *register* is a hardware device that holds the information until the peripheral can use it.)

Setting up Subaddresses

To illustrate, I'll create four subaddresses within each select code. Being obstinate, as computer designers often are, I'll call these subaddresses 4, 5, 6, and 7 (nobody starts at zero any more). These four subaddresses are registers that serve as portals to the peripheral.

Four subaddresses require two wires for selection because two wires can assume four binary states. These states are:

State of line #1	State of line #2	Register addressed
0	0	4
1	0	5
0	1	6
1	1	7

(Remember, digital signals may only

New address effective March 15,
111 Providence Rd., CHAPEL HILL, N.C. 27514
(919) 463-1451

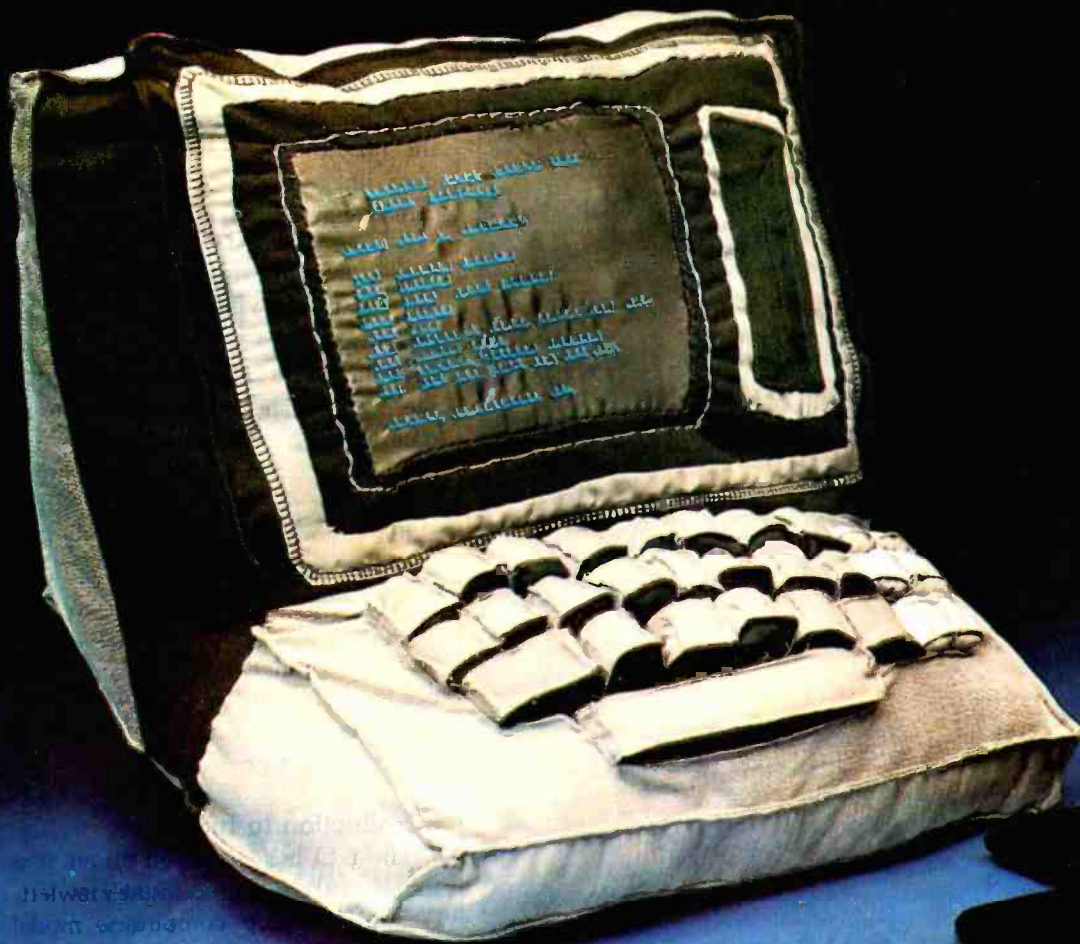

State-of-the-art hardware demands state-of-the-art software

Operating Systems & Support Software from Technical Systems Consultants

To perform to its fullest capabilities, your hardware demands software designed to meet the specialized requirements of today's microprocessors. State-of-the-art software from Technical Systems Consultants keeps pace with the rapid advancements in computer technology so your hardware can live up to its full potential. Our complete line of state-of-the-art software includes:

The UniFLEX™ Operating System

UniFLEX, a true multi-user, multi-tasking system for the 6809 and 68000 microprocessors, supports such features as:

- hierarchical file systems
- device independent I/O
- four Gigabyte disk capacities
- full file protection
- inter-task communication via pipes
- I/O redirection
- task swapping
- full random-access files
- comprehensive shell command language

UniFLEX, structured for large-scale microprocessor systems, will not run with minimal systems and thus has avoided design compromise. (Off-the-shelf versions and OEM licenses are available.)

The FLEX™ Operating System

FLEX, a powerful, easy-to-use operating system designed for the 6800 and 6809 microprocessors, includes:

- dynamic filespace allocation
- random files
- batch job entry
- automatic space compression
- English error messages
- user environment control
- disk resident commands
- flexible device I/O
- printer spooling

Plus, FLEX can accommodate hard disks as well as floppies. The System is available off-the-shelf for a variety of systems and in a field-adaptable version. (OEM licenses available.)

FLEX and UniFLEX are trademarks of Technical Systems Consultants, Inc.

Support Software

Technical Systems Consultants offers a full line of state-of-the-art support software compatible to FLEX and UniFLEX, some of which are:

- native C and Pascal compilers for advanced programming
- extended BASIC for business and educational applications
- text editing and processing software
- sort/merge package for business applications
- variety of absolute and relocatable assemblers
- debug and diagnostic packages

... and more. Write or call today for our brochures describing our complete product line.



Box 2570, 1208 Kent Avenue
West Lafayette, Indiana 47906
(317) 463-2502 Telex: 27-6143

Sculpture by Joann Chaney

Turn your TV into a time-sharing videotex display for \$399.*

Now you can connect your family to the informative and entertaining world of CompuServe, The Source, Dow Jones News/Retrieval and other time-sharing and data-base networks.

All you need is the RCA VP-3501 Videotex Data Terminal (with built-in modem and RF modulator), your telephone and your TV set. You can get instant access to regional newspapers and newsletters...weather reports and sports results...computer games and more. You can use the VP-3501 to make airline reservations...find restaurant recommendations in cities around the world. Plus stock market and corporate data. Or access your school or business computer. You can even send electronic mail and buy products.

In addition to information retrieval, the VP-3501 provides full interactive communications with a host computer. What you have working for you is a versatile, feature-packed interactive data terminal which can be worth far more to you than its low price. Its unique color-locking circuitry gives you sharp color graphics and rainbow-free characters. You get 20- and 40- character formats in one of eight foreground colors and separate color backgrounds.

With reverse video, you can emphasize certain letters, words, or sentences. A built-in tone generator...plus a white noise generator...let you create everything from the sound of explosions to the sound of music. The spill-proof, easy-to-clean keyboard is highly suitable for hostile environments. And its membrane key switches give you a natural feel.

The VP-3501 is truly a fine Videotex Data Terminal. And don't forget, it's made by RCA...the first name in television...now the foremost name in videotex terminals.

See a demonstration at your computer or electronics dealer, or contact RCA. Order now and you'll get a free password and a free hour's time-sharing on both CompuServe and Dow Jones News/Retrieval! (Limited time offer.)

For more information or to order, call toll-free. 800-233-0094. (In Pennsylvania, call 717-393-0446.) Visa or MasterCard orders accepted by phone. Or send a check including \$3.00 delivery charge plus your local sales tax to RCA MicroComputer Products, New Holland Avenue, Lancaster, PA 17604.

*Suggested User Price.

PRIME TIME-SHARING



assume one of two states: on or off, "1" or "0.")

Although four registers could do the job, there's a complication: the data lines are bidirectional, and bi-directional registers are complex to construct. It's easier to use eight registers—four for input and four for output. The I/O line will specify from which group of four the register address lines will select. Remember that the I/O line specifies the direction of data flow on the data lines and so is ideal for selecting between the input and output registers.

I've now constructed a simple I/O bus that can convey information between the computer and external devices. This I/O bus isn't the most advanced, but it will satisfy present needs. I'll upgrade this "bunch of wires" later, but first let's confront a more pressing problem.

Introduction to Interfaces

The I/O bus discussed above is a subset of the bus used in the Hewlett-Packard desktop computers, model 9825 and Systems 35 and 45. It would be convenient if all peripherals came with circuitry that directly interfaced to the I/O bus.

Unfortunately, present interfacing methods are far from ideal. The bus constructed above is *parallel-oriented*, which means that every binary digit (bit) of a piece of information (such as a character) is available simultaneously on the 16 data lines.

Not all peripherals use 16 data lines; some peripherals don't have any parallel interfaces but instead send information one bit at a time in a time-serial fashion. No peripherals use the eight-register scheme discussed above, while several use incompatible voltage levels to represent "1" and "0." This appears to be quite a problem. In fact, there isn't a single peripheral that can talk to our I/O bus in its present state.

Interfaces as Translators

It's necessary to interpose some specialized circuitry between the I/O bus and the peripheral device to adapt the signals from the computer to those used by the peripheral. This

Circle 337 on inquiry card.

COMPUTER WAREHOUSE

CALL TOLL FREE **1-800-528-1054**

ATARI

Special 32K 800 System	
800 w/32K, recorder, star raiders, joysticks	Call
Above w/48K	Call
800 (16K)	Call
400	Call
810 Disk Drive	\$440
825 Printer	\$590
850 Interface	\$160
410 Recorder	\$ 75
830 Modem	\$150
16K Memory	\$75
32K Memory	\$150

DISK DRIVES

Lobo	
Apple 1st Drive	\$490
Apple 2nd Drive	\$410

MODEMS

Novation	
CAT	\$140
D-CAT	\$155
Apple Cat II	\$349
Auto Cat	\$235

PRINTERS

C. Itoh	
F-10 — Parallel	Call
F-10 — Serial	Call
55CPS — Series	Call
Prowriter	Call

Datasouth	
DS 180	\$1260

Diablo	
630 RO w/Tractors	\$2260
630 RO wo/Tractors	\$2050

Epson	
MX-80	Call
MX-80 F/T	Call
MX-100	Call

Infoscribe	
500	Call
1000	Call

NEC	
PC-8023A	Call
3510	\$1690
7710	Call
7720	Call

Okidata	
Microline 80	\$330
Microline 82-A	\$470
Microline 83-A	\$740
Microline 84	Call

Paper Tiger	
560G	\$1050

Texas Instruments	
810 Basic	Call
810 Loaded	Call

ATARI®
Novation
ZENITH data systems
NorthStar
SOROC TECHNOLOGY, INC.
TeleVideo™
3M **TEXAS INSTRUMENTS**
EPSON
 EPSON AMERICA, INC.
OKIDATA
California Computer Systems

Prices & availability subject to change without notice.

VIDEO TERMINALS

Adds	
Viewpoint	\$535
Altos	
Altos I	Call
Soroc	
IQ 120	\$660
IQ 130	Call
IQ 135	Call
IQ 140	Call
Televideo	
910 C	\$570
912 C	\$690
920 C	\$735
925 C	\$740
950 C	\$925
Zenith	
Z-19	\$680

DISKETTS

Scotch	
5¼" 0. 10. 16 Sector (Qty 100)	\$250
8" 0. 32 Sector (Qty 100)	\$260

Personal checks will delay shipping two weeks.

COMPUTERS

Altos	
ACS 8000-15	\$3995
ACS 8000-2 w/CPM*	\$2695
Alspa	
ASCI-1	Call
ASCI-2	Call
NEC	
Call	
Northstar	
Advantage	\$2990
Horizon II 64K DD	\$2750
Horizon II 64K QD	\$3050
Televideo Systems	
System I	Call
System II	\$2255
TS-802	\$5045
TS-802H	\$2700
TS-802H	\$5050
Zenith	
Z-89 48K w/CPM*	\$2160
Z-90 64K w/CPM*	\$2385
Both above w/supercalc	
MONITORS	
Zenith	
12" Green Screen	\$115



2222 E. Indian School Rd. • Phoenix, Arizona 85016
 Order Line: 1-800-528-1054
 Other Information: 602-954-6109



Store Hours: Tues.-Fri. 10-5 MST Saturday 10-2 MST

Prices reflect 3% cash discount. Product shipped in factory cartons with manufacturers warranty. Add 2% a minimum of \$5 for shipping and handling.

specialized circuitry is called an *interface*. The interface, which actually plugs into the I/O bus, acts as an intermediary, translating voltages, signal formats, and whatever else is required to establish communications between the computer and the peripheral.

If every peripheral manufactured in the last decade required a different interface, it would be impossible for the computer to communicate with even a small fraction of them. Computer manufacturers simply cannot make products for that many different interfaces. Fortunately, several devices require only one of four basic types of interface: parallel I/O, serial I/O, HPIB (GPIB), and BCD (binary-coded decimal).

To connect with a peripheral, the parallel interface uses a set of wires much like those of the I/O bus. This interface is the most common among current peripherals because it's the simplest to build and usually transfers data the fastest. Major variations involve (1) the connector used between the peripheral and the interface circuitry and (2) the sense of the data and control lines. Does zero volts mean logic zero (positive true logic) or logic one (negative true logic)?

A flexible parallel interface should be available with several connectors and an unterminated cable so that a custom connector can be installed. The logic sense of the data and control lines and even the logic levels used can all be adjusted to suit the needs of a particular device.

A serial interface takes data from

the I/O bus and serializes it into a stream of bits. Incoming serial data is converted into parallel data and sent to the computer. Only two wires are required for serial communications—transmit data and receive data—however, control lines exist in serial interfaces because serial I/O dominates the special environment of long-distance data communications.

Interrupts force the processor to leave the part of the program it's executing and start executing the code in a different location in memory.

HPIB, a relatively new interface, is standardized. HPIB stands for Hewlett-Packard Interface Bus. Due to standardization, it's also known as the General Purpose Interface Bus (GPIB). Formally known as IEEE-488-1978, HPIB has well-defined signals, connector, logic sense, and logic levels. This interface allows simple connection to multiple devices over a bus structure. Since the connector and signals are standardized, you just bolt the connecting cable to the peripheral for the computer to begin communicating. You then can concentrate on the software needed to run the peripheral. A single HPIB interface can connect a computer to 14 peripheral devices.

Older instruments use a different type of interface known as binary-coded decimal (BCD). Data is transferred in 4-bit chunks, and each group of 4 bits represents a numeral (0 through 9). BCD interfaces are generally used for transmitting numeric information.

In the third and fourth installments of this primer, I'll examine these types of interfaces in depth. For now, though, let's turn to this month's main topic, interrupts and direct memory access (DMA).

Getting the Processor's Attention

What do you think is the most important part of a telephone? The dial? The receiver? The cord? I submit that it's the bell. If the telephone had no way to summon you when a call came in, you'd have to check it periodically to see if there was someone on the line. Having to lift the receiver every few minutes would make the instrument a maddening inconvenience. Fortunately, telephones do have bells that interrupt you when someone calls.

Earlier I discussed the relative speeds of computer processors and peripheral devices. The mismatch in speeds forced the creation of *handshaking* lines the processor could check to determine the peripheral's availability. Without these lines, the speedy processor would inundate the poor peripheral with data. Using these handshake lines is the simplest form of I/O. The computer spends much of its time patiently waiting for the peripheral to signal readiness for

**SMALL PRICE
BIG PERFORMANCE**

- COMPATIBLE WITH Z80/8080/85 CP/M* DISK BASED COMPUTERS, prom data stored as named files on disk for low cost storage / retrieval. *trademark — Digital Research, CA
- STANDARD RS-232 SERIAL INTERFACE, selectable 110 to 9600 baud.
- USER ORIENTED SOFTWARE AND DOCUMENTATION, 21 single keystroke commands including copy, verify, and a complete editor.
- NO PERSONALITY MODULES REQUIRED
- PROGRAMS ALL 24 AND 28 PIN EPROMS, single or triple supply voltage. 2704/08, TMS2716, 2532, 2716/32/64, 2732A, 68732/64 and more.

\$695.00 **UP-8 PROM PROGRAMMER — PRICE / PERFORMANCE LEADER**

DEALER INQUIRIES INVITED **ADVENT PRODUCTS, INC.** 965 N. Main Street, Orange, CA 92667 (714) 997-0800

COBOL the language of business.

The language of Micro Focus

CIS COBOL

Our CIS COBOL product family brings you the most successful business programming tool ever devised, COBOL, in a form optimized for today's most cost effective hardware, the microcomputer. Standard COBOL as defined by ANSI X3.23-1974.

The reliability and performance of CIS COBOL are strongly emphasized by its' continued qualification for U.S. government contracts. In January 1981 CIS COBOL entered its 2nd year of G.S.A. certification.

CIS COBOL is powerful but simple to use. Its screenhandling, dynamic module loading and fast ISAM let you take full benefit from micro computer facilities.

Our FORMS-2 utility is a COBOL source code generator to help you build interactive applications with ease. Using our unique demonstration "How to create a COBOL program in 20 minutes," you can quickly try out new application ideas.

And if you are developing software for resale, the variety of systems running CIS COBOL offers you a very large available market.

WITH FORMS-2

CIS COBOL and FORMS-2 are available through our dealers and distributors for many 8080, Z80 and LSI-11 systems including Apple II with Softcard and CP/M.

For OEM purchase on 8086, PDP-11, UNIX and other order codes approach us direct. Our system transfer technology has made CIS COBOL first on a number of processors and enabled us to interface to 30 different operating systems.

For more information about CIS COBOL fill in the coupon below.

To: Micro Focus Inc. 1601 Civic Center Drive,
Santa Clara, Ca 95050, USA.
Phone: (408) 496 0176. Telex: 278704 MFCIS UR

Please send me

A brochure on CIS COBOL

A brochure on FORMS-2

A set of Applications Notes

..... (Qty) CIS COBOL manual(s) at \$75
(inc. p+p) for which I enclose a check
for \$.....

My chief interest is in; (please tick box)

8080

8086

UNIX

Apple II

Name

Position

Company

Address

Tel No.....

 **MICRO FOCUS**

CIS COBOL and FORMS-2 are trademarks of Micro Focus. 8080 is a trademark of Intel Corp. Z80 of Zilog. LSI-11 and PDP-11 of Digital Equipment Corp. Apple II of Apple Computer. Softcard of Microsoft Consumer Products. CP/M of Digital Research and UNIX of Bell Laboratories.



Figure 4: A computer system with memory bus, I/O bus, and added interrupt line. Interrupts allow the processor to start I/O processes, then go on to other tasks. The peripheral uses the interrupt line to indicate readiness for another transaction.

the next transaction.

Interrupting

Waiting for peripherals is tolerable if the computer has nothing else to do. Often, however, there are many other things the computer could be doing, making the handshaking I/O highly inefficient. Fortunately, most computers now offer an alternative called *interrupt I/O*.

Let's first make clear exactly what will be interrupted. The computer is continuously executing a program in its memory. If there's no user program running, then at least the operating system will be. Thus there are at least two program levels in the computer, with the higher level being the user program, usually written in a language such as BASIC.

Because microprocessors can't run a BASIC program directly (although that day isn't far off), they use a lower-level program called an *interpreter*, which is written in a machine language the processor *can* run directly. The interpreter takes the BASIC program and interprets it by deciding which machine-language routines to call to perform the tasks requested in the BASIC program. Another type of lower-level program, a *compiler*, can translate a high-level language program into machine code. I'll consider only interpreters here.

Interrupts are hardware mechanisms that force the processor to leave the part of the program it's executing and start executing the code in a different location in memory. Figure 4 shows the I/O bus with an interrupt request line added. That's the only change the bus needs in order to add interrupt capability.

Interruption takes place at the machine-code level. It's helpful in synchronizing external events with the computer program but must be used carefully. Let's take an example.

Suppose a user program asks the computer to calculate the value of

$2.5 + 2.5$, produce the resulting value on a printer, then calculate the value of $3 + 3$. The computer will first execute the BASIC interpreter's routine for floating-point addition and produce the first sum: 5.00. Then there will be six characters to print: 5, ., 0, 0, <CR>, and <LF>. <CR> and <LF> are carriage return and linefeed characters usually sent to advance the printer to the next line on the paper.

Assume the addition takes around two milliseconds. If the printer produces ten characters per second, it will take 0.6 seconds to print the first answer (actually, a little more time will be needed because carriage return and linefeed take extra time on most printers).

Handshake I/O requires the computer to wait the full 0.6 seconds before calculating the second sum because the computer is waiting to send the printer another character during that time.

Interrupt I/O's alternative is to place characters to be printed in a buffer somewhere in memory. Interrupt routines can then withdraw characters from this buffer whenever the printer can accept them, and the computer can push on through the program.

Interrupting Machine Code

When the first character to be printed is removed from the buffer and sent to the printer, the printer interface "goes busy," transferring the character to the printer and waiting for a signal that indicates completion of the printing. Meanwhile, the computer can proceed to the next BASIC statement. When that first character has finally been printed, the printer will "go ready" for the next one. At that time, the printer interface will interrupt the processor and request another character.

Note that the machine code interpreter is interrupted, *not* the BASIC

program. The flow of execution of the BASIC statements is not changed but merely halted while the interruption is serviced. The interpreter, however, does branch to a different routine. This special routine, also in machine code, is called an interrupt service routine. The author of the BASIC program doesn't have to write interrupt service routines for Hewlett-Packard desktop computers, as needed routines are provided in the interpreter. This is convenient because interrupt service routines must handle many factors.

An interrupt forces a branch to the location in memory where the interrupt service routine is stored. If the processor doesn't remember where it was before the interruption, the processor will be unable to return to that location. In fact, the processor will be "lost" and unable to continue processing. Most microprocessors automatically save the address of the location being executed before the interrupt, and a return from the interrupt is sufficient to store that address.

If the interrupt routine uses any of the internal registers in the processor, the routine must carefully save the contents of these registers before using them. This procedure is called *context switching* because the registers will be used for a different purpose in the interrupt service routine than in the main program. Upon completion of the interrupt service routine, the routine must restore the saved values of the registers.

Interrupting BASIC

Occasionally, the buffered I/O routines for servicing interrupts are not sufficient for handling a problem. Some interrupts are more complex than those needed for data transfer. Maybe the computer is monitoring a water system and the dam bursts. Such crises require the processor's immediate attention; a simple data transfer will not suffice. A branch is needed in the high-level program to a special high-level routine written to handle the interrupt. You *did* write the "Dam Burst" routine, didn't you?

Interrupting a program in BASIC or another high-level language is considerably more complex than inter-

**If you think two dimensions
of computer calculating power
have been useful, wait until
you get your hands on three.**

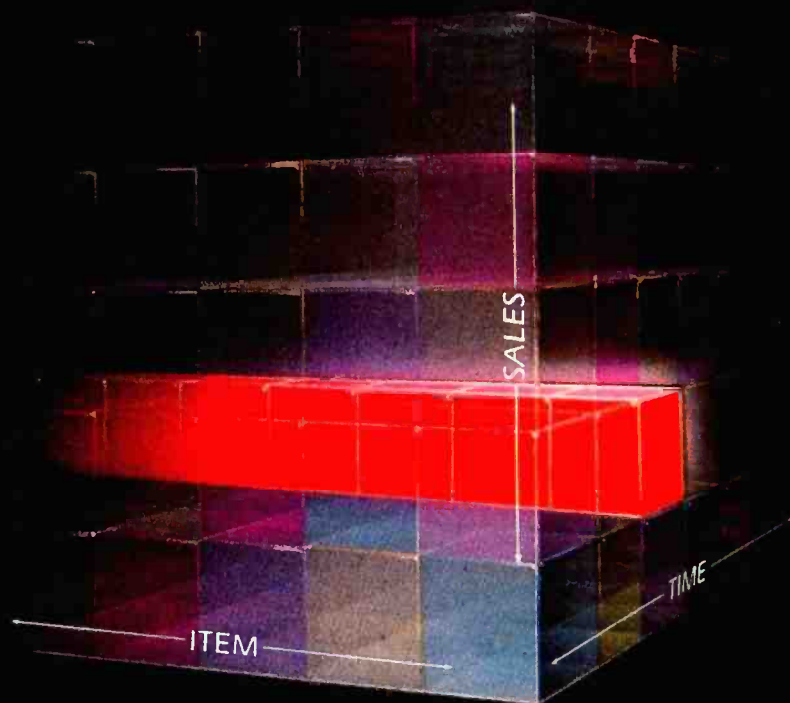

NEC Introduces Report Manager™ for the PC-8000 microcomputer, giving you an astounding mastery of labels, numbers, and formulas in a unique 3-dimensional matrix, the "Data Cube."™

All the power and flexibility of the best electronic spread sheet ever created...now available with an axis of depth in addition to the standard horizontal and vertical.

You get an electronic book, not just an electronic page. Easy as A, B, C...and powerful as X, Y, Z!

The best way to learn about the solid wonders of Report Manager is to see it in action.

Three dimensions of calculating power, not just two: Unprecedented flexibility in any direction. Powerful editing commands to change or add to contents of a cell. Versatile report features that allow easy control over portions of data, columns on a page, pages on a row, etc. Four independent viewing regions can be created on the same screen. And there are built-in time and calendar functions, so you can manage duration as well as dimension.

See Report Manager run on the PC-8000 at your nearest NEC Home Electronics (USA) dealer.

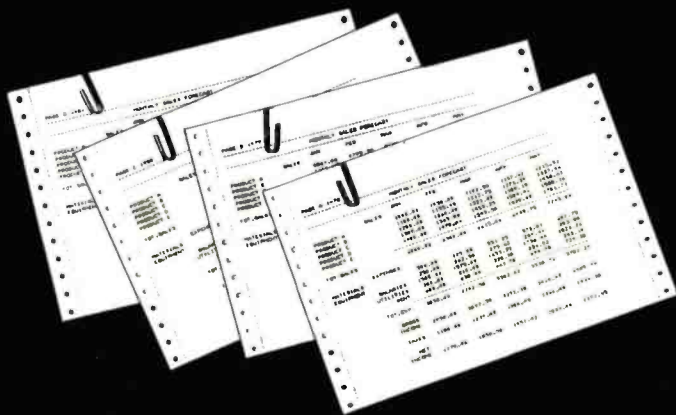

Sample printout showing use of X, Y, and Z axes.
Report Manager and Data Cube are trademarks of The Image Producers, Inc.



**Productivity
at your fingertips**

NEC

**NEC Home Electronics (USA)
Personal Computer Division
1401 Estes Avenue
Elk Grove Village, IL 60007**

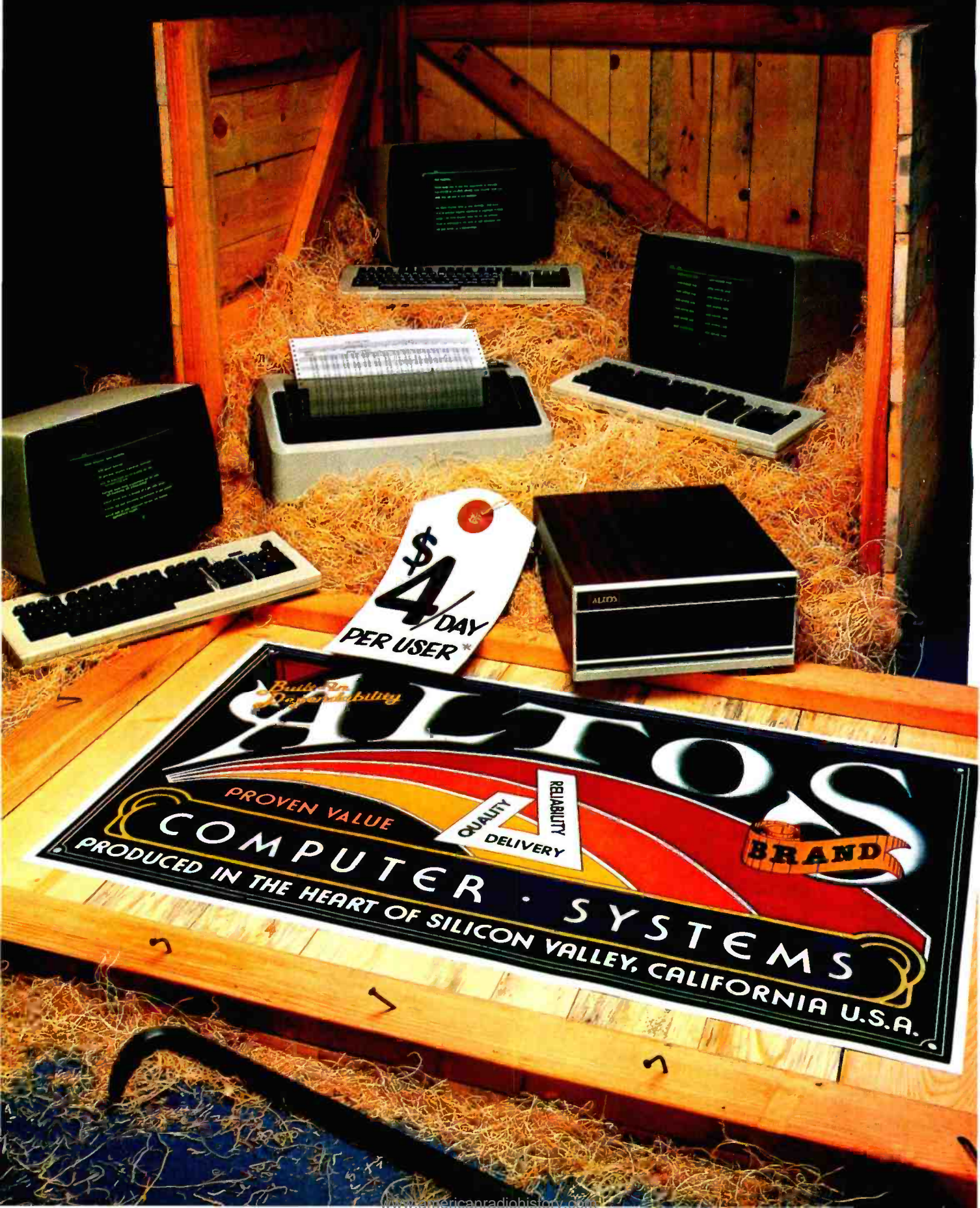

\$4/DAY
PER USER*

Builds On Dependability
APPLE II
PROVEN VALUE
COMPUTER · SYSTEMS
RELIABILITY
QUALITY DELIVERY
BRAND
PRODUCED IN THE HEART OF SILICON VALLEY, CALIFORNIA U.S.A.

ANOTHER CRATE IDEA FROM ALTOS!

**The complete multi-purpose, multi-terminal
desktop business computer system
with a built-in tutor.**

Get everything you need to computerize your business. An Altos Series 5 computer, with highly reliable 5 MByte Winchester hard disk that stores up to 1,800 pages. Three of our new smart terminals, and a speedy draft quality printer. Plus an Altos Computer Tutor, the self-teaching business software package.

All for less than \$4 a day per user.

For a quick, productive start, the Altos Computer Tutor provides simple, self-paced, step-by-step instructions and training.

Operators will become faster and much more accurate because, when you have an Altos system, it's like having three computers in one.

While your bookkeeper prepares payroll, other users can check inventory, look up needed information, or produce error-free reports. Plus Altos lets you communicate with other computers, main frames, and even allows networking.

Need more?
For less than \$1 a day additional, each user can also have WordStar™ for

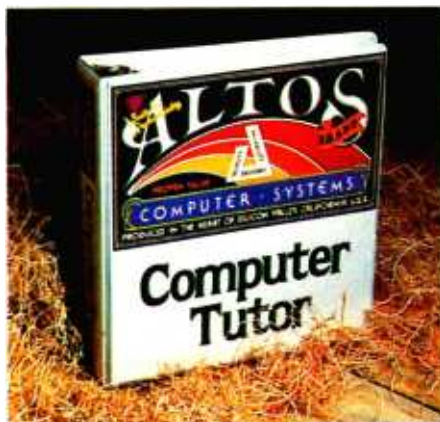

word processing and Microplan™ for business analysis. And your Altos dealer has hundreds of other popular CP/M,® MP/M II™ and OASIS applications programs for Altos computers. And most importantly, he can arrange for on-site service, nationwide.

Join thousands of businesses, professionals and institutions who rely on Altos.

Call our toll free number. We'll put you in touch with your local Altos sales and service dealer who'll crate an Altos business computer system just for you.

*Complete 3 user system for \$4 a day per user. Price approximate and may vary in your area. Daily lease based on \$13,800 principal, 20% annual interest, five year term. Packaged system includes Altos Series S-SD computer with 5 MByte Winchester hard disk, draft quality printer, three Altos 1 smart terminals, and the Altos Computer Tutor software package. Price does not include tax, installation, training and maintenance.

**Packed with
fresh ideas
for business**



2360 Bering Drive
San Jose, California 95131

800-538-7872
(In Calif. 800-662-6265)

WordStar is a trademark of MicroPro International Corp. Microplan is a trademark of Chang Laboratories, Inc. CP/M is a registered trademark and MP/M II is a trademark of Digital Research, Inc. OASIS is a product of Phase One Systems, Inc. © 1982 Altos Computer Systems

Circle 18 on inquiry card.

rupting a machine-language routine for data transfer. High-level statements can affect large portions of memory through the use of variables, arrays, and strings. If a variable is in the process of being changed when the interrupt comes in and the BASIC interrupt routine uses that same variable, the interrupt routine may use the wrong value or a garbled value. If the dam has burst and you need to close some locks downstream immediately to save a town, you and the townspeople have a strong interest in seeing that the interrupt routine uses the right value.

logged in, but it will not be serviced until the end of the current program line.

Machine-code or low-level interrupts are generally called *hardware interrupts* because the processor hardware grants the interrupt request and performs the subsequent branching. Interrupts to the BASIC or high-level program are called *software interrupts* because several instructions in the operating system are required to log in the interrupt, request an end-of-line branch, then take control of program flow at the end of the line.

A Misunderstanding

A classic example of misunderstanding interrupt operations occurs whenever a first-time writer of interrupt service routines tries to use an interrupt for input. The typical programmer will enable the interface to interrupt and expect that when the interrupt comes, the interface will have the desired data. Unfortunately, the interface interrupts when it isn't busy. This may happen when the interface

wasn't told to do anything or when an operation has completed. Since the interrupt routine didn't originally make the interface busy by requesting a data input operation before the interrupt was enabled, the interface interrupts immediately but has nothing to offer. Such a miswritten interrupt routine always produces incorrect information on the first data transfer. Remember, to use interrupts properly, you must see that data transfer is started before interrupts are enabled. That way, the first interrupt will occur when the first data transfer is complete.

End of the Line

To prevent such problems, Hewlett-Packard desktop computers allow the BASIC program to be interrupted only at the completion of program line execution. This feature is called *end-of-line branching* because the branch to a BASIC interrupt service routine is allowed only when the end of a line is reached. The interrupt may occur at any time and will be

DMA: The I/O Superhighway

Thus far, I've covered the hardware within a computer and the interfacing circuitry necessary to interface peripheral devices with computers. All the discussions have assumed that the computer processor is in control of the data-transfer process, which is true for many peripheral devices. The processor is usually fast enough so that the peripheral determines the data-transfer rate.

Some devices, however, are too fast for processor-controlled I/O. These devices can handle data at rates approaching the speed of the computer memory and therefore require a different I/O technique. One technique for interfacing these fast peripherals is called direct memory access.

If the peripheral device is slightly slower than the computer processor, the processor may be able to execute only the few machine instructions needed for the I/O transfer before the peripheral is ready for another transfer. In that case, there's a good match between the I/O software and the peripheral speeds, and programmed I/O will suffice for the task.

Some peripherals, however, are too fast for the processor to execute even the few instructions needed to perform programmed I/O. As long as these peripherals are not faster than the computer's basic memory cycle, direct memory access can perform the required I/O.

In order to discuss DMA and how it works, we must return to the model of the processor/memory/I/O sys-



Carbonless checks, invoices and statements

- ★ Standard formats...plus Custom Design Service!
 - ★ Small quantities (as low as 500)...plus money-saving prices!
 - ★ Super-fast service (shipped 5 days after receipt of order!)
- SEND COUPON...OR CALL TOLL-FREE: 1-800-328-9697.



82

To: Delmart Company, Division of Deluxe Check Printers, Inc., 530 N. Wheeler St., P.O. Box 43495, St. Paul, MN 55164-0495

YES, please send free color catalog!

Name _____ Title _____

Firm _____

Street _____ Phone (____) _____

City _____ State _____ Zip _____

B 3

SUPERVYZ—THE NEXT INDUSTRY STANDARD

SUPERVYZ is a revolutionary software concept designed to overcome the frustrations of using CP/M®. This allows you to crack any non-technical market without the hassles of teaching the operating system. Instead, users are greeted with a series of self-prompting, self-explaining menus linking the user directly to the application. We'll supply the menus or you create your own, to meet the exact needs of your customers. SUPERVYZ presents unlimited software flexibility by providing a system to coordinate multiple application programs. The menus tie it all together, allowing program interaction. Even the most complicated commands between programs can be a simple menu choice.

Dealer inquiries invited,
foreign or domestic.



Epic Computer Corporation
7542 Trade Street
San Diego, CA 92121
Tel: 714-695-3560

Circle 155 on Inquiry card.

MANUFACTURERS

Ship SUPERVYZ with every computer you sell. SUPERVYZ means software support interactive help files . . . dealer confidence . . . instant foreign market access . . . vertical market packaging . . . more computer sales!

DEALERS

Buy SUPERVYZ as a separate program . . . bundle software from different suppliers . . . demonstrate capabilities, not confusion . . . sell computers more efficiently - SUPERVYZ does the teaching . . . end after-the-sale handholding . . .

SOFTWARE SPECIALISTS

Package SUPERVYZ into every system you deliver . . . SUPERVYZ is compatible with over 2000 programs, 300 computers. Target your market with SUPERVYZ.

USERS

Insist on SUPERVYZ . . . don't buy a computer without it.

SUPERVYZ™

YOUR NEW MARKETING TOOL FOR INCREASED SALES OF CP/M COMPUTERS AND APPLICATION SOFTWARE

INTRODUCTORY
RETAIL PRICE

\$95

*Calif. orders 6% sales tax
or resale number

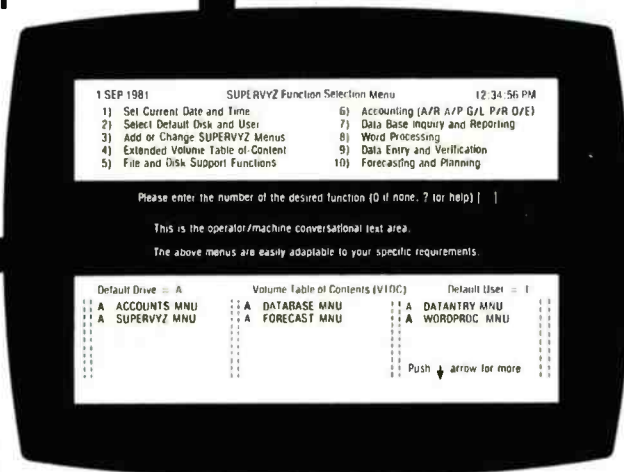

*Supervyz is a trademark of Epic Computer Corporation. CP/M is a trademark of Digital Research.

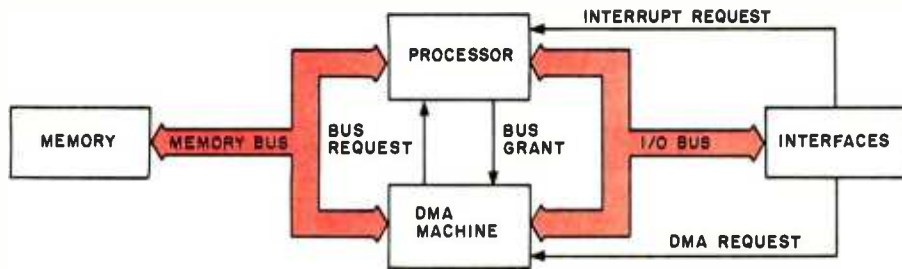

Figure 5: A computer system with an added DMA (direct memory access) machine. The DMA machine, which parallels the processor, can generate the signals necessary for controlling both the memory bus and the I/O bus.

tem. Recall that the processor is linked to the memory via a set of lines called a memory bus and to the I/O interfaces via an I/O bus. Both buses require the processor to generate address signals and control signals to synchronize the flow of data over these buses.

Generally, I/O consists of taking information from the interfaces through the I/O bus and transmitting this information to the memory using the memory bus—or vice versa. During this transfer, the processor is also using the memory and memory bus to supply machine instructions so that it knows how to effect the data transactions. If you assume that the processor takes only nine machine instructions to perform one data transaction, you can see that the effective I/O throughput is only ten percent of the rate that the memory could support. That is, of every ten memory cycles, nine instruct the processor and only one places data for I/O. Only the simplest data transactions can be performed with nine machine instructions. Formatting and code conversions require many more instructions.

The only way to speed up the I/O process is to eliminate the slowest link in the data path. For high-speed peripherals, the slowest link is clearly the processor itself! How can you eliminate the processor when it's the component that links the I/O and memory buses and is required for generation of the signals that actually make these buses work? The answer is to build a specialized circuit designed to transfer data at the full speed of memory. Since this transfer is the only function this circuitry must perform, the capability can be wired into the circuit. Instructions from memory, which would reduce

the effective memory bandwidth, are not needed.

By placing this special circuitry so that it bridges the I/O and memory buses and also by giving it the capability of generating the address and control signals required by these buses, you then have a machine that can perform I/O at the full speed of memory. Such special circuitry is called a direct memory access machine. Figure 5 shows how one might add a DMA machine to the I/O bus.

All that remains is to decide which device will have control of the buses: the processor or the DMA machine. Normally, the processor will have control of the buses, since the DMA I/O must be infrequent enough to allow some processing to get done. The DMA machine must therefore have a way to acquire bus control from the processor whenever necessary. The processor can enable the DMA machine to request bus control, but the interface must actually request service through the DMA machine because only the interface knows when an attached peripheral requires DMA service. Thus some connecting signals must exist between the interface and the DMA machine and between the DMA machine and the processor. To give the interface a means of requesting service from the DMA machine, let's add a signal called *DMA Request* (DMAR) to the collection of signal lines on the I/O bus.

Upon receipt of a DMA Request, the DMA machine must request bus control from the processor. If the processor decides that the request comes at an inopportune time, it can temporarily withhold transfer of control. This is a job for the ever-present handshake! Let's create two handshake

lines, *Bus Request* and *Bus Grant*. The DMA machine will ask for bus control with *Bus Request* and will take control after receiving a signal on *Bus Grant*. As a result, the processor can maintain control of the memory and address buses as long as required.

The kind of DMA I've been discussing is called *burst DMA* because the data transfer is done in a burst during which the DMA machine totally controls the memory and I/O buses. This provides the I/O with the full speed of the memory bus at the expense of completely halting processor activity. If half the memory bus bandwidth were sufficient to solve the high-speed I/O problem, we could use another type of DMA called *cycle-steal DMA*. In the cycle-steal arrangement, the DMA machine alternates control of the buses with the processor, each using every other memory cycle. Cycle-steal DMA allows the processor to operate at 50 percent efficiency while still providing relatively high-speed I/O.

Summary

It would simplify matters greatly if all devices could agree on data representation, format, signal levels, timing, or even the number of wires used for interconnection. Attempts at standardization have been made, but the swift pace of computer technology renders some standards obsolete before they're published. In addition, the need for compromises seems to arise with every new system. Older equipment also needs to be interconnected; otherwise, replacement of a computer would dictate replacement of the entire system.

Fortunately, present technology can reach backward as well as forward. The computer itself can make adaptations, since computers excel at changing one value into another. Furthermore, interface circuitry that links the computer's memory or I/O bus to the I/O of the peripheral device can overcome hardware incompatibility. Next month I'll discuss two basic types of hardware interface presently used in computer systems: the parallel and HPIB (GPIB) interfaces. ■

Whitesmiths, Ltd.
is now shipping Pascal Compilers
for 10 (count 'em ten) different
operating system families:

ISIS-II*

CP/M, CDOS

Idris/B80

RT-11

RSX-11M, RSTS/E, IAS

Idris/R11, UNIX/V6, UNIX/V7

VERSA dos

Idris/S68K

VMS

UNIX/32V*

*Available in source form only.

Idris is a trademark of Whitesmiths, Ltd. ■ UNIX is a trademark of Bell Laboratories ■ CP/M is a trademark of Digital Research ■ RSX-11M, RSTS/E, RT-11, and VMS are trademarks of Digital Equipment Corporation ■ VERSAdos is a trademark of Motorola Inc.

All implementations support the full ISO Pascal (Level 0). All pass the Tasmanian Validation Suite with flying colors. And all are free of those tempting non-standard extensions—because we added the only extension you need.

Separate Compilation.

You can partition your Pascal program into separately maintainable files. You can write library functions to add to the extensive set we give you (about 100 of them). And you can mix in modules written in other languages, like assembler (if you must) or C (to preserve portability).

In fact, C language support comes with every Pascal Compiler we sell.

Our native Pascal Compilers are only \$950, including shipping in the continental U.S. Cross Compilers, for most combinations of host system and target machine, \$1350. Interested? Write or call.

Distributors: **Australia**, Fawnray Pty Ltd., Brighton-Le-Sands 522 5574
Japan, Advance Industries, Chiyoda-ku, Tokyo 03-258-0839
United Kingdom, Real Time Systems, Newcastle upon Tyne 0632 733131

Whitesmiths, Ltd.

P.O. Box 1132 Ansonia Station New York, N.Y. 10023 (212) 799-1200 Telex 645 592

A BASIC Plotting Subroutine

Sophisticated Plotting with Your MX-80

Lawrence J. Bregoli
106 South Longyard Rd.
Southwick, MA 01077

Since the introduction of the MX-80 printer, several articles have described most of its outstanding features, including the remarkable print quality for the price. I'd like to showcase another great feature of this printer: its ability to plot data curves. By combining its features with simple software routines, the MX-80 can emulate sophisticated plotters.

Plotter Criteria

Several features constitute a good plotting routine. First, it should be a subroutine that, when called, plots data generated in the main program and, if needed, returns to the main program with the data unmodified for further processing. Second, the plot routine should be automatically scaling so that the operator of the main program doesn't have to worry about keeping tabs on all the maximum and minimum values sent to the plotting routine. Last but not least, the hard-copy output should have enough resolution to allow in-

About the Author

Lawrence J. Bregoli has a bachelor's degree in electrical engineering and is currently employed as a research engineer working on electrochemical aspects of fuel cell research at UTC in South Windsor, CT.

terpretation of the data. After all, that's why a plot was deemed necessary in the first place.

Once a linefeed is generated, there's no turning back.

The MX-80 printer easily meets these criteria, as evidenced by figure 1. The plot is a straight line of the form $y=mx+b$. Note that the plotting routine provides its own graph paper by inserting horizontal and vertical grid lines; legends for both axes are included. Ah, you say, any print routine could handle a straight line with ease. Figure 2 is a better test of the printer and plotting routine. Here, concentric circles are plotted with radii of 1 and 0.5. Note that the auto-scaling routines in this case must handle both positive and negative values, and that, although the circles are not perfect, they have enough resolution for most plotting applications.

Resolution of these plots is set by the maximum number of data points allowed by the plotting routine. In the plots shown, the number of points

was limited to 101 X,Y pairs. The number of points chosen was based on several criteria. First, the maximum number of print positions that can be set in the horizontal direction is 132. Using 101 of these positions for data plotting leaves 31 positions for printing the Y-axis scale values and the Y-axis title. In the vertical direction, the MX-80 can be set so that every linefeed increment moves the paper up by as little as $\frac{1}{2}$ inch. Therefore, resolution to a single printed dot can be obtained. I chose only 101 points in the vertical direction for several practical reasons. In most cases, this is all the resolution needed to obtain a smooth fit of the data. Most important, though, each data point plotted takes time to print, and the increased printing time is not warranted in most cases.

About the Program

The program for generating the plots, shown in listing 1, was written in Microsoft MBASIC 5. The size of the program can be cut down considerably by removing the REM statements and by combining several program lines into one multiple-statement line. As written, the program doesn't need a main program to gen-

MORROW DESIGNS

Now, Complete 5 1/4" System
5 Mbytes \$2,495

Leading edge technology in hard disk systems.

Complete systems. Morrow Designs hard disk subsystems are delivered complete with hard disk, controller, cabinet, power supply, fan, cables and CP/M^{*} 2.2 operating system.

Widest range. Morrow Designs offers the widest range of hard disk systems available from a single supplier. 5 1/4," 8," 14." Five to over 100 megabytes of formatted hard disk storage. \$2,995 to \$17,980. Cost effective systems that work. And keep working.

S-100 and more. Morrow Designs hard disk systems are designed for use with the CP/M operating system. Available software packages allow our systems to run on any IEEE696/S-100 Standard system with no hardware modification. Plus, Cromemco^{***}, North Star^{**}, Vector Graphics, Godbout, Dynabyte, Exidy^{****}, IMSAI, Micromation, Processor Technology and California Computer Systems.

Reliable systems. Morrow Designs is committed to hard disk system reliability. Not simply with a 90-day warranty, but with a money back guarantee. If our system fails to perform to specification, send it back. We'll send back your money.

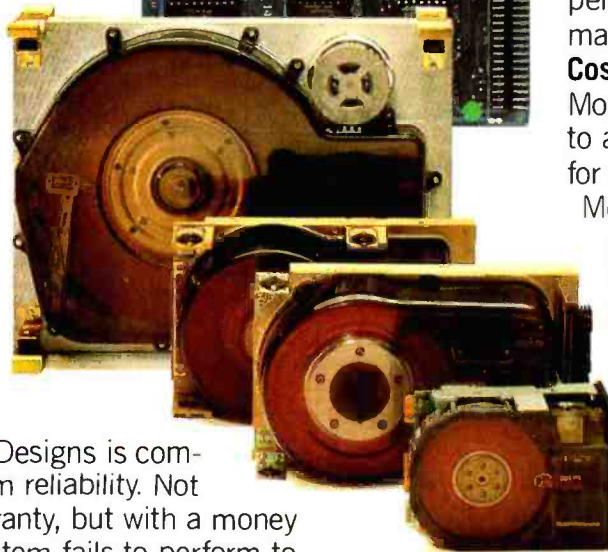
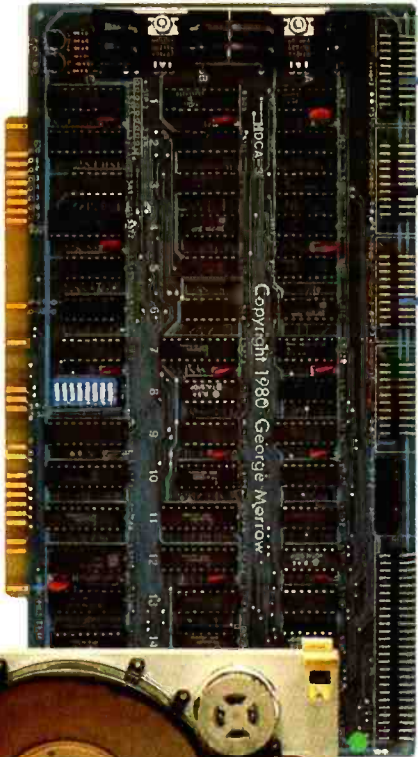

Experience. As of April, 1981, there were over fifteen hundred Morrow Designs hard disk systems successfully installed. In fact, over 200 independent systems integrators now use our hard disks to solve their mass storage problems.

Performance answers. Morrow Designs hard disk systems have been benchmarked against all other systems. None is faster under CP/M. Morrow Designs hard disks operate at 10 times the speed of a floppy disk drive. Transfer rates range from 590,000 bytes to 900,000 bytes per second. That kind of performance can become addictive.

Cost effective answers. Compare Morrow prices and performance to anything presently available for S-100 systems. You'll find Morrow's price/megabyte/performance ratio to be unmatched. Leadership in disk systems technology earned us leadership in price/performance. And that may have earned us a call from you. Circle the Reader Service Number for our full line data sheets. Can't wait? Call us at (415)

524-2101. And yes, OEM quantity prices are available. **LOOK TO MORROW FOR ANSWERS.**

MORROW DESIGNS

5221 Central Avenue, Richmond, CA 94804
(415) 524-2101



Circle 266 on inquiry card.

^{*}CP/M is a trademark of Digital Research.
^{**}Northstar is a trademark of North Star Computers, Inc.
^{***}Cromemco is a trademark of Cromemco, Inc.
^{****}Exidy is a trademark of Exidy Corporation.

STRAIGHT LINE --> $Y=mX+b, b=0$

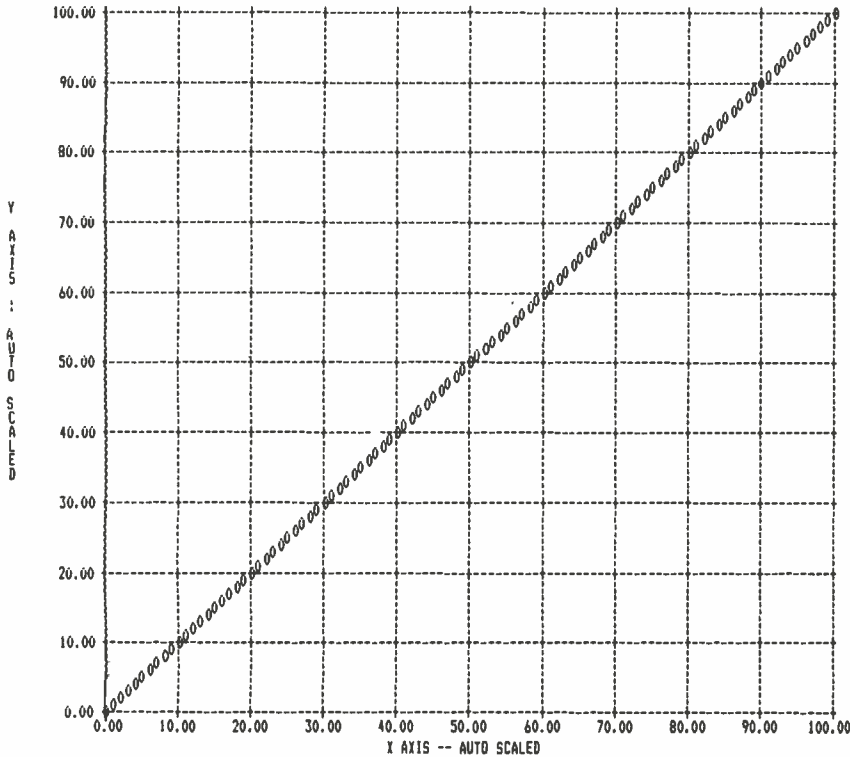

Figure 1: Sample plot of a straight line using auto-scaling ($y = mx + b, b = 0$).

CONCENTRIC CIRCLES-->Radii=1 and 0.5

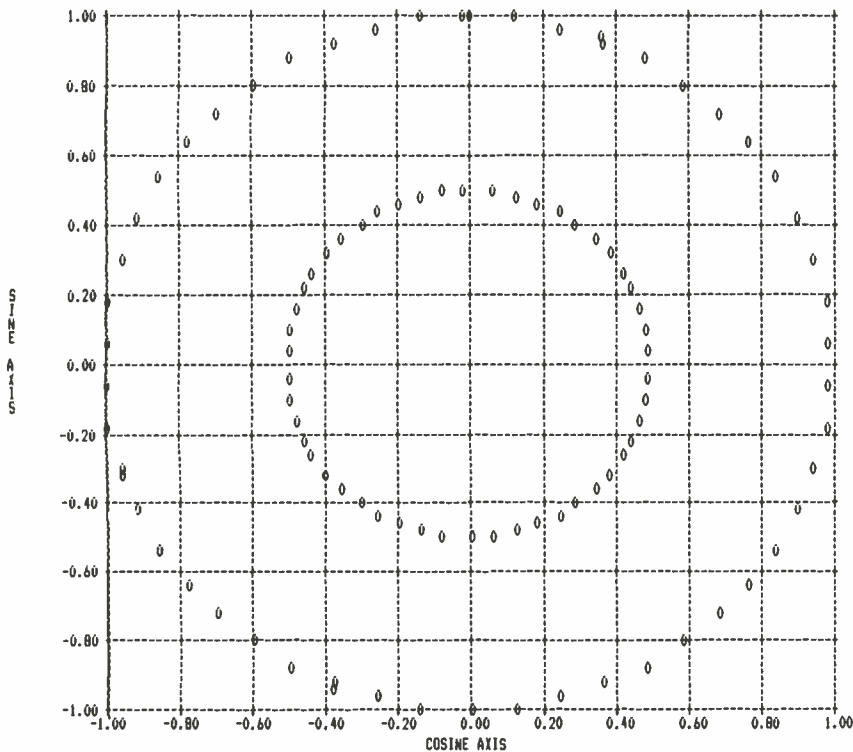

Figure 2: Sample plot of concentric circles using auto-scaling (radii=1 and 0.5).

erate X,Y data sets. It was written this way so that it could be tested immediately for errors using data generated in lines 5120 through 5200. In normal operation, the DIM statement in line 5160 would be in the calling program, and the entry point to the plotting routine would be at line 5250. Line 5670 would also be changed from END to RETURN.

Lines 5250 through 5310 allow the user to enter the graph's title and legends for the X and Y axes. These strings are then centered in 50-character strings so they are printed at the center of the X and Y axes, independent of the title or legend length. Manual or automatic scaling can then be selected by answering the prompt in line 5320.

The main body (lines 5460 to 5670) and its subroutines are where the real plotting action occurs. Most dot-matrix printers print from the top of the page down and do not allow this top-down mode to be reversed. The MX-80 also fits into this category. The resulting limitation forces special handling of the data to be printed so that all the data of a given Y value is printed on a line before the next linefeed occurs. Once a linefeed is generated, there's no turning back to print another data point on the line above it.

In the main body, the first few lines set up the printer for 132 characters per line and $\frac{1}{36}$ inch per linefeed. With these settings, a plot size of somewhat over $5\frac{1}{2}$ inches in both directions is obtained when two linefeeds are performed for each of 101 data positions in the Y direction. Line 5520 performs a very important function in that it converts the line number position presently being pointed to on the plot to a numeric value proportionate to the total span of the data, which is set by the maximum and minimum scale values. (I didn't even understand that!) In other words, consider line number 100 to be at the top of the plot and line number 0 at the bottom; also suppose that $Y_{MAX}=1$ and $Y_{MIN}=-1$ as shown in figure 2. Then, if the present line number were 20 lines down from the top, the value of YN would be:

Systems II Ex a total business system.

JOB COSTING MENU

1. TRANSACTION ENTRY/DATE
2. JOB/TASK TABLE MAINTENANCE
3. JOB COST FILE MAINTENANCE
4. JOB COST REPORTING
5. EMPLOYEE TABLE MAINTENANCE
6. RETURN TO MASTER MENU

SELECT (1-6)?

SYSTEMS II EX MASTER MENU

1. INVENTORY
2. PAYABLES
3. RECEIVABLES
4. PAYROLL
5. LEDGER
6. JOURNAL
7. CHART OF ACCTS.
8. VENDOR MAINT.
9. CUST. MAINT.
10. CHANGE DATE
11. SYS./BACKUP
12. STOP PROCS'S'G.
13. OPTIONAL PROCS'S'G.

SELECT (1-13)?

DATABASE MENU

1. FILE MAINTENANCE
2. REPORTS/REPORT MAINT.
3. UTILITIES
4. RETURN TO SYSTEM MENU

SELECT (1-4)?

ACCOUNTS PAYABLES MENU

1. FILE MAINTENANCE
2. PAYMENT SELECTION
3. PRINT CHECKS AND REGISTER
4. MONTH END
5. RETURN TO MASTER MENU

SELECT (1-5)?

RECEIVABLES SYSTEM MENU

1. FILE MAINTENANCE
2. RECEIPT OF PAYMENTS
3. GENERATE BILLING
4. MONTH END
5. PAST DUE REPORT
6. APPLY MONTHLY INTEREST
7. RETURN TO MASTER MENU

SELECT (1-7)?

LEDGER SYSTEM MENU

1. FILE MAINTENANCE
2. BAL SHEET/INCOME STATEMENT
3. YEAR END PROCESS
4. RETURN TO MASTER MENU

SELECT (1-4)?

INVENTORY SYSTEM MENU

TIME DATE

1. FILE MAINTENANCE
2. POINT OF SALES
3. REORDER REPORT
4. RETURN TO MASTER MENU

SELECT (1-4)?

STATE PAYROLL MENU

1. MISC./TAX TABLE MAINT.
2. TRANSACTION FILE
3. MISC. PAY/DEDUCTION FILE
4. EMPLOYEE MASTER FILE
5. CALCULATE/PRINT CHECKS
6. PRINT W2's
7. RETURN TO MASTER MENU

SELECT (1-7)?

SYSTEMS II EX — EX for EXTENDED PERFORMANCE. Westware brings you the most completely integrated and simplest to use business software for your Apple Computer. The SYSTEMS II EX is complete with an integrated Database. Yes! The DBII Database can move your system's files into Database format for customized reports or labels.

Although the SYSTEMS II EX is a fully integrated system, you may purchase

individual modules and later add additional modules, such as Job Costing for contractors. The power of our system is in the KSAM Firmware card that plugs into the Apple. This card permits high speed searches and eliminates running sort routines to get your files in order.

SYSTEMS II is available on 5 1/4" drives, and also on the Corvus hard disk. A Corvus based system will give you the power and capacity that challenges larger computers.

COMING SOON — Cash flow analysis with graphics, Database II with graphics, and Bill of Materials for small manufacturers.

CURRENT OPTIONS AVAILABLE — Job Costing, Cycle Invoicing, Order entry, and Layaway.

All Checks, statements and invoices use NEBS forms.

Dealer and OEM inquiries invited.

Apple is a trademark of Apple Computers.



2455 S.W. 4th Ave.
Suite 2
Ontario, OR 97914
(503) 881-1477

Circle 411 on inquiry card.



Yes, I would like to sample your software. Please send me the Systems II Demo Package. My check for \$25 is enclosed.

Name _____

Title _____

Company Name _____

Address _____

City _____ State _____ Zip _____

2455 S.W. 4th Ave.
Suite 2
Ontario, OR 97914
(503) 881-1477

www.americanradiohistory.com

```

5000 REM
5010 REM *****
5020 REM *          PLOT PROGRAM FOR MX-80          *
5030 REM *          BY          *
5040 REM *          LAWRENCE J. BREBOLI          *
5050 REM *****
5060 REM
5070 REM *****
5080 REM *          USE THE FOLLOWING SPACE TO CALCULATE A 101 BY 101 *
5090 REM *          DATA ARRAY IN X(I) AND Y(I).          *
5100 REM *          ENTER PROGRAM BELOW THIS SECTION IF ARRAY EXISTS *
5110 REM *****
5120 REM
5130 REM
5140 REM          SAMPLE ARRAY->CONCENTRIC CIRCLES
5150 REM
5160 DIM Y(101),X(101):REM          MOVE DIM TO MAIN PROGRAM
5170 FOR I=0 TO 50
5175 X(I)=SIN(I*6.282/50):Y(I)=COS(I*6.282/50)
5180 NEXT I
5185 FOR I=51 TO 100
5186 J=I-50
5187 X(I)=.5*SIN(J*6.282/50):Y(I)=.5*COS(J*6.282/50)
5190 NEXT I
5200 REM
5210 REM *****
5220 REM *          ENTER TITLE OF PLOT AND AXIS LEGENDS          *
5230 REM *****
5240 REM
5250 XTITLE=SPACE$(50):YTITLE=SPACE$(50):PTITLE=SPACE$(50)
5260 LINE INPUT "ENTER TITLE OF PLOT (50 CHARACTERS OR LESS) ";T$
5270 LINE INPUT "ENTER Y AXIS TITLE (50 CHARACTERS OR LESS) ";Y$
5280 LINE INPUT "ENTER X AXIS TITLE (50 CHARACTERS OR LESS) ";X$
5290 MID$(YTITLE$, (LEN(YTITLE$)-LEN(Y$))/2)=Y$
5300 MID$(XTITLE$, (LEN(XTITLE$)-LEN(X$))/2)=X$
5310 MID$(PTITLE$, (LEN(PTITLE$)-LEN(T$))/2)=T$
5320 INPUT "DO YOU WANT (A)UTO OR (M)ANUAL SCALING ";Y$
5330 IF Y$="M" THEN 5360
5340 IF Y$="A" THEN GOSUB 6550 ELSE 5320
5350 GOTO 5460
5360 INPUT "ENTER MAXIMUM VALUE OF Y AXIS";YMAX
5370 INPUT "ENTER MINIMUM VALUE OF Y AXIS";YMIN
5380 INPUT "ENTER MAXIMUM VALUE OF X AXIS";XMAX
5390 INPUT "ENTER MINIMUM VALUE OF X AXIS";XMIN
5400 REM
5410 REM *****
5420 REM *          MAIN BODY OF PROGRAM STARTS HERE          *
5430 REM *****
5440 REM
5450 REM
5460 LPRINT:LPRINT:LPRINT TAB(15);PTITLE$:REM          PRINT TITLE OF PLOT
5470 LPRINT:LPRINT
5480 GOSUB 5810:REM          SET COMPRESSED CHAR MODE
5490 LSPACE=2:GOSUB 5780:REM          SET LINE SPACING
5500 RSTOP=20:CHAR$="!":GOSUB 5850:REM          FORCE CARRIAGE LEFT
5510 FOR LNND=100 TO 0 STEP -1
5520 YN=YMAX-((YMAX-YMIN)/100)*(100-LNND):REM          NORMALIZED Y VALUE
5530 YD=ABS((YMAX-YMIN)/100):REM          VALUE OF EACH LINE
5540 GOSUB 6250:REM          PRINT VERTICAL TITLE
5550 IF LNND/2-FIX(LNND/2)=0 THEN GOSUB 5910:REM          PLOT VERTICAL LINES
5560 GOSUB 6020:REM          PLOT DATA
5570 GOSUB 6140:REM          PRINT HORIZONTAL LINE
5580 LPRINT
5590 RSTOP=20:CHAR$="!":GOSUB 5850:REM          FORCE CARRIAGE LEFT
5600 LPRINT
5610 NEXT LNND
5620 GOSUB 6350:REM          PRINT X SCALE
5630 GOSUB 6460:REM          PRINT X AXIS TITLE
5640 LSPACE=12:GOSUB 5780:REM          SET NORMAL LINE SPACING
5650 GOSUB 5830:REM          SET NORMAL CHAR WIDTH
5660 FOR I=1 TO 23:LPRINT:NEXT I:REM          TOP OF NEXT FORM
5670 END
5680 REM
5690 REM *****
5700 REM *          END OF MAIN BODY-SUBROUTINES START HERE          *
5710 REM *****
5720 REM
5730 REM
5740 REM *****
5750 REM *          PRINTER CONTROL SUBRDUTINES          *
5760 REM *****
5770 REM
5780 LPRINT CHR$(27)"A"CHR$(LSPACE)CHR$(27)"2":REM          EDIT WITH GRAFTRAX OPTION
5790 RETURN:REM          SET LINE SPACING
5800 REM
5810 LPRINT CHR$(15):RETURN:REM          SET COMPRESSED MODE
5820 REM
5830 LPRINT CHR$(18):RETURN:REM          SET NORMAL MODE
5840 REM
5850 LPRINT SPC(RSTOP);CHAR$;:RETURN:REM          PRINT CHAR AT RSTOP
5860 REM
5870 REM *****
5880 REM *          PLOT VERTICLE LINE SUBROUTINE          *
5890 REM *****
5900 REM
5910 CHAR$="!":RSTOP=20:LPRINT CHR$(13);:GOSUB 5850
5920 RSTOP=9
5930 FOR I=1 TO 10

```

$$\begin{aligned}
 YN &= 1 - (((1 - (-1)) / 100) \\
 &\quad \times (100 - 80)) \\
 &= 0.6
 \end{aligned}$$

This value is subsequently tested against the data in the PLOT DATA subroutine. If a match with any data in the Y array occurs, a point is plotted at the proper X position as determined by the value in the corresponding X array.

The overall action performed on any given line can be summed up as follows:

1. The value of YN is calculated.
2. A character in the Y-axis title is printed.
3. The vertical grid line segments are printed.
4. The data is plotted for that line, if any.
5. If a horizontal line is called for, it's printed along with the scale.
6. The cycle is repeated for the next line down.

A special precaution must be taken to ensure exact horizontal indexing on printers like the MX-80, as they use bidirectional printing. Because the print head doesn't physically return to the left-hand stop each time a new line is printed, a slight but distracting misalignment occurs in the vertical grid lines. To overcome this, lines 5500 and 5590 were inserted to force the print head to the left prior to each new line printed. If you take a close look at the left-hand vertical grid lines in figures 1 and 2, you can see this slight misalignment. If your particular printer is perfectly aligned or if you can put up with a slight misalignment error, then remove these line numbers. Removal of these lines will save a lot of time in actually plotting the data.

While I'm on the subject of time, it takes about eight minutes to complete a plot using the program shown in listing 1. This may seem a bit long to some users, but consider plotting 101 X,Y points by hand from a table of data. I'd rather sip my coffee and watch the MX-80 go about that agony. Later, I'll discuss a way to take about two minutes off this time.

Another program statement which

Listing 1 continued on page 148

MICRO



BUSINESS WORLD INC.
Information Line (213) 996-2252
TOLL FREE MAIL ORDER LINES
(800) 423-5886 Outside Calif



OUR PRICE **\$1995.00** *Special Of The Month*

MSL 3250.00
Save
1255.00

The HP85
We Turn Problems Into Solutions

HP DISC DRIVE
Single Master Model 82902M
Our Price **\$1099.00** *Save* 401.00

Dual Master Model 82901M
\$1849.00
MSL \$1500.00 *Save* 651.00
MSL \$2500.00 *Save*

SHARP BUSINESS COMPUTER 64K SYSTEM

- 5.25" diskette
- 284K byte per disk drive
- 2 disk drives per unit
- Expandable up to 4 units
- Including SHARP's FDOS (Floppy Disk Operating System)

MSL 5995.00
OUR PRICE **\$3995.00** *Save* \$2000.00

NEC STUDENT SYSTEM 64K

*NEC PC 8001 A Computer
*NEC PC 8012 A Expansion
*NEC PC 8031 A Dual Drive
12" Grn. Phs. Video Monitor

MSL 3565.00
OUR PRICE **\$2395.00** *Save* \$1170.00

XEROX 820 WORD PROCESSING SYSTEM (INCLUDES SOFTWARE)

MSL 3495.00
OUR PRICE **\$2649.00** *Save* 846.00

Commodore COLOR COMPUTER VIC-20

MSL 299.00
OUR PRICE **\$255.00** *Save* 44.00

Vic-TV Modual \$19.00
Vic Cassette \$69.00
Vic Disk Drive \$ Call
Vic 6 Pack program \$44.00

HEWLETT PACKARD

List	Our Price
HP-125 Microcomputer	3750.00 2750.00
HP-85 Microcomputer	3250.00 2475.00
HP-83 Microcomputer	2250.00 1777.00
16K Exp-Memory Module	295.00 255.00
Graphics Plotter 7225	2450.00 2075.00
Personality Mod. For 7225	750.00 665.00
2631B Impact/Printer/Hvy Dty	3950.00 3250.00
Option 020 For 2631B	150.00 125.00
8 Drives to Choose from 82902S	1300.00 1125.00
8985A 8" Dual Drive	6850.00 5500.00
Graphics Tablet 9111A	2050.00 1678.00
HP-11C Slim-Line Advanced	135.00 119.00
HP-12C Slim-Line Financial	150.00 129.00
HP 41 CV New 2.2 Bytes Mem	325.00 250.00
HP 41 C Calculator	250.00 185.00
Card Reader For 41CVC	215.00 162.00
Printer For 41CVC	385.00 289.00
Optical Wand For 41 CVC	125.00 97.00
Quad Ram Equals 4 Mem. Mods	95.00 81.00
Memory Modules For 41C	750.00 595.00
HP-97 Programmable Printer	375.00 295.00
HP-67 Programmable Calculator	150.00 117.00
HP-34C Programmable Scientific	150.00 117.00
HP-38C Programmable Bus. R/E	150.00 117.00
HP-37E Adv. Scientific	55.00 48.00
HP-37E Business Mgmt.	75.00 57.00

PRINTERS

EPSON

List	Our Price
MX 80 FT	\$ 745.00 \$ 549.00
MX 80 IMPACT	645.00 450.00
MX 70 IMPACT	500.00 390.00
MX 100	995.00 749.00

ANADIX 9501

List	Our Price
5510	3195.00 2445.00
5515	3295.00 2545.00
3510	2495.00 1795.00
3515	2545.00 1849.00

OKIDATA

List	Our Price
MICROLINE 80	545.00 395.00
MICROLINE 82	649.00 548.00
MICROLINE 83	1050.00 769.00

PAPER TIGER

List	Our Price
445G with Graphics	795.00 695.00
460G with Graphics	1,394.00 995.00
590G New full size	1,695.00 1,139.00

DIABLO (LETTER QUALITY)

List	Our Price
630 R102 bi-directional Tractors	2,965.00 2,450.00
1640K1109 keyboard Tractors	4,000.00 2,899.00
630 RO Receive Only 1650K 136 keyboard Tractors	2,710.00 2,250.00
	4,000.00 3,100.00

TERMINALS TELEVIDEO

List	Our Price
910	\$ 699.00 \$ 599.00
912C	950.00 699.00
920C	995.00 795.00
950C	1,195.00 949.00

DISKETTES SOLD IN BOXES OF 10 (Min. Purchase) \$100

List	Our Price
DYLAN 1041 5" SOFT SECTOR 1041ID = " DBL. DEN. SOFT SEC.	6.00 3.99
3740/I 8" SOFT SECTOR 3740/ID 8" DBL DEN. SOFT SECTOR	6.40 4.60
3740/ID 8" DBL DEN. SOFT SECTOR	7.25 4.75
MAXELL MD-1 5" SOFT SEC. TOR/DBL DEN.	10.75 6.90
MD-2 SOFT SECTOR/DBL. SIDE/DBL. DEN.	5.00 3.50
FD-1 8" SOFT SEC./DBL. DEN.	7.00 4.90
FD-1 8" SOFT SEC./DBL. SIDE/DBL. DEN.	6.50 4.50
	8.50 5.95

SOFTWARE FOR COMMODORE

List	Our Price
Diz-The Information Wizard	395.00 289.00
Wordcraft 80	395.00 289.00
Ima-info Retrieval & Mgmt. Aid	495.00 389.00
Dow Jones Portfolio Mgmt.	149.00 119.00
Pascal Development Pkg	295.00 219.00
Ebs-Receipts, Inventory	750.00 569.00
Bpl-General Ledger	395.00 389.00
Word Pro 3-40 Column	250.00 175.00
Word Pro 4-80 Column	375.00 259.00
Word Pro 4 Plus	450.00 319.00

MODEMS

List	Our Price
NOVATION CAT MODEM	189.95 140.00
NOVATION D CAT	199.00 150.00
NOVATION APPLE-CAT	389.00 329.00
HAYES MICROMODEM	379.00 295.00
HAYES SMARTMODEM	279.00 239.00

Commodore

List	Our Price
8032-32K 80 Col Crt	1495.00 1097.00
4032-32K 40 Col Crt	1295.00 989.00
4016-16K 40 Col Crt	995.00 788.00
8050-Dual Disk 950K	1795.00 1344.00
4040-Dual Disk 343K	1295.00 989.00
C2N Cassette Drive	95.00 77.00
4022-80 Col Printer	795.00 639.00
8024-Mannsmann Talley	1995.00 1545.00
25CPS-Starwriter	1895.00 1399.00
CBM-IEEE Modem	279.00 225.00
Voice Synthesizer	395.00 325.00
VIC 20	299.00 255.00
PET to IEEE Cable	39.95 34.00
IEEE to IEEE Cable	49.95 39.00

MONITORS

List	Our Price
BMC 12" Grn. Phs HQ (15 Hz)	219.00 165.00
12" Grn. Phs EQ (18 Hz)	\$249.00 185.00
12" Grn Phs (20 Hz)	279.00 209.00
12" Colour Composite Hi Res. Grn. Phs 12"	439.00 319.00
NEC Grn. Phs. 12"	225.00 179.00
Zenith 12"	159.00 119.00

DRIVES

List	Our Price
CORVUS 5 MBYTES	3,750.00 3,050.00
10 MBYTES	5,350.00 4,449.00
20 MBYTES	6,450.00 5,325.00

EXPANSION BOARD Q STAR 16K RAM BOARD

LIST 199.00 OUR PRICE 129.00

CALCULATORS

List	Our Price
CASIO HR-10 Paper Feed	49.95 39.00
HR-12 Paper Feed	54.95 42.00
FR-100 Paper Feed	79.95 59.00
FR-1210 Paper Feed	129.95 99.00
PO-20	29.95 23.00
LC-785	12.95 10.00
LC-3165	12.95 10.00
Fx 68 Scientific	29.95 23.00
Fx 81 Scientific	19.95 17.00
Fx-3600P Scientific	39.95 29.95
Fx-602P "Computer Talk" 88 Memories Pro gramming Upper & Lower Case Dot Matrix 512 Step	129.95 99.00
Fx-702P Solves Problems with Alpha-Numeric Clarity, uses Basic Language	199.95 159.00

XEROX

List	Our Price
Xerox 820-1 5-1/4" Disk	2995.00 2399.00
Xerox 820-2 8" Disk	3795.00 2995.00
CP/M Operating System	200.00 169.00
Word Processing Software	500.00 429.00
Super Calc	295.00 249.00

LE MONITOR

- 9" B & W 179.00 159.00
- 9" Green Phs 189.00 165.00
- 12" B & W 209.00 185.00
- 12" Green Phs. 229.00 199.00
- 12" Green Phs. 199.00 159.00
- Anti Reflective Screen
- T.V. Grade Screen

SANYO MONITORS

List	Our Price
13" Color (new) High quality	\$550.00 399.00
12" Green Phs.	360.00 269.00
12" B & W	340.00 239.00
15" B & W	370.00 255.00
9" B & W The Best Seller!	235.00 159.00
9" Green Phs.	275.00 199.00

SOFTWARE FOR APPLE II

List	Our Price
Language System with Apple Pascal	495.00 399.00
BPI General Ledger System	395.00 319.00
Visidex	200.00 159.00
Visicalc	200.00 159.00
Desktop Plan II	200.00 159.00
Microlab Database System	150.00 119.00
Stoneware DB Master	229.00 189.00
Muse Superflex II	150.00 119.00
Solshape Magic Window	99.00 72.00

TELE. ANSW. DEVICES

List	Our Price
PHONE MATE	119.95 86.00
900 Economy	395.00 319.00
905 Remote Dual Tape Sys.	199.95 144.00
910 60 Calls Per Side	159.95 115.00
920 C Fax	199.95 144.00
925 Remote Call Monitor	239.95 173.00
950 Remote Twin Cass.	299.95 216.00
950 Remote Built In Tele Microcomputer Controlled	339.95 245.00
	399.95 288.00

TEXAS INSTRUMENTS

List	Our Price
TI 9914A Console New Improved	950.00 369.00
399.95	339.95
32K Memory Module	399.95 312.95
Speech Synthesizer	149.95 127.95
Disk Memory Drive	499.95 390.95
RF Modulator	49.95 42.50
Telephone Coupler (Modem)	224.95 185.95
Printer (Solid State)	399.95 315.95

1 Year Extended WARRANTY \$99.00

INQUIRE

AVINGS SERVICE ELECTION ATISFACTION

MICRO BUSINESS WORLD WAREHOUSE MAIL ORDER
18720 Oxnard, #108 Torrance, CA 91335
Telex: 182852 Answer: MICKO TZNA

*California residents add 6% sales tax.
** Add 3% Shipping & Handling - Add 3% surcharge for credit cards. Orders cannot be shipped unless accompanied by payment, including shipping, handling and tax where applicable.

Name (Please print) _____
Address _____
City _____ State _____ Zip _____

Qty	Make	Model	Description	Price	Total

TOTAL ORDER \$ _____
TAX IF APPLICABLE * _____
SHIPPING & HANDLING ** _____
TOTAL ENCLOSED \$ _____

Certified Check or M.O. Allow 2 weeks clearance for personal check VISA MasterCard

Bank Wire Transfer

CREDIT CARD # _____ Signature _____
Exp Date _____

INDUCTIVE COUPLED MODEM

Eliminates noise, vibration problems. Originate/Answer. Bell 103. Cassette port saves data.



Money back if not delighted

\$129⁹⁵

MFJ-1230 INDUCTIVE COUPLED MODEM eliminates room noise, vibration caused by acoustic coupling. Gives more reliable data transfer. Used like acoustic modem. 0-300 Baud, Bell 103 compatible. Originate/Answer. Half/Full duplex. RS-232, TTL, CMOS compatible. Use any computer. Cassette tape ports save data. 110VAC or 9V batteries. Crystal controlled. Carrier detect, power LEDs. 9x1 1/2x4". MFJ-1231, \$39.95. Optional cable, software for Apple II, II Plus. Plugs into game port. No serial board needed.

\$99⁹⁵ MFJ-1108, AC POWER CENTER. Adds convenience, prevents data loss, head bounce, equipment

damage. Relay latches power off during power transients. Multi filters isolate equipment, eliminate interaction, noise, hash. Varistors suppress spikes. 3 isolated switched socket pairs. 1 unswitched for clock, etc. Lighted power, reset switch. Pop-out fuse. 3 wire 6 ft. cord. 15A/125VAC, 1875 watts. Aluminum case. Black. 18x2 3/4x2". MFJ-1107, \$79.95. Like 1108 less relay. 8 sockets, 2 unswitched. Other models available.



\$79⁹⁵

MFJ-1240 RS-232 TRANSFER SWITCH. Switches computer between 2 peripherals (printer, terminal, modem, etc.). Like having extra port. Pushbutton switches 10 lines (pins 2,3,4,5,6,8,11,15,17,20). Change plug or cable to substitute other lines. Pushbutton reverses transmit - receive lines. LEDs monitor pins 2,3,4,5,6,8,20. PC board eliminates wiring, crosstalk, line interference. 3 RS-232 25 pin connectors. 7x2x6 inches.

Order from MFJ and try it. If not delighted, return within 30 days for refund (less shipping). One year unconditional guarantee.

Order yours today. Call toll free 800-647-1800. Charge VISA, MC. Or mail check, money order. Add \$4.00 each for shipping and handling.

CALL TOLL FREE . . . 800-647-1800

Call 601-323-5869 for technical information, order/repair status. Also call 601-323-5869 outside continental USA and in Mississippi.

MFJ ENTERPRISES, INCORPORATED

921 Louisville Road, Starkville, MS 39759

Listing 1 continued:

```

5940 GOSUB 5850
5950 NEXT I
5960 RETURN
5970 REM
5980 REM *****
5990 REM * PLOT DATA SUBROUTINE *
6000 REM *****
6010 REM
6020 CHAR$="0"
6030 FOR I=0 TO 100
6040 IF (Y(I))>YN+.50001*YD OR (Y(I))<YN-.50001*YD THEN 6080
6050 XP=FIX((X(I)-XMIN)*100/(XMAX-XMIN))
6060 IF XP<0 OR XP>100 THEN 6080
6070 LPRINT CHR$(13);RSTOP=XP+20:GOSUB 5850
6080 NEXT I:RETURN
6090 REM
6100 REM *****
6110 REM * PLOT Y SCALE AND HORIZONTAL LINE SUBROUTINE *
6120 REM *****
6130 REM
6140 IF LNND/10-FIX(LNND/10)<>0 THEN RETURN
6150 LPRINT CHR$(13);RSTOP=10:CHAR$="":GOSUB 5850
6160 LPRINT USING "#####.##";(YMAX-YMIN)*LNND/100+YMIN;
6170 LPRINT CHR$(13);RSTOP=20:CHAR$="-":GOSUB 5850
6180 LPRINT STRING$(100,"-");
6190 RETURN
6200 REM
6210 REM *****
6220 REM * PRINT Y AXIS TITLE *
6230 REM *****
6240 REM
6250 IF LNND/2-FIX(LNND/2)<>0 THEN RETURN
6260 LPRINT CHR$(13);RSTOP=7
6270 CHAR$=MID$(YTITL$,FIX(((100-LNND)/2)+1),1)
6280 GOSUB 5850
6290 RETURN
6300 REM
6310 REM *****
6320 REM * PRINT X SCALE SUBROUTINE *
6330 REM *****
6340 REM
6350 LPRINT:LPRINT
6360 RSTOP=13:CHAR$="":GOSUB 5850
6370 FOR I=0 TO 10
6380 LPRINT USING "#####.##";(XMAX-XMIN)*I/10+XMIN;
6390 NEXT I
6400 RETURN
6410 REM
6420 REM *****
6430 REM * PRINT X AXIS TITLE *
6440 REM *****
6450 REM
6460 LPRINT:LPRINT:LPRINT
6470 LPRINT:LPRINT:LPRINT
6480 RSTOP=45:CHAR$=XTITL$:GOSUB 5850
6490 RETURN
6500 REM
6510 REM *****
6520 REM * AUTO SCALING SUBROUTINES *
6530 REM *****
6540 REM
6550 YMAX=Y(0);XMAX=X(0);YMIN=Y(0);XMIN=X(0)
6560 FOR I=1 TO 100:REM
6570 IF Y(I)>YMAX THEN YMAX=Y(I)
6580 IF Y(I)<YMIN THEN YMIN=Y(I)
6590 IF X(I)>XMAX THEN XMAX=X(I)
6600 IF X(I)<XMIN THEN XMIN=X(I)
6610 NEXT I
6620 RESTORE 6830:REM-----
6630 MSD=(YMAX-YMIN)/10:REM
6640 FOR I=-2 TO 4
6650 FOR K=1 TO 3:READ J
6660 IF MSD<=J*10^(I) THEN MSD=J*10^(I):GOTO 6680
6670 NEXT K:RESTORE 6830:NEXT I
6680 FOR I=10 TO -10 STEP -1
6690 IF (YMAX<=I*MSD)*(YMAX>I*MSD-.99999*MSD) THEN YMAX=I*MSD
6700 NEXT I
6710 YMIN=YMAX-10*MSD
6720 RESTORE 6830:REM-----
6730 MSD=(XMAX-XMIN)/10:REM
6740 FOR I=-2 TO 4
6750 FOR K=1 TO 3:READ J
6760 IF MSD<=J*10^(I) THEN MSD=J*10^(I):GOTO 6780
6770 NEXT K:RESTORE 6830:NEXT I
6780 FOR I=10 TO -10 STEP -1
6790 IF (XMAX<=I*MSD)*(XMAX>I*MSD-.99999*MSD) THEN XMAX=I*MSD
6800 NEXT I
6810 XMIN=XMAX-10*MSD
6820 RETURN
6830 DATA 1,2,5
6840 REM
6850 REM *****
6860 REM * LIST OF VARIABLE NAMES USED IN PROGRAM *
6870 REM *****
6880 REM
6890 REM Y(I) Y AXIS DATA ARRAY
6900 REM X(I) X AXIS DATA ARRAY
6910 REM YMAX MAXIMUM VALUE OF Y AXIS
6920 REM YMIN MINIMUM " " " "
    
```

Listing 1 continued on page 150

Best prices anywhere. We beat 'em all!

COMPUTERS

INTERSYSTEMS



DPS1, DPS1A, DPS2A CALL FOR PRICES

DYNABYTE List Less 30%

ALTOS List Less 20%

NORTHSTAR

Horizons & Advantages CALL

TELEVIDEO COMPUTER SYSTEMS CALL

SUPERBRAIN

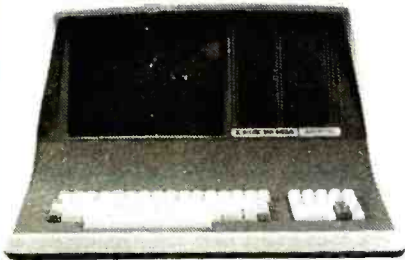

64K DD. \$2639
64K QD. \$2949
DSS-10MEG Hard Disk. \$3195

CROMEMCO

CS-1 List \$3495. OUR PRICE **\$3195**

CS-2 List \$4695. OUR PRICE **\$3549**

CS-3 List \$7995. OUR PRICE **\$6349**

Z2H List \$9995. OUR PRICE **\$7995**

ZENITH

data systems



Z-89 List \$2895
OUR PRICE \$2099

TERMINALS

TeleVideo



Televideo 910C. CALL
912C. CALL
920C. CALL
925C. CALL
950C. CALL

INTERTUBE. \$725
Emulator. \$725

OKIDATA

Microline 80 \$359
Microline 82A \$469
Microline 83A \$749

C.ITOH CALL FOR PRICES

SOROC

Soroc IQ120. \$679
IQ130. \$585
IQ135. \$719
IQ135 w graphics \$789
IQ140. \$995

HAZELTINE

1420. CALL
1500. SAVE
1510. CALL

ZENITH Z19 \$639

Prices quoted are for prepaid orders only, and reflect a cash discount. C.O.D.'s and chatge cards slightly higher.

Most items in stock for immediate delivery. factory sealed cartons w full factory warranty. NYS residents add appropriate sales tax. Prices do not include shipping. C.O.D. orders require 25% deposit. Prices subject to change without notice.

PRINTERS

CENTRONICS



749-1 PAR. \$699
739-3 SER. \$619
704-11 parallel. \$1569
704-9 (RS232). \$1519

TI 810

810 Basic. \$1289
810 Full Option. \$1599
820 RO Basic. \$1545
820 KSR Basic. \$1739

NEC 7710 (RS232) SERIAL \$2395
7730 PARALLEL \$2395

Qume CALL FOR PRICE

Diablo 630 RO \$2049
1640 KSR. \$3495
1640 RO. \$3095

Paper Tiger 445G \$739
460. \$799
460G. \$839
560G. \$1099

Epson

MX-80 \$465
MX-80FT \$548
MX 100 \$745

DISK SYSTEMS

MORROW

Discus 2D \$835
Dual Discus 2D \$1385
Discuss 2 + 2 \$1089
M 5 5meg Hard Disk \$3750
M 10 10 meg Hard Disk \$2999
M26 26 meg Hard Disk \$3349

CORVUS 5 meg Hard Disk \$3109
CORVUS 10 meg Hard Disk \$4439
CORVUS 20 meg Hard Disk \$5349

COMPUTERS WHOLESAL

P.O. Box 144 Camillus, N.Y. 13031

315-472-2582

Prices subject to change without notice

Listing 1 continued:

```

6930 REM XMAX      MAXIMUM VALUE OF X AXIS
6940 REM XMIN      MINIMUM " " " "
6950 REM LNND      Y AXIS LINE NUMBER
6960 REM RSTOP     CHARACTER TAB STOP
6970 REM LSPACE    SIZE OF LINEFEED AT PRINTER
6980 REM YN        NORMALIZED Y AXIS VALUE
6990 REM YD        DELTA VALUE FOR EACH Y AXIS LINE
7000 REM XP        CHARACTER POSITION ON X AXIS
7010 REM MSD       MINIMUM SCALE DELTA
7020 REM J         SCALE DELTA
7030 REM K         INDEX COUNTER
7040 REM I         INDEX COUNTER
7050 REM T$        PLOT TITLE
7060 REM PTITLE$   PLOT TITLE CENTERED IN 50 SPACES
7070 REM Y$        Y AXIS TITLE
7080 REM YTITLE$   Y AXIS TITLE CENTERED IN 50 SPACES
7090 REM X$        X AXIS TITLE
7100 REM XTITLE$   X AXIS TITLE CENTERED IN 50 SPACES
7110 REM CHAR$     STRING PRINTED AT RSTOP
7120 REM

```

may be difficult to interpret occurs in the PLOT DATA subroutine. Line 6040 compares a data value in the Y array with the value of YN discussed above. If the value in the Y array equals YN plus or minus 51 percent of the value between lines, it's printed on the plot at an X position determined by the corresponding value in the X array. This value (XP) is calculated in line 6050. The PLOT DATA subroutine checks every data value in the Y array each time the subroutine is called to make sure that

all data corresponding to YN is plotted before a new value of YN is calculated and a new linefeed occurs.

Automatic Scaling

The type of automatic scaling used in a plot program can be one of the most critical factors in determining usefulness of the resulting plot. I've run programs containing auto-scaling features that actually make the resulting plot worthless. These programs seem to be written so that the highest data point falls on the top line and the

lowest falls on the bottom line—without any consideration of the intermediate scale values. This type of scaling is the easiest to implement but makes data interpretation extremely difficult. One of the problems in developing auto-scaling routines involves individual preference regarding the scales selected. Some people may prefer the type of scaling mentioned above, some may choose scale deltas that vary in the 1-2-5 sequence which many analog plotters have adopted, and others may accept any sequence as long as it has integer values. Because of this, I've written auto-scaling routines in which you can tailor the scaling sequence simply by inserting a new DATA statement with user-selected values.

The auto-scaling subroutines start at line 6550. The extreme values in both the X and Y arrays are determined in lines 6550 through 6610; then the X and Y scales are determined. Determination of the scales starts by restoring the DATA statement in 6830. Then the minimum scale delta

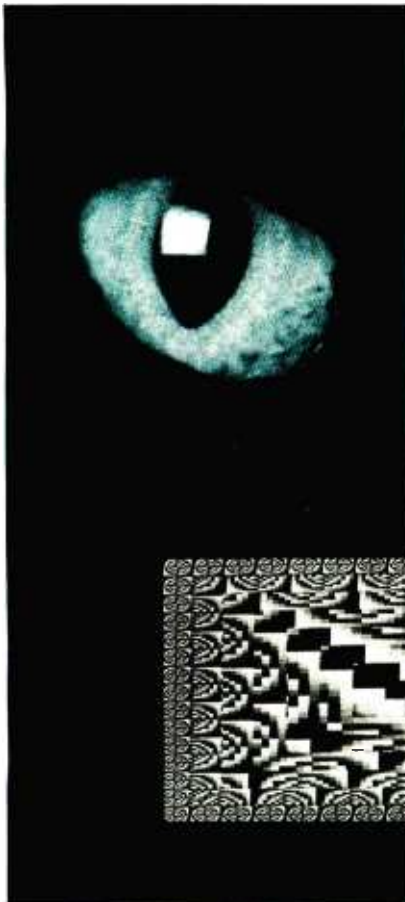

THE CAT'S-EYE VIEW

Get a lion's share of graphic capabilities at a price that will make you purr.

CAT digital graphic systems interface with S-100, PDP-11, LSI-11 and other host computers to create incredibly detailed images. Look at the features that a CAT can deliver:

- **Flash digitizer** to grab your image from camera, broadcast or recording in as little as 1/60 of a second.
- **Highest possible resolution**—up to 484x512x8, 242x512x16 or 242x256x24.
- **Dynamic color mapping** to produce animation and other effects.
 - **Maximum color palette** of 16.7 million hues, with displays of 65,536 simultaneous colors or 256 levels of gray.
 - **Light-pen input** and other useful options.
 - **Flexibility** to fit your computer imaging needs within the CAT-100 through CAT-800 and CBX series. Call us for a CAT that suits your application . . . and your budget.

 **DIGITAL GRAPHIC SYSTEMS, INC.**

935 Industrial Avenue, Palo Alto, CA 94303
Call (415) 856-2500

©1981 by J. Pines.

IBM COMPATIBLE BOARDS

BY **ZOBEX**

256 K MEMORY WITH PARITY
\$ 998

HARD DISC SUBSYSTEM FOR
IBM AND S-100 \$ 2495

HA62 IBM BUS HARD DISK INTERFACE FOR WD-1000
4SP 4 SERIAL PORTS FOR IBM
PB PROTOTYPING BOARD FOR IBM
EB EXTENDER BOARD FOR IBM

S-100 BOARDS

ZOBEX CPU
Z-80A CPU WITH 4 SERIAL AND 3 PARALLEL PORTS

ZOBEX DDFDC
DOUBLE DENSITY DISK CONTROLLER

ZMS-100
64K RAM

HDCI
S-100 HARD DISK INTERFACE FOR WD-1000

ZOBEX

7343 J. RONSON RD.
SAN DIEGO, CA. 92111
(714) 571-6971

ZOBEX is trademark of ZOBEX CORPORATION
IBM is trademark of International Business Machines Corporation

The New Idea Computer from TeleVideo® Systems.



Two great single-user computers that can grow for multi-user applications when you need it.

We're bursting with new ideas when it comes to small business computers and peripherals designed to give you much more value for your money. That's why we've zoomed to our No. 1 position among independent suppliers of CRT terminals. We make it our business to get new ideas to market first. So, meet our latest new idea. The Model TS 802.

The new TS 802 has been designed with upgradeability and growth in mind. You can start out with a Model TS 802, using it as a powerful, single-user work station with a full data processing and word processing capability. Then, as your computer needs expand, you can add our TS 806 or TS 816 multi-user hard disk system to build a versatile multi-station mass storage computer for up to 16 users and 70 Mbytes of on-line storage.

The TeleVideo TS 802 computer. It can grow as your needs grow. That's computer power with no restrictions or hassles. Now, that's *a real new idea!*

New Technology Galore

Looking at the hardware, our new idea TS 802 Series comes in two different versions. The TS 802 features two 5¼-inch floppy disks for 1 Mbyte of on-line storage, a Z80A micro-processor, 64K or RAM memory, and a 4K EPROM for diagnostics. The TS 802H computer has one 5¼-inch Winchester disk drive with 10 Mbytes of on-line storage, and a single 500 Kbyte minifloppy disk unit. Both versions come in an attractive, low-profile desktop enclosure that can enhance any modern office decor.

Nationwide Service:

All computers are backed and serviced by General Electric's Instrumentation and Communication Equipment Service Centers.

Circle 381 on inquiry card.

Worth Looking Into

Both versions of the TS 802 computer offer an easy-to-read green phosphor CRT display with an exclusive patented character resolution that spells goodbye to eyestrain. The telescreen gives you advanced editing with wraparound, smooth scrolling, special graphics characters, and versatile screen attributes. And the detachable keyboard can be placed conveniently anywhere you want it.

Just the Software You Want

In its stand-alone mode, our new TS 802 Series uses the *CP/M® operating system. In the multi-user mode, each TS 802 satellite user station runs CP/M under TeleVideo's unique ‡MmmOST™ Service processing system that provides scheduling, file/record locking, and data base access control formerly only possible with much more expensive and sophisticated multi-user operating systems.

The Price is Right, Too!

Our *new idea* Model TS 802 computer is priced at just \$3495. And the Model TS 802H is only \$6995. These two revolutionaries can deliver *new idea* features you might have to pay \$30,000 for elsewhere. If you want to get down to business, try a new idea computer from TeleVideo today.



TeleVideo Systems, Inc.
1170 Morse Ave.
Sunnyvale, CA 94086 408/745-7760;
800/538-8725 (toll-free outside California)
Georgia: Norcross (404) 447-1231
Illinois: Lombard (312) 969-0112
New York: New York (212) 308-0705
Europe: Netherlands (31) 075-287-461
TLX: 844-19122 (TLVDO NL)

*CP/M® is a registered trademark of Digital Research, Inc.
‡MmmOST™ (Multi-User, multi-task, multi-processor Operating System Technology) is a trademark of TeleVideo Systems, Inc.

Listing 2: Additional software to presort data prior to plotting.

```

5450 REM
5452 REM *****
5454 REM *   SPEED UP MODIFICATIONS USING SORT ROUTINE   *
5456 REM *****
5458 REM
5465 TOP=100;TEMPTOP=100
5468 GOSUB 6890:REM                               SORT DATA
5970 REM
5980 REM *****
5990 REM *   PLOT SORTED DATA SUBROUTINE               *
6000 REM *****
6010 REM
6020 CHAR#="0"
6030 FOR I=TOP TO 0 STEP -1
6033 IF Y(I)>Y+.50001*YD THEN 6080
6035 IF Y(I)<Y-.5*YD THEN I=0:GOTO 6080
6040 TEMPTOP=I
6050 XP=FIX((X(I)-XMIN)*100/(XMAX-XMIN))
6060 IF XP<0 OR XP>100 THEN 6080
6070 LPRINT CHR$(13);RSTOP=XP+20:GOSUB 5850
6080 NEXT I:TOP=TEMPTOP:RETURN
6840 REM
6850 REM *****
6860 REM *   SHELL SORT OF DATA                         *
6870 REM *****
6880 REM
6890 M=100
6910 M=INT(M/2):IF M=0 THEN RETURN
6920 J=0:K=100-M
6930 I=J
6940 L=I+M:IF Y(I)<Y(L) THEN 6970
6950 T=Y(I):T1=X(I):Y(I)=Y(L):X(I)=X(L):Y(L)=T:X(L)=T1:I=I-M
6960 IF I<0 THEN 6970 ELSE 6940
6970 J=J+1:IF J<K THEN 6930 ELSE 6910
6980 REM
    
```

(MSD) is determined, based on the data extremes. This value is the smallest that can be used between major scale divisions yet still fit all the data on a plot with ten major divisions. Line 6640 starts a

FOR. .NEXT loop which selects the multiplier for the scale divisions; the nested FOR. .NEXT loop beginning at line 6650 selects the value of the major scale divisions using the DATA statement in line 6830. Lines 6660

through 6710 then use this information to determine new maximum and minimum scale values which in turn are used in the data plotting routines. Scaling of both the X and Y axes is handled in the same manner.

Although the logic of these routines would become quite clear with some study, you don't have to understand these routines at all to select your own personalized auto-scaling factors. Simply change the DATA statement in line 6830 and the limit of the FOR. .NEXT loops in lines 6650 and 6750. For example, suppose you like any even integer scaling. Change the DATA statement from 1, 2, 5 to 1, 2, 3, 4, 5, 6, 7, 8, 9, and change the upper limits in the READ loops from 3 to 9. I don't like scales with increments of 3, 6, 7, 8, or 9 and typically use a scaling of 1, 2, 2.5, 4, 5. As I've stated, though, this depends strictly on your esthetic values. The program uses 1, 2, 5 scaling as an example.

Figure 3 is a plot of EXP(X) versus X using 1, 2, 2.5, 4, 5 auto-scaling values. Exponential curves such as

JANUS™

the language that is based on the past but looks to the uses of the future.

DATA

Now You Can Have JANUS On Your System.

JANUS is a subset of the famous ADA language developed by the U. S. Department of Defense. This new language was designed to ease maintenance of programs, yet be easy to program in. ADA combines the best features of ALGOL and Pascal to produce a powerful programming language. ADA puts an emphasis on Modular programming and program portability.

The JANUS implementation of an ADA subset includes features found in no other micro-processor programming language. It features true modular programming, where the computer, rather than the programmer, remembers which modules are being used. JANUS also features full error walk-backs and line number error messages. And there is much, much more.

The JANUS system comes complete — no other programs to buy — *It includes:*

- Compiler
- Assembler
- Disassembler
- Screen Editor
- Linker
- Full Documentation



The JANUS package produces ROMable, Re-entrant 8080, optimized Z80, or 8086 machine code.

You too can take a step forward into the future.

8080 or Z80, CP/M (requires 56K memory) — \$300.00

8086, CP/M-86 or 86-DOS (requires 64K memory) — \$400.00

JANUS is supplied on IBM formatted, single density 8" floppy disks. Other formats are available.

 **SOFTWARE**

CP M and CP M 86 are trademarks of Digital Research, Inc.
86-DOS is a trademark of Seattle Computer Inc.
* ADA is a trademark of the U S Department of Defense

specialists in state of the art programming

P.O. BOX 1512 MADISON, WISCONSIN 53701

(608) 244-6436

IBM's new baby just grew up.

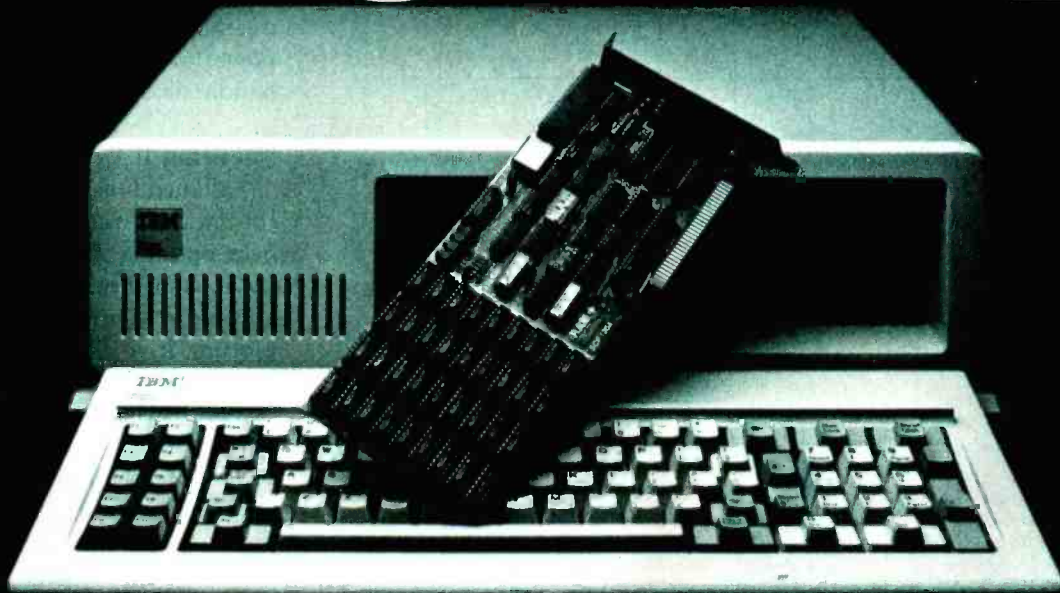

SEATTLE COMPUTER'S NEW RAM+ GIVES YOU THE MEMORY YOU NEED AT A PRICE YOU CAN'T FORGET.

A great new machine, the IBM personal computer, just got better. With RAM+, the new expansion memory from Seattle Computer.™

RAM+ can change your personal IBM from a pony to a workhorse by adding up to 256 K of memory. RAM+ is expandable, reliable and is made by Seattle Computer, the people who created the operating system for the IBM personal computer.

To make your IBM work even better, each RAM+ card has a RS-232 serial port which uses IBM supplied software. And RAM+ comes fully assembled, tested and with a 90 day guarantee.* The RAM+ is available in 64 K, 128 K, 192 K or 256 K, with affordable prices ranging from \$475. to \$1,075. Expansion kits are also available.

How to order: Call Anna Ford at (206) 575-1830 for the location of the nearest RAM+ dealer.

The RAM+ — a great addition to your IBM personal computer. At a great price.

Dealer inquiries welcome.

 **SEATTLE
COMPUTER**

1114 Industry Drive, Seattle, Washington 98188

*Extended warranty available.

Circle 350 on Inquiry card.

EXPONENTIAL CURVE

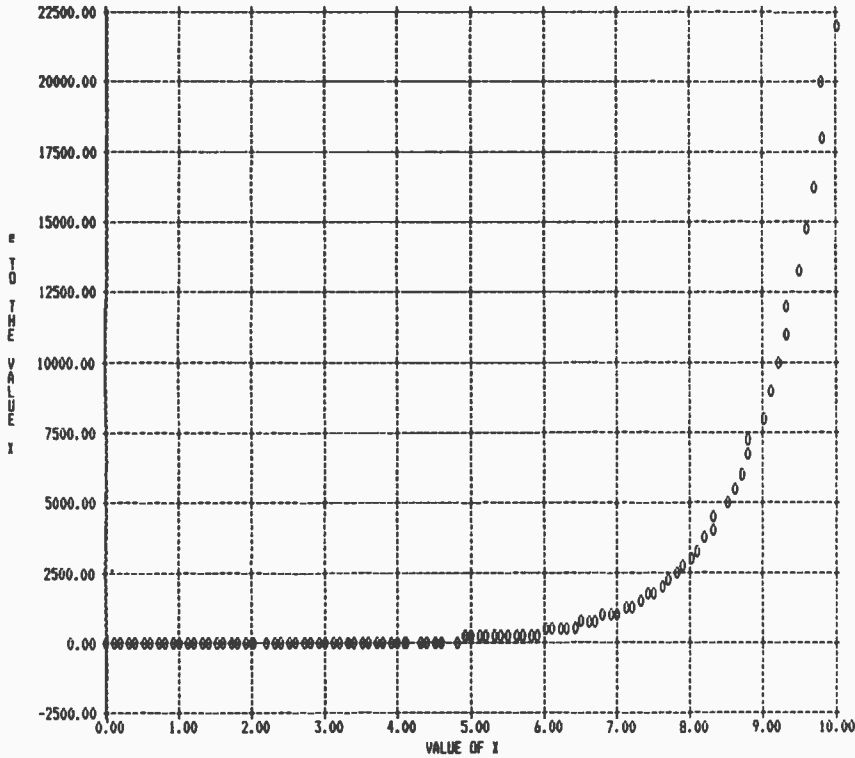

Figure 3: Sample plot of exponential curve using auto-scaling ($Y = \text{EXP}(X)$).

EXPONENTIAL CURVE (LOW VALUES)

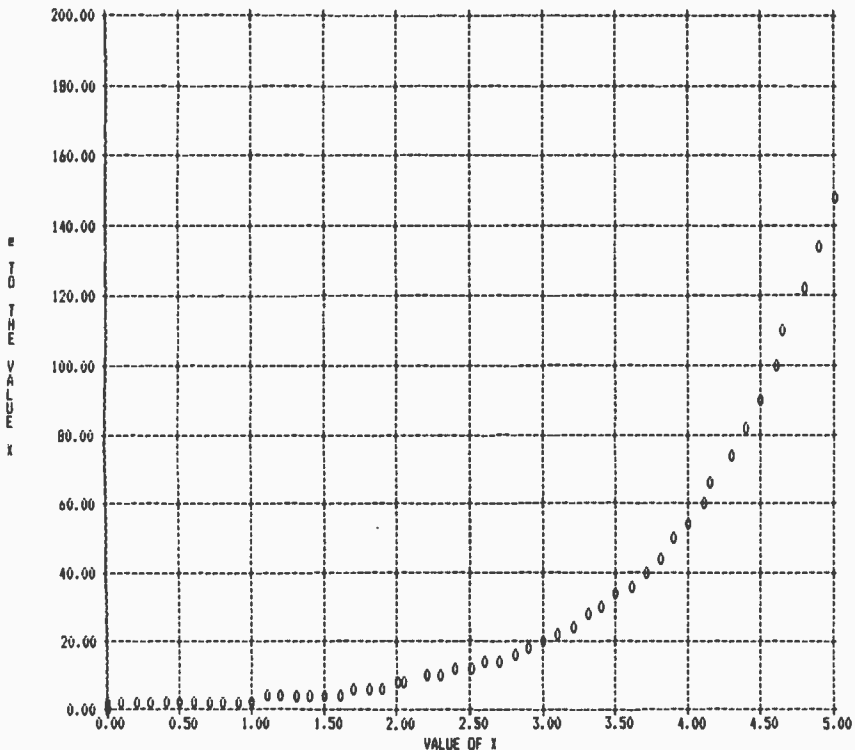

Figure 4: Sample plot of exponential curve using manual scaling (expanded section of figure 3).

the one shown are particularly difficult for any linear plot routine to handle because of the wide range of values usually involved. It's obvious from figure 3 that much of the data falls below the Y value of 200 and below the X value of 5. With this type of data, it's sometimes desirable to have a higher-resolution plot of this section of the data. You can accomplish that by now replotting this section of data using the MANUAL feature of the program. Figure 4 shows a plot of the same data with the Y scale manually set from 0 to 200 and with the X scale manually set from 0 to 5. Use of auto-scaling to present all of the data and manual scaling to expand features of the overall plot can provide a very powerful tool for those who have to handle data regularly.

Speeding It Up

As I mentioned before, this plotting routine isn't very fast and has never been optimized to make it faster. One obvious method to decrease the overall time is to presort the data prior to plotting it so that the PLOT DATA routine doesn't have to scan every bit of data each time through. Listing 2 shows the lines that have to be added or modified to sort and plot the data with the sort routine given. Inserting these lines will cut almost two minutes off each plot, but there's no free lunch here either. What price is paid for this speed-up feature? The data isn't the same as when it entered the routine, since the array numbers have been altered. You could save the arrays in other arrays to maintain the integrity of your data, but this will cost you variable space. Again, use of these options is strictly up to the user and the particular application.

I've written the software for a standard MX-80 *without* the Graftrax-80 option. Those of you having this option should delete the last part of line 5780, since the CHR\$(27)"2" is no longer needed.

Please feel free to write and let me know of any features of the MX-80 or of the program I've missed that would reduce the plot time—my mailman will love it! ■

Why Pay More?

MICRO-TERM

Gives You Complete
Performance for the
Price With Features
Others Don't Have

MIME 740

VT-100* compatible terminal with advanced video and printer port standard. Additional features include two pages of memory, plain English set-ups, user programable function keys, diagnostic mode, X-OFF indication, and green screen with screen saver. Better than all these features is the price.

MIME-2A/ACT-5A

Fully featured smart terminals with smooth scroll, bi-directional printer port, function keys, editing, and four non-volatile video attributes. Both terminals feature 7x11 dot matrix with true descenders. MIME-2A emulates popular DEC, Hazeltine, and Soroc terminals.

MIME 340

Low end terminal with block mode, full editing, protected fields, printer port, host definable function keys, numeric keypad, green monitor and LEAR Siegler, Hazeltine or ANSI Codes. So reliable it carries a full one year warranty. Very smart -- very inexpensive.

*VT-100 is a registered trade mark of Digital Equipment Corporation.



MICRO-TERM, INC.

Terminals are our only product, and we put more into them.

CALL OR WRITE:

1314 HANLEY INDUSTRIAL COURT, ST. LOUIS, MISSOURI 63144,
(314) 968-8151, TWX: 9107601662, MICROTERM, STL

Modify Your Paper Tiger for Different Paper Thicknesses

R. P. Sarna
39 Cushnoc Dr.
Augusta, ME 04330

Are you tired of removing the printer cover of your Paper Tiger to adjust for different paper thicknesses? A simple modification can change all that.

The various Paper Tiger models produced by Integral Data Systems (IDS) are popular with microcomputer owners because they're rugged, reliable, extremely flexible in operation, and well supported by the manufacturer. That tremendous flexibility, however, is marred by one "bug" in the IDS 460. I use my high-speed printer to generate business

reports (using both single- and multiple-part copy paper), form letters, and address labels. This necessitates a change from thick address labels to thin fanfold paper to single sheets in holders to carbonless multiple-part copy-forms, and back again.

The paper-thickness control knob is located *inside* the cover. In order to adjust it, you must remove the cover, adjust the control, replace the cover (try not to snag the ribbon or damage the circuit board), and then run the printer to see if it's adjusted correctly.

If it isn't, you have to start all over again.

A simple modification solves this problem, making it easy to adjust to the proper paper thickness from *outside* the printer. All you have to do is drill a hole in the cover and cut a slot in the adjusting rod for a screwdriver.

(Editor's Note: *IDS says that this modification isn't necessary for the newest version of the model 460, as there is a lever attached to the paper-thickness control knob which allows it to be adjusted from outside the printer. You can purchase this lever and knob by contacting Customer Support Group, Integral Data Systems Inc., Milford, NH 03055. If you choose to make the modifications described in this article, IDS says it will still repair its printers no longer under warranty, as long as the printer mechanism itself has not been modified....SJW*)

The first step is to locate the position for the hole. Put the printer on a light-colored table or piece of paper and remove the cover. Set a drafting triangle or a small carpenter's square on the table (see photo 1) and make a mark on the table or paper directly below the center of the paper-thickness control knob. Then mark on the triangle the height of the center of the control knob from the table. Without moving the printer, carefully replace the cover. Using the marks on the table and on the triangle, find the spot on the cover where the two marks intersect (see photo 2). Mark

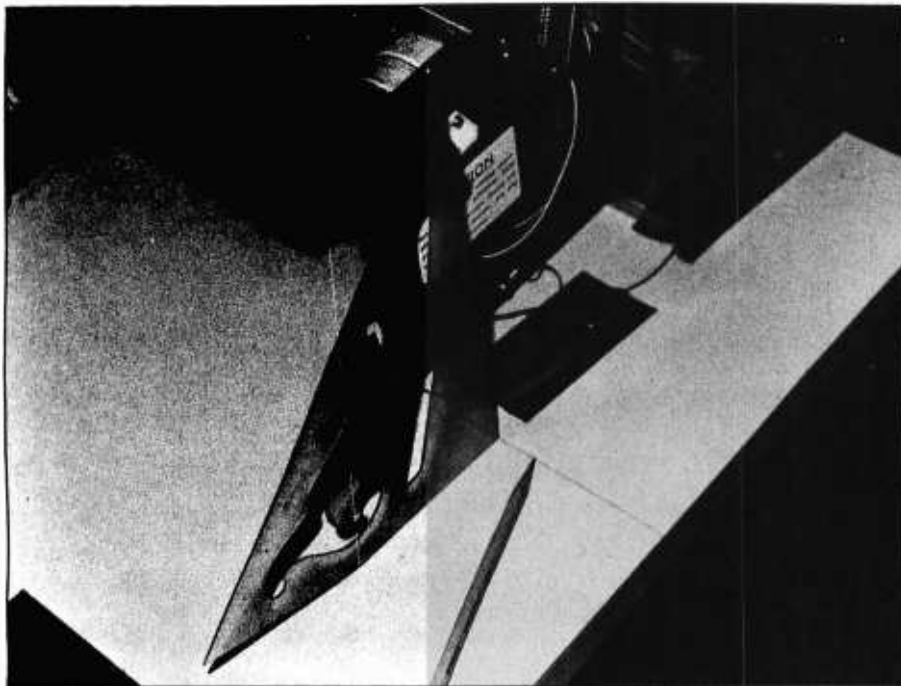

Photo 1: Use a square or a drafting triangle to mark the table directly beneath the center of the knob. Measure the height of the shaft above the table and mark the triangle.

9:00AM-8:00PM ET!
VISA AND MASTERCARD WELCOME!

SHOP SMART

FOR ORDERS · PRICE QUOTES · AVAILABILITY

1-800-523-9511

IN PENNSYLVANIA

1-215-868-8219

SORCIM

SUPERCALC 225.00

SUPERSOFT

DIAGNOSTICS II 84.00

DISK DOCTOR 84.00

FORTRAN 80 218.00

SSS FORTRAN

WITH RATFOR 285.00

TINY PASCAL 74.00

TERM 131.00

ASHTON-TATE

dBASE II 599.00

HAYDEN

APPLESOFT COMPILER . 167.00

PERSONAL

VISICALC★ 155.00

VISIDEX★ 159.00

VISIFILE★ 200.00

VISIPILOT★ 149.00

VISITERM★ 128.00

VISITREND-VISIPILOT★ .. 220.00

DESKTOP PLAN II★ 160.00

MICROSOFT

BASIC 80 285.00

BASIC COMPILER 315.00

COBOL 80 568.00

FORTRAN 80 345.00

muSIMP-muMATH..... 215.00

MACRO 80 140.00

FOR APPLE®

CP/M®

BASIC COMPILER 315.00

TASC APPLESOFT

COMPILER..... 150.00

FORTRAN 80 165.00

COBOL 80 568.00

ALDS..... 105.00

ADVENTURE..... 24.95

OLYMPIC DECATHALON 21.95

CP/M is a registered trademark of Digital Research.

*Registered trademarks of MicroPro International.

★Registered trademarks of Personal Software Inc.

APPLE is a registered trademark of Apple Computers.

ALL ITEMS SUBJECT TO AVAILABILITY

PRICES AND SPECIFICATIONS SUBJECT TO CHANGE WITHOUT NOTICE

CALL MICROHOUSE FOR ALL PRINTER ACCESSORIES AND SUPPLIES. WE CARRY A COMPLETE LINE OF INTERFACE CABLES, TRACTOR FEEDS, AND PRINTER PAPERS.

MICROPRO

WORDSTAR 3.0* 299.00

SUPERSORT* 170.00

MAILMERGE* 105.00

DATASTAR* 244.00

SPELLSTAR* 165.00

CALCSTAR* 225.00

FOR APPLE®

WORDSTAR* 245.00

SUPERSORT* 130.00

MAILMERGE* 85.00

DATASTAR* 207.00

SPELLSTAR* 145.00

CALCSTAR* 255.00

TELEVIDEO

950 TERMINAL 950.00

920 TERMINAL 779.00

912 TERMINAL 745.00

910 TERMINAL 595.00

MODEMS

HAYES MICROMODEM II 307.00

HAYES SMARTMODEM . 230.00

NOVATION D-CAT 156.00

NOVATION AUTO-CAT .. 213.00

NOVATION APPLE-CAT.. 335.00

ACCESSORIES

Z-80 CARD 299.00

MICROSOFT 16K RAM .. 150.00

MOUNTAIN COMPUTER

MULTI/O 178.00

VIDEX VIDEOTERM 290.00

CENTRONICS

739 SERIAL 888.00

739 PARALLEL 793.00

ANADIX

ANADIX DP-9501 1299.00

ANADIX DP-9500 1299.00

ANADIX DP-9001 1250.00

ANADIX DP-9000 1250.00

ANADIX DP-8000 776.25

ANADIX DP-8000

for APPLE 600.00

C.I.TOH

STARWRITER I P 1562.50

STARWRITER I S 1500.75

STARWRITER II P 1850.00

STARWRITER II S 1950.00

COMET I 295.00

COMET II P 875.00

COMET II S 950.00

PROWRITER P 545.00

PROWRITER S 599.00

DIABLO

DIABLO 630 2095.00

EPSON

EPSON MX-70 CALL

EPSON MX-80 CALL

EPSON MX-80FT CALL

EPSON MX-100 CALL

EPSON GRAFTRAX CALL

OKIDATA

MICROLINE 80 449.00

MICROLINE 82A 535.00

MICROLINE 83 795.00

PAPER TIGERS

IDS 445 695.00

IDS 445G 769.00

IDS 460G 985.00

IDS 560G 1200.00

ALL COMPUTERS ARE NOT CREATED EQUAL

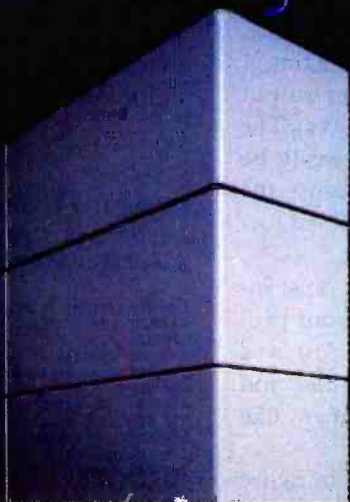

**ZEμS™ is a minicomputer
AND a microcomputer.**

Through multiprocessor technology, each user has a dedicated Z-80A-based single-board microcomputer module, housed in the system mainframe.

But users enjoy minicomputer performance and capacity. Including modular hard disk storage of 34 to 600 megabytes. Tape backup. Shared printers with spooling and queuing. Disk caching. Access to a common database.

Unequaled flexibility and reliability. The completely modular, stackable system can expand to 64 users. To add a user, add only a dumb terminal and an inexpensive user microcomputer module.

OSM

**ZEμS sounds powerful.
Now prove it.**

Name

Company

Address

City/State/Zip

Phone

Trademarks
ZEμS, MUSE: OSM Computer Corporation
Registered trademark:
CP/M: Digital Research

And ZEμS isn't fazed by lightning, voltage variations, or power failures. Power for the entire system is "buffered" through a battery/recharger system that provides up to 20 minutes of operating power.

Unequaled value. MUSE™ multiprocessor operating system is compatible with CP/M®. Minicomputer performance and capacity. New levels of reliability and flexibility. All at a per-user price that is shockingly competitive. If the coupon isn't fast enough, call.

OSM Computer Corporation
2364 Walsh Avenue
Santa Clara, CA 95051
(408) 496-6910 TWX 910-338-2099

BASIC Formatted Printing

Dr. Malladi Subbaiah
301-46 Caltech
Pasadena, CA 91125

How often would you like to have the results of a computation printed in a selected format? Unlike FORTRAN or Extended BASIC, a minimal BASIC such as TI BASIC does not usually have FORMAT statements. Listing 1 shows a routine that I developed to obtain printer output in any desired format with my BASIC programs. The routine, written in TI BASIC (although it can easily be adapted to other BASICs), is simple to use because the PRINT statement can directly access the user-defined format functions without any conditional transfers.

To use the format routine in a program, you must include the statements in lines 230 through 320 in your program before the first PRINT statement. Line 510 is a typical example of such a PRINT statement. Titles and string variables are printed using a PRINT statement like that shown in line 490.

An example of the formatted output is shown in figure 1b. The results would have been printed as in figure 1a if a regular PRINT statement with semicolon print separators (line 470) was used. (Figures 1a and 1b are on page 164.)

The formatting routine takes advantage of the string variables used in TI BASIC. To print a real variable, say X, print the formatted string RF\$(X). Similarly, use IF\$(I) to print an integer, I. To obtain print titles, use RFT\$(X\$) to print X\$ as the title associated with the real numbers. IFT\$(I\$) is a similar function for titles of integer fields. RFT\$(X\$) and IFT\$(I\$) can, of course, be used like RFS\$ and IF\$ to print any string variables.

The format field is controlled by the variables FL, FD, and IL (see the DATA statement on line 250). FL and IL represent the total length of the field for real and integer variables, and FD is the number of decimal places chosen for the real numbers. The real numbers are rounded off to the desired digits. (The effect of the two format descriptions is similar to using the FORTRAN statements FORMAT(F FL,FD) for real numbers and FORMAT (I IL) for the integer numbers.)

The program prints right-justified entries in the user-selected field in both real and integer formats. When the value of the variable is larger than can be accommodated in the allocated field, a starred output is printed as shown in figure 1b. ■

Listing 1: The format routine embedded in this program (lines 230 through 320) allows control of printer output without the use of FORMAT statements.

```
100 REM FORMAT PRINTING
110 REM IN TI BASIC
120 REM
130 REM PROGRAM BY
140 REM MALLADI SUBBAIAH
150 REM
160 REM FL- PRINT LENGTH
170 REM FOR REAL NOS.
180 REM FD- DECIMAL DIGITS
190 REM IL- PRINT LENGTH
200 REM FOR INTEGER NOS.
210 REM *****
220 REM
230 RESTORE 250
240 READ FL,FD,IL
250 DATA 10,3,6
255 FLD=FL-FD-1
260 BLNK$=""
262 STAR$=""
264 DEF C1(X)=INT(((ABS(X)>10^FLD)+(ABS(X)>1E10)-1)/-2)
266 DEF C2(I)=INT(((ABS(I)>10^IL)+(ABS(I)>1E10)-1)/-2)
270 DEF RX(X)=STR$(X+SGN(X+1E-40)*0.5/10^FD)
295 DEF RFS(X)=SEG$(STAR$&BLNK$&RX$(X),1+(24-FL+POS(RX$(X),".",1)+FD)*(1-C1(X),
FL)
305 DEF IF$(I)=SEG$(STAR$&BLNK$&STR$(I),1+(24-IL+LEN(STR$(I)))*(1-C2(I)),IL)
310 DEF RFT$(X$)=SEG$(BLNK$&X$&BLNK$,LEN(BLNK$)-(FL-FD-1-LEN(X$)/2),FL)
320 DEF IFT$(I$)=SEG$(BLNK$&I$,LEN(BLNK$)-IL+LEN(I$)+1,IL)
330 REM
340 REM *****
350 REM END FORMAT ROUTINE
360 REM
370 DIM M(10),X(10),Y(10),XY(10)
380 READ M(1),M(2),M(3),M(4),M(5),M(6),M(7),M(8),M(9),M(10)
390 READ X(1),X(2),X(3),X(4),X(5),X(6),X(7),X(8),X(9),X(10)
400 READ Y(1),Y(2),Y(3),Y(4),Y(5),Y(6),Y(7),Y(8),Y(9),Y(10)
410 DATA 12,-25,1E12,167,-5,432,29,7618219,14,9527
420 DATA -1.7962,23.95,4741.111111,1E21,1E-14,-0.0265,79830.90145,134.91672,245.
92135,216.9821
430 DATA -2.1,0.97,1.86372,0.01754,7.8924,6.9159,1.15,3.000145,176.36241,213.567
434 N=10
435 U=1
440 OPEN #1:"RS232"
450 FOR I=1 TO N
460 XY(I)=X(I)*Y(I)
470 PRINT #U:;I;M(I);X(I);Y(I);XY(I)
480 NEXT I
490 PRINT #U:;:IFT$(I);IFT$(M(I));RFT$(X(I));RFT$(Y(I));RFT$(X(I)*Y(I)
");:
500 FOR I=1 TO N
510 PRINT #U:IF$(I);IF$(M(I));RFS(X(I));RFS(Y(I));RFS(XY(I))
520 NEXT I
530 CLOSE #1
540 STOP
```

Esprit™

has a timely announcement
on buyer protection for only

Any terminal can claim to be reliable. Esprit™ backs it up! Each Esprit is backed by two warranty options that protect owners against repair cost.

They're warranties that are unavailable with any other low cost terminal. Unavailable with any terminal at any cost.

\$49.95.

Telegram

western union

Telegram

western union

TWO WARRANTY OPTIONS.

HAZELTINE, IN COOPERATION WITH WESTERN UNION, NOW OFFERS:

() RETURN TO FACTORY FOR REPAIR AT NO COST FOR MATERIALS AND LABOR, OR

() ON-SITE SERVICE CONTRACT THROUGH 1982 IN ANY WESTERN UNION ZONE 1 AREA* FOR ONE-TIME CHARGE OF ONLY \$49.95 PER TERMINAL.

THESE SERVICE OPTIONS ARE AVAILABLE ON ESPRIT TERMINALS PURCHASED AFTER FEBRUARY 1, 1982, FOR SERVICE RENDERED THROUGH DECEMBER 31, 1982.

TO QUALIFY, CHECK THE OPTION DESIRED AND MAIL THIS COUPON ALONG WITH THE COMPLETED WARRANTY REGISTRATION CARD TO:

HAZELTINE CTE CUSTOMER SERVICE
780 PARK AVE GREENLAWN NEW YORK 11740

COMPANY-----

ADDRESS OF TERMINAL LOCATION-----

-----ZIP-----

PHONE AT TERMINAL LOCATION-----EXT-----

NUMBER OF TERMINALS AT LOCATION-----

TERMINALS PURCHASED FROM-----

AUTHORIZED SIGNATURE-----

Now, that's a very smart idea!



These warranty options are also available through your Hazeltine Esprit distributor.

*Zone 1 coverage is within an approximate 25-mile radius of any one of 65 Western Union Authorized Service Centers located throughout the U.S. Call toll free to check your location (800) 645-5300 or in New York (516) 549-4627.

Circle 177 on Inquiry card.

```

1 12 -1.7962 -2.1 3.77202
2 -25 23.95 .97 23.2315
3 1.E+12 4741.111111 1.86372 8836.1036
4 167 1.E+21 .01754 1.754E+19
5 -5 1.E-14 7.8924 7.8924E-14
6 432 -.0265 6.9159 -.18327135
7 29 79830.90145 1.15 91805.53667
8 7618219 134.91672 3.000145 404.7697229
9 14 245.92135 176.36241 43371.28196
10 9527 216.9821 213.567 46340.21615
    
```

Figure 1a: Sample of printer output from the program in listing 1 without the format routine.

```

I M(I) X(I) Y(I) X(I)*Y(I)
1 12 -1.796 -2.100 3.772
2 -25 23.950 .970 23.232
3 ***** 4741.111 1.864 8836.104
4 167 ***** .018 *****
5 -5 .000 7.892 .000
6 432 -.027 6.916 -.183
7 29 79830.901 1.150 91805.537
8 ***** 134.917 3.000 404.770
9 14 245.921 176.362 43371.282
10 9527 216.982 213.567 46340.216
    
```

Figure 1b: Using the format routine, the printer output can be formatted to suit your needs. If a number exceeds the length available for a variable, the program in listing 1 will print a string of stars, as shown in lines 3, 4, and 8.

Lowest Prices Largest Selection Fastest Deliveries

AMPEX • INTERTEC
TEXAS INSTRUMENTS
GENERAL DATA
ANDERSON JACOBSON
C. ITOH • QUME
BEEHIVE • DATASOUTH
DIABLO

TERMINALS TERRIFIC

MICROS

INTERTEC:
Superbrain\$2895.00
Superbrain QD 3375.00

TERMINALS TERRIFIC

PRINTERS

DATASOUTH:\$1355.00
NEC:
7710\$2350.00
7715 2400.00
7730 2350.00
7720 2750.00
7725 2850.00
Standard Forms 200.00
Bi-Directional Forms 300.00
QUME:
Sprint 5, 55RO\$2575.00
Sprint 5, 55KSR 2900.00
Sprint 9, 45RO,
Full Panel\$2250.00
Limited Panel 2120.00
Standard Forms 200.00
Bi-Directional Forms 200.00

DIABLO:

630 R.O.\$1995.00

TERMINALS TERRIFIC

TERMINALS

AMPEX:
Dialogue 30\$ 775.00
Dialogue 80 950.00
BEEHIVE:
DM5\$ 745.00
DM5A 930.00
DM310 1095.00
C. ITOH:
CIT 101\$1350.00
TEXAS INSTRUMENTS
745 Standard\$1390.00
810 Basic 1375.00
810 Package 1600.00
820 RO Package 1775.00
820 KSR Package 1940.00
840 RO Basic 795.00
840 RO Tractor Feed Pkg. . 1059.00

TERMINALS TERRIFIC

DISC DRIVES

QUME:
DataTrack 8\$ 575.00
DataTrack 5 350.00

Special! While They Last!

SOROC:

IQ 120\$ 675.00
IQ 130 575.00
IQ 135 750.00
IQ 140 1095.00

TERMINALS TERRIFIC

COUPLERS

STAR:

300 Band\$ 150.00

TERMINALS TERRIFIC

SOFTWARE

BISYNE — 80 RJE\$ 806.00
Forms 2 199.00
Wordstar 445.00
Data Star 310.00
Cobol 849.00
Mail Merge 131.00
Spell Guard 266.00
Plan 80 355.00
Super Calc 266.00
Milestone 266.00

Add 2% for shipping and insurance to a maximum of \$15.00. Superbrain shipped freight collect. VISA and Mastercards welcomed. All equipment is in factory cartons with manufacturers warranty. No C.O.D. orders. Toll Free 800-368-3404. Virginia Call Collect. (703) 237-8695.

TERMINALS TERRIFIC

Terminals Terrific, Incorporated, P.O. Box 490, Falls Church, VA 22046, 800-368-3404

WESTICO — The Software Express Service that really delivers:

LANGUAGE PROCESSORS

When it comes to providing quality programs for serious microcomputer users — come to Westico. And you'll find more than quality software. You'll find instant response. In most cases, your order will be shipped within 24 hours. You'll also find the technical expertise on staff when you need help. For language processors and lots more, it's Westico. Here's just a sample of the more than 150 quality programs currently in stock:

PL/I-80™ — Powerful application programming language for microcomputers. Implements on a micro the ANS Subset G language for minicomputers. Includes native code compiler, LINK-80 linkage editor, LIB-80 subroutine library manager, PLILIB run-time library and RMAC relocatable macro assembler. **\$475/\$35**. LINK-80 and RMAC also available separately.

BT-80™ — Efficient B-tree key indexed access method for PL/I-80. Features key length to 63 bytes, unique or duplicate keys, and data records to 4096 bytes. Datasets can be spread over 8 files for a total of 64 megabytes. **\$200/\$30**.

BASIC-80 — Extremely fast interpreter features double precision floating point math, 40 character variable names, CHAIN/Common, random and sequential files, EDIT, CALL with parameters and an overlay technique. **\$350/—**.

BASIC COMPILER — Compatible with BASIC-80. Produces extremely efficient, optimized 8080/Z80 machine code. Includes macro assembler, linkage editor and subroutine library manager. Compiled programs can be linked with FORTRAN-80, COBOL-80, and assembly language programs. **\$395/—**.

CBASIC™ — BASIC language compiler/interpreter for development of financial and business application programs. System **\$120/\$20**.

CBASIC-86 — Implementation of CBASIC for CP/M-86. INT files compatible with CBASIC and supports 128K main memory. Requires CP/M-86 or MP/M-86. **\$325/\$30**.

CB-80™ — Native code 8080 compiler of CBASIC language. Offers all of the features of CBASIC plus the speed and versatility of a compiler. Includes linkage editor which can create overlay modules. Supports CP/M and MP/M II. **\$500/\$30**.

FORTRAN-80 — Includes full ANSI standard X3.9 except COMPLEX data type. **\$500/—**.

LYNX™ — Friendly overlay linkage editor for creating COM files from Microsoft compatible REL files. Constructs programs that use all available memory including that used by LYNX itself. Program size can be increased at least 9K without using the overlay feature. The overlay option is vital to programs larger than available memory. Easy to use with BATCH and HELP commands. **\$250/\$25**.

PASCAL/MT+™ — Compiler produces 8080/Z80 code. Standard REL file can be linked with other languages. Includes linker, debugger disassembler and special Speed Programming Package with editor and Pascal syntax checker. **\$475/\$30**.

COBOL-80 — Complies with ANSI Level 1 requirements and most useful features of Level 2. SCREEN SECTION for definition of CRTs. **\$750/—**.

XASMxx — Family of microprocessor cross-assemblers. Designed to run on 8080/Z80 based microcomputers under a CP/M-like operating system. Support for Motorola 6800, 6801, 6803, 6805, 6809; RCA 1802; COP400; Intel 8048, 8051; MOS 6502. **\$200/\$25**.

XLT86™ — Translates Intel 8080 assembly language source code into optimized Intel 8086 source code. **\$150/\$10**.

The Westico 24-Hour Computer Hotline (203) 853-0816 (300 baud) for detailed information and quick access ordering.



• Westico has more than 150 programs for professionals and businesses that use a wide variety of microcomputers including: TRS-80 Model II, Apple, Vector Graphic, Cromemco, North Star, Micropolis, Ohio Scientific, Altos, Dynabyte, IBM, Intertec, Xerox, Zenith, Northern Telecom, AVL Eagle and more. We're working hard to be your software company.

For FREE catalog
circle reader service number. More
than 150 quality programs in stock.

4 Ways to order

- **Write** Westico, Inc., 25 Van Zant Street, Norwalk, CT 06855.
- **Call** (203) 853-6880.
- **Telex** 643-788
- **Dial-up** our 24-hour computer (300 baud) (203) 853-0816.

COD, MasterCard and VISA accepted.

Prices do not include shipping and are subject to change. In CT add 7½% sales tax. All sales final.

Manual price may be credited toward purchase of software.

Dealer inquiries invited.

WES-43

Copyright © 1982 Westico, Inc.

WESTICO
The Software Express Service

25 Van Zant Street • Norwalk, Connecticut 06855
(203) 853-6880 • Telex 643-788

Epson MX-80 Print-Control Program for the Apple II

Bill Starbuck
2100 East Edgewood Ave.
Shorewood, WI 53211

How many times have you, after buying a new "toy" for your computer, installed the hardware, read the manual carefully, and played with the equipment until its functions become familiar, only to go back to your regular activities and forget much of what you've learned?

This is what happened after I bought my Epson MX-80 printer. I studied the manual conscientiously and learned all the printer-control codes. For weeks thereafter, I did nothing with the printer except turn it on and off. By the time my Epson Graftrax-80 bit-plot graphics option arrived, I had forgotten how the printer worked.

This time I entrusted the information to the Apple's memory instead of my own. I wrote a print-control program in Applesoft BASIC, called MX-80 (see listing 1), that I keep on disk with my Applewriter text editor.

When the program is run, the screen displays a menu of available printer options (see figure 1). The on-screen display has some of the instruction codes highlighted as black on white. The highlighted options are the choices transmitted to the printer when one of the three termination codes (EDITOR, PRINTER, or QUIT) is entered. To review the inventory of (nongraphics) printer signals, I can choose the INVENT option.

There is no way to query the printer about its current status, so the program records a status file, called MX.STATUS, that recalls the last instructions sent to the printer. This status file is used to initialize the program the next time it is run. The status file is especially conven-

ient when a given typeface is used repeatedly. So that there will be a file for the print-control program to read

Text continued on page 170

STANDARD = STANDARD FONT
ITALIC = ITALIC FONT

STRIKE1 = SINGLE STRIKE
STRIKE2V = TWO VERTICAL STRIKES
STRIKE2H = TWO HORIZONTAL STRIKES*
STRIKE4 = QUADRUPLE STRIKES*
* ONLY WITH NORMAL LETTERS

SMALL = SMALL LETTERS, UP TO 132/LINE
NORMAL = NORMAL LETTERS, UP TO 80/LINE

SPACEN = NORMAL SPACING BETWEEN LINES
SPACET = TIGHT SPACING BETWEEN LINES
SPACEO = NO SPACE BETWEEN LINES

INVENT = INVENTORY OF MX-80 SIGNALS

EDITOR = SHIFT TO APPLEWRITER'S EDITOR
PRINTER = SHIFT TO APPLEWRITER'S PRINTER
QUIT = QUIT

ENTER INSTRUCTION CODE:

Figure 1: Menu from the MX-80 print-control program. The menu offers 36 combinations: 24 with normal letters (two fonts by four strikes by three spacings); 12 with small letters (two fonts by two strikes by three spacings). You can also choose INVENT, an inventory of the control signals for the Graftrax-80 function codes, and one of three program-termination options—EDITOR, PRINTER, and QUIT.

TRS-80* COMPUTING EDITION

©1981 Percom Data Co., Inc.

The Percom Peripheral

35 cents

Percom's DOUBLER II™ tolerates wide variations in media, drives

GARLAND, TEXAS — May 22, 1981 — Harold Mauch, president of Percom Data Company, announced here today that an improved version of the Company's innovative DOUBLER™ adapter, a double-density plug-in module for TRS-80* Model I computers, is now available.

Reflecting design refinements based on both theoretical analyses and field testing, the DOUBLER II™, so named, permits even greater tolerance in variations among media and drives than the previous design.

Like the original DOUBLER, the DOUBLER II plugs into the drive controller IC socket of a TRS-80 Model I Expansion Interface and permits a user to run either single- or double-density diskettes on a Model I.

With a DOUBLER II installed, over four times more formatted data — as much as 364 Kbytes — can be stored on one side of a five-inch diskette than can be stored using a standard Tandy Model I drive system.

Moreover, a DOUBLER II equips a Model I with the hardware required to run Model III diskettes.

(Ed. Note: See "OS-80™: Bridging the TRS-80* software compatibility gap" elsewhere on this page.)

The critical clock-data separation circuitry of the DOUBLER II is a proprietary design called a ROM-programmed digital phase-lock loop data separator.

According to Mauch, this design is more tolerant of differences from diskette to diskette and drive to drive, and also provides immunity to performance degradation caused by circuit component aging.

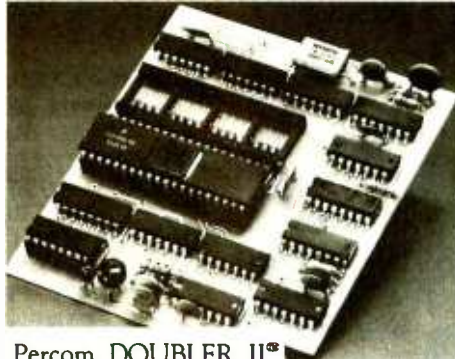

Percom DOUBLER II™

Mauch said "A DOUBLER II will operate just as reliably two years after it is installed as it will two days after installation."

The digital phase-lock loop also eliminates the need for trimmer adjustments typical of analog phase-lock loop circuits.

"You plug in a Percom DOUBLER II and then forget it," he said.

The DOUBLER II also features a refined Write Precompensation circuit that more effectively minimizes the phenomena of bit-and-peak-shifting, a reliability-impairing characteristic of magnetic data recording.

The DOUBLER II, which is fully software compatible with the previous DOUBLER, is supplied with DBLDOS™, a TRSDOS™-compatible disk operating system.

The DOUBLER II sells for ~~\$219.95~~, including the DBLDOS diskette. **Now \$169.95!**

Circuit misapplication causes diskette read, format problems. High resolution key to reliable data separation

GARLAND, TEXAS — The Percom SEPARATOR™ does very well for the Radio Shack TRS-80* Model I computer what the Tandy disk controller does poorly at best: reliably separates clock and data signals during disk-read operations.

Unreliable data-clock separation causes format verification failures and repeated read retries.

CRC ERROR—TRACK LOCKED OUT

The problem is most severe on high-number (high-density) inner file tracks.

As reported earlier, the clock-data separation problem was traced by Percom to misapplication of the internal separator of the 1771 drive controller IC used in the Model I.

The Percom Separator substitutes a high-resolution digital data separator circuit, one which operates at 16 megahertz, for the low-resolution one-megahertz circuit of the Tandy design.

Separator circuits that operate at lower frequencies — for example, two- or four-

megahertz — were found by Percom to provide only marginally improved performance over the original Tandy circuit.

The Percom solution is a simple adapter that plugs into the drive controller of the Expansion Interface (EI).

Not a kit — some vendors supply an untested separator kit of resistors, ICs and other paraphernalia that may be installed by modifying the computer — the Percom SEPARATOR is a fully assembled, fully tested plug-in module.

Installation involves merely plugging the SEPARATOR into the Model I EI disk controller chip socket, and plugging the controller chip into a socket on the SEPARATOR.

The SEPARATOR, which sells for only \$29.95, may be purchased from authorized Percom retailers or ordered directly from the factory. The factory toll-free order number is 1-800-527-1222.

Ed. note: Opening the TRS-80 Expansion Interface may void the Tandy limited 90-day warranty. Circle 308 on Inquiry card.

The Percom DOUBLER II is available from authorized Percom retailers, or may be ordered direct from the factory. The factory toll-free order number is 1-800-527-1222.

Ed. note: Opening the TRS-80 Expansion Interface may void the Tandy limited 90-day warranty. Circle 309 on Inquiry card.

All that glitters is not gold

OS-80™ Bridging the TRS-80* software compatibility gap

Compatibility between TRS-80* Model I diskettes and the new Model III is about as genuine as a gold-plated lead Krugerrand.

True, Model I TRSDOS* diskettes can be read on a Model III. But first they must be converted and re-recorded for Model III operation.

And you cannot write to a Model I TRSDOS* diskette. Not with a Model III. You cannot add a file. Delete a file. Or in any way modify a Model I TRSDOS diskette with a Model III computer.

Furthermore, your converted TRSDOS diskettes cannot be converted back for Model I operation.

TRSDOS is a one-way street. And there's no re-writing. A point to consider before switching the company's payroll to your new Model III.

Real software compatibility should allow the direct, immediate interchangeability of Model I and Model III diskettes. No read-only limitations, no conversion/re-recording steps and no chance to be left high and dry with Model III diskettes that can't be run on a Model I.

What's the answer? The answer is Percom's OS-80™ family of TRS-80 disk operating systems.

OS-80 programs allow direct, immediate interchangeability of Model I and Model III diskettes.

You can run Model I single-density diskettes on a Model III; install Percom's plug-in DOUBLER™ adapter in your Model I, and you can run double-density Model III diskettes on a Model I.

There's no conversion, no re-recording.

Slip an OS-80 diskette out of your Model I and insert it directly in a Model III.

And vice-versa.

Just have the correct OS-80 disk operating system — OS-80, OS-80D or OS-80/III — in each computer.

Moreover, with OS-80 systems, you can add, delete, and update files. You can read and write diskettes regardless of the system of origin.

OS-80 is the original Percom TRS-80 DOS for BASIC programmers.

Even OS-80 utilities are written in BASIC.

OS-80 is the Percom system about which a user wrote, in Creative Computing magazine, "... the best \$30.00 you will ever spend."[†]

Requiring only seven Kbytes of memory, OS-80 disk operating systems reside completely in RAM. There's no need to dedicate a drive exclusively for a system diskette.

And, unlike TRSDOS, you can work at the track sector level, defining and controlling data formats — in BASIC — to create simple or complex data structures that execute more quickly than TRSDOS files.

The Percom OS-80 DOS supports single-density operation of the Model I computer — price is \$29.95; the OS-80D supports double-density operation of Model I computers equipped with a DOUBLER or DOUBLER II; and, OS-80/III — for the Model III of course — supports both single- and double-density operation. OS-80D and OS-80/III each sell for \$49.95. Circle 310 on Inquiry card.

PRICES AND SPECIFICATIONS SUBJECT TO CHANGE WITHOUT NOTICE.

PRICES DO NOT INCLUDE HANDLING AND SHIPPING.

PERCOM DATA COMPANY, INC. 11220 Pagemill Road Dallas, Texas 75243 (214) 340-7081

*Trademark of Percom Data Company, Inc. †TRS-80 and TRSDOS are trademarks of Tandy Corporation which has no relationship to Percom Data Company. †Creative Computing Magazine, June, 1980, page 26.

Wizard-80™

INSTANT 80 COLUMN APPLE*

The miracle of the 80's... everything you want in an 80-column card.

STOP STARING AT 40 COLUMNS

WIZARD-80 lets you see exactly what you will get when typing 80-column format. It gives you a full 80-column by 24-line display with all these features.

- Fully compatible with Apple II® and Apple II Plus™*
- Fully compatible with most word processors, micro-modems and prom programmers, plus all current Apple II expansion boards
- Lists BASIC programs, integer and Applesoft
- Fully compatible with Pascal
- Uses software to switch between 40 and 80 column formats

- Displays 7 x 9 matrix characters
- Provides upper/lower case characters with full descenders
- Fully edits...uses ESCape key for cursor movement
- Scrolling stop/start uses standard Control-S entry Retains text on screen while it is being printed
- Contains crystal clock for flicker-free character display
- Has low power consumption for cool reliable operation
- Leads soldered directly to board for maximum reliability
- 2K on-board RAM, 50 or 60 Hz operation
- Inverse video selection standard

Available at all fine
Computer Stores \$295.00

 **WESPER MICRO
Systems**

SUBSIDIARY OF WESPERCORP

*Registered trademarks
of Apple Computer Inc.



System Notes

Listing 1: MX-80, an Applesoft program that controls the print of an Epson MX-80 printer equipped with the Graftrax-80 option.

```
1  REM LISTING 1:
10  REM MX-80
    BY BILL STARBUCK
20  REM THIS PROGRAM SETS THE
    TYPEFACES OF THE EPSON
    MX-80 PRINTER EQUIPPED
    WITH GRAFTRAX-80.
30  TEXT ;A$ = CHR$ (4);D$ = CHR$
    (27); PRINT A$"NOMON C,I,O";
    PRINT A$"OPEN MX.STATUS"; PRINT
    A$"READ MX.STATUS"; INPUT A;
    INPUT B; INPUT C; INPUT D; PRINT
    A$"CLOSE MX.STATUS"
40  PRINT A$"PR# 0"; HOME ; IF A =
    1 THEN INVERSE
50  PRINT "STANDARD"; NORMAL ; PRINT
    " = STANDARD FONT"; IF A = 2
    THEN INVERSE
60  PRINT "ITALIC"; NORMAL ; PRINT
    " = ITALIC FONT"; PRINT ; IF
    B = 1 THEN INVERSE
70  PRINT "STRIKE1"; NORMAL ; PRINT
    " = SINGLE STRIKE"; IF B =
    2 THEN INVERSE
80  PRINT "STRIKE2V"; NORMAL ; PRINT
    " = TWO VERTICAL STRIKES"; IF
    B = 3 THEN INVERSE
90  PRINT "STRIKE2H"; NORMAL ; PRINT
    " = TWO HORIZONTAL STRIKES*";
    IF B = 4 THEN INVERSE
100 PRINT "STRIKE4"; NORMAL ; PRINT
    " = QUADRUPLE STRIKES*"; PRINT
    TAB( 15) "*" ONLY WITH NORMAL
    LETTERS"; IF C = 1 THEN INVERSE

110 PRINT "SMALL"; NORMAL ; PRINT
    " = SMALL LETTERS, UP TO 1
    32/LINE"; IF C = 2 THEN INVERSE

120 PRINT "NORMAL"; NORMAL ; PRINT
    " = NORMAL LETTERS, UP TO 8
    0/LINE"; PRINT ; IF D = 1 THEN
    INVERSE
130 PRINT "SPACEN"; NORMAL ; PRINT
    " = NORMAL SPACING BETWEEN
    LINES"; IF D = 2 THEN INVERSE

140 PRINT "SPACET"; NORMAL ; PRINT
    " = TIGHT SPACING BETWEEN L
    INES"; IF D = 3 THEN INVERSE

150 PRINT "SPACE0"; NORMAL ; PRINT
    " = NO SPACE BETWEEN LINES"
    ; PRINT ; PRINT "INVENT = I
    NVENTORY OF MX-80 SIGNALS"; PRINT
    ; PRINT "EDITOR = SHIFT TO
    APPLEWRITER'S EDITOR"
160 PRINT "PRINTER = SHIFT TO AP
    PLEWRITER'S PRINTER"; PRINT
    "QUIT = QUIT"; PRINT ; INPUT
```

Circle 408 on inquiry card.

Listing 1 continued:

```
170 IF B$ = "INVENT" GOTO 440
180 IF B$ = "STANDARD" THEN A =
1: GOTO 40
190 IF B$ = "ITALIC" THEN A = 2:
GOTO 40
200 IF B$ = "STRIKE1" THEN B = 1
: GOTO 40
210 IF B$ = "STRIKE2V" THEN B =
2: GOTO 40
220 IF B$ = "STRIKE2H" AND C = 2
THEN B = 3: GOTO 40
230 IF B$ = "STRIKE2H" GOTO 330
240 IF B$ = "STRIKE4" AND C = 2 THEN
B = 4: GOTO 40
250 IF B$ = "STRIKE4" GOTO 330
260 IF B$ = "SPACEN" THEN D = 1:
GOTO 40
270 IF B$ = "SPACET" THEN D = 2:
GOTO 40
280 IF B$ = "SPACE0" THEN D = 3:
GOTO 40
290 IF B$ = "SMALL" AND B > 2 GOTO
330
300 IF B$ = "SMALL" THEN C = 1: GOTO
40
310 IF B$ = "NORMAL" THEN C = 2
GOTO 40
320 GOTO 40
330 HOME : VTAB 12: PRINT "SMALL
LETTERS CANNOT BE": PRINT "
COMBINED WITH TWO HORIZONTAL
STRIKES.": PRINT : GOTO 490

340 PRINT A$"PR# 1": IF D < 3 THEN
PRINT D$;(4 - 2 * D);: GOTO
360
350 PRINT D$;"1";
360 E = 80: IF C = 2 THEN E = 81
370 PRINT D$; CHR$(84);D$; CHR$(
E); PRINT D$;: IF B < 3 THEN
PRINT CHR$(70);: GOTO 390

380 PRINT CHR$(69);
390 PRINT D$;: IF B = 1 OR B = 3
THEN PRINT CHR$(72);: GOTO
410
400 PRINT CHR$(71);
410 PRINT D$;(6 - A); PRINT A$"P
R# 0": PRINT A$"OPEN MX.STAT
US": PRINT A$"WRITE MX.STATU
S": PRINT A: PRINT B: PRINT
C: PRINT D: PRINT A$"CLOSE M
X.STATUS": IF B$ = "PRINTER"
THEN PRINT A$"BRUN PRINTER
"

420 IF B$ = "EDITOR" THEN PRINT
A$"BRUN TEDITOR"
430 END
440 HOME : PRINT TAB(9)"$ DEND
TES CHR$(27)=ESC": PRINT "ST
ANDARD FONT"; SPC(24);"$5":
PRINT "ITALIC FONT"; SPC(2
6);"$4": PRINT "SINGLE STRIK
"ENTER INSTRUCTION CODE: ";
B$: IF B$ = "QUIT" OR B$ = "
PRINTER" OR B$ = "EDITOR" GOTO
340
```

Listing 1 continued on page 170

Circle 409 on inquiry card.

Wizard-16K™

16K RAM APPLE MEMORY CARD

Unleashes your Apple II* and Apple II Plus* computer.

ON TO MAXIMUM MEMORY

Wizard-16K gives your 48K Apple II or Apple II Plus the last bit of directly accessible add-on memory it can accept. And, it interfaces with all Z80** cards to give you CP/M***.

- Fully compatible with Apple II and Apple II Plus
- Adds 16K bytes of Random Access Memory (RAM)
- Fully compatible with Z80 microprocessor cards for CP/M
- Used with Z80 card, it turns your Apple II into a two-microprocessor system with 56K of usable memory
- With a Z80 card, it lets you run BASIC-80****.

COBOL-80****, FORTRAN-80****, BASIC Compiler****, and Assembly Language Development System****, plus Applesoft BASIC*, Integer BASIC*, Apple Pascal System*, Apple FORTRAN* and Apple Pilot*

- Utilizes Apple DOS 3.3* 16-sector system to permit loading both Applesoft* and Integer BASIC*
- Compatible with VisiCalc*****
- Offers all features of Apple Language Card* (except Autostart ROM)

Available at all fine Computer Stores \$149.00

 **WESPER MICRO Systems**

SUBSIDIARY OF WESPERCORP

*Registered trademarks of Apple Computer Inc.

**Registered trademark of Zilog

***Registered trademark of Digital Research

****Registered trademarks of Microsoft

*****Registered trademark of Personal Software



System Notes

Listing 1 continued:

```
E"; SPC( 22);"F#H"
450 PRINT "TWO VERTICAL STRIKES"
; SPC( 15);"F#B"; PRINT "TW
O HORIZONTAL STRIKES"; SPC(
13);"H#E"; PRINT "QUADRUPLE
STRIKES"; SPC( 18);"E#B"; PRINT
"SMALL LETTERS (16.5/INCH,13
2/LINE) #T#P"
460 PRINT "NORMAL LETTERS (10/
INCH,80/LINE) #T#Q"; PRINT "
# WIDE LETTERS (8.25/INCH,66
/LINE) #B#P"; PRINT "# DOUBL
E LETTERS (5/INCH,40/LINE)
#Q#B"; PRINT "# RETURN PRINT
HEAD LEFT W/O LINEFEED #<"; PRINT
TAB( 8)"# THESE TERMINATE A
T END OF LINE"; PRINT "SPACE
6 LINES/INCH"; SPC( 19);"#2
"
470 PRINT "SPACE 8 LINES/INCH"; SPC(
19);"#0"; PRINT "SPACE #/72
/INCH (0<#<86)"; SPC( 10);"#
A #"; PRINT "SPACE #/216/INC
H (0<#<255)"; SPC( 9);"#3 #
"; PRINT "FORMFEED"; SPC( 23)
;"CHR*(12)"; PRINT "FORM LEN
GTH = # LINES (0<#<256) #
C #"; PRINT "SET HORIZONTAL
TABS"; SPC( 6);"#D #1 #2 ...
0"
480 PRINT "HORIZONTAL TAB MOVE";
SPC( 8);"POKE 49296,9"; PRINT
"SET VERTICAL TABS"; SPC( 8)
;"#B #1 #2 ... 0"; PRINT "VE
RTICAL TAB MOVE"; SPC( 14);"
CHR*(11)"
490 INPUT "PRESS 'RETURN' TO CON
TINUE. ";C#; GOTO 40
```

Text continued from page 166:

the first time it is run, I've included a brief program, shown in listing 2, that creates a status file. (Listing 2 also

Listing 2: This program creates a disk file, called MX.STATUS, that is accessed by the program in listing 1. You must run this short program prior to running the MX-80 printer program for the first time.

```
10 REM THIS PROGRAM CREATES
A FILE, MX.STATUS, OF
PARAMETERS THAT ARE
USED BY THE MX-80
PROGRAM.
20 A = 1:A# = CHR*(4); PRINT A#
"OPEN MX.STATUS"; PRINT A#"
RITE MX.STATUS"; PRINT A; PRINT
A; PRINT A; PRINT A; PRINT A
#"CLOSE MX.STATUS"
```

shows the italic font that is available with the Graftrax-80.)

The print-control program is designed for the Applewriter word processor, but can be adapted to other text editors by modifying lines 150, 160, 410, and 420. To use the program with Applewriter:

1. Enter S to save the text file.
2. Enter Q to quit Applewriter.
3. Enter RUN MX-80.
4. Turn on the printer.
5. Enter choices from the menu.
6. Enter Printer to quit the MX-80 program.
7. Enter L to load the text file.
8. Enter P to print.

Do not turn the printer off between running the print-control program and the actual printing because your choices will be lost as the printer resets to its default options (STANDARD, STRIKE1, NORMAL, SPACEN). You may switch the printer offline and manually advance the paper by pressing the formfeed or linefeed buttons without affecting the typeface settings. ■



THE 488+3 IEEE 488 TO S-100 INTERFACE

IEEE-488

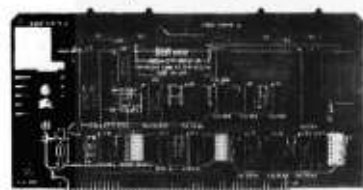

S-100

- Handles all IEEE-488 1975/78 functions
- IEEE 696 (S-100) compatible
- MBASIC subroutines supplied; no BIOS mods required
- 3 parallel ports (8255A-5)
- Industrial quality; burned in and tested
- \$375

(Dealer inquiries invited)

D&W DIGITAL

1524 REDWOOD DRIVE
LOS ALTOS, CA 94022 (415) 966-1460

Grab a byte at the 5 & 10



12 bites, unless
you're in a hurry

700 K or 350 K
floppy storage

5 or 10 Megabytes
hard disk storage



5 or 10 Megabytes in a desk-top micro

If you need 5 Megabyte capacity grab our **SUPERFIVE**[®]
Grab our **SuperTen** for 10 Megabytes and join the
hundreds of users world-wide.

- 12" CRT
- 5 or 10 Mbyte (formatted) 5 1/4" Winchester type hard disk
- Complete and ready to run with CP/M™ 2.2
- 700K or 350K floppy disk back up
- Dual Z-80A processors with 64K RAM
- 4 MHZ Clock frequency
- Dual RS232 ports
- Full ASCII keyboard, numeric pad, user-programmable function keys

CMC INTERNATIONAL

A Division of Computer Marketing Corporation

10058 Main • Suite 220 • Bellevue, WA 98004 • Phone (206) 453-9777 • Telex: 152556 SEATAC
Call or write for the dealers nearest you. Call Toll-Free 1-800-426-2963

Circle 77 on inquiry card.

Distributed by:

Compu Data
1 Bala Cynwyd Plaza
Bala Cynwyd, PA 19004
(215) 667-6843

Diversified Data
8043 W. 82nd
Indianapolis, IN 46278
(317) 253-5878

Input SRL
Chile 1830
1227 Buenos Aires, Argentina
Telex: 9191 FINCO

Featherbed (Pty.) Ltd
156 Main Reef Road
Johannesburg, South Africa

Dialog Computer Treuhand
Seeburgstrasse 18
6002 Luzern
Switzerland
Telex: 72227 DCL

Graphics II by Selanar

High-Resolution Hard Copy from a DECwriter

Daniel Macero, Daniel Holmes
Thomas Banks and Lloyd Burgess
Department of Chemistry
Syracuse University
Syracuse, NY 13210

A picture, a thousand words, or both—that's what you can print out on a DECwriter II terminal outfitted with the Selanar Graphics II attachment. This versatile modification provides a host of features for the DECwriter (by Digital Equipment Corporation): high-resolution graphics, bidirectional linefeed, multiple character sets, the ability to print standard, boldface, and double-width characters that can be rotated in any one of four directions, and several other useful options that cost extra if purchased from DEC.

Our interest in this unit began when we saw it featured in the new-products section of a digital-electronics trade magazine. We were es-

pecially interested in the claim that, with this attachment, a dot could be printed anywhere on a standard DECwriter page and that up to 1,045,440 points could be addressed. For \$850 (less a 5 percent educational discount), this seemed like a low-cost way to high-resolution graphics, so we ordered a Graphics II modification from Selanar Corporation.

In less than three weeks the unit arrived. The box contained the Graphics II circuit board, a power cable consisting of three wires: blue, black, and orange (the same color-coding used by DEC), six #8 nylon screws and nylon washers (already attached to the circuit board), and a user's manual.

Installation and Testing

With the help of the user's manual, installing the Graphics II board was simple and straightforward. First, we examined the board for any damaged or loose components. (The manual

provides a list of likely sources of trouble.) In our case, we found the ground connection of the TTL (transistor-transistor logic) interface socket (J4) to be loose and had to touch it up with a bit of solder; otherwise, everything was in order.

Next, the board was prepared for installation by selecting from the several available jumper options (i.e., parity, bell, serial interface, and data-transfer rate). Step-by-step instructions are accompanied by two full-page photographs that show the inside of the DECwriter before and after installation of the Graphics II board. The photos are invaluable for locating and identifying the various components important to the installation.

Following the instructions given in the user's manual, the original DECwriter board was removed. (A screwdriver is all that is necessary for this and the following operations.) The Graphics II board was attached to the

DEC and DECwriter are trademarks of Digital Equipment Corporation, Maynard, Massachusetts.

Graphics II is a registered trademark of Selanar Corporation, Santa Clara, California.

Now it can be Revealed

GBS

The business software that solves problems your way.

So useful and
adaptable it's like
having an Award
Winning programmer
on staff.

What is GBS?

GBS is both a powerful, relational data base management system . . . and, more importantly, a very powerful applications development tool. As such, it can deliver programs that match your specific business requirements . . . not just those of the average business. The final result is increased productivity now and in the future.

Surprisingly Easy to Use

GBS has been honed and refined for two years, so it meets the needs of the user who wants programs that work without a lot of computerese! To that end, GBS operates with a simplified fill-in-the-blanks approach. The user merely fills in blanks and GBS does the rest . . . acting like an in-house programming whiz!

Since you need know **only 15 instructions** to utilize the full scope of GBS you should be able, after studying our exceptional documentation for a few hours, to develop your own business programs . . . general ledger, inventory control, order entry, job costing and more.

Relational Data Base

Management of business records is a must for profitability. GBS handles it for you with unbelievable accuracy, speed and ease. For example, three data files of up to 64 thousand records and 1 million characters can be concurrently in use . . . and multiple indexes fully maintained (yes, fully maintained!). GBS . . . truly the quality solution in business software.

Only \$700. On disk, including documentation.
Requires CP/M*

Dealer and distributor inquiries invited.



QUALITY SOFTWARE
6660 Reseda Blvd., Suite 105
Reseda, Calif. 91335
(213) 344-6599



Circle 328 on inquiry card.

*CP/M is a trademark of Digital Research.

MBC SYSTEMS Inc.

(203) 342-2747

COMPUTERS

ONYX C8002	
256K 10 MEG HD	\$13590
" " 18 MEG HD	\$14990
ALTOS SYSTEMS	
ACS 8000-2 1 MEG FD	\$2990
ACS 8000-6 14 MEG HD	\$8990
ACS 8000-10 10 MEG HD	\$6895
COMMODORE	
CBM 9000 SUPERPET	\$1699
CBM 8300 LETTER QUALITY	\$1990
CBM-64 CP/M, 64K, GRAPHIC	\$ TBA
CBM 8023 (132COL, 150CPS)	\$ 799
CBM 8052 2 MED FD	\$ TBA
ATARI	
800 16K	\$ 749
400 16K	\$ 349
ZENITH	
Z-89 GA	\$2068
Z-89 ALL-IN-ONE-SYSTEM	\$2275
HEWLETT-PACKARD	
HP-85	\$2395
HP-83	\$1790
HP CALCULATORS - 20% OFF	\$\$\$
XEROX SYSTEMS	
810 5 1/4 FLOPPY SYS	\$2395
820 8 " FLOPPY SYS	\$2990
NORTH STAR	
HRZ-1Q-64K-HD5 SAVE	\$1600 \$\$\$
ADVANTAGE 64K-QD	\$3550
INTERTEC SUPERBRAIN	
64K-DD	\$2775
64K-QD	\$3180

DISKETTES	
SINGLE SIDE (BOX OF 10)	\$24.50
DOUBLE SIDE (BOX OF 10)	\$35.00
CABLES- RS232 M/M 6'	\$17.95
M/F 6'	\$18.95

PRINTERS

OLYMPIA ES-100 TYPEWRITER	
WITH, RS-232, PARALLEL, IEEE	\$1250
IDS PRISM-80 (200CPS) F/T	\$ 999
560-G 132COL	\$1090
PRISM-132 COLOR F/T	\$1690
CENTRONICS 739-1	\$ 560
739-3	\$ 675
OKIDATA MICROLINE 82A	\$ 495
MICROLINE 83A	\$ 749
EPSON MX-80, MX80-F/T, MX-100	\$\$\$
IN STOCK INCLUDING CARDS&CABLES	
ALWAYS COMPETITIVELY PRICED	\$\$
C. ITOH	\$1499
DIABLO 630	\$1990
NEC SPINWRITER 7710/7730	\$2590
NEC SPINWRITER 3510/3530	\$1950
NEC SPINWRITER 7720 KSR	\$2890
ANADIX 9500/9501	\$1199

TERMINALS

TELEVIDEO 920C	\$ 775
912C	\$ 695
950	\$1050
ZENITH Z-19	\$ 820

ABOVE ITEMS MAY BE ORDERED BY MAIL OR PHONE. FACTORY SEALED, MANUFACTURERS WARRANTY INCLUDED
-----PRICES SUBJECT TO CHANGE-----

(203) 342-2747 MULTI-BUSINESS COMPUTER SYSTEMS INC.

28 MARLBOROUGH STREET
PORTLAND, CONN. 06480
TWX/TELEX 710-428-6345

six mounting points on the DEC-writer back panel using the attached nylon hardware. The cables provided with the DECwriter were then connected to the new circuit board and the three-wire cable was connected to

the terminal's power supply. This completed the assembly of the unit.

Sufficient warnings are included at each step to insure a virtually foolproof installation. Total installation time was about 30 minutes. After verifying that all connectors to the Graphics II board and all components on the board were secure, and that there were no loose parts, tools, or other items left on the circuit board or in the internal cabinet area of the terminal, the unit was ready for testing.

The testing procedure is straightforward and can be done without sophisticated test equipment. By switching the DECwriter to local operation, the user can run through the various features, including graphics, and verify that everything is working properly. Once everything is operational, the I/O (input/output) interface is checked and the printer is ready to use.

Printer Adjustment

Our unit worked immediately and we were soon printing out the different character sets in boldface and double-width; however, some characters did not seem well formed. In addition, the tractor drive had a tendency to slip. The character problem, we were told, was caused by minor variations in parts such as the drive and stepper motors used in different DECwriters; this can result in different levels of performance depending on the user's specific terminal. To compensate for these variations, the Graphics II unit has built-in adjustments that can be set to obtain optimum performance. An oscilloscope, preferably one with dual-trace capability, is necessary for making these adjustments. The procedure outlined in the user's manual gives two types of adjustments: print columns and print-speed control. In our case, we simply adjusted the forward and reverse print-speed controls and the characters printed out perfectly.

In operation, the enhanced DEC-writer can function as an unmodified terminal, as a terminal featuring many of the options offered by DEC at extra cost, and in the graphics mode (a completely new feature). System commands are selected by

At a Glance

Name

Graphics II

Use

Enhancement to the DECwriter II printer

Manufacturer

Selanar Corporation
3054 Lawrence Expressway
Santa Clara, CA 95051

Dimensions

48.3 x 26.7 cm (19 x 10.5 inches)

Price

\$895

Hardware Needed

DECwriter LA35 or DECwriter LA36

Software Needed

None

Hardware Options

Precision tractors, \$50 extra

Documentation

50-page manual, includes schematics

Audience

DECwriter owners desiring high-resolution hard-copy graphics

Features

Print speed: character mode, average 36 cps—graphics mode, average 1 ips; transmission rates: selectable to 1200 bps, with X-on and X-off; interfaces: 20 mA current loop, EIA RS232, TTL (for modem); line length: character mode, 132 characters—graphics mode, 1320 dots; spacing: character mode, horizontal, 10 cpi—vertical, 6 lpi; graphics mode: horizontal, 100 dots per inch—vertical, 72 dots per inch; four complete character sets including uppercase and lowercase: ASCII character set, APL character set, Math/Greek character set, user-defined character set (load from keyboard or computer into memory); boldface: all characters; four rotations: all characters; double width: all characters

Paper

Variable width 7.6 cm (3 inches) to 37.8 cm (14 7/8 inches); up to 6-part forms 0.020 in maximum thickness; tractor-drive line feed

Power Requirements

120 V AC 50/60 Hz



“We provide business programs as individual as your business needs.”

“Allow me to introduce myself. I’m a Vector computer, dedicated to the advancement of society. And I’d like to tell you how a computer can help you manage your business more efficiently. Especially if that computer is a Vector, like me. Because we’re probably the most flexible and cost-effective computers you can find.

“Our programs are the key. Because they enable me to handle sales forecasting, budgeting, job costing and proposals, commissions, personalized mass mailings, charts and graphs. We Vectors can even talk to each other and to other bigger computers.

“Unique combinations of our individual programs can actually customize me to meet your specific requirements. Any combination of our software packages can be assembled right off the shelf, to help you realize your full potential as a salesman, merchant, stockbroker, clergyman, contractor, real estate or insurance agent or whatever your business.

“Choose from Memorite III for word processing and mail list management, Execuplan for financial planning and forecasting, Business Accounting, Data Management for filing and sorting information, Communications and a host of others. And, of course, all we Vectors come with the popular CP/M operating system.

“For more information and your local dealer, call us at (805)499-5831 or (800)235-3547. In California, call (800)322-3577. Or write to us at 500 North Ventu Park Road, Thousand Oaks, CA 91320.

“We’ll show you how we small information systems can mean big business for you!”

Circle 400 on inquiry card.

VECTOR

Vector Graphic, Inc.

COMPUTERS FOR THE ADVANCEMENT OF SOCIETY.

Sold and supported by 400 dealers worldwide.
Vector Products are approved on General Services Administration authorized ADP scheduled price list.

Control Code	Name	Description
cL	Form feed	Advance paper to beginning of next form (top of page).
cN	APL character set	Selects second character set (factory set with APL characters). Once selected, all characters printed are as defined from this PROM.
cO	Normal character set	Selects normal character set.
ESC 5	Print entire character set	Test mode.
ESC 7	Upside-down print mode	Rotates characters 180°.
ESC 8	Sideways I print mode	Rotates characters 90°.
ESC 9	Sideways II print mode	Rotates characters 270°.
ESC 0	Double-width characters	Prints double-width characters.
ESC A	Boldface characters	Prints each character in boldface.
ESC C	Special reset	Returns DECwriter to normal configuration.
ESC F	Power-up reset	Resets all modes, character styles, tabs, and top of form (also occurs at power-up).
ESC G	Up 1/4 line	Moves paper up 1/4 line at a time.
ESC H	Down 1/4 line	Moves paper down 1/4 line at a time.
ESC N	Third character set	Selects third character set (factory set for mathematics symbols and selected Greek letters).
ESC P	Fourth character set	Selects fourth character set as defined in programmable memory.
ESC Q	Load-memory character set	Defines fourth character set to be loaded into programmable memory.
ESC B	Enter graphics mode	Enters graphics mode. All characters ignored except "(" ":", ":", ":", ":", and digits 0 through 9. In graphics mode, prints all seven dots instead of one at a time.
ESC J	Set bar mode	
ESC C	Exit graphics mode	

Table 1: Command codes used by the LA36 DECwriter II with the Selanar Graphics II modification. Codes in the table preceded by a lowercase "c" are entered by holding down the Control key while entering the indicated code (similar to the standard procedure for typing any uppercase letter by using the shift key). Other codes are entered by typing ESC (escape) followed by the indicated letter.

either a Control code or an ESC (escape) code. The Control code is obtained by simultaneously pressing the Control key and another key to select a given function. The ESC code is a two-step operation: first the ESC key is pressed, then the key that selects the desired function. Pressing ESC a second time cancels this command sequence. Table 1 is a list of some of the more important ESC and Control commands that function in the normal (nongraphics) and graphics modes.

Other system commands that can be implemented with Graphics II are horizontal tab control (advances the print head to the next column position with a set tab); vertical tab (advances the paper vertically to the next line with a vertical tab); set horizontal tab (sets a tab where the head is positioned, up to 16 tabs may be set); reset horizontal tab (resets the individual horizontal tabs at each desired head position); set vertical tab (sets a tab to any one or all of 16 vertical tab positions); and reset vertical tab (resets an individual vertical tab at the present position of the print head).

In addition, you can activate the bell, reset the top-of-form position, enable the automatic linefeed with carriage return, backspace, and issue a special *Here-is* message where up to

64K-256K Parity Memory for IBM Personal Computer
\$495 Includes one year warranty
 Single quantity price for MP-064

- Also available:**
- (A) 2-Port, RS 232; Capable of ASYNC, BISYNC, SDLC & HDLC Model: CC-232 \$240
 - (B) Wire-wrap Development Kit (w/w board & Extender) Model: WW-070 \$95

Available Soon:
 64K-256K Error Correcting Memory

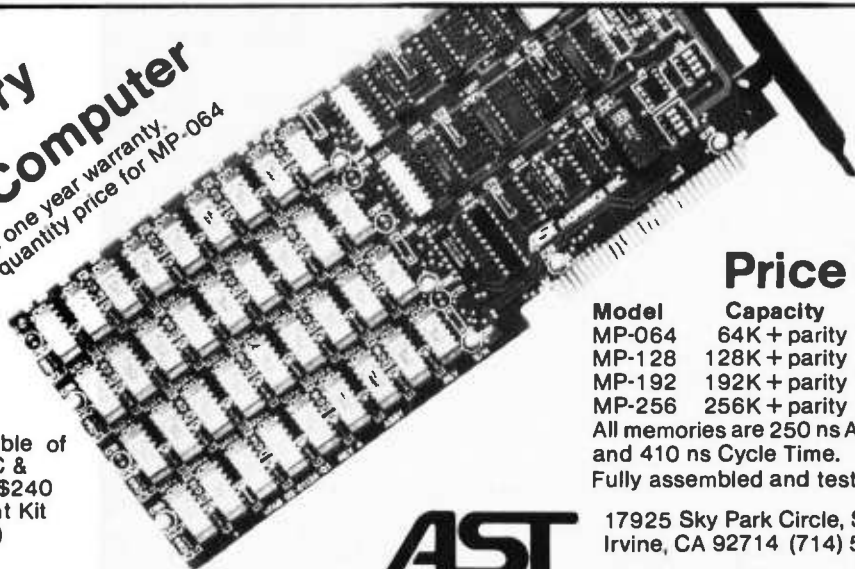

Price

Model	Capacity	Unit Price
MP-064	64K + parity	\$ 495
MP-128	128K + parity	\$ 995
MP-192	192K + parity	\$1295
MP-256	256K + parity	\$1595

All memories are 250 ns Access Time and 410 ns Cycle Time. Fully assembled and tested.

AST
RESEARCH INC.

17925 Sky Park Circle, Suite B
 Irvine, CA 92714 (714) 540-1333

Dealer inquiries welcome.



VistaVision 80

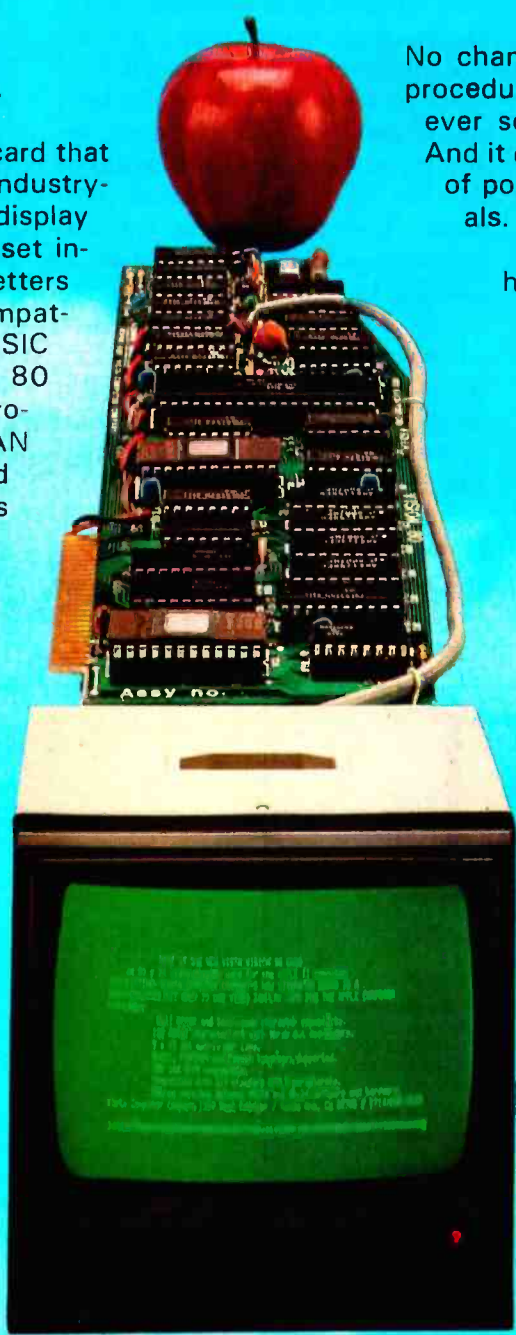

Invisible or Invincible?

It all depends on your perspective.

The Vision 80[®] is a video display card that gives your Apple[™] terminal an industry-standard 80 column by 24 line display screen with a full 128 character set including upper and lower case letters with three dot descenders. It is compatible with all existing Apple[™] BASIC software and allows the use of 80 column lower case text with programs written in BASIC, FORTRAN Pascal, Microsoft CP/M[™] and ASSEMBLER. Full communications driver support allows the Apple II[™] to operate as an intelligent terminal

Definitely invincible. Ask Softalk magazine editors, who rated Vision 80[®] the Best Apple-video display card on the market.

But the Vision 80[®] card has an "Apple" command vocabulary including H-tab, V-tab, HOME, TEXT, PR# GRAPHICS).

No changes in operating or programming procedures are necessary to produce whatever sophisticated displays you require. And it doesn't interfere with the operation of popular Apple[™] compatible peripherals. Except for the enhanced display, it's as if you had never installed the Vision 80[®] in your Apple II[™] computer.

Definitely invisible.

Ask your local computer dealer for a demonstration of the invincible, invisible Vision 80[®] video display card by Vista Computer Company. Or correspond with us directly: Vista Computer Company, Inc. 1317 East Edinger, Santa Ana CA 92705, (714) 953-0523. Toll free order line: (800) 854-8017.

Be sure to inquire about our new Vision 40, a softscreen programmable character generator for Apple II[™] computers. It's great for graphics and perfect for foreign language applications.

Perceptive Perspective

Vista

COMPUTER COMPANY, INC.

1317 East Edinger • Santa Ana, CA 92705
714-953-0523 800-854-8017

Circle 404 on Inquiry card.

©1981 Vista Computer Co., Inc.

Apple and Apple II are trademarks of Apple Computer Inc.

www.americanradiohistory.com

CP/M is a trademark of Digital Research Inc.

32 characters encoded in PROM (programmable read-only memory) are transmitted as if from the keyboard (e.g., for an automatic password sign-on to a remote computer).

"Normal" Printing Operations

In the printing mode the Selanar Graphics II acts as a normal DEC-writer printer with enhanced capabilities. We can select any one of four character sets: standard, APL, mathematical, and user-defined. The first three sets are encoded in PROM, the fourth is stored in programmable memory. The fourth character set may be loaded from the host computer or entered manually from the keyboard; once loaded, it remains in memory until the DECwriter is turned off.

The programmable character set can contain up to 94 printable characters. Each of these is represented as a 7-by-7 dot matrix with the top dot corresponding to the most significant bit and the bottom dot to the least.

Seven bytes are required to define each character: one for each column of the matrix. For convenience in entering characters from the keyboard, each byte can be entered as an ASCII (American Standard Code for Information Interchange) character.

Using the boldface character option, we are able to emphasize words and headings, or even print out an entire document in this type style for a more pleasing appearance. Figure 1 shows the first three character sets and the various type styles available with the Graphics II enhanced DEC-writer. The one-quarter-up and one-quarter-down linefeed option is invaluable for printing the superscripts or subscripts that are often necessary when writing chemical or mathematical equations (see figure 1), as well as printing chemistry manuscripts, examinations, and writing computer-assisted instruction units.

Data Buffer

The Graphics II unit also has a

1000-character buffer for serial I/O. In this mode, the printer will automatically print characters as fast as it can. Data not ready for printing will be temporarily stored in the buffer; however, the programmer must be careful not to overflow the buffer. To prevent this, an X-off character is sent to the host computer when the buffer is filled to within 100 bytes of overflow; an X-off character is then sent for every additional character received. When the buffer is emptied to fewer than 100 characters, an X-on character is transmitted. Thus, the programmer does not have to worry about overflowing the buffer or other timing considerations, and data transfer rates of up to 1200 bps (bits per second) are possible. The X-on/X-off option need not be used if the programmer is careful to take into account the time needed to execute a carriage return and line feed, horizontal tab, vertical tab, graphic vectors, and Here Is, to avoid overflowing the buffer.



TELEX LINK

Telecommunications package to interface your Microcomputer to the Western Union Telex II (TWX) Network. Your outgoing messages are edited to perfection using your text editor, and are then formatted and sent by TXL.



Incoming messages are received, displayed on your CRT, stamped with the current date & time, and written to disk storage.

Order TXL today and put the power of your Micro-computer to work on your most important communications!

(Currently requires Z-80 CPU and CP/M)

TXL: Telex Link is available now for Telex II (TWX) from: Our Dealer: John D. Owens Assoc. (See their ad elsewhere) or direct from:

Cawthon Scientific Group
 24224 Michigan Ave.
 Dearborn, Michigan 48124
 Phone: 313-565-4000 Telex II: 810-221-1265

GRAPHICS II CHARACTER SETS

STANDARD

```
!@#%&'()*+,-./0123456789:;<=>?
ABCDEFGHIJKLMNOPQRSTUVWXYZ[\]^_
`abcdefghijklmnopqrstuvwxyz{|}~
!@#%&'()*+,-./0123456789:;<=>?
ABCDEFGHIJKLMNOPQRSTUVWXYZ[\]^_
`abcdefghijklmnopqrstuvwxyz{|}~
```

```
!"#$%&'()*+,-./0123456789:;<=>?
ABCDEFGHIJKLMNOPQRSTUVWXYZ[\]^_
`abcdefghijklmnopqrstuvwxyz{|}~
!"#$%&'()*+,-./0123456789:;<=>?
ABCDEFGHIJKLMNOPQRSTUVWXYZ[\]^_
`abcdefghijklmnopqrstuvwxyz{|}~
```

MATHEMATICS

```
!@#%&'()*+,-./0123456789:;<=>?
ABCDEFGHIJKLMNOPQRSTUVWXYZ[\]^_
`abcdefghijklmnopqrstuvwxyz{|}~
!@#%&'()*+,-./0123456789:;<=>?
ABCDEFGHIJKLMNOPQRSTUVWXYZ[\]^_
`abcdefghijklmnopqrstuvwxyz{|}~
```

APL

```
~)(<=>]v^*+,-./0123456789:;<=>?
ABCDEFGHIJKLMNOPQRSTUVWXYZ[\]^_
`abcdefghijklmnopqrstuvwxyz{|}~
!@#%&'()*+,-./0123456789:;<=>?
ABCDEFGHIJKLMNOPQRSTUVWXYZ[\]^_
`abcdefghijklmnopqrstuvwxyz{|}~
```

CHEMICAL EQUATIONS

(2) $Cu^{2+} + 2e^{-} \rightarrow Cu(s) + Cl_2(g)$

Figure 1: The character sets and type styles preprogrammed into the Graphics II modification. Under the Normal printing mode, subscripts and superscripts can be printed easily with the 1/4 linefeed capability, and characters may be printed as boldface, large, or double width.

How to maximize your Model III:

You don't have to settle for standard equipment. Let MTI and Alpha Byte help you build the Model III you want.

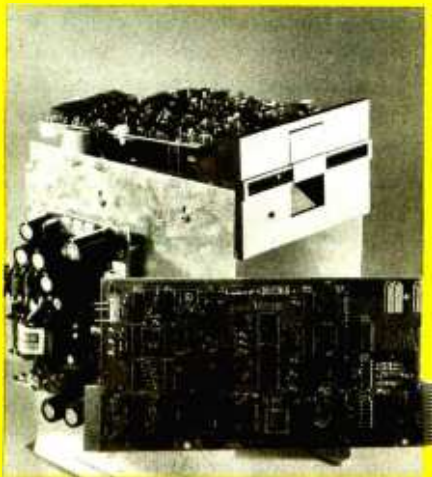

MTI FLOPPY DISK ADD-ON KITS

Now you can upgrade your 16K level II Model III to a full 48K Disk System the easy way with MTI's Double Density Disk Controller and your choice of Disk Drives. You can choose 40 track, Double-Sided 40 track or Double-Sided 80 track Drives to supply your disk storage needs. Forty Track Drives store 175K, Double-sided 40 Track drives store 350K. Four Double-Sided 80 Track Drives provide up to 3 MEGABYTES of On-Line storage.

INTERNAL DISK DRIVE KITS

The first drive kit includes one Tandon Disk Drive, MTI Double Density Controller, Switching power supply, 32K of RAM, all mounting hardware, cables and Detailed Installation Instructions. The second internal drive kit includes a second drive and the necessary installation hardware.

40 TRACK DRIVE SYSTEM	
DRIVE NO 1 KIT	695 00
DRIVE NO 2 KIT	279 00
40 TRACK DUAL HEAD SYSTEM	
DRIVE NO 1	779 00
DRIVE NO 2	389 00
80 TRACK DUAL HEAD SYSTEM	
DRIVE NO 1	929 00
DRIVE NO 2	569 00

EXTERNAL DRIVE KITS

Two external drives can be attached to any dual drive Model III Computer.

40 TRACK EXTERNAL DRIVES	
DRIVE NO 3	379 00
DRIVE NO 4	359 00
DUAL HEAD 40 TRACK EXTERNAL DRIVES	
DRIVE NO 3	499 00
DRIVE NO 4	479 00
DUAL HEAD 80 TRACK EXTERNAL DRIVES	
DRIVE NO 3	679 00
DRIVE NO 4	659 00

FIVE MEGABYTE EXTERNAL WINCHESTER HARD DRIVE 2795.00

Add the Ultimate in Fast High Capacity Disk Storage to any Model III Floppy Disk system. Reliable Winchester technology provides enough storage for the largest business files. Winchester disk drives have greatly increased data transfer rates and that means faster program and file loading. This is a complete self contained system that connects to a standard Model III Disk System in minutes without any modification to the computer.

MODEL III DIAGNOSTIC PROGRAM 49.95

A complete diagnostic program for the Model III. Tests RAM and ROM, video display and all disk drives. Catch problems while they're small and be sure that your Model III is in perfect running condition.

MODEL III CP/M-80 NOW AVAILABLE! . . . 849.00 CP/M® & 80 Column Kit.

Now you can run proven CP/M based software on your Model III, with standard 80-column display. A simple internal modification will transform your Model III into a NEW computer and allow you to run CP/M the industry-standard operating system and assure you of a large supply of fine software. Includes CP/M 2.2.

MODEL III SPEED-UP MOD 149.00

Now you can run your Model III at 4 MEGAHERTZ, that's almost double the standard speed. This simple-to-install kit does require some soldering.

MODEL III COOLING KIT 44.95

Heat build up is a major cause of system failures and 'flakey' operation. This kit provides excellent cooling.

DOSPLUS OPERATING SYSTEMS FOR THE MODEL III

Solid BUG-FREE operating systems for the Model III. Supports different size drives on the same system and Basic Program Chaining with variables saved in memory.

40 TRACK	99 00
80 TRACK	119 00
EXPANDED DOSPLUS 3.3.8	149 00
Read and Write 40 Track Diskettes on an 80 Track System	149 00
HARD DISK DOSPLUS	299 00
Supports the MTI 5 MEG HARD DISK	
CP/M is a reg. trademark of Digital Research	

Alpha Byte

COMPUTER PRODUCTS

We guarantee everything for 30 days. If anything is wrong, return the item and we'll make it right. And, of course, we'll pay the shipping charges.

We accept Visa and Master Card on all orders; COD orders, up to \$300.00.

Add \$2.00 for standard UPS shipping and handling on orders under 50 lbs, delivered in continental U.S. Call for shipping charges over 50 lbs. Foreign, FPO and APO orders add 15% for shipping. Californians add 6% sales tax.

Prices quoted are for stock on hand and are subject to change without notice.

31245 LA BAYA DR, WESTLAKE VILLAGE, CALIFORNIA 91362

To order, or for information, call:
(213) 706-0333

To use our 24-hour modem order line, call: (213) 883-8976.

(2a)

THE GRAPHICS MODE

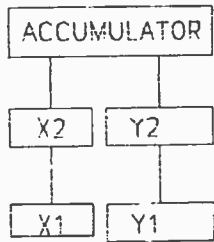

GRAPHICS COMMANDS

- (X2 TO X1, Y2 TO Y1,
CLEAR ACCUMULATOR
 - , ACCUMULATOR TO X2, AND CLEAR
 - . ACCUMULATOR TO Y2, AND CLEAR
 -) DRAW LINE FROM X1,Y1 TO X2,Y2
- POSITION PRINT HEAD TO X1,Y1

(2b)

EXAMPLES USING GRAPHICS COMMANDS

LOCAL - (800,200.(900,)(1000,150.)

BASIC - LPRINT "(";STR\$(800);",";STR\$(200);".(";STR\$(900);
",)" ;STR\$(1000);",";STR\$(150);")"

LOCAL - (900,500.(1000,450.)800,450.)800,550.)1000,550.)

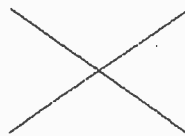

Figure 2: Graphics-mode sample output. Figure 2a gives a summary of the graphics command procedures, as printed in the graphics mode. Figure 2b shows how straight lines are drawn.

Graphics Operation

The graphics mode is entered at any time with an ESC B and exited with a ESC C command. Graphics are done a page at a time, with each page consisting of 792 lines with 1320 dots per line. The origin (0,0) is located at the upper left-hand corner of the page; the bottommost right-hand corner corresponds to the point (1319,791).

In the graphics mode, the system responds only to the digits 0 through 9, parentheses, the right bracket, the comma, and the period; all other characters are ignored.

The comma transfers the previously entered number from the accumulator to the X2 register and then clears the accumulator. A left parenthesis copies X2 into X1 and Y2 into Y1 and also clears the accumulator; a right parenthesis is the command for drawing a line between X1,Y1 and X2,Y2. This sequence of operations is summarized in figure 2a. Examples of lines drawn using these commands are shown in figure 2b. Also illustrated is a BASIC print statement that shows the method of drawing lines under program control. Note that a comma indicates that the number preceding it is an ordinate value and a period indicates that the preceding number represents an abscissa.

Thus, (A,B.(C,D.) will draw a line between A,B and C,D; (A,B.(C.) draws a horizontal line between A,B

ACT-85

THE CP/M* TERMINAL WITH BUILT IN LOCAL NETWORK



*CPM is a registered trademark of Digital Research

NETWORK

- access to all printers and disks from any terminal
- CP/M* runs in each terminal
- single twisted shielded pair up to 1500 feet
- 880,000 baud SDLC protocol
- 32 terminals per line

MONITOR

- 12" monitor
- 24 lines of 80 characters
- reverse video
- highlighting
- blinking
- underlining
- separate keyboard
- 38,400 baud effective speed

MASS STORAGE

- 0 to 8 drives in each terminal:

FLOPPIES

SHUGART
400, 410, 450
460, 801, 851

WINCHESTERS

5 1/4" - 5, 10 or 15 Megabyte
8" - 10, 20, 30 or 40 Megabyte

COMPUTER

- 8085 cpu
- 10 mhz crystal
- 64 K ram
- two RS-232 ports

autocontrol
INCORPORATED

11400 Dorsett Rd.
St. Louis, MO 63043
(314) 432-1313

THE ANN ARBOR AMBASSADOR™

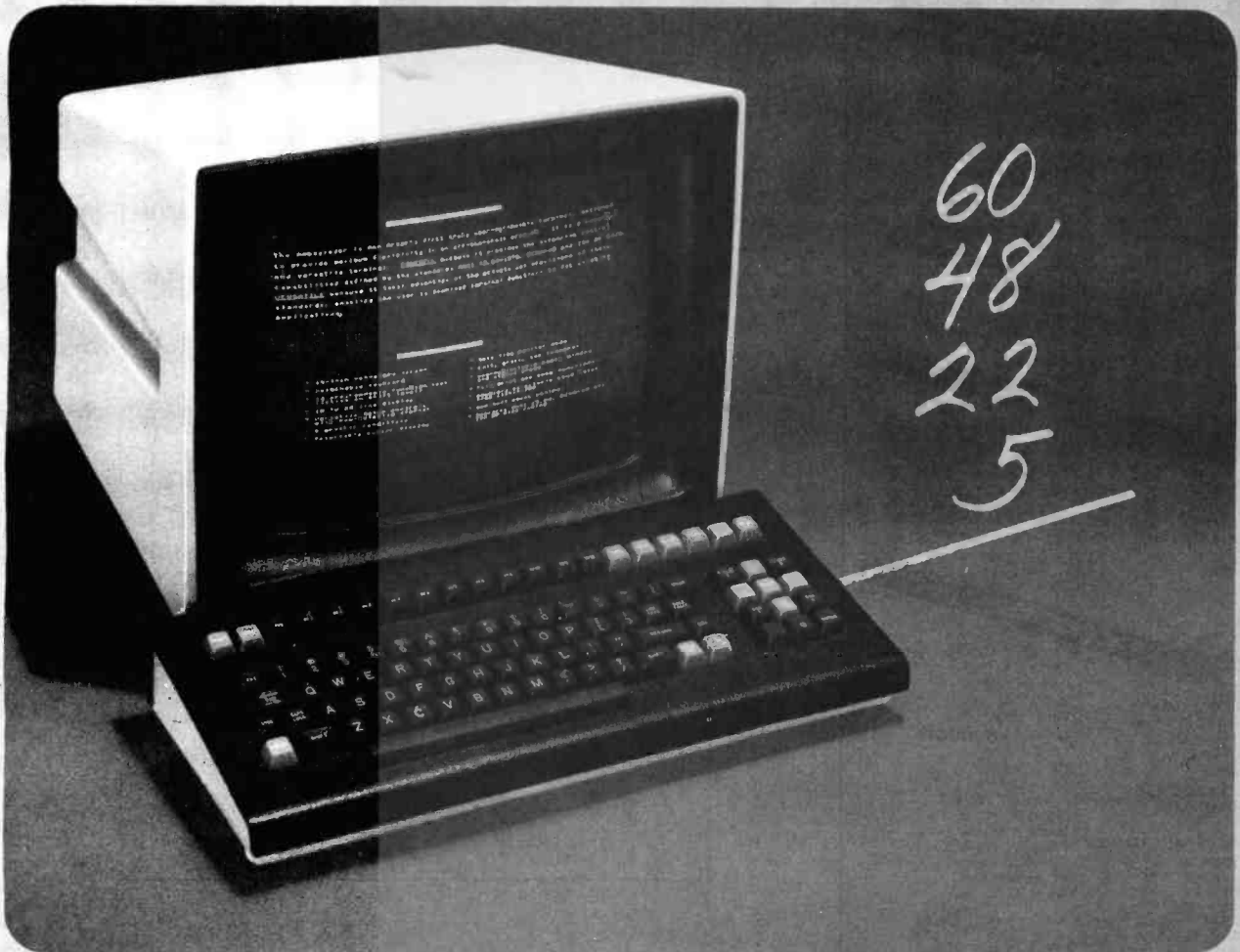

IT ALL ADDS UP...

to Full Capability in a Full Page Display

The Ann Arbor Ambassador offers you a combination of features unmatched in its price range. Its **60-line display** lets you see more of your program or report; and it's selectable from the keyboard or host. There are other user-friendly features, too—**48 programmable function keys**, **22 operator convenience modes**, **5 graphic renditions**, protected and guarded areas, erase and edit controls, local and remote printer output, block and character transmission.

Call Ann Arbor Terminals for more information at (313) 663-8000



6175 JACKSON ROAD • ANN ARBOR, MICHIGAN 48103 • TEL: 313-663-8000 • TWX 810-223-6033

Buy with Confidence from the best

GREAT PRICES. GREAT SERVICE. GUARANTEED
COMPUTERS, PRINTERS, TERMINALS

Apple
IEEE-488
card now
available

CALL TOLL FREE: 1 800 421-1520
In Calif. 213 320-4772

COMPUTERS & TERMINALS
CALL TOLL FREE FOR PRICES

COMPUTERS:

- Altos
- Apple
- Atari
- Commodore
- Hewlett-Packard
- B.M.C
- Interlec/Superbrain
- N.E.C.
- Northstar
- Onyx
- Point Four
- Sharp
- Televideo
- Vector

Xerox
Zenith

**VIDEO TERMINALS
& MONITORS:**

- ADDS
- Amdek
- Ampex
- Apple
- B.M.C.
- Hazeltine
- I.B.M.
- Lear-Siegler
- N.E.C.
- Sanyo
- Soroc
- Televideo
- Zenith



PRINTERS

THERMAL

- Apple
- Trendcom

DOT MATRIX

- Anacom
- Anadex
- Centronix
- Commodore

- Epson
- I.D.S./Paper Tiger
- Microline/Okidata
- M.P.I.
- Novell
- Texas Instruments

LETTER QUALITY
Diablo/Xerox
N.E.C



ACCESSORIES

**80 COLUMN
VIDEO CARDS**

- Double Vision
- Smart-Term
- Videx

**LOWER CASE
ADAPTERS**

- Dan Paymar

INTERFACE CARDS

- Apple
- California Computer
- Mountain Computer
- Microsoft
- S.S.M. Products
- Thunderclock

LANGUAGES

- Basic Compiler
- C.I.S. Cobol

- CP/M
- Fortran
- Pascal
- Vanguard AP/L

OTHER PRODUCTS

- Bar Code Readers
- Card Readers
- Game Controls
- Graphics Tablet
- Music System
- Numeric Keypads
- Programming Aids
- Type-and-Talk
- Video Digitizers
- Voice Entry

The best non-technical
"How to Choose a Computer
Book for Laymen." \$12.95.
Complete Directory for
Apple Software only \$14.95.

PRINTERS - MONITORS

NEW
MX 100 &
MX 80 F/T

MONITORS

- BMC & NEC Green Screen
- NOW IN STOCK

EDUCATORS

- We have the CORVUS
systems to hook up several
Apple computers at once!

NEC & DIABLO PRINTERS

- Anadex, Paper
Tiger CALL
for latest prices

The new 136
column Epson
printer with graphics and the
Friction/tractor MX 80 are in
stock. WE HAVE THE GRAPHIC
PACKAGE FOR MX 80 coll.
SILENTYPE PRINTER
ONLY \$284.00

ACCESSORIES - SOFTWARE

SOFTWARE

- Vidcalc 3.3 \$159 Reg \$199
- BPI GL INV AR etc 299/Reg 399
- Tax Preparer by Howardsoll 79/Reg 99
- Real Estate Analyzer/Howardsoll 125/Reg 150
- Creative Financing Howardsoll 125/Reg 150
- ASCII Express II by SDS 55/Reg 65
- 2-TERM (CPM) 116 sector 85 Reg 100
- TRS 80 & ATARI SOFTWARE TOO

Amazing Mountain Hardware
CPS Multi-function card
ALL IN ONE:
Parallel/Serial/Clock/Calen

- PLOTTERS
- Bausch&Lomb plotters
- for your computer by
- Houston Instruments
- CALL

CALL TOLL FREE

1(800)421-1520
In Cal (213)3204772

20% OFF ALL SOFTWARE

Visit our retail store
Net Profit Computers
521 W Chapman Ave
Anaheim, Cal 92802
714 750-7318

Mail orders ONLY:
NET PROFIT COMPUTERS
2908 Oregon Court, Bid G1
Torrance, Ca 90503
1(800)421-1520
in Cal 213 320-4772

Prices may change without notice

LETTER DAT

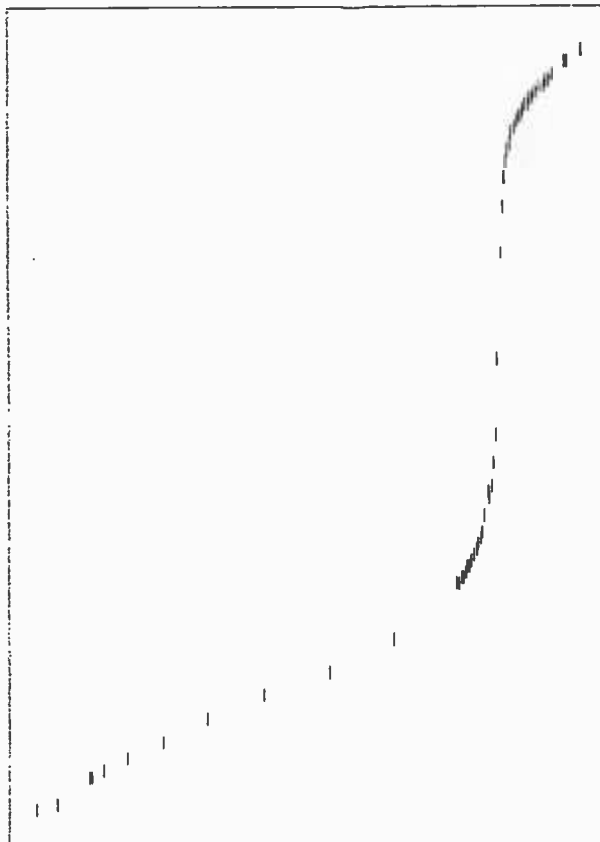

VOLUME TITRANT ADDED

Figure 3: Typical acid/base titration curve. Data points are drawn as short bars, the curve is enclosed by a border, and the heading and labels are printed double width.

and C,B; (A,B.) prints a single dot; and the right bracket, as in A,B.(), positions the print head at location A,B without printing. Two examples are illustrated in figure 2b where, in the top example, a horizontal line is drawn between the points 800,200 and 900,200 and then a line from 900,200 to 1000,150. The intersecting lines in the bottom example are drawn in the same manner. First, a line is drawn between the points 900,500 and 1000,450; then a line between 900,500 and 800,450; a line between 900,500 and 800,550; and finally, a line between 900,500 and 1000,550.

The Use of Precision Tractors

Another modification of the DEC-writer, which is particularly useful in graphics mode, is the installation of a set of precision paper-feed tractors in place of the standard tractors supplied with a conventional DEC-writer. (These can be obtained from the Selanar Corporation for \$50.) Their purpose is to insure that lines originating from the same point (such as in a radial pattern) begin at that point every time a new line is drawn—otherwise the pattern shows a distinct discontinuity. The improvement in the printed results due to the use of the precision tractors can be seen in



**In an age when new standards are constantly emerging,
one disk consistently meets or exceeds them all.**

Maxell. The Gold Standard.

Not all disks are created equal. Some are better than others. To find out what's best for you, look for Maxell disks. They now carry the Gold Standard symbol of quality. It's your assurance Maxell disks meet or exceed every definition of quality. No matter who establishes it. We've earned this universal superiority by never relaxing our uniquely demanding quality control. Every aspect of manufacturing is checked, then checked again.

Your benefits are many. Take the perpetual problem of drop-outs. A drop-out is a tiny defect that wastes time and degrades computer accuracy and performance. Now that you understand what a drop-out is, forget it. Maxell disks don't have any. Each disk comes to you certified

drop-out free at the time of manufacture. You can depend on this quality protecting your valuable programs and programming time, indefinitely. We've run disks over ten million passes under conditions designed to find weak points and wear. We couldn't. And you won't.

There is a Maxell disk for the floppy system you use, or plan to use. Check your computer's instructions. Or write for our complete, highly informative brochure.

When you set the Gold Standard as your level of quality, you'll benefit from improved disk performance, immediately. Bank on it.



maxell®

Maxell Computer Products Division, 60 Oxford Drive, Moonachie, N.J. 07074, 201-440-8020

ACCEPT EVERY

Why this operating system?

Ask the leading independent software vendors. They know Intel's iRMX 86 well enough to know it's an industry standard; that it allows them to plug into VLSI technology, and to design in a heap of high-performance features.

Ask OEM's. They'll point out how it lets them tap a vast reservoir of mass-market application software. And how major software houses have already packed it with popular languages.

And both will tell you that iRMX 86's performance and cost advantages are flat out impressive. Which makes it a marvelous match for the industry's most widely used VLSI microcomputers—the iAPX 86 and iAPX 88.



How marvelous? iRMX 86 has two to five times the multitasking talents of any other microcomputer operating system. So users can perform various chores simultaneously—with blazing, realtime system response. Thanks to ultra-fast context switching, task synchronization and memory-based message passing.

And iRMX 86 even supports multiprocessing. Not only overseeing our 8087 numeric processor and 8089 I/O processor, but going even further. Often helping a whole team of 8086, 8088 microprocessors and 8087, 8089 processor extensions work together. While you're reaping the rewards of multiprocessing performance—without

PTED WHERE.

having to wrestle with multiprocessing software.

Most importantly, iRMX 86 is the only operating system taking full advantage of VLSI—already putting its advanced architectural virtues into silicon.

A prime example being our iAPX 80130 operating system processor. It squeezes timing tasks, interrupt processing and key functions of the iRMX 86 nucleus all onto a chip. Marking the first major chapter in our commitment to bring operating software into silicon—so performance goes up as the cost goes down..

And when it's time to tie into a communications network, you won't have to get tangled up writing complicated software: built-in software drivers are already in place. In fact, iRMX 86 is the only microcomputer operating system to support Ethernet,* the de facto standard for local area networks.

Incidentally, all these features are available for \$130/unit in OEM quantities. Plus all are backed by extensive docu-

mentation, development tools, workshops, field support, software maintenance, and a company name that's liable to turn up anywhere.

Who knows, maybe everywhere.

For a free copy of our article "Choosing a Microcomputer Operating System," contact your local distributor. Or write our Literature Department,

3065 Bowers Avenue, Santa Clara, CA 95051, (408) 987-8080.

The leading software vendors have added the most popular languages to iRMX 86.

<u>Company</u>	<u>Language Available</u>
Microsoft	BASIC Interpreter BASIC Compiler COBOL
Microfocus	CIS COBOL
Digital Research	CBASIC
Intel	FORTRAN Pascal PL/M Macroassembler

intel[®] delivers
solutions

Europe: Intel International, Brussels, Belgium. Japan: Intel Japan, Tokyo. United States and Canadian distributors: Alliance, Almac/Stroum, Arrow Electronics, Avnet Electronics, Component Specialties, Hamilton/Avnet, Hamilton/Electro Sales, Harvey, Industrial Components, Pioneer, L.A. Varah, Wyle Distribution Group, Zentronics.

(4a)

EXAMPLES OF PERSHEY CHARACTER ALPHABETS

ABCDEFGHIJ

ABCDEFGHIJ

abcdefghij

ABCDEFGHIJ

ABCDEFGHIJ

ABCDEFGHIJ

abcdefghij

(4b)

HEA P S I M < O Z B V C L E D J D O H A Y A H O P P E T C A R P T U > W S I S H E A

USE A 2-D ROTATIONAL ALGORITHM

$$\begin{vmatrix} X_1 & Y_1 & 1 \\ X_2 & Y_2 & 1 \\ X_H & Y_H & 1 \end{vmatrix} * \begin{vmatrix} \cos(Q) & -\sin(Q) & 0 \\ \sin(Q) & \cos(Q) & 0 \\ 0 & 0 & 0 \end{vmatrix} = \begin{vmatrix} X_1 & Y_1 & - \\ X_2 & Y_2 & - \\ X_H & Y_H & - \end{vmatrix}$$

EXAMPLES

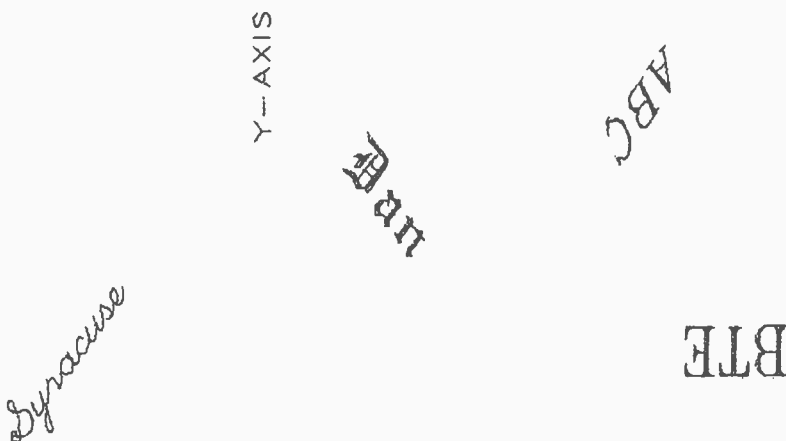

Figure 4: Various type fonts produced by the program of listing 1 from data stored on disk. The rotation feature is shown in figure 4b.

figure 2b, where the lines all originate from the point 900,500. The precision tractors are no trouble to install and otherwise perform exactly like the original tractors.

Figure 3 shows a typical acid/base titration curve. Note the use of the double-width characters to label the graph, the box enclosing the curve, and the use of the bar-print mode to emphasize the individual data points. This graph was generated with a FORTRAN program and is a good example of the combined use of printing characters and graphics. The four character sets, double-width, bold-face, and character rotation options all make the Selanar Graphics II board a powerful addition to any DECwriter.

Generating Character Sets

The excellent resolution available with the Graphics II and the fact that it prints vector-generated graphics prompted us to explore the use of graphics to draw characters as well as plot curves. Normally, we would have to do this by developing tables of coordinates for each alphanumeric character. But fortunately, there is an invaluable reference work that provides all the information needed: *A Contribution to Computer Typesetting Techniques: Tables of Coordinates from Hershey's Repertory of Occidental Type Fonts and Graphic Symbols*. (Published by the U.S. Department of Commerce, the book is now out of print, although many libraries have a copy.)

This document lists the coordinates used to generate 1377 different alphabetic and graphic characters on either a video terminal or a hard-copy digital plotter. The tables were originally developed by Dr. A. V. Hershey of the Naval Weapons Laboratory in Dahlgren, Virginia. Dr. Hershey's assiduous digitization of these many character sets and symbols is as much a work of art as it is a scientific achievement, and it includes symbols from mathematics, engineering, music, and other disciplines. The typeset quality of the characters and symbols is certain to enhance any graphics display.

Figure 4a presents several examples

Text continued on page 196

RM/COBOL™¹ MAKES IT ACROSS!

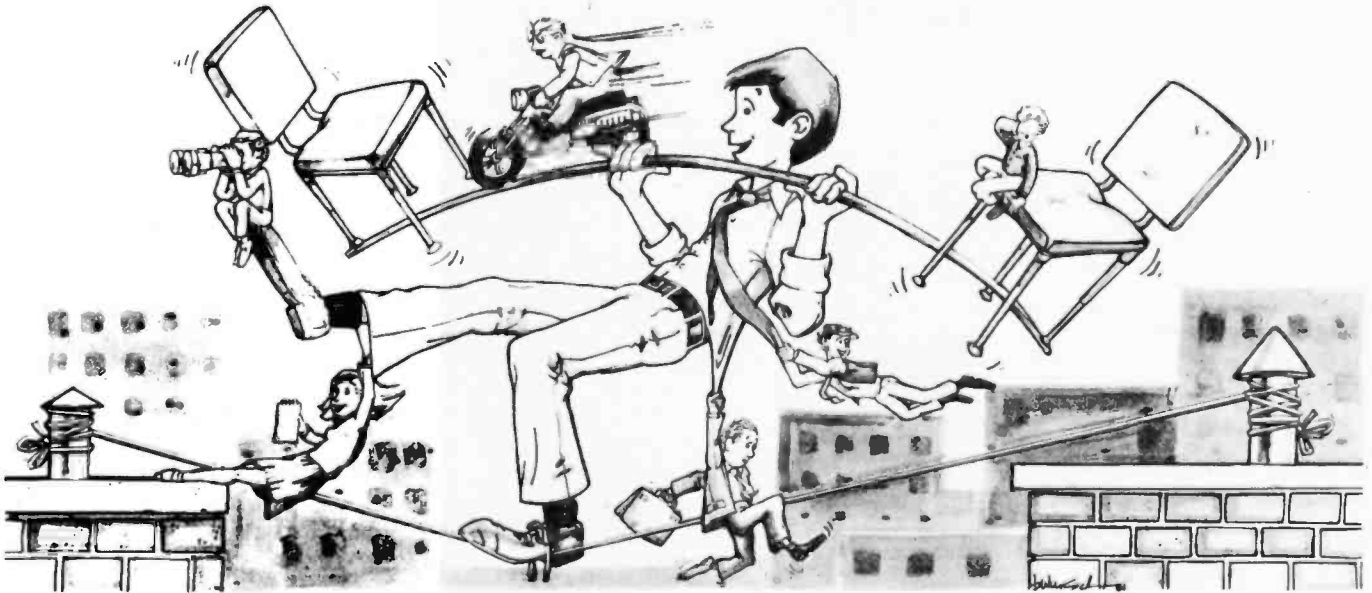

**...FROM ONE OPERATING SYSTEM TO ANOTHER!
A VITAL WAY TO PROTECT YOUR SOFTWARE INVESTMENT FOR THE FUTURE!!**

The **RM/COBOL** language runs on more different Operating Systems and more

different-sized computers than any other similar language. For starters, it runs on NCR and TI minicomputers and, in the micro field, on the CP/M², MP/M², CP/M86², MP/M-86², TRSDOS³, OASIS⁴, MOASIS⁴, and UNIX⁵, (ONYX version) Operating Systems ... to mention only a few.

Until now, serious business software of the scope and flexibility seen in the minicomputer world has not been available on micros. **RM/COBOL** now allows transfer of such software with a minimum of fuss.

We have participated in such a mini-to-micro transfer of a major set of general business software ... using **RM/COBOL**, as the transfer mechanism, of course. Running on literally thousands of minicomputers, these refined, enhanced, and proven software packages cover A/R, A/P, G/L, P/R, Order Entry (with Invoicing and Inventory Control) as well as Sales Analysis. The Packages define a new level of achievement for features and flexibility in micro applications software and offer top quality at a reasonable price.

For immediate information, call 714/848-1922 for your complete product descriptions.

Trademarks of:

1-Ryan-McFarland Corp.; 2-Digital Research, Inc.; 3-Tandy Corp.; 4-Phase One Systems, Inc.; 5-Bell Telephone Laboratories, Inc.; 6-Cybernetics, Inc.



8041 NEWMAN AVE., SUITE 208
HUNTINGTON BEACH, CA 92647
714/848-1922

RM/COBOL and CRT!™⁶ from CYBERNETICS ARE GOING STEADY...

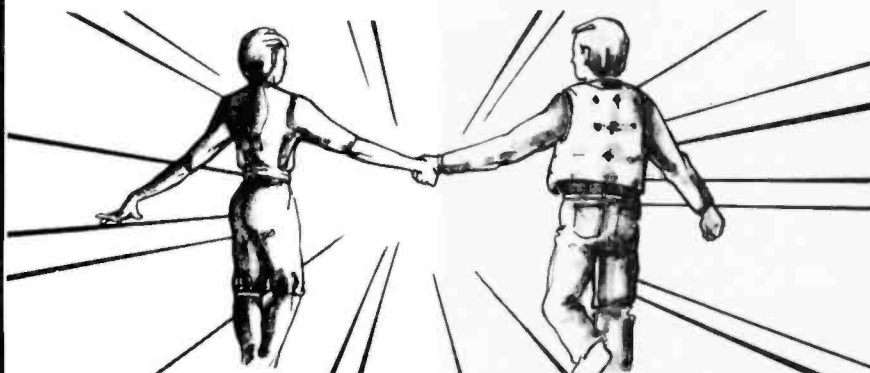

...AND YOU'RE GONNA LOVE 'EM TOO!!

Use your computer to program itself. **CRT!** (Cobol Reprogramming Tool!) from Cybernetics is a program generator for **RM/COBOL** that produces error-free **RM/COBOL** source programs for data input, file maintenance, and report printing programs.

A full feature interactive program generator, not a subset! Call Now! 714/848-1922.

(5a)

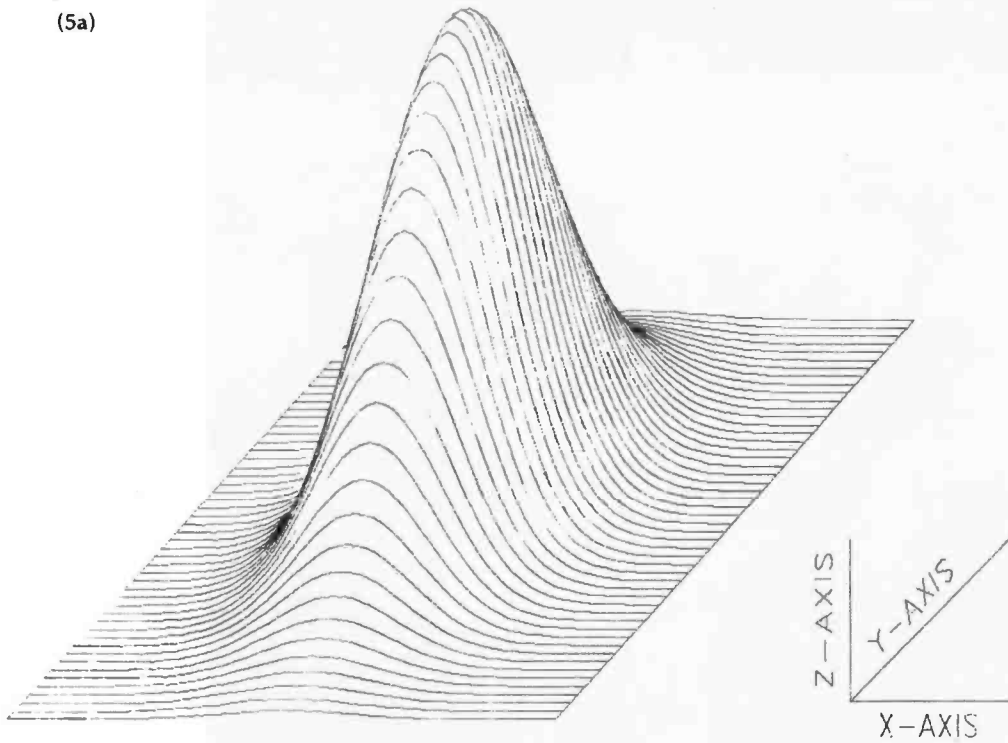

PLOT OF $\text{EXP}(-(X^2+Y^2))$

(5b)

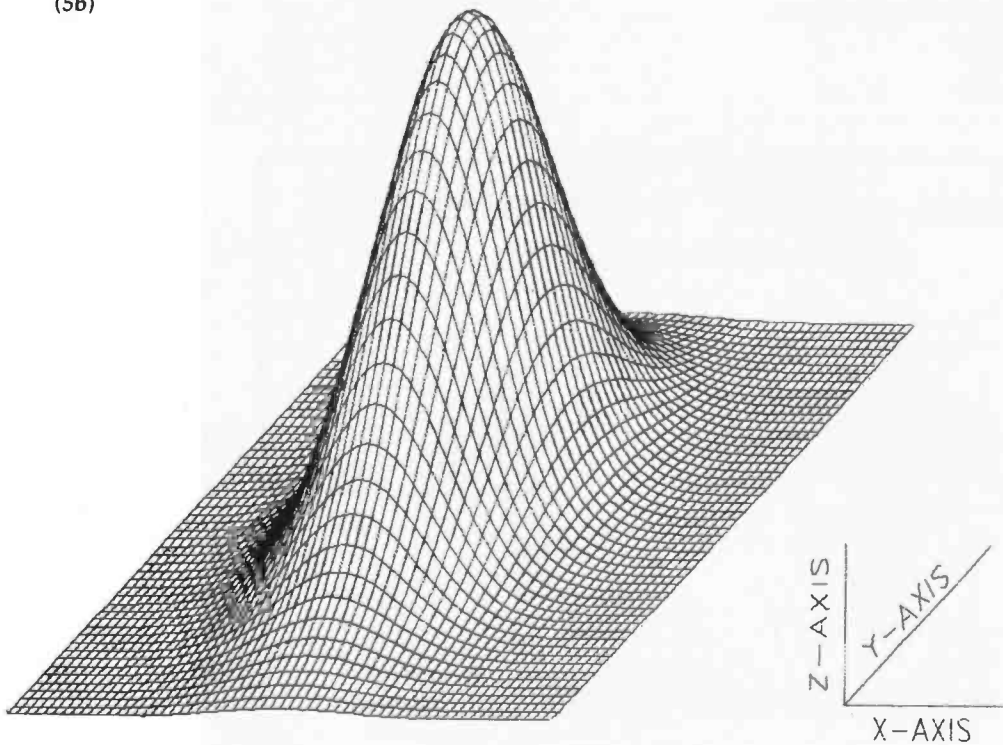

PLOT OF $\text{EXP}(-(X^2+Y^2))$
USING CROSS-HATCHING

Figure 5: Three-dimensional plotting in the graphics mode. Figures 5a and 5b show the same function but with differing detail; figure 5c (on page 190) is a "two-dimensional particle in a box."

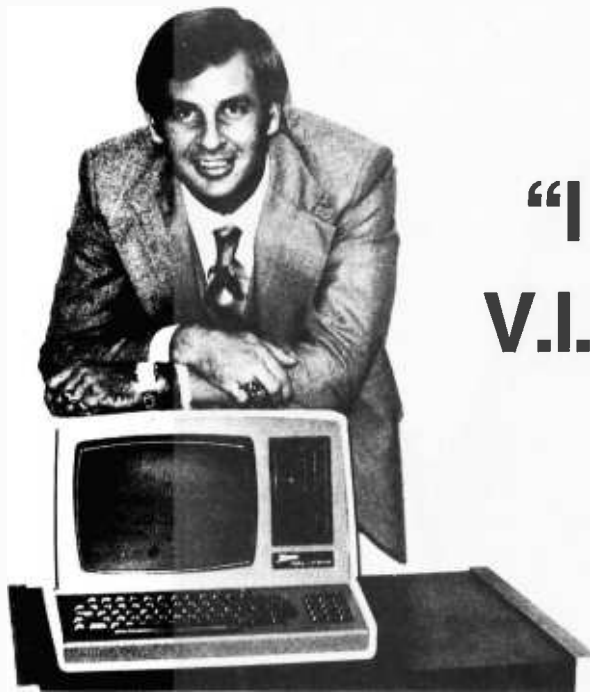

“I found out why
V.I.P.’s call A.E.I.”

I learned that I could get *specific advantages* when purchasing from A.E.I.

A.E.I. has valuable knowledge gained from selling millions of dollars of computer equipment, and will take the time to discuss which equipment is right for me.

Based on its vast experience, A.E.I. sells only reliable equipment.

A.E.I. can test and configure equipment to match my system.

A.E.I. will initialize my software to match my system, saving me valuable time.

A.E.I. stocks repair parts and can answer my

technical questions, and expedite repairs to my equipment when necessary.

A.E.I. is price competitive even when compared to No-Service sales companies.

I learned that 40% of all A.E.I. sales are to public and semi-public institutions,* such as the Universities of Nebraska, Virginia, Kentucky, California, M.I.T., the U.S. Air Force, Princeton, as well as scores of major corporations.

Calling A.E.I. is the *smart* thing to do.

*A.E.I. does not wish to imply that any of these fine organizations endorse A.E.I., merely that A.E.I. is proud to have them as customers.

A PARTIAL LIST OF PRODUCTS AVAILABLE AT A.E.I.



TELEVIDEO COMPUTER

	List	Sell
TS-800 User Station	1795	1450
TS-801 Computer	3295	2650
TS-802 CompuTerminal	3495	2796
TS-802H CompuTerminal	6995	5596
TS-806 Multi User Proc.	7195	5749



TELEVIDEO TERMINALS

	List	Sell
910 Terminal	699	.575
912 Terminal	925	559
920 Terminal	995	725
925 Terminal	995	750
950 Terminal	1195	900



NEC PRINTERS

	List	Sell
3510-1 30CPS Serial	2450	2050
7710-1 55CPS Serial	CALL	CALL
7720-1 KSR Serial	CALL	CALL
Forms Tractors	CALL	CALL



NORTHSTAR HORIZON PRODUCTS

	List	Sell
HRZ-20-64K	4495	3148
HRZ-10-64K-HD5	6695	4999
HRZ-10-64K-HD18	9270	6749

NorthStar is discontinuing many of their horizon products. Call for availability and price of any product not listed.



NORTHSTAR SOFTWARE

	List	Sell
Northword DIO	300	295
Mailmanager DIO	299	235
Informanager DIO	499	365
General Ledger DIO	599	475
A/R DIO	599	475
A/P DIO	599	475



TEXAS INSTRUMENTS PRINTERS

	List	Sell
TI-810 BASIC	1645	1398
TI-810 Full ASCII	1745	1479
TI-810 Package	1845	1649
TI-820 R/O BASIC	1995	1625
TI-820 KSR Package	2395	1950



NORTHSTAR ADVANTAGE COMPUTER

	List	Sell
ADV-20-64K	3995	CALL
SI0 Board	175	CALL
PI0 Board	200	CALL
FPB Board	399	CALL
Graphics Option	299	CALL



MODEMS

	List	Sell
Cat Modem	189	140
D-Cat	199	150
Auto-Cat	249	190
Apple-Cat	309	310
DC Hayes Micro-100	379	330
DC Hayes Smart Modem	279	240



EPSON PRINTERS

	List	Sell
MX-80	645	CALL
MX-80 FT	745	CALL
MX-100	995	CALL

Call for pricing on interfaces and cables



MORROW DECISION COMPUTER

	List	Sell
Decision 1 BASIC	1725	1350
Decision 2	CALL	CALL
65 K Static Ram	1000	780
Switchboard I/O	259	210

Select drives from Morrow disc systems for desired configuration.



MORROW DISC SYSTEMS

	List	Sell
Discus 2D 1 Drive	1095	849
Discus 2D 2 Drive	1875	1389
Discus 2 + 2 1 Drive	1395	1075
Discus 2 + 2 2 Drive	2495	1859
M26 Hard Disc	4495	3395

CP/M & Microsoft Basic Included



LINE PRINTERS

	List	Sell
Okidata 82A	719	550
Okidata 83A	1195	899
Anadex 9500	1850	1285
Anadex 9501	1850	1285



SYSTEMS GROUP

	List	Sell
2800 Computer	5035	3595
DM-6400 Memory	780	585
DMB-5400 Memory	995	735
CPC-2813 CPU + I/O	480	365
FDC-2801 Controller	465	370



MICROPRO SOFTWARE

	List	Sell
Wordstar	495	330
Apple Wordstar	375	275
Spellstar	250	190
Mailmerge	150	100
Datasstar	350	250
Supersort	250	190



DISC-CABLES

	List	Sell
Memorex 5" 1D	47	27
Memorex 5" 2D	55	36
Verbatim 5" 1D	40	30
Verbatim 5" 2D	55	45
RS-235 5' Cable	30	20
RS-232 10' Cable	40	25

—SEE THESE PRODUCTS AND MORE IN OUR SHOWROOM—
PRICES CHANGE DAILY—CALL OR VISIT FOR CURRENT PRICING



AUTOMATED EQUIPMENT, INC.

18430 WARD STREET, FOUNTAIN VALLEY, CALIFORNIA 92708

Call and International
(714) 963-1414
Out of State
(800) 854-7635

TWO-DIMENSIONAL
PARTICLE IN A BOX

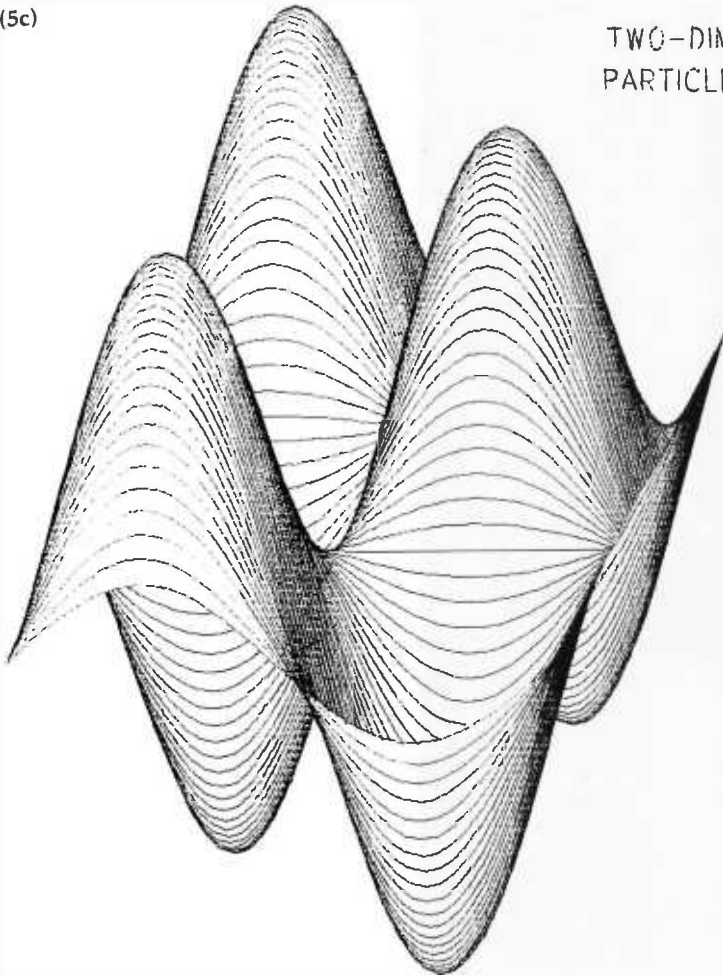

Listing 1: Program used to print characters in the various type fonts from data stored on disk. The program (written in Microsoft BASIC-80, Version 5.0) produces output, such as that shown in the figures, on the modified DECwriter.

```

10 REM *****
15 REM *
16 REM * DANIEL S. HOLMES *
17 REM * CHEMISTRY DEPARTMENT *
18 REM * SYRACUSE UNIVERSITY *
21 REM *
22 REM *****
30 REM THIS PROGRAM OUTPUTS ANY OF A NUMBER OF HERSHEY
32 REM CHARACTERS AS TEXT. THE TEXT AND NUMBER OF LINES
34 REM ARE USER SELECTED, ALONG WITH THE MAGNIFICATION
36 REM FACTOR, AND THE ANGLE OF ROTATION (0-360 DEGREES).
38 REM
40 REM
42 REM ENTER GRAPHICS MODE
44 LPRINT CHR$(27);"B"
46 REM
47 REM THIS PART OF THE PROGRAM IS TO INPUT ALL USER SELECTED DATA
48 REM
50 DIM X$(10,100),A$(250),A(250), S(3,120),Q(3,120)
70 PRINT " CHARACTER SETS #REC/CHARACTER"
80 PRINT "CROMAN 1"
90 PRINT "SIMSCRIPT 2"
100 PRINT "COMITPRN 2"
110 PRINT "TROMAN3 3"
120 PRINT "GOTHICENG4 4"
130 PRINT "LCGOTH3 3"
140 PRINT:PRINT:INPUT "WHICH CHARACTER SET DO YOU WANT ";C$
150 OPEN "R",1,C$
160 PRINT : INPUT "# RECORDS / CHARACTER ";REC
190 PRINT
200 PRINT " ENTER TEXT":PRINT
210 INPUT "# OF LINES (UP TO TEN) ";Q2

```

Listing 1 continued on page 192

Anadex Printer Distributors

NORTHWEST (Oregon, Washington, W. Idaho)
Sigma Distributing
Bellevue, WA (206) 454-6307

NORTHERN CALIFORNIA
Basic Electronic Distributors
Santa Clara, CA (408) 727-1800
Terminal Rentals
San Jose, CA (408) 292-9915
Byte Industries
Hayward, CA (415) 783-8272
Computerland
San Leandro, CA (415) 895-9363

SOUTHERN CALIFORNIA
Basic Electronic Distributors
Inglewood, CA (213) 673-4300;
San Diego, CA (714) 288-8000
Terminal Rentals
Tustin, CA (714) 832-2414

SOUTHWEST
(Texas, Oklahoma, Arkansas, W. Louisiana)
Barnhill Associates, Inc.
Richardson, TX (214) 231-2573;
Houston, TX (713) 688-9971; Austin, TX (512) 451-0217

ROCKY MOUNTAIN STATES (Colorado, Wyoming,
Montana, Utah, E. Idaho, Arizona, New Mexico)
Barnhill Associates, Inc.
Englewood, CO (303) 779-3600;
Scottsdale, AZ (602) 947-7841;
Albuquerque, NM (505) 299-7658;
Murray, UT (801) 262-3000

MIDWEST (Illinois, Missouri, Kansas, Nebraska,
N. Dakota, S. Dakota, Minnesota, Indiana, W. Kentucky,
Iowa, Wisconsin)
Tek-Aids, Inc.
Arlington Heights, IL (312) 870-7400
Comtel Corporation
Chicago, IL (312) 539-4838; St. Louis, MO (314) 428-5508;
Shawnee Mission, KS (913) 722-1030; Minneapolis, MN
(612) 835-3060; Indianapolis, IN (317) 253-1681;
Cedar Rapids, IA (319) 377-9434;
Brookfield, WI (414) 786-1940

NORTHEAST (Connecticut, Vermont, Massachusetts,
Maine, Rhode Island, New Hampshire)
Pat Jenks Associates
North Haven, CT (203) 239-6201;
Woburn, MA (617) 938-0488
Microamerica Distributors
Needham, MA (617) 449-4310

NEW YORK METROPOLITAN AREA
Logon, Inc.
Fort Lee, NJ (201) 224-6911 / (212) 594-8202

MID-ATLANTIC STATES (Maryland, Washington, DC,
Virginia, W. Virginia, E. Pennsylvania, S. New Jersey)
Micro Distributors, Inc.
Rockville, MD (301) 468-6450
Plymouth Meeting, PA (215) 265-1600

SOUTHEAST STATES (Louisiana, Florida, Alabama,
Mississippi, Georgia, N. Carolina, S. Carolina)
Currie, Peak & Frazier, Inc.
Huntsville, AL (205) 536-1506;
Orlando, FLA (305) 855-0843;
Greensboro, NC (919) 273-3040

CANADA
Nelma Electronics Ltd.
Mississauga, Ont. (416) 624-0334



The important plus in matrix printers:

grafixPLUS.™



Since their introduction in mid-1980, the Anadex high-resolution DP-9500 Series matrix printers have set new standards for printer quality and performance. All models feature the rugged Anadex 9-wire print head that combines long life with resolutions of 72 dots/inch vertical and up to 75 dots/inch horizontal. With this kind of resolution, fineline graphics (under data source control) and razor sharp characters are pluses built into every printer.

Performance Plus

The full standard ASCII 96 character set, with descenders and underlining of all upper and lower case letters, is printed bi-directionally, with up to 5 crisp copies, at speeds up to 200 CPS. Models DP-9500 and DP-9501 offer 132/158/176 and 132/165/198/220 columns respectively. Print densities are switch- or data-source selectable from 10 to 16.7 characters/inch. All characters can be printed double-width under communications command.

Interface Plus

Standard in all models are the three ASCII compatible interfaces (Parallel, RS-232-C, and Current Loop). Also standard is a sophisticated communications interface to control Vertical Spacing, Form Length and Width, Skip-Over Perforation, Auto Line Feed, X-On/Off, and full point-to-point communications.

Features Plus

As standard, each model features forms width adjustment from 1.75 to 15.6 inches, shortest-distance sensing, full self-test, 700 character FIFO buffer (with an additional 2048 characters, optional), and a quick-change, 6 million character life ribbon.

Quality Plus

Beyond the built-in performance of the grafixPLUS series printers, the engineered-in quality and support are equally important. The result? Approval of both UL and FCC, Class A; operating noise levels under 65dbA; and a nationwide service organization second to none.

To see for yourself why the grafixPLUS printers offer more pluses for your printing dollar, contact us today.

 **Anadex**
the plus in printers

Circle 22 on inquiry card.

Made in
U.S.A.
for the World

ANADEx, INC. • 9825 DeSoto Avenue • Chatsworth, California 91311, U.S.A. • Telephone: (213) 998-8010 • TWX 910-494-2761
U.S. SALES OFFICES, San Jose, CA (408) 247-3933 • Irvine, CA (714) 557-0457 • Wakefield, MA (617) 245-9160 • Austin, TX (512) 327-5250
ANADEx, LTD. • Weaver House, Station Road • Hook, Basingstoke, Hants RG27 9JY, England • Tel: Hook (025672) 3401 • Telex: 858762 ANADEx G

Save \$2500⁰⁰

Are you faced with having to spend \$3000 and up for a letter-quality printer?

Mediamix offers an alternative.



For only \$500 the **Mediamix ETI²** lets you connect the IBM Electronic Typewriter Models 50,60, or 75 to **any** computer. Why invest in two separate machines? Your office typewriter can do both jobs, yielding better type quality, a consistent corporate image and renowned IBM service.

The **ETI²** is no simple black box, either. It is a sophisticated micro-computer with 2000



characters of memory, over 39 special commands and the option of doing typesetting on the IBM Model 50.

Write or Call

MEDIAMIX

P.O. Box 67B57
Los Angeles, California 90067
(213)475-9949

Listing 1 continued:

```

220 PRINT : PRINT "USE CONTROL-H TO BACKSPACE"
230 FOR J=1 TO Q2
240 PRINT "-----LINE ";J;"-----"
250 X=1
260 X$(J,X)=INPUT$(1)
270 IF ASC(X$(J,X))=B THEN X=X-1 : PRINT CHR$(B); : GOTO 310
280 IF X$(J,X)=CHR$(13) THEN 320
290 PRINT X$(J,X);
300 X=X+1
310 GOTO 260
320 PRINT
330 D(J)=X-1
340 NEXT J
350 PRINT :PRINT
360 INPUT "IS THIS THE STRING YOU WANTED ";Y$
370 IF Y$="YES" THEN 390 ELSE 170
390 INPUT " WHAT MAGNIFICATION POWER ";MAG
400 PRINT
410 INPUT "WHAT ROTATION ANGLE (0-360) ";T1
420 T2=T1/57.2958
430 PRINT
440 INPUT "WHAT IS THE STARTING POINT ON THE PAGE ";A,B
450 A1=A : B1=B
490 REM
495 REM
500 REM THE COORDINATE PAIRS ARE STORED IN A RANDOM ACCESS FILE
505 REM THE RECORD NUMBER IS DETERMINED BY THE ASCII VALUE OF
510 REM THE LETTER TO BE WRITTEN. NOTE: THE CHARACTERS ARE
515 REM NOT STORED IN SEQUENTIAL ASCII FORMAT.
516 REM
517 REM
520 FOR J=1 TO Q2
530 FOR Q=1 TO D(J)
540 IF ASC(X$(J,Q))>96 THEN 600
550 IF ASC(X$(J,Q))>64 THEN 610
560 IF X$(J,Q)=" " THEN C=27*REC-REC+1:GOTO 620
570 IF X$(J,Q)="=" THEN C=28*REC-REC+1:GOTO 620
580 IF X$(J,Q)="?" THEN C=29*REC-REC+1:GOTO 620
590 C=(ASC(X$(J,Q))-10)*REC-REC+1 : GOTO 620
600 C=(ASC(X$(J,Q))-47)*REC-REC+1 : GOTO 620
610 C=(ASC(X$(J,Q))-64)*REC-REC+1
620 PRINT "THE RECORD # IS ";C
630 REM
635 REM
640 REM HERE WE GET THE COORDINATE PAIRS.
645 REM SOME OF THE CHARACTER SETS TAKE UP MORE
650 REM THAN ONE RECORD/CHARACTER.
660 REM
665 REM
670 FIELD #1,1 AS M$,2 AS L$,2 AS R$,2 AS H$
680 Z=0
690 FOR G=1 TO 59 STEP 2
700 FIELD #1,Z*4+7 AS U$,2 AS A$(G),2 AS A$(G+1)
710 Z=Z+1
720 NEXT G
730 GET #1,C
740 L=CVI(L$)
750 R=CVI(R$)
760 H=CVI(H$)
770 I=1
780 A(I)=CVI(A$(I))
790 A(I+1)=CVI(A$(I+1))
800 IF A(I+1)=-64 THEN 1100
810 IF I=59 THEN 850 ELSE I=I+2 : GOTO 780
840 GOTO 1100
850 H1=60
860 FOR Y=1 TO REC-1
870 I=0
880 FOR X=H1+1 TO H1+59 STEP 2
890 FIELD #1,I*4 AS U$,2 AS A$(X),2 AS A$(X+1)
900 I=I+1
910 NEXT X
920 C=C+1
930 GET #1,C
940 FOR X=H1+1 TO H1+59 STEP 2
950 A(X)=CVI(A$(X))
960 A(X+1)=CVI(A$(X+1))
970 IF A(X+1)=-64 THEN 1100
980 NEXT X
990 H1=H1+60
1000 NEXT Y
1050 REM
1055 REM
1060 REM THIS IS THE PART OF THE PROGRAM THAT OUTPUTS
1065 REM THE LETTER TO THE DECWRITER. THE DECWRITER
1070 REM ACCEPTS THE STRING REPRESENTATION OF EACH CHARACTER.
1075 REM A (-64,0) IS A LIFT PEN INSTRUCTION.

```

Listing 1 continued on page 195

A Good-Buy Present.

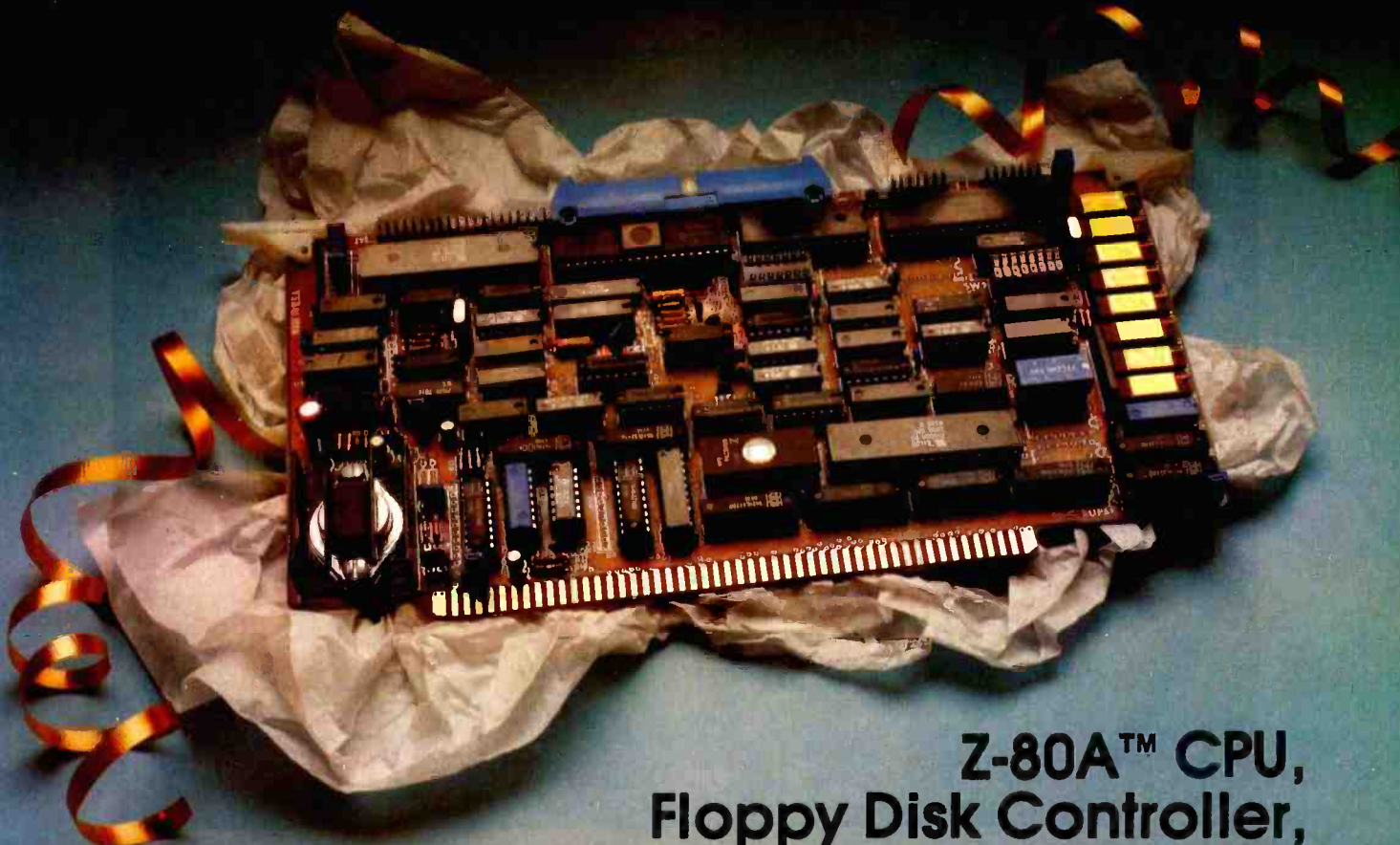

Z-80A™ CPU, Floppy Disk Controller, 64K of Memory, Serial & Parallel I/O Ports . . . all on a SINGLE S-100 BOARD!

Your business computer market has problems—expensive, power-hungry machines that are hard to expand and even harder to service. Advanced Micro Digital Corporation has the solution—SUPER/NET®, a TRULY single S-100 board computer that will seem like a dream to skeptical technicians and salesmen—not to mention your customers. SUPER/NET® is less expensive, less difficult to service and expand and requires less power than traditional four board S-100 systems—yet it contains all their popular features.

- IEEE S-100 Standard
- Z-80A™ CPU
- 64K Bank Select Memory
- Both 8" or 5¼" Floppy Disk Controller (WD 1793 chip)
- 2 Serial & 2 Parallel I/O Ports
- Real Time Clock Interrupts
- 2K Monitor EPROM
- Extended Addressing
- Runs with CP/M™, MP/M™ and CP/NET™
- One Year Warranty

Advanced Micro Digital Corporation is dedicated to the research and development of S-100 computer technology. The maintenance of superb quality in our product line is our priority.

Now you can say "Good-Bye!" to all your old S-100 boards without giving up convenience and configurability, because now it's all on a single S-100 computer board.



For more information
on SUPER/NET® write or call:

7201 Garden Grove Blvd. • Suite E • Garden Grove CA 92641 • (714) 891-4004 • TELEX: 678401 tab lin

™ Registered Trade Mark of Digital Research Corp.

© Copyright 1982 Advanced Micro Digital Corp.

Circle 9 on inquiry card.

www.americanradiohistory.com



Fill this space with a GRAFTRAX graphic and win a trip to Japan.

The Epson "Softwear" Sweepstakes.

We're looking for the Picasso of programming. So we drew up an art contest for people who don't know a painting pallet from a PROM.

If you've got an Epson printer, a computer and a little imagination, you could win a week-long trip for two to Japan. Or our top-of-the-line 136-column MX-100 printer. Or his and hers Seiko Quartz Watches. Or a whole lot of honorable mention prizes. And you'll get a T-shirt with the winning graphic just for entering.

All you have to do is program a GRAFTRAX graphic — abstract, landscape, still life, whatever — using an Epson MX-70, MX-80, MX-80 F/T or MX-100 printer. We'll not only put it on our T-shirts, we'll be displaying the winning entries for all to see in June at the National Computer Conference in Houston.

Why, you may ask, are we being so generous? It's simply because GRAFTRAX is the most incredible graphics capability made for micros. And we want to see it used to its full potential.

All entries will be judged on originality, creativity and best use of computer equipment. They must be postmarked no later than May 1, 1982, and be accompanied by the software program, so we can recreate the winning entries for verification. Make sure the graphic is no larger than 8" x 10" and no smaller than 4" x 6". And remember, if you digitize art or a photograph, it must have been originally created by you.

So get busy and enter. You might be a winner. And your software could be your "softwear."



EPSON
EPSON AMERICA, INC.

3415 Kashiwa Street • Torrance, California 90505

www.americanradiohistory.com



EPSON "SOFTWARE" SWEEPSTAKES RULES

- 1) Any computer equipment may be used to format the entry, but the graphics output must have been printed on an Epson MX-70, MX-80, MX-80 F/T or MX-100 printer with either built-in or optional GRAFRAX. Winning entries will be re-created by Epson for verification.
- 2) Each entry must be accompanied by the software program used to create it. All entries and software and the rights to use them become the property of Epson America, Inc.
- 3) All entries must be at least 6"x4" and no larger than 8"x10" in size.
- 4) Art or photographs, if used, must have been created by the entrant.
- 5) All entries will be judged by an independent panel of judges on their creative merit, originality and best use of computer equipment. Decision of the judges is final.
- 6) This contest is valid from January 1, 1982 until May 1, 1982. Entries must be postmarked no later than May 1, 1982.
- 7) Participation in the Epson "Software" Sweepstakes is open to any except the following: employees of Epson America, Inc., its service agencies, or their families.
- 8) Winners will be notified by mail no later than June 1, 1982. A list of winners will be made available by sending a stamped, self-addressed envelope to Epson America, Inc., 3415 Kashiwa Street, Torrance, CA 90505.
- 9) Entries will be maintained on file at Epson America, Inc. until January 1, 1983.
- 10) Prizes are as follows: First prize includes round-trip economy air transportation for two to Tokyo, from the airport nearest the winner's place of residence, and six nights standard hotel accommodations, double occupancy. Trip does not include airport departure taxes, hotel service charges, cost of transportation or other expenses incurred before leaving the airport of initial departure, returning to Tokyo airport and returning home from the airport of initial departure; nor does it include meals or gratuities. Second prize consists of one Epson MX-100 Printer. Third prize consists of his and hers Seiko Quartz Watches. Additional prizes include 25 Micro-Nine Printheads, 50 Epson Digital Watches, and 100 Epson Ribbon Cartridges.
- 11) You may enter more than once, but each entry must be accompanied by the official entry coupon below.
- 12) Void where prohibited by law.

Attach this form firmly to the back of each graphic you enter.

NAME _____
STREET _____
CITY _____
STATE _____ ZIP _____
PHONE (____) _____
COMPUTER EQUIPMENT USED _____

PRINTER MODEL AND SERIAL NUMBER _____

T-SHIRT SIZE ____S ____M ____L ____X.

Mail entries to:

"SOFTWARE" SWEEPSTAKES
Epson America, Inc.
3415 Kashiwa Street
Torrance, California 90505

EPSON
EPSON AMERICA, INC.

Listing 1 continued:

```

1080 REM A (-64,-64) IS AN END OF CHARACTER INSTRUCTION.
1090 REM
1095 REM
1100 A=A-L*MAG*COS(T2)
1110 B=B-L*MAG*-SIN(T2)
1120 GOSUB 2000
1130 IF H=1 THEN 1300
1140 LPRINT "(";STR$(INT(A(1)*MAG+A));";";STR$(INT(A(2)*MAG+B));";".(J)
1150 FOR G=1 TO H*2-1 STEP 2
1160 IF A(G+1)=-64 THEN 1300
1170 IF A(G)=-64 THEN 1270
1180 A(G)=A(G)*MAG
1190 A(G+1)=A(G+1)*MAG
1200 A(G)=A(G)+A
1210 A(G+1)=A(G+1)+B
1220 LPRINT "(";STR$(INT(A(G)));";";STR$(INT(A(G+1)));";".;";
1230 IF V=1 THEN 1250
1240 LPRINT ")";
1250 V=0
1260 GOTO 1290
1270 LPRINT
1280 V=1
1290 NEXT G
1300 A=A+R*MAG*COS(T2)
1310 B=B+R*MAG*-SIN(T2)
1320 NEXT R
1360 REM
1365 REM
1370 REM NOW WE GO BACK TO THE START OF THE NEXT LINE
1380 REM
1390 REM
1400 IF REC>1 THEN 1440
1410 A1=A1+15*MAG*SIN(T2)
1420 B1=B1+15*MAG*COS(T2)
1430 GOTO 1465
1440 A1=A1+30*MAG*SIN(T2)
1450 B1=B1+30*MAG*COS(T2)
1465 A=A1 : B=B1
1470 NEXT J
1472 REM
1475 REM
1480 REM CHECK FOR ANYTHING ELSE TO PRINT OUT
1490 REM
1495 REM
1500 INPUT "DO YOU HAVE MORE TEXT ";Y$
1510 IF Y$="NO" THEN 1550
1520 PRINT
1530 INPUT "DO YOU WANT TO CHANGE CHARACTER SETS ";Y$
1540 IF Y$="YES" THEN CLOSE : GOTO 70
1542 REM
1543 REM
1545 GOTO 190
1547 REM
1548 REM
1550 LPRINT CHR$(27);"C"
1560 END
2000 REM
2010 REM
2020 REM THIS IS THE ROTATIONAL ALGORITHM USED TO ROTATE THE
2030 REM CHARACTERS ANY ANGLE FROM 0-360 DEGREES.
2033 REM THE COORDINATE PAIRS ARE STORED IN A 3*3 MATRIX, AND
2035 REM MULTIPLIED BY THE ROTATION MATRIX (ROTATION ABOUT
2038 REM THE POINT 0,0).
2040 REM
2045 REM
2050 IF T1=0 THEN RETURN
2060 FOR I=1 TO H
2070 S(1,I)=A(I*2-1)
2080 S(2,I)=A(I*2)
2090 S(3,I)=1
2100 NEXT I
2110 T(1,1)=COS(T2)
2120 T(2,2)=COS(T2)
2130 T(1,2)=SIN(T2)
2140 T(2,1)=-SIN(T2)
2150 T(3,1)=0
2160 T(3,2)=0
2170 T(3,3)=1
2180 FOR Y5=1 TO H
2190 IF A(Y5*2-1)=-64 THEN 2250
2200 FOR X5=1 TO 3
2210 Q(X5,Y5)=S(1,Y5)*T(X5,1)+S(2,Y5)*T(X5,2)+S(3,Y5)*T(X5,3)
2220 NEXT X5
2230 A(Y5*2-1)=INT(Q(1,Y5)+.5)
2240 A(Y5*2)=INT(Q(2,Y5)+.5)
2250 NEXT Y5
2260 RETURN

```

Text continued from page 186:

of Hershey-character alphabets. Starting from the top of the figure, these are: simplex Roman, simplex script, complex italic, triplex Roman, and Gothic English. At our laboratory, we now have the coordinates of these various character-printer sets stored on disk and can send them to the DECwriter under program control in any size desired. The coordinates for the simplex Roman characters occupy approximately 7K bytes of disk storage space, while the Gothic English files require more than four times that amount.

In addition to being able to vary the size of the displayed Hershey character sets, we also included in our program the ability to rotate characters to any angle. The effects of this routine, adapted from *Mathematical Elements for Computer Graphics*, by D. F. Rogers and J. A. Adams (see references), are shown in figure 4b, which displays several examples of character rotation; also shown is the

rotational algorithm that does the calculations necessary for the individual rotations. The BASIC program that outputs the Hershey coordinates as letters, starting at any location on the page, with any magnification and any degree of rotation, is given in listing 1.

Figure 5a is a three-dimensional plot of an exponential function showing the use of the graphics mode to display the lettering as well as the mathematical function itself. Figure 5b is a three-dimensional plot of the same function with certain lines hidden, with cross hatching, and labeled with graphically generated Hershey characters. Finally, shown in figure 5c is the three-dimensional representation of the quantum-mechanical wave function for a two-dimensional particle in a box.

Conclusion

The Selanar unit has been in operation in our laboratory for over a year and has performed flawlessly during

that time. The illustrations of the various graphs shown, especially the three-dimensional plots, with or without hidden lines, coupled with the development of programs to encode and output the different Hershey character sets, has made our DECwriter a truly versatile and low-cost generator of high-quality, high-resolution hard copy. ■

References

1. *GRAPHICS II Installation and User Manual*. Selanar Corporation, Santa Clara, CA 1979.
2. Rogers, D.F. and J.A. Adams. *Mathematical Elements for Computer Graphics*. New York: McGraw-Hill, 1976, page 202.
3. Wolcott, N.M. and J. Hilsenrath. *A Contribution to Computer Typesetting Techniques: Tables of Coordinates from Hershey's Repertory of Occidental Type Fonts and Graphic Symbols*. Washington, D.C.: National Bureau of Standards Special Publication No. 424, U.S. Department of Commerce, U.S. Government Printing Office, 1976. Out of print.



68000 XAVAX systems

XAVAXtwo includes:

- 68000 processor at 8MHz
- 32 bit registers, operations
- 7 vectored interrupt levels
- 256KB parity checking RAM
- 10MB Winchester hard disk
- 960KB floppy disk
- Graphics display monitor
- Multibus™/IEEE architecture
- XVX multiuser operating system
- Option: UNIX™, CP/M
- Screen editor, filer, linker
- Language: (Pascal, C, COBOL, FORTRAN, BASIC, or Assembler)
- Option: add 10MB Winchester with 10MB tape backup
- Option: on site service

Software: A-Counts™ accounting and inventory control

Bizgraf™ business color graphics

Textext™ scientific word processor

TeleSoft-Ada™ to DOD specifications.

- * UNIX™ of Bell Laboratories
- * CP/MTM of Digital Research
- * Multibus™ of Intel Corp
- * Ada™ Dept. of Defense

Representatives worldwide.

IMMEDIATE ATTENTION!

B382

Please send specifications on the system checked below:

- XAVAXOne (board only, 128KB RAM) (\$2,000) XAVAXThree (\$14,000)
 XAVAXTwo (with 10MB Winchester) (\$8,500) XAVAXFour (\$40,000)

Name Title

Company MS

City State Zip Phone

Phone: **XAVAX Corporation** Cable: XAVAXCORP
 (319) 344-0550 300 Northwest Tower, Bettendorf, Iowa 52722



WHILE OUR COMPETITORS TALK ABOUT PRINTER RELIABILITY, DATAROYAL PROVES IT.

Many printer companies talk about how reliable their products are. But very few can publish hard evidence supporting those claims.

Dataroyal knows that every printer breakdown, service call, or extra maintenance procedure increases the cost of owning and operating your system. So we don't make claims we can't prove.

Dataroyal tests our IPS-5000 printers non-stop at 100% duty cycle and page density. These printers have now surpassed an MTBF (mean time between failure) figure of 2000 hours-without failure, maintenance, or any special treatment. Under normal conditions, this performance rating means years of reliable operation between service calls.

And our printhead life now exceeds 500 million characters. All of this reliability spares you the time and expense you might now be spending on your existing printers.

This superior performance has made Dataroyal the intelligent choice for major domestic and international OEM systems manufacturers. Want to see our proof? Contact us, and we will send you our latest test results. And that's not just talk.

235 MAIN DUNSTABLE ROAD, NASHUA, NH (USA) 03061
(603) 883-4157

2801 FAR HILLS AVENUE, SUITE 200, DAYTON, OHIO 45419
(513) 294-6426

3150 EAST LAPALMA AVENUE, SUITE D, ANAHEIM, CA. 92806
(714) 632-9310

DATAROYAL
INCORPORATED

Circle 117 on Inquiry card.

Custom and Standardized Forms for the Microcomputer User

Philip Lemmons
c/o BYTE Publications Inc.
POB 372
Hancock, NH 03449

To help you find forms for your software, we are offering this brief account of the current marketplace of forms for microcomputer users.

Some microcomputer users have written their own software; others have bought one or more commercial programs. Many microcomputer users run both software of their own and commercial programs.

A number of companies stand ready to help you with various *stock*, *custom*, or *standardized* forms. Table 1 (page 200) lists companies active in this market. Table 2 (page 202) summarizes the product offerings of these companies and the minimum orders required for custom and standardized forms. I have also included brief information about these companies' offerings, if any, of continuous custom letterheads.

While stock forms are of several common types, they are not written

specifically for one company's computer or software. Nevertheless, stock forms *do*, in fact, work with many commercial programs. Companies offering stock forms are too numerous to list. If stock forms will work with your commercial programs, or if you can write software that uses stock forms, you will be able to get the forms you need at an economical price. Some companies make the use of stock forms easier by providing programmer's guides for use of the form, e.g., a grid with rows and columns numbered and data fields highlighted.

But the focus of this article is on *custom* and *standardized* forms. Custom forms, of course, are designed to go with unique, user-written software. What I am calling *standardized* forms are designed to go with specific pieces of commercial software. If you buy an accounting

program from the fictitious Ersatz Software, for example, and you know someone who sells forms for the Ersatz programs, you won't need to spend any time adapting the software to your forms or spend any legwork looking for stock forms that happen to be compatible with the software.

Custom Forms

If you absolutely must do things your own way down to the last detail, custom-designed and printed forms are for you. Many companies produce custom forms. These companies are found under "Business Forms" in the Yellow Pages. Minimum order quantities vary greatly. The companies listed in table 2 that do custom forms accept orders for minimums ranging from 1000 to 5000. Pricing varies with the com-

THE CENTRONICS 739. IT'S A LOT MORE THAN YOU'D EXPECT TO SELL FOR THE PRICE.

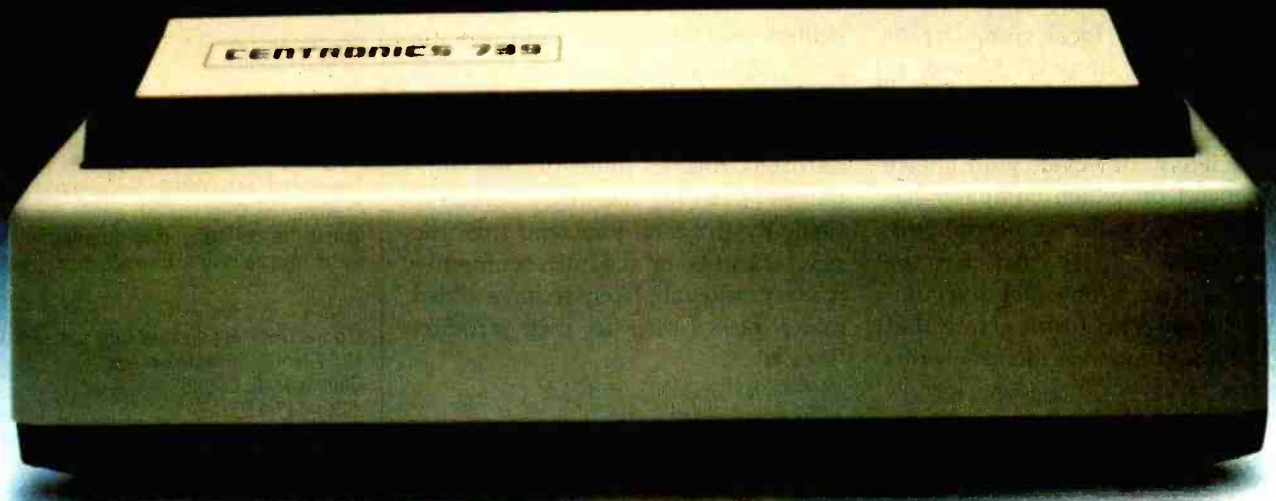
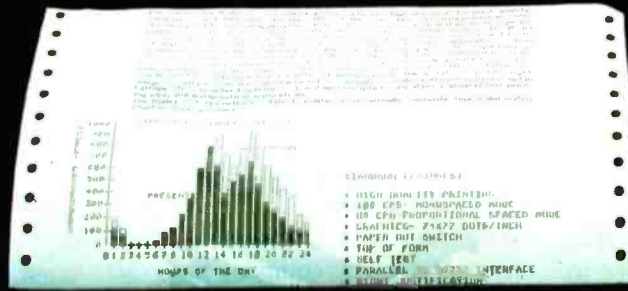

Inexpensive doesn't have to mean incomplete, and the quiet, dependable Centronics 739 is the classic example. It's complete in capability and because it's from Centronics you can expect it to perform just like the workhorse printers that have made Centronics a leader in the business for more than a dozen years. So when you shop for a desk-top printer and compare features, here's what you can expect from a 739:

CORRESPONDENCE

QUALITY — Clear, high density characters plus right justification and proportional spacing that produce correspondence, direct mail, and other important documents that demand a "custom" quality appearance.

BUSINESS GRAPHICS

What good is a printer that can't print your technical business/management information? The 739 produces a range of graphics — from bar charts and curves to illustrative material — almost anything your computer can produce.

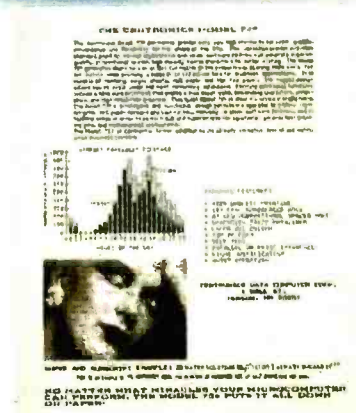

3-WAY PAPER

HANDLING — Cut sheets for correspondence; roll paper for day-to-day operations; fan-folded forms for normal data printout.

DEPENDABILITY — You depend on your printer for hard copy of timely information and that means it must operate dependably. With Centronics reputation behind the 739, reliability is a foregone conclusion. More than 350,000 Centronics printers sold worldwide is the proof.

SERVICE — Someday you may need it. Where do you find it? With Centronics worldwide network of service locations it's not very far. And now, there are authorized Centronics sales and service dealers, and "walk-in" service centers in an expanding number of key cities throughout the U.S.

When it comes to printers, Centronics is the leading independent printer manufacturer — chosen by computer professionals in major industry brand preference studies. So when you look for an inexpensive printer don't settle for incomplete. Choose the Centronics 739. It comes complete with a commitment — to performance, dependability and service. See it at your Centronics dealer. Or write for information.

CENTRONICS® PRINTERS

Circle 70 on Inquiry card.

Centronics Data Computer Corp.
One Wall Street, Hudson, New Hampshire 03051

www.americanradiohistory.com

plexity of the form. Many companies stress that it makes little sense to buy only 1000 custom forms because 5000 cost relatively little more—much of the cost lies in the unique design of the form.

Standardized Forms

A few companies are now offering forms to go with standard, commercial software packages for microcomputers. NEBS, Checks-to-Go, DFS, Moore, and Trinity are all active in this market. Your choice of a company might depend on whether you want to buy forms by telephone or mail, from your local computer or software dealer, or (with Moore, at least) from the company's own local office.

More likely, however, your choice will depend on which company has the forms for your commercial programs. Table 3 (page 204) lists the kinds of software for which the companies shown sold forms. Note that not all these companies identify forms

the same way. Some companies list their standardized forms primarily by reference to software houses. Others refer primarily to computer companies: you tell them what kind of computer you use, and they tell you what forms they have for it. Some companies list standardized forms by a combination of software house and computer company. Since many computer companies sell software as well as hardware, you can't always be sure which forms company has exactly what you need.

Perhaps the wisest course is to contact all the companies or their local dealers and ask about your specific needs. Although table 3 lists the kinds of microcomputers and software for which various companies offer standardized forms, some of the companies have only recently entered the field. By the time you read this, the new entrants in the microcomputer forms market are likely to have added many new forms to their product lines. ■

Check-Mate
POB 103
Randolph, MA 02368
(617) 963-7694
Comments: Check-Mate sells only by direct mail and telephone. Its custom forms are limited to checks; its standard computer forms are for Radio Shack and Libra software only.

Checks-to-Go
8384 Hercules St.
La Mesa, CA 92041
(800) 854-2750
(800) 552-8817 (California residents only)
Comments: Checks-to-Go sells only by direct mail and telephone. Tell Checks-to-Go what kind of computer you have and you will receive a sample kit of its forms for your computer.



DFS Computer Forms
POB 643
Townsend, MA 01469
Comments: DFS has an extensive line of forms for existing microcomputer software and sells only through local dealers.

Moore Business Forms inc.
1205 North Milwaukee Ave.
Glenview, IL 60025
(800) 447-4700
(800) 322-4400 (Illinois residents only)
Comments: Moore sells forms through more than 600 of its own local sales offices around the United States. Check the Yellow Pages or call Moore's toll-free numbers to find out the name of your local dealer.

NEBS Computer Forms
78 Hollis St.
Groton, MA 01471
(800) 225-9550
(800) 922-8560 (Massachusetts residents only)
Comments: NEBS sells only by direct mail and telephone. On request, NEBS sends a helpful, cross-indexed Forms Selector Guide and a catalog with programmer's guides for each form.

Trinity Forms Company
Micro Computer Forms Program
Carrollton, TX 75006
(800) 527-0625
(800) 492-5232 (Texas residents only)
Comments: Trinity sells through local dealers only. Contact Trinity on a toll-free number for the name of your local dealer. Trinity plans to introduce a large line of standard forms for many different microcomputer software packages.

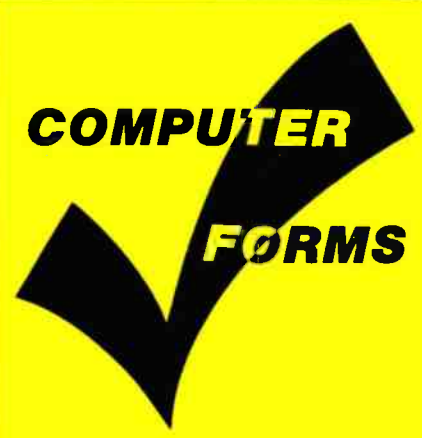
Table 1: Some companies selling standardized or custom forms for microcomputers.

<p><i>"We Bring Quality Forms To The Micro Industry"</i></p> <ul style="list-style-type: none"> • 7 working day RUSH service • FREE demo samples • Quality design • Very COMPETITIVE PRICES • Personalized assistance • FREE shipping - in continental U.S. • COMPLIMENTARY quotes on custom forms 	<p>COMPUTER FORMS</p> 
<p>CHECKS</p> <p>STATEMENTS</p> <p>INVOICES</p> <p><i>...and any other continuous form you may need!</i></p>	<p>Currently providing forms support for:</p> <p>Systems Plus • Vector • TCS • Alpha Micro Radio Shack • Insoft • IMS • Continental • DIBS Libra • Structured Systems Group • Peachtree Anchor • Accounting Plus • BPI • Designer • MCS Graham Dorian • MCBA • Durango • Dynabyte</p> <p>Call NOW for FREE sample forms packet. Your customer service representative is waiting to assist you with your continuous forms needs!</p> <p> Checks To-Go 8384 Hercules St.  La Mesa, CA 92041</p>

CALL TOLL FREE: (800) 854-2750; (800) 552-8817 in CA

THE GRAPHIC DIFFERENCE

BETWEEN ATARI® COMPUTERS AND ALL OTHERS.



3.7 million reasons why the ATARI Home Computer is something to see.

The display screen used with our computers is composed of 192 horizontal lines, each containing 320 dots. Delivering color and luminosity instructions to each dot for a second requires 3.7 million cycles... a lot of work for the normal 6502 processor.

That's why the ATARI computer has equipped its 6502 with its own electronic assistant. It's called ANTIC, and it handles all the display work, leaving the 6502 free to handle the rest. What this means to you is uncompromisingly spectacular display capabilities without loss of computer power needed to carry out the demands of your program.

That's a quality you just don't find in ordinary personal computers. And it's one of the reasons some computer experts say that ATARI computers are so far ahead of their time.

There's more... which is what you'd expect from ATARI.

Language. The ATARI Personal Computer uses several programming languages to give the user maximum control of its extraordinary capabilities. PILOT, Microsoft BASIC* and ATARI BASIC are understood and spoken by the ATARI computer. You'll also find our Assembler Editor cartridge indispensable for machine language programming.



Sound. An ATARI computer has four sound generators, or voices, activated by a separate microchip. This leaves the principal microprocessor chips free to perform other tasks. And you can take full advantage of this capability which is designed for easy programming.

Change. ATARI Home Computers have been designed to make change and expansion easy. The ATARI computer has a modular operating system* that can be easily replaced as new technology develops. If you need it, memory expansion requires no more than inserting additional RAM modules* And the ATARI ROM cartridge system also makes it easy to change languages. In short, your ATARI computer won't be obsoleted by future developments... *because it already incorporates the future.*

Sharing. To learn more about the amazing capabilities of ATARI computers, visit your local computer store for a demonstration. Or send for our Technical User's Notes, intended for the serious programmer. They are only \$27 and contain a lot more information about our computers' special capabilities than most companies could tell. See your ATARI dealer, or send \$30 (\$27 plus \$3 postage and handling), payable to ATARI, to Technical User's Notes, c/o ATARI Customer Service, 1340 Bordeaux Avenue, Sunnyvale, CA 94086.

ATARI®

*ATARI 800™ computer only.

	Check-Mate	Checks-to-Go	DFS	Moore	NEBS	Trinity
How Sold	Mail and telephone	Mail and telephone	Local dealers	Local offices	Mail and telephone	Local dealers
CUSTOM FORMS	Checks only	Y		Y	N	Y
Minimum quantity	5000	5000		1000-2500		1000
CUSTOM CONTINUOUS LETTERHEAD	Y	Y		Y	Y	Y
Minimum quantity	1000	5000		1000-2500	500	1000
STANDARDIZED FORMS	Y	Y	Y	Y	Y	Y
Minimum quantity	1000	500		1000	500	500

Table 2: Information about how six companies sell custom and standardized forms for microcomputers. Important considerations include minimum order quantities and sales methods—whether through a company's own local offices, through local dealers, or by mail and telephone.

COMPUTERS

IMPORTS



NEC 8023A \$495
Epson MX-80's, 100's etc. Call
Okidara 82A \$469
Okidara 83A \$749
Okidara 84 \$1059

NORTHSTAR TELEVIDEO



Sall® CP/M® increases drive capacity - \$149. Why buy your components from several sources when we can burn and test your Northstar, printer and/or terminal as a system? Best prices overall.
HRZ II 64K Quad \$3145
Advantage Call
TSS/18-4 \$8295

The new all-in-one that's backed by G.E. Built in CRT, detachable keyboard, 750K formatted, dual floppy, 64K, CP/M® and more. Five software business modules \$695.
Televideo 802 \$2795
Televideo 802H (10MG.) \$5555

LOW COST



Adds Viewpoint \$544
Televideo 910 \$589
ADM 3A \$569
Soroc IQ 130 \$589

HIGH SPEED



Anadex 9500.
9501 \$1245
Datasaath DS-180 \$1269
TI 810 Basic \$1365
Infoscrite Call

ALTOS ZENITH



The high-quality 8" system with 28 local service centers.
8000-2 w CP/M \$2749
8000-15 \$3849
8000-10,12,14 call

The all-in-one that's backed by your local Zenith-Heath Service center. Green Screen, CP/M®, Supercalc, and Basic Incl.
Z-89 w/48K \$2135
Z-90-82 w/64K \$2395

CROMEMCO, XEROX, ADDS, NEC, DYNABYTE Call

TELEVIDEO



Televideo 912 \$699
Televideo 920 \$728
Televideo 925 \$775
Televideo 950 \$927

LETTER QUALITY



C.Iroh Starwriter-IP \$1324
C.Iroh Starwriter II S \$1595
NEC 3500 \$1995
NEC 7710/7730 \$2340
Diablo 630 \$2295



Scottsdale Systems Ltd.

6730 E. McDowell Road, Suite 110, Scottsdale, Arizona 85257

 **(602) 941-5856** 

Call 8-5 Mon.-Fri.
(We Expon) TWX 910-950-0082 (IMEC SCOT)

TERMINALS



Ampex D80 \$925
Dialogue 80 Amber \$969
Mime Acr 5A \$799
Soroc IQ 120 \$729
Volker Craig 404 \$599

MORE PRINTERS

Paper Tiger 460G \$789
Paper Tiger 560G \$1129
Centronics 739P \$649
Centronics 739S \$729

C.Iroh Prowriter Serial \$679
Mailbu 200 Call
M.P.I. 99G \$719
Tally MT 1805 \$1645

ORDERING

— MAIL ORDER ONLY —

2% cash discount included/charge cards add 2%. Prices subject to change, product subject to availability. Arizona residents add 5%, F.O.B. point of shipment Scottsdale. 0-20% restocking fee for returned merchandise. Warranties included on all products. Personal checks take 3 weeks to clear.
CP/M and MP/M are registered trademarks of Digital Research.

Financial Planning... from

SuperSoft

SCRATCHPAD: SUPERSOFT'S ELECTRONIC WORKSHEET

ScratchPad is a user-interactive data modeling program suitable for financial planning or any general purpose modeling. Whether you are an executive, a researcher, or planning the family budget; you will find ScratchPad an invaluable tool in giving you the numeric correlations you need for sound decision making.

ScratchPad provides for labels and corresponding numeric data entries cross-referenced by row and column. Data entries are then defined as dependent variables in a user-created algebraic formula. You can now quickly see how changes in one or more variables affects all others.

ScratchPad includes the following

- Multiple screen splitting which allows two or more sections of the worksheet to be viewed simultaneously.
- Both immediate and deferred calculation modes allowing calculations to be either made as data is entered or deferred until later.

- Flexibility in entry and editing functions so that data can be entered or changed easily.
- Column widths are variable.
- Portions of the worksheet not currently being viewed can be quickly brought to the screen for either single or split screen viewing.
- Any portion of the worksheet can be printed as hardcopy at the user's discretion.

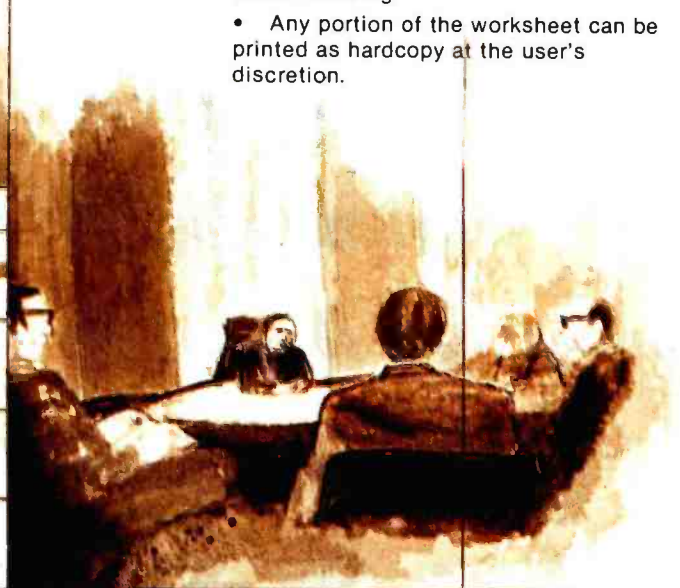

STATS-GRAPH: SUPERSOFT'S STATISTICAL DISPLAY PACKAGE

Stats-graph performs statistical analyses on user data and displays the results in graphic form.

Graphic formats include:

- Pie Graph
- Bar Graph
- Scatter Graph

Statistical Analyses include:

- Mean
- Median
- Minimum and Maximum values
- Standard Deviation
- Regression Analysis

Stats-graph is an easy-to-run, user-interactive program that presents valuable and often complex information in a concise and easily understood form.

DATA-VIEW: THE EXECUTIVE ORGANIZER

Data-view is an easy-to-use, free formatted system for organizing information. It can be used as an electronic filing cabinet, an automated date book, or a computerized listing device. Insertion and retrieval of information is both simple and quick. Data may be retrieved by file, string, or key word, and any type of information can be stored.

ScratchPad:	\$200.00
Stats-graph:	\$200.00
Data-view:	\$200.00
Total Package:	\$500.00
Manuals only:	\$ 15.00

Software available for virtually all CP/M systems. Specify your system.

Available from fine dealers everywhere, or directly from:
SUPERSOFT, INC.
P.O. BOX 1628
CHAMPAIGN, IL 61820
217-359-2112 Telex: 270365
Technical Hot Line: 217-359-2691



U.K. and Europe:
DIGITAL DEVICES
134 LONDON ROAD
SOUTH-BOROUGH, KENT
TUNBRIDGE WELLS
TN4, OPL
ENGLAND
Tel: Tunbridge Wells 1089213/977/9
Telex: 35502

Japan:
ASR CORPORATION INTERNATIONAL
3-23-8 NISHISHIMBASHI, MINATO-KU
TOKYO 105
JAPAN
Tel: 03-437-5371
Telex: 0242-223

First in Software Technology

Circle 366 on inquiry card.

Check-Mate	Checks-to-Go	Moore	NEBS	Trinity	DFS
		Accounting Plus Allison Crain	Agency Computer Systems		Agency Computer Systems
	Alpha Micro Anchor Systems				
	Apple Computer	Apple Computer	Antech Apple Computer Applied Business Software Atlanta Business Computer Balcones Computer Corp. Biss		Antech Apple Computer Applied Business Software Atlanta Business Computer Balcones Computer Corp. Biss
	BPI Systems Briareus	BPI Systems		BPI Systems	
	Cado	Cado Canon U.S.A.	Broderbund Software Business Enhancement Compuservice		Broderbund Software Business Enhancement Compuservice
	Centurion-Warrex-Eds Cimarron		Cape Cod Computer		Cape Cod Computer
	Computax		CMS Software Systems Coelco Software Systems COM Business Computer Systems Compumax Associates		CMS Software Systems Coelco Software Systems COM Business Computer Systems Compumax Associates
	Continental Software	Cromemco	Computerease Inc. Computer Products International Computer Research Computerware Inc. Computhink Continental Software		Computerease Inc. Computer Products International Computer Research Computerware Inc. Computhink Continental Software
		Data General	CTI Custom Accounting Customation Custom Computing D.B. Software Dakin-5		CTI Custom Accounting Customation Custom Computing D.B. Software Dakin-5
		Data Train	Data Solutions Data Train Data Universal Datavision Davis-Lane		Data Solutions Data Train Data Universal Datavision Davis-Lane
		DEC	Delphic Systems Delta Software Denver Software Company		Delphic Systems Delta Software Denver Software Company
	Designer Software DIBS Digilog Digital Systems				
	Durango Dynabyte	Durango	Digital Tech Duchess Enterprises Durango		Digital Tech Duchess Enterprises Durango
			Ecosoft EDP Business Systems Electronic Information Systems Fox Computer Systems Functional Solutions Glenn/Cliff Associates Haland Data Systems H & E Computronics		Ecosoft EDP Business Systems Electronic Information Systems Fox Computer Systems Functional Solutions Glenn/Cliff Associates Haland Data Systems H & E Computronics
	IBM 5120 IBM Systems 32/34	Hewlett-Packard			

Table 3: Hardware and software sources for which these companies produce standardized forms. Keep in mind that a company that produces forms for one program from a particular software house may not produce forms for all programs from that house. Furthermore, a company that produces forms for one computer from a certain manufacturer may not produce forms for every computer from that manufacturer. In addition, since some of these forms companies entered this market shortly before the research was done for this article, they may by now offer forms for more computers and more software.

Check-Mate	Checks-to-Go	Moore	NEBS	Trinity	DFS
	IMS		ICM Computer Systems Idea Micro Design		ICM Computer Systems Idea Micro Design
	Insoft		Info Designs		Info Designs
			Interactive Operations Associates		Interactive Operations Associates
			International Computer Service		International Computer Service
			International Data Tech Key Systems		International Data Tech Key Systems
			Legler Systems		Legler Systems
			Lenz, Masterson & Associates		Lenz, Masterson & Associates
Libra	Libra	Libra	Mark/Donn Associates George Matyjewica & Company		Mark/Donn Associates George Matyjewica & Company
	MCBA MCS		Medfield Computer Software		Medfield Computer Software
			Microcomputer Consultants Micro-Management		Microcomputer Consultants Micro-Management
			Midwest Data Services		Midwest Data Services
			Mitex		Mitex
		Moore	Montour Computer Systems		Montour Computer Systems
			Murray Jones Murray Engineers		Murray Jones Murray Engineers
	NEC North Star	NEC			
	Osborne Peachtree	Open Systems Peachtree		Peachtree	
			P.G. & J. P K Systems		P.G. & J. P K Systems
Radio Shack	R & B Systems Radio Shack	Radio Shack	Radio Shack Realistic Computing of Georgia		Realistic Computing of Georgia
			G.A. Rock Systems Group		G.A. Rock Systems Group
			Rocky Mountain Software		Rocky Mountain Software
			RTG Data Systems		RTG Data Systems
			S & M Systems		S & M Systems
		Serendipity Software	Score		Score
	Shasta		Small Business Systems Group		Small Business Systems Group
			Small Systems Software Software Services		Small Systems Software Software Services
			Software Technology for Computers		Software Technology for Computers
	Structured Systems	Structured Systems	Synergetic Computer Systems		Synergetic Computer Systems
	Systems Plus		Tailored Data Taranto & Associates	Systems Plus	Tailored Data Taranto & Associates
			Targhee Software Engineering		Targhee Software Engineering
			TBSB		TBSB
	TCS Software	TCS Software Texas Instruments		TCS Software	
			The Bottom Shelf The Software Exchange		The Bottom Shelf The Software Exchange
		The Software Shoppe			
	Timberline		The Systems Shop		The Systems Shop
			Utility Computing Service		Utility Computing Service
	Vandata Vector Graphic Wang		Vandata		Vandata
			Westware Woodbury Computer Associates		Westware Woodbury Computer Associates
			Xtra Soft		Xtra Soft

Base 2 Printer

Walter Jeffries
RFD 1
Readfield, ME 04355

Recently, after considering it for quite awhile, I added a printer to my system. My choice was the Base 2 printer, which I use with an Exidy Sorcerer with 32K bytes of RAM (random-access read/write memory). I bought the printer used for \$470, complete with most of its options (tractor feed, graphics option, and expanded character buffer). Parts of this article may not apply to Base 2 printers that lack these options.

Construction

This compact printer measures 7.5 by 24.5 by 35.6 cm (3 by 11 by 15 inches) and is constructed of aluminum, which makes the printer surprisingly heavy for its size. The aluminum chassis acts as a heat sink for the large-scale integrated (LSI) circuits, making a fan unnecessary if the printer has an unimpeded airflow. Designed around the 8085 microprocessor and other LSI chips, the printer has few components but great flexibility. Behind the tractor mechanism is a removable panel that provides access to two erasable programmable read-only memories (EPROMs).

One EPROM contains the printer's program and the standard character set, consisting of 96 ASCII characters. The other EPROM can contain auxiliary character sets; it does not come standard with the printer. The paper inlet is located in the bottom of the printer, and the friction

feed mechanism is located inside. In the upper left-hand corner of the printer's back panel is the power switch. Also on the back panel are the three interface connectors, power inlet, mode switches, and the reset/self-test switch. On the front panel are the formfeed (FF) and unit-select switches.

Interfaces

The Base 2 printer has three interface connectors that support four popular interfaces: RS-232, 20-milliampere (mA) current loop, Centronics parallel, and IEEE-488. You select the interface mode by using two switches of an eight-position miniature DIP (dual-inline package) switch located under the power switch. The next four switches set the default line length from any of five of the six line densities. The remaining two switches determine the "pinout" (lines assigned to the socket pins) for the serial interfaces. Also on the back panel is the data rate/unit-number switch, which consists of a 16-position thumb-wheel switch. In the serial mode this switch determines one of 15 data rates ranging from 75 to 9600 bits per second. In the IEEE-488 interface mode this switch acts as the unit-number switch. In the parallel mode this switch is not used.

An additional mode recommended for the TRS-80 uses the parallel interface and a line length of 80

At a Glance

Name

Base 2 printer

Use

Medium-quality printer

Manufacturer

Base 2 Inc.
POB 3548
Fullerton, CA 92634
(714) 533-0111

Dimensions

7.5 by 24.5 by 35.6 cm (3 by 11 by 15 inches)

Price

\$699

Hardware Needed

Host computer with one of four interfaces: RS-232, 20-mA current loop, Centronics parallel, IEEE-488

Software Needed

Appropriate driver for interface

Hardware Options

Tractor feed, paper holder, graphics option, expanded buffer

Features

Print speed: 100 cps bidirectional. Form-feed speed: 1.5 inches per second. Six character densities with elongated printing. Standard 96 ASCII characters in 5 by 7 dot-matrix font. Nine additional user-defined character fonts.

Documentation

74-page paperback

Audience

Computer hobbyist desiring a flexible, inexpensive printer

How to turn your HP-41 into a handheld computer.



Introducing the Hewlett-Packard Interface Loop.

Starting today, your HP-41C or HP-41CV can be more than just a great little calculator. It's a great little computer, capable of controlling a quickly-expanding family of peripherals.

The new Hewlett-Packard Interface Loop (HP-IL) makes it all possible. HP-IL is an easy-to-use, low-cost interfacing system, specifically designed for battery-operable devices.

The Interface Module and Peripherals.

At the heart of the system is the Interface Module, which plugs into any one of four HP-41 ports. You can control up to 30 peripherals, using only one port in your HP-41 calculator.

One of the key HP-IL peripherals is the new Digital Cassette



Drive. This battery-operable device provides an

Circle 178 on Inquiry card.

incredible 131,000 bytes of mass memory!

Another work-saving HP-IL peripheral is the new, battery-operable Thermal Printer/Plotter with enhanced formatting options and graphics.

This is just the beginning.

There are many more HP-IL products on the way. And they're all designed to provide the versatility and adaptability you expect from HP. You see, Hewlett-Packard is committed to a very big idea: small devices talking to each other, giving you big system capabilities – at small system prices!

For details and the address of your nearest dealer, CALL TOLL FREE: 800 547-3400, Dept. 276J, except Hawaii/Alaska. In Oregon, call 758-1010, or write Hewlett-Packard, Corvallis, OR 97330, Dept. 276J. TTY users (503) 758-5566.

611/18.

When performance must be measured by results.



**HEWLETT
PACKARD**

ASCII	Hexadecimal	Decimal	Code	Operation
CTL I	09	09	HT	Horizontal Tab
CTL J	0A	10	LF	Linefeed
CTL K	0B	11	VT	Vertical Tab
CTL L	0C	12	FF	Formfeed
CTL M	0D	13	CR	Carriage Return
CTL N	0E	14	SO	Elongated Characters
CTL Q	11	17	X-ON	Selects unit online
CTL S	13	19	X-OFF	Deselects unit offline

Table 1: The control codes of the Base 2 printer.

characters, with automatic linefeed (LF) on receipt of a carriage return (CR).

Power Supply

My printer came wired for 110 volts of alternating current, but it can easily be rewired for 210 volts. Written directions and diagrams are in the operator's manual. Since the stepping motors are direct current (DC) and independent of the line frequency, the printer does not need to compensate for frequencies of 50 or 60 hertz (Hz).

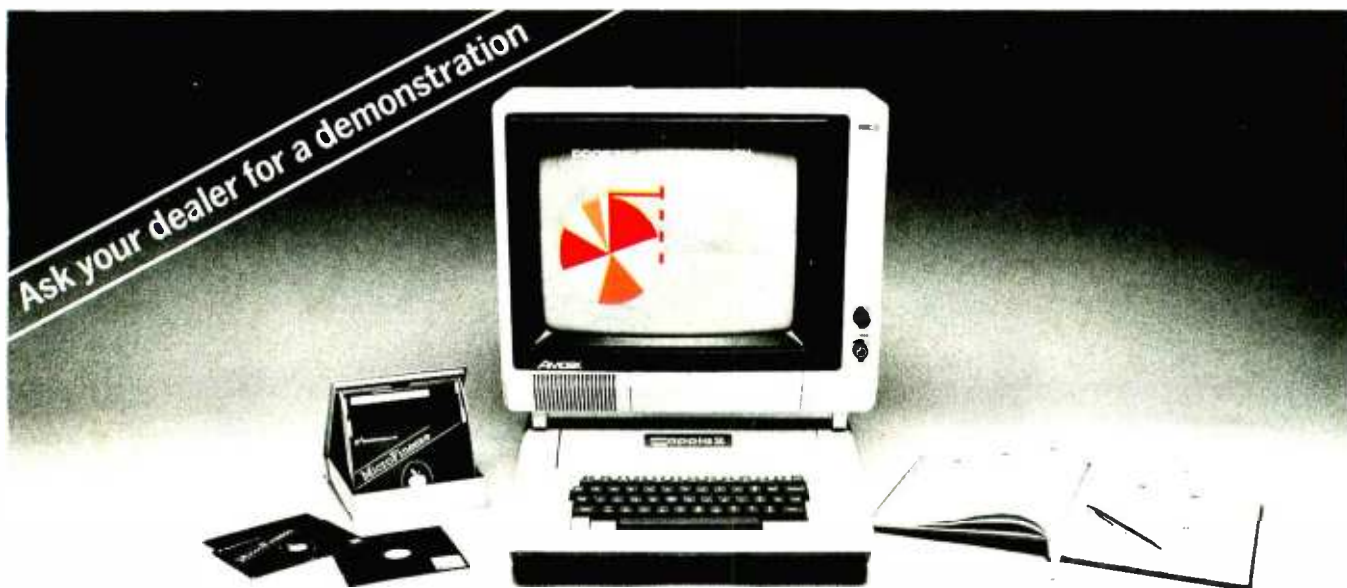

Chart your financial future with MicroFinesse™

In this fast-paced business world, the best way to stay competitive is to chart your financial alternatives clearly and make decisions fast.

MicroFinesse is a complete planning package providing professional forecasting PLUS full high-resolution color graphics support, including pie charts, histograms and graphs, for the financial projections you create.

With this evolutionary resource planning tool you can consolidate or expand your financial models,

generate up to 15 user-defined reports per model, with visuals, all without bothersome reprogramming.

Previously available only for mainframe applications, MicroFinesse can now be purchased for the 48K Apple II® with the Apple Language Card.

So when your variables are many and your time is limited, take a good look at the financial artistry of MicroFinesse.



MicroFinesse™

630 Bancroft Way, Berkeley, CA 94710, (415) 548-2805, Distributed by:  OSBORNE/McGraw-Hill

Apple II is a registered trademark of Apple Computer, Inc. MicroFinesse is a trademark of P-E Consulting Group Limited.



★ ★ ★ ★ ★ ★ ★ ★ ★ ★

THE FUTURE TERMINAL ★ WILL COST \$465.⁰⁰ ★



★ ★ ★ ★ ★ ★ ★ ★ ★ ★

WELCOME TO THE FUTURE.

★ ★ ★ ★ ★ ★ ★ ★ ★ ★

For \$465.⁰⁰ this full feature terminal is
a lot smarter than you think!

Call the "800" number today to order or for more
information.

★ ★ ★ ★ ★ ★ ★ ★ ★ ★

800-277-1258

In California call 800-972-5286

★ ★ ★ ★ ★ ★ ★ ★ ★ ★

The

Alpha

★ ★ ★ ★ ★ ★ ★ ★ ★ ★

Emulog Inc.

48881 Kato Road
Fremont, CA 94538
(415) 490-1290

STAR

Manufactured by Emulog Inc.

Sold exclusively through
Phasar Marketing

Manual Control

The Base 2 printer's front panel consists of a unit-select switch and a formfeed switch. When the unit-select switch is on, the formfeed switch causes the printer to eject paper to the top of the next form (default form length is 66 lines per page). When the switch is off, the formfeed switch causes the paper to advance at a rate of 1.5 inches per second.

In the upper right-hand corner of the printer's back panel is the reset/self-test switch. When toggled to the left, this switch resets the printer to its default mode. When the reset/self-test switch is toggled to the right, the printer prints a line of characters using the present mode. The self-test switch allows testing the printer independently of the host computer.

Software Control

Two sets of software controls have functions that overlap to a slight degree. One set consists of "control codes" (table 1); the other set consists of "function codes" (table 2). To take effect, the function codes must be prefixed by an ESC (ASCII 27). Some of the function codes must be followed by data, as when setting tabs.

The Base 2 printer supports six character densities (64, 72, 80, 96, 120, and 132 characters per line), as well as elongated characters (10 dots wide rather than 5) in all character densities.

The standard character set contains 96 ASCII characters in a 5 by 7 dot-

ASCII	Hexadecimal	Decimal	Function
J	4A	74	General printer reset
H	48	72	Unit select
I	49	73	Unit deselect
j	6A	106	Enable unidirectional printing
k	6B	107	Enable bidirectional printing
R	52	82	Enable 1920 character buffer
S	53	83	Disable 1920 character buffer
5	35	53	Disable print on buffer full
6	36	54	Enable print on buffer full
7	37	55	Enable auto LF following CR
8	38	56	Disable auto LF following CR
B	42	66	Enable CR recognition
C	43	67	Disable CR recognition
D	44	68	Enable LF recognition
E	45	69	Disable LF recognition
V	56	86, n1...n16	Set horizontal tabs
X	58	88	Reset horizontal tabs
Y	59	89, n1...n10	Set vertical tabs
a	61	97	Reset vertical tabs
@	40	64	Enable elongated characters
A	41	65	Disable elongated characters
T	54	84, n	Set form length to n lines
9	39	57, n	Set auto FF count
:	3A	58	Enable auto FF
:	3B	59	Disable auto FF count
F	46	70, n	Set eject to n lines
G	47	71	Eject
d	64	100	Set line length to 64 chars.
0	30	48	Set line length to 72 chars.
1	31	49	Set line length to 80 chars.
2	32	50	Set line length to 96 chars.
3	33	51	Set line length to 120 chars.
4	34	52	Set line length to 132 chars.
b	62	98, n	Set vertical line density
c	63	99, data	Enable and send graphics
K	4B	75, data	Load user-defined characters
L	4C	76	Enable user-defined chars.
M	4D	77	Enable Standard ASCII chars.
O	4F	79	Enable optional chars. 1
P	50	80	Enable optional chars. 2
Q	51	81	Enable optional chars. 3
e	65	101	Enable optional chars. 4
f	66	102	Enable optional chars. 5
g	67	103	Enable optional chars. 6
h	68	104	Enable optional chars. 7
i	69	105	Enable optional chars. 8

Table 2: The function codes of the Base 2 printer. All function codes must be preceded by an ASCII <ESC> (escape, hexadecimal 1B, decimal 27) in order to take effect.



\$32.50

McGraw-Hill Bookstore

Are programmers available? Are they needed?

APPLICATION DEVELOPMENT WITHOUT PROGRAMMERS

by James Martin, Prentice-Hall

With the wide range of software available and the great proliferation of computers, there may not be enough programmers to go around.

Here's how to put the computer to work without a programmer.

A wide range of methods is described. Each has its place; the ability to apply the right approach to each trade becomes an essential new DP skill. 320 pp

McGraw-Hill Bookstore
1221 Avenue of the Americas
N.Y., N.Y. 10020



Please send me _____ copies of
Application Development without Programmers by James Martin at \$32.50.

MasterCard___ Visa___ AmerExp___

Account No. _____ Expires _____

Name _____

Address _____

City _____ State _____ Zip _____

Add sales tax plus \$2.50 postage, handling

DEALER DEMO SOFTWARE FOR 3¢ ON THE DOLLAR



Look at what you get for just \$295.

How can we afford to make available over \$9,000 worth of the finest software in the microcomputer industry for just \$295? Our answer is how can we afford not to?

We both know that professional demonstration is the best sales closer. It sells your computers and it sells our top quality software. That's why we'll send you all the business applications listed below for just \$295.

You'll also receive important promotional materials and our exclusive video sales presentation designed to help you make the sale.

Just give us a call, or drop us a card and we'll send you the whole package for just 3¢ on the dollar . . . we'd like to lose less, but we can't afford to.

FINANCIAL

General Ledger • Accounts Payable • Accounts Receivable • Payroll • Cash Receipts/Disbursements • Job Costing • Mailing List Management

MEDICAL/DENTAL

Office Scheduler • Patient Billing • Accounts Receivable • Insurance Forms

GOVERNMENTAL/EDUCATIONAL

Student Record Keeping • Student Scheduling • Fund Accounting

WHOLESALE DISTRIBUTION

Purchasing and Receiving • Inventory Control • Invoicing and Receivables • Sales Commission Reporting • Backorder Management

MANUFACTURING

INVENTORY CONTROL

Finished Goods Inventory Management • Parts Inventory Management • Parts Purchasing and Receiving • Bill of Material • Production Scheduling

All IMS business applications require CP/M* or MP/M* and CBASIC II* registered trademarks of Digital Research Corp.

Call for details (913)677-1137



INTERNATIONAL MICRO SYSTEMS

6445 METCALF • SHAWNEE MISSION, KS. 66202

NOW TWO LOCATIONS

SAVE TIME • SAVE SHIPPING



Computers
for people.™



800™ \$679

410 Recorder	\$76.00
810 Disc Drive	\$449.00
822 Printer	\$229.00
825 Printer	\$629.00
830 Modem	\$159.00
820 Printer	\$269.00
850 Interface	\$169.00
New DOS 2 System	\$21.00
CX30 Paddle	\$18.00
CX40 Joy Stick	\$18.00
CX853 16K RAM	\$89.00
Microtek 16K RAM	\$75.00
Microtek 32K RAM	\$159.00
Ramcrum (128K)	\$539.00
One year extended warranty	\$50.00



ATARI 400
16K. . . . \$329
32K. . . . \$478
48K. . . . \$555

ATARI SOFTWARE

CX404 Word Processor	\$119.00
CX405 PILOT (educational)	\$105.00
CX413 MicroSOFT Basic	\$68.00
CX4101 Invitation To Programming I	\$17.00
CX4102 Kingdom	\$13.00
CX4103 Statistics	\$17.00
CX4104 Mailing List	\$17.00
CX4105 Blackjack	\$13.00
CX4106 Invitation to Programming 2	\$20.00
CX4107 Biorythm	\$13.00
CX4108 Hangman	\$13.00
CX4109 Graph II	\$17.00
CX4110 Touch Typing	\$20.00
CX4112 States & Capitals	\$13.00
CX4114 European Countries & Capitals	\$13.00
CX4115 Mortgage & Loan Analysis	\$13.00
CX4116 Personal Fitness Program	\$59.00
CX4117 Invitation To Programming 3	\$20.00
CX4118-20 Conversational Languages (ea.)	\$45.00
CX4121 Energy Czar	\$13.00
CXL4001 Educational Master	\$21.00
CX6001-17 Talk & Teach Series (ea.)	\$23.00
CX8106 Bond Analysis	\$20.00
CX8107 Stock Analysis	\$20.00
CX8101 Stock Charting	\$20.00
CXL4002 Basic Computing Language	\$46.00
CXL4003 Assembler Editor	\$46.00
CXL4004 Basketball	\$24.00
CXL4005 Video Easel	\$24.00
CXL4006 Super Breakout	\$30.00
CXL4007 Music Composer	\$45.00
CXL4008 SPACE INVADERS	\$32.00
CXL4009 Chess	\$30.00
CXL4010 3-D Tic-Tac-Toe	\$24.00
CLS4011 STAR RAIDERS	\$39.00
CXL4012 MISSILE COMMAND	\$32.00
CXL4013 ASTEROIDS	\$32.00
CXL4015 TeleLink	\$20.00
Visicalc	\$149.00
Letter Perfect (Word Processor)	\$109.00
Source	\$89.00
CX481 The Entertainer	\$75.00
CX482 The Educator	\$130.00
CX483 The Programmer	\$54.00
CX484 The Communicator	\$329.00

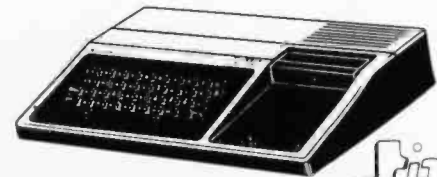

Texas Instruments

TI-99/4A \$359

PHP 1600 Telephone Coupler	\$169.00
PHP 1700 RS-232 Accessories Interface	\$169.00
PHP 1800 Disk Drive Controller	\$239.00
PHP 1850 Disk Memory Drive	\$389.00
PHP 2200 Memory Expansion (32K RAM)	\$319.00
PHA 2100 R.F. Modulator	\$43.00
PHP 1100 Wired Remote Controllers(Pair)	\$31.00
32K Expansion	\$329.00
PHP Printer Solid State	\$319.00

CALL FOR SOFTWARE
SELECTION AND PRICES

XEROX 820

Xerox 820	
System I 5 1/4"	\$2450.00
System II 8"	\$2950.00
CPM 5 1/4"	\$169.00
Word Processing	\$429.00
Super Calc	\$269.00

CALL FOR MORE INFORMATION

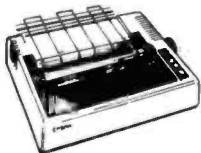

PRINTERS

Centronics 739-1	\$649.00
Diablo 630 Special	\$1799.00
Epson	
MX70	\$359.00
MX80	\$469.00
MX80FT	Call
MX100	Call
NEC	
8023	\$639.00
7730	Call
7720	Call
7710	Call

Okidata	
82A	\$499.00
83A	\$769.00
84	\$1129.00
Citoh Starwriter	
25 CPS-P	\$1329.00
45 CPS-P	\$1699.00
Paper Tiger	
445G	\$699.00
460G	\$899.00
560G	\$1129.00
Talley	
8024-7	\$1399.00
8024-L	\$1629.00

Terminals

Televideo	
910	\$579.00
912C	\$699.00
920C	\$749.00
950	\$939.00
Call for computers	
Zenith Z19	\$749.00
Adds	\$549.00

Modems

Novation Auto	\$239.00
D Cat	\$169.00
Cat	\$159.00
Hayes	
Smart	\$239.00

HOW TO ORDER: Phone orders invited or send check or money order and receive free shipping in the continental United States. PA and NEV. add sales tax.

computer mail order west

800-648-3351

IN NEVADA, CALL (702) 588-5654
P.O. BOX 6689, STATE LINE, NEVADA 89449

TO SAVE YOU MORE!

COSTS • SAVE SALES TAX

 **HEWLETT
PACKARD**

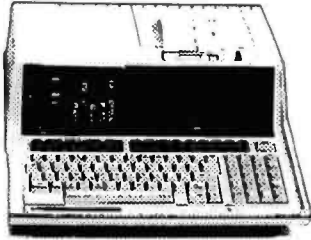

HP-85 \$1999

80 Column Printer	\$799.00
NEW! HP-125	\$2999.00
HP-83	\$1699.00
HP-85 16K Memory Module	\$249.00
5 1/4" Dual Master Disc Drive	\$2129.00
Graphics Plotter (7225B)	\$2079.00

NOW IN STOCK!
The new HP41CV Calculator
\$259

41 C	\$189.00
11 C	\$119.00
12 C	\$129.00
34 C	\$117.00
38 C	\$119.00
HP-41 Printer	\$340.00
Card Reader	\$164.00
Optical Wand	\$99.00

HPIL CALCULATOR PERIPHERALS

IL Modul	\$104.00
Digital Cassette	\$449.00
Printer/Plotter	\$419.00

CALL FOR SOFTWARE INFORMATION

Monitors

Amdex 12" B&W	\$149.00
12" Green	\$169.00
13" Color	\$349.00
Sanyo 12" B&W	\$259.00
12" Green	\$269.00
13" Color	\$449.00
TI 10" Color	\$349.00

Electronics

Pioneer Laser Disk	\$599.00
BSR X-10 Systems	
PK 500	\$84.00
LM 501	\$16.00
AM611	\$17.00
AM286	\$17.00

 **commodore**

CBM 8032

\$1039



SOFTWARE

WordPro3 Plus	\$199.00
WordPro4 Plus	\$299.00
Commodore Tax Package	\$399.00
Visicalc	\$149.00
BPI General Ledger	\$329.00
OZZ Information System	\$289.00
Dow Jones Portfolio	\$129.00
Pascal	\$239.00
Legal Time Accounting	\$449.00
Word Craft 80	\$289.00
Power	\$79.00
Socket 2-Me	\$20.00
Jinsam	\$Call
MAGIS	\$Call
The Manager	\$209.00
Softrom	\$129.00
Real Estate Package	\$799.00
BPI Inventory Control	\$319.00
BPI Job Costing	\$319.00
BPI Payroll	\$319.00

4032	\$969.00
4016	\$769.00
8096	\$1569.00
Super Pet	\$1599.00
2031	\$529.00
8050	\$1299.00
4022	\$599.00
4040	\$949.00
8300 (Letter Quality)	\$1799.00
8023	\$769.00
Pet to IEEE Cable	\$37.00
IEEE to IEEE Cable	\$46.00
Tractor Feed for 8300	\$240.00
8010 Modem	\$229.00

**VIC 20
\$259**

COMPLETE



Vic 6 Pack Program	\$44.00
VIC 1530 Commodore Datassette	\$69.00
VIC 1540 Disk Drive	\$499.00
VIC 1515 VIC Graphic Printer	\$339.00
VIC 1210 3K Memory Expander	\$32.00
VIC 1110 8K Memory Expander	\$53.00
VIC 1011 RS232C Terminal Interface	\$43.00
VIC 1112 VIC IEEE-488 Interface	\$86.00
VIC 1211 VIC 20 Super Expander	\$53.00
VIC 1212 Programmers Aid Cartridge	\$45.00
VIC 1213 VICMON Machine Language Monitor	\$45.00
VIC 1901 VIC AVENGERS	\$23.00
VIC 1904 SUPERSLOT	\$23.00
VIC 1906 SUPER ALIEN	\$19.00
VIC 1907 SUPER LANDER	\$23.00
VIC 1908 DRAW POKER	\$23.00
VIC 1909 MIDNIGHT DRIVE	\$23.00
VT106A Recreation Pack A	\$44.00
VT107A Home Calculation Pack A	\$44.00
VT164 Programmable Character/Graphematics	\$12.00
VT232 VICTerm I Terminal Emulator	\$9.00

New VIC Software

Household Finance	\$27.00
VIC Games	\$19.00
VIC Home Inventory	\$13.00
VIC Rec/Ed II	\$13.00
I SAM	\$79.00
General Ledger	\$229.00
Accounts Receivable	\$229.00
Inventory	\$229.00
Terminal	\$13.00
Un Word	\$13.00
Grafix Managerie	\$11.00
VIC PICS	\$15.00
Ticker Tape	\$13.00
Banner Headliner	\$13.00
RS 232	\$39.00

Above are cash prices, add 3% for Master Card and Visa purchases.

computer mail order east

800-233-8950

IN PA. CALL (717) 327-9575
501 E. THIRD ST., WILLIAMSPORT, PA 17701

matrix font. With software, you can define 96 other characters as an alternate character set. Up to eight other character sets can be contained in a 2732 EPROM, or four in a 2716 EPROM. A function code selects each of the 10 character sets. These extra character sets, especially the user-defined set, allow for special character sets, for example, APL characters, math symbols, and foreign alphabets.

The expanded buffer allows storage within the printer of a full screen (1920 characters). The buffer contents are printed either when the buffer is full or the print-buffer function code is received. The print on buffer full can be optionally disabled with a function code.

The graphics feature provides six horizontal densities up to 99 dots per inch and a constant vertical density of 72 dots per inch. Table 3 shows the character set in different densities. To use the graphics mode, you send the graphics-mode-enable function code

followed by a full line of graphics data. The graphics data consist of bytes in which the lower 7 bits control the seven wires in the print head. The printer automatically prints the line of graphics upon receiving a full line of data. Since the printer does not linefeed automatically in the graphics mode, you must send an LF after each line of data. Figure 1 shows a printout of my name in script, produced by using the graphics mode.

Documentation

The documentation for the Base 2 printer is well done. It consists of a single 74-page *Operator's Reference Manual* that is divided into five sections plus appendixes. The sections cover installation, operation, internal specifications, and software control. Each control code and function code has a complete written description followed by a demonstration program in BASIC. The appendixes cover the hardware, providing full

schematic diagrams and component layouts for the logic boards, as well as the parts lists.

Disaster and Recovery

After I wrote the first draft of this article, disaster struck at a most inconvenient time (couldn't Murphy have waited?). I had used my computer to write my term papers in school and had saved the papers on tape. When the time came to print the papers and pass them in, the printer blew a fuse. Okay, I thought, no problem. Just a fuse. Having noticed that the lights had flickered earlier, I thought it was probably just a power surge. I made sure that none of the mechanical parts had stuck, and then I inserted a new fuse. That blew immediately. My printer was not under warranty. Besides, I needed the printer *now*; I could not afford to wait six weeks for the company to fix it. Well, everything was not against me. With the help of the *Operator's*

64 characters per line: ! "#\$%&'()*+,-./0123456789:;<=>?@ABCDEFGHIJKLMNPOQRSTUVWXYZ Elongated: ! "#\$%&'()*+,-./0123456789:;<=>?@ABCDEFGHIJKLMNPOQRSTUVWXYZ
72 characters per line: ! "#\$%&'()*+,-./0123456789:;<=>?@ABCDEFGHIJKLMNPOQRSTUVWXYZ Elongated: ! "#\$%&'()*+,-./0123456789:;<=>?@ABCDEFGHIJKLMNPOQRSTUVWXYZ
80 characters per line: ! "#\$%&'()*+,-./0123456789:;<=>?@ABCDEFGHIJKLMNPOQRSTUVWXYZ Elongated: ! "#\$%&'()*+,-./0123456789:;<=>?@ABCDEFGHIJKLMNPOQRSTUVWXYZ
96 characters per line: ! "#\$%&'()*+,-./0123456789:;<=>?@ABCDEFGHIJKLMNPOQRSTUVWXYZ Elongated: ! "#\$%&'()*+,-./0123456789:;<=>?@ABCDEFGHIJKLMNPOQRSTUVWXYZ
120 characters per line: ! "#\$%&'()*+,-./0123456789:;<=>?@ABCDEFGHIJKLMNPOQRSTUVWXYZ Elongated: ! "#\$%&'()*+,-./0123456789:;<=>?@ABCDEFGHIJKLMNPOQRSTUVWXYZ
132 characters per line: ! "#\$%&'()*+,-./0123456789:;<=>?@ABCDEFGHIJKLMNPOQRSTUVWXYZ[]^_` Elongated: ! "#\$%&'()*+,-./0123456789:;<=>?@ABCDEFGHIJKLMNPOQRSTUVWXYZ[]^_`

Table 3: Printouts of the Base 2 printer character set. The densities range from 64 characters per line to 132 characters per line.

TAKE A TEST DRIVE.



With a reliable
TRAXX™ 100/200/300
series add-on
drive system.

Our drives feature excellent engineering, and all of the advanced performance features you've come to expect from the nation's leading disk drive manufacturers. All systems are completely burned-in and tested. And, you'll see at least five quality assurance stamps on each and every drive, which is how we make sure our drives will run and will continue to run past our optional two year extended warranty.

Our drive packages start at \$250.00 and include a comprehensive operations manual and an attractive static free, dust free cover.

Systems available for Altos,¹ Apple™, Atari, Heath™, North Star™, S-100,² TRS-80™ (Model I, II, III, Color), Zenith™.

If one of our drives fails to meet your highest expectations of how trouble free and reliable a disk drive can be, then return it to us for a complete refund.*

So, before you buy another drive, take a test drive with one of ours. We're sure that you'll find TRAXX to be the finest.

IT'S GUARANTEED!

Circle 387 on inquiry card.

TRAXX
COMPUTER CORPORATION

Call our toll-free TRAXX LINE: 1-800-621-3102. In Illinois, call: (312) 987-1024. 10AM-6PM CST. Monday thru Friday. *For full refund drives must be returned within 10 days of purchase.

¹ Apple is a registered trademark of Apple Computer Inc.

² TRS-80 is a registered trademark of Radio Shack, a Tandy Company.

**NEVER
UNDERSOLD!**

**We Meet or Beat
Any Advertised Price!
NORTHSTAR**

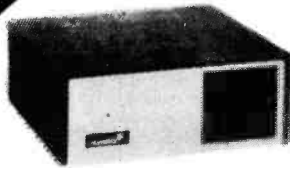

**HORIZON II
64k Double Density
Reg. \$4195
\$3050**

**HORIZON II
64k Quad Density**
•2 5/8" Dbl Side
Dbl. Density Drives
•Full Factory Warranty
•List \$4495

**PCB PRICE
ONLY**

\$3275

NORTHSTAR ADVANTAGE

Complete with graphics,
12" green screen, 64k RAM,
QD floppy drives.

\$3125

SUPERBRAIN™



64k RAM, double density
single-side, double density disk
drives

\$2650

QD 64k RAM, dual 5 1/4"
Double side, double density
disk drives **\$2945**

DISK DRIVES

Superbrain Add-on Drives
Includes case, software, power supply.

Single side, one 5 1/4" drive	List \$595	PCB \$495
Single side, two 5 1/4" drives	List \$995	PCB \$795
Double side, one 5 1/4" drive	List \$745	PCB \$595
Double side, two 5 1/4" drive	List \$1295	PCB \$995

HARD DISKS

TARGA 5mb for IBM, TRS-80, Superbrain, Heath H-89, S-100, Apple LIST	\$2795	CORVUS 10mb LIST \$5350 20mb LIST \$6450 Mirror Backup Multiplexer	\$4295 \$5300 \$650 \$775
---	---------------	--	--

TELEVIDEO

910C	\$595
912C	\$665
920C	\$720
950	\$950

SOFTWARE

C Basic II	\$98
M Basic 80	\$275
MT Pascal	\$430
Fortran 80	\$450
Cobol 80	\$650
M Basic Compiler	\$329
Word Star	\$310

SUPERBRAIN

S-100 Bus Adapter	LIST \$595	\$475
SUPERBRAIN Parallel Port	LIST \$90	\$75
	LIST \$205	
SBE Prom		\$155

GRAPHICS

For SUPERBRAIN	
Graphics Board	\$895
Symbol Generator	\$175
Graphics Plotter	\$175
3-D Graphics	\$345
Surface Plotter	\$395
Graphics Terminal	
Emulator	\$395

DISKETTES

Verbatim 525-01	Box of 10	\$29
Dysan 5 1/4, SS, DD Soft	Box of 10	\$34 ⁷⁰

To Order Call (206) 453-8159

Mail and telephone orders only. Mastercharge, VISA add 3%. No COD. All prices
FDB origin. Send for catalog. Mail all correspondence to P.O. Box 3952, Bellevue, Wa. 98009

PACIFIC COMPUTER BROKERS

P.O. Box 3952, Bellevue, WA 98009

Walter Vorse Jeffery

Figure 1: A printout produced using the Base 2 printer's graphics mode. The printer renders the author's name in script.

Reference Manual and a multimeter, I was able to determine that the diodes in one of the bridge rectifiers of the power supply had blown, creating a short circuit. The parts were standard; the night before my papers were due, I got the parts and fixed the printer.

This experience put quite a strain on my nerves, but it did teach me that the printer is quite simple to dismantle and repair.

Conclusions

The following conclusions can be made about the Base 2 printer. It is rugged and is backed up with a good manual listing all the parts and containing schematics and layouts.

The printer's format is very flexible and can be changed under software control or, to a lesser degree, by hand. It requires a driving program in the host computer to do the handshaking.

The printer can support as many as 10 character fonts: standard 96-character ASCII, user-defined, and eight more fonts, all in EPROM.

It accommodates four major interfaces: RS-232, 20-mA current loop, Centronics parallel, and IEEE-488. The printer provides high-resolution graphics.

The print rate is 100 characters per second, with bidirectional printing. Both hardware and software are well documented with many diagrams and examples. ■

A Public Service of This Magazine & The Advertising Council



**Need help?
Call us.**



Alspa + Hard Disk

CP/M*



MORE COMPUTER POWER MINIMUM REAL ESTATE

NOW! All ALSPA computers come standard with a CORVUS** hard disk interface. In less than 5 minutes you'll be up and running. In the space of a standard 8 inch drive, ALSPA computers have three RS-232, one parallel, and one hard disk port; 8 inch drives; and run CP/M software. Optional clock/calendar. ALSPA performance starts at \$1995, list.

DEALER/DISTRIBUTOR INQUIRIES
INVITED



Alspa Computer, Inc.

300 HARVEY WEST BLVD., SANTA CRUZ, CA 95060 • (408) 429-6000

*CP/M is a trademark of DIGITAL RESEARCH, INC.
**CORVUS is a trademark of CORVUS SYSTEMS, Inc.

The Fill Forms System

CP/M Programs to Cut Down on Paperwork

Bill Roch
24000 Bessemer St.
Woodland Hills, CA 91367

We live in a paper-mill world with a form for just about everything. And someone has to fill out all those forms. A computer can make form handling easier because it can be programmed to do the complete job, but if there are many forms then you'll need many programs to fill out these forms—right? Wrong. You can do it with three programs.

The Fill Forms System is composed of three CP/M-based programs. The first, FFGRID-1, is used to determine the line and column position for each data field. The next, FFTABL-1, is used to build a control table that is used by the third program, FFORM-1, for data entry and forms

printing. These programs are relatively simple and, best of all, easy to use.

Form designers have been known to ignore the fact that typewriters and printers are generally unable to handle forms with unusual line spacing.

Each of these programs is written in Microsoft BASIC and is designed for use on a CP/M-based system (CP/M versions 1.4 through 2.2).

Determining Field Positions

The idea behind the system is to establish the line and column position for each data field to be printed on the form, then enter the data and print it in the proper position.

Field positions may be determined by measuring the number of lines in the form and finding the width by counting the spaces from the left side

of the form (see figure 1). Once line position 1 and column position 1 are established as reference points, all other field locations can easily be determined—if you count correctly.

This method works fine for a form with a few fields, but when there are a number of fields, it is better to draw a grid on the form and then determine the field positions from the intersections of the horizontal and vertical lines of the grid.

Gridding the Form

The FFGRID-1 program is used to produce a grid on a form (see listing 1). The program prints a row of col-

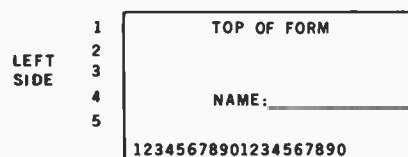

Figure 1: Each field position is determined by its particular reference points. The form is divided into numbered rows and columns. In this example, the data for the NAME field should be placed on line position 4 and start in column position 14.

Editor's Note: Copies of these programs, on either 8-inch single-density CP/M disks or 5¼-inch single-density disks for North Star CP/M users complete with instruction manual can be obtained for \$20 from Elliam Associates, 24000 Bessemer St., Woodland Hills, CA 91367. Programs with the enhancements mentioned in the article are also available.

Wild Hare Software Systems Multiply the Capabilities of Data General's

**RDOS
INFOS®
ICOS
DOS**

Wild Hare gives Data General users a choice when upgrading to a multi-user environment and eliminates the need to use AOS. Wild Hare makes it easy for you. It creates a true multi-lingual, multi-user environment for your current system. No user software modifications are necessary. There is no need to install a new operating system. And, no expensive hardware upgrade is required.

Features

- Each user is totally independent of all other users.
- Each user may run all standard Data General software.
- Each user may independently edit, compile, execute and debug programs written in any language supported by RDOS, INFOS®, ICOS and DOS.
- Standard languages supported include: Fortran IV, Fortran V, COBOL, ALGOL, RPG, DG/L™, BASIC, PASCAL, MAC, etc.
- All NOVA's® and ECLIPSE's® are supported.
- Wild Hare guarantees its software systems on a money back basis.

**Wild Hare's Software
Gives Data General Users
A Choice!**

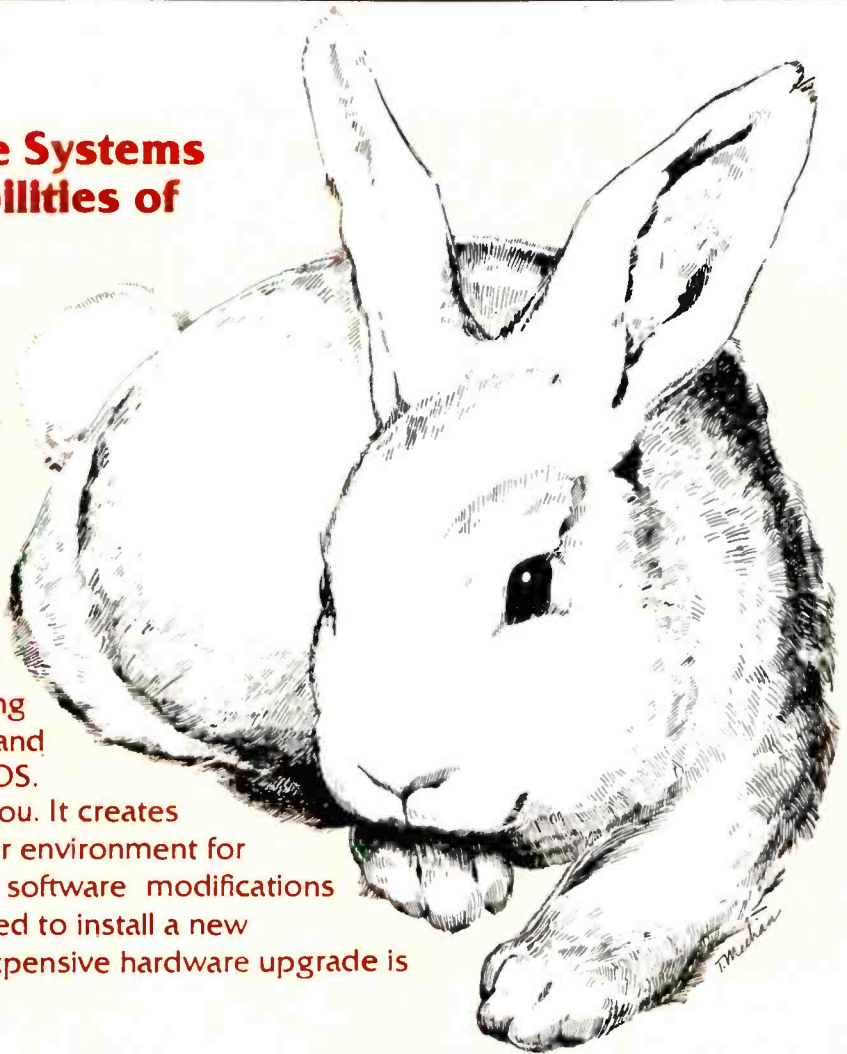

WILD HARE
COMPUTER
SYSTEMS INC.

P.O. Box 3581, Boulder, Colorado 80307
(303) 494-0221

NOVA, ECLIPSE, and INFOS are registered trademarks of Data General Corporation.

Unbeatable prices.....

Orange Micro



NEW NEC 8023 DOT MATRIX



High resolution graphics: 144 x 160 dots/inch · Proportional spacing · Lower case descenders · 9 x N dot matrix · 8 character sizes · 5 unique alphabets · Greek character set · Graphic symbols · 100 cps print speed · Bidirectional, logic seeking printing

Adjustable tractors · Single sheet friction feed · Paper empty sensor · Vertical & horizontal tabbing · Bidirectional paper feed · Bold & underlined print

NEC 8023 DOT MATRIX

(List \$795) \$ Call

EPSON MX 80/MX 80 FT

9 x 9 dot matrix · Lower case descenders · 180 CPS · Bi-directional, logic seeking · 40, 66, 80, 132 columns per line · 64 special graphic characters · TRS-80 Compatible · Form handling · Multi-page printing · Adjustable tractors
 MX 80 (List \$645) \$ Call
 Graftrax-80 Dot Graphics Upgrade (List \$95) \$ Call
 MX 80 FT includes Friction Feed

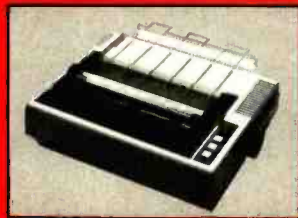

(List \$745) \$ Call

EPSON MX 70



Super low-priced dot resolution graphics · 5 x 7 dot matrix · User replaceable printhead & Top of Form
 MX 70 (List \$450) \$ Call

EPSON MX 100

Same basic features as the MX 80 · PLUS friction feed for single sheets · PLUS 15" wide carriage
 MX 100 (List \$945) \$ Call



C. ITOH STARWRITER

Daisy Wheel Letter Quality 25 CPS (Optional 45 CPS) · Typewriter quality · Centronics parallel · RS 232C Serial (Optional) · Proportional spacing · Bi-directional · Programmable VFU · Self Test · Diablo compatible · Friction feed (Optional tractor) · 136 printable columns · Manufactured by TEC



C. ITOH STARWRITER

(List \$1525) \$ Call

NEC SPINWRITER

High Speed Letter Quality · 55 CPS · Typewriter quality · Bi-directional · Plotting & Proportional spacing · 77XX RO, Serial/Parallel
 (List \$3055) \$2575



QUME 9/45 typewriter quality \$ Call
 DIABLO 630 typewriter quality \$ Call



NEW MALIBU 200

165 cps standard (250 cps optional) · Letter quality font · 12 optional fonts · Bidirectional, logic seeking · 19 x 18 dot matrix · Expanded characters (2x, 4x) · Dot resolution graphics · Underlining
 MALIBU 200 (List \$2995) \$ Call

TELEVIDEO CRT'S

TV1910, TV1920C, TV1920C, TV1950 — Please call toll free. Prices are too low to advertise. \$ Call

CENTRONICS 739



With graphics and word processing Print Quality · 18 x 9 dot matrix, suitable for word processing · Underlining · proportional spacing · right margin justification · serif typeface · 80/100 CPS · 9 1/2" Pin Feed/Friction feed · Reverse Platen · 80/132 columns · Top of Form

CENTRONICS 739-1 (Parallel)
 CENTRONICS 739-3 (Serial)

(List \$955) \$ Call
 (List \$1045) \$815

...technical expertise.

The printer specialists.

ANADEX

Dot Graphics, Wide Carriage - 11 x9 dot matrix, lower case descenders - Dot resolution graphics - Bi-directional logic seeking - Up to 200 CPS - RS 232 Serial & Parallel - Forms control - X-ON/X-OFF - Up to 6 part copy
ANADEX 9501/9500



(List \$1650) \$1350

IDS PAPER TIGERS



Dot Resolution Graphics, quality print, speed 9 wire staggered printhead with lower case descenders - Over 150 CPS - Bi-directional logic seeking - 8 character sizes, 80-132 columns - Adjustable tractors - High-resolution dot graphics - Proportional spacing & text justification

IDS 460G (List \$1094) \$ Call
IDS 560G (List \$1394) \$ Call
IDS PRISM COLOR PRINTER (List \$1995) \$ Call

INTERFACE EQUIPMENT

CCS APPLE SERIAL Interface & Cable \$150
ORANGE INTERFACE for Apple II parallel interface board & cable \$110
TRS-80 CABLES to keyboard or Exp Interface \$ Call
NOVATION D-CAT direct connect modem \$ Call
ATARI, NORTHSTAR printer cables \$ Call
ALL EPSON ACCESSORIES \$ Call

THE GRAPPLER™

APPLE INTERFACE AND CABLE by Orange Micro

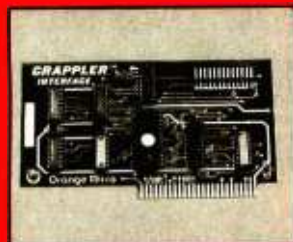

The Grappler™ interface card is the first to provide on-board firmware for Apple high resolution dot graphics. No longer does the user need to load clumsy software routines to dump screen graphics—it's all in a chip. Actually, it's our E-PROM, and it is replace-

able to accommodate the Anadex, Epson MX-70, 80* and 100, IDS Paper Tigers, Centronics 739, NEC 8023, C ITOH Prowriter, and future graphic printers. The Grappler™ accepts 18 software commands including Hi-Res inverse, 90° rotation, double size, and much more. Invented by, and available from Orange Micro and Orange Micro dealers only. \$ Call for price

Circle 288 on Inquiry card.

*Requires GRAFTRAX 80

VISIT OUR RETAIL STORES

If you live in California, or are visiting don't miss our two Printer Stores. Expert consultation and know-how is available to assist you in getting the best printer for the application. We provide live demonstrations for a wide selection of Printers.



SANTA CLARA, 3216 Scott Blvd., (408) 980-1213
SHERMAN OAKS, 13604 Ventura Blvd., (213) 501-3486
ANAHEIM, 3150 E. La Palma, Suite 1, (714) 630-3622
Store Hours: M-F 10-6, Sat. 10-4

At Orange Micro our printer specialists fit the right printer to your application. Call us today for free consultation (and don't forget to ask for your free catalog)

Phone orders are WELCOME, same day shipment. Free use of VISA and MASTERCARD. CODs accepted. Personal checks require 2 weeks to clear. Manufacturers warranty Included on all equipment. Prices subject to revision.

CALL FOR FREE CATALOG TOLL FREE (800) 854-8275

CA, AK, HI (714) 630-3322



Orange Micro Inc.

3150 E. La Palma, Suite G, Anaheim, CA 92806

Copyright © 1981 by Orange Micro, Inc.

Sell Your Software

How to Sell Your Micro Software: Profit from your software. This new book will show you how to sell your own micro software or have others sell it for you. Written specifically for owners of personal computers it shows -how to package software products - how to sell via mailorder - exhibit at computer shows - design ads and brochures - sell through computer stores, software distributors, brokers, publishers, manufacturers, clubs and user groups. Also contains latest ideas on pricing strategy and software protection including patents, copyrights, disk protection and trade secret agreements. Contains many valuable names of distributors, buyers for major chains, and much more. A complete guide to the business of micro software entrepreneurship. Written by B.J. Korites PhD, author of the popular "Free-Lance Software Marketing". - \$18.50

The 1982 Software Writer's Market: This is the *where to sell your software* directory for independent software writers and small software businesses. It's filled with more than 2000 names and addresses of people and companies who will buy your software or market it for you - software publishers - manufacturers - book publishers - software brokers - distributors - service bureaus - consulting companies - 1500 retail computer stores - 850 Apple computer dealers. Also computer shows, mail list vendors, software catalogs and much more. In-depth writeups on individual companies tell what kinds of software they want, how much they pay, and *who to contact* with names, addresses and phone numbers. Companies interviewed include Apple, Atari, Hewlett-Packard, Tandy, Addison-Wesley, Hayden, Lifeboat Associates and hundreds more. This is the only directory of its kind. It is your best source of contacts, guaranteed to help you win your share of the exploding market for packaged software. - \$28.50

VISA/MASTERCHARGE

KERN PUBLICATIONS

190 Duck Hill Rd. Box 1029M-Duxbury, MA 02332

Add \$2 per book for 4th cl mail in US and Canada, \$3 for 1st cl UPS in US, \$4.50 1st cl Canada, \$12 air Europe and Central America, \$18 air elsewhere

Call (617)934-0445 for faster delivery

umn positions across the top of the form and on every tenth line. It also prints each line position on both edges of the form as well as horizontal and vertical grid lines. Since plus and minus characters are used, the grid intersections are at the center of a character rather than to the left and under it.

The program requires that you enter only the form size: the number of lines per page and the width in columns. After you position the form, the program prints an asterisk (*) in line position 1 and column position 1. You can then reposition the form if necessary. Any number of attempts at repositioning may be tried, since

Text continued on page 228

Listing 1: The FGRID-1 program prints a grid on your form. Each plus or minus character denotes the center of a character.

```

10      ^*****
20      ^**
30      PRINT: PRINT
40      PRINT " FGRID-1.BAS"
50      PRINT " Form Grid Program"
60      PRINT "Copyright 1981 by Elliam Assoc."
70      ^**
80      ^** This program prints a grid on a
90      ^** form.
100     ^**
110     ^*****
120     ^
500     PRINT: INPUT "Form length: ",L%
510     INPUT " Form Width: ",W%
520     PRINT: INPUT "Position Form c/r ",X$
530     LPRINT "**";
540     PRINT
550     INPUT "OK (Y or N): ",X$
560     IF X$="Y" GOTO 1020
570     LPRINT CHR$(13);
580     GOTO 520
590     ^
1000    ^BUILD COLUMN NUMBER LINE
1010    ^
1020    HORZ$="": FOR K%=1 TO W%
1030    A$=MID$(STR$(K%),2)
1040    HORZ$=HORZ$+RIGHT$(A$,1)
1050    NEXT
1060    ^
1200    ^BUILD GRID LINE
1210    ^
1220    DP$="": DASHPLUS$="----+"
1230    FOR K%=1 TO W%/5+1
1240    DP$=DP$+DASHPLUS$
1250    NEXT
1260    DP$=LEFT$(DP$,W%)
1270    ^
1300    ^PRINT TOP COL NUM LINE
1310    ^
1320    LPRINT MID$(HORZ$,2)
1330    J%=1
1340    ^
1400    ^PRINT GRID LINES
1410    ^
1420    FOR K%=2 TO L%-1
1430    A$=MID$(STR$(K%),2)
1440    LPRINT A$;
1450    IF J%=0 GOTO 1500
1460    DPLUS$=MID$(DP$,LEN(A$)+1)
1470    DPLUS$=LEFT$(DPLUS$,LEN(DPLUS$)-LEN(A$))
1480    LPRINT DPLUS$;A$
1490    GOTO 1520
1500    GOSUB 3020
1510    LPRINT HZ$;A$
1520    J%=J%+1: IF J%=10 THEN J%=0
1530    NEXT
1540    ^
2000    ^PRINT BOTTOM COL NUM LINE
2010    ^
2020    A$=MID$(STR$(K%),2)
2030    GOSUB 3020
2040    LPRINT A$;HZ$;A$
2050    END
2060    ^
3000    ^SETUP COL NUM LINE
3010    ^
3020    HZ$=MID$(HORZ$,LEN(A$)+1)
3030    HZ$=LEFT$(HZ$,LEN(HZ$)-LEN(A$))
3040    RETURN
    
```

THE 256K BOARD YOU NEED AND:

NO COMPROMISE



No Compromise in Performance

- Operates in any S-100 System IEEE 696* or not.
- Main-frame type memory mapping or 24-BIT extended addressing.
- DMA operation fully supported*
- 8/16 data transfer protocol*
- Up to 6 MHZ with no wait states;
Up to 10 MHZ with automatic wait state assertion
- Parity error detection*

No Compromise in Features

- Easy overall characterization
- No timing characterization required: optimal refresh mode selection.

No Compromise in Quality

- Multilayer board and bus signal filtering for noise-free operation
- Highest quality tested components
- Highest standard workmanship
- Thorough, rigid 100% final test and burn-in

No Compromise in Customer Support

- Comprehensive technical manual
- User hot-line
- Full one year parts and labor warranty

*In accordance with IEEE 696 S-100 Standard

ORDER NOW

(213) 887-5737

If you wish, send a check or money order for \$1,379 (in California add 6% sales tax where applicable).

MACROTECH International Corp.,
22133 Cohasset St. Canoga Park,
California 91303



MACROTECH International Corp.,
22133 Cohasset St. Canoga Park,
California 91303
(213) 887-5737

Circle 223 on inquiry card.

APPLESCOPE

DIGITAL STORAGE OSCILLOSCOPE
Interface for the Apple II Computer

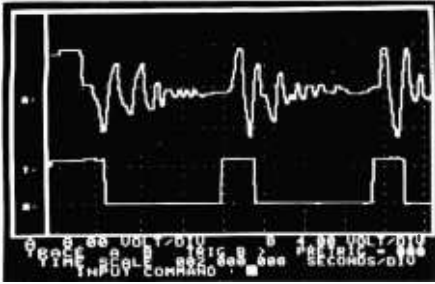

The APPLESCOPE system combines two high speed analog to digital converters and a digital control board with the high resolution graphics capabilities of the Apple II computer to create a digital storage oscilloscope. Signal trace parameters are entered through the keyboard to operational software provided in PROM on the DI control board.

- DC to 3.5 Mhz sample rate with 1024 byte buffer memory
- Pretrigger Viewing
- Programmable Scale Select
- Continuous and Single Sweep Modes
- Single or Dual Channel Trace

Price for the two board Applescope system is **\$595**
EXTERNAL TRIGGER ADAPTER **\$29**

APPLESCOPE ACCESSORIES

APPLESCOPE-HR12 High resolution 12 bit analog to digital converter with sample rates to 100 KHz. Requires 48K Apple II with disk drive. Software provided on floppy disk includes basic SCOPE DRIVER package.
Price per channel **\$895**

APPLESCOPE-HRHS High Resolution AND High Speed. Circuit combines two 6 bit flash analog to digital converters to give a 10 bit dynamic range. The 10 bit converter resolution is maintained at sampling rates up to the 7 Mhz. maximum for signal slew rates less than .5 volts per microsecond. Larger inputs slew rates will reduce the converter resolution to 6 bits until the signal stabilizes within the .5 Volt per microsecond limit. Requires 48K Apple II with disk drive. Software provided on disk includes the basic SCOPE DRIVER package. Price per channel **\$695**

APPLESCOPE-EXT External trigger adapter has a switch selectable external trigger input to a BNC connector mounted in a rear slot of the Apple II computer. Price **\$29.00**

APPLESCOPE-BNC BNC adapter connects the Berg stick connectors on the AI circuit card to male BNC plugs mounted in a rear slot of the Apple II computer. Price **\$14.95**

BUS EXTENDERS Allow easy access to Apple II peripheral circuit cards. Price **\$19.95**

SCOPE PROBES Oscilloscope probes for use with the APPLESCOPE - BNC adapter. Price **\$29.95**

SCOPE DRIVER Advanced software for the Applescope system provided on 5 1/4" floppy disk. Available options include:

- Signal Averaging - Acquires 1 to 255 signal sweeps and displays the averaged result.
- Digital Volt Meter - Allows use as a real time DVM or use to measure points on an acquired sweep.
- Hard Copy - Uses graphics printer to produce hard-copy output of displayed traces.
- Disk Storage - Allows automatic storage and recover of acquired data on floppy disks.
- Spectrum Analyzer - Calculates and displays frequency spectrum of acquired data.

BUS RIDER

LOGIC ANALYZER for the APPLE II
The BUS RIDER circuit card silently rides the Apple II peripheral bus and allows real time tracking of program flow. Software provided on EPROM allows set up of trace parameters from the keyboard and read back of disassembled code after a program has been tracked.

- 32 bit by 1024 sample memory buffer
- Monitors Data and Address bus plus 8 external inputs
- Trigger on any 32 bit word or external trigger
- Pretrigger viewing

The BUS RIDER is an invaluable development tool for anyone working with Apple II or Apple II+ computers.
Price **\$295**

RC ELECTRONICS INC.

7265 Tuolumne St., Goleta, CA 93117

(805) 968-6614

M/C

Listing 2: Using the positions determined from the gridded form, the FFTABL-1 program can develop a control table that displays the field name for each piece of data, sets the maximum field length, and enters the exact line and column position for each data field.

```

10 *****
20 **
30 PRINT: PRINT
40 PRINT " FFTABL-1.BAS"
50 PRINT " FillForm Table Program"
60 PRINT "Copyright 1981 by Elliam Assoc."
70 **
80 *** This program Builds or Updates a **
90 *** Control table file that is used **
100 *** with FFORM-1.BAS **
110 **
120 *** MICROSOFT BASIC **
130 *****
140
150 'Set for 100 records
160
500 'INITIALIZATION
510 *****
520 *** Dimension arrays, Set flags and Initialize**
530 *** variables. **
540 *****
550
560 DIM LCL$(3),LNE$(100),COL$(100),LN$(100),FLDNA$(100)
570 FALSE%=0: TRUE%=-1
580 NOREC%=0 'Max Number of Records
590 CTFLG%=FALSE% 'Record counter flag
600 RFL%=FALSE% 'Re-enter flag
610 UDT%=FALSE% 'File read flag
620 ERFLG%=FALSE% 'Error flag
630 DEF FNLS(Q$)=LEFT$(A$,1)
640 CHD1$="Item Ln Col Fld"
650 CHD2$=" No No No Len Field Name"
660 INV$="Invalid": FIL$=""
670 LCL$(1)="Line No.": LCL$(2)="Column No.": LCL$(3)="Length"
680 CMDSS$(1)="VALID COMMANDS": CMDSS$(2)=" "
690 CMDSS$(3)="D# - Deletes item no. #"
700 CMDSS$(4)="I# - Allows record to be inserted at item no. #"
710 CMDSS$(5)="R# - Allows new item to replace item no. #"
720 CMDSS$(6)="L - Lists all items"
730 CMDSS$(7)="L# - Lists item no. #"
740 CMDSS$(8)="L#-# - Lists Range of Items"
750
1000 'COMMAND MODE
1010 *****
1020 ** This section directs the control of the **
1030 ** program. **
1040 *****
1050
1060 PRINT
1070 INPUT "Build Table, Update Table, List Table or END (B, U, L or E): ",A$
1080 IF FNLS(Q$)="B" GOTO 1130
1090 IF FNLS(Q$)="U" GOTO 1140
1100 IF FNLS(Q$)="L" GOTO 1160
1110 IF FNLS(Q$)="E" GOTO 7050
1120 GOTO 1060
1130 GOSUB 2190: GOTO 1050 'Build Mode
1140 GOSUB 1560: IF A$="<" GOTO 1050 'Read table file
1150 GOSUB 4090: GOTO 1050 'Update Mode
1160 GOSUB 1560: IF A$="<" GOTO 1050 'Read table file
1170 GOSUB 5860: GOTO 1050 'List file
1180
1500 'READ CONTROL TABLE FILE
1510 *****
1520 ** This routine reads the sequential control **
1530 ** table file and places each field in the **
1540 ** appropriate array for updating. **
1550 *****
1560
1570 IF UDT% THEN RETURN 'If file has been read ret
1580 INPUT "Drive (A or B): ",DRV$ 'Get drive for file
1590 IF DRV$="<" THEN RETURN
1600 IF DRV$<>"A" AND DRV$<>"B" GOTO 1580
1610 INPUT "Enter Table Name: ",FIL$ 'NOTE: <filename>
1620 IF FIL$="<" GOTO 1580 'extension set to "TBL"
1630 OPEN "I",1,DRV$+":"+FIL$+".TBL"
1640 PRINT "Reading {",FIL$,"} Table"
1650 FOR I%=1 TO 1000
1660 IF EOF(1) GOTO 1710
1670 INPUT #1,LNE$(I%),COL$(I%),LN$(I%)
1680 LINE INPUT #1,A$
1690 A$=MID$(A$,2): FLDNA$(I%)=LEFT$(A$,LEN(A$)-1) 'Strip quotes
1700 'from string
1710 NOREC%=I%-1 'Number of records
1720 PRINT: PRINT NOREC% "Table Entries Read"
1730 PRINT
1740 UDT%=TRUE% 'Set file read flag
1750 CLOSE #1 'Close file
1760 RETURN
1770
2000 'BUILD CONTROL TABLE
2010 *****
2020 ** This routine builds and also is used to **

```

Listing 2 continued on page 226

S-100 STATIC MEMORY BREAKTHROUGH

Come see us at
West Coast Computer Fair
Booth 1347

MAKE YOUR NEXT PURCHASE A MEMORABLE ONE!

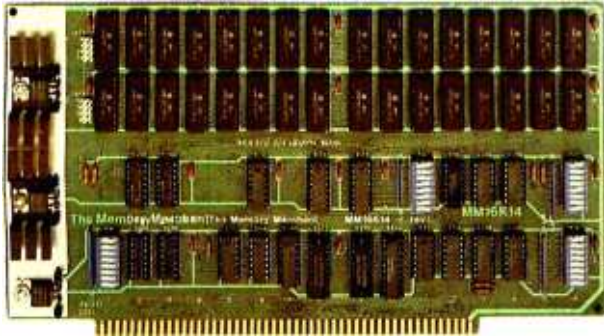

16K STATIC RAM \$169



64K STATIC RAM \$795

32K PARTIALLY POPULATED \$479 48K PARTIALLY POPULATED \$659

Finally, you can buy state-of-the-art S-100 static memory for your computer at unprecedented savings.

Memory Merchant's memory boards provide the advanced features, quality and reliability you need for the kind of operational performance demanded by new high-speed processors.

COMPLETELY ASSEMBLED

These memory boards are not kits, nor skeletons—but top quality, high performance memories that are shipped to you completely assembled, burned-in, socketed, tested and insured with one of the industry's best warranties.

SUPERIOR DESIGN & QUALITY

Memory Merchant's boards are created by a designer, well-known for his proven ability in advanced, cost-efficient memory design. Innovative circuitry provides you with highly desired features and incredible versatility.

Only first quality components are used throughout, and each board is rigorously tested to assure perfect and dependable performance.

SHIPPED DIRECT FROM STOCK

All Memory Merchant's boards are shipped direct from stock, normally within 48 hours of receipt of your order.

NO RISK TRIAL

We are so convinced that you will be absolutely delighted with our boards that we extend a no risk trial offer. After purchasing one of our boards, you may return it (intact) for any reason within 15 days after shipment and we will refund the purchase price.

NEW 18 MONTH LIMITED WARRANTY!

The reliability of our boards, through quality controlled production and proven performance, has enabled us to extend our warranty to a full 18 months. This includes a 6 month exchange program for defective units.

HOW TO ORDER

Please send check, money order, VISA or MASTERCHARGE (add ICA#) with your order. Sorry, no C.O.D.'s. Specify model number, and quantity desired. Shipping and handling charge is \$5.00 per board. California residents add 6% Sales Tax. Credit card purchases may be telephoned to (415) 483-1008.

OEM and DEALER inquiries invited.



14666 Doolittle Drive
San Leandro, CA 94577
(415) 483-1008

64K RAM, Model MM65K16S

Cool running operation to 10 MHz

Ultra low-power consumption

Fully loaded 64K board draws:

Typ. 350 Ma. (Max. current 550 Ma.)

Bank Select Capability

Extended Addressing Capability

One 16K submodule equipped with a 2K window which may be located in any of the 2K segments

2716 (5V) EPROM Compatibility:

Programmed 2716 EPROM's may replace any or all of the RAM

Four independently addressable 16K submodules on one board organized as two pair of independent 32K banks or as one 64K Extended Address Page. Each 32K bank responds independently to phantom. Bank Select logic is compatible with either Cromemco Cromix* or standard Bank Select software.

*Cromix is a trademark of Cromemco.

New 16K (2K X 8) 150ns Static RAM

Runs on any S-100, 8-bit system

MPM Conversion Option: Write for details.

16K RAM, Model MM16K14

Bank Select Capability

Extended Addressing Capability

One 4K segment equipped with 1K windows

Four independent 4K X 8 byte segments

Uses field proven 2114 (1K X 4)

Low-power consumption (Typ. 1.3 Amps)

Runs on any S-100 8080, 4 MHz Z-80 or 5 MHz 8085 system.

Prices, terms, specifications subject to change without notice.

Circle 233 on Inquiry card.

S-100 Boards from S. C. Digital

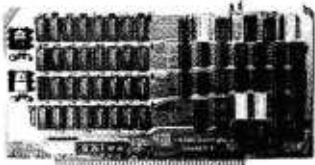

64K DYNAMIC RAM 'Uniselect: 2'

features: Model 64KUS
 ● 16 or 24 bit addressing. ● 8 bit data. ● Bank Select by SW settable Port, Bits in Two blocks. ● Two 32KB (or 128KB) addressing. ● Transparent refresh with delay lines, giving unlimited DMA, immune to Wait States, halts, resets.
 ● Fast access time - 220nsec from Smemr or Psync high, will run with Z80, Z8000 to 4mhz, 8080, 8085, 8088, 8086 to 5mhz without wait states. ● Provision to expand to 256KB using 64K by 1 chips.



32K Static Ram 'Uniselect: 3'

features: Model 32KUS
 ● Fully Static using 2k by 8 NMOS chips. ● 16 or 24 bit address. ● 8/16 bit wide data. ● Bank Select by port and bit in 32K block. ● Two 16K block addressing with window capability in 2k increments. ● EPROM can be mixed with RAM. ● Fast access - 250nsec from address valid - will run with Z80, Z8000 to 4mhz, 8080, 8085, 8088, 8086 or 88000 to 8mhz without Wait States. ● Provision for Battery Backup using NMOS or CMOS.



I/O, Memory Interface 'Interface: 1'

features: Model 3SPC
 ● 3 serials using UART, RS-232C or 20ma current loop. ● 1 Parallel I/O with hand shakes. ● 4k Ram, 4k EPROM (not supplied). ● Built in Kansas City Audio Cassette interface. ● Baud rate generator from 19.2kbaud to 110 baud.

2K Z80 Monitor Program

available for M:3SPC

features: many routines including breaker points, cassette record and play back ... etc. Comes in 2 EPROMs and 1K RAM.

Z80 CPU Board Model CPU1-Z80

features: ● 2 or 4mhz clock. ● Jump on Reset ● 2K of EPROM (not supplied). ● 8 levels of prioritized vectored interrupts.

16K Static Ram 'Uniselect: 1'

features: Model 16KUS
 ● Fully static using 2114L-2, 200nsec chips. ● Bank Select by port and bit. ● 8 bit data, 16 bit address.

All boards conform to IEEE896/S100 specifications, fully socketed, screened legends, masks, Gold contacts. Guaranteed One Full year.

Model	with	A&T	List	Our Price
64KUS	with 64KB	A&T	\$520	\$479
64KUS-16	with 16KB	A&T	\$309	\$284
32KUS	with 32KB	A&T	\$435	\$399
32KUS-16	with 16KB	A&T	\$295	\$269
32KUS-N	no mem chips	A&T	\$165	\$149
3SPC	with cassette	A&T	\$249	\$229
3SPC-KC	with cassette	Kil	\$159	\$159
CPU1-Z80	with interrupt	A&T	\$239	\$219
CPU1-Z80-K	no interrupt	Kil	\$149	\$149
16KUS	200 nsec chips	A&T	\$210	\$195
16KUS-K	200 nsec chips	Kil	\$175	\$175
2K Monitor	with 1K Ram		\$ 55	

Delivery is within 3 working days. MC, Visa or COD orders accepted. Illinois residents add 5 1/4% sales tax.

D.E.M. & DEALER PRICING AVAILABLE

S.C. DIGITAL

P.O. Box 906, Aurora, Illinois 60507

Phone: (312) 897-7749

Listing 2 continued:

```

2030  ** update the control table. The user may  **
2040  ** go back and re-enter a previous field by **
2050  ** entering '<' or to any item no. by enter- **
2060  ** ing '<N' where 'N' is the item number.  **
2070  ** Data is entered as a string with a ', ' **
2080  ** as a required delimiter between fields.  **
2090  ** An 'END' entry terminates the building of **
2100  ** a table. If entering the Build Mode from **
2110  ** the Update Mode entries will be added to **
2120  ** the end of the file. Entries are edited **
2130  ** for delimiters as well as sequential line **
2140  ** and column positions - also for overlapp- **
2150  ** ing fields. **
2160  ** A 'CHD' entry will cause a column heading **
2170  ** to be displayed. **
2180  *****
2190
2200  PRINT "<< BUILD MODE >>": PRINT
2210  PRINT CHD1$: PRINT CHD2$ 'Display Column Heading
2220  IF UDT% THEN C% = NOREC%: GOTO 2240 'If file read set counter
2230  C% = 0
2240  C% = C% + 1: C1% = C% 'Increment counter
2250  RFL% = FALSE%: CTFLG% = TRUE% 'Set/Reset flags
2260  PRINT RIGHT$( " "+STR$(C%),4) + ". "; 'Display Record No.
2270  LINE INPUT " ", AS 'Get record from Kbrd
2280  IF LEFT$(AS,1) <> "<" GOTO 2370 'Ck for re-enter
2290  CTFLG% = FALSE% 'Reset counter flag
2300  IF LEN(AS) < 1 THEN GOTO 2330 'Test for record number
2310  C% = C% - 1: IF C% < 1 THEN C% = 1 'Decrement counter
2320  GOTO 2260 'Go re-enter Prev record
2330  C% = VAL(MID$(AS,2)): IF C% < 1 THEN C% = 1 'Get record number
2340  IF UDT% = TRUE% AND C% > NOREC% THEN C% = NOREC% 'Range test record no.
2350  IF UDT% = FALSE% AND C% > C1% THEN C% = C1%
2360  RFL% = TRUE%: GOTO 2260 'Set reenter flag
2370  IF AS = "CHD" THEN PRINT CHD1$: PRINT CHD2$: GOTO 2260
2380  IF AS = "END" THEN RETURN 'End of entries
2390  FOR K% = 1 TO 3: J% = INSTR(AS, ", ") 'Test for Field
2400  IF J% < 0 GOTO 2420 ' delimiters
2410  PRINT INV$: "delimiter": GOTO 2260 'Error message
2420  BS(K%) = LEFT$(AS, J% - 1)
2430  AS = MID$(AS, J% + 1) 'Break up entry string
2440
2450  BS(4) = AS 'Field name
2460  FOR K% = 1 TO 3 'Test for numeric
2470  FOR J% = 1 TO LEN(BS(K%))
2480  IF MID$(BS(K%), J%, 1) = "0" AND MID$(BS(K%), J%, 1) <= "9" GOTO 2510
2490  PRINT INV$: 'Display Error msg
2500  PRINT LCL$(K%): GOTO 2260 'Field not Numeric
2510  NEXT
2520
2530  NEXT
2540  IF EDFLG% THEN GOSUB 3260: IF ERFLG% GOTO 2260 'Go Edit
2550  IF C% = 1 GOTO 2560 'Skip if first record
2560  GOSUB 3060: IF ERFLG% GOTO 2260 'Go Edit against Prev
2570  LNS$(C%) = BS(1): COL$(C%) = BS(2) 'Store fields
2580  LN$(C%) = BS(3): FLNDS$(C%) = BS(4)
2590  UDT% = TRUE% 'Set no-read flag
2600  IF CTFLG% THEN NOREC% = NOREC% + 1 'Increment Max rec ctr
2610  IF RFL% THEN C% = C1% - 1: RFL% = FALSE% 'Reset Counter & flag
2620  IF EDFLG% THEN RETURN ELSE GOTO 2240
2630
3000  'CHECK AGAINST PREV RECORD
3010  *****
3020  ** Test line numbers and column positions to **
3030  ** prevent backward movement and overlapping **
3040  ** fields. **
3050  *****
3060
3070  ERFLG% = FALSE% 'Reset Error flag
3080  IF VAL(BS(1)) > VAL(LNS$(C% - 1)) GOTO 3110 'Test line number
3090  PRINT "Line no. (" ; BS(1) ; ") Less than Previous Line No. (" ; LNS$(C% - 1) ; ") "
3100  GOTO 3390 'Display error message
3110  IF VAL(BS(1)) > VAL(LNS$(C% - 1)) GOTO 3360 'Test for overlapping
3120  IF VAL(COL$(C% - 1)) > VAL(LN$(C% - 1)) & VAL(BS(2)) GOTO 3140 'fields
3130  PRINT "Overlapping fields": GOTO 3390 'Display error message
3140  GOTO 3360 'Go finish test
3150
3200  'CHECK AGAINST NEXT RECORD
3210  *****
3220  ** Test line numbers and column positions to **
3230  ** prevent backward movement and overlapping **
3240  ** fields. **
3250  *****
3260
3270  IF C% = NOREC% + 1 THEN RETURN 'No test if appending
3280  IF C% = NOREC% AND EDPLG% THEN RETURN 'No test if repl last
3290  ERFLG% = FALSE% 'Reset Error flag
3300  IF VAL(BS(1)) < VAL(LNS$(C% + 1)) GOTO 3330 'Test line number
3310  PRINT "Line no. (" ; BS(1) ; ") Greater than Next Line No. (" ; LNS$(C% + 1) ; ") "
3320  GOTO 3390 'Display error message
3330  IF VAL(BS(1)) < VAL(LNS$(C% + 1)) GOTO 3360 'Test for overlapping
3340  IF VAL(BS(2)) & VAL(BS(3)) & VAL(COL$(C% + 1)) GOTO 3360 'fields
3350  PRINT "Overlapping fields": GOTO 3390 'Display error message
3360  FOR K% = 1 TO 3: IF BS(K%) = "0" GOTO 3380 'Test for zero
3370  NEXT: RETURN
3380  PRINT LCL$(K%); " can not be zero" 'Display error message
3390  ERFLG% = TRUE%: RETURN 'Set Error flag
3400
4000  'UPDATE
4010  *****
4020  ** In the Update Mode records may be Insert- **
4030  ** ed, Replaced, Deleted and Listed. Enter **
4040  ** the code letter for the function and the **

```

IMAGINE IT..

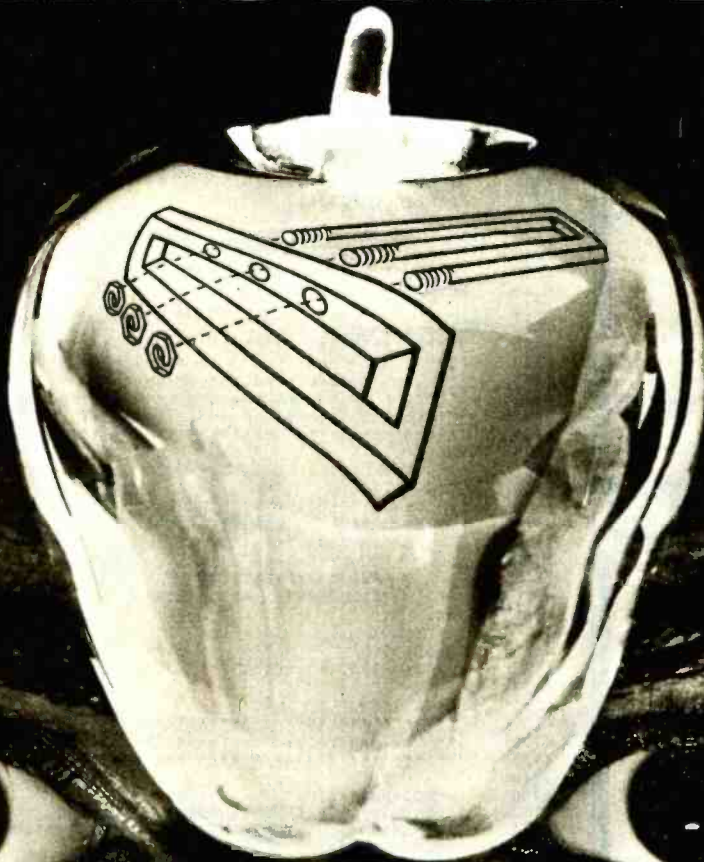

CAPTURE IT.

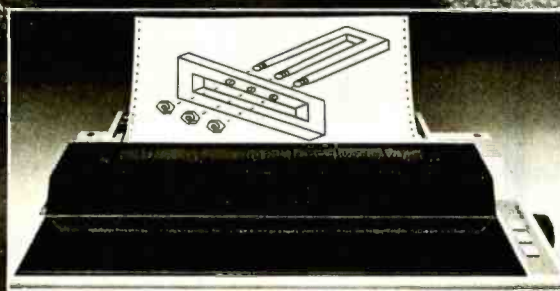

ACTUAL APPLE II PRINTOUT USING GRAPPLER™ AND EPSON MX100

With **The Grappler**
Printer Interface

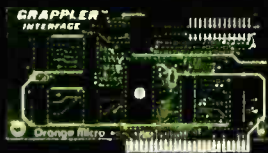

Orange Micro
inc.

3150 E. La Palma, Suite G, Anaheim, CA 92806

(800) 854 8275 TOLL FREE

(714) 630 3322 CA; AK; HI.

The Grappler's features include:

- Graphics Screen Dump
- Inverse Graphics
- Emphasized Graphics
- Double Size Picture
- 90° Rotation
- Center Graphics
- Chart Recorder
- Mode Block Graphics
- Bell Control
- Skip-over-Perf
- Left and Right Margins
- Variable Line Length
- Text Screen Dump.

The Grappler™ works with Pascal and CPM.

The Grappler™ is the most intelligent Apple interface available. Simple commands from the keyboard or user program, are all you need to dump screen graphics to your printer. The Grappler's exclusive EPROM chip makes high resolution graphics that easy. There are Grappler versions to accommodate the Anadex, Epson Series,* IDS Paper Tigers, Centronics 739, NEC 8023, C. Itoh Pro-writer, Okidata 82A,* Malibu 200, and future graphic printers.

*Requires Graphics Upgrade.

For information contact:
CompuCable Corporation
(714) 635 7330
High Technology
(314) 838 6502
Kal Tronics
(312) 291 1220
Micro Distributors
(800) 638 6621

Circle 289 on inquiry card.

Microamerica Distributing
(800) 343 4411
Waybern Corporation
(800) 854 8348
In England:
Pete & Pam Computers
Rawtenstall, Lancashire
(070) 622 7011

© 1982, Orange Micro, Inc.

MMSFORTH VERSION 2.0: MORE FOR YOUR RADIO SHACK TRS-80 MODEL I OR MODEL III !

★ MORE SPEED

10-20 times faster than Level II BASIC.

★ MORE ROOM

Very compact compiled code plus VIRTUAL MEMORY makes your RAM act larger. Variable number of block buffers. 31-char-unique word names use only 4 bytes in header!

★ MORE INSTRUCTIONS

Add YOUR commands to its 79-STANDARD-plus instruction set!
Far more complete than most Forths: single & double precision, arrays, string-handling, clock, more.

★ MORE EASE

Excellent full-screen Editor, structured & modular programming
Word search utility
THE NOTEPAD letter writer
Optimized for your TRS-80 with keyboard repeats, upper/lower case display driver, full ASCII, single- & double-width graphics, etc.

★ MORE POWER

Forth operating system
Interpreter AND compiler
8080 Assembler
(Z80 Assembler also available)
Intermix 35- to 80-track disk drives
Model III System can read, write & run Model I diskettes!
VIRTUAL I/O for video and printer, disk and tape (10-Megabyte hard disk available)



THE PROFESSIONAL FORTH FOR TRS-80

(Over 2,000 systems in use)

MMSFORTH Disk System V2.0 (requires 1 disk drive & 32K RAM, apcely Model I or III). 129.95*

AND MMS GIVES IT PROFESSIONAL SUPPORT

Source code provided
MMSFORTH Newsletter
Many demo programs aboard
MMSFORTH User Groups
Inexpensive upgrades to latest version
Programming staff can provide advice, modifications and custom programs, to fit YOUR needs.

MMSFORTH UTILITIES DISKETTE: Includes FLOATING POINT MATH (L2 BASIC ROM routines plus Complex numbers, Rectangular-Polar coordinate conversions, Degree mode, more), plus a full Forth-style Z80 ASSEMBLER; plus a powerful CROSS-REFERENCER to list Forth words by block and line. All on one diskette (requires MMSFORTH V2.0, 1 drive & 32K RAM). 39.95*

FORTHCOM: communications package provides RS-232 driver, dumb terminal mode, transfer of FORTH blocks, and host mode to operate a remote TRS-80 (requires MMSFORTH V2.0, 1 drive & 32K RAM). 39.95*

THE DATAHANDLER V1.2: a very sophisticated database management system operable by non-programmers (requires MMSFORTH V2.0, 1 drive & 32K RAM). 59.95*

MMSFORTH GAMES DISKETTE: real-time graphics & board games w/source code. Includes BREAKFORTH, CRASHFORTH, CRYPTOQUOTE, FREEWAY, OTHELLO & TICTACFORTH (requires MMSFORTH V2.0, 1 drive & 32K RAM). 39.95*

Other MMSFORTH products under development

FORTH BOOKS AVAILABLE

MMSFORTH USERS MANUAL - without Appendices, for non-owners 17.50*

STARTING FORTH - best companion to our manual 15.95*

THREADED INTERPRETIVE LANGUAGES - advanced, excellent analysis of MMSFORTH-like language. 18.95*

PROGRAM DESIGN & CONSTRUCTION - intro. to structured programming, good for Forth 13.95*

FORTH -79 STANDARD MANUAL - official reference to 79-STANDARD word set, etc. 13.95*

FORTH SPECIAL ISSUE. BYTE Magazine (Aug. 1980) we stock this collector's item for Forth users and beginners 4.00*

ORDERING INFORMATION: Software prices include manuals and require signing of a single system, single-user license. SPECIFY for Model I or Model III! Add \$2.00 S/H plus \$3.00 per MMSFORTH and \$1.00 per additional book; Mass. orders add 5% tax. Foreign orders add 20%. UPS COD, VISA & MC accepted; no unpaid purchase orders, please.

Send SASE for free MMSFORTH information
Good dealers sought

Get MMSFORTH products from your
computer dealer or

**MILLER MICROCOMPUTER
SERVICES (B3)**

61 Lake Shore Road, Natick, MA 01760
(617) 653-6136

Listing 2 continued:

```

4050  ** Item No. The "L" (list) by itself will  **
4060  ** list the whole Control Table. "L#" lists **
4070  ** Item #. "L#-" lists a range of item Nos.**
4080  ~~~~~
4090  /
4100  PRINT: PRINT "<< UPDATE MODE >>": PRINT
4110  INPUT "Insert, Replace, Delete, List, END or ?(I#,R#,D#,L#-#,E or ?): ",A$
4120  EDFLG:=FALSE: PRINT "Reset Edit flag"
4130  IF FNLS(Q$)="E" THEN RETURN "Done updating"
4140  EDFLG:=TRUE: DPB$="D" "Set Edit flag"
4150  CMD$=FNLS(Q$): A$=MID$(A$,2) "Strip cmd char"
4160  FOR K#=1 TO 5
4170  IF CMD$=MID$("IRDL?",K#,1) GOTO 4190 "Valid entry?"
4180  NEXT: GOTO 4110 "Go redo"
4190  INSR REPL DELT LIST ?
4200  ON K# GOSUB 4470,4740,5060,5450,4240
4210  PRINT: GOTO 4110
4220  /
4230  ^LIST COMMANDS
4240  /
4250  FOR K#=1 TO 8: PRINT CMD$(K#): NEXT
4260  RETURN
4270  /
4280  ^INSERT ITEM
4290  ~~~~~
4300  ** Records are always inserted ahead of the **
4310  ** item number used. Records are moved up to**
4320  ** room to insert the new record. The Max **
4330  ** record counter is incremented. **
4340  ~~~~~
4350  /
4360  /
4370  /
4380  /
4390  /
4400  /
4410  /
4420  /
4430  /
4440  /
4450  /
4460  /
4470  /
4480  /
4490  /
4500  /
4510  /
4520  /
4530  /
4540  /
4550  /
4560  /
4570  /
4580  /
4590  /
4600  /
4610  /
4620  /
4630  /
4640  /
4650  /
4660  /
4670  /
4680  /
4690  /
4700  /
4710  /
4720  /
4730  /
4740  /
4750  /
4760  /
4770  /
4780  /
4790  /
4800  /
4810  /
4820  /
4830  /
4840  /
4850  /
4860  /
4870  /
4880  /
4890  /
4900  /
4910  /
4920  /
4930  /
4940  /
4950  /
4960  /
4970  /
4980  /
4990  /
5000  /
5010  /
5020  /
5030  /
5040  /
5050  /
5060  /
5070  /
5080  /
5090  /
5100  /
5110  /
5120  /
5130  /
5140  /
5150  /
5160  /
5170  /
5180  /
5190  /
5200  /
5210  /
5220  /
5230  /
5240  /
5250  /
5260  /
5270  /
5280  /
5290  /
5300  /
5310  /
5320  /
5330  /
5340  /
5350  /
5360  /
5370  /
5380  /
5390  /
5400  /
5410  /
5420  /
5430  /
5440  /
5450  /
5460  /
5470  /
5480  /
5490  /
5500  /
5510  /
5520  /
5530  /
5540  /
5550  /
5560  /
5570  /
5580  /
5590  /
5600  /
5610  /
5620  /
5630  /
5640  /
5650  /
5660  /
5670  /
5680  /
5690  /
5700  /
5710  /
5720  /
5730  /
5740  /
5750  /
5760  /
5770  /
5780  /
5790  /
5800  /
5810  /
5820  /
5830  /
5840  /
5850  /
5860  /
5870  /
5880  /
5890  /
5900  /
5910  /
5920  /
5930  /
5940  /
5950  /
5960  /
5970  /
5980  /
5990  /
6000  /
6010  /
6020  /
6030  /
6040  /
6050  /
6060  /
6070  /
6080  /
6090  /
6100  /
6110  /
6120  /
6130  /
6140  /
6150  /
6160  /
6170  /
6180  /
6190  /
6200  /
6210  /
6220  /
6230  /
6240  /
6250  /
6260  /
6270  /
6280  /
6290  /
6300  /
6310  /
6320  /
6330  /
6340  /
6350  /
6360  /
6370  /
6380  /
6390  /
6400  /
6410  /
6420  /
6430  /
6440  /
6450  /
6460  /
6470  /
6480  /
6490  /
6500  /
6510  /
6520  /
6530  /
6540  /
6550  /
6560  /
6570  /
6580  /
6590  /
6600  /
6610  /
6620  /
6630  /
6640  /
6650  /
6660  /
6670  /
6680  /
6690  /
6700  /
6710  /
6720  /
6730  /
6740  /
6750  /
6760  /
6770  /
6780  /
6790  /
6800  /
6810  /
6820  /
6830  /
6840  /
6850  /
6860  /
6870  /
6880  /
6890  /
6900  /
6910  /
6920  /
6930  /
6940  /
6950  /
6960  /
6970  /
6980  /
6990  /
7000  /
7010  /
7020  /
7030  /
7040  /
7050  /
7060  /
7070  /
7080  /
7090  /
7100  /
7110  /
7120  /
7130  /
7140  /
7150  /
7160  /
7170  /
7180  /
7190  /
7200  /
7210  /
7220  /
7230  /
7240  /
7250  /
7260  /
7270  /
7280  /
7290  /
7300  /
7310  /
7320  /
7330  /
7340  /
7350  /
7360  /
7370  /
7380  /
7390  /
7400  /
7410  /
7420  /
7430  /
7440  /
7450  /
7460  /
7470  /
7480  /
7490  /
7500  /
7510  /
7520  /
7530  /
7540  /
7550  /
7560  /
7570  /
7580  /
7590  /
7600  /
7610  /
7620  /
7630  /
7640  /
7650  /
7660  /
7670  /
7680  /
7690  /
7700  /
7710  /
7720  /
7730  /
7740  /
7750  /
7760  /
7770  /
7780  /
7790  /
7800  /
7810  /
7820  /
7830  /
7840  /
7850  /
7860  /
7870  /
7880  /
7890  /
7900  /
7910  /
7920  /
7930  /
7940  /
7950  /
7960  /
7970  /
7980  /
7990  /
8000  /
8010  /
8020  /
8030  /
8040  /
8050  /
8060  /
8070  /
8080  /
8090  /
8100  /
8110  /
8120  /
8130  /
8140  /
8150  /
8160  /
8170  /
8180  /
8190  /
8200  /
8210  /
8220  /
8230  /
8240  /
8250  /
8260  /
8270  /
8280  /
8290  /
8300  /
8310  /
8320  /
8330  /
8340  /
8350  /
8360  /
8370  /
8380  /
8390  /
8400  /
8410  /
8420  /
8430  /
8440  /
8450  /
8460  /
8470  /
8480  /
8490  /
8500  /
8510  /
8520  /
8530  /
8540  /
8550  /
8560  /
8570  /
8580  /
8590  /
8600  /
8610  /
8620  /
8630  /
8640  /
8650  /
8660  /
8670  /
8680  /
8690  /
8700  /
8710  /
8720  /
8730  /
8740  /
8750  /
8760  /
8770  /
8780  /
8790  /
8800  /
8810  /
8820  /
8830  /
8840  /
8850  /
8860  /
8870  /
8880  /
8890  /
8900  /
8910  /
8920  /
8930  /
8940  /
8950  /
8960  /
8970  /
8980  /
8990  /
9000  /
9010  /
9020  /
9030  /
9040  /
9050  /
9060  /
9070  /
9080  /
9090  /
9100  /
9110  /
9120  /
9130  /
9140  /
9150  /
9160  /
9170  /
9180  /
9190  /
9200  /
9210  /
9220  /
9230  /
9240  /
9250  /
9260  /
9270  /
9280  /
9290  /
9300  /
9310  /
9320  /
9330  /
9340  /
9350  /
9360  /
9370  /
9380  /
9390  /
9400  /
9410  /
9420  /
9430  /
9440  /
9450  /
9460  /
9470  /
9480  /
9490  /
9500  /
9510  /
9520  /
9530  /
9540  /
9550  /
9560  /
9570  /
9580  /
9590  /
9600  /
9610  /
9620  /
9630  /
9640  /
9650  /
9660  /
9670  /
9680  /
9690  /
9700  /
9710  /
9720  /
9730  /
9740  /
9750  /
9760  /
9770  /
9780  /
9790  /
9800  /
9810  /
9820  /
9830  /
9840  /
9850  /
9860  /
9870  /
9880  /
9890  /
9900  /
9910  /
9920  /
9930  /
9940  /
9950  /
9960  /
9970  /
9980  /
9990  /
10000 /

```

Listing 2 continued:

```

5860
5870 PRINT: BOT%=1: TOP%=NOREC%:SCNT%=0:LCNT%=0 'Set list range for all
5880 INPUT "Display, Print or Both (D, P OR B): ",A$
5890 DPB$=A$: IF A$="C" THEN RETURN
5900 IF A$="D" THEN PRINT CHD1$: PRINT CHD2$: GOTO 5940
5910 IF A$<>"P" AND A$<>"B" GOTO 5880
5920 INPUT "Position Paper: c/r ",A$
5930 GOSUB 6090 'Heading
5940 FOR I%=BOT% TO TOP%
5950 A$=RIGHT$(" "+STR$(I%),4)+". " 'Record number
5960 IF DPB$="P" GOTO 5990
5970 PRINT A$;LNE$(I%);TAB(13-LEN(COL$(I%)));COL$(I%);
5980 PRINT TAB(18-LEN(LN$(I%)));LN$(I%);TAB(22);FLDNA$(I%)
5990 IF DPB$="D" GOTO 6050
6000 LPRINT A$;LNE$(I%);TAB(13-LEN(COL$(I%)));COL$(I%);
6010 LPRINT TAB(18-LEN(LN$(I%)));LN$(I%);TAB(22);FLDNA$(I%)
6020 LCNT%=LCNT%+1: IF LCNT%<=62 GOTO 6050 'Test for end of page
6030 FOR K%=LCNT% TO 66: LPRINT 'End of page spacing
6040 NEXT: LCNT%=0: GOSUB 6090'Page heading
6050 IF DPB$="P" GOTO 6070
6060 SCNT%=SCNT%+1: IF SCNT%=18 THEN SCNT%=0: INPUT "c/r ",A$
6070 NEXT: RETURN
6080
6090 'HEADING
6100 LPRINT: LPRINT
6110 LPRINT "Control Table {";FIL$;"}":LPRINT
6120 LPRINT CHD1$: LPRINT CHD2$: LPRINT 'Column Headings
6130 LCNT%=7: RETURN 'Set line counter
6140
'WRITE CONTROL TABLE FILE
7000 *****
7010 '** This routine writes the Control Table data**
7020 '** to a sequential file. **
7030 *****
7040
7050
7060 IF A$="C" GOTO 1060
7070 INPUT "Write File (Y or N): ",A$
7080 IF A$="Y" GOTO 7100
7090 IF A$<>"N" GOTO 7070 ELSE GOTO 8060
7100 INPUT "Write to Drive (A or B): ",DRV$
7110 IF DRV$="C" GOTO 7070
7120 IF FIL$="" GOTO 7170
7130 IF DRV$<>"A" AND DRV$<>"B" GOTO 7100
7140 INPUT "Same File Name (Y or N): ",A$
7150 IF A$="C" GOTO 7100
7160 IF A$="Y" GOTO 7190
7170 INPUT "Enter Table Name: ",FIL$
7180 IF FIL$="C" GOTO 7100
7190 OPEN "O",1,DRV$+";"+FIL$+".TBL" 'Open output file
7200 PRINT "Writing {";NOREC%;} Records"
7210 FOR I%=1 TO NOREC%
7220 PRINT #1,LNE$(I%);";";COL$(I%);";"; 'Line No & Col Posn
7230 PRINT #1,LN$(I%);";"; 'Length
7240 WRITE #1,FLDNA$(I%) 'Field name
7250 NEXT
7260 CLOSE #1 'Close file
7270
'AGAIN
8000 *****
8010 '** This routine allows the user to Build or **
8020 '** Update another Control Table without **
8030 '** leaving the program. **
8040 *****
8050
8060
8070 INPUT "Again (Y or N): ",A$
8080 IF A$="N" THEN END
8090 IF A$<>"Y" GOTO 8070
8100 INPUT "Same Control Table (Y or N): ",A$
8110 IF A$="C" GOTO 8070
8120 IF A$="N" THEN NOREC%=0:UDTA=FALSE%:GOTO 1060 'Reset Max ctr & flag
8130 IF A$<>"Y" GOTO 8100 ELSE GOTO 1060

```

Text continued from page 222:

the program issues only a carriage return and waits for a response. If your printer includes a line feed, you will have to crank the form back one line before repositioning. When the form is aligned satisfactorily, the program prints the grid on the form. Figure 2 shows a sample standard purchase-order form that has been gridded with the FFGRID-1 program.

Building a Forms-Control Table

Using the gridded form, you can determine the line and column posi-

tions to be used in building a control table (see listing 2). At the same time, the maximum length for each field can be specified.

Listing 3 shows the control table created with the FFTABL-1 program for the purchase-order form. This control-table file will also be used by the FFORM-1 program to display the field names for data entry, determine the maximum field length, and provide the line and column position for each data field.

FFTABL-1, like the other programs, scrolls up from the bottom of

Listing 3: A sample control table developed using the purchase order form shown in figure 1.

Control Table {PO}

Item No	Ln No	Col No	Fld Len	Field Name
1.	4	10	30	Company Name
2.	4	44	8	"Contact:"
3.	4	57	25	Contact name
4.	5	10	30	Company Address
5.	5	57	14	Contact Phone
6.	6	10	30	City, State, Zip
7.	9	10	30	PO to Company
8.	9	58	25	Ship to Name
9.	11	10	30	PO to Address 1
10.	11	58	25	Ship to Address
11.	12	10	30	PO to Address 2
12.	13	10	30	PO to City,
				State, Zip
13.	13	58	25	Ship to City,
				State, Zip
14.	17	2	12	For
15.	17	20	14	Req.No.
16.	17	37	12	How Ship
17.	17	51	8	Date Required
18.	17	60	8	Terms
19.	17	70	11	Date
20.	20	5	5	Ordered 1
21.	20	12	5	Received 1
22.	20	20	42	Item Desc 1
23.	20	64	7	Price 1
24.	20	74	7	Unit 1
25.	22	5	5	Ordered 2
26.	22	12	5	Received 2
27.	22	20	42	Item Desc 2
28.	22	64	7	Price 2
29.	22	74	7	Unit 2
30.	24	5	5	Ordered 3
31.	24	12	5	Received 3
32.	24	20	42	Item Desc 3
33.	24	64	7	Price 3
34.	24	74	7	Unit 3
35.	26	5	5	Ordered 4
36.	26	12	5	Received 4
37.	26	20	42	Item Desc 4
38.	26	64	7	Price 4
39.	26	74	7	Unit 4
40.	28	5	5	Ordered 5
41.	28	12	5	Received 5
42.	28	20	42	Item Desc 5
43.	28	64	7	Price 5
44.	28	74	7	Unit 5
45.	30	5	5	Ordered 6
46.	30	12	5	Received 6
47.	30	20	42	Item Desc 6
48.	30	64	7	Price 6
49.	30	74	7	Unit 6
50.	32	5	5	Ordered 7
51.	32	12	5	Received 7
52.	32	20	42	Item Desc 7
53.	32	64	7	Price 7
54.	32	74	7	Unit 7

the screen, so no cursor positioning is required.

When the FFTABL-1 program comes up in the command mode, you are given the choice of building a new control table, updating or changing an existing control table, listing an existing control table to the screen or printer, or ending the program and writing out the control table to disk. The program always returns to the command mode after each mode is finished.

Build Mode: When the Build mode is entered, a column heading is dis-

played with item number 1 on the next line. After each entry is made, the item number is incremented by one. An entry consists of the line number, the column position, the maximum field length, and a field name (see figure 3). The field name is displayed by the FFORM-1 program for data entry. Commas are required as delimiters between fields.

While in the Build mode you may reenter the previous field by entering a < or go back to any previously entered item by entering <N, where N is the item number. The program issues an error message if N is less than 1 or greater than the largest item

number. The Build Mode is terminated by entering the word END.

List Mode: After the Build mode is ended, you may list the control table on the screen or print the table. The program lists 18 lines on the screen and then requests a carriage return before listing the next 18 lines. If printed, the program takes care of column headings for a 66-line page. A previously prepared control table can also be read and listed.

Update Mode: In the Update mode you can:

- **Insert:** Enter the code IN, with N being the item number of the record

to be inserted. If I9 is used, item 9 will be renumbered to 10, 10 will be moved to 11, etc. The inserted record becomes item 9. All previous records are moved up to make room for the insertion. Item numbers greater than N will be incremented. To append records to the end of the file use I to insert an item number greater than the highest item number in the file or return to the Command mode and use the Build mode.

- **Replace:** The entry of RN will allow a new entry for item N. This entry replaces the existing record with the new record.

- **Delete:** DN causes item N to be deleted. All records will be moved down. Item numbers greater than the N used will be decremented.

- **List:** The list commands allow you to L all items, L# a single item, or L#-# a range of items (# is the number of an item).

- **End:** END terminates the Update mode and returns the program to the Command mode.

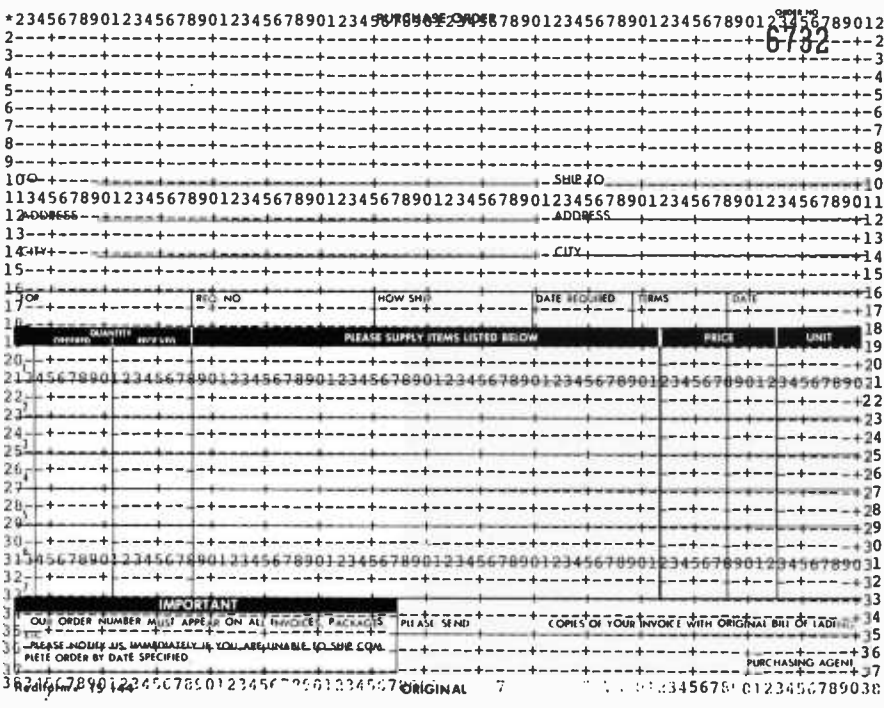

Figure 2: The FFGRID-1 program prints a grid over your form that allows you to determine the coordinates for the various data fields.

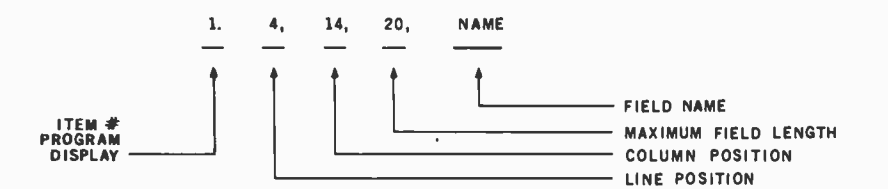

Figure 3: In the Build mode, the FFTABL-1 program prompts you to enter the data for each field.

Valid Entries

The fields that make up a record are entered as a string, then broken up into individual fields. This allows use of < and END, which would never work in BASIC if the line-number field was a numeric field. The program edits each record to make sure it is valid by

- Checking for commas as delimiters between fields

- Checking for line or column positions less than 1

- Checking to make sure that line numbers increment (for example, you cannot insert line number 20 ahead of line number 15)

- Checking to make sure that fields on a line do not overlap (a field starting in column position 20 that is 20 characters long cannot be followed by a field starting in column 30)

- Issuing error messages when the record is not valid and displaying the same item number again for a correct entry

Once a control table is built, it can be changed by running the control-

GALAXY OF FEATURES

A **GALAXY** of features makes the **LNW80** a remarkable computer. As you explore the **LNW80**, you will find the most complete, powerful, ready to run, feature-packed personal and business computer ever made into one compact solid unit.



MODEL I COMPATIBILITY – The **LNW80** is fully hardware and software compatible with the Model I. Select from a universe of hardware accessories and software – from VisiCalc® to space games, your **LNW80** will launch you into a new world of computing.

FULLY LOADED – A full payload includes an on-board single and double density disk controller for 5 1/4" and 8" single or double sided disk drives. RS232C communications port, cassette and parallel printer interfaces are standard features and ready to go. All memory is fully installed – 48K RAM, 16K graphics RAM and 12K ROM complete with Microsoft **BASIC**.

QUALITY CONSTRUCTION – Instrumentation quality construction sets **LNW80** computers apart from all the rest. Integrated into the sleek solid steel case of the **LNW80** is a professional 74-key expanded keyboard that includes a twelve key numeric keypad.

HIGH RESOLUTION GRAPHICS & COLOR – The stunning 480 X 192 resolution gives you total display control – in color or black and white. The choice of display formats is yours; 80, 64, 40 and 32 columns by 24 or 16 lines in any combination of eight colors.

PERFORMANCE – Lift-off with a 4MHz Z80A CPU for twice the performance. The **LNW80** outperforms all computers in its class.



Our down to earth price won't send you into orbit

LNW Research Corp.

2620 WALNUT, Tustin, CA. 92680

(714) 641-8850 (714) 544-5744

Monitor and Disk drives not included
TM Personal Software, Inc.

Circle 217 on inquiry card.

www.americanradiohistory.com

table file through the FFTBAL-1 program. Use the Update mode to insert, delete, or replace the line and column positions that need adjusting so that the data fields will fit properly on the form.

Filling in a Form

After building a control table, the FFORM-1 program is used to enter the data to be printed on the form (see listing 4). When the program is loaded it goes into the Command mode and gives you the following options:

- **Build:** Build new data arrays; these may be printed or written to disk.
- **Change:** Change the data in the data array or data file (fix errors).
- **List:** List the data-array file, showing the line and column position and data for each field. The listing may be displayed or sent to the printer. You can specify that the whole file, a single field, or a range of fields be listed.
- **Print:** Print out the form on the printer or display the data on the screen as it would look on the form.

While in the Command mode, the FFORM-1 program functions the same as the other two programs. User options include:

Build: The control table that provides the line and column positions and field names is first read into an array. The program then displays the first field number and field name, together with underscores corresponding to the maximum field length. You enter the data for that field and hit the carriage return. The program will display the field number and field name for the second field. For blank fields, a carriage return is entered. The use of the < and <N for reentering data is the same as in the FFTBL-1 program. If you want to stop before reaching the end of the table, enter <END to go back to the Command mode.

Form designers have been known to ignore the fact that typewriters and printers are generally unable to han-

Listing 4: The FFORM-1 program prints out the form or allows you to enter or change data in the data file.

```

10 *****
20 **
30 PRINT: PRINT **
40 PRINT " FFORM-1.BAS" **
50 PRINT "FillForm File and Print Program" **
60 PRINT "Copyright 1981 by Elliam Associates" ***
70 **
80 ** This Program Builds a Form File **
90 ** and/or Fills Out a Form - uses **
100 ** a control table built with **
110 ** FFTBL-1 **
120 **
130 *****
140
150 ^Program set for 100 fields
160
500 ^INITIALIZATION
510 *****
520 ** Dimension arrays, Set flags and Initialize**
530 ** variables **
540 *****
550
560 DIM LCL$(3),LNE$(100),COL$(100),LNS$(100),FLDNA$(100)
570 DIM FLNE$(100),FCOL$(100),FDTA$(100)
580 FALSE%=0: TRUE%=-1
590 NOREC%=0 ^Max No of Ctl Tbl Records
600 NODTA%=0 ^Max No of Data Records
610 CTPG%=FALSE% ^Record counter flag
620 RFL%=FALSE% ^Re-enter flag
630 UDT%=FALSE% ^Control tbl read flag
640 FUDT%=FALSE% ^Data file read flag
650 EDPLG%=FALSE% ^Edit flag
660 CNTR%=0 ^Record ctr in print routine
670 OK%=0 ^Alignment flag
680 C1%=0 ^Line number
690 C2%=0 ^Column position
700 LNO%=0 ^Print line counter
710 SCNT%=0 ^Screen line counter
720 LCNT%=0 ^List print line ctr
730 DEF FNLS(Q$)=LEFT$(A$,1)
740 CHD1$=" Item Lne Col"
750 CHD2$=" No No No Field Data"
760
1000 ^COMMAND MODE
1010 *****
1020 ** This section directs the control of the **
1030 ** program **
1040 *****
1050
1060 PRINT
1070 PRINT "Build File, Change File, List File, Print File or END ";
1080 INPUT "(B,C,L,P or E):",A$
1090 CMLS=A$
1100 IF FNLS(Q$)="B" GOTO 1160
1110 IF FNLS(Q$)="C" GOTO 1170
1120 IF FNLS(Q$)="L" GOTO 1180
1130 IF FNLS(Q$)="P" GOTO 1190
1140 IF FNLS(Q$)="E" GOTO 7050
1150 GOTO 1060
1160 FUDT%=FALSE%: GOSUB 2170: GOTO 1060 ^Reset Read data flag
1170 GOSUB 4100: GOTO 1050
1180 GOSUB 4570: GOTO 1050
1190 GOSUB 8490: GOTO 1050
1200
1500 ^READ CONTROL TABLE
1510 *****
1520 ** This routine reads the sequential control **
1530 ** table file and places each field in the **
1540 ** appropriate array for use in building a **
1550 ** data file. **
1560 *****
1570
1580 IF UDT% THEN RETURN ^If file has been read ret
1590 INPUT "Control Table Drive (A or B): ",A$ ^Get drive for file
1600 DRV$=A$: IF DRV$="<" THEN RETURN
1610 IF DRV$<>"A" AND DRV$<>"B" GOTO 1590
1620 INPUT "Enter Table Name: ",FIL$
1630 IF FIL$="<" GOTO 1590 ^NOTE: <filename>
1640 OPEN "I",1,DRV$+"."+FIL$+".TBL" ^extension set to ".TBL."
1650 PRINT: PRINT "Reading {",FIL$,"} Table" ^Open file
1660 FOR I%=1 TO 1000 ^Display message
1670 IF EOF(1) GOTO 1720 ^Read Table file
1680 INPUT #1,LNE$(I%),COL$(I%),LNS$(I%)
1690 LINE INPUT #1,A$
1700 AS=MID$(A$,2): FLDNA$(I%)=LEFT$(A$,LEN(AS)-1) ^Strip quotes
1710 ^from string
1720 NEXT ^Number of table recs
1730 NOREC%=I%-1
1740 PRINT: PRINT NOREC% "Table Entries Read"
1750 PRINT: UDT%=TRUE% ^Set update flag
1760 CLOSE #1 ^Close file
1770 RETURN
2000 ^BUILD DATA FILE
2010 *****
2020 ** This routine builds a data file. It is **
2030 ** also used to change a data field. The **
2040 ** user may go back and re-enter a previous **
2050 ** field by entering "<" or to any field **

```

Text continued on page 236

Listing 4 continued on page 234

Look What Apparat has for your IBM Personal Computer.



Apparat announces our Initial line of add-on boards for your IBM Personal Computer. We are committed to further product introductions to enable you to build on your new IBM system. Add Functionality and Capability with These New P.C. Boards

Apparat has the following products available for delivery in the first quarter 1982:

Prom Blaster will program most 1K to 4K byte EPROMS of 25XX and 27XX single or multivoltage type. Complete with personality modules and read/write software. Priced at \$149.00.

Clock Calendar features seconds, minutes, hours, day of week, date,

month and year. Backup battery, leap year and crystal time base. Priced at \$129.00. **Prototype Card** 3.5 by 8 Inches wirewrap area holds over 150-14 Pin Dips. Priced at \$29.95.

RGB Color Monitors choose from NEC, AMDEK and TECO CRTs. Priced at \$1,095.00 for the NEC and \$999.00 for AMDEK. TECO available in April 1982.

More Products Coming Soon Apparat has more products for your IBM system in production and ready for introduction in the second quarter 1982: 3rd and 4th add-on disk drives expansion cabinet houses up to two IBM compatible drives. Priced at \$499.00 for cabinet and one 160K drive, two drives at

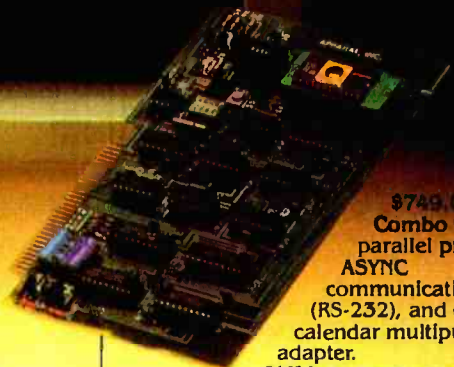

\$749.00 **Combo Card** parallel printer, ASYNC communication (RS-232), and clock calendar multipurpose adapter.

64K byte hardware print-spooler — (with parallel printer adapter) buffers 15 minutes of print output (at 80 characters/second). **300 Baud Modem Card** with ASYNC serial adapter.

Apparat will continue developing add-on products to support your IBM Personal Computer. Call today to find out more information about the above products or to order yours. Dealer inquiries welcome.

(303) 741-1778

IBM Personal Computer is a trademark of IBM.



Apparat, Inc.

4401 So. Tamarac Parkway, Denver, CO 80237 (303) 741-1778

"ON GOING SUPPORT FOR MICROCOMPUTERS"

Circle 28 on Inquiry card.
www.americanradiohistory.com



What's Better Than Basic?

BASIC B+™ IS!

Delphic Systems has merged its Z80 BASIC with FairCom's MICRO B+™ to produce BASIC B+™, the first all purpose interpreter featuring a B-TREE file structure implemented using NEW commands. No more messy CALLS or difficult assembly language interfacing! Instead, use the following BASIC B+™ functions to manage an index without ever reorganizing the file:

BOPEN BCLOSE NEWB
 KILLB FINDB GETB
 NEXB PREVB STATS

In addition, BASIC B+™ was written using Z80 code in order to minimize size and enhance speed performance.

Features & Requirements

- Search a 10,000 entry index in one second
- No index reorganization needed
- Uses fast and compact Z80 code
- CP/M® Versions 1.4 or 2.2
- 12 Digit precision
- Program Chaining
- Read only file protection
- Sequential and random files

BASIC B+™

with documentation

\$325.00

Delphic Systems

2260 Compton Avenue

St. Louis, MO 63104

314/773-6753

Coming Next

INVENTORY B+™

VISA

MasterCard

MICRO B+™ IS a Trademark of FairCom

Listing 4 continued:

```

2060  *** number by entering '<N' where 'N' is the **
2070  *** field number. Each field name is display- **
2080  *** ed followed by a number of underscores. **
2090  *** The number of underscores corresponds to **
2100  *** maximum length of the field. If the **
2110  *** entry is to long an error message is dis- **
2120  *** played and the field name is redisplayed. **
2130  *** If no data is to be entered in a field **
2140  *** then enter a c/r. To escape before all **
2150  *** fields are filled enter '<END'. **
2160  *****
2170
2180  GOSUB 1570 'Read control tbl file
2190  PRINT "<< EUILD MODE >>": PRINT 'If data file in memory
2200  IF FUdT% THEN C%=NODTA%: GOTO 2220
2210  C%=0
2220  C%=C%+1: C1%=C% 'Increment counter & save
2230  RFL%=FALSE%: C1FLG%=FALSE% 'Preset flags
2240  PRINT TAB(LEN(FLDNAS(C%))+9); 'Tab & Display underscores
2250  PRINT STRING$(VAL(LNS(C%)), " ");CHRS(13); ' then c/r to left
2260  PRINT RIGHT$(" "+STR$(C%),4)+". ";FLDNAS(C%);"; " 'field name
2270  LINE INPUT "",AS 'enter data
2280  IF AS%=<END" THEN NODTA%=C%-1: RETURN 'Check for escape
2290  IF AS%=<STOP" GOTO 2400
2300  IF LEFT$(AS,1)<>"<" THEN C1FLG%=TRUE%: GOTO 2380 'ck for re-enter
2310  IF LEN(AS)>1 THEN GOTO 2340 'Test for record no.
2320  C%-C%-1: IF C%<1 THEN C1%=1 'Decrement field ctr
2330  GOTO 2240
2340  C%=VAL(MID$(AS,2)); IF C%<1 THEN C%=1 'Get field number
2350  IF UDT%=TRUE% AND C%>NOREC% THEN C%=NOREC% 'Range test field no.
2360  IF UDT%=FALSE% AND C%>C1% THEN C%=C1% ' " " " "
2370  RFL%=TRUE%: GOTO 2240 'Set re-enter flag
2380  IF LEN(AS)<=VAL(LNS(C%)) GOTO 2400 'Test length
2390  PRINT "<<<T o o L o n g>>": GOTO 2240 'Error message
2400  FLNES(C%)=LNS(C%): FCOL$(C%)=COL$(C%) 'Store line & col posn
2410  PDTA$(C%)=AS 'Store data
2420  FUdT%=TRUE%: IF C%=NOREC% THEN RETURN 'Set no read data flag
2430  IF RFL% THEN C%=C1%-1: RFL%=FALSE% 'Reset counter & flag
2440  IF EDPLG% THEN RETURN ELSE GOTO 2220
2450
4000  CHANGE
4010  *****
4020  *** This routine allows a user to change the **
4030  *** in an existing file by field number. If **
4040  *** no field number is supplied from the **
4050  *** Command mode the program requests a field **
4060  *** number. The old data is displayed so the **
4070  *** user can see what was in the field. Also **
4080  *** the line and column position are displayed**
4090  *****
4100
4110  GOSUB 9050: IF AS%=<" THEN RETURN 'Read Data file
4120  GOSUB 1570: IF AS%=<" THEN RETURN 'Read Ctl tbl
4130  EDPLG%=FALSE% 'Reset edit flag
4140  AS%=MID$(CMD$,2) 'Get field no.
4150  IF VAL(AS)<1 OR VAL(AS)>NOREC% THEN INPUT "Record #: ",AS
4160  IF AS%=<" THEN RETURN 'No change - return
4170  IF VAL(AS)>0 AND VAL(AS)<=NOREC% GOTO 4190 'Range test field no.
4180  PRINT "Line No. out of Range": GOTO 4150 'Display error msg.
4190  EDPLG%=TRUE% 'Set edit flag
4200  C%=VAL(AS): DPB$="D" 'Set Rec# & Display
4210  BOT%=C%: TOP%=C% 'Set Rec #
4220  GOSUB 4850: GOSUB 2240: RETURN 'List/Enter Chg
4230
4500  LIST CONTROL
4510  *****
4520  *** This section sets up the parameters for a **
4530  *** listing. All fields, single field or a **
4540  *** range of fields depending on the **
4550  *** entered. **
4560  *****
4570
4580  GOSUB 9050: IF AS%=<" THEN RETURN 'Read Data file
4590  DPB$="D": AS%=MID$(CMD$,2)
4600  IF AS%="" THEN BOT%=1:TOP%=NODTA%: GOTO 4640 'No prams - All
4610  J%=INSTR(AS,"-"):IF J%=0 THEN LNENO%=VAL(AS): GOTO 4660
4620  BOT%=VAL(LEFT$(AS,J%-1)): IF BOT%<1 THEN BOT%=1 'Test range
4630  TOP%=VAL(MID$(AS,J%+1)): IF TOP%>NODTA% THEN TOP%=NODTA%
4640  IF BOT%>TOP% THEN GOSUB 4770: RETURN 'Go list
4650  GOTO 4670
4660  IF LNENO%>0 AND LNENO%<=NODTA% GOTO 4680 'Test range of fields
4670  PRINT "Line No. out of Range": RETURN 'Error message
4680  BOT%=LNENO%: TOP%=LNENO%: GOSUB 4770: RETURN
4690
4700  LIST DATA FILE
4710  *****
4720  *** Displays or prints the selected part of **
4730  *** the data file. Field numbers, line nos, **
4740  *** column numbers and data are output. A **
4750  *** Column heading is available when printing.**
4760  *****
4770
4780  PRINT
4790  INPUT "Display, Print or Both (D, P OR B): ",AS
4800  PRINT: DPB$=AS: IF AS%=<" THEN RETURN
4810  IF AS%="D" THEN PRINT CHD1$: PRINT CHD2$: GOTO 4850
4820  IF AS%<>"P" AND AS%<>"B" GOTO 4790
4830  INPUT "Position Paper: c/r ",AS
4840  GOSUB 8910 'Heading
4850  SCNT%=0
4860  FOR I%=BOT% TO TOP%
4870  AS=RIGHT$(" "+STR$(I%),4)+". " 'Field number

```

Listing 4 continued:

```

4880         IF DPBS="P" GOTO 4940
4890         PRINT AS;FLNES(I%);TAB(16-LEN(FCOLS(I%)));
4900         PRINT FCOLS(I%);TAB(20);FDTAS(I%)
4910         IF DPBS<>"D" GOTO 4950
4920         SCNT%=SCNT%+1: IF SCNT%<18 GOTO 5000 'Screen line count
4930         INPUT "c/r ",A$: SCNT%=0: GOTO 5000
4940         IF DPBS="D" GOTO 5000
4950         LPRINT AS;FLNES(I%);TAB(16-LEN(FCOLS(I%)));
4960         LPRINT FCOLS(I%);TAB(20);FDTAS(I%)
4970         LCNT%=LCNT%+1: IF LCNT%<62 GOTO 5000 'Test for end of page
4980         FOR K%=LCNT% TO 66: LPRINT 'End of page spacing
4990         NEXT: LCNT%=0: GOSUB 8910 'Heading
5000
5010 NEXT: RETURN
5020
5030 WRITE DATA FILE
5040 *****
5050 ** This routine writes the data in the arrays**
5060 ** to a sequential file. **
5070 *****
5080 GOSUB 1560 'Get control table
5090 INPUT "Write File (Y or N): ",AS
5100 IF AS="Y" GOTO 7100
5110 IF AS<>"N" GOTO 7070 ELSE GOTO 8080
5120 INPUT "Write to Drive (A or B): ",AS
5130 DRVS=AS: IF AS="C" GOTO 7070
5140 IF DRVS<>"A" AND DRVS<>"B" GOTO 7100
5150 INPUT "Enter File Name: ",FILS
5160 IF FILS="C" GOTO 7100
5170 IF FILS="" THEN FILS=FFILS
5180 OPEN "O",1,DRVS+";"+FILS+".FLE"
5190 PRINT "Writing {";NODTA%;"} Records"
5200 FOR I%=1 TO NODTA%
5210 PRINT #1,LCNT$(I%);";";COLS(I%);";"; 'Line & col Posn
5220 WRITE #1,FDTAS(I%) 'Data field
5230 NEXT
5240 CLOSE #1
5250
5260 AGAIN
5270 *****
5280 ** This section allows the user to: **
5290 ** 1. Build another data file. **
5300 ** 2. Print another data file. **
5310 ** 3. Change another data file. **
5320 ** without leaving the program. **
5330 *****
5340 INPUT "Again (Y or N): ",AS
5350 IF AS="N" THEN END
5360 IF AS<>"Y" GOTO 8090
5370 INPUT "Same Control Table (Y or N): ",AS
5380 IF AS="C" GOTO 8090
5390 IF AS="N" GOTO 1060
5400 IF AS<>"Y" GOTO 8120
5410 INPUT "Same Data File (Y or N): ",AS
5420 IF AS="C" GOTO 8120
5430 IF AS="N" THEN FUDT%=FALSE%: GOTO 1060
5440 IF AS<>"Y" GOTO 8160 ELSE GOTO 1070
5450
5460 PRINT CONTROL
5470 *****
5480 ** This routine uses a line counter LNO%, **
5490 ** when the line number CL% in the record **
5500 ** matches LNO% the data is printed at TAB **
5510 ** position C2%. After the first data field **
5520 ** is printed the program allows the user to **
5530 ** realign the form if necessary. **
5540 *****
5550 GOSUB 9050: IF AS="C" THEN RETURN 'Read data file
5560 PRINT
5570 INPUT "Display, Print or Both (D, P OR B): ",AS
5580 FDPBS=AS: IF AS="C" THEN RETURN
5590 IF FDPBS<>"D" THEN LPRINT 'Clear Printer Buffer
5600 IF FDPBS<>"P" THEN INPUT "Position Form: ",AS
5610 C1%=LINE, C2%=SPOSN, CNTR%=PRINT LINR COUNTER
5620 CNTR%=0: :OK%=0: LNO%=0 'Clear counters & flag
5630 C1%=VAL(FLNES(CNTR%)): C2%=VAL(FCOLS(CNTR%)) 'Line #/Col posn
5640 IF LEN(FDTAS(CNTR%))=0 GOTO 8750 'No data for field?
5650 IF C1%-LNO%=1 GOTO 8640 'Check for matching lines
5660 LNO%=LNO%+1 'Increment line counter
5670 IF FDPBS="D" OR FDPBS="B" THEN PRINT: GOTO 8600 'Blank line
5680 IF FDPBS="P" OR FDPBS="B" THEN LPRINT: GOTO 8600 'Blank line
5690 GOSUB 8840 'Print Field
5700 ON OK% GOTO 8750 'Continue or align
5710 PRINT
5720 IF FDPBS="D" THEN AS="Y": GOTO 8730
5730 INPUT "Alignment OK, Ck Next Field or Quit (Y, C or Q): ",AS
5740 IF AS<>"Q" GOTO 8730
5750 IF FDPBS<>"P" THEN PRINT
5760 IF FDPBS<>"D" THEN LPRINT
5770 RETURN
5780 IF AS<>"Y" AND AS<>"C" GOTO 8670 'Test valid entry
5790 OK%=0: IF AS="Y" THEN OK%=1 'Set continue flag
5800 CNTR%=CNTR%+1: IF CNTR%<=NODTA% GOTO 8580 'Inc Ctr & Test EOF
5810 PRINT: IF FDPBS<>"D" THEN LPRINT: RETURN
5820
5830 PRINT FIELD
5840 *****

```

Listing 4 continued on page 236

LET'S TALK EPROM PROGRAMMING AND THE S-100 BUS!

You say your eprom programming needs are varied, but your engineering budget doesn't permit the purchase of that \$5,000-\$7,000 stand-alone programmer?

a.d.s. has the solution!

Hardware

The ads Prom Blaster eprom programming card sits on the I.E.E.E. 696/S-100 bus as an I/O device.

Does not require memory locations!

Handles the following devices: 2708's thru 2764's, single and three supply parts, and the Hitachi 48016 eeprom! Device plugs into on-board LIF socket.

Software

Runs under CP/m* or adsmon MC6809 monitor. Price: \$299.00 A & T + shipping. Includes board & software.

For complete details contact:

ackerman
digital systems, inc.
110 n. york rd.
elmhurst, il. 60126
(312) 530-8992

*CP/m

trademark

Digital

Research, Inc.

```

8800  ** Check for <STOP to allow for repositioning**
8810  ** the Form. Print date field at line number**
8820  ** and column Position.
8830  *****
8840
8850  IF FDTAS(CNTR%)<>"<STOP" GOTO 8870          'Test for reposn
8860  INPUT "Reposition Form c/r ",Z$:          RETURN
8870  IF FDPBS<>"P" THEN PRINT TAB(C2%);FDTAS(CNTR%); 'display field
8880  IF FDPBS<>"D" THEN LPRINT TAB(C2%);FDTAS(CNTR%); 'Print field
8890  RETURN
8900
8910  'HEADING
8920  LPRINT: LPRINT
8930  LPRINT "Data File {";FFILS;"}": LPRINT
8940  LPRINT CHD1$: LPRINT CHD2$: LPRINT          'Print column heading
8950  LCNT%=7: RETURN                              'Set line counter
8960
9000  'READ DATA FILE
9010  *****
9020  ** This routine reads a data file and places **
9030  ** the data in appropriate arrays.
9040  *****
9050
9060  IF FUDT% THEN RETURN
9070  INPUT "Form File Drive (A or B): ",AS: DRV$=AS
9080  IF DRV$="<" THEN RETURN
9090  IF DRV$<>"A" AND DRV$<>"B" GOTO 9070
9100  INPUT "Enter Form File Name: ",FFILS
9110  IF FFILS="<" GOTO 9070
9120  OPEN "I",1,DRV$+";"+FFILS+".FILE"
9130  PRINT: PRINT "Reading {";FFILS;"} Form File"
9140  FOR I%=1 TO 1000
9150      IF EOF(1) GOTO 9200
9160      INPUT #1,FLNES(I%),FCOLS(I%)
9170      LINE INPUT #1,AS
9180      AS=MID$(AS,2): FDTAS(I%)=LEFT$(AS,LEN(AS)-1) 'Strip quotes
9190                                          'from string
9200  NEXT
9210  NODTA%=I%-1
9220  PRINT: PRINT NODTA% "Form File Entries Read": PRINT
9230  FUDT%=TRUE%
9240  CLOSE #1
          RETURN

```

Text continued from page 232:

dle forms with unusual line spacing. If the form has unusual line spacing, the print program can be stopped so the form can be realigned: just enter <STOP for the field name and the program will stop on the selected line at the selected column. Reposition Form will be displayed on the screen.

Once back in the Command mode the data can be changed, listed, written to disk, displayed on the screen, or sent to the printer.

Change: If the change command is used when the program starts up, you will be requested to enter the file name for a previously saved data file and control table. If you enter C while using the FFORM-1 program, it will request the field number to change. If you enter CN, the program will display the current data for field N. You can then change the data for that field and the program will be ready for the next command.

List: The list command, like the change command, can be used with a

BREAKTHROUGH!

View and edit many files simultaneously.

Draw diagrams as easily as typing text.

Cut text from one window and paste it into another.

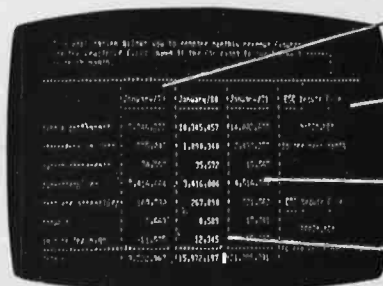

Automatic Horizontal and Vertical scrolling.

Create your own commands for your applications.

Automatic memory management of large files.

Compare, contrast, review or analyze.

A MULTI-WINDOW TEXT EDITOR FOR UNDER \$200.

Imagine this kind of productivity: Your 4 favorite files right before your eyes on the screen of your CRT.

Divide the screen of your CRT into any combination of horizontal and vertical windows, each with its own workspace. Or, windows can share a workspace—so you can edit different parts of the same file.

You get true on-screen editing, plus the ability to add or delete any of 10 windows, at any time, anywhere on the screen.

Using CP/M compatible files and simple, easy to remember commands, THE ELECTRIC BLACKBOARD™ has functions to satisfy the needs of the most demanding professional computer scientist. Yet THE ELECTRIC BLACKBOARD™ can be used just as productively by the novice within minutes. A step-by-step Learning Guide,

designed for the novice, will guide you gently through the learning process.

Unleash the extraordinary power and flexibility of THE ELECTRIC BLACKBOARD™ on your Z80-based micro-computer today.

Requires 48k CP/M or CDOS, Z80 processor, and CRT with cursor addressing. Distributed on SSSD 8" diskette. Includes reference manual, learning guide, and quick reference card. Price: \$198, manuals only: \$30.

Call or write for more information:

SANTA CRUZ SOFTWARE SERVICES

1711 Quail Hollow Road, Ben Lomond, CA 95005
(408) 336-2170

CP/M is a trademark of Digital Research CDOS is a trademark of Cromemco
Z80 is a trademark of Zilog

Introducing The FinalWord!

Word processing that goes beyond the stars.

How could anyone call their word processor The FinalWord? Take the best features of the most popular word processors, combine them and add a few more in one text editor/formatter and you'd be off to a good start. Then, write the program in C to allow user customization and make it capable of supporting any printer on the market and you'd be ahead of everybody else. If you went one step further and made your word processor transportable from one terminal to another you'd have—The FinalWord.



Supports multiple printers: The FinalWord allows you to produce high-speed draft copies on one printer, and letter-quality on another. It also means you'll never need another version just because you bought a new printer.

User-installable on different hardware: With The FinalWord you can upgrade your system and still have a familiar screen display. And since we've written The FinalWord in C, new versions are available almost as soon as new computers.

Features that go beyond the stars: Look at what you get with The FinalWord: automatic generation of Table of Contents, Index, footnoting and chapter/section numbering; enhanced command sets (delete/move a letter, word, sentence, paragraph, page); multiple buffers and windows, deletion recovery, true proportional spacing and more. And because we wrote The FinalWord to be easily reconfigured for different systems, our price can be lower.

Features	The FinalWord	WordStar	Magic Wand
Full-Screen Editing	Yes	Yes	Yes
Directory Access while Editing	Yes	Yes	Yes
Simultaneous Printing while Editing	Yes	Yes	Yes
External Commands while Editing	Yes	Yes	No
Video Highlighting	Yes	Yes	No
Automatic Footnotes	Yes	No	No
User-Defined Commands	Yes	No	No
Multiple File Editing	Yes	No	No
Deletion Recovery	Yes	No	No
Supports Multiple Printers	Yes	No	No
Crash Recovery	Yes	No	No
Dynamic Include Files	Yes	No	Yes
Suggested Retail Price	\$300	\$495	\$395

The FinalWord requires a 56K CP/M system and video terminal with cursor positioning character sequences. It is presently available in 8" standard format for the TRS-80 Model II, Vector Graphics and Altos Systems. There are compatible versions for the HP-125, Xerox 820, Cromemco, Micropolis, Ohio Scientific and Dynabyte Systems, and there are 5¼" versions for the Heath/Zenith Z-89, Northstar, Apple and Superbrain. **Coming Soon: The FinalWord for the IBM Personal Computer.**

The FinalWord is available through leading retailers, Westico, and Discount Software, or directly from:

Mark of the Unicorn
 PO BOX 423
 Arlington, Massachusetts 02174
 (617) 489-1387

Dealer and OEM inquiries invited.
 Call for delivery schedule.
 Reserve yours now!



Mark of the Unicorn

Listing 5: A sample data file developed with the FFORM-1 program. The data is also shown in the completed form in figure 4.

Data File (RIDE)

Item No	Line No	Col No	Field Data
1.	4	10	Easyoff Riding Stables
2.	4	44	Contact:
3.	4	57	Fred Horseman
4.	5	10	123 Pony Lane
5.	5	57	(555) 123-4567
6.	6	10	Mustang, AZ 10001
7.	9	10	Mavrick Supply Company
8.	9	58	Easyoff Riding Stables
9.	11	10	456 Whitehorse Blvd.
10.	11	58	Back Gate
11.	12	10	Quarterhoss, AZ 10002
12.	13	10	
13.	13	58	Mustang, AZ 10001
14.	17	2	Stock
15.	17	20	S78-9
16.	17	37	Livery Wagon
17.	17	51	Y'terday
18.	17	60	net 10
19.	17	70	Mo/Da/Yr
20.	20	5	12
21.	20	12	
22.	20	20	Soft Pillows
23.	20	64	3.75
24.	20	74	each
25.	22	5	1
26.	22	12	
27.	22	20	Saddle Glue
28.	22	64	37.50
29.	22	74	case
30.	24	5	1
31.	24	12	
32.	24	20	Saddle sore liniment
33.	24	64	27.80
34.	24	74	box

PURCHASE ORDER

ORDER NO
6731

Easyoff Riding Stables
123 Pony Lane
Mustang, AZ 10001

Contact: Fred Horseman
(555) 123-4567

TO Mavrick Supply Company SHIP TO Easyoff Riding Stables
ADDRESS 456 Whitehorse Blvd. ADDRESS Back Gate
CITY Quarterhoss, AZ 10001 CITY Mustang, AZ 10001

FOR Stock	REQ NO	HOW SHIP	DATE REQUIRED	TERMS	DATE
	S78-9	Livery Wagon	Y'terday	net 10	Mo/Da/Yr
PLEASE SUPPLY ITEMS LISTED BELOW					
QUANTITY	RECEIVED			PRICE	UNIT
1	12	Soft Pillows		3.75	each
2	1	Saddle Glue		37.50	case
3	1	Saddle sore liniment		27.80	box
4					
5					
6					
7					

IMPORTANT
OUR ORDER NUMBER MUST APPEAR ON ALL INVOICES, PACKAGES, ETC.
PLEASE NOTIFY US IMMEDIATELY IF YOU ARE UNABLE TO SHIP COMPLETE ORDER BY DATE SPECIFIED.

Rediforms 15 144 ORIGINAL *FH* PURCHASING AGENT

Figure 4: The result of the FFORM-1 program. The information on this form is the same as that in the data file in listing 5.

data file or used to list the fields just completed. All the fields may be listed by entering L; a single field can be listed using LN; a range of fields can be listed using LN-N, where N is the field number (see listing 5 for a sample data file).

The listing of the sample data file created with the FFORM-1 program contains the item number, line position, column position, and data to be printed at that location.

Print: The print command allows you to display either the array data (created by FFORM-1) or field data, formatted as it would look on the form, or the field data can be used to fill in the form on the printer.

When a printout of a form is requested, the program first asks you to position the form, then prints the first field and allows you to reposition the form. It can then print the next field and stop for forms alignment check, print the rest of the form, or quit. If a data field contains <STOP, the program will stop to allow you to reposition the form. Figure 4 shows the completed purchase order that was printed using sample data fields.

Saving the Data: In the Command

mode, the program can be ended by entering E. You then have the option of writing the data arrays to a disk file for future use or rerunning the program.

Depending upon your needs, you can add a number of enhancements to

These programs work best when there is constant use of a standard form, such as insurance forms, applications, or government paperwork.

these programs that will make them easier to use, for example:

- Multiple page forms with more than 100 data fields
- Command letters in either uppercase or lowercase
- Left- or right-justified data fields
- String or numeric fields
- An alert to any entry-required fields
- Print constants from the control table

- Special editing and range checking of data
- Use of the INP statement instead of INPUT to eliminate the need of the carriage return for completely filled fields
- Making a mask that looks similar to the form to be filled in and placing it over the screen—then filling in the data in the mask fields (this enhancement requires the use of a display that has an addressable cursor)

Most of these enhancements could be implemented by expanding the number of fields in the control table, then adding more code to support them.

Summary

The Fill Forms System is a relatively simple set of programs that can be used in a wide variety of situations. They work particularly well in situations where a standard form is required—for insurance agencies, application forms, or government documents. The more complex the form and the more frequently it is used, the more time you'll save by using this system. ■

Don't gamble with your business!



Invest in an M System

"Okay, which entry-level, single-user microcomputer should I own?"
The BOS M System.

"Which multi-user system should I own?"

The BOS M System.

"If I want a larger system with the ultimate in performance and capacity, what should I own?"

The BOS M System Multiprocessor.

"How much more does it cost to own a single-user set-up and upgrade it, than to start with a larger system?"

Not a penny more.

"Can I have diskette, tape, and large rigid disk storage?"

Yes.

"How about really good accounting software?"

The MBSI* package (GL, AR, AP, PR, OE/INV, Sales Analysis — all in Cobol) is probably the best available on any system...this is one you have to see to believe.

"How about Word Processing?"

WordStar†‡, and others.

"Can I run all the other software I've seen?"

Yes, if it's CP/M* compatible, almost certainly!**

"Will I have to change the operating system when I expand?"

No, with BOS/TURBODOS**, just upgrade it.**

"Well, this is important...will service be available when I need it?"

Yes, with a large dealer network, strategically placed maintenance depots, and fast factory repair turn-around.

"Sounds great! But isn't it too good to be true?"

No...and it's not even expensive! So, why take a chance with somebody else?

"Okay, how can I get one?"

Contact your dealer, systems house, or consultant — or call us toll-free!

**Dealer and OEM
Inquiries Welcome**

BOS

**Business Operating Systems, Inc.
2835 East Platte Avenue
Colorado Springs, Colorado 80909
In Colorado Call: (303) 634-1541
Toll Free Number: 1-800-525-3898**

Tele-VIC

Commodore Breaks the \$100 Price Barrier for Modems

Max Lebow
2121 Locust St.
Philadelphia, PA 19103

A really good modem takes a telephone number stored in your computer's memory, dials it, selects the appropriate originate/answer frequencies, and starts communicating at 9600 bits per second (bps). Unfortunately, a really good modem can also cost as much as a good used car.

If you are willing to dial your own telephone, set a manual switch to select originate/answer frequencies, and settle for 300 bps, Commodore's new modem may be an inexpensive solution. In fact, for the price of a moderately good 1200-bps modem, Commodore will sell you its modem and a VIC-20 home computer to go with it.

The modem is the VICMODEM. It is contained in a slim plastic case with an edge connector at one end and a modular telephone jack (for the *handset* cord) at the other. The edge connector attaches directly to the VIC-20, which has a special telecommunications slot to accept this modem or Commodore's RS-232 interface (see photo 1). (The VIC-20 is named for the Video Interface Chip, which provides the necessary interface between the computer and a television set. The VIC-20 has built-in connectors for a television (RF) and a video monitor. It also has a type-

writer-style keyboard, which is unusual for a computer in this price range.)

The modem is compactly designed on a single circuit board and conforms to the Bell 103 modem frequencies. It uses Motorola modem integrated-circuit chips and has a crystal to ensure frequency stability. Selection of originate or answer frequencies is accomplished manually

by setting a small slide switch on the side of the unit. A carrier-detection LED (light-emitting diode) is also provided.

A cassette contains the object code for the interface program VICTERM I. The features included in this software are impressive. They include:

Word wrap: If the word at the end of a line is too long to fit on that line, it



Photo 1: This low-cost modem for Commodore's VIC-20 home computer takes a modular plug from a telephone handset and plugs directly into VIC-20's telecomputing slot. The modem shown here is a prototype with a provisional model number.

Announcing A Media Event From IMS



Configuration shown includes two slimline double sided, double density drives, 40 M byte Winchester subsystem with tape back-up.

The New 8000 SX Micro Computer System With Winchester And Floppy And Tape

Winchester technology brought a tremendous increase in capacity, but it also dumped a big problem in your lap.

How to dump all that data?

Trying to transfer 10 to 40M bytes of data between Winchester and floppies takes an armload of diskettes and a lot of time.

Cartridge tape is fast, but not efficient for random file handling.

Answer?

The new 8000 SX Micro Computer System with Winchester plus Floppy and Tape. It lets you back up and restore a single file or a complete drive with maximum efficiency.

Choose from 10, 20 and 40M byte Winchester subsystems, with error detection and correction, capable of loading a 20K byte system program in less than a second.

The floppy subsystem offers up to 1.2M byte per 8" drive.

The bulk memory subsystem, an incremental cartridge tape drive, stores up to 17M byte on a single cartridge.

And, of course, the computer itself offers proven IMS top performance and reliability. Compare its full 2-year warranty.

Operating systems include CP/M, MP/M, and the incredibly

powerful TurboDOS.

For all the facts and the location of your nearest IMS International dealer, call us today at (714) 978-6966. Or write:

IMS
INTERNATIONAL

We Build Computers As If Your Business
Depended On Them.
2800 Lockheed Way, Carson City, NV 89701
Telex: 910-385-6051

CP/M & MP/M, TM of Digital Research • TurboDOS, TM of Software 2000 • FMS-80, TM of DJR Associates • WORDSTAR, TM of MICROPRO • ACCOUNTING PLUS, TM of SOFTWARE DIMENSIONS

Circle 186 on Inquiry card.

www.americanradiohistory.com

CHOOSE...

Choose an Apple Desk



A compact Bi-Level desk ideal for the Apple computer system. This 42" x 29½" desk comes with a shelf to hold two Apple disk drives. The top shelf for your TV or monitor and manuals can also have an optional paper slot to accommodate a printer. It is shown here with the optional Corvis shelf which will hold one Corvis disk drive. The Corvis shelf is available on the 52" x 29½" version of the Apple desk.

Choose a Micro Desk



The Universal Micro desk accommodates the S-100 type microcomputers. The desk is available in four sizes: 17.75 inch, 19.06 inch, and 20.75 inch wide openings with 24 inch front-to-rear mounting space. The fourth size is a 20.75 inch wide opening with a 26.50 inch front-to-rear mounting space.

Choose a Mini Rack



Mini racks and mini micro racks have standard venting, cable cut outs and adjustable RETMA rails. Choose a stand alone bay or a 48", 60", or 72" desk model in a variety of colors and wood tones. A custom rack is available for the Cromemco.

Choose a Printer Stand

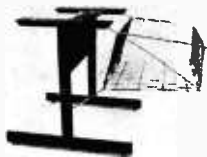

The Universal printer stand fits the:

Centronics 700's	Diablo 1600's & 2300's
Dec LA 34	T.I. 810 & 820
NEC Spinwriter	Okidata Slimline
Lear Siegler 300's	Anadex 9500's

Delivery in days on over 200 styles and colors in stock. Dealer inquiries invited.

**ELECTRONIC SYSTEMS
FURNITURE
COMPANY**

17129 S. Kingsview Avenue
Carson, California 90746
Telephone: (213)538-9601

Product Description

is whisked to the beginning of the next line. This feature is particularly useful for the VIC-20 with its maximum line length of 22 characters. Without this word-wrap feature, the screen would quickly become cluttered with many word fragments at the beginnings and ends of lines. (A 40-character-line software option for the VIC-20 is under consideration. However, it would use a 3 by 5 dot matrix to form the characters and might be difficult to read.)

Half or full duplex: Half duplex means that the "echoplex" used by some data networks is not utilized. Communication still takes place in two directions on two frequency-multiplexed "channels," but the host computer no longer echoes what the user types. Instead, the VIC-20 displays what the user types directly on its own screen. This feature is also menu-selectable.

Color separation: In the half-duplex mode, the software can display what the user types in one color, while displaying the host computer's output in another color. This feature makes user-computer dialogues easier to read.

Data rate: This selection on the menu goes from 0 to 300 bps. Some data-communications aficionados may turn up their noses at a data rate of 300, but most economy modems do not exceed it. Three hundred bps translates into 300 five-letter words per minute. This is faster than most of us type and faster than a radio announcer can read.

Five parity settings: These are also menu-selectable. They are: even parity, odd parity, parity set to one (mark), parity set to zero (space), and no parity (eighth bit treated as data). This feature goes a long way toward assuring that the modem will make the VIC-20 compatible with most 8-bit-byte transmission schemes. More on this feature later.

By now, a cartridge with even more features should be available, priced around \$50.

If you decide not to buy the VICTERM I software, Commodore provides a free printed copy of a

short BASIC program with the modem (see listing 1). You key this program in before dialing and eventually record it on your own cassette. It has none of the features listed above for the VICTERM I software.

What do engineers at large data networks recommend when using an inexpensive modem to connect to their expensive computers? Mike Marburger, Tymnet's Eastern Region Technical Manager, recommends setting parity to zero (space) on the modem and typing control-H immediately after the Terminal Identifier (TID) to disable Tymnet's

At a Glance

Name
VICMODEM

Use
Telecommunications for the VIC-20

Manufacturer
Commodore Business Machines Inc.
681 Moore Rd.
King of Prussia, PA 19406

Dimensions
Approximately 15 by 10 by 3.75 cm (6 by 4 by 1½ inches)

Price
\$109.95 (includes \$9.95 VICTERM I cassette software)

Hardware Needed
VIC-20, modular telephone, television set or video monitor, cassette recorder

Software Needed
VICTERM I cassette software or cartridge equivalent

Hardware Options
If you already own an acoustic coupler, it can be used with Commodore's RS-232 interface

Features
Direct connection to VIC-20 and telephone, crystal control, carrier-detect LED, originate/answer switch. With VICTERM I: word wrap, color separation (see text), menu-selectable data rate, parity options, cursor (on/off)

Documentation
User-friendly, step-by-step, illustrated manual

Audience
Anyone desiring an inexpensive telecommunication device

Pascal Computer Design

Volume No. 4

PENN YAN, NEW YORK

25 CENTS Cheap

IMP Debuts

**A Generation Beyond
MuMath and FORTRAN**

Penn Yan-Programmer/Engineer John Clarke has released his IMP (Instant Mathematical Programming) for use with all UCSD p-System machines, as well as for CP/M users with Pascal/M. The program, which was introduced at \$225, permits anyone (yes, a non-programmer) to generate sophisticated Pascal programs to solve complex linear and non-linear equations.

IMP Writes It

The IMP software first simplifies an algebraic problem statement (entered in simple text form), then writes a Pascal source program which, when compiled, gives the user a solution. The compiled program then permits the user to *Interactively* redefine constants or variables, or to maximize given parameters. Reviewers claim this system may replace FORTRAN as the engineer's computer standard.

TURNKEY CHEAPER THAN CP/M

Eliminate Need for Operating System Boot to Run Applications Approach (End Users Relieved)

P-System Turnkey Packages are now available for applications developers to distribute with their programs. The software allows the end-user to "Boot and Run" without needing to learn about operating system commands. Full backup, editing and file handling capabilities also available at a fraction of the full system cost. This should prove to be a boon to systems houses...and it's cheaper than CP/M!

LOGICALC (TM) moves "Calc" Software to UCSD Environs

LOGICALC (TM) gives spreadsheet capability to all those other micros. Does -Does Regression Analysis -Accepts Database In-Out

Penn Yan-Logicalc (TM) has swept the Pascal world by storm. Only \$295 a complete package.



RADIO SHACK II, III GET p-SYSTEM

Now Can Share Programs with Apple, DEC and IBM

Penn Yan-PCD Systems, who originally installed the p-System on the TRS-80 Model II have announced release of the complete system for the TRS-80 Model III. The p-System requires a 48K Model III with 2 disk drives. Now Radio Shack users can write programs compatible with Apple, Commodore, IBM (Personal Computer) and DEC machines (and vice versa).

A spokesman from the company noted that p-System software for DEC, Altos, Terak and Apple are already available from PCD Systems, Inc.

Chapin Refuses to Reveal True Meaning of CPR

Penn Yan- Chip Chapin, who recently released his CPR "text formatter" refuses to reveal the true meaning of his new program's title.

CPR, which was designed for use with the UCSD p-System operating system software, takes raw text files produced from the Editor and formats them for printing. At \$195, CPR provides sophisticated word processing capabilities for a fraction of the cost.

So, when someone mentions CPR, don't think "first aid", think "text aid".

Now available at PCD Systems, Inc.

SCP/M is a tm of Digital Research
iDEC, PDP-11, LSI-11 & RT-11 are tm of Digital Equipment Corp.

*MuMath is a tm of Microsoft

*p-System is a tm of the Regents of California

*TRS Model II, III & TRSDOS are tm of the Tandy Corp.

*Z-80 is a tm of Zilog Corp.

UCSD p-System To Burst CP/M's Balloon

Experts predict 8-Bit to 16-Bit Portability Crucial Support from IBM, Texas Instruments, Philips, Hewlett Packard, Commodore Announced

San Diego- Sources close to the battle predict that recent Version IV.O release and the master design that allows programs compiled on an 8-bit machine to run unchanged on the new 16-bit micros will give the p-System the "industry standard" status presently enjoyed by CP/M. They say that SofTech and PCD Systems have come up with the most viable system for the 80's.

Cross assemblers and "Pseudo-Code" allow programs developed on an 8-bit 6502 (such as Apple or Commodore) to be transported to a 16-bit 8088 (IBM) or LSI-11 (DEC) in **OBJECT CODE FORM**. A program can be executed without change on dozens of different machines with any common terminal.

Structured Programming lowers Maintenance Costs

P-System structured languages give developers powerful tools. A complete implementation of Pascal (plus many useful extensions) is available, as is FORTRAN-77, which supports the ANSI-77 subset for that language. A new BASIC compiler and a full range LISP interpreter round out the high level languages available. The structured approach to programming eliminates maintenance headaches which plague present users of standard BASIC and FORTRAN systems.

Speed No Longer an Issue

Linkage of Code segments in assembly language and/or use of the **NATIVE CODE** generators give compact code *without the sacrifice of speed* expected from p-Code interpretation. One can have one's cake and eat it too!

Dynamic Memory Management

Virtual operating system characteristics with nearly unlimited overlaying of program segments allows the user to run larger programs than other microcomputer operating systems. Program chaining, print spooling, 128K addressing capability and efficient use of system library units, universal screen control coding, and many peripherals configurations are fully supported. Command files, asynchronous I/O processing, p-Code debugger, procedural cross referencer and many more capabilities are being hailed by thousands of users.

Cross Assemblers, File Conversion Transfer

A complete set of native code generating cross assemblers generate absolute or relocatable code for the Z-80, Z-8, 8080, PDP-11, LSI-11, 6502, 6800, 6809 and 9900 microprocessors and are available through PCD Systems. File conversion programs for transferring data between TRSDOS, CP/M, RT-11, Microengine and IBM 3741 formats and p-System format add depth to system capabilities.

Complete Portable Environment

The standard p-System still includes that amazing screen editor (with its programming and word processing modes), file handler, interpreter, formatter, backup and configuration programs, and your choice of compiler. PCD Systems together with UCSD and SofTech have advanced the state of the art!

20% Off List

Penn Yan-PCD Systems is giving purchasers 20% off SofTech Microsystems suggested list price for those who buy a complete UCSD Development System by July 1st. Operating System, File Handler, Screen Editor (with word processing capabilities) system Library, Assembly Code Linker, Pascal Compiler and full documentation over 1000 pages is being sold for only \$600 complete. Compare other systems of this power and capability at three times the price!

For a Catalog of UCSD p-System and Applications Software

write to **PCD Systems, Inc.**
P O Box 143
Penn Yan, NY 14527
(315) 536-7428

(or stop in, Penn Yan is no stranger than Armonk)

Circle 307 on Inquiry card.

North Star offers you an

North Star **ADVANTAGE**

MOTHERS PIE SHOP DAILY SALES ANALYSIS

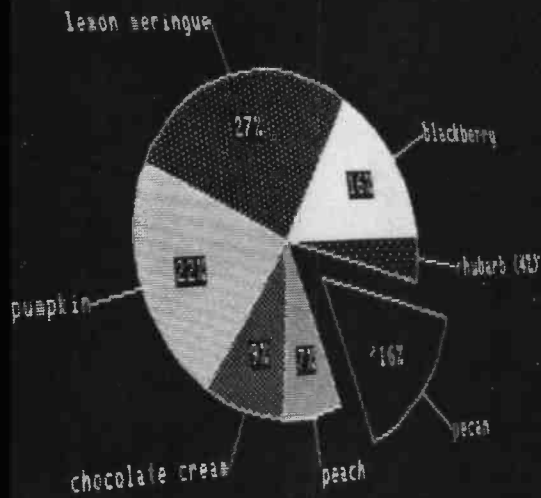

incredible AdvantageTM over IBM and Apple.

The ADVANTAGETM desktop computer from North Star is better in every category than either the IBM Personal Computer or the Apple III. Compare for yourself!

Incredible Data Storage:

The ADVANTAGE has twice the diskette capacity of either the IBM PC or the Apple III. This means you have twice as much information at hand.

Incredible Graphics:

The ADVANTAGE gives you a higher precision display. A revolutionary software package called BUSIGRAPHTM is provided at no extra charge for preparing graphs, bar charts, and pie charts.

Incredible Software:

The ADVANTAGE is fully CP/MTM compatible. Neither IBM nor Apple provides this ability to run the broadest range of industry-standard applications. In addition, only North Star offers 10 application packages for word processing, financial analysis, accounting and data base management.

Incredible Convenience:

ADVANTAGE is the only one of the three that's fully-integrated. It fits attractively on your desk without the clumsiness of the multiple-enclosure, multiple-cable approach taken by IBM and Apple.

Incredible Price:

The ADVANTAGE from North Star offers you the best in price/performance. You get more data storage per dollar invested, more applications programs, more available languages, and more graphics capabilities. At an incredible list price of \$3999.

To find out more about our incredible family of desktop computers with graphics, call TOLL FREE 800-447-4700. (Illinois 800-322-4400.) North Star Computers, Inc. 14440 Catalina St., San Leandro, CA 94577 USA (415) 357-8500. TWX/Telex (910) 366-7001.

North Star, ADVANTAGE and BUSIGRAPH are trademarks of North Star Computers, Inc. CP/M is a registered trademark of Digital Research, Inc.

THE INCREDIBLE ADVANTAGE COMPUTER COMPARISON CHART*			
	NORTH STAR ADVANTAGE	IBM PERSONAL COMPUTER	APPLE III
MICROPROCESSOR(S)	I-80A Central processor 803S Auxiliary processor	8088 processor	6502A processor
GRAPHICS DISPLAY RESOLUTION	640x240 pixels	640x200 pixels	560x192 pixels
DUAL FLOPPY DISC CAPACITY	720K bytes	320K bytes	280K bytes
CONVENIENT DESKTOP PACKAGE*	Yes, all in one enclosure	No, 3 enclosures	No, 3 enclosures
BUSINESS GRAPHICS SOFTWARE INCLUDED?	Yes	No	No
CP/M COMPATIBLE?	Yes	Partial	No
LANGUAGES SUPPLIED BY MANUFACTURER	Graphics BASIC, PASCAL, COBOL, FORTRAN, C	BASIC, PASCAL	BASIC, PASCAL
APPLICATIONS S/W PACKAGES SUPPLIED BY MANUFACTURER	10 packages	5 packages	5 packages
SELF-TEST DIAGNOSTIC	Yes	Yes	No
NATIONAL ON SITE SERVICE	Yes	No	No
MANUFACTURER SUPPLIED PRINTERS	Letter quality/matrix (136 columns)	Matrix (80 columns)	Letter quality/matrix (80 columns)
RETAIL PRICE PER KILOBYTE OF DISK STORAGE	\$5.55	\$11.17	\$15.57

* Professional configuration: Dual Floppy Disks, Monochrome Display, Keyboard, CPU, 64K bytes (or minimum) RAM Memory, and Printer Interface.
Source: Dataquest and Manufacturer's Literature, November 1981.

FOLLOW THE STAR
NorthStarTM

Circle 281 on Inquiry card.

Product Description

Listing 1: A simple BASIC program that allows the Commodore VIC-20 to communicate using the modem. VICTERM I, a more sophisticated program, is available at extra cost.

```

100 OPEN 2,3,CHR$(6):DIMF(255):T(255)
210 FORJ=32T064:T(J)=J:NEXT:T(13)=13:T(20)=8:RV=18:CT=0
220 FORJ=65T09D:K=J+32:T(J)=K:NEXT:FORJ=91T095:T(J)=J:NEXT
240 FORJ=193T0218:K=J-128:T(J)=K:NEXT:T(146)=16:T(133)=16
260 FORJ=0T0255:K=T(J):IFK<>0THENF(K)=J:F(K+128)=J
270 NEXT:PRINT"
300 GET#5,A$:SR=ST:IFA$=""ORSR<>0THEN310
305 PRINT" II"CHR$(F(ASC(A$)))::IFF(ASC(A$))=34THENPRINTCHR$(34):
306 GOTO300
310 PRINTCHR$(RV)" II"::GETA$:IFA$<>""THENPRINT#5,CHR$(T(ASC(A$)))
315 CT=CT+1:IFCT=8THENCT=0:RV=164-RV
320 IF(FEEK(37151)AND64)=1THEN320
330 GOTO300
  
```

default (automatic) echo state. Tymnet can, at the interface to a host computer (not a terminal or home computer), routinely strip parity coming in from terminals and microcomputers and put on whatever type of parity the host computer requires.

General Electric Information Services Company operates a network similar to Tymnet, although GE's is much larger. In fact, it is the largest international data-communications network in the world. Robert McCalley, manager of the communications and distribution system, recommends setting the modem to half duplex and no parity (treating the eighth bit as data) before logging on.

Keith Boyer, a spokesman for Compuserve's technical services, noted that although any parity setting will put ASCII characters on the screen, the eighth bit must be sendable and receivable as data in order for Compuserve's A and B file-transmission protocols to work properly. These protocols are used for important functions such as downloading programs to user memory. Also, transmission of some graphics characters requires the eighth bit. The "no parity" selection on the VICTERM I menu should be selected when using the A and B protocols or graphics programs.

As this article was being completed, The Source had some information for VIC users in its Commodore Business Machines database.

The VICMODEM was developed under the watchful eyes of Michael Tomczyk. The development process took four months from start to finish, he said in a recent interview. The toughest part was bringing it in at the right price. Tomczyk, who has an astute sense of the marketplace for home computers, assessed the future of the modem this way: "We think this modem may sell as many VICs as the game cartridges."

With a growing number of giant publishing firms gearing up to supply electronic newspapers, videotex, and other home data products, he may well be right. ■



Here's 256K Performance At an Economy Price!

InterSystems has done it again! The new Series III operates at 6 MHz and includes software to fully utilize the 256K high speed memory. You can buy it from BRIDGE for \$5545—check out these features. . .

- Operating system software that effectively utilizes the 256K RAM
- CP/M 2.2 and Cache BIOS™ that speeds operation up to 4 times
- 6 MHz CPU with powerful 1 MByte memory management system
- 256K memory—6 MHz with parity and 8/16 bit transfers
- S-100 Bus follows IEEE 696 Standards
- Two serial ports and four parallel ports with two interrupt controllers
- Dual double-density soft-sectored 5¼" drives (0.8 MByte total)
- Easily upgraded to 6-user MP/M system.

But we are sure that you want turnkey operation, so we have packaged a system that includes . . .

- InterSystems Series III Computer P/N CB-256/525
- BMATE™ screen oriented text editor/word processor
- Zenith Z-19 or Televideo 950 Terminal.

INTRODUCTORY OFFER		
ORDERING INFORMATION	List	Special Offer
InterSystem CB-256/525 Computer with software	\$6545.	\$5545.
As above with BMATE™ and Zenith Z-19 Terminal	7590.	6495.
As above with BMATE™ and Televideo 950 Terminal	7935.	6725.

For something still more powerful, ask about the BRIDGE enhanced systems, including the FORTRAN Development and the Compiler systems, based on InterSystems computers.

Call to order, or send for complete information. Dealer inquiries invited.



Authorized Distributor

Cache BIOS is a trademark of Ithaca InterSystems, Inc.
BMATE is a trademark of BRIDGE Computer Company,
Division of Sea Data Corporation.



BRIDGE™
Computer Company
DIVISION OF SEA DATA CORPORATION

ONE BRIDGE STREET
NEWTON, MASS. 02158 U.S.A.
PHONE: (617) 244-3203

NEW HIGHER PRINTING SPEED, NEW LOWER PRINTER PRICE

High-speed printer

The Heath/Zenith 25 Printer is a heavy-duty, high-speed dot matrix printer that gives you sharp, clear printouts. It prints crisp, clear copy at speeds over 150 characters per second with quiet smoothness.

Baud rates from 110 to 9600 are user-selectable.

Versatile printer

The 25 prints the entire 95-character ASCII set in upper case and lower case with descenders, in a 9x9 matrix. Also, 33 block graphic characters – which are compatible with the Heath/Zenith 89 All-In-One Computer and the 19 Smart Video Terminal – let you create graphs and charts. All functions and timing are microprocessor-controlled.

Plug-in ribbon cartridges make ribbon replacement a no-mess snap.

The 25 works with most computers and terminals – using an RS-232C Serial Interface or a 20 mA current loop with handshaking control signals.

Low-priced printer

The 25 has all the features you've been looking for in a high-quality, high-speed dot matrix printer – for only \$1095 in kit form, or for only \$1595 assembled and tested.

Free demonstration awaits you at your Heathkit Electronic Center †

Pick the store nearest you from the list below. And stop in today for a demonstration of the new Heath/Zenith 25 Printer. If you can't get to a store, send \$1.00 for the latest Zenith Data Systems Catalog of assembled commercial computers. We'll also send you a free copy of the latest Heathkit® catalog. Write to Heath Company, Dept. 334-874, Benton Harbor, MI 49022.

HEATH/ZENITH

Your strong partner

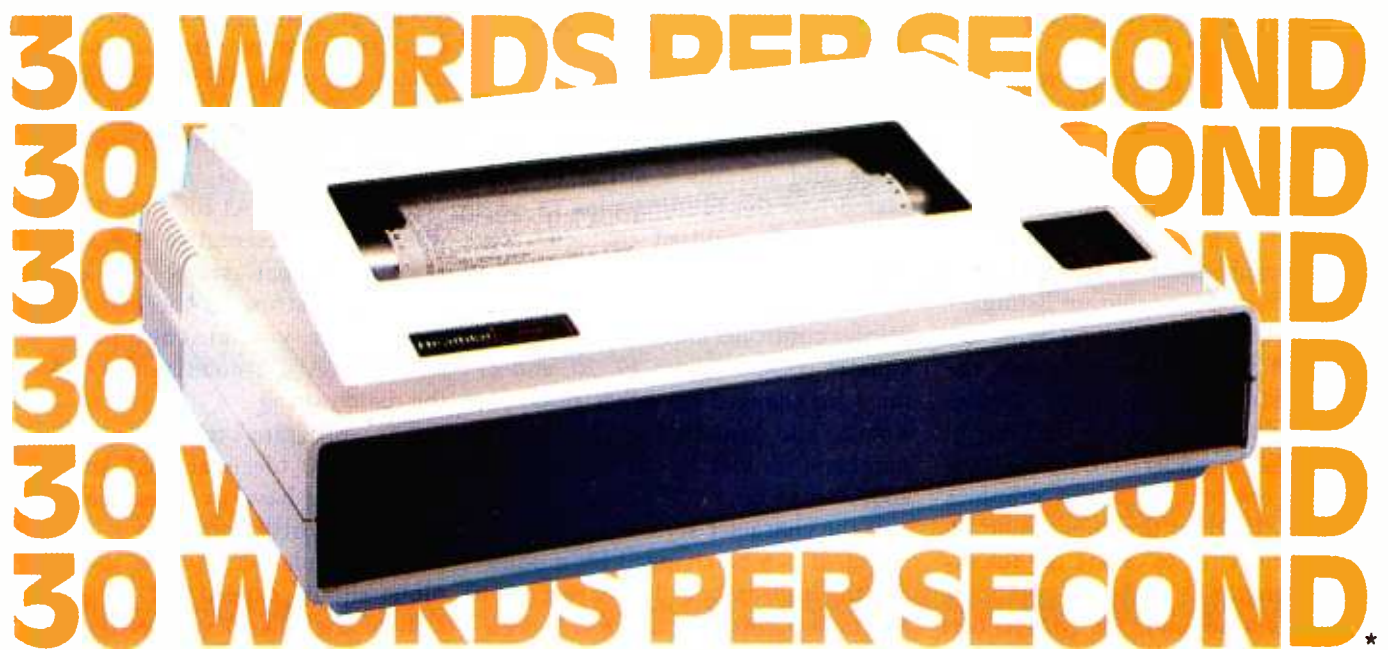

*150 characters per second

Visit your Heathkit Electronic Center †

Where Heath/Zenith Products are displayed, sold and serviced.

PHOENIX, AZ 2727 W. Indian School Rd. 602-279-6247	SACRAMENTO, CA 1860 Fulton Ave. 916-486-1575	ATLANTA, GA 5285 Roswell Rd. 404-252-4341	BALTIMORE, MD 1713 E. Joppa Rd. 301-861-4446	ST. PAUL, MN 1645 White Bear Ave. 612-778-1211	ROCHESTER, NY 937 Jefferson Rd. 716-424-2560	FRAZER, PA 630 Lancaster Pk. (Rt. 30) 215-647-5555	SAN ANTONIO, TX 7111 Blanco Rd. 512-341-8876
ANAHEIM, CA 330 E. Ball Rd. 714-776-9420	WOODLAND HILLS, CA 22504 Ventura Blvd. 213-883-0531	CHICAGO, IL 3462-66 W. Devon Ave. 312-583-3920	ROCKVILLE, MD 5542 Nicholson Lane 301-881-5420	BRIDGETON, MO 3794 McKelvey Rd. 314-291-1850	N. WHITE PLAINS, NY 7 Reservoir Rd 914-761-7690	PHILADELPHIA, PA 6318 Roosevelt Blvd. 215-288-0180	MIDVALE, UT 58 East 7200 South 801-566-4626
CAMPBELL, CA 2350 S. Bascom Ave. 408-377-8920	DENVER, CO 5940 W. 38th Ave. 303-422-3408	DOWNS GROVE, IL 224 Ogden Ave. 312-852-1304	PEABODY, MA 242 Andover St. (Rt. 114) 617-531-9330	OMAHA, NE 9207 Maple St. 402-391-2071	CLEVELAND, OH 28100 Chagrin Blvd. 216-292-7553	PITTSBURGH, PA 3482 Wm. Penn Hwy. 412-824-3564	ALEXANDRIA, VA 6201 Richmond Hwy. 703-765-5515
EL CERRITO, CA 6000 Potrero Ave. 415-236-8870	AVON, CT 395 W. Main St. (Rt. 44) 203-678-0323	INDIANAPOLIS, IN 2112 E. 62nd St. 317-257-4321	WELLESLEY, MA 165 Worcester Ave. (Rt. 9) 617-237-1510	ASBURY PARK, NJ 1013 State Hwy. 35 201-775-1231	COLUMBUS, OH 2500 Morse Rd. 614-475-7200	WARWICK, RI 558 Greenwich Ave. 401-738-5150	VIRGINIA BEACH, VA 1055 Independence Blvd. 804-460-0997
LA MESA, CA 8363 Center Dr. 714-461-0110	HIALEAH, FL 4705 W. 16th Ave. 305-823-2280	MISSION, KS 5960 Lamar Ave. 913-362-4486	DETROIT, MI 18645 W. Eight Mile Rd. 313-535-6480	FAIR LAWN, NJ 35-07 Broadway (Rt. 4) 201-791-6935	TOLEDO, OH 48 S. Byrne Rd. 419-537-1887	DALLAS, TX 2715 Ross Ave. 214-826-4053	SEATTLE, WA 505 8th Ave. N. 206-682-2172
LOS ANGELES, CA 2309 S. Flower St. 213-749-0261	PLANTATION, FL 7173 W. Broward Blvd. 305-791-7300	LOUISVILLE, KY 12401 Shelbyville Rd. 502-245-7811	EAST DETROIT, MI 101 Shady Oak Rd. 313-772-0416	AMHERST, NY 3476 Sheridan Dr. 716-835-3090	WOODLAWN, OH 10133 Springfield Pike 513-771-8850	FORT WORTH, TX 6825-A Green Oaks Rd. 817-737-8822	TUKWILA, WA 15439 53rd Ave. S. 206-246-5358
POMONA, CA 1555 N. Orange Grove Ave. 714-623-3543	TAMPA, FL 4019 W. Hillsborough Ave. 813-886-2541	KENNER, LA 1900 Veterans Mem. Hwy. 504-467-6321	HOPKINS, MN 101 Shady Oak Rd. 612-938-6371	JERICHO, LI, NY 515 Jericho Turnpike 516-334-8181	OKLAHOMA CITY, OK 2727 N. W. Expressway 405-848-7593	HOUSTON, TX 1704 W. Loop N. 713-869-5263	VANCOUVER, WA 516 S. E. Chaklov Or. #1 206-254-4441
REDWOOD CITY, CA 2001 Middlefield Rd. 415-365-8155							MILWAUKEE, WI 5215 W. Fond du Lac 414-873-8250

†Heathkit is a registered trademark of Heath Company. Heath Company and Veritechnology Electronics Corporation are wholly-owned subsidiaries of Zenith Radio Corporation. Heathkit Electronic Centers are operated by Veritechnology Electronics Corporation.

Lowercase Descenders for the Epson MX-70

Bruce Piggott
35 Beverley Rd.
Stevenage, Hertfordshire
SG1 4PR, England

Like most home-computer owners, I wanted a printer and, like most, couldn't afford one. But as prices began to fall, I gradually realized I could afford the Epson MX-70.

The MX-70 uses ordinary paper and has a graphics mode, but unfortunately it does not do lowercase descenders. This didn't worry me too much because most of the printing I wanted to do was program listings.

However, after working with the printer, I realized that although the MX-70 has eight print wires, it uses only seven in text mode. That meant lowercase descenders would be possible by switching to the graphics mode at the right time and using all eight print wires to create the lowercase letters.

Strangely enough, the MX-70 can print true descenders mechanically, but electronically the option was not available. I decided to write a machine-language program to modify the output.

The technique is to have a small program that examines the output of a printing routine. It looks at the ASCII (American Standard Code for Information Interchange) character in the microprocessor's A register to see if it is a lowercase letter with descender (e.g., g, j, p, q, or y). If one of those letters is not in that register, then the program jumps to

the standard output routine and prints the character in the normal way.

If, however, the letter requires a lowercase descender, the program switches the printer into the graphics mode and outputs a string of data that drives the printing pins to construct the improvised character (see listing 1).

The program assumes that the printer controller card is in slot 1. The equates (EQU) in lines 19, 20, and 21 must be changed for other slots: for slot 2, add hexadecimal 100 to the numbers, for slot 3, add hexadecimal 200, and so on.

If the character style is not to your liking, it can be changed by modifying the appropriate data string. The format is 5 dots wide and 8 dots deep, with the first byte defining the left side of the character and with the most significant bit at the top. The data string must end in a zero, as this is the delimiter for the program.

The program can also be extended to modify other characters or create some that are not in the standard ASCII set, for example:

- to change the number sign (#) to the English pound sign (£)
- to intercept normally unprintable codes (0 through 7) and print graphics
- to print Chinese characters

Plan the character you wish to design on graph paper. Convert the vertical columns into hexadecimal values using the tables in the MX-70 operation manual (remember the top bit is most significant). Then insert the resulting string into the source code in the DATA1 file (line 93), and insert the representative ASCII code into the "match" string (line 87). If you add a string at the end of the DATA1 file, you must also place the matching ASCII code at the end of the match string.

The program resides at hexadecimal 300 (decimal 768) and this address will have to be entered into the printer driver program.

Anyone planning to use this technique should expect that the operation of the MX-70 will seem a little strange at first. Whenever the MX-70 enters the graphics mode, it completes printing whatever is in the buffer up to that point, then backsteps to print the graphics. Consequently, the speed of the printer will slow down proportional to the number of lowercase letters with descenders. For this reason, I use the routine only for the final copy.

But the combination of the MX-70 and this program has saved me over \$150 compared to the price of the MX-80. And now I also have the use of the graphics mode. ■

Listing 1: The Lowercase Descender program for the MX-70 and Apple II. Not only can you get true lowercase descenders, but you can program your own characters.

```

SOURCE FILE: MX-70
0000:      1 *****
0000:      2 * LOWER CASE DESCENDERS FOR MX-70
0000:      3 *
0000:      4 * PROGRAM INTERCEPTS LOWER CASE :- G,J,P,Q,Y AND
0000:      5 * USING BIT MODE GRAPHICS, CONSTRUCTS TRUE
0000:      6 * DESCENDING CHARACTERS.
0000:      7 *
0000:      8 * PROGRAM ASSUMES THAT PRINTER INTERFACE-
0000:      9 * IS IN SLOT ONE. FOR OTHER SLOTS CHANGE-
0000:     10 * PRINTER,POUT AND PSENSE EQUATES.
0000:     11 * EG. FOR SLOT TWO ADD HEX. 100 TO ALL THREE EQUATES.
0000:     12 *
0000:     13 * BRUCE PIGGOTT. 6/20/81
0000:     14 *
0000:     15 *****
0000:     16 *
FF4A:     17 SAVE     EQU  $FF4A      :SAVE ALL REGISTERS
FF3F:     18 RESTORE EQU  $FF3F      :RESTORE ALL REGISTERS
C102:     19 PRINTER EQU  $C102
C090:     20 POUT     EQU  $C090
C1C1:     21 PSENSE  EQU  $C1C1      :SWITCHED ROM LOCATION
0000:     22 *
0000:     23 * MAIN PROGRAM ENTRY POINT
0000:     24 *
----- NEXT OBJECT FILE NAME IS MX-70.OBJ0
0300:     25          ORG  $300
0300:20 4A FF     26 ENTER   JSR  SAVE      : THIS ROUTINE SAVES ALL
0303:     27 *                REGISTERS BUT DESTROYS THE
0303:     28 *                CHARACTER IN THE 'A' REG.
0303:A5 45     29          LDA  $45      : REPLACE CHAR. FROM IT'S STORE.
0305:A2 04     30          LDX  #4          : SET UP X AS COUNTER FOR CHAR. SCAN
0307:00 6E 03   31 LOOP1   CMP  MATCH,X    :COMPARE CHAR WITH MATCH LIST + X
030A:F0 09     32          BEQ  MODIFY    :IF IN LIST.X REG TELLS WHICH
030C:CA       33          DEX
030D:10 F8     34          BPL  LOOP1    : IF X NOT < 0
030F:20 3F FF   35          JSR  RESTORE   : IT WAS NOT IN LIST SO RESTORE
0312:4C 02 C1   36          JMP  PRINTER  :-- AND GO TO STANDARD ROUTINE
0315:     37 *
0315:     38 *****
0315:     39 *
0315:     40 * THE CHARACTER HAS BEEN IDENTIFIED AS G,J,P,Q OR Y
0315:     41 * THE X REGISTER IDENTIFIES WHICH.
0315:     42 * FIRST STEP IS TO MULTIPLY X BY 6 SO THAT IT CAN BE USED
0315:     43 * AS AN INDEXED OFFSET TO THE DATA LIST.
0315:     44 *
0315:8A       45 MODIFY  TXA          :PUT X IN A TO ALLOW MANIPULATION
0316:0A       46          ASL  A          : DOUBLE A
0317:80 6D 03   47          STA  SUM        :STORE RESULT
031A:0A       48          ASL  A          : QUADRUPLE A
031B:18       49          CLC          : CLEAR CARRY FOR NEXT ADD
031C:60 6D 03   50          ADC  SUM        : 4XA + 2XA = 6XA
031F:48       51          PHA          : SAVE RESULT FOR LATER
0320:     52 *
0320:     53 * NOW PUT PRINTER IN BIT MODE FOR 6 BYTES
0320:A2 03     54          LDX  #3        : COUNTER
0322:BD 4B 03   55 LOOP2   LDA  DATA0,X    : GET NEXT DATA0
0325:80 90 C0   56          STA  POUT        : SEND TO PRINTER
0328:20 43 03   57          JSR  SENSE       : WAIT TILL PRINTER DONE
032B:CA       58          DEX
032C:10 F4     59          BPL  LOOP2    : IF NOT DONE

```

Listing 1 continued on page 254

INTERESTED?



LET'S TALK

CONCEPT: PRIVATE COMPUTERS

Our marketplace is maturing. Those of you that were around in 1977 will remember what it took then to make a sale...*(anything that worked!)*

The two beautiful faces at the left are evidence that *changes have occurred* in the industry!!!

Besides an excellent, well proven S-100, CP/M, Z-80 4MHZ computer system, we have a few extra things to offer. *(Not the model!)*

Delta specializes in something called a **Private Computer**. It's for those of you systems integrationists that have matured with the market. You stopped assembling systems in your garage a long time ago, but still need a totally flexible computer line that your customers won't find at *Wards* or *Sears*.

- 1.** A **Private Computer means** you will never see one of our computer systems on the shelf of your local department store or computer shop. We only sell to systems integrationists who add value to our product.
- 2.** A **Complete Range of Products** is available. No other micro company in the world offers a more complete line of equipment to satisfy your needs. We have everything from low end single user systems to the top of the line 64 user distributed processing networks.
- 3.** The **DP Software Library** is growing every month. We supply Accounting, Business Management, Code Writing, Medical, Dental, Chiropractic, Word Processing, Property Management and other programs. We have the source code in most cases and can negotiate customization if needed. Video taped training cassetts to aid you and your customers in learning how to use the programs and run the hardware are available.
- 4.** **Factory Support and Service** is available in most large cities. There are 66 fully stocked factory maintainance centers in the U.S. and 12 outside the U.S. In more remote areas, our 24 hour fast turnaround component pool can be used to insure reasonable response times to satisfy customers. We have a customer service *Hotline* independant of sales or service. We have a **24 Hour Modem Engineering Advisory Billboard**.
- 5.** Our **Engineering Assistance and Software Development Program** can make headaches turn into profits. We maintain a staff of Engineers and Programmers whose services can be leased to expand your range of services. Problems from something as simple as hooking up a new printer or modifying an existing software program to customize a screen display can be resolved with this service.
- 6.** **Financial Assistance** is available through a flexible credit program that can not only get the product to you quickly but keep your cash busy where it will do the most good. 30 - 60 - 90 day flooring plans can be arranged to allow you to collect your money before you have to pay us.

Sherry Starkey is on line right now at Delta to direct you to your area representative. If you have a half inch Beta or VHS video machine, ask Sherry for a sales demonstration in your own home or office. **See the Plant, the People and the Program.**

DELTA PRODUCTS INC. • 15392 ASSEMBLY LANE, HUNTINGTON BEACH, CA 92649
(714) 898-1492 • MON to FRI - 8 AM to 5 PM • TELEX: 681-367 DELTMAR HTBH

Circle 128 on Inquiry card.

NEW FROM NETRONICS AUTO-PATCH HARD DISK

With plug-in multi-user ports
Automatically Installs Itself Into
Your Present CP/M® 2.2 Operating
system & Floppy Disk Hardware.
It's Exclusive!

6 megabytes... \$2995.00 12 megabytes... \$3495.00



What's the big concern of S100 owners when they consider adding Hard Disks? They worry that it will be difficult to install, that it won't be compatible with their present software and hardware, and that it may cause down-time on their S100 system.

Worry no more — Netronics new AUTOPATCH Hard Disk Systems are here. AUTOPATCH installs in just one-two-three: (1) plug in the hard disk S100 card; (2) run three short programs supplied on disk; (3) disable the boot on your floppy controller and enable the boot on your hard disk controller (this step not required if you wish to continue to boot to your floppy drives).

And that's it: The AUTOPATCH feature automatically finds the end of your existing BIOS and then self-relocates and patches itself into the existing BIOS. A virgin copy of CCP and BIOS are loaded into memory, a customized SBOOT is added to the front of CCP and the whole memory image is written to the reserved tracks on your hard disk. You can add up to 4 hard disks to the controller supplied. The new BIOS will automatically rename any old devices as B; and C; and define the hard disk as drive A; All with the lift of one finger!!! If your BIOS is large you may have to re-sysgen your system down 1 or 2 k. If this is necessary the AUTOPATCH program will prompt you to do so.

AUTOPATCH Hard Disk Systems are available in 6 and 12 megabyte models. Included in the system: 6 or 12 megabyte Hard Disk Drive... Controller for up to 4 Hard Disk drives... S100 Hard Disk card with provisions for adding 8 additional I/O ports to be used when adding a multi-user operating system... Power Supply... Deluxe Steel Cabinet... All necessary cables... AUTOPATCH Programs supplied on either 8" or 5 1/4" IBM formatted single density diskettes (specify style required)... Complete installation instructions... Fully wired and tested, ready to go.

SPECIFICATIONS

Unformatted Recording Capacity: 6.4 or 11.6 MB
No. of tracks: 612 or 1380... Data Transfer Rate: 3 ms
Bytes/sector format: 512... Communication Port: DO (other ports available on special order)... Programs supplied on 5 1/4" or 8" single density IBM formatted diskettes (North Star CP/M™ version available on special order)

10 DAY MONEY BACK OFFER

Continental U.S.A. Credit Card Buyers Outside Conn.

CALL TOLL FREE 800-243-7428

To Order From Connecticut Or For Tech. Assist. Call (203) 354-9375

NETRONICS R&D LTD. Dept.

333 Litchfield Road, New Milford, CT 06776

Please send the items checked below:

- AUTOPATCH/6 Hard Disk System... \$2995.00
 - AUTOPATCH/12 Hard Disk System... \$3495.00
 - Additional 6-megabyte drive with power supply, cabinet, cables and necessary software... \$1995.00
 - Additional 12-megabyte drive with power supply, cabinet, cables and necessary software... \$2495.00
- All plus \$15.00 P&I (postage & insurance). For Canadian orders, double the postage (\$30.00). Conn. res. add sales tax.

Total Enclosed \$

Personal Check Cashier's Check/M.O.
 VISA MasterCard (Bank No. _____)
Acct. No. _____ Exp. Date _____
Signature _____
Print Name _____
Address _____
City _____ State _____ Zip _____

Big sale on K's!

16K... \$149.95
32K... \$199.95
48K... \$249.95
64K... \$299.95

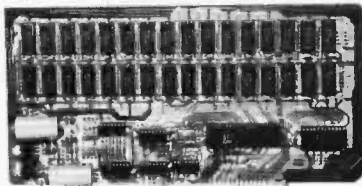

New JAWS-IB

The Ultrabyte Memory Board

Due to the tremendous success of our JAWS I, we were able to make a special purchase of first-quality components at below-cost prices for JAWS-IB. And we are sharing our cost saving with you. But don't be surprised if the next time you see this ad the prices have gone up substantially. Better yet, order now, and get the best memory on the market at the best price on the market.

ONE CHIP DOES IT ALL

JAWS-IB is the Rolls-Royce of all the S100 dynamic boards. Its heart is Intel's single chip 64K dynamic RAM controller. Eliminates high-current logic parts... delay lines... massive heat sinks... unreliable trick circuits. JAWS-IB solves all these problems.

LOOK WHAT JAWS-IB OFFERS YOU

Hidden refresh... fast performance... low power consumption... latched data outputs... 200 NS 4116 RAM's... on-board crystal... RAM Jumper selectable on 8K boundaries... fully socketed... solder mask on both sides of board... phantom line... designed for 8080, 8085, and Z80 bus signals... works in Explorer, Sol, Horizon, as well as all other well-designed S100 computers.



Continental U.S.A. Credit Card Buyers Outside Connecticut:
TO ORDER CALL TOLL FREE 800-243-7428
From Connecticut Or For Assistance:
(203) 354-9375

Please send the items checked below:

- JAWS-IB kit:
 - 16K... \$149.95*
 - 32K... \$199.95*
 - 48K... \$249.95*
 - 64K... \$299.95*

JAWS-IB Fully Assembled, wired & Tested:

- 16K... \$179.95*
- 32K... \$239.95*
- 48K... \$299.95*
- 64K... \$359.95*

EXPANSION KIT, 16K RAM Module, to expand JAWS-IB in 16K blocks up to 64K. \$59.95
*All prices plus \$2 postage and insurance (\$4.00 Canada). Connecticut residents add sales tax.

Total enclosed: \$

- Personal Check Money Order or Cashier's Check
- VISA MasterCard (Bank No. _____)

Acct. No. _____ Exp. Date _____
Signature _____
Print Name _____
Address _____
City _____
State _____ Zip _____

NETRONICS R&D Ltd.
333 Litchfield Road, New Milford, CT 06776

Now with added words! * ELECTRIC MOUTH



Now available for TRS-80 Model III

ELF II VERSIO

for S100, Elf II, Apple TRS-80, Level II* From \$99.95 kit

Now — teach your computer to talk, increasing interaction between you and your machine.

That's right: the ELECTRIC MOUTH actually lets your computer talk! Installed and on-line in just minutes, it's ready for spoken-language use in office, business, industrial and commercial applications, and in games, special projects, R&D, education, security devices — there's no end to the ELECTRIC MOUTH's usefulness. Look at these features:

- Supplied with 143 letters/words/phonemes/numbers, capable of producing hundreds of words and phrases
- Expandable on-board up to thousands of words and phrases with additional speech ROMs (see new speech ROM described below).
- Four models: that plug directly into S100, Apple, Elf II and TRS-80 Level II computers.
- Get ELECTRIC MOUTH to talk with either Basic or machine language (very easy to use, complete instructions with examples included).
- Uses National Semiconductor's "Digitaler."
- Includes on-board audio amplifier and speaker, with provisions for external speakers.
- Installs in just minutes.

Principle of Operation: The ELECTRIC MOUTH stores the digital equivalents of words in ROMs. When words, phrases and phonemes are desired, they simply are called for by your program and then synthesized into speech. The ELECTRIC MOUTH system requires none of your valuable memory space except for a few addresses if used in memory mapped mode. In most cases, output ports (user selectable) are used.

SPOKEN MATERIAL INCLUDED (Vox II)

one	eighteen	at	dollar	inches	number	ss	c	i
two	nineteen	cancel	down	is	of	second	d	u
three	twenty	case	equal	it	off	act	e	v
four	thirty	error	kilogram	on	space	f	w	
five	forty	five	left	out	speed	g	x	
six	fifty	800hertz tone	few	less	over	start	h	y
seven	sixty	20ms silence	fuel	lesser	parenthesis	start	i	z
eight	seventy	40ms silence	gallon	limit	percent	stop		
nine	eighty	80ms silence	go	low	please	than	k	
ten	ninety	100ms silence	gram	lower	plus	the	l	
eleven	thousand	320ms silence	great	mark	point	time	m	
twelve	million	cent	meter	round	try	n		
thirteen	hundred	check	have	mile	pulses	up	o	
fourteen	zero	comma	high	milli	rate	volt	p	
fifteen	again	control	higher	minus	re	weight	q	
sixteen	ampere	danger	hour	minute	ready	u	r	
seventeen	and	degree	in	near	right	s		

ADDITIONAL VOCABULARY NOW AVAILABLE (VOX II)

about	complete	fills	light	put	station
adjust	continue	fire	load	quarter	switch
alarm	copy	first	lock	range	system
alarm	correct	floor	longer	reached	temperature
alert	create	fourth	more	receive	test
all	"de"	forward	move	record	"th"
ask	deposit	from	next	reverse	think
assistance	dial	gas	no	round	third
attention	door	get	normal	repair	this
blue	east	going	north	repeat	turn
brake	"ed"	green	not	replace	under
button	emergency	hate	notice	room	use
buy	enter	heat	open	safe	wailing
called	"er"	hello	operator	second	warning
caution	"eth"	help	or	secure	was
causis	evacuate	hurts	pass	select	west
centigrade	exit	hot	power	service	wind
change	fail	in	press	side	window
circuit	failure	incorrect	pressure	slow	yellow
cigar	fahrenheit	intruder	process	slower	yes
close	fast	key	pull	smoke	zinc
cold	faster	level	in	push	zinc

*Registered Trademarks

Continental U.S.A. Credit Card Buyers Outside Connecticut
TO ORDER

Call Toll Free: 800-243-7428

To Order From Connecticut, or For Technical Assistance, call (203) 354-9375

NETRONICS R&D LTD.
333 Litchfield Road, New Milford, CT 06776

Please send the items checked below:

- S100 "Electric Mouth" kit w/Vox I... \$ 99.95
- Elf II "Electric Mouth" kit w/Vox I... \$ 99.95
- Apple "Electric Mouth" kit w/Vox I... \$119.95
- TRS-80 Level II "Electric Mouth" kit w/Vox I... \$119.95
- VOX II (Second Word Set)... \$ 39.95

Add \$20.00 for wired tested units instead of kits. VOX II postage & insurance \$1.00 all others \$3.00 postage and insurance. Conn. res. add sales tax.

Total Enclosed \$

- Personal Check Cashier's Check/Money Order
- Visa Master Charge (Bank No. _____)

Acct. No. _____ Exp. Date _____
Signature _____
Print Name _____
Address _____
City _____
State _____ Zip _____

FOR ONLY \$129.95 Learn Computing From The Ground Up

Build a Computer kit that grows with you, and can expand to 64k RAM, Microsoft BASIC, Text Editor/Assembler, Word Processor, Floppy Disks and more.

EXPLORER/85

Here's the low cost way to learn the fundamentals of computing, the all-important basics you'll need more and more as you advance in computer skills. For just \$129.95 you get the advanced-design Explorer/85 motherboard, with all the features you need to learn how to write and use programs. And it can grow into a system that is a match for any personal computer on the market. Look at these features: 8085 Central Processing Unit, the microprocessor "heart" of the Explorer/85. (Join the millions who will buy and use the 8085/8085 this year ahead!). Four 8-bit plus one 6-bit output ports from which you can input and output your programs, as well as control exterior switches, relays, lights, etc. . . a cassette interface that lets you store and reload programs you've learned to write. . . deluxe 2,000 byte operating system/monitor makes it easy to learn computing in several important ways: • It allows simpler, faster writing and entering of programs • It permits access by you to all parts of the system so you can check on the status of any point in the program • It allows tracing each program step by step, with provision for displaying all the contents of the CPU (registers, flags, etc.) • . . . and it does much more!

You get all this in the starting level (Level A) of the Explorer/85 for only \$129.95. Incredible! To use, just plug in your 6VDC power supply and terminal or keyboard/display — if you don't have them, see our special offers below.

Level A computer kit (Terminal Version) . . . \$129.95 plus \$3 P&I.
Level A kit (Hex Keypad/Display Version) . . . \$129.95 plus \$3 P&I.*

LEVEL B — This "building block" converts the motherboard into a two-slot S100 bus (industry standard) computer. Now you can plug in any of the hundreds of S100 cards available.

Level B kit . . . \$49.95 plus \$2 P&I.*
S100 bus connectors (two required) . . . \$4.85 each, postpaid.

LEVEL C — Add still more computing power: this "building block" mounts directly on the motherboard and expands the S100 bus to six slots.

Level C kit . . . \$39.95 plus \$2 P&I.*
S100 bus connectors (five required) . . . \$4.85 each, postpaid.

LEVEL D — When you reach the point in learning that requires more memory, we offer two choices: either add 4k of a memory directly on the motherboard, or add 16k of 64k of memory by means of a single S100 card, our famous "JAWS".

Level D kit (CHECK ONE) . . . 4k on-board . . . \$49.95 plus \$2 P&I.*
16k S100 "JAWS" . . . \$149.95 plus \$2 P&I.*
32k S100 "JAWS" . . . \$199.95 plus \$2 P&I.*
64k S100 "JAWS" . . . \$299.95 plus \$2 P&I.*

LEVEL E — An important "building block" it activates the 8k ROM/EPROM space on the motherboard. Now just plug in one 8k Microsoft BASIC or your own custom programs.

Level E kit . . . \$5.95 plus 50¢ P&I.*
Microsoft BASIC — It's the language that allows you to talk English to your computer! It is available three ways: • 8k cassette version of Microsoft BASIC (requires Level B and 12k of RAM) . . . minimum, we suggest a 16k S100 "JAWS" — see above . . . \$24.95 plus \$2 P&I.*
• 8k ROM version of Microsoft BASIC (requires Level B & Level E and 4k RAM; just plug into your Level E sockets. We suggest either the 4k Level D RAM expansion or a 16k S100 "JAWS") . . . \$24.95 plus \$2 P&I.*
• Disk version of Microsoft BASIC (requires Level B, 32k of RAM, floppy disk controller, 8" floppy disk drive) . . . \$32.95 postpaid.

TEXT EDITOR/ASSEMBLER — The editor/assembler is a software tool (a program) designed to simplify the task of writing programs. As your programs become longer and more complex, the assembler can save you many hours of programming time. This software includes an editor program that enters the programs you write, makes changes, and saves the programs on cassettes. The assembler performs the clerical task of translating symbolic code into the computer-readable object code. The editor/assembler program is available either in cassette or in ROM version.

Editor/Assembler (Cassette version; requires Level B and 8k (min.) of RAM — we suggest 16k "JAWS" — see above) . . . \$59.95 plus \$2 P&I.*
Editor/Assembler (ROM version, supplied on an S100 card; requires Level B and 4k RAM (min.) — we suggest either Level D or 16k "JAWS") . . . \$99.95 plus \$2 P&I.*

FLOPPY DISK — A remarkable "building block" Add our 8" floppy disk when you need faster operation, more convenient program storage, perhaps a business application, and access to the literally thousands of programs and program languages available today. You simply plug them into your Explorer/85 disk system — it accepts all IBM-formatted CP/M programs.

8" Floppy Disk Drive . . . \$499.95 plus \$12 P&I.*
Floppy Controller Card . . . \$199.95 plus \$2 P&I.*
Disk Drive Cabinet & Power Supply . . . \$69.95 plus \$3 P&I.*
Drive Cables (set up for two drives) . . . \$25.00 plus \$1.50 P&I.*

CP/M 2.2 Disk Operating System; includes Text Editor/Assembler, dynamic debugger, and other features that give your Explorer/85 access to thousands of existing CP/M-based programs . . . \$150.00 postpaid.

NEED A POWER SUPPLY? Consider our AP-1. It can supply all the power you need for a fully expanded Explorer/85 (note: disk drives have their own power supply). Plus the AP-1 fits neatly into the attractive Explorer steel cabinet (see below).

AP-1 Power Supply kit (6V @ 5 amps) in deluxe steel cabinet . . . \$39.95 plus \$2 P&I.*

NEED A TERMINAL? We offer you choices: the least expensive one is our Hex Keypad/Display kit that displays the information on a calculator-type screen. The other choice is our ASCII Keyboard/Computer Terminal kit that can be used with either



1. Plug in Netronics's Hex Keypad/Display
2. Add Level B to convert it to ASCII
3. Add 4k RAM
4. Plug in Level E board (accepts Microsoft BASIC or Editor/Assembler in ROM)
5. Add two S100 boards
6. Add your own custom circuits (prototyping area)
7. Connect terminal

a CRT monitor or a TV set (if you have an RF modulator).
Hex Keypad/Display kit . . . \$69.95 plus \$2 P&I.*

ASCII Keyboard/Computer Terminal kit featuring a full 128 character set, full cursor control, 75 ohm video output, convertible to baudot output, selectable baud rate, RS 232-C or 20 mA I/O, 32 or 64 character by 16 line format . . . \$149.95 plus \$3 P&I.*

Steel Cabinet for ASCII Keyboard/Terminal . . . \$19.95 plus \$2 P&I.*

RF Modulator kit (allows you to use your TV set as a monitor) . . . \$8.95 postpaid.

12" Video Monitor (10MHz bandwidth) . . . \$139.95 plus \$5 P&I.*

Deluxe Steel Cabinet for the Explorer/85 . . . \$48.95 plus \$3 P&I.*

Fan for cabinet . . . \$15.00 plus \$1.50 P&I.*



ORDER A SPECIAL-PRICE EXPLORER/85 PAK — THERE'S ONE FOR EVERY NEED.

Beginner Pak (Save \$26.00) — You get Level A (Terminal Version) with Monitor Source Listing (\$25 value) AP-1, 5-amp. power supply, Intel 8085 Users Manual . . . (Reg. \$199.95) SPECIAL \$169.95 plus \$4 P&I.*

Experimenter Pak (Save \$53.40) — You get Level A (Hex Keypad/Display Version) with Hex Keypad/Display, Intel 8085 User Manual, Level A Hex Monitor Source Listing, and AP-1, 5-amp. power supply . . . (Reg. \$279.95) SPECIAL \$218.95 plus \$5 P&I.*

Special Microsoft BASIC Pak (Save \$103.00) — You get Level A (Terminal Version), B, D (4k RAM), E, 8k Microsoft in ROM, Intel 8085 User Manual, Level A Monitor Source Listing, and AP-1, 5-amp. power supply . . . (Reg. \$439.70) SPECIAL \$329.95 plus \$7 P&I.*

ADD A ROM-VERSION TEXT EDITOR/ASSEMBLER (Requires Levels B and D or S100 Memory) . . . \$99.95 plus \$2 P&I.*

8" Disk System — Includes Level A, B floppy disk controller, one CDC 8" disk-drive, two-drive cable, two S100 connectors; just add your own power supplies, cabinets and hardware . . . (Reg. \$1095.00) SPECIAL \$999.95 plus \$13 P&I.*
32k Starter System, \$1049.95 (Reg. \$119.95) SPECIAL \$189.95 plus \$13 P&I.*
64k Starter System, \$1149.95 plus \$13 P&I.*
Add to any of above Explorer steel cabinet, AP-1 five amp. power supply, Level C with two S100 connectors, disk drive cabinet and power supply, two sub-D connectors for connecting your printer and terminal . . . (Reg. \$225.95) SPECIAL \$199.95 plus \$13 P&I.*
Complete 64k System, Wired & Tested . . . \$1850.00 plus \$26 P&I.*

Special Complete Business Software Pak (Save \$625.00) — Includes CP/M 2.2 Microsoft BASIC, General Ledger, Accounts Receivable, Accounts Payable, Payroll Package . . . (Reg. \$1325) SPECIAL \$699.95 postpaid.

*P&I stands for "postage & insurance." For Canadian orders, double this amount.

Continental Credit Card Buyers Outside Connecticut:
TO ORDER
Call Toll Free: 800-243-7428

To Order From Connecticut, or For Technical Assistance, call (203) 354-9375

★ (Clip and mail entire ad) ★

SEND ME THE ITEMS CHECKED ABOVE
Total Enclosed (Conn. Residents add sales tax): \$
Paid by:

Personal Check Cashier's Check/Money Order
 VISA MASTER CARD (Bank No. _____)

Acct. No. _____ Exp. Date _____

Signature _____
Print Name _____

Address _____
City _____

State _____ Zip _____

ANNOUNCING TWO NEW TERMINALS

Smart • Fast • Graphics • Matching Modem and \$295 Printer

Netronics announces a state of the art breakthrough in terminals. Now at prices you can afford, you can go on-line with data-bank and computer phone-line services. It's all yours: "electronic newspapers," educational services, Dow-Jones stock reports, games, recipes, personal computing with any level language, program exchanges, electronic bulletin boards . . . and more every day!!!



Netronics offers two new terminals, both feature a full 56 key/128 character typewriter-style keyboard, baud rates to 19.2 kilobaud, a rugged steel cabinet and power supply. The simplest one, FASTERM-64, is a 16 line by 84 or 32 character per line unit, with a serial printer port for making hard copy of all incoming data, and optional provisions for block and special character graphics. The "smart" version, SMARTERM-80, features either 24 line by 80 characters per line or 16 by 40 characters per line, it offers on-screen editing with page-at-a-time printing, 12,000 pixel graphics, line graphics, absolute cursor addressing, underlining, reverse video, one-half intensity and much more . . . simply plug them into your computer or our phone modem and be on-line instantly. Use your TV set (RF modulator required) or our deluxe green-phosphor monitor pictured above. For hard copy just add our matched printer.

Price breakthrough!!! Own the FASTERM-64, a complete terminal kit, ready to plug in for just \$199.95 or order the SMARTERM-80 kit for just \$299.95. (both available wired and tested.) On-line with the million-dollar computers and data services today . . . we even supply the necessary subscription forms.

More good news: All the components in our terminals are available separately (see coupon), so you buy only what you need!!!

FASTERM-64 . . . DISPLAY FORMAT: 64 or 32 characters/line by 16 lines . . . 96 displayable ASCII characters (upper & lower case) . . . 8 baud rates: 150, 300, 600, 1200, 2400, 4800, 9600, 19, 200, (switch sel.) . . . LINE OUTPUT: RS232C or 20 ma current loop . . . VIDEO OUTPUT: 1V pp (EIA RS-170) . . . CURSOR MODES: home & clear screen, erase to end of line, erase cursor line, cursor up & down, auto carriage return/line feed at end of line & auto scrolling . . . REVERSE VIDEO . . . BLINKING CURSOR . . . PARITY: off, even or odd . . . STOP BITS: 1, 1.5, 2 . . . DATA BITS PER CHARACTER: 5, 6, 7 or 8 . . . CHARACTER OUTPUT: 5 by 7 dot matrix in a 7 by 12 cell . . . PRINTER OUTPUT: prints all incoming data . . . 1K ON BOARD RAM . . . 2K ON BOARD ROM . . . CRYSTAL CONTROLLED . . . COMPLETE WITH POWER SUPPLY . . . OPTIONAL GRAPHICS MODE: includes 34 Greek & math characters plus 30 special graphics characters . . . ASCII ENCODED KEYBOARD: 56 key/128 characters.

SMARTERM-80 . . . DISPLAY FORMAT: 80 characters by 24 lines or 40 characters by 16 lines 128 displayable ASCII characters (upper & lower case) 8 baud rates: 110, 300, 600, 1200, 2400, 4800, 9600, 19, 200 . . . LINE OUTPUT: RS232C or 20 ma current loop . . . VIDEO OUTPUT: 1V pp (EIA RS-170) . . . EDITING FEATURES: insert/delete line, insert/delete character, forward/back tab . . . LINE OR PAGE TRANSMIT . . . PAGE PRINT FUNCTION . . . CURSOR POSITIONING: up, down, right, left, plus absolute cursor positioning with read back . . . VISUAL ATTRIBUTES: underline, blink, reverse video, half intensity, & blank . . . GRAPHICS: 12,000 pixel resolution block plus line graphics . . . ON-SCREEN PARITY INDICATOR . . . PARITY: off, even or odd . . . STOP BITS: 110 baud 2, all others 1 . . . CHAR. OUTPUT: 7 by 11 character in a 9 by 12 block . . . PRINTER OUTPUT . . . 60 or 50 Hz VERTICAL REFRESH . . . BLINKING BLOCK CURSOR . . . CRYSTAL CONTROLLED . . . 2K ON BOARD RAM . . . ASCII ENCODED KEYBOARD: 56 key/128 character . . . 4K ON BOARD ROM . . . COMPLETE WITH POWER SUPPLY.

TELEPHONE MODEM 103 OIA . . . FULL DUPLEX, FCC APPROVED . . . DATA RATE: 300 baud . . . INTERFACE: RS232C and TTY . . . CONTROLS: talk/data switch (no need to connect and disconnect phone), originate/answer switch on rear panel . . . NO POWER SUPPLY REQUIRED.

ASCII KEYBOARD ASCII-3 . . . 56 KEY/128 CHARACTER ASCII ENCODED . . . UPPER & LOWER CASE . . . FULLY DEBOUNCED . . . 2 KEY ROLL-OVER . . . POS OR NEG LOGIC WITH POS STROBE . . . REQUIRES +5 & -12V DC (SUPPLIED FROM VIDEO BOARDS) . . . PRINTER COMET I . . . SERIAL I/O TO 9600 BAUD . . . 80 CHARACTER COLUMN (132 COMPRESSED) . . . 10" TRACTOR FEED . . . UPPER/LOWER CASE . . . INDUSTRY STANDARD RIBBONS . . . 4 CHARACTER SIZES . . . 9 BY 7 DOT MATRIX . . . BI-DIRECTIONAL PRINTING

FASTERM-64 . . . DISPLAY FORMAT: 64 or 32 characters/line by 16 lines . . . 96 displayable ASCII characters (upper & lower case) . . . 8 baud rates: 150, 300, 600, 1200, 2400, 4800, 9600, 19, 200, (switch sel.) . . . LINE OUTPUT: RS232C or 20 ma current loop . . . VIDEO OUTPUT: 1V pp (EIA RS-170) . . . CURSOR MODES: home & clear screen, erase to end of line, erase cursor line, cursor up & down, auto carriage return/line feed at end of line & auto scrolling . . . REVERSE VIDEO . . . BLINKING CURSOR . . . PARITY: off, even or odd . . . STOP BITS: 1, 1.5, 2 . . . DATA BITS PER CHARACTER: 5, 6, 7 or 8 . . . CHARACTER OUTPUT: 5 by 7 dot matrix in a 7 by 12 cell . . . PRINTER OUTPUT: prints all incoming data . . . 1K ON BOARD RAM . . . 2K ON BOARD ROM . . . CRYSTAL CONTROLLED . . . COMPLETE WITH POWER SUPPLY . . . OPTIONAL GRAPHICS MODE: includes 34 Greek & math characters plus 30 special graphics characters . . . ASCII ENCODED KEYBOARD: 56 key/128 characters.

SMARTERM-80 . . . DISPLAY FORMAT: 80 characters by 24 lines or 40 characters by 16 lines 128 displayable ASCII characters (upper & lower case) 8 baud rates: 110, 300, 600, 1200, 2400, 4800, 9600, 19, 200 . . . LINE OUTPUT: RS232C or 20 ma current loop . . . VIDEO OUTPUT: 1V pp (EIA RS-170) . . . EDITING FEATURES: insert/delete line, insert/delete character, forward/back tab . . . LINE OR PAGE TRANSMIT . . . PAGE PRINT FUNCTION . . . CURSOR POSITIONING: up, down, right, left, plus absolute cursor positioning with read back . . . VISUAL ATTRIBUTES: underline, blink, reverse video, half intensity, & blank . . . GRAPHICS: 12,000 pixel resolution block plus line graphics . . . ON-SCREEN PARITY INDICATOR . . . PARITY: off, even or odd . . . STOP BITS: 110 baud 2, all others 1 . . . CHAR. OUTPUT: 7 by 11 character in a 9 by 12 block . . . PRINTER OUTPUT . . . 60 or 50 Hz VERTICAL REFRESH . . . BLINKING BLOCK CURSOR . . . CRYSTAL CONTROLLED . . . 2K ON BOARD RAM . . . ASCII ENCODED KEYBOARD: 56 key/128 character . . . 4K ON BOARD ROM . . . COMPLETE WITH POWER SUPPLY.

TELEPHONE MODEM 103 OIA . . . FULL DUPLEX, FCC APPROVED . . . DATA RATE: 300 baud . . . INTERFACE: RS232C and TTY . . . CONTROLS: talk/data switch (no need to connect and disconnect phone), originate/answer switch on rear panel . . . NO POWER SUPPLY REQUIRED.

ASCII KEYBOARD ASCII-3 . . . 56 KEY/128 CHARACTER ASCII ENCODED . . . UPPER & LOWER CASE . . . FULLY DEBOUNCED . . . 2 KEY ROLL-OVER . . . POS OR NEG LOGIC WITH POS STROBE . . . REQUIRES +5 & -12V DC (SUPPLIED FROM VIDEO BOARDS) . . . PRINTER COMET I . . . SERIAL I/O TO 9600 BAUD . . . 80 CHARACTER COLUMN (132 COMPRESSED) . . . 10" TRACTOR FEED . . . UPPER/LOWER CASE . . . INDUSTRY STANDARD RIBBONS . . . 4 CHARACTER SIZES . . . 9 BY 7 DOT MATRIX . . . BI-DIRECTIONAL PRINTING

FASTERM-64 . . . DISPLAY FORMAT: 64 or 32 characters/line by 16 lines . . . 96 displayable ASCII characters (upper & lower case) . . . 8 baud rates: 150, 300, 600, 1200, 2400, 4800, 9600, 19, 200, (switch sel.) . . . LINE OUTPUT: RS232C or 20 ma current loop . . . VIDEO OUTPUT: 1V pp (EIA RS-170) . . . CURSOR MODES: home & clear screen, erase to end of line, erase cursor line, cursor up & down, auto carriage return/line feed at end of line & auto scrolling . . . REVERSE VIDEO . . . BLINKING CURSOR . . . PARITY: off, even or odd . . . STOP BITS: 1, 1.5, 2 . . . DATA BITS PER CHARACTER: 5, 6, 7 or 8 . . . CHARACTER OUTPUT: 5 by 7 dot matrix in a 7 by 12 cell . . . PRINTER OUTPUT: prints all incoming data . . . 1K ON BOARD RAM . . . 2K ON BOARD ROM . . . CRYSTAL CONTROLLED . . . COMPLETE WITH POWER SUPPLY . . . OPTIONAL GRAPHICS MODE: includes 34 Greek & math characters plus 30 special graphics characters . . . ASCII ENCODED KEYBOARD: 56 key/128 characters.

SMARTERM-80 . . . DISPLAY FORMAT: 80 characters by 24 lines or 40 characters by 16 lines 128 displayable ASCII characters (upper & lower case) 8 baud rates: 110, 300, 600, 1200, 2400, 4800, 9600, 19, 200 . . . LINE OUTPUT: RS232C or 20 ma current loop . . . VIDEO OUTPUT: 1V pp (EIA RS-170) . . . EDITING FEATURES: insert/delete line, insert/delete character, forward/back tab . . . LINE OR PAGE TRANSMIT . . . PAGE PRINT FUNCTION . . . CURSOR POSITIONING: up, down, right, left, plus absolute cursor positioning with read back . . . VISUAL ATTRIBUTES: underline, blink, reverse video, half intensity, & blank . . . GRAPHICS: 12,000 pixel resolution block plus line graphics . . . ON-SCREEN PARITY INDICATOR . . . PARITY: off, even or odd . . . STOP BITS: 110 baud 2, all others 1 . . . CHAR. OUTPUT: 7 by 11 character in a 9 by 12 block . . . PRINTER OUTPUT . . . 60 or 50 Hz VERTICAL REFRESH . . . BLINKING BLOCK CURSOR . . . CRYSTAL CONTROLLED . . . 2K ON BOARD RAM . . . ASCII ENCODED KEYBOARD: 56 key/128 character . . . 4K ON BOARD ROM . . . COMPLETE WITH POWER SUPPLY.

TELEPHONE MODEM 103 OIA . . . FULL DUPLEX, FCC APPROVED . . . DATA RATE: 300 baud . . . INTERFACE: RS232C and TTY . . . CONTROLS: talk/data switch (no need to connect and disconnect phone), originate/answer switch on rear panel . . . NO POWER SUPPLY REQUIRED.

ASCII KEYBOARD ASCII-3 . . . 56 KEY/128 CHARACTER ASCII ENCODED . . . UPPER & LOWER CASE . . . FULLY DEBOUNCED . . . 2 KEY ROLL-OVER . . . POS OR NEG LOGIC WITH POS STROBE . . . REQUIRES +5 & -12V DC (SUPPLIED FROM VIDEO BOARDS) . . . PRINTER COMET I . . . SERIAL I/O TO 9600 BAUD . . . 80 CHARACTER COLUMN (132 COMPRESSED) . . . 10" TRACTOR FEED . . . UPPER/LOWER CASE . . . INDUSTRY STANDARD RIBBONS . . . 4 CHARACTER SIZES . . . 9 BY 7 DOT MATRIX . . . BI-DIRECTIONAL PRINTING

FASTERM-64 . . . DISPLAY FORMAT: 64 or 32 characters/line by 16 lines . . . 96 displayable ASCII characters (upper & lower case) . . . 8 baud rates: 150, 300, 600, 1200, 2400, 4800, 9600, 19, 200, (switch sel.) . . . LINE OUTPUT: RS232C or 20 ma current loop . . . VIDEO OUTPUT: 1V pp (EIA RS-170) . . . CURSOR MODES: home & clear screen, erase to end of line, erase cursor line, cursor up & down, auto carriage return/line feed at end of line & auto scrolling . . . REVERSE VIDEO . . . BLINKING CURSOR . . . PARITY: off, even or odd . . . STOP BITS: 1, 1.5, 2 . . . DATA BITS PER CHARACTER: 5, 6, 7 or 8 . . . CHARACTER OUTPUT: 5 by 7 dot matrix in a 7 by 12 cell . . . PRINTER OUTPUT: prints all incoming data . . . 1K ON BOARD RAM . . . 2K ON BOARD ROM . . . CRYSTAL CONTROLLED . . . COMPLETE WITH POWER SUPPLY . . . OPTIONAL GRAPHICS MODE: includes 34 Greek & math characters plus 30 special graphics characters . . . ASCII ENCODED KEYBOARD: 56 key/128 characters.

SMARTERM-80 . . . DISPLAY FORMAT: 80 characters by 24 lines or 40 characters by 16 lines 128 displayable ASCII characters (upper & lower case) 8 baud rates: 110, 300, 600, 1200, 2400, 4800, 9600, 19, 200 . . . LINE OUTPUT: RS232C or 20 ma current loop . . . VIDEO OUTPUT: 1V pp (EIA RS-170) . . . EDITING FEATURES: insert/delete line, insert/delete character, forward/back tab . . . LINE OR PAGE TRANSMIT . . . PAGE PRINT FUNCTION . . . CURSOR POSITIONING: up, down, right, left, plus absolute cursor positioning with read back . . . VISUAL ATTRIBUTES: underline, blink, reverse video, half intensity, & blank . . . GRAPHICS: 12,000 pixel resolution block plus line graphics . . . ON-SCREEN PARITY INDICATOR . . . PARITY: off, even or odd . . . STOP BITS: 110 baud 2, all others 1 . . . CHAR. OUTPUT: 7 by 11 character in a 9 by 12 block . . . PRINTER OUTPUT . . . 60 or 50 Hz VERTICAL REFRESH . . . BLINKING BLOCK CURSOR . . . CRYSTAL CONTROLLED . . . 2K ON BOARD RAM . . . ASCII ENCODED KEYBOARD: 56 key/128 character . . . 4K ON BOARD ROM . . . COMPLETE WITH POWER SUPPLY.

TELEPHONE MODEM 103 OIA . . . FULL DUPLEX, FCC APPROVED . . . DATA RATE: 300 baud . . . INTERFACE: RS232C and TTY . . . CONTROLS: talk/data switch (no need to connect and disconnect phone), originate/answer switch on rear panel . . . NO POWER SUPPLY REQUIRED.

ASCII KEYBOARD ASCII-3 . . . 56 KEY/128 CHARACTER ASCII ENCODED . . . UPPER & LOWER CASE . . . FULLY DEBOUNCED . . . 2 KEY ROLL-OVER . . . POS OR NEG LOGIC WITH POS STROBE . . . REQUIRES +5 & -12V DC (SUPPLIED FROM VIDEO BOARDS) . . . PRINTER COMET I . . . SERIAL I/O TO 9600 BAUD . . . 80 CHARACTER COLUMN (132 COMPRESSED) . . . 10" TRACTOR FEED . . . UPPER/LOWER CASE . . . INDUSTRY STANDARD RIBBONS . . . 4 CHARACTER SIZES . . . 9 BY 7 DOT MATRIX . . . BI-DIRECTIONAL PRINTING

FASTERM-64 . . . DISPLAY FORMAT: 64 or 32 characters/line by 16 lines . . . 96 displayable ASCII characters (upper & lower case) . . . 8 baud rates: 150, 300, 600, 1200, 2400, 4800, 9600, 19, 200, (switch sel.) . . . LINE OUTPUT: RS232C or 20 ma current loop . . . VIDEO OUTPUT: 1V pp (EIA RS-170) . . . CURSOR MODES: home & clear screen, erase to end of line, erase cursor line, cursor up & down, auto carriage return/line feed at end of line & auto scrolling . . . REVERSE VIDEO . . . BLINKING CURSOR . . . PARITY: off, even or odd . . . STOP BITS: 1, 1.5, 2 . . . DATA BITS PER CHARACTER: 5, 6, 7 or 8 . . . CHARACTER OUTPUT: 5 by 7 dot matrix in a 7 by 12 cell . . . PRINTER OUTPUT: prints all incoming data . . . 1K ON BOARD RAM . . . 2K ON BOARD ROM . . . CRYSTAL CONTROLLED . . . COMPLETE WITH POWER SUPPLY . . . OPTIONAL GRAPHICS MODE: includes 34 Greek & math characters plus 30 special graphics characters . . . ASCII ENCODED KEYBOARD: 56 key/128 characters.

SMARTERM-80 . . . DISPLAY FORMAT: 80 characters by 24 lines or 40 characters by 16 lines 128 displayable ASCII characters (upper & lower case) 8 baud rates: 110, 300, 600, 1200, 2400, 4800, 9600, 19, 200 . . . LINE OUTPUT: RS232C or 20 ma current loop . . . VIDEO OUTPUT: 1V pp (EIA RS-170) . . . EDITING FEATURES: insert/delete line, insert/delete character, forward/back tab . . . LINE OR PAGE TRANSMIT . . . PAGE PRINT FUNCTION . . . CURSOR POSITIONING: up, down, right, left, plus absolute cursor positioning with read back . . . VISUAL ATTRIBUTES: underline, blink, reverse video, half intensity, & blank . . . GRAPHICS: 12,000 pixel resolution block plus line graphics . . . ON-SCREEN PARITY INDICATOR . . . PARITY: off, even or odd . . . STOP BITS: 110 baud 2, all others 1 . . . CHAR. OUTPUT: 7 by 11 character in a 9 by 12 block . . . PRINTER OUTPUT . . . 60 or 50 Hz VERTICAL REFRESH . . . BLINKING BLOCK CURSOR . . . CRYSTAL CONTROLLED . . . 2K ON BOARD RAM . . . ASCII ENCODED KEYBOARD: 56 key/128 character . . . 4K ON BOARD ROM . . . COMPLETE WITH POWER SUPPLY.

TELEPHONE MODEM 103 OIA . . . FULL DUPLEX, FCC APPROVED . . . DATA RATE: 300 baud . . . INTERFACE: RS232C and TTY . . . CONTROLS: talk/data switch (no need to connect and disconnect phone), originate/answer switch on rear panel . . . NO POWER SUPPLY REQUIRED.

ASCII KEYBOARD ASCII-3 . . . 56 KEY/128 CHARACTER ASCII ENCODED . . . UPPER & LOWER CASE . . . FULLY DEBOUNCED . . . 2 KEY ROLL-OVER . . . POS OR NEG LOGIC WITH POS STROBE . . . REQUIRES +5 & -12V DC (SUPPLIED FROM VIDEO BOARDS) . . . PRINTER COMET I . . . SERIAL I/O TO 9600 BAUD . . . 80 CHARACTER COLUMN (132 COMPRESSED) . . . 10" TRACTOR FEED . . . UPPER/LOWER CASE . . . INDUSTRY STANDARD RIBBONS . . . 4 CHARACTER SIZES . . . 9 BY 7 DOT MATRIX . . . BI-DIRECTIONAL PRINTING

FASTERM-64 . . . DISPLAY FORMAT: 64 or 32 characters/line by 16 lines . . . 96 displayable ASCII characters (upper & lower case) . . . 8 baud rates: 150, 300, 600, 1200, 2400, 4800, 9600, 19, 200, (switch sel.) . . . LINE OUTPUT: RS232C or 20 ma current loop . . . VIDEO OUTPUT: 1V pp (EIA RS-170) . . . CURSOR MODES: home & clear screen, erase to end of line, erase cursor line, cursor up & down, auto carriage return/line feed at end of line & auto scrolling . . . REVERSE VIDEO . . . BLINKING CURSOR . . . PARITY: off, even or odd . . . STOP BITS: 1, 1.5, 2 . . . DATA BITS PER CHARACTER: 5, 6, 7 or 8 . . . CHARACTER OUTPUT: 5 by 7 dot matrix in a 7 by 12 cell . . . PRINTER OUTPUT: prints all incoming data . . . 1K ON BOARD RAM . . . 2K ON BOARD ROM . . . CRYSTAL CONTROLLED . . . COMPLETE WITH POWER SUPPLY . . . OPTIONAL GRAPHICS MODE: includes 34 Greek & math characters plus 30 special graphics characters . . . ASCII ENCODED KEYBOARD: 56 key/128 characters.

SMARTERM-80 . . . DISPLAY FORMAT: 80 characters by 24 lines or 40 characters by 16 lines 128 displayable ASCII characters (upper & lower case) 8 baud rates: 110, 300, 600, 1200, 2400, 4800, 9600, 19, 200 . . . LINE OUTPUT: RS232C or 20 ma current loop . . . VIDEO OUTPUT: 1V pp (EIA RS-170) . . . EDITING FEATURES: insert/delete line, insert/delete character, forward/back tab . . . LINE OR PAGE TRANSMIT . . . PAGE PRINT FUNCTION . . . CURSOR POSITIONING: up, down, right, left, plus absolute cursor positioning with read back . . . VISUAL ATTRIBUTES: underline, blink, reverse video, half intensity, & blank . . . GRAPHICS: 12,000 pixel resolution block plus line graphics . . . ON-SCREEN PARITY INDICATOR . . . PARITY: off, even or odd . . . STOP BITS: 110 baud 2, all others 1 . . . CHAR. OUTPUT: 7 by 11 character in a 9 by 12 block . . . PRINTER OUTPUT . . . 60 or 50 Hz VERTICAL REFRESH . . . BLINKING BLOCK CURSOR . . . CRYSTAL CONTROLLED . . . 2K ON BOARD RAM . . . ASCII ENCODED KEYBOARD: 56 key/128 character . . . 4K ON BOARD ROM . . . COMPLETE WITH POWER SUPPLY.

TELEPHONE MODEM 103 OIA . . . FULL DUPLEX, FCC APPROVED . . . DATA RATE: 300 baud . . . INTERFACE: RS232C and TTY . . . CONTROLS: talk/data switch (no need to connect and disconnect phone), originate/answer switch on rear panel . . . NO POWER SUPPLY REQUIRED.

ASCII KEYBOARD ASCII-3 . . . 56 KEY/128 CHARACTER ASCII ENCODED . . . UPPER & LOWER CASE . . . FULLY DEBOUNCED . . . 2 KEY ROLL-OVER . . . POS OR NEG LOGIC WITH POS STROBE . . . REQUIRES +5 & -12V DC (SUPPLIED FROM VIDEO BOARDS) . . . PRINTER COMET I . . . SERIAL I/O TO 9600 BAUD . . . 80 CHARACTER COLUMN (132 COMPRESSED) . . . 10" TRACTOR FEED . . . UPPER/LOWER CASE . . . INDUSTRY STANDARD RIBBONS . . . 4 CHARACTER SIZES . . . 9 BY 7 DOT MATRIX . . . BI-DIRECTIONAL PRINTING

FASTERM-64 . . . DISPLAY FORMAT: 64 or 32 characters/line by 16 lines . . . 96 displayable ASCII characters (upper & lower case) . . . 8 baud rates: 150, 300, 600,

Listing 1 continued from page 249:

```
032E:          60 *
032E:          61 * NOW OUTPUT CHARACTER DATA
032E:          62 *
032E:68        63          PLA          : GET OFFSET TO CHAR.
032F:AA        64          TAX          : PUT IN X AS INDEX
0330:BD 4F 03  65 LOOP3   LDA  DATA1,X    : GET NEXT CHAR. DATA
0333:C9 00     66          CMP  #0       : DELIMITER?
0335:F0 09     67          BEQ  EXIT      : IF DONE
0337:8D 90 C0  68          STA  POUT      : SEND TO PRINTER
033A:20 43 03  69          JSR  SENSE     : WAIT TILL PRINTER DONE
033D:E8        70          INX          :
033E:10 F0     71          BPL  LOOP3     : IF NOT DONE
0340:          72 *
0340:          73 * ALL DONE SO EXIT VIA RESTORE ROUTINE
0340:          74 *
0340:4C 3F FF  75 EXIT    JMP  RESTORE
0343:          76 *
0343:          77 *****
0343:          78 * SUB ROUTINE TO SENSE THAT PRINTER HAS
0343:          79 * FINISHED PRINTING LAST CHARACTER.
0343:          80 *****
0343:          81 *
0343:AD C1 C1    82 SENSE   LDA  PSENSE     : GET PRINTER STATUS
0346:C9 FE     83          CMP  ##FE     : STILL BUSY ?
0348:F0 F9     84          BEQ  SENSE     : IF YES
034A:60        85          RTS          : IF PRINTER READY
034B:          86 *
034B:          87 *
034B:          88 *****
034B:          89 * DATA GROUPS
034B:          90 *
034B:00 06 4B    91 DATA0   DFB  0,6,$4B,$1B : CONT.K,6 IN REV.ORDER
034E:1B
034F:          92 *
034F:18 25 25    93 DATA1   DFB  $18,$25,$25,$25,$5A,0 :G DATA
0352:25 5A 00
0355:02 01 21  94          DFB  2,1,$21,$BE,$20,0 : J DATA
0358:BE 20 00
035B:3F 24 24  95          DFB  $3F,$24,$24,$24,$18,0 : P DATA
035E:24 18 00
0361:18 24 24  96          DFB  $18,$24,$24,$24,$3F,0 : Q DATA
0364:24 3F 00
0367:39 05 05  97          DFB  $39,5,5,5,$3E,0 : Y DATA
036A:05 3E 00
036D:          98 *
036D:00          99 SUM     DFB  0           :SCRATCH DATA
036E:          100 *
036E:E7 EA F0 101 MATCH   DFB  $E7,$EA,$F0,$F1,$F9 :G, J, P, Q, Y
0371:F1 F9
0373:          102 *
0373:          103 * END OF SOURCE
0373:          104 *****
0373:          105 * TEST ABOVE ROUTINE
0373:          106 *****
0373:A9 54      107 TEST   LDA  #$54       : 'T'
0375:20 02 C1   108          JSR  PRINTER
0378:A9 F9     109          LDA  ##F9       : LOWER CASE "Y"
037A:20 00 03  110          JSR  ENTER
037D:A9 0A     111          LDA  #A         : LINEFEED
037F:4C 02 C1  112          JMP  PRINTER     : EXIT VIA PRINTER
0382:          113 *****
```

*** SUCCESSFUL ASSEMBLY: NO ERRORS

Next to keeping all your data on Verbatim Datalife™ flexible disks, the best thing you can do for your computer or word processor is to keep it running clean and error-free.

And the way to do just that is with Verbatim's new Datalife Head Cleaning Kit. It can remove up to 90% of the debris contaminating your drive heads. Dust, dirt and debris that causes data loss and errors, hinders system performance.

Quick and easy to use

All you have to do is remove a Cleaning Disk from its protective pouch, put the disk in the special jacket, insert it into your drive and turn it on.

In just 30-60 seconds, your drive heads are cleaned.

Cleaning, with no cleaning mess

With your Datalife Head Cleaning Kit there's no hit-and-miss applying solvents that can splash and spill.

What's more, with Datalife Cleaning Disks every time you clean your heads, you can do it with a fresh, clean, disposable disk.

Cleans both Single and Dual Head Drives Safely

There's no worry about damaging your system with Datalife Cleaning Disks. And you can use them on single or dual head drives.

Protect your investment

The Datalife Head Cleaning Kit will help you guard against data loss, errors, and degradation of system performance because of debris contamination.

So if you want your data back verbatim, keep it on Verbatim disks. And keep your disk drives clean with Verbatim's Datalife Head Cleaning Kit.

Call (800) 538-1793 for the name of your nearest Verbatim dealer. (In California and outside the U.S. call (408) 737-7771 collect.)

Verbatim®

Introducing the second best thing you can do for your computer.

Datalife
The Verbatim

Head Cleaning Kit
Includes Special Jacket And 2 Cleaning Disks

FREE INTRODUCTORY OFFER!
Take this coupon to your Verbatim dealer/distributor and Get a Datalife Head Cleaning Kit FREE when you buy 10 Datalife Head Cleaning Disks.

Name _____ State _____ Zip _____
Address _____
City _____ Dealer/Distributor _____

To the Consumer: This coupon good only on required purchase of specified product. Cash value 1/20 cent. Void where prohibited.
To Seller: Verbatim Corporation authorizes you to accept this coupon for redemption. We will reimburse you in accordance with our Cleaning Disk Promotion Plan (Q1/81). A copy of the Promotion Plan is available from Verbatim Corporation or any authorized Verbatim distributor. One coupon per customer. Offer expires 4/30/82.

Add a Full-Sized Keyboard to Sinclair's ZX80

Wayne J. Cosshall
Swinburne Institute of Technology
POB 218
Hawthorne 3122
Swinburne, Australia

The Sinclair ZX80 keyboard has several obvious limitations. After only a short period of use, the user will begin to realize that the keyboard is awkward and doesn't really allow any degree of speed. Another limitation is not so obvious: the lack of a true reset button. This may not be apparent when running BASIC programs, as the break key works well, but a reset button is necessary when running machine-code programs or subroutines. Thankfully, all of these limitations can be eliminated (see photo 1).

Adding the Keyboard

The ZX80 decodes its keyboard by software. To the processor, the keyboard appears as a block of I/O (input/output) ports. The upper 8 bits of the address bus, A8 through A15, are apparently used to strobe the keyboard sequentially, and the resulting values on the data bus are decoded. Figure 1 shows this interconnection as it appears from the back (solder side) of the ZX80 printed-circuit board. If software makes address line A9 high while the A key is pressed, D1 will be high, but D0



Photo 1: The ZX80 in operation with its new keyboard.

AH-HA!



EUREKA!

ALL-RIIIGHT!

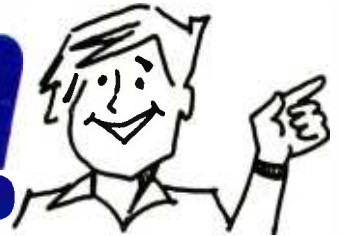

Introducing "Popular Computing," the key to understanding.

Now you don't have to be a computer professional to unlock all the mysteries, potential, and pleasures of home and small business computers. *Popular Computing*, the new monthly magazine from McGraw-Hill, is the key.

Created in response to growing demand for our informative quarterly *onComputing*, *Popular Computing* explores every aspect of personal computers and their use. All reported in easy-to-understand nontechnical language.



The answer to "Computerphobia."

Even the most computer-unsophisticated reader will find *Popular Computing* interesting and stimulating. Every issue will contain straight-talking product reviews,

special news briefs, and feature articles by famous guest contributors (like Isaac Asimov). There'll even be a helpful glossary of computer jargon we couldn't avoid using, and much, much more.

Special Introductory Offer.

Send in this coupon today, and take advantage of *Popular Computing's* Special Introductory Offer.



POPULAR COMPUTING

THE KEY TO UNDERSTANDING
P.O. Box 397, Hancock, NH 03449

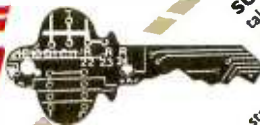

Mail Today to:
POPULAR COMPUTING
P.O. Box 307, Martinsville, NJ 08836

SUPER SAVINGS FOR ME...I'm taking advantage of this super introductory offer of 12 issues for only \$11.97 saving me \$3.03 on the basic rate of \$15.00—and saving me \$18.03 of the 12 issue news-stand rate of \$30.00. If my 30-day review of your first issue doesn't 100% please me, I may cancel my subscription and you will promptly refund ALL my money or give me a FULL credit on my charge card marked below:

Check Enclosed for \$11.97
 Charge \$11.97 to:
 Visa Mastercard

Card No. _____
Signature _____
Name (Please Print) _____
Address _____
City _____ State _____ Zip _____

System Notes

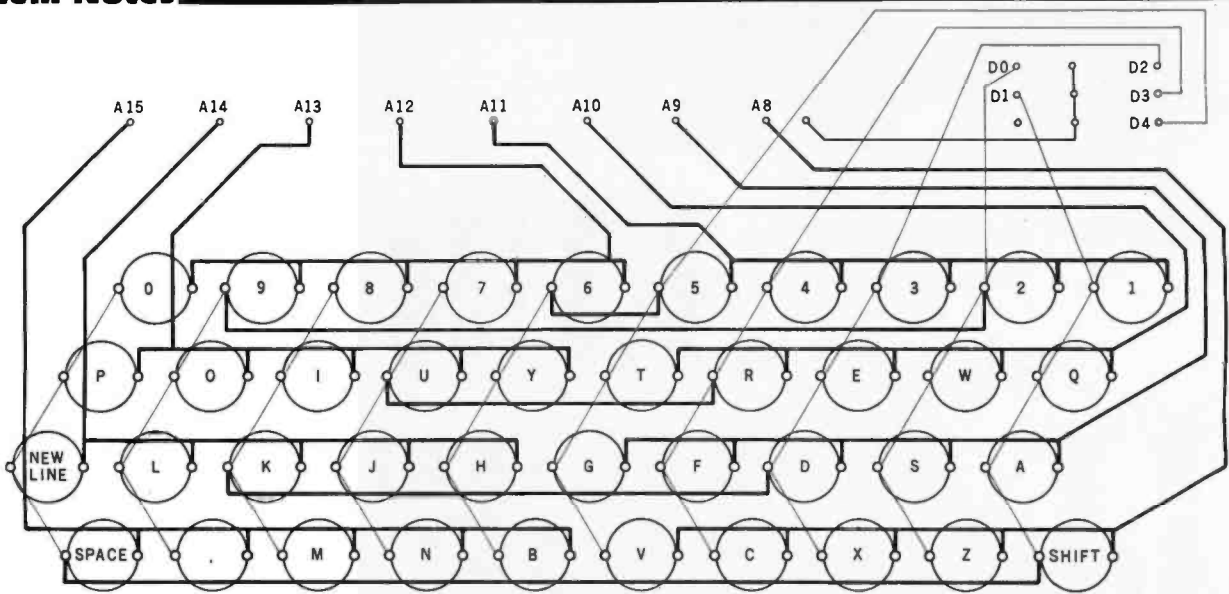
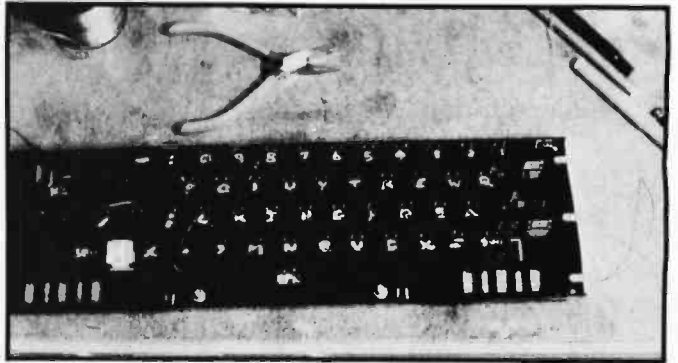

Figure 1: The connection of keys on the Sinclair ZX80 keyboard. The black lines represent actual traces on the "solder side" of the printed-circuit board. The red lines are connections made on the other side of the board. The ribbon-cable connection to the new keyboard is made to the points labeled A8 through A15 and D0 through D4. When wiring the new keyboard, all connections should follow this diagram.

(2a)



(3a)



(2b)

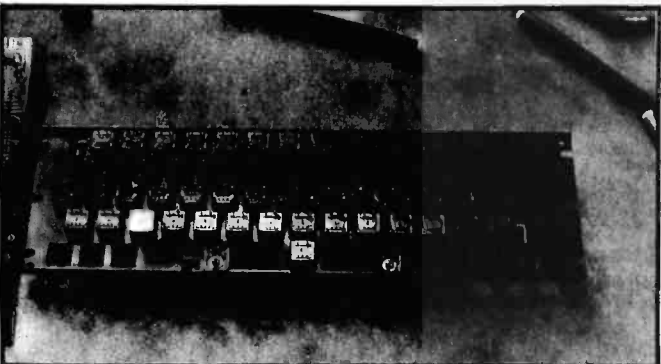

(3b)



Photo 2: The standard-sized keyboard shown in photo 2a is made of a metal plate into which the keyswitches are pressed. Photo 2b shows the solder lugs to which connections will be made.

Photos 3a and 3b: Wiring the new keyboard. Photo 3a shows the first set of installed jumpers. The wire is standard 30 AWG wrapping type, wrapped once around each post before soldering. Photo 3b shows the completed jumper system.

and D2 through D4 remain low.

Photo 2a shows the keyboard I used, consisting of a metal base with holes into which the keyswitches are pushed. Two solder lugs on the back of each keyswitch make the connections (see photo 2b). Many of the symbols that are unshifted on a normal keyboard are obtained by using the shift key on the ZX80; consequently a number of keys on the new keyboard will not be used.

The first step is to wire the keys together (use figure 1 as a guide). Keys do not have to be arranged as they are on the ZX80, as long as the connections remain the same, and two or more keys may be used for the same function by wiring them in parallel (i.e., wire one as shown, then wire the two posts of the second key to the corresponding posts on this first key—I did this with the shift key to use the second shift key on the keyboard). Photo 3 shows how to wire the keys together. I used striped Kynar (wire-wrap) wire to make the connections and insulating tape to shield the wires where necessary. A connector may be added to the free end of the ribbon cable.

The second step involves the connection at the ZX80 end. The ribbon cable should be carefully soldered to the points shown in photos 4a through 4c, then extra solder added to obtain a good connection. Avoid applying too

much heat as it can damage the board or solder pads. Again, a connector can be added to the ribbon cable.

Once the final connection is made, you're ready to test the keyboard. If you have problems, recheck your wiring on the new keyboard for a short circuit or broken connection. I had no such problems—the keyboard worked perfectly from the start. One potential problem, key bounce, never arose. Apparently the touch-sensitive keys on the ZX80 aren't as prone to this phenomenon as other keyboards. A constant worry was that the technique the ZX80 used to handle key bounce would not allow sufficient time for the key bounce on the new keyboard to settle down. In practice, however, this was not a problem.

Adding the Reset Key

To reset, simply connect the reset pin of the Z80A processor, pin 26, to ground. There are two ways of doing this. The first uses the expansion bus. Pin 21A on the component side is the reset line, and pins 4B and 5B on the solder side are ground. All that is required is to connect a momentary contact switch between these two pins.

The second technique involves making these connections closer to the processor. I chose this approach because connections had already been made on the

(3c)

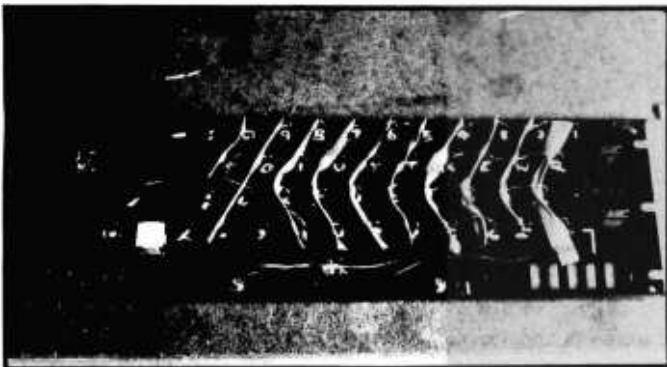

(3d)

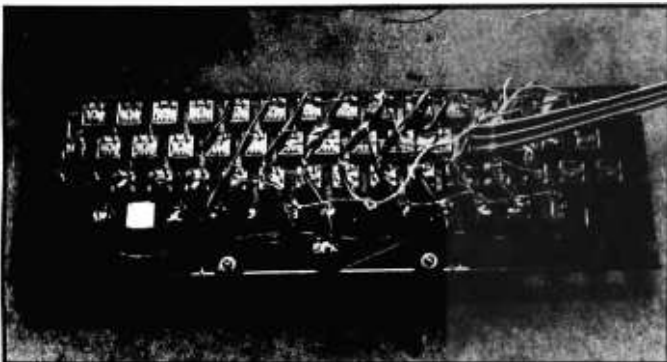

Photos 3c and 3d: Extra insulation is added in photo 3c, and photo 3d shows the installed ribbon cable.

(2a)

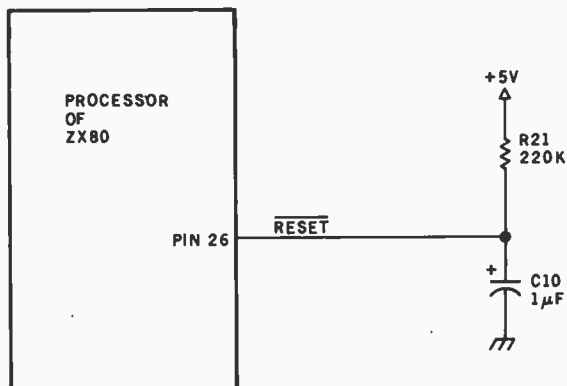

(2b)

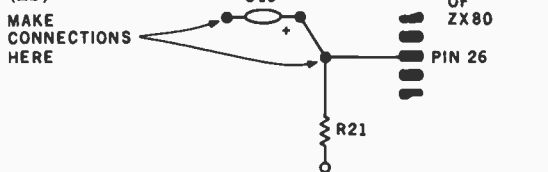

Figure 2: Diagram of the reset system used in the ZX80. Figure 2a is a schematic representation of the reset circuitry. Figure 2b is a sketch of the solder side of the circuit board where the connection to the reset key is made.

STARTING YOUR OWN MICROCOMPUTER BUSINESS

Starting your own microcomputer business is easy if you know the right steps to take. Two volumes of the new book **Your Fortune In The Microcomputer Business** describe the things you should know to start right and to build your business successfully.

Many people have good ideas for a successful microcomputer business. But they don't know how to put their ideas into action. These people are plenty smart. That's not the problem. The problem is in knowing simple things: How to analyze the market. How to select the right product or service. How to get enough startup money. How to plan your growth and success. The answers to these problems are not hard to understand. All you need is the right information. **Your Fortune In The Microcomputer Business** gives you the knowledge tools to start right, grow and prosper.

This practical reference manual has no hocus-pocus. It does not tell you how to do astrology or dating services. It does give you clear, complete, step-by-step instructions on how to get started right and insure your success!

Volume I Includes:

- The hottest trends in the market
- The seven best test markets
- How to read between the lines at a trade show
- 107 ways to reach your market
- Examples of the best ads in the business
- How to get free advertising
- The 21 steps to set up your business
- How to start a manufacturing business
- How to write a newsletter
- How to give a seminar
- How to start a service business
- How to package software for the mass market
- How to be a highly paid consultant
- Franchising—the good, the bad and the ugly
- Interviews with six successful microcomputer businesses
- How to use the RLC factor to be street smart, lean, mean and successful

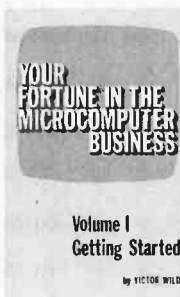

Volume II Includes:

- Strategies for growth
- Straight facts on incorporation
- How to build your organization
- How to manage cash flow
- How to develop your accounting system
- How to manage employees, wages and salaries
- How to survive a cash crunch
- What to do if things get really bad
- How to maximize your profits
- How to grow by acquisition
- How to value your business
- How and when to sell your business

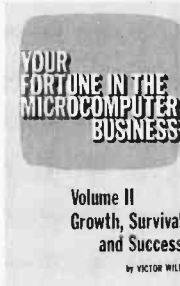

WRITE OR CALL—DON'T WAIT!

Wildfire Publishing, 326 DC Toro Canyon
Carpinteria, CA 93013 Ph. (805) 684-1489

Please send the following book(s) by return mail. I understand if I want to return them for any reason within 90 days of receipt, I can do so and get a prompt full refund.

- Your Fortune In The Microcomputer Business Vol. I, Getting Started, \$20.00.**
- Your Fortune In The Microcomputer Business Vol. II, Growth, Survival and Success, \$20.00.**

Please add \$1.50 per book for shipping, Calif. residents please add \$1.20 each sales tax.

Name _____
 Street _____
 City _____ State _____ Zip _____
 Enclosed is _____ or charge my MasterCharge or Visa
 Card # _____
 Ex. Dt. _____ MCIInterbank # _____
 Signature _____ © 1982 Wildfire Pub.

System Notes

(4a)

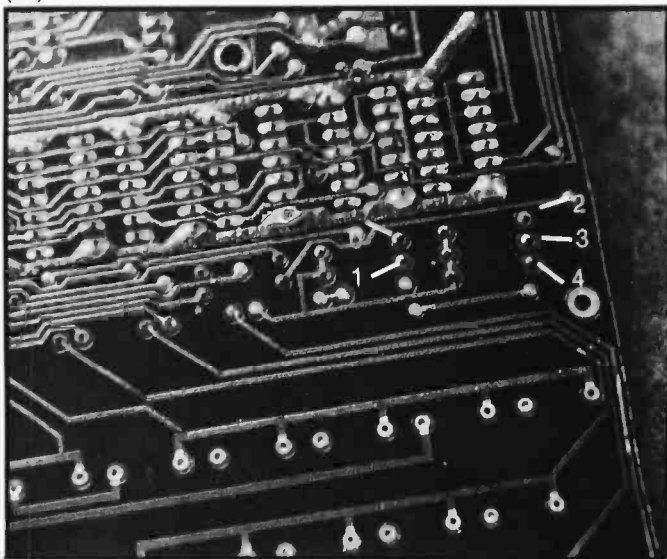

(4b)

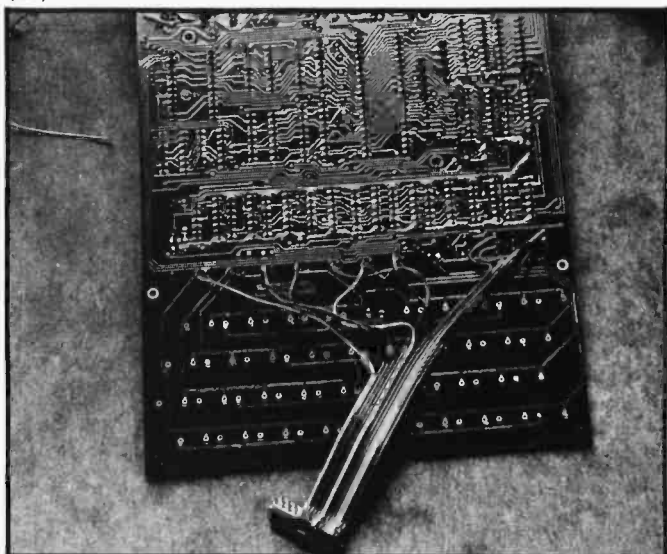

Photos 4a and 4b: Ribbon-cable connections to the ZX80. Photo 4a shows the solder pads to which the data-bus connections should be made (labeled 0 through 4). Photo 4b is the completed ribbon-cable connection.

underside of the board for the keyboard, so two more didn't matter.

Pull-up resistor R21 and capacitor C10 on the ZX80 are connected to the reset pin of the processor (see figure 2a). Thus, the reset switch can be connected between pin 26 of the processor and the grounded side of the capacitor (see figure 2b). I ran two lines with the ribbon cable to the keyboard I had added and connected *two* spare keys in series such that both have to be pressed together for a reset. This minimizes the chance of an accidental reset.

These simple modifications greatly increased the accuracy, speed, and ease of use of the Sinclair ZX80, and neither process is beyond the ability of anyone who has used a soldering iron on printed-circuit boards. ■

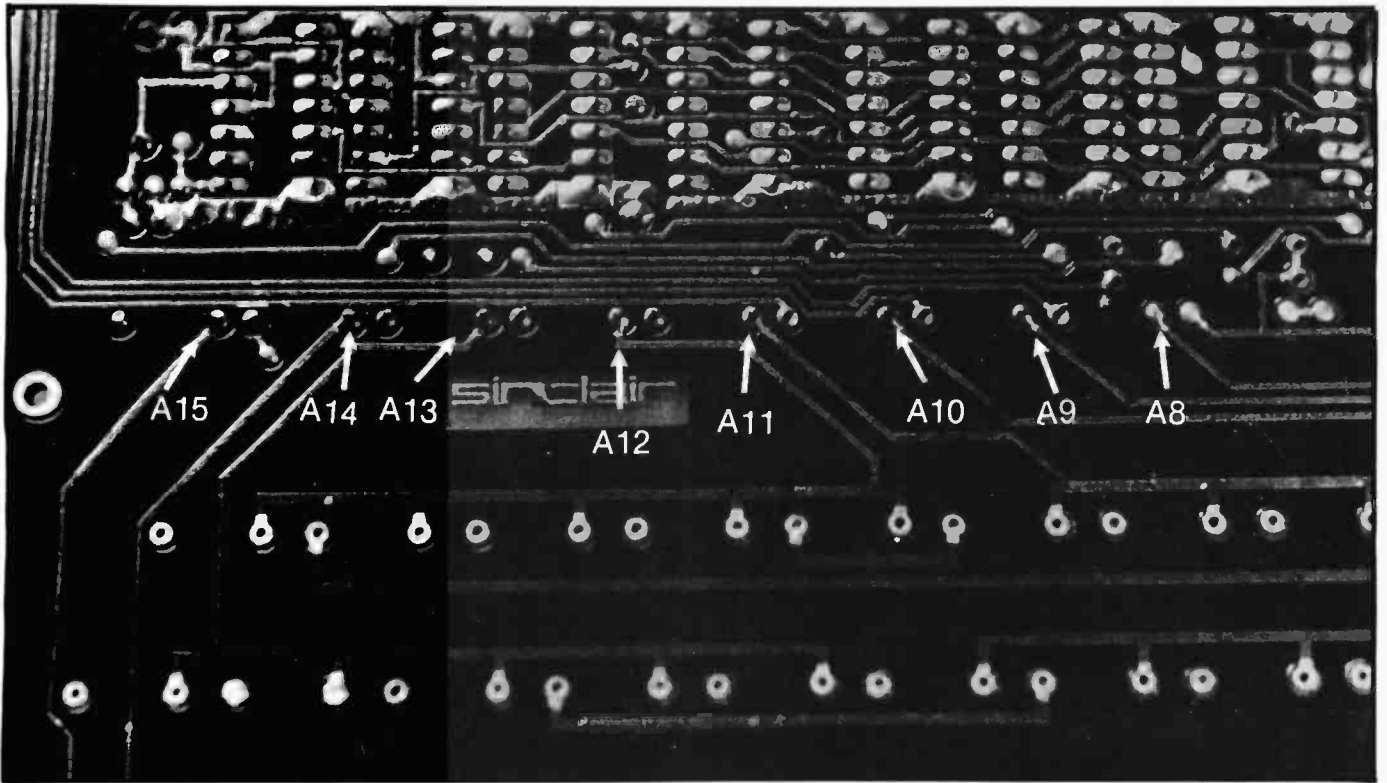

Photo 4c: The pads to which the address lines should be connected.

Marymae INDUSTRIES, INC.

In Texas Orders
Questions & Answers
1-713-392-0747

21969 Katy Freeway
Katy (Houston) Texas 77450

To Order
1-800-231-3680
800-231-3681

SAVE BIG DOLLARS ON ALL TRS-80[®] HARDWARE & SOFTWARE

TRS-80[®] BY RADIO SHACK. Brand new in cartons delivered. Save state sales tax. Texas residents add only 5% sales tax. Open Mon.-Fri. 9-6, Sat. 9-5. We pay freight and insurance. Come by and see us. Call us for a reference in or near your city. Ref: Farmers State Bank, Brookshire, Texas.

WE OFFER ON REQUEST

Federal Express (Overnight Delivery)

Houston Intercontinental
Airport Delivery (Same Day)

U.P.S. BLUE (Every Day)

References from people who have
bought computers from us probably
in your city



In stock TRS-80 Model
II and III

No Tax on Out of Texas Shipments!

WE ALWAYS OFFER

NO extra charge for Master Card
or Visa.

We use Direct Freight Lines. No
long waits.

We always pay the freight and
insurance

Toll free order number

Our capability to go to the giant
TRS-80[®] Computer warehouse 5
hours away, in Ft. Worth, Texas,
to keep *you* in stock.

® TRS-80 is a Registered Trademark of Tandy Corp

ED McMANUS



We Specialize In Overseas Shipments

Telex 77-4132 (Flaks Hou)

Save
10% 15%
OR MORE

JOE McMANUS



Text Editing with Compuview's VEDIT

H. Bradford Thompson
Department of Chemistry
University of Toledo
Toledo, OH 43606

VEDIT is a fast, friendly, adaptable, full-screen editor for use with CP/M and compatible operating systems. It is the first software product from Compuview, based in Ann Arbor, Michigan. If you're writing programs on the editor that came with CP/M, and particularly if you've never used a full-screen editor, then what follows will probably be of interest to you. With VEDIT, you always have a full screen of text in front of you. To add or change, you just type. If this review gives you an appetite for simplicity while editing, then VEDIT, at \$130, is well worth considering.

If you already own a word processor or a full-screen editor, you might still be interested in VEDIT. It's very adaptable to your video-display terminal, to your preferences in assigning special keys, and to the task at hand. I keep three versions: one for general text writing, one for BASIC programming, and one for assembler programming. (More about this under Customization.) VEDIT performs best as a programmer's editor. You can write notes, letters, and even manuscripts on it, but VEDIT is not a word processor.

What It's Like to Use VEDIT

VEDIT has two operating modes: a command mode (which works like a conventional command editor) and a visual mode. In visual mode, the screen is filled with a portion of the text. Most work is done in visual mode, so I'll describe that first.

The portion of text on the screen is called the *window*. I began the final version of this article by giving CP/M the command:

VEDIT BYTVEDIT.REV

If the file BYTVEDIT.REV had not existed, the message NEW FILE would have appeared briefly, after which the screen would have been cleared, with the cursor at upper left ready for entry of text. Until you have a change or correction to make, you just type in your text. In this case, the file already existed, so the window filled with the first lines of the file, with the cursor at upper left. You can move the cursor over the window at will, adding, changing, or inserting text. If the cursor rests on

existing text, what you type normally overwrites the old text. With one key, however, you can switch to an insert

At a Glance

Name
VEDIT

Type
Full-screen text editor

Manufacturer
Compuview Products Inc.
618 Louise
Ann Arbor, MI 48103
(313) 996-1299

Price
\$130; order directly from Compuview

Format
5¼- or 8-inch floppy disk

System needed
An 8080- or Z80-based computer with a video-display console and CP/M or CDOS operating system

Documentation
65 pages punched for 3-ring binder; approximately 15 pages of assembly-language listing also provided in two disk files

Audience
Programmers and anyone else who writes text on a video-display device

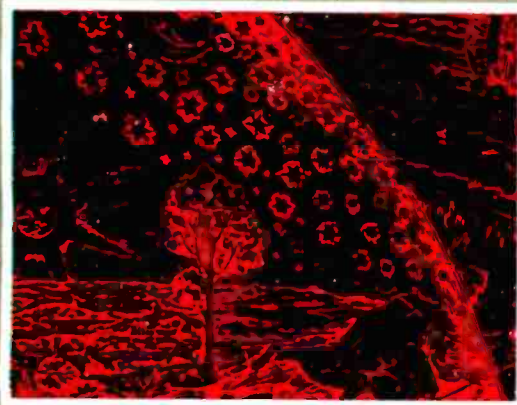

THE WORD FROM SYBEX...

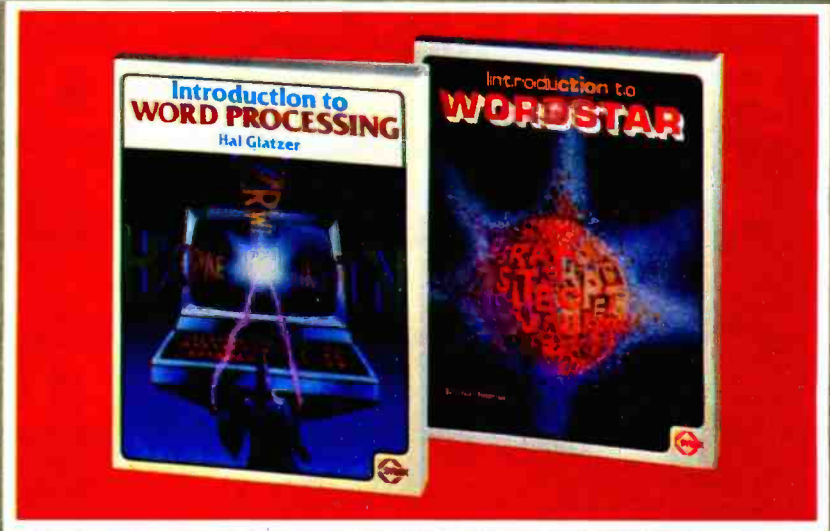

Introduction to WordStar™

by Arthur Naiman

Learn the wonders of WordStar.
A guide through the many important features of this powerful CP/M-based word processing system—from simple cursor movements, editing, boldfacing, and right-justifying, to sophisticated commands like global editing and electronic “cut and paste.” This book is for anyone who has WordStar, is considering buying it, or simply wants to know what a high-powered word processing program can do. Includes special sections on the Apple and TRS-80 versions of WordStar.

200 pp., 30 illustr., Ref. W110
ISBN: 0-89588-077-6, \$8.95

Introduction to Word Processing

by Hal Glatzer

The latest word on word processors. Learn how a word processor can save you time and improve accuracy. Discover how word processing improves productivity in homes and offices. Find out what to look for when you buy one. An important introduction to an essential new technology.

232 pp., 70 illustr., Ref. W101
ISBN: 0-89588-076-8, \$12.95

Circle 368 on Inquiry Card.

WordStar™ is a trademark of Micro Pro Int'l Corp.

PLEASE SEND ME INTRODUCTION TO WORD PROCESSING INTRODUCTION TO WORDSTAR SEND ME YOUR FREE CATALOG

SYBEX
MAIL TO:
SYBEX DEPT. 2B
2344 SIXTH STREET
BERKELEY, CA 94710
PHONE ORDERS:
INSIDE CA 415-848-8233
TOLL FREE OUTSIDE CA 800-227-2346

NAME _____
ADDRESS _____
CITY _____ STATE _____ ZIP _____
ADD \$1.50/book PS or 75¢/book 4th class mail or 68¢/book overseas airmail (CA add tax)
Total Amt. Enclosed _____ OR CHARGE MY VISA MC AM EX.
CARD NO. _____ EXP. DATE _____
SIGNATURE _____



IN A WORLD FULL OF MEDIA HYPE, HOW DID DYSAN COME SO FAR SO QUIETLY?

Or so fast? We didn't become a \$100 million-plus company in less than nine years by producing just any magnetic media. We did it by making the best. The best in disc packs. In single rigid discs. In disc cartridges. In diskettes. And in mini-diskettes. Many major OEM's have recognized the difference that Dysan quality can make. And have endorsed it with their own private label.

Today, there are sales offices and distributors in the United States and

throughout the world, selling and servicing Dysan precision magnetic media... to OEM's, end users and retail outlets. If our media was just like everyone else's, we never would have come this far this fast.

Precision magnetic media from Dysan. Our media says it all.

For the location of the Dysan sales outlet nearest you, contact Dysan at: (408) 988-3472 Toll Free: (800) 538-8133 Telex: 171551 DYSAN SNTA TWX: 910-338-2144

Dysan Corporation, U.S. Sales Offices:

St. Louis, MO, (314) 434-4011 / Sunnyvale, CA, (408) 730-2145 / Sherman Oaks, CA, (213) 907-1803 / McLean, VA, (703) 356-6441 / Irvine, CA, (714) 851-9462 / New York, NY, (212) 687-7122 / Schaumburg, IL, (312) 882-8176 / Fair Oaks, CA, (916) 966-8037 / Glendora, NJ, (609) 939-4762 / Bellevue, WA, (206) 455-4725 / Atlanta, GA, (404) 952-0919 / Arlington, TX, (817) 261-5312 / Burlington, MA, (617) 273-5955 / Rocky River, OH, (216) 333-3725 (in Cleveland) (412) 261-0406 (in Pittsburgh) / Livonia, MI, (313) 525-8240.

Dysan Magnetic Media is also available Worldwide:

Argentina, Australia, Austria, Belgium, Brazil, Canada, Chile, Colombia, China, Denmark, Ecuador, Finland, France, French Polynesia, Greece, Guatemala, Hong Kong, Iceland, India, Israel, Italy, Ireland, Japan, Korea, Malaysia, Martinique, Mexico, Netherlands, New Zealand, Norway, Peru, Philippines, Puerto Rico, Saudi Arabia, Singapore, South Africa, Spain, Sweden, Switzerland, Taiwan, Thailand, United Kingdom, Uruguay, Venezuela, Western Germany

Dysan Flexible Diskettes are also available from all Computerland Stores, Sears Business System Centers, and many independent computer outlets nationwide.



dy
an **Dysan**
CORPORATION

Our Media Is Our Message

5201 Patrick Henry Drive
Santa Clara, CA 95050

Circle 142 on Inquiry card.

mode, where the new text is inserted and everything to the right is shifted to make room.

Old text can be deleted by typing spaces over it (which leaves blanks), by backspacing (which moves the cursor left, deletes that character, and closes up the line), or by hitting Delete (which does the same without moving the cursor). In addition to the usual moves up, down, left, and right, VEDIT's cursor commands include single-key moves to the start or end of the current line, to the beginning of the next line, or to the next tab stop.

Once you've mastered on-screen maneuvers, how do you move the window? VEDIT has one-key instructions that page up or down a little less than one screen-height; others move the window and cursor to the beginning or end of the text. If you want to move up or down just a few lines, move the cursor up until it reaches the third line (or fourth or fifth, the value is set during customization). From that point on, additional Up Cursor keystrokes move the text

down through the window (unless, of course, you're already at the beginning). Moving the cursor close to the bottom also scrolls the text up through the window.

An editor should be able to perform functions in addition to these on-screen manipulations. VEDIT handles these via an adequate command mode, which is designed to work nicely in tandem with the visual mode. For example, to replace every occurrence of the word OLD with the word NEW, the command string is:

```
#<S OLD $ NEW $> $$
```

The # means "do the contents of <> as often as necessary." S is the substitute command, and \$ is echoed when the escape key is used. By adding a V command,

```
#<S OLD $ NEW $V> $$
```

VEDIT enters the visual mode after each substitution, with the cursor marking the point where the change was made. If the substitution is sat-

isfactory, you press one key to return to command mode. Since the V command is inside the <>, you're immediately back in visual mode, with the cursor marking the next substitution. Of course, you may discover that you set up the substitute command incorrectly. VEDIT's author has provided another escape from visual to command mode, which jumps out of the <>.

Command mode has an adequate set of editing commands, considering you'll spend most of your time in visual mode. It also provides file-handling commands and a means for changing disks and escaping from write-error and full-disk situations. I made up a full disk for testing and VEDIT did indeed let me off the hook in two ways: by deleting a file to make space or by changing disks.

Customizing VEDIT

For those of us tinkering with new systems, VEDIT's strongest point may be its adaptability. The process is versatile, simple, and well documented.

VEDIT comes in versions for 8080 or Z80 processors and for serial interface or memory-mapped video displays. I've tested only the Z80, video-display version. You set up VEDIT by running a customization program called VEDSET, which leads you stepwise through the required choices. VEDSET first presents a list of nineteen popular terminals, including the Lear-Siegler ADM-3A, Heath H-19/Z-19, DEC VT52, Hazeltine, and Televideo, from which you identify your own. This lets VEDSET install the display-control escape sequences unique to your terminal, unleashing the speed made possible by those expensive features. If your terminal isn't included or if you've built your own, VEDSET provides special instructions and even an assembly listing of the terminal-dependent routines and tables.

I've done most of my testing of VEDIT on a North Star Horizon with 51K bytes of memory, two disk drives, and a Zenith Z-19 (alias Heath H-19) terminal. I've also used a Cambridge Development Labs Graphics Display plus a homebrew character

TO START OF BUFFER	PAGE UP	
Switch insert mode	Cursor up	Undent
TO START OF THIS LINE	NEXT TAB	TO END OF THIS LINE
Cursor left		Cursor right
TO START OF NEXT LINE	PAGE DOWN	TO END OF BUFFER
Indent	Cursor down	
COPY TO TEXT REGISTER	MOVE TO TEXT REGISTER	INSERT TEXT REGISTER

Figure 1: Suggested keypad layout for Heath H-19 terminal. Shading (shifted keys) indicates large cursor movement and accompanying window movement as required. The H-19 should be set to Heath mode, the keypad shifted using internal switches and also set to Alternate keypad mode by including the sequence ESC = in the terminal initiation routine in the BIOS section of CP/M.

QUADRAMTM

Our plug-in I/O boards can do it.

You already know you've got one of the finest microcomputers available. IBM[®] made it. Now Quadram Corporation sets the standards for hardware that helps you realize the full capabilities of your Personal Computer... for the very lowest price.

Expanded memory. Until now, if you wanted a floppy disk, an RS-232C board, and 192K bytes of memory—all five slots were

**Add more
byte to your
IBM Personal
Computer.**

filled. Thanks to Quadram, you can now have 192K on just one card, freeing up the other four slots for additional functions. Choose the I/O board that allows your computer to grow with you (each board is user-expandable to 192K):

64K RAM card (no-parity)—\$359; 64K RAM card—\$395; 128K RAM card—\$595; 192K RAM card—\$795.

And more. Quadram offers additional boards for your IBM Personal Computer, including: Serial RS-232C asynchronous adapter (expandable to two ports); expansion ROM card; clock/calendar; 8K non-volatile RAM (expandable to 16K); parallel printer interface. Several other boards will be available soon, all with the same high-quality performance you'd expect from any Quadram product, and all for a similarly low price.

Available right now. Expanded memory... additional capabilities... and unbeatable prices. Quadram's ready now to help your IBM bite off more.

Circle 325 on Inquiry card.

For further information and the name of your nearest dealer, call (404) 923-6666 or fill in this coupon and mail to: Quadram Corporation, 4357 Park Drive, Norcross, Georgia 30093.

Name _____
Company _____ Title _____
Address _____
City _____ State _____ Zip _____

See us at booth 1242-44 at the Computer Faire.

generator and terminal emulator, which provided a pretty rigorous test of those special instructions. VEDIT makes good use of smart terminal features when they're available. However, unforeseen questions may arise. For example, H-19 users should be aware that VEDSET assumes your H-19 is in "Heath Mode." If you've set the internal switch to "ANSI Mode," you'll want to set it back. It didn't take me long to work this out, but Compuview's literature, including the special sheet on the H-19, failed to mention it. Other terminals may have similar problems.

The Compuview people urge you to contact them if you have trouble, and my experience indicates that they mean it. A phone call (on a different question) yielded technical assistance right away, and when things became complicated, I was connected with VEDIT's author, Ted Green.

The next step in customization is assignment of keys for cursor and window movements and for a dozen other special operations in visual mode. If your terminal has special function keys, you can assign them. You can also use any control character (except CTRL-M) or ESC followed

by any letter. The assignment process is simple: VEDSET names the function, and you strike the key(s) you want to use. VEDSET will reject unsuitable choices. A sample layout for a keyboard without special keys is provided. My package included a suggested layout for the H-19, but I devised one I like better; its third revision is shown in figure 1. The instructions encourage you to try one of the sample setups and then revise it to suit yourself.

In the final segment of customization, you enter your screen size in characters, the number of lines up and down that you want the window to move when paging, and similar parameters. You can also set up two features of special convenience to programmers. First, there's a selective lowercase-to-uppercase conversion that operates on each line of text until some particular character is encountered. This lets you leave the caps lock off when entering programs, type your code in all caps, and type your comments in lowercase. VEDIT switches modes when it crosses the ; (semicolon) in 8080/Z80 code, the ' (apostrophe) in Microsoft BASIC, or the ! (exclamation point) in DEC BASIC Plus. This feature can be set up during customization and then altered during use from command level.

Second, there's Indent/Undent. You define a special key for Indent and another for Undent during setup and also specify an indent increment (say, 5 spaces). Each time you press the Indent key, it changes the position the cursor goes to when you press Return. One Indent and you return to position 6 instead of position 1; press Indent again and you now return to space 11, and so on. Each tap of the Undent key undoes one Indent. Even if the language you're writing doesn't require specific indents, this makes it easy to improve the readability of your code.

Other Special Features

A feature highly touted in VEDIT publicity is the Undo key. Whatever you've done on the line you're editing, one stroke on Undo and the whole line is restored—you're back

★ ★ ★ FEATURING 8 and 16 BIT S-100 SYSTEMS ★ ★ ★

WE OFFER A WIDE RANGE OF CRTS, PRINTERS, GRAPHICS EQUIPMENT, SOFTWARE FOR ALL SYSTEMS. EACH SYSTEM IS COMPLETELY TESTED, INTEGRATED AND READY FOR PLUG-IN OPERATION WHEN YOU RECEIVE IT. WE TAILOR & CONFIGURE SYSTEMS TO MEET YOUR BUDGET AND NEEDS. WE WELCOME YOUR REQUEST FOR TECHNICAL INFO BY PHONE OR LETTER.

NEW SYSTEMS FROM IMS 2 yr warantee on boards! Integrated system with built-in monitor, detached keyboard, 5 1/4" drives. Systems w/8" drives, optional 10,20 or 40 MB Winchester, built-in tape back up, multi-user capability (TURBODOS or MP/M). Z-80, S-100 bus. Over 150 configurations to match your specific needs. On site service contracts for NY tri-state area.

SEATTLE COMPUTER 8086 SYSTEMS Featuring 86-DOS, the IBM PC Operating System.
 System I: 8 MHZ CPU set w/1 serial, 1 parallel I/O (additional I/O options) 64KB 16 bit Static RAM, Tarbell DD controller, TEI 22 slot mainframe w/constant voltage transformer\$2,695. System II: with 128K Static RAM\$3,550.
 Interfaced to dual Shugarts 801\$1,275. or dual QUME DT-8\$1,680.

CROMEMCO: Sale! 25% off systems/software; 15% off boards/components.

CALIFORNIA COMPUTER SYSTEMS 2210A High quality, low price. Z80 CPU, 1 serial port, disk controller w/CP/M 2.2 64K RAM\$1,750.
 Add our Max Box w/dual Shugarts or Qumes and IMS I/O w/2 serial, 1 parallel.

LOMAS DATA 8088 SYSTEMS same CPU & Operating System as IBM PC.
 Complete LOMAS card set in TEI 12 slot mainframe, 86-DOS, dual Shugarts, Televideo 912, assembled and tested\$4,424.
 LOMAS controller will also interface to 5 1/4" drives, mix of 5 1/4" & 8" possible.

TECMAR 8086 and Z80 Video Digitization systems 5% off list.
 IBM PC boards and accessories produced by TECMAR also discounted.

GRAPHIC SYSTEMS: Advertising*Architects*Designers*Complete package including powerful interactive graphics software plus MicroAngelo Graphics Subsystem w/20 MHZ high resolution green phosphor screen; M9900 16 bit, IEEE S-100 computer w/dual 8" floppies, 64K RAM, Multi user capability, Houston Instruments HIPAD Digitizer, Mauro Plotter. . . . \$10,200. 10MB Hard Disk Subsystem option . . . \$3,400.

GODOBOUT: Complete product line now available.

MAX BOX DISK DRIVE SUBSYSTEM mfg by John D. Owens Assoc. Dual drive cabinet w/regulated power supply, fan, complete internal cabling. Will hold Shugarts, Qumes, Tandons and/or 8" Winchester, horizontally mounted. Excellent design and engineering. 17 1/2" x 5 1/2" x 22. Attractive buff color.
 W/2 Shugart 801\$1,275. W/2 QUME DT-8 dble sided drives\$1,680.

PER SCI - The King and Queen of Drives.
 Model 299B\$2,300. Model 277\$1,245. Slim line cabinet\$325.

TURBODOS: SPECTACULAR CP/M COMPATIBLE MULTI-USER OPERATING SYSTEM. Z80 Code, interrupt driven. Up to 6X faster than CP/M; up to 35% increased disk capacity. Now available for IMS, TRS-80 Model II, CCS & Tarbell controller.

Prices subject to change without notice

JOHN D. OWENS Associates, Inc.
 12 Schubert Street, Staten Island, New York 10305
 212 448-6283 212 448-2913 212 448-6298

where you started. That seems like a good thing, but I don't use it much.

VEDIT also has a *text register* for moving or copying a block of text. Place the cursor at the beginning of the block, hit the Move key, move the cursor to the end of the block, and hit Move again. The block, now placed in the text register, disappears from the screen. You then move the cursor to wherever you want the text and hit the Insert key. Copy works the same way but doesn't delete the copied text from its original location. The Move key can also be used to delete a block of text.

One of VEDIT's best features is its speed in visual mode. VEDIT rarely rewrites the screen when it isn't necessary, and even when it does, the time required is not excessive. On the Z-19 at 9600 bps (bits per second), most operations seem instantaneous. Command mode, however, is another matter. A loop I set up to remove the first six characters from each line of a 200-line file took about 30 seconds.

VEDIT and Large Files

On my 51K-byte system, VEDIT's text buffer holds 35,786 bytes. (For comparison, Microsoft's EDIT80 holds 32,974, and Digital Research's ED holds 28,589.) That's almost 900 40-character lines. I rarely write single program modules that long, so I have limited experience with VEDIT's disk buffering for large files. On a 32K byte system, the buffer would hold about 17K bytes or over 400 lines.

Like most simple editors, VEDIT processes long texts by reading lines from an input file into the text buffer, where editing can take place, then writing into an output file. Progress is one-way. You can move the window at will over the text in the buffer, but once lines have been written to the output file, the entire text must pass through before the beginning can be reread.

VEDIT has command mode instructions to open and close files, to read and write lines, and to switch logged-in disks. There's even a single command to process the entire text and restart at the top of the file. However, these instructions aren't

needed in the simplest cases. VEDIT does auto-buffering while in visual mode: if you page past the end of the buffer contents, the first lines are written to output and new lines are read from the input file. Normally, the buffer is no more than 80 percent full, leaving lots of room for insertions. VEDIT also writes to the output file if you fill the buffer by insertions.

My experience with other editors proved that supposedly legal operations could hopelessly scramble files on my disks. I've tried all the combinations that usually cause trouble,

but VEDIT seems to handle them flawlessly.

What VEDIT Doesn't Do

I haven't found any serious bugs in VEDIT. A minor problem arises when you use the terminal's Repeat button to move the cursor around quickly or to delete a long string of characters. This works until VEDIT is required to do more than a simple operation. For instance, a repeated Up Cursor works until the cursor reaches the line where VEDIT must scroll down and write a new top line for each incoming Up Cursor. If Up Cur-

★ ★ ★ WRITE OR CALL FOR FREE CATALOGUE ★ ★ ★

<p>EPSON MX 80 \$475. MX80 F/T \$630. MX 100 \$725. Graftrax option \$ 95. Rs232 interface \$ 70. 2K Buffer \$140.</p> <p>3M SCOTCH® Diskettes In storage box 5 box minimum, price per box 740, 8" ss/sd \$29.00 741, 8" ss/dd \$35.50 743, 8" dd/dd \$45.50 744-0, 5¼" soft sectored or 744-10, hard sectored, single sided \$28.50 Head cleaning kit \$28.00</p> <p>TEI MAINFRAMES, S-100 MCS 112... \$ 620. MCS 122... \$ 745. RM 12 \$ 655. RM 22 \$ 790. OEM & Qty. discounts offered</p> <p>HOUSTON INSTRUMENTS PLOTTERS Standard & Intelligent models w/surface areas of 8½" x 11" to 11" x 17". Front panel electronic controls. DMP-2 .. \$ 935. DMP-3 .. \$1,195. DMP-4 .. \$1,295. DMP-5 .. \$1,455. DMP-6 .. \$1,685. DMP-7 .. \$1,865.</p> <p>TARBELL Double density controller \$435. Z80 CPU 395.</p> <p>CORVUS: Hard disk & Constellation networks for S-100 systems, TRS 80 Mod III, Apple II, Zenith, Xerox 820, Vector, Superbrain, Northstar, NEC, DEC LSI-11, Altos, Alpha Micro Discount prices.</p> <p>PMMI S-100 Modem \$385. Compatible w/telex & Twx. 51 to 600 baud. On board pulse dialer.</p> <p>HAZELTINE 1500 \$ 885. 1510 \$ 980. 1520 \$1,210. ESPRIT \$ 695.</p> <p>TELETYPE Model 4320 AAK \$1,140. Model 43ASR, 8 level, 1" tape .. \$2,595.</p>	<p>MICROANGELO <i>Price Lowered</i> SUBSYSTEM W/LIGHT PEN \$2,300. Includes S-100 graphic card, 15" moni- tor, detached keyboard, light pen. Without light pen \$1,930. Graphics card alone \$ 975. Screenware Pak II \$ 350. TEKEM: Tektronix emulator \$ 350. Color systems from 4 to 256 colors. Basic color system (4 colors) \$2,330.</p> <p>WHITESMITH: The Complete C-com- piler produces optimized native code for Z80. PASCAL from Whitesmith allows intermixing of C & PASCAL Full PAS- CAL as defined by Jensen & Werth, discounted price.</p> <p>dBASE II Brings power of mainframe database software to a microcomputer. Manual and demo software \$75. Complete package with money back guarantee: \$595.</p> <p>COMMUNICATIONS SOFTWARE Enables communications from a micro to a terminal or to another micro, mini or maxi computer. Source code \$500.</p> <p>MICROSOFT COBOL-80 \$560. BASIC-80 (interpreter) \$270. BASIC COMPILER: \$305. FORTRAN-80 \$380. X-MACRO-86: \$275. muLISP/muSIMP: \$190.</p> <p>MICROPRO WORDSTAR: \$320. MAIL MERGE: \$110.</p> <p>TWX (TELEX II) SOFTWARE \$350. Send/receive with a microcomputer con- nected directly to WU line. Eliminate paper tape. Messages can be formatted w/text editor.</p> <p>OLIVETTI DAISY WHEEL PRINTERS Model 311 (34CPS) \$2,150.</p> <p>QUICKSCREEN \$149. Use CRT as scratch pad, produce quality screens, create reports & forms.</p>
--	--

WE EXPORT Overseas Callers: TWX 710 588 2844
 Phone 212 448-6298 or Cable: OWENASSOC

JOHN D. OWENS Associates, Inc.

SEE OUR AD ON FACING PAGE

THINK BIG. BUY SMART.

You can save buying wholesale with our buying service. As your agent we will buy computer equipment on the wholesale market for you. Our fee is one fourth of what we save you off the list price. We have access to over 500 manufacturers. Call for present wholesale market conditions. Examples of total prices being paid by our clients (including our fee) are:

COMPUTERS

Alpha Micro 1030	\$12,047.00	Dynabyte 5615-A1	8,396.00
Alpha Micro 1051	17,634.00	Ithaca C.B. 128KSS/OD	5,421.00
Alpha Micro AM-1011	9,313.00	Ithaca Sys. 2A W/Panel	2,941.00
Altos 8000-10	6,397.00	NEC 8001A	865.00
Altos 8000-15	3,585.00	NEC 8012A	565.00
Altos 8000-2	2,629.00	NEC 8031A	865.00
Altos 8600-10	9,385.00	North Star 64K DD	3,073.00
Archives Model I	4,794.00	North Star Advantage	2995.00
Archives Model II	5,532.00	Televideo System I	2,380.00
Archives Model III	6,269.00	Televideo System II	5,311.00
CCS Series 300-1A	4,414.00	Televideo TS-800 Term.	1,324.00
CCS Series 400-1A	6,374.00	Televideo TS-802	2,629.00
Cromemco System 3	5,650.00	Televideo TS-802 H	5001.00
Cromemco Z-2H	7,521.00	Vector 2600	4,221.00
Dynabyte 5200-A2	3,216.00	Vector 3005	6,458.00
Dynabyte 5200-B2	4,896.00	Vector 5005	7,308.00

SOFTWARE

Dbase II	500.00	Wordstar	305.00
Spellguard	200.00	Basic Compiler	277.00
Datastar	230.00	Fortran 80-CPM	375.00
Spell Star	180.00	Visi Calc	160.00

PRINTERS

Anadex 9000	1,100.00	NEC 5510	2,345.00
Anadex 9501	1,278.00	NEC 5520 KSR	2,645.00
C. Itoh 25 P	1,325.00	NEC 5530	2,345.00
C. Itoh 45 P	1,700.00	NEC 7710	2,345.00
Diablo 630	2,075.00	Epson MX80 in stock	485.00
Diablo 1640	2,444.00	Qume Sprint 9-35	1,738.00
Malibu 165	1,796.00	Qume Sprint 9-45	1,996.00
Malibu 200	2,320.00	Qume Sprint 9-55	2,085.00
NEC 3510	1,795.00		

CRT, DISK DRIVE, MODEMS

Alpha Micro AM-600	8,075.00	Houston Instrument DMP-7	1,528.00
Anderson Jacobsen 1256	641.25	Lobo Dual 8" DS/DD	2,234.00
DEC VT 100	1,495.00	Lobo Dual Mini Drives	855.00
Hayes Micromodem Apple	275.00	Morrow 10MEG	2,750.00
Hayes Micromodem S-100	319.00	Morrow 20 MEG	3,650.00
Houston Instrument DMP-2	819.00	Morrow 26 MEG	3,375.00
Houston Instrument DMP-4	1,063.00		

For latest wholesale prices and to order Call Toll Free 800-227-2288. In California call 415-376-9020.

Assembly, integration and testing also available from our service department.

ASK ABOUT OUR LEASING PROGRAM.

Credit cards add 3% handling fee. Prices subject to change without notice. Minimum fee \$100. 15% cancellation fee.



We are buying agents for overseas computer dealers. Export services available. International Telex 470851

THE PURCHASING AGENT

1635 School St., Suite 101, Moraga, CA 94556

sor consists of the sequence ESC A, the Escapes can get lost, and one or several As may appear in your text. VEDIT's author, Ted Green, tells me that this problem is at its worst on the Heath H-19 terminal—the Repeat just sends too fast. In the absence of an interrupt-driven input buffer routine, the only remedy is a light touch on the Repeat button.

You can't enter control characters or reverse-video text into VEDIT's text buffer while in visual mode, presumably because any control character is a potential special function key. You can, however, switch to command mode, insert, say, your CTRL-L form feed, switch back to visual mode, and there it is, represented by the usual ^L.

Unfortunately, VEDIT doesn't provide a means for sending text to a printer. The only way you can print current text is to exit and use some other program. I find this annoying, but it hasn't caused me to take my command editors out of retirement.

Conclusions

VEDIT is a convenient, friendly, full-screen editor available at a reasonable price. It has several features specifically designed for program preparation and, for that purpose, has distinct advantages over command editors. It's readily adaptable to a wide variety of terminals and takes advantage of smart-terminal features. Special function keys can be assigned whatever functions you wish. If you don't have special function keys, substitute control characters and escape sequences of your own choice. The well-documented customization process is easily accomplished.

In addition to its screen mode, VEDIT has an adequate command mode. The command mode is useful in setting up string searches and substitutions; it also allows iteration macro commands that include transfers into visual mode and back. You won't spend much time in command mode. As part of a word-processing system, VEDIT has several limitations. You can't underline or even insert control characters in visual mode, and you can't send text to a printer. ■

MicroMed™ and MicroDent™ make your practice perfect.™

Simply the best!

They're the real solution to the problems confronting every physician's and dentist's office. Each is a unique package, developed through years of work in close conjunction with doctors and dentists. They'll help you treat your patients more efficiently and accurately, while saving you time and money in the process.

Versatility.

Whether you are in private practice or a member of a busy group, there's sufficient capacity to handle your needs. Thousands of patients can be accommodated on floppies, and even more on hard disk. MicroMed and MicroDent can easily handle everything in your practice from billing to patient records to complex insurance forms. With millions of hours of actual use in medical and dental offices throughout the country, they stand alone at the top, in a class by themselves.

Solutions, not more problems.

We know you're after solutions, not more problems. Our menus are simplicity itself, and are designed for your convenience (not our programmers'). The computer displays your options at every step. What could be simpler? Your own office staff can easily take care of the routine so that you can devote your valuable time to your patients.

You are the boss.

Forget about problems with outside billing services or manual record-keeping. You exercise absolute control over your billing procedures. Finger-tip patient recall lets you know instantly whose accounts are due and what services were performed. Account aging is automatic, and past-due notices or statements are printed and addressed, ready for mailing. All types of reports may be requested to help you better understand your finances and cash flow. Daily backups are created automatically.

Multiple Insurance Forms.

Many patients have several different types of insurance coverage. With MicroMed and MicroDent you can enter almost any form, keep track of which patients it applies to, and get it processed and ready for mailing. When new forms come out (as we all know they will) you don't have to pay for custom programming, you can modify the form print format yourself. With our exclusive Formulator™ system it takes just minutes.

Economic Sense.

The biggest surprise of all is that MicroMed and MicroDent are just \$2000 each. Plus, having your own office computer provides you with great tax advantages. If you like what you see, contact your nearest computer store. They can provide you with MicroMed or MicroDent on any CP/M® based computer for an amazingly economical price. Or, if you already have a computer, a demo disk and manual set is available for just \$75, and allows you to run the entire program. The manual separately is \$50. Send for one today, and make your practice perfect!

Features:

- Automatic billing for any patient load
- Handles practices with up to 20 doctors
- Accepts all insurance forms
- Exclusive "Formulator" form system
- Multiple insurance coverage
- Insurance preauthorization
- Automatic statements with aging
- Instant access to patient records
- Full transaction and treatment details
- Cumulative totals by doctor
- Profitability analysis reports
- Mailing list maintenance
- Can be linked to word-processing
- Appointment recall with reminders
- Maintains hospital and lab codes
- Keeps track of referring doctor codes

Demo disk and manual set \$75!

Dealerships are available to established computer vendors on a territorial basis.

**See Us At
West Coast
Computer Faire**

*MicroMed, MicroDent, and Formulator are trademarks of SoftwareHows
©CP/M is a registered trademark of Digital Research
Copyright ©1981, SoftwareHows

SOFTWARE HOWS

P.O. Box 36275, Los Angeles, CA 90036

(213) 731-0876 • TWX: 910-321-2378

Add a Cassette Interface to Your VIC-20

William R. Hale
3309 June St. NE
Albuquerque, NM 87111

During the time I've owned a Commodore VIC-20, I've found it to be an excellent home computer. You really get a lot for your money. With so many excellent peripherals being introduced recently, the VIC-20 will be a great addition to the home computer market. I do feel, however, that the price (almost \$100) Commodore is asking for a cassette recorder is a little high. Thus, I decided to design my own interface.

Figure 1 (on page 274) is a schematic of an interface that allows use of an ordinary, portable audio-cassette recorder to store programs from a VIC-20. The cost of the few parts needed, including a plastic case, runs about \$10; the parts are available at Radio Shack and other electronic parts stores. The audio tape needed to store programs need not be of high quality due to the tones the VIC-20 uses. The cassette "shell" itself should not be so cheap that it causes the tape to drag.

Most of the components I used were already in my home stock, including the 6-pin connector to the VIC-20 motherboard. (See figure 1 for part numbers.) The VIC-20 outputs 0 to +4 volts (V) and prefers as an input a signal of an amplitude between 0 and -4 V. (Later testing has shown that the VIC-20 will accept a 0- to +4 V input if the signal consists of true square waves and does indeed range from 0 to +4 V.) Capacitor C1 allows the recorder to receive a normal AC input; the combination of C2 and CR1 allows DC restoration for

the VIC-20 input. R2 is merely a fuse to protect the VIC-20.

L1 is an LED used to indicate that data is coming into the interface and is of sufficient level to properly operate IC1, which is being used as a wave-shaping circuit. L1 isn't a necessary part of the interface, but since the SN7404 has extra inverters, you might as well use one for the indicator. Switch S1 is also unnecessary because you can tie the line coming to it low. However, if you do this, be sure your recorder is in PLAY for the load and verify operations and in RECORD for any save operations before pressing the return key. Switch S2 is needed to rewind the tape. Always return this switch to REMOTE immediately after using it in MANUAL.

My particular recorder, Superscope Model C-76, uses +6.7 V to drive its motor, so I was able to use the VIC-20's motor-power line directly. Figure 1 also illustrates an alternate method for controlling the recorder using the VIC-20's +6.7 V motor line as a control signal.

Notice that the shield on the AUX input of the recorder is not connected to the VIC-20 system ground. I found that if I tied this line to the VIC-20 ground, noise would appear on the external speaker output of the recorder while I was attempting to load a program from the recorder. This noise was of sufficient level to trigger the input of inverter IC1 prematurely and cause an error message to be generated by the VIC-20. ■

COMPUTER SPECIALTIES



"DISCOUNT PRICING ON QUALITY PRODUCTS"

FREE SHIPPING
on prepaid cash orders

FREE SHIPPING
on prepaid cash orders

FAST DELIVERY ON ALL MAJOR BRANDS — ACCESSORIES — SOFTWARE

ORDER TOLL-FREE! 1-800-854-2833

VIC 20
Personal Computer

\$255



Vic-20 3K by MPC	69
Vic-TV Module	19
Vic Cassette	68
Vic 6 Pack Program	44
VIC1530 Commodore Datassette	69
VIC1540 Disk Drive	499
VIC1515 VIC Graphic Printer	399
VIC1210 3K Memory Expander	32
VIC1110 8K Memory Expander	53
VIC1011 RS232C Terminal Interface	43
VIC1112 VIC IEEE-488 Interface	86
VIC1211 VIC 20 Super Expander	53
VIC1212 Programmers Aid Cartridge	45
VIC1213 VICMON Machine Language Monitor	45
VIC1901 VIC AVENGERS	23
VIC1904 SUPERSLOT	23
VIC1906 SUPER ALIEN	19
VIC1907 SUPER LANDER	23
VIC1908 DRAW POKER	23
VIC1909 MIDNIGHT DRIVE	23
VT106A Recreation Pack A	44
VT107A Home Calculation Pack A	44
VT164 Programmable Character/Graphics	12
VT292 VIC Term I Terminal Emulator	9

apple



ACCESSORIES

16K Ramcard by MPC	99
CPS Multifunction Card by Mtn Comp	185
Expansion Chassis by Mtn Comp	595
Joystick by TG	47
Micromodem II by Hayes	295
CCS #7720A	99
Smartmodem by Hayes	239
Versa-Writer Digitizer Drawing Sys. by Versa Comp.	199
videoterm (80 Column Card) by Videx	269
Z-80 Softcard by Microsoft	299
Numeric Keypad by Keyboard Co.	119
Joyport by Sirius	69
Keyboard Enhancer II	129
Corvus Hard Disk Drive	CALL
Lower Case Adapter by MPC	35
Paddle Adapple	21
Serial Card by CCS #7710A	129

NEW!

32K RAM	139
MetaCard by Metamorphic	CALL
Speechlink 2000 by Heuristics	249

NEC PC-8001A
32K

\$849



The WEDGE I/O Unit 32K RAM	549
32K Memory Board for use with The WEDGE	179
NEC 12" Green Screen	169
NEC Add-on dual Mini Drive	CALL
NEC Computer PC8001-A 32K	995
NEC Dual Mini-Drive	CALL
NEC FDC I/O Port	149
NEC Hi-Res Color Monitor	929
NEC I/O Unit 32K RAM	595
NEC Impact Printer Cable	49
NEC Impact Printer F/T	695
NEC Low Res Color Monitor	CALL
NEC Spinwriter #5510 (Serial)	2785

SOFTWARE

WordStar configured for NEC	299
SuperCalc configured for NEC	279
NEC Wordprocessor & Accounting Software	CALL

Many more software packages and language: (Pascal, Fortran, Cobol, etc) are available configured for the NEC 8001A Computer.
Please call or write for a product price list.

FREE CATALOGUE
1-800-854-2833

SAVE!
CALL FOR BEST PRICES

commodore

CBM 8032 \$1095

4016	799
4032	995
8096	1795
CBM4022 Printer	629
Tally 8024	1699
CBM4040 Dual Disk Drive	995
CBM8050 Dual Disk Drive	1339
CBM 2031 Single Disc Drive	525

SOFTWARE

WordPro 3 Plus	229
WordPro 4 Plus	329
Commodore Tax Package	399
Visicalc	149
BPI General Ledger	329
OZZ Information System	299
Dow Jones Portfolio	114
Pascal	229
Legal Time Accounting	449
Word Craft 80	289
Create-A-Base	249

COMMODORE 64 CALL

HOW TO ORDER

Ordering information: Phone orders using VISA, MASTERCARD, AMERICAN EXPRESS, DINER'S CLUB, CARTE BLANCHE, bank wire transfer, cashier's or certified check, money order, or personal check (allow ten days to clear). Unless prepaid with cash, please add 5% for shipping, handling and insurance. (minimum 5.00) California residents add 6% sales tax. We accept CODs. OEM's Institutions and corporations please send for a written quotation. All equipment is subject to price change and availability without notice. All equipment is new and complete with manufacturer's warranty (usually 90 days). Showroom prices may differ from mail order prices.

ATARI

800 16K

\$695



Atari 400 Computer	319
Atari 410 Program Recorder	59
Atari 810 Disk Drive	425
Atari 820 Printer	249
Atari 825 Printer	599
Atari 850 Interface	159
Assembler/Editor	45
Atari Joysticks	17
Atari Paddles	17
Basketball	30
Computer Chess	30
Invitation to Programming	17
Music Composer	45
Star Raiders	35
Super Breakout	30
Missile Command	32
Asteroids	32
Visicalc	180
Atari 16K RAM by MPC	89
Atari 32K RAM by MPC	149
Atari Le Stick	35

SOFTWARE

Apple Panic	24
Alkemstone by Level 10	34
Asteroid Field by Cavalier	19
Business Pkgs by Continental	199
Castle Wolfenstein	24
DB Master III by Stoneware	169
DB Master Utility Pkg	89
Desktop Plan II by Personal Software	159
Epoch by Sirius	29
Flight Simulator by Sub-Logic	34
Continental Software	CALL
Gorgon by Sirius	35
Home Money Minder by Continental	29
Hungry Boy by Astar	21
Magic Window by Art-Sci	89
Olympic Decathlon	24
Personal Filing System	69
PFS Report	69
Raster-Blastor	29
Robot Wars by Muse	31
Sargon II Chess Game by Hayden	29
Space Eggs by Sirius	25
Spellstar by Micropro	169
Super Stellar Trek by Rainbow	33
Supertext II by Muse	119
Tax Preparer by Howardsoft	139
Thunderbirds by Astar	19
Visicalc II by Personal Software	155
Visitrend/Visiplot by Personal Software	199
Visifile by Personal Software	199
Wordstar by Micropro	239
Peach Tree Accounting Software	CALL

*APPLE IS A REGISTERED TRADEMARK.

WE HAVE IT ALL . . . JUST CALL IF YOU DON'T SEE IT!

SALE!
EPSONS

MX80 CALL
MX80 F/T CALL
MX100 CALL

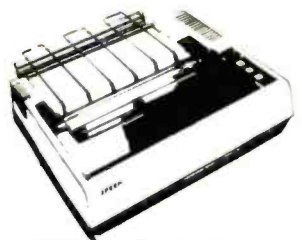

WE CARRY
A HUGE SELECTION OF
MONITORS
AMDEK, SANYO, NEC & ZENITH
PRINTERS
PAPER TIGERS, C. ITOL & QUME
MEDIA
DYSAN, VERBATIM, ETC.

COMPUTER SPECIALTIES

(714) 579-0330
MAIL TO: 1251 BROADWAY
EL CAJON, CA. 92021

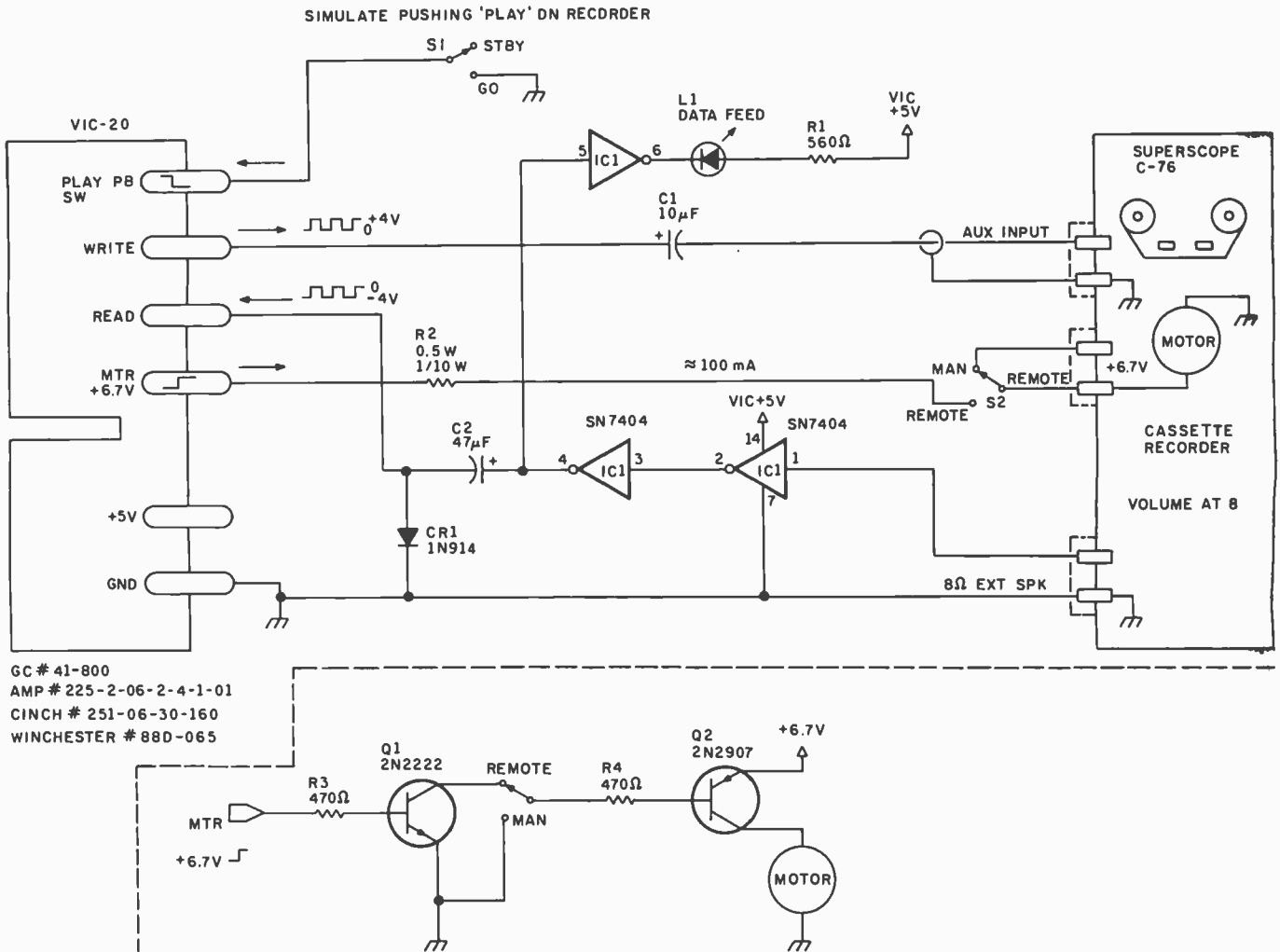
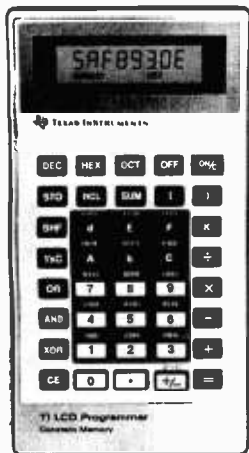

Figure 1: Interface between the VIC-20 and a standard cassette recorder. Although the VIC-20 outputs 0 to +4 V, it seems to prefer a 0 to -4-V input. Switch S1 could be eliminated (see text), but it's safer to include it. Alternate sources for the connector to the VIC-20 are listed; an alternate motor control circuit is also shown.



New! TI LCD Programmer.

Hexadecimal and Octal Calculator/Converter.

The brand new tilt-top TI LCD Programmer can save you hours of work. It was designed specifically for the problems you do, and has features that make it ideally suited for applications in computer programming, debugging, repair and digital logic design.

- Performs arithmetic in any of three number bases — OCT, DEC, HEX.
- Integer, two's complement arithmetic in OCT and HEX.
- One's complement capability in OCT and HEX.
- Converts numbers between OCT, DEC and HEX.
- Fifteen sets of parentheses available at each of four processing levels.
- Logical functions AND, OR, EXCLUSIVE OR and SHIFT operate bit by bit on OCT or HEX numbers.

Unisource Electronics has committed to buy TI's initial production of this unique product. Availability is limited! Order now.

15-Day Free Trial.

The best way to evaluate the TI LCD Programmer is to try it yourself — on the job — for 15 days. If you're not 100% satisfied, simply return it for a full refund. Order now by calling toll-free:

1-800-858-4580

In Texas call 1-808-745-8835

Lines open 8 am to 6 pm CST



Just give us your name, shipping address and Visa or MasterCard number and we will charge the tax deductible* \$75.00 purchase price, plus \$2.00 shipping and handling (Texas residents also add 5% sales tax) to your account. Or send your check or money order to:

Unisource Electronics, Inc.
 P.O. Box 64240 • Lubbock, Tx. 79464

* When used for business.

Introducing . . .
THE TEC-86 SERIES OF 16 BIT MICROCOMPUTER SYSTEMS
TEC-86 — COMPLETE 16 BIT 8086 MICROCOMPUTER SYSTEM — \$4390

FEATURES

- Two 8 Inch DD Floppy Disk Drives (1.2 MB Total)
- ROM Boot for MP/M-86™
- 64K Bytes of Memory
- Vectored Interrupts
- 16 Bit 8086 CPU
- Heavy Duty Power Supply
- IEEE 696 S-100



- Two RS232 Serial Ports
- Baud Rates from 50 to 19200 Baud
- Independent Baud Rate for each Serial Port
- 24 Parallel I/O lines (Three 8 Bit Ports)
- Attractive Industrial Quality Enclosure

TEC-86M4 — \$7595.
FOUR USER TEC-86 SYSTEM
WITH ½ MEGABYTE OF MEMORY

TEC-86W — \$10990.
TEC-86 SYSTEM WITH WINCHESTER
31 MegaBYTE HARD DISK

ONE YEAR
WARRANTY

TEC-86M4W — \$12990.
FOUR USER TEC-86 SYSTEM WITH ½ MEGABYTE OF MEMORY
AND 31 MegaBYTE WINCHESTER HARD DISK

TEC-86 OPTIONS

- CP/M-86™ Single User Operating System
- MP/M-86™ Multi-User Operating system
 Concurrent File Access File Password Protection
 File Time and Date Stamping Print Spooling
- Additional Memory, 64K and 256K byte increments
 up to a system total of one full Megabyte
- Languages
 BASIC-86™, FORTRAN-86™, PASCAL-86™,
 CBASIC/86™, PASCAL/M86™, FORTH,
 CIS-COBOL and other High Level Languages
- Double sided double density floppy disks (2.4 MB total)
- 31 Megabyte Winchester Hard Disk
- Attractive Wood Grain Desk Top Enclosure
- Rack Mounted enclosure
- Alphanumeric terminals (80 chars x 24 lines)
- Matrix, correspondence quality, letter quality, and graphics printers

ANALOG TO DIGITAL DIGITAL TO ANALOG
DATA ACQUISITION AND CONTROL BOARDS AND SYSTEMS

APPLE A/D \$695
w/Timer-Counter

ANALOG TO DIGITAL Converter with
 Timer/Counter
 12 Bit Accuracy, 16 Channels, 30 KHz
 Conversion, Three programmable
 Timer/Counters to:

- Trigger Conversions
- Count Conversions
- Count External Signals
- Count Bus Clock

Options: Programmable Gain; 14, 16 Bit
 Accuracy; 40, 100, or 125 KHz; Expansion
 to 256 Channels

DIGITAL TO ANALOG
CONVERTERS

12 Bit Resolution
 3 Microsecond Conversion
 Jumper Selectable Outputs
 ±2.5V, ±5V, ±10V, 0 to
 +5V, 0 to +10V

Each operates independently
 Each DAC holds previous value
 until an entire new word
 is presented to it
 Fully assembled and tested

Circle 378 on inquiry card.

\$100 A/D \$765

Analog to Digital Converter
with Timer/Counter

12 Bit Accuracy, 16 Channels,
 30 KHz Conversion, Five
 Programmable Timer/Counters for:

- Time of Day
- Triggering Conversions
- Counting Conversions
- Counting External Signals
- Interrupting the CPU

Options: Programmable Gain;
 14, 16 Bit Accuracy;
 40, 100, 125 KHz Conversion;
 Expansion to 256 Channels

OTHER FINE \$100 and APPLE PRODUCTS AVAILABLE, INCLUDING:

ANALOG to DIGITAL CONVERTERS (12, 14, 16 bit accuracy, 30, 40, 100, 125 KHz Conversion rates, 16 to 256 Channels, programmable gain, timer/counters). **DIGITAL to ANALOG CONVERTERS** (12 bit accuracy, 3 microsecond conversion rate). 8086 CPU Board, I/O Boards 64K/256K Memory Boards, Real-time Video Digitizer and Display. Complete Systems also available for Data Acquisition, Video Digitization, and General Purpose Applications.

REQUEST OUR CATALOG FOR COMPLETE LISTING, AND SPECIFICATIONS ON THE ENTIRE TECMAR PRODUCT LINE.



DEALER INQUIRIES INVITED

23600 Mercantile Rd. • Cleveland, OH 44122

TECMAR, INC.
(216) 464-7410

WE'LL "DRIVE" YOU WILD

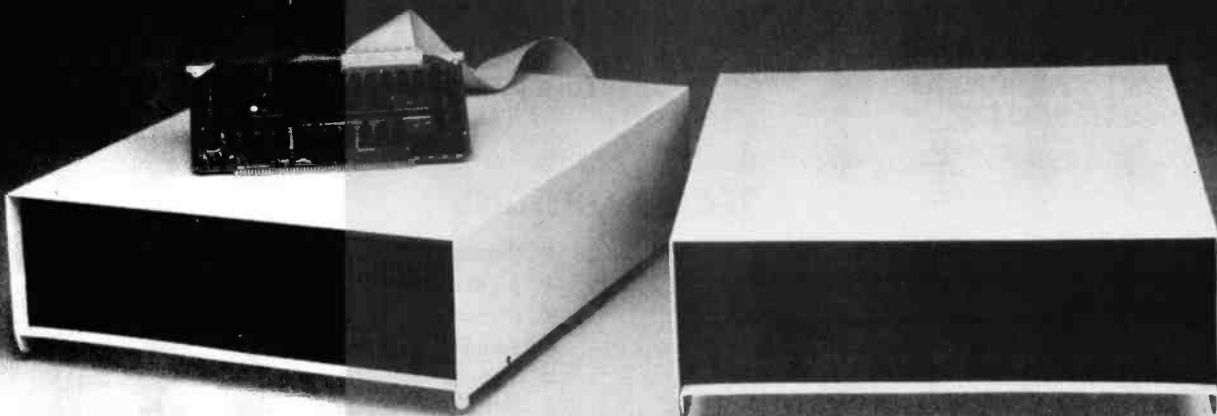

with our variety of quality disk drives.

ASAP carries only the highest quality floppy disk drives, to provide you with years of trouble-free service and superior performance.

Data Trak™ double-sided, double-density drives from Qume® feature state-of-the-art technology. You get superior data integrity through improved disk life, data reliability and drive serviceability.

Data Trak™ 5 (ANSI 5¼" compatibility) Call for price

Data Trak™ 8 (IBM compatibility) Call for price

Shugart drives have been setting industry quality and reliability standards for years. Shugart's Bi-Compliant™ head assembly provides superior media compliance and high reliability.

Model 801 (standard floppy) \$400.00

Model 850 \$640.00

Dual Disk Drive Cabinet \$225.00

ASAP also provides a full line of high reliability disk drive subsystems.

Part No. — Description* Price

HDC8/1-HD — Cabinet with (1) Priam 10 megabyte hard disk drive with Microbyte Controller Call for price

HDC8/1F+1HD — Cabinet with (1) Qume® DT-8 double-sided, double-density drive, and (1) Priam 10 megabyte hard disk drive with Microbyte Controller Call for price

CAB8H — Dual cabinet for 8" floppy disk drives (horizontal mounting) \$ 225.00

CAB8V — Cabinet for 8" floppy disk drives (vertical mounting) \$ 225.00

CAB8H/V+1S — Dual cabinet with (1) Shugart SA801R installed (horizontal or vertical mounting) \$ 695.00

CAB8H/V+2S — Dual cabinet with (2) Shugart SA801R's installed (horizontal or vertical mounting) \$1095.00

CAB8H/V+1Q — Dual cabinet with (1) Qume® DT-8 double-sided double-density drive installed (horizontal or vertical mounting) \$ 775.00

CAB8H/V+2Q — Dual cabinet with (2) Qume® DT-8's double-sided double-density drive installed (horizontal or vertical mounting) \$1275.00

*All cabinets come complete with power supply, fan and internal cables.

asap
computer
products, inc.

1198 E. Willow St., Signal Hill, CA 90806

Toll free outside California:

(800) 421-7701

Inside California:

(213) 595-6431

(714) 891-2663

For superior quality, high reliability disk drives, contact ASAP today.

ASAP offers a 30-day buyer protection policy: full money-back guarantee if not totally satisfied.

Ordering information: name, address, phone; ship by: UPS or truck. Please call for shipping charges.

Terms: We accept cash, check, money orders, Visa and Master Charge (U.S. funds only). Tax: 6% Calif. res. COD's and terms available on approval (school PO's accepted).

Printers

Okidata Dot Matrix Printers

82A — 80 column printer w/tractor
Throughput @ 80 characters per line: 76 lines
per minute
Print Speed: 120 CPS

83A — 136 column printer w/tractor
Throughput @ 136 characters per line: 76 lines
per minute
Print Speed: 120 CPS

84A — 136 column printer w/tractor
Throughput @ 136 characters per line: 114 lines
per minute
Print Speed: 200 CPS
Centronics & RS-232C interfaces standard on
models 82A & 83A. 2K serial buffer board (RS-232)
optional on all models. Centronics 8-bit parallel
interface and Okigraph HI-RES Graphics standard
on Model 84A

Epson MX-80

80 Column Dot Matrix Printer
Character set: full 90-character ASCII with
descenders
Graphics characters: 64 block characters
Centronics-style 8-bit parallel interface
standard; Apple, TRS-80, RS-232 interfaces optional.
MX-80 FT/Friction Feed
MX-100/132 Column
CALL FOR PRICE & DELIVERY

Apple Parallel Interface:

AEI-1 W/Cable \$69.95

- Standard Interface
- Compatible with Epson & Okidata Printers
- On-board Firmware (2708)
- Optional Cables: \$25.00
- AEC-2/Atari to Epson Printer
- TREC-2/TRS-80 to Epson/Okidata Printer
- RSC-1/RS-232 (male to male)

Serial Interface SEI-1 \$55.00

- Asynchronous 300, 1200, 2400 or 9600 BPS
- Compatible with Epson Printers
- 75 to 9600 BPS

Modems

Manufacturer	Model #	Price
Novation	CAT	\$ 149.00
Novation	d-CAT	\$ 160.00
Novation	Auto-Cat	\$ 229.00
DC Hayes	Smart Modem	\$ 245.00
DC Hayes	Micro Modem II (Apple)	\$ 320.00
DC Hayes	Micro Modem 100	\$ 335.00
Lexicon	Lex-11	\$ 139.00
Livmore	LIV-Star 20M	\$ 149.00
UDS	UDS 103 LP	\$ 185.00
UDS	UDS 202 LP	\$ 245.00

Monitors

Manufacturer	Model #	Price
Amdek	100/12" B&W	\$ 125.00
Amdek	100-80	\$ 169.00
Amdek	100G/12" Grn.	\$ 149.00
Amdek	Color-1 13"	\$ 375.00
Sanyo	DM 5109CX/9" Grn.	\$ 175.00
Sanyo	DM 5012/12" B&W	\$ 270.00
Sanyo	DM 5112ex/12" Grn.	\$ 290.00
Sanyo	DM C6013/13" Color	\$ 450.00
Zenith	ZVM-121/12" Grn.	\$ 115.00

Terminals

Manufacturer	Model #	Price
Ampex	Dialogue 80	\$ 899.00
Lear Siegler	ADM-5	Call for price
Lear Siegler	ADM-3A	Call for price
Lear Siegler	ADM-3A+	Call for price
Lear Siegler	ADM-31	Call for price
Lear Siegler	ADM-32	Call for price
Lear Siegler	ADM-42	Call for price
Televideo	TVI 910	\$ 625.00
Televideo	TVI 912C	\$ 725.00
Televideo	TVI 950C	\$ 925.00
Televideo	TVI 925	\$ 825.00

Components

4116's (200 nS)/5290-3

Apple, TRS-80, Heath
1-15 \$1.85 each 50-99 \$1.60 each
16-49 \$1.70 each 100 up \$1.40 each

2114 L-2/200 nS

Low-Power 1K x 4 Static RAM
1-16 \$2.80 each 50-99 \$2.60 each
17-49 \$2.70 each 100 up \$2.45 each

2708/450 nS

1K x 8 EPROM \$3.00 each or 8/\$22.00

2716/5 Volt

2K x 8 EPROM \$4.95 each

74LS240 \$1.25 each 74LS373 \$1.25 each
74LS241 \$1.10 each 74LS374 \$1.25 each
74LS244 \$1.25 each 8T245 \$1.50 each

Support Chips

8080A-CPU \$ 2.50 Z80A-SIO \$22.00
Z80A-CPU \$ 8.95 8255AC5 \$ 6.95
Z80A-CTC \$ 8.95 8257AC5 \$15.00
Z80A-DART \$13.95

Regulators

320T5 \$.80 320T12 \$.80
340T5 \$.70 340T12 \$.75

Connectors

	1-9	10-24	25 up
DB25P	\$2.25	\$2.15	\$2.00
DB25S	\$3.25	\$3.10	\$2.90
DB25C	\$.95	\$.85	\$.75

100 Pin IMSAI

Gold/S-100 Solderetail Connectors
\$2.60 each or 10/\$2.40 each

Capacitors

1 @ 12 Volt Ceramic 8c each or 100/\$7.00

DIP Sockets

Description	1-9	10-49	50-99	100 up
14 pin tin st	\$.15	\$.13	\$.12	\$.11
16 pin tin st	\$.16	\$.14	\$.13	\$.12
18 pin tin st	\$.19	\$.18	\$.16	\$.14
20 pin tin st	\$.25	\$.23	\$.21	\$.20
24 pin tin st	\$.26	\$.24	\$.22	\$.20
28 pin tin st	\$.32	\$.30	\$.29	\$.27
40 pin tin st	\$.42	\$.40	\$.38	\$.34

DISKETTES from ASAP

Part #	Verbatim 5 1/4" Diskettes		Price
	Sector		
MD525-01	Soft	10/527.50	
MD525-10	Hard 10	10/527.50	
MD525-16	Hard 16	10/527.50	

Part #	8" Diskettes		Price
	Sector		
FD32-1000	Hard	10/535.00	
FD34-1000	Soft	10/535.00	

Part #	Memorex 5 1/4" Diskettes		Price
	Slide/Dens	Sector	
MEM 3403	1/Sgl	Hard 10	10/525.00
MEM 3405	1/Sgl	Hard 16	10/525.00

Part #	8" Diskettes		Price
	Slide/Dens	Sector	
MEM 3060	1/Sgl	Soft	10/535.00
MEM 3101	2/Sgl	Soft	10/545.00
MEM 3090	1/Dbi	Soft	10/545.00
MEM 3102	2/Dbi	Soft	10/555.00

Part #	Scotch 3M 5 1/4" Diskettes		Price
	Slide/Dens	Sector	
744-0	1/Sgl	Soft	10/533.00
744-10	1/Sgl	Hard 10	10/533.00
744-16	1/Sgl	Hard 16	10/533.00
745-0	2/Dbi	Soft	10/559.00
745-10	2/Dbi	Hard 10	10/559.00
745-16	2/Dbi	Hard 16	10/559.00

Part #	Maxell 5 1/4" Diskettes		Price
	Slide/Dens	Sector	
MD1	1/Sgl	Soft	10/535.00
MD20	2/Dbi	Soft	10/549.00
MH1	1/Sgl	Hard 16	10/539.00
-MH20	2/Dbi	Hard 16	10/555.00

Part #	8" Diskettes		Price
	Slide/Dens	Sector	
FD1-128	1/Sgl	Soft	10/545.00
FH1-32	1/Sgl	Soft 32	10/545.00
FD2-XD	2/Dbi	Soft	10/555.00

Elephant Memory Systems

Part #	Slide/Dens	Sector	Price
EMS-1	1/Sgl	Soft	\$25.00

Part #	SRW Media Storage Cases		Price
	Size		
SRW-5	5 1/4"		\$2.50 ea.
SRW-8	8"		\$3.25 ea.

SYSTEMS WITH SPICE from CALIFORNIA COMPUTER SYSTEMS FOR APPLE II™ USERS

Synchronous Serial Interface Part Number 7712A	Price: \$149.00
Programmable Timer Part Number 7440A	Price: \$ 95.00
Asynchronous Serial Interface Part Number 7710A	Price: \$139.00
Calendar/Clock Module Part Number 7424	Price: \$ 99.00
3 1/2 Digit BCD A-to-D Converter Part Number 7470A	Price: \$ 95.00
12K ROM/PROM Module Part Number 7114A	Price: \$ 85.00
Parallel Interface Part Number 7720A	Price: \$125.00
Arithmetic Processor Part Number 7811A	Price: \$349.00
Centronics Printer Interface Part Number 7728A	Price: \$125.00

FOR S-100 USERS

32K Static RAM Board Part Number 2032C	Price: \$610.00
16K Static RAM Board Part Number 2116C	Price: \$290.00
64K Dynamic RAM Board Part Number 2065C	Price: \$550.00
Z80A CPU Board Part Number 2810A	Price: \$265.00
Floppy Disk Controller Part Number 2422A	Price: \$365.00
CP/M™ Version 2.2 Free With Purchase	
S-100 Mainframe Part Number 2200A	Price: \$475.00
2201A (220VAC)	\$475.00
S-100 Motherboard Part Number 2501A	Price: \$150.00
4-Port Serial I/O Interface Part Number 2710A	Price: \$245.00
2-Serial, 2-Parallel I/O Board Part Number 2719A	Price: \$275.00
4-Port Parallel I/O Board Part Number 2720A	Price: \$195.00

Microbyte Boards

Z80A/I-O CPU Board
• A complete single board Z80A CPU with serial/parallel interface (2) Ser. (3) Parallel
• Fully compatible with proposed IEEE S-100 Bus Standard
• Z80A CPU (4MHz version of the Z80)
\$329.00 Assembled & Tested
Optional Monitor Program \$40.00

Floppy Disk Controller

- DMA to within 16 Mbyte of memory
- State-of-the-art NEC765 LSI Controller
- IEEE S-100 compatible
- DMA arbitration allows use of multiple boards within a system

\$329.00 Assembled & Tested

*CP/M \$150.00 Available (Optional)

4-Port I/O Board

- Quad RS-232-C serial ports. One 20 mA current loop port
- Fully IEEE S-100 bus compatible
- Asynchronous communications with Z80A-DART™ or synchronous communications with Z80A-SIO/I/O™
- Full set of modem control signals, including RI (Ring Indicator)
- Easily configurable to any type of terminal interface

\$265.00 Assembled & Tested

Cables Available (Optional)

All prices subject to change without notice. Call for best price.

ASAP offers a 30-day buyer protection policy: full money-back guarantee if not totally satisfied.

Ordering information: name, address, phone, ship by: UPS or Mail. Shipping charge: add \$2.50 up to 1 lb. for UPS blue; add \$1.50 for U.S. Mail (U.S. only) (\$25.00 minimum order). Call for larger shipments.

Terms: We accept cash, check, money orders, Visa & Master Charge (U.S. Funds only). Tax: 6% Calif. res. COD's and terms available on approval (school PO's accepted).

asap
computer
products, inc.

1198 E. Willow St., Signal Hill, CA 90806

64K Dynamic RAM Board

- Fully S-100 bus compatible (4 MHz)
- 64K x 8 bit dynamic RAM
- Low power: +8VDC @ 700 mA +16VDC @ 100 mA -16VDC @ 25 mA
- Built-in capacity with LED indicator and vector interrupt

\$475.00 Assembled & Tested

*CP/M™ Trade Mark of Digital Research

ATARI COMPUTER PRODUCTS

ATARI 800

- (16K) Personal Business Computer Features:
- Computer console
 - Atari 8K basic
 - 57 full stroke alpha-numeric keyboard with four function keys
 - Operator's manual
 - RF modulator
 - Power supply
- Call for price

Special Offer: Additional 16K RAM FREE with purchase of system

ATARI 400 \$349.00

Atari Optional Accessories

Model #	Description	Price
810	Disk Drive System	\$ 455.00
820	40 Column Dot Matrix Printer	\$ 279.00
822	40 Column Thermal Printer	\$ 299.00
825	80 Column Dot Matrix Printer	\$ 625.00
830	Acoustic Modem	\$ 159.00
650	Interface Module	\$ 169.00
410	Cassette Recorder	\$ 80.00
CX30-04	Paddle Controls	\$ 17.95
CX40-04	Joysticks (pair)	\$ 17.95

INTRODUCING ASAP'S

Atari 800 16K RAM Module: \$55.00

1 year warranty parts & labor

Atari Software (Many more available)

Basketball	\$ 30.00
Super Breakout	\$ 30.00
Chess	\$ 32.00
Video Easel	\$ 25.00
3-D Tic Tac Toe	\$ 25.00
Star Raiders	\$ 36.00
Asteroids	\$ 32.00
Music Composer	\$ 42.00
Educational ROM	\$ 19.95
Assembler/Editor	\$ 45.00
Teletink I	\$ 24.00
Space Invaders	\$ 30.00
Kingdom	\$ 12.95
Missile Command	\$ 32.00
Biorhythm	\$ 12.95
Graph It	\$ 17.95
Energy Czar	\$ 12.95
Mailing List	\$ 19.95
Touch Typing	\$ 19.95
Stock Charting	\$ 19.95
Stock Analysis	\$ 19.95
Bond Analysis	\$ 19.95
Word Processor	\$119.00
Personal Finance	\$ 64.95
Microsoft BASIC	\$ 75.00
Ghost Hunter (Cassette)	\$ 25.00
Ghost Hunter (Disk)	\$ 30.00

Toll free outside California:

(800) 421-7701

Inside California:

(213) 595-6431

(714) 891-2663

BYTE Printer Directory

Curtis P. Feigel
Technical Editor

To say that the printer market has blossomed is to make an apt analogy. An immense crop of printers with exciting features has flourished in the last few years. Unfortunately, a handful of thorns is waiting for those who make a hasty grab without carefully examining the field. Only an understanding of the present state of the art and knowledge of the printers available will help the personal-computer user choose the best printer for an application.

The printer provides an important and common man-machine interface. Recent advances in printer technology allow the use of personal computers in many new ways: producing letters, checks, and even pictures. However, a printer still represents a large investment to most people—sometimes as much as the rest of the computer system. BYTE provides this list of printers and their features to help you get the necessary information.

The newest printers offer standard features that illustrate the progressive thinking of designers and manufacturers, at a low cost that would have been impossible two years ago. Through the use of dedicated microprocessors, new printers pro-

vide bidirectional printing, short-line seeking, and multiple-font capability—features that are difficult to implement with mechanical printers. The presence (or absence) of these features is the key to selection of the proper printer.

Understanding Printers

Although a variety of printing technologies is available, the traditional *impact* printer is still the most common. The other printing concepts find favor in special applications (e.g., if copy must be produced at high speed, an ink-jet system might be used) where special attributes are used to advantage. The following is a description of the printing technologies you will discover in the microcomputer printer market:

Impact: Uses a type element with a raised character that strikes an inked ribbon against the paper, thus transferring the outline of the character to the paper. This is the same concept used in the common typewriter, but manufacturers have added several twists to the idea. In *daisy-wheel* or *thimble-type* printers, the complete set of type elements can be removed and replaced as a single

unit. This makes it possible to change type fonts (the style of the letters) or install characters not commonly available.

The typical small-computer owner usually opts for an impact printer that uses a *dot-matrix* type element. This device prints characters made from dots in a closely spaced grid. It is popular because of its flexibility. In many units, the characters' form is stored in memory and can be changed easily. The presence or absence of dots can be controlled by the computer (in some fashion) so that graphs and pictures can be printed.

A rather unusual printer that might be classed with impact types uses a stylus to form the characters (an idea analogous to having a machine that draws with a pencil). The theory is that this system should provide the flexibility of a dot-matrix design with the fully formed characters of a daisy-wheel-type printer.

Thermal and Electrostatic: Both use a form of the dot-matrix print head, but depend on special paper to create the image, rather than ink from a ribbon. These printers are usually small, allow only 20 or 40 characters on a line, and have few extra features

Surprising Symmetries in Design and Letterforms . . .



"Kim is the Escher-of-the alphabet. He has created a new art-form that blends beauty and ingenuity, and has made it so clear to us that we can try it ourselves"

Issac Asimov, Author

Inversions

A Catalog of Calligraphic Cartwheels by Scott Kim
Foreword by Douglas Hofstadter
Backword by Jef Raskin

The striking designs that grace the pages of Scott Kim's new book appeal to us as both viewers and readers, for words themselves are the subject of his calligraphic creations. With imagination and care, Kim bends, shapes, and sculpts words into novel and intriguing works of art. *Inversions* is more than a showpiece, though, as the author details the theories and techniques that lie behind his art and draws parallels to related perceptual exercises in music, linguistic wordplay, and even mathematics.

ISBN 0-07-034546-5
128 pages; softcover
\$8.95

"Scott Kim has perfected a personal art form—one with grace, elegance, subtlety, and surprises."

Douglas Hofstadter, author

Gödel, Escher, Bach: an Eternal Golden Braid

"Scott Kim's *Inversions* . . . is one of the most astonishing and delightful books ever printed."

Martin Gardner

Scientific American

" . . . sure to dazzle and delight anyone to whom writing is dear . . ."

The New York Times Book Review



A New Frontier Between Sight and Sound . . .

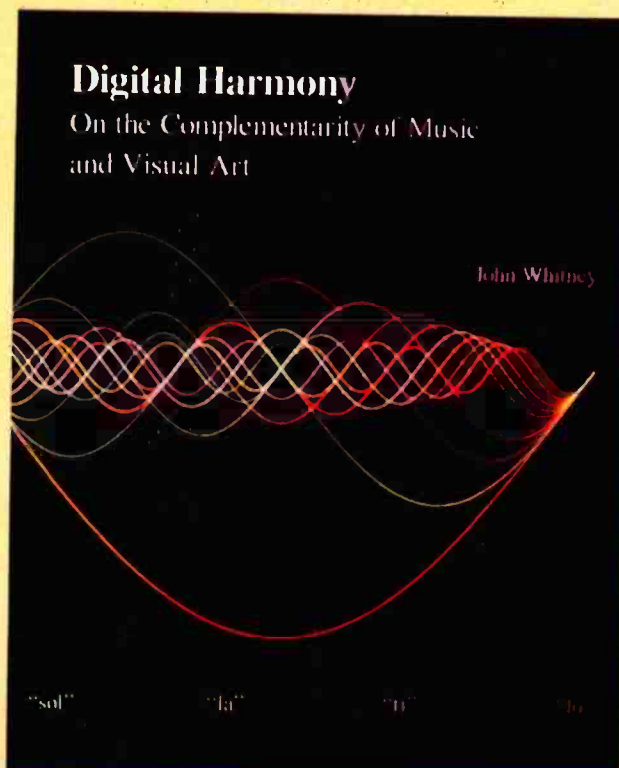

"Here in this beautiful book John Whitney marries art to modern technology. Scenes that previously we would have strained to imagine, Whitney can now show us."

Jearl Walker, Scientific American

Digital Harmony by John Whitney

On the Complementarity of Music and Visual Art

Digital Harmony is the art of music made visible. Already acclaimed for pioneering the striking visual effects in *2001* and *Star Wars*, author John Whitney here establishes a new art form in representing the magic of music through computer-generated color graphics. The author also delves into the technicalities of his work, offering to share his methods with others who would explore this field of vast artistic promise. *Digital Harmony* is the vanguard of what is sure to be one of the most exciting art forms for years to come.

ISBN 0-07-070015-X
240 pages; hardcover
\$21.95

"Digital Harmony is a peek into the future when computerization will bridge the gap between art, science, and self-understanding. I loved it."

Seymour Papert

Author, Professor Massachusetts Institute of Technology

Call Toll-Free 800/258-5420

BYTE Books 70 Main St. Peterborough, N.H. 03458

**NOW!
MORE THAN EVER**



When You Have To Face A Deadline...

Since its introduction, Pascal/MT+ has been used to produce thousands of professional solutions to industrial, business and systems level application problems. In addition to implementing the complete ISO STANDARD, Pascal/MT+ contains a host of powerful features and facilities which make program construction a snap!

Pascal/MT+ is a total programming system including our native machine code compiler, linker, Pascal-level debugger, disassembler, run-time subroutine library and the exclusive SpeedProgramming™ Package

With the advent of 16-bit machines and increasing customer demands, you can no longer afford to write programs in anything but a professionally constructed and professionally supported package like Pascal/MT+. MT MicroSYSTEMS has demonstrated its commitment to keeping your programs and programmers productive with our recent introduction of Pascal/MT+86 and Pascal/MT+88K for the 8086.

While Pascal/MT+ provides the capability to write non-portable programs when the need arises, true portability between radically different machines is a reality while still translating

into efficient, optimized native machine code.

Our Pascal/MT+ compilers and SpeedProgramming Package are available on a wide variety of processors and operating systems, with more to come! We are continually working to provide innovative solutions to the ever present problem of translating your ideas into software solutions.

The Pascal/MT+ System Compiler:

- Generates ROMable Native Code
- Complete ISO Standard (superset of Jensen & Wirth)
- Powerful Extensions Include:**
 - Modular Compilation, Direct production of binary relocatable modules
 - Dynamic strings
 - Chaining
 - Powerful Overlay system
 - Address and Size returning functions
 - Bit manipulation (test, set, clear, shifts)
 - Byte manipulation (high, low, swap)
 - Imbedded assembly language
 - Easy linkage to external assembly language
 - Full NEW and DISPOSE procedures
 - Direct access to I/O ports
 - Fast floating point, both software and AMD 9511
 - Accurate 18 digit BCD (fixed point, 14,4)
 - Include files
 - Hex literal numbers
 - and more...

...Arm Yourself With Pascal/MT+®



Linker:

Combines relocatable modules into executable files • Can generate Hex format for use with PROM programming.

Interactive Symbolic Debugger:

Variable display • High-level breakpoints by procedure/function name • Tracing/single step by Pascal statement • Procedure/function entry and exit trace available.

Disassembler:

Combines a relocatable module with its listing file to produce interleaved Pascal and approximate assembly language code.

The SpeedProgramming Package™:
The SpeedProgramming Package is an integrated set of tools which allows you to create Pascal/MT+ programs, check them for correct syntax and undefined identifiers, format them to display flow of control, and do this all within the editing environment before you ever invoke the compiler. Programmers like SpeedProgramming because it frees them from the time consuming chore of repeated compilations to correct simple syntactic and typing errors. Managers find that SpeedProgramming improves productivity, thereby reducing development costs. SpeedProgramming combined with our field tested Pascal/MT+ package gives you a comfortable, powerful, interactive programming environment in which to create your professional quality software. Your products demand production quality tools. Order Pascal/MT+ with SpeedProgramming today!

Screen Editor:

User configurable • Standard random cursor movement, file access, search and replace, insert, delete, exchange, etc. • Structured language editing features such as automatic indent, line adjustment, reading from and writing to a file, block text insertion and duplication. • Requires: 24 x 80 CRT (or larger), ASCII keyboard (7 bit data), random cursor addressing.

Interactive Syntax Scanner:

Finds syntax errors in text being edited • Enters SPEED, puts cursor at error, prints error text.

Variable Checker:

Catches undefined and mis-spelled variables before the compiler is invoked.

On-Line Reformatter:

Beautifully programs in seconds • Clearly shows structure and program flow.

Source Code Management Tools:

Automatic Modification Log and Backup utility program.

PRICING: *Read carefully, some systems do not include the SpeedProgramming Package but do include the compiler, linker, disassembler, debugger and other utilities.

AVAILABLE NOW!

*8080/8085/Z80 without SpeedProgramming 56K or larger CP/M	Price \$350.00
8080/8085/Z80 complete including SpeedProgramming 56K or larger CP/M	Price \$475.00
8080/8085/Z80 for special MP/M environments	Contact Factory
*8086/8088 without SpeedProgramming CP/M-86 or MP/M-86, requires 116K program area	Price \$600.00
8086/8088 complete including SpeedProgramming	Price \$800.00

All 8086/8088 packages include 9511 and 8087 support and program to convert MT object files into Intel OBJ 8086 files.

Digital Research, Inc. is now the sole distributor for Pascal/MT+, and is proud to add it to the Digital Research family of operating systems, languages and utilities.

Available on 8" (3740) Single Density Disks. Contact Distributors For Other Formats.

Pascal/MT+, CP/M, MP/M are trademarks of Digital Research, Inc.

FOR: 8080/8085/Z80/8086

DIGITAL RESEARCH™

P.O. Box 579
160 Central Ave.
Pacific Grove, CA. 93950
Phone No. 408/849-3896
TWX 910-380-5001

*All prices and specifications subject to change without notice.

Circle 278 on Inquiry card.

www.americanradiohistory.com

because of their low cost. They are most popular in calculator-sized computer systems where space is at a premium.

Ink-Jet: This is actually a controlled spray of ink directly onto paper. Small droplets of ink formed at a nozzle are directed by electrostatic fields to cover the proper areas on the paper. This is a fast way to print whole pages because the inertia of the droplets is far smaller than that of mechanical systems. The system is flexible because the form of each character is computer-controlled.

Laser: Uses a raster-scan system similar in idea to a video display. The laser moves across a sensitized drum, "burning" a row of dots; as each row is completed, the beam moves down to begin the next row. The image is then transferred to paper, just as in a photocopier. Obviously, laser printers contain precision optical and mechanical parts, so they cost tens of

thousands of dollars; but they are very flexible and fast.

Because many of these systems are relatively new, manufacturers have not been able to bring down their cost. Because of this money factor, we will mainly consider the impact, electrostatic, and thermal types. Even the least expensive of today's impact printers has features that set it apart from the teletypewriter that was the common hard-copy appliance 10 years ago. Here is an explanation of the concepts behind these features:

Print Quality: An obvious consideration for most people and small businesses. The quality of the characters that appear on paper is mostly determined by the printer technology used. Daisy-wheel and thimble-type printers produce *fully formed* characters that look similar to those produced by typewriters or typesetting equipment. Dot-matrix printers, although usually faster, are not as a

rule capable of producing high-quality printing (the exception is multipass types that allow their dots to overlap, giving a fully formed look). In dot-matrix printers, the number of dots in the matrix is a good guide to the visual quality of the printing (i.e., a 9-by-14-dot character will probably look far better than a 5-by-7-dot one).

Character Sets: They can be an overriding factor if special characters are required. Although the type elements of daisy-wheel and thimble-type printers can be changed manually, many dot-matrix printers can be *programmed* with alternate character sets; some come with several preprogrammed sets. Almost all printers follow the ASCII (American Standard Code for Information Interchange) convention that assigns each standard character with a 7-bit binary number. Few printers, however, allow all 128 ASCII characters.

A related concern is the *font*, or style of type, used by the printer. This governs whether parts of the lowercase letters g, j, p, q, and y actually descend below the print line, whether the vertical lines of the characters are slanted, and whether or not the characters have serifs (short lines that extend at an angle from the ends of the main strokes of the letter). Many dot-matrix printers provide a feature to condense or expand the characters horizontally; some even slant or rotate the characters.

Although most printers produce characters that all take the same amount of space, an important feature on high-quality units is proportional spacing. (Perhaps you have noticed that typesetting—such as is used in magazines, newspapers, and books—produces characters that have a variety of widths.) This contributes much to the look of a printed page.

Speed: Many printers include features that allow them to print characters at a high rate. This may be as simple as a character set that is draft-quality (the printer doesn't spend much time making the character look pretty).

ATTENTION GOVERNMENT D P USERS AND PURCHASERS

We represent many fine micro products and manufacturers on the U.S. Government's GSA Schedule, including

***Apple, Cromemco, Micropolis, NorthStar,
Osborne and Seequa Computers***

Purchasing from the Schedule will save you the time consumed by the bid process. Products shipped throughout the United States and world-wide. Visit or write any of our stores for more information or to receive our catalogue of products represented.

**Computers,
Etc.....
the dependable store**

257 West Street, Annapolis, MD 21401 — (301) 268-6505
13A Allegheny Avenue, Towson, MD 21204 — (301) 296-0520
9330 Georgia Avenue, Silver Spring, MD 20910 — (301) 588-3748
6671 Backlick Road, Springfield, VA 22150 — (703) 644-5500
Plaza 38, 2442 Route 38, Cherry Hill, NJ 08002 — (609) 779-0023
Callers outside metropolitan areas served by our stores
Please call (301) 268-5801

*Career Opportunities Available * An Equal Opportunity Employer*

The Logo Language is Here for the Apple II

```
TO SQUIRAL :ANGLE :DISTANCE
  IF :DISTANCE > 200 THEN STOP
  FORWARD :DISTANCE
  RIGHT :ANGLE
  SQUIRAL :ANGLE :DISTANCE + 3
END
```

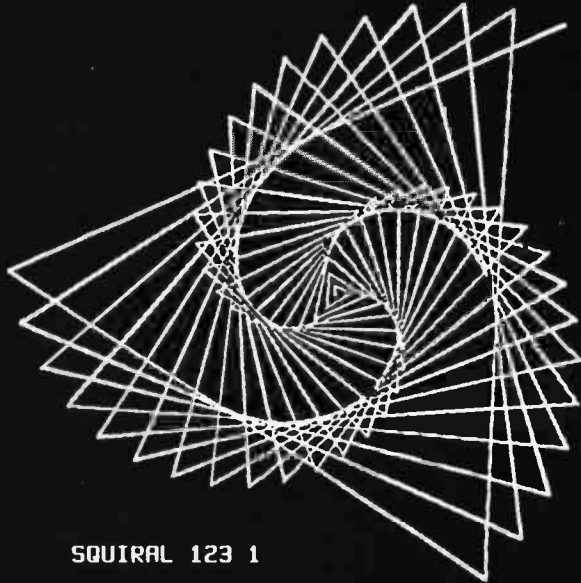

SQUIRAL 123 1

Terrapin, the Turtle Company, brings you the Terrapin Logo Language for the Apple II with Turtle graphics, now ready for immediate delivery.

The Terrapin Logo language is a sophisticated and powerful language that is easy for anyone to use. Although originally intended for children, the Logo language is one that the most advanced programmers will enjoy using too. It includes many features common to artificial intelligence research languages permitting programs of great power to be written quickly and easily. Writing comparable programs in other languages is usually much more difficult and time consuming.

The Turtle graphics is fun and easy. With simple commands such as FORWARD, RIGHT, and PENUP you can draw in six hi-res colors. In just a few short sessions you can learn to create figures more complex than the one above whether you know how to program or not.

But the Terrapin Logo language is more than just a graphics language. It supports:

- list structure, allowing easy manipulation of words (strings) and lists
- user defined procedures which can be used exactly as if they were part of the language.
- fully integrated screen editor for procedures and text
- floating point and integer arithmetic
- a total of 120 primitives (commands) including 30 graphics commands
- recursion
- assembly-language interface capability

The Terrapin Logo language was developed by the Artificial Intelligence lab at the Massachusetts Institute of Technology. Terrapin is now authorized by MIT to distribute the results of its 12 years of research to you. To provide quality support for the language, Terrapin has assembled a team that includes two of the three authors who developed the Logo language for the Apple II at MIT, as well as Dr. Feurzeig, the originator of the Logo language.

Every copy of the Terrapin Logo language comes with complete documentation. To run the language, a 48K Apple II with a 16K RAM card or a language card, and one disk drive is required.

Terrapin also offers the robot Turtle, and the following books: *Turtle Geometry*, *Special Technology for Special Children*, *Mindstorms*, *Katie & the Computer*, and *Apple Logo* from Byte Books.

Suggested retail price: \$149.95

To order or for more information, call or write:



Terrapin, Inc.

678 Massachusetts Avenue
Cambridge, MA 02139
(617) 492-8816

"Logo" trademark under license from Bolt, Beranek & Newman, Inc.

However, two logical concepts are important to the speed of any printer: bidirectional printing and short-line seeking. A printer that does bidirectional printing does not waste time moving the print head from the end of one line, at the right of a page, to the beginning of the next line at the left. It simply prints the next line backward, beginning at the right. A short-line-seeking printer skips over multiple spaces at a higher than normal speed and slows when the print head is located at the first printable character.

Forms: Paper that the printer will accept is usually limited to one or two

types. A large amount of computer printouts are done on *fanfold* paper. However, *cut sheets* are preferred for correspondence and reports. Some printers accept only roll paper, as used on adding machines. *Forms controls* that allow the printer to automatically find the top of the next fanfold page, and feeding mechanisms that load the printer with a single sheet of paper, are also available.

(Fanfold continuous paper is separated into sheets by perforations along the top and bottom of each "page." A series of holes is provided along each margin for a *tractor* to move the paper vertically through the printer. Fanfold paper is available in

a variety of styles and widths, including preprinted forms such as invoices and checks.)

Following is a listing of printer manufacturers and their products. Where possible, the information has been taken directly from the maker's literature. But please remember this caveat: a manufacturer may emphasize one feature and neglect to mention other features. Although we have made every attempt to keep the specifications accurate and up-to-date, errors do occur. Also, keep in mind that manufacturers reserve the right to alter specifications without notice.

A D Data Systems Inc.
200 Commerce Dr.
Rochester, NY 14623
(716) 334-9649

Addmaster Corporation
416 Junipero Serra Dr.
San Gabriel, CA 91776
(213) 285-1121

170: impact, 5 by 7 dot matrix; 18 or 21 char/line; 50 cps; 6 line/inch; ASCII or Baudot characters; time-of-day clock with battery backup; self test; friction feed; 2.25 inch wide roll paper; RS-232, 63 char buffer; Centronics or Apple II parallel; 8.25 by 12 by 5; 7 lbs; \$299

180: impact, 5 by 7 dot matrix (9 by 7 optional); 34 or 40 char/line; 48 cps; 6 line/inch; ASCII or Baudot characters; time-of-day clock with battery backup; self test; friction or tractor feed; 4.5 inch wide roll paper or labels; RS-232, 40 char buffer; Centronics parallel; \$399

Alphacom Inc.
3031 Tisch Way
San Jose, CA 95128

Sprinter 20: thermal, 5 by 8 dot matrix; 20 char/line; 96 char ASCII; graphics; rotated printing; roll paper; RS-232, 110 to 9600 bps; parallel; \$175

Sprinter 40: thermal, 5 by 8 dot matrix; 40 char/line; 96 char ASCII; graphics; rotated printing; roll, fanfold paper; RS-232, 110 to 9600 bps; parallel; \$350

Alps Electric Inc.
100 North Center Ave.
Rockville Center, NY 11570

(516) 766-3636
1200: stylus; 15, 18, 24, or 36 char/line; 6 cps; four colored ballpoint pens; graphics; all characters created under software control of the host computer; friction feed; 2.25 inch wide roll paper; 8.5 by 5.9 by 1.25; 1.1 lbs; \$450

1100: same as 1200 except: one color only; \$325

Amperex Electronics Corporation
230 Duffy Ave.
Hicksville, NY 11802

GP300: impact, 9 by 9 dot matrix; 120 or 144 char/line; 80 or 300 cps; vertical tab; paper out indicator; graphics; self test; two character sets; friction feed and tractor feed; sheet or fanfold paper; RS-232, 300 to 9600 bps; parallel; 20.5 by 17.5 by 7.4; 44 lbs; \$3165

Anacom General Corporation
Computer Products Division
1116 Vallencia Dr.
Fullerton, CA 92631
(714) 992-0223

150: impact, 9 by 9 dot matrix; 136 char/line; 150 cps; 6 or 8 line/inch; 96 char ASCII; lowercase descenders; double-width characters; bidirectional printing; short-line seeking; self test; graphics optional; paper-out indicator; top-of-form control; tractor feed adjustable to 15 inches wide; fanfold paper; RS-232, buffer optional; parallel; 34 lbs; \$1495

150Z: impact, dot matrix; 40

or 220 char/line; 180 cps; four selectable char sets; graphics; tractor feed; fanfold paper; RS-232; parallel; \$1650

160: impact, 9 by 9 dot matrix; 80 char/line; 150 cps; 6 or 8 line/inch; 94 char ASCII; graphics; lowercase descenders; paper-out indicator; top-of-form control; tractor feed adjustable to 10 inches wide; fanfold paper; RS-232 with handshaking, 110 to 9600 bps; 256 char buffer (1K to 4K char buffer optional); parallel; 17.5 by 18.5 by 7.9; 34 lbs; \$1450

160Z: same as 160 except: 96 char ASCII, 2 pass high-quality mode; preprogrammed and programmable character sets; 70 by 70 dot graphics; self test; 4K char buffer

Anadex Inc.
9825 De Soto Ave.
Chatsworth, CA 91311
(213) 998-8010

DP8000: impact, 9 by 7 dot matrix; 80 char/line; 112 cps; 6 line/inch; 96 char ASCII; bidirectional printing; vertical tabs; double-width chars; paper-out indicator; self test; tractor feed; fanfold paper; RS-232, 110 to 9600 bps, 2 K char buffer; parallel; 18.6 by 14.2 by 7.3; 27 lbs; user-replaceable print head; \$1125

DP8000 AP: same as DP8000 except: 96 char/line; 134 cps; Apple parallel interface

DP9000: impact, 9 by 9 dot matrix; 80 char/line; 150 cps; 6 or 8 line/inch; 96 char ASCII; bidirectional printing; graphics, 72 by 60; compressed characters give 106 char/line at 200 cps; self test; tractor feed; fanfold paper; RS-232; Centronics parallel; 22 by 15.4 by 8.3; 30 lbs; \$1550

DP9001: impact, 9 by 9 dot matrix; 80 char/line; 120 cps; 96 char ASCII; compressed characters give 132 char/line at 200 cps; tractor feed; fanfold paper; RS-232; Centronics parallel; \$1550

DP9500: impact, 9 by 9 dot matrix; 80 or 132 char/line; 150 cps; 6 or 8 line/inch; 96 char ASCII; lowercase descenders; underlining; double-width characters; condensed characters; bidirectional printing; short-line seeking; graphics; top-of-form control; self test; tractor feed adjustable to 15.6 inches wide; fanfold paper; RS-232, 800 char buffer; Centronics parallel; 35 lbs; \$1650

DP9501: impact, 11 by 9 dot matrix; 80 or 132 char/line; 120 cps; 96 char ASCII; 6 or 8 line/inch; lowercase descenders; double-width characters; compressed characters give 176 char/line at 200 cps; underlining; graphics; bidirectional printing; short-line seeking; paper-out indicator; self test; tractor feed adjustable to 15.6 inches wide; fanfold paper; top-of-form control;

INTRODUCING CALCSTAR.[™] ANOTHER INDISPENSABLE BUSINESS PROGRAM FROM MICROPRO,[™] THE WORDSTAR[™] PEOPLE.

Presenting CalcStar — another standard-setting software product in the WordStar tradition.

CalcStar is MicroPro's new electronic spread sheet and financial modeling program — a sophisticated, yet easy to use, calculating and planning tool for CP/M[®]-based computers.

The ultimate electronic spread sheet.

CalcStar calculates solutions to complex numerical problems in business and finance. Helps you make budget plans and sales forecasts with greater speed and accuracy. And projects figures into the future to answer the "what if" questions you face in business.

And CalcStar also has a unique MicroPro advantage: It joins with WordStar to combine spread-sheet and word-processing capabilities in several powerful ways.

CalcStar software eliminates the need to use ledger paper ever again. It turns your video screen into a "window" on a giant electronic ledger sheet, with up to 600 entries arranged the way you want. Then, by inserting formulas into CalcStar, you create financial models that simulate the future numerically. And predict the outcomes of your business decisions.

When you notice what CalcStar can do for your business, you'll wonder how you ever got along without it. (If you're now a WordStar user, you probably already know the feeling.)

The MicroPro bonus. Like WordStar, CalcStar is packed with innovative features that make it versatile and easy to use. Features like Automatic Forms Mode, which lets an inexperienced user enter data into a spread sheet quickly and with less chance of error.

CalcStar's greatest innovation is its ability to join with WordStar. Which means, for example, you can use WordStar's printing options, like boldface and underlining, to dress up financial documents. And you can insert sections of CalcStar's spread sheets into your WordStar documents.

This kind of flexibility should come as no surprise if you're already familiar with the MicroPro software family — a line of programs designed to work together to multiply your problem-solving power. Visit your MicroPro dealer to find out just how big a difference *all* our products can make in your business. We predict you'll discover it's not just CalcStar or WordStar that's indispensable. It's MicroPro.



A glance at CalcStar features

Runs on CP/M version 2.0 or above, with 80-column screen, addressable cursor, and at least 48K memory. 56K or more is recommended for fullest utilization.

Highly user friendly: Call up full screen of help or use help menu. WordStar-like cursor commands. User's guide shows you the basics. Install from menu OR a WordStar file.

Stores formulas and formats along with data, for convenience and less chance of error.

Math functions include average, minimum, maximum, logarithms, exponents, and regression analysis.

SOFTWARE
THAT MEANS BUSINESS

MicroPro[™]

INTERNATIONAL CORPORATION

1299 Fourth Street, San Rafael, California 94901
(415) 457-8990; Telex: 340-388

CP/M is a trademark of Digital Research, Inc.
Dealer and distributor inquiries invited.



RS-232, 800 char buffer; Centronics parallel; 35 lbs; \$1650
Apple Computer Inc.
10260 Bandy Dr.
Cupertino, CA 95014
(408) 996-1010
Silent Type: thermal, dot matrix; 40 char/line; friction feed; thermally sensitive paper
Astronautics Corporation of America
POB 523
Milwaukee, WI 53201
(414) 671-5500
Autek Systems Corporation
3200 Coronado Dr.
Santa Clara, CA 95051
(408) 496-0400
Axiom Corporation
5932 San Fernando Rd.
Glendale, CA 91202
(213) 245-9244
GP-80M: impact, 5 by 7 dot matrix formed by single hammer; 80 char/line; 30 cps; 6 line/inch; 96 char ASCII; graphics; double-width characters; tractor feed adjustable to 9.5 inches wide; fanfold paper; RS-232; parallel; 13 by 6.75 by 5; 5 lbs; \$399
EX-801 Micro Printer: electrostatic, 5 by 8 dot matrix; 20 or 80 char/line; 5 line/inch; 96 char ASCII; RS-232, 50 to 1200 bps, 256 char buffer; 11.75 by 12.75 by 4.4; 12 lbs; \$599
EX-850 Video-Screen Printer: impact, dot matrix; 13 seconds/page; prints any screen image formed by dots; friction feed; sheet paper; \$1595
IMP-1: impact, dot matrix; 80, 96, or 132 char/line; 100 cps; 96 char ASCII; graphics, 70 by 70 dots; friction feed; sheet paper; RS-232; parallel; \$699
IMP-2: impact, dot matrix; 80, 96, or 132 char/line; 100 cps; 96 char ASCII; graphics; bidirectional printing; friction and tractor feed; sheet or fanfold; RS-232; Centronics parallel, Apple II, PET, and IEEE-488 interfaces
IMP-4: impact, 7 by 9 dot matrix; 80 char/line; 100 cps; 8 line/inch; 96 char ASCII; graphics, 19008 dot/inch; bidirectional printing; friction or tractor feed; sheet, fanfold, or roll paper; RS-232; Centronics parallel, Apple II, and IEEE-488 interfaces
Azurdata
4102 148th Ave. NE

Redmond, WA 98052
(206) 881-5100
40-Column Desktop: impact, 7 by 5 dot matrix; 40 char/line; 80 cps; 96 char ASCII; friction feed; 2.8 inch wide roll paper; RS-232, 1200 bps, 80 char buffer; 10 by 6.5 by 12.75; 11 lbs
40-Column Vehicle-Mounted: same as 40-Column Desktop except: 10.5 to 15 VDC; 0.1 A (standby), 4 A (printing); 6 by 12 by 13.5; 7 lbs
80-Column Desktop: impact, 9 by 9 dot matrix; 80 char/line; 57 cps; 96 char ASCII; double-width characters; bold characters; bidirectional printing; tractor feed adjustable to 10 inches wide; fanfold paper; RS-232, 9600 bps, 80 char buffer; 14.75 by 4.25 by 12; 12 lbs
Base 2
POB 3548
Fullerton, CA 92634
(714) 533-0111
800MST: impact, dot matrix; 80 or 132 char/line; 100 cps; 96 char ASCII; graphics; friction or tractor feed; RS-232, buffer; Centronics parallel
850: impact, 5 by 7 dot matrix; 80 or 132 char/line; 100 cps; 6 line/inch; 96 char ASCII; short-line seeking; bidirectional printing; vertical tabs; graphics; self test; friction and tractor feed; fanfold or roll paper; RS-232, 75 to 9600 bps, 2K char buffer; Centronics parallel; 15 by 11 by 3; 15 lbs; \$799
BDS Computer Corporation
1120 Crane St.
Menlo Park, CA 94025
(415) 325-2115
Canon USA Inc.
—Components
10 Nevada Dr.
Lake Success, NY 11040
(516) 488-6700
Cardinal Scale Manufacturing Company
POB 151
Webb City, MO 64870
(417) 673-4631
2170: impact, 9 by 9 dot matrix; 132 char/line; 100 cps; 96 char ASCII; draft- and high-quality fonts; double-width, tall, boldface, and combination characters; bidirectional printing; short-line seeking; self test; upside-down printing; dual friction or dual tractor drives allow printer to be

loaded with two types of forms; fanfold paper; RS-232; Centronics parallel; 20 by 20 by 7; 70 lbs
Centronics Data Computer Corporation
1 Wall St.
Hudson, NH 03051
(603) 883-0111
150: impact, 7 by 9 dot matrix; 80 char/line; 150 cps; 96 char ASCII; "international" character set optional; bidirectional printing; short-line seeking; top-of-form control; friction or tractor feed; sheet, fanfold, or roll paper to 10 inches wide; Centronics parallel; 14.9 by 13.8 by 5.9; 22 lbs
352: impact, 7 by 8 dot matrix; 132 char/line; 200 cps; 6 or 8 line/inch; 96 char ASCII; alternate character sets optional; bidirectional printing; short-line seeking; vertical tabs; graphics; programmable forms control; friction or tractor feed; sheet, fanfold, or roll paper; RS-232, 50 to 19200 bps, 2K char buffer; Centronics parallel; 22 by 18 by 8; 40 lbs
353: same as 352 except: also has high-quality printing mode at 50 cps
700: impact, dot matrix; 132 char/line; 69 cps; 64 char ASCII (96 char ASCII optional); friction and tractor feed; sheet or fanfold paper; Centronics parallel; \$1460
701: impact, dot matrix; 132 char/line; 60 cps; 64 char ASCII (96 char ASCII optional); bidirectional printing; friction and tractor feed; sheet or fanfold paper; Centronics parallel; \$1700
702: impact, 9 by 7 dot matrix; 132 char/line; 120 cps; 96 char ASCII; bidirectional printing; tractor feed; fanfold paper; Centronics parallel; \$2660
703: same as 702 except: 180 cps; \$2965
704: same as 702 except: 180 cps; RS-232; \$1795
730: impact, 5 by 7 dot matrix; 80 char/line; 100 cps; 6 line/inch; 96 char ASCII; double-width characters; friction or tractor feed; sheet or fanfold paper to 9.5 inches wide; Centronics parallel; 11 lbs; \$795
737: impact, line-wide by 9 dot matrix; 80 char/line; 100 cps; 6 line/inch; 96 char ASCII; lowercase descenders; underlining;

double-width characters; condensed characters; proportional spacing; reverse linefeed; friction or tractor feed; sheet or fanfold paper to 9.5 inches wide; Centronics parallel (RS-232 optional); 12 lbs; \$995
739: impact, line-wide by 9 dot matrix; 80 or 132 char/line; 100 cps; 6 line/inch; 96 char ASCII; lowercase descenders; double-width characters; condensed characters; underlining; bidirectional printing; reverse linefeed; paper-out indicator; graphics; proportional spacing; self test; top-of-form control; friction feed; roll or fanfold paper to 9.5 inches wide; RS-232; 14.5 by 11 by 5; 12 lbs; \$995
753: impact, line-wide by 9 dot matrix; 80 char/line; 150 cps; 6 or 8 line/inch; 96 char ASCII; bidirectional printing; short-line seeking; programmable forms control; paper-out indicator; tractor feed; fanfold paper; Centronics parallel; 24.5 by 19.5 by 8; 60 lbs
761: impact, dot matrix; 132 char/line; 30 cps; 64 char ASCII (96 char ASCII optional); tractor feed; fanfold paper; RS-232, 300 bps; \$1865
779: impact, dot matrix; 80 char/line; 60 cps; 64 char ASCII; friction or tractor feed; sheet or fanfold paper; Centronics parallel; \$1485
Mico PI: electrostatic, dot matrix; 40 char/line; 100 cps; 90 char ASCII; friction feed; aluminized roll paper; Centronics parallel
Commodore Business Machines
3330 Scott Blvd.
Santa Clara, CA 95051
(408) 727-1130
4022: impact, 5 by 8 dot matrix; 40 char/line; 30 cps; 6 line/inch; 96 char ASCII, preprogrammed alternate character set; lowercase descenders; double-width characters; bold characters; bidirectional printing; self test; top-of-form control; tractor feed; fanfold paper; IEEE-488 interface; 14.75 by 13 by 4.25; 14.6 lbs; \$795
Computer Devices Inc.
25 North Ave.
Burlington, MA 01803
Computer Printers International
340 East Middlefield Rd.
Mountain View, CA 94043

MACRO OPERATIONS FOR MICRO SYSTEMS

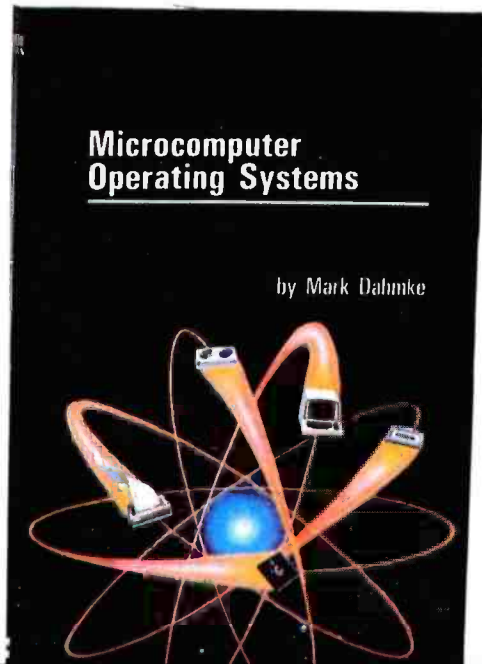
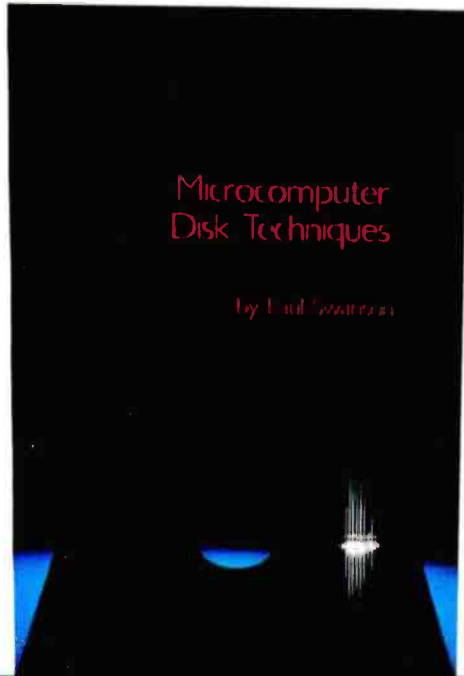

Microcomputer Disk Techniques by Paul Swanson

Rarely has so much useful information been presented as clearly and logically as it is in *Microcomputer Disk Techniques*. The author shows how sophisticated methods used on larger computers may be implemented on a personal computer. Building from a basic introduction, Paul Swanson goes on to detail random-access, sequential, and key files, parameter-driven subroutines, and, finally, the art of programming itself. This volume will help both novices and experienced computer users squeeze every bit of use out of a disk system.

Price \$15.00
ISBN 0-07-062582-4

Microcomputer Operating Systems by Mark Dahmke

A uniquely helpful volume, *Microcomputer Operating Systems* details the structures and capabilities of the operating systems that link the computer user to the hardware itself. The author explains small systems and their monitors, larger systems with terminals and disk storage, and the function of command languages. Data and memory management, multiprocessing, user interference, multiuser environments, and system design are among the more specific topics included in this comprehensive guide. Two particular operating systems—CP/M and Unix—are covered in appendices.

Price \$15.95
ISBN 0-07-033356-4

Please send _____ *Microcomputer Disk Techniques* \$15.00
_____ *Microcomputer Operating Systems* \$15.95

Name _____

Address _____

City _____

State _____

Zip _____

Call Toll-Free 800/258-5420

Check Enclosed _____

Bill Visa/
MasterCard # _____

Expiration Date _____

BYTE Books 70 Main Street Peterborough, N.H. 03458

Please add .75 per book to cover shipping cost.



B 3

Circle 58 on inquiry card.

www.americanradiohistory.com

Go with McGraw-Hill's

**TAKE ANY 3 BOOKS
FOR ONLY \$1⁰⁰ EACH**
when you join the
**COMPUTER PROFESSIONALS'
BOOK CLUB** (values up to \$75.00)*



THE PASCAL HANDBOOK. By Jacques Tiberghien. 471 pp. A single reference manual that tames this unruly language. Every feature of Pascal is explained in a brilliantly organized format that covers the major Pascal dialects, including Jensen and Wirth's original definition, with the CDC implementation ... the proposed ISO Standard ... UCSD Pascal ... Pascal 1000 (HP1000) ... OMSI Pascal-1 ... and Pascal/Z.
582365-9B \$35.00
(Counts as 2 of your 3 books)

MICROPROCESSOR APPLICATIONS MANUAL. By Motorola Semiconductor Products, Inc. 720 pp., illus., 8½ x 11 format. With nuts-and-bolts practicality, this manual by the Motorola people (who should know) gives you detailed applications information on microprocessors. Assumes no prior knowledge on your part about MPUs.
435/278B \$42.50
(Counts as 2 of your 3 books)

COMPUTER CAPACITY. By Melvin J. Strauss. 288 pp., tables and charts. The key purpose of the book is to provide both senior management and DP practitioners with a methodology for identifying and quantifying issues of capacity and demand within the data center without becoming entrapped by language problems
582317-9 \$24.95

BUILD YOUR OWN Z80 COMPUTER. By Steve Ciarcia. 330 pp., diagrams, softbound. Written for people who don't need an introductory electronics handbook. Its admirably achieved objective is to present a practical, step-by-step analysis of digital computer architecture and the construction details for a complete and functional microcomputer.
109/621 \$15.95

DATA STRUCTURES USING PASCAL. By Aaron M. Tenenbaum and Moshe J. Augenstein. 544 pp., illus. With its emphasis on structured design and programming techniques, this definitive work takes you on a trailblazing journey through Pascal. Separate chapters are devoted to the stack, recursion, queues and lists, Pascal list processing, trees, graphs and their applications.
582230-X \$23.95

HOW TO BUILD YOUR OWN WORKING MICROCOMPUTER. By Charles K. Adams. 308 pp., 214 illus. and tables. Everything you need to know to build your own microcomputer with a handful of chips! The author takes you through the hardware ... assembly and running of the system ... and details the instruction set and mechanics of programming.
582267-9 \$16.95

APPLE PASCAL: A Hands-On Approach. By Arthur Luehrmann & Herbert Peckham. 426 pp., spiral-bound. Finally, a how-to-use-PASCAL book for Apple computer users that makes a complex language as easy as (forgive us!) applesauce. Takes you from "total ignorance" all the way up to very impressive competence in the use of that rather complex language, PASCAL.
491/712 \$14.95

MICROPROCESSORS/MICROCOMPUTERS/SYSTEM DESIGN. By Texas Instruments Learning Center and the Engineering Staff of Texas Instruments, Inc. 634 pp., illus., outsized 7¼ x 10¼ format. The book takes you through the development of memory-to-memory architecture, shows you the components, and details programming methods and techniques.
637/58XB \$26.95
(Counts as 2 of your 3 books)

MINICOMPUTER SYSTEMS: Organization, Programming, and Applications. By Richard H. Eckhouse, Jr. and L. Robert Morris. 2nd Ed., 491 pp., illus. Updated, revised, and expanded, this is a book for every systems programmer, systems designer, computer scientist, and application specialist who wants to know more about microcomputer hardware, software, and design.
787/026 \$21.95

AUTOMATIC DATA PROCESSING HANDBOOK. Edited by The Diebold Group. 976 pp., 269 illus. Written by a staff of internationally recognized authorities on ADP, this comprehensive handbook explains systems, programming and the languages, communications processes, and the design and installation of today's computers.
168/075B \$49.95
(Counts as 2 of your 3 books)

SOFTWARE DEBUGGING FOR MICROCOMPUTERS. By Robert C. Bruce. 351 pp., illus. Takes you through the fundamental methods for finding errors, glitches, and faults in programs ... goes on to techniques for tracking down and exterminating program bugs ... then combines these techniques into a complete debugging plan.
582075-7 \$18.95

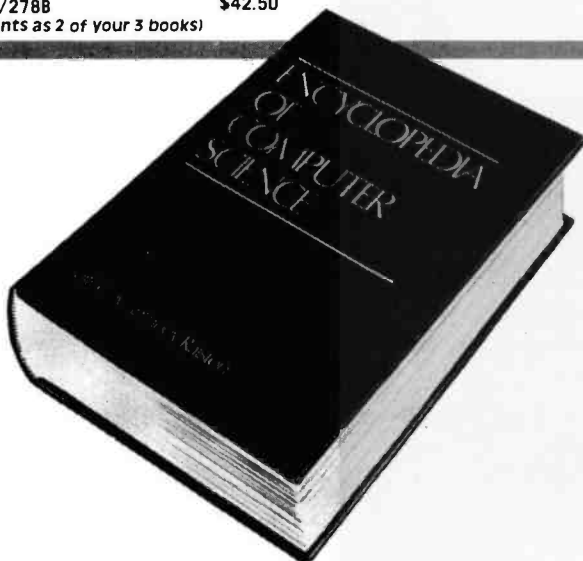

ENCYCLOPEDIA OF COMPUTER SCIENCE. Edited by Anthony Ralston and C. L. Meek. 1,500 pp., 60 illus., 100 charts, 7 x 10 format. This first and only in-depth coverage of the entire field of computer science in a single volume is comprehensive and completely up to date.
769/01X A \$60.00
(counts as 3 of your 3 books)

EXPERIENCE!

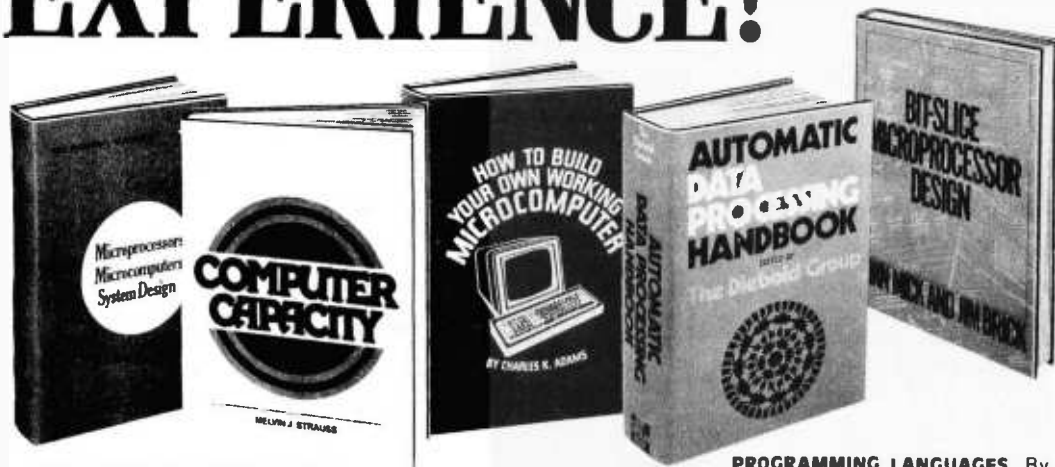

THE DEVIL'S DP DICTIONARY. By Stan Kelley. Bootle. 160 pp., softbound. This devilishly clever little book is guaranteed to fill anyone who has ever slaved over a hot terminal with savage delight. Some 500 computer words and terms are misdefined, from abacus to your program. 340/226 \$7.50

MICROCOMPUTER INTERFACING. By Bruce Artwick. 352 pp., 117 illus. In this up-to-date, complete design guide you'll find the detailed descriptions and explanations necessary to enable you to select, build, and interface micro-computer systems to virtually all applications. Advanced interface devices and methods are thoroughly examined and illustrated. 789/436 \$24.95

PERSONAL COMPUTING: Hardware and Software Basics. Electronics Book Series. 224 pp., 175 illus., 8 1/2 x 11 format. Gives you comprehensive guidance to the present state of the art in personal computers—an overall survey of the technology and methods available to perform various tasks, facts about the work others are doing—and just how they are doing it. 191/514 \$24.50

PROGRAMMING AND INTERFACING THE 6502—With Experiments. By Marvin L. De Jong. 414 pp., heavily illus., softbound. This guide not only teaches you all you must know about programming and interfacing the 6502, but it also carries you to a high level of understanding and proficiency quickly and painlessly. 582080-3 \$15.95

Z80 USERS MANUAL. By Joseph Carr. 326 pp., with diagrams, charts and tables. Takes you through every opportunity the ZAP can offer. It covers Z80 pin definitions, CPU control signals, support chips, interfacing peripherals, and much more. It also includes a 177-page Z80 instruction set so you can study the instructions on a one-by-one basis. 582336-5 \$18.95

ELECTRONIC GAMES: Design, Programming, and Troubleshooting. By W. H. Buchsbaum and R. Mauro. 335 pp., 338 illus. Information you need to design, program, and troubleshoot electronic games is right here in this widely popular hands-on guide. 087/2108 \$26.95 (Counts as 2 of your 3 books)

PROGRAMMING LANGUAGES. By Allen B. Tucker, Jr. 439 pp., illus. Gives you not only the principles of design but the applications of six major programming languages. Shows you their strengths and weaknesses in solving various representative "benchmark" problems. 654/158B \$28.50 (Counts as 2 of your 3 books)

BIT-SLICE MICROPROCESSOR DESIGN. By John Mick and Jim Brick. 398 pp. All in one place—the crucial information you've been needing about the 2900 family of bit-slice microprocessor components. This remarkable "first" designs right before your eyes not just one but two complete 16-bit machines! 417/814 \$24.00

Be sure to consider these important titles as well!

6502 SOFTWARE DESIGN. By L. J. Scanlon 582138-9 \$10.50

THE GIANT HANDBOOK OF COMPUTER PROJECTS. By the Editors of 73 Magazine 582012-9 \$15.95

SYNTAX OF PROGRAMMING LANGUAGES: Theory and Practice. By R. C. Backhouse 582064-1B \$25.95 (Counts as 2 of your 3 books)

STRUCTURED PROGRAMMING: Theory and Practice. By R.C. Linger, H.D. Mills, & B.I. Witt 788/537B \$22.95 (Counts as 2 of your 3 books)

THE BYTE BOOK OF PASCAL. Edited by B. W. Liffick 789/673B \$25.00 (Counts as 2 of your 3 books)

THE Z-80 MICROCOMPUTER HANDBOOK. By W. Barden, Jr. 784/914 \$8.95

COMPILER DESIGN AND CONSTRUCTION. By A. Pyster 582026-9 \$24.50

COMPUTER PERIPHERALS FOR MINICOMPUTERS, MICROPROCESSORS AND PERSONAL COMPUTERS. By L.C. Hohenstein 294/518 \$19.50

16-BIT MICROPROCESSOR ARCHITECTURE. By T. Dollhoff 582003-X \$24.95

PRINCIPLES OF INTERACTIVE COMPUTER GRAPHICS. By W. M. Newman & R. Sproull 463/387B \$28.95 (Counts as 2 of your 3 books)

*If you join now for a trial period and agree to purchase three more books—at handsome discounts—during your first year of membership. (Publishers' prices shown)

Why YOU should join now!

■ **BEST AND NEWEST BOOKS IN YOUR FIELD**—Books are selected from a wide range of publishers by expert editors and consultants to give you continuing access to the best and latest books in your field.

■ **BIG SAVINGS**—Build your library and save money too! Savings ranging up to 30% or more off publishers' list prices—usually 20% to 25%.

BONUS BOOKS—You will immediately begin to participate in our Bonus Book Plan that allows you savings of between 70%—80% off the publishers' prices of many professional and general interest books!

■ **CONVENIENCE**—12-14 times a year (about once every 3-4 weeks) you receive the Club Bulletin FREE. It fully describes the Main Selection and alternate selections. A dated Reply Card is included. If you want the Main Selection, you simply do nothing—it will be shipped automatically. If you want an alternate selection—or no book at all—you simply indicate it on the Reply Card and return it by the date specified. You will have at least 10 days to decide. If, because of late delivery of the Bulletin you receive a Main Selection you do not want, you may return it for credit at the Club's expense.

As a Club Member you agree only to the purchase of 3 books during your first year of membership. Membership may be discontinued, by either you or the Club at any time after you have purchased the 3 additional books.

Other McGraw-Hill Book Clubs: Accountants' and Controllers' Book Club • Architects' Book Club • Chemical Engineers' Book Club • Civil Engineers' Book Club • Electronics and Control Engineers' Book Club • Mechanical Engineers' Book Club

For more information, write to:
McGraw-Hill Book Clubs
 1221 Avenue of the Americas, 26th fl., New York, NY 10020

MAIL THIS COUPON TODAY

McGraw-Hill Book Clubs
 Computer Professionals' Book Club
 P.O. Box 582, Hightstown, New Jersey 08520

Please enroll me as a member and send me either the ENCYCLOPEDIA OF COMPUTER SCIENCE, billing me only \$3.00, or any three other books, billing me only \$1.00 each, plus local tax, shipping and handling. I agree to purchase a minimum of three additional books during my first year of membership as outlined under the Club plan described in this ad. A shipping and handling charge is added to all shipments.

Check here if you want ENCYCLOPEDIA OF COMPUTER SCIENCE (769/01X).

Check here if you prefer three other volumes, and indicate below by number the books you want.
 A few expensive books (noted in the description) count as more than one choice.

Name _____

Address/Apt. _____

City/State/Zip _____

Corporate Affiliation _____

This order subject to acceptance by McGraw-Hill. All prices subject to change without notice. Offer good only to new members. Orders from outside the U.S. cannot be accepted.

P39549

(415) 969-6161
Continental Resources Inc.
175 Middlesex Turnpike
Bedford, MA 01730
(617) 275-0850
Coosol Inc.
POB 743
Anaheim, CA 92805
101B-48E: impact, 5 by 7 to 10 by 14 dot matrix; 48 char/line; 100 cps; 6 line/inch; 96 char ASCII; friction feed; 4 inch wide roll paper; RS-232, 110 to 9600 bps; parallel; 12 lbs; \$355
101B-80E: impact, 5 by 7 to 10 by 14 dot matrix, multipass; 80 char/line; 160 cps; 6 line/inch; 96 char ASCII; tractor feed adjustable to 10 inches wide; RS-232, 110 to 9600 bps; parallel; 20 lbs; \$545
102B-133E: impact, 5 by 7 to 10 by 14 dot matrix, multipass; 132 char/line; 160 cps; 6 line/inch; 128 char ASCII; TRS-80 graphics characters; bidirectional printing; RS-232, 110 to 9600 bps; parallel; 20 lbs; \$595
Data Electronic Devices (Data ED)
18 Bridge St.
Salem, NH 03079
(603) 893-2047
DE-80SG: impact, 7 by 9 dot matrix; 80 char/line; up to seven preprogrammed character sets including bar code; graphics; tractor feed; fanfold paper; RS-232 with handshaking, 50 to 9600 bps; 17 by 16 by 7; 20 lbs; \$995
Data General Corporation
Route 9, 15 Turnpike Rd.
Westborough, MA 01581
(617) 485-9100
Dasher: impact, dot matrix; 60 cps; RS-232, to 19200 bps
Dasher TP2: same as Dasher except: 180 cps
Datapoint
9725 Datapoint Dr.
San Antonio, TX
(512) 690-7151
Dataproducts Corporation
6200 Canoga Ave.
Woodland Hills, CA 91365
(213) 887-8000
M-100: impact, 9 by 9 dot matrix; 132 char/line; 130 cps; 6 or 8 line/inch; 96 char modified ASCII; bidirectional printing; short-line seeking; 70 by 84 dot graphics; tractor feed adjustable to 16 inches wide; fanfold paper; tape and direct access forms control; parallel (RS-232 or Centronics parallel optional);

26.6 by 23.4 by 8; 60 lbs; \$2200
Dataq Corporation
637 Oritz Ave.
Sand City, CA 93955
(408) 899-4888
Dataroyal Inc.
235 Main Dunstable Rd.
Nashua, NH 03060
(603) 883-4157
IPS5000: impact, 9 by 9 dot matrix; 80 char/line; 125 cps; 6 line/inch; 96 char ASCII; bidirectional printing; vertical tabs; self test; tractor feed; fanfold paper; RS-232, 110 to 9600 bps; parallel; 14 by 18.3 by 7; 30 lbs; \$1110
IPS7000: impact, dot matrix; 132 char/line; 150 cps; 96 char ASCII; tractor feed; fanfold paper; RS-232, expandable buffer; parallel; \$2295 to \$2860
Datasouth Computer Corporation
474 Dwight Evans Rd.
Charlotte, NC 28210
(704) 523-8500
DS180: impact, 9 by 7 dot matrix; 132 char/line; 6 or 8 line/inch; 96 char ASCII; bidirectional printing; vertical tabs; graphics; double-width characters; paper-out indicator; self test; tractor feed; fanfold paper; RS-232, 110 to 9600 bps; 1K char buffer; 24 by 16 by 7; 34 lbs; \$1595
Di-An Controls Inc.
944 Dorchester Ave.
Boston, MA 02125
(617) 288-7700
Diablo Systems Inc.
26460 Corporate Ave.
Hayward, CA 94545
(415) 786-5000
KSR1640: impact, daisy wheel; 132 char/line; 45 cps; manually changeable print element; friction or tractor feed; RS-232; \$3100
KSR1650: impact, daisy wheel; 132 char/line; 45 cps; manually changeable print element; friction or tractor feed; sheet or fanfold paper; RS-232; \$3295
RO630: impact, daisy wheel; 132 char/line; 25 cps; manually changeable print element; friction or tractor feed; sheet or fanfold paper; \$2430
Digi-Data Corporation
8580 Dorsey Run Rd.
Jessup, MD 20794
2511: 200 cps; bidirectional printing; underlining; RS-232, expandable buffer, 1200 to 19,200 bps; 22 by 18.5 by 8.5; 40 lbs; \$1550
Digital Equipment Corpora-

tion (DEC)
1 Iron Way
Marlborough, MA 01752
(617) 493-4622
LA34: impact, 5 by 7 dot matrix; 132 char/line; 30 cps; condensed characters; self test; paper-out indicator; friction or tractor feed adjustable to 15 inches wide; sheet or fanfold paper; RS-232; \$1450
LA36: impact, dot matrix; 132 char/line; 30 cps; 96 char set; tractor feed; fanfold paper; parallel (RS-232 optional); \$2695
LA120: impact, dot matrix; 132 char/line; 120 cps; tractor feed; fanfold paper; parallel (RS-232 optional)
Letterprint 100: impact, 9 by 9 dot matrix; 132 char/line; 240 cps; 2 to 12 line/inch; 96 char ASCII, draft- and two high-quality fonts (high-quality fonts print at 30 cps and 80 cps); graphics; vertical tabs; friction or tractor feed (adjusts to 15 inches wide); sheet or fanfold paper; RS-232, 50 to 9600 bps; 22 by 15 by 7; 25 lbs
Dip Inc.
745 Atlantic Ave.
Boston, MA 02111
(617) 482-4214
Dip-81: impact, 7 by 7 dot matrix; 40 or 80 char/line; 100 cps; 6 or 8 line/inch; 96 char ASCII; bidirectional printing; condensed characters; self test; friction feed; sheet, fanfold, or roll paper; RS-232, 110 to 1200 bps, 80 char buffer; parallel; 17 by 9.75 by 3.5; \$499
Dip-82: impact, 7 by 7 dot matrix; 80 char/line; 100 cps; 6 or 8 line/inch; 96 char ASCII; bidirectional printing; vertical tabs; graphics; condensed characters; self test; tractor and friction feed; sheet, fanfold, or roll paper; RS-232, 110 to 1200 bps, 80 char buffer; 17 by 9.75 by 3.5; \$695
Dip-84: impact, dot matrix; 40 or 80 char/line; 100 cps; 96 char ASCII; tractor feed; sheet paper; RS-232, (3K character buffer optional); parallel; \$795
Dip-85: impact, dot matrix; 80 or 132 char/line; 100 cps; 96 char ASCII; graphics; RS-232, with handshaking; parallel; \$895
Eaton Corporation
901 South 12th St.
Watertown, WI 53094
(414) 261-4070
7000+40: impact, dot matrix; 40 char/line; 125

cps; uppercase only; friction feed; sheet paper; parallel (120 char buffer optional); \$425
7000+64: impact, dot matrix; 64 char/line; 125 cps; uppercase only; friction feed; sheet paper; \$443
Epson America Inc.
3415 Kashiwa
Torrance, CA 90505
(213) 539-9140
MX-70: impact, 5 by 7 dot matrix; 80 char/line; 80 cps; 6 to 10 line/inch; 96 char ASCII; graphics; self test; tractor feed adjustable to 10 inches wide; top-of-form control; Centronics parallel; 14.75 by 12 by 4.5; 12 lbs; \$450
MX-80: impact, 9 by 9 dot matrix; 80 char/line; 80 cps; 6 or 10 line/inch; 96 char ASCII; bidirectional printing; vertical tabs; graphics; double-width characters give 40 char/line; compressed characters give 132 char/line; paper-out indicator; self test; tractor feed; fanfold paper; Centronics parallel; (RS-232, 80 char buffer optional); 14.75 by 12 by 4.5; 12 lbs; \$645
MX-80F/T: same as MX-80 except: tractor and friction feed; sheet or fanfold paper; graphics, 120 by 72 dots; \$745
MX-100: impact, 18 by 18 dot matrix formed by multiple passes; 132 char/line; 80 cps; 6 line/inch; 96 char ASCII; bidirectional printing; vertical tabs; graphics, 120 by 72 dots; double-width characters give 90 char/line; compressed characters give 233 char/line; paper-out indicator; self test; tractor and friction feed; sheet, fanfold, and roll paper to 15 inches wide; Centronics parallel (RS-232 optional); 23.3 by 12.5 by 5.2; 21 lbs; \$995
Engineering Dynamics
618 South Greenwood Pl.
Burbank, CA 91506
(213) 843-9036
Facit Data Products
66 Field Point Rd.
Greenwich, CT 06830
4525: impact, 9 by 9 dot matrix; 80 char/line; 150 cps; 6 or 8 line/inch; 96 char ASCII; bidirectional printing; vertical tabs; compressed characters; tractor feed; fanfold paper; RS-232, 512 char buffer; parallel; 18.3 by 14 by 7; 30 lbs; \$1595
4526: impact, 9 by 9 dot

NO LEADING IMPORT IS HIGHER THAN SUBARU IN OWNER LOYALTY.

Subaru owners have a lot in common. Including the habit of trading in one Subaru for another Subaru.*

If that isn't the best endorsement any car can earn, we don't know what is.

One good reason people stick with Subaru is for its day in, day out reliability. The last time Road and Track surveyed Subaru owners, they reported "... one of the most trouble-free cars we ever surveyed."**

Another reason is the wide choice of models. There's the sporty 2-door hardtop. The luxurious 4-door sedan. The versatile hatchback. And the roomy station wagon.

Every Subaru has full-time front wheel drive. In addition, three of our models — Hatchback, Station Wagon, Brat — are also available with *On Demand Four Wheel Drive*. Which is four wheel drive at the flick of a lever. Without stopping.

(Any other 4 wheeler around requires a full stop before switching.

And stopping is exactly what you can't do sometimes.)

Some attractive options we offer are the Hill-Holder™ (a device on our manual transmission models† that keeps you from drifting back after stopping on steep hills), as well as power windows and power steering, AM/FM stereo, cassette deck, cruise control. All the wonderful unnecessary of driving.

Plus one huge necessity: outstanding gas mileage. Our cars are designed to squeeze every last mile out of every last drop. Year after year.

Just remember that it's quite easy to find an inexpensive car. The trick is to find one that stays that way.

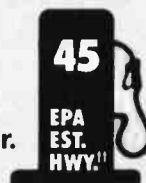

SUBARU®
INEXPENSIVE. AND BUILT
TO STAY THAT WAY.



* THE J. I. POLK AND COMPANY 1980 SURVEY OF LATE MODEL OWNERS.

** ROAD & TRACK — NOVEMBER 1979 ISSUE

† AVAILABLE ON SELECTED MODELS.

††† EPA ESTIMATES FOR OUR FWD & SPEED W/ HATCHBACK.

SEE OUR APPROXIMATE COMPARISONS; YOUR MILEAGE MAY DIFFER DEPENDING ON DRIVING SPEED, TRAFFIC CONDITIONS AND TRIP LENGTH. ACTUAL HWY MILEAGE WILL PROBABLY BE LESS.

© SUBARU OF AMERICA, INC. 1981

matrix; 132 char/line; 150 cps; 6 or 8 line/inch; bidirectional printing; vertical tabs; compressed characters; tractor feed; fanfold paper; RS-232, 512 char buffer; parallel; 24 by 14 by 7; 35 lbs; \$1697.

Florida Data Corporation
600 D John Rodes Blvd.
Melbourne, FL 32935
OSP120: impact, 36 by 16 dot matrix formed by two passes; 198 char/line; 600 cps; 6 or 8 line/inch; 96 char ASCII; bidirectional printing; vertical tabs; compressed characters; paper-out indicator; self test; friction feed; sheet or fanfold paper; RS-232; 25 by 20.5 by 8.5; 60 lbs; \$3900
Forte Technology Inc.
611 Neponset St.
Canton, MA 02021
(617) 828-7478

Fujitsu America Inc.
2945 Oakmead Village Court
Santa Clara, CA 90505
SP830: impact, daisy wheel; 163 char/line; 80 cps; 127 char set; bidirectional printing; vertical tabs; graphics; paper-out indicator; friction feed and tractor feed; sheet or fanfold paper; RS-232; 23.5 by 17.7 by 7.3; 40 lbs; \$2650

General Electric Company
Data Com Products Division
GE Drive
Waynesborough, VA 22980
(703) 924-8161
Terminet 2030: impact, 9 by 7 dot matrix; 80 or 132 char/line; 30 cps; 2 to 12 line/inch; 96 char ASCII; bidirectional printing; vertical tabs; paper-out indicator; self test; integral modem (optional); friction or tractor feed; fanfold or roll paper; RS-232, 110 to 1200 bps, 640 char buffer; 22 by 18.5 by 5.5; 22 lbs; \$1475

Terminet 2120: impact, 9 by 7 dot matrix; 150 cps; bidirectional printing; paper-out indicator; self test; friction feed; sheet or roll paper; RS-232, 110 to 1200 bps; 22 by 18.5 by 5.5; 24 lbs; \$2120

Gulton Industries Inc.
Gulton Industrial Park
East Greenwich, RI 02818
(401) 884-6800
AP-20L: thermal, 5 by 7 dot matrix; 20 char/line; 6 line/inch; 50 cps; 64 char ASCII uppercase only; friction feed; 2.25 inch wide

sensitized roll paper; RS-232, 20 char buffer; IEEE-488; 11.5 by 13 by 4.75
Microplot-44: thermal, 1 by 256 (line wide) dot matrix produces 5 by 7 to 8 by 12 dot characters; 44 char/line; 6 line/inch; 2 lps; 96 char ASCII; dot-addressable graphics; rotated printing; compressed characters; double-height characters; boldface characters; friction feed; 5 inch wide sensitized roll paper; RS-232; IEEE-488; 9.9 by 11.5 by 4.3
Microplot-80: same as *Microplot-44* except: 1 by 512 (line wide) dot matrix; 8 inch wide sensitized roll paper; 13.8 by 11.8 by 4.5
Versatrak-60: thermal, 5 by 7 dot matrix; 20 char/line; 6 line/inch; 80 cps; 64 char ASCII uppercase only; directly accepts analog signals for chart recorder applications at infinitely variable speeds; graphic plotting; rotated printing; reverse linefeed; friction feed; 2.75 max width sensitized roll paper; RS-232 with handshaking; 5.75 by 10.75 by 6.25

Heath Company
Benton Harbor, MI 49022
(800) 253-0570
H-14: impact, dot matrix; 5 by 7 matrix; 80, 96, or 132 char/line; 6 or 8 line/inch; 40 cps; 96 char ASCII; double-width characters; print head temperature protection; forward and reverse linefeed, and top-of-form; tractor feed, 2.5 to 9.5 inch width; RS-232, 110 to 4800 bps; 18.33 by 14.33 by 4.80 inches; 23 lbs; kit: \$495, assembled: \$595
H-25: impact, 9 by 9 dot matrix; 132 char/line; 150 cps; 6 or 8 line/inch; 96 char ASCII; graphics; bidirectional printing; self test; tractor feed adjustable to 17.75 inches wide; fanfold paper; RS-232, 110 to 9600 bps; 26.5 by 18.5 by 8.25; 80 lbs; \$1095

Hecom Corporation
31-45 Park Rd.
Tinton Falls, NJ 07724
(201) 542-9200

Hewlett-Packard
1501 Page Mill Rd.
Palo Alto, CA 94304
Hi-G Company
580 Spring St.
Windsor Locks, CT 06096
(203) 623-3363

9/80: impact, 9 by 9 dot matrix; 80 char/line; 150 cps

draft-quality, 75 cps high-quality; 96 char ASCII; bi-directional printing; short-line seeking; vertical tabs; graphics; top-of-form control; tractor or friction feed; sheet or fanfold paper; RS-232, 110 to 9600 bps, 350 char buffer, expandable to 3422 char; Centronics parallel; 21.25 by 16.5 by 7.25

9/132: same as *9/80* except: 132 char/line
Howard Industries
2031 East Cerritos Ave.
Anaheim, CA 92806
(714) 778-3443

Typrinter 221: impact, daisy wheel; 132 char/line; 20 cps; 100 char modified; ASCII; bidirectional printing; intelligent text editing; vertical tabs; paper-out indicator; self test; friction feed; sheet paper; RS-232; \$2850

Informer Inc.
8332 Osage Ave.
Los Angeles, CA 90045
(213) 649-2030

Infoscribe
2720 South Croddy Way
Santa Ana, CA 92704
(714) 641-8595
500: impact, dot matrix; 136 char/line; 150 cps; 96 char ASCII (draft- and high-quality fonts); tractor feed; fanfold paper; RS-232; parallel; \$1595
1000: impact, dot matrix; 136 char/line; 200 cps; 96 char ASCII (draft- and high-quality fonts); program- mable character set; tractor feed; fanfold paper; RS-232; parallel; \$1825

1500: impact, 9 by 9 dot matrix; 136 char/inch; 360 cps; 96 char ASCII; bidirectional printing; tractor feed adjustable to 16 inches wide; fanfold paper; RS-232, 110 to 9600 bps; parallel; \$1895

Integral Data Systems (IDS)
Milford, NH 03055
(603) 673-9100
445: impact, dot matrix; 80 or 132 char/line; 198 cps; 96 char ASCII; graphics (optional); tractor feed; fanfold paper; parallel (RS-232 optional); \$795
460: impact, dot matrix; 80 char/line; 150 cps; 96 char ASCII; bidirectional printing; auto justification; proportional spacing; graphics, 84 by 84 dots; \$995

560: impact, dot matrix; 132 or 220 char/line; 198 cps; 96 char ASCII; bidirectional printing; single-dot graphics; tractor feed; fanfold paper;

RS-232; parallel (optional); \$1695
Prism: impact, 24 by 9 overlapping dot matrix; 200 cps draft mode, 150 cps high-quality; 96 char ASCII; double-width characters; bold characters; bi-directional printing; short-line seeking; color graphics; proportional spacing; friction or tractor feed; sheet or fanfold paper; RS-232, 300 to 9600 bps; Centronics parallel; 21.75 by 12.5 by 8.5; 29 lbs

Integrex Inc.
233 North Juniper
Philadelphia, PA 19107
(215) 627-0966

CX80 Colour: impact, 5 by 7 dot matrix; 80 char/line; 125 cps; 6 or 8 line/inch; 96 char ASCII; preprogrammed and programmable graphics characters; dot graphics; prints in up to seven colors using special ribbon; self test; tractor feed adjustable to 10 inches wide; fanfold paper; RS-232, 75 to 9600 bps; Centronics parallel; IEEE-488; Apple II; 16.25 by 12.8 by 7.5; 21 lbs

Innovative Electronics Inc.
15200 Northwest 60th Ave.
Miami Lakes, FL 33014
(305) 558-1591

Interface Mechanics Inc.
4405 Russell Rd.
Lynnwood, WA 98036
(206) 743-7036

C. Itoh Electronics Inc.
5301 Beethoven St.
Los Angeles, CA 90066
(212) 682-0420

Comet I: impact, dot matrix; 80 char/line; 125 cps; 96 char ASCII; bidirectional printing; tractor feed; fanfold paper; RS-232, 2K char buffer; parallel; \$455
Comet II: impact, dot matrix; 136 char/line; 125 cps; 96 char ASCII; bidirectional printing; tractor feed; fanfold paper; RS-232, 2K char buffer; parallel; \$1290
Star Writer I: impact, daisy wheel; 132 char/line; 25 cps; friction or tractor feed; sheet or fanfold paper; RS-232; parallel; \$2380

Star Writer II: impact, daisy wheel; 132 char/line; 45 cps; friction or tractor feed; sheet or fanfold paper; RS-232; parallel; \$2898

Ivo Industries Inc.
1109 Green Grove Rd.
Neptune, NJ 07757
(201) 922-3600

Landis and Gyr Inc.
Industrial Products

EPSON

PRINTERS & ACCESSORIES

Common Features of the MX80, MX80FT & MX100 Printers

- * 80 characters per second
- * Replaceable print head by user
- * User programmable from BASIC
- * Bi-directional logic seeking printhead
- * 96 ASCII characters
- * Programmable tabs (vert./horz.)
- * Cartridge ribbons
- * Self-test mode
- * Tractor/pin feed paper flow
- * Extreme reliability
- * 12 type fonts under software control
- * 9x9 & 9x18 matrix
- * Programmable form feeds
- * Compressed/expanded letters
- * Parallel interface standard
- * Double strike & emphasized modes

MX80...The Printer that started it all. All of the above features plus extreme ease of use. Complete TRS80 block graphics set as well as user selectable international symbols. Gives correspondence quality printing in several user selectable modes. Dip switch pins may be set for dedicated applications. Complete forms programmability from BASIC software.

MX80FT...All the features of the MX80 but with FRICTION feed as well for the use of single sheets of paper or roll paper. An exceptional buy for the user needing the single sheet capability. In the compressed mode 132 characters can be printed across the width of a page which means it can be used for any printouts that normally need a 15 inch wide printer.

MX100... An exceptional printer with an extra quiet printhead and extra heavy duty construction for the intense use of a business environment. Does not have the TRS80 graphic blocks but comes standard with Bit-Image graphics which allow the user control of individual dots for designing specialized graphs, symbols, etc. A best buy for business use.

MX70...For the budget minded an excellent entry level printer. It has most all of the features mentioned above including Bit-Image graphics in place of the TRS80 graphic blocks set. The Printer is unidirectional only. Expandable text can be printed but not compressed. Only single density printings is supported on the MX70. An inexpensive heavy duty printer.

\$CALL for BEST prices on Epson Printers All Printers & accessories in STOCK now!!!

If you buy your EPSON somewhere else you'll probably pay too much!

EPSON ACCESSORIES, INTERFACES & CABLES

- GRAFTRAX 80 option (bit-image & italics) \$79
 - CABLE Model I interface & Model III.....\$35*
 - * \$25 if purchased with printer
 - CABLE & INTERFACE to Model I Keyboard \$85
 - APPLE interface & cable.....\$89
 - PET IEEE interface & cable (Pet).....\$79
 - SERIAL RS232 unbuffered int.card.....\$65
 - SERIAL RS232 2k buffered int.card.....\$149
 - Epson to Color Computer card/cable.....\$59
- All RIBBONS and CARTRIDGES in Stock

\$CALL

800-433-5184

Radio Shack LINE PRINTERS	Line Printer VI.....	\$988
Daisy Wheel II.....	Line Printer VII.....	\$325
Line Printer V.....	Line Printer VIII.....	\$699

CUSTOM SOFTWARE FROM TCS

Completely Integrated **BINARY SEARCH TREE** programs now available. This series of programs fully implements the B-TREE structures including INSERTION, DELETION, EDITING & TRAVERSAL. No more sorting or long data file searches and yet files can be larger than memory. Duplicate keys are fully supported. Files can be retrieved in sorted order via B-TREE Traversal. Each of the programs come with fully commented source code so that you can use the modules in your own programming. A Screen oriented input routine is also included in each module. The following B-TREE programs are now available and each includes all of the mentioned modules and full documentation:

- B-TREE Library (organize your home library keyed by author).....\$39.95
- B-TREE Video (organize your video cassette library, prints labels, etc.).....\$39.95
- B-TREE Mailing List (keyed by name or zip,label printing,etc.).....\$49.95

EPSON PACK A Utility Software package for MX80 & 80FT.

MX80/CMD will send all printer commands from DOS. BIGLETT/BAS prints large Graphic Letters. EPSON/SUB merges with BASIC programs allowing 2 letter mnemonic commands to be sent to printer. JKL Patches allow JKL in NEWDOS 80 1.0 & NEWDOS 2.1 to send graphics properly. DEMO/BAS tutorial program of use of printer.LABEL/BAS custom label making program with graphics. DEF-STATE/SUB allows one word BASIC commands for centered titles, titles with borders, etc. A great program package for EPSON fans. SPECIAL DEAL: \$24.95 with printer \$34.95 separately. Specify Model 1 or III. disk only

EPSON PACK 2 - GRAFTRAX

version for MX80, 80FT & MX100. This package includes updated versions of modules in original Epson Pack. A screen oriented BIT IMAGE GRAPHICS generator utility is provided. Create your special characters, symbols, etc. directly on your monitor and then send to printer. Printout includes code to generate graphics and will save needed code as BASIC program line to disk. Then MERGE these into your BASIC program. Also demo programs showing use of Bit-Image graphics. Full documentation. **INTRO SPECIAL: \$24.95 with printer or GRAFTRAX. \$34.95 separately. \$7.50 for update of old Epson Pack**

ZAP3 - Direct read/write access to any TRSDOS 1.2 or 1.3 sector. Disable Passwords & access levels. Self prompting. Modify any sector in HEX or ASCII. Includes many patches to TRSDOS 1.2 & 1.3. Also COPYIT to allow backups of SCRIPST. VISICALC, etc. Just...\$24.95

SDIR - Super directory manipulation for TRSDOS 1.2 or 1.3. Alpha 4 column directory & free space. Display a range of programs by extension. Change name and date. Generate report of location of any program on diskette. Just...\$14.95

SPECIAL DEAL: Buy ZAP3 & SDIR together for \$29.95

CASIO ELECTRONIC ORGANS have arrived!!!

The fantastic CASIO Electronic Organs are here in force. Fully equal to any \$2000 traditional Organ with dozens of exciting NEW features not seen on other musical instruments:

- CASITONE CT-403 (25 instruments,16 rhythms, chord memory,etc.).....\$519
- CASITONE CT-701 (programmable, barcode reader,51 keys,etc.,etc.).....\$835

TEXAS COMPUTER SYSTEMS

Offers Lowest Prices on

TRS-80

Model II 64K

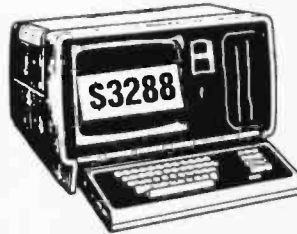

The best buy for small business needs and yet completely expandable as your business grows. Easy to use for the beginning operator. We have in STOCK all accessories and disk expansions as well as printers and software. **IMPORTANT:** We also have CP/M for the Model II plus a large amount of support software. All of these items at our fabulous DISCOUNT prices. We ship from DFW by air and fully insured for FAST safe delivery.

HARD DISK SUPPORT FOR THE MODEL II...NOW!

5, 10 or 20 Megabytes (up to 80 Megabytes) for the Model II. Full CP/M support. Also full support for TRSDOS and all TRSDOS software. Multiple computers (multi-user) can be connected to these hard disk systems and can share and access common data bases under both CP/M and TRSDOS. The same common data base can even be accessed simultaneously by several users. We use top of the line CORVUS Hard Disk Drives which have a proven track record and have outsold all of their competitors combined in the microcomputer market. Model I and III are also supported by these Hard Disk Systems. \$CALL for our LOW prices.

COLOR COMPUTERS

Original 1yr warranty on these items:	TCS 180 day Limited warranty on TCS items:
4K Level 1.....\$308	16K Level 1.....\$369
16K Level 1.....\$439	16K Extended Basic.....\$439
16K Extended Basic.....\$459	32K Extended Basic.....\$499
32K Extended Basic.....\$569	32K Upgrade Kit (TCS).....\$79
Color Disk 0.....\$499	Disk 1.....\$349
	EPSON/COLOR Int.& cable.....\$59

TRS80 MODEL III COMPUTER SYSTEMS

The following with Radio Shack Warranty:

Model III 16k.....\$825	The following with quality TCS memory & our own 180 day limited warranty:
Model III 32k.....\$979	Model III 32K.....\$909
Model III 48k.....\$1089	Model III 48K.....\$969
Model III 48k 2 Drives RS232 \$2069	

MODEL III DISK EXPANSION KITS

We use the highest quality fiberglass **CONTROLLER BOARDS** with double sided glass epoxy board and gold plated contacts in our TCS systems. The finest switching **POWER SUPPLY** available is also provided. The aluminum **MOUNTING HARDWARE** has slotted holes for easy installation of the drives and includes all the power and data cables necessary to install the controller, drives and power supply.

Our **DISK DRIVES** are made by Tandon the same company that makes the drives used by Radio Shack. These drives are 40 track, double density, 5 millisecond stepping rate and are fully burned in for 48 hours. These drives have the same specifications as the drives used by Radio Shack. No soldering or modifications to existing circuitry is necessary. The following kits are available:

- KIT 1 Controller, Power Supply & Mounting Hardware.....\$379
- KIT 2 Controller, Power Supply, Hardware & 1 Disk Drive.....\$595
- KIT 3 Controller, Power Supply, Hardware & 2 Disk Drives.....\$819
- KIT 4 One Tandon Disk Drive (bare drive only).....\$219
- KIT 5 16K of High Quality TCS Memory chips.....\$49.95
- KIT 6 32k of High Quality TCS Memory chips.....\$79.95

MODEL III 48K 2 DISK DRIVES KIT...\$1753

Yes, you read it right. A complete 48k 2 Disk Drive Model III computer system for just \$1753. Here's what you get: one TRS80 Model III 16k Computer in factory carton, one **CONTROLLER, POWER SUPPLY & HARDWARE** kit (kit 1), two Tandon Disk Drives and 32K of TCS Memory. You also receive several important extras that make this a complete super kit. These extras include a complete illustrated instruction and trouble shooting manual, a TRSDOS 1.3 operating system and manual and a special diagnostic Diskette for testing the unit after you have put it together. The only tool necessary - a screwdriver. **EVERYTHING** is included in this kit and the price is right...\$1753

MODEL III 48k 2 DISK DRIVES ... \$1895

Above KIT fully assembled, with 48 hour burn-in test & 180 day TCS Limited Warranty!!

DEALER INQUIRIES ARE INVITED ON THE ABOVE TCS KITS

For fast, efficient service. **Heart of** we can air freight from Dallas

TEXAS COMPUTER SYSTEMS

P.O. Box 1327 Arlington, Texas 76004-1327

★ Toll Free Number 800 433-5184

Texas Residents 817 274-5625

Payment: Money order, cashiers or certified check. Prices above reflect 3% cash Discount. Call for Visa/MC card prices.

Prices subject to change at any time. No Tax out-of-state. Texans add 5%. Many items shipped FREE. Call for quote.

4 Washington Plaza
Elmsfield, NY 10523
(914) 592-4400
Lear-Siegler Inc.
714 North Brookhurst St.
Anaheim, CA 92803
310 *Ballistic*: impact, 7 by 9 dot matrix; 136 char/line; 180 cps; 128 char ASCII; vertical tabs; compressed characters (optional); programmable forms control tractor feed; fanfold paper; RS-232, 70 to 9600 bps (2K char buffer optional); parallel; 27 by 19.8 by 8; 50 lbs; \$2045
Litton Industries
Westrex OEM Products
1140 Bloomfield Ave.
West Caldwell, NJ 07006
(201) 227-7290
Mag Labs Inc.
1 Crown Dr.
Apalachin, NY 13732
(807) 625-2161
Malibu Electronics Corporation
2301 Townsgate Rd.
Westlake Village, CA 91361
(805) 496-1990
165: impact, 10 by 9 dot matrix; 165 cps; graphics; RS-232; parallel; \$2295
200: impact, 9 by 18 dot matrix, double pass; 132 char/line; 250 cps; 6 or 8 line/inch; 96 char ASCII (multiple fonts); bidirectional printing; graphics, 120 by 144 pixels; self test; friction and tractor feed; sheet or fanfold paper; RS-232, 110 to 9600 bps; 23.9 by 17.1 by 7; 41 lbs; \$2995
Mannesman-Talley
8024 South 180th St.
Kent, WA 98031
(206) 251-5524
MT-1800: impact, 7 by 9 dot matrix, double pass; 132 or 218 char/line; 200 cps; 6 or 8 line/inch; bidirectional printing; vertical tabs; double-width characters; compressed characters; paper-out indicator; self test; tractor feed; fanfold paper; RS-232, 300 to 9600 bps; parallel; 25.5 by 19.5 by 18.5; 63 lbs; \$2495
Matchless Systems
18444 Broadway
Gardena, CA 90248
(213) 327-1010
MDS Trivex
3180 Redhill Ave.
Costa Mesa, CA 92626
(714) 546-7781
MPI (Micro Peripherals Inc.)
4426 South Century Dr.
Salt Lake City, UT 84107
(801) 263-3081
88C: impact, 11 by 7 dot

matrix; 80 or 132 char/line; 100 cps; 6 or 8 line/inch; 96 char ASCII (draft- and high-quality fonts); bidirectional printing; graphics; friction or tractor feed; sheet, fanfold, or roll paper; RS-232, 1K char buffer; Centronics parallel; 16.3 by 10.8 by 6.3; 15 lbs; \$749
Microtek Inc.
9514 Chesapeake Dr.
San Diego, CA 92123
Tekwriter-1 (formerly Bytewriter 1): impact, 7 by 7 dot matrix; 80 char/line; 80 cps; friction feed; sheet or roll paper; parallel Centronics, Apple II, or Atari; \$349
Tekwriter-2: impact, 9 by 9 dot matrix; 80 or 132 char/line; graphics; Centronics parallel
MT-80: impact, dot matrix; 80 char/line; 125 cps; 96 char ASCII; tractor feed; fanfold paper; RS-232, 3K char buffer; parallel; \$795
Miltope Corporation
9 Fairchild Ave.
Plainview, NY 11803
(516) 349-9500
Newman Computer Exchange Inc.
1250 North Main St.
Ann Arbor, MI 48104
(313) 994-3200
NEC Information Systems Inc.
5 Militia Dr.
Lexington, MA 02173
5510: impact, thimble; 132 char/line; 55 cps; 6 or 8 line/inch; 128 char ASCII (multiple fonts); bidirectional printing; vertical tabs; paper-out indicator; friction and tractor feed; sheet or fanfold paper; cut-sheet feeder; RS-232, 110 to 1200 bps, 256 char buffer; 25 by 16.5 by 8.7; 45.5 lbs; \$3055
5520: impact, thimble; 132 char/line; 55 cps; 128 char ASCII (multiple fonts); friction or tractor feed; sheet or fanfold paper; cut-sheet feeder; RS-232, 110 to 1200 bps; \$3415
5530: impact, thimble; 132 char/line; 55 cps; 128 char ASCII (multiple fonts); friction or tractor feed; sheet or fanfold paper; cut-sheet feeder; parallel; \$3055
Okidata Corporation
111 Gaither Dr.
Mount Laurel, NJ 08054
(609) 235-2600
Microline 80: impact, dot matrix; 80 or 132 char/line; 80 cps; 96 char set; friction

and tractor feed; sheet or fanfold paper; parallel; \$475
Microline 82A: impact, 9 by 9 dot matrix; 80 or 132 char/inch; 120 cps; 6 or 8 line/inch; short-line seeking; bidirectional printing; graphics; double-width characters; compressed characters; friction and tractor feed; sheet or fanfold paper; RS-232, 110 to 1200 bps; parallel; 14.2 by 12.9 by 5.2; 20 lbs; \$645
Microline 83: impact, dot matrix; 132 char/line; 120 cps; 96 char ASCII; bidirectional printing; tractor feed adjustable to 15 inches wide; fanfold paper; RS-232; parallel
SL300: impact, dot matrix whole-line printer; 132 char/line; 300 lpm; 96 char ASCII; software selectable fonts, oversized chars; barcode font; graphics; tractor feed; parallel; \$3995
Olivetti Peripheral Equipment
505 White Plains Rd.
Tarrytown, NY 10591
(914) 631-3000
DY-211: impact, daisy wheel; 132 char/line; 20 cps; 5 or 6 line/inch; 96 char ASCII; manually changeable print element; friction feed accepts paper up to 17 inches wide; RS-232, 110 to 9600 bps; 36 lbs; \$1900
DY-311: impact, daisy wheel; 150 char/line; 32 cps; 5 or 6 line/inch; 96 char ASCII; bidirectional printing; manually changeable print element; friction or tractor feed; sheet or fanfold paper; RS-232, 100 to 9600 bps; parallel; 39.5 lbs; \$2850
DY-811: impact, daisy wheel; 150 char/line; 65 cps; 5 or 6 line/inch; 96 char ASCII; bidirectional printing; manually changeable print element; friction or tractor feed; sheet or fanfold paper; RS-232, 110 to 9600 bps; parallel; 79 lbs; \$4280
DM80/180: impact, 8 by 7 dot matrix; 150 char/line; 80 cps; 5 or 6 line/inch; 96 char ASCII; bidirectional printing; friction or tractor feed; sheet or fanfold paper; RS-232, 110 to 9600 bps; parallel; 79 lbs; \$4280
Pertec Computer Company
12910 Culver Blvd.
Los Angeles, CA 90066
Stylist 360: impact, daisy wheel; 198 char/line; 17 cps; 100 char modified ASCII; bidirectional printing; fric-

tion feed; sheet or fanfold paper; RS-232; parallel; 20.9 by 13 by 5.5; 29 lbs; \$1500
Printek Inc.
1517 Townline Rd.
Benton Harbor, MI 49022
(616) 925-3200
910: impact, 9 by 9 dot matrix; 80 char/line; 170 cps; 96 char ASCII, programmable character set; double-width characters; bidirectional printing; tractor feed; fanfold paper; RS-232, 1800 char buffer; parallel; 23 by 17 by 7; \$1695
920: same as 910 except: 340 cps; \$2345
Printer Terminal Communications Corporation
124 10th St.
Ramona, CA 92065
879: impact, 7 by 9 dot matrix; 80 or 132 char/line; 180 cps; 6 line/inch; 96 char ASCII; bidirectional printing; vertical tabs; compressed characters; friction and tractor feed; sheet, fanfold, or roll paper; RS-232, 300 to 9600 bps, 256 char buffer; parallel; 18 by 22 by 7.5; 25 lbs; \$1299
Printronix
17421 Derian Ave.
Irvine, CA 92713
(714) 549-8272
Qantex
60 Plant Ave.
Hauppauge, NY
(516) 582-6060
Qume Corporation
2350 Qume Dr.
San Jose, CA 95131
(408) 942-4000
Sprint 5/45: impact, daisy wheel; 132 char/line; 45 cps; friction or tractor feed; sheet or fanfold paper; cut-sheet feeder; RS-232; parallel; \$3137
Sprint 5/55: impact, daisy wheel; 132 char/line; 55 cps; 3 to 8 line/inch; manually changeable print element; bidirectional printing; vertical tabs; graphics; paper-out indicator; self test; friction feed; sheet paper; RS-232, 110 to 9600 bps; 24.3 by 16.8 by 6.5; 45 lbs; \$3726
Sprint 9/35: impact, daisy wheel; 132 char/line; 35 cps; manually changeable print element; friction or tractor feed; sheet or fanfold paper; RS-232; parallel
Sprint 9/45: same as 9/35 except: 45 cps
Sprint 9/55: same as 9/35 except: 55 cps
Sprint Wide-Track: impact, daisy wheel; 240 char/line; 55 cps; manually changeable

In Los Angeles, your great escape could take place in minutes.

As a Data Processing specialist at Northrop, you'll surround yourself with the benefits of a climate and location that lets you enjoy it all -- the arts, educational opportunities and the great outdoors. Every day. All year round.

Located in Southern California, Northrop offers the professional opportunities you seek plus the flexibility of lifestyle that makes hours off the job exceptionally pleasurable. And, you'll appreciate our location with easy access to beach, desert, and mountains

If you're up for the challenge of membership in a department that supports corporate information systems activities at every level, look into career opportunities at Northrop

Make the Great Escape that could last a life time

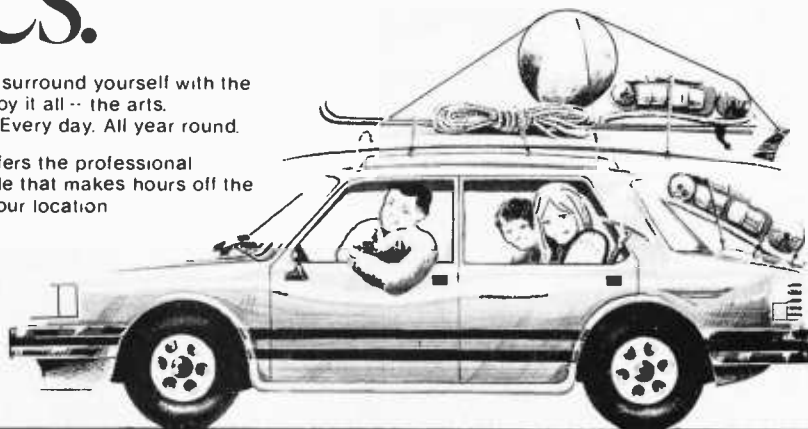

Low Desert - 45 min.
High desert - 98 min.
Beaches - 10 min.
Forest - 25 min.
Mountains - 30 min.
Big mountains - 40 min.
Very big mountains - 240 min.

Skiing - 70 min.
Better skiing - 180 min.
Sailing - 15 min.
Golf - 17 min.
Running - change your shoes
Cricket - 23 min.
Disneyland - 45 min.

Hollywood Bowl - 45 min.
Universities - 30 min.
Surfing - 10 min.
Knott's Berry Farm - 45 min.
Rollerskating -
change your shoes again
Universal Studios - 50 min.

Scientific Applications Programmer Analysts

Experience with IBM 3033, Engineering and Graphics Applications, FORTRAN.

MVS Systems Programmers

Using SMP4, TSO and SPF maintenance tools.

Computer Operations Personnel

Console Operators, Control Clerks, Tape Librarians.

Numerical Control Systems Support

Knowledge of IBM, APT-AC systems, FORTRAN, ASSEMBLY and familiarity with numerical control environment.

Data Base Analysts

Experience in IMS Data Base and Data Communications.

Business Applications Programmers

To design and maintain business, finance, and manufacturing applications on large scale IBM computers.

We will arrange a personal interview for you. We will fly you to California, travel and accommodations paid, or we will send a representative to your location. Investigate the opportunities outlined above by sending your resume to:

Barbara Nettles
Dept. NDP-BYTE 1853
P.O. Box 4625
Long Beach, CA 90804

NORTHROP

Making advanced technology work

Northrop Corporate Data Processing Center
Equal Opportunity Employer M/F/H / Proof of U.S. Citizenship Required

print element; friction feed; sheet paper; RS-232; parallel; \$4315

Radio Shack
1 Tandy Center
Fort Worth, TX 76102
Daisywheel II: impact, daisy wheel; 136 char/line; 43 cps; manually changeable print element; proportional spacing; friction feed; sheet paper; Centronics parallel; \$1860
Lineprinter IV: impact, dot matrix; 80 or 132 char/line; 50 cps; 96 char ASCII; friction or tractor feed; sheet or fanfold paper; Centronics parallel; \$999
Lineprinter V: impact, dot matrix; 132 char/line; 120 cps; 96 char ASCII; tractor feed; fanfold paper; Centronics parallel; \$1860
Lineprinter VI: impact, dot matrix; 132 char/line; 100 cps; 96 char ASCII plus graphics characters; bidirectional printing; self test; Centronics parallel; \$1160
Lineprinter VII: impact, 5 by 7 dot matrix; 40 or 80 char/line; 30 cps; 6 line/inch; graphics; tractor feed; fanfold paper; RS-232, 100 to 600 bps; Centronics parallel; \$399
Lineprinter VIII: impact, 9 by 12 dot matrix; 80 char/line; 80 cps; 8 or 12 line/inch; graphics; bidirectional printing; short-line seeking; proportional spacing; friction or tractor feed; sheet, fanfold, or roll paper; self test; RS-232, 600 or 1200 bps; Centronics parallel; 15.4 by 11 by 4.7; 16.5 lbs; \$799
Quick Printer II: electrostatic, dot matrix; 16 char/line; 32 cps; uppercase only; compressed characters give 32 char/line at 64 cps; friction feed; aluminized roll paper 2.4 inches wide; \$219

Sanders Technology
Columbia Drive
Amherst, NH 03061
(603) 882-1000
Media 12/7: impact, line-wide dot matrix, overlapping passes; 80 char/line; 96 char ASCII (draft- and high-quality); 220 cps draft-quality, 60 cps high-quality; preprogrammed alternate fonts; proportional spacing on some fonts; high-quality compressed-character font gives 117 char/line at 120 cps (proportional spacing); friction feed; sheet paper; cut-sheet feeder; RS-232,

2400 bps with handshaking; Centronics parallel; \$4395

Sci Systems Inc.
8600 South Memorial Parkway
Huntsville, AL 35802
(205) 881-1611

Sentinel Computer Corporation
9902 Carver Rd.
Cincinnati, OH 45242
(513) 984-6622

Siemens Corporation
OEM Data Products Division
240 East Palais
Anaheim, CA 92805
(714) 991-9700

Smith-Corona
65 Locust Ave.
New Canaan, CT 06840
(203) 972-1471
TP-1: impact, daisy wheel; 105 or 125 char/line; 12 cps; manually changeable print element; friction feed; sheet paper; \$845

Star Micronics Inc.
200 Park Ave.
New York, NY 10166
(212) 986-6770
DP-8480: impact, 7 by 9 dot matrix; 132 char/line; 80 cps; 96 char ASCII; short-line seeking; bidirectional printing; graphics; double-width characters; compressed characters; self test; friction and tractor feed; sheet or fanfold paper; RS-232, 256 char buffer; 15.3 by 12.2 by 4.9; 19 lbs; \$495

Systemed Corporation
POB 18
Mountain City, TN 37683
(615) 727-6000
Typrinter: impact, daisy wheel; 180 char/line; 12 cps; manually changeable print element; friction feed; fanfold paper; parallel; \$599

Syntest Corporation
169 Milham St.
Marlborough, MA 01752
(617) 481-7827

TDC
203 East Main St.
Riverton, WY 82501
(307) 856-7111

TEI Inc.
5075 South Loop East
Houston, TX 77033
(910) 881-3639
3431: impact, 9 by 9 dot matrix; 136 char/line; 150 cps; 6 or 8 line/inch; 94 char ASCII; bidirectional printing; double-width characters; paper-out indicator; self test; tractor feed; fanfold paper; RS-232, 110 to 9600 bps, 256 char buffer; parallel

Telecom Terminal Systems
3903 Grand View Blvd.
Los Angeles, CA 90066
(213) 390-9494

Teletype Corporation
5555 Touhy Ave.
Skokie, IL 60077
(312) 982-2000
43: impact, dot matrix; 80 or 132 char/line; 30 cps; 96 char ASCII; friction or tractor feed; RS-232; \$1388

Texas Instruments
POB 225012
M/S 84
Dallas, TX 75265
(312) 982-2000
743: electrostatic, dot matrix; 80 char/line; 30 cps; 96 char ASCII; APL char set (optional); friction feed; aluminized roll paper; RS-232; \$1995
765: electrostatic, dot matrix; 80 char/line; 30 cps; 96 char ASCII; bubble-memory storage up to 80K char; dual communications ports; friction feed; aluminized roll paper; RS-232 (integral modem optional); \$2995
810: impact, 9 by 7 dot matrix; 132 char/line; 150 cps; 6 or 8 line/inch; 64 char modified ASCII (96 char ASCII optional); double-width characters (optional); compressed characters (optional); bidirectional printing; vertical tabs; paper-out indicator; self test; tractor feed; fanfold paper; RS-232, 110 to 9600 bps; \$2165
825: impact, 9 by 7 dot matrix; 75 cps; 6 or 8 line/inch; bidirectional printing; RS-232, 110 to 600 bps, 256 char buffer; \$1565

Toshiba America Inc.
2441 Michelle Dr.
Tustin, CA 92680
(714) 730-5000

Trendcom
480 Oakmead Parkway
Sunnyvale, CA 94086
(408) 737-0747
100: thermal, dot matrix; 40 char/line; 40 cps; 96 char ASCII; friction feed; sensitized roll paper; Centronics parallel, IEEE-488

United Systems Corporation
918 Woodley Rd.
POB 458
Dayton, OH 45401

Victor Business Products
3900 North Rockwell St.
Chicago, IL 60618

Vista
1317 East Edinger Ave.
Santa Ana, CA 92705
(714) 953-0523

Wang Laboratories
1 Industrial Ave.
Lowell, MA 01851
2231 W-1: impact, 7 by 9 dot matrix; 112 char/line; 120 cps; 96 char ASCII; vertical tabs; double-width characters; paper-out indicator; self test; Wang serial interface, 112 char buffer; 24 by 18 by 10; 60 lbs; \$2900
2281W: impact, daisy wheel; 157 char/line; 30 cps; 6 line/inch; 96 char ASCII; bidirectional printing; vertical tabs; graphics; Wang serial interface; \$4500

Wasomark Inc. (Data Printer Division)
1 Willard Rd.
Norwalk, CT 06856
(203) 847-7251

Williams Laboratories
125 Northview Rd.
Ithaca, NY 14850
(607) 272-1132
Bytewriter: impact, daisy wheel; 100 char/line; 12 cps; manually changeable print element; self test; underlining; friction feed; sheet paper; Centronics parallel; 21 lbs; \$795

Xerox Corporation
Xerox Square
Rochester, NY 14644
(716) 423-3411
1730: impact, daisy wheel; 132 char/line; 40 cps; manually changeable print element; friction feed; sheet paper; RS-232; \$2710
1740: impact, daisy wheel; 132 char/line; 45 cps; manually changeable print element; friction feed; sheet paper; RS-232; \$3375
1750: impact, daisy wheel; 132 char/line; 45 cps; manually changeable print element; friction feed; sheet paper; RS-232; \$3555

Xymec Inc.
17905 J Sky Park Circle
Irvine, CA 92714
(714) 423-3411
HY-Q 1000: impact, daisy wheel; 198 char/line; 20 cps; manually changeable print element; boldface characters; paper-out indicator; self test; RS-232; parallel

Zentec Corporation
2400 Walsh Ave.
Santa Clara, CA 95050
(408) 246-7662■

Computer Exchange

P.O. Box 1380, Jacksonville, OR 97530

929

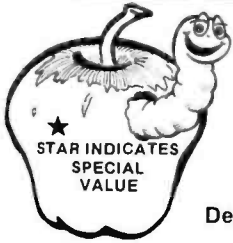

APPLE SUPPLY CENTER

Dealer inquiries invited

HARDWARE for Apple II/III+

Direct Substitute for Apple Drives

Micro-Sci A2 is a direct substitute for Apple II drives. Save \$300 on a dual disk system. The A2 does not include DOS Software

Micro-Sci 5" Drives for Apple II	SAVE
A2, 143K, 5" Drive	\$ 395 18%
A2 Controller Card for A2 Drives	\$ 85 15%
A70, 286K, 5" Drive	\$ 489 20%
A40, 160K, 5" Drive	\$ 369 18%
Controller Card for A70 or A40	\$ 79 21%

320K RAM substitute for Disk System

AXLON, RAMDISK 320K Memory System	\$ 1145 20%
-----------------------------------	-------------

MONITORS:

NEC	12" Color	\$ 359 24%
	12" Green	\$ 169 22%
SANYO:	9" B&W	\$ 149 31%
	9" Green	\$ 159 31%
	12" B&W	\$ 219 30%
	12" Green	\$ 229 30%
	13" Color	\$ 399 28%
	NEW 13" RGB Color	\$ 899 25%
ZENITH	12" Green	\$ 119 20%

DISKETTES, 5", box of 10:

Maxell	\$ 39 33%
Memorex	\$ 25 45%

80 COLUMN VIDEO CARDS:

Videx Videoterm	\$ 249 18%
M&R Sup R Term	\$ 319 19%
ALS: Smarterm	\$ 269 30%

MISCELLANEOUS:

Apple:		
Graphics Tablet (CLOSE OUT)	\$ 650 20%	
CCS: Serial Interface 7710A	\$ 139 22%	
Parallel Interface 7720A	\$ 99 20%	
Other CCS Cards In Stock,	CALL CALL	
Hayes: Micromodem II	\$ 299 26%	
Smartmodem	\$ 249 11%	
Keyboard Company:		
Joystick II	\$ 45 10%	
Game Paddle	\$ 25 17%	
Numeric Keypad	\$ 119 21%	
M&R: RF Modulator	\$ 25 27%	
SUP R FAN	\$ 39 25%	
★ Microsoft: Z80 Softcard	\$ 279 33%	
16L RAM Card	\$ 159 20%	
Mountain:		
CPS Multifunction Card	\$ 209 13%	
Clock/Calendar	\$ 239 15%	
Orange Micro Grappler	\$ 129 21%	
SSM AIO Serial/Para. Interface	\$ 159 20%	
★ ALS: Smarterm 80 Col Card	\$ 269 30%	
★ Z-Card (Z-80)	\$ 209 22%	
★ Addram 16K Card	\$ 119 20%	
★ Synergizer Package	\$ 549 27%	
NEC		
16K Expansion Chips for Apple II	\$ 39 35%	

LETTER QUALITY PRINTERS:

Qume Letter quality printer	
Sprint 9 45RO	\$ 2295 20%
Sprint 5 45RO	\$ 2395 20%
Olympia (Typewriter/Printer)	
ES-100, 18CPS	
w/full interface to Apple II	\$ 1695 22%

PRINTERS:

Integral Data	
445 Tiger w/Graphics & 2K	\$ 695 23%
460 Tiger w/Graphics	\$ 895 20%
560 Tiger w/Graphics	\$ 1095 22%
Prism color printer w/Graphics	\$ 1695 16%
Epson, See special Epson section at right	

Above prices for mail orders only. Our store showroom is 126 NE "F" St., Grants Pass, OR. Store prices, which include software service, differ from mail order prices. No mail order sales at store. CALL ORDER DESK.

ORDERING INFORMATION:

Minimum order \$100. Money Orders, Cashier Checks or Bank Wire welcomed. Visa and MC orders add 3%. Personal or company checks accepted (allow 20 days to clear). Add 3% for shipping, handling and insurance; UPS ground is standard. 6% total for UPS Blue or 10% total for foreign orders or US Parcel Post. Include your telephone number. No COD's. Prices are subject to change without notice. Order desk hours are 8 to 5 PST, 10 to 3 Saturdays. APO is sent by US Post.

SOFTWARE for Apple II/III+

Apple Software:	
Apple Fortran	\$ 149 25%
Apple Pilot	\$ 119 27%
Apple Plot	\$ 49 30%
Dow Jones News & Quotes	\$ 69 28%
Dow Jones Portfolio Eval.	\$ 40 20%
Microcourier	\$ 189 24%
Ashton-Tate	
dBase II for Apple II	\$ 495 30%
Broderbund Software	
Payroll	\$ 269 30%
General Ledger	\$ 349 30%
Apple Panlc	\$ 21 30%
Arcade Machine	\$ 32 30%
Red Alert	\$ 21 30%
Space Warrior	\$ 18 30%
Many Others In Stock	CALL CALL
Budgetco, Raster Blaster	\$ 22 27%
★ Calif. Pacific, Ultima	\$ 30 25%

★ Central Point Software:
Copy II Plus \$ 35 10%
Will copy most copy protected software for your backup in 45 seconds! NEW

Continental Software	
Home Accountant	\$ 56 25%
Home Money Minder	\$ 26 25%

Data Most

Snack Attack	\$ 22 25%
Thief	\$ 22 25%
Epson, MX 80 Graphics Dump	\$ 9 30%
Hayden, Sargon II (chess)	\$ 29 22%
Howard Software	
Tax Preparer	\$ 75 25%
Real Estate Analyzer	\$ 115 25%
Creative Financing	\$ 115 25%

Info Unlimited,

Easywriter (PRO)	\$ 199 20%
Innovative	
Apple Spellguard	\$ 219 26%

★ Insoft:
Electric Duet NEW \$ 25 20%
ALD System II or III \$ 110 10%
TransFORTH II or III \$ 110 10%
Accounting \$ 355 66%

A full professional quality integrated GL, A/R, A/P, Payroll package. Hotline support available. Send for free sample printouts. Requires Z80 and 16K RAM card.

Micro Lab

Data Factory, ver. 5.0	\$ 249 20%
------------------------	------------

★ Micro Pro

Word Star	\$ 239 36%
Super Sort	\$ 129 36%
Mail Merger	\$ 79 36%
Data Star	\$ 189 36%
Spell Star	\$ 159 36%

Microsoft

A.L.D.S.	\$ 110 10%
BASIC Compiler	\$ 299 25%
Cobol 80	\$ 559 25%
Fortran 80	\$ 149 25%
Olympic Decathlon	\$ 24 24%
TASC Compiler	\$ 159 22%
Typing Tutor II	\$ 19 30%

On-Line

Expediter II	\$ 75 25%
Superscribe II	\$ 95 27%
Pegasus II	\$ 22 25%
Threshold	\$ 30 25%
Cranston Manor	\$ 26 25%
Mission Astrold	\$ 15 25%
Mystery House	\$ 19 25%

★ Osborne (Disk and Book)

Some Common Basic Programs, 75 Business, Statistics and Math programs for the Apple II + \$ 49 50%

Peachtree Software

Magic Wand	\$ 250 37%
GL or A/R or A/P or PR or Inv. \$ 189	38%

Personal Software:

Desktop Plan II	\$ 159 21%
Vlsicalc 3.3	\$ 159 25%
Vlsiplot	\$ 149 21%
Vlsitrend Vlsiplot	\$ 199 31%
Vlsldex	\$ 159 30%
Vlsiterm	\$ 119 21%
Vlsifile	\$ 199 30%

Software Publishing:

PFS: Filing/Data Base	\$ 69 28%
PFS: Report	\$ 69 28%

Stoneware,

DB Master (new version)	\$ 179 22%
-------------------------	------------

Sub Logic

Flight Simulator	\$ 28 20%
------------------	-----------

For specific software not listed, CALL (800) 547-1289

REFERENCES:

We have been an Apple dealer since 1978. Our bank reference is First Interstate Bank (503) 776-5620. We belong to the Chamber of Commerce. (503) 772-6293.

IBM 3101-10 Terminal \$ 1295

HEWLETT PACKARD

HP-85A Microcomputer with built-in printer and monitor	SAVE \$ 1995 27%
HP-125 New! Microcomputer 64K CPU/Terminal/Keyboard/Monitor	\$ 3095 18%

HP-41CV New! 2.2K Memory Calculator	\$ 245 25%
HP-41C Calculator	\$ 185 26%
Memory module for HP41C	\$ 25 25%

Call for other HP equipment, software and accessories!

OTECH PROPlot 350 3-COLOR PROFESSIONAL PLOTTER

Plotter 11" wide. For Apple and Visicalc.	\$ 795 15%
Automatic 3 color option	CALL CALL
Interface to Apple II	\$ 79 15%
Visicalc/Apple II software, insoft	CALL CALL
Serial RS 232 Interface	\$ 209 15%

800 16K \$ 759 SAVE 30%
ATARI 400 16K \$ 339 SAVE 20%

Atari 810 Disk Drive	\$ 425 29%
Atari 16K RAM Module	\$ 83 27%
Atari 850 Interface	\$ 149 32%
More software and accessories in stock	CALL CALL

INTERTEC DATA SYSTEMS SUPERBRAIN

Superbrain 64K QD \$ 2895 28%

EPSON PRINTERS

MX 70 w/Graftrax	\$ 359 20%
MX80	\$ 449 31%
MX80 F/T	\$ 555 25%
MX100 F/T w/graphics	\$ 729 27%
MX80/100 Apple Interface and Cable	\$ 95 15%
MX80 Friction feed adapter	\$ 59 22%
MX80 Graftrax	\$ 79 20%
MX80/100 Atari Cable	\$ 29 22%
MX80/100 TRS 80 Cable	\$ 29 22%

NEC Microcomputer

32K Computer PC8001	\$ 750 25%
286K Total Dual Drive PC8031	\$ 750 25%
32K add-on and I/O Unit PC8012	\$ 495 24%
NEC PC Software	CALL CALL

5 Meg Hard Disk	\$ 2995 21%
10 Meg Hard Disk	\$ 4345 20%
20 Meg Hard Disk	\$ 5245 20%
Omni-Net, Constellation, Mirror, In Stock	CALL CALL

XEROX 820 System II

Complete system Includes monitor, keyboard, CPU and two disk drives	SAVE
With 5 1/4 inch dual drives	\$ 2495 18%
With 8 inch dual drives	\$ 3095 19%

commodore

VIC 20 Home Computer	\$ 249 16%
CBM 8032 Computer	\$ 1195 20%
CBM 4032 Computer	\$ 995 22%
CBM 4040 Disk Drives (2) 343K	\$ 1019 21%
CMB 8050 Disk Drives (2) 1 Meg	\$ 1295 28%

ALTOS COMPUTER SYSTEMS

ACS 8000-15, 208K, 4 User	\$ 4,450 11%
Other Altos Systems In Stock,	

Hardware Technical Hotline (503) 772-3803 (CUSTOMERS ONLY) PLEASE HAVE INVOICE # OR PACKING SLIP #

VISA

master charge

NO SALES TAX

Oregon Order Desk (503) 772-3803

TOLL FREE NATIONAL ORDER DESK (800)547-1289

Free gift with your order if you mention this ad.

MARCH

**OKIDATA MICROLINE 80A
MATRIX PRINTER**



\$329.00

SPECIALS

ATARI 810 DISK DRIVE



\$429.00

PERSONAL COMPUTERS

CALL TOLL FREE!

EAST COAST

1-800-556-7586

COMPUTER SHOPPING CENTER

12 Meeting St.
Cumberland, RI 02864
1-401-722-1027
TELEX 952106

WEST COAST

1-800-235-3581

COMPUTER SHOPPING CENTER

3533 Old Conejo Rd. #102
Newbury Park, CA 91320
1-805-499-3678
CA TOLL FREE 1-800-322-1873
TELEX 182889

COMPUTER SHOPPING CENTER

We Accept C.O.D.'s • Stock Shipments Same Day or Next • No Surcharge for Credit Cards • All Equipment Factory Fresh w/MFT Warranty • We Carry the Complete Line of Personal Software • Prices do not Reflect Shipping Charges
Rhode Island and California residents please add 6% Sales Tax

NEC PC-8023 Printer	\$629.00
NEC 7710 Spinwriter	2345.00
NEC 7720 Spinwriter	2695.00
NEC 7730 Spinwriter	2345.00
NEC JC 1201 M(A) - Color 12" Monitor	359.00
NEC JB 1201 M 12" Green Monitor	159.00
Okidata Microline-80	329.00
Okidata Microline-82A	499.00
Okidata Microline-83A	729.00
Diablo 630	1995.00
M & R Sup-R-Terminal	279.00
Microsoft Soft Card (Z-80)	279.00
Hazeltine 1420	799.00
Northstar Horizon II 32K QD	2925.00
Anadex DP-9500/9501	1249.00
Televideo 910	559.00
Televideo 912C	669.00
Televideo 920C	689.00
Televideo 950	929.00
CBM 8032 Computer	1149.00
CBM 8050 Disk Drive	1349.00
CBM 4032 Computer	1029.00
CBM 4040 Disk Drive	1029.00
CBM 4022 Printer	649.00
CBM VIC-20	269.00
Leedex/Amdek 100G	159.00
Leedex/Amdek Color - 1 13" Color Monitor	329.00
Microtek 16K Ramboard for Atari 800	79.00
Microtek 32K Ramboard for Atari 400 and 800	149.00
Qume Sprint 9/45 (Full Panel)	2295.00
Atari 400 16K	339.00
Atari 410 Recorder	60.00
Atari 825 Printer	599.00
Atari 850 Interface	139.00
Atari 830 MODEM	159.00
Atari 810 Disk Drive	429.00
Atari 800 16K	749.00
Epson MX-70	349.00
Epson MX-80	449.00
Epson MX-80 FT	549.00
Epson MX-100 FT	729.00

**COMMODORE MICROTEK DIABLO
AMDEK QUME OKIDATA ATARI
TELEVIDEO EPSON LEEDEX NEC**

PRICES ARE SUBJECT TO CHANGE WITHOUT NOTICE

WE CARRY THE COMPLETE LINE OF ATARI SOFTWARE, PERIPHERALS AND ACCESSORIES

**PERSONAL COMPUTERS
COMPUTER SHOPPING CENTER**



**NEC GREEN 12" MONITOR
JB 1201M
\$159.00**

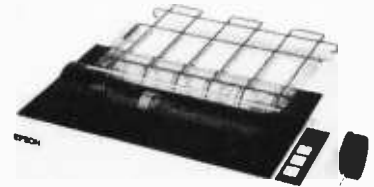

**EPSON MX-80
INTERFACES & CABLES
IEEE \$55. RS-232 \$70.
TRS-80 CABLE \$35.
\$449.00**

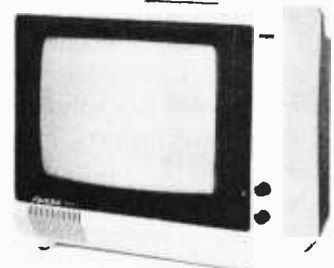

**AMDEK COLOR-1 MONITOR
\$329.00**

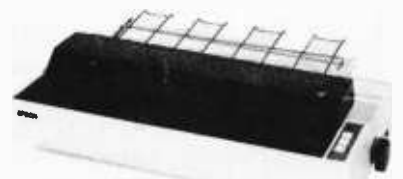

**EPSON MX-100 FT PRINTER
\$729.00**

An Underline Filter for Matrix Printers

Adam Reed
Center for Human Information Processing
UCSD C-009
La Jolla, CA 92093

Although matrix printers such as Digital Equipment Corporation's Decwriter III have the advantages of relatively high speed and fairly low cost, they do have an important disadvantage when it comes to printing manuscript copy. By convention, some items in manuscripts (the names of cited journals, for example) are underlined in the text. Matrix printers, if they underline at all, do so by overprinting the bottom line of each "underlined" character. Besides being slow and aesthetically unappealing, this type of "underlining" makes the text nearly illegible.

Fortunately, many matrix printers, including the Decwriter, can achieve half-line vertical spacing. The program in listing 1 sets this option, converts the underline

characters to minus signs (which are the same length as underline characters on most matrix printers, including the Decwriter), then moves them onto a separate line to be printed under the corresponding line of text. The result is clear, fast, legible underlining. At the end of the text file, the program restores the Decwriter to normal vertical spacing.

The program in listing 1 is written in C to act as a "filter" under the Unix operating system. Its input is a text file with standard underlining, and its output is the input to the matrix printer. It can be translated readily into other languages, such as BASIC or FORTRAN, for use with other operating systems and matrix printers. ■

Listing 1.

```
1 /* This program improves Decwriter underline handling by using a line buffer */
2 /* and may also be used to change, temporarily, the dw3's horizontal pitch. */

4 #include <stdio.h>
5 #include <stty.h>
6 #include <signal.h>

8 int dwreset();

10 main(argc,argv) int argc; char *argv[]; {

12     register char c, h, *p;
13     int b, ni
```

Listing 1 continued on page 302

BOY, IS THIS COSTING YOU.

It's really quite basic: time is money.

And BASIC takes a lot more time and costs a lot more money than it should every time you write a new business software package.

Especially when you could speed things up with dBASE II.

dBASE II is a complete applications development package.

Users tell us they've cut the amount of code they write by up to 80% with dBASE II.

Because dBASE II is the high performance relational database management system for micros.

Database and file handling operations are done automatically, so you don't get involved with sets, lists, pointers, or even opening and closing of files.

Instead, you write your code in concepts.

And solve your customers' problems faster and for a lot less than with BASIC (or FORTRAN, COBOL or PL/I).

dBASE II uses English-like commands.

dBASE II uses a structured language to put you in full control of your data handling operations.

It has screen handling facilities for setting up input and output forms.

It has a built-in query facility, including multi-key and sub-field searches, so you can DISPLAY some or all of the data for any conditions you want to apply.

You can UPDATE, MODIFY and REPLACE entire databases or individual characters.

CREATE new databases in minutes, or JOIN databases that already exist.

APPEND new data almost instantly, whether the file has 10 records or tens of thousands.

SORT the data on as many keys as you want. Or INDEX it instead, then FIND whatever you're looking for in seconds, even using floppies.

Organize months worth of data in minutes with the built-in REPORT. Or control every row and column on your CRT and your printer, to format input and output exactly the way you want it.

You can do automatic calculations on fields,



records and entire databases with a few keystrokes, with accuracy to 10 places.

Change your data or your entire database structure without re-entering all your data.

And after you're finished, you can protect all that elegant code with our run-time compiler.

Expand your clientbase with dBASE II.

With dBASE II, you'll write programs a lot faster and a lot more efficiently. You'll be able to write more programs for more clients. Even take on the smaller jobs that were out of the economic question before. Those nice little foot-in-the-database assignments that grow into bigger and better bottom lines.

Your competitors know of this offer.

The price of dBASE II is \$700 but you can try it free for 30 days.

Call for our Dealer Plan and OEM run-time package prices, then take us up on our money-back guarantee. Send us your check and we'll send you a copy of dBASE II that you can exercise on your CP/M system any way you want for 30 days.

Then send dBASE II back and we'll return all of your money, no questions asked.

During that 30 days, you can find out exactly how much dBASE II can save you, and how much more it lets you do.

But it's only fair to warn you: business programmers don't go back to BASIC's.

Ashton-Tate, 9929 Jefferson, Los Angeles, CA 90230. (213) 204-5570.



Ashton-Tate

©Ashton-Tate 1981

Programming Quizzes

Listing 1 continued:

```
14     char opstrings[256] ;
15     char *option = opstrings ;
16     char *pmax, *plast;
17     static char buf[256];
18     setbuf( stdout, (char *)malloc( BUFSIZ ));

20         /* Make sure to reset decwriter if interrupted */

22     signal(SIGHUP, dwreset);
23     signal(SIGINT, dwreset);
24     signal(SIGQUIT, dwreset);
25     signal(SIGKILL, dwreset);
26     signal(SIGPIPE, dwreset);
27     signal(SIGALRM, dwreset);
28     signal(SIGTERM, dwreset);

30         /* Get the option from the command */
31
32     strcat (option,argv[1]) ;
33     if (*option == NULL) c = '2';
34     else {
35         c = *option++;
36         if (c == '+' || c == '-') c = *option++ ;
37         if (c == '1') c = *option++ ;
38         if (c == 'P' || c == 'p') c = '0' ;
39         if (c == 'n' || c == 'N') c = '6' ;
40         if (c == 'w' || c == 'W') c = '8' ;
41     }
42         /* Then, initialize the Decwriter */
43
44     putchar(27); printf("[3z");
45     putchar(27); printf("[132t");
46     putchar(27); printf("[1,132r");
47     putchar(27);
48     if          (c == '0'){printf("[1w");putchar(27);printf("[1;84s");}
49     else if (c == '6'){printf("[4w");putchar(27);printf("[1;140s");}
50     else if (c == '8'){printf("[8w");putchar(27);printf("[1;70s");}
51     else          {printf("[2w");putchar(27);printf("[1;102s");}
52
53         /* Then process the file: */
54
55     c=getchar();
56     while ( c != EOF ) {
57         /* Main loop: process each line in turn: */
58
59
60
61
62         h=b=0;
63         plast=pmax= &buf[255];
64         p=buf;
65         while ( p<plast ) *p++ = 32;    /* clear under line buffer */
66         plast=p=buf;
67         while ( c!=10 && c!=EOF && c!= 13 && p<pmax ) {
68
69             /* loop for processing characters. */
```

Listing 1 continued on page 304

THE FORTH SOURCE™

Specializing in the FORTH Language

FORTH MANUALS, GUIDES, & DOCUMENTS

	PRICE
<input type="checkbox"/> "Starting FORTH" by Brodie. Prentice Hall. Best user's manual available. (soft cover)	\$16.00
<input type="checkbox"/> "Starting FORTH" (hard cover)	20.00
<input type="checkbox"/> "Systems Guide to fig-FORTH" by Ting. Excellent guide to inner mechanisms.	25.00
<input type="checkbox"/> "Using FORTH" by FORTH, Inc. Guide to concepts	25.00
<input type="checkbox"/> "A FORTH Primer" by Stevens. In-depth self-study manual	25.00
<input type="checkbox"/> "Caltech FORTH Manual" by Ewing. Overview and Structure.	12.00
<input type="checkbox"/> "Threaded Interpretive Languages" by Loeliger. Byte Books. FORTH adapted for Z80	20.00
<input type="checkbox"/> "Invitation to FORTH" by Katzan. Petrocelli Books. Limited Introduction.	20.00
<input type="checkbox"/> "PDP-11 FORTH User's Guide" by James.	20.00
<input type="checkbox"/> "AIM FORTH User's Manual" by Rockwell-International	12.00
<input type="checkbox"/> "APPLE FORTH-79 User's Manual" by MicroMotion	20.00
<input type="checkbox"/> "TRS-80 MMSFORTH User's Manual" by Miller Microcomputer Services.	18.50
<input type="checkbox"/> "FORTH-79". Latest FORTH Standard.	15.00
<input type="checkbox"/> "FORTH-79 Standard Conversion" by Smith. Implementation aids.	10.00
<input type="checkbox"/> "METAFORTH" by Cassady. Cross compiler with 8080 code.	30.00
<input type="checkbox"/> "Tiny PASCAL in fig-FORTH" by Zimmer.	10.00
Proceedings of Technical Conferences	
<input type="checkbox"/> "1980 FORML" (FORTH Modification Laboratory)	25.00
<input type="checkbox"/> "1981 FORML" Two Volume Set	40.00
<input type="checkbox"/> Volume I, Language Structure	25.00
<input type="checkbox"/> Volume II, Systems and Applications.	25.00
<input type="checkbox"/> "1981 Rochester University"	25.00

FORTH HARDWARE

<input type="checkbox"/> AIM65 Microcomp by Rockwell. 4K RAM, FORTH IC's and manuals (plus \$20.00 handling and shipping)	\$530.00
---	----------

INSTALLATION DOCUMENTS

<input type="checkbox"/> Installation Manual for fig-FORTH, contains FORTH model, glossary, memory map, and instructions	\$15.00
<input type="checkbox"/> Source Listings of fig-FORTH, for specific CPU's and computers. The above installation manual is required for implementation. Each	15.00
<input type="checkbox"/> 1802 <input type="checkbox"/> 6502 <input type="checkbox"/> 6800 <input type="checkbox"/> AlphaMicro	
<input type="checkbox"/> 8080 <input type="checkbox"/> 8086/88 <input type="checkbox"/> 9900 <input type="checkbox"/> APPLE II®	
<input type="checkbox"/> PACE <input type="checkbox"/> 6809 <input type="checkbox"/> NOVA <input type="checkbox"/> PDP-11/LSI/11	

Cross Compilers by Nautilus (NS), Talbot Microsystems (TM), Laboratory Microsystems (LM) and Inner Access (IA).
Allows extending, modifying and compiling for speed and memory savings, can also produce ROMable code.

FORTH DISKS WITH DOCUMENTATION

	PRICE
fig-FORTH Model and Source Listing, with printed Installation Manual and Source Listing.	
<input type="checkbox"/> APPLE II® 5¼ <input type="checkbox"/> 8080/Z80® 8	
<input type="checkbox"/> 8086/8088 8 <input type="checkbox"/> H89/Z89 5¼	\$65.00
<input type="checkbox"/> APPLE II/II+® by MicroMotion. Version 2. FORTH-79 Standard, editor, assembler, 200 pg manual, 5¼	\$100.00
<input type="checkbox"/> Option 1 - floating point and HiRes Turtle Graphics	50.00
<input type="checkbox"/> Option 2 - DBMS, DOS/FORTH, modem utilities	50.00
<input type="checkbox"/> Combo Package - All of the above	\$180.00
<input type="checkbox"/> APPLE II by Kuntze. fig-FORTH editor, assembler, source listing and screens, 5¼	\$90.00
<input type="checkbox"/> ATARI® by Pink Noise Studio. fig-FORTH, editor, assembler, missile graphics, sound and handle drivers, 5¼	\$90.00
<input type="checkbox"/> CROMEMCO® by Inner Access fig-FORTH editor, assembler, 5¼ or 8	\$100.00
<input type="checkbox"/> PET® by FSS. fig-FORTH editor and assembler, 5¼	\$90.00
<input type="checkbox"/> PET® with floating point, strings, disk I/O	\$150.00
<input type="checkbox"/> TRS-80II® by Nautilus Systems fig-FORTH, editor and assembler, 5¼	\$90.00
<input type="checkbox"/> TRS-80I or III by Miller Microcomputer Services. MMSFORTH, FORTH-79 subset, editor, assembler, dbl-precision. arrays, utilities & applications. 210 pg. manual, 5¼	\$130.00
<input type="checkbox"/> HP-85 by Lange. fig-FORTH, editor and assembler, 5¼	\$90.00
<input type="checkbox"/> H89/Z89 by Haydon. fig-FORTH, CP/M® source, editor, assembler, & tutorial on disk, 5¼	\$175.00
<input type="checkbox"/> CP/M®, Z80 by MicroMotion. Version 2.x, FORTH-79 Standard, editor, assembler, 200 pg manual 5¼	\$100.00
<input type="checkbox"/> Enhancement Package - floating point, DBMS & modem utilities.	\$70.00
<input type="checkbox"/> Combo Package - all of the above	\$150.00
<input type="checkbox"/> 6800 by Talbot Microsystems. fig-FORTH, editor, assembler, disk I/O, FLEX® 5¼ or 8	\$100.00
<input type="checkbox"/> 6809 by Talbot Microsystems. fig-FORTH, editor, assembler, disk I/O, FLEX® 5¼ or 8	\$100.00
<input type="checkbox"/> 6809 Enhanced 2nd screen editor, macroassembler, tutorial, tools and utilities, FLEX	\$250.00
<input type="checkbox"/> Z80® by Laboratory Microsystems. Editor and assembler, CP/M, 8	\$50.00
<input type="checkbox"/> Z80 with floating point	\$150.00
<input type="checkbox"/> Z80 with AMD 9511 support	\$150.00
<input type="checkbox"/> Z80 by Inner Access. Editor, assembler and manual. CP/M, 8	\$100.00
<input type="checkbox"/> 8080 by Inner Access. Editor, assembler, and manual. CP/M, 8	\$100.00
<input type="checkbox"/> 8086/88 by Laboratory Microsystems. Editor, assembler, CP/M-86®, 8	\$100.00
<input type="checkbox"/> 8086/88 with floating point, CP/M-86	\$200.00
<input type="checkbox"/> 8086/88 with AMD 9511 support CP/M-86	\$200.00

<input type="checkbox"/> CP/M (NS) \$200	<input type="checkbox"/> TRS80/II (NS) \$200
<input type="checkbox"/> H89/Z89 (NS) \$200	<input type="checkbox"/> Northstar (NS) \$200
<input type="checkbox"/> Z80 (LM) \$200	<input type="checkbox"/> 8086 (LM) \$300
<input type="checkbox"/> 6809 (TM) \$250	<input type="checkbox"/> Cromemco (IA) \$450
<input type="checkbox"/> CP/M (IA) \$450	

ORDERS ONLY (415) 961-4103

Ordering Information: Check, Money Order (payable to MOUNTAIN VIEW PRESS), VISA or MasterCard accepted. No COD's or unpaid PO's. California residents add 6½% sales tax. Shipping costs in US included in price. Foreign orders, pay in US funds on US bank, include for handling and shipping by Air: \$5.00 for each item under \$25.00, \$10.00 for each item between \$25.00 and \$99.00 and \$20.00 for each item over \$100.00. Minimum order \$ \$10.00. All prices and products subject to change or withdrawal without notice. Single system and/or single user license agreement required on some products.

DEALER & AUTHOR INQUIRIES INVITED

MOUNTAIN VIEW PRESS, INC.

PO BOX 4656

MOUNTAIN VIEW, CA 94040

(415) 961-4103

Programming Quickies

Listing 1 continued:

```
71         if ( c== 3 ) dreset(); /* catch interrupt signals */
73
74         if ( c=='\t' ) {          /* tab both text and ul line */
75             putchar ( '\t' ) ;
76             *p++ = '\t' ;
77             if (plast<p) plast=p;
78         }
79         else if ( c=='_' ) {      /* underline, backspace? */
80             if ((c = getchar()) == '\b') {
81                 b=2;
82             }
83             else {
84                 *p++ = '-';
85                 if (plast<p) plast=p;
86                 putchar(32);
87                 h=1; /* a character is waiting */
88             }
89         }
90         else if ( c=='\b' ) {    /* backspace, underline? */
91             if ((c = getchar()) == '_') {
92                 if (plast<p) plast=p;
93                 *(p-1) = '-';
94             }
95             else {
96                 h = 1 ;
97                 putchar('\b');
98                 --p;
99             }
100        }
101        else {                    /* ordinary char */
102            putchar(c);
103            ++p;
104            if ( b==2 ) {        /* previously underlined char */
105                b = 0 ;
106                if (plast<p) plast=p;
107                *(p-1) = '-';
108            }
109        }
110        if ( h==1 ) h=0;        /* character read already */
```

Listing 1 continued on page 306

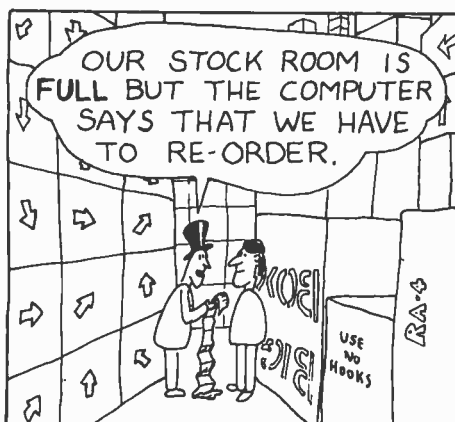



NEECO

WHY BUY FROM THE BEST?

Service... Support...
Software...



MULTI-CLUSTER

For Commodore Systems, allows 3 CPU's (Expandable to 8) to access a single Commodore Disk.
MULTI-CLUSTER (3 CPU's) \$ 795
Each Additional CPU (up to 8) . . . \$ 199



16K B (16K RAM-40 Column) - Lim. Qty	\$ 995
32K B (32K RAM-40 Clm.) - Lim. Qty	\$1295
4016 (16K RAM 4.0 Basic-40 Clm.)	\$ 995
4032 (32K RAM 4.0 Basic-40 Clm.)	\$1295
8032 (32K RAM 4.0 Basic-80 Clm.)	\$1495
8050 Dual Disk (1 Meg. Storage)	\$1795
4040 Dual Disk (343K Storage)	\$1295
8010 IEEE Modem	\$ 280
C2N Cassette Drive	\$ 95
CBM - IEEE Interface Cable	\$ 40
IEEE - IEEE Interface Cable	\$ 50
VIC 20 Home/Personal Computer	\$ 295

CALL NEECO FOR ANY OF YOUR COMMODORE COMPUTER NEEDS

EPSON PRINTERS

MX-80 PRINTER	\$ 645
MX-80 FT	\$ 745
MX-100	\$ 945
MX-70	\$ 459
INTERFACE CARDS	
8141 (RS-232)	\$ 75
8150 (2K Buffered RS-232)	\$ 150
8161 (IEEE 488)	\$ 55
8131 (Apple Card)	\$ 85
8230 (Apple Card)	\$ 25
8220 (TRS-80 Cable)	\$ 35

DIABLO 630 PRINTER

DIABLO 630 - Serial - RS-232	\$2710
Tractor Option	\$ 250

AMDEK MONITORS

Video 100 12" B+W	\$ 179
Video 300 12" Green	\$ 249
Color I 13" Low Res	\$ 449
Color II 13" High Res	\$ 999

INTERTEC COMPUTERS

64K Superbrain (360 Disk Storage), CP/M™ . . .	\$3495
64K QD Superbrain (700K Disk Storage), CP/M™ . .	\$3995

*CP/M is a registered trademark of Digital Research.



ATARI COMPUTERS

Atari 400 (16K RAM)	\$ 399
Atari 800 (32K RAM) - good thru 8/31	\$1080
Atari 410 RECORDER	\$ 89.95
Atari 810 DISK DRIVE	\$ 599.95

NEECO carries all available ATARI Software and Peripherals.



APPLE

16K APPLE II+	\$1330
32K APPLE II+	\$1430
48K APPLE II+	\$1530
APPLE DISK w/3.3 DOS	\$ 650
APPLE DRIVE Only	\$ 490
APPLE III 128K - In Stock! w/Monitor + Info Analystpak	\$4740

PROFESSIONAL SOFTWARE

WordPro 1 8K	\$ 29.95
WordPro 3 (40 Clm.)16K	\$ 199.95
WordPro 3+	\$ 295
WordPro 4 (80 Clm.) 32K	\$ 375
WordPro 4+	\$ 450

JUST A SAMPLE OF THE MANY PRODUCTS WE CARRY, CALL US FOR OUR NEW 60-PAGE CATALOG. WE WILL MATCH SOME ADVERTISED PRICES ON CERTAIN PRODUCTS LISTED UNDER SIMILAR "IN STOCK" CONDITIONS.



NEECO

679 HIGHLAND AVE.
NEEDHAM, MA 02194

(617) 449-1760

Telex: 951021

MON-FRI 9:00 - 5:00



MasterCharge and VISA Accepted

Programming Quickies

Listing 1 continued:

```
110             else c=getchar();
111         }
112         putchar (10);           /* so down to underline position */
113         p=buf;
114         while ( p<plast ) {     /* output and clear under line */
115             putchar(*p);
116             *p++ = 32;
117         }
118         plast=buf;
119         putchar(10);
120         if ( c!=10 && c!=13 ) break; /* any c other than LF or CR */
121                                     /* at end-of line indicates error */
122         c=getchar();           /* otherwise get first c in new line */
123                                     /* or EOF */
124     }
125
126     /* after EOF the end is near, so reset decwriter to normal mode */
127
128     alarm(120);
129     dwreset();
131 }                                     /* THE END */
133 dwreset() {                         /* Subroutine to reset the decwriter to normal mode */
135     signal(SIGINT,SIG_IGN);
136     putchar(27); printf("[1z");
137     putchar(27); printf("[66t");
138     putchar(27); printf("[1,66r");
139     putchar(27); printf("[2w");
140     putchar(27); printf("[1,i02s");
141     exit();
143 }
```

The Graphics Family...

**the most versatile, easiest-to-use
graphics available for your Apple II.**

The A2-3D1/3D2 with A2-GE1 Graphics Editor package lets you put simultaneous multiple images on your screen . . . where you want, in the size you want, in your choice of orientation, complete with upper and lower case text. Because the most important part of your computer system is you. \$119.85

subLOGIC

Communications Corp.
713 Edgebrook Drive
Champaign, IL 61820
(217) 359-8482
Telex: 206995

*Apple is the registered trademark of Apple Computer Inc.



**NEW
LOW PRICE!**

Now for **\$5995*** you can own a professional quality small business computer.

It seems like everybody's selling computers these days. Personal computers. Hobby computers. Computers that play games. Computers with incredibly low prices.

But if you're interested in a professional quality small business computer that can stand up to all the punishment your business can dish out, the bargains start at \$5995.

That's the price of Digital's DECmate Work Processor™ system. It includes the Work Processor itself, a BASIC operating system that lets you write your own programs, plus two of our most popular software packages. One for financial modeling, and one for mailing lists. You also get a printer. That's everything you need to start managing your business more efficiently.

For an extra \$500, you can even get the software to do word processing. And other software packages are reasonably priced, too.



So if you're looking for bargains, start with the Work Processor from Digital. And for just \$5995, you can run your small business like a big business.

*Destination charges not included.

Look what the Work Processor system can do for you! **

Word processing

- Word processing
- Applicant tracking
- Office management system (telephone log and directory, signature log, calendar, tickler file)
- Smart mailer for mailing lists
- Math
- Sort
- Communications

Data Processing

- BASIC, FORTRAN, PAL 8, DIBOL
- Financial modeling
- Accounts receivable
- Accounts payable
- Payroll
- General ledger
- Invoicing and inventory control
- Construction management system
- Dental practice management
- Lawyer's client accounting
- CPA client write-up
- Communications

**With optional software

digital

**We change the way
people work.**

To arrange a free demonstration or for more information call 800-258-1577 extension 1010.
In New Hampshire, call 603-884-7492.

BUSINESS and UTILITIES

MAILMASTER (Atari diskette only) Price: \$39.95 Diskette
MAILMASTER is a very versatile software package for managing and manipulating mail lists and mini data bases. Each disk can hold over 700 customer entries, containing name, address, three 3-letter key words and a phone number. The display is made so that entries may be made and edited with ease. The status (e.g., disk space left, options, etc.) is shown at all times. Labels may be printed 1.2 or 3 way, and all sorting (by code and alphabetically) is performed by a fast machine language program.

PERSONAL FINANCE SYSTEM (Atari and North Star only) Price: \$39.95 Diskette
PFS is a single diskette, menu-oriented system composed of ten different programs. Besides recording your expenses and tax deductible items, PFS will sort and summarize expenses by month, and display information on expenditures by any of 26 user defined codes by month or by payer. PFS will even produce payable and graphs of your expenses by category. This powerful package requires only one disk drive, minimal memory (124K Atari, 32K North Star) and will store up to 600 records per disk (and over 1000 records per disk by making a few simple changes to the program). You can record check plus cash expenses so that you can finally see where your money goes and eliminate guesswork and tedious hand calculations. Contains high speed machine language sort. PFS has been demonstrated on network (CBS) TV!

FAMILY BUDGET (Apple and Atari only) Price: \$34.95 Diskette
FAMILY BUDGET is a very convenient financial record-keeping program. You will be able to keep track of cash and credit expenditures as well as income on a daily basis. You can record tax deductible items and charitable donations. FAMILY BUDGET also provides a continuous record of all credit transactions. You can make daily cash and charge entries to any of 21 different expense accounts as well as to payroll and tax accounts. Data are easily reviewed giving the user complete control over an otherwise complicated (and unorganized) subject.

INTELINK (Atari only) Price: \$49.95 Diskette
This software package contains a menu-driven collection of programs for facilitating efficient two-way communications through a full duplex modem (required for use). In one mode of operation you may connect to a data service (e.g., the SOURCE or MicroNet) and quickly load data such as stock quotations onto your diskette for later viewing. This greatly reduces "connect time" and thus the service charge. You may also record the complete contents of a communications session. Additionally, programs written in BASIC, FORTRAN, etc. may be built off-line using the support text editor and later "up loaded" to another computer, making the Atari a very smart terminal. Even Atari BASIC programs may be uploaded. Further, a command file may be built off-line and used later as controlling input for a time-share system. That is, you can set up your sequence of time-share commands and programs, and the Atari will transmit them as needed; batch processing. All this adds up to saving both connect time and your time!

TEXT EDITOR II (CP/M) Price: \$29.95 Diskette/\$33.45 Disk
This is the second release version of DYNACOMP's popular TEXT EDITOR I and contains many new features. With TEXT EDITOR II you may build text files in chunks and assemble them for later display. Blocks of text may be appended, inserted or deleted. Files may be saved in a diskette or entered for format to be later printed by either TEXT EDITOR II or the CP/M ED facility. Further, ASCII CP/M files (including BASIC and assembly language programs) may be read by the editor and processed. In fact, text files can be built using TEXT EDITOR II. All in all, TEXT EDITOR II is an inexpensive, easy to use, but very flexible editing system.

PAYFIVE (Apple II plus diskette, two drives required) Price: \$149.95
This is an enormously flexible employee payroll system with extraordinarily good human engineering features. PAYFIVE prints checks and completes the required federal, state and local forms for up to 148 employees. The pay methods may be hourly, salary, commission or any combination. There are multiple options for pay periods, and they also can be used in any combination. PAYFIVE includes many other features and comes extremely well documented with a 300 page manual. The manual may be purchased separately for \$30, and that payment later applied to the software purchase.

SHOPPING LIST (Atari only) Price: \$12.95 Cassette/\$16.95 Diskette
SHOPPING LIST stores information on items you purchase at the supermarket. Before going shopping, it will remind you of all the things you might need, and then display for (optionally print) your shopping list and the total cost. Adding, deleting, changing and storing data is very easy. Runs with 16K.

TAX OPTIMIZER (North Star only) Price: \$59.95 Diskette
The TAX OPTIMIZER is an easy-to-use, menu oriented software package which provides a convenient means for analyzing various income tax strategies. The program is designed to provide a quick and easy data entry. Income tax is computed by all tax methods (federal, income averaging, maximum and alternate minimum tax). The user may immediately observe the tax effect of critical financial decisions. TAX OPTIMIZER has been thoroughly field tested in CPA offices and comes complete with the current tax tables in its data files. TAX OPTIMIZER is tax deductible!

UTIL (Apple only, 48K) Price: \$19.95 Diskette
UTIL is a disk-oriented utility system which permits examining and changing of the contents of DOS 3.2 and 3.3 diskettes at the bit (or byte) level. With UTIL you can easily examine the contents of a diskette sector by sector, restructure the sector pointers, reallocate sectors (e.g. bad sectors may be "hidden"), and perform many other sophisticated operations. For the experienced programmer.

TURNKEY AND MENU (Atari only) Price: \$17.95 Diskette
TURNKEY is a utility program which allows you to create autoboot/autorun diskettes easily. Simply load and run TURNKEY, load the program diskette to be modified, and answer the questions! The TURNKEY also comes with DOS 2.0 and includes another program, MENU. MENU lists the contents of your diskette alphabetically, and permits the running of any BASIC program on the diskette by typing a single key. TURNKEY and MENU provide you with the ability to run any program on your diskette by simply turning on the computer and pressing a single key.

STOCKAID (Atari only) Price: \$19.95 Diskette
STOCKAID provides a powerful set of tools for stock market analysis. With STOCKAID you can display plot and figure charts, as well as bar charts with oscillators. You can also examine long term moving averages and on-balance volume features. STOCKAID allows you to input daily data with a single diskette storage capability of 239 days - 16 stocks. Included are real time dividend and split adjustment capabilities. A very professional package!

SHAPE MAGICIAN (Apple II, 48K, diskette only) Price: \$19.95
At last! An utility for painlessly creating graphics shapes for the Apple. Create, edit and save up to 10 shapes which can then be used to develop arcade games or to simply enhance your programs. Add that professional touch!

EDUCATION

HODGE PODGE (Apple only, 48K Applesoft or Integer BASIC) Price: \$14.95 Cassette/\$18.95 Diskette
Let HODGE PODGE be your child's teacher. Prerequisite any age your Apple will result in a different and intriguing "happening" related to the letter or number of the chosen key. The program's graphics, color and sound are a delight for children from ages 1's to 7. HODGE PODGE is a non-intimidating teaching device which brings a new dimension to the use of computers in education. See the excellent review of this very popular program in INFOWORLD and SOFTALK.

TEACHER'S AIDE (Atari only) Price: \$149.95 Cassette/\$17.95 Diskette
TEACHER'S AIDE consists of three basic modules contained in one program. The first module provides addition and subtraction exercises of varying levels of difficulty. The second module consists of multiplication problems in which the student may be tested both on the front or the back of the number of the chosen key. The third module consists of division problems; one particularly nice feature of the division module is that the long hand division steps can be displayed along with the remainder in order to clearly demonstrate the procedure by which the remainder is derived. Using TEACHER'S AIDE is not merely a drill, but rather a learning experience.

PHARMACOLOGY UPDATE (PET only) Price: \$149.95 Cassette/\$153.95 Diskette
This is DYNACOMP's first educational software entry for the medical profession (more are coming). PHARMACOLOGY UPDATE was written by a R.N. as a masters project, with the aid of a practicing pharmacist and an electronics instructor. This package comes in two parts. The first part is a 200 page manual which is divided into 10 sections. Each of these sections provides both concise information and probing questions. The second part consists of 10 programs that are keyed to the text and which test the degree of your understanding of the text material. This package has great educational value for the beginning student as well as the professional interested in an efficient way to review and update his or her knowledge.

ORDERING INFORMATION

All orders are processed and shipped within 48 hours. Please enclose payment with order and include the appropriate computer information. If paying by VISA or MasterCard, include all numbers on card. Purchase orders accepted.

Shipping and Handling Charge
Within North America: Add \$2.00
Outside North America: Add 15% (Air Mail)

Delivery
All orders (excluding books) are sent First Class.

Quantity Discounts
Deduct 10% when ordering 3 or more programs. Dealer discount schedules are available upon request.

8" CP/M disks
Add \$2.50 to the listed diskette price for each 8" floppy disk (IBM soft sector CP/M format). Programs run under Microsoft MBASIC or BASIC 80.

5 1/4" CP/M disks
All software available on 5 1/4" CP/M disks is also available on 5 1/4" disks, North Star and Osborne format.

Ask for DYNACOMP programs at your local software dealer. Write for detailed descriptions of these and other programs from DYNACOMP.

DYNACOMP, Inc. (Dept. B)

1427 Monroe Avenue
Rochester, New York 14618
24 hour order phone: (716) 442-8731 recording
Office phone (9AM-5PM EST): (716) 442-8960

New York State residents please add 7% NYS sales tax.



STATISTICS and ENGINEERING

DIGITAL FILTER (Available for all computers) Price: \$39.95 Cassette/\$43.95 Diskette
DIGITAL FILTER is a comprehensive data processing program which permits the user to design his own filter function or choose from 8 menu of filter forms. The filter forms are subsequently converted into non-recursive convolution coefficients which permit rapid data processing. In the explicit design mode the shape of the frequency transfer function is specified by directly entering poles and zeros at the desired filter curve. In the menu mode, ideal low pass, high pass and bandpass filters may be approximated to varying degrees according to the number of points used in the calculation. These filters may optionally also be smoothed with a Hanning function. In addition, multi-stage Butterworth filters may be selected. Features of DIGITAL FILTER include plotting of the data before and after filtering, as well as display of the chosen filter functions. Also included are convenient data storage, retrieval and editing procedures.

DATA SMOOTHER (Not available for Atari) Price: \$19.95 Cassette/\$23.95 Diskette
This special data smoothing program may be used to rapidly derive useful information from noisy business and engineering data which are equally shared. The software features choice in degree and range of fit, as well as smoothed first and second derivative calculation. Also included is automatic plotting of the input data and smoothed results.

FOURIER ANALYZER (Available for all computers) Price: \$19.95 Cassette/\$23.95 Diskette
Use this program to examine the frequency spectrum of limited duration signals. The program features automatic scaling and plotting of the input data and results. Practical applications include the analysis of complicated patterns in such fields as electronics, communications and business.

TFA (Transfer Function Analyzer) Price: \$16.95 Cassette/\$23.95 Diskette
This is a special software package which may be used to evaluate the transfer functions of systems such as hi-fi amplifiers and filters by examining their response to pulsed inputs. TFA is a major modification of FOURIER ANALYZER and contains an engineering-oriented decibel versus log-frequency plot as well as data editing features. Whereas FOURIER ANALYZER is designed for educational and scientific use, TFA is an engineering tool. Available for all computers.

HARMONIC ANALYZER (Available for all computers) Price: \$24.95 Cassette/\$28.95 Diskette
HARMONIC ANALYZER is a special software package for analyzing data sets consisting of repetitive waveforms. Features include data file generation, editing and storage/retrieval as well as data and spectrum plotting. One particularly unique facility is that the input data need not be equally spaced or in order. The original data is sorted and a cubic spline interpolation is used to create the data file required by the FFT algorithm. FOURIER ANALYZER, TFA and HARMONIC ANALYZER may be purchased together for a combined price of \$49.95 (three cassettes) and \$59.95 (three diskettes).

REGRESSION I (Available for all computers) Price: \$19.95 Cassette/\$23.95 Diskette
REGRESSION I is a unique and exceptionally versatile one-dimensional least squares "polynomial" curve fitting program. Features include very high accuracy; an automatic degree determination option; an extensive internal library of fitting functions; data editing; automatic data curve and residual plotting; a statistical analysis for standard deviation, correlation coefficient, etc.) and much more. In addition, new fits may be tried without reentering the data. REGRESSION I is certainly the cornerstone program in any data analysis software library.

REGRESSION II (PARAFIT) (Available for all computers) Price: \$19.95 Cassette/\$23.95 Diskette
PARAFIT is designed to handle those cases in which the parameters are imbedded (possibly nonlinearly) in the fitting function. The user simply inserts the functional form, including the parameters (A11, A12, etc.) as one or more BASIC statements. Data, results and curve are manipulated and plotted as with REGRESSION I. Use REGRESSION I for polynomial fitting, and PARAFIT for those complicated functions.

MULTILINEAR REGRESSION (MLR) (Available for all computers) Price: \$24.95 Cassette/\$28.95 Diskette
MLR is a professional software package for analyzing data sets containing two or more linearly independent variables. Besides performing the basic regression calculation, this program also provides easy to use data entry, storage, retrieval and editing functions. In addition, the user may interrogate the solution by supplying values for the independent variables. The number of variables and data size is limited only by the available memory.

REGRESSION I, II and MULTILINEAR REGRESSION may be purchased together for \$51.95 (three cassettes) or \$63.95 (three diskettes).

ANOVA (Not available on Atari cassette or for PET/CPM) Price: \$39.95 Cassette/\$43.95 Diskette
In the past the ANOVA (analysis of variance) procedure has been limited to the large mainframe computers. Now DYNACOMP has brought the power of this method to small systems. For those concerned with ANOVA, the DYNACOMP software package includes the 1-way, 2-way and N-way procedures. Also provided are the Yates 2^{k-p} factorial designs. For those unfamiliar with ANOVA, do not worry. The accompanying documentation was written in a tutorial fashion (by a professor in the subject) and serves as an excellent introduction to the subject. Accompanying ANOVA is a support program for building the data base. Included are several convenient features including data editing, deleting and appending.

BASIC SCIENTIFIC SUBROUTINES, Volumes 1 and 2 (Not available for Atari)
DYNACOMP is the exclusive distributor for the software used in the popular text BASIC SCIENTIFIC SUBROUTINES, Volumes 1 and 2 by Robert S. Stearns in BYTE magazine. These subroutines have been assembled according to chapter. Included with each collection is a menu program which selects and demonstrates each subroutine.

Volume 1
Collection #1: Chapters 2 and 3 - Data and function plotting; complex variables and functions.
Collection #2: Chapter 4 - Extended matrix and vector operations.
Collection #3: Chapters 5 and 6 - Random number generators (Poisson, Gaussian, etc.); series approximations.
Price per collection: \$14.95 Cassette/\$18.95 Diskette
All three collections are available for \$39.95 (three cassettes) and \$49.95 (three diskettes).

Volume 2
Collection #1: Chapter 1 - Linear, polynomial, multidimensional, parametric least squares.
Collection #2: Chapter 2 - Series approximation techniques (economization, inversion, reversion, shifting, etc.).
Collection #3: Chapter 3 - Functional approximations by iteration and recursion.
Collection #4: Chapter 4 - CORDIC approximations to trigonometric, hyperbolic, exponential and logarithmic functions.
Collection #5: Chapter 5 - Table interpolation, differentiation and integration (Newton, Lagrange, splines).
Collection #6: Chapter 6 - Methods for finding the real roots of functions.
Collection #7: Chapter 7 - Methods for finding the complex roots of functions.
Collection #8: Chapter 8 - Optimization by steepest descent.
Price per collection: \$14.95 Cassette/\$18.95 Diskette
All eight collections are available for \$99.95 (eight cassettes) and \$129.95 (eight diskettes).
Because the texts are a vital part of the documentation, BASIC SCIENTIFIC SUBROUTINES, Volumes 1 and 2 are available from DYNACOMP.

BASIC SCIENTIFIC SUBROUTINES, Vol 1 (319 pages): \$19.95 + 75¢ postage
BASIC SCIENTIFIC SUBROUTINES, Vol 2 (790 pages): \$23.95 + \$1.50 postage

See reviews in KILBOAUD and Dr. Dobbs.

SOFTNET (Apple II 48K, diskette only) Price: \$129.95
SOFTNET may be used to create models of liquid pipeline systems to evaluate their flow performance. Up to 150 nodes with up to 150 connecting elements may be simulated, and models may be combined to form yet larger models. If you are involved in water distribution systems, chemical fluid flow problems, building plumbing, or similar situations, this is an ideal analysis tool.

ACTIVE CIRCUIT ANALYZER (ACAP) (48K Apple only) Price: \$25.95 Cassette/\$29.95 Diskette
ACAP is the analog circuit designer's answer to LOGIC SIMULATOR. With ACAP you may analyze the response of an active or passive component circuit (e.g., a transistor amplifier, band pass filter, etc.). The circuit may be probed at equal steps in frequency, and the resulting complex (i.e., real and imaginary) voltages at each component juncture examined. By plotting the magnitude of these voltages, the frequency response of a filter or amplifier may be completely determined with respect to both amplitude and phase. In addition, ACAP prints a statistical analysis of the range of voltage responses which result from tolerance variations in the components. ACAP is easy to learn and use. Simply describe the circuit, and the program will generate their placement, and execute. Circuit descriptions may be saved onto cassette or diskette to be recalled at a later time for execution or editing. ACAP should be part of every circuit designer's program library.

LOGIC SIMULATOR (Apple only, 48K RAM) Price: \$24.95 Cassette/\$28.95 Diskette
With LOGIC SIMULATOR you may easily test your complicated digital logic design with respect to given set of inputs to determine how well the circuit will operate. The elements which may be simulated include multiple input AND, OR, NOR, EXOR, ENOR and NAND gates, as well as inverters, J-K and D flip-flops, and one-shots. The response of the system is available every clock cycle. Inputs may be clocked in with varying clock cycle lengths/displacements and delays may be introduced to probe for glitches and race conditions. At the user's option, a timing diagram for any given set of nodes may be plotted using HIRES graphics. Save your breadboarding until the circuit is checked by LOGIC SIMULATOR.

NUMBERRUNNER (TRS-80 only) Price: \$69.95 Cassette/\$73.95 Diskette
This program is the most complete numerical analysis system available for the TRS-80. It can handle up to 255 data sets, each set having a six character name. It includes complete data editing facilities and convenient data input/output capability. The analyses available are multiple linear regression and correlation determination of residuals; data transformations and extensive graphics generation, including axis naming, and more. The supporting documentation is extremely well written and well organized, and includes appendices which describe the numerical procedures used in the program.

STATSORT (TRS-80 only) Price: \$19.95 Cassette/\$23.95 Diskette
STATSORT consists of several menu selected programs which allow the user to create (build, edit, merge), format and print files, (machine) sort them on any field, and numerically analyze (maximum, minimum, average, variance, standard deviation) tabulated data. STATSORT is well documented and easy to use. The cassette version can also be employed to create a data type which can be read by the Radio Shack Advanced Statistical Package.

STATTEST (TRS-80 only) Price: \$19.95 Cassette/\$23.95 Diskette
This is a statistical inference package which helps you make wise decisions in the face of uncertainty. In an interactive fashion you can build and edit data files and test the difference between two means, variances and proportions. STATTEST will also perform data analysis as well as do linear correlation and regression. This menu-driven statistical workbook is rounded out with a chi-square contingency test and a (uniform and normal) random sample generator. The documentation is written by a college professor who guides you through the various tests.

ABOUT DYNACOMP

DYNACOMP is a leading distributor of small system software with sales spanning the world (currently in excess of 50 countries). During the past three years we have greatly enlarged the DYNACOMP product line, but have maintained and improved our high level of quality and customer support. The achievement in quality is apparent from our many repeat customers, and the software reviews in such publications as COMPUTERS, THE SOFTWARE CRITIC, A.N.A.L.O.G., Softalk, Creative Computing and Kilobaud. DYNACOMP software has also been chosen for demonstration on network television. Our customer support is as close as your phone. It is always friendly. The staff is highly trained and always willing to discuss products or give advice.

software ... with lots of technical support

CALICO SYSTEMS

(213) 475-8104
TO ORDER, CALL TOLL-FREE
(800) 854-2003, ext. 75
(800) 522-1500, ext. 75 in Calif.

CP/M®

Specify format.
Most disk formats available.

LANGUAGES		disk with manual/only
Basic	Microsoft	\$289/-
Basic Compiler	Microsoft	\$329/-
C-Basic	Dig. Research	\$110/20
CB 80	Dig. Research	\$437/37
COBOL 80	Microsoft	\$574/-
C Compiler	Supersoft	\$169/-
Forth	Supersoft	\$169/45
Fortran	Supersoft	\$209/30
Fortran 80	Microsoft	\$375/-
muLISP	Microsoft	\$169/-
Pascal/M	Sorcim	\$345/30
Pascal Z	Ith. Intersys.	\$349/30
RATFOR	Supersoft	\$85/-
Fortran + RATFOR		\$289/35
S-Basic	Micro AP	\$269/25
Tiny Pascal	Supersoft	\$79/25

ASSEMBLERS/UTILITIES		
ACT I	Sorcim	\$152/25
Despool	Dig. Research	\$50/-
Diagnostic II	Supersoft	\$84/20
Macro 80	Microsoft	\$162/-
MAC	Dig. Research	\$85/15
P/L I-80	Dig. Research	\$469/40
QSORT	Struc. Sys.	\$90/-
SID	Dig. Research	\$70/15
ZSID	Dig. Research	\$90/15

WORD/TEXT PROCESSING		
Edit 80	Microsoft	\$90/-
Letterright	Struc. Sys.	\$156/-
Magic Wand	Peachtree	\$289/45
Mail Merge	MicroPro	\$108/25
Spellguard	ISA	\$225/25
Spell Star	MicroPro	\$175/40
TEX	Dig. Research	\$100/10
Textwriter III	Organic Softwr	\$110/-
Word Star	MicroPro	\$318/60
Word Star + Mail Merge		\$415/85

ANALYSIS/MODELING		
Calc Star	MicroPro	\$229/45
Milestone	Organic Softwr	\$269/-
muMATH/muSIMP	Microsoft	\$225/-
Supercalc	Sorcim	\$259/50
Worksheet	Soho Group	\$185/-

DATA BASE MANAGEMENT		
dBASE II	Ashton-Tate	\$599/40
Series 20-1	Condor	\$249/50
Series 20-2	Condor	\$509/50
Data Star	MicroPro	\$245/60
FMS-80-1	Systems Plus	Call
FMS-80-2	Systems Plus	Call

INCOME TAX MICRO TAX		
Lev 1 (Indvl.)		\$225/-
Lev 2 (Prof.)		Call
Lev 3 (Partner)		Call
Lev. 2 & 3		Call
State Tax		Call

ACCOUNTING TCS		
G/L or A/P		
or A/R or Payroll		\$75/25
All four		\$250/99

ACCOUNTING PLUS™		
G/L		\$439/67
A/P		\$375/67
A/R		\$375/67
Payroll		\$375/67
Inventory		\$375/67
Sales Order		\$375/67
Point of Sale		\$375/67
Purch. Order		\$375/67

PEACHTREE-SERIES 5		
G/L		\$437/40
A/P		\$437/40
A/R		\$437/40
Payroll		\$319/40
Inventory		\$437/40
Sales Invoice		\$437/40

CALICO SYSTEMS - Mar. 82
1746 1/2 Westwood Blvd.
Los Angeles, CA 90024
(213) 475-8104
YES, WE'VE GOT HARDWARE TOO!
VISIT OUR NEW COMPUTER STORE.

APPLE II®

I.J.S.	
Datadex	\$258
Easy Writer (40 col)	\$88
Easy Mailer (40 col)	\$61
Forth	\$123
Pro. Easy Mailer	\$149
Pro. Easy Writer	\$225

MICROPRO	
Mail Merge	\$97
Super Sort I	\$159
Word Star	\$260
Word Star + Mail Merge	\$349

MICROSOFT	
A.L.D.S.	\$105
Basic Compiler	\$320
Fortran-80	\$175
16K RAM Card	\$149
Z-80 Soft Card	\$295

PEACHTREE	
G/L	\$219
A/R	\$219
A/P	\$219
Payroll	\$219
Inventory	\$219
Mail List	\$219

HOWARD SOFTWARE	
Income Tax	Call

PERSONAL SOFTWARE	
Desktop Plan II	\$159
VisiCalc	\$159
VisiDex	\$159
VisiFile	\$199
VisiPlot	\$149
VisiTerm	\$149
VisiTrend/VisiPlot	\$229

MASTER CHARGE/VISA

CALICO SYSTEMS

1746 1/2 Westwood Blvd.
Los Angeles, CA 90024
(213) 475-8104

Add \$3.50/item for shipping, handling. Overseas add \$10. California residents add 6% sales tax. Allow time for checks to clear. Prices subject to change without notice. All items subject to availability. *Registered trademark.

Programming Quickies

A Shape-Drawing Program for Diablo Printers

Thomas D. Brock
1227 Dartmouth Rd.
Madison, WI 53705

The Diablo Model 1620 and 1640 daisy-wheel printers have a lot of nice graphics features that aren't generally used. After working with high-resolution graphics shape tables on the Apple II computer, I decided to write a shape-list generator for the Diablo in BASIC. [We call this construct a "shape list" to distinguish it from the binary-coded Apple shape tables...RSS]

The program I devised permits the definition of a variety of shapes and the printing of these shapes at any chosen size. No attempt has been made to write a complete graphics package, but the shape-list generator could easily be incorporated into a larger program. Changing the position of printing on the paper and rotating the shapes could also be added.

Each shape is defined in terms of the instructions needed to print it on the paper. The move and print instructions are coded into character strings that are interpreted by a series of subroutines. The program can be used on any BASIC interpreter that supports string variables and permits dissection of strings into substrings.

The details of the Diablo codes for graphics can be found in the Diablo user's manual. The printer is placed into graphics mode by sending to it an Escape, "3" sequence and is taken out of graphics mode through an Escape, "4" sequence. When in graphics mode, carriage movement is not tied to character printing, but space and backspace cause carriage movements of 1/60 inch forward and backward, respectively. Also the linefeed character causes paper-feed movement of 1/48 inch, and "negative linefeed," initiated by sending an Escape, linefeed sequence, causes paper movement of 1/48 inch in the opposite direction. Other paper-movement commands such as vertical tab, formfeed, and margin control remain unchanged.

Thus, to print a horizontal line, it is necessary to send an alternating sequence of periods (decimal ASCII code 46) and spaces or backspaces; the length of the line in inches will be 1/60 times the number of periods printed. To print a vertical line, one sends an alternating sequence of periods and linefeeds, or negative linefeeds; the length

Hitachi Oscilloscopes ...
satisfying a wide variety of needs.
Hitachi oscilloscopes are innovative modern scopes featuring wider band width, more compact design, and light weight. Through adopting circuitry with linear IC's and logic IC's plus modern manufacturing techniques, including automatic component-insertion machines, these scopes offer increased stability, improved reliability, excellent performance, and enhanced operating ease.



Hitachi 15 MHz Single Trace

• 1 mV Sensitivity • 5" CRT
with One X10 Probe
V-151B \$570.00

Hitachi 15 MHz Dual Trace

• 1 mV Sensitivity • 5" CRT
with Two X10 Probes
V-152B
Reg. \$735 WITH COUPON \$640

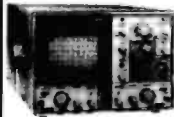

Hitachi 20 MHz Dual Trace

• 1 mV Sensitivity • 5.5" CRT
with Two X10 Probes
V-202
Reg. \$850 WITH COUPON \$755

Hitachi 30 MHz Single Trace

• 1 mV Sensitivity • 5" PDA CRT
• Signal Delay with One X10 Probe
V-301 \$745



Hitachi 30 MHz Dual Trace

• 1 mV Sensitivity • 5" PDA CRT
• Signal Delay with Two X10 Probes
V-302B
Reg. \$995 WITH COUPON \$849

Hitachi 35 MHz Dual Trace

• 1 mV Sensitivity • 5.5" PDA CRT
• Signal Delay with Two X10 Probes
V-352
Reg. \$1150 WITH COUPON \$988

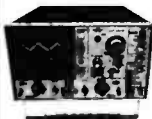

Hitachi 50 MHz Dual Trace

• 1 mV Sensitivity • 6" PDA CRT
• Cal. Delay Sweep with Two X10 Probes
V-550B
Reg. \$1745 CALL FOR SPECIAL PRICE

Hitachi 100 MHz Four Trace Operation

• 0.5 mV Sensitivity • 6" PDA CRT
• Cal. Delay Sweep with Two X10 Probes
V-1050
Reg. \$2390 CALL FOR SPECIAL PRICE



Waveform Monitor/Portable Oscilloscope

• 7 MHz • 10 mV Sensitivity • 5" CRT
with Battery Pack and One X10 Probe
V-059B \$1200

Waveform Monitor

Small Size NTSC Waveform Monitor
AC/DC Operation
V-099 \$1350



COMMODORE

CBM-8032 Computer

Regular \$1495.00
EXTRA SPECIAL WITH COUPON \$1040

80 Column Screen
32K Memory
Typewriter Styled Keyboard

THANDAR TG105 PULSE GENERATOR



• Period: 200ns to 200ms (5MHz-5Hz)
• Pulse Width: 100ns to 100ms
• 50 ohm output range: 0.1V-10V
• TTL output • Sync. output
• Compliment and square wave

TG105 ... Reg. \$219 **SPECIAL WITH COUPON \$195.00***

CARBON FILM RESISTORS

Only in Multiples of 100 pieces per value (ohms)
1/4W 5% ... \$1.69 per 100
1/4W 5% ... \$1.79 per 100

10	100	1.0K	10K	100K	1.0M
11	110	1.1K	11K	110K	1.1M
12	120	1.2K	12K	120K	1.2M
13	130	1.3K	13K	130K	1.3M
15	150	1.5K	15K	150K	1.5M
16	160	1.6K	16K	160K	1.6M
18	180	1.8K	18K	180K	1.8M
20	200	2.0K	20K	200K	2.0M
22	220	2.2K	22K	220K	2.2M
24	240	2.4K	24K	240K	2.4M
27	270	2.7K	27K	270K	2.7M
30	300	3.0K	30K	300K	3.0M
33	330	3.3K	33K	330K	3.3M
36	360	3.6K	36K	360K	3.6M
39	390	3.9K	39K	390K	3.9M
43	430	4.3K	43K	430K	4.3M
47	470	4.7K	47K	470K	4.7M
51	510	5.1K	51K	510K	5.1M
56	560	5.6K	56K	560K	5.6M
62	620	6.2K	62K	620K	6.2M
68	680	6.8K	68K	680K	6.8M
75	750	7.5K	75K	750K	7.5M
82	820	8.2K	82K	820K	8.2M
91	910	9.1K	91K	910K	9.1M

CARBON FILM RESISTOR KIT

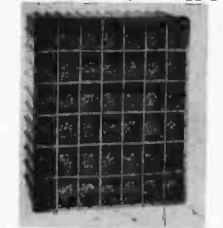

COMPLETE WITH STORAGE BIN
Each kit contains 20 each of 42 different 1/4 watt, 5% tolerance, CARBON FILM RESISTORS.
from .68Ω to 4.7MΩ **\$24.90**

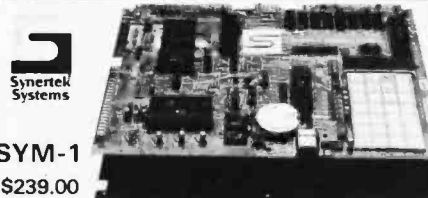

SYM-1
\$239.00

Intersil LED or LCD 3 1/2 DIGIT PANEL METER KITS

BUILD A WORKING DPM IN 1/2 HOUR WITH THESE COMPLETE EVALUATION KITS
Text: these new parts for yourself with Intersil's low cost prototyping kits. Complete with A/D converter and LCD display (7106) or LED display (7107). Kits provide all materials, incl. PC board, for 4 functioning panel meter. IC1 7106EV (LCD) ... \$34.45 IC1 7107EV (LED) ... \$28.70



Universal Oscilloscope

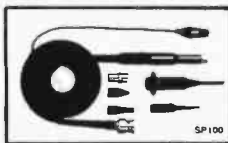

Probe \$36.00
with Battery Pack

SWITCHABLE X1 and X10 Attenuation Factor
KEY ADDITIONAL FEATURES: • 100MHz bandwidth • Heavy duty tip • Break resistant center conductor • Slender, flexible cable • 6ft. cable length • Wide compensation range • Fits all scopes • Ground reference can be activated at tip • Includes SPIRITUNG HOOK, I.C. TIP, BNC ADAPTOR, INSULATING TIP and TRIMMER TOOL ACCESSORIES.

6500 SERIES MICROPROCESSOR IC'S

A = (2 MHz)		B = (3 MHz)		C = (4 MHz)	
P6502	5 8.82	P6506A	58.82	P6520A	53.74
P6502A	9.66	P6507	8.09	P6820	3.40
P6502B	15.02	P6507A	8.82	P68B20	3.74
P6502C	21.00	P6512	8.82	P6521	4.90
P6503	8.09	P6512A	9.66	P6521A	5.34
P6503A	8.82	P6513	8.09	P6821	4.90
P6504	8.09	P6513A	8.82	P68B21	5.34
P6504A	8.82	P6514	8.09	P6522	8.40
P6505	8.09	P6514A	8.82	P6522A	11.24
P6505A	8.82	P6515	8.09	P6530-004	15.84
P6506	8.09	P6520	3.40		

* SPECIAL 20% DISCOUNT WITH COUPON *

ANCRONA P.O. Box 2208Y, Culver City, CA 90230

SPECIAL COUPON

Bring this Coupon into one of our stores or mail to our Mail Order address shown below and receive the Special Discounts listed on this page with purchases of \$50.00 or more.
Offer EXPIRES on April 30, 1982

NAME _____
ADDRESS _____
CITY _____ STATE _____
ZIP _____ PHONE _____

Coupons accepted only with full name and address filled in

FLUKE Hand Held Digital Multi-Meters

When you need dependable, accurate, easy, measurements from a handheld DMM ... look to FLUKE.
You'll be owning the finest quality DMM available.

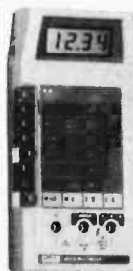

FLUKE MODEL 8020B

- 3 1/2 Digits
- Eight Functions, Including: Audible Continuity, Conductance & Diode Test
- 0.1% Basic DC Accuracy
- 2 Year Warranty
- High-speed Audible Continuity Testing
- Extensive Overload Protection
- Shock and Vibration per MIL-T-28800, Class 5
- Low Battery Indicator
- Extended Measurement with Optional Accessories

Model 8020B DMM \$189.00



FLUKE MODEL 8021B

- 3 1/2 Digits
- Seven Functions, Including: Audible Continuity and Diode Test
- 2 Year Warranty
- 2 Year Calibration Cycle
- Extensive Overload Protection
- Shock and Vibration per MIL-T-28800, Class 5
- Probes for RF, High Voltage, High Current, and More

Model 8021B DMM \$149.00

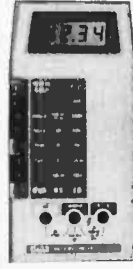

FLUKE MODEL 8022B

- 3 1/2 Digits
- Six Functions, Including Diode Test
- Fluke's Lowest Priced DMM
- 2 Year Warranty
- 2 Year Calibration Cycle
- Extensive Overload Protection
- Shock and Vibration per MIL-T-28800, Class 5
- Probes for RF, High Voltage, High Current, and More

Model 8022B DMM \$139.00



FLUKE MODEL 8024B

- 3 1/2 Digits
- 2 Year Calibration Cycle
- Eleven Functions, Including: Visual and Audible Continuity, Peak Hold, Temperature (with optional K thermocouples), Level Detection Conductance and Diode Test
- 0.1% Basic DC Accuracy
- Extensive Overload Protection
- Fast AC or DC Transient Capture
- Shock and Vibration per MIL-T-28800, Class 5
- 2 Year Warranty
- Extended Measurements with Optional Accessories
- Low Battery Indicator

Model 8024B DMM \$239.00

VISIT A STORE NEAR YOU TODAY - We stock a large selection of Technical Books, Discrete Components, Integrated Circuits, Test Equipment and Electronic Supplies.

ANCRONA
P.O. BOX 2208Y, CULVER CITY, CA 90230
STORES DO NOT ACCEPT MAIL ORDERS **MAIL ORDER**

PHONE ORDERS: (213) 641-4064

Minimum Order \$10.00. Add \$2.00 to cover postage and handling. Master Charge and VISA welcomed. Please include your charge card number, interbank number and expiration date. Some items are subject to prior sale. Not responsible for typos. Store pricing may vary from Mail Order pricing. We reserve the right to substitute manufacturer.

ATLANTA
3330 Piedmont Rd. N.E.
Atlanta, GA 30305
(404) 281-7100

CULVER CITY
11080 Jefferson Blvd.
Culver City, CA 90230
(213) 390-3595

HOUSTON
2649 Richmond
Houston, TX 77098
(713) 529-3489

PORTLAND
1125 N.E. 82nd Ave.
Portland, OR 97220
(503) 257-9464

SANTA ANA
1300 E. Edinger Ave.
Santa Ana, CA 92705
(714) 547-8424

SUNNYVALE
1054 E. El Camino Real
Sunnyvale, CA 94087
(408) 243-4121

TUCSON
4518 E. Broadway
Tucson, AZ 85711
(602) 881-2348

Programming Quicksies

Listing 1: *Diablo printer shape-table program in BASIC for the Apple II computer.*

```
1  REM  DIABLO SHAPE TABLE GENERATOR
2  REM  BY THOMAS D. BROCK, MADISON, WI.
3  REM  FIRST DEFINE CODES FOR DIABLO.  E$=ESCAPE.SP$=SPACE.
4  REM  LF$=LINE FEED.G$=3.TX$=4.PE$=PERIOD (PRINT CHARACTER).
5  REM  BS$=BACKSPACE.NF$=NEGATIVE LINE FEED.
10 E$ = CHR$ (27):SP$ = CHR$ (32):LF$ = CHR$ (10):G$ = CHR$ (51)
11 TX$ = CHR$ (52):PE$ = CHR$ (46):BS$ = CHR$ (8)
12 NF$ = CHR$ (27) + CHR$ (10)
19  REM  SHAPE TABLE REFERENCES
20  INPUT "SHAPE#?";N
22  INPUT "SCALE?";S
28  REM  TURN ON PRINTER.INITIALIZE GRAPHICS MODE
30  PR# 3: PRINT " ";E$;G$;
40  ON N GOSUB 1000,1100,1200,1300
45  GOTO 200
48  REM  MOVE AND PRINT ROUTINES
50  FOR I = 1 TO M * S
52  PRINT SP$;PE$;
54  NEXT I: RETURN
60  FOR I = 1 TO M * S
62  PRINT LF$;PE$;
64  NEXT I: RETURN
70  FOR I = 1 TO M * S
72  PRINT BS$;PE$;
74  NEXT I: RETURN
80  FOR I = 1 TO M * S
82  PRINT NF$;PE$;
84  NEXT I: RETURN
198 REM  RETURN TO TEXT MODE
200 PRINT E$;TX$;; PR# 0: END
998 REM  LINES 1000,1200 DEFINE SHAPES
999 REM  ANY SHAPES MAY BE INSERTED HERE
1000 SH$ = "L3D3R2XL2D3R3"
1001 GOSUB 5000: RETURN
1100 SH$ = "XD3L2U4R4D4L2"
1101 GOSUB 5000: RETURN
1200 SH$ = "XD3L2XL1XULU3XULXR1R3XR1XD1D3XD1XL1L2": GOSUB 5000: RETURN
1998 REM  TEST FOR PRINT DIRECTION
2000 IF M$ = "R" THEN GOSUB 50
2010 IF M$ = "D" THEN GOSUB 60
2020 IF M$ = "L" THEN GOSUB 70
2030 IF M$ = "U" THEN GOSUB 80
2040 RETURN
4998 REM  INTERPRET STRING AS SHAPE
5000 FOR J = 1 TO LEN (SH$)
5020 IF MID$ (SH$,J,1) = "X" THEN PE$ = CHR$ (0):J = J + 1
5030 M$ = MID$ (SH$,J,1):J = J + 1:M = VAL ( MID$ (SH$,J,1)): GOSUB 2000
5100 PE$ = CHR$ (46): NEXT J
5200 RETURN
```

of the vertical line in inches will be 1/40 times the number of periods printed. To move the print head without printing a line, the print-head-movement command is sent without the corresponding periods.

The program in listing 1 is fairly self-explanatory. The shapes are stored as character strings in lines 1000 to 1200, and could, of course, also be input just before starting execution by a change in line 20.

\$389.

Made by Seikosha, AXIOM's new GP-100 is the finest printer a little money can buy. It uses standard 8-1/2 x 11 paper and has AXIOM's fabulous graphics interfaces for Apple, TRS-80, Atari, PET, HP and more! See the GP-100 at your AXIOM dealer today!



AXIOM

AXIOM CORPORATION

Seikosha is the leading company of the worldwide Seiko Group.

1014 Griswold Avenue, San Fernando, CA 91340 • Telephone: (213) 365-9521 • TWX: 910-496-1746

Circle 42 on Inquiry card.

www.americanradiohistory.com

LISP

for
TRS-80 Models I & III
AND NOW, CP/M*

SuperSoft LISP allows the TRS-80 to become a complete Artificial Intelligence laboratory! It is the tool that takes you to the frontier of Computer Science.

The SuperSoft LISP is a *complete and full* implementation. (It is NOT a subset!) It contains an efficient garbage collector which optimizes the usage of user RAM, and supports the TRS-80 graphics. Below are some features:

- Runs in 16k level II (with only 6K overhead)
- Fully implements atom property list structure.
- PROG is supported.
- FUNARG device is implemented.
- Efficient garbage collection.
- Complete with LISP editor and trace.
- Allows complete range of single precision numeric data.
- Works with old as well as new ROMs.
- Contains 97 functions.
- Sample Programs.

The LISP package is supplied on tape or discette and with a complete user manual.

cassette version TRS-80: \$75.00
 (requires 16K level II)

Disk version TRS-80: \$100.00
 (requires 16K disk)

CP/M version: \$150.00
 (requires 32K CP/M)

(manual only: \$15.00)

Software available for virtually all CP/M systems. Specify your system.

Available from fine dealers everywhere, or directly from:

SUPERSOFT, INC.
 P.O. BOX 1628
 CHAMPAIGN, IL 61820
 217-359-2112 Telex: 270365
 Technical Hot Line: 217-359-2691



U.K. and Europe
 DIGITAL DEVICES
 13A LONDON ROAD
 SOUTHBOROUGH, KENT
 TUNBRIDGE WELLS
 TN4, OPL
 ENGLAND
 Tel: Tunbridge Wells (0892)37977/9
 Telex: 95582

Japan
 ASR CORPORATION INTERNATIONAL
 3-23-8 NISHI-SHIMBASHI, MINATO KU
 TOKYO 105
 JAPAN
 Tel: 03-437-5371
 Telex: 0242-2723

SuperSoft
First in Software Technology

TRS-80 TRADEMARK TANDY CORP

*CP/M REGISTERED TRADE MARK DIGITAL RESEARCH

Programming Quickies

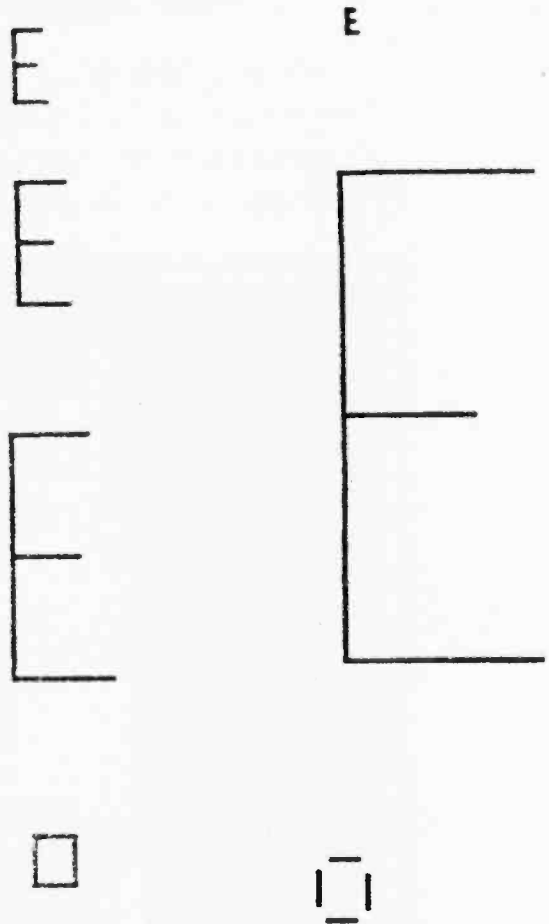

Figure 1: Sample printout produced on a Diablo printer of the 1600 series with the program of listing 1.

The shape string selected is interpreted in the sub-routine at line 5000. If an X is present, it means move without printing, an R means move right, an L means move left, a U means move up, and a D means move down. The number after the move instruction provides the relative amount of movement, which is stored in the variable M.

The actual amount of movement depends upon the size of the shape, selected at line 22. The whole shape is quickly printed by the program. Printing is then stopped so that another instruction can be fetched, if desired. A typical printout is shown in figure 1.

Although the Diablo printer has several different ways by which graphics can be created, the shape-list program provides a simple means to make nonnumerical drawings. By permitting the selection of any desired size (and position on the paper, with routines easily added) some useful tasks can be performed. Because of the simplicity and shortness of the program, it can be run with virtually any BASIC interpreter that supports string functions. ■

H & E COMPUTRONICS INC.

• EVERYTHING FOR YOUR TRS-80* • ATARI* • APPLE* • PET* •

*TRS-80 is a trademark of the Radio Shack Division of Tandy Corp. - *ATARI is a trademark of Atari Inc. - *Apple is a trademark of Apple Corp. - *Pet is a trademark of Commodore



★ All orders processed within 24-Hours
★ 30-Day money back guarantee on all Software

BUSINESS PAC 100

100 Ready-To-Run

Business Programs

(ON CASSETTE OR DISKETTE).....Includes 110 Page Users Manual.....5 Cassettes (Or Diskettes)

Inventory Control.....Payroll.....Bookkeeping System.....Stock Calculations.....

Checkbook Maintenance.....Accounts Receivable.....Accounts Payable.....

BUSINESS 100 PROGRAM LIST

1 RULE78	Interest Apportionment by Rule of the 7's	59 WACC	Weighted average cost of capital
2 ANNU1	Annuity computation program	60 COMBPAL	True rate on loan with compensating bal. required
3 DATE	Time between dates	61 DISCBAL	True rate on discounted loan
4 DAYYEAR	Day of year a particular date falls on	62 MERGANAL	Merger analysis computations
5 LEASEJNT	Interest rate on lease	63 FINRAT	Financial ratios for a firm
6 BREAKEVN	Break-even analysis	64 NPV	Net present value of project
7 DEPRSL	Straightline depreciation	65 PRINDLAS	Laspeyres price index
8 DEPRSY	Sum of the digits depreciation	66 PRINDPA	Paasche price index
9 DEPRDB	Declining balance depreciation	67 SEASIND	Constructs seasonal quantity indices for company
10 DEPRDDB	Double declining balance depreciation	68 TIMETR	Time series analysis linear trend
11 TAXDEP	Cash flow vs. depreciation tables	69 TIMEMOV	Time series analysis moving average trend
12 CHECK2	Prints NFRS checks along with daily register	70 FUPRINF	Future price estimation with inflation
13 CHECKBK1	Checkbook maintenance program	71 MAILPAC	Mailing list system
14 MORTGAGE/A	Mortgage amortization table	72 LETWRT	Letter writing system-links with MAILPAC
15 MJLTMON	Computes time needed for money to double, triple, etc.	73 SORT3	Sorts list of names
16 SALVAGE	Determines salvage value of an investment	74 LABEL1	Shipping label maker
17 RRVARIN	Rate of return on investment with variable inflows	75 LABEL2	Name label maker
18 RRCONST	Rate of return on investment with constant inflows	76 BUSBJD	DOME business bookkeeping system
19 EFFECT	Effective interest rate of a loan	77 TIMECLK	Computes weeks total hours from timeclock info.
20 FVAL	Future value of an investment (compound interest)	78 ACCTPAY	In memory accounts payable system-storage permitted
21 PVAL	Present value of a future amount	79 INVOICE	Generate invoice on screen and print on printer
22 LOANPAY	Amount of payment on a loan	80 INVENT2	In memory inventory control system
23 REGWITH	Equal withdrawals from investment to leave 0 over	81 TELDIR	Computerized telephone directory
24 SIMPDISK	Simple discount analysis	82 TIMUSAN	Time use analysis
25 DATEVAL	Equivalent & nonequivalent dated values for oblig.	83 ASSIGN	Use of assignment algorithm for optimal job assign.
26 ANNUDEF	Present value of deferred annuities	84 ACCTREC	In memory accounts receivable system-storage ok
27 MARKUP	% Markup analysis for items	85 TERMSPAY	Compares 3 methods of repayment of loans
28 SINKFUND	Sinking fund amortization program	86 PAYNET	Computes gross pay required for given net
29 BONDVAL	Value of a bond	87 SELLPR	Computes selling price for given after tax amount
30 DEplete	Depletion analysis	88 ARBCOMP	Arbitrage computations
31 BLACKSH	Black Scholes options analysis	89 DEPRSF	Sinking fund depreciation
32 STOCVAL1	Expected return on stock via discounts dividends	90 UPSZONE	Finds UPS zones from zip code
33 WARVAL	Value of a warrant	91 ENVELOPE	Types envelope including return address
34 BONDVAL2	Value of a bond	92 AUTOEXP	Automobile expense analysis
35 EPSEST	Estimate of future earnings per share for company	93 INSFIL	Insurance policy file
36 BETAALPH	Computes alpha and beta variables for stock	94 PAYROLL2	In memory payroll system
37 SHARPE1	Portfolio selection model-i.e. what stocks to hold	95 DILANAL	Dilution analysis
38 OPTWRITE	Option writing computations	96 LOANAFFD	Loan amount a borrower can afford
39 RTVAL	Value of a right	97 RENTPRCH	Purchase price for rental property
40 EXPVAL	Expected value analysis	98 SALELEAS	Sale-leaseback analysis
41 BAYES	Bayesian decisions	99 RRCONVBD	Investor's rate of return on convertible bond
42 VALPRINF	Value of perfect information	100 PORTVAL9	Stock market portfolio storage-valuation program
43 VALADINF	Value of additional information		
44 UTILITY	Derives utility function		
45 SIMPLEX	Linear programming solution by simplex method		
46 TRANS	Transportation method for linear programming		
47 EOQ	Economic order quantity inventory model		
48 QUEUE1	Single server queueing (waiting line) model		
49 CVP	Cost-volume-profit analysis		
50 CONDPFOP	Conditional profit tables		
51 OPTLOSS	Opportunity loss tables		
52 FQJQQ	Fixed quantity economic order quantity model		
NAME	DESCRIPTION		
53 FQEOWSH	As above but with shortages permitted		
54 FQEOPB	As above but with quantity price breaks		
55 QUEUECB	Cost-benefit waiting line analysis		
56 NCFANAL	Net cash-flow analysis for simple investment		
57 PROFIND	Profitability index of a project		
58 CAPI	Cap. Asset Pr. Model analysis of project		

- CASSETTE VERSION \$99.95
- DISKETTE VERSION \$99.95
- TRS-80* MODEL II VERSION \$149.95

ADD \$3.00 FOR SHIPPING IN UPS AREAS
ADD \$4.00 FOR C.O.D. OR NON-UPS AREAS
ADD \$5.00 OUTSIDE U.S.A., CANADA & MEXICO

COMPUTRONICS
MATHEMATICAL OPERATORS SERVICE

50 N. PASCACK ROAD
SPRING VALLEY, NEW YORK 10977



**NEW TOLL-FREE
ORDER LINE**
(OUTSIDE OF N.Y. STATE)
(800) 431-2818

**24 HOUR
ORDER
LINE**
(914) 425-1535



Four Implementations of Pascal

Thomas H. Woteki
FEROX Microsystems Inc.
1701 North Ft. Myer Dr.
Suite 611
Arlington, VA 22209

Paul A. Sand
Sandpiper Software
10 Hemlock Forest
Dover, NH 03820

The programming language Pascal was developed in the late 1960s and early 1970s by Niklaus Wirth. According to Wirth, principal aims were to create a language suitable for teaching and facilitating disciplined and systematic programming and to develop reliable and efficient implementations of the language on computers then available. Here, we review four implementations of Pascal designed for today's microcomputers. Three of these—Pascal/M, Pascal/MT+, and Pascal/Z—are designed to operate under the CP/M operating system; the fourth, Softech's UCSD Pascal, is an entire operating system designed to run on a variety of microcomputers, including Z80-based machines.

Wirth's Pascal, or standard Pascal, is defined in the *Pascal User Manual and Report* (K. Jensen and N. Wirth. New York: Springer Verlag, second edition, 1974) and is the common basis for the implementations considered. Each implementation is essentially a superset of this standard and incorporates features of the proposed International Standards Organization (ISO) draft proposal for the language, ISO/DP 7185. The ISO proposal extends Wirth's Pascal.

Differences in Implementations

The four implementations of Pascal described here differ chiefly with respect to these kinds of features:

- Extensions to the ISO standards.
- Nature of code generated, whether machine code that can be directly executed in the target processor, or P-code (pseudo-machine code, also called intermediate code) that must be translated into machine code by an interpreter when the program is run.
- Types and variety of input and output primitives (intrinsic procedures for input and output).
- Support for separate compilation of modules or libraries of procedures and data structures (so that the separate modules can be called and used by other programs, eliminating the need to rewrite commonly used procedures).
- Support for memory overlays (an overlay is a section of code brought into main memory in an area previously occupied by another section of the same program). An overlay reduces the amount of main memory necessary for a program to run.
- Ease of use. The nature of the code generated and the steps required to generate it do much to determine ease of use.

We will describe each of the four implementations of Pascal and then examine the way they handle some of the Pascal features just mentioned. Some of the terms used to describe programming languages are defined separately in the text box "Programming Language Terms" on page 354.

Tired Of Your GENERAL LEDGER?

VERSA- LEDGER

- ★ THE ULTIMATE PERSONAL CHECK REGISTER
- ★ A PROFESSIONAL ACCOUNTING SYSTEM
- ★ A PERSONAL FINANCIAL MANAGER
- ★ A SMALL BUSINESS ACCOUNTING SYSTEM
- ★ A COMPLETE GENERAL LEDGER

FOR YOUR TRS-80 MODEL I, II, III & 7 COLOR COMPUTER • APPLE II • I.B.M. • XEROX • ATARI
ALL MICROSOFT BASIC COMPUTERS

HOW IT WORKS

VERSALEDGER is a complete accounting system that grows as you or your business grows. To start, your **VERSALEDGER** acts as a simple method of keeping track of your checkbook. Just enter your check number, date and to whom the check is made out to. As you or your business grows, you may add more details to your transactions account number, detailed account explanations, etc.

- **VERSALEDGER** can give you an instant cash balance at anytime. (IF YOU WANT IT TO)
- **VERSALEDGER** can be used as a small personal checkbook register. (IF YOU WANT IT TO)
- **VERSALEDGER** can be used to run your million dollar corporation. (IF YOU WANT IT TO)
- **VERSALEDGER** prints checks. (IF YOU WANT IT TO)
- **VERSALEDGER** stores all check information forever. (IF YOU WANT IT TO)
- **VERSALEDGER** can handle more than one checkbook. (IF YOU WANT IT TO)
- **VERSALEDGER** can be used to replace a general ledger. (IF YOU WANT IT TO)
- **VERSALEDGER HAS AN ALMOST UNLIMITED CAPACITY**
 (300 checks per month on single density 5 1/4" disk drives such as the TRS-80 Model-I)
 (500 checks per month on the Apple II)
 (2400 checks per month on the TRS-80 Model III)
 (6000 checks per month on the TRS-80 Model II)
 (3000 checks per month on single density 8" CP/M)
- **VERSALEDGER** will soon have an add-on payroll package. (IF YOU NEED IT)

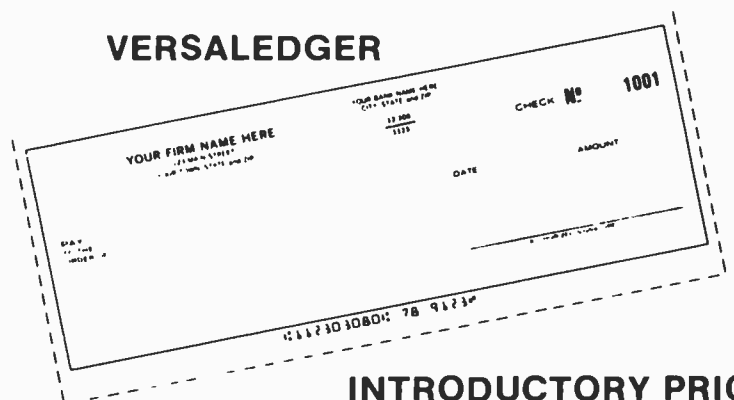

INTRODUCTORY PRICE
\$99.95

— CAN BE USED WITH 1 or MORE DISK DRIVES —

**VERSALEDGER HAS BEEN CREATED
WITH THE FIRST TIME COMPUTER USER IN MIND**

COMPUTRONICS
MATHEMATICAL APPLICATIONS SYSTEMS

50 N. PASCACK ROAD
SPRING VALLEY, NEW YORK 10977

- ★ ADD \$3.00 FOR SHIPPING IN UPS AREAS
- ★ ADD \$4.00 FOR C.O.D. OR NON-UPS AREAS
- ★ ADD \$5.00 TO CANADA AND MEXICO
- ★ ADD PROPER POSTAGE OUTSIDE U.S., CANADA & MEXICO



24 HOUR
ORDER
LINE
(914) 425-1535



**NEW TOLL-FREE
ORDER LINE**
(OUTSIDE OF N.Y. STATE)
(800) 431-2818

*** ALL PRICES & SPECIFICATIONS SUBJECT TO CHANGE ***

FREE Computer Forms Catalog

with 32 pages of continuous business forms for small computer systems

Send today for our NEW full color 32 page catalog with programming guides, prices and order forms for continuous checks, invoices, statements, envelopes, stock paper and labels.

- Quality products at low prices
- Available in small quantities
- Fast Service
- Money Back Guarantee
- Convenient TOLL-FREE ordering

Fast Service by mail or...PHONE TOLL FREE

1 + 800-225-9550

Mass. residents 1 + 800-922-8560

8:30 a.m. to 5:00 p.m. Eastern Time Monday — Friday

Please rush a new computer forms catalog to: CODE 22460

Name _____

Company _____

Street _____

City, State and Zip _____

Phone _____

Computer make & model _____

 **Nebs
Computer Forms**

78 Hollis Street, Groton, Mass. 01471
A Division of New England Business Service, Inc.

Pascal/Z

Ithaca Intersystems' Pascal/Z is a compiler for the Z80 processor and is designed to run under Digital Research's CP/M Version 2.2 operating system. Pascal/Z requires 56K bytes of RAM (random-access memory), including the space used by the operating system and at least one disk drive. According to the developer, the Pascal/Z compiler generates optimized macro-assembler code that is capable of being written into a read-only memory device (ROM-able) and capable of being interrupted and later reentered at the point of interruption (reentrant).

To execute a Pascal program with Pascal/Z, you must compile the source text, assemble the resulting Z80 assembler code, and link the resulting code file to a run-time library. The linked code is then ready for execution under CP/M.

The Pascal/Z compiler, assembler, and linker are all part of the Pascal/Z package, retailing for \$395.

Pascal/M

The Pascal/M compiler, made by Sorcim of Santa Clara, California, is a one-pass compiler that produces a P-code file as output. Pascal/M was designed to run under CP/M 2.0, MP/M, Cromemco CDOS, and Oasis operating systems on Z80 or 8080/8085 machines. Pascal/M requires 56K bytes of memory and one disk drive. The Pascal/M package includes the compiler, a run-time library, and a run-time interpreter. It costs \$225. (Our thanks to Digital Marketing of Walnut Creek, California, for making a copy of Pascal/M available to us.)

Pascal/M is identical to UCSD Pascal—in all its extensions to standard Pascal—with two important exceptions. The similarity includes the naming and definition of strings and the built-in procedures for handling them, along with low-level, byte-oriented procedures for moving information from one part of memory to another.

The important differences between Pascal/M and UCSD Pascal are in the operating system and library facilities. Pascal/M operates under CP/M, but UCSD Pascal is an independent operating system. Pascal/M has no apparent facility for separate compilation of libraries of procedures; UCSD Pascal is well endowed in this regard. Pascal/M allows memory overlays.

UCSD Pascal

UCSD Pascal, originally developed at the University of California, San Diego, is supplied by Softech Microsystems Inc. of San Diego. The UCSD Pascal system requires at least 48K bytes of contiguous RAM (64K bytes are recommended) and at least 175K bytes of disk storage.

UCSD Pascal comprises an entire operating system and can run on a variety of machines. The operating system includes a file handler, a character-oriented editor, a one-pass compiler that generates P-code, a conditional macro assembler, a linker, and a librarian utility. The operating

Investigate Robotics

with a

RHINO XR-1

Complete Robotic System \$2400

The high-tech robotic system designed for education, research and industry—robotic arm, power pak, controller card, cables, 150 page manual and tool kit

The RHINO® XR-1 is built with the same operating technology as large industrial robots.

- Compatible with all computers having RS-232C interface (3 wires)
- Digital choppers on all axes
- Six powerful DC Servo gear motors
- Controller card with Intel® 8748 CPU
- Rigid ¼" aluminum arm construction
- Built-in self-test program
- Specs: reach—22.5" maximum, height—32", width—14" grasp—opens 2" (larger opening available) lift—1 lb. at extension
- Options: two hands with seven finger combinations, computer controlled carousel, conveyor and lateral slide base

Available for immediate delivery. Shipped F.O.B. Champaign, IL via UPS in Continental USA. (Illinois residents please add 5% sales tax) We reserve the right to alter prices and specifications without notice. Dealer/Rep. inquiries invited.



Sandhu Machine Design, Inc.
308 S. State, Champaign, IL 61820
217/352-8485

"Hands-on-Introduction to ROBOTICS, The Manual for XR-1", included with the robotic system, may be purchased separately @ \$20 ea. p.p.

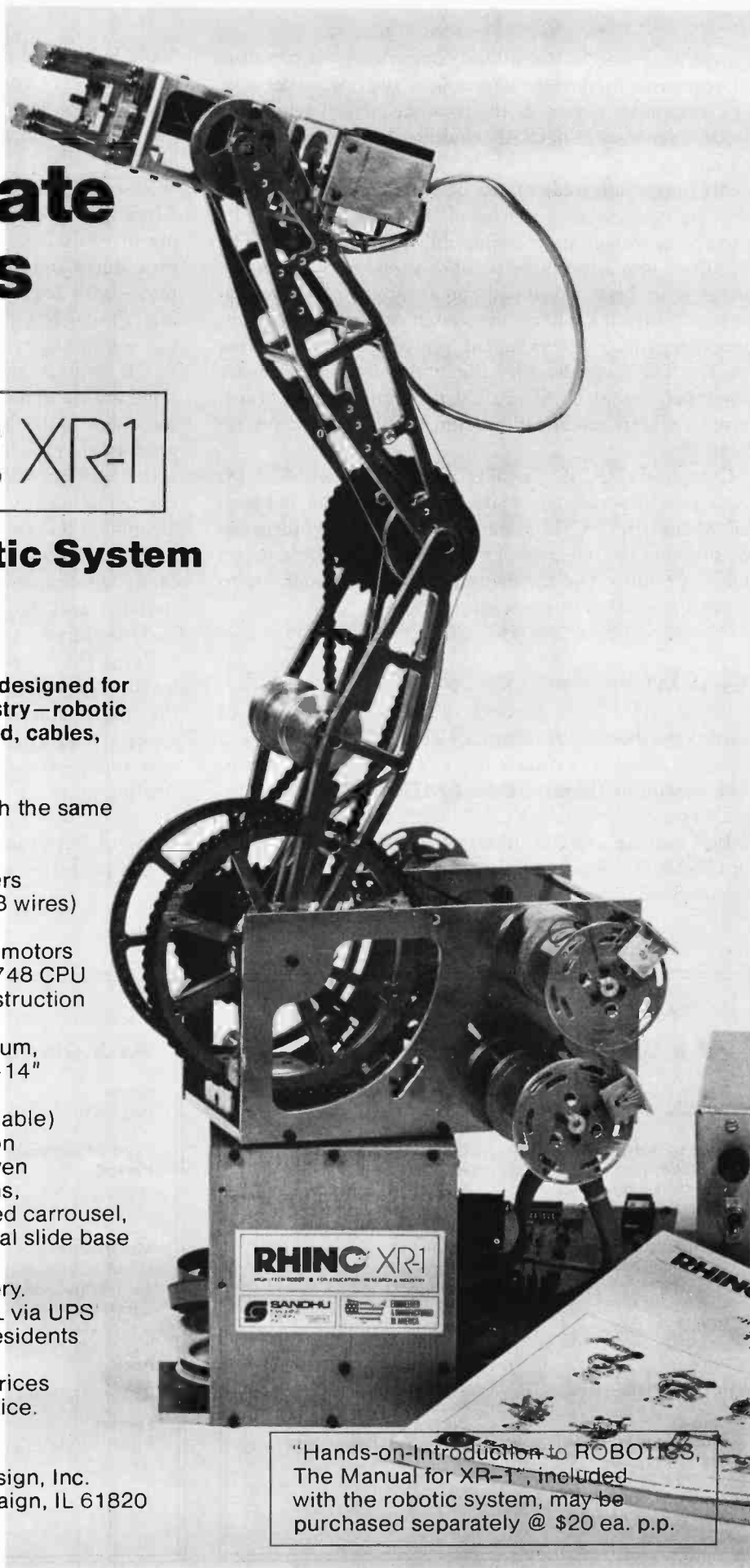

system is written in Pascal and supported by a run-time interpreter written in the language of the host processor. The interpreter is part of the package, which retails for \$500. A separate FORTRAN compiler is available for the system.

An important trade-off to be noted by CP/M users who are considering purchase of the UCSD system is its portability versus its incompatibility with CP/M. The UCSD system is portable because versions of the interpreter have been developed for a variety of microprocessors. Softech supports the system well, and this support will probably be extended to more processors in the future. The considerable advantage to the software developer is that UCSD Pascal programs can be transferred without modification from one hardware system to another.

Conversely, UCSD Pascal is incompatible with CP/M. Data files are not automatically transferable between CP/M and the UCSD system. This causes problems in maintaining the integrity of databases. The problems are only partially offset by the availability of programs to convert files from one system to another.

Pascal/MT+

Pascal/MT+ is a product of MT Microsystems of Cardiff-by-the-Sea, California. This Pascal includes a compiler, a linker, a disassembler, a debugger, and a run-time subroutine library. Pascal/MT+ requires an 8080 or Z80 processor running CP/M with at least 140K bytes of disk storage and 52K bytes of RAM, including space for CP/M. For developing large programs, a minimum of

300K bytes of disk storage and 60K bytes of RAM are suggested. The compiler generates relocatable, optimized Z80 code, or 8080 code (if desired) that must be linked to the run-time library. The Pascal/MT+ package costs \$450.

Pascal/MT+ is an interesting and powerful tool. Alone among the four implementations, it supports passing of procedures and functions as parameters to other procedures and functions and supports "conformant" arrays—both features required by the ISO standard. In fact, Pascal/MT+ is the only implementation that claims full compatibility with the ISO standard.

The conformant-arrays scheme is important because there are no dynamic arrays in Pascal. The programmer must change the declaration of an array in the source program to change the bounds of the array at run time. This restriction imposes a burden on the programmer. The conformant-array scheme provides greater flexibility. For example, you can pass bounds derived by the source program to a library program, provided the array in the library program is of the same type as the array originally declared and the bounds passed are within those originally declared.

Pascal/MT+ provides several facilities for machine-level programming from Pascal and also makes possible the use of interrupts. Also, several nonstandard data types are built in. For example, Pascal/MT+ provides two types of real data: fixed-point binary-coded and floating-point.

Control Statements and Data Structures

The program control statements included in standard

At a Glance

Name
Pascal/M, Version 3.3

Type of Software Package
Implementation of Pascal programming language

Manufacturer
Sorcim
POB 32505
San Jose, CA 95152
(408) 248-5543

Price
\$225

Format
8-inch standard CP/M floppy disk

Type of Compiler
Pseudo-code compiler

supported by a run-time interpreter

Computer Needed
Any Z80- or 8080/8085-based computer running either CP/M Version 1.4 or later, or MP/M, Cromemco CDOS or OASIS, with 56K bytes of RAM and one floppy-disk drive

Documentation
A 77-page, staple-bound manual

Audience
Applications software developers, Pascal users

At a Glance

Name
Pascal/MT+, Version 5.2

Type of Software Package
Implementation of the Pascal programming language

Manufacturer
MT Microsystems
1562 Kings Cross Dr.
Cardiff-by-the-Sea, CA 92007
(714) 755-1366

Price
\$450

Format
8-inch standard CP/M floppy disk

Type of Compiler
True Z80 compiler

Computer Needed
Any Z80- or 8080-based computer running CP/M Version 2.2 with 52K bytes of RAM (56K or more preferred) and 140K of floppy-disk storage (300K preferred)

Documentation
A 165-page, staple-bound manual

Audience
Applications software developers, Pascal users

TRS*-CP/M*

TRS-80 owners...if you would like to learn more about CP/M, call or write for our free brochure.

OMIKRON proudly presents

THE WORKS

the ultimate CP/M package for your TRS-80* Model I

The WORKS includes:

\$399

Mapper I & CP/M 2.2, CBASIC II, MBASIC-80 and WordStar

WordStar is widely recognized as the most advanced product on the market. It is featured by many computer manufacturers, including Xerox, for wordprocessing applications.

List price: \$495

MBASIC-80 is the CP/M version of Microsoft BASIC. The conversion of TRS-DOS BASIC programs to MBASIC is easy because the syntax is almost identical.

List price: \$349

CP/M 2.2 is the latest version of CP/M from Digital Research. Our package also includes the MAPPER I CP/M adapter and a sophisticated set of utilities and drivers designed to optimize the CP/M system for the TRS-80.

List price: \$239

CBASIC II is the most widely used BASIC for CP/M applications programs. This version of BASIC contains all of the features necessary to develop complex business programs.

List price: \$149

OMIKRON

Products that set Precedents

1127 Hearst Street, Berkeley, CA 94702 (415) 845-8013

*TRS-80™ Radio Shack/Tandy Corporation

CP/M™ Digital Research

At a Glance

Name

Pascal/Z, Version 3.3

Type of Software Package

Implementation of Pascal programming language

Manufacturer

Ithaca Intersystems Inc.
1650 Hanshaw Rd.
POB 91
Ithaca, NY 14850
(607) 257-0190

Price

\$395

Format

8-inch standard CP/M floppy disk

Type of Compiler

True Z80 compiler

Computer Needed

Any Z80-based computer running CP/M Version 2.2 with 54K bytes of RAM (64K preferred) and at least one disk drive (two drives preferred)

Documentation

A 198-page, loose-leaf bound manual

Audience

Applications software developers, Pascal users

Pascal are the WHILE...DO, REPEAT...UNTIL, IF...THEN...ELSE, the FOR...DO loop, the CASE statement, and the GOTO statement. All of these constructs are supported in the four implementations. All the implementations but UCSD Pascal have provided for an OTHERWISE clause in the CASE statement—an addition included in the ISO standard. A restricted form of GOTO (which precludes exiting the body of a procedure) is supported in all versions except Pascal/MT+, which provides unrestricted GOTOs.

The primitive data types defined in standard Pascal include integers, reals, Boolean data, user-defined scalars and subrange types, and character data. The defined, structured types include arrays, sets of scalars, pointers, record types, and files of records. Wirth's Pascal calls for text files and permits packing of structured types to conserve memory space.

All these data types and structuring techniques except packing are available in each of the four Pascals. Packing is not explicitly available in the native-code compilers Pascal/Z and Pascal/MT+. These two allocate memory in bytes, whereas the other two allocate in words; that is,

Now available from your computer store—the whole line of AJ couplers and modems.

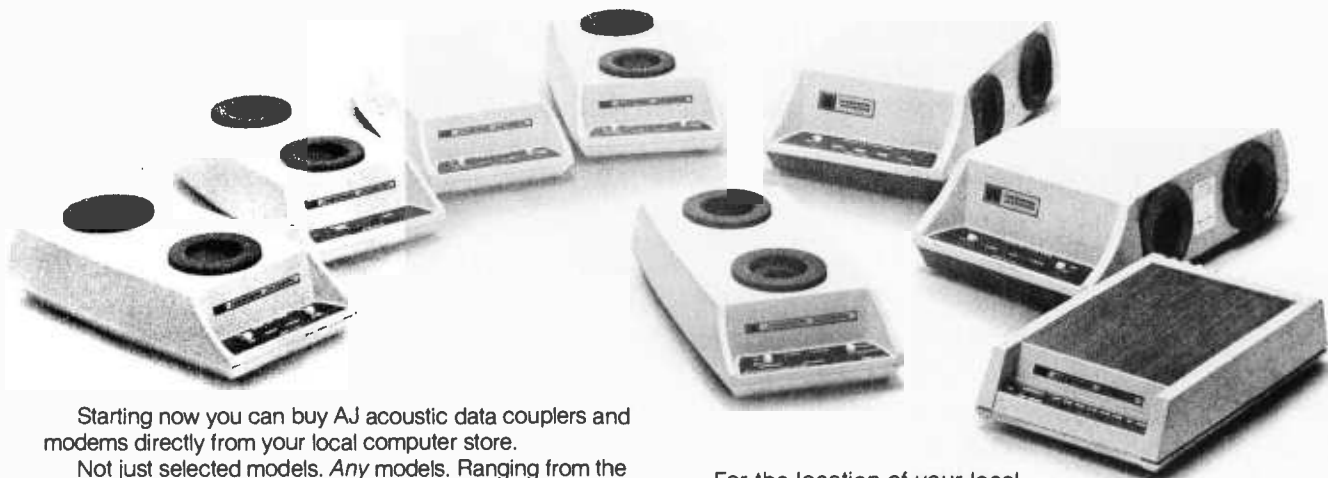

Starting now you can buy AJ acoustic data couplers and modems directly from your local computer store.

Not just selected models. Any models. Ranging from the 0-450 bps A 242A, the world's most widely used acoustic data coupler, to the revolutionary AJ 1259 triple modem that handles 300 bps Bell 103, 1200 bps Bell 212A, and 1200 bps VA 3400 protocols.

Whether you need full or half duplex or both in one; originate or answer, auto answer; acoustic coupling, or direct-connect—there's a model for you in the AJ line.

Starting now you don't have to settle for second best.

For the location of your local computer store handling the AJ line, call toll-free:

800/538-9721

California residents call 408/263-8520, Ext. 307.

 **ANDERSON
JACOBSON**



TASC™. The Applesoft* Compiler. It turns your Apple into a power tool.

Step up to speed. TASC, the Applesoft Compiler, converts a standard Applesoft BASIC program into super-fast machine code. By increasing program execution speed up to 20 times, Microsoft gives you a power tool for Applesoft BASIC programming.

Highest capacity available.

TASC will compile and run larger programs than any other Applesoft Compiler. As a disk-based system, it doesn't require the simultaneous presence of compiler and program in memory. The memory you save allows you to compile significantly bigger programs.

Power without bulk. Code expansion of up to 100% severely restricts other compilers. TASC's special code compression schemes typically limit code expansion to only 25%. You'll really appreciate that with complex programs or programs that utilize Apple's hi-res graphic pages.

More BASIC power. TASC's powerful new commands increase Applesoft BASIC programming capability. Chain with COMMON allows compiled programs to share variables, so a main menu

*Applesoft is a trademark of Apple Computer, Inc.



supports several programs in a single runtime environment.

TASC's True Integer Arithmetic and Integer FOR...NEXT capabilities maximize the execution speed of compiled programs.

TASC's near total compatibility with Applesoft speeds compilation of existing programs with little or no modification.

What about mistakes? You perfect your programs interactively with Applesoft. If something does slip by, TASC recovers

from errors discovered in compilation and traps all runtime errors. It even permits graceful interruptions during compilation.

See for yourself. Ask for a demonstration of TASC at your Microsoft dealer. Discover the software package that turns your Apple into a power tool.

MICROSOFT

CONSUMER PRODUCTS

A Division of Microsoft Inc.
10700 Northup Way • Bellevue, WA 98004

Circle 254 on inquiry card.

ECLECTIC SYSTEMS CORPORATION

Authorized Commodore service center
Repair of the complete line of Commodore products
In a hurry? Check our modular exchange program



HARDWARE:		SOFTWARE:	
CBM 8032 Computer,		OZZ	\$299
80 Column	\$1095	Wordcraft 80	299
CBM 8050 Disk Drive	1340	Tax Preparation System	380
CBM 4032 Computer,		IRMA	380
40 Column	995	Dow Jones Portfolio	
CBM 4040 Disk Drive	995	Management System	115
CBM 4022 Printer	649	Personal Tax	55
CBM VIC 20 Computer	263	Pascal	229
CBM VS100 Cassette	68	Assembler Development	
PET to IEEE Cable	33	Package	77
IEEE to IEEE Cable	39	Wordpro 4+	329
BASF Diskette, Box of 10	30		

Order TOLL FREE 1+800-527-3135

10 AM to 4 PM CDT Monday through Friday

Texas residents call 1+214-661-1370

VISA, MASTER CHARGE, MONEY ORDERS, AND C.O.D.
 "Certified Check" accepted.

Units in stock shipped within 24 hours, F.O.B. Dallas, Texas.
 All equipment shipped with manufacturer's warranty.

Residents of Texas, Louisiana, Oklahoma City and Tulsa,
 Oklahoma must add applicable taxes.

Eclectic shortly will be announcing products that are designed to work with CBM systems.

1. ROMIO: two RS232 ports—three parallel ports—26K EPROM memory-managed alternate character set, software controlled—EDOS (extended DOS).
2. Terminal program (options with ROMIO)
3. EPROM programmer
4. Front-end processor
5. Additional firmware to be announced

Be sure to write the address below for more information;
 dealer inquiries welcome.

P.O. Box 1166 • 16260 Midway Road
Addison, Texas 75001 • (214) 661-1370

the native-code compilers always pack data. Generally speaking then, the native-code compilers are more conservative in terms of memory needed for data than are the other two implementations, although similar and sometimes even greater conservation can be achieved by packing data in the other two.

All the versions extend standard Pascal to include a predefined string type. Strings of length N may be defined up to a maximum length of 255, and the actual length of a string may vary from 0 to N during program execution. The next section discusses built-in procedures for manipulating strings.

Pascal/M and UCSD Pascal have provided long (32-bit) integers as a predeclared data type. The operations permitted with long integers are addition, subtraction, and comparisons. Pascal/MT+ has provided two types of reals: floating-point reals and fixed-point, binary-coded decimal reals with 18 digits, four decimal. Pascal/Z provides floating-point reals and fixed-point reals with user-declared precision.

Built-in Procedures and Functions

Standard Pascal includes a number of intrinsic procedures and functions, including transcendental-arithmetic functions, memory-management procedures, and several

At a Glance

Name
UCSD Pascal, Version 2.0

Type of Software Package
Implementation of Pascal programming language, including the UCSD operating system

Manufacturer
Softech Microsystems
9494 Black Mountain Rd.
San Diego, CA 92126
(714) 578-6105

Price
\$500. Note: price is for Version 4.0. We tested Version 2.0

Format
8-inch IBM 3740-compatible disk

Type of Compiler
Pseudo-code compiler supported by a run-time interpreter

Computer Needed
Any Z80-, 8080/8085-, 6502-, or 6800-based computer with 48K bytes of con-

tiguous RAM (64K recommended) and a floppy-disk system with at least 175K bytes of online storage, or any Digital Equipment Corp. LSI-11 or PDP-11 computer

Documentation
A 450-page, paper-bound manual; includes documentation for the UCSD operating system

Audience
Applications software developers, Pascal users

Comments
The UCSD system has its own file handler and operating system, including compiler, linker, assembler, editor, and librarian utility. When the system is used on machines already equipped with CP/M, only the BIOS routines from CP/M are used. Non-CP/M users will need to write their own simplified basic input/output subsystem (SBIOS) and bootstrap module. Documentation for how to write the SBIOS is included.

Application Developers...

PROFESSIONALS KNOW THE DIFFERENCE!

...MDBS makes professional mainframe software available on micro computers at micro prices

Quality application development is expensive and time-consuming. Over 50% of the development effort for applications is usually related to the problems of data storage and retrieval.

The MDBS Data Base Management System...

- is the "state-of-the-art" tool which can cut application development costs by 50% or more.
- is the first and only true and complete DBMS for micro computers.
- is also available for the PDP-11.
- offers features not available anywhere else...not on any machine...not at any price—even surpassing mainframe DBMS's costing over \$100,000!

In no other system can you get all these advantages:

- fully integrated, data dictionary driven
- unparalleled data structuring abilities...far surpassing the older and more limited hierarchical, network, and relational approaches.
- unmatched query system...powerful, non-navigational, and English-like...enables nested queries.

- extensive recovery facilities...ability to roll DB back to previous state.
- built-in data compression, data security, data encryption.
- numerous performance tuning abilities.
- true multi-user capabilities.
- highly portable...available for most operating systems and languages (BASIC, COBOL, PASCAL, C, PL/1, FORTRAN, etc.)

MDBS overcomes the disadvantages of the older hierarchical, relational, and CODASYL approaches to data base management. MDBS is not restricted by any of those limitations typical of "data base pretenders" (file management systems). MDBS is the only true and complete data base management system currently available on micro computers.

MDBS, Inc., also offers professional training seminars and consulting services to assist application developers in developing the highest quality application software in the shortest time possible.

Don't be misled by pretenders claiming to be "relational"...

PROFESSIONALS KNOW THE DIFFERENCE!

Setting standards of excellence for data base software...worldwide.

Micro Data Base Systems, inc.

Box 248-B
Lafayette, Indiana 47902
317-448-1616/TWX 810-342-1881

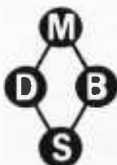

Dealer/distributor/OEM inquiries invited.

As a professional application developer, I need to know more about MDBS...

- Yes, I'm interested. Please call me.
- Please send me the complete MDBS Manual Set (5 Manuals + tutorial materials) at \$85 per Set. Indiana residents please add \$3.40 sales tax.

Name _____ Title _____
(Please print)

Company _____

Address _____

City _____ (State) _____ (Zip) _____

Phone _____

MAIL TO: Micro Data Base Systems, Inc.
P.O. Box 248-B
Lafayette, IN, 47902

input/output (I/O) procedures. We will consider the I/O procedures in a later section; for now, we will concentrate on other intrinsics and built-ins.

In standard Pascal you are permitted to dynamically allocate and deallocate memory for user-defined data types on a variable-by-variable basis. Only Pascal/MT+ fully implements this standard. In the other versions, you can allocate space on a variable-by-variable basis, but you can only deallocate blocks of memory cells at a time. In these cases, memory is a heap of undifferentiated cells; the programmer can mark the top of the heap, dynamically allocate memory to variables, and then deallocate memory back to the old top of the heap.

A useful function for dynamic-memory management is one that returns the amount of memory available at the time the function is called. Such a function can inform the programmer that allocating more memory may clobber some portion of the current program. All but Pascal/Z provide this function.

All the versions have provided built-in functions for manipulating the string types just described. Pascal/Z provides functions for appending one string to another, determining the length of a string, and finding the position of a substring within a string. The other versions have these three built-in functions, and functions for inserting, deleting, and copying substrings from a string.

UCSD Pascal, Pascal/MT+ and Pascal/M have provided several high-speed, built-in procedures for moving bytes between memory locations. You can move data between packed arrays of data and similar data structures, initialize packed arrays, and search arrays for specified bit patterns on a byte-by-byte basis.

Pascal/M, Pascal/MT+, and UCSD Pascal have a procedure called EXIT that permits clean exits from procedures, functions, and programs. A typical application would be to exit a program after flagging an egregious user error, such as bad input from the keyboard.

Pascal/M and UCSD Pascal support random screen-cursor addressing through the built-in function GOTOXY(X,Y). Pascal/M also has built-in procedures that permit homing the cursor, clearing to end of line, and so on. UCSD Pascal supplies the utility program SETUP that matches the operating system to the characteristics of the user's terminal.

Pascal/MT+ has several built-in procedures and operators for byte and bit manipulation. For example, you can perform an "OR" operation on two integers that is a logical OR on their bit representations, and you can test bits, shift bits, and swap bytes in 16- and 8-bit variables. There are also built-in primitives for handling interrupts at the Pascal level. The programmer can enable and disable interrupts and designate up to seven Pascal proce-

SAVE UP TO \$750.00 NOW on TRS-80™ & Hewlett-Packard® Computers With This Coupon*

Now you can own a great little computer at a great big discount off the manufacturer's list price.

- **FREE SHIPPING** in the 48 continental contiguous states on prepaid orders of \$100 or more.
- **NO SALES TAX** collected on out-of-state orders.
- **CONVENIENT ORDERING** — Call us TOLL FREE — 800/531-7466
- **FREE COMPLETE PRICE LIST** available upon request.

TRS-80
Model II



Catalog Number	Description	List Price	Cashier's Check	Cash Price You Save
Radio Shack® TRS-80 Model II				
26-4002	64K 1-Disk Model II	3,899.00	3,299.00	600.00
26-4150	Model II Hard Disk System (Installation Not Included)	4,495.00	4,045.50	449.50
Radio Shack® TRS-80 Model III				
26-1062	Model III 16K	999.00	859.00	140.00
26-1065	Model III 48K — 1 Disk	1,995.00	1,795.50	199.50
26-1066	Model III 48K — 2 Disk	2,495.00	2,099.00	396.00
Radio Shack® TRS-80 Color Computer				
26-3001	4K Color Computer	399.00	315.00	84.00
26-3002	16K Color Computer	599.00	475.00	124.00
26-3003	32K Color Computer	699.00	585.00	114.00
Hewlett-Packard® HP-85A Personal Computer				
		2,750.00	Call for Price	
Hewlett-Packard® HP-125				
		3,750.00	2,999.00	751.00

Pan American Electronics

CALL TOLL FREE 800/531-7466 • Texas & Principal Number 512/581-2766 • Telex 767339
Dept. 15 • 1117 Conway Avenue • Mission, Texas 78572
FORT WORTH BRANCH:
2912 N. Main, Fort Worth, Texas 76106 • Phone Number 817/625-6333

NEW 256KB IBM PERSONAL COMPUTER MEMORY!

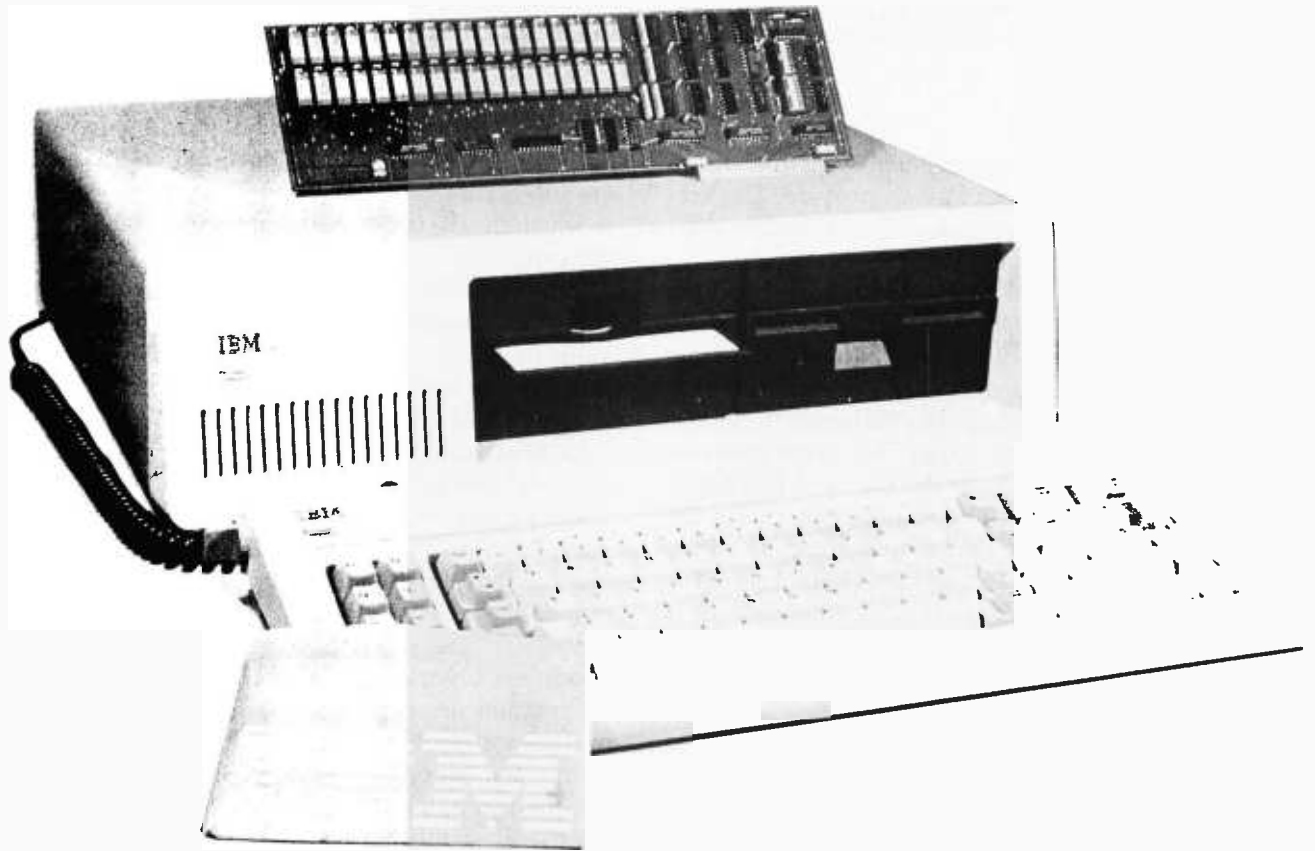

SINGLE BOARD 256KB IBM PERSONAL COMPUTER MEMORY

Designed Specifically for IBM's PERSONAL COMPUTER is Chrislin Industries newest CI-PCM Memory Module.

FEATURES INCLUDE:

- On-board parity generator checker
- Addressable as a contiguous block in 64K byte increments through 1 megabyte
- Access time of 225 NSEC
- Requires only one I/O expansion slot for 256K bytes memory
- Power requirements are +5V at 1.0A max.
- Cycle time of 400 NSEC

**SEE YOUR LOCAL COMPUTER STORE FOR DETAILS
OR CALL US.**

DON'T ASK WHY WE CHARGE SO LITTLE, ASK WHY THEY CHARGE SO MUCH.



Chrislin Industries, Inc.

31352 Via Colinas • Westlake Village, CA 91362 • 213-991-2254
TWX 910-494-1253 (CHRISLIN WKVG)

Circle 75 on Inquiry card.

dures as interrupt procedures. The programmer assigns a vector number to an interrupt procedure and the compiler generates code to load the vector number with the procedure address.

Only Pascal/Z permits functions to return structured data values. In the other Pascals, functions can return only unstructured types.

Input-Output Procedures

Not surprisingly, there is significant variation in the I/O procedures that these four Pascals provide. The versions differ in adherence to standard Pascal and in their extensions to the standard.

Standard Pascal specifies four primitive file-handling procedures—GET(F), PUT(F), RESET(F), and REWRITE(F), where F is an arbitrary file type—and certain procedures for reading and writing text files. PUT(F) appends data to F, GET advances the file-position pointer and retrieves the next record, RESET resets the file-position pointer to the beginning of the file, and REWRITE initializes a file for writing. The text-file procedures are READ and READLN, which reads to the end of a line, and their counterparts WRITE and WRITELN. Left to the Pascal implementer is the way that an external disk file is associated with the internal file. Standard Pascal makes no provision for random access I/O.

Pascal/MT+, Pascal/M, and UCSD Pascal all supply the standard procedures; Pascal/Z subsumes the operations of GET and PUT under general-purpose READ and WRITE procedures. All four Pascals have simple methods for assigning disk files and external devices to internal file variables. All versions provide some form of random access for nontext files.

All four versions have built-in facilities for purging files from disk directories. All but Pascal/Z have an added procedure for closing an open file; in Pascal/Z, files are automatically closed on exit from the procedure block in which the file is declared, but there is no way to close a file explicitly.

Pascal/M, Pascal/MT+, and UCSD Pascal all provide a built-in function IORESULT that returns an integer value to indicate the result of the last I/O operation. The function can trap fatal execution-time I/O errors, such as failure to find a required disk file.

UCSD Pascal, Pascal/M, and Pascal/MT+ all provide low-level procedures to perform I/O on untyped files. These procedures transfer memory-image bytes with no interpretation. In addition, Pascal/M and Pascal/MT+ provide built-in primitives for manipulating Z80 input-output ports.

Modules, Overlays and Chaining

Programmers developing large application programs face several problems that can become acute on microcomputers. Among these are limitations on memory size, the time-consuming need to recompile large programs when only small changes are made, and the need to link high-level programs to low-level routines for speed or convenience in special applications. The four Pascals reviewed here are reasonably well equipped with tools to solve these problems.

Two techniques for mitigating limitations on memory size are overlays (program segmentation) and chaining (calling one program from another). For the overlay approach, the programmer declares segments within a host program, with the segments either procedures or functions. A segment is brought into memory from disk when needed and remains active in memory only as long as needed; control returns to the host program. Segment procedures can access global data and procedures in the host program, just as they do ordinary procedures. With chaining, the currently active program calls the next link in the chain, which is then loaded from disk. There need be no host program per se and no relationship between the global declarations of chained programs.

UCSD Pascal and Pascal/M support overlays. In UCSD Pascal, a program can have a maximum of 16 segments, while Pascal/M can support as many as 10 segments. Both versions count the host program as one segment. Pascal/Z and Pascal/MT+ allow chaining. Both provide mechanisms for sharing global data between chained programs, but not for sharing global procedures. Pascal/Z, UCSD Pascal, and Pascal/MT+ support the ability to divide large programs into separately compil-

L I S P

for the Apple II

The gnosis version of P-LISP has been acknowledged as the finest and most complete available for Apple microcomputers, and, with the addition of floating point math and HI-RES graphics, it becomes an indispensable tool for educators, scientists, business executives, mathematicians, or applications requiring artificial intelligence. This excellent program is now available for only \$199.95 (DOS 3.3 only)

Included in an attractive binder is a ninety page user's manual which will aid you in creating your P-LISP programs. This manual is also available separately for \$20.00, which is fully refundable on purchase of the program.

P-LISP will run on a 48K or larger APPLE II/II+, and will take advantage of ALL avail-

able memory. Supplied with the interpreter are several sample programs including a complete ELIZA.

For those of you who do not fully understand P-LISP, we have available the P-LISP Tutorial for \$25.00. This expertly written text is bound in a handsome binder and is packaged to include a disk containing all the sample programs referenced in the text at no extra charge.



Applesoft in ROM or a language card is needed for floating point math.

gnosis

formerly Pegasys Systems, Inc.

4005 Chestnut Street—Philadelphia, PA 19104

Orders Only: 800-523-0725—Penna. Residents: 215-387-1500

Pennsylvania residents add 6% sales tax. Apple is a trademark of Apple Computer, Inc.



MC-1000

**There is More
Brewing in
Milwaukee
Than Just Beer**

\$995.00
(QTY 1)

MC-1000 SERIES **COMPUTERS**

Our new **MC-1000 Computer System** is proof that the age of affordability in computers has arrived. Thanks to single board design we can offer not only the **lowest priced** computer in its class but also the **most reliable**. *For information and ordering call:*

(414) 784-2312

ALL STANDARD

- 64K Memory
- 2-5¹/₄" Disk Drives (225K Total Storage)
- Real Time Clock
- 2-RS-232 Interfaces
- Parallel Printer Port (Centronics Type)
- Extensive Self Diagnostics (In Rom)
- 2 Year Limited Warranty

OPTIONS

- Disk Capacity to 1.8 MBYTE
- UCSD* Pascal, Basic, Fortran

*TM U. Of California

MILWAUKEE COMPUTERS INC.
16235 W. RYERSON ROAD * NEW BERLIN, WI 53151 * (414) 784-2312



TYPE-'N-TALK™

The exciting
text-to-speech
synthesizer with
unlimited vocabulary.

Get your computer talking
for only \$375.00.

- Text-to-speech algorithm
- A one-watt audio amplifier
- SC-01 speech synthesizer chip (data rate: 70 to 100 bits per second)
- 750 character buffer
- Data switching capability
- Selectable data modes for versatile interfacing
- Baud rate (75-9600)
- Data echo of ASCII characters
- Phoneme access modes
- RS 232C interface
- Complete programming and installation instructions

The Votrax Type-'N-Talk™ is one of the easiest-to-program speech synthesizers on the market. It uses the least amount of memory and it gives you the most flexible vocabulary available anywhere.

Order now. Toll free.



Call the toll-free number below to order or request additional information. MasterCard or Visa accepted. Charge to your credit card or send a check for \$375.00 plus \$4.00 delivery. Add 4% sales tax in Michigan.

1-800-521-1350

For product information call: 1-313-588-0341



500 Stephenson Highway, Troy, MI 48084

Type-'N-Talk™ is covered by a limited warranty. Write Votrax for a free copy.

able pieces and the concomitant ability to develop modules or libraries of logically related procedures.

UCSD Pascal offers UNITS, which consist of three major syntactical pieces: an INTERFACE portion, an IMPLEMENTATION portion, and initialization code. The INTERFACE portion contains the declarations (data, procedures, and functions) accessible to a host program. The IMPLEMENTATION portion contains the code for the procedures declared in the INTERFACE and any additional data structures and code required to perform the tasks of the unit; the latter declarations are not accessible to the host program. The initialization code is used to initialize the UNIT and is unknown to the host.

UCSD UNITS come in two varieties: intrinsic UNITS and regular UNITS. An intrinsic UNIT must be stored in the system library, which must be online when a program using the unit is executed. Intrinsic UNITS are prelinked to their hosts and do not have to be relinked if either the host or the UNIT is changed. Regular UNITS must be linked to the host by the programmer. Once linked, they need not be online, since the UNIT's code is duplicated in the host's code file. Regular UNITS count against the number of segments allowed in a program; intrinsic UNITS do not.

Pascal/MT+ provides what it calls modular compilation. When combined with a certain compiler option, this feature is comparable to the UCSD regular UNIT except for the initialization code. Pascal/MT+ modules may be somewhat more convenient to use than UCSD UNITS because the former can be broken into as many modules as desired at any time, while the latter require more forethought for effective use.

Pascal/Z provides a somewhat more limited version of modular compilation than Pascal/MT+. First, the number of modules is held to 10, including the host program. Also, there can be no hidden portions to a Pascal/Z module; in the language of UCSD UNITS, Pascal/Z modules consist of only an INTERFACE block. Finally, a Pascal/Z module cannot contain any global data declarations; it can only contain procedures and functions with local (private) data structures.

Like UCSD UNITS, Pascal/Z and Pascal/MT+ modules must be linked explicitly to their hosts. Unlike UCSD Pascal, Pascal/Z and Pascal/MT+ make the programmer responsible for insuring that data and procedures used by the host and its modules are declared consistently across modules.

Modules in Pascal/Z and Pascal/MT+ can freely use procedures declared in other modules. Procedures can be similarly cross-referenced by UCSD UNITS, but this requires more planning than in the other two Pascals.

Pascal/Z, Pascal/MT+ and UCSD Pascal all allow the user to link Z80 assembly-language programs to Pascal programs. Pascal/MT+ features a special declaration INLINE whereby the programmer can include hexadecimal code for machine-language programs in the body of a Pascal program without using externally assembled routines.

LETTER PERFECT T.M. LJK

WORD PROCESSING

ATARI 400/800

APPLE II & II+

EASY TO USE — Letter Perfect is a single load easy to use program. It is a menu driven, character orientated processor with the user in mind. FAST machine language operation, ability to send control codes within the body of the program, mnemonics that make sense, and a full printed page of buffer space for text editing are but a few features. Screen Format allows you to preview printed text. Indented margins are allowed. Data Base Merge with **DATA PERFECT** by LJK, form letters, accounting files and mailing labels only with **MAIL MERGE/UTILITY** by LJK. **FEATURES** — Proportional/Incremental spacing * Right Justification * File Merging * Block movement * Headers * Footers * Print Multiple Copies * Auto Page Numbering * Scroll forward/backward * Search and Replaces * Full cursor control * Underlining * Boldface * Superscripts * Subscripts * Auto page numbering * Insert character/line * Delete character/line * Centering * Horizontal tabs/changeable * Multifunction format line (line spacing — left margin — page width — lines/page — change fonts — top/bot margin adjust) **MUCH MORE!** \$149.95

ATARI VERSION 2.0 #2001

Uses proportional font, right justified with Atari 825/Centronics* 737, 739 printers. Uses EPSON MX* Series + Graftrax/italized font. Can mix type fonts on same page; mix boldface and enhanced font in same line with justification. Can be used with 16K Atari/400.

"Compared to the price of many other word processors, this package is a steal. It does everything the advertisement claims and more. On top of this the software is very easy to use." A.N.A.L.O.G. MAGAZINE

APPLE VERSION 5.0 #1001

DOS 3.3 compatible — Use 40 or 80 column interchangeably (Smarterm — ALS; Videoterm-Videx; Full View 80 — Bit 3 Inc.; Vision 80 — Vista; Sup-R-Term — M&R Ent.) Reconfigurable at any time for different video, printer, or interface. **USE HAYES MICROMODEM II*** LCA necessary if no 80 column board, need at least 24 K of memory. Files saved as either Text or Binary. Shift key modification allowed. Data Base Merge compatible with **DATA PERFECT*** by LJK.

"For \$150, Letter Perfect offers the type of software that can provide quality word processing on inexpensive micro-computer systems at a competitive price." INFOWORLD

DATA PERFECT T.M. LJK

Complete Data Base System. User orientated for easy and fast operation. 100% Assembly language. Easy to use. You may create your own screen mask for your needs. Searches and Sorts allowed, Configurable to use with any of the 80 column boards of Letter Perfect word processing, or use 40 column Apple video. Lower case supported in 40 column video. Utility enables user to convert standard files to Data Perfect format. Complete report generation capability. **Much More!**

EDIT 6502 T.M. LJK

This is a coresident — two pass **ASSEMBLER, DISASSEMBLER, TEXT EDITOR, and MACHINE LANGUAGE MONITOR**. Editing is both character and line oriented. Disassemblies create editable source files with ability to use predefined labels. Complete control with 41 commands, 5 disassembly modes, 24 monitor commands including step, trace, and read/write disk. Twenty pseudo opcodes, allows linked assemblies, software stacking (single and multiple page) plus complete printer control, i.e. pagination, titles and tab setting. User can move source, object and symbol table anywhere in memory. Feel as if you never left the environment of BASIC. Use any of the 80 column boards as supported by **LETTER PERFECT**, Lower Case optional with LCG.

LJK DISK UTILITY APPLE \$29.95

This menu driven program allows the user to manipulate a variety of different file types. Binary, Text, and Source files may be easily converted into each other. The program may be used with **APPLESOFT***, **VISICALC***, and other programs. These program files may be readily adapted for multiple use including editing with **LETTER PERFECT** word processings.

APPLE & ATARI DATA BASE MANAGEMENT \$99.95

MAIL MERGE/UTILITY ATARI \$29.95

This menu driven program combined with **LETTER PERFECT** allows user to generate form letters and print mailing labels. With the Atari, you may **CONVERT ATARI DOS FILES**, or Visicalc files compatible for editing with **LETTER PERFECT**. Utility creates Data Base files for Letter Perfect.

LOWER CASE CHARACTER GENERATOR \$24.95



Lower Case Character Generator for the Rev. 7, Apple II or II+ computers. When installed, this Eprom will generate lower case characters to the video screen. Lower case characters set has two dot true descenders. Installation instruction included. Manual includes listing of software for full support and complete instructions for shift key modification. Compatible with **LETTER PERFECT**.

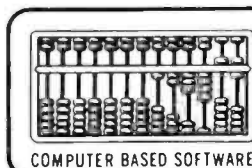

LJK T.M.

ENTERPRISES INC.

LJK ENTERPRISES INC.
P.O. Box 10827
St. Louis, MO 63129
(314) 846-6124

**DEALER
INQUIRES
INVITED**

*Trademarks of: Apple Computer — Atari Computer — Epson America — Hayes Microcomputers — Personal Software — Videx — Bit 3 Inc. — M&R Ent. — Advanced Logic Systems — Vista Computers

Ease of Use

Ease of use of any given language implementation lies mainly with the user. Ease of use may be defined as a measure of how quickly and reliably an implementation can help a programmer accomplish a given programming task.

The main advantage of Pascal is the ease with which the programmer can express the control and data structures that seem to arise naturally when designing a program. Beyond the standard Pascal, however, there is much that the language implementer can do to simplify the programmer's job. Since the programmer spends (or should spend) a great deal of time designing and writing programs, the relevant question is whether the language implementation helps or hinders the programming process. String functions, for example, have proved very useful in manipulating character data of arbitrary length, and all the Pascals we examined had string functions in one form or another. We feel that other additions to standard Pascal can be of great help, as long as they do not detract too much from the resulting program's portability to other systems. We previously discussed most of these useful features.

In addition to programming ease, there is debugging ease that reduces the time necessary for the programmer to sit in front of the video display. The sequence of com-

mands that the user types to compile, link, and run a program can be simple (e.g., with UCSD Pascal, in the simplest case, you can execute a source program just by typing an "R") or complex (e.g., Pascal/Z, which in the simplest case requires three separate CP/M commands to transform a source file into a runnable program). Fortunately, CP/M commands can themselves be gathered into a file and executed using the SUBMIT feature.

Finally, the documentation can be a source of either help or frustration. The manuals that accompany these packages are uniformly poor; unfortunately, they were probably written by the programmers who developed the packages. Any user who expects to learn Pascal from these will be bitterly disappointed. (Although to be fair, the manuals do not claim to be tutorials.) We also found the manuals disorganized, with poor indexes and tables of contents. Finding the answer to any specific question was a challenge, and the clarity of the English in the documentation is best left without critique.

We mentioned earlier that UCSD Pascal comprises an entire operating system, but failed to express the grief we experienced in getting the system configured for our machine, compounded by the confusing and contradictory documentation. The configuration process per se is simple. The difficulty is in reaching the point at which you can start the configuration process.

S-100 INNOVATORS:

C
I
T
R
O
N
I
C
S
I
N
C.

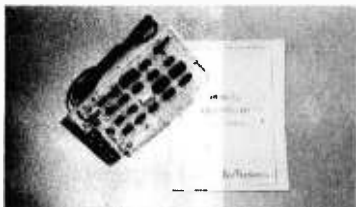

REMOTE CONTROLLER—Innovative Features:

- * Complete 256 address control—not just 16
- * No ultrasonic link—prevents erratic operation
- * 120,208,240 and 277VAC control—for single & 3 phase operation
- * Hardware driven—requires minimal software
- * Complete line of industrial switches available—to 5.5KW



REAL TIME CLOCK—Innovative Features:

- * First to use LSI OKI clock chip
- * Crystal controlled for .002% accuracy
- * 4 software selectable clock generated interrupts
- * Full clock and calendar data
- * Lithium battery backup good for 6000 hours!

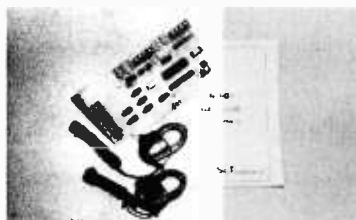

ENERGY WATTCHER™—Innovative Features:

- * First microcomputer based energy monitor
- * Clip on probes for easy installation
- * Monitors **Real Power**, not volt-amps
- * Peak Power and continuous power readings
- * Single and 3 phase operation

See your local computer dealer or contact SciTronics directly for more information. Watch for future innovative products from SciTronics Inc., 523 So. Clewett St., P.O. Box 5344, Bethlehem, PA 18015 (215) 868-7220

KEEP YOUR EYE ON THE BALL

THE FORMULA™ allows the computer professional to focus on the most important part of business: the needs of the client. Customized systems for any business application can be created in a fraction of the time required by conventional methods.

- Interactive data entry, file updating, and maintenance routines are automatically generated from a definition of the fields.
- Reports can be created through a unique full screen editor simply by typing a sample format.
- Menus and job streams are defined through a preprogrammed parameter-driven procedure.
- Fast response time is insured because each routine can be interpreted directly by the computer and data management is controlled by an efficient ISAM algorithm.

THE FORMULA™ is a complete system language which brings the process of developing applications closer to the user's description of his needs. That's **THE FORMULA™** for success.

Disk and manual, \$595. Manual only, \$60.

THE FORMULA™ will run on any 8080 or Z80 computer with CP/M,* 48K RAM, 300K total disk storage, and a CRT.

DMA • WE SPEAK YOUR LANGUAGE.

THE FORMULA™ For Success can help you build systems. Now, the General Accounting System, created with **THE FORMULA™**, is available at no extra charge.

The General Accounting System includes:

- General Ledger: Journals, Trial Balance, Income Statement, Balance Sheet, etc.
- Accounts Payable: A/P Journals, Checks, Aged Payables, Vendor Report, etc.
- Accounts Receivable: A/R Journals, Aged Receivables, Customer Statements, Customer Activity Report, etc.

**AT NO EXTRA
CHARGE**

In addition, two new optional packages have been developed for use with **THE FORMULA™**:

Professional Time Management \$80

Manager's Billing Report, Employee
Production Report, Client Invoices, etc.

Label Option Pak \$80

Name Inversion, Multiple Up Labels,
Customized Label Size and Format, etc.

Circle 135 on Inquiry card.

DYNAMIC MICROPROCESSOR ASSOCIATES • 545 Fifth Avenue, New York, New York 10017 • (212) 687-7115

We ship prepaid and COD orders. Shipping & handling charges extra: \$5 UPS areas; \$7 non-UPS areas, Mexico, Canada; \$10+ elsewhere. MasterCard and VISA accepted. New York State residents add appropriate sales tax. *CP/M is a trademark of Digital Research.

We point this out not to dissuade the reader from using UCSD Pascal, but to inform you of what to expect. If you are interested in UCSD Pascal, it may be worthwhile to seek out a configuration matched to your machine. Some preconfigured versions are available.

different implementations. We certainly do not represent these programs as the "best" programming solutions available for the problems they solve.

Our first benchmark, PRIMES (see listing 1), is a program to calculate the first 1000 prime numbers, using a method from Donald Knuth's *The Art of Computer Programming, Volume I: Fundamental Algorithms* (Reading, MA: Addison-Wesley, 1968), pages 143-144. The only statements that needed change, as we moved from one version of Pascal to the next, were in the routine to read the time from the Mountain Computer clock board, which required Z80 hardware port input. Pascal/M and Pascal/MT+ had intrinsic routines to do such input; for UCSD Pascal and Pascal/Z, we wrote small assembler routines to do the job. To minimize rewriting, we isolated the version-dependent code in a function that was different for each implementation.

We also made two ease-of-use measurements while we were compiling and running the program. First, we measured the time needed to transform the Pascal source file into a running program. For the CP/M Pascals, we used a SUBMIT file containing the necessary commands

Benchmarks

To test each version of Pascal for speed, ease of use, and other features, we wrote and ran a series of benchmark programs. We did all testing on a Cromemco System III computer, which has 64K bytes of memory and two 8-inch floppy-disk drives capable of handling more than a million bytes of data each. The CP/M-compatible versions of Pascal were run under CP/M version 2.2 (from Intelligent Terminals Corporation). We timed the programs using Mountain Computer's 100,000 Day Clock. The results appear in table 1.

A few words of caution: the results of these (or any other) benchmarks should not be taken as absolute indicators of any Pascal's inherent quality. Our programs are necessarily simple and relatively portable between the

Language Implementation Program	Pascal/M	Pascal/MT +	Pascal/Z	UCSD Pascal
PRIMES				
Execution time	94.2 sec	24.1 sec	35.1 sec	70.0 sec
"Compile time"	35 sec	93 sec	132 sec	46 sec
Keystrokes required to run	31	56	68	16
PRECISION				
Small	5.96E -08	1.19E -07	2.38E -07	5.96E -08
Big	3.36E +07	1.68E +07	8.39E +06	3.36E +07
BLOWUP				
Memory available for dynamic variables	37.4 K	52.3 K	52.4 K	38.9 K
BENCHMARK				
(All numbers are execution times in seconds)				
Random number generation	3.4	2.7	1.1	2.0
Writing array to disk	3.5	4.3	3.9	6.9
Shell sort	332	152	93	193
Reading array from disk	1.4	2.0	1.8	2.4
Quicksort	31	14	15	18
Binary tree generation	51	21	8	25
Writing tree to disk	28	25	21	45
Displaying array on CRT	46	10	14	22
Displaying tree on CRT	48	11	14	23

Table 1: Results of benchmarking programs for four implementations of Pascal. All testing was done on a Cromemco System III computer with two 8-inch disk drives. PRIMES, shown in listing 1, is a program that calculates the first 1000 prime numbers. PRECISION, shown in listing 2, determines the precision of floating-point calculations in each implementation of Pascal. BLOWUP, shown in listing 3, determines the approximate amount of memory space available for dynamically allocated variables. BENCHMARK, shown in listing 4, performs a series of tasks common in applications programs.

~~UNBELIEVABLE!~~

BELIEVE IT!

**State-of-the-art Single-Board computer now available!
Can be used in S-100 (Master, Slave, Multi or Single user)
or Stand-Alone configurations.**

FINALLY, state-of-the-art performance is available at an affordable price.

COMPARE THESE FEATURES:

- Z80A or Z80B
- 4 TIMERS (ZCTC)
- 64K RAM (64KX1 CHIPS)
- 2 SERIAL PORTS (ZSIO)
- 4 PARALLEL PORTS (ZPIO)
- UP TO 16K EPROM (2732)
- NEC FLOPPY DISK CONTROLLER
(UP TO FOUR 8" DOUBLE SIDED/DOUBLE DENSITY DRIVES)
- INTELLIGENT WINCHESTER INTERFACE
- ON-BOARD EPROM BURNER
(DOES NOT REQUIRE 24V)

FOR THESE SINGLE QUANTITY PRICES:

- 4 MZ VERSION (Z80A) **\$895⁰⁰**
- 6 MZ VERSION (Z80B) **\$1,195⁰⁰**
- 4 MZ SLAVE PROCESSOR
(NO DISK CONTROLLERS ON BOARD) **\$795⁰⁰**
- 6 MZ SLAVE PROCESSOR
(NO DISK CONTROLLERS ON BOARD) **\$1,095⁰⁰**

The S-100 version of this product can act as a Master processor, Slave processor, or Intelligent peripheral controller. Intra-processor communication is achieved through the use of efficient, high speed buss transfers using special hardware/software techniques.

We also have what we think is one of the best implementations of a CP/M BIOS available off the shelf. The BIOS has the following features:

- All Devices **INTERRUPT DRIVEN**
 - Type Ahead Input/Output Buffers
 - Real-Time Clock
 - Time Of Day Clock
 - Multi-level User Password Support
 - Menu Driven Utilities for Format, Disk Copy, etc.
 - Unique Configuration Utility Program for Setting Baud Rates, Changing Step Time, Changing Passwords, etc.
 - Cylinder Concept used for Double Sided /Double Density Configuration Resulting in Increased Performance
- Std. size 5 x 10.

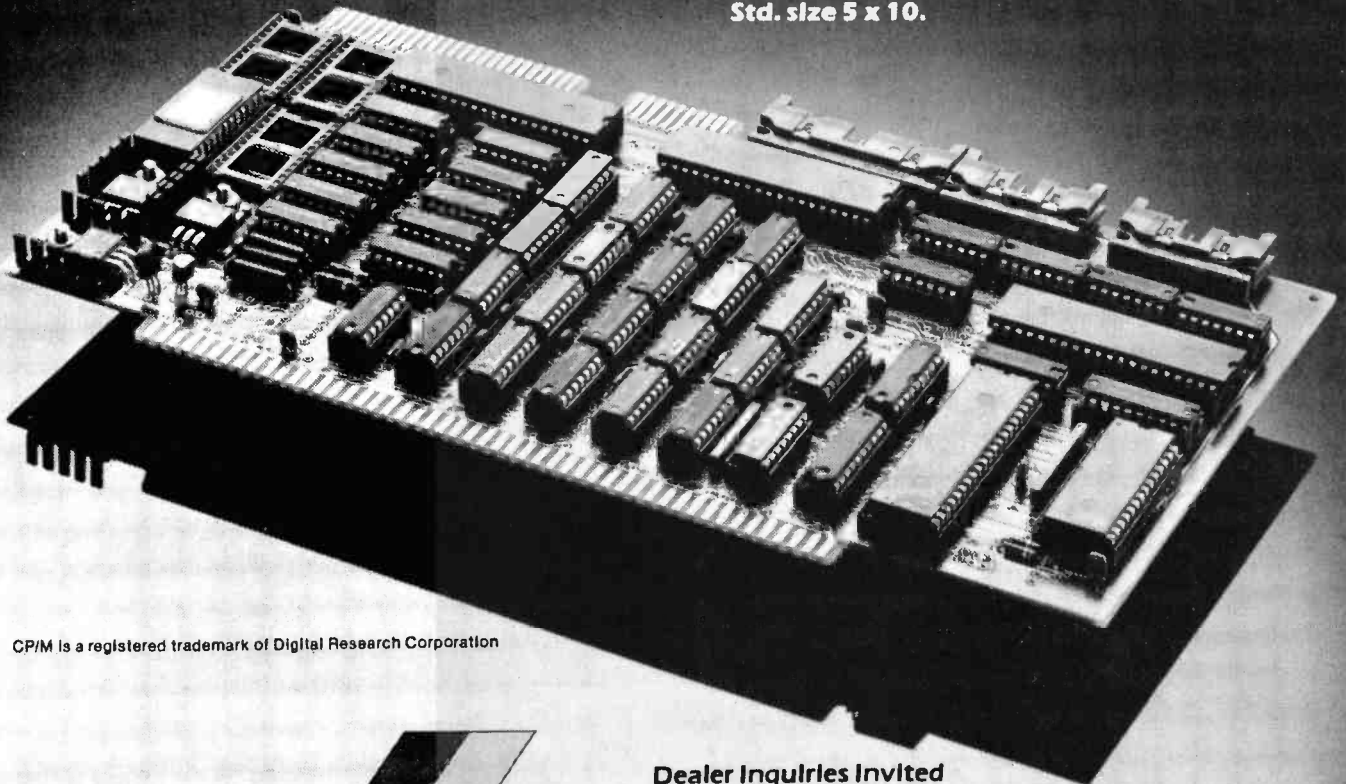

CP/M is a registered trademark of Digital Research Corporation

**HARDWARE
SOFTWARE**



Dealer Inquiries Invited

SIERRA DATA SCIENCES

Fresno, California

Marketing Division

21162 Lorain Ave./Fairview Park, Ohio 44126 / (216) 331-8500

Listing 1: PRIMES, a Pascal program that calculates the first 1000 prime numbers, based on an algorithm from Donald Knuth's *The Art of Computer Programming, Volume I: Fundamental Algorithms*.

```
PROGRAM Primes;
CONST
  maxvec=14; (* used by the timing routine *)
  np=1000; (* number of Primes *)
TYPE
  timevec=ARRAY[0..maxvec] OF INTEGER;
VAR
  Junk,lapse:REAL;
  t:timevec;
  Pr:ARRAY [1..np] OF INTEGER;
  J,k,n,a,r:INTEGER;

FUNCTION portin(port:INTEGER):INTEGER; (* Pascal-M version *)
VAR
  i:INTEGER;
BEGIN
  inport(port,i);
  portin:=i;
END;

FUNCTION tick(VAR t:timevec):REAL;
CONST
  baseport=32;
VAR
  i:INTEGER;
  prev:timevec;
BEGIN
  FOR i:=0 TO maxvec DO
    prev[i]:=t[i];
  FOR i:=0 TO maxvec DO
    t[i]:=portin(baseport+i);
  tick:=0.0001*(t[ 0]-prev[ 0])+ (* 100 microseconds *)
        0.001*(t[ 1]-prev[ 1])+ (* milliseconds *)
        0.01*(t[ 2]-prev[ 2])+ (* 10 milliseconds *)
        0.1*(t[ 3]-prev[ 3])+ (* 100 milliseconds *)
        1.0*(t[ 4]-prev[ 4])+ (* seconds *)
        10.0*(t[ 5]-prev[ 5])+ (* 10 seconds *)
        60.0*(t[ 6]-prev[ 6])+ (* minutes *)
        600.0*(t[ 7]-prev[ 7])+ (* 10 minutes *)
        3600.0*(t[ 8]-prev[ 8])+ (* hours *)
        36000.0*(t[ 9]-prev[ 9])+ (* 10 hours *)
        86400.0*(t[10]-prev[10])+ (* days *)
        864000.0*(t[11]-prev[11])+ (* 10 days *)
        8640000.0*(t[12]-prev[12])+ (* 100 days *)
        86400000.0*(t[13]-prev[13])+ (* 1000 days *)
        864000000.0*(t[14]-prev[14])+ (* 10000 days *)
END;

BEGIN
  writeln('The first ',np,' Primes:');
  Junk:=tick(t);
  Pr[1]:=2;
  Pr[2]:=3;
```

Listing 1 continued on page 338

“ well done ...
impressive ... comprehensive ... ”
—Datamation
“ authoritative ... well written ... strongly
recommended. ” —Computer Management

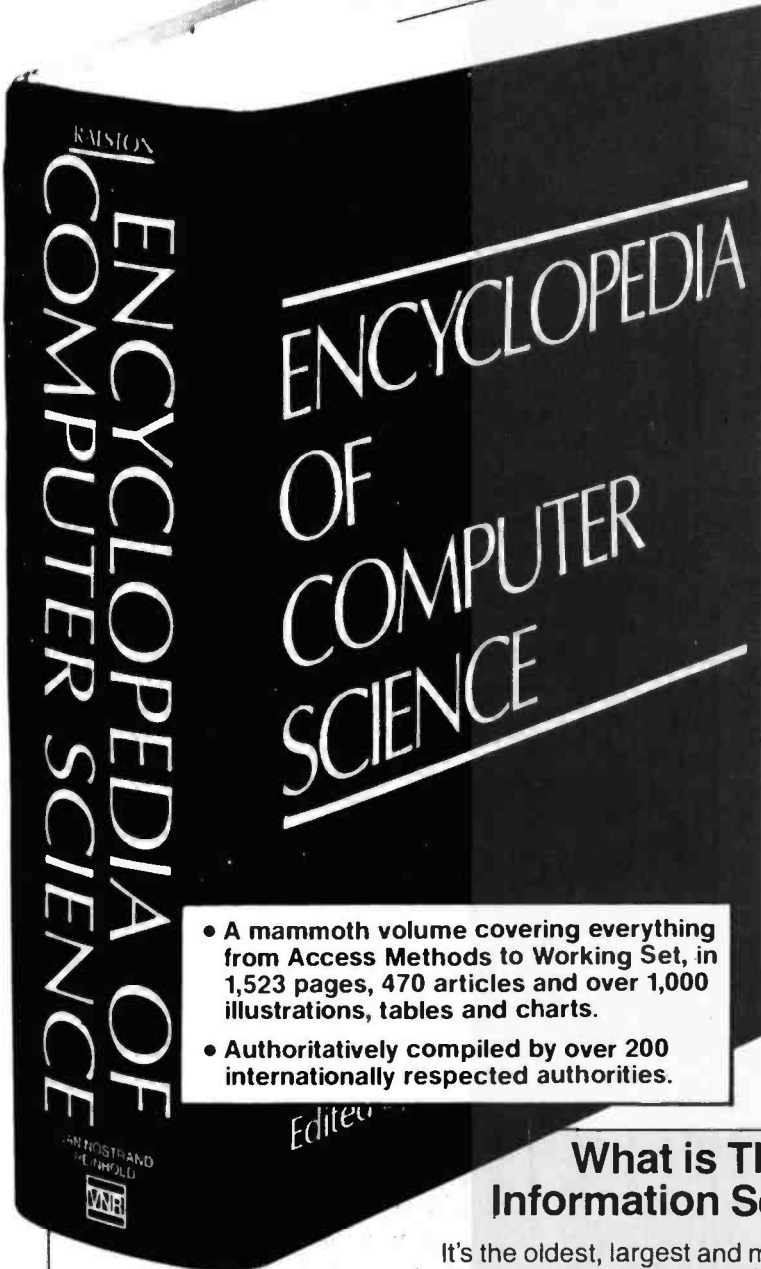

- A mammoth volume covering everything from Access Methods to Working Set, in 1,523 pages, 470 articles and over 1,000 illustrations, tables and charts.
- Authoritatively compiled by over 200 internationally respected authorities.

Take the **ENCYCLOPEDIA OF COMPUTER SCIENCE**

YOURS FOR ONLY

\$295

when you join The Library of Computer and Information Sciences. You simply agree to buy 3 more books—at handsome discounts—within the next 12 months.

(a \$60.00 value)

Find the answers to virtually all your data processing questions in the ENCYCLOPEDIA OF COMPUTER SCIENCE.

Thousands of photos, diagrams, graphs and charts completely illuminate the ENCYCLOPEDIA'S clear and thorough coverage of every area of the computer sciences—software, hardware, languages, programs, systems, mathematics, networks, applications, theory, history and terminology.

Appendices provide abbreviations, acronyms, special notations and many numerical tables. An additional highlight is a complete cross-reference system that assists the reader seeking in-depth information.

What is The Library of Computer and Information Sciences?

It's the oldest, largest and most respected book club especially designed for the computer professional. In the incredibly fast-moving world of data processing, where up-to-date knowledge is essential, we make it easy for you to keep totally informed on all areas of the information sciences. In addition, books are offered at discounts up to 30% off publishers' prices.

Begin enjoying the club's benefits by accepting the ENCYCLOPEDIA OF COMPUTER SCIENCE. It's the perfect reference for computer professionals... and it's a great bargain, too.

If reply card has been removed, please write: **The Library of Computer and Information Sciences**, Dept. 7-BA2, Riverside, N.J. 08075, to obtain membership information and application.

Listing 1 continued:

```

n:=3;
J:=2;
REPEAT
  REPEAT
    n:=n+2;
    k:=1;
    REPEAT
      k:=k+1;
      a:=n DIV Pr[k];
      r:=n-a*Pr[k];
    UNTIL (a<Pr[k]) OR (r=0);
  UNTIL r<>0;
  J:=J+1;
  Pr[J]:=n;
UNTIL J=np;
lapse:=tick(t);
FOR J:=1 TO np DO
  writeln('Prime(',J,')= ',Pr[J]);
writeln('The calculation took ',lapse,' seconds. ');
END.

```

to eliminate variation due to typing speed. We started timing when the compilation of the program began and

stopped when the program's message "The first 1000 primes:" was displayed. Then we counted the number of keystrokes that would have been necessary for compilation.

As expected, we found that the execution time of programs produced by the native-code compilers was much less than that of programs produced by the P-code compilers. On the other hand, the compilation time and the number of keystrokes necessary to run the program were much greater for the native-code compilers; there is a trade-off between calculational speed and ease of use. Perhaps the ideal situation would have P-code used for software development and native code employed for the final version.

Our second benchmark is PRECISION (see listing 2). It is an attempt to determine the precision of floating-point calculation for each Pascal. We calculated two numbers, BIG and SMALL. BIG was defined to be the largest number such that:

$$(BIG + 1.0) > BIG$$

given the limitations of floating-point arithmetic. Similarly, SMALL was defined to be the smallest number such that:

$$(1.0 + SMALL) > 1.0$$

Here we found that all our Pascals had approximately seven digits of precision, some slightly more and others slightly less. (Note that all four versions include some means of doing extended-precision arithmetic.)

DISCOUNT PRICES:

**MICROCOMPUTER
HARDWARE/
SOFTWARE**

**WE ALSO BROKER
USED MICROS.**

SYSTEMS			
ZENITH			
Z89-1	48K	100MB	\$2255
Z90-2	64K	160MB	2499
Z87			977
Z37			1620
NEC			
NEC 32K WITH GREEN MONITOR			1039
32K EXPANSION			530
5" DUAL DISK			863
ATARI			
400 (8K)			332
800 (16K)			692
XEROX			
820-1 (5" DRIVES)			2545
820-2 (8" DRIVES)			3170

PRINTERS		SOFTWARE	
EPSON MX80	\$ CALL	D BASE II*	\$499
EPSON MX80 FII	\$ CALL	FMS 80*	715
EPSON MX100	\$ CALL	CONDOR I*	499
MICROLINE 82A		CONDOR II*	715
MICROLINE 83A	\$ 499	WORDSTAR* CP/M*	296
	787	MAILMERGE* CP/M	130
DIABLO 630		SPELLSTAR*	130
	2175	SUPERCALC*	230
NEC P8023A		CALCSTAR*	180
	548	DATASAR*	210
NEC SPINWRITERS		WORDSTAR* -APPLE	224
7710	2365	MAILMERGE* -APPLE	75
7720	2750	Also available: Microsoft, Structured Systems, Systems Plus and Personal Software.	
7730	2365		
PAPER TIGER IDS 460G	879		
PAPER TIGER IDS 560G	1119		

Allow 20 days for personal checks to clear. Money orders, cashiers check or Bank Wire welcomed. Certified COD's accepted. Add 3% for Visa or Mastercard. Add 3% for shipping, handling & insurance. Calif. residents add 6% sales tax. All equipment subject to price change and availability.

The MicroExchange P.O. Box 3790, Manhattan Beach, CA 90266
(213) 372-7381, outside Calif. (800) 227-2634 Ext. 951 for call back.

© Base II a registered trademark of Ashton Tait. FMS 80 a registered trademark of Systems Plus. Condor I & II a registered trademark of Condor Computer Corp. CP/M a registered trademark of Digital Research. SuperCalc a registered trademark of Sorbus. Wordstar Mailmerge Spellstar, Calcstar & Datasar registered trademarks of Intertec.

338 March 1982 © BYTE Publications Inc

Circle 241 on inquiry card.

www.americanradiohistory.com

STOP SOFTWARE FAILURES

*Using a micro in a product sounds easy...
One piece of software can make the difference
between success and failure.*

What do you do when the software doesn't work? Over the years, we have seen many good products fail, either before or after they reached the market, because the microprocessor software did not do its job.

WHAT WENT WRONG?

Many of the failures occurred because the people programming the micro did not know how to organize a large control program. Those responsible for the product implementation were wizards at hardware design and had easily coded small micro control programs before. But the programming techniques that worked for less than 2K bytes of code simply fell apart as the program grew beyond 4K bytes.

Unfortunately, the loops and tests and flags that work so well for a small program get out of control very rapidly as the program grows. Pretty soon, some of the things the program must do are not being done fast enough. The code gets too complicated, difficult to modify and unreliable. The result: another software failure!

Fortunately, these problems can be avoided by using a program manager. You can divide your complex control program into a number of separate, more manageable programs, called *tasks*, each designed to do one job. For example, a Keyboard Task might handle user input; a Printer Task might generate reports. Each task can be written and tested separately and then combined to form a reliable, finished system.

The program manager, called a *multitasking executive*, supervises the orderly execution of these tasks, assuring that the most important jobs always get done first. Tasks appear to be executing simultaneously. It's almost like having a separate CPU for each task!

That is why professional software designers are now turning to AMX as the starting point for their product and system designs. They know that AMX will shield them from the difficulties of managing the micro, freeing them to concentrate on their application.



AMX is our **multitasking executive** for the 8080, 8085, Z80 and 6809 processors. We're rather proud of it. We made AMX compact, very fast, and ROMable to meet our own application needs. Even though the AMX nucleus is less than 1400 bytes in size, it features multiple task priorities, intertask message passing with priority queuing, external event synchronization, and interval timing with 32-bit precision. Each feature is clearly explained in the AMX Reference Manual.

RELIABILITY BUILT IN

We don't know anyone who can write an executive without errors, so we thoroughly tested AMX in real applications before ever offering it as a product. That is why not one system malfunction has ever been attributed to AMX. That kind of reliability just isn't an accident.

HARDWARE INDEPENDENCE

AMX does not require a particular hardware configuration. Of course, it does need a microprocessor, but even there we offer you a choice. *You* control your environment. *You* pick the I/O method. *You* decide the most optimum interrupt service technique for your system. AMX will support your choice.

High level language interface modules are available separately to allow AMX to be used with most popular programming languages including PASCAL, C, PL/M and FORTRAN. Of course, you can also code in assembly language if required.

Users of the CP/M and FLEX Operating Systems can utilize our AMX interface modules to access information on diskette in real time.

COMPLETE DOCUMENTATION

AMX can be judged by the quality of our documentation. The positive response from our users has exceeded our expectations. Our manuals are especially valuable to those just being introduced to real-time multitasking. More experienced users will appreciate the fact that we deliver AMX source on diskette to permit AMX to be moved to the software development system of your choice.

HOW TO ORDER

A specification sheet and price list are available, free. Your check or money order for \$75 will purchase the AMX Reference Manual for immediate evaluation (specify 8080, 8085, Z80 or 6809 processor). Add \$25 for postage and handling outside USA and Canada. The standard AMX Multitasking Executive package, including source code, is available for \$800 after signing our liberal license agreement.

AMX is the choice of professionals the world over. Make it yours, today.



KADAK Products Ltd.

1847 West Broadway Avenue
Vancouver, B.C., Canada V6J 1Y5
Telephone (604) 734-2796
Telex 04-55670

Listing 2: *PRECISION*, a program that determines the precision of floating-point calculations for each Pascal.

```
PROGRAM Precision;
VAR
  small, bis, factor, test: REAL;
BEGIN
  small:=1.0;
  factor:=3.0;
  WHILE factor>(1.0+small) DO
    BEGIN
      test:=small/factor;
      WHILE ((test+1.0)>1.0) AND (test<small) DO
        BEGIN
          small:=test;
          test:=test/factor;
        END;
      factor:=(1.0+factor)/2.0;
    END;
  writeln('Small= ',small);

  bis:=1.0;
  factor:=3.0;
  WHILE factor>(1.0+small) DO
    BEGIN
      test:=bis*factor;
      WHILE ((test+1.0)>test) AND (bis<test) DO
        BEGIN
          bis:=test;
          test:=test*factor;
        END;
      factor:=(1.0+factor)/2.0;
    END;
  writeln('Bis= ',bis);
END.
```

Our third benchmark, BLOWUP (see listing 3), was designed to measure the amount of memory each implementation had available for dynamically allocated variables. The program successively allocates 100-byte blocks of memory until a run-time error occurs due to lack of additional memory. The program continuously prints out the number of blocks it has successfully allocated; the last number it prints (before the run-time error), divided by 10, is the approximate dynamic-memory space in kilobytes. All the versions of Pascal except for Pascal/MT+ generated such an error; running the program with Pascal/MT+ eventually caused the system to "hang," apparently due to overwriting the memory containing the program or the operating system. Pascal/MT+ does not check for such memory overflow; the programmer must do it with one of the built-in procedures. (For many programmers, this may be a desirable feature.)

From this program we found that the native-code compilers have more space for program code and dynamic variables than do the P-code versions. This is probably

because of the extra memory required for the P-code interpreters, which results in less memory available to user programs. This test is somewhat misleading, however, since for larger programs this situation could be reversed. P-code should be more compact than native code, and the compactness should atone for the interpreter overhead in large programs. (We did not test this hypothesis.)

The final benchmark is called BENCHMARK (see listing 4), which is an attempt to measure the different Pascals' performances in the more realistic applications of sorting, disk I/O, and data-structure generation. The program first generates a pseudorandom array of 1024 integers, then writes it to disk. (Pascal allows writing the entire array as a single entity, which turns out to be infinitely faster on our system than writing each element of the array individually.) The array is sorted using the Shell-Metzner algorithm. The random array is then read back into memory from disk (again, as a single entity) and sorted using the quicksort algorithm. (Both sorting algorithms are adapted from *Algorithms Plus Data Struc-*

Text continued on page 352

HUNTINGTON COMPUTING

ONE OF THE WORLD'S LARGEST INVENTORIES

GAMES

Red Alert	\$29.95	now	\$26.29
Empire I World Builders	\$32.95	now	\$28.99
Golden Mountain	\$19.95	now	\$16.89
Space Eggs	\$29.95	now	\$19.99
Apple Panic	\$29.95	now	\$19.99
Thiel	\$29.95	now	\$23.39
Snack Attack	\$29.95	now	\$23.39
Med Fly Mania	\$29.95	now	\$24.59
The Book	\$19.95	now	\$17.99
Hi-Res Soccer	\$29.95	now	\$23.39
Apple Odds	\$29.95	now	\$23.39
Wurst of Huntington Computing			\$19.99
Ultima	\$39.95	now	\$33.89
Autobahn	\$49.95	now	\$25.39
Battle Cruiser Action	\$39.95	now	\$38.89
Gorgon	\$39.95	now	\$33.89
Super Stellar Trek	\$39.95	now	\$33.89
Hellfire Warrior	\$39.95	now	\$33.89
Gamma Goblins	\$29.95	now	\$25.39
Mission Asteroid	\$19.95	now	\$17.99
Wizardry	\$49.95	now	\$42.49
Warp Factor	\$39.95	now	\$33.99
Microsoft Adventure	\$29.95	now	\$25.39
Wizard and the Princess	\$32.95	now	\$28.99
Flight Simulator	\$34.95	now	\$29.49
Odyssey	\$29.95	now	\$25.39
Sargon II	\$34.95	now	\$29.69
Space Eggs	\$29.95	now	\$23.39
Hi-Res Cribbage	\$24.95	now	\$21.19
Lords of Karma (cass.)	\$20.00	now	\$16.99
Oh Shoot		now	\$19.99
ABM	\$24.95	now	\$21.19
Computer Conflict	\$39.95	now	\$33.99
Computer Air Combat	\$59.95	now	\$52.99
Temple of Apsah	\$39.95	now	\$33.89
Zork II	\$39.95	now	\$33.99
All Nibble Software			15% off list
Robot Wars	\$39.95	now	\$33.99
Cranston Manor	\$34.95	now	\$29.69
Dragon's Eye	\$24.95	now	\$21.19
Twala's Last Redoubt	\$29.95	now	\$25.39
Snoggle	\$24.95	now	\$21.19
Alien Rain	\$24.95	now	\$21.19
Alien Typhoon	\$24.95	now	\$21.19
Raster Blast	\$29.95	now	\$25.39
Creature Venture	\$24.95	now	\$21.19
Hedge Podge	\$19.95	now	\$17.49
Solitaire	\$29.95	now	\$25.39
Arcade Machine			\$39.49
Time Zone	\$99.95	now	\$87.99
Mouskattack	\$39.95	now	\$33.89
Ceiling O			\$26.29
The Game Show			\$34.29
Shadow Hawk I			\$43.89
Mummy's Curse			\$26.39
Dragon Fire	\$49.95	now	\$42.49
Jawbreaker	\$29.95	now	\$26.29
Hadron	\$34.95	now	\$30.69
Dark Forest	\$29.95	now	\$26.29
Southern Command	\$39.95	now	\$35.89
Beer Run	\$29.95	now	\$26.29
Hungry Boy	\$24.95	now	\$21.19
Ring of Saturn	\$39.00	now	\$33.89
Streets of the City & Trucker	\$24.95	now	\$21.19
Race for Midnight	\$29.95	now	\$25.39
Galactic Empire	\$24.95	now	\$21.19
Space Warrior	\$24.95	now	\$21.19
Pulsar II	\$29.95	now	\$25.39
Star Cruiser	\$24.95	now	\$20.99
Both Barrels	\$24.95	now	\$21.89
Cyber Strike	\$39.95	now	\$36.99
Castle Wolfenstein	\$29.95	now	\$23.39
Upper Reaches of Apsah	\$19.95	now	\$16.89
Bridge Tutor	\$39.95	now	\$35.19
Crossfire	\$29.95	now	\$26.29
Epoch	\$29.95	now	\$23.39
Outpost	\$29.95	now	\$26.29
Ulysses	\$34.95	now	\$29.69
Space Quark	\$29.95	now	\$23.39
Birth of the Phoenix	\$14.95	now	\$12.69
Goblins	\$27.50	now	\$23.29
Super Stellar Trek	\$39.95	now	\$33.89
Waterfoot II	\$49.95	now	\$42.39
Kaves of Karkhan	\$49.95	now	\$42.39
Phantom 5	\$29.95	now	\$23.39
Meteoroids in Space	\$19.95	now	\$16.99
Dragon Fire	\$49.95	now	\$42.49

STOCK PROGRAMS

Portfolio Master	\$75.00	now	\$63.69
Market Charter	\$129.95	now	\$110.39
Dowlog for Market Charter	\$99.95	now	\$89.99
Investment Decisions	\$99.95	now	\$84.99
Stock Tracker	\$190.00	now	\$161.49
Stock Tracker (Auto. Ver.)	\$300.00	now	\$254.99

Softlights

By Fred Huntington

We are proud to introduce our first major piece of software, **Understand Yourself**. Written by Mike Taylor, this series of programs is based on the Chicago Review Press book, **The Test Yourself Book** by Dr. Harry E. Gunn.

The disk contains several hundred questions and consists of the programs: Assertive Test, Conscience Test, Manipulation Test, Personal Equation Test, Marital Adjustment Test, Individual Scale of Values, Preferred Activities Test, and Sexual Attitudes Test.

The price of **Understand Yourself** is **\$24.99**. The book, which contains all the tests plus a lot more, is a bargain at **\$7.95**. Dealer inquiries are welcome.

VOLCANOES

Just took a look at a new program called **Volcanoes**. Has great graphics and tremendous teaching potential for home or school use. It lists for \$49.95 and our price is **\$44.99**.

Foreign Orders

We are no longer able to accept foreign checks not drawn upon U.S. banks. We welcome charge cards. We also take wire transfers to our bank (\$6.00 service charge). We had one check that by the time all the fees were taken out of it, we owed \$8.00. Help!

Maxell Disks

We are now authorized distributors for the best diskettes made today - Maxell. We are selling the Apple /Atari version of these fine disks, **10 for \$36.99**. Once you try these, you'll never go back to the cheaper versions. The tolerances on these disks are so close that they never need hub rings. We stock the complete line of Maxell disks, including all the eight inch variety. Dealer inquiries welcome.

Great Grandma Huntington

Great Grandma Huntington always said to try harder - and we do. We will soon have tee shirts for sale with Great Grandma Huntington's picture on them. Watch for Granny! son's picture on them. Watch for Granny!

FOREIGN ORDERS

We regret that we can no longer accept checks (bank charges were sometimes greater than the amount of the check). We will gladly accept U.S. currency, VISA, MasterCard or American Express at no extra charge, or you may make direct wire transfers to our bank, Security Pacific, Corcoran, CA 93212, for a \$6.00 charge. All overseas orders are shipped by air.

BUSINESS APPLICATIONS

DataDex			\$250.69
Invoice Factory (Special)	\$200.00	now	\$149.00
Regression Trend Analysis	\$26.95	now	\$22.89
Multiple Regression	\$29.95	now	\$23.39
Microsoft Fortran	\$200.00	now	\$163.69
Microsoft Cobol-80	\$750.00	now	\$637.49
Business Pac 100	\$99.95	now	\$84.99
Desktop Plan II	\$200.00	now	\$169.99
Visicalc 3.3	\$200.00	now	\$149.00
Visiplot	\$179.95	now	\$132.89
Visitrend/Visiplot	\$259.95	now	\$220.89
Visitrem	\$149.95	now	\$127.39
DB Master	\$229.95	now	\$194.59
PFS	\$95.00	now	\$80.69
PFS Report	\$95.00	now	\$80.69
Thinker	\$495.00	now	\$420.69
Request	\$225.00	now	\$191.19
Super Kram	\$175.00	now	\$148.89
ASCII Express	\$99.95	now	\$84.99
BPI Accounts Receivable	\$395.00	now	\$335.69
BPI General Ledger	\$395.00	now	\$335.69
The Mail Room	\$29.95	now	\$23.39
Continental General Ledger	\$250.00	now	\$212.49
Cont Accounts Receivable	\$250.00	now	\$212.49
Cont Accounts Payable	\$250.00	now	\$212.49
Continental Payroll	\$250.00	now	\$212.49
Broderbund Payroll	\$395.00	now	\$335.69
Inform II	\$49.95	now	\$42.49
Creative Financing	\$150.00	now	\$127.49
Real Estate Analyzer	\$150.00	now	\$127.49
Spell Star	\$250.00	now	\$212.49
Muse Form Letter	\$100.00	now	\$84.99
Property Management System	\$225.00	now	\$191.19

PERSONAL/HOME

Soft Touch Recipe Handler	\$39.95	now	\$33.09
Interlude (disk)	\$19.95	now	\$16.99
Handwriting Analysis	\$19.95	now	\$16.89
Decision Master	\$29.95	now	\$23.39
The Correspondent	\$44.95	now	\$38.19
Diet Planning	\$24.95	now	\$21.19
Win at the Races	\$39.95	now	\$33.89
Pro Football (SDL)	\$26.95	now	\$22.89
College Football (SDL)	\$26.95	now	\$22.89
Grocery List	\$19.95	now	\$16.89
Financial Management System II	\$39.95	now	\$33.89
Home Money Minder	\$34.95	now	\$29.69

WORD PROCESSORS

Sensible Apple Speller	\$75.00	now	\$65.99
The Dictionary	\$89.95	now	\$87.99
Magic Window	\$100.00	now	\$84.99
Easy Writer Professional	\$250.00	now	\$219.00
Letter Perfect	\$150.00	now	\$127.49
Super Text	\$150.00	now	\$127.49
Superscribe	\$129.95	now	\$118.39
Executive Secretary	\$250.00	now	\$212.49
Apple Wordstar	\$375.00	now	\$284.00
Hebrew II	\$60.00	now	\$50.99
Apple Writer Extended	\$34.95	now	\$30.69
Select	\$595.00	now	\$523.39
Word Handler	\$249.00	now	\$219.99

MISCELLANEOUS

Wordstar Made Easy (Book)	\$7.95	now	\$7.15
Kern Graphic Software	\$18.95	now	\$16.59
CS MX80/100 Enhanced Graphics	\$44.95	now	\$39.49
CS MX80/100 Graphic Writer	\$34.95	now	\$30.69
Z-Card	\$269.00	now	\$239.00
Hayes Micromodem	\$375.00	now	\$299.00
Hayes Smart Modem	\$279.00	now	\$249.00
460G Paper Tiger	\$1094.00	now	\$961.99
560G Paper Tiger	\$1394.00	now	\$1235.00
Tiger Trax	\$16.95	now	\$15.23
Z-80 Softcard	\$395.00	now	\$299.00
NEC 12 Green on Black	\$260.00	now	\$179.00
Videx 80-col	\$350.00	now	\$299.00
TG Joystick	\$59.95	now	\$50.89
TG Game Paddles	\$39.95	now	\$35.89
Paymar LCA Rev. 7			\$27.99
Verbatim DataLife-plain w/hubs		10 for	\$49.99
Dysans		10 for	\$20.80
Flipsort Box			\$26.99
Scotch Disk Cleaner	\$29.95	now	\$26.99
E-Z Port	\$24.94	now	\$21.19
Atari /TRS-80 /Pet			Write for information
Escape from Acturus	\$29.95	now	\$23.39
Basic Mailer	\$69.95	now	\$59.49
Memory Management II	\$49.95	now	\$42.89
Beneath Apple DOS (book)	\$19.95	now	\$16.89
Painter Power	\$39.95	now	\$33.89
U.S. Constitution	\$29.95	now	\$25.39
Merger	\$49.95	now	\$42.49
LISA	\$79.95	now	\$67.89
Brain Surgeon	\$49.95	now	\$42.49
Info Master	\$150.00	now	\$127.49
Speedstar	\$139.95	now	\$114.69
Dos Boss	\$24.00	now	\$20.39

HUNTINGTON COMPUTING

Post Office Box 1235
Corcoran, California 93212

Order by Phone 800-344-5109
In California 800-692-4146

Apple is a registered trademark of Apple Computer, Inc.
Pet is a registered trademark of Commodore.
TRS-80 is a registered trademark of Tandy Corp.
Atari is a registered trademark of Atari, Inc.



We take MasterCard, American Express or VISA (include card # and expiration date). California residents add 6% tax. Include \$2.00 for postage. Foreign and hardware extra. Send for free catalog. Prices subject to change.

Listing 3: *BLOWUP*, a program that measures the amount of memory available for dynamically allocated variables. The program successively allocates 100-byte blocks of memory until a run-time error occurs.

```
PROGRAM blowup;
CONST
  blocksize=100;
TYPE
  byte=0..255;
  block=PACKED ARRAY[1..blocksize] OF byte;
  blockptr=^block;
VAR
  p: blockptr;
  i, j: INTEGER;
BEGIN
  i:=0;
  WHILE TRUE DO
    BEGIN
      new(p);
      FOR j:=1 TO blocksize DO
        p[j]:=0;
        i:=i+1;
        writeln(i);
      END;
    END;
  END.
```

Listing 4: *BENCHMARK*, a program that measures performance in tasks that occur commonly in applications programs. The program generates a random array of integers; writes the array to disk; sorts the array with the Shell-Metzner algorithm; reads the random array back into memory from disk; sorts the array with the quicksort algorithm; reads the unsorted array into memory yet again, using the integers as keys by which dummy data are stored in a binary tree; and writes the tree elements individually to disk. Along the way, the program displays the array elements on the terminal screen to insure that the disk input/output and the sorts are done correctly, as well as to see how fast each version of Pascal can output text.

```
PROGRAM benchmarks;

CONST
  maxlen=1024;
  maxvec=14; (* part of timing package *)

TYPE
  index=0..maxlen;
  vector=ARRAY[index] OF INTEGER;
  link=^node;
  dummydata=RECORD
    key: INTEGER;
    frequency: index;
    datafield: STRING[16];
  END;
  node=RECORD
    dd: dummydata;
    left, right: link;
  END;
  timevec=ARRAY[0..maxvec] OF INTEGER; part of timing package

VAR
  v: vector;
  root: link;
  nodecount: INTEGER;
```

Listing 4 continued on page 344

If you want a choice in print wheels, here's the first choice in printers.

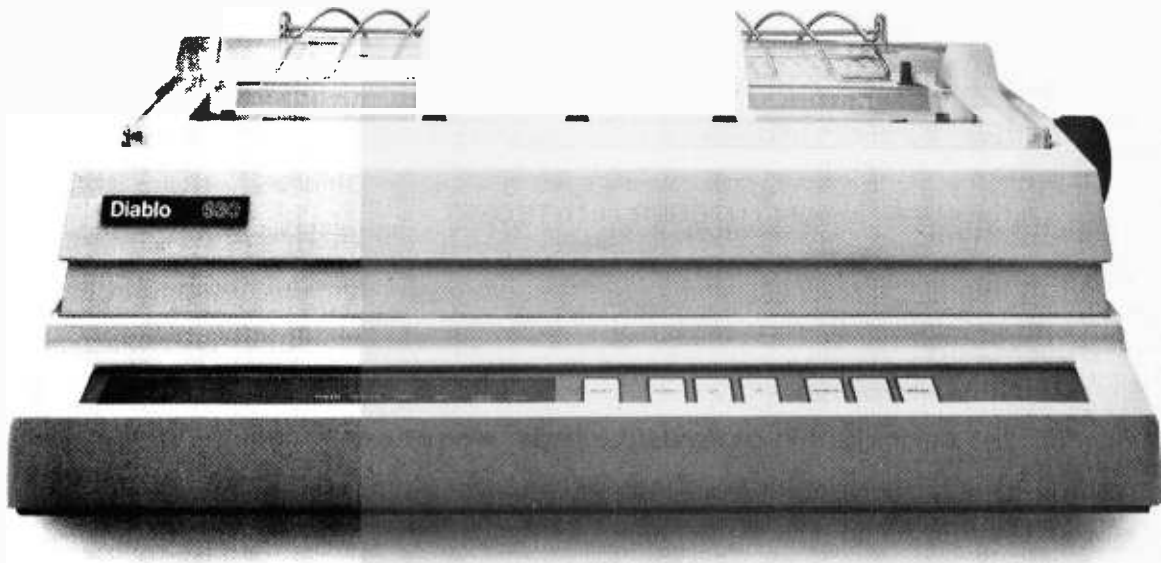

The Diablo 630.

It's the first printer that lets you use either metal or plastic print wheels. So you can choose the print wheel that's just right for the job.

The 630 works as well with a 96-character plastic daisy print wheel as it does with an 88-, 92-, or 96-character metal daisy print wheel. In over 100 different type styles.

Every 630 has fewer moving parts than competitive printers, which makes it more reliable. And it offers unsurpassed print quality. Compatibility with Diablo supplies. And bi-directional printing capability.

So if you want to change your print wheels, you'll just have to change your printer.

To a Diablo 630 printer.

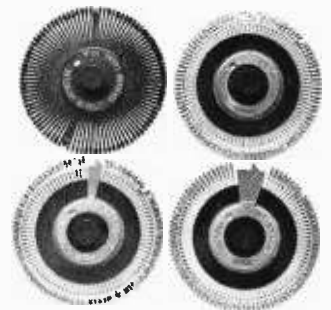

Diablo Systems

XEROX

Diablo® and XEROX® are trademarks of XEROX CORPORATION.

Circle 129 on Inquiry card.

BYTE March 1982 343

Listing 4 continued:

```
Junk:REAL: part of timing package
t:timevec

(* define 'portin' and 'tick' as in PROGRAM primes: *)

FUNCTION portin(port:INTEGER):INTEGER;
BEGIN
...
...
END;

FUNCTION tick(VAR t:timevec):REAL;
BEGIN
...
...
END;

PROCEDURE randgen(VAR v:vector);
VAR
  s:INTEGER;
  i:index;

FUNCTION random(VAR seed:INTEGER):INTEGER;
CONST
  multiplier=3;
  increment=5;
  modulus=8192;
BEGIN
  random:=seed;
  seed:=(multiplier*seed+increment) mod modulus;
END;

BEGIN (* randgen *)
  s:=3;
  FOR i:=1 TO maxleneth DO
    v[i]:=random(s);
  END;

PROCEDURE writearray(VAR v:vector);
VAR
  f:FILE OF vector;
BEGIN
  rewrite(f,'vector.dat');
  f^:=v;
  put(f);
  close(f,lock);
END;

PROCEDURE readarray(VAR v:vector);
VAR
  f:FILE OF vector;
BEGIN
  reset(f,'vector.dat');
  set(f);
  v:=f^;
END;
```

Listing 4 continued on page 346

WE HAVE A HARD-ONE FOR YOU!

WHO MAKES A
WINCHESTER HARD DISK for
IBM-PERSONAL COMPUTER,
TRS-80™ MODEL III, etc.?

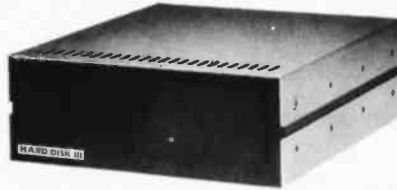

THE VR DATA HARD DISK III™
WINCHESTER SUBSYSTEM
6.5 MEG to 19 MEG per UNIT
FROM \$2895*

*Subsystem includes 6.5 MEG Winchester Drive Power Supply, Controller, I/O Controller Adaptor, Enclosure, Cables.

Other Quality Products Available

IBM - Personal Computer 2nd Floppy Disk Drive	\$265.00
Superbrain & QD Parallel Output Port	99.00
TRS-80 - Model III Disk III Floppy Subsystem 2nd Drive	599.00 265.00
VR-RS232C	75.00

Quality Products in the QUEUE

IBM - Personal Computer Memory Expansion - 192K D-CON • Integral Direct Connect Mode VR-RS232C
TRS-80 Mod III D-CON • Integral D.C. Modem Computer w/Integral Hard Disk III and Disk III

DEALERS & OEM'S INVITED

SERVICE • 215-461-5300

800-345-8102 • 215-461-5300 - PA • TELEX 845-124

PRICES SUBJECT TO CHANGE W/O NOTICE
TRS-80 - TRADEMARK OF TANDY CORP.
DISK II, HARD DISK III, D-CON - TRADEMARKS OF VR DATA CORP.

VR Data

VR Data Corporation
777 Henderson Boulevard • Folcroft, PA 19032



Listing 4 continued:

```

PROCEDURE shellsort(VAR v:vector);
VAR jump,m,n:index;
    temp:INTEGER;
    done:BOOLEAN;
BEGIN
    jump:=maxlength;
    WHILE jump>1 DO
        BEGIN
            jump:=jump DIV 2;
            REPEAT
                done:=TRUE;
                FOR m:=1 TO (maxlength-jump) DO
                    BEGIN
                        n:=m+jump;
                        IF v[m]>v[n] THEN
                            BEGIN
                                temp:=v[m];
                                v[m]:=v[n];
                                v[n]:=temp;
                                done:=FALSE;
                            END;
                        END:(* FOR *)
                    UNTIL done;
                END:(* WHILE *)
            END:(* shellsort *)

PROCEDURE quicksort(VAR v:vector);

PROCEDURE sort(left,right:index);
VAR i,j:index;
    pivot,temp:INTEGER;
BEGIN

    i:=left;j:=right;
    pivot:=v[(left+right) DIV 2];
    REPEAT
        WHILE v[i]<pivot DO i:=i+1;
        WHILE pivot<v[j] DO j:=j-1;
        IF i<=j THEN
            BEGIN
                temp:=v[i];
                v[i]:=v[j];
                v[j]:=temp;
                i:=i+1;
                j:=j-1;
            END;
        UNTIL i>j;
        IF left<j THEN sort(left,j);
        IF i<right THEN sort(i,right);
    END;

BEGIN
    sort(1,maxlength);
END;

```

Listing 4 continued on page 348

Call today.

United States:

Arizona Phoenix	602/258-9333
California San Francisco Mountain View Los Angeles Van Nuys Torrance Century City Irvine San Diego	415/434-2410 415/969-4910 213/386-5500 213/781-4800 213/540-7500 213/203-8111 714/833-1730 714/231-1900
Colorado Denver Englewood	303/571-4450 303/773-3700
Connecticut Hartford Stratford	203/522-6590 203/375-7240
District of Columbia Washington	202/466-5890
Florida Miami Ft. Lauderdale	305/624-3536 305/491-0145
Georgia Atlanta Northeast Downtown North	404/325-8370 404/588-9350 404/953-0200
Illinois Chicago Northfield Oak Brook Rolling Meadows	312/782-0857 312/441-5200 312/986-0422 312/392-0244
Indiana Indianapolis	317/631-2900
Kansas Overland Park	913/888-8885
Kentucky Louisville	502/581-9900
Louisiana New Orleans	504/561-6000
Maryland Baltimore Rockville Towson	301/727-4050 301/258-8800 301/321-7044
Massachusetts Boston Burlington Wellesley	617/482-7613 617/273-5160 617/237-3120
Michigan Detroit Southfield	313/259-7607 313/352-6520
Minnesota Minneapolis West Downtown St. Paul	612/544-3600 612/332-6460 612/227-6100
Missouri St. Louis Clayton Kansas City	314/231-4880 314/862-3800 816/474-3393
New Hampshire Nashua	603/880-4047
New Jersey Cherry Hill Edison Morristown Paramus	609/482-2600 201/494-2800 201/267-3222 201/845-3900
New York New York City Penn Station Wall Street Grand Central Syosset, L.I. White Plains Rochester	212/736-7445 212/962-8000 212/557-8611 516/364-0900 914/683-8300 716/263-2670
Ohio Akron Cincinnati Cleveland Columbus Dayton	216/535-1150 513/769-5080 216/771-2070 614/224-0660 513/461-4660
Oklahoma Tulsa	918/599-7700
Oregon Portland	503/223-6160
Pennsylvania Philadelphia King of Prussia Pittsburgh Wilkins Twnshp.	215/685-1717 215/265-7250 412/281-6540 412/247-4400
Texas Dallas North Central Fort Worth Houston S.W. Freeway Downtown N. Loop West San Antonio	214/387-1600 214/749-1900 817/338-9300 713/626-8705 713/751-0100 713/957-8555 512/344-0217
Virginia McLean	703/790-5610
Washington Bellevue	206/454-6400
Wisconsin Milwaukee	414/277-0345
Canada: Toronto Don Mills Montreal	416/865-1125 416/425-5730 514/849-7043

Are you keeping up with computer salaries?



Get the latest data in our new report. It's FREE!

With compensation rising rapidly and sweeping technological changes occurring practically overnight in the computer profession, you can quickly become out-of-touch with salary and career trends. Are you—and is your salary—keeping up?

If you haven't kept in touch with computer salaries in the past six months or so, you might be surprised at the changes.

In our recent survey, which polled more than 50,000 computer professionals, new statistics about compensation differences emerged. Here is a sampling:

- While some computer professionals have increased their salaries dramatically during the past twelve months, others,

performing the same type of work and having the same general level of experience, have barely managed to keep pace.

- While length of experience in computing bears a direct relationship to compensation, type of experience is often a more critical factor.
- Some emerging technologies—microcomputer systems, for example—are having an unusual impact on compensation in the field.

Salaries for 48 positions are compared.

1982 salary data for 48 different position categories—at various levels of experience and computer installation sizes—are reviewed in the report. Included are positions in programming, software,

systems design, data communications, mini/micro systems, data base, EDP auditing, computer marketing and more.

It's free to computer professionals.

The report is available without charge. Call today,

and a copy will be mailed to you in strict confidence, with absolutely no obligation.



North America's largest, non-franchised recruiting firm devoted exclusively to the computer profession.

Call for your FREE report today.

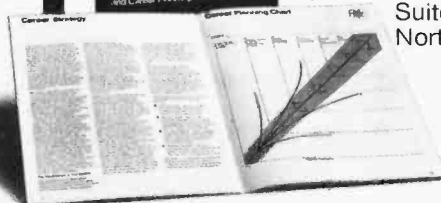

The new report is available to you without charge. Call the office nearest you that's listed to the left for your copy. Our 28-page Survey will be sent to you in strict confidence, without obligation. If you're unable to call, please write:
Source Edp, Department B-1
Two Northfield Plaza,
Suite 227
Northfield, Illinois 60093

Listing 4 continued:

```
PROCEDURE treesen(UAR root:link;VAR v:vector);
VAR
  nodecount: INTEGER;
  i: index;

PROCEDURE insert(UAR ref:link;VAR nodecount: INTEGER; newkey: INTEGER);
BEGIN
  IF ref=nil THEN
    BEGIN
      new(ref);
      nodecount:=nodecount+1;
      WITH ref^ DO
        BEGIN
          left:=nil;
          right:=nil;
          WITH dd DO
            BEGIN
              datafield:='0123456789ABCDEF';
              key:=newkey;
              frequency:=1;
            END;
          END;
        END;
      ELSE WITH ref^ DO
        IF newkey<dd.key THEN insert(left,nodecount,newkey)
        ELSE IF newkey>dd.key THEN insert(right,nodecount,newkey)
        ELSE (*duplicate key! update frequency.*)
          dd.frequency:=dd.frequency+1;
        END;
      END;
    END;
  ELSE WITH ref^ DO
    IF newkey<dd.key THEN insert(left,nodecount,newkey)
    ELSE IF newkey>dd.key THEN insert(right,nodecount,newkey)
    ELSE (*duplicate key! update frequency.*)
      dd.frequency:=dd.frequency+1;
    END;
  END;
END;

BEGIN
  root:=nil;
  nodecount:=0;
  i:=0;
  REPEAT
    i:=i+1;
    insert(root,nodecount,v[i]);
  UNTIL i=maxlength;
  writeln(nodecount,' distinct nodes created.'):
END;

PROCEDURE writetree(root:link);
VAR
  dummyfile:FILE OF dummydata;
  counter: INTEGER;

PROCEDURE traverse(ref:link;VAR counter: INTEGER);
BEGIN
  IF ref<>nil THEN
    BEGIN
      traverse(ref^.left,counter);
      dummyfile^:=ref^.dd;
      put(dummyfile);
    END;
  END;
END;
```

Listing 4 continued on page 350

More performance than you ever imagined — for \$1995. If you're considering a DEC® terminal, C. Itoh now has two reliable alternatives that could easily change your mind.

Take our 132-column CIT 101, for example. Unlike DEC's VT100®, it includes full AVO performance — as standard equipment. You also get a 96 ASCII character set, plus 128 special characters. Characters may appear single-width and double-width, double-height. Reverse video, blinking, half-intensity and underscore may be used in up to 16 combinations. The cursor may be underline or block, blinking or non-blinking, or invisible to the viewer — all under computer control. There's

raster graphics too. And 19.2K Baud asynchronous communications. Human engineered features include a non-glare screen and detached selectric-type keyboard. Of course, if all you need is 80-column capability, have we got a terminal for you.

The \$1195 80-column terminal that performs like a 132. It's C. Itoh's CIT 80, the DEC VT52® emulator that's packed with features many big-ticket terminals don't offer. Things like smooth scrolling, soft setup mode, line drawing graphics and unidirectional RS 232-C printer port. A 19.2K Baud main port features X/ON-X/OFF protocol as well as full and half-duplex in conversation mode. Video attributes include

blinking, underline, half intensity — even reverse video. You get CIT 101-type human engineered features too. Plus socketed firmware for maximum OEM flexibility.

Both terminals are backed by our 90-day warranty, fully field supported and ready for immediate shipment. So if you're thinking of getting a DEC terminal, consider the alternatives: CIT 80 and CIT 101.

For full details, contact our exclusive representative, ACRO Corporation, 18003-L Skypark South, Irvine, CA 92714. (714) 557-5118.

 **C. ITOH
ELECTRONICS, INC.**
One world of quality.

Before you order a VT100, think twice.



Circle 62 on Inquiry card.

*Registered trademark of Digital Equipment Corporation

www.americanadvertising.com

Listing 4 continued:

```
        counter:=counter+1;
        traverse(ref^.right, counter);
    END;
END;

BEGIN
    rewrite(dummyfile, 'dummy.dat');
    counter:=0;
    traverse(root, counter);
    close(dummyfile, lock);
    writeln(counter, ' records written. ');
END;

PROCEDURE disparray(VAR v:vector);
VAR
    i:index;
BEGIN
    FOR i:=1 TO maxlen do writeln(v[i]);
END;

PROCEDURE disetree(ptr:link);
BEGIN
    IF ptr<>nil THEN BEGIN
        disetree(ptr^.left);
        writeln(ptr^.dd.key);
        disetree(ptr^.right);
    END;
END;

BEGIN
    Junk:=tick(t);

    randgen(v);
    writeln('Random array generation took ', tick(t), ' sec. ');

    disparray(v);
    writeln('Displaying array took ', tick(t), ' sec. ');

    writearray(v);
    writeln('Writing array to disk took ', tick(t), ' sec. ');

    shellsort(v);
    writeln('Shell sort took ', tick(t), ' sec. ');

    disparray(v);
    writeln('Displaying array took ', tick(t), ' sec. ');

    readarray(v);
    writeln('Reading array from disk took ', tick(t), ' sec. ');

    disparray(v);
    writeln('Displaying array took ', tick(t), ' sec. ');

    quicksort(v);
    writeln('Quicksort took ', tick(t), ' sec. ');
```

Listing 4 continued on page 352

YOUR COMPUTER HEADQUARTERS



BUSINESSMAN'S SPECIAL

- Apple II plus 48K
- Apple Disc Drive II w/interface DOS 3.3
- 12" High Resolution Green Monitor
- Visicalc 3.3 Software

\$2059⁰⁰

PERSONAL TAX PLAN

- Apple II plus 48K
- Apple Disc Drive II w/DOS 3.3
- 12" High Resolution Green Monitor
- Aardvark Personal Tax Plan
- 1 Box Diskettes

\$2015⁰⁰

WORD PROCESSOR SYSTEM

- Apple II plus 48K
- Apple Disc Drive II w/DOS 3.3
- 12" High Resolution Monitor
- IUS Orig. Easywriter
- OKIDATA Microline 80 Printer
- Printer cable w/Interface

\$2445⁰⁰

ACCESSORIES FOR APPLE

- Videx Videoterm - 80 Col. \$279⁹⁵
- Videx Keyboard \$119⁹⁵
- Enhancer II \$119⁹⁵
- DC Hayes Micromodem II \$298⁹⁵
- Microsoft Z-80 CP/M Card \$289⁹⁵
- Microsoft 16K Ram Card \$159⁹⁵
- Saturn 32K Ram Card \$200⁹⁵
- VC Expand for Saturn Card \$85⁹⁵
- Mountain CPS
- Mountain Function Card \$189⁹⁵
- Mountain Clock \$239⁹⁵
- Keyboard Company
- Numeric Keypad \$135⁹⁵
- Apple Language System with Pascal \$405⁹⁵
- Apple High Speed \$158⁹⁵
- Serial Interface \$158⁹⁵
- Dan Paymar \$158⁹⁵
- Lower Case Chip \$39⁹⁵
- R.H. Superfan II \$65⁹⁵

WORD PROCESSORS

- IUS - Pro Easywriter \$200⁹⁵
- Orig. Easywriter \$79⁹⁵
- Apple Pie (word Proc. 40 Col) \$100⁹⁵
- LJK Letter Perfect \$129⁹⁵
- Supertext II \$129⁹⁵
- Dogscrite II \$104⁹⁵
- Executive Secretary \$200⁹⁵
- Magic Window \$85⁹⁵

EDUCATIONAL

- FOR APPLE
- Edu-Ware Math/Fractions \$34⁹⁵
- Math/Decimals \$34⁹⁵
- Arithmetic Skills \$43⁹⁵
- Algebra I \$34⁹⁵
- Compuspell System \$26⁹⁵
- Data Disc Lev. 4-5-6-7-8 .ea. \$18⁹⁵
- CMA Teacher Plus \$44⁹⁵
- CMA Teacher Plus Pack \$60⁹⁵
- PDEI New Step-by-Step \$69⁹⁵

SOFTWARE FOR APPLE

- Fortran 80 \$154⁹⁵
- A.L.D.S. \$99⁹⁵
- Basic Compiler \$295⁹⁵
- Tasc Compiler \$149⁹⁵
- Cobol - 80 \$595⁹⁵
- Context Connector \$145⁹⁵

MICRO PRO

- Wordstar 3.0 \$269⁹⁵
- Spell Star \$170⁹⁵
- Mail Merge \$95⁹⁵
- Super Sort-1 \$139⁹⁵

MICROLAB

- Data Factory \$120⁹⁵
- Invoice Factory \$159⁹⁵

HOWARD SOFTWARE

- Tax Preparer New 1982 \$120⁹⁵
- Real Estate Analyzer \$129⁹⁵

PERSONAL SOFTWARE

- Visicalc 3.3 \$159⁹⁵
- Visiplot \$159⁹⁵
- Visidex \$159⁹⁵
- Visitrend/Visiplot \$239⁹⁵
- Visiterm \$79⁹⁵
- Visifile \$199⁹⁵
- Desktop Plan II \$199⁹⁵

THE SOURCE

- Telecommunication \$90⁹⁵

AARDVARK

- Personal Tax Plan \$105⁹⁵
- Individual Tax Plan \$200⁹⁵

SYSTEM PLUS

- Accounting Plus II \$CALL

ASHTON TATE

- dBase II \$595⁹⁵

HIGH TECHNOLOGY

- Info. Master \$119⁹⁵
- Store Manager \$199⁹⁵
- Data Master \$79⁹⁵
- Job Control System \$595⁹⁵

SOUTHEASTERN SOFTWARE

- Data Capture 4.0 40 Col. \$49⁹⁵
- Data Capture 4.0 80 Videx \$69⁹⁵

SOFTWARE PUBLISHING

- PFS \$77⁹⁵
- PFS Report \$77⁹⁵

PHOENIX SOFTWARE

- Zoom Graphics \$35⁹⁵

Master Diagnostic

- (Formerly Brain Surgeon) \$42⁹⁵

STONEWARE

- DB Master Vers. 3 \$179⁹⁵
- Utility Pack I \$90⁹⁵
- Z-Term (CP/M) \$80⁹⁵
- ASC II Express 3.3 \$65⁹⁵
- Brodebund Payroll \$300⁹⁵

GAME AND HOBBY

- Temple of Asphal \$32⁹⁵
- Hellfire Warrior \$32⁹⁵
- Rescue at Rigel \$24⁹⁵
- Crush, Crumple & Chomp \$25⁹⁵
- Jabber Talky \$24⁹⁵
- Major League Baseball \$26⁹⁵
- Allen Rain \$21⁹⁵
- Apple Panic \$24⁹⁵
- Snack Attack \$24⁹⁵
- Joy Breaker \$24⁹⁵
- Space Quarks \$24⁹⁵
- Genetic Drift \$24⁹⁵
- Red Alert \$24⁹⁵
- Ultima \$32⁹⁵
- Star Thief \$24⁹⁵
- Bug Attack \$24⁹⁵
- Sargon II \$30⁹⁵
- Pool 1.5 \$30⁹⁵
- Shuffle Board \$24⁹⁵
- Trick Shot \$32⁹⁵
- Dogs Fight \$24⁹⁵
- Olympic Decathlon \$24⁹⁵
- Three Mile Island \$32⁹⁵
- ABM \$21⁹⁵
- Robot War \$32⁹⁵
- Castle Wolfenstein \$24⁹⁵
- Zork \$32⁹⁵
- Falcons \$24⁹⁵
- Bear Run \$30⁹⁵
- Outpost \$24⁹⁵
- Raster Blaster \$24⁹⁵
- Space Eggs \$32⁹⁵
- Gorgon \$32⁹⁵
- Cops and Robbers \$30⁹⁵
- Tigers in the Snow \$32⁹⁵
- The Battle of Shiloh \$48⁹⁵
- The Shattered Alliance \$32⁹⁵
- Computer Baseball \$32⁹⁵
- Quarterback \$32⁹⁵
- Phantoms Five \$24⁹⁵
- Sneakers \$24⁹⁵
- TG Joystick \$48⁹⁵
- TG Game Paddies \$34⁹⁵



HOME MONEY MINDER

- Apple II plus 48K
- Apple Disc Drive II w/Interface DOS 3.3
- 12" High Resolution Resolution Monitor
- Money Minder

\$1899⁰⁰

THE HOME ACCOUNTANT PACKAGE

- Apple II plus 48K
- Apple II Disc Drive w/ DOS 3.3
- 12" High Resolution Green Monitor
- The Home Accountant

\$1945⁰⁰

THE FAMILY SYSTEM

NOW ONLY

\$2099⁰⁰

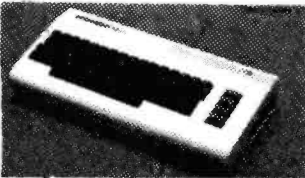

PERSONAL COMPUTER

VIC 20 w/RF Modulator (Expands up to 32K) \$262⁹⁵

VIC Phone Modem

by Bizcom \$152⁹⁵

DATA Tapes Recorder (Cassette Programs) \$69⁹⁵

VIC 1210 3K Memory Expands \$39⁹⁵

VIC 1110 8K Memory Expands \$59⁹⁵

VIC 1906 Super Alien (Cartridge, Plugs Directly Into VIC 20 Computer) \$27⁹⁵

VT 106A Recreational Program A Consists of: A 6 Pack of (Cassettes) (1) Biorhythm (2) Car Chase (3) Black Jack (4) Space Game (5) Math (6) Slither \$58⁹⁵

VT 107 Cassette Six Pack (1) Personal Filing System 1 (2) PFS 2 (3) VIC Typing Tutor (4) Expense Calendar (5) Mortgage & Loan (6) Home Inventory \$58⁹⁵

"Introduction To Basic & Computers" (Book) \$22⁹⁵

2 Atari Joysticks (for Games Requiring Them) \$19⁹⁵

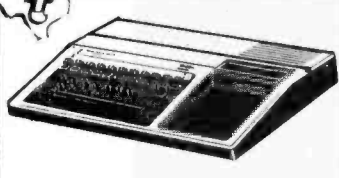

TI 99/4A

Designed to be the first Computer for the skilled user, or the beginner.

Now Only **\$349⁹⁵**

- Disc Dr. Controller \$239.50
- Disc Memory Drive \$399.50
- Solid State Printer \$319.00
- RF Modulator \$39.95
- Solid State Speech Synthesizer \$119.50
- Telephone Coupler (modern) \$174.50
- RS-232 Accessories Interface \$172.50
- Memory Expansion by 32-K \$295.00
- 10" Color Monitor \$324.50

ENTERTAINMENT MODULES

- 3052 Tombstone City \$37.50
- 3053 Invaders \$37.50
- 3054 Car Wars \$37.50

TI LOGO A limitless learning environment for children \$199⁹⁵

We carry the full line of TI and HP Programmable Calculators.



HP-125 PERSONAL OFFICE COMPUTER

The HP 125 is a new kind of personal office computer w/VisiCalc™ software to increase the accuracy & speed, of sales forecasts, budget estimates & financial models. With its powerful Graphics capabilities you can turn hard-to-understand data into easy-to-understand charts, color graphs & even transparencies for presentations. The HP-125 uses simple English-language operating commands.

HP-125 Reg. \$3750 \$2785⁰⁰

HP 85A Reg. \$3250 \$1982⁰⁰

HP 82091 M 5 1/4" Disc Drive \$1995⁰⁰

HP 7225B Graphics Plotter \$1939⁰⁰

HP 2631 B Impact Printer \$2500⁰⁰

HP 82905 B Serial Printer \$749⁰⁰

ATARI 800 w/16K \$719⁰⁰

810 Disc Drive \$459⁰⁰

410 Programmable Recorder \$79⁹⁵

PRINTERS

OKIDATA

82A Graphics, 120 CPS, Bidirectional, Friction & Pin Feed, 80/132 Columns \$519.95

83A Graphics, 120 CPS, Bidirectional, Friction and Tractor, 136 Columns, Takes 15 inch Paper \$795.00

CENTRONICS

739 Graphics, 100 CPS monospaced mode, Right Justification, FT \$599.00

NEC

8023 Pro Writer, 100 CPS, 136 Column, Parallel, Bidirectional, Tractor and Friction, High Resolution Graphics \$519.00

EPSON PRINTERS

MX-80, MX-80FT, MX-100FT .. CALL

MONITORS

SANYO

VM-4509 9" B&W \$169.95

DM-5112CX 12" Green \$269.95

DMC-8013 13" Color \$449.95

NEC

JB1201 12" Green \$179.95

JC1201 12" Color \$349.95

AMDEK

13" Color \$369.95

CORPORATE ACCOUNTS WELCOME

47st. photo

Cameras • Electronics • Audio • Video • Computers • Darkroom • Accessories

OPEN SUNDAY



(212)260-4410

FREE OUT OF STATE

800-221-7774

800-221-5858

800-223-5661

67 West 47th Street, New York, N.Y. 10036
115 West 45th Street, New York, N.Y. 10036
MAIL ORDER ADDRESS: 36 E. 19th St. New York, N.Y. 10003

Items on sale for limited time only, and are subject to limited availability. Not responsible for typographical errors. These ad supersedes all other ads prior to March '82. Prices effective as of January 24, 1982. All orders subject to verification and acceptance. Minimum shipping and handling \$4.95

Listing 4 continued:

```
displayarray(v):
writeln('Displaying array took ', tick(t), ' sec. ');

readarray(v):
writeln('Reading array from disk took ', tick(t), ' sec. ');

disparray(v):
writeln('Displaying array took ', tick(t), ' sec. ');

treegen(root, v):
writeln('Generating binary tree took ', tick(t), ' sec. ');

disptree(root):
writeln('Displaying tree took ', tick(t), ' sec. ');

writetree(root):
writeln('Writing tree to disk took ', tick(t), ' sec. ');
END.
```

Text continued from page 340:

tures Equals Programs by Niklaus Wirth, Prentice-Hall, 1975.) After this, the unsorted array is again read into memory, and the integers are used as keys by which dummy data are stored in a binary tree. The tree elements are then written individually to disk. The array elements are displayed on the monitor along the way to insure that the disk I/O and the sorting are done correctly. Displaying the array also measures how fast the Pascal can output textual information.

The incompatibilities between the Pascal implementations for this program only involved the way the disk data were accessed. Slight changes in the program were made for opening, closing, reading, and writing to the disk files. (Obviously, the changes described for reading the clock also had to be made.)

Again, native-code compilers were faster in the computation-intensive tasks such as sorting and were also noticeably faster in output to the terminal. All Pascals took about the same time to write and read from the disk.

The four Pascals reviewed here defy classification as good or bad; they seem almost to represent different philosophies of language implementation. We cannot recommend one Pascal over another or say that you would find any of them unacceptable for your purposes. We only hope that you now have enough information to decide for yourself. ■

Updates seem to be published faster than magazines are. Some information on new versions of the Pascals tested in this article is given on page 356. . . . G.W.

**A
PROFESSIONAL
MICROCOMPUTER**

\$2990



THE BEST VALUE ON THE MARKET

- 280 4MHZ
- 64K RAM
- DUAL 8" DRIVES
- 1.2 MB STORAGE
- 2 SERIAL I/O
- 2 PARALLEL I/O
- OPERATING SYSTEM AND UTILITIES

MICRO BUSINESS ASSOCIATES, INC.
500 SECOND STREET
SAN FRANCISCO, CA 94107
415-957-1343

Circle 238 on inquiry card.

HY-TYPE I • HY-TYPE II

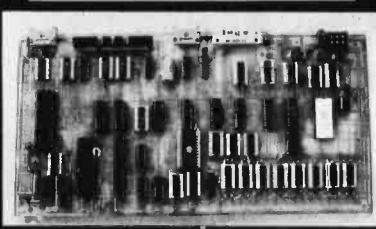

INTELLIGENT PRINTER INTERFACE
16,000 BYTE BUFFER / STAND ALONE
PARALLEL / SERIAL INPUT (BAUD RATES - 50 to 19,200)

OPTIONS INCLUDE: GRAPHICS • REVERSE PRINT • BOLD PRINT
UNDER-SCORE • REPRINT OF BUFFER
ADJUSTMENT OF LINES PER-INCH
CHARACTERS PER-INCH SELECTION
DOUBLE LINE

CUSTOM OPTIONS ALSO AVAILABLE
A & T FROM \$450.00 BARE BOARD \$80.00

MASTER CARD & VISA ACCEPTED

WARN ELECTRONICS, LTD.
PO BOX 526 KNIGHTDALE, NC 27545 (919) 266-9411

Circle 406 on Inquiry card.

IPEX **NEW!**

**"ELF" Interface
Converts Your
Typewriter Into Printer**



- Finest print quality
- Low cost
- Easy Installation
- Quick delivery
- Fits IBM Selectric® and Electronic Typewriters
- Models for all popular computers
- Call or write for more information, today!

- We export to all countries -

IPEX INTERNATIONAL INC.
5115 Douglas Fir Rd.
Calabasas, CA 91302 U.S.A.
Tel: (213) 710-1444 TLX/TWX: 910 494 2100

Circle 197 on Inquiry card.

Qume® Data Trak™ Floppy Disk Drives

Distributed
by: **asap**
computer
products, inc.

The Data Trak™ 5 double-sided double-density drive uses state-of-the-art technology to give you superior data integrity through improved disk life, data reliability, and drive serviceability using 5¼" media.

Qume's independent head load yields wear characteristics far superior to competitive drives. This superior wear performance produces savings on both diskette usage and drive maintenance.

Improved data reliability, resulting from superior amplitude and bit shaft characteristics, optimizes operator efficiency and reduces processing time for end-users.

And Data Trak's unique modular design means simplified field servicing for you and your customers.

Design Features

Expanded storage capacity • Two-sided, double-density

Proven head carriage assembly • Ceramic head with tunnel erase • Dual-head flex mounting arrangement • Superior head load dynamics

Precise lead screw actuator • Fast access time — 12 ms track-to-track • Low friction and minimum wear • Low power dissipation

Additional features • Industry standard 5¼" media format • ISO standard write protect • Door lock out for media protection • Requires DC voltage only • Daisy Chain up to 4 drives • Heads load on command independent of loading media

Product Specifications

Performance Specifications • Capacity: Unformatted: 437.5K or 500K bytes; Qume Formatted: 286.7K or 327.7K bytes • Recording Density: 5456 BPI • Track Den-

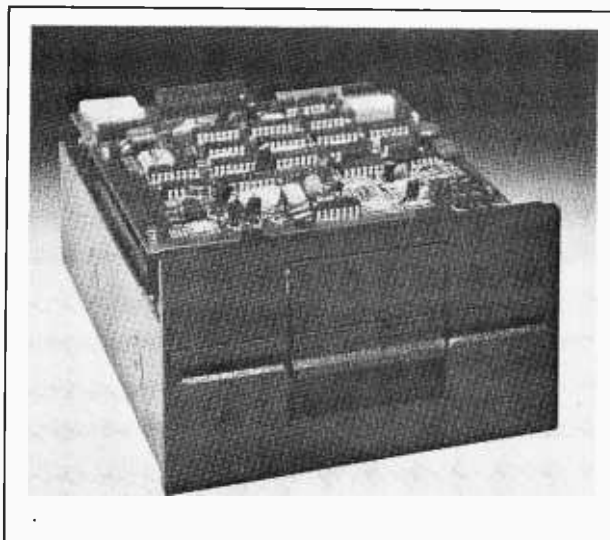

sity: 48 TPI • Cylinders: 35 or 40 • Tracks: 70 or 80 • Recording Method: FM or MFM • Rotational Speed: 300 RPM • Transfer Rate: 250K bits/second • Latency (avg.): 100 ms • Access Time: Track-to-track 12 ms; Settling 15 ms • Head Load Time: 50 ms

The Data Trak™ 8 double-sided double-density drive uses state-of-the-art technology to give you superior data integrity through improved disk life, data reliability, and drive serviceability.

Qume's innovative approach to controlling head load dynamics yields wear characteristics far superior to competitive drives. In independent evaluation, Data Trak 8 is setting industry standards for tap test performance. This superior wear performance produces savings on both diskette usage and drive maintenance.

Improved data reliability, resulting from superior amplitude and bit shift characteristics, optimizes operator efficiency and reduces processing time for end-users.

And Data Trak's unique modular design means simplified field servicing for you and your customers.

Design Features

Expanded storage capacity • Two-sided, double-density

Fully IBM compatible • IBM 3740 and System 32 drives • IBM 3600 and 4964 drives • IBM System 34 drives

Proven head carriage assembly • Ceramic head with tunnel erase • Dual-head flex mounting arrangement • Superior head load dynamics

Fast, precise steel belt drive • Fast access time — 3 ms track-to-track • Low friction and minimum wear • Low power dissipation

Additional features • ISO standard write protect • Programmable door lock • Negative DC voltage not required • Daisy Chain up to 4 drives • Side-by-side mounting in standard 19" RETMA rack • Compatible with Shugart SA850/SA851

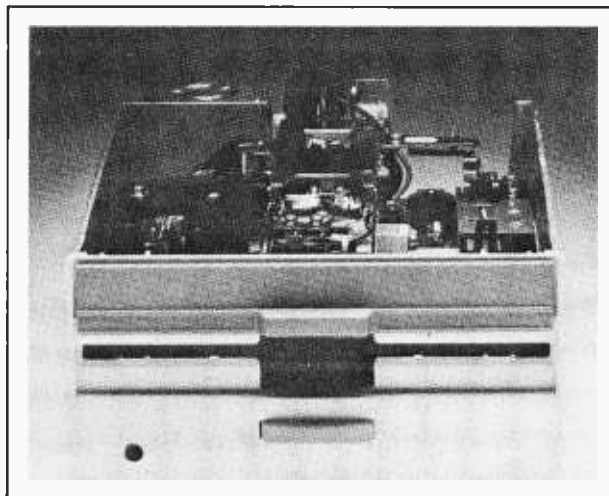

Product Specifications

Performance Specifications • Capacity: Unformatted: 1.6 Mbytes/disk; IBM Format: 1.2 Mbytes/disk • Recording Density: 6816 BPI • Track Density: 48 TPI • Cylinders: 77 • Tracks: 154 • Recording Method: MFM • Rotational Speed: 360 RPM • Transfer Rate: 500Kbits/second • Latency (avg.): 83 ms • Access Time: Track-to-track 3 ms; Settling 15 ms; Average 91 ms • Head Load Time: 35 ms • Disk: Diskette 2D or equivalent

asap
computer
products, inc.

1198 E. Willow, Signal Hill, CA 90806

Call Toll Free (800) 421-7701

AUTHORIZED DISTRIBUTOR FOR QUME
CALL FOR PRICE AND DELIVERY

(213) 595-6431 or (714) 891-2663 In California

Programming Language Terms

Machine language, also called object code, is binary; it consists entirely of zeros and ones. Words made of zeros and ones represent both op codes, which define basic operations in the processor, and addresses of the data on which an operation is to be performed. The accurate reading and writing of machine language is difficult.

Machine-language statements that use the correct op codes for a specific processor are said to be the native code for that processor.

Intermediate between machine language and higher-level languages like Pascal is assembly language. Assembly language substitutes standard mnemonics—more easily remembered names—for machine-language instructions. Statements in assembly language are not directly executable. An assembler is a program that translates assembly-language code into machine code; a macro assembler allows the programmer to use a single name to represent a sequence of assembly-language instructions. Assembly-language mnemonics vary from one processor to the next, and an assembly-language program written for one processor will not run on another.

A compiler is a program that translates the programmer's statement in a source language or higher-level language (such as BASIC or Pascal) into machine language. The resulting machine-language code needs no support software to run (except an operating system). Compilers process an entire program at one time; the resulting machine-language code can be executed only after the whole program is compiled.

Single-pass compilers complete the translation of a program in source language into machine language in a single, continuous operation. Multiple-pass compilers divide the process of translation into different stages. The advantage of multiple-pass compilers is that they usually reduce demands on main memory, though single-pass compilers work faster.

An interpreter is a program that translates each source-language statement into machine language as the statement is read and then immediately executes the machine-language translation of the statement.

Some higher-level language implementations such as CBASIC (from Compiler Systems) and Pascal/M compromise between the compiler approach and the interpreter approach. These implementations compile source code into a nonexecutable intermediate code; a separate interpreter must then be run to execute the intermediate code. The intermediate code produced by a Pascal compiler is called P-code. Unlike assembly language, P-code is the same for different versions of Pascal that use the intermediate-code approach.

A linker is a program that combines into a single module two or more program segments that have been separately compiled.

A program library is a set of programs distributed with a program language to provide code to perform frequently used operations. Programmers save time and labor by incorporating code from the library in programs under development. A linker can incorporate library program segments into a program whose other segments were written by an applications programmer and separately compiled.

AT LAST... A catalog of business software programs that are easy to use, and easy to buy.



SEND FOR YOUR FREE
48-PAGE CATALOG TODAY!

Here's a **FREE** catalog of serious business software for today's most popular microcomputers. You'll find programs for accounts receivable, payroll, payables, managerial forecasting and more. Each program has been thoroughly tested, whether it's a popular best-seller... or an exciting new application. And each program is complete with all the matching business forms and accessories you need!

A wide selection of proven software programs, at direct-by-mail savings... it's like having a convenient personal computer store at your fingertips.

To receive your **FREE** catalog, simply call Toll Free 800-323-0628 (In Illinois, call 312-377-0990) or circle Reader Service Card number below.

Computer Supplies and Accessories by
Mail for More Than 35 Years

VISIBLE COMPUTER SUPPLY CORPORATION

A subsidiary of Wallace Computer Services, Inc. 3626 Stern Drive • St. Charles, Illinois 60174

Ten reasons why your floppy disk should be a BASF FlexyDisk®



More than four decades of experience in magnetic media – BASF invented magnetic recording tape, the forerunner of today's wide range of magnetic media, back in 1934, and was the first independent manufacturer of IBM-compatible floppy disks.

Tough Tyvek sleeve – no paper dust, no static electricity.

Special self-cleaning jacket and liner help eliminate data errors and media wear and tear.

Packaging to suit your requirements – standard flip-top box, Cassette 10® storage case, or bulk pack.

Center hole diameter punched to more accurate standards than industry specifications, for top performance.

100% certification – every single disk is tested at thresholds 2-3 times higher than system requirements, to be 100% error-free.

Bi-axially oriented polyester substrate – for uniform and reliable performance year after year.

For the name of your nearest supplier, write BASF Systems, Crosby Drive, Bedford, MA 01730, or call 617-271-4030.

Cross-linked oxide coating – for low head wear and long trouble-free media life.

Total capability – one of two manufacturers in the world that makes both 8" and 5.25" models, has tape and disk experience, and manufactures floppy disk drives.

Double lubrication – lubricants both in the formula and on the disk surface, to minimize media wear due to head friction.



BASF

Floppy Disks Mag Cards Cassettes Computer Tapes Disk Packs Computer Peripherals

Circle 44 on Inquiry card.

www.americanradiohistory.com

Pascal Updates

Each Pascal has been revised and improved in the past few months. All of the vendors claim bug fixes, increased speed for low-level support routines, and better user interfaces. We were unable to test the new versions. Version numbers and prices were current as of October 1981.

Pascal/Z Version 4.0

An interactive debugger and the ability to segment programs are the major additions to Pascal/Z. The debugger is fully symbolic. Among other things, you can symbolically display and modify local and global variables (including record fields), trace program flow, and display run-time memory requirements.

Overlays, or segments, are compiled separately like modules. They are then processed by a system program that prepares the memory maps and relocation information needed by a host that uses the overlay. Finally, they are linked to the host.

Version 4.0 costs \$395. The cost of updating from Version 3.3 is \$50; new manuals are included in the update.

Pascal/M Version 4.02

Major enhancements to Pascal/M are an interactive symbolic debugger, the ability to perform 14-digit BCD arithmetic, and an increase from 10 to 40 in the number of program segments permitted.

Pascal/MT+ Version 5.5

Several changes have been made to Pascal/MT+ to increase its power and compatibility with other CP/M software. The compiler has been reduced in size by 7K bytes, substantially adding to the amount of symbol table space for compiling user programs. Users can compile larger programs than were heretofore possible.

A converter program has been added to the collection of utility programs. The new program converts code files produced by the compiler to a format acceptable to Microsoft linkers. Overlays are now allowed. A program is permitted 16 overlay "areas" with up to 16 overlays per area. The programmer is burdened with supplying code address information to the linker before the overlays can be used by a host program.

The new version can be purchased with a speed programming kit that consists of a menu-driven program whose op-

tions include a screen-oriented character editor, a Pascal syntax scanner for preprocessing program texts, and an identifier frequency counter. The latter can be used, for example, to spot identifiers referenced only once in a program, such as uncalled procedures or unreferenced variables.

The manuals have been rewritten with improved indexes. Version 5.5, including the speed programming kit, is \$475.

UCSD Pascal Version 4.0

(Note: Version 3.0 is specially designed for Western Digital's Microengine.)

Major enhancements to UCSD Pascal include an increase in the number of segments and units allowed to 255 and easier compilation and cross-referencing of units, facilitating the development of very large application programs. Programmers can also control the residency of segments and units in memory through calls to intrinsic procedures. Overlay segments can be protected from being overwritten by other segments until the programmer permits, and potentially time-consuming, annoying disk I/O (due to repeated calls to a segment) can be defeated. Chaining is also permitted in Version 4.0.

Procedures for memory management have also been augmented. One of these permits a form of dynamic arrays and should considerably increase the ease of development for libraries of procedures operating on arrays.

Concurrent processes have been implemented in Version 4.0. Concurrent processes, or tasks, are controlled by "semaphores" (a term coined by E. W. Dijkstra), which synchronize tasks and control access to critical code sections and resources. Semaphores can be associated with hardware interrupts so that interrupt handlers can now be written in UCSD Pascal.

Intrinsic procedures for redirecting program and system I/O have been included. Redirection of system I/O means that the system can be driven from a script in a manner similar to CP/M's SUBMIT facility. Redirection of program I/O enables the programmer to collect the input to (or output from) a program from any peripheral device or disk file.

Additions to the system's utilities include an interactive debugger, a procedural cross-referencer, and a console screen control unit. The documentation has also been completely rewritten.

Version 4.0 costs \$500. Preconfigured versions are available for a variety of machines.

Industrial marketing problems?

Regardless of what marketplace you are staking out, its position or size, we can help you draw a precise circle around it.

Why? Because as the leading business/technical/professional publishing company, we probably already know your market and can apply our expertise to your research needs.

Give us a call. Phone Ann Graham-Hannon at 212-997-6401 or write her as Director, Marketing Research, McGraw-Hill Research, 1221 Avenue of the Americas, New York, NY 10020.

Call McGraw-Hill Research



If it's a marketing research problem,
we probably pioneered the solution.

Now... Multi-User, Multi-Tasking Distributed Processing Systems ...at Personal Computer Prices



Now you can utilize the storage capacity, access speed and reliability of Winchester disk technology . . . and the economy and portability of floppy disk systems with the Columbia Data Products' single and multi-user, multi-tasking 1500/1800 microcomputer series.

The 1500/1800 product line provides a complete selection of 5 1/4 and 8 inch floppy and Winchester disks, Z-80A microprocessor architecture, up to 256K RAM and DMA disk controllers. Two parallel ports allow for interface of high-speed peripherals such as printers and expansion storage, and six RS-232 ports give you up to five user stations in a true CP/M® and MP/M® operating system environment. The sixth RS-232 port is available for modems, serial printers or an additional CRT station.

With our new microcomputer series, you can configure your system solution by selecting the terminals and printers best suited for your application based on cost, appearance, performance and such features as intelligence, video attributes, graphics (both black and white and color), and ergonomic factors . . . you need not compromise any longer.

Cost effectiveness, versatility, performance superiority, hardware expandability, and application flexibility are now yours from Columbia Data Products.

And prices start under \$900* list per user . . .

CALL US FOR DEALER PROGRAM INFORMATION

* Price excludes display terminals and printers.

* Trademark of Digital Research

COLUMBIA

DATA PRODUCTS, INC.

Home Office:
Columbia Data Products
8990 Route 108
Columbia, MD 21045
Telephone: 301-992-3400
TWX: 710-862-1891

West Coast:
Columbia Data Products
3901 MacArthur Blvd.
Suite 211
Newport Beach, CA 92660
Telephone: 714-752-5245
Telex: 692 310

Europe:
Columbia Data Products
P.O. Box 1118
4050 Moenchengladbach 1
West Germany
Telephone: 021-61-33159
Telex: 852 452

Circle 80 on Inquiry card.

Microsoft's BASIC Compiler for the TRS-80

Mahlon G. Kelly
268 Turkey Ridge Rd.
Charlottesville, VA 22901

At a Glance

Name

BASIC Compiler

Type

A BASIC compiler package, including a compiler, linker, routine library file, and run-time package

Manufacturer

Microsoft Consumer Products
400 108th Ave., Suite 200
Bellevue, WA 98004

Price

Model I, \$195

Format

Model I, 5-inch floppy disk; (also available for the TRS-80 Model II)

Language

Z80 machine language

Computer needed

TRS-80 Model I, minimum of 48 K bytes of memory and one disk drive

Documentation

More than 200 pages in a three-ring binder

Audience

TRS-80 BASIC programmers who want to increase the speed of their programs

Do you have friends who tell you that BASIC is a toy language or that it's only for beginners and those too lazy to learn more "sophisticated" languages? Such snobs seem to fall into one of three categories: the machine- or assembly-language fan who wants to commune directly with the hardware and keep track of where every bit goes; the structured-program maven who feels that the machine must force a person to write well-organized programs; and the traditionalist who still thinks that the only "real" higher-level languages are FORTRAN, COBOL, and ALGOL.

Machine and assembly languages are essential when you need fast execution that can't be accomplished with a higher-level language. Structured languages like Ada and Pascal make it much easier to monitor long, convoluted programs.

But we should listen carefully to the traditionalists; they probably learned to program on an IBM 650 in 1956 and have sage minds. Most of them will tell you that FORTRAN, COBOL, and the like are superior because they are compiled languages that use a computer much more efficiently. They forget that BASIC—originally written at Dartmouth College as a simple beginner's language for easy interaction with the computer—is now at least as sophisticated and as easily compiled as older languages.

IBM'S DOS or CP/M-86?TM

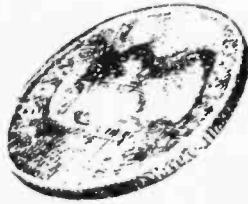

Confused about operating system options for your IBM Personal Computer? **HAVE IT BOTH WAYS WITH LIFEBOAT'S CP/EMULATORTM.** CP/EMULATOR solves the problem by permitting you to use all the software written for IBM's PC for both DOS and CP/M-86.

This high performance, low cost DOS utility allows you to fully integrate and mix programs. You can use a DOS editor to write a program, compile it under a CP/M-86 compiler and execute the finished application under DOS.

CP/EMULATOR extends the scope and capacity of all of your software. With CP/EMULATOR, CP/M-86 programs run quicker with faster file access than with CP/M-86 itself.

Additionally, your program will enjoy all the other DOS advantages, such as large file size, dated directory displays, and more. The DOS peripherals are already installed and DOS commands are fully available. The package even contains a utility program to transfer programs and data files from a CP/M-86 diskette to a standard DOS diskette.

NO NEED TO LEARN A NEW SET OF UTILITIES AND COMMANDS;

NO NEED TO END UP WITH TWO INCOMPATIBLE SETS OF DISKETTES;

NO NEED TO SPEND HUNDREDS OF DOLLARS ON CP/M-86, WHEN CP/EMULATOR COSTS \$75.

NO NEED TO WONDER WHICH OPTION IS BEST FOR YOUR IBM PERSONAL COMPUTER.

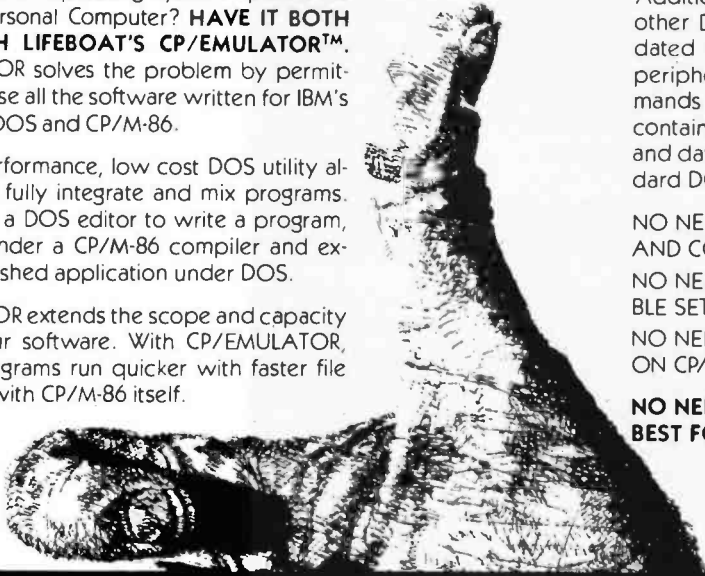

PMATE: Editor-in-ChiefTM

Perform miracles of manipulation on your keyboard with Lifeboat's PMATE.

This new generation text editor is the most sophisticated text editor available today and is bristling with features previously unavailable on microcomputers, making it ideal for virtually any program or data file editing.

PMATE's command set includes full screen single keystroke editing, horizontal scrolling, automatic disk buffering, macro command language, text formatting, expression evaluation, conditional branching, I/O with prompting, and other programming language constructs. PMATE makes use of 11 buffers for storage, and includes commands permitting work on more than one text at a time. Unique to PMATE is the facility for user customization. Keystroke functions can be redefined, and sequences can be programmed to directly execute macros. Video commands can be changed, and macro functions can be written, to emulate any other editor with which you may be familiar. PMATE provides full side-scrolling, and can be used with virtually ANY video terminal on the market. IF you use an editor, you need PMATE.

PMATE is the **only** text editor you'll ever need.

PMATE-86 is available for IBM's Personal Computer DOS, SB-86TM and MS-DOSTM. Also available is PMATE for SB-80 and other CP/M-80-compatible operating systems.

Lifeboat Worldwide offers you the world's largest library of software from its offices in the U.S.A., U.K., Switzerland, France, West Germany and Japan.

For more information, send to:

Lifeboat Associates

1651 Third Avenue
New York, New York 10028
Tel: (212) 860-0300
TWX: 710-581-2524 (LBSOFT NYK)
Telex: 640693 (LBSOFT NYK)

2021

SB-80 and SB-86 are trademarks of Lifeboat Associates
PMATE and PMATE-86 are trademarks of Phoenix Software Asso. Ltd.
MS-DOS is a trademark of Microsoft, Inc.
CP/EMULATOR is a trademark of Lifeboat Associates.
CP/M-80 and CP/M-86 are registered trademarks of Digital Research, Inc.
This ad was designed by DocuSetTM
Copyright © 1981, by Lifeboat Associates



LIFEBOAT HAS THE ANSWER



MODEMS

All Modems connect to any
RS232 Computer or Terminal!

1200 Baud and 300 Baud-Bell 212A
Style. Penril 300/1200\$799
Originate/answer/auto-answer. Full duplex.
RS232. Phone line connection via standard
phone jack. 1 yr. warranty.
Auto-dial option\$350



300 Baud Phone Link\$129
Originate/answer. Sleek, low profile. 15 ozs.
Half/full duplex. Self test. RS232. Light displays
for On Carrier, Test, Send & Receive Data. 1 yr.
warranty.

300 Baud. USR-330D\$249
Originate/answer/auto-answer. Phone line connection
via standard jack. 1 yr. warranty.

300 Baud. USR-330A\$299
Same as USR-330D PLUS Auto-Dial. Call for
quote and technical information on higher speed
modems and multiplexors.

1200 and 300 Baud. AJ1235
Acoustic Coupler\$799
Vadic Compatible. Originate only.

1200 Baud. AJ1234
Acoustic Coupler\$639
Vadic Compatible Originate only.

1200 and 300 Baud. AJ1256\$719
Direct connect to phone lines. Vadic compatible.
Originate/Auto-answer.

1200 and 300 Baud. AJ1259.
Triple Modem\$819
Vadic and Bell 212A compatible. Originate/
Auto-answer. Direct connect to phone lines.



Printing Terminals

The new generation
from General Electric.



Printing Terminals



30/60 CPS. GE Terminet 2030\$999
110/300/60/1200 Baud. User selectable lines per
inch and chars. per inch. True descenders and
underlining. Up to 217 cols per line. Top of form.
vert. and hor. tabs. Friction feed std., tractor
feed opt. Answerback. 1 yr. warranty on parts.
Nationwide servicing. Extremely compact. 15 in.
paper. Only 22 lbs. SUPERIOR TO DEC LA34AA
at lower cost.

120/150 CPS.
GE Terminet 2120\$1,799
Housed in same compact package as the 2030
with all the features of the 2030 PLUS 150 char.
per. sec. print rate.

**Slash Your Connect Time and Printer
Delay Time**

Text Editor For GE2030 & 2120\$799
Includes 32K buffer inside terminal for data
receipt and transmission at up to 9600 baud.
Also Available: Receive only/Printer only ver-
sions of GE2030 & 2120.

CRTs

ADDS Viewpoint\$549
Detachable keyboard. Numeric keypad. Tiltable
screen. Cursor control keys. Function keys.
Auto-repeat on all keys. 110 to 19,200 baud.
Transparent mode. Printer Port. Compact. 20
lbs. Visual attributes.

TAB 132/15\$1,999
15 inch screen. 132 cols x 24 lines. 4 pages
memory. Green Phosphor. Soft programmable
function keys. Full editing. Detachable keyboard.
VT52, VT100, VT132 compatible. Superior
Screen quality. Smooth Scrolling. Horizontal and
Vertical Scrolling.

We also stock: **NEC** **DEC**
OKidata **Televideo**
Teletype **Altos Computers**
Dynabyte Computers

Call for pricing and technical information.

Visit our showroom for product
demonstrations.

M-F 8:30-5:00. Sat. —Call for appointment.



VISA/MasterCard Accepted. Corporation and In-
stitution purchase orders accepted. Leasing rates
available on request. Your satisfaction Guaranteed.
All equipment may be returned for full credit. We
offer full service, on-site maintenance plans on all
equipment. All equipment in stock.

U.S. ROBOTICS INC.



803 N. WABASH SALES (312) 346-5650
SUITE 1718 GENERAL OFFICES (312) 346-8651
CHICAGO, ILL 60601 SERVICE (312) 733-0497

Listing 1: A small BASIC program used to demonstrate the
compiler.

```
10 DEFSNG A-Z
20 FOR I=1 TO 2000
30 A=I+2
40 NEXT I
50 PRINT CHR$(7)
```

What It Does

A compiler is a machine-language program that trans-
lates a higher-level language, such as FORTRAN or
BASIC, into machine code. This compiled program can
be stored on disk and run as if originally written in
machine language. On the other hand, an interpreter,
used in many microcomputers with BASIC, "translates"
each line of a program while the program is running. If a
line is executed many times, it must be "translated" many
times.

A compiled program is therefore much faster than an
interpreted one and uses the computer more efficiently
despite the lengthy compilation time (which need only be
done once). Compilation also allows more flexibility and
offers options unavailable with interpretation. Converse-
ly, an interpreted program can be run immediately,
without waiting for compilation, and thus is much easier
to debug, edit, and modify. Although this may be a poor
practice, it is a good way to learn programming and is
usually necessary to refine a moderately long program.

Microsoft's BASIC compiler gives you the best of both
worlds. It is now possible to debug and modify a pro-
gram using the TRS-80's built-in interpreter. Then, when
it's doing just what you want, it compiles the program to
get rapid execution.

I've often wished I could do that with FORTRAN on
our university's Cyber 172; in fact, I have been known to
write and rewrite a program in interpreted BASIC until it
did what I wanted, then translate it "by hand" into
FORTRAN for fast execution.

We can evaluate the Microsoft compiler in five ways:
ease of use (and quality of documentation); compatibility
with TRS-80 disk BASIC; speed; added features com-
pared to interpreted BASIC; and any special quirks,
bugs, or problems that may get in the way.

This compiler has many versions; the one I review here
is the latest available for the TRS-80. It is much improved
over that machine's first version, and anyone with the
earlier version can obtain an update from Microsoft for a
nominal charge.

Procedures for Use

The compiler is very easy to use, although that's not
conveyed in Microsoft's documentation. The compiler is
really a package of four software modules: the actual
compiler (BASCOM/CMD); a library file (BASLIB/REL); a linker (L80/CMD) that links machine
code from the library file to the program as compiled by
BASCOM; and a "run-time package" (BRUN/CMD)

YOU CAN'T BUY A FASTER S100 BUS SYSTEM

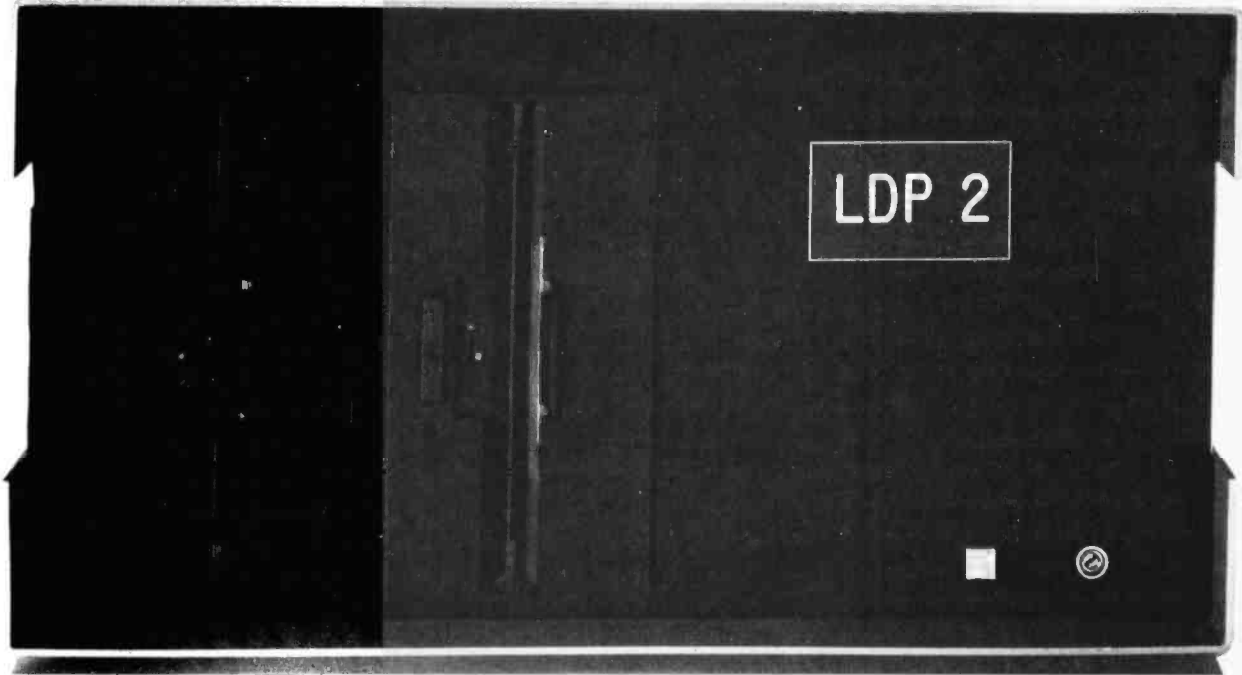

Presenting the LDP 1/2 S100 Bus System:

Standard features:

- Lightning One CPU
- 2 Serial Ports
- 2 Parallel Ports
- 128K RAM
- 600K bytes floppy storage
- MS-DOS** or CP/M-86* operating system

Options available:

- 10 MHz 8086
- 8087 - 8089 co-processor (onboard, not tacked on)
- 128K static RAM
- Multi-user option including MP/M-86*
- 1.2M bytes disk storage
- 2.4M bytes disk storage
- 11.2M bytes disk storage

The LDP 1/2 system incorporates the fastest S100 bus CPU, the *Lightning One™*. The *Lightning One*, when coupled with our other fine board products offers a level of performance comparable to many large 16-bit minicomputers. Our multi-user system *doesn't lose steam* as with other 8-bit systems.

In addition to *Lightning* performance, Lomas Data Products has the widest selection of operating systems software. We offer both MS-DOS** and CP/M-86* for single user systems and MP/M-86 for multiuser systems. A wide variety of high-level languages are available including: BASIC (interpreter and compiler), FORTRAN, PASCAL, COBOL, C, and FORTH. Call or write for our benchmark comparisons with other systems.

We have saved the best for last: Our standard system, the LDP 1 with 600K bytes of disk storage is available for just \$4150.

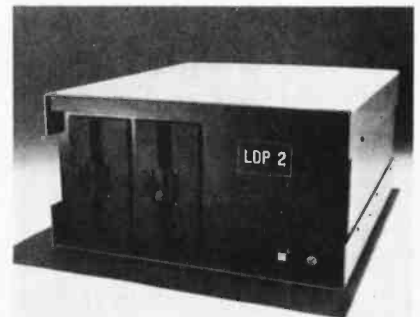

Dealer and OEM inquiries invited.

**For 16 bit computing
on the S100 bus,
come to the leader...**

LOMAS DATA PRODUCTS, INC.

729 Farm Road
Marlboro, Massachusetts 01752
Telephone: 617-481-2822

Lightning One trademark of Lomas Data Products, Inc.
*CP/M-86 and MP/M-86 trademark of Digital Research.
**MS-DOS trademark of Microsoft Inc.

The Landlord™ Apartment Management Software

Keeping track of apartment availabilities, rent payments, security deposits, leases and other administrative functions consumes a great deal of time and attention for apartment owners and managers. You and your staff probably spend countless hours dealing with the paperwork necessary to manage your property.

With the Landlord™ apartment management software and an Apple II* computer, file cabinets full of paperwork and the frustrations of cumbersome bookkeeping procedures can be eliminated. The clerical work for your apartments can be accomplished with greater accuracy in a fraction of the time you presently spend. The Landlord™ will keep up-to-date files on apartments and residents as well as detailed records of property income and expenses.

You'll be able to enter, change, or delete information by following the simple English instructions that appear on the screen of the Apple II*. With the Landlord™, your resident manager can instantly determine where apartment vacancies exist and when additional units will become available for rental. The Landlord™ also keeps track of resident payments, letting you see at a glance who is behind on rent or other payments. Property and tax analysis reports are printed automatically each month and allow you to monitor the profitability of your apartments.



MIN MICROCOMPUTER SOFTWARE, INC
5835-A Peachtree Corners East
Norcross, Ga. 30092 (404) 447-4322

The Landlord
is a trademark of MIN Microcomputer Software, Inc.
*Apple II is a registered trademark of Apple Computer, Inc.

Listing 2: *The compiled version of the program shown in listing 1.*

BASCOM 5.23 - COPYRIGHT 1979, 80 (C) BY MICROSOFT - 08542 BYTES FREE

```

0014 0007      10 DEFSNG A-Z
      **      0014'      CALL $4.0
      **      0017'L00010:

0017 0007      20 FOR I=1 TO 2000
      **      0017'L00020:  CALL $FASA
      **      001A'      DW  I1
      **      001C'      DW  ,CONST.
      **      001E'I00000:

001E 000B      30 A=I+2
      **      001E'L00030:  CALL $FADA
      **      0021'      DW  I1
      **      0023'      DW  ,CONST.
      **      0025'      CALL $FASO
      **      002B'      DW  A1

002A 000F      40 NEXT I
      **      002A'L00040:  CALL $FADA
      **      002D'      DW  I1
      **      002F'      DW  ,CONST.
      **      0031'      CALL $FASO
      **      0034'      DW  I1
      **      0036'      CALL $LEJA
      **      0039'      DW  I1
      **      003B'      DW  ,CONST.
      **      003D'      DW  I00000

003F 000F      50 PRINT CHR$(7)
      **      003F'L00050:  CALL $PROA
      **      0042'      LD  HL,0007
      **      0045'      CALL $CHR
      **      0048'      CALL $PV2D

004B 000F      **      004B'      CALL $END

005C 0019

```

00000 FATAL ERROR(S)

08219 BYTES FREE

Listing 3: *The same compiled version of the program, except with two errors inserted to show the response of the compiler.*

BASCOM 5.23 - COPYRIGHT 1979, 80 (C) BY MICROSOFT - 13512 BYTES FREE

```

0014 0007      10 DEFSNG A-Z
      **      0014'      CALL $4.0
      **      0017'L00010:

0017 0007      20 FOR I=1 TO 2000
      **      0017'L00020:  CALL $FASA
      **      001A'      DW  I1
      **      001C'      DW  ,CONST.
      **      001E'I00000:

001E 000B      30 A=I+2
      **      001E'L00030:  CALL $FADA
      **      0021'      DW  I1
      **      0023'      DW  ,CONST.
      **      0025'      CALL $FASO
      **      002B'      DW  A1

002A 000F      40 NXT I
      **      002A'L00040:
error pointer, syntax error SN

```

Listing 3 continued on page 364

NEW PRINTERS. NEW PERIPHERALS. SAME OLD RELIABLE QUALITY AND VALUE.

1982 will find more OEM's, businesses, dealers and personal computer users turning to MICROTEK than ever before.

TekWriter-1

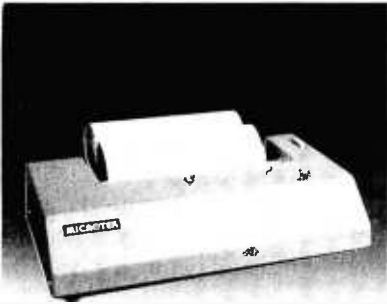

80 Column Dot Matrix Printer (Formerly BYTEWRITER-1)

The Tekwriter-1 printer is, dollar for dollar, the finest value in the industry. And we've proved it by comparing the Tekwriter-1 to the Epson MX-80. Our print speed is 14 lines per minute faster, our life expectancy is longer, the character sets are the same, and the interface, warranty and printhead replacement cost are all identical.* But the biggest difference is the price. The Tekwriter-1 is about \$300 less.

Our extensive testing has proved that the Tekwriter-1 interfaces problem-free to most parallel Centronics and serial (RS-232) computers.

The Tekwriter-1 is tough to beat for performance and quality.

*Data Source: Epson MX-80 Operation Manual

Parallel \$349
Serial \$389

TekWriter-2

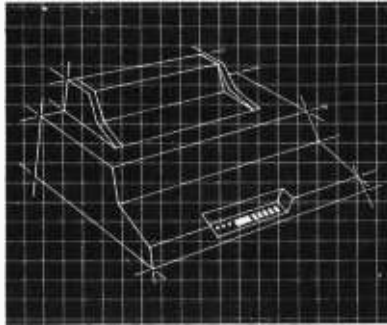

NEW! 80/132 Column Dot Matrix Printer

The Tekwriter-2 is perfectly suited to personal, business or OEM applications. Tekwriter-2 is designed to accept single sheet, roll or pin feed paper. It has a 9-wire dot matrix impact print head which produces crisp characters and has underlining capability. The printer is manufactured to run extremely quietly even while operating at peak output levels.

Tekwriter-2 is especially well suited to handle word processing applications because of its data buffer expansion capabilities to 25K. This ability makes it an efficient graphics generator.

Parallel interface (Centronics type). Interfaces all models of TRS-80, Apple, and Atari 400/800, and most computers with Centronics printer interface.

\$695

Peripherals

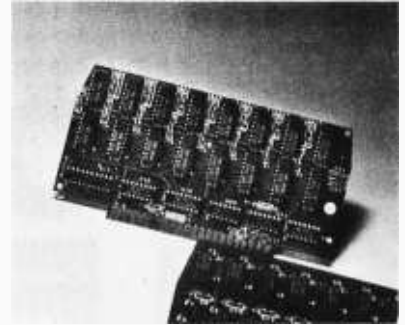

Parallel/Serial Data Buffer Converter

Interfaces with most computers and printers on the market today. Switch selectable parallel or serial input/parallel or serial output. Ideal for word processing and data communications. Data buffer 2K standard — expandable to 62K. Serial I/O BAUD rates switch independently selectable.

16K Apple Memory Board

Apple Parallel Interface Card

16K-32K Atari Memory Boards

Atari Parallel or Serial Printer Cables

8K-16K VIC-20 Memory Boards

64K to 256K IBM Memory Board

Quantity and OEM discounts available.

Continuing our quest for excellence.

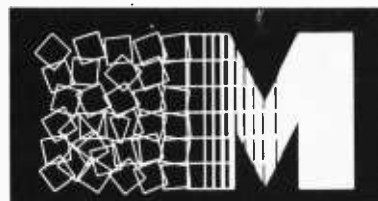

MICROTEK inc.

MICROTEK

9514 Chesapeake Drive
San Diego, CA 92123
(714) 278-0633
Outside CA call
Toll Free (800) 854-1081
TWX. 910-335-1269

TRS-80 is a trademark of Radio Shack, Inc.
Apple II is a trademark of Apple Computer, Inc.
Atari 400/800 are trademarks of Atari, Inc.
Microsoft is a trademark of Microsoft Consumer Products, Inc.
Z-80 is a trademark of Zilog, Inc.
Visicalc is a trademark of Personal Software, Inc.

LEARN TO SELECT μPs

Take advantage of our experience with microprocessor design. Enroll in our one-day seminar and learn how to choose the right 8- and 16-bit microprocessors for your particular application. A \$25 fee provides you with lunch and the seminar materials. To enroll for the seminar in a city near you, call Tektronix collect at (503) 642-8951.

City	Date	City	Date
Irvine, CA	February 23	Denver, CO	March 5
Woodland Hills, CA	February 24	Atlanta, GA	March 8
Boston, MA	February 25	Raleigh, NC	March 9
Washington, D C	February 25	Orlando, FL	March 11
Dallas, TX	February 25	Ft. Lauderdale, FL	March 12
Bellevue, WA	February 25	Rochester, NY	March 12
Philadelphia, PA	February 26	San Diego, CA	March 16
Houston, TX	February 26	Albuquerque, NM	March 17
Santa Clara, CA	February 26	Detroit, MI	March 22
St. Louis, MO	March 1	Cleveland, OH	March 23
Saddlebrook, NJ	March 1	Phoenix, AZ	March 23
Woodbury, NY	March 2	Pittsburgh, PA	April 5
Kansas City, MO	March 2	Columbus, OH	April 6
Salt Lake City, UT	March 3	Charlotte, NC	April 6
Chicago, IL	March 4	Cincinnati, OH	April 7
Albany, NY	March 4	Indianapolis, IN	April 8
St. Paul, MN	March 5	Baltimore, MD	April 14

Tektronix
COMMITTED TO EXCELLENCE

© 1981 Tektronix. All Rights Reserved 124

Listing 3 continued:

```
002A 000F      50 PRINT CHR$(7)
      **      002A'L00050:  CALL $PROA
      **      002D'      LD    HL,0007
      **      0030'      CALL $CHR
      **      0033'      CALL $PV2D

0036 000F
      **      0036'      CALL $END
                        error pointer, FOR-NEXT error FN

0041 000F

00002 FATAL ERROR(S)

13286 BYTES FREE
```

with additional machine code accessed by the linked program while it is running.

Compilation is best understood by following a program through the whole process. Programs are compiled in many ways, but the following procedure is used in almost all cases. (Other options, invaluable when needed, are rarely used.) First, write and debug a BASIC program (see listing 1). The program is then saved as an ASCII file, using the command:

```
SAVE "TEST1/BAS",A
```

(My most common error is forgetting to save it as an ASCII file; also, the BAS extension is needed for recognition by the compiler.) After returning to the DOS with CMD"S", the program is compiled by typing the command:

```
BASCOM TEST2,TEST3=TEST1
```

This will produce a listing file (called TEST3/LST) of the compiled code in assembly language (see listing 2) and a partially complete and relocatable machine-language program (called TEST2/REL) that must be linked to other machine code using L80. TEST1/BAS was the BASIC source program.

Error diagnosis is excellent—any errors in the BASIC source code will be listed to the screen and shown in the listing file (see listing 3). The command:

```
L80 TEST2,TEST4-N-E
```

will link machine code from BASLIB/REL and produce the file TEST4/CHN (for chain) from TEST2/REL. The "-N" and "-E" are "switches" that in turn tell L80 to write the /CHN file to disk and exit to DOS. A variety of other switches are available for L80 and BASCOM. Again, errors will be listed to the screen. TEST4/CHN can then be run as a machine-language program with the command:

```
BRUN TEST4
```

Obviously BRUN/CMD must be available any time the program is run, but the other programs are unnecessary. Other names could have been used for any file, and disk drive numbers could have been specified. Usually, all of the names are the same (e.g., TEST/XXX). In that case, we create files called TEST/BAS, TEST/LST,

VICTOR... Number 1 in Impact Matrix Printing!

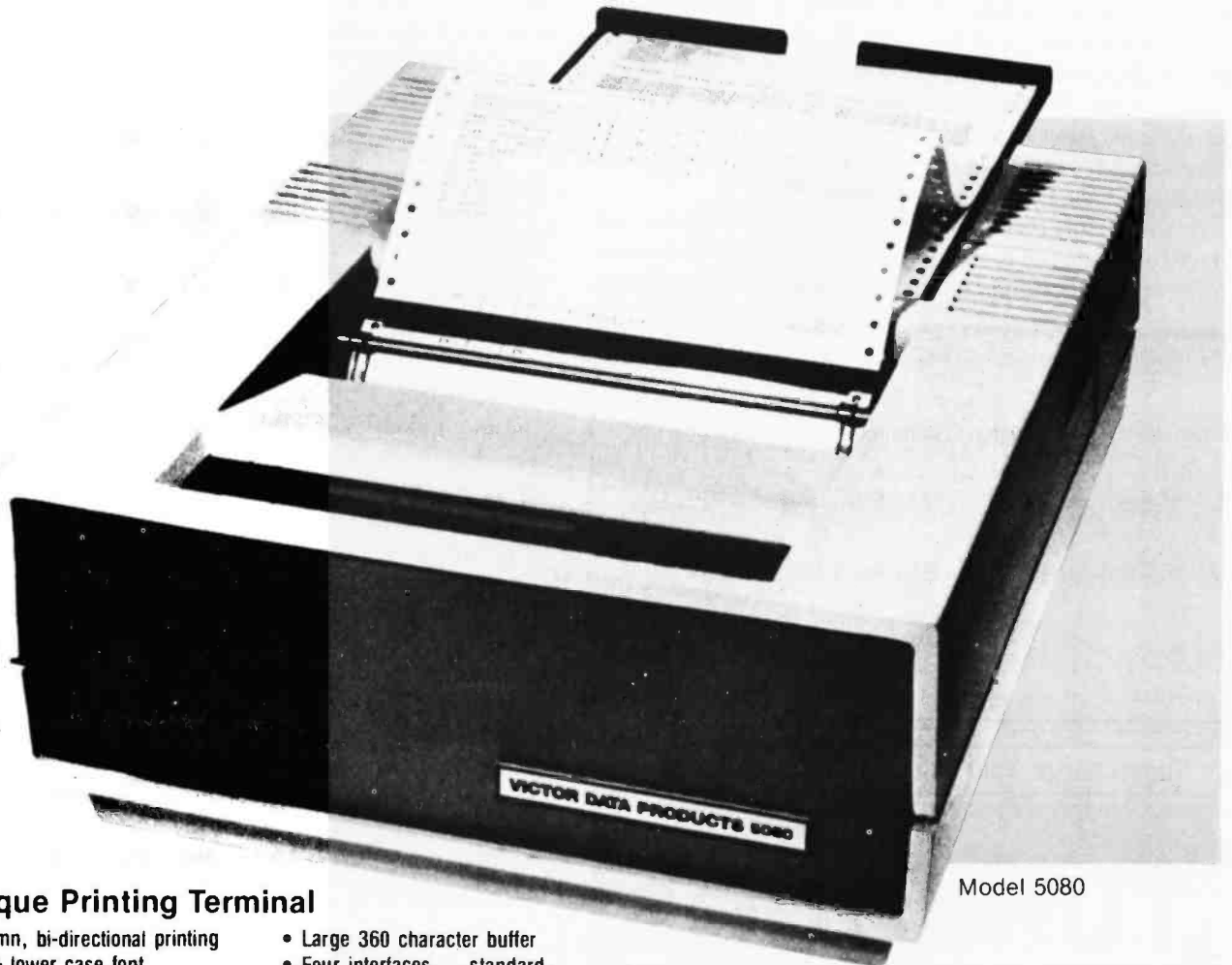

Model 5080

A Unique Printing Terminal

- 80 column, bi-directional printing
- Upper & lower case font
- Full graphics — 480 columns per line
- Top of form & horizontal tabs
- True 60 lpm throughput
- Bi-directional friction and sprocket paper feed
- Large 360 character buffer
- Four interfaces — standard parallel & RS232 & TTY & IEEE-488
- Baud rate switch selectable
- Self-test
- UL/CSA approved
- Intelligent shortest path head return

The Model 5080, shown above, is a heavy-duty printing terminal offered for sale at most competitive prices. Only \$995 in single quantity! This printer has been designed to conform to the most stringent computer specifications, including software on/off control, status feedback signals and a busy signal should you fill our extra large buffer. Don't delay, order now to insure early delivery!

Victor has delivered more than 700,000 industrial, quality matrix printers. These are terminals, mechanisms, and heads designed to solve your problems. Products that are backed by a strong application engineering staff, worldwide service and 50 years of Victor pride in product.

VICTOR DATA PRODUCTS

Subsidiary of Walter Kidde & Company, Inc.

KIDDE

3900 North Rockwell Street, Chicago, Illinois 60618 Telephone: 312-539-8200

GREAT BRITAIN — DATAPLUS, 0242-30030 ITALY — C.A.I., 23.63.851
 SPAIN — CETA, 254 6607 SWITZERLAND — ERNI, 01 833 33 33 CANADA — MUNRO, (416)676-1042
 FRANCE — METROLOGIE, (1) 791 44 44 SOUTH AFRICA — EAGLE, 45-1421
 SINGAPORE — OG, 917788 or 918592 HONG KONG — GILMAN, 3-427144

Circle 432 on inquiry card.

A Complete Line of Impact Matrix Printers

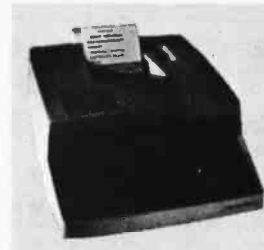

Model 5010

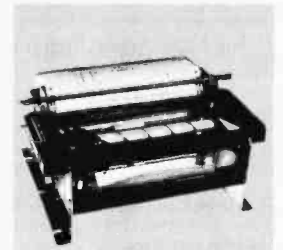

Model 80



Model 130



Model 129

TEST/REL, and TEST/CHN. If the compiled program runs correctly, the /LST and /REL files can be deleted.

Although the procedure I describe is used with three disk drives, the sequence is very similar using one or two drives, though disk swapping is necessary. Actually, the process is so cumbersome with one drive that Microsoft doesn't recommend it. (Microsoft also points out that, for almost all purposes, 48 K bytes of memory are needed.) Three double-density drives are ideal. I can use drive 0 for the operating system, drive 1 for the compiler software and Microsoft's FORTRAN and macro assembler, and drive 2 for the various programs.

At this point, the compiler may seem awkward. With practice, it's simple to use and any program needs compilation only once if interactively debugged. Also, the com-

	TIMES (seconds)			
	Integer		Single Precision	
	Interpreted	Compiled	Interpreted	Compiled
PRINT(I)	45	18	55	39
A = PEEK(I)	39	2	44	14
A = LEFT\$("ABC",1)	37	6	38	9
A! = SIN(3.14159)	149	50	150	50
A = I + 2	40	2	44	8
FORJ = 1 TO 10: NEXT	169	4	188	8

Table 1: Execution speeds with the above statements substituted for line 30 in Listing 1.

pilation time is very short in relation to the run time if the program is to be run several times. There are some cases, however, when compilation is superfluous. For example, a program that spends most of its time with disk I/O (input/output) will gain little speed by compilation. On the other hand, a program that does a lot of iterative number crunching with little I/O will be greatly quickened. If you use short programs or those that wait a long time for I/O, a compiler won't help much.

Flexibility and Documentation

The compiler is designed to be very flexible; in fact, I can't fully describe its tremendous range of options. For example, subroutines written in Microsoft FORTRAN can be called from BASIC by using the command:

CALL SUBR (A,B,C)

where SUBR is the name of a subroutine in a compiled (but not linked) FORTRAN program and A, B, and C are variables to be passed to the subroutine as sequentially declared in the FORTRAN subroutine statement. You can write a personal subroutine library in FORTRAN that can be called from BASIC. The ability to write a user library of language-independent subroutines is usually found only on mainframe computers or very large minicomputers. Working with the compiler on a microcomputer is much less awkward than it would be on a large computer system. This means, however, that L80 must have a provision for specifying a FORTRAN program that will be searched for subroutines. In other words, flexibility means some complexity in compilation, and there are a wide variety of different procedures for compilation. For example, typing BASCOM and then after a prompt:

TEST2,*PR=TEST1

sends the listing to a line printer. Many other features are too complex and lengthy to be described here.

Unfortunately, this flexibility and complexity mean rather unclear documentation. Microsoft has tried to describe all of the options, special features, and peculiarities of the system before a user becomes acquainted with the rudiments. In some instances, the system's complexity seems to have confused even the writer of the manual.

For example, in one section a COMMON statement is described in great detail, while another section tells us that it's not implemented. In another case, it gives an excellent table comparing Level II BASIC, disk BASIC, and "standard" Microsoft BASIC (BASIC-80) with compiled BASIC, but several statements and commands that are available in compiled BASIC (and BASIC-80) are omitted.

The manual is very complete and includes an introductory section (confusing); a technical section (also confusing) detailing the features of compiled BASIC; and the BASIC-80 manual that gives the syntax of statements not found in either Level II or TRS-80 disk BASIC, but with (distractingly) almost everything in the TRS-80 lan-

Supercharge Your Micro's Performance With



The Professional Operating System with CP/M™ Compatibility

- **Spectacular Performance.** Programs run 3 to 10 times faster compared with TRSDOS or CP/M. Benchmark results up to 20 times faster obtained with some applications by independent firm!
- **Double-Sided Drive Support.** Provides 1 25 Megabytes of storage per 8" double-sided/density disk. Intermix any combination of single- or double-sided drives on-line.
- **Expanded Directories.** Store larger number of files and more information per disk.
- **Automatic Density/Side Recognition.** Detects changes in disk format automatically. Change disks at any time without compromising data or "BDOS/Read-Only" errors.
- **Fast Disk Backups.** Copy a complete 8" 5.25/DD diskette (610K) in less than 80 seconds. Copy a double-sided/density diskette (1 25 Megabytes) in less than 1 minute 45 seconds!
- **Hard Disk Drive Support.** Supports large hard disks in excess of 1,000 Megabytes without partitioning.
- **Advanced Utilities.** Complete set of disk utilities, system date and time functions, communications channel interface etc. provided as standard features.
- **Enhanced Automatic Print Spooling.** Run multiple printers simultaneously, support for multiple queues and printers is standard feature on spooling versions.
- **CP/M Compatibility.** Virtually any CP/M (version 2.x) program will run under TURBODOS without modification. Also fully media compatible with standard CP/M-format diskettes.
- **Advanced Mainframe-like features.** Includes read-after-write validation of all disk update operations, type-ahead buffers, incremental disk backup utility, password/log-on security, system date and time functions, accepts string of multiple commands, and numerous other capabilities not available under CP/M or TRSDOS. Multi-user, networking versions also available.

TRS-80 Model II and Xerox 820 versions **\$195** Dealer and OEM inquiries invited
Special Introductory Price **Data-Rx, Inc.**
Easily adaptable to any Z80-based computer.

(408) 375-2775 • 686 Lighthouse Avenue • Monterey, 93940

TURBODOS is the registered trademark of Software 2000
CP/M, MP/M, and CP/NET are registered trademarks of Digital Research

NOW. OASIS-16. STRICTLY BUSINESS.

The 16 bit operating system designed specifically for *business micro-computing*.
Application software?—it's here, NOW!

OASIS-16*: the operating system designed for business. Not just a hobby or development system rewritten for business use, it is the natural evolution of OASIS**: the multi-user system with a world-wide reputation as *the standard* for those who take business seriously.

And here's more good news: there's no waiting for *application software* because what now runs on OASIS is upward compatible to run on OASIS-16. That means plenty of proven software, *available immediately*.

OASIS-16 puts it all in one package.
For manufacturers: one source for operating systems, languages, tools; custom implementation to maximize hardware potential; international support & training; flexible licensing agreements.
For software developers: complete portability keeps application software machine independent; integrated tool set makes development easier, faster.
For end-users: user-friendliness; data security; portability simplifies system expansion; plus an extensive application software library.

Computing professionals have long told us 'OASIS makes micros run like minis'—with OASIS-16, it's truer than ever. And that's strictly good business.

*For 8086, 68000, Z8000, LSI-11, & others.

**For Z80.

THE OASIS-16 PACKAGE CONTAINS: Operating System; EXEC JCL Language; Editor; Script Output Text Formatter; Assembler; Linkage Editor; Diagnostic & Conversion Utilities; BASIC Interpreter & Compiler; 'C' Compiler.



FEATURES: File & Automatic Record Locking; Logon, Password & Privilege Level; User Accounting; Re-Entrant BASIC Interpreter & Compiler; ISAM, Keyed, Direct & Sequential Files; and more. Plus some of the best, most extensive documentation in the industry.

OPTIONS: COBOL; PASCAL; FORTRAN; RDBMS; 2780/3780 Bisync; Networking; and others.

.....

PHASE ONE SYSTEMS, INC.

7700 Edgewater Drive, Suite 830
Oakland, CA 94621-3051
Telephone 415/562-8085 TWX 910-366-7139

I'm serious about my business—
please send me quick:

- OASIS-16 Manual, \$75
- OASIS Manual, \$60
- Free Application Software Directory and put me on your mailing list.

(Add \$3 for shipping; California residents add sales tax.)

Name _____

St. (No Box #) _____

City _____ State _____ Zip _____

Check enclosed UPS C.O.D.

VISA Mastercharge

Card No. _____ Exp. date _____

Signature _____

OASIS16

STRICTLY BUSINESS

Circle 427 on inquiry card.

guages described as well. I spent several days trying to decipher some simple features (like the CALL statement mentioned above), but everything I needed to know was eventually found within the several different sections. The software is easily used, but the simplicity is obscured by very confusing documentation. In fairness to Microsoft, I have seen much worse obfuscation in documentation from CDC, DEC, and IBM.

Compatibility

The package is compatible with TRS-80 disk BASIC. Disk BASIC is more forgiving in some things, like FOR . . . NEXT loops, but if you use *legal* disk BASIC the compiler will recognize everything (except, of course, things like EDIT and CLOAD). CLEAR is not needed by the compiler, but if it's in the source program it will be ignored and a nonfatal error message will be given (which may be ignored). Also, there's no provision for data I/O with tapes. There are a few other minor differences, but

OPTION BASE	SWAP	WAIT
WHILE	WEND	WIDTH
FRE	HEX\$	OCT\$
INP(I)	INPUT\$	LPOS
POS	SPACE\$	SPC
CHAIN	%INCLUDE	

Table 2: Some statements, commands, etc., supported by Microsoft's compiled BASIC, but not by TRS-80 disk BASIC.

almost any program written in standard TRS-80 BASIC will compile successfully. The reverse, however, is not true. The compiler recognizes many statements and commands not used by TRS-80 BASIC.

Speed

All compiled programs are much faster, but the compilation process itself takes some time. The trivial program in listing 1 took less than two minutes to compile and link. A game using 11K bytes took one minute and 46 seconds to compile and two minutes and 50 seconds to link without a listing file. With a BASIC listing file but no object code between the lines, compilation took two minutes and 11 seconds, and the listing file required about 14K bytes or 13 "grans." It was impossible to compile the program with object code; the listing file needed more than 100 grans of disk space. This is a problem with the compiler that's not mentioned in the documentation; object code listings may need more storage than is available on any blank disk. However, it's probably never necessary to get a complete listing file with object code. A "-N" switch after the BASCOM line will inhibit the object code.

Some differences in run times for various interpreted and compiled programs are given in table 1, which shows the execution times for statements placed in line 30 of listing 1. Speed increases vary from more than 40 times, with integer variables in simple functions, to less than three times faster using SIN, COS, and similar functions. Nevertheless, there's always a speed increase that varies depending on the program.

Special Features

Compiled BASIC has many features unavailable in interpreted TRS-80 BASIC. In fact, they're not all listed in the documentation. Table 2 gives the additional statements and commands, although they are too numerous to fully describe. For example, SWAP(A,B) exchanges the value assigned to the two variables, and transcendental functions will return double precision. Perhaps the most important are WHILE and WEND statements; they allow writing structured program code. Variables may be of any length; that is, the compiler will consider J, JOS, and JOSEPH to be different variables. This may pose a problem when compiling a program that uses variable abbreviations; the compiler may recognize more variables than were originally intended.

Microsoft's original BASIC compiler had many defects, but all of the problems seem cured in this new version. I have some BASIC programs that will not compile using BASCOM, but that's always because standard TRS-80 conventions were not used. For example, Radio Shack's backgammon game will not compile because it branches to subroutines from within a loop; that is disallowed but forgiven by interpreted BASIC. Also, some things may be mistaken for bugs. For example, I thought there were problems with linking because L80 is different for Microsoft FORTRAN and BASIC. But the two act the same if a "-R" switch is used with the BASIC version.

PEEK AT PERISOFT'S PRODUCTS FOR YOUR APPLE™!!



\$139.95 A+T

PRINTER+REAL TIME CLOCK

ECONOMICALLY PRICED FOR THE USER NEEDING BOTH PARALLEL PRINTER INTERFACE AND REAL TIME CLOCK. CAPABILITIES THIS BOARD HAS ALL THE FEATURES MENTIONED BELOW FOR OUR PRINTER/PARALLEL AND REAL TIME CLOCK BOARDS. COMES WITH ADDITIONAL SOFTWARE.



\$109.95 A+T

ASync. SERIAL BOARD

THIS RS232C COMPATIBLE INTERFACE BOARD HAS A CMOS UART, HANDSHAKING LINES, CRYSTAL CONTROL, AND 9' CABLE. IT CAN HANDLE FULL OR HALF DUPLEX, ODD, EVEN, NO PARITY, 1, 1.5, 2 STOP BITS, 7 OR 8 BIT WORD AND 50 TO 19.2K BAUD.



\$109.95 A+T

REAL TIME CLOCK BOARD

PROVIDES REAL TIME AND DATE INFORMATION. ON BOARD MONITOR FACILITIES TIME, DAY, MONTH, YEAR SETTING. COMES WITH NICAD RECHARGEABLE BATTERY. CRYSTAL CONTROLLED. JUMPER ENABLED INTERRUPT RATES OF 1/1024 SEC, 1 SEC, 1 MINUTE OR 1 HOUR.



\$99.95 A+T

PRINTER/PARALLEL BOARD

CONFIGURABLE AS A PRINTER INTERFACE WITH HANDSHAKING SIGNALS OR AS A TWO WAY PORT. CABLES FOR VARIOUS PRINTERS AVAILABLE. COMES STANDARD WITH CENTRONICS COMPATIBLE SOFTWARE. SPACE IN EPROM FOR PROGRAMS WRITTEN BY THE USER.

ALL OF THESE BOARDS MADE BY PERISOFT INC.:

- COME ASSEMBLED AND TESTED
- PASS A 72 HOUR BURN IN PERIOD
- HAVE AUTO SAVE POWER CIRCUITRY
- HAVE SOLDER MASK + SILK SCREEN
- HAVE GOLD PLATED FINGERS
- INCLUDE FULL DOCUMENTATION
- ARE COMPATIBLE WITH APPLE II™ AND APPLE II PLUS™*

PERISOFT INC.

5126 Calle De Sol, Santa Clara, CA 95050
(408) 727-9989

DEALER
INQUIRIES
INVITED

*APPLE II AND APPLE II PLUS ARE TRADEMARKS OF APPLE COMPUTER INC.

If you don't know a baud from a floppy... **YOU NEED TO KNOW THE QDP-100 MICROCOMPUTER**

Most people who need computers don't have the time, or desire, to become full-time computer "wizards."

With the budget-priced QDP-100 you get all the time-saving precision information you want from a computer, now and in the future, without all the unnecessary complexity associated with less considerate computers.

QDP-100 IS A FULL-SCALE 8-bit computer, readily upgradeable to 16 bits as your business or professional information-processing needs grow. It uses the IEEE S-100 bus, compatible with CP/M and MP/M disk operating systems.

QDP-100 HANDLES BOTH floppy disks and hard disks to give you total software versatility.

QDP-100 CONNECTS INSTANTLY to any standard terminal and printer. Both serial and parallel ports are available. Features most micro-computers can't match.

It does more, does it easier, and costs a lot less.

QDP-100 HAS SINGLE BOARD SIMPLICITY. Eliminates the hassle of complex multi-chip, multi-board computers.

QDP-100 IS EASY to learn and to operate. Most owners use their QDP-100 with professional skill and results in short order. Our instruction manual doesn't need an interpreter.

If you'd rather be a wizard with computer results, than with computers, choose the QDP-100. Call or write for literature and full details.

QDP NEEDS A FEW MORE GOOD DEALERS. Attractive, profitable, protected dealerships are still available in several high-potential computer market areas.



Quasar Data Products

10330 Brecksville Road
Cleveland, Ohio 44141
216/526-0838 Telex: 241596

CP/M and MP/M
are registered trademarks
of Digital Research Corp.



Circle 329 on Inquiry card.

www.americanradiohistory.com

I've yet to find any "real" bugs—only things that I either misinterpreted or didn't understand.

If you have code that you want to run faster, or if you need any of the features like a FORTRAN library, this is definitely a worthwhile product. If you're not accustomed to a compiler, compilation may be annoying. But this is a professional package, just as flexible and much easier to use than some compilers on mainframe computers.

Conclusions

Microsoft's BASIC compiler allows compilation of any BASIC program written for a disk-based TRS-80. This results in a three to 30 times increase in execution speed. The system includes a compiler (BASCOM), linker (L80), routine library (BASLIB), and run-time package (BRUN). For most purposes, 48 K bytes of memory and two disk drives are needed. The package is nearly identical to the interpreter that Microsoft designed for the TRS-80.

The software is readily used by those familiar with a compiler and compilation is quick. The documentation is confusing but complete, and a novice should be operating the system within an hour. Full use of its very flexible and extensive special features will require several days' study, which would be reduced with better documentation.

There are more than 20 features in the package that are not available in disk BASIC, including structured loops

and calls to FORTRAN subroutines. Because of ambiguities in documentation, full use of the features requires long study and experimentation.

This is a very professional software package that gives the TRS-80 features found only on much larger systems. Except for the documentation, the package is superlative in all respects. ■

A Public Service of This Magazine
& The Advertising Council 

Red Cross is counting on you to help.

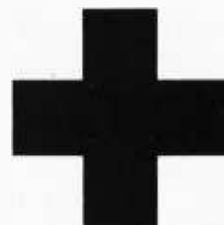

Give Your TRS-80* a Tremendous Boost with RACET COMPUTES Software

RACET COMPUTES Utility Software makes the TRS faster, more efficient, and easier to use. Our programming aids improve your productivity. Our reputation is for products that are professional in design and work as advertised!!!

FIELD PROVEN HARD DISK DRIVES AND OPERATING SYSTEM

Now you can use RACET's Hard/Soft Disk Operating System (HSDS) with the ARM Winchester Disk Drive on the Model II. This cost effective combination provides 15 Megabytes per drive including ECC Error Correction Code and an advanced sequencer to further ensure data integrity. An incremental backup to floppy is provided so that only those sectors that were changed from the last backup are saved. A full monthly service contract is available at \$30 per month per drive.

The HSDS Software has more than One Year's FIELD Experience. The latest HSDS version adds several enhancements including maintenance of system files on the hard drive, files as large as the disk, the ability to segment the disk as logical drives, definable directory size, and many utilities including bulk copies between floppy and hard drives, multiple purge, Superzap, and Directory Catalog System. Full program compatibility with TRSDOS 2.0a is maintained. Mixed floppy and hard drive operation is supported.

HSDS is available for the Cameo, Cynthia Bull, Corvus, Data Peripherals, and Santa Clara Systems hard disk systems as well as the ARM Winchester Drive.

ARM 15 Megabyte Drive Subsystem \$3895. HSDS Software \$400.
Cameo 5/5 Cartridge Drive \$5995. Cynthia Bull 10/10 Drive \$7995

NEW PRODUCT ★ Model II Fast Backup Utility ★ \$75

5 to 10 times faster backups!!! Full disk backup (including verify) 55 seconds!!! on two drive system — 2:15 on single drive system. In business, time is money, and one BACKUP is worth 1000 tears!!

NEW PRODUCT ★ INTEGRATED BUSINESS SYSTEM ★

ISAM File Structure — Multi-Company Capability. Modular structure. Each module includes complete user documentation which guides the user through installation and allows "practice" using a sample data base. When ready, the user simply names his data base and begins. The Integrated Business System program set includes General Ledger, Accounts Receivable, Accounts Payable, Payroll, Inventory, General Journal, Asset Management and more.

Business Programs \$250/module Mod III, \$300/module Mod II, \$795 for all four Mod III, \$995 for all four Mod II. General Ledger and Accounts Receivable available now. Accounts Payable and Payroll 1st Quarter 1982.

 RACET COMPUTES LTD.
1330 N. GLASSSELL, SUITE M, ORANGE, CA 92667

CIRCLE READER RESPONSE BELOW FOR FREE CATALOG
* TRS-80 IS A REGISTERED TRADEMARK OF TANDY CORPORATION

CHECK, VISA, M/C, C.O.D. PURCHASE ORDER
TELEPHONE ORDERS ACCEPTED (714) 997-4950

Circle 428 on inquiry card.

GET THE MOST FROM YOUR NEC PC-8001 WITH RACET COMPUTES SOFTWARE!!

RACET NECDOS \$175

RACET NECDOS does more for your PC-8001 than any other DOS. It's faster, more efficient and easier to use. It's loaded with extra features to let you stretch the limits of your system. This advanced operating system works with the ROM NBASIC to give full compatibility with color and other BASIC commands.

USER FRIENDLY — Emphasizes integrity. No MDUNT or REMOVE commands!!! Excellent protection from improper diskette swapping. AGAIN, HELP, FIND and REF commands. File password protection.

ADVANCED DESIGN. RACET NECDOS utilizes the computer in the 8031 for most disk I/O functions minimizing memory utilization in the PC-8001. The Dynamic Transient Area (DTA) allows multiple transients to be scatter loaded and relocated in memory simultaneously. This unique capability optimizes use of valuable memory, yet provides an almost limitless growth potential.

ADVANCED FEATURES. All DOS functions and commands may be used directly in a BASIC program!!! Special RUN option allows merging of programs, retaining all variables in memory. Fixed block spanned records, AUTO and DO commands. Machine language loads and saves. MATPRINT and MATINPUT to disk. Complete directory ALL supervisory calls documented and available to the machine language programmer. Superzap utility included.

CONVERT TRS-80* PROGRAMS TO RACET NECDOS WITH 'PROTRAN' \$99.95

COMPLETE utilities for file transfer and BASIC program conversion. Model III diskettes may be read directly. Model I and II via RS-232. Transfer BASIC programs, data files, or machine language files. NO support is provided for conversion of machine language files or PEEK's, POKE's, or USR's to function on PC-8001. Includes Mod I, Mod II and RACET NECDOS Datadisk with complete documentation on conversion requirements and syntax differences.

MULTI-KEY SORT 'MKS' \$60

SUPER FAST Machine Language In-Memory Sorts. Three-key sort on 500 elements in 4 Seconds!!! Simple one-line BASIC functions — SORTV and SORTC verbs. Mixed ascending and descending keys

KFS-80 KEYED FILE SYSTEM \$150

Machine language BASIC ISAM utility provides keyed and sequential access to multiple files. Simple interface to BASIC. Binary tree keyed-file index system provides rapid access to records.

RACET COMPUTES software for the NEC is distributed by the Waybern Corporation and is available from your local NEC Dealer.

 Waybern Corporation

13911 Enterprise Dr., Garden Grove, CA 92643
(714) 554-4520 • (213) 222-7514

CIRCLE READER RESPONSE BELOW FOR FREE CATALOG

RACET COMPUTES

Circle 429 on inquiry card.

1-UPMANSHIP.



We opened our doors with two basic goals:

To distribute as many software packages to as many dealers as possible.

And to make money doing so.

Our success on both counts is the result of hard work, a positive business attitude and a recognition that you, as a retailer, have a right to be treated fairly and honestly by your distributor.

We're 1-up for three good reasons:

1. We always offer a wide selection of the latest and best microcomputer software packages available anywhere. (Why should you have to hunt for what you need?)
2. Our dealer discounts start with quantities of 1. (Remember all those times you just wanted one or two to see how they'd sell?)
3. We don't play The BackOrder Game. (If we can't ship your order within 48 hours we'll let you know, instead of hanging you out to dry.)

If there's anything else we can do for you, just let us know. Because we're 1-up and we intend to stay that way.

Software Distributors, 9929 Jefferson Blvd., Culver City, CA 90230. Telex 4990032 BVHL, ATT: SOFT

For our dealer info package, call (213) 559-9330.

SOFTWARE DISTRIBUTORS

We won't leave you holding the bag.

LDOS—Disk Operating System for the TRS-80

Tim Daneliuk
4927 North Rockwell
Chicago, IL 60625

The TRS-80 microcomputer has evolved from a rather simple, cassette-based experimenter's delight to a complex and powerful disk-centered system. With disks came the necessity of a DOS (disk operating system) for control and communication with the computer. The first DOS came from Radio Shack, but independent vendors have since released others. The latest of these is LDOS from Logical Systems Inc.

LDOS was created out of need. Lobo Drives International wanted to market a new disk interface for the TRS-80 Model I that supported not

only 5¼-inch floppy disks, but 8-inch and hard disks as well. Additionally, the floppy-disk interface supported both single- and double-density operation. At the time of the hardware design, no existing DOS could support this diversity of hardware. Therefore, LDOS was created. Originally, it started as a debugged and enhanced version of VTOS 4.0. However, the present version is essentially all new code. VTOS users will be quite comfortable with LDOS because the command structure and syntax of VTOS have been largely maintained. The present version of LDOS supports both the Radio Shack expansion interface and the Lobo LX-80 interface. It is compatible with TRSDOS 2.3. Also, it supports both the Percom Doubler and double-sided operation. A version of LDOS is also available for the TRS-80 Model III.

It is always difficult to review a software product of this magnitude. I hope I have successfully avoided the tendency to get lost in infinite detail. I will stress the highlights of the system based on extensive use of LDOS 5.0.2 on a Model I and limited use of LDOS 5.1 on a Model III. The features discussed reflect primarily LDOS 5.1. As this is being written, this latest version, called 5.1.1 for the Model I, has just been released. Therefore, the operating features of both Model I and Model III LDOS are identical.

The LDOS Command Library

TRSDOS 2.3 could be viewed as a subset of LDOS. Every TRSDOS command has been implemented, and

most have been significantly enhanced. LDOS also provides many new commands never previously available on any one TRS-80 DOS. Table 1 contains a brief listing and descriptions of the major enhancements and extensions found in LDOS. The major features are described below.

If you do any assembly-language programming, you will find the LDOS extended DEBUG a tremendous tool. All of the old commands are included, but many new ones have been added, too. Some of the extensions are:

- enter data directly into entire sections of memory
- fill a block of memory with a specific byte
- jump over a byte in program execution
- locate first occurrence of a specific byte or word in memory
- print a block of memory
- send or display a byte to or from any I/O (input/output) port
- type ASCII (American Standard Code for Information Interchange) characters directly into memory
- compare two blocks of memory

There is also a disk read/write utility that allows reading or writing to any sector of any disk, even the directory sectors!

The fact that LDOS supports hard disks and 8-inch floppy disks is evident in the changes to the DIR (directory) command. An unconditional call for a disk directory on a 10-mega-byte hard disk would be a messy proposition. LDOS allows directories

At a Glance

Name

LDOS (logical disk operating system)

Type

Systems software/disk operating system

Manufacturer

Logical Systems Inc.
11520 North Port Washington Rd.
Mequon, WI 53092
(414) 241-3066

Price

\$169

Format

5¼-inch floppy disk

Computer

TRS-80 Model I or III with 32K bytes of memory and a disk drive

Language

Z80 machine language

Documentation

Approximately 250 pages in a three-ring binder

Audience

All TRS-80 disk system users

We have ways...

to make it talk!

Give your computer the magic of speech with an ECHO™ Speech Synthesizer!

There are four new models to choose from: the ECHO 80 (TRS-80 models I & III), ECHO 100 (S-100), the ECHO GP (general-purpose, serial/parallel) and the ECHO SBC (single board computer). These join the popular ECHO II (Apple).

ECHO Speech Synthesizers use LPC synthesis pioneered by Texas Instruments, combined with a phoneme-based operating system to provide any vocabulary you desire while using a minimum of your computer's memory.

The TEXTALKER Speech Generator, standard with all ECHOs except the SBC, translates normal English text to speech automatically.

Circle 362 on Inquiry card.

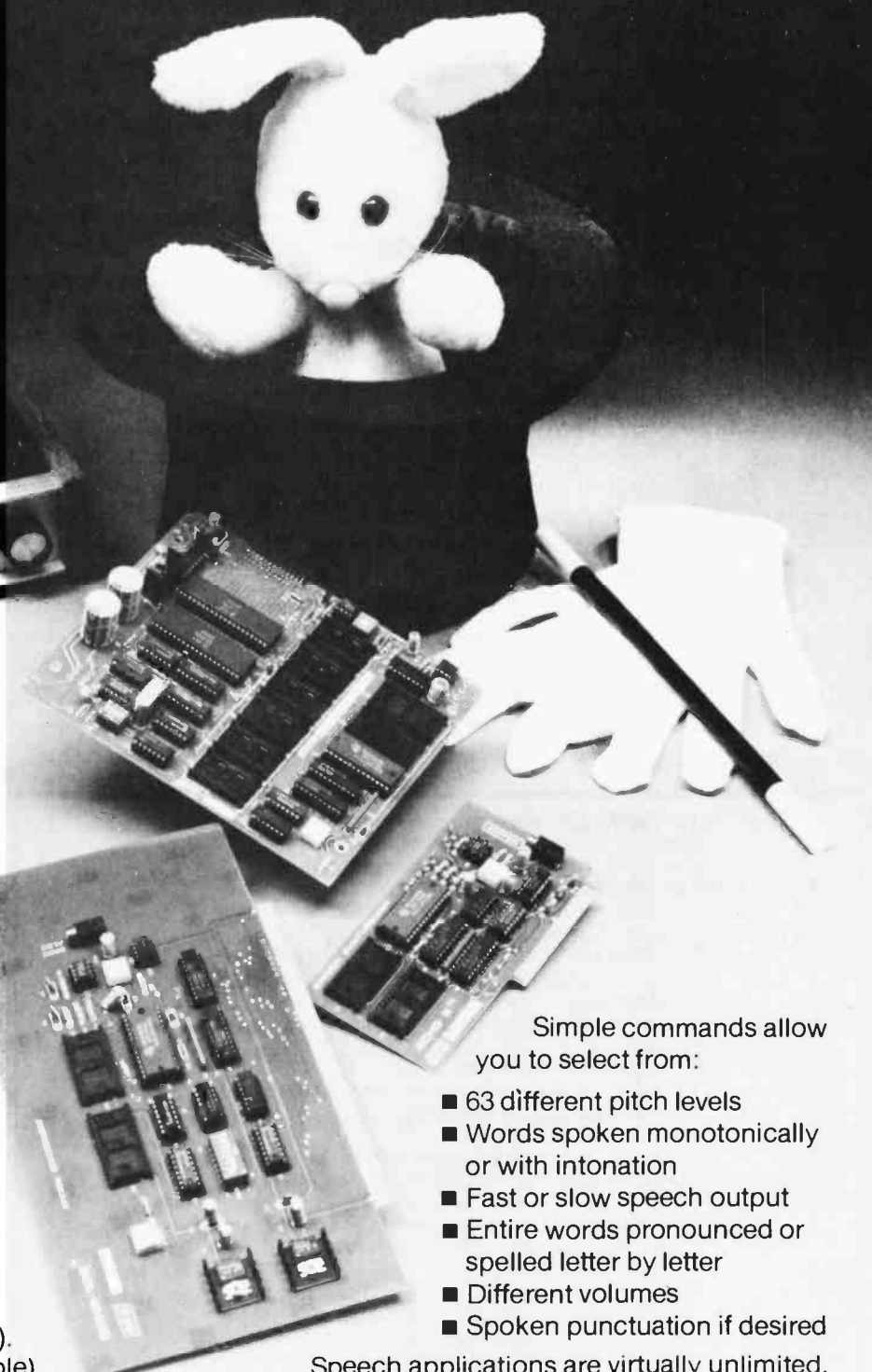

Simple commands allow you to select from:

- 63 different pitch levels
- Words spoken monotonically or with intonation
- Fast or slow speech output
- Entire words pronounced or spelled letter by letter
- Different volumes
- Spoken punctuation if desired

Speech applications are virtually unlimited, ranging from education to games to aiding the handicapped. The flexibility and low price of ECHO Speech Synthesizers make them the logical choice when adding speech to your system.

For more information see your dealer or contact:

SEC STREET ELECTRONICS CORPORATION
3152 E. La Palma Avenue, Suite D
Anaheim, CA 92806 Telephone: 714/632-9950

by class and date. For example, a directory of only files with the extension "/TXT" could be shown. Or all files created on, before, or after a specific date could be shown. This is a real time-saver when you are trying to find a specific file in a full disk. Any DIR command also shows the amount of free space in kilobytes on a specific disk, as well as the usual disk name, creation date, and drive number.

The LINK and ROUTE commands are very sophisticated and offer features normally found only on mini-computer and mainframe operating systems. LDOS is a device-independent operating system. Each peripheral is seen by the operating system as a DCB (device control block) in memory independent of the actual hardware. This means that data can be transferred between peripherals (called devices) in any manner you want. Additionally, so-called dummy-devices can be created so that data intended for one destination can be made to go elsewhere (a disk file, for example). In essence, device-

independence allows you to redirect I/O any way you like without having to rewrite the machine-language I/O drivers. This may sound terribly complicated, but it is extremely easy to use and offers unbelievable versatility.

The ROUTE command allows you to change the destination of data. For example, routing the video to the line printer forces anything normally displayed on the screen to be printed on the printer. Another application for ROUTE is to send anything from the RS-232 serial port to a disk file, instead of the screen, when the computer is unattended. LINK is similar to ROUTE in function. However, instead of redirecting data to another device, it simultaneously adds a second (or third, or fourth . . .) destination device. This would allow you to send anything appearing on the screen to the printer, too, or vice versa. I have a disassembler that only goes to the screen. By linking the video display to the printer, the disassembled code appearing on the screen is simultaneously sent to the printer,

thus providing hard copy. The LINK command takes 10 seconds to type in; writing a new I/O driver could have taken days.

The SPOOL command has many uses, but its greatest application is when long printouts are required. Rather than tying up the computer completely while printing, SPOOL sends the data to be printed to a buffer located in memory or on a disk. Then, as the computer has time (in between keystrokes, for example), the data are sent to the printer. You can choose the size of the buffer, as well as whether to spool to memory or the disk. When using SPOOL, it seems that the TRS-80 is doing two things at once. However, it's just using time much more efficiently! Small-business users will love this feature because you can print a long report or a general ledger and use the computer for other things at the same time.

A final highlight of the LDOS library is the SYSTEM command. This allows you to customize LDOS for a particular installation. The disk-drive stepping rate, blinking cursor, keyboard type-ahead, and break key disable are but a few of the many features that can be configured. The final configuration can then be saved. Each time that LDOS system disk is booted, the configuration is also loaded. SYSTEM will be a real favorite with a single-drive user because it allows you to load many of the "/SYS" files into memory. This in turn frees a great deal of disk space for data. It also has the effect of speeding up disk I/O since overlays are not being called from the disk. Potentially, you could have the full operating system at your disposal, and about 60K bytes of disk space in a single-drive, single-density, 35-track system. Finally, SYSTEM allows you to reassign which physical drive is logical drive 0. You must load LDOS the usual way, but after that anything goes. This will find application among Model III users who have a 35-track drive left from their Model I. By making this external drive the system drive, the two higher-capacity 40- or 80-track drives in the Model III

APPEND	Can ECHO to screen while appending, and can back up 1 byte in destination file to merge Scripsit files.
ATTRIB	Can make files VISible and INVisible.
AUTO	Can disable BREAK key.
BOOT	Software reset "button." Reloads LDOS.
BUILD	Creates ASCII or HEX files for PATCHING, JCL, etc.
COPY	Simplified syntax. Can specify LRL. CLONE attributes of source file. ECHO characters to screen while copying. Single-drive copy from non-system disk.
CREATE	Preallocate disk space for a file in either kilobytes or number of records.
DEBUG	Extended significantly (see text).
DEVICE	Shows all important disk-configuration data.
DIR	Extended significantly (see text).
DO	Used to execute JCL file.
DUMP	Will dump in ASCII. End of text marker can be specified.
FILTER	Modify I/O flow.
FREE	Shows amount of space used and available, creation date, disk name, number of directory entries used and available, free space in K, and space map. Can be sent to printer.
LINK	Change I/O flow (see text).
LIST	Can number lines, dump in HEX, expand tabs, begin at specific record or line number, specify LRL, and output to printer.
LOAD	Can load from a nonsystem disk in single-drive systems.
MEMORY	Can show or modify top of memory. Can display, jump to, or modify specific memory locations.
PURGE	Multiple kill of files.
RESET	Reconnect peripherals to standard I/O drivers.
ROUTE	Modify I/O flow (see text).
RUN	Execute file from nonsystem disk on a single-drive system.
SET	Connect device to new I/O driver routine.
SPOOL	Data spooler (see text).
SYSTEM	Configure system parameters (see text).

Table 1: The major enhancements of LDOS as compared to TRSDOS 2.3. Not all library features are listed here.

Gain instant access to over 1,200 information and communication services for as little as \$4.25 an hour.

They're all at your fingertips when you join The Source,SM America's Information Utility.

The Source can improve your efficiency, speed your work, and reduce expenses in your organization by giving you access to personal and business services that run the gamut. From electronic mail and discount buying services to stock reports and hotel reservations. And in most cases, you can reach The Source with a local phone call using any standard microcomputer, communicating word processor, or data terminal.

SourceMailSM... faster than U.S. Mail, cheaper than most long distance calls.

SourceMail is an electronic mail system that lets you send messages to other Source subscribers, anywhere in the country. Use it to communicate with your field offices or traveling sales representatives. Create your own network to clients, associates, outlets or suppliers. Store information for later retrieval when needed. The Source can even correct spelling errors.

Best of all, communicating through The Source can be cheaper than any other method... including long-distance phone, Telex, facsimile, express mail, or messenger.

Streamline your business operations.

Just feed The Source your figures and it will calculate your taxes, cash flows, equity capital, lease vs. equipment purchase, loan amortizations, annual interest rate on installment loans, depreciation schedules. Use its Model 1 service for financial planning, simulation, and analysis.

You can use The Source's powerful mainframe computers to write and store your own programs, with computer languages like BASIC, COBOL, FORTRAN, RPG11 and assembly language. Naturally, we give you a private access code so your programs and data inputs are secure.

Your electronic travel agent.

Plan your trips with instant national and international flight schedule information. Use The Source Travel ClubSM to arrange airline tickets, rent a car, and make hotel reservations. Use The Source to check the weather ahead or find



the best place to eat using our electronic Mobil Restaurant Guide.

Instant access to the stock market.

Whatever your investments — stocks, bonds, mutual funds, T-bills, commodities, futures or others — The Source will give you updated investment information 22 hours a day. We go beyond mere market quotes to add economic, business, and financial commentary by noted economists and securities analysts.

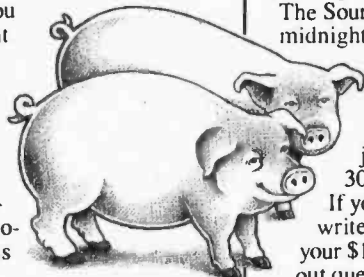

Get news, hot off the UPI wire.

Around the world or around the corner, find out about the latest news straight from United Press International. You can select only the news, business reports, sports or features you want... geographically, by date, or subject matter. Get the latest update within 2½ minutes of a filed report, or go back to earlier coverage.



That's just the beginning.

There's so much more. The Source has an electronic personnel search network. It lets you barter your goods and services with other businesses. Orders hard-to-find technical and business books direct from the publisher. Gives you a daily review of Washington activities. Lets you order thousands of business and consumer items at discount prices. Maintains your stock portfolio. And we're improving and adding to our subscriber services every day.

Anyone can use The Source.

You don't have to know computer languages or have programming skills. The Source operates on simple, logical English commands. It comes with a complete user's manual, categorized directory, and private sign-on codes.

The Source isn't limited to your office. You can access it from home, or on the road, 22 hours a day. Use it to catch up with office work, or for self-improvement and family fun. The Source will play bridge with you, coach your children in foreign languages, help select dinner wines, give you the latest movie reviews, and more. It's amazingly versatile.

The value with the guarantee.

For all the communications and information services, you pay only a \$100, one-time subscription fee and \$18 per hour during the business day when you are actually using it. From 6 P.M. to midnight and on weekends and holidays The Source is just \$5.75 an hour. From midnight to 7 A.M. the rate drops to \$4.25. Minimum monthly usage charge is only \$10.

What's more, we're so sure you'll find The Source just what you need, we offer a 30-day money-back guarantee. If you're not completely satisfied, write us and cancel. We'll refund your \$100 hookup fee in full, without question. You pay only for time actually used.

See your computer dealer, mail coupon, or call for free brochure.

To learn more about THE SOURCE, visit one of the more than 800 independent computer stores that offer THE SOURCE. Or get our free 16-page color brochure and index of over 1,200 Source services now by mailing the coupon or calling toll-free 1-800-323-1718 (In Ill. call 1-800-942-8881) and ask for Operator 91.

Find out how much THE SOURCE can do for you.

THE SOURCE
AMERICA'S INFORMATION UTILITY

Department 0-2M
1616 Anderson Road
McLean, VA 22102

Please send me your free 16-page color brochure without obligation.

(name) (Please Print)

(telephone)

(Company if for business use)

(address)

(city/state/zip)

Do you own a microcomputer, terminal or communicating word processor?

If yes: (make/model)

The Source is a servicemark of Source Telecomputing Corporation, a subsidiary of The Reader's Digest Association, Inc.

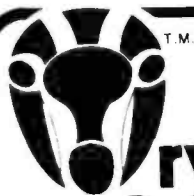

Oryx software

What does the Oryx, an African antelope, have in common with reliable service? They are both almost extinct.

Oryx Software wants to bring trustworthy service back to life. We're here to stay!

GUARANTEED LOWEST PRICES!
To celebrate our opening, we are matching any advertised price. Just show us the ad.

**ORDER TOLL FREE - Outside WI
1-800-826-1589**

SOFTWARE

Graphpower	299.00
Tax Preparer '82	127.00
Real Estate Analyzer	127.00
Creative Financing	127.00
Word Processor	425.00
Financial Projection	550.00
Mail Management	250.00
Micropro Wordstar	248.00
Mailmerge	90.00
Spellstar	169.00
Supersort II	159.00
Context Connector	180.00
Easywriter (Pro)	195.00
Easymover	45.00
Tellstar II	70.00
Easymailer	160.00
Daladex	249.00
Microplan Basic	419.00
Executive Secretary	212.00
Nevada CoBoI	129.00
Visicalc (3.3)	159.00
Apple Panic	25.00
SpellGuard	239.00
Computer Air Combat	53.00
PFS & Report	80.00
Sublogic Flight Simulator	28.00
SpeedStar	115.00
Systems Plus Acc'g. Module	425.00
Micropainter	34.00
Zork II	33.00
Edu-ware (Apple)	35.00
Painter Power	34.00
Invoice Factory	148.00
Locksmith	99.00
Raster Blaster	25.00
SuperCalc	269.00
Visiterm	120.00
Visiplot	145.00
Visidex	159.00
Visitrend/Visiplot	199.00
Magic Window	79.00
Int'l Grand Prix	25.50
Estimator	295.00
A-stat 79	145.00
SuperVyz	95.00
Graphic Software	19.00
C. O. R. P. I	235.00
Real Estate Office Mngmt.	425.00
Electronic I, II, or III	39.00
WordPro 3 +	295.00
Mailing List Program	50.00
Apple Doc	49.00

... AND MANY MORE!

Quoted prices valid for stock on hand and subject to change without prior notice.

Ask for our **FREE** catalog.

For **Peripherals** see our other ad, page 470

Please:

- Wisconsin residents - add 4% sales tax
- Foreign orders - please add 15%
- Add \$2.50 for shipping per software and small item. Call regarding others.

We Welcome:

- Visa, MasterCard - (Add 4%)
- Checks (Allow 1-2 weeks for clearing)
- COD (Add 4%)

TOLL FREE - Outside Wisconsin.

1-800-826-1589

For Technical Info & in Wisconsin

715-848-2322

Oryx Software

P.O. Box 1961 • Wausau, WI 54401



are free to handle data disks.

LDOS Utilities

LDOS includes the familiar BACKUP and FORMAT utilities, which have been greatly enhanced, plus several new utilities. As with the command functions, BACKUP and FORMAT provide support for larger disk drives. BACKUP by class can be invoked, for example, to back up only nonsystem files. FORMAT provides the necessary functions to format disks of various sizes, densities, and single- or double-sided usage. As with most sophisticated operating systems, LDOS requires that a disk be formatted before a backup is allowed.

CMDFILE is a utility that allows the transfer of files stored on tape to disk, or vice versa. Where necessary, the utility will offset program locations from the tape version to insure that no conflict with the operating system is encountered. Disk-to-disk transfers are also supported. The PATCH utility allows modification of disk files to make minor changes or repairs without having to rewrite the entire file. Model III LDOS comes with a CONV utility to convert Model III TRSDOS disks to LDOS.

A final utility of interest is LCOMM. It provides communications software compatible with both the Radio Shack and the Lobo LX-80 serial ports. This is *not* a "dumb-terminal" program, but a full-blown communications package with features like file transfers and downloading.

LDOS Filters and Drivers

One of the unique features of LDOS is its ability to "filter" data. By loading an appropriate program, it is possible to modify data before they are sent to a particular device. Three such filters are provided with LDOS, but documentation is provided to help the assembly-language programmer write others. The KEYSTROKE MULTIPLY filter allows you to program any key to generate a phrase when pressed. I programmed some commonly used BASIC phrases into my keyboard. By pressing CLEAR and G together, the phrase GOTO is

generated. Another possible application for this filter would be to reduce complicated DOS commands to a single keystroke. LDOS does provide abbreviation for certain commonly used library commands such as FREE and DIR by means of the MINIDOS filter. The third filter is the PRINTER filter. Its features include adding a linefeed after a carriage return, specifying the number of characters to be printed on a line, and setting the left margin of the printed page.

Logical Systems is also releasing an entire disk of filter routines to be used with LDOS. This disk will sell for \$60. It has many extended features, such as redefining every ASCII character. This would allow, for example, translation from ASCII to another data code such as EBCDIC. Another filter on this disk allows decimal and hexadecimal arithmetic while in another program (EDTASM, for example).

LDOS has a provision for loading custom I/O drivers as well. With one command, it is possible to change peripheral control from the LDOS drivers to one you have written. An RS-232 driver is provided for applications involving the serial port.

Job Control Language

It is impossible to do justice to the Job Control Language (JCL) feature short of writing a separate review of it. This is essentially a way of writing programs using LDOS library commands. Let's say you want to load a disk, and from then on have hands-off operation while the computer updates your mailing list, realphabetizes it, and prints labels. Normally, you would have to type in four separate DOS and BASIC commands:

```
BASIC
RUN "NEWDATA"
RUN "ALPHABET"
RUN "LABELS"
```

In LDOS, you simply create a file with these commands in it (using the LDOS BUILD command or a text editor such as Scripsit). Then tell LDOS to DO this file and sit back! Program execution is automatic. JCL

Move Up to Tarbell



The Serious Business Machine

Do you have a small computer system that operates with mini-floppies and has limited storage capacity? Then it's time to move up to the Tarbell Empire Series System. Tarbell starts where small systems leave off, providing storage from 1 to 20 megabytes. This means Tarbell is capable of growing right along with your business. (It also makes sense to start with Tarbell if you're a first-time computer buyer.)

Tarbell is the serious general purpose business machine, backed by years of experience with disk systems. It gives you word processing, inventory control with bill of materials, mailing lists — all in addition to accounting applications: general ledger, payables, receivables, payroll with cost accounting and order entry. Whatever your need may be, Tarbell can provide the working software that gets the job done.

With the Tarbell System you get a Z80 4 Mhz CPU with memory management, timer and full interrupt capability, 2 RS-232 serial ports with handshaking, 64 K bytes of random-access memory, double density floppy disk interface, 2 double density floppy disk drives, cabinet, power supply, and cables.

The software includes: CP/M™ 2.2 disk operating system, Tarbell Disk BASIC, Tarbell Database System, and all manuals and documentation.

Tarbell also offers the MP/M™ Multi-User Operating System and 4 additional RS-232 serial ports.

The Tarbell Empire Series is delivered assembled, tested, and with a FULL six-month warranty on parts and labor.

And when you need even more mass storage, Tarbell also has a hard disk that's system-compatible and provides easy back-up.

If your business is growing or you need more than a few hundred K bytes — it's time to move up to Tarbell. Call your local Tarbell dealer for competitive prices.

Tarbell
Electronics

The One-Stop Shopping Service

950 Dovlen Place, Suite B
Carson, CA 90746
(213) 538-4251

CP/M and MP/M are trademarks of Digital Research

also has the capability of prompting the user for input from the keyboard, to make decisions, to wait for a specific time on the clock before executing, and many other features. One application could be running long business programs unattended at night. This feature alone is worth the entire package price.

LBASIC

As with Disk BASIC 2.2, LBASIC is an adjunct to the BASIC interpreter in the TRS-80. It is compatible with programs written in Radio Shack BASIC, but has extended features that significantly enhance the language.

LBASIC adds many new random and sequential file controls. One of the best is the implementation of the Blocked File mode. In this mode of operation, an LRL (logical record length) between 1 and 256 bytes per record may be selected. This means that although the physical record size is still 256 bytes per record, you can deal with logical records that are less

than this. Let's say you wanted to write a random-access file that contained nothing but names up to 32 characters long. Rather than FIELDing the buffer for eight separate data fields and writing 256-byte records, LBASIC allows you to have records that are exactly 32 bytes long as far as *you* are concerned, while maintaining actual physical records that are 256 bytes. Another random-access file control, OPEN, has been modified to allow the opening of a file only if it already exists or, conversely, only if it does *not* already exist.

The sequential file controls have been enhanced as well. It is now possible to write to the end of (append) a sequential file directly without having to first load the file into memory, modify it, and write it back to disk. As with the random files, OPEN can be made dependent upon whether the file does or does not already exist.

LBASIC implements some features that greatly enhance writing and debugging programs. The more com-

monly used BASIC commands such as AUTO, EDIT, and LIST have been reduced to a single-letter command, and it is possible to single-step through a BASIC program. To facilitate program documentation and debugging, LBASIC includes a powerful line-renumber command and a cross-reference generator.

Several totally new BASIC commands have been added. RESTORE lets you go to a specific line of a program rather than always to the first DATA statement. When chaining programs, it is possible to specify at what line of the next program execution is to begin. Variables can also be passed from program to program while chaining. Thus, it is no longer necessary to save the variables in a file and read them back in when the next program has been loaded. A final addition is the ability to reset the EOF (end-of-file) marker in a random file, effectively allowing you to make random files smaller at will.

A final enhancement in LBASIC is the extended use of the CMD com-

INTRODUCING EXECUPORT® 400

The little portable that's making a **Big Impact!**

- Lightweight — 12 lbs.
- Compact — 12" by 14" footprint
- Inexpensive — \$795 to \$1195
- Plain paper impact printing
- Multi copy capability
- 30 cps throughput
- 80 cps maximum print speed
- RS 232 and 20 Ma interface
- Multiple type fonts
- Compressed print
- Nationwide maintenance service



EXECUPORT — *first with the best*



Computer Transceiver Systems, Inc.

P.O. Box 15 • East 66 Midland Avenue • Paramus, NJ 07652 • Phone: (201) 261-6800

Three Models Available

420	Receive Only printer (RO) 2K print buffer Up to 9600 baud rate
430	Keyboard Send-Receive (KSR)
440	Keyboard Send-Receive (KSR) Built-in 300 baud modem Dual RJ-11c phone jack Optional acoustic coupler Automatic dialing



LASTING MEMORY™

The LASTING MEMORY™

uses byte-wide electrically

eraseable PROM's (E²PROM's) to bring ease of

firmware development and non-volatile memory to the S100

bus. An E²PROM programmer on this 32K (8 bit only) board gener-

ates all required timing and voltages. Single bytes can be erased and

written using normal memory write instructions. E²PROM's can be operated and

programmed in the same socket. All sockets also accomodate static RAM's and 2716 type

EPROM's. Prices for the LASTING MEMORY™ start at \$299 without memory IC's. Call or write for pricing on additional configurations.

For your general memory needs, remember THE LAST MEMORY™ 64 K static RAM/EPROM board for 8 bit S100 systems. Prices start at less than \$100.



static memory systems inc.

15 So. Van Buren Ave. Suite 209
Freeport, Illinois 61032 (815) 235-8713
9 A.M. to 4 P.M. Monday - Friday

MC, VISA accepted
All prices net, FOB Freeport, IL
OEM discounts available
Dealer inquiries invited.

Circle 426 on inquiry card.

mand. Any legal LDOS command that does not affect protected memory can be executed from within LBASIC. To do a directory, for example, simply type in CMD "DIR". You can also load "/CMD" files from LBASIC by typing in CMD "filespec".

Documentation

It is claimed that of the approximately \$100,000 spent on the LDOS project, the manual alone cost more

than \$25,000 to develop. This is not difficult to believe because LDOS has the best, most comprehensive documentation and manufacturer support I've ever seen for a microcomputer. In excess of 250 pages, the LDOS manual is plainly the work of professionals. It will bring particular joy to assembly-language programmers because all major system entry vectors are thoroughly documented and all old *documented* TRSDOS vectors

have been maintained. (I gained a great deal of insight into TRSDOS by reading the LDOS technical section.) The nontechnical user is by no means left out though. The manual is extremely readable and full of good examples.

The documentation is further supported by a toll-free telephone number, an excellent update policy, a Micronet bulletin board, and a quarterly news magazine. The phone-in customer service is available for four hours daily. The magazine is free for the first year. New releases of LDOS can be obtained by sending \$5 and the original master disk to the manufacturer. If you prefer, you can update LDOS by logging in to Micronet and copying the updated version at no charge. As newer versions of LDOS become available, existing owners will be able to upgrade to the new version for a nominal fee (depending on the nature of the new revision). In short, the LDOS documentation and support system have no peers. They can be expected to become the standard by which all others are measured.

Benchmarks

LDOS boots quickly and seems to operate quite efficiently. One of its nicer features is the fact that the real-time clock is kept on during disk I/O operation. While this keeps the clock much more accurate than other systems, it can lead to a rather mysterious problem. If the disk drive is turning at exactly 300 rpm (revolutions per minute), the interrupt for the clock can occur at the same time the directory track becomes available to be read. This can result in long waits during disk I/O. The problem is remedied by reducing disk-drive speed by several rpm. The first quarterly magazine includes a BASIC program that indicates drive speed allowing you to see if your drives need a slight readjustment. The 15 minutes it takes to do this minor correction is a small price to pay for the added clock accuracy, though, and the problem is intermittent and minor at most.

Listing 1 is the Benchmark program used to compare the speeds of LDOS

Listing 1: The Benchmark program used to compare the speed of TRSDOS and LDOS.

```
100 CLEAR 1000
110 CLS
120 DEFINT A-Z
130 ' ** Program to test speed of system **
139 ' Set display delay
140 DODELAY=2000
200 PRINT@256," Do You wish to make a <R>ead or <W>rite test
??:":INPUT MODE$
210 ' Set Read or Write mode
220 IF MODE$="R" OR MODE$="r" THEN MODE=0:GOTO 300
230 IF MODE$="W" OR MODE$="w" THEN MODE=1:GOTO 300
240 GOSUB 9999:GOTO 200
300 CLS
310 PRINT@256," What is the name of the file to use ??:":INPUT
FILE$
320 IF LEFT$(FILE$,1)<"A" OR LEN(FILE$)>12 THEN GOSUB 9999:GOTO
300
340 CLS
350 PRINT@256," Which drive shall be used (0 to 7) ??:":INPUT
DRIVE$
360 IF LEN(DRIVE$)>1 OR VAL(DRIVE$)>7 THEN GOSUB 9999:GOTO 340
370 CLS
380 PRINT@256," What Logical record length (1 to 256)?:":INPUT
LRL$
390 IF VAL(LRL$)<1 OR VAL(LRL$)>256 THEN GOSUB 9999:GOTO 370
400 CLS
410 PRINT@256," How many records shall be Processed ??:":INPUT
REC
420 IF MODE THEN CLS:PRINT@256," If the file exists do You want
it KILLED (Y/N) ??:":INPUT KI$: ELSE GOTO 500
430 IF KI$="Y" OR KI$="y" THEN KI=1
500 CLS
510 FILE$=FILE$+" "+DRIVE$:PRINT@256," Filename      : ";FILE$
520 PRINT@384,"          Record size : ";LRL$
530 PRINT@512,"          # of Records : ";REC
540 PRINT@640,"          File MODE   : ";IF MODE
THEN PRINT"WRITE" ELSE PRINT"READ"
550 PRINT:PRINT" IS THIS CORRECT (Y/N) ??:":INPUT GO$
560 IF GO$="n" OR GO$="N" THEN RUN
600 IF KI THEN ON ERROR GOTO 15000:IF MODE THEN KILL FILE$
601 ON ERROR GOTO 0
602 Q$="HELLO"+"GOODBYE"
605 SIZE=VAL(LRL$):IF LRL$="256" THEN LRL$=""
610 OPEN"r",1,FILE$,VAL(LRL$):FIELD #1, SIZE-1 AS REC$
620 PRINT@288,"START   :";TIME$
630 PRINT@416,"FINISH  :";
640 PRINT@544,"RECORD  :";
690 IF MODE THEN 800
700 FOR L=1 TO REC:PRINT@552,L: GET 1,L: IF REC$=Q$ THEN 1000
ELSE NEXT:CLOSE:GOTO 900
800 FOR L=1 TO REC:PRINT@ 552,L:LSET REC$=STR$(L)+"This is a
test of file handling in Basic":PUT 1,L:NEXT:CLOSE:GOTO 900
900 PRINT@424,TIME$:PRINT@900,,:END
1000 PRINT" E R R O R ":GOTO 900
9999 CLS:PRINT@400," I N V A L I D   R E S P O N S E ":
10000 FOR TIMER= 1 TO DODELAY:NEXT ' ** PAUSE LOOP
10001 CLS:RETURN
15000 RESUME NEXT
```

CMC INTERNATIONAL

Price Performance Reliability



CMC IS MEETING TODAY'S HIGH STANDARD OF EXCELLENCE WITH TOSHIBA, CMC'S OWN SUPERFIVE AND SUPERTEN, 5- AND 10-MBYTE MICROCOMPUTERS, AND OTHER FINE PRODUCTS

TOSHIBA DESKTOP COMPUTERS

CMC International offers dealers the new Toshiba computer line, CP/M® -based micros with lots of flexibility...your choice of one or two drives, either 5¼ or 8 inch. Toshiba computers come with C/PM, Microsoft Basic80 and CBasic®. We're proud to offer a system with day-in, day-out dependability, backed by one of the world's largest electronics manufacturers. And, we offer a comprehensive dealer program including parts and module inventory, and prepaid freight for warranty repairs (if you ever need it).

ALSO DISTRIBUTING:

- Corvus
- NEC
- Dysan
- Epson
- Verbatim
- Tandon
- Seagate
- MPI
- Superbrain
- Compustar
- C.Itoh
- MicroPro
- Accounting Plus
- Peachtree
- dBase II

YOUR STOCKING DISTRIBUTOR



A Division of Computer Marketing Corporation

CMC INTERNATIONAL

11058 Main, Suite 125 Bellevue, WA 98004

PHONE (206) 453-9777

T-200 64k RAM, 80x24 12" green phosphor screen, complete with CP/M, MBasic80 and CBasic.

Model 3
One 5¼" 280k
Disk Drive
List **\$3700**

Model 2
Two 5¼" 280k
Disk Drives
List **\$4500**

T-250 64k RAM, 80x24 12" screen, complete with CP/M, MBasic80 and CBasic.

Model 3
One 8" 1mbyte
Disk Drive
List **\$4750**

Model 2
Two 8" 1mbyte
Disk Drives
List **\$5750**

EXCELLENT DEALER DISCOUNTS

To Order Call Toll Free
1-800-426-2963

TELEX: 152 556 SEATAC

and TRSDOS. Table 2 is a summary of the results of that benchmark. For the Model III, TRSDOS 1.3 was used. The Model I benchmark presented a problem since TRSDOS 2.3 does not officially support variable LRLs (i.e., logical record lengths less than 256 bytes). The latest version, TRSDOS 2.3B, does support variable LRLs on the Radio Shack Compiler BASIC package, but not with the interpreter. Variable LRLs are partially implemented in TRSDOS 2.3 and 2.3B, but they cause errors to occur. In investigating this, I discovered that it was possible to write records in this file mode, but not to read them. Furthermore, the write procedure appeared to work fine, except that when the file was to be CLOSED an error message appeared. Consequently, the timings given for TRSDOS on the Model I should not be treated as true benchmarks. They are included here only as a point of interest. It is interesting to note that, even with the errors being generated, the figures for the Model I and Model III are remarkably similar. This seems to indicate that, if Radio Shack ever implemented variable LRLs on the Model I, no significant improvement in efficiency could be expected unless the entire procedure was rewritten.

Summary and Conclusions

It is probably apparent that I really like LDOS. It is by far the most sophisticated piece of systems software available for the TRS-80 (and probably for any computer priced under \$5000). It offers unprecedented features, giving the TRS-80 new applications previously impossible without a massive programming effort. I had been considering selling my Model I and upgrading. After using LDOS, it became apparent that, while I might improve the hardware, I would be hard-pressed to come up with a more usable and better supported system in an affordable price range.

Specifically, LDOS offers these unique features:

- A user-oriented DOS that doesn't require in-depth technical knowledge to use well.

- A level of documentation and technical support almost unheard of in anything but minicomputers and mainframes.

- Virtually problem-free operation. In the months I have used LDOS, the only problem encountered was the disk-speed problem mentioned earlier.

- The possibility of true portability between members of the TRS-80 family, as well as some S-100 computers. Versions of LDOS for the Model II and certain S-100 computers are planned. These will probably be CP/M-compatible to some extent and will allow transporting data disks between any machines running under LDOS (provided the media are compatible).

- An exceptional bargain! If the in-

dividual features of LDOS were bought separately, the price would be near \$1000. The SPOOL feature alone would cost almost as much as the complete LDOS package.

It is difficult to conceive of a TRS-80 user who would not benefit from LDOS. In fact, the overall programming efficiency should at least double. Even if you are using another advanced DOS, it would be worthwhile to look into LDOS because its advanced features are yet to be rivaled in any one competitive operating system. If you are about to purchase a disk system or a new DOS, you'll find LDOS to be a professional, debugged, and efficient tool that will free your time and talents to write better applications software. ■

Function	Model III				Model I			
	TRSDOS 1.3		LDOS 5.1		TRSDOS 2.3B		LDOS 5.0.2	
	Real Time	Clock Time	Real Time	Clock Time	Real Time	Clock Time	Real Time	Clock Time
Write New File LRL = 2 2000 Records	13:23	2:09	1:28	1:28	13:36	-----	1:37	1:38
Write To Existing File LRL = 2 200 Records	1:21	0:13	0:09	0:09	1:23	-----	0:11	0:11
Read Existing File LRL = 2 2000 Records	6:37	1:54	0:49	0:49	-----	-----	1:05	1:06
Write New File LRL = 128 200 Records	1:52	0:26	1:05	1:05	1:42	-----	1:28	1:30
Write New File LRL = 256 100 Records	-----	-----	-----	-----	0:45	0:20	0:55	0:55
Read Existing File LRL = 256 50 Records	-----	-----	-----	-----	-----	-----	0:10	0:11

Table 2: The results from the Benchmark program. Times given are in minutes and seconds. Blank spaces indicate tests not run on the Model III, or not possible with the Model I.

Double your disk storage capacity...

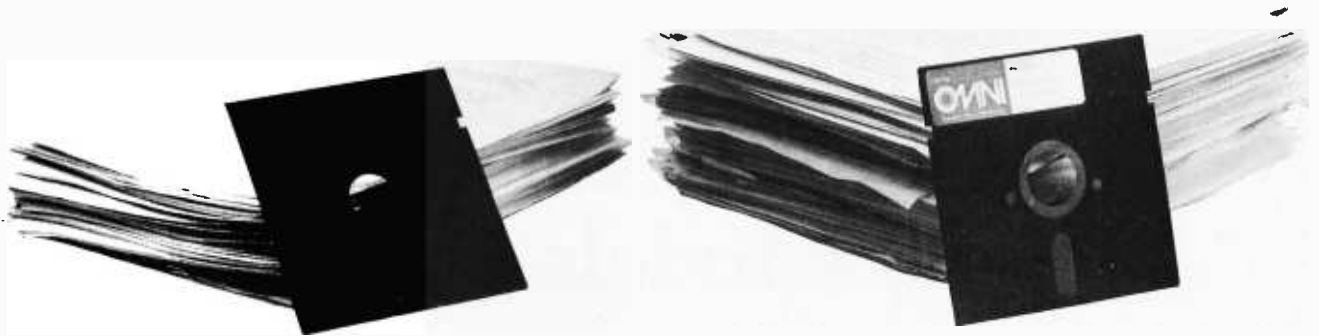

simply by switching to Omni's new reversible disk.

If you have an Apple, TRS-80, Zenith, North Star or any other single-sided 5 1/4" disk drive, you can double disk capacity by simply switching to the Flip/Floppy disk from Omni. It works just like your present disks, except you can flip it over and record on the reverse side. So you can consolidate programs and files that used to require two disks. You can halve your disk requirements. And save money.

Each disk comes with some impressive specifications: They're certified error-free at more than twice the error-threshold of your system. Rated for more than 12 million passes without disk-related errors or significant wear. And precision fabricated with such standard features as reinforced hub rings.

Call Omni toll-free today. Get premium disks. Twice the capacity. A full money-back guarantee. Unbeatable price. And if you order a ten pack now, a free \$5.00 storage case as well.

OMNI

Omni Resources Corporation

4 Oak Pond Avenue, Millbury, MA 01527
(800) 343-7620 In Mass. (617) 799-0197

Dealer inquiries invited.

Software Houses: We also offer duplicating and formatting services.

\$26.00-Five pack

(Equivalent to 10 single-sided disks)

\$50.00-Ten pack

(Equivalent to 20 single-sided disks)

Free

Protective plastic storage case with each 10 pack ordered by 5/1/82



Order toll-free (800) 343-7620.
In Mass. (617) 799-0197.

Send the following Flip/Floppy disks.

I understand they have a full 90 day money-back guarantee if I'm not completely satisfied.

System & model # _____

___ Five packs @ \$26.00 \$ _____

___ Ten packs @ \$50.00 * \$ _____

* includes plastic case

Shipping and handling \$ _____ 1.50

5% sales tax (Mass. only) \$ _____

Total \$ _____

___ Check (to Omni Resources) ___ C.O.D.

___ Master Card ___ Visa

Card # _____ Exp _____

Name _____

Address _____

Tel _____

COBOL for the TRS-80 Models I and III

Rowland Archer Jr.
Flint Ridge Apartment 59
Hillsborough, NC 27278

COBOL on a TRS-80 Model I? Yes, I was skeptical myself. Visions of COBOL's notoriously verbose source code rapidly filling memory and floppy disks led me to believe that Radio Shack had probably exceeded the limitations of the TRS-80 this time. I have been surprised in the past by some things people have converted from mainframes and minicomputers to microcomputers, but COBOL seemed like too much. Now, after substantial use of the system, I can happily report that Radio Shack's COBOL package is professionally done and well suited to the TRS-80.

COBOL is the most widely used programming language in the world. Over the years, the American National Standards Institute (ANSI) CODASYL committee has overseen the evolution of COBOL into a powerful language highly suited for business applications. It is particularly strong in its file-handling capabilities. Also, Radio Shack has announced that all the business-application software it develops in the future for the TRS-80 Model II will be done in COBOL.

Radio Shack COBOL (RSCOBOL) is a complete COBOL program development system. It implements a substantial portion of the ANSI X3.23-1974 COBOL Standard (the most recently approved standard). The package contains two 5¼-inch

floppy disks for the TRS-80 Model I and one for the Model III. My report is based on the use of the Model I system. The Model III version is supposed to be functionally identical.

The disks contain:

1. CEDIT, a line-oriented text editor for preparing COBOL source programs. This editor is similar to the one provided with the Model I EDTSAM (Editor-Assembler) package, with tab settings for COBOL and several additional commands.

2. The RSCOBOL compiler supplied in Z80 machine-language format. It produces an object file, listing file, and cross-reference list in a single pass over the source code.
3. The RUNCOBOL run-time package, including an interactive COBOL debugger. The output of the RSCOBOL compiler can be run immediately with no need to go through a linking/loading phase, such as the one required by Radio Shack's FORTRAN package.

At a Glance

Name
RSCOBOL

Type
TRS-80 COBOL development system

Author
Ryan-McFarland Corporation
Software Products Group
Aptos, CA 95003

Distributor
Tandy Corporation
One Tandy Center
Fort Worth, TX 76102
(817) 390-3583

Price
\$199

Software
All software needed to run COBOL on both Model I and Model III TRS-80s, provided on three 5¼-inch floppy disks. This includes a line-oriented text editor.

overlaid COBOL compiler, interactive COBOL debugger, and run-time package.

Software Format
Model I version requires TRSDOS 2.3B, which is provided with the package; Model III version requires TRSDOS 1.1, which is also provided.

Computer
TRS-80 Model I or III with 48K bytes of RAM and at least two disk drives

Documentation
Concise but complete explanation of system operation; lengthy and thorough description of language; written in the style of a reference manual, not a tutorial; 368 pages.

Audience
Programmers in need of a COBOL development system for the TRS-80 Model I or III

Interested in computers or robotics? Looking for info on hardware, software, theory, and applications?



The Computer Book Club offers you an incredible range of computer books and a huge variety of tapes and disks . . . ALL at low, low member prices!

Select 6 fact-filled books for only \$2.95 (total value up to \$111.70)

1000 List \$10.95: 57 PRACTICAL PROGRAMS & GAMES IN BASIC

1070 List \$14.95: Digital Interfacing With An Analog World

1209 List \$11.95: THE MC6809 COOKBOOK

1053 List \$12.95: Microprocessor Cookbook

1290 List \$15.95: IC TIMER HANDBOOK

1332 List \$16.95: HOW TO DESIGN, BUILD & PROGRAM YOUR OWN ADVANCED WORKING COMPUTER SYSTEM

1050 List \$10.95: THE MOST POPULAR SUBROUTINES IN BASIC

1341 List \$18.95: HOW TO DESIGN & BUILD YOUR OWN CUSTOM ROBOT

1333 List \$16.95: 101 MICROPROCESSOR SOFTWARE & HARDWARE PROJECTS

1169 List \$15.95: ROBOT INTELLIGENCE with experiments

1200 List \$16.95: HOW TO BUILD YOUR OWN WORKING MICROCOMPUTER

1187 List \$15.95: PLAYING THE STOCK & BOND MARKETS WITH YOUR PERSONAL COMPUTER

1275 List \$14.95: 33 Challenging Computer Games for TRS-80 /Apple /PET

1191 List \$16.95: COMPUTER TECHNICIAN'S HANDBOOK

1187 List \$15.95: THE FORTRAN Cookbook

1305 List \$15.95: MICROCOMPUTERS IN AMATEUR RADIO

1195 List \$12.95: 67 Ready-To-Run Programs in BASIC: graphics, home & business, education, games

1251 List \$16.95: HOW TO DESIGN/BUILD REMOTE CONTROL DEVICES

1277 List \$19.95: How to Design & Build Your Own Custom TV Games

1101 List \$15.95: DIGITAL ELECTRONICS TROUBLESHOOTING

985 List \$9.95: Programming Microprocessors

1160 List \$12.95: 1001 THINGS TO DO WITH YOUR PERSONAL COMPUTER

1228 List \$12.95: 34 MORE Tested, Ready-To-Run Game Programs In BASIC

1108 List \$12.95: LASERS, THE LIGHT FANTASY

1141 List \$11.95: HOW TO BUILD YOUR OWN WORKING ROBOT PET

1088 List \$13.95: ILLUSTRATED DICTIONARY OF MICROCOMPUTER TERMINOLOGY

1303 List \$14.95: HOW TO SOLVE STATISTICAL PROBLEMS WITH YOUR POCKET CALCULATOR

7 very good reasons to try The Computer Book Club

Blue Ridge Summit, PA 17214

- **Reduced Member Prices.** Save up to 75% on books sure to increase your know-how
- **Satisfaction Guaranteed.** All books returnable within 10 days without obligation
- **Club News Bulletins.** All about current selections—mains, alternates, extras—plus bonus offers. Comes 10 times a year with dozens of up-to-the-minute titles you can pick from
- **"Automatic Order".** Do nothing, and the Main selection will be shipped automatically! But . . . if you want an Alternate—or no books at all—we'll follow the instructions you give on the reply form provided with every News Bulletin
- **Continuing Benefits.** Get a Dividend Certificate with every book purchased after fulfilling membership obligation, and qualify for discounts on many other volumes
- **Extra Bonuses.** Take advantage of added-value promotions, plus special discounts of software, games, and more
- **Exceptional Quality.** All books are first-rate publisher's editions, filled with up-to-the-minute info



THE COMPUTER BOOK CLUB

Blue Ridge Summit, PA 17214

Please accept my membership in the Computer Book Club and send the 6 volumes circled below. I understand the cost of the books selected is \$2.95 (plus shipping/handling). If not satisfied, I may return the books within ten days without obligation and have my membership cancelled. I agree to purchase 4 or more books at reduced Club prices during the next 12 months, and may resign any time thereafter.

554 985 1000 1050 1053 1070 1088 1101 1108
1141 1160 1169 1187 1191 1195 1200 1209 1228 1250
1251 1275 1277 1290 1303 1305 1332 1333 1341

Name _____ Phone _____

Address _____

City _____

State _____ Zip _____

(Valid for new members only. Foreign and Canada add 20%. Orders outside U.S. or Canada must be prepaid with international money orders in U.S. dollars.)

BY-382

**more . . .
SPECTACULAR
OFFERS**



BASF



WABASH



MAXELL



OPUS

We stock the complete line of BASF diskettes, reel-to-reel tapes, mag cards, disk packs and cartridges. We also carry MAXELL, OPUS and WABASH products. All are 100% certified and fully guaranteed.

Box of 10 diskettes:	5 1/4"	8"
OPUS ss/sd	\$20	\$21
BASF ss/sd	23	24
WABASH ss/sd	23	24
MAXELL . . . TOO LOW TO QUOTE.	CALL	

5 1/4" -10 sector-now available
Securing must be specified.

5 1/4" or 8" Vinyl Storage Pages 10/\$5

LIBRARY CASES

8" Kas-sette/10 **\$2.99**
5 1/4" Mini Kas-sette/10 . . . **\$2.49**



HARDHOLE DISK PROTECTORS
Reinforcing rings of tough mylar protect disk hole edge from damage.

Applicators	5 1/4"	8"
Hardhole Rings (50)	\$3	\$4
	\$6	\$8

**DISK DRIVE HEAD
CLEANING KITS**

Prevent head crashes and ensure error-free operation.
5 1/4" or 8" **\$19.50**



SFD C-10 CASSETTES 10/\$7
(All cassettes include box and labels.)



Get 8 cassettes, C-10 Sonic, and Cassette/8 Library-Album, as illustrated, for only **\$8**

SNAP-IT POWER CENTER

Turns 1 outlet into 6. Wall mount or portable. Circuit breaker, lghted switch and UL approved.



4"x3"x2" **\$19.95**

We also offer printer ribbons, printwheels, type elements, equipment covers, power consoles, paper supplies, storage and filing equipment, furniture and many other accessories for word and data processing systems. Write for our free catalog.

VISA • MASTERCHARGE • MONEY ORDERS • CERTIFIED CHECK • FOR PERSONAL CHECKS ALLOW TWO WEEKS • C.O.D. REQUIRES A 10% DEPOSIT • CAL. RES. ADD 6% SALES TAX • MIN \$2 SHIPPING & HANDLING • MINIMUM ORDER \$10 • SATISFACTION GUARANTEED OR FULL REFUND

**ABM
PRODUCTS**

8868 CLAIREMONT MESA BLVD.
SAN DIEGO, CALIFORNIA 92123

Toll Free 800-854-1555 Order Only
For Information or California Orders
(714) 268-3537

A New TRSDOS?

TRSDOS 2.3B is being provided with RSCOBOL, the new RSBASIC Model I BASIC Compiler, and the Series 1 Editor/Assembler. Each of these packages requires TRSDOS 2.3B and will not run under older versions of TRSDOS or other disk operating systems from alternate vendors (at least not at the time of this writing; the alternate DOS vendors will probably do something to remedy this situation).

Because of its dependence on certain features of TRSDOS 2.3B, the RSCOBOL package cannot be used without modification on systems that support double-density disk storage on the Model I, such as LDOS and NEWDOS/80, although the extra disk storage would certainly be useful for this package.

A utility, UPGRADE, is provided to convert a disk made with older versions of TRSDOS to run under 2.3B. However, once the disk is upgraded it can no longer be used with an older TRSDOS. UPGRADE also deletes any system (TRSDOS) files that happen to be on the disk being upgraded. Therefore, make sure you really want this to happen before you run the program!

The major change to TRSDOS is in the way it maintains the end-of-file (EOF) information in a disk's directory. The old systems maintained a 2-byte count of sectors in use by the file, plus a 1-byte offset of the last byte in use in the last sector. The new system maintains these 3 bytes differently. Together, the 3 bytes comprise a true total byte length of the file; if the EOF offset byte is not zero, the sector-count byte is one less than it was under the old system.

Ironically, this is the way Apparat's NEWDOS systems have always maintained the EOF internally. It was a "correction" to TRSDOS 2.1 noted in the documentation for NEWDOS 2.1, released more than two years ago. NEWDOS systems, however, convert the EOF data to be compatible with TRSDOS 2.3's "incorrect" method when they write the EOF to the disk directory. This makes NEWDOS-created disk files compatible with TRSDOS 2.3 and earlier systems, but incompatible with TRSDOS 2.3B—which uses the NEWDOS EOF method not only internally, but also in the disk directory. If you are confused, imagine the fun this creates when you have disks generated by both systems in your library!

In practice, this means that any machine-language program that does physical record disk I/O and maintains the EOF pointer itself will not function properly under TRSDOS 2.3B. For example, you cannot use Radio Shack's Scripsit to edit RSCOBOL source files without using a utility to move the files back and forth between TRSDOS 2.3 and 2.3B disks. However, Radio Shack provides only a utility for converting all the files on a 2.3 disk to 2.3B format. It is unfortunate that Radio Shack had to make these changes to TRSDOS, as they will certainly cause lots of confusion for thousands of TRS-80 users. [Editor's Note: TRSDOS 2.3B is not a replacement for TRSDOS 2.3. Radio Shack says it is only required for use with the RSCOBOL, Series 1 Editor/Assembler, and RSBASIC Compiler packages. . . . SJW]

New TRSDOS

One of the biggest surprises of this package was the introduction of a new version of DOS (disk operating system) for the Model I, TRSDOS 2.3B. I had seen no mention of this upgrade when I purchased RSCOBOL. Although this new release is only slightly different from TRSDOS 2.3, one of its changes is significant enough to make 2.3B disks

incompatible with any other TRS-80 disk operating system, including NEWDOS, LDOS, TRSDOS 2.3, and its predecessors. This raises many "interesting" (read "painful") problems with file sharing between the various systems.

System Overview

The RSCOBOL system is heavily disk oriented. It requires two disk

ORDER TOLL-FREE

consumer computers Mail Order DISCOUNTS

FREE SHIPPING
on all pre-paid cash orders

NEC Microcomputer



PC-8001A 32K Computer
PC-8012A I/O Unit w/32K RAM
PC-8013A Dual Mini-Disk Drive Unit
PC-8001 Multi Cardware (FDI/O & 32K)
CP/M 2.2 Operating System for NEC
WordStar configured for NEC
SuperCalc configured for NEC
NEC Wordprocessor & Accounting Software
Many more software packages and languages:
(Pascal, Fortran, Cobol, etc) are available configured for the NEC 8001A Computer.
Please call or write for a product price list.

CALL FOR PRICES

Software for the Apple

VisiCalc version 3.3 199
VisiFile (NEW data base manager) 249
VisiTrend / VisiPlot 249
VisiDex 199
VisiTerm 99
Desktop Plan II 159
DB Master 189
Wordstar (Apple 80-col version) 299
Easywriter Word Processor (80 col) 199
Tax Preparer 89
Real Estate Analyzer 129
Creative Financing 139
Personal Filing System (PFS) 79
Peachtree Accounting Software CALL
BPI Accounting Software CALL
Systems Plus Acctng Software CALL

Apple Cards and Hardware

16K RamBoard by ConComp Industries 129
Hayes Micromodem II 299
Novation Apple-Cat 339
Videx Videoterm 80 Column card 249
Videx Keyboard Enhancer 115
Z-80 Softcard by Microsoft 299
16K RamCard by Microsoft 159
ThunderClock Plus clock/calendar card 129
Smarterm 80 column card 299
Corvus Winchester Hard Disk Drives CALL
ALF 3 Voice Music Card 199
ALF 9 Voice Music Card 149
Lazer Lower Case Plus + 55
Lazer Keyboard Plus + 99
23 Key Numeric Keypad by Keyboard Co 120
Joystick II by Keyboard Co 45
6809 CPU Card (The Mill) by Stellation 319
AIO Serial & Parallel Interface by SSM A&T 189
Music System (16 voices) 299
A/D + D/A Interface 279
Expansion Chassis (8 slots) 569
Introl X-10 Controller Card 169
Clock / Calendar Card 225
CPS Multi-Function Card 175
SuperTalker SD-200 159
Romplus + Card 135
Romwriter Card 149
Symtec Hi-Res Light Pen 210
Sup-R-Fan ventilation system for Apple II 45
Sup-R-Terminal 80 column card by M&R 329
SVA 2VX4 Megabyte 8" Disk Controller 589
SVA 2+2 Single Den. 8" Disk Controller 345
Speechlink 2000 by Heuristics 249
Versawriter Digitizer Tablet 229
Asynchronous Serial interface card by CCS 139
Centronics Parallel Interface card by CCS 119
We carry all California Computer System Cards CALL
We stock many more items for the Apple II.
Please call or write for current price list.

Printers

Epson MX-80 or MX-80 FT CALL



Anadex 9501 w/2K Buffer 1349
C. Itoh Starwriter 25 CPS daisywheel 1449
C. Itoh Starwriter 45 CPS daisywheel 1649
Epson MX-70 CALL
Epson MX-80 & MX-80 FT CALL
Epson MX-100 CALL
NEC 8023 Impact Dot Matrix 629
NEC Spinwriters (Latest models) CALL
Paper Tiger IDS-460G w/graphics 899
Paper Tiger IDS-560G w/graphics 1099
Qume Spring Daisywheels (Latest models) CALL
Diablo 630 Daisywheel 40 CPS 1795

Video Monitors

Amdek / Leedex Video 100 12" B&W 129
Amdek / Leedex Video 100G 12" Green Phosphor 149
Amdek (Hitachi) 13" Color w/ audio output 389
NEC 12" Green Phosphor Display JB-1201M CALL
NEC 12" Lo-Res Color Display CALL
NEC 12" Hi-Res RGB Color Display CALL
Sanyo 9" B&W Display 185
Sanyo 9" Green Display CALL
Sanyo 12" B&W Display 269
Sanyo 12" Green Phosphor Display 285
Sanyo 13" Color Display 449
Zenith 12" Green Phosphor Display 139

16K RAMBOARD by ConComp for Apple II Computers

\$129

FOR ONLY

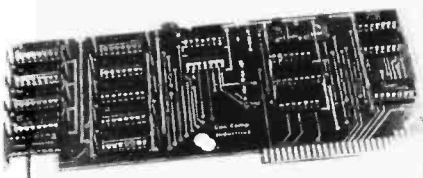

AVAILABLE NOW



ZENITH 12" GREEN \$139

AVAILABLE NOW!

IBM ACCESSORIES BY TECMAR

256 K Dynamic Ram Card CALL FOR BEST PRICES
Hi-Speed Parallel I/O Card
Hi-Speed Serial I/O Card
Real-Time System Clock
Card Expansion Chassis
And Many More Accessories!

Ordering information: Phone orders using VISA, MASTERCARD, AMERICAN EXPRESS, DINER'S CLUB, CARTE BLANCHE, bank wire transfer, cashier's or certified check, money order, or personal check (allow ten days to clear). Unless prepaid with cash, please add 5% for shipping, handling and insurance (minimum 5.00). California residents add 6% sales tax. Foreign customers please add 10% for shipping. OEM's, Institutions and corporations please send for a written quotation. All equipment is subject to price change and availability without notice. All equipment is new and complete with manufacturer's warranty (usually 90 days). Showroom prices may differ from mail order prices.

Send Orders to:
consumer computers Mail Order
8314 Parkway Drive
La Mesa, California 92041

ATARI PERSONAL COMPUTERS



ATARI 800 16K PLEASE CALL FOR BEST PRICE

Atari 400 w/16K 349
410 Program Recorder 65
810 Disk Drive 449
825 80 col. 7x8 Dot matrix impact printer 699
822 40 col. Quiet Thermal Printer 349
850 Interface Module 159
Atari 16K Ram Module 69
Axlon Ramcram 32K Module 189
Asteroids, Missile Command and Star Raiders 35 ea.

VIC20™ \$259

Personal Computer
Color * Sound * Graphics
Call or write for more info.
Disk drives available soon!

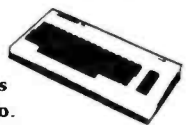

ORDER TOLL FREE 800-854-6654
In California and outside continental U.S.
(714) 698-8088
Telex 695-000 Beta CCMO

Circle 108 on Inquiry card.

DONT GET BURNT

There's a lot of excellent computers on the market, but make sure you don't get sold a system that isn't right for your needs. Find out about available software before buying hardware or you may end up with a lemon instead of an apple.

The International Microcomputer Software Directory (IMSD) is quite simply the best reference source on microcomputer software. Five important features have put it first in its field.

1 Comprehensive: Our database contains full details of over seven thousand programs covering every conceivable business application.

2 Up-to-date: The directory is being continually updated to include the very latest software available.

3 Relevant: The IMSD only contains programs specifically written for microcomputers.

4 Easy-to-use: Fully indexed and cross-referenced so you can access the information you need in a matter of seconds.

5 Independent: We have no affiliation with any computer manufacturer or software houses listed so all the information is completely objective.

ON-LINE SERVICE: The IMSD is available on-line through Lockheed Dialog Information Services starting early 1982.

ON-DEMAND SERVICE: We are also able to provide up-to-the-minute information on demand by telephone or mail.

MINI-COMPUTER DIRECTORY: Available early 1982. Details on request.

INTERNATIONAL MICROCOMPUTER SOFTWARE DIRECTORY



1982 Edition now available — Includes January '82 update. ORDER YOUR COPY TODAY — ONLY \$34.95.

No risk offer. If not absolutely delighted, purchase price will be refunded.

Name _____
Address _____

Check enclosed, please add \$2.95 postage.

All Major credit cards accepted. Telephone orders welcome.

Acc. No. _____

Please state which _____ Exp. Date _____

Imprint Software
420 SOUTH HOWES
FORT COLLINS, CO 80521
TEL (303) 482-5574

drives. Since the compiler and the run-time module both use overlays, these disks must always be online during compilation and execution.

During compilation, the files in table 1 must be online. During execution of COBOL programs, the files in table 2 must be online. The best way to set up the disks in a two-drive system has the disk in drive 0 containing TRSDOS and either all the files needed to compile a program or all the files needed to run one. This allows the disk in drive 1 to be formatted as a "data disk," with all its space available for COBOL source code, object code, and/or the files used by applications programs. In fact, the disk containing both TRSDOS and the run-time system has enough space for a sizable COBOL object program, allowing drive 1 to be used entirely for data.

Unfortunately, Radio Shack didn't see it this way and its disks are set up differently. Only the run-time disk contains the TRSDOS system files. This disk does *not* contain the run-time debugger overlay, RSCBLD13/OBJ. That file is on the disk that must go in drive 1. The second disk con-

tains the COBOL compiler, all overlays, and the COBOL editor. Even since this disk does not contain TRSDOS, you must have a disk containing TRSDOS in drive 0 while you are compiling. Where should you put your COBOL source code and object code? Take your pick, but you must share space on the same disk with either TRSDOS or the compiler and its overlays.

Why the fuss about file placement? After all, can't you just use COPY to move the files around to achieve more logical placement? Due to an inexplicable move on Radio Shack's part, you can't. Although the disks as a whole can be copied using BACKUP utility, all the COBOL system files are password protected and can't be copied individually. Frankly, the logic of this escapes me. There is no protection against piracy as both disks may be copied freely with no restrictions. But the license owner of the system is prevented from moving individual files around to increase the usefulness of the system. Does anyone in Fort Worth care to explain this policy? It is either a slip-up or Radio Shack is trying

File	Function	Size, GRANS
RUNCOBOL/CMD	COBOL Run-time	25
RSCBLD13/OBJ	Debugger overlay (Only needed if debugger is used)	2

*One GRAN = five 256-byte sectors, or 1280 bytes.

Table 1: These files must be online during program compilation.

File	Function	Size, GRANS
RSCOBOL/CMD	COBOL Compiler	23
RSCBL213/OBJ	Compiler overlay	6
RSCBL313/OBJ	Compiler overlay	6
RSCBL413/OBJ	Compiler overlay	5

*One GRAN = five 256-byte sectors, or 1280 bytes.

Table 2: These files must be online during program execution.

ONE-STOP LEASING

at your
FALS Dealer.



Your Ford Authorized Leasing System Dealer offers a comprehensive package of benefits designed to take the hassle out of leasing a car. Just purchase the parts of the package that suit you best. It's as simple as that.

- The Ford Extended

Service Plan gives parts and service protection beyond the normal car warranty • FALS Maintenance Leasing. It means your car is cared for by Ford-trained professionals using the latest diagnostic equipment and tools • A Ford Auto Club membership provides you with

emergency road service reimbursement • Preferred Insurance Program. Your insurance can be conveniently arranged by your FALS Dealer. One-stop leasing. It's simple, comprehensive and hassle free. Just see your FALS Dealer for details.

Check your Yellow Pages for your nearest Ford Authorized Leasing System Dealer.



FORD DIVISION 



LOOK OUT WORLD HERE COMES FORD



KISS BASIC GOODBYE



Announcing the new quick and easy way to write custom business applications in hours instead of weeks.

At last, you can get a microcomputer business application development system that is designed for one purpose only . . . fast production of bug-free professional-looking custom business applications.

"Thinks" the Way Business Thinks

Quic-N-Easi is the revolutionary screen-format-oriented application development system that thinks in terms of transactions, records and fields. The same way business thinks. **Quic-N-Easi** expects an application to include custom formatted key entry. It lets you set up the character, field, and record validity checks business wants by merely filling in the blanks. It automatically signals in real time when errors occur and "explains" what is wrong in plain English messages you select for each custom application.

Much Faster than BASIC

Quic-N-Easi programming is much faster than BASIC because the standard business applications (key input, file handling, and output reporting) are handled via pre-programmed parameter driven sub-routines. To produce finished professional looking custom business programs, you merely:

- Draw the business formats directly on the CRT in minutes.
- Fill in the blanks for field attributes, validations, tables, etc.
- Invoke the **Quic-N-Easi** interpreter to check fields against tables, check limits, access data files, and perform business calculations, etc.

- Optionally define file and output formats right on the screen.

Pays for Itself in a Week

By eliminating the coding drudgery of writing screen, field, file, and format programs in BASIC, programmers are free to concentrate on the unique business aspects of each custom application. No professional programmer can afford to develop one more business application without **Quic-N-Easi**. The savings are so significant with **Quic-N-Easi**, it can actually pay for itself in only one week.

Gives You Much More than a Screen Builder . . . the Only Complete Business Development System for Microcomputers

Quic-N-Easi handles the entire application development job from key entry to final output. You get everything you need, including detailed documentation to begin writing professional programs the first day. **You get . . .**

- A singularly capable **Quic-N-Easi** screen builder
- A comprehensive parameter driven **Quic-N-Easi** content editor
- A full **Quic-N-Easi** interpreter language
- A complete **Quic-N-Easi** file management system with Index Sequential, Random, and Sequential File Access Method
- A complete **Quic-N-Easi** print format handler
- A detailed **Quic-N-Easi** reference manual

- A **Quic-N-Easi** self-teaching guide
- A **Quic-N-Easi** quick reference card
- An interface to other program files

ORDER NOW—Don't Waste One More Day Coding BASIC

Your time is too valuable to waste hours on end writing BASIC code. The first week you use **Quic-N-Easi**, your finished business programs will look better, run better, and return more dollars to you. Don't delay. Order **Quic-N-Easi** today. Phone . . . **215 968-0689**

QUIC-N-EASI™

STANDARD MICROSYSTEMS INC.
136 GRANITE HILL COURT, LANGHORNE, PA 19047

Pricing Information

- Complete **Quic-N-Easi** system **\$395**
- Manual only **\$60**
- **Visa** and **Mastercard** accepted
- **Dealer Inquiries Invited**

Minimum System Requirements

- 280 • 48K • Floppy Disc
- CP/M (except TRS80 Mod III)

Disk Formats

- 8" Single Density • VECTOR GRAPHICS • MICROPOLIS Mod 2 • TRS80 Mod II • TRS80 Mod III • APPLE • OSBORNE • INTERTEC • ZENITH

Apple, CP/M, Intertec, Micropolis, and TRS80 are trademarks of Apple Computer, Digital Research, Intertec Data Systems, Micropolis Corp., and Tandy Corp.

Listing 1: A sample program created using the COBOL development system. The program searches sequential disk files for records that match the key entered by the user. For a further explanation of how this COBOL program operates, see the text box on page 392.

TRS-80 Model I/III COBOL (RM/COBOL 1.3B) 08/17/81 08:30:52 PAGE 1
SOURCE FILE: SAMPLE OPTION LIST: (T X L=1 O=1

```

LINE  DEBUG  PG/LN  A...E.....
1      000100 IDENTIFICATION DIVISION.
2      000110 PROGRAM-ID.
3      000120 SAMPLE.
4      000130 AUTHOR.
5      000140 ROWLAND ARCHER.
6      000150 DATE-WRITTEN.
7      000160 29 JULY 1981.
8      000170
9      000180 ENVIRONMENT DIVISION.
10     000190
11     000200 CONFIGURATION SECTION.
12     000210 SOURCE-COMPUTER. RMC.
13     000220 OBJECT-COMPUTER. RMC.
14     000230
15     000240 INPUT-OUTPUT SECTION.
16     000250 FILE-CONTROL.
17     000260 SELECT INFILE ASSIGN TO INPUT, "INFILE/DAT:1".
18     000270
19     000280 DATA DIVISION.
20     000290
21     000300 FILE SECTION.
22     000310 FD INFILE
23     000320 LABEL RECORDS ARE OMITTED.
24     000330 01 INFILE-RECORD PIC X(80).
25     000340
26     000350 WORKING-STORAGE SECTION.
27     000360
28     000370 01 IN-RECORD.
29     000380 05 RECORD-KEY PIC X(5).
30     000390 05 REST-OF-RECORD PIC X(75).
31     000400
32     000410 01 USER-QUITS-FLAG PIC XXX VALUE "NO".
33     000420 88 USER-QUITS VALUE "YES".
34     000430
35     000440 01 MORE-DATA-REMAINS-FLAG PIC XXX VALUE "YES".
36     000450 88 NO-MORE-DATA-REMAINS VALUE "NO".
37     000460 88 MORE-DATA-REMAINS VALUE "YES".
38     000470
39     000480 01 REQUEST-KEY-MSG.
40     000490 05 FILLER PIC X(40)
41     000500 VALUE "TYPE SELECTION KEY (OR Q TO QUIT)".
42     000510
43     000520 01 WAIT-MSG.
44     000530 05 FILLER PIC X(40)
45     000540 VALUE "HIT <ENTER> TO CONTINUE".
46     000550 05 WAIT-CHAR PIC X(2).
47     000560
48     000570 01 SELECT-KEY PIC X(5).
49     000580
50     000590 EJECT
51     000600 PROCEDURE DIVISION.
52     000610
53     >0000 000620 RECORD-SELECTION-AND-DISPLAY.
54     >0000 000630 PERFORM GET-KEY-AND-SEARCH-FILE
55     000640 UNTIL USER-QUITS.
56     >000A 000650 STOP RUN.
57     000660
58     >000C 000670 GET-KEY-AND-SEARCH-FILE.
59     >000C 000680 DISPLAY REQUEST-KEY-MSG, LINE 2, ERASE.
60     >0014 000690 ACCEPT SELECT-KEY, POSITION 0, PROMPT, ECHO.
61     >001C 000700 IF SELECT-KEY = "Q"
62     000710 MOVE "YES" TO USER-QUITS-FLAG
63     000720 ELSE
64     000730 OPEN INPUT INFILE
65     000740 PERFORM SEARCH-FILE-AND-DISPLAY-RECORD
66     000750 UNTIL NO-MORE-DATA-REMAINS
67     000760 CLOSE INFILE
68     000770 MOVE "YES" TO MORE-DATA-REMAINS-FLAG
69     000780 DISPLAY WAIT-MSG
70     000790 ACCEPT WAIT-CHAR, POSITION 0, PROMPT, ECHO.
71     000800
72     >0050 000810 SEARCH-FILE-AND-DISPLAY-RECORD.
73     >0050 000820 READ INFILE INTO IN-RECORD
74     000830 AT END MOVE "NO" TO MORE-DATA-REMAINS-FLAG.
75     >0060 000840 IF MORE-DATA-REMAINS
76     000850 AND RECORD-KEY IS EQUAL TO SELECT-KEY
77     000860 DISPLAY IN-RECORD.
78     000870
79     000880 END PROGRAM.

```

sell more disk drives. [Editor's Note: Radio Shack replied saying that they have been using this same method of protecting their application software program files on all Model II software. They stressed that this does not represent a change in Tandy policy and emphasized that there are no restrictions on backups, only on copying individual files. . . .SJW]

For those who own disk editors such as Apparat's Superzap and are familiar with the disk-directory structure, it is a simple matter to overcome this problem by zapping the passwords. However, sensible use of the system should not be restricted to those with this knowledge.

One of the biggest surprises was the introduction of a new version of DOS for the Model I.

On the positive side, all components of the RSCOBOL system appear to honor the high memory pointer address stored at location hexadecimal 4049. This is not documented, but by using a disassembler I found code referencing hexadecimal 4049 during the start-up phase of both the compiler and the run-time package in a manner that suggested it was using hexadecimal 4049 as a pointer to the top of available memory. I have also been using a serial printer driver that protects itself by storing the last available address below itself at hexadecimal 4049. I have experienced no difficulties with the use of this driver during compilation and execution of COBOL programs. If you have an application for this, I recommend careful testing to make sure that it works.

In case you haven't seen a reference to this before, most Model I DOS systems, including TRSDOS 2.3B, store a pointer at location hexadecimal 4049 to the last byte of available memory. Anything stored after the address contained in hexadecimal 4049 is "protected"; programs that follow this protocol, as RSCOBOL appears to, are careful not

A Sample RSCOBOL Program

The sample RSCOBOL program shown in listing 1 prompts the user to type in a selection key (a string of up to five characters); it then reads through a sequentially organized disk file and compares the first five characters of each record in that file against the string typed in at the keyboard. All records whose first 5 bytes match the specified string are listed on the screen. This process is repeated until the user types Q instead of a key value.

The IDENTIFICATION DIVISION of the program, lines 1 through 7, is treated as a comment by the compiler. It tells the program's name, its author, and the date it was written.

The ENVIRONMENT DIVISION contains a CONFIGURATION SECTION. This identifies the SOURCE COMPUTER, or the system on which the program was compiled, as RMC (Ryan-McFarland COBOL). The OBJECT COMPUTER is the system on which the program will run; this is also RMC.

The INPUT-OUTPUT SECTION serves to establish connections between real disk file names and program identifiers for files. In this instance, line 17 logically connects the program file identifier INFILE with the TRSDOS file INFILE/DAT:1. A program variable could have been specified instead of the literal string INFILE/DAT:1, which would have allowed the file name to be specified at run-time rather than compile-time. The keyword INPUT specifies that this file is to be used for INPUT only.

The DATA DIVISION contains declarations for all program variables. Program variables in COBOL are referred to as "data items." The FILE SECTION contains a description of the disk records that will be read from the sequentially organized file INFILE. The WORKING-STORAGE SECTION contains declarations for all the program data items. IN-RECORD is the

name for the "group" data item comprising RECORD-KEY and REST-OF-RECORD. The clause PIC X(5) on RECORD-KEY declares that data item to be a 5-byte long string of alphanumeric characters. (PIC stands for PICTURE; X stands for a number or an alphabetical character.)

The data item USER-QUITS-FLAG in line 32 illustrates one of COBOL's powerful tools for enhancing program readability. This flag is a 3-byte character string (PIC XXX) that initially has the value "NO". USER-QUITS in line 33 is a "Level 88" item; it gives a name to a possible value of USER-QUITS-FLAG. In line 54 of the program, the statement PERFORM GET-KEY-AND-SEARCH-FILE UNTIL USER-QUITS serves to repeatedly perform the code paragraph labeled GET-KEY-AND-SEARCH-FILE until the USER-QUITS-FLAG assumes the value named by USER-QUITS, in this case the string "YES". MORE-DATA-REMAINS-FLAG is another example of the use of "Level 88" data items.

REQUEST-KEY-MSG and WAIT-MSG are data items containing prompts to be printed on the screen using the DISPLAY statement. The VALUE clause gives them initial values.

The PROCEDURE DIVISION of a COBOL program is where the work gets done. It is divided into "paragraphs," each labeled by a name starting in the second column. The first paragraph is named RECORD-SELECTION-AND-DISPLAY. It contains only two statements: one that has been explained already, and STOP RUN, which halts program execution and returns control to TRSDOS.

The next paragraph, labeled GET-KEY-AND-SEARCH-FILE, is the one PERFORMed repeatedly by the first paragraph. It clears the screen (ERASE) and puts the REQUEST-KEY-MSG on the second line of the screen.

It then ACCEPTs a user response from the keyboard, which goes into the data item called SELECT-KEY. POSITION 0 means leave the cursor where it is; PROMPT puts out a prompt of underscores the size of the data item SELECT-KEY; ECHO sends what is typed at the keyboard to the screen. The user is not allowed to type in more characters than will fit in the data item (one per underscore prompt character).

The IF statement in line 61 tests the value of SELECT-KEY typed by the user; if Q is typed, it puts the value "YES" in the USER-QUITS-FLAG. This causes termination of the program because the UNTIL USER-QUITS test in line 55 now evaluates as true.

If the user types anything other than Q, the ELSE part of the IF statement is executed starting at line 64. The file IN-FILE is opened for INPUT, and the paragraph SEARCH-FILE-AND-DISPLAY-RECORD is performed for each record in the file. When the file has been completely processed, it is closed in line 67, the flag MORE-DATA-REMAINS is reset to "YES" for the next time through the loop, and a message is displayed telling the user to hit the ENTER key to continue (lines 69 and 70).

The SEARCH-FILE-AND-DISPLAY-RECORD paragraph reads the next record from INFILE into the data item IN-RECORD. When the end of the file is reached, the word "NO" is put into the MORE-DATA-REMAINS-FLAG. This makes the test UNTIL NO-MORE-DATA-REMAINS in line 66 evaluate as true. If the end of the file is not reached, the RECORD-KEY field of the record read in from the file is compared to the SELECT-KEY typed in by the user. If they match, the entire record is displayed on the screen by the DISPLAY statement in line 77.

to use any memory past this point. This means that you can load any machine-language routines into high memory and set hexadecimal 4049 to point below them; the RSCOBOL system will not clobber your machine-language programs.

To give you a feeling for the

system, I will explain the procedure followed to create, compile, and run the COBOL program shown in listing 1. This is a short (by COBOL standards) program that searches a sequential disk file (very similar to a BASIC sequential file) for records whose key fields match the one typed

in at the keyboard. All matching records are displayed on the screen.

COBOL Editor

To create a COBOL source program, some type of text editor must be used. If you are accustomed to full-screen editors, you will be disap-

The Newest, Easiest to Use, Low-Cost Word Processor

Available
for the Apple II™

The word processor you choose should be powerful, yet simple to use. It should have the features of expensive word processors, and still be reasonably priced. And it should be able to run on any Apple II computer without requiring you to spend a few hundred dollars to buy additional hardware to make the program compatible with the computer.

The word processor that best meets these requirements is Hayden's new PIE Writer: Word Processing System. Here's what John Martellaro of *Peelings II* magazine (the only independent magazine devoted solely to the evaluation of Apple software) has to say about an earlier version of PIE Writer, "...one of the best Word Processors available for the money. It has an abundance of user-oriented features... is very fast and has a powerful editor... has to be considered a best-buy word processor. For the money spent, it cannot be beat. The aesthetics of the input, the power of the editor and formatter and the flexibility are impressive."

PROPORTIONAL AND INCREMENTAL SPACING ADDED

And now PIE Writer is even better. We've added the ability to do incremental spacing so that fractions of a space can be added between words when justifying text. This makes the distribution of the space required to fill out a justified line more uniform and less noticeable. In addition, with its optional proportional spacing formatter program, PIE Writer becomes the ONLY word processor that can print true proportionally spaced documents. Even WordStar™ at almost 3 times the price, can't do that. PIE Writer can also

save the final formatted text on a disk for printing at a later time.

PIE WRITER IS EASY TO USE

Because it is so simple to learn, PIE Writer can be used by anyone who can use a typewriter. The new, simplified manual and interactive tutorial will have even the inexperienced user up and running quickly. In just a matter of minutes you will learn how to enter and delete text, modify what has already been entered and format your information so that it is printed exactly the way you want it.

PIE WRITER IS VERSATILE

Versatility and compatibility are two important features of PIE Writer. While some word processors for the Apple II computer will only work with specific accessories, such as 80-column display boards, lowercase adapters and printers. PIE Writer is versatile enough to work with almost any combination of these. For example, the standard version is available for use on standard Apple II computers with a 40-column display. However, if you have any of the commonly available 80-column display boards, such as the Videx Video Term, Sup'r Term, Smarterm or Double Vision, we have a version of PIE Writer for you. Specify the version you want when ordering.

While the standard Apple computer does not permit the user to enter lowercase characters from the keyboard, PIE Writer does. Even more, PIE Writer supports a wide variety of lowercase adapters that are available, such as those that are available from Dan Paymar, Lazer Systems and Videx.

In addition, PIE Writer permits the user to display and print lines as long as 132 characters (for the 80-column version of PIE Writer). If you want to

see what your text will look like on the printed page before it gets there, you can preview the final page 24 lines at a time and check for page breaks and even get a final page count before the document is printed.

So why settle for less than the best. Get PIE Writer today. A comparison with the other leading word processor ought to convince you.

	PIE Writer	WordStar™
Incremental spacing (microspacing)	Yes	Yes
Proportional spacing	Yes*	No
Split and glue	Yes	Yes
Word Wrap Around	Yes	Yes
Page scrolling (forward & backward)	Yes	Yes
Supports upper & lower case adapters	Yes	Yes
Automatic centering	Yes	Yes
Custom form letters	Yes	Yes
Saves text or binary files	Yes	No
Flexible formatting	Yes	Yes
Suppressed & continued page numbering	Yes	Yes
Hyphenation	No	Yes
Save text segment to a new file	Yes	Yes
Insert text from another file	Yes	Yes
Underlining	Yes	Yes
Automatic search & replace	Yes	Yes
Edits page breaks	Yes	Yes
Status display	Yes	Yes
80-column board versions for the Apple	6	3
Price of software	\$149.95	\$375.00
Total installed price	\$149.95	\$724.00**
* Optional		
** Includes \$349 for a Z80 card.		

How to order: call 800-631-0856, or write to Hayden Book Co., Inc., 50 Essex Street, Rochelle Park, N.J. 07662. Also available from your local computer store.

WordStar is a registered trademark of MicroPro International. Apple is a registered trademark of Apple Computer, Inc. neither is affiliated with Hayden Book Co.

CP/M[®] SOFTWARE

LARGEST SELECTION IN U.S.A.

dBASE II[®] Ashton-Tate \$595	QUICKSCREEN[®] Fox & Geller \$149	WORDSTAR[®] Micropro \$299
CB-80[®] Compiler Systems \$419	SUPERCALC[®] Sorcim \$239	MICROTAX[®] Microtax Systems CALL
SPELLSTAR[®] Micropro \$169	MAILMERGE[®] Micropro \$99	T/MAKER[®] Lifeboat Assoc. \$229
MICROPLAN[®] Chang Labs \$349	CALCSTAR[®] Micropro \$219	BASIC COMPILER[®] Microsoft \$325
BASIC 80[®] Microsoft \$284	SELECT[®] S.I.S. \$395	FMS-80[®] Systems Plus \$649

SAVE ON HARDWARE

TELEVIDEO 910	\$575.00	MICROSOFT SOFTCARD	\$289.00
TELEVIDEO 950	\$955.00	ALTOS PRODUCTS	LESS 20%
C I TOH STARWRITER	\$1429.00	ZENITH PRODUCTS	LESS 20%
C I TOH PROWRITER	\$559.00	C.C.S. PRODUCTS	LESS 20%
IDS 560G	\$1060.00	ARCHIVES PRODUCTS	LESS 20%
		XEROX COMPUTERS	LESS 15%

CP/M is a Trademark of Digital Research

standard software

CORPORATION OF AMERICA

10 MAZZEO DRIVE, RANDOLPH, MA. 02368

617-963-7220



SOFTWARE - HARDWARE - SUPPLIES - DISCOUNT PRICES

pointed with RSCOBOL's editor. Until there is a version of Scripsit or another full-screen editor that works with TRSDOS 2.3B, your only option is to use the line-oriented editor included with the RSCOBOL package. This editor, CEDIT, is written in assembly language. It is very similar to the original Model I EDTASM (Editor-Assembler) package, which in turn bears a close resemblance to the Level II BASIC editor. CEDIT does have a few enhancements, most noticeably the inclusion of a global "replace text" command. All CEDIT commands can be abbreviated to a single letter.

**If you are accustomed
to full-screen editors,
you will be
disappointed with
RSCOBOL's editor.**

CEDIT loads all the text to be edited into memory and saves everything to disk at once. It is not a memory buffer editor, such as the one supplied with Radio Shack's FORTRAN package. Thus, you are restricted to editing files that will fit in memory all at one time. CEDIT saves COBOL source programs on disk in a plain ASCII format; blanks and line numbers are not compressed in any way.

If you look through the CEDIT portion of the RSCOBOL manual, do not be misled by the section titled "Source File Format" on page 3. It implies that each line of source code takes up its own 256-byte disk record. Fortunately, this is not true. Source code lines are packed together and terminated by carriage returns, as in most other TRS-80 editors. The entire file is terminated by a hexadecimal 1A byte.

When you are ready to use CEDIT to create a COBOL source program, you must decide which disks to put online. I have a disk that contains TRSDOS, CEDIT, and the RSCOBOL compiler. This disk goes into drive 0, and a blank disk in drive 1 holds the COBOL source code being edited. Decide in advance which disk

A feast of computing ideas.



You'll love every byte.

If you work with a 6502 or 6809 based system, you're probably hungry for the facts and ideas that will help you understand the inner workings of your computer. You want to go beyond canned software—use your computer for more than games—learn the advanced programming techniques that enable you to get the most out of your 6502/6809 system.

MICRO, The 6502/6809 Journal, gives you page after page, month after month, of solid information to sink your teeth into. **MICRO** is the premier how-to magazine for serious users of the Apple, PET/CBM, OSI, Atari, AIM, SYM, KIM, and all 6809 based systems including the TRS-80 Color Computer. It's a resource journal internationally respected by professionals in business, industry, and education.

SUBSCRIPTION RATES (U.S. dollars)
 Yearly subscription (ISSN 027-9002) saves 20% off the single-issue price.
 U.S., \$24 (SPECIAL OFFER: Save 30% off single-issue price: 2 years, \$42)
 Other countries, \$27 (via surface mail. Foreign air rates available on request.)

Get more out of your Apple . . .

with the **MICRO ON THE APPLE** series

with the most important book ever published for the Apple

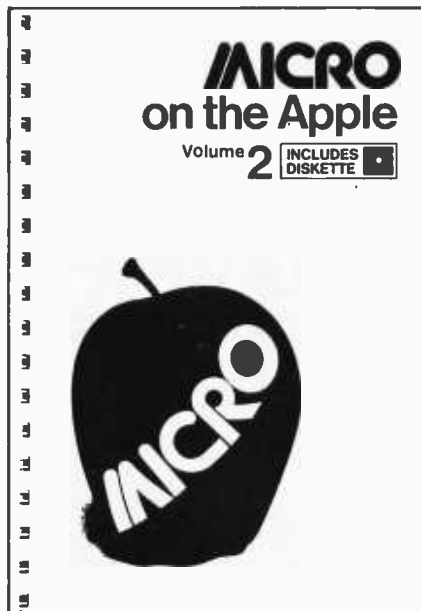

VOLUME 2 just released!

More than 40 new programs on diskette to help you get more from your Apple:

- Machine Language Aids
- I/O Enhancements
- Runtime Utilities
- Graphics and Games
- Hardware and Reference Information

31 choice articles

46 tested programs on diskette
 (13 sector DOS 3.2 format)

Volume 1 also available at \$24.95. Together **MICRO on the Apple 1 & 2** provide more than 70 programs on diskette for less than \$1.00 each. No need to type in hundreds of lines of code.

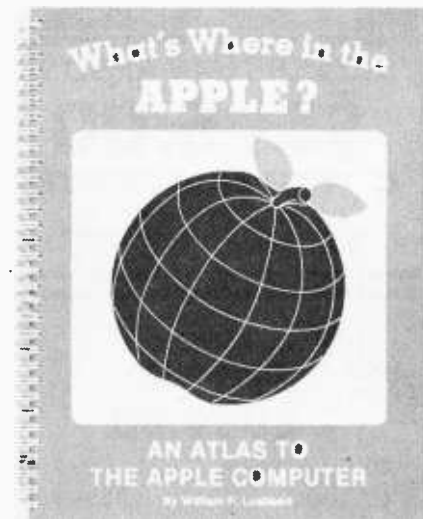

The most comprehensive description of Apple II firmware and hardware ever published—all in one place.

What's Where in the Apple?

- Guides you—with a numerical Atlas and an alphabetical Gazetteer—to over **2,000** memory locations of **PEEKs**, **POKEs** and **CALLs**.

- Gives names and locations of various **Monitor**, **DOS**, **Integer BASIC**, and **Applesoft** routines—and tells you what they're used for.

- Helps BASIC users to speed up their programs.

- Enables assembly language programmers to simplify coding and interfacing.

All Apple users will find this book helpful in understanding their machine, and essential for mastering it!

- ★ Look for all these **MICRO INK** publications at your local computer store, or
- ★ Call our **toll-free** number: **1-800-227-1617, ext. 564** (In California, 1-800-772-3545, ext. 564) and charge it to your VISA or MasterCard, or
- ★ Use the order form below. Send your check (payable to MICRO) and the form to: MICRO, Dept. OA, P.O. Box 6502, Chelmsford, MA 01824.

QTY	ITEM	PRICE EACH	COST	<input type="checkbox"/> Check enclosed	<input type="checkbox"/> Charge my credit card below
_____	MICRO on the Apple 2	@ \$24.95	_____		
_____	MICRO on the Apple 1	@ \$24.95	_____		
_____	What's Where in the Apple?	@ \$14.95	_____		
_____	MICRO (U.S.) 1 yr @ \$24; 2 yrs @ \$42		_____		
_____	MICRO (Foreign) 1 yr @ \$27		_____		
	Subtotal		_____		
	Massachusetts residents add 5% sales tax		_____		
	Add \$2 per book for shipping		_____		
	MICRO Journal excluded. Allow 4-6 weeks for delivery.		_____		
	TOTAL		_____		
				Name _____	
				Company _____	
				Street _____	
				City _____ State _____ ZIP _____	
				Signature _____ <input type="checkbox"/> VISA <input type="checkbox"/> MasterCard	
				Card Number _____	
				Expiration Date _____	

MICROMAIL WON'T TAKE A BYTE OUT OF YOUR BUDGET.

BETTER THAN EPSON!!

\$595.00
C. ITOH 8510 PRINTER
★ NEW ★

ONE PER CUSTOMER

\$499.00
TEC 511 CRT
★ SAVE ★

SPECIAL

DEC

LA 34 DA
\$849.00

DEC LA 34AA \$999.00
VT 100 \$1399.00

TELEVIDEO

910 \$569.00
912 \$689.00
920 \$725.00
950 \$939.00
925 NEW! CALL

ANADIX

DP 9500 \$1199.00
DP 9501 \$1199.00
DP 8000 AP \$749.00

SPECIAL

TEXAS INSTRUMENTS

810/2 \$1399.00
(includes upper/lower case option)
810/2 VFC/CP \$1549.00
(includes u/l case, forms control & compressed print)

LETTER QUALITY PRINTERS

DIABLO

• 630 RO
\$1949.00
• 630 KSR... CALL
• 1640 CALL

QUME

• SPRINT 9/45
\$1849.00
• SPRINT 9/35
CALL FOR PRICE

NEC

• 7700 SERIES
• 3500 SERIES
CALL FOR OUR
LOW PRICES

SOROC

IQ 120 \$689.00
IQ 140 \$1075.00
C. ITOH
CIT 101 \$1399.00

Special!

SPECIAL

TELETYPE 43
PF(TTL) **\$899.00**

CALL TOLL FREE (800) 854-6028

To Order: Send check to MICROMAIL, P.O. Box 3297, Santa Ana, CA 92703. Personal or company checks require two weeks to clear. Visa/MasterCard accepted. C.O.D. requires a 15% deposit. Handling: Add 3% to orders less than \$750.00, and 2% for orders \$751.00 or over. NOTE: Handling charges are waived on orders pre-paid in advance by check. Shipping: We ship FREIGHT COLLECT via UPS or Motor Freight. Air and Express delivery is available. Prices subject to change without notice.

WE SELL INTERNATIONALLY

MICROMAIL

P.O. Box 3297
Santa Ana, CA 92703
Phone: 714/731-4338
TWX: 910 595 1146

will hold your COBOL program; once in the editor, you cannot go back to TRSDOS to look at the disk directory without losing what is in memory.

Since the COBOL language requires much similar information at the start of every program, I recommend that you create a "skeleton" or "template" file that contains this information. Then, when you create a new program, load this file and edit it as needed, rather than having to type in all the header information every time. Referring to listing 1, my skeleton file contains the IDENTIFICATION DIVISION, the ENVIRONMENT DIVISION, and part of the DATA DIVISION seen in this listing. My DATA DIVISION skeleton includes a FILE SECTION with a couple of FDs and the WORKING-STORAGE section with some often-used identifiers. Experience will help you decide which things are frequently repeated.

Line numbers are provided by the editor during the text creation process. The INSERT command, abbreviated I, is used much like BASIC's AUTO command; it automatically enters a line number, then you type the line. During text insertion, if the line number of a new line is the same as that of an existing line, the entire text is automatically renumbered from the current line to prevent overwriting the existing line. This gives you the advantage of never running out of room during text insertion. However, the disadvantage is that automatic renumbering causes the line numbers of existing lines to change. INSERT does not notify you that this has happened. This makes it more difficult to find and correct a line that was the cause of a compilation error, since error messages use the old line numbers. However, the offending line's contents are printed along with the error message. Therefore, you can use the editor's FIND command to locate the line.

FIND lets you search a range of source text for any string of characters. Another "new" command is CHANGE, which lets you change any string of characters to a different

1982 NATIONAL COMPUTER CONFERENCE

JUNE 7-10 • ASTROHALL • HOUSTON, TEXAS

“ADVANCING PROFESSIONALISM”

Register now for the most prestigious computer conference in the world.

- ★ The conference that has progressed in quality each year since its inception.
- ★ The conference that continues its dedication to Advancing Professionalism — through an intensified emphasis on excellence in:
 - Plenaries and technical sessions
 - Professional Development Seminars
 - Services to international visitors
 - Exhibits of the latest technological advances

★ The conference that this year honors the developers of FORTRAN, the pioneer computer language.

To pre-register, just clip and mail this coupon. You'll save money on full conference registration. And you'll avoid time-consuming registration lines at the 1982 National Computer Conference.

★ The one computer conference you can't afford to miss.

Yes, I want to pre-register for NCC '82.
Please send me information.

Name _____

Title _____

Company _____

Address _____

City _____ State _____ Zip _____



Mail to: NCC '82
AFIPS
Box 9658
Arlington, VA 22209

FI

FREE
with software purchase—
One CPM Handbook

DISCOUNT SOFTWARE

Ad#23

ULTIMATE SOFTWARE PLAN

We'll match any advertised price on any item that we carry. And if you find a lower price on what you bought within 30 days of buying it, just show us the ad and we'll refund the difference. It's that simple.

Combine our price protection with the availability of full professional support and our automatic update service and you have the Ultimate Software Plan.

It's a convenient, uncomplicated, logical way to get your software.

✓ (New items or new prices)

CP/M®	DISK WITH MANUAL	MANUAL ONLY	CP/M users: specify disk systems and formats. Most formats available.
ARTIFICIAL INTELLIGENCE*			
Medical(PAS-3)	\$849/\$40		
Dental(PAS-3)	\$849/\$40		
ASYST DESIGN*			
Prof Time Accounting	\$549/\$40		
General Subroutine	\$269/\$40		
Application Utilities	\$439/\$40		
COMPLETE BUS. SYSTEMS*			
Creator	\$269/\$25		
Reporter	\$169/\$20		
Both	\$399/\$45		
COMPUTER CONTROL*			
Fabs (B-tree)	\$159/\$20		
UltraSort II	\$159/\$25		
COMPUTER PATHWAYS*			
Pearl (level 1)	\$ 99/\$25		
Pearl (level 2)	\$299/\$40		
Pearl (level 3)	\$549/\$50		
DIGITAL RESEARCH*			
CP/M 2.2			
NorthStar	\$149/\$25		
TRS-80 Model II (P+T)	\$159/\$35		
Micropolis	\$169/\$25		
PL/I-80	\$459/\$35		
BT-80	\$179/\$30		
Mac	\$ 85/\$15		
Sid	\$ 65/\$15		
Z-Sid	\$ 90/\$15		
Tex	\$ 90/\$15		
DeSpool	\$ 50/\$10		
CB-80	\$459/\$35		
CBasic-2	\$ 98/\$20		
D.M.A.			
Ascsm	\$149/\$15		
Formula	\$539/\$45		
GRAHAM-DORIAN*			
General Ledger	\$729/\$40		
Acct Receivable	\$729/\$40		
Acct Payable	\$729/\$40		
Job Costing	\$729/\$40		
Payroll II	\$729/\$40		
Inventory II	\$729/\$40		
Payroll	\$493/\$40		
Inventory	\$493/\$40		
Cash Register	\$493/\$40		
Apartment Mgt	\$493/\$40		
MICRO-AP*			
S-Basic	\$269/\$25		
Selector IV	\$295/\$35		
Selector V	\$495/\$50		
MICRO DATA BASE SYSTEMS*			
HDBS	\$269/\$35		
MDBS	\$795/\$40		
DRS or QRS or RTL	\$269/\$10		
MDBS PKG	\$1295/\$60		
MICROPRO*			
WordStar	\$319/\$60		
Customization Notes	\$429/\$na		
Mail-Merge	\$109/\$25		
WordStar/Mail-Merge	\$419/\$85		
DataStar	\$249/\$60		
WordMaster	\$119/\$40		
SuperSort I	\$199/\$40		
Spell Star	\$175/\$40		
CalcStar	\$259/\$na		
MICROSOFT*			
Basic-80	\$298		
Basic Compiler	\$329		
Fortran-80	\$349		
Cobol-80	\$629		
M-Sort	\$124		
Macro-80	\$144		
Macro-86	\$259		
Edit-80	\$ 84		
MuSimp/MuMath	\$224		
MuLisp-80	\$174		
Multi Plan	Call		
Manager Series	Call		
DON'T SAY "UNCLE," SAY "MICROTAX" TODAY!			
Individual	\$ 250/\$na		
Professional	\$1000/\$na		
Partnership	\$ 750/\$na		
Package	\$1500/\$na		
ACRS, depreciation, batch computing/printing of over 30 forms/schedules, and much more.			
ORGANIC SOFTWARE*			
TextWriter III	\$111/\$25		
DateBook II	\$269/\$25		
Milestone	\$269/\$30		
OSBORNE*			
General Ledger	\$ 59/\$20		
Acct Rec/Acct Pay	\$ 59/\$20		
Payroll w/Cost	\$ 59/\$20		
All 3	\$129/\$60		
All 3 + CBASIC-2	\$199/\$75		
Enhanced Osborne	\$269/\$60		
PEACHTREE*			
General Ledger	\$399/\$40		
Acct Receivable	\$399/\$40		
Acct Payable	\$399/\$40		
Payroll	\$399/\$40		
Inventory	\$399/\$40		
Surveyor	\$399/\$40		
Property Mgt	\$799/\$40		
CPA Client Write-up	\$799/\$40		
Mtg Address	\$349		
P5 Version	Add \$129		
MagiCalc	\$269/\$25		
Other	less 10%		
SOFTWARE WORKS*			
Adapt (CDOS to CP/M)	\$ 69/\$na		
Ratfor	\$ 86/\$na		
SOHO GROUP*			
MatchMaker	\$ 97/\$20		
WorkSheet	\$177/\$20		
STRUCTURED SYSTEMS*			
Business Packages, Call for Price			
SORCIM*			
SuperCalc	\$269/\$na		
Trans 86	\$115		
Act	\$157		
TCS*			
GL or AR or AP or Pay.	\$ 79/\$25		
All 4	\$269/\$99		
Compiled each	\$ 99/\$25		
Inventory	\$ 99/\$25		
SUPERSOFT*			
Diagnostic I	\$ 49/\$20		
Diagnostic II	\$ 84/\$20		
Disk Doctor	\$ 84/\$20		
Forth (8080 or Z80)	\$149/\$30		
Fortran	\$219/\$30		
Fortran w/Ratfor	\$289/\$35		
C Compiler	\$174/\$20		
Star Edit	\$189/\$30		
Other	less 10%		
UNICORN*			
Mince	\$149/\$25		
Scribble	\$149/\$25		
Both	\$249/\$50		
WHITESMITHS*			
"C" Compiler	\$600/\$30		
Pascal (incl "C")	\$850/\$45		
"PASCAL"			
Pascal/MT+ Pkg	\$429/\$30		
Compiler	\$315		
Sp Prog	\$175		
Pascal/Z	\$349/\$30		
Pascal/UCSD 4.0	\$670/\$50		
Pascal/M	\$355/\$20		
"DATA BASE"			
FMS-80	\$649/\$45		
dBASE II	\$595/\$50		
Condor II	\$899/\$50		
Access 80 Level 1	\$249		
Access 80 Level 2	\$429		
Access 80 Level 3	\$679		
Optimum	\$749/\$50		
"WORD PROCESSING"			
WordSearch	\$179/\$50		
SpellGuard	\$229/\$25		
VTS/80	\$259/\$65		
Magi Wand	\$289/\$45		
✓ Magic Spell	\$269/\$25		
Spell Binder	\$349/\$45		
Select	\$495/\$na		
"OTHER GOODIES"			
Micro Plan	\$419/\$na		
Plan 80	\$269/\$30		
Target	\$189/\$30		
BSTAM	\$149/\$na		
BSTMS	\$149/\$na		
Tiny C	\$ 89/\$50		
Tiny C Compiler	\$229/\$50		
✓ Nevada Cobol	\$179/\$25		
MicroStat	\$224/\$25		
Verdit	\$130/\$15		
MiniModel	\$449/\$50		
StatPak	\$449/\$40		
Micro B+	\$229/\$20		
Raid	\$224/\$35		
String/80	\$ 84/\$20		
String/80 (source)	\$279/\$na		
ISIS CP/M Utility	\$199/\$50		
Lynx	\$199/\$20		
APPLE II®			
INFO UNLIMITED*			
EasyWriter	\$199		
Datadex	\$249		
EasyMail	\$128		
Other	less 15%		
MICROSOFT*			
Softcard (Z-80 CP/M)	\$298		
Fortran	\$179		
Cobol	\$499		
Tasc	\$139		
MICROPRO*			
WordStar	\$269		
MailMerge	\$ 99		
WordStar/MailMerge	\$349		
SuperSort I	\$159		
SpellStar	\$129		
PERSONAL SOFTWARE*			
Visicalc 3.3	\$159		
Desktop/Plan II	\$159		
Visitem	\$129		
Visidex	\$159		
Visiplot	\$149		
Visirend/Visiplot	\$229		
Visifile	\$199		
PEACHTREE*			
G/L, A/R, A/P, Pay or Inventory (each)	\$224/\$40		
"OTHER GOODIES"			
VU #3R (use w/Visicalc)	\$ 79		
Context Connector (use w/Visicalc)	\$129		
Micro Courier	\$219		
Super-Text II	\$127		
Data Factory	\$134		
DB Master	\$184		
Charles Mann	less 15%		
STC	less 15%		
IBM PC SOFTWARE			
Business/Med/WP			
Call for Price			

ORDERS ONLY—CALL TOLL FREE VISA • MASTERCARD

1-800-854-2003 ext. 823 • Calif. 1-800-522-1500 ext. 823

Outside Continental U.S.—add \$10 plus Air Parcel Post • Add \$3.50 postage and handling per each item • California residents add 6% sales tax • Allow 2 weeks on checks. C.O.D. \$3.00 extra • Prices subject to change without notice. All items subject to availability. ®—Mfgs. Trademark. Blue Label \$3.00 additional per item.

THE DISCOUNT SOFTWARE GROUP

6520 Selma Ave. Suite 309 • Los Angeles, Ca 90028 • (213) 837-5141

Int'l TELEX 499-0446 DISCSOFT LSA • USA TELEX 194-634 (Attn: 499-0446)

TWX 910-321-3597 (Attn: 499-0446)

string in as many places as you want. This is useful if you discover that a data item name is a COBOL reserved word, e.g., KEY. KEY can be changed to RECORD-KEY in all lines of a program with the CEDIT command:

C/KEY/RECORD-KEY/*

The "*" means change KEY to RECORD-KEY everywhere it occurs in the program. A number N, instead of "*", means change it the next N times it occurs. The "X" command behaves like CHANGE, but it asks you if the change should be made every time it finds a match for the search string.

Another useful command is MEMORY, which tells how big your program is in bytes and how much free memory is left.

CEDIT's remaining commands have counterparts in the Level II BASIC and EDTASM editors. These include commands to list a range of lines to the screen or printer, delete a range of lines, replace a range of lines, renumber the lines, and move to the top or bottom of the program file. The EDIT command provides editing of a single line; character insertion, deletion, and replacement; extension of the line, etc., in a manner nearly identical to Level II BASIC's EDIT command.

Once a program is completely typed in, it is saved to disk with the WRITE command. A default file name extension of /CBL is automatically provided. For example, typing W SAMPLE:1 saved the sample program's source file on drive 1 with a file name of SAMPLE/CBL.

RSCOBOL Compiler

All the files in table 1 must be online before compilation begins. Several options are available at compile-time. I used the command:

RSCOBOL SAMPLE
(P X L=1 O=1)

to compile the sample program. The options selected are printed at the top of each listing page. The P option means send a listing to the printer; an

Quality Computer Services presents..

Hard Disk Systems

12m \$3195

For TRS®, Apple®, Heath®, S-100 and more
6,12,20,40 and 80 Megabyte systems

Completely assembled and tested subsystem including:

- Switchable power supply
- Winchester drive
- Host adapter card
- Sealed case
- Expansion

The enclosure, controller and power supply have been designed to allow for future backup hardware or increased storage

- Software
- Auto attach CP/M*
- Hard disk utilities
- Real time clock

- Formatting program
Assigns alternate sectors for any weak sectors detected during formatting assuring the lowest possible error rate

- Warranty: The system has a full one year warranty on all parts and workmanship
- Also available: attach for TRSDOS, OASIS*, Apple DOS
- Optional 5 1/4" floppy (shown)

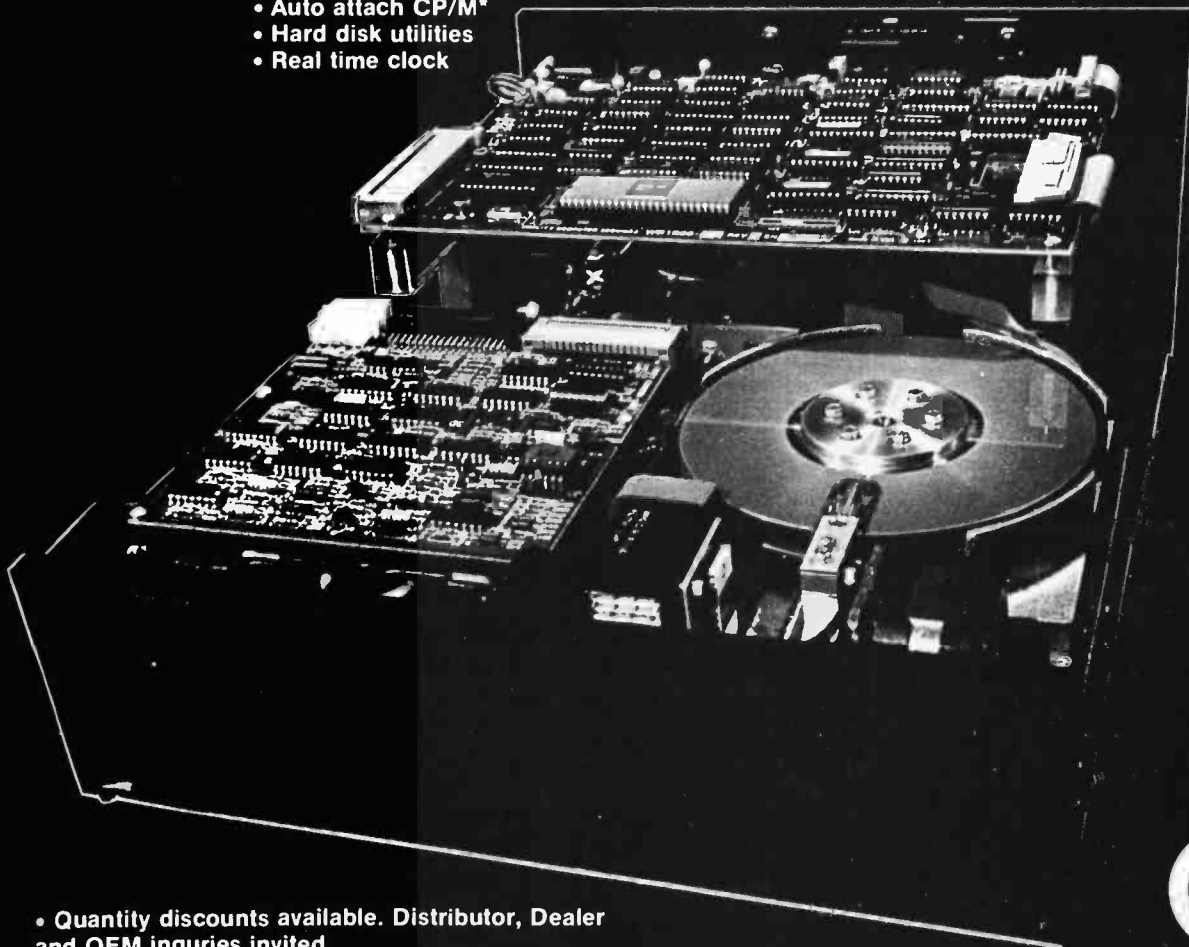

See local dealer
or call:
QuCeS
178 Main Street
Metuchen, New J
201-548-2135

• Quantity discounts available. Distributor, Dealer and OEM inquiries invited.

*OASIS is a trademark of Phase One Systems, CP/M is trademark of Digital Research

Circle 327 on Inquiry card.

QC
u em

Toll free number: 800 631 5

example is listing 1. The X option generates a cross-reference of PROCEDURE and DATA DIVISION names. This appears at the end of listing 1. The L=1 option sends a copy of the listing to a disk file on drive 1. O=1 means put the object file on drive 1. If O=N had been selected, no object file would have been created.

RSCOBOL provides a COPY statement that allows COBOL source files to be included directly from disk in the compilation of a program. For example, a common record definition could be kept in a file called RECDEF, and the source program statement COPY RECDEF would open that file and compile its contents just as if it were part of the main source file being compiled.

One problem with the implementation of COPY is that all COPY files must be online during compilation. If one of them is not, the compilation aborts with an error message. It would have been simple to have the compiler pause if the file were not found and ask the user to mount the disk containing the file instead of aborting the compilation. This would

have extended the size of source files that could be compiled for users with only two disk drives.

A couple of other options are available that were not used in the sample compilation. The D option compiles all the "debug" lines. Simply stated, any program line starting with D is ignored during compilation unless the D option is specified. Therefore, you can write your program with as much extra code as you want to help during debugging, and then have it all eliminated from the final version of your program by simply compiling without the D option. Debug code is commonly used to DISPLAY the value of some data item while testing a program. However, there is no restriction on the type of source code line that can be flagged in this way.

If the compiler finds any errors in your program, they are clearly marked with a pointer to the offending word and an error message in English. More than 70 error messages are possible, and I have never had a problem figuring out what they meant. Each error message has a brief explanation in the manual.

The compiler does not stop until it reaches the end of the source file, no matter how many errors it finds. This helps you to find as many errors as possible with a single compilation. If you specify the E option when you compile, only error messages are sent to the listing files. This is useful when compiling for the first time; you are likely to have some errors and can save wear and tear on your printer by printing only the error lines.

The T option directs the listing output to the screen. You can specify as many listing destinations as you wish—it is possible to direct output to a disk file, the printer, and the screen all at once. The sample program in listing 1 creates a disk file and a print-out at the same time.

As you can see from listing 1, the compiler provides a complete program listing. The date and time of compilation appear at the top of each page, along with the name of the source file and any options selected. The leftmost number in each line is a line number supplied by the compiler. The next column contains information needed when using the interactive debugger. Next is the editor line number, and then the source code line itself.

A summary of all program data items is provided in the order in which they were defined in the DATA DIVISION. Information provided for each data item includes from left to right:

- its address relative to the start of data storage, for use during debugging
- its size in bytes
- a three-character type code used during debugging; ANS = alphanumeric, GRP = group, etc. (there are 12 in all)
- the "Order," which is the number of subscripts a data item requires
- the data item type name in English
- the data item name

This listing is followed by the size of the read-only portion of the program (presumably the code block) in bytes, the size of the read/write portion (the data area) in bytes, and the

Listing 2: A summary of all data items from the program in listing 1.

```

FRS-80 Model I/III COBOL (RM/COBOL 1.3B)      08/17/81 08:30:52 PAGE 3
SOURCE FILE: SAMPLE                          OPTION LIST: (T X L=1 O=1)

```

ADDRESS	SIZE	DEEUG	ORDER	TYPE	NAME
>0000	80	ANS	0	FILE ALPHANUMERIC	INFILE INFILE-RECORD
>0054	80	GRP	0	GROUP	IN-RECORD
>0054	5	ANS	0	ALPHANUMERIC	RECORD-KEY
>0059	75	ANS	0	ALPHANUMERIC	REST-OF-RECORD
>00A4	3	ANS	0	ALPHANUMERIC	USER-QUITS-FLAG
			0	CONDITION-NAME	USER-QUITS
>00AB	3	ANS	0	ALPHANUMERIC	MORE-DATA-REMAINS-FLAG
			0	CONDITION-NAME	NO-MORE-DATA-REMAINS
			0	CONDITION-NAME	MORE-DATA-REMAINS
>00AC	40	GRP	0	GROUP	REQUEST-KEY-MSG
>00D4	42	GRP	0	GROUP	WAIT-MSG
>00FC	2	ANS	0	ALPHANUMERIC	WAIT-CHAR
>00FE	5	ANS	0	ALPHANUMERIC	SELECT-KEY

```

READ ONLY BYTE SIZE = >0122
READ/WRITE BYTE SIZE = >0142
OVERLAY SEGMENT BYTE SIZE = >0000
TOTAL BYTE SIZE = >0264

0 ERRORS
0 WARNINGS

```

“Without touching your program
I can move it to and from Z80, LSI-11™,
8086, 6502, 8080, 6809, 68000 and
9900-based computers.”

JULIE ERWIN, Vice President, Marketing, SofTech Microsystems, Inc.

You can do it too, with SofTech Microsystems' unique software development and execution environment, the UCSD p-System™.

Our UCSD p-System is the only genuinely machine-independent operating system for 8-bit and 16-bit microcomputers. And to over 50,000 end-users and scores of applications developers it is the one proven, reliable answer to software obsolescence.

For software development, it allows you to work in any combination of UCSD Pascal™, FORTRAN-77, BASIC, and assembly language. It provides you support for dynamic memory management and multitasking, with a full arsenal of powerful enhancements, such as a versatile Screen Editor, Native Code Generators, a Print Spooler, TURTLEGRAPHICS and XenoFile™, for easy access to CP/M® disks and files.

Users report that our UCSD p-System's friendly, fast and compact execution environment makes it their first choice in software. So whether it's for IBM, Apple, Tandy, Commodore, Texas Instruments, Philips or any other small computer, your best move is to our UCSD p-System. Nothing else touches it.

Our UCSD p-System is available for distribution licensing as well as single copy purchase. Visa and MasterCard orders are welcome, or you may write to us for more details.

SOFTech
MICROSYSTEMS
A SUBSIDIARY OF SOFTECH

9494 Black Mountain Road, San Diego,
CA 92126. (714) 578-6105
TWIX: 910-335-1594

UCSD p-System and UCSD Pascal are trademarks of the Regents of the University of California. LSI-11 is a trademark of Digital Equipment Corporation. XenoFile is a trademark of SofTech Microsystems, Inc. CP/M is a registered trademark of Digital Research, Inc. Apple is a trademark of Apple Computer, Inc.

total size in bytes. The total size for the sample program and its data is hexadecimal 0264 (612 decimal) bytes, which is fairly compact for this COBOL program.

For the sample program, a cross-reference table was requested. All PROCEDURE and DATA DIVISION names are listed in alphabetical order. For each entry, the line numbers in

which it is declared and referenced are given. The line numbers in which a data item is declared are surrounded by slashes. Lines in which the value of a data item may be altered are marked with asterisks, e.g., *0073* for the variable IN-RECORD. In line 73, IN-RECORD is the destination of a record read from INFILE.

The COBOL compiler resides from

hexadecimal locations 5200 to AAFF in memory. This leaves hexadecimal 5500, or 21,760, bytes of memory free. The compiler is so large that it had to be split into overlays as shown in table 1. Different overlays are loaded from disk to compile different divisions of a COBOL program. It is not documented whether these overlays eat into the 21,760 bytes of free storage. A couple of internal error messages tell when the compiler's working storage has been exceeded. This could happen, for example, if a program has too many symbols to store in the compiler's symbol table.

If this should happen, the subroutine CALL can be used to alleviate the problem. A program can be split into a main program and subroutines, each separately compiled. At run-time, when the main program CALLs a subroutine, it is loaded dynamically from disk. This also provides a method for controlling memory usage at run-time. But it is not the only method. A single program can be broken into overlays. A program

Listing 3: A cross-reference of all PROCEDURE and DATA DIVISION names in alphabetical order. The line number where it is declared and referenced is also listed.

```

TRS-80 Model I/III COBOL (RM/COBOL 1.3B)      08/17/81 08:30:52 PAGE 4
SOURCE FILE: SAMPLE                          OPTION LIST: (T X L=1 O=1)

CROSS REFERENCE                               /DECL/ *DEST*

GET-KEY-AND-SEARCH-FILE                       0054 /0058/
INFILE                                         /0017/ /0022/ 0064 0067 0073
INFILE-RECORD                                 /0024/
IN-RECORD                                      /0028/ *0073* 0077
MORE-DATA-REMAINS                             /0037/ 0075
MORE-DATA-REMAINS-FLAG                       /0035/ *0068* *0074*
NO-MORE-DATA-REMAINS                         /0036/ 0066
RECORD-KEY                                    /0029/ 0076
RECORD-SELECTION-AND-DISPLAY                 /0053/
REQUEST-KEY-MSG                              /0039/ 0059
REST-OF-RECORD                               /0030/
SEARCH-FILE-AND-DISPLAY-RECORD              /0065/ /0072/
SELECT-KEY                                    /0048/ *0060* 0061 0076
USER-QUITS                                    /0033/ 0055
USER-QUITS-FLAG                              /0032/ *0062*
WAIT-CHAR                                     /0046/ *0070*
WAIT-MSG                                      /0043/ 0069
  
```

Learn about the Z8000™ from the people who are pioneering the Microworld.

Zilog's Z8000 Architecture Course takes you into the world of faster, smarter, smaller micro-processors without leaving your home. Our five-part correspondence course covers the details of the Z8000's 16-bit architecture,

techniques of memory management, methods for interfacing memory and peripherals, plus use of the Z8000's powerful instruction set.

You study at your own pace. Each test is individually graded and critiqued, then returned to you.

This course can make you an expert on Z8000 technology for only \$39. Enroll today by sending us the coupon*. Allow six weeks for delivery of your first lesson.

Zilog Training and Education, 1315 Dell Avenue, Bldg. C, Campbell, CA 95008

Enroll me today in Zilog's Z8000 Architecture Course. Enclosed is my check or money order (no cash or purchase orders, please) for \$39. Make check payable to Zilog, Inc.

Please charge my MasterCard or Visa account

□□□□□□□□□□□□□□□□□□

Expiration date: Mo: _____ Year: _____ Signature: _____

BUSINESS ADDRESS

Name _____ Title _____
 Company _____
 Address _____
 City/State/Zip _____
 Telephone _____
 Area code number extension



BILLING ADDRESS (as shown on charge card)

Name _____
 Company _____
 Address _____
 City/State/Zip _____

An affiliate of EXON Corporation

Please mail my lessons to: _____ Business Address _____ Billing Address

*Offer expires August 27, 1982. Good only in the U.S.

FMS-80

Organizes Your Organization

FMS-80, a data base management system, offers the user a quick and easy way to organize and efficiently manipulate data so sound decisions can be made on facts displayed.

FMS-80***

is the most powerful stand alone DBM program available to the micro computer industry.

Complete menu driven and written in assembly language it offers these features:

- User definable
File Definitions
Screen Displays
Reports (with math and field break analysis)
Selection Criteria (on any or all fields)
Menus (that applications programs can be selected from)
- Instantaneous data query on indexed records.
- Mathematical manipulation of numeric data fields using the report generator or the programming language EFM (Extended File Maintenance)
- Easy to use video "how to" training tapes are available.
- Manipulation of up to 19 different data files (using EFM) at one time and displaying this information on the screen, generating

rating reports, generating other data files or on-line updating of input files that already exist

- FMS-80 is able to call other programs like sub-routines in EFM
- FMS-80 is able to read data files that other programs have generated
- No restrictions to record size other than available RAM memory space
- Operates under CP/M[®], MP/M[®] or CDOS[®]

FMS-80 allows the flexibility to quickly create

programs that allow data to be entered in a form that a secretary recognizes and generates reports that the manager requires.

If you're continuously asked to do applications programs and don't have time to do it in BASIC, consider FMS-80.

For additional information contact

Systems Plus,
1120 San Antonio Road,
Palo Alto, CA
94303. Phone
415/969/7047

Systems Plus



***TM of DJR Associates

**TM of Cromemco, Sunnyvale, CA

*TM of Digital Research, Pacific Grove, CA

segmented in this manner is compiled in one piece, but the overlays are loaded into memory dynamically at run-time when they are entered via a GOTO or PERFORM statement. These two options, CALL and overlays, combine to provide the most dynamic memory-management system that I have seen in any TRS-80 language.

A word on compiler performance. With both the input of source text and the output of object code involving disk I/O (input/output), and the compiler itself requiring several disk overlay loads during the course of a single compilation, this compiler is no speed demon. The sample program, with the options shown, took 135 seconds to compile. This works out to about 35 lines per minute. This includes printing a listing and creating a listing file on disk, both including cross-reference lists. Choosing options of T and E (create an object file on disk and print any errors on the screen), sped things up to about 50 lines per minute. It then took 95 seconds to compile the sample program.

Testing a Program

The RSCOBOL system provides a simple run-time interactive debugger. This debugger allows you to test many aspects of a COBOL program without having to program in a lot of special debugging statements. Combined with the compiler's D option described earlier, RSCOBOL provides a decent debugging environment.

To make full use of the interactive debugger requires a current printed listing of the program under test. A printer is not a prerequisite for use of RSCOBOL, but I strongly recommend having one.

The command RUNCOBOL invokes the RSCOBOL run-time module. The debugger is invoked by specifying the D option. Once in the debugger, a COBOL program can be single-stepped a sentence or group of sentences at a time. This is achieved by typing S, optionally followed by N (where N is the number of sentences to execute). To execute all

the way up to a particular sentence, type A followed by the address in the DEBUG column preceding the sentence at which execution should stop.

The final debugger command is D. It is used to DUMP the contents of different data items in a readable format. For the sample program, by typing D 54, 5, ANS, the current value of the data item RECORD-KEY is displayed on the screen. It is permissible

A printer is not a prerequisite for use of RSCOBOL, but I strongly recommend having one.

to request the display of a data item in other than the default format; a hexadecimal dump is available, for example.

Some important features that this debugger lacks include:

1. The capability to alter data item values.
2. A way of setting program breakpoints. The current system lets you specify that execution should proceed to a particular COBOL sentence; it is desirable to be able to specify a number of points in the code at which execution should halt, passing control to the debugging monitor.
3. A way to reference data symbolically rather than requiring the use of hexadecimal values representing actual data-storage locations.
4. A way to step through the statements of a COBOL sentence. In listing 1, there is only one value in the DEBUG column for the entire range of program lines from 61 to 71. This value represents the beginning of the COBOL sentence starting with "IF". You cannot step partially through this sentence; you must execute it in full.

If you are not using the debugger, the RSCBLD13/OBJ file need not be present during run-time.

Run-Time Environment

The RSCOBOL package includes a substantial run-time module that must be resident during the execution of any COBOL program. The run-time code resides from locations hexadecimal 5200 to B1FF, leaving about 20K bytes of user program space. This is respectable for a small machine.

There is a trade-off in using a standard run-time module rather than linking in only those pieces specifically required by each program. Use of a run-time module allows much faster program development; the linking phase otherwise required is usually very time-consuming. It involves a lengthy search of a large library module to find those pieces required by a particular program. A run-time module also cuts down on the size of user programs; without one, every user program must contain a lot of the code that is otherwise in the run-time module, resulting in much duplicated code on a disk holding several user programs.

The disadvantage is that, in most cases, not all of the run-time code is needed for a particular program. Therefore, some memory space is taken up unnecessarily. RSCOBOL compensates for this somewhat with its overlay and CALL statements for memory management.

Two options besides D (invoke interactive debugger) are available at run-time:

1. S=nn..n: This option allows the setting of "switches" at run-time. A COBOL program can test for the value of these switches and make decisions accordingly. The eight switches each can assume the value 0 or 1.
2. T=hhhh: This sets the top memory address that will be used by RSCOBOL at run-time. It is used to protect user machine-language programs from the run-time system. As discussed previously, it appears that if your assembly-language program stores this value in location hexadecimal 4049 (for the Model I), the same effect is achieved.

Many English-language error

OMEGA

**The Last Disassembler
You Will Ever Need!**

Mnemonics Externally Defined

Zilog, Intel, PASM Supplied

ASCII/HEX Preconditioner

Can Externally Def. Equates

Optional Address Listing

ASM/PASM/M80 Compatible

DB statements forcible over user
specified range

\$150. complete/\$25. manual only
for further information contact

COMPUTER TOOLBOX, INC.

1325 East Main St.
Waterbury, Ct. 06705
Phone (203) 754-4197

Circle 438 on inquiry card.



Entertainer Kit	88.00	Atari 800 16K	710.00
Programmer Kit	56.00	Atari 400 16K	359.00
Communicator Kit	320.00	Atari 410 Cassette	80.00
Microsoft Basic	72.00	Atari 810 Disk	480.00

**ALL ATARI SOFTWARE 20% OFF
Plus Loads of 3rd Party Software!
VOTRAX TYPE-N-TALK: 340.00**

**ALSO EPSON & CENTRONICS PRINTERS
ZENITH & TELEVIDEO TERMINALS**

BBI Mail Order is a company made up of computer professionals. We are able to provide low prices as well as technical support. Give us a call and find out why we consider the Atari the best home computer on the market today. You won't be disappointed.



BBI Mail Order

Specializing in Atari Home Computers
P.O. Box 365
Newton Highlands, MA 02161
(617) 964 3080

Circle 435 on inquiry card.

THIN is IN!

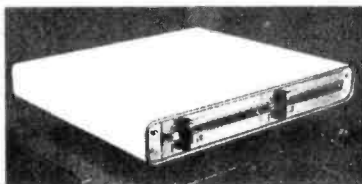

State-of-the-art 8" disk drive subsystems give you a remarkable 2.4 MB in the space of a single-drive cabinet, 4.8 MB storage capacity in the space of a 2-drive cabinet. Perfect add-ons for IBM, Apple, Radio Shack and all 8" Shugart compatible computers.

2-Drive — \$1695, 4-Drive — \$2995, 2-Drive
Horizontal — \$1750, write protect switch
option \$30/drive

Columbia microSystems, Inc.

905 E. Broadway, Columbia, MO 65201
(314) 875-8900

Circle 437 on Inquiry card.

1 MEGABYTE FLOPPY \$415.00

CALDISK MODEL 142M 8" FLOPPY \$385.00

DbI Den, Sgl Sided, Reconditioned

CALDISK MODEL 143M 8" FLOPPY \$415.00

DbI Den, 48 TPI, 1 Mbyte Capacity
50 Pin Edge Connector, Reconditioned

TANDON TM-100 5 1/4" FLOPPY \$219.00

DbI Den, Sgl Sided, SA400 Connector Compatible
(This is the one used in IBM's personal computer)

SHUGART SA400 5 1/4" FLOPPY \$212.00

MOTOROLA M3970 CRT MONITORS

\$99.00 (P31) \$89.00 (P4)

12", 412v, 15 MHz Bandwidth, P4 or P31 Phosphor
TTL Compatible, 10 Pin Circuit Card Edge Connector

CENTRONICS PRINTERS (Used)

• 701 with stand \$600.00 • 761 with stand \$675.00
• 703 with stand \$750.00 • 6300 with stand \$1800.00

PAPER TIGER IDS 440 (Used) \$529.00



CALDISK

Box 555, Provo, UT 84603
(801) 375-0000
TWX 9109715889

Phone orders welcome with MasterCard and VISA.

Circle 436 on Inquiry card.

VOICE SYNTHESIZER WITH INTERACTIVE TELEPHONE INTERFACE

For APPLE II compatible dial-up voice response and remote data-base access arrangements, consider a V100 series design from VYNET CORPORATION.

- Direct connect, auto-dial/answer
- Control via Touch-Tone™ detection
- Allophone (LPC) based voice synthesizer
- Includes 1,000 word vocabulary
- Editor for custom vocabulary
- Extensive application software
- Programmable buffered port
- Upgrade available for high quality LPC vocabulary
- \$395.00

Telephone interface may be purchased without synthesizer. TRS-80™ and IBM versions available soon.

**VYNET
CORPORATION**

2405 QUME DRIVE
SAN JOSE, CA 95131
(408) 942-1037

Circle 440 on Inquiry card.

The 7th System

— FORTH-like direct threaded interpretive system with structured assembly language (8080 mnemonics).

— Application development can utilize all CP/M (tm) capabilities (editor, file system, etc.).

— Includes re-entrant multi-task executive with counting semaphores for TASK/MSG synchronization.

— Supports strings, single and double precision integers.

— Capable of generating ROM-based stand-alone systems for dedicated applications.

— All source code supplied. No royalties on derivative software.

— Fully documented with 200 page reference manual including glossary and index of all standard words.

— Training seminar available on request.

— Send check or money order for \$495.00 to receive manual and system (8" single-sided single density diskette). Demo system with manual \$75.00. Manual only \$45.00. Alabama residents add 6% sales tax.

UNITED CONTROLS CORPORATION

P.O. Box 4620 Huntsville, Alabama 35802
(205) 837-8144

Circle 439 on Inquiry card.

Circle 441 on inquiry card.

CP/M DATA ENTRY "RADAR"

RADAR is a high speed data entry system that will run on any CP/M system providing a "3741" style key-to-disk environment. RADAR is ideal for replacing KEYPUNCH machines and older, slower key-to-disk systems like the 3741's and 42's.

Features:

Verify Mode

Check Digit Processor

Auto Dup/Manual Dup

16 Accumulators

Parameter Driven (No
Programming)

"Virtual" File Access

Add or Delete Records

Record Retrieval By Number
Or Content

Full Editing Capability

Operator Prompts

Extremely Fast (Written In
Assembly Language)

In addition to "heavy-duty" data entry, RADAR is also the ideal "front-end" for many applications programs, providing acquisition and retrieval of keyed data with a degree of reliability simply not possible with any other technique. RADAR can cut programming time by more than 30%, simply because there is no longer any need to write the "input" portion of a program, just let RADAR handle it!

Write or call for free brochure. The RADAR manual is also available separately for \$25.00.



**SOUTHERN
COMPUTER
SYSTEMS,
Inc.**

P.O. Box 3373A
Birmingham, AL 35255
Phone: 205-933-1659

BYTE March 1982 405

messages can appear at run-time. They are carefully documented in the RSCOBOL manual.

My overall impression of run-time performance is favorable. Every program I have written which reads from the disk, computes something, and writes the results to the printer has managed to keep the printer moving at full speed (60 characters per second bidirectional). Interpreted BASIC programs I have written, which perform similar formatted I/O with the PRINT USING statement, pause noticeably between the output of formatted data items. By comparison, RSCOBOL is quite snappy and moves right along.

Language Implementations

RSCOBOL is based on the ANSI X3.23-1974 COBOL Standard. The ANSI Standard defines "levels" of implementation for different aspects of the language. Table 3 lists the levels of implementation provided by RSCOBOL. The more advanced the implementation, the higher the level number. The Federal Information Processing Standard (FIPS) lists 2 as a relatively "high" level of implementation for most language components. RSCOBOL's implementation does quite respectably.

Table 3 is somewhat misleading in that there are exceptions to the levels of implementation stated, i.e., certain features defined by ANSI as part of a level are not implemented. A complete list of these exceptions is in the

back of the RSCOBOL manual. Notable exceptions include:

- Multiple results are not supported in arithmetic statements. For example, you cannot state ADD A TO B C; you must state ADD A TO B and ADD A TO C.
- REMAINDER is not supported in the DIVIDE statement.
- INSPECT data items are restricted to a single character.
- Compound TALLYING and REPLACING clauses in the INSPECT statement are not supported.
- Exponentiation to a noninteger power is not supported.
- Abbreviated combined relation conditions are not supported. You cannot say IF A EQUALS 1 OR 2; you must say IF A EQUALS 1 OR A EQUALS 2.
- The STRING and UNSTRING statements are not supported.

Some extensions to the stated levels of implementation are available, mostly nonstandard. One that struck me as quite interesting was the inclusion of several statements having to do with the locking and unlocking of disk records. These statements allow simultaneous access to a disk file by multiple users in a controlled fashion.

It is worth mentioning that the rather powerful MOVE CORRESPONDING statement is implemented. This lets you move all like-named fields from one record to another with a single statement. MOVE CORRESPONDING is fre-

quently left out of small-machine implementations of COBOL. Also implemented are ADD CORRESPONDING and SUBTRACT CORRESPONDING.

The ACCEPT and DISPLAY statements provide good capabilities for interacting with the display and keyboard. In listing 1, the ACCEPT statement in line 60 puts out a field of underscore characters the size of the data item SELECT-KEY, and allows only that many characters to be input. DISPLAY is a programmatical simple way of printing a data item's contents on the screen.

Assembly-language programs can be called from RSCOBOL. They are dynamically loaded from disk and must be in standard TRSDOS load format. An arbitrary number of parameters can be passed to an assembly-language program via the USING clause of the CALL statement. Parameters are passed by reference, i.e., the address of the data item itself is passed. This is a very flexible system. Loading assembly-language programs from disk at run time gives the same flexibility for managing memory used by assembly-language programs as for that used by COBOL subroutines.

File I/O

COBOL probably has the most complete set of commercial file handling statements of any language. It is a substantial challenge to implement them for a 48K-byte RAM, dual floppy-disk Model I. RSCOBOL provides three major COBOL file types: sequential, relative, and indexed sequential.

Sequential files can have fixed- or variable-length records. Variable-length records contain a byte at the beginning of each record telling the length of that record. Lengths vary from 2 to 255 bytes. Fixed-length records do not contain any bytes telling the length. Sequential files, containing records of either type, must be accessed in order, that is, one record after the other in the order they were stored.

Relative or random files contain fixed-length records. Any particular

Function Module	Implementation
Nucleus	Level 2
Table Handling	Level 1 +
Sequential I/O	Level 2
Relative I/O	Level 2
Indexed I/O	Level 2
Sort-Merge	Null (nothing provided)
Report Writer	Null
Segmentation	Level 1
Library	Level 1
Debug	Nonstandard
Inter-program	
Communication	Level 1
Communication	Modified ACCEPT and DISPLAY for terminal communication

Table 3: Radio Shack COBOL's level of implementation as compared to the ANSI X3.23-1974 COBOL Standard.

The MICROMINT Z8 BASIC COMPUTER/CONTROLLER board represents a milestone in microcomputer price-performance. It is cheap enough to be programmed directly in a high level language, and efficient enough to be battery operated if required. The entire computer is 4" by 4½" and includes a tiny BASIC interpreter, 4K bytes of program memory, one RS-232 serial port and two parallel ports, plus a variety of other features. Using a powerful Z8 microcomputer chip and Z6132 4K X 8 RAM, the Z8 BASIC COMPUTER/CONTROLLER board is completely self-contained and optimized for use as a dedicated controller. The unit is assembled and tested and comes with over 200 pages of documentation.

The price, in single quantity, a tiny \$195.*

Optional power supply (+5, +12 and -12V) \$35.

Please include \$4 for shipping and handling.

*Call Micromint for quantity pricing

Z8 MICROCOMPUTER

- On board tiny BASIC Interpreter.
- Parallel and serial I/O ports.
- 6 interrupts.

RS-232 CONNECTOR

- Just attach a CRT terminal and immediately write control programs in BASIC.

4K BYTES OF RAM

- Z6132 4K X 8 low power quasi-static RAM. EPROM pin compatible.

SWITCH SELECTABLE BAUD RATES

- 110-9600 BPS.

FULLY EXPANDABLE

- Data and address buses available for 124K memory and I/O expansion.
- 2 onboard parallel ports.
- 7.3728MHZ crystal for fast control operations.

JUMPER SELECTABLE MEMORY OPTIONS

- 4K RAM, 2716 or 2732 EPROM operation.

LOW POWER

- Consumes only 1½ WATTS at +5, +12 and -12V (optional power supply available).

To Order:
Call Toll Free
1-800-645-3479

For Information Call
1-516-374-6793

MICROMINT INC.
917 Midway
Woodmere, N.Y. 11598



Micromint will put both a computer development system and an OEM dedicated controller in the palm of your hand for only \$195.

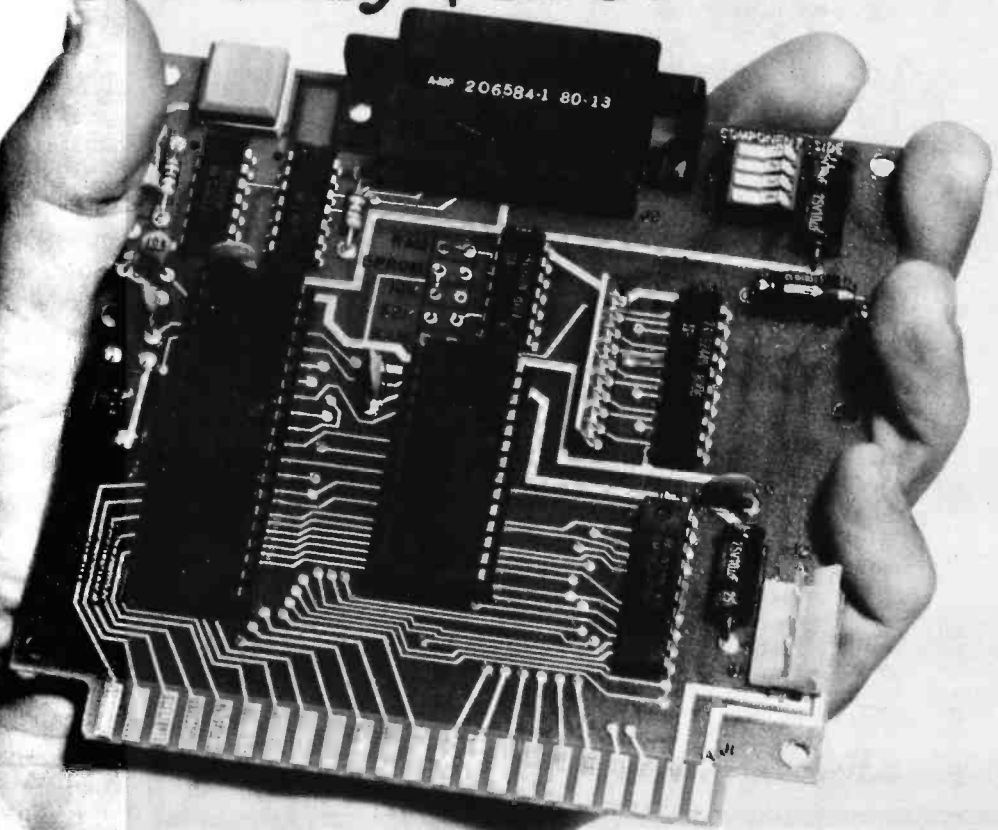

Circle 244 on Inquiry card.

As featured in Byte Magazine, July, August, 1981.

PFAS

The portable ISAM for the UCSD p-System™, Pascal MT +™, and the HP-1000 Pascal

PFAS is the professional, easy to use program development tool with advanced features such as:

- * Variable length records
- * Alternate and partial key access
- * Unlimited number of records in a file.
- * A B+ tree index.

PFAS is a set of modules which link to your PASCAL program making powerful ISAM functions part of Pascal.

Programs using PFAS are not limited to a single machine or operating system. Since PFAS is written in Pascal it is truly machine independent, from Apple to Zenith, from HP-125 to HP-1000. Only PFAS is this portable.

Now available for the p-System is PHOSFORM, our formatted screen input system. PHOSFORM allows you to quickly create and customize fill-in-the-form type input for your programs. PHOSFORM configures itself to run on any terminal making your software portable.

When you use PFAS and PHOSFORM to input, organize, and maintain your data, your time can be more effectively spent dealing with the creative facets of your software.

- * PFAS with Manual from \$200
- * PHOSFORM with Manual (Introductory Price) \$ 95
- * Manual only \$ 15

C.J. Wigglesworth Software / Gryphon Systems

P.O. Box 755, Cardiff-by-the-Sea, CA 92007 (714) 436-1455

* UCSD Pascal and p-System are trademarks of the Regents of the University of California.
 * Pascal MT + is a trademark of MT MicroSYSTEMS.

record can be accessed "at random" by specifying its record number. The first record is number 1, the second number 2, etc. The maximum length of a relative record is 253 bytes.

Indexed sequential access method (ISAM) files are the most powerful ones provided by RSCOBOL. Records in an ISAM file are fixed-length, but can be up to 4096 bytes long. When creating an ISAM file, one or more "keys" must be specified. A key is simply a field of the record that is used later as a search argument over the file.

For example, an employee record may contain a Social Security number field. If this field is specified as a key when the file is created, you can later retrieve a particular employee's record by specifying the Social Security number. Such a method is usually easier to program than relative files, which require that you provide a record's number in order to directly retrieve it.

When an ISAM file is created, records are stored in sorted order on their "primary keys." The primary key must be guaranteed unique; the Social Security number is a good example of such a field. Secondary keys can also be specified for a record. A record can be retrieved by specifying the value of any secondary-key field. Secondary keys can have duplicates, that is, two or more records can have the same value in a field designated as a secondary key.

The sample program in listing 1 uses a sequential-type file, not ISAM. It does a sequential search of the file when looking for a record whose key field matches the value typed in at the keyboard. If an ISAM file had been used, the record desired could have been located directly by its key value.

In summary, the records of an ISAM file can be sequentially retrieved in the sorted order of any key field, and directly retrieved by specifying the value of a particular key field. This powerful access method reduces the amount of user programming required for many data-storage applications.

ISAM files do pay a space penalty for this generality in retrieving

THE Answer Book The Unabridged!

- THE MOST AUTHORITATIVE DICTIONARY OF ITS KIND
 - Comprehensive—more than 260,000 entries; 2,091 pages; large format 9"x12" page size; 9 lbs 14 oz.
 - Up-to-Date—with new words and terms
 - Easy to Use—more than 50,000 example phrases and sentences; 2,000 illustrations; 10,000 synonym lists and studies; thumb-indexed
 - Full-color ATLAS; much, much more
- \$49.95, now at your bookstore
- RANDOM HOUSE**

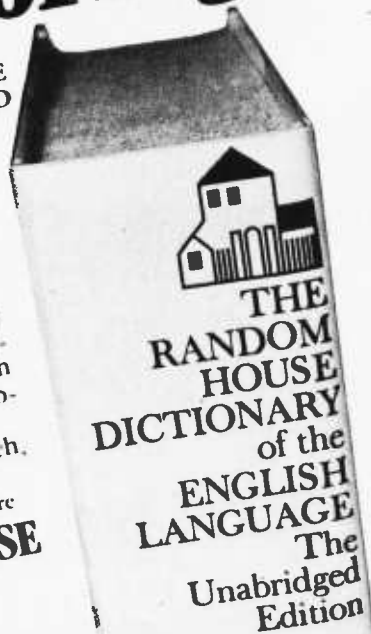

Robotics • Fiber Optics • Lasers • Pollution Control • Pollution Monitoring •

Up-to-date, inside-track reports now available from the vast resources of McGraw-Hill Research and Standard & Poor's

Turn with confidence to these INDUSTRY PROFILES to keep up with technological trends, marketing opportunities, and your competitors' activities in today's key industries.

Each Profile gives you current and immediately useful facts on a major growth industry. Each condenses a wealth of hard data and essential information for either quick access or concentrated study.

INDUSTRY PROFILES are now available for five key industries: industrial robots, fiber optics, industrial lasers, pollution control equipment, and pollution monitoring equipment.

Developed from a unique data base comprising nearly a quarter of a million documents, they reflect the combined, unparalleled resources of McGraw-Hill Research and Standard & Poor's.

In these Profiles you'll find the most relevant and up-to-date industry information, distilled in a clear and accessible format from government documents, private reports, and the world's business press.

No other single source offers you this unique opportunity — at such an affordable price — to obtain concentrated, reliable information on industries vital to your company's growth and success.

Now available — INDUSTRY PROFILES in these five rapidly developing areas:

Industrial Robots

Explores the rapid technological and economic expansion of this growing industry sector; describes markets, market leaders, and major foreign producers; highlights current technology and research programs; summarizes political and environmental pressures; *and more.*

Fiber Optics

Examines an industry which is just reaching its turning point — estimated world demand for all fiber optics applications will grow to around \$40 billion by the year 2000. Details the reasons for the predicted explosive growth; identifies fiber optics production by component type as well as component consumption by application; *and more.*

Industrial Lasers

Reviews the industrial, scientific, and defense applications of this growing business; focuses on nineteen user industries; discusses competing, new, and emerging technologies; offers unique marketing projections; gives details on more than 170 producing companies; *and more.*

Pollution Control Equipment

Assembles extensive data on air, water, noise, marine, and other pollution controls; examines future standards and comments on the \$22 billion to be spent in compliance; outlines foreign sales and sales by SIC; reviews legislation; identifies nearly 500 companies in the product area; *and more.*

Pollution Monitoring Equipment

Spotlights trends, technology, uses, and sales of monitoring devices; identifies major companies and their products; details domestic and foreign markets; shows current R&D expenditures; traces the role of the EPA and other regulatory agencies; *and more.*

Join the forward-looking executives who rely on INDUSTRY PROFILES for

- data to support decisions on new products, expanded markets, mergers, acquisitions
- forecasting — a finger on the pulse of industry development and activities
- succinct overviews of specific industries — their economic and technological patterns
- sales backup — data, contacts, and details on competitors

Each INDUSTRY PROFILE covers these vital subjects ...

- ✓ *Background* — including legal, sociological, and historical data
- ✓ *Economics* — applications, users, sales, forecasts
- ✓ *Competition* — who's producing what, who's making the sales
- ✓ *Technology* — state-of-the-art and research programs
- ✓ *Political and Foreign Implications* — perspectives, trends, major foreign producers

Each Profile is assembled in a handsome and durable portfolio. To receive your copies, at \$250 each, send in this coupon or write to:

INDUSTRY PROFILES
McGraw-Hill Research
1221 Avenue of the Americas
New York, NY 10020



INDUSTRY PROFILES

McGraw-Hill Research
Dept. B

1221 Avenue of the Americas
New York, NY 10020

Please send me the INDUSTRY PROFILE(s) checked below:
at \$250 each postpaid (plus applicable sales tax)

- INDUSTRIAL ROBOTS
 FIBER OPTICS
 INDUSTRIAL LASERS
 POLLUTION CONTROL EQUIPMENT
 POLLUTION MONITORING EQUIPMENT

Also send me, on a regular basis, updates of the following PROFILE(s):



I understand the updates, available to subscribers at the special price of only \$195 each, are published every six months and will be billed at the time of mailing.

Check enclosed. Please bill me/my company.

Name _____

Title _____

Company _____

Street _____

City _____ State _____ Zip _____

records. An index structure is stored in the file for each field specified as a key. The manual states that the use of secondary (ALTERNATE) keys causes a geometric growth in the time required to create a file. However, the time required to access a record by its key is relatively uniform throughout the file.

The RSCOBOL manual gives the following formula for estimating the number of 256-byte sectors required for an ISAM file with the specified parameters:

$$\begin{aligned} \text{NRECS} = & \text{INT} ((S+33)/32) \times R/8 \\ & + (R \times 2) / \text{INT} (252 / (K_n + 8)) \quad \text{For each key} \\ & + (R \times D) / 8 \quad \text{If duplicates are allowed} \end{aligned}$$

where R = maximum number of records desired
 S = size of records in bytes
 K_n = size of key n in bytes
 D = number of keys that allow duplicates

I created an ISAM file containing one hundred 61-byte records, each containing a 5-byte primary key and no secondary keys. The input records used to create the file were read from a sequential file on disk. The ISAM file took 3 minutes and 40 seconds to create (2.2 seconds per record), and it used 37 sectors on the disk (8 grams). Since the formula predicts 35.5 sectors, it appears to be fairly accurate. A record file created by Disk BASIC would take 25 sectors (four records per sector) to hold this same amount of data. Therefore, the indexes do produce some overhead. Of course, you could not access the Disk BASIC records by key value, and this is the function you are buying with this extra disk space.

Performance wise, the disks kept spinning the whole time the ISAM file was being generated. An interpreted BASIC program creating a record file usually leaves the disks idling at intervals while it is performing computations. Two factors could further

speed up the file creation process. First, TRSDOS 2.3B steps my MPI disk-drive heads at a slow 40 milliseconds (ms) per track; they are capable of 5 ms per track. Second, I had the file of input records used to create the ISAM file on the same drive as the ISAM file itself. By placing these two files on separate drives, less disk-head movement would occur and the files would be accessed faster.

Documentation

The manual accompanying RSCOBOL is a substantial one. It comes in a 3-inch-thick loose-leaf binder containing 368 offset-printed pages in a readable dot-matrix font. This is definitely not a beginner's guide; a good COBOL textbook is a necessity if you have not used the language much. If you are already familiar with COBOL, however, you will find complete information about every aspect of RSCOBOL, written in the style of a reference manual.

BUILD YOUR COMPUTER BREADBOARDS & INTERFACES FASTER AND EASIER WITH NEW VECTOR PLUGBOARDS

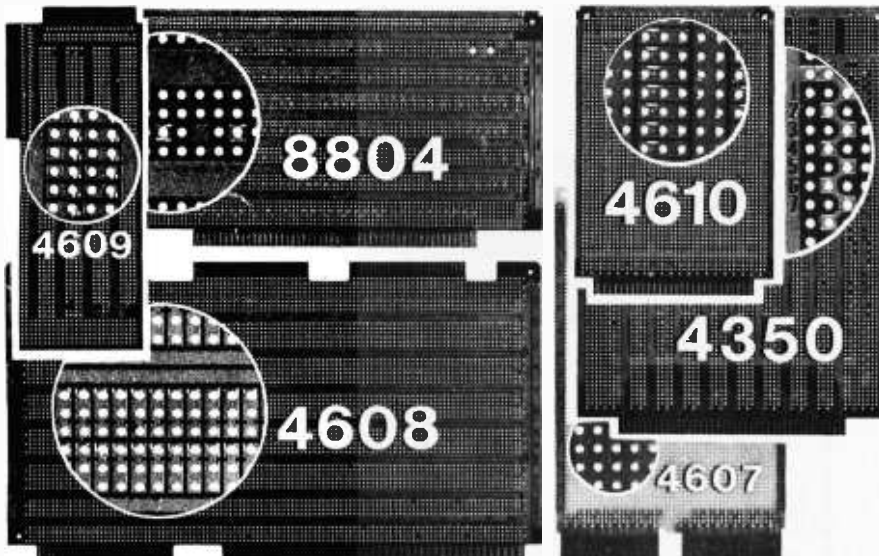

4610 series – for STD-BUS-WW, solderable and unpatterned models.

4608 series – for Intel/National SBC/BLC 80-WW solderable, or unpatterned.

8804 series – for S-100. Five models available.

4607 – for DEC LSI-11/PDP8-11, Heath-11.

4609 – for Apple II, Super-Kim, Pet Commodore with Expandamem.

4350 – for TI 980 Computer.

4611 series – for Motorola Exorciser,™ Rockwell AIM65 expansion.

Send for FREE brochure!

New RACK MOUNTING CAGES & ENCLOSURES AVAILABLE.

Everything in this ad is available through distributors or factory direct, from stock, if not available locally.



12460 Gladstone Ave., Sylmar, CA 91342; (213) 365-9661, TWX (910) 496-1539

Circle on inquiry card: 393 for 4610, 394 for 4608, 395 for S100, 396 for 4607, 397 for 4609, 398 for 4350, 399 for 4611.

BYTE'S Best Cellar List



Ciarcia's Circuit Cellar, Volumes I, II, & III by Steve Ciarcia

Collections of Steve Ciarcia's perennially popular columns from BYTE Magazine, these three volumes are sure to please home computer users and electronics hobbyists. **Volume I** includes power conversions, programming EPROMs, remote terminal interfacing, touch-input video display, and more. **Volume II**, focusing on projects which interface the personal computer with the home, features useful applications such as a computer-controlled home security system, computerized appliances, input-output expansion for the TRS-80, and even a computer-controlled wood stove. **Volume III** offers low-cost construction projects such as an ultrasonic rangefinder, handheld remote computer control, two speech synthesizers, and a remote-control motorized platform, to name just a few.

Build Your Own Z80 Computer

This complete guide to building a working computer offers engineers, students, and hobbyists an exciting alternative to buying a computer. With clear instructions, Steve Ciarcia fully explains how to build a basic single-board micro-computer based on the Zilog Z80 microprocessor. The finished product features a 1 K-byte operating system, serial and parallel ports, hexadecimal display, audio cassette mass storage, and easy expansion to include a video terminal.



Please send

- Ciarcia's Circuit Cellar, Vol. I \$8.00
 Ciarcia's Circuit Cellar, Vol. II \$12.95
 Ciarcia's Circuit Cellar, Vol. III \$12.95
 Build Your Own Z80 Computer \$15.95

Call Toll-Free 800/258-5420

Name _____

Check Enclosed

Address _____

Bill Visa/
MasterCard #

City _____

State _____

Zip _____

Expiration Date



70 Main Street Peterborough, N.H. 03458

Please add .75 per book to cover shipping cost.

Circle 59 on Inquiry card.

WHEN WAS THE LAST TIME YOU CONDUCTED A SYMPHONY ORCHESTRA?

We can't wheel the Berlin Philharmonic into your living room, but we can supply you with an ALF Music Card — and that's almost as good.

Play what you choose — whether it be the umpteenth variation of "Heart and Soul" or the ultimate interpretation of "Toccata and Fugue"; the music is totally yours.

Can't play an instrument? No matter — all you need is your Apple® II, your stereo, and an ALF Music Card.

Wait 'til you hear the applause!

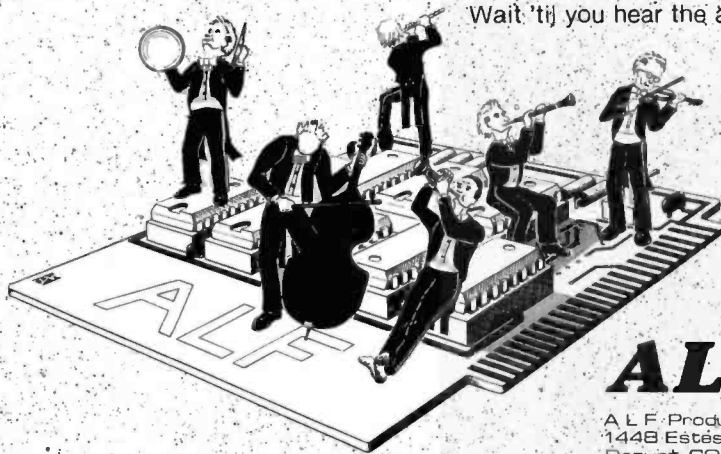

ALF

ALF Products Inc.
1448 Estes
Denver, CO 80215
(303) 234-0871

priced from \$195 at your local dealer

Choice

GNT Makes a Tape Punch Station and a Tape Reader/Punch Combination.

Both are small, quiet, and economical.
One of them will fit your needs exactly.

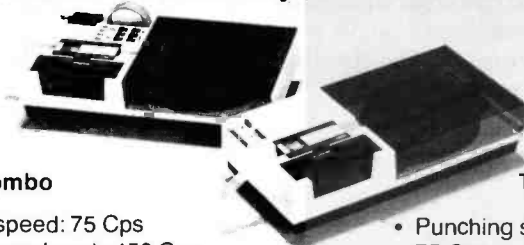

The 4601 Combo

- Punching speed: 75 Cps
Reading speed: up to 150 Cps
- RS-232-C serial interface
- Utilizes all types of Mylar® and paper tape
- Reliability: MTBF 100 million characters

The 3601 Punch

- Punching speed: 50 or 75 Cps
- RS-232-C serial interface
- Utilizes all types of Mylar® and paper tape
- Reliability: MTBF 100 million characters

Serviced nationally by **Carterfone**

GNT AUTOMATIC INC.

1560 Trapelo Road, Waltham, MA 02154 (617) 890-3305 Telex: 923318

The first section describes the use of the system, including discussions on how to use the compiler, the run-time module, and the interactive debugger. Compile-time and run-time error messages are listed and explained. An appendix gives sample program listings, including one that demonstrates many error messages. The source code for these sample programs is included on the disk that comes with the system.

The second section of the manual describes CEDIT. Several examples are given for each command. You should have no problems using the editor based on these instructions.

The third section is by far the largest at 297 pages. It gives a thorough definition of the RSCOBOL language, with detailed semantics for every language feature. The organization of the parts discussing file I/O is nicely divided into sections on sequential, relative, and indexed files.

There is a good table of contents, but no index is provided. Every error message the system can produce is documented with a sentence or two of descriptive text. There is an appendix listing all the COBOL reserved words. A thorough 24-page glossary describes special terms. The last appendix gives a skeleton description of the complete language syntax.

Conclusions

Radio Shack has provided a very complete, professionally done COBOL package. The memory-management options do almost everything possible to compensate for the inherent limits of the Model I and III machines—a small main memory of 48K bytes and limited floppy-disk storage. The most powerful features of this system, especially the multi-keyed ISAM files, are limited by the floppy-disk system for anything but the smallest applications. Use the formula given earlier for computing disk-space requirements and make sure your application will fit before you invest in this software. However, if you just want to learn how to program in COBOL and you already have the hardware, this is an excellent package. ■

1 Infinity:

First in a series of t-shirts by Scott Kim

Inversions

An "inversion" is a word that has been written so that it reads symmetrically.

For instance, words that are the same upside down and right side up are inversions. A few words exist in the English language that do this naturally, such as "SWIMS" and "NOON." But alas, the great majority of words, when turned upside down, don't do anything interesting at all.

Fortunately for lovers of inversions, letters are quite flexible. Look around you and you will see the letter "a" written in hundreds

of different ways. And all of them we have learned to read as the same letter.

By bending and stretching the shapes of letters, we can turn ordinary asymmetrical words into symmetrical inversions. Not all words will work, but when they do, the results are inevitably fascinating.

Scott Kim's new book *Inversions: a Catalog of Calligraphic Cartwheels*, published by Byte Books, is a collection of more than 60 inversions, exploring a wide range of ideas and lettering styles.

In the accompanying text, Scott explains how inversions are created, so that you may try your hand at them.

"Scott Kim's Inversions . . . is one of the most astonishing and delightful books ever printed . . . Over the years Kim has developed the magical ability to take just about any word or short phrase and letter it in such a way that it exhibits some kind of striking geometrical symmetry."

— Martin Gardner,
Scientific American

Infinity



Infinity

In this design, Scott Kim mixes idea and image, art and technology, in a swirling evocation of infinity. This intricate design was created with the aid of a computer program, which took a basic hand-drawn design,

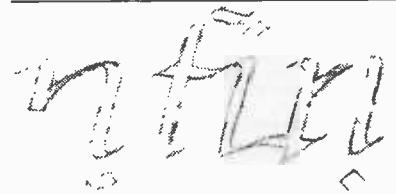

repeated it symmetrically,



then bent it into a continuously expanding spiral.

As you look at the design, you'll discover that it can be read in two different ways. Notice that the letters "fi" when turned upside down become the "y" at the end of "infinity." And so the spiral can be read as either "infinity" going in or "infinity" coming out! Which do you see?

Infinity is the first in a series of wearable wordplays from the book *Inversions: a Catalog of Calligraphic Cartwheels* by Scott Kim. The book is available through your local bookstore, or by calling Byte Books toll-free at 800-258-5420.

Give the Infinity shirt as a gift, wear it while doing double back somersaults, take one on your next space flight. The possibilities are infinite.

name _____

address _____

city _____

state _____ zip _____

___xs ___s ___m ___l ___xl Black on white @ \$8.00 _____
 ___xs ___s ___m ___l ___xl White on black @ \$8.75 _____

Infinity: 100% cotton, silkscreened. Postage (add \$1 per shirt) _____
 Check or money order only. Calif. residents: add _____
 Sorry — no C.O.D. Dealer inquiries 6½% sales tax _____
 invited. Total Enclosed \$ _____

Inversions Dept. B³, P.O. Box 50697, Palo Alto, CA 94303-0662

Circle 60 on inquiry card.

John Bell Engineering's Apple II Parallel Interface Board

Ned W. Rhodes
2001 North Kenilworth
Arlington, VA 22205

One reason I bought an Apple II was the potential for expansion on its motherboard. I'd planned to add a parallel I/O (input/output) port, a real-time clock, and a couple of other items I was going to design and build. After working with the board for two years, though, I concluded that buying one that already had these features would put me ahead of the game.

Fortunately, I discovered that John Bell Engineering produces an Apple II parallel interface board—actually a multifunction module. It contains two 6522 Versatile Interface Adapters (VIAs) and can function as a parallel interface, clock, or counter. To explain the capabilities of the card, I need only elaborate on the capabilities of the 6522 chip.

About the Author

Ned Rhodes earned a BEE from the University of Minnesota and a master's in computer science from George Washington University. He presently develops minicomputer-based distributed processing systems for the MELPAR division of E-Systems Inc. in Falls Church, Virginia.

The 6522 VIA

The 6522 is a 40-pin support chip compatible with the 6502 microprocessor family. The chip is designed for connection to the data and address bus of a 6502 microprocessor, and it provides two bidirectional, 8-bit I/O ports (where the direction of each bit is programmable). In addition

to the parallel ports, each 6522 has two 16-bit, fully programmable clocks that can be used as counters or interval timers. The chip also includes a shift register for use with one of the timers to clock serial data into or out of the 6522. Each 6522 fully supports the 6502 interrupt structure, finally allowing you to constructively use

At a Glance

Name

Apple II Parallel Interface

Use

Board may be used for parallel I/O, timing, or serial-to-parallel/parallel-to-serial conversions

Manufacturer

John Bell Engineering
POB 338
Redwood City, CA 94064
(415) 367-1137

Dimensions

3 inches by 5 (7.5 by 12.5 cm); plugs into any Apple slot

Price

Assembled, \$69.95; kit, \$59.95; board only, \$22.95

Features

Board contains two 6522 Versatile Interface Adapters with a total of four 8-bit, bidirectional I/O data ports; eight I/O control lines; four independent, 16-bit timers; and two 8-bit, serial-to-parallel/parallel-to-serial shift registers. User can choose the IRQ or NMI interrupt lines

Software Needed

All user-written—no software provided

Documentation

A 16-page booklet containing a circuit board description and a 6522 data sheet

Audience

Assembly-language programmers and others with some hardware experience

QUALITY parts at DISCOUNT PRICES

<p>4PDT PRINTED CIRCUIT 12 VDC</p> <p>14 pin style 3 amp contacts BRAND NEW P.C. Mount \$ 2.75 EA.</p>	<p>SUPER SMALL PHOTO FLASH 170 MFD 330 VOLT 1 1/4" X 7/8" 2 for \$1.50 10 for \$7.00</p>	<p>JOYSTICK PRECISION DEVICE... CONTAINS 4 50K CENTER TAPPED ALPS POTS..... \$4.75 each</p>	
<p>SPECIAL 1000 MFD 25 VOLT 2 FOR \$1.00</p>	<p>RFI/EMI FILTER FOR NOISE SUPPRESSION C/DW APFS40W RATED: 5 AMPS 250 VAC \$3.50 each</p>	<p>SPECIAL MRF 901 MICROWAVE TRANSISTOR \$2.50 EA.</p>	
<p>COMPUTER GRADE CAPACITOR 1700 mfd. 150VDC \$2.00 2 1/2" DIA X 4 3/4" HIGH 3.600 mfd. 40VDC \$1.00 2 1/2" DIA X 4 1/2" HIGH 6,400 mfd. 60VDC \$2.50 1 3/8" DIA X 4 1/4" 12,000 mfd. 40 VDC \$3.00 2" DIA X 4 1/4" HIGH 18,000 mfd. 75VDC \$4.00 2 1/2" DIA X 4 1/2" HIGH 20,000 mfd. 25VDC 2" DIA. X 2 1/2" HIGH \$2.00 22,000 mfd. 15 VDC 2" DIA. X 2 1/2" HIGH \$2.00 22,000 mfd. 40VDC 2" DIA. X 6" HIGH \$3.00 25,000 mfd. 75 VDC \$4.50 3" DIA X 4 3/8" HIGH 45,000 mfd. 25 VDC 2" DIA. X 2" HIGH \$3.50 72,000 mfd. 15VDC 2" DIA. X 6" HIGH \$3.50 CLAMPS TO FIT CAPACITORS 50c ea.</p>	<p>Free! SEND FOR NEW 1982 40 PAGE CATALOG Free!</p>		
<p>L.E.D.'s STANDARD JUMBO DIFFUSED RED 10 FOR \$1.50 GREEN 10 FOR \$2.00 YELLOW 10 FOR \$2.00 FLASHER LED 5 VOLT OPERATION JUMBO SIZE 2 FOR \$1.70 BI POLAR LED 2 FOR \$1.70 SUB MINI LED .079" X .098" 20mA at 1.75v 10 FOR \$1.00 200 FOR \$18.00 QUANTITY PRICES AVAILABLE</p>	<p>14 CONDUCTOR RIBBON CABLE SCOTCHFLEX #3365 28 AWG STRANDED GRAY WITH RED MARKER 10 FEET for \$2.50 100 FOOT ROLL \$12.00</p>	<p>TRANSFORMERS 120 volt primaries 6 VOLTS at 150 mA \$1.25 12 V.C.T. at 500 mA \$2.50 16.5 V. at 3 AMPS \$6.50 18 VOLTS at 1 AMP \$4.50 25.2 V.C.T. at 2.8 AMP \$5.50</p>	
<p>ALL ELECTRONICS CORP. 905 S. Vermont Ave. P.O. BOX 20406 Los Angeles, Calif. 90006 (213) 380-8000 Mon. - Fri. Saturday 9 AM - 5 PM 10 AM - 3 PM</p>			<p>TERMS • Quantities Limited • Min. Order \$10.00 • Add \$2.50 Shipping USA • Calif. Res. Add 6% • Prompt Shipping</p>

Model 953A EPROM PROGRAMMER



- Programs 2508, 2758, 2516, 2716, 2532 and 2732 five volt EPROMS.
- Complete - no personality modules to buy.
- Intelligent - microprocessor based, programs and verifies any or all bytes.
- RS-232 serial interface - use with computer or terminal.
- Verify erasure command - verifies that EPROM is erased.
- Extended diagnostics - error output distinguishes between a bad EPROM and one which needs erasing.
- May be used for extremely reliable data or program storage.
- All power on programming socket under processor control. LED warning light indicates when power is applied.
- Complete with Textool zero insertion force socket.
- High performance/cost ratio.
- Standard DB-25 I/O connector.

PRICE \$289

BAY TECHNICAL ASSOCIATES, inc.
HWY. 603, P.O. BOX 387
BAY ST. LOUIS, MISSISSIPPI 39520
(601) 467-8231

ORDER: 1-800-547-2492

IN OREGON CALL

SERVICE: 503-479-4150

ATARI	400 (16K)	\$325	800 (16K)	\$669
EPSON			I.D.S.	OKIDATA
MX-70	\$369	445G Printer	\$689	80 \$389
MX-80	\$459	460G Printer	\$799	82A \$539
MX-80FT	\$559	560G Printer	\$999	83A \$829
MX-100	\$739			84 \$1229

OLIVETTI 121 - PRINTER/TYPEWRITER
w/Magnum RS 232 or Parallel \$1495

WORD PROCESSOR PACKAGE
WORDSTAR 80 Column enhanced character set
Z-80 & 16K Card by ALS \$1049

TERMS:
SHIPPING: Add 3% of total transaction for UPS brown (ground) or 5% for UPS blue (air), Parcel Post, or any special arrangements.
PAYMENT: Cashier's checks, certified checks, money orders, and bank wires honored immediately. Wire transfer funds to U.S. National Bank of Oregon, South Grants Pass Branch. Credit RCE, account number 501-981, to the attention of Rose. Add 3% for Visa and Master Charge. Allow 20 days for personal checks to clear.
REFUNDS: 10% restocking charge on all returns or exchanges. No refunds on opened software. Call first.
GUARANTEE: All products with full manufacturer's warranty. Sanyo and Apple warranty available. We have full repair and service facilities for all electronic repairs with HP, Dynascan, Pioneer, Sanyo and Apple trained and certified technicians. For any technical service call them for instant advice or questions right on their benches at (503) 479-4150.
REPAIRS: Out of warranty guarantee. Labor 30 days from date of your receipt. 90 days on parts. Call for details on quality guaranteed discount repair and reconditioning service. We have been repairing electronic equipment for 12 years and love it!
MINIMUM ORDER - \$100.00 MINIMUM SHIPPING CHARGES - \$4.00

"A Unique Combination of Quality Products, Competitive Prices, and Service"

APPLE HARDWARE

MICRO SCI DISK DRIVE (DIRECT APPLE REPLACEMENT)
A-2 DISK DRIVE \$429
CONTROLLER 31 & 12 \$79
VIDEX 80 COLUMN \$269
CORVIS 5 MEG DRIVE \$3049
LOWER CASE ADAPTOR \$39
16K RAM CARD (MICROSOFT) \$149
Z-80 CARD (MICROSOFT) \$299
MICROMODEM (HAYES) \$289
SMART MODEM (HAYES) \$229
NOVATION MODEMS
APPLE CAT \$309
AUTO CAT \$209
CAT \$139
II CAT \$149
MOUNTAIN CLOCK \$239
MOUNTAIN MUSIC SYSTEM \$469
MOUNTAIN A/D CONVERTER \$299
MOUNTAIN INTROL/X-10 CARD \$169
MOUNTAIN C.P.S. \$189
10 KEYPAD (A.B.T.) \$99
SUP-R-TERM (80 COLUMN) \$299
SUP-R-MOD R.F. MODULATOR \$24
16K MEMORY EXPANSION \$39
JOYSTICK (T.G.I.) \$39
12" B&W MONITOR (SANYO) \$145
9" H&W MONITOR (N.E.C.) \$149
12" B&W MONITOR (SANYO) \$189
12" GREEN MONITOR (SANYO) \$229
12" GREEN MONITOR (ZENITH) \$114
12" GREEN MONITOR (BMC) \$255
13" COLOR MONITOR (SANYO) \$385
EPSON CABLE & INTERFACE \$79
EPSON GRAFTRAX \$70
SANYO SLIM II CASS DECK \$29

ATARI HARDWARE

CK-2600 VIDEO GAME \$139
410 PROGRAM RECORDER \$59
810 DISK DRIVE \$429
820 PRINTER \$249
822 PRINTER \$339
825 PRINTER \$579
830 MODEM \$149
850 INTERFACE MODULE \$135
853 16K MEMORY EXPANSION \$179
RAM CRAM 32K \$85

SOFTWARE

VISICALC (ATARI) \$149
BASIC (ATARI) \$449
VISICALC II \$139
VISIDEX \$139
VISIPILOT \$129
VISITERM \$109
VISITREND/PLOT \$179
MICROLAB DATA FACTORY \$129
D B MASTER (STONEWARE) \$179
SUP-R-TEXT II \$109
WORDSTAR \$249
B.P.I. SOFTWARE (each) \$319
STOCKPILE INVENTORY \$369
ADVENTURE \$29
ZORK \$29
SARGON CHESS \$29
GALAXIAN \$22
FUJI CASS TAPE/10 \$19
VERBATIM \$25
MAXELL \$38

PRICES SUBJECT TO CHANGE WITHOUT NOTICE

WRITE FOR CATALOG





RALSTON-CLEARWATERS ELECTRONICS

530 N.E. 'E' Street • Grants Pass, Ore. 97526
ALL BRAND NAMES ARE REGISTERED TRADE MARKS

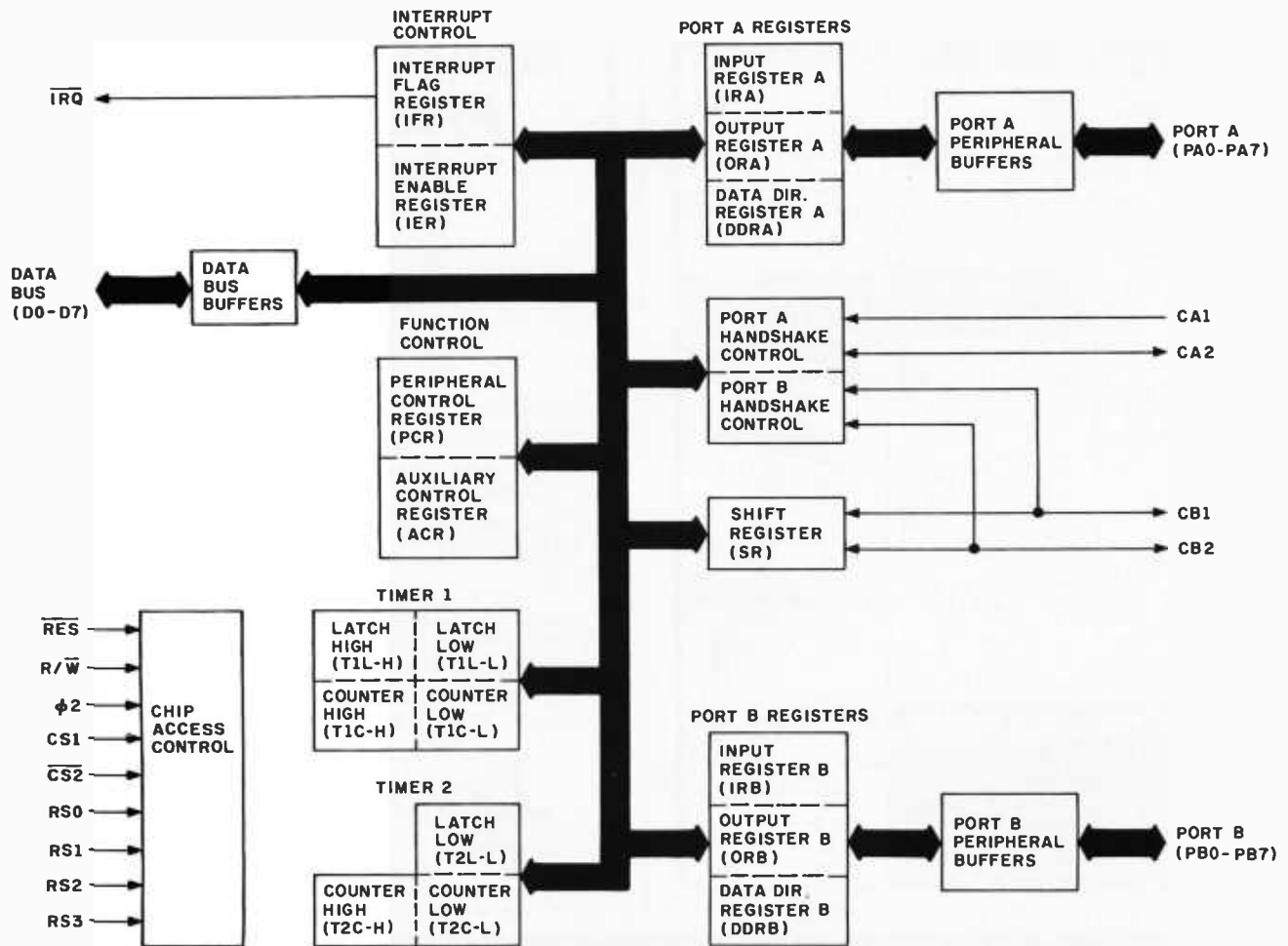

Figure 1: Block diagram of the internal configuration of the 6522 VIA (Versatile Interface Adapter) integrated circuit.

the Apple interrupts.

All communication with the 6522 occurs through 16 internal registers. Two of the 16, IRB/ORB and IRA/ORR, are used as I/O registers for the two 8-bit parallel ports. Two others, DDRB and DDRA, are data-direction registers that define the direction of each bit (either input or output) of the parallel ports. Four registers are set aside to control the two programmable counter/timers, and one I/O register controls the serial-shift register. Two registers select the operating mode of the timers and shift register; they also determine whether the chip will recognize positive- or negative-going control pulses.

The 6522 has a dedicated interrupt flags register that allows the chip to generate interrupts upon detection of

(1) a positive- or negative-going edge on any of the four control lines, (2) a timeout (overflow) condition on either of the timers, or (3) the completion of a shift-register shift cycle. One register selectively enables and disables interrupt generation, while the last register is reserved for special forms of I/O through port A. Figure 1 is a block diagram of the 6522 chip's internal layout.

6522 on the Apple

Due to a design limitation in the Apple II, the 6522 can't work properly if it's merely attached to the bus; the 6522 requires a phase 2 clock pulse that isn't available on the Apple. The Apple 6502 processor generates the phase 2 clock signal, but that pin is unavailable at the expansion slot connectors.

Therefore, the I/O board must gen-

erate its own phase 2 clock signal. The phase 2 clock pulse is simulated by delaying the phase 0 clock signal by 80 nanoseconds. I must point out that simply delaying phase 0 may not match the duty cycle specification of the phase 2 clock, but that doesn't seem to matter. The 6522s accept the simulated phase 2 clock signal and work just fine.

The Circuit Board

The board may be purchased in three different forms. For those of you with no hardware experience, it's available as a fully assembled and tested card. It may also be bought as a complete kit or as a bare board for which you supply the parts. I chose the bare board, then ordered the sockets and 6522 chips from a mail-order supplier.

The board is very simple to build.

We review products from every source and carry ALL of THE BEST

STOP FOR COLOR COMPUTER PRODUCTS SHOPPING

We offer products from
 Mark Data • Micro Works
 Radio Shack • Book Publishers
 Epson • NEC • Centronics • Moore

SOFTWARE: Color Invaders • Color Pac Attack
 Monitor • Adventure Games • Text Editors
 Assemblers • PASCAL • Magikube
 Finance Programs • Color Data Organizer
 Graphic Games • Disassembler

HARDWARE: 32K RAM Expansion Board • 16K RAM Set
 Cables • Interfaces • Power Pack ROM Cartridge • Printers

ACCESSORIES: Books • Cassettes • Supplies • Service Manuals

Look to **COMPUTERWARE** for DISK SOFTWARE

*** NEW PRODUCTS ***

16 PLUS BOARD — just plug in to expand from 16K to 32K
PAC ATTACK — graphics action game — **PAC ATTACK**
 32K versions of Editor, Assembler, Monitor, PASCAL, BERSERK game —
 Micro Text (communications) — **STAR BLASTER**

Shipping from stock

CALL OR WRITE FOR COMPLETE INFORMATION



Dept. C • Box 668
 6809 Specialists Encinitas, CA 92024 • (714) 436-3512
 Computerware is a trademark of Computerware.

DISCOUNT PRICES



WE'RE ON THE EAST COAST

DUPRÉ ENTERPRISES, INC.
 MICROCOMPUTER SALES DIVISION
 SUITE 6 NELSON BLDG. (201) 461-8086
 271 FORT LEE ROAD WE HONOR VISA and MASTERCHARGE
 LEONIA, NJ 07605 9 AM-3 PM MON.-FRI.

OLYMPIC SALES COMPANY

Authorized Dealer
Apple Computer
 LARGE INVENTORY LOWER THAN EVER PRICES
NEW APPLE FAMILY SYSTEM
 • 48K Apple II+ Retail: \$2495.00
 • Disk w/controller Call for BEST Price!
 • RF Modulator
 • 7 Personal & game disks
 Large Inventory of:
 Disk with controller DDS 3.3
 Second Disk Drives
 Pascal—Fortran—Cobol languages
 Dow Jones & Quote reporter
 Graphics Tablets
 Visicalc for Apple II & III
 Smartem 80 column card
 Micromodem II by DC Hayes
WE ALSO CARRY SOFTWARE!
 Personal Software Innovative
 Peach Tree Software American
 Microsoft System Plus
 Micropro
 We are an authorized servicing Apple dealer for Apple II & III. Immediate delivery on all models—we carry an enormous inventory of Apple products at all times!
 Just some of the software in stock NOW—
 Magic Window, Raster Blaster, Ultima, Home S Minder, Tax Preparer, Pool T.S., Typing Tutor, Olympic Decathlon, ABM, Robot War, Castle Wolfenstein, Cranston Manor, Expediter, OO-Tapas, Cyborg, Gorgon, Falcons, Wizardry, Personal Filing System, PFS: Report, Flight Simulator...

hp HEWLETT PACKARD
HP-11C Advanced Programmable Scientific LCD Retail: \$130.00 **Your Cost: \$114.95**
HP-12C Advanced Programmable Financial LCD Retail: \$150.00 **Your Cost: \$129.95**
HP-125 New Microcomputer 64K CPU/Terminal/Keyboard Retail: Your Cost **\$375.00 3195.00**
HP-85 Microcomputer— built-in printer/monitor 3250.00 2499.00
HP-93 Microcom— built-in mon 2250.00 1799.00
HP-2631B Printer, dot matrix 3950.00 3199.00
HPB2905A 80 col printer 945.00 755.00
HP-2601A Letter quality prtr 3495.00 3495.00
HP-82901M Dual master 2500.00 1999.00
 Call us for the lowest prices on 7 disk drives
Graphics plotter 7225 2450.00 2089.00
Personality module—a must
 for 7225 750.00 636.00
Graphics Tablet 9111A 2050.00 1699.00
HP-41CV 325.00 256.00
Card Reader for 41CV 215.00 171.00
Printer for 41CV 385.00 294.00
Quad Ram 95.00 84.95
Optical Wand for 41CV 125.00 99.95
HP-41C Calculator 250.00 188.95
Memory mod. for 41C 26.95 26.95
HP-97 Programmable printer 750.00 579.95
HP-34C Programmable scientific 150.00 117.95
HP-38C Programmable business R/E 150.00 119.95
HP-32E Advanced scientific 55.00 48.95
HP-37E Business management 75.00 58.95
 We carry a complete inventory of _____
 Libraries, accessories & supplies.

Mattel 1670 Race Horse Computer Ret. \$125.00 Y/C: \$24.95
ATARI Programmable Color TV Game Video Console: Retail: \$225.00 **\$137.95**
MATTEL ELECTRONICS Intellivision Retail: \$325.00 **Your Cost: \$234.95**
VIDEO TAPES
 Min order: 3, mixed OK
SONY L500 2 hr \$11.89
SONY L750 3 hr \$4.69
RCA VK250 6 hr \$13.95
TEXAS INSTRUMENTS Retail You Pay
 TI-59 295.00 179.95
 TI-3011 LCD Stu Slide/NEW 18.95
 TI-35SP LCD Sci 22.50
 TI-40 LCD Sci/NEW 28.95
 Bus. Anal. I 19.95
 Bus. Anal. II 44.95
 Bus. Card 39.95
 MBA 54.95
 Invest. Analyst 48.95
 TI-54 Adv. LCS Sci/NEW 39.95
 TI-5511 NEW 44.95
 TI-57 Prog. Sci 39.95
 TI-58C 480 Step. Prog. 89.95
 PC-100C Print/Plot 149.95
 LCD-Programmer/NEW 59.95

Main Showroom & Offices:
 216 South Oxford Avenue
 Los Angeles, CA 90004
 WE HONOR VISA and MASTERCHARGE
 TELEX: 67 34 77
ORDER DESKS open 7 Days a Week!
 7:00 AM to 7:00 PM Mon thru Sat
 Sunday Noon to 5:00 PM
 Order Desks: (213) 739-1130
TOLL-FREE (outside Calif.) 800-421-8045
TOLL-FREE (within Calif.) 800-252-2153
 All goods subject to availability; this ad supersedes all previous ads; we are not responsible for typographical errors; we will meet or beat any advertised prices if the competition has the goods on hand.
 Minimum shipping and handling \$4.95.
 All orders subject to verification and acceptance.

EPSON SUBJECT PAPER TIGER PRINTERS

Model	Retail	Your Cost
MX80	645.00	499.00
Optional Graftax Chip 80		95.00
MX80 FT	745.00	599.00
MX100	995.00	749.00

DIABLO 630 PAPER TIGER PRINTERS

Letter Quality	460G graphics	1094.00	969.95
12" daisy wheel	560	1295.00	1099.00
w/tractors	560G graphics	1394.00	1195.00
Retail \$3395.00	445	795.00	695.00
Y/C: \$2595.00	445G	894.00	789.00

SANYO MONITORS High resolution

Model	Resolution	Retail	Your Cost
13" Color (new) high quality	550.00	419.95	
12" Green phosphorus	360.00	259.95	
12" Black & white	340.00	239.95	
15" Black & white	370.00	259.95	
9" Black & white (the best seller)	235.00	169.95	

AMDEK (Leadex) High Quality Monitors

Model	Resolution	Retail	Your Cost
100 12" B/W, 12 MHz	179.00	139.95	
100-G 12" Green, 12 MHz	199.00	174.95	
300-G 12" Green, 18 MHz	249.00	199.95	
Color I 13" Color, NTSC comp. input	449.00	339.95	

Texas Instruments Home Computer
 New—1982 Model with full typewriter-style keyboard, TI-99/4A U/L case & more! Retail: Your Cost **\$369.95 \$950.00 \$369.95!**
10" color monitor for 99/4 650.00 319.95
32K Exp. mem. module 399.95 314.95
Extended Basic, a MUST for 32K module 100.00 75.00
Speech synthesizer 150.00 129.95
Disk memory drive 500.00 397.95
RF modulator 69.50 49.50
Telephone coupler (modem) 225.00 189.95
Printer (solid state) 400.00 319.95
 We carry a large inventory of software, & accessories

ATARI COMPUTERS

Model	Retail	Your Cost
800 16K	1080.00	759.95
810 Disk Drive	600.00	469.95
Atari VisiCalc	200.00	169.95
825 Impact Printer 1000.00		779.95

(Centronics 737)
SUPER SPECIAL—ATARI 400 (16K)
 Retail: \$595.00 Your Cost: \$339.95
 Language Cart. not included—Opt'l at \$54.95

OHIO SCIENTIFIC Professional Computers Retail Your Cost
CBPDF-48K 3495.00 3195.00
 • Dual 8" Drives • 64 col x 32 line/color
 • 7 MIPS FAST! • Many more standard features
 Fortran & Pascal available
 Many other OSI products available
 —at discounted prices, of course!

All you do is mount two 40-pin sockets, four 16-pin sockets, one 14-pin socket, and two bypass capacitors. Then plug in the chips and you're ready to go. The documentation suggests that you use "standard assembly and soldering techniques." I guess that means you shouldn't lift the solder donuts by applying excessive heat and that solder bridges between pins are taboo. I managed to avoid both perils.

Connections are made through the four 16-pin DIP (dual in-line package)

sockets; each socket handles eight bits. If interrupts are used, two jumper wires must be installed to enable them. One of the 6522s can be attached to the IRQ (interrupt-request) line, while the other can be attached to the NMI (nonmaskable interrupt) line. Note that the interrupt lines *cannot* be shared—you can have only one 6522 attached to an interrupt line.

Documentation accompanying the board is sparse, and the unadventurous user may get lost. The board

comes with a two-page circuit diagram and register identification list, a two-page circuit description and a two-page list of all possible board addresses (whose availability depends upon which slot is used on the Apple). A ten-page 6522 data sheet is also provided.

If you can read the data sheet, you can use the 6522. If you find the data sheet difficult to understand, chances are this product isn't for you. The manufacturer has provided no software examples because of "the numerous uses of the board." I believe that limits the board's usefulness. Hold on, though; I've provided two software routines to demonstrate the capabilities of the parallel interface board and the 6522s.

Software

I was unable to write software that would test *all* of the 6522 functions, so I chose two of the more common applications: parallel I/O and clock

Parallel Printer Routine. The first software example, in listing 1, is a parallel output routine for a printer such as the Epson MX-80. Two basic sections comprise the routine. In the first section, the output routine is "hooked" through DOS, so that any character output to the screen will also appear on the printer. The horizontal-tab counter and the screen-echo flag are initialized at that time. The 6522 is then set up for output, and a Control X is sent to the printer, clearing its internal buffer. In the routine's second section, the characters are output, one at a time to the printer.

The 6522 initialization is unique. First, you enable port A for output by placing a hexadecimal FF in the data direction register (DDRA) for port A. Then set up the data-output strobe and the data-ready flag, which are the handshaking signals required for parallel communications. When the printer is ready to receive data, it indicates this with a pulse. With the MX-80, a negative-going pulse indicates ready, so you tie it to the C line (one of the control lines for port A). The other signal, the data strobe

Text continued on page



The DS120 Terminal Controller makes your LA36 perform like a DECwriter® III.

The Datasouth DS120 gives your DECwriter® II the high speed printing and versatile performance features of the DECwriter® III at only a fraction of the cost. The DS120 is a plug compatible replacement for your LA36 logic board which can be installed in minutes. Standard features include:

- 165 cps bidirectional printing
- Horizontal & Vertical Tabs
- Page Length Selection
- 110-4800 baud operation
- 1000 character print buffer
- X-on, X-off protocol
- Self Test
- RS232 interface
- 20 mA Current Loop interface
- Top of Form
- Adjustable Margins
- Double wide characters
- Parity selection
- Optional APL character set

Over 5,000 DS120 units are now being used by customers ranging from the Fortune 500 to personal computing enthusiasts. In numerous installations, entire networks of terminals have been upgraded to take advantage of today's higher speed data communications services. LSI microprocessor electronics and strict quality control ensure dependable performance for years to come. When service is required, we will respond promptly and effectively. Best of all, we can deliver immediately through our nationwide network of distributors. Just give us a call for all the details.

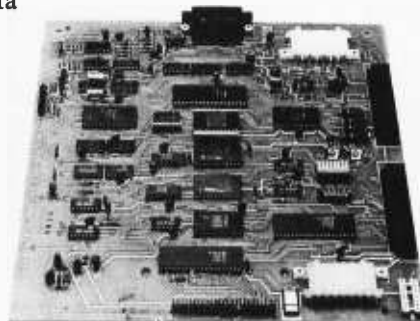

datasouth computer corporation

4740 Dwight Evans Road • Charlotte, North Carolina 28210 • 704/523-8500

MORE
POWER
 FOR YOUR APPLE
ASPEED II AND II+
 LANGUAGE SYSTEMS

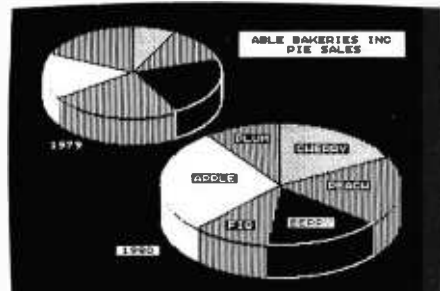
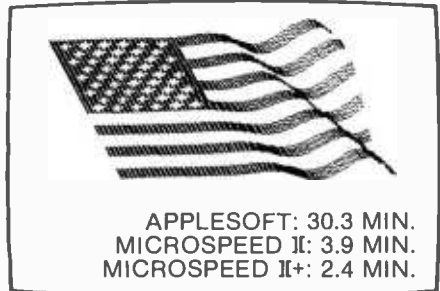

FASTEST: UP TO 100 TIMES FASTER THAN APPLESOFT

MOST POWERFUL: MORE POWER THAN BASIC PASCAL OR FORTRAN

EXPANDABLE: LANGUAGE BASED ON FORTH

CREATIVE: GROW YOUR OWN LANGUAGE

USER-FRIENDLY: EASIEST FOR YOU TO LEARN

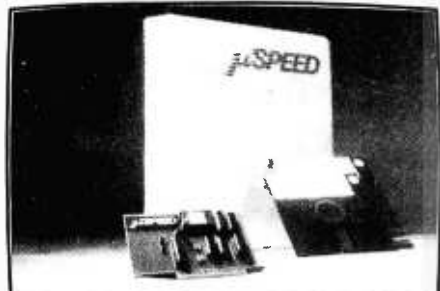

REQUIRES APPLE, SINGLE DISK
 μ SPEED II USES 2mHz PROCESSOR
 μ SPEED II+ USES 4mHz PROCESSOR

SEE YOUR DEALER OR CONTACT:

applied analytics incorporated

8910 Brookridge Dr., Suite 609, Upper Marlboro, Md. 20870
 (301) 627-6650

I'm Interested: Please Send

μ SPEED II '495. 160 page Manual '35.
 μ SPEED II+ '645. Detailed Information

Name _____
 Address _____
 City _____
 State _____ Zip _____

Listing 1: Parallel printer output routine for the John Bell Engineering parallel board. Written in 6502 assembly language, this program is designed to drive an Epson MX-80 printer.

```

1000 *
1010 *
1020 * MX-80 PRINTER DRIVER
1030 * DJG 3/81
1040 * MODIFIED BY NWR FOR USE WITH JOHN BELL CARD
1050 *
1060 * NORMAL MODE ECHOES ON SCREEN
1070 * CNTL-H (BACK ARROW) ABORTS SCREEN ECHO SO
1080 * BASIC LISTINGS WILL USE FULL 80 COLUMNS
1090 * CNTL-G (BELL) IS ALWAYS SENT TO SCREEN ONLY
1100 *
1110 *
1120 * 6522 REGISTER EQUATES
1130 *
1140 *
C300- 1150 SLT1 .EQ $C300  SLOT 3 6522 REGISTERS
C301- 1160 ORA .EQ SLT1+1  OUTPUT REGISTER A
C303- 1170 DDRA .EQ SLT1+3  DATA DIRECTION REGISTER
C30C- 1180 PCR .EQ SLT1+$C  PERIPHERAL CONTROL REGISTER
C30D- 1190 IFR .EQ SLT1+$D  INTERRUPT FLAG REGISTER
1200 *
1210 *
1220 * PROGRAM EQUATES
1230 *
1240 *
0024- 1250 CH .EQ $24  SCREEN HOR. CURSOR POSITION
0479- 1260 HCNT .EQ $0479 CHARACTER COUNTER IN SLOT 1 RAM
04F9- 1270 FLAG .EQ $04F9 FLAG FOR ECHOING ON SCREEN
0579- 1280 ACC .EQ $0579 ACCUMULATOR STORAGE
0011- 1290 ENBL .EQ $11  ENABLE PRINTER CHARACTER
0098- 1300 CNTX .EQ $52  CONTROL X CHARACTER
FDF0- 1310 SCRAN .EQ $FDF0 SCREEN SUBROUTINE
0036- 1320 DHOK .EQ $36  OUTPUT HOOK LOCATION
03EA- 1330 HOOK .EQ $3EA DOS HOOK ROUTINE
0087- 1340 BELL .EQ $87  BELL CHARACTER
0008- 1350 SLNT .EQ $8  CONTROL-H ECHO ON PRINTER ONLY
000D- 1360 CAR .EQ $D  CARRIAGE RETURN
00A0- 1370 SPAC .EQ $A0  SPACE CHARACTER
1380 *
1390 *
1400 * .OR $C300  START IT HERE
1410 * .TF MX80.BELL.OBJ
1420 *
1430 *
1440 * MX80 INITIALIZATION
1450 *
1460 * CALL THIS PORTION OF THE ROUTINE TO
1470 * SET UP THE PRINTER DRIVER TO SEND
1480 * CHARACTERS TO THE PRINTER
1490 *
1500 *
0300- A9 FF 1510 MX80 LDA #$FF  SET PORT A FOR
0302- 8D 03 C3 1520 STA DDRA  OUTPUT
0305- A9 0A 1530 LDA $0A  CA1 ON NEGATIVE EDGE
0307- 9D 0C C3 1540 STA PCR  CA2 GIVES PULSE
030A- A9 11 1550 LDA $ENBL ENABLE PRINTER (SO IFR1 WILL
030C- 8D 01 C3 1560 STA ORA  BE SET FOR FIRST CHARACTER)
C30F- A9 98 1570 LDA $CNTX CNTL X ERASES BUFFER
0311- 8D 79 05 1580 STA ACC  SAVE IT
0314- 20 69 03 1590 JSR POUT SEND IT
0317- A9 28 1600 LDA $PRNT ADDRESS OF NEW OUTPUT ROUTINE
0319- 85 36 1610 STA DHOK SAVE IT
031R- A9 03 1620 LDA $PRNT ADDRESS OF NEW OUTPUT ROUTINE
C31D- 85 37 1630 STA DHOK+1 SAVE IT
031F- 20 EA 03 1640 JSR HOOK HOOK NEW OUTPUT ROUTINE TO DOS
0322- A9 00 1650 LDA #00 GET INITIAL VALUE
0324- 8D 79 04 1660 STA HCNT ZERO HORIZONTAL CHARACTER POSITION
0327- 8D F9 04 1670 STA FLAG SCREEN ECHO ON
032A- 50 1680 RTS DONE WITH INITIALIZATION
1690 *
1700 *
1710 * OUTPUT ROUTINE
1720 *
1730 *
032B- C9 87 1740 FRNT CMP $BELL A BELL CHARACTER??
032D- F0 36 1750 BEQ TV YES, AVOID PRINTER'S RACKET
032F- 29 7F 1760 AND #$7F REMOVE MSR
0331- 48 1770 PHA SAVE ACCUMULATOR
0332- C9 08 1780 CMP $SLNT DISABLE SCREEN ECHO??
0334- D0 03 1790 BNE CR NO
0336- 8D F9 04 1800 STA FLAG PUT NON-ZERO IN FLAG
0339- C9 0D 1810 CR CMP $CAR CARRIAGE RETURN?
033B- D0 05 1820 BNE TAB NO
033D- A9 FF 1830 LDA #$FF COUNTER WILL BE ZERO AFTER CR
033F- 8D 79 04 1840 STA HCNT RELOAD HORIZONTAL CHARACTER-1
0342- AD 79 04 1850 LDA HCNT COMPARE COUNTER WITH SCREEN
0345- C5 24 1860 CMP CH HOR. POSITION
0347- 80 08 1870 BCS CHAR BRANCH IF IN PROPER POSITION
1880 *
1890 *
1900 * OUTPUT SPACES UNTIL PRINTER IS AT THE PROPER
1910 * HORIZONTAL CHARACTER POSITION
1920 *
1930 *
0349- A9 A0 1940 LDA $SPAC GET A SPACE
034B- 8D 79 05 1950 STA ACC SAVE AS PRINT CHARACTER
034E- 20 69 03 1960 JSR POUT PRINT IT
0351- 4C 42 03 1970 JMP TAB CHECK HOR. POSITION AGAIN
0354- 68 1980 CHAR PLA GET CHARACTER
0355- 8D 79 05 1990 STA ACC SAVE AS PRINT CHARACTER
035B- 20 69 03 2000 JSR POUT GO PRINT IT
035E- AD F9 04 2010 LDA FLAG ECHO ON SCREEN?
035E- D0 08 2020 BNE RET NO
    
```

Listing 1 continued on page 422

MITSUBISHI FLEXIBLE DISK DRIVE

SETTING NEW STANDARDS FOR RELIABILITY AND DURABILITY

- FULLY IBM AND SHUGART SA850R COMPATIBLE
- DOUBLE-SIDED, DOUBLE-DENSITY
- 1.6 MBYTE/DISK
- SOFTOUCH™ PROPRIETARY HEAD LOAD MECHANISM
- 3 MS TRACK-TO-TRACK ACCESS TIME
- HIGH QUALITY, ALL FERRITE MnZn HEADS
- PRECISION BUILT/MODULAR CONSTRUCTION
- 6 MONTH WARRANTY

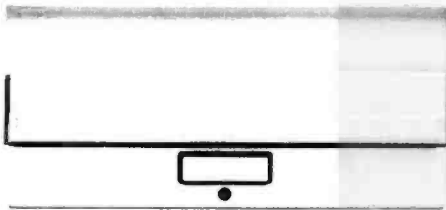

***\$525.00** Available from stock. Terms: cash, check, money orders, VISA, MasterCard. Tax: 6% if California resident. *Price subject to change without notice.

NCDATA

1333 Lawrence Expressway, Suite 408
 Santa Clara, California 95051
 (408) 247-3450/TWX 910-338-7442
 AUTHORIZED SALES AND SERVICE AGENT
 FOR INFORMATION CONTACT HOLLY SAUER
 OEM INQUIRIES INVITED

TRISWATCH

Keeps your TRS-80 Mod II up with the times.

The Triswatch, formally known as the CCB-II, is a **clock, calendar, and audio alarm** rolled into one!

- For TRSDOS users, the CCB-II eliminates the hassle of setting the time and date when you reset your Mod II.
- The P&T CP/M® 2 system date and time are synchronized to the CCB-II each time the system is reset.
- The CCB-II is directly accessible from any language that allows direct port input and output.
- A pacemaker battery is included, which provides over 8 years of continuous timekeeping.

Keep up with the times and order the CCB-II for \$175 plus shipping.



TRS-80 is a trademark of Tandy Corp.
 CP/M is a registered trademark of Digital Research Inc.
PICKLES & TROUT
 P. O. BOX 1206, GOLETA, CA 93116. (805) 685-4641

Warning: Installation requires opening the Model II, which may void its warranty. We suggest waiting until the warranty period has expired before installing the CCB-II.

TERMINALS

★ ADDS ★
VIEWPOINT
\$579.00

SOROC
 IQ 120
\$689.00

FACTORY WARRANTY
 One year warranty on CRT and keyboard. Advance installation. Warranted forever.

82 I.C. MASTER

CARDS MICROSOFT
 Z80 \$295.00
 16K RAM \$160.00
 VIDEOTERM 80 columns \$295.00

COMPUTERS

ATARI® 800™ COMPUTER SYSTEM

400 w/16K \$350.00
 800 w/16K \$699.00
 *800 Computer w/48K **\$825.00** (BEST BUY)

ATARI PERIPHERALS:

Printer "825" - 650.00 Asteroids - 32.50
 Disk Dr. "810" - 485.00 Missile Com. - 32.50
 Record "410" - 82.00 Sup. Brk. Out - 16.95
 Paddle (pr) - 16.95 Assem. Edit - 49.00
 Joystick (pr) - 16.95 Star Raiders - 45.00
 32k RAM - 179.95 Basketball - 28.00
 Basic Cart - 49.00 Chess - 32.00

COMPONENTS 74 S00

SN7400N	16	SN7487N	30	74S00	39	74S138	75
SN7402N	22	SN7489N	49	74S02	45	74S140	100
SN7404N	21	SN7493N	45	74S03	38	74S158	75
SN7408N	22	SN7495N	50	74S04	39	74S174	135
SN7410N	16	SN7499N	80	74S05	39	74S175	135
SN7412N	20	SN74122N	99	74S10	39	74S182	75
SN7413N	22	SN74126N	95	74S15	45	74S189	475
SN7414N	20	SN74127N	99	74S20	55	74S201	675
SN7416N	27	SN74151N	65	74S22	55	74S240	275
SN7417N	29	SN74152N	58	74S30	75	74S244	295
SN7420N	17	SN74154N	125	74S37	55	74S251	275
SN7425N	20	SN74155N	75	74S50	65	74S287	295
SN7430N	17	SN74157N	58	74S51	49	74S288	295
SN7437N	26	SN74160N	89	74S54	65	74S295	575
SN7438N	24	SN74161N	85	74S74	65	74S299	975
SN7440N	16	SN74163N	85	74S86	95	74S471	950
SN7442N	45	SN74164*	87	74S112	195	74S473	950
SN7445N	64	SN74174N	88	74S132	145	74S474	950
SN7443N	42	SN74165N	55				
SN7447N	19	SN74178N	98				
SN7454N	19	SN74175N	79				
SN7454N	19	SN74180N	75				
SN7474N	27	SN74181N	115				
SN7475N	45	SN74393N	165				

DISKETTE «SALE»

Wabash: 5 1/4 → 10/ \$24.90
 Binch →
 SS/SO: More Avail.
 QTY. PRICE AVAIL

REAL-TIME CLOCK CALENDAR (MSM 5832)

Description: Mono Metal Gate CMOS I.C.
 Features:
 - Time, Month, Date, Year, & Day of Week
 - Bus Oriented
 - 4 Bit Data Bus
 - R/W Hold Select
 - Inter Signal
 - 32.768KHz xtal Control
 - 5v Pow Sup
 - Low Power Dissipation

\$7.45
 XTAL \$2.85

* MONITORS *

ZENITH 1 12in. 15MHz: 1. Green Phos. HI-Res. → **\$118.50** ☆
 J.C.S. 2 12in. 18MHz: 2. Green Phos. HI-Res. → **\$169.50** ☆
 AMDEK 3 12in. 12MHz: 3. Green Phos. HI-Res. → **\$155.50** ☆
 13in. Color 3a 3a. Lo-Res. → **\$375.50** ☆

74LS00

74LS00	28	74LS158	60	2102	.95	450MS	.95	1103A	.75
74LS02	28	74LS161	83	NE565	.27	NE565	.27	UPD785	10.85
74LS03	28	74LS162	89	74LS04	28	74LS163	98	74LS05	27
74LS04	28	74LS164	66	74LS06	29	74LS165	66	74LS07	28
74LS05	22	74LS164	66	74LS08	28	74LS169	155	74LS09	28
74LS06	29	74LS165	66	74LS10	26	74LS170	175	74LS11	26
74LS07	28	74LS169	155	74LS12	26	74LS174	85	74LS13	26
74LS08	28	74LS170	175	74LS14	26	74LS174	85	74LS15	26
74LS09	28	74LS174	85	74LS16	26	74LS175	85	74LS17	27
74LS10	26	74LS175	85	74LS17	27	74LS180	85	74LS18	27
74LS11	26	74LS180	85	74LS18	27	74LS181	125	74LS19	27
74LS12	40	74LS181	125	74LS19	27	74LS182	89	74LS20	27
74LS13	27	74LS182	89	74LS20	27	74LS183	98	74LS21	27
74LS14	27	74LS183	98	74LS21	27	74LS184	66	74LS22	37
74LS15	26	74LS184	66	74LS22	37	74LS185	66	74LS23	37
74LS16	26	74LS185	66	74LS23	37	74LS186	66	74LS24	37
74LS17	27	74LS186	66	74LS24	37	74LS187	75	74LS25	37
74LS18	27	74LS187	75	74LS25	37	74LS188	75	74LS26	37
74LS19	27	74LS188	75	74LS26	37	74LS189	75	74LS27	37
74LS20	27	74LS189	75	74LS27	37	74LS190	75	74LS28	37
74LS21	27	74LS190	75	74LS28	37	74LS191	125	74LS29	37
74LS22	37	74LS191	125	74LS29	37	74LS192	125	74LS30	37
74LS23	37	74LS192	125	74LS30	37	74LS193	165	74LS31	37
74LS24	37	74LS193	165	74LS31	37	74LS194	165	74LS32	37
74LS25	37	74LS194	165	74LS32	37	74LS195	165	74LS33	37
74LS26	37	74LS195	165	74LS33	37	74LS196	165	74LS34	37
74LS27	37	74LS196	165	74LS34	37	74LS197	165	74LS35	37
74LS28	37	74LS197	165	74LS35	37	74LS198	165	74LS36	37
74LS29	37	74LS198	165	74LS36	37	74LS199	165	74LS37	37
74LS30	37	74LS199	165	74LS37	37	74LS200	165	74LS38	37
74LS31	37	74LS200	165	74LS38	37	74LS201	165	74LS39	37
74LS32	37	74LS201	165	74LS39	37	74LS202	165	74LS40	37
74LS33	37	74LS202	165	74LS40	37	74LS203	165	74LS41	37
74LS34	37	74LS203	165	74LS41	37	74LS204	165	74LS42	37
74LS35	37	74LS204	165	74LS42	37	74LS205	165	74LS43	37
74LS36	37	74LS205	165	74LS43	37	74LS206	165	74LS44	37
74LS37	37	74LS206	165	74LS44	37	74LS207	165	74LS45	37
74LS38	37	74LS207	165	74LS45	37	74LS208	165	74LS46	37
74LS39	37	74LS208	165	74LS46	37	74LS209	165	74LS47	37
74LS40	37	74LS209	165	74LS47	37	74LS210	165	74LS48	37
74LS41	37	74LS210	165	74LS48	37	74LS211	165	74LS49	37
74LS42	37	74LS211	165	74LS49	37	74LS212	165	74LS50	37
74LS43	37	74LS212	165	74LS50	37	74LS213	165	74LS51	37
74LS44	37	74LS213	165	74LS51	37	74LS214	165	74LS52	37
74LS45	37	74LS214	165	74LS52	37	74LS215	165	74LS53	37
74LS46	37	74LS215	165	74LS53	37	74LS216	165	74LS54	37
74LS47	37	74LS216	165	74LS54	37	74LS217	165	74LS55	37
74LS48	37	74LS217	165	74LS55	37	74LS218	165	74LS56	37
74LS49	37	74LS218	165	74LS56	37	74LS219	165	74LS57	37
74LS50	37	74LS219	165	74LS57	37	74LS220	165	74LS58	37
74LS51	37	74LS220	165	74LS58	37	74LS221	165	74LS59	37
74LS52	37	74LS221	165	74LS59	37	74LS222	165	74LS60	37
74LS53	37	74LS222	165	74LS60	37	74LS223	165	74LS61	37
74LS54	37	74LS223	165	74LS61	37	74LS224	165	74LS62	37
74LS55	37	74LS224	165	74LS62	37	74LS225	165	74LS63	37
74LS56	37	74LS225	165	74LS63	37	74LS226	165	74LS64	37
74LS57	37	74LS226	165	74LS64	37	74LS227	165	74LS65	37
74LS58	37	74LS227	165	74LS65	37	74LS228	165	74LS66	37
74LS59	37	74LS228	165	74LS66	37	74LS229	165	74LS67	37
74LS60	37	74LS229	165	74LS67	37	74LS230	165	74LS68	37
74LS61	37	74LS230	165	74LS68	37	74LS231	165	74LS69	37
74LS62	37	74LS231	165	74LS69	37	74LS232	165	74LS70	37
74LS63	37	74LS232	165	74LS70	37	74LS233	165	74LS71	37
74LS64	37	74LS233	165	74LS71	37	74LS234	165	74LS72	37
74LS65	37	74LS234	165	74LS72	37	74LS235	165	74LS73	37
74LS66	37	74LS235	165	74LS73	37	74LS236	165	74LS74	37
74LS67	37	74LS236	165	74LS74	37	74LS237	165	74LS75	37
74LS68	37	74LS237	165	74LS75	37	74LS238	165	74LS76	37
74LS69	37	74LS238	165	74LS76	37	74LS239	165	74LS77	37
74LS70	37	74LS239	165	74LS77	37	74LS240	165	74LS78	37
74LS71	37	74LS240	165	74LS78	37	74LS241	165	74LS79	37
74LS72	37	74LS241	165	74LS79	37	74LS242	165	74LS80	37
74LS73	37	74LS242	165	74LS80	37	74LS243	165	74LS81	37
74LS74	37	74LS243	165	74LS81	37	74LS244	165	74LS82	37
74LS75	37	74LS244	165	74LS82	37	74LS245	165	74LS83	37
74LS76	37	74LS245	165	74LS83	37	74LS246	165	74LS84	37
74LS77	37	74LS246	165	74LS84	37	74LS247	165	74LS85	37
74LS78	37	74LS247	165	74LS85	37	74LS248	165	74LS86	37
74LS79	37	74LS248	165	74LS86	37	74LS249	165	74LS87	37
74LS80	37	74LS249	165	74LS87	37	74LS250	165	74LS88	37
74LS81	37	74LS250	165	74LS88	37	74LS251	165	74LS89	37
74LS82	37	74LS251	165	74LS89	37	74LS252	165	74LS90	37
74LS83	37	74LS252	165	74LS90	37	74LS253	165	74LS91	37
74LS84	37	74LS253	165	74LS91	37	74LS254	165	74LS92	37
74LS85	37	74LS254	165	74LS92	37	74LS255	165	74LS93	37
74LS86	37	74LS255	165	74LS93	37	74LS256	165	74LS94	37
74LS87	37	74LS256	165	74LS94	37	74LS257	165	74LS95	37
74LS88	37	74LS257	165	74LS95	37	74LS258	165	74LS96	37
74LS89	37	74LS258	165	74LS96	37	74LS259	165	74LS97	37

SOFTWARE DEVELOPMENT TOOLS FOR INDUSTRY

CP/M CROSS-ASSEMBLERS

Fast, comprehensive cross-assemblers to run under CP/M.* Extensive pseudo-ops include full listing control, nested conditionals, mnemonic synonyms, and inclusion of external source files. Generate object file, assembly listing, and symbol table from source code for nine popular microprocessor families.

XASM05	6805
XASM09	6809
XASM18	1802
XASM48	8048/8041
XASM51	8051
XASM65	6502
XASM68	6800/6801
XASMF8	F8/3870
XASM400	COP400

Assemblers... \$200.00 each
Manual only... \$ 25.00

8048 DEVELOPMENT PACKAGE

Now you can use the 8048 family of single-chip microcomputers without buying expensive equipment. Develop 8048 software with the XASM48 cross-assembler. Then plug our EPR-48 board into your S-100 system to program the 8748 EPROM version.

8048 Development Package ... \$574.00
EPR-48 alone \$449.00

EPROM SIMULATOR BOARD

Debug dedicated systems quickly. Our PSB-100 PROM Emulator is an S-100 board with up to 8K of RAM. Cable with 24-pin plug replaces 2708 or 2716 EPROM(s) in your target system for instant program testing

PSB-100 EPROM Simulator ... \$445.00
w/2K RAM

*Trademark of Digital Research



804 SOUTH STATE ST.
DOVER, DEL. 19901
302-734-0151

Visa and Mastercharge accepted. We ship 8" single-density and Softcard + 5.25" diskettes. Ask us about other formats. OEM AND DEALER INQUIRES INVITED.

+ Trademark of Microsoft

Listing 1 continued:

```

0340- AD 79 05 2030 LDA ACC GET CHARACTER AGAIN
0343- 09 80 2040 ORA #80 SET MSB FOR SCREEN
0345- 4C FO FD 2050 TV JNF SCRN OUTPUT TO SCREEN
0348- 60 2060 RET RTS NORMAL RETURN
      2070 *
      2080 *
      2090 * POUT SUBROUTINE
      2100 *
      2110 * HANDLES OUTPUT TO PRINTER
      2120 * CHARACTER TO BE PRINTED IS IN ACC
      2130 *
      2140 *
0349- A9 02 2150 POUT LDA #02 LOAD COMPARE MASK
034B- 2C 00 C3 2160 BIT IFR IS PRINTER READY??
034E- FO F9 2170 BEQ POUT NO, WAIT
0370- AD 79 05 2180 LDA ACC GET CHARACTER TO PRINT
0373- 80 01 C3 2190 STA ORA PRINT IT
0376- EE 79 04 2200 INC HCNT BUMP CHAR. COUNTER
0379- 60 2210 RTS RETURN
      2220 .EN
  
```

SYMBOL TABLE

```

0579- ACC
0087- BELL
0000- CAR
0024- CH
0354- CHAR
0098- CNTX
0339- CR
C303- DDRA
0036- DHDK
0011- ENBL
04F9- FLAG
0479- HCNT
03EA- HDOK
C300- IFR
0300- MX80
C301- ORA
C30C- PCR
0369- POUT
032B- PRNT
0728- RET
F0F0- SCRN
0008- SLNT
0300- SLT1
00A0- SPAC
0342- TAB
0345- TV
  
```

Listing 2: This routine uses the parallel board as a real-time clock. The time will be continuously displayed on the screen.

*** SYNTAX ERROR

```

:ASM
1000 *
1010 *
1020 *
1030 * DOSCLOCK -- REAL TIME CLOCK WITH CORRECTION
1040 * FOR DISK USE. THIS PROGRAM USES THE JOHN BELL
1050 * ENGINEERING PARALLEL BOARD AS A REAL TIME DIGITAL
1060 * CLOCK.
1070 *
1080 * NOTE -- THIS ROUTINE IS ASSEMBLED TO START NEAR
1090 * THE END OF THE INPUT LINE BUFFER. THIS MEANS THAT
1100 * YOU WILL NOT BE ABLE TO ENTER REALLY LONG LINES
1110 * OF TEXT. THIS ROUTINE IS NOT COMPATIBLE WITH
1120 * THE PROGRAM LINE EDITOR BECAUSE THAT PROGRAM USES
1130 * LOCATION $45 WHICH IS WHERE THE MONITOR STUFFS
1140 * THE ACCUMULATOR DURING INTERRUPT PROCESSING.
1150 *
1160 * BECAUSE THE 6522 IS ATTACHED TO THE APPLE
1170 * BUSS, THE PUSHING OF THE RESET BUTTON WILL RESET THE
1180 * 6522 AS WELL AS THE APPLE. THAT MEANS THAT YOU WILL
1190 * HAVE TO RESTART THE CLOCK EVERY TIME RESET IS PUSHED.
1200 *
1210 * IN ORDER TO USE THIS ROUTINE WITH THE JBE BOARD, YOU
1220 * HAVE TO ENABLE TIMER T2 TO COUNT THE NUMBER OF TICKS
1230 * OF TIMER T1. THIS IS ACCOMPLISHED BY JUMPING PINS
1240 * 7 AND 8 ON J2 TOGETHER
1250 *
1260 * RAM VERSION FOR SLOT 3
1280 *
1290 * DJG 4/81 (DERIVED FROM AN AIM CLOCK ROUTINE
1300 * BY DEJONG IN MICRO)
1310 * NWR 8/81 (MODIFIED FOR SLOT 3 AND THE
1320 * JBE PARALLEL BOARD)
1330 *
1340 *
1350 * PROGRAM ADDRESSES:
1360 *
1370 * ENTRY POINT (TO START CLOCK):
1380 * $0280 (CALL 640)
1390 *
1400 * TO CONTROL SCREEN TIME DISPLAY:
1410 * $77F (POKE 1919,X)
1420 * (NON-ZERO VALUE DISPLAYS TIME CONTINUOUSLY)
1430 *
1440 * TO STOP CLOCK:
1450 *
1460 * LOAD LOCATION $C30E WITH $40
1470 * (POKE -15&02,64)
1480 *
1490 *
  
```

Listing 2 continued on page 424

BYTE

TOLL-FREE

SUBSCRIPTION LINE

1-800-258-5485

New Hampshire Residents Dial 924-9281

The Quickest Way To

- Order a Subscription
- Renew a Subscription
- Change or Correct an Address
- Give a Friend a Gift Subscription
- Inquire about a Subscription

We are waiting to help you. Call us between:

8:30-4:00 Mon.-Thurs.

8:30-12:30 Fridays

(Eastern Time)

BYTE the small systems journal

WHO

*has the LOWEST
ADVERTISED PRICES
on any item over \$500
in this magazine?*

THE PURCHASING AGENT
will tell you for

FREE

800-227-2288

(415) 376-9020 (In Calif.)

ECTTM

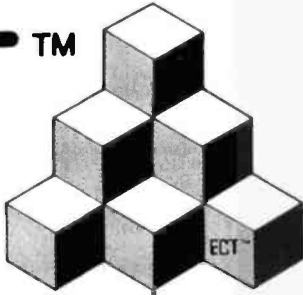

Building Blocks for Microcomputer Systems, Dedicated Controllers and Test Equipment.

**R²/I/O
S-100 ROM,
RAM & I/O
BOARD**

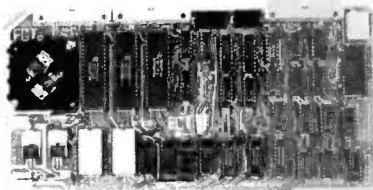

ECT's R²/I/O is an S-100 Bus I/O Board with 3 Serial O Ports (UART's), 1 Parallel I/O Port, 4 Status Ports, K of ROM with the 8080 Apple Monitor Program and K of Static RAM.

\$295.00

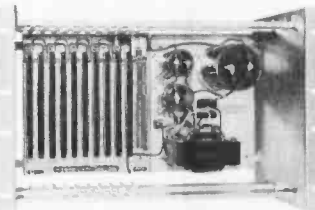

**RM-10
S-100
RACK MOUNT
CARD CAGE**

ECT's RM-10 is a rack mount 10 slot Card Cage with Power Supply, consisting of an ECT-100 rack mount Card Cage (19"W x 12.25"H x 8"D), the MB-10 Mother Board (with ground plane and termination) all 10 connectors and guides and the PS-15A Power Supply (15A @ 8V, 1.5A @ ± 16V).

\$295.00

*Specializing in Quality Microcomputer Hardware
Industrial • Educational • Small Business • Personal*

Card Cages, Power Supplies, Mainframes, CPU's, Memory, I/O, OEM Variations

ECTTM ELECTRONIC CONTROL TECHNOLOGY (201) 686-8080

763 Ramsey Ave., Hillside, NJ 07205

We will meet or beat any price in the U.S.A. on



TRS-80 MICROCOMPUTERS

In fact, no matter what price you see advertised by Micro Management, Perry Oil, Pan American, or any authorized Radio Shack dealer for TRS-80 Computers with pure factory installed memory and full warranty, we'll beat it!

ATARI[®]
MICROCOMPUTERS



We have consistently offered the complete TRS-80, ATARI, EPSON, APPLE, and MAXELL lines at the best prices in the U.S.A. And we offer the best delivery from the largest inventory in the Northeast.

If you're looking for the best prices in the U.S.A., check the others but call Computer Discount of America.

TRS-80 and Radio Shack are trademarks of Tandy Co.

**CALL TOLL FREE:
800-526-5313**

Computer Discount of America

COMPUTER DISCOUNT OF AMERICA, INC.
15 Marshall Hill Road, West Milford Mall
West Milford, New Jersey 07480-2198
In New Jersey Call 201-728-8080

Listing 2 continued:

```

1500 *      PROGRAM EQUATES
1510 *
1520 *
0045- 1530 ACC .ED $0045  MONITOR SAVE ACC HERE ON IRQ
0420- 1540 SCRN .ED $0420  RIGHT HAND TOP LINE OF SCREEN
047F- 1550 FREE .ED $047F  SLOT 7 SCRATCH RAM -- SEE APPLE REFERENCE MANUAL
047F- 1560 FRAC .ED FREE  INTERRUPT COUNTER
04FF- 1570 SEC  .ED FREE+$80 SECONDS COUNTER
057F- 1590 MIN  .ED FREE+$100 MINUTES COUNTER
05FF- 1590 HOUR .ED FREE+$180 HOURS COUNTER
067F- 1600 Tmpl .ED FREE+$200 TEMP STORAGE
06FF- 1610 TmpH .ED FREE+$280 TEMP STORAGE
077F- 1620 FLAG .ED FREE+$300 DISPLAY FLAG
03FE- 1630 IRQV .ED $03FE   IRQ VECTOR
1640 *
1650 *
1660 *
1670 *
1680 *
6222 REGISTER EQUATES
C300- 1690 DS1  .ED $C300  SLOT 3 6522 ADDRESSES
C300- 1700 PB   .ED DS1    PORT B
C304- 1710 T1L  .ED DS1+4  TIMER 1 LOW LATCH
C305- 1720 T1H  .ED DS1+5  T1 HIGH
C309- 1730 T2L  .ED DS1+8  TIMER 2 LOW LATCH
C309- 1740 T2H  .ED DS1+9  T2 HIGH
C30B- 1750 ACR  .ED DS1+$B  CONTROL REG
C30D- 1760 IFR  .ED DS1+$D  INTERRUPT FLAGS
C30E- 1770 IER  .ED DS1+$E  INTERRUPT ENABLE
1780 *
1790 *
1800 *
1810 *
1820 *
1830 *
1840 *
1850 *
1860 *
1870 *
1880 *
1890 *
0280- 78      1900 CLOK SEI      DISABLE IRQ
0281- A9 B0   1910 LDA $ISR  ADDRESS OF INTERRUPT SERVICE ROUTINE
0283- 8D FE 03 1920 STA IRQV  SAVE IN IRQ
0286- A9 02   1930 LDA /ISR  LAST HALF OF ADDRESS
0288- 8D FF 03 1940 STA IRQV+1 SAVE IT
1950 *
1960 *
1970 *
1980 *
1990 *
028B- A9 C0   2000 LDA $$C0  ENABLE T1 INTERRUPT
028D- 8D 0E C3 2010 STA IER  BY LOADING THIS LOCATION
0290- A9 E0   2020 LDA $$E0  T1 FREE RUN MODE
0292- 8D 0B C3 2030 STA ACR  AND T2 COUNTS PB6
2040 *
2050 *
2060 *
2070 *
2080 *
2090 *
0295- A9 20   2100 LDA $$20  SET T1 TO F920
0297- 8D 04 C3 2110 STA T1L  WHICH IS 1/16TH OF
029A- A9 F9   2120 LDA $$F9  A SECOND
029C- 8D 05 C3 2130 STA T1H  START T1
029F- A9 08   2140 LDA $$08  T2 OVERFLOWS AFTER 1 SECOND IF
02A1- 8D 09 C3 2150 STA T2L  D05 TURNED OFF IRQ INTERRUPT
02A4- A9 00   2160 LDA $00  $800 IS ONE SECOND
02A6- 8D 09 C3 2170 STA T2H  T2 COUNTS T1
02A9- A9 F0   2180 LDA $$F0  COUNT 16 INTERRUPTS
02AB- 8D 7F 04 2190 STA FRAC  PRELOAD THE LOCATION
02AE- 58      2200 CLI      ENABLE IRQ
02AF- 60      2210 RTS     RETURN
2220 *
2230 *
2240 *
2250 *
2260 *
2270 *
2280 *
2290 *
02B0- EE 7F 04 2270 ISR  INC FRAC  BUMP COUNTER
02B3- D0 70   2280 BNE UNDO  NOT A FULL SECOND
02B5- A9 F0   2290 LDA $$F0  RESET INTERRUPT COUNTER
02B7- 8D 7F 04 2300 STA FRAC  SAVE IT HERE
02BA- AD 00 C3 2310 LDA PB   IF T1 HAS ALREADY TICKED
02BD- 10 03   2320 BPL TOUT WE HAVE TO ADD
02BF- EE 7F 04 2330 INC FRAC  ONE TO THE COUNT
02C2- A9 20   2340 TOUT LDA $$20  GET MASK
02C4- 2C 0D C3 2350 BIT IFR  T2 TIMED OUT??
02C7- D0 62   2360 BNE CORR NO
02C9- A9 08   2370 LDA $$08  RESET T2 COUNTER
02CB- 8D 0B C3 2380 STA T2L  WITH A $800
2390 *
2400 *
2410 *
2420 *
2430 *
2440 *
2450 *
02CE- EE FF 04 2440 SECS INC SEC  BUMP SECONDS
02D1- AD FF 04 2450 LDA SEC  GET CURRENT SECONDS
02D4- C9 3C   2460 CMP #60  60 SECONDS??
02D6- 90 23   2470 BCC SHOW NO
02D8- A9 00   2480 LDA $00  RESET SECONDS
02DA- 8D FF 04 2490 STA SEC  TO ZERO
02DD- EE 7F 05 2500 MINS INC MIN  BUMP MINUTES
02E0- AD 7F 05 2510 LDA MIN  GET CURRENT MINUTES
02E3- C9 3C   2520 CMP #60  60 MINUTES??
02E5- 90 14   2530 BCC SHOW NO
02E7- A9 00   2540 LDA $00  RESET MINUTES
02E9- 8D 7F 05 2550 STA MIN  TO ZERO
02EC- EE FF 05 2560 HRS  INC HOUR  BUMP HOURS
02EF- AD FF 05 2570 LDA HOUR  GET CURRENT HOUR
02F2- C9 18   2580 CMP #24  24 HOURS??
02F4- 90 05   2590 BCC SHOW NO
02F6- A9 00   2600 LDA $00  RESET HOURS
02F8- 8D FF 05 2610 STA HOUR  TO ZERO
2620 *
2630 *
2640 *
DISPLAY THE TIME IF DESIRED

```

Listing 2 continued on page

EXPRESS

CATCH THE S-100 INC. BUS!



Move up to an
8MHZ 8086 Super System

System Support Board

1 serial/1 parallel port, 8 MHZ 8086 CPU (16 Bit Processor)
86 DOS Disk Operating System
Realtime Clock
Timers

Monitor EPROM

86 DOS Disk Operating System
64K byte (32k word) Static RAM (70 NS)
Double Density DMA Disk Controller
10 Slot Mainframe w/2 Qume Data Trak 8 drives

Assembled & Tested

LIST PRICE OVER \$4300
SPECIAL CASH PRICE \$3499

Assembly and check out available for \$200 extra

Offer Expires March 31, 1982

Subject to Available Quantities • Prices Quoted Include Cash Discounts.
Shipping & Insurance Extra.

S-100, inc.

14425 North 79th Street, Suite B
Scottsdale, Arizona 85260
Order Number 800-528-3138
Technical 602-991-7870

STRETCH THE POWER

Of Your HP-85 or Commodore Pet/CBM With TNW's IEEE-488 Bus System Building Blocks...

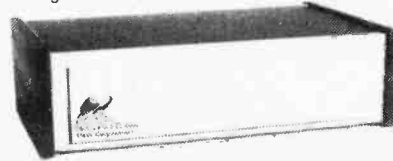

TNW-2000

TNW's RS-232 SERIAL INTERFACES

Connect your PET/CBM to any RS-232 Serial Printer, Plotter, CRT Terminal, Modem, or other device:

TNW-1000	ONE CHANNEL OUTPUT ONLY	\$129
TNW-2000	ONE CHANNEL INPUT AND OUTPUT	\$229
TNW-232D	TWO CHANNELS, INPUT & OUTPUT. 12 RS-232 CONTROL SIGNALS	\$369

TURN YOUR PET INTO A TERMINAL

Access Timesharing Systems and Bulletin Boards with TNW's Pterm Software and full service telephone modem:

TNW-103	AUTO ANSWER/AUTO DIAL USE WITH DAA	\$389
----------------	---------------------------------------	--------------

Pterm also works with acoustical couplers and other modems interfaced to the PET with the TNW-2000 or TNW-232D. Electronic mail and TWX Terminal programs also available. All units are addressable IEEE-488 devices, complete with power supply cabinet, full documentation and one year warranty.

TNW CORPORATION

3351 Hancock St. • San Diego, CA., 92110 (714) 225-1040
TWX910-335-1194
Visa/Mastercharge Welcome • Dealer inquiries invited

PRODUCTS FOR YOUR RADIO SHACK

NEW!

COLOR COMPUTER

MICROTEXT COMMUNICATIONS VIA YOUR MODEM!

Now you can use your printer with your modem! Your computer can be an intelligent printing terminal. Talk to timeshare services or to other personal computers; print simultaneously through a second printer port; and re-display text stored in memory. Download text to Basic programs; dump to a cassette tape, or printer, or both. Microtext can be used with any printer or no printer at all. It features user-configurable duplex/parity for special applications, and can send any ASCII character. You'll find many uses for this general purpose module! Available in ROMPACK, ready-to-use, for \$59.95.

SOFTWARE DEVELOPMENT SYSTEM

The Micro Works Software Development System (SDS80C) is a complete 6809 editor, assembler and monitor package contained in one Color Computer program pack! Vastly superior to RAM-based assemblers/editors, the SDS80C is non-volatile, meaning that if your application program bombs, it can't destroy your editor/assembler. Plus it leaves almost all of 16K or 32K RAM free for your program. Since all three programs, editor, assembler and monitor are co-resident, we eliminate tedious program loading when going back and forth from editing to assembly and debugging!

The powerful screen-oriented Editor features finds, changes, moves, copies and much more. All keys have convenient auto repeat (typamatic), and since no line numbers are required, the full width of the screen may be used to generate well commented code.

The Assembler features all of the following: complete 6809 instruction set; complete 6800 set supported for cross-assembly; conditional assembly; local labels; assembly to cassette tape or to memory; listing to screen or printer; and mnemonic error codes instead of numbers.

The versatile ABUG monitor is a compact version of CBUG, tailored for debugging programs generated by the Assembler and Editor. It features examine/change of memory or registers, cassette load and save, breakpoints and more. **SDS80C Price: \$89.95**

GAMES



Star Blaster — Blast your way through an asteroid field in this action-packed Hi-Res graphics game! Available in ROMPACK; requires 16K. **Price: \$39.95**

Pac Attack — Try your hand at this challenging game by Computerware, with fantastic graphics, sound and action! Cassette requires 16K. **Price: \$24.95**

Berserk — Have fun zapping robots with this Hi-Res game by Mark Data Products. Cassette requires 16K. **Price: \$24.95**

Adventure — *Black Sanctum* and *Calixto Island* by Mark Data Products. Each cassette requires 16K. **Price: \$19.95 each.**

ROMLESS PAK I — is an empty program pack capable of holding two 2716 or 2732 EPROMs, allowing you up to 8K of program! The PC board inside comes with sockets installed, ready to go with the addition of your custom EPROMs. **Price: \$24.95**

2-PASS DISASSEMBLER — with documentation package. 16K; cassette. 80C Disassembler **Price: \$49.95**

CBUG — Machine language monitor. CBUG Cassette **Price: \$29.95**

CBUG ON 2716 EPROM: Can plug into Romless Pak I. CBUG ROM **Price: \$39.95**

PARALLEL PRINTER INTERFACE — serial to parallel converter allows use of all standard parallel printers. P180C **Price: \$69.95**

Assembly Language Programming, by Lance Leventhal. **Price: \$16.95**

MEMORY UPGRADE KITS: 4-16K Kit **Price \$39.95**. 16-32K (requires soldering experience) **Price: \$39.95**

PARTS & SERVICES: SAMs, 6809Es, RAMs, PIAs. Call for prices.

THE MICRO WORKS



GOOD STUFF!

WE SHIP FROM STOCK!

Master Charge/Visa and COD Accepted

P.O. BOX 1110 DEL MAR, CA 92014 714-942-2400



SITTING PRETTY

You can use just about any desk for a computer terminal stand. But with CF&A, you're sitting pretty. Our full range of desks, workstations, and terminal stands are designed to accommodate a variety of computer equipment. Choose from our Classic Series desks, DR Series desks and enclosures, specialty items like our Apple II desk, or a universal printer stand. You'll be sitting pretty with attractive color selections, durable construction, versatile configurations, useful options, competitive prices, quick delivery, and personal service. It's our way of doing business.

CF&A

Computer Furniture and Accessories, Inc.
 1441 West 132nd Street
 Gardena, CA 90249
 (213) 327-7710

Listing 2 continued:

```

2650 *
2650 *
02FB- AD 7F 07 2670 SHOW LDA FLAG DISPLAY TIME??
02FE- FO 20 2680 REG DONE NO
0300- BE 7F 05 2690 STX THPL SAVE X
0303- BC FF 05 2700 STY THPH SAVE Y
0306- A2 00 2710 LDX #00 CLEAR X
0308- AD FF 05 2720 LDA HOUR GET THE CURRENT HOUR
030B- 20 84 03 2730 JSR DSPL PRINT IT
030E- AD 7F 05 2740 LDA MIN GET CURRENT MINUTE
0311- 20 7C 03 2750 JSR DCOL PRINT IT
0314- AD FF 04 2760 LDA SEC GET CURRENT SECONDS
0317- 20 7C 03 2770 JSR DCOL DISPLAY IT
031A- AE 7F 06 2780 LDX THPL RESTORE X
031D- AC FF 06 2790 LDY THPH RESTORE Y
2800 *
2810 *
2820 *
2830 *
2840 *
0320- A9 00 2850 DONE LDA #00 GET A ZERO
0322- BD 09 C3 2860 STA T2H START T2
0325- AD 04 C3 2870 UNDO LDA T1L CLEAR INTERRUPT FLAG
032B- A5 45 2880 LDA ACC RESTORE ACCUM
032A- 40 2890 RTI INTERRUPT RETURN
2900 *
2910 *
2920 *
2930 *
2940 *
032B- 38 2950 CORR SEC SAVE 2'S COMPLEMENT OF T2
032C- A9 00 2960 LDA #00 BY SUBTRACTING
032E- ED 0B C3 2970 SRC T2L FROM ZERO
0331- BD 7F 06 2980 STA THPL SAVE PARTIAL RESULT
0334- A9 00 2990 LDA #00 ANOTHER ZERO
0336- ED 09 C3 3000 SRC T2H AND THE SUBTRACT
0339- BD FF 06 3010 STA THPH SAVE IT
3020 *
3030 *
3040 *
3050 *
3060 *
033C- AD 7F 06 3070 SETF LDA THPL SET FRACTION
033F- 29 07 3080 AND #07 TO CORRECT
0341- 0A 3090 ASL 1/16
0342- 6D 7F 04 3100 ADC FRAC OF A SEC
0345- BD 7F 04 3110 STA FRAC SAVE IT BACK
0348- 29 0F 3120 AND #0F CORRECT T2
034A- 4A 3130 LSR TO THE PARTIAL
034B- 49 FF 3140 EOR #FF NUMBER OF
034D- 18 3150 CLC OF TICKS
034E- 69 09 3160 ADC #09 LEFT IN ITS INTERVAL
0350- BD 0B C3 3170 STA T2L AND SAVE BACK
0353- 4E FF 06 3180 LSR THPH DIVIDE BY EIGHT
0356- 6E 7F 06 3190 ROR THPL TO GET NUMBER
0359- 4E FF 06 3200 LSR THPH OF FULL SECONDS
035C- 6E 7F 06 3210 ROR THPL TO ADD TO THE
035F- 4E FF 06 3220 LSR THPH TIME TO CORRECT
0362- 6E 7F 06 3230 ROR THPL FOR DOS BEING ON
0365- 18 3240 CLC SETUP THE CARRY
0366- AD FF 04 3250 LDA SEC ADD THE FULL
0369- 69 01 3260 ADC #01 SECONDS
036B- 6D 7F 06 3270 ADC THPL AND STORE IN
036E- BD FF 04 3280 STA SEC SECONDS COUNTER
0371- 38 3290 SEC CHECK FOR GREATER
0372- E9 3C 3300 SRC #60 THAN 60 SECONDS
0374- 90 B5 3310 BCC SHOW TO SEE IF A MINUTE
0376- BD FF 04 3320 STA SEC UPDATE IS
0379- 4C DD 02 3330 JMP MINS REQUIRED
3340 *
3350 *
3360 *
3370 *
3380 *
037C- A8 339C RCOL TAY SAVE COUNT
037D- A9 BA 3400 LDA #BA GET A COLON
037F- 9D 20 04 3410 STA SCRNX SHOW IT
0382- E8 3420 INX BUMP COUNTER
0383- 98 3430 TYA RESTORE COUNT
0384- A9 FF 3440 DSPL LDY #FF DISPLAY TIME
0386- C8 3450 CNTY INY Y WILL COUNT BY 10
0387- 38 3460 SEC SET CARRY
0389- E9 0A 3470 SRC #10 MINUS 10
038A- 80 FA 3480 BCS CNTY GET RID OF TENS
038C- 69 CA 3490 ADC #10 RESTORE REMAINDER
038E- 48 3500 PHA AND SAVE
038F- 78 3510 TYA DISPLAY TENS DIGIT
0390- 09 80 3520 ORA #B0 MAKE IT ASCII
0392- 9B 20 04 3530 STA SCRNX SHOW IT
0395- E8 3540 INX BUMP X
0396- 68 3550 PLA GET ONES DIGIT
0397- 09 80 3560 ORA #B0 MAKE IT ASCII
0399- 9B 20 04 3570 STA SCRNX SHOW IT
039C- E8 3580 INX BUMP THE COUNT
039D- 60 3590 RTS RETURN
3600 *

```

SYMBOL TABLE

0045- ACC	0300- IFR	04FF- THPH
0308- ACR	03FE- IRQV	067F- THPL
0280- CLK	028J- ISR	02C2- TOUT
0386- CNTY	057F- MIN	0325- UNDO
032B- CORR	07BD- MINS	
037C- DCOL	038C- PR	
0320- DONE	042C- SCRNX	
0300- DS1	04FF- SEC	
0384- DSPL	02DF- SECS	
027E- FLAG	034C- SETF	
047E- FRAC	034D- SHOW	
047E- FREE	0305- T1H	
05F- HOUR	0306- T1L	
02EC- HRS	0309- T2H	
030E- IER	0309- T2L	

I(nterchange)

I(nterchange) is a general purpose file maintenance program for use with the CP/M™ operating system. Since it is a single program written in optimized Z-80™ code, it is much faster and easier to use than other file maintenance programs. Features include: DIR as usual plus listing all files *excluding* those with a specified character(s), ERA as usual plus *exclusive* erases. Also, a "Q" switch can be used to query each erase, a "W" allows erases of R/O files without query (normally you are queried), and an "R" switch if system files are to be included, LIST permits listings and uses TAB, WIDTH, LINES and WRAP for control, COPY as usual plus *exclusive* copies and supports the "Q", "W" and "R" switches plus an "E" switch for query on existing files, STAT with ambiguous, unambiguous and exclusive listings and produces an alphabetized listing with file length, total directory entries and space used and unused, START-END allows for copying contiguous data files, and RENAME as usual plus ambiguous renames. Other commands include: QT, DATE, TIME and SETIT (for the QT clock board) plus CLEAR, RESET, HELP and TYPE. Disk copies can even be continued after a disk full condition by simply inserting a new disk. All of this in one program without ever having to leave I(nterchange) and wait until you see the speed improvement . . .

The price for I(nterchange) is \$59.95 and the manual is available for \$10.00 (credited towards purchase). I(nterchange) is recommended for 32K or larger systems using CP/M™ 2.0 or later. It will not run on an 8080 CPU and only User 0 is supported.

All programs are available on 8" SD or North Star 5 1/4" disk. Microstat is available for North Star Basic, Microsoft's Basic-80 (Rel. 5.0 or later) or compiler Systems CBasic2. Please specify when ordering.

CP/M is a registered trademark of Digital Research.

ECOSOFT, INC.

P.O. BOX 68602
INDIANAPOLIS, IN 46268-0602
(317) 283-8883



EPISODE™
THE
VERSATILE
COMPUTER



JUST ADD
PERIPHERALS

EPISODE is a CP/M® computer with 1.6 M byte of disk storage on dual 5 1/4 floppies. Its compact design provides a wide range of standalone or network applications including data base sharing.

EPISODE gives you total flexibility. You can add your own CRT and Printer, whatever brand and price range you choose. All the logic including the 64K RAM memory is contained on a single 6" x 8" circuit board ensuring maximum reliability.

EPISODE includes a unique software system called SUPERVYZ™ - a menu based software control system that allows the user to integrate application programs.

Dealer inquiries invited, foreign and domestic.



Epic Computer Corporation
7542 Trade Street
San Diego, CA 92121
Tel: 714-695-3560

*Supervyz is a trademark of Epic Computer Corporation. CP/M is a trademark of Digital Research.

SAVE \$600.00
On TRS-80® 48K Model III

Limited Supply Now Available
For The Low-Low Price Of \$1895.00

TRADEMARKS:
TRS-80 and TRSDOS/Radio Shack/Tandy Corp.
LDOS/Logical Systems Inc.
Kit III/Morgan Products Inc.



Includes all the standard basic features of the TRS-80® Model III with 48K of RAM and disk expansion Kit III™ with two 40 track double density disk drives.

Also available — TRS-80® Model III same as above with two 80 track disk drives for only *2145.00

If You Own A 16K Model III.

You can easily expand your capabilities with our low cost disk expansion **Kit III™**

Completely compatible with TRSDOS™ and LDOS™ the Kit III™ single drive assembly includes: One 40 track 5 1/4" double density disk drive, power supply, floppy disk control card, mounting hardware, applicable cables and instructions. **ONLY \$599.00**

Also available — Kit III™ same as above with one 80 track disk drive for only *724.00

LDOS™ disk operating system

Printers available . . . call for more information.

Call TOLL FREE (800) 851-4614

In Illinois Call (618) 233-0018

We accept: Visa, Master Charge, Certified Checks (Personal checks require three weeks clearance), Money Orders, and C.O.D.



Morgan Products Incorporated 104 Berkshire Drive Belleville, Illinois 62223

Main/Frames

Main/Frames

from
\$200

- 30 Models of Enclosures
- Assembled and tested
- Quasi-Coax Motherboards
- Power Supply
- Card cage and guides
- Fan, line, cord, fuse, power & reset switches

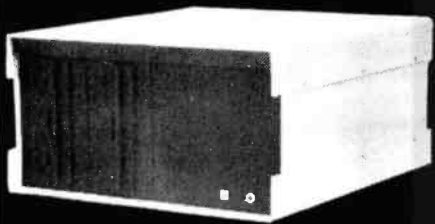

8" Floppy Main/Frame

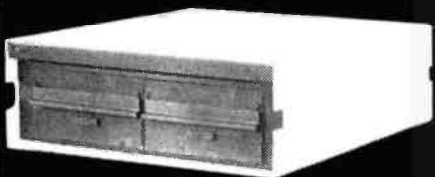

8" Disc Enclosure

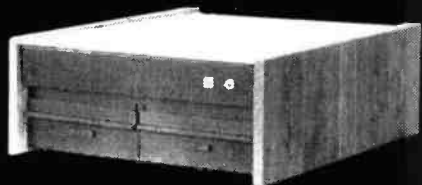

Phase/80 8" Floppy Mainframe

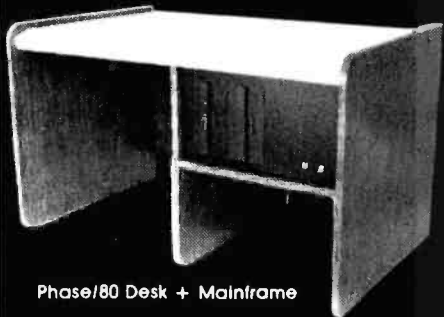

Phase/80 Desk + Mainframe

Write or call for our brochure which includes our application note: "Building Computers — A Recipe"

INTEGRAND

8620 Roosevelt Ave. • Visalia, CA 93294
209/733-9288

We accept BankAmericard/Visa and MasterCard

Text continued from page 418

clocks data into the printer's internal buffer. Again, the MX-80 requires a negative-going pulse for the data strobe; use control pin CA2 for this function.

The 6522 allows you to choose a negative- or positive-going pulse for either of two signals; inform the 6522 of the desired polarity by loading the Peripheral Control Register (PCR). With the MX-80, hexadecimal 0A is the proper code. This bit pattern is determined by consulting the coded values on the data sheet. We enable the printer by sending it a Control Q (hexadecimal 11) and then a Control X to clear the internal buffer.

The actual output routine is quite simple. First, check the horizontal character position and compare it with the current character position in the output line. If they differ, output spaces until reaching the proper character position. To print characters, check bit 2 in the Interrupt Flag Register (IFR) to see if the printer has sent its data-ready flag. This bit will

be set if the 6522 has detected a negative edge on control pin 1 (CA1), which is the ready line.

If the printer is busy or has yet to send the ready pulse, keep testing the bit until the printer is ready. When the printer is ready to receive data, store the character to be printed in the output register for port A. As you place the character in the output register, it's clocked into the printer's internal register because pin CA2 goes low and acts as the data strobe. The printer becomes busy while accepting the character. Once it's processed, the ready pulse is given and the printer will accept another character.

Time-of-Day Clock. Listing 2's routine is a time-of-day clock that continuously displays the time on the screen. The routine uses interrupts so that the clock runs while you develop and run BASIC programs. The routine is compatible with DOS 3.3; DOS disables the IRQ interrupt while it does I/O and then re-enables the interrupt when finished. (I haven't tried

Listing 3: This BASIC routine will load and initialize the clock. It will also protect the time display.

```

:PR#0
>LIST
10 REM
20 REM
30 REM ROUTINE TO LOAD AND START THE DOSCLOCK
40 REM
50 REM
60 PRINT "LOAD DOSCLOCK,BELL.OBJ"
70 POKE 34,0: CALL -936
80 PRINT "THE CURRENT TIME IS -- >": POKE 34,2
90 UTAB 10
100 INPUT "ENTER HH,MM,SS ",H,M,S
110 POKE 1535,H: REM HOURS
120 POKE 1407,M: REM MINUTES
130 POKE 1279,S: REM SECONDS
140 CALL 640: REM START THE CLOCK
150 POKE 1919,1: REM DISPLAY TIME
160 END
    
```

Make America smarter.
Give to the college
of your choice.



CF
AE
Council for Financial Aid to Education, Inc.
680 Fifth Avenue, New York, N.Y. 10019

A
d
C
Council
A Public Service of This Magazine
& The Advertising Council.



EIGHTY/ APPLE COMPUTER SHOW

(Formerly the Nat'l TRS-80 Show)

**FOR APPLE* and
TRS-80* COMPUTER
SYSTEMS**

April 2-4, 1982
New York Statler
7th. Ave. & 33rd. Street
New York, NY

The EIGHTY/APPLE COMPUTER SHOW will feature over 100 exhibitors of equipment, supplies, books, magazines, parts, software and accessories for the TRS-80 and Apple Computer systems. There will be demonstrations of new and exciting products for the TRS-80 and Apple systems, for the businessman, professional, educator and hobbyist. In addition, most exhibitors will be selling their products at the show for immediate delivery. If you own a TRS-80 or Apple Computer, or have been thinking of purchasing one of these two exciting systems, don't miss the Eighty/Apple Computer Show. SAVE \$2.00 on admission by bringing in the coupon below!

SHOW HOURS

Friday April 2 11AM to 7 PM
Saturday April 3 11AM to 7 PM
Sunday April 4 11AM to 5 PM

REGISTRATION \$5.00 Day

Children under 12 - \$1.00

**FOR EXHIBITOR INFORMATION
CONTACT**

Kengore Corporation
3001 Route 27
Franklin Park, NJ 08823
(201) 297-2526

*TRS-80 is a Trademark of Tandy Corp. and Apple is a Trademark of Apple Computer Co.

SAVE \$2.00

This coupon is good for Two Dollars (\$2.00) off the regular daily registration fee of \$5.00. Limit one coupon per person, not applicable to children's admission. Only original copies of this coupon will be accepted.

EIGHTY/APPLE SHOW

April 2-4, 1982
NY Statler
(NO CASH VALUE)

SAVE \$2.00

the routine with earlier DOS versions. If you plan to, back up your disks in the event of failure.)

My method of implementing the clock involves both timers on one 6522 and a couple of tricks. First, set up timer T1 to interrupt (tick) every $\frac{1}{16}$ second. Simultaneously, enable timer T2 to count the number of times that T1 ticks by simply installing a jumper wire to feed the output of T1 to the input of T2. T2 is now counting the number of times T1 ticks. If DOS turns off the IRQ interrupt (for I/O), when it is re-enabled T2 will contain the number of clock ticks you missed.

The interrupt service routine for the clock keeps the hours, minutes, and seconds in dedicated locations. Whenever the seconds count is changed, the top line of the screen is updated with the current time. The BASIC routine in listing 3 will set up the current time of day and protect the top line. From then on, time will be displayed continuously. The clock routine can determine execution times of routines or schedule other events at certain times during the day. Because no two Apples have identical time bases, some correction factors may have to be used. The listing indicates where to apply those factors.

Conclusions

- The Apple parallel board may be used for all interfacing projects where parallel I/O is needed or where timing or counting is required.
- The board contains two 6522 support chips for input or output, timing or counting, and serial-to-parallel/parallel-to-serial operations.
- The board is available fully assembled, as a kit, or alone. The kit is easy to build, but you must be able to read a circuit diagram.
- Documentation is sparse, though all required information for use of the 6522 is included. The manufacturer does *not* hold your hand, relying instead on the user community to publish software that uses the board.
- The Apple parallel board is a good, inexpensive way to enhance the Apple with the power of the 6522 Versatile Interface Adapter. ■

Help!



HELP IS COMING FOR ALL PERSONAL COMPUTER OWNERS:

Stop going broke buying software and hardware to find out it's not what you want!

The Personal Computer Owners Directory can eliminate a lot of wasted time and aggravation. Through the use of the directory, you can become aware of people in your area and nationally who have the same system or interests. Find out what is worth buying before spending your \$\$\$\$\$. The directory will be listed by cities and interests (e.g.) **Games, business, art, robotics, education, etc.)**

To have your information listed and place your order for the Directory. SEND \$19.95 ppd (check or money order) plus the following:

Name, Address, Computer Type, Interests. will you help others, are you willing to trade information? Plus any other vital information.

If you want your name entered, but do **not** wish to receive a directory, send \$1.00 and the above info.

The directory will be open for listings until May 1, 1982, at which time it will go to print.

MASS. residents add 5% sales tax.

**PERSONAL
COMPUTER OWNERS,
INC.**

P.O. BOX 426
FEEDING HILLS, MASS.
01030
(413) 789-1555

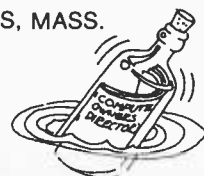

ATTENTION S-100 USERS, OEMs & ISOs!

**MM-103 IS THE ONLY MODEM
FOR YOUR NEEDS!**

In previous issues, we listed more than 50 reasons why PMMI MM-103 modems are superior, along with a list of satisfied users that is now too long to print. Quality, integrity and low cost have made the MM-103 America's most popular modem. PMMI was the first to gain FCC approval and meet IEEE-696 S-100 standards. You won't find another modem for the S-100 bus with a wider range of Baud rates, more extensive and controllable software and such an unbeatable warranty. And since PMMI has eliminated the need for an acoustic coupler or an RS 232 adapter, your connection is more reliable and you buy no unnecessary hardware.

SO DON'T DELAY!

GO WITH THE MODEM WITH EXPERIENCE!



COMMUNICATIONS

(POTOMAC MICRO-MAGIC, INC.)

For further information, call or write:

Three Skyline Place
5201 Leesburg Pike, Suite 604
Falls Church, VA 22041
(703) 379-9660

Or dial into our 24 hour a day Modem Test Center
(703) 379-0303 (300 Baud)

**AFTER ALL...
ALL MODEMS ARE NOT
CREATED EQUAL!**

XCEL™ MICROCOMPUTER RETROFIT GRAPHICS

512 x 240
RESOLUTION

FOR COMPUSTAR®
SUPERBRAIN®
TRS-80® MODEL II
Z-89

HARDWARE RETROFIT
FROM **\$895.00**

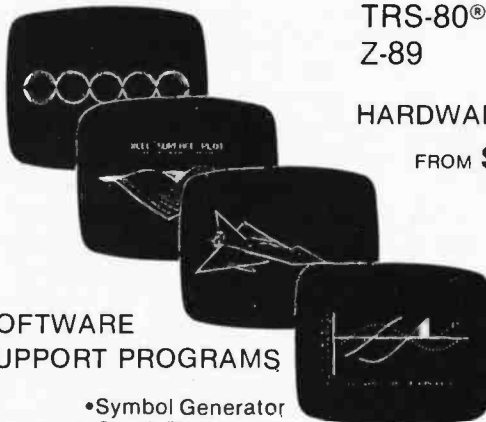

SOFTWARE
SUPPORT PROGRAMS

- Symbol Generator **\$175.00**
 - Graph Plotter **\$175.00**
 - 3D Generator **\$345.00**
 - Surface Plotter **\$395.00**
 - Graphics Terminal Emulator **\$395.00**
 - Screen Printer **\$65.00**
- ANADEX
EPSON
IDS

(800) 421-1423
IN CALIFORNIA CALL
(213) 320-6604



MAXTEK, INC. 2908 Oregon Court, Torrance, CA 90503

Available in Europe from Micronex Ltd., Chew Magna, England 3042 (STD 027-589 3042)

TRS 80 registered trademark Tandy Corp. Superbrain trademark Interlec Data Systems
Telexlink registered trademark Telexlink Inc. CPM registered trademark Digital Research

YOU'VE PROBABLY HEARD IT BEFORE! BUT NOW EVERYONE KNOWS IT!

We Definitely Have The Lowest

EPSON Prices In The World!

Our Volume Sales Are So High
That Absolutely No One Can Get Close!

7 DAYS A WEEK

CALL 1 (800) 525-7877

THE WORLD'S FIRST
EPSON
HOTLINE

COMPARE! Drives For / With Controller \$459
Apple / Add-On \$389

IN COLORADO (303) 279-2727

ALSO CCS, VISTA, APPLE II, PLUS LOBO, NEC, XEROX, ZENITH, HAYES, IBM. . .
ALL AT EQUALLY COMPETITIVE PRICES.



COMPUTERWORLD INTERNATIONAL, INC. (303) 279-2727

SUITE 133, P.O. BOX 81, WHEAT RIDGE, COLORADO, U.S.A. 80034-0081

TERMS: MAIL ORDER/VISIT BY APPOINTMENT, WE WILL SHIP UPS FREIGHT COLLECT OR ADD 3% FOR SHIPPING.
COLORADO RESIDENTS ADD APPROPRIATE SALES TAX. MASTERCHARGE/VISA ACCEPTED.

Books Received

Aircraft Electricity and Electronics, 3rd edition, Ralph D. Bent and James L. McKinley. New York: Gregg/McGraw-Hill, 1981; 359 pages, 27.5 by 20.5 cm, softcover, ISBN 0-07-004793-6, \$19.95.

The Complete Problem Solver, John R. Hayes. Philadelphia, PA: The Franklin Institute Press, 1981; 255 pages, 25 by 17.5 cm, hardcover, ISBN 0-89168-028-4, \$19.50.

The Computers Are Coming, Irv Brechner. Livingston, NJ: Irv Brechner (POB 453), 1981; 92 pages, 22.5 by 14.5 cm, softcover, ISBN none, \$4.95.

Digital Circuits and Microprocessors, Herbert Taub. New York: McGraw-Hill,

1982; 541 pages, 23.5 by 16.5 cm, hardcover, ISBN 0-07-062945-5, \$28.95.

The Electronic Cottage, Joseph Deken. New York: William Morrow and Company, 1982; 344 pages, 23.5 by 16 cm, hardcover, ISBN 0-688-00664-7, \$14.95.

50 More Programs in BASIC for the Home, School & Office, 2nd edition, Jim Cole. Woodsboro, MD: Arcsoft Publishers, 1981; 96 pages, 21 by 13.5 cm, softcover, ISBN 0-86668-502-2, \$9.95.

The Handbook of Artificial Intelligence, Volume 1, Avron Barr and Edward A. Feigenbaum, eds. Los Altos, CA: William Kaufmann, 1981; 409 pages, 23.5 by 15.5 cm, hardcover, ISBN 0-86576-

005-5, \$30.

Handbook of Semiconductor and Bubble Memories, Walter A. Triebel and Alfred E. Chu. Englewood Cliffs, NJ: Prentice-Hall, 1982; 401 pages, 23 by 18.5 cm, hardcover, ISBN 0-13-381251-0, \$24.95.

How to Break into the Computer Field, L. Peter Carron. Easton, PA: L. P. Carron Publishers (205 Ridge-wood Rd.), 1981; 138 pages, 22.5 by 14.5 cm, softcover, ISBN 0-9607242-0-6, \$7.95.

Introduction to Microprocessors, Charles M. Gilmore. New York: Gregg/McGraw-Hill, 1981; 310 pages, 27.5 by 21 cm, softcover, ISBN 0-07-023301-2, \$14.96.

Learning Digital Electronics Through Experiments, Ed-

ward J. Pasahow. New York: Gregg/McGraw-Hill, 1982; 215 pages, 22 by 14.5 cm, softcover, ISBN 0-07-048622-7, \$8.95.

The Making of the Micro. A History of the Computer, Christopher Evans. New York: Van Nostrand Reinhold, 1981; 118 pages, 26 by 18.5 cm, hardcover, ISBN 0-442-22240-8, \$14.95.

Mathematics into Type, revised edition, Ellen Swanson. Providence, RI: American Mathematical Society (POB 6248), 1979; 90 pages, 24.5 by 17.5 cm, softcover, ISBN 0-8218-0053-1, \$12.40.

Murder in the Mansion, And Other Computer Adventures in Pocket-BASIC for the TRS-80, 2nd edition, Jim Cole. Woodsboro, MD:

(213) 891-5705

Complete product line for Apple, NEC, S-100, IBM.
Low Prices, high quality, and just delivery.

Apple: Add-on Mini-floppy	\$375
Apple: 5 M Byte Hard Disk System	\$2250
Apple: 128K RAM Card	\$700
Apple: Double-density 8" Floppy Controller	\$400
IBM: Add-on Mini-floppy	\$275
S-100: 64K Low Power Static RAM Card	\$475
S-100: Sierra Data SBC, 4MHz Master	\$825
NEC PC-8000 System	New Low Prices
Epson MX-100.	\$685
ADDS Viewpoint - Green	\$545
Tandon Thinline 8" - Double Sided.	\$510
5 1/4" Diskettes	\$22/Box of 10

All items new, guaranteed. On-site service center.

We claim to have more satisfied customers per square inch of ad space than any other Brite advertiser.



BISON
PRODUCTS

Mail: P.O. Box Q, Sherman Oaks, CA 91423
Store: 16709 Roscoe Blvd., Sepulveda, CA 91343
(213) 891-5705

BDOS ERROR ON B:BAD SECTOR

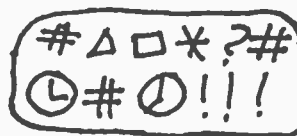

Before disk errors ruin your work again order BADLIM.

- BADLIM assures the reliability of your CP/M computer.
- You can use your disks 10 times longer without losing your data AND your time.
- BADLIM checks thoroughly your disk marking all the blocks which have defective sectors. The operating system will know that those sectors should be skipped.
- BADLIM is the only program that gives protection for soft and hard errors.
- The first time BADLIM will list which files in your disk are on bad sectors, so you can take action to correct it.
- But thereafter the bad areas in your disk will be automatically by-passed.
- For CP/M 1.4 single density and for CP/M 2.xx of any format and density. It is a must for Winchester as the media cannot be replaced.

BADLIM cost only \$73. Whatever the reason you have to use a computer you need BADLIM. Contact your dealer or call us today:

BLAT R&D Corp., 8016 188th. St SW, Edmonds WA 98020. Phone: (206) 771-1408

DEALER INQUIRIES INVITED.

BADLIM

Everybody's making money selling microcomputers. Somebody's going to make money servicing them.

**New NRI Home-Study Course Shows You How to Make Money Servicing, Repairing,
and Programming Personal and Small Business Computers**

Seems like every time you turn around, somebody comes along with a new computer for home or business use. And what's made it all possible is the amazing microprocessor, the tiny little chip that's a computer in itself.

Using this new technology, the industry is offering compact, affordable computers that handle things like payrolls, billing, inventory, and other jobs for businesses of every size...perform household functions including budgeting, environmental systems control, indexing recipes. And thousands of hobbyists are already owners, experimenting and developing their own programs.

Growing Demand for Computer Technicians

This is only one of the growth factors influencing the increasing opportunities for qualified computer technicians. The U.S. Department of Labor projects over 100% increase in job openings for the decade through 1985. Most of them *new* jobs created by the expanding world of the computer.

Learn at Home in Your Spare Time

NRI can train you for this exciting, rewarding field. Train you at home to service not only microcomputers, but word processors and data terminals, too. Train you at your convenience, with clearly written "bite-size" lessons that you do evenings or weekends, without going to classes or quitting your present job.

Your training is built around the latest model of the world's most popular computer. It's the amazing TRS-80™ Model III, with capabilities and features to perform a host of personal and business functions. No other small computer has so much software available for it, no other is used and relied on by so many people. And it's yours to keep for personal or business use.



You get plenty of practical experience. Using the NRI Discovery Lab® that also comes as part of your course, you build and study circuits ranging from the simplest to the most advanced. You analyze and troubleshoot using the professional Beckman LCD digital multimeter you keep to use later in your work. Then you use the lab and meter to actually access the interior of your computer...build special circuits and write programs to control them. You "see" your computer at work and demonstrate its power.

Become the Complete Computer Person

You're also trained in writing and debugging both BASIC and advanced machine language programs...gain hands-on experience in the operation and application of computers to business and personal jobs. You're trained to become the fully rounded, new breed of technician

who can interface with the operational, programming, and service facets of today's computers. You're ready to take your place in the new electronic age.

Other Opportunities

NRI has been giving ambitious people new electronic skills since 1914. Today's offerings also include TV/Audio/Video Systems servicing with training on our exclusive computer-programmable 25" diagonal color TV...Communications Electronics for servicing and installing microwave, broadcast, CB, radar, etc...and other state-of-the-art courses.

Free Catalog...Mail Card No Salesman Will Call

Send the postage-paid card for our 100-page catalog showing all courses with equipment and complete lesson plans. There's no obligation other than to yourself. See how NRI can help you grow with the most exciting and important new field of the 80's. If card has been removed, please write to us.

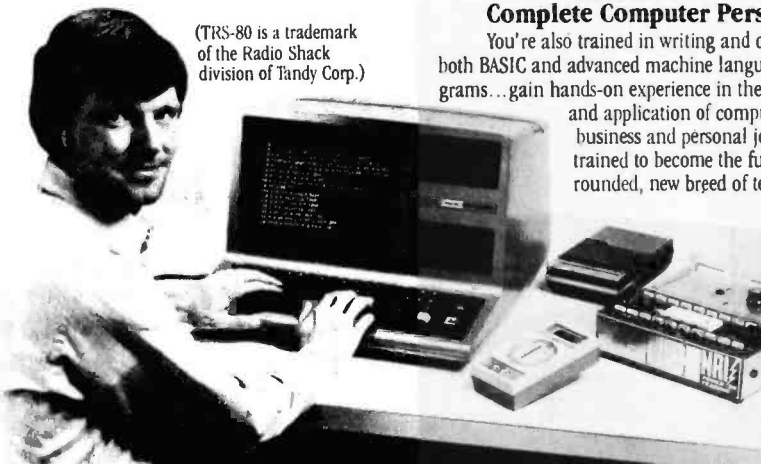

(TRS-80 is a trademark of the Radio Shack division of Tandy Corp.)



NRI SCHOOLS
McGraw-Hill Continuing
Education Center
3939 Wisconsin Ave.
Washington, DC 20016

We'll give you tomorrow.

REPAIR PCB'S ANYWHERE.

With the NEW Pace Micro!

Perform power desoldering and soldering anywhere. Depot. Service center. Mobile van. On-site. Anywhere! Operates on AC or 12 VDC.

Write or call today for a FREE brochure.



© 1981, Pace, Inc.

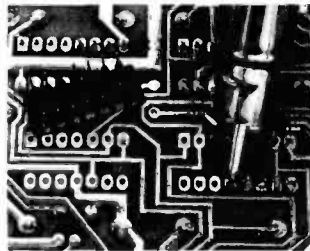

PAGE

Micro Portable

Systems for PCB Repair Anywhere™

9893 Brewers Court
Laurel, Md. 20707, U.S.A.
(301) 490-9860.
Telex 87446.

TERMINALS FROM TRANSNET

PURCHASE PLAN • 12-24 MONTH FULL OWNERSHIP PLAN • 36 MONTH LEASE PLAN

DESCRIPTION	PURCHASE PRICE	PER MONTH		
		12 MOS.	24 MOS.	36 MOS.
DEC				
LA36 DECwriter II	\$1,095	\$105	\$ 58	\$ 40
LA34 DECwriter IV	995	95	53	36
LA34 DECwriter IV Forms Ctrl.	1,095	105	58	40
LA120 DECwriter III KSR	2,295	220	122	83
LA120 DECwriter III RD	2,095	200	112	75
VT100 CRT DECScope	1,695	162	90	61
VT101 CRT DECScope	1,195	115	67	43
VT125 CRT Graphics	3,295	315	185	119
VT131 CRT DECScope	1,745	167	98	63
VT132 CRT DECScope	1,995	190	106	72
VT18XAC Personal Computer Option	2,395	230	128	86
TEXAS INSTRUMENTS				
T1745 Portable Terminal	1,595	153	85	58
T1765 Bubble Memory Terminal	2,595	249	138	93
T1 Insight 10 Terminal	695	67	37	25
T1785 Portable KSR, 120 CPS	2,395	230	128	86
T1787 Portable KSR, 120 CPS	2,845	273	152	102
T1810 RD Printer	1,695	162	90	61
T1820 KSR Printer	2,195	211	117	80
LEAR SIEGLER				
ADM3A CRT Terminal	595	57	34	22
ADM5 CRT Terminal	645	62	36	24
ADM32 CRT Terminal	1,165	112	65	42
ADM42 CRT Terminal	1,995	190	106	72
DATAMEDIA				
DT80/1 CRT Terminal	1,695	162	90	61
DT80/3 CRT Terminal	1,295	125	70	48
DT80/5L APL 15" CRT	2,295	220	122	83
TELEVIDEO				
920 CRT Terminal	895	86	48	32
950 CRT Terminal	1,075	103	57	39
NEC SPINWRITER				
Letter Quality, 7715 RD	2,895	278	154	104
Letter Quality, 7725 KSR	3,295	316	175	119
GENERAL ELECTRIC				
2030 KSR Printer 30 CPS	1,195	115	67	43
2120 KSR Printer 120 CPS	2,195	211	117	80
HAZELTINE				
Executive 80/20	1,345	127	75	49
Executive 80/30	1,695	162	90	61
EPSON				
MX-80 F/T Printer	745	71	42	27
MX-100 Printer	895	86	48	32

FULL OWNERSHIP AFTER 12 OR 24 MONTHS • 10% PURCHASE OPTION AFTER 36 MONTHS

MICROCOMPUTERS

APPLE • COMMODORE • HP85 • DEC LSI 11

ACCESSORIES AND PERIPHERAL EQUIPMENT

ACOUSTIC COUPLERS • MODEMS • THERMAL PAPER • RIBBONS • INTERFACE MODULES • FLOPPY DISK UNITS



TRANSNET CORPORATION

1945 ROUTE 22 • UNION, N. J. 07083 • (201) 688-7800
TWX 710-985-5485 800-526-4965 OUTSIDE N. J.

Books Received

Arcsoft Publishers, 1981; 96 pages, 21 by 13 cm, softcover, ISBN 0-86668-501-4, \$6.95.

Nonlinear System Theory, The Volterra/Wiener Approach, Wilson J. Rugh. Baltimore, MD: The Johns Hopkins University Press, 1981; 325 pages, 23 by 18.5 cm, hardcover, ISBN 0-8018-2549-0, \$32.50.

Optimization: A Simplified Approach, William Conley. Princeton, NJ: Petrocelli Books, 1981; 248 pages, 23.5 by 15.5 cm, hardcover, ISBN 0-89433-121-3, \$20.

Programs for Beginners on the TRS-80, Fred Blechman. Rochelle Park, NJ: Hayden Book Company, 1981; 150 pages, 17.5 by 24.5 cm, softcover, ISBN 0-8104-5182-4, \$8.95.

Real Time Programming—Neglected Topics, Caxton C. Foster. Reading, MA: Addison-Wesley, 1981; 190 pages, 23 by 15.5 cm, softcover, ISBN 0-201-01937-X, \$9.95.

RPG & RPG II Primer, A Modern Approach, H. Mullish and R. Kestenbaum. New York: Holt, Rinehart and Winston, 1982; 189 pages, 27.5 by 20.5 cm, softcover, ISBN 0-03-056918-4, \$17.95.

Standard BASIC Programming for Business and Management Applications, James S. Quasney and John Maniotes. San Francisco, CA: Boyd & Fraser Publishing Company, 1980; 408 pages, 17.5 by 25 cm, softcover, ISBN 0-87835-081-0, \$13.95.

VLSI Systems and Computations, H. T. Kung, Bob Sproull, and Guy Steele, eds. Rockville, MD: Computer Science Press, 1981; 415 pages, 23.5 by 16 cm, hardcover, ISBN 0-914894-35-8, \$29.95.

Webster's Microcomputer Buyer's Guide, Tony Webster. Rochelle Park, NJ: Hayden Book Company, 1981; 326 pages, 26.5 by 21 cm, softcover, ISBN 0-9594624-2-2, \$25.

Without Me You're Nothing: The Essential Guide to Home Computers, Frank Herbert and Max Barnard. New York: Pocket Books, 1981; 304 pages, 20.5 by 13 cm, softcover, ISBN 0-671-43964-2, \$5.95. ■

This is a list of books received at BYTE Publications during this past month. Although the list is not meant to be exhaustive, its purpose is to acquaint BYTE readers with recently published titles in computer science and related fields. We regret that we cannot review or comment on all the books we receive; instead, this list is meant to be a monthly acknowledgment of these books and the publishers who sent them.

BYTE's Bugs

Inflated Bug

Joe Hadleman's inflation calculator program in the July 1981 BYTE has a bug in line 440, page 302. (See "Computing Inflation with the Consumer Price Index," page 300.) If:

$$\text{STR}\$(\text{P2}-\text{INT}(\text{P2}))$$

is less than 0.01 (in other words, if the rounding error is less than a penny), the calculation is handled in scientific notation and the output is garbage. To correct this, insert:

$$\text{OR IF } (\text{P2}-\text{INT}(\text{P2})) < .01$$

before the "THEN" of line 430.

Michael D. Decker, MD
5869 North Glenwood #1
Chicago, IL 60660

DYMARC
INDUSTRIES, INC.

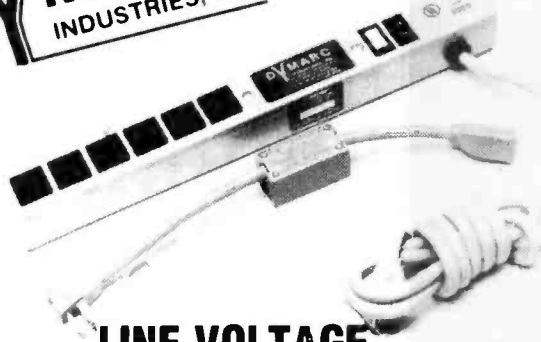

**LINE VOLTAGE
TRANSIENT SUPPRESSORS**

Features Parallel Operation 5000 Hits/Second

Clipstrip™ AND Clipper™

PROTECTS:

- Computers
- Micro-Computer Systems
- Word Processors
- Cash Registers
- Power Supplies

PROTECTS AGAINST:

- High Energy Voltage Transients
- On-Off Switching
- Lightning Induced Transients
- Inrush of On/Off Power

DYMARC
INDUSTRIES, INC.

DEALER INQUIRIES INVITED

7133 Rutherford Rd. Baltimore, Md. 21207
(301) 298-3130 800-638-9098

Clipstrip
977E



LISTED

Clipper
678F



LISTED

**START YOUR OWN
COMPUTER CO.**

HOW TO START YOUR OWN SYSTEMS HOUSE
7th edition, November 1981

\$36.

Written by the founder of a successful systems house, this fact-filled 220-page manual covers virtually all aspects of starting and operating a small systems company. It is abundant with useful, real-life samples: contracts, proposals, agreements and a complete business plan are included in full, and may be used immediately by the reader. Proven, field-tested solutions to the many problems facing small turnkey vendors are presented.

HOW TO BECOME A SUCCESSFUL COMPUTER CONSULTANT
by Leslie Nelson, 4th revised edition, December 1981

\$28.

Independent consultants are becoming a vitally important factor in the micro-computer field, filling the gap between the computer vendors and commercial/industrial users. The rewards of the consultant can be high: freedom, more satisfying work and doubled or tripled income. This manual provides comprehensive background information and step-by-step directions for those interested to explore this lucrative field.

FREE-LANCE SOFTWARE MARKETING
by B.J. Korites, 3rd edition, June 1980

\$30.

Writing and selling computer programs as an Independent is a business where • you can get started quickly, with little capital investment • you can do it full time or part time • the potential profits are almost limitless. This best-seller by Dr. Korites explains how to do it.

SOFTWARE VENDOR DIRECTORY
5th edition, October 1981

\$59.95

Essential for every developer, distributor and user of microcomputer software. In this unique reference directory, software vendors and program categories are cross referenced by every major hardware brand and operating system. • Over 1400 software vendors • Over 100 hardware vendors and operating systems • Languages • Utilities • DBMS • Accounting • Scientific • Engineering • Applications by Industry • and much more.

Send check, money order, VISA, Master Charge or American Express # and exp. date. Publisher pays 4th class shipping. Add \$1.00 per book for UPS shipping (USA only). NJ residents add 5% sales tax. For faster shipment on credit card orders call (201) 783-6940.

ESSEX PUBLISHING CO. Dept. 2
285 Bloomfield Avenue • Caldwell, N.J. 07006

S-100 HIGH RESOLUTION GRAPHICS

16 colors, 640 x 512 resolution \$3,175*

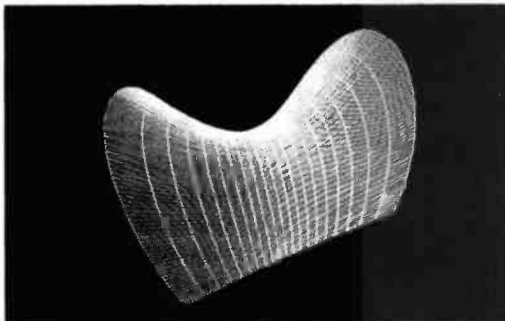

High speed: up to 500,000 dots per second with 8 bit processor, even faster with 16 bit processor

- Lightpen option
- Bit plane write protect option for overlays
- Gray levels and monochrome systems
- Full user's guide, separate Service Guide
- Compatible printers and monitors

*includes hardware, basic software package, 160 K bytes of graphics memory

Graphics Software

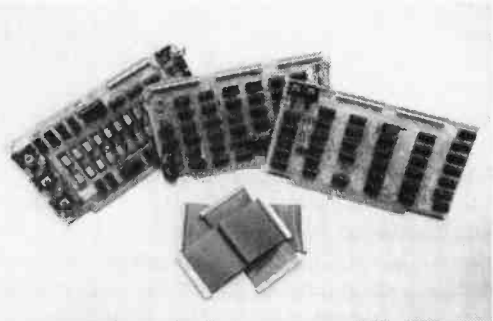

- Program in BASIC, FORTRAN, PASCAL, or assembler
- Programmable characters with 80 characters per line
- Graphical BASIC interpreter with PEEK and POKE
- Logo TURTLE graphics, relative coordinates
- Tektronix emulator
- Cartesian plotting package
- 3-D perspective with rotation
- Hidden line processing
- Screen dump to matrix printer or pen plotter
- Screen dump to disk and replay



**CAMBRIDGE DEVELOPMENT
LABORATORY**

36 Pleasant St., Watertown, MA 02172
(617) 926-0869

News and Speculation about Personal Computing

Conducted by Sol Libes

Random Rumors: IBM is rumored to be increasing production of its personal computer system, with 175,000 units expected to be sold before Christmas 1982. IBM will probably soon announce a graphics package and X.25 communications options for the personal computer. . . . Epson America is expected to introduce several video terminals, including one with a flat screen. The rumor is that they will be shown at the NCC (National Computer Conference) in June; look for Sinclair, Sony, and Hitachi to introduce similar products at NCC. Also due at NCC are 80- and 160-megabyte 8-inch Winchester hard-disk drives from Micropolis and 16- and 30-megabyte 5¼-inch Winchesters from Control Data Corp. . . . Reportedly, a 15-inch flat-screen monitor is due from Japan shortly. . . . DEC (Digital Equipment Corporation) is expected to introduce a PDP-8 replacement, a 16-bit version of its recently introduced personal-computer board for the VT-100 terminal, and a complete personal computer. Incidentally, DEC is budgeting \$500 million for research and development, with half going to software development and its 2000-member software development team. . . . Hearsay has it that Centronics is working on a ribbonless dot-matrix printer. . . . NEC (Nippon Electric Company) is supposedly about to introduce two new systems in the U.S., both of which are already on the market in Japan: the PC6000, a consumer-oriented machine, and the PC8800, an 8086-based machine for the

business market. . . . Commodore is said to be working on a new version of the VIC computer for introduction early next year. The unit should have 256K bytes of memory and 80-column black and white or color video display. . . . Look for the upgrade of the Osborne-I to be introduced later this year. It's rumored to have an 80-character-wide display (versus the current 52-column unit), double-density floppy-disk drives, a built-in modem, and a communications package. A significant jump in price will probably accompany it. . . . Toshiba is also expected to introduce into the U.S. a product it's already selling in Japan—a Z80-based system that runs CP/M, T-Basic, and UCSD Pascal.

Random Bits: At the recent Comdex show held for dealers, emphasis changed from the hobbyist to a business orientation, with Apples and TRS-80s all but replaced by integrated business systems. This change should be reflected in computer stores shortly. . . . NEC, Toshiba, and Okidata Corporation are currently supplying samples of 256K-bit dynamic memory devices and expect to start volume delivery in June. These ICs should begin showing up in equipment by the middle of 1983. . . . S D Systems will introduce yet another local-network system called MARS/NET. . . . Mitsubishi is supplying samples of its 5¼-inch Winchester disk drives and half-wide floppy-disk drives; Toshiba is also considering sale of its 5¼-inch Winchester in the U.S. Shugart's half-height 5¼-inch

SA210 floppy-disk drive will make its first appearance in Xerox's new Sabre line of electronic typewriters. . . . WD (Western Digital) is expected to shortly introduce a single-chip Winchester controller that replaces 25 TTL (transistor-transistor logic) parts. Also due from WD is a new floppy-disk drive controller IC that incorporates the data separator, comparator, and write-precompensation circuits missing from current controllers. . . . IBM recently opened its tenth computer store; more are in the works. . . . Seagate has introduced a 6-megabyte, 5¼-inch Winchester with removable media. . . . Emulog of Fremont, California, has introduced a full-feature video terminal with a \$465 list price. . . . HP (Hewlett-Packard) has separated its personal-computer operation from the calculator division and created a Personal Computation Group. HP has also increased dealer discounts on models 80, 85, and 125 systems by as much as 25 percent over previous discounts. . . . Radio Shack has beaten Apple into the 16-bit market with the introduction of its new Model 16, 68000-based microcomputer. For more details on this machine and other new products, see page 40. Radio Shack has also established an online videotex-information data-base system for subscribers in the Forth Worth area.

Unix Royalty Fees Cut: Western Electric recently introduced its Unix System III update which combines Ver-

sion 7 Unix and the PWB (Programmer's Workbench) into a single system. Some enhancements have also been added. They raised the source code license fee to \$43,000 but lowered the distribution deposit from \$50,000 to \$25,000 against royalties. The royalty fees have been reduced to \$100 for a single user and \$250 for systems for 2 to 16 users. (Previously, a license cost \$1500 plus \$250 per user.)

Royalties prepaid under the old rates will not be refunded. Licensees will, in effect, start with a clean slate. Hence, Microsoft will lose the \$200,000 it had prepaid to obtain a discount advantage, an advantage it no longer has.

The reduction in royalty fees removes what has been a significant deterrent for people wishing to use Unix, namely that it was very expensive. This should increase competition among Unix and its look-alikes. More important, it puts Unix in a much better position to compete with other single- and multi-user operating systems such as CP/M-86 and MP/M-86. Microsoft's president, Bill Gates, indicated that despite his unhappiness about the lost royalty payment, the royalty change would help his company sell copies of Xenix, its version of Unix.

Ada Update: Ada is finally becoming available as a working language. Telesoft Incorporated of San Diego, California, released its Ada package for 68000 systems last August, and RR Software of Madison, Wisconsin, in November released Janus, a

version for Z80 computers running CP/M. Both compile subsets of the Ada language. The Telesoft Ada compiler retails at \$2400, while Janus sells for \$250.

The DOD (Department of Defense) holds the trademark on the name "Ada" and stipulates that commercial companies can use the name only if they have or are developing a full-language compiler. To acquire legal access to the name "Ada," a company must submit its product to a DOD Ada-validation office for approval. Validation will ensure that programs written with the compiler will be fully portable between computers. Portability of that type doesn't exist for system-oriented languages such as Pascal, FORTH, and C.

Western Digital, based in Irvine, California, has also demonstrated its microAda and expects to be the first company to submit a complete Ada compiler to the DOD for validation. WD plans to submit it within the next 3 to 4 months. The WD Ada will run only on WD's new PAL 16-bit computer; a WD microAda license will cost \$2000.

SuperSoft Associates of Champaign, Illinois, has demonstrated its Ada compiler for Z80 systems, also expected to be ready for submission to the DOD for validation sometime this year. SuperSoft intends to release Intel 8086/8088, Motorola 68000, and Zilog Z8000 versions, with the Z80 version to sell for under \$300.

Telesoft is developing versions of its Ada compiler to run on the 8086, DEC VAX, and IBM 370 machines. Intel has developed an Ada compiler for its iAPX432 32-bit microcomputer currently running at beta test sites. Intel is preparing to submit the compiler for DOD validation.

And Ethernet's Fate?

A report issued by Strategic Incorporated, a market-research firm in San Jose, California, predicts Xerox Corporation's Ethernet local-area network will be a total failure within two years. According to Strategic's president, Michael Killen, "Xerox is headed for the worst failure in the company's history." He believes that Xerox lacks technological and price advantages, sales force, and customers interested in buying large systems. Further, he contends that Ethernet's baseband approach to local networking will prove inferior over the long haul to the broadband approach taken by Xerox's competitors. He points out that broadband systems are better suited to carry video, heavy voice and data transmissions, among other applications.

In response to the report, Xerox issued the following statement: "Based on the level of customer satisfaction with our existing network installations, the backlog of orders for network products and service, and the interest in Ethernet on the part of major accounts, we are confident that Xerox will be a leading vendor in office automation."

Bell Set to Move Into Computer-Related Markets:

AT&T (American Telephone and Telegraph) is undergoing a major management reorganization to comply with the FCC-required separation of regulated and deregulated activities. As a result, look for the Bell System to become an unbridled competitor in computer-related markets. It will probably begin marketing terminals and business computers soon, competing directly

with companies such as IBM, Wang, Xerox, and DEC in the intelligent-terminal and workstation markets and with Tymnet and Telenet in the communications-processing field. It is unlikely that Bell will compete directly with IBM in the mainframe business.

The Bell System itself presents a large, captive market for computer products. Actually, the Bell System is IBM's biggest customer outside of the U.S. government. Bell is expected to sell business and personal computers through its many Phone Center stores.

AT&T has also agreed to provide CBS (Columbia Broadcasting System) with home-computer terminals, data-entry equipment, and transmission facilities for a joint teletext experiment scheduled to begin this fall in New Jersey.

A National Amateur Computer Society:

The Japan Microcomputer Club is well organized, registers close to 4000 members, and has chapters in every major city in Japan. Hobbyists in England also work together through one central organization, providing an excellent base for the computer industry.

Computer hobbyists have long been the backbone of technological growth, but in the U.S., the hobbyist community is fragmented into several hundred independent clubs. A handful of clubs have over 1000 members, but most include fewer than 100. While some attempts have been made to found a national organization, none has succeeded.

Personal computing as a hobby is a breeding ground for computer professionals of tomorrow. Therefore, it's vital that we organize a national

amateur computer society while we are still the world's technological leader in computing.

CPM Goes Into Firmware:

Digital Research has signed an agreement with Intel which will allow the latter to sell ROMs encoded with the CP/M-86 operating system. The ROM will also contain timers and some logic; it should be available by mid-year. The ROM is intended for use in a CP/net system where systems containing CP/M in firmware don't have any disk but must communicate with a CP/M or MP/M server.

Intel will also sell CP/M-86 and MP/M-86 on disk for its single-board and 86/330 system. Intel has contracted with Microsoft for its MS-DOS (used on the IBM personal computer). Intel will sell its own RMX-86 DOS and plans to acquire Unix from Western Electric. Hence, Intel users and systems houses will be able to select among a wide variety of operating systems. Intel also expects to market applications software.

Digital Research Buys MT Microsystems:

Digital Research has acquired its second software company in less than three months by purchasing MT MicroSystems Incorporated of San Diego, California, supplier of Pascal/MT. Previously, Digital Research had purchased Compiler Systems Incorporated, supplier of CBasic.

Exxon Buys Out Zilog:

Over the years, Exxon Corporation has moved from a minor investor in Zilog Incorporated, supplier of the Z80, to a major investor, owning

90 percent of the stock. Zilog has bought the remaining 10 percent and will become a wholly owned Exxon subsidiary. One result is that Exxon will no longer be required to break out Zilog's quarterly earnings for shareholders. Zilog, incidentally, has yet to report a profit. In fact, the Exxon Enterprises operation, which includes all of Exxon's electronics subsidiaries, incurred a loss of \$51 million in the first nine months of 1981.

Microprocessor

Trends: Did you know that there are currently 51 different general-purpose microprocessors in production, that 17 are 4-bit devices, 14 are 8-bit devices, 6 are 16-bit devices, 4 are 32-bit devices with 16-bit I/O, 4 are bipolar, and 5 are microframe or special (e.g., Intel iAPX432)? Futher, did you know that seven more have been announced but are not yet in production, and that 42 companies currently manufacture microprocessors?

The microprocessor recently celebrated its tenth birthday. Credit for creating the microprocessor goes to Intel. (See this month's Editorial on page 6.) Ten years ago, the

companies that designed micros were mostly small, freewheeling organizations employing a great deal of ingenuity. Today, it is a totally different ballgame. Most of those early pioneers were either swallowed up by large companies (e.g., Zilog and MOS Technology) or are now very large companies (e.g., Intel, AMD, and National Semiconductor). Furthermore, leadership in design and production appears to be passing to the Japanese.

The microprocessor scene has changed a lot over these ten years. The question now is: what are the current trends and directions of the new micros? First of all, suppliers are making micros easier to program. National and Zilog already have micros with software-in-silicon. They each provide single-chip computers that execute BASIC statements directly in an interpretive mode. Futhermore, Intel is developing one micro with the capability to execute MP/M and another with a sophisticated on-board operating system. Also, there are rumors of a one-chip FORTH computer. There's no doubt that both National and Zilog have been successful with BASIC-processing ICs.

Second, microcomputer ICs are getting more sophisticated, having floating-point capability, multiply/divide functions, enhanced interrupt handling, and the like.

The most glamorous changes will occur in the 16/32 bit micros. All of these devices are getting coprocessors to extend their capabilities into the minicomputer field. Incidentally, Zilog has disclosed that it's working on a 32-bit micro. If the 8-bit unit is a Z80, the 8/16-bit device is a Z800, and the 16-bit micro is the Z8000, what will its 32-bitter be called? You guessed it! The Z80000! Maybe Zilog would be better off calling it the Z8x10⁴.

Memory Trends... or, What Is Turbo and Parity?

I occasionally look back with fondness to my first micro. It had 256 bytes of memory and used an Intel 8008. That was only 8 years ago. The next year, I graduated to an Altair 8800 that had an 8080, six printed-circuit cards containing 4K bytes of RAM, an I/O channel, and a huge power supply. How times have changed!

The most significant change

has been in memory. Today the 16K-bit, single-voltage RAMs dominate the marketplace, providing cost savings (mostly by shrinking power-supply requirements), yielding faster operation, and making the 64K-byte computer memory nearly standard. The 64K-bit RAM ICs are just starting to appear, and we find that computer memory sizes of 128K bytes and 256K bytes are becoming more common and will probably become the standard microcomputer memory size by the end of 1983. The 256K-byte RAM chips are now going into production. I expect that by 1985 1 megabyte will probably be the typical microcomputer memory size. Also, as the volumetric memory space decreases, the associated access time decreases, resulting in increased system performance.

Some of the most interesting changes in memory design are improving memory reliability and speed. Memory manufacturers are beginning to introduce multifunction memory systems that perform parity or error-checking and correction functions previously handled by a computer's processor, if they were done at all. In fact, National



Clubs and Newsletters

Apple Group In Little Rock

The Little Rock Apple Addicts publish a newsletter and hold meetings and program swaps. Guest speakers have shown members how to diagnose ailing Apples and have demonstrated programs and peripherals. Contact Little Rock Apple Addicts, POB 55215, Little Rock, AR 72205.

Free Newsletter

The Software Newsletter is a free bimonthly publication of the Software Store in Los Angeles, California. It features news about personal and business CP/M software. Also included are reviews of microcomputer books, magazines, and games. Contact the Software Store, 11768 West Pico

Blvd., West Los Angeles, CA 90064, (213) 473-1136.

Llano Estacado Computer Club

Llano Estacado Computer Club would like to exchange ideas with other computer clubs. Members are interested in all microcomputers. Write to John L. Peters, Llano Estacado Computer Club, 1509 Fairway Terrace, Clovis, NM 88101.

Computer Association In Central Texas

The Central Texas Computer Association (CTCA) meets on the fourth Monday of the month at the Farm & Home Savings Building in

Austin, Texas. Club meetings include short demonstrations or informal talks on a variety of subjects relating to personal computers. A monthly journal, *PRINT-OUT*, has information on hardware and software, new equipment critiques, and a classified ad section free to members. The CTCA is active in community service, with a number of projects underway for the deaf. Membership dues are \$15. Contact CTCA, POB 17303, Austin, TX 78760.

HUGs In Pittsburgh

The Pittsburgh Heath Users Group (HUG) meets the third Tuesday of every month at the Heathkit store (3482 William Penn Hwy.) from 7 to 9 p.m. For more information, call (412) 824-3564.

Computer Dealers Society

The American Society of Computer Dealers (ASCD) is a new group devoted to promoting sound business practices in the used-computer industry. ASCD intends to cooperate fully with the Computer Dealers and Lessors Association in promoting ethical conduct standards. A code of ethics for ASCD members has been adopted. Meetings will be held twice a year, in February and July. For further details, contact ASCD, 3500 Southland Center, Dallas, TX 75201, or call Jerry Roberts at (313) 689-6200.

Magazine for War Gamers

The War Machine is a bimonthly magazine dedicated to fans of computer war games. It features news,

reviews of complex games for all microcomputers, and advice for independent software writers. The latest issue can be obtained for \$3 from Emjay, 17 Langbank Ave., Rise Park, Nottingham NG5 5BU, England.

Two New Groups In Munich

Two new microcomputer groups have been organized in Munich, West Germany. The European Branch of the Pascal Z Users Group has been formed in association with the American Pascal Z Users Group. And the second, the Ithaca Intersystems/S-100 Users Group plans to coordinate Ithaca users' efforts in Europe and to form a program exchange. Both groups can be contacted by writing George Brooke, Sebastian Bauerstrasse 20c, 8000 Munich 83, West Germany.

Dental Computer News

The *Dental Computer Newsletter* is a publication serving an international group of dentists, physicians, and office-management personnel who share a common interest in office computers. Members also have access to a software exchange and a computer bulletin board. Dues are \$15 domestic, \$23 overseas. Contact *Dental Computer Newsletter*, c/o E. J. Neiburger, 1000 North Ave., Waukegan, IL 60085. ■

Maxell Floppy Disks

The Mini-Disks
with maximum quality.



Dealer inquiries invited. C.O.D.'s accepted. Call FREE (800) 235-4137.

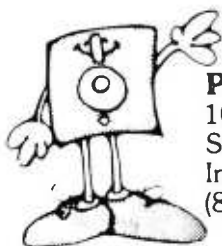

PACIFIC EXCHANGES
100 Foothill Blvd., San Luis
San Luis Obispo, CA 93401.
In Cal. call (800) 592-5935 or
(805)543-1037.

Software Received

Apple

Adventure in Time, an adventure game for the Apple II. Floppy disk, \$29.95. Phoenix Software Inc., 64 Lake Zurich Dr., Lake Zurich, IL 60047.

Birth of the Phoenix, a tutorial adventure for the Apple II. Floppy disk, \$14.95. Phoenix Software Inc. (see address above).

Circuit Design System, a digital electronics design and simulation package for the Apple II. Floppy disk, \$149. Smart Software Co., POB 1292, Orem, UT 84057.

Comma Usage/Semicolon and Colon Usage, a punctuation usage tutorial for the Apple II. Cassette, \$20; floppy disk, \$25. LARA Software, 980 Hunting Valley Pl., Decatur, GA 30033.

Context Connector, a Visicalc utility program for the Apple II. Floppy disk, \$180. Context Management Systems Inc., 23864 Hawthorne Blvd., Torrance, CA 90505.

Datalink, a telecommunications package in Pascal for the Apple II. Floppy disk, \$100. Link Systems, 1655 26th St., Santa Monica, CA 90404.

Linkdisk, a disk-utility package in Pascal for the Apple II. Floppy disk, \$70. Link Systems (see address above).

Linkindex, a rapid key data-file retrieval system in Pascal for the Apple II. Floppy disk, \$150. Link Systems (see address above).

Linksamplere, a tutorial package in Pascal for the Apple II. Floppy disk, \$60. Link Systems (see address above).

Linkvideo, a screen utility in Pascal for the Apple II. Floppy disk, \$55. Link Systems (see address above).

Red Alert, an arcade-style game for the Apple II Plus. Floppy disk, \$29.95. Broderbund Software Inc., 2 Vista

Wood Way, San Rafael, CA 94901.

Shadow Hawk One, an arcade-style game for the Apple II. Floppy disk, \$49.95. Horizon Simulations, 107 East Main #2, Medford, OR 97501.

Zoom Grafix, a graphics/printer control package for the Apple II. Floppy disk, \$39.95. Phoenix Software Inc. (see address above).

Atari

Easytext Word Processor, a word-processing system for the Atari 800. Floppy disk, \$50. Dataworks Inc., 97 Jackson St., Cambridge, MA 02140.

The I Ching, a program for casting and displaying hexagrams for the Atari 800. Floppy disk, \$44.95. Alternate Reality Software, 2111 West Arapahoe Dr., Littleton, CO 80120.

Shadow Hawk One, an arcade-style game for the Atari 400/800. Floppy disk, \$49.95. Horizon Simulations, 107 East Main #2, Medford, OR 97501.

CP/M

Office System 80, a utility system for the CP/M operating system. 8-inch floppy disk, \$195. The Information People, 443 Hudson Ave., Newark, OH 43055.

Quickscreen, a screen-formatting program for the CP/M operating system. 8-inch floppy disk, \$149. Fox and Geller Associates Inc., POB 1053, Teaneck, NJ 07666.

The Formula, a multifunctioned, business-oriented data-processing package for CP/M. 8-inch floppy disk, \$595. Dynamic Microprocessor Associates, 545 5th Ave., New York, NY 10017.

XLT86, an assembly-lan-

guage conversion utility to convert CP/M programs to CP/M-86. 8-inch floppy disk, \$150. Digital Research Inc., 801 Lighthouse Ave., POB 579, Pacific Grove, CA 93950.

TRS-80

LOG, a simple database management program for the TRS-80 Models I and III. Floppy disk, \$44.95 (Model I), \$49.95 (Model III). KSoft, 318 Lakeside Dr., Brandon, MS 39042.

Modem 80, a telecommunications software package for the TRS-80 Models I and III. Floppy disk, \$39.95. The Alternate Source, 1806 Ada St., Lansing, MI 48910.

Smart Terminal, a telecommunications software package for the TRS-80 Models I and III. Cassette, \$69.95.

Howe Software, 14 Lexington Rd., New City, NY 10956.

Uniterm, a telecommunications software package for the TRS-80 Models I and III. Floppy disk, \$29.95. BT Enterprises, 171 Hawkins Rd., Centereach, NY 11720.

Other Computers

Quadcube, an extended graphics simulation of the Rubik cube puzzle for the Texas Instruments TI-99/4. Cassette, \$14.95. Linear Aesthetic Systems, POB 23, West Cornwall, CT 06796.

The ZX80 Business Package, a business-oriented program package for the ZX80 and MicroAce computers. Cassette, \$9.95. Lamo-Lem Laboratories, POB 2382, La Jolla, CA 92038. ■

This is a list of software packages that have been received by BYTE Publications during the past month. The list is correct to the best of our knowledge, but it is not meant to be a full description of the product or the forms in which the product is available. In particular, some packages may be sold for several machines or in both cassette and floppy-disk format; the product listed here is the version received by BYTE Publications.

This is an all-inclusive list that makes no comment on the quality or usefulness of the software listed. We regret that we cannot review every software package we receive. Instead, this list is meant to be a monthly acknowledgment of these packages and the companies that sent them. All software received is considered to be on loan to BYTE and is returned to the manufacturer after a set period of time. Companies sending software packages should be sure to include the list price of the packages and (where appropriate) the alternate forms in which they are available.

BYTE's Bugs

Closer Look Spies Bug

PC: The Independent Guide to the IBM Personal Computer is a bimonthly publication, not a monthly as stated on page 60 of Gregg Williams' article "A Closer Look at the IBM Personal Computer" (January 1982 BYTE). Subscriptions to the

magazine cost \$12 for six issues.

Please note that the new address for *PC: The Independent Guide to the IBM Personal Computer* is 1239 21st Ave., San Francisco, CA 94122, (415) 753-8088. ■

Ask BYTE

Conducted by Steve Ciarcia

Speech Synthesizer Application

Dear Steve,

I read with great interest your article, "Build an Unlimited-Vocabulary Speech Synthesizer" (September 1981 BYTE, page 38), and have found a possible use for it. I have a Perkin-Elmer 3220 computer and would like to use the synthesizer to answer telephone calls into the computer, mainly to respond to salesmen who have phoned orders into the computer. The synthesizer would respond with appropriate messages, telling the salesmen if transmission was successful or what problem occurred. Could the synthesizer feasibly be used in this capacity on my computer, with or without modifications, and what modifications would be necessary, if any?

Derek Pitcher
Highland Park, NJ

The speech synthesizer requires only a Centronics-compatible parallel output port commonly used for printers. The port comprises 9 output lines and 2 input lines. If your computer has this capability, then the synthesizer can be easily interfaced as described in the article.

Your application is an excellent one. Many companies, including Ma Bell, use speech synthesizers on the telephone. Listen carefully the next time you dial a phone number that has been changed. . . . Steve

Problems with EPROM

Dear Steve,

I was very glad to see your

article, "Build an Intelligent EPROM Programmer," in the October 1981 BYTE (see page 36). For the past several months, I have been trying to build a circuit to program EPROMs (erasable programmable read-only memory) using my homebrew 6809 computer and three output ports from 6820 Peripheral Interface Adapters. It was a bit of a surprise to see that my circuit is almost the same as yours. Mine does not work, however, and I can't figure out why.

I am using the 5-volt-only version of the 2716 EPROM, and my timing is done by a wait loop in software rather than by the one-shot TTL (transistor-transistor logic) device that you used. When I try to program a "known-good" 2716, it comes out with about one-fourth the bytes programmed (the rest are hexadecimal FF), and those bytes that are programmed are not necessarily right.

I checked all the address lines and data lines over and over again. I even single-stepped through the program, monitoring all the voltages as I went. Every pin is what it should be, but it just doesn't work right. I was wondering if you knew of any little idiosyncrasies of the 2716 that may cause such a symptom. Did you run into any such trouble with your circuit?

Matthew G. Cimbala
State College, PA

It sounds as if you have a software problem in which the addresses are not being placed on the EPROM in the right sequence. Perhaps your address-incrementing routine is resetting too soon.

The fact that you are getting data into the EPROM

(assuming that all bytes were hexadecimal FF prior to programming) indicates that the program timing loop is okay. The 2716 is a very reliable EPROM and I am not aware of any idiosyncrasies that would cause this problem. I suggest you leave it alone for a few days and then walk through the software, paying close attention to your indexing instructions. . . . Steve

Modem Interface

Dear Steve,

I acquired an acoustically coupled modem made by Multi-tech Systems from New Brighton, Minnesota. This is the model FM 30; it has a full- or half-duplex switch on the bottom and also what appears to be an RS-232C input connector. I was wondering if you could provide any information on interfacing this with my Apple II Plus. Would one of the commercial interfaces work, such as the Apple Communications board or Mountain Computer's CPS Multifunction card? Any information would be greatly appreciated.

Steven M. Babick
Dolton, IL

Any board that provides an RS-232C serial input will be adequate to interface your modem to the Apple II Plus. The commercial interfaces that you mentioned are fine for this purpose.

For an explanation of how modems work, and some of the terminology associated with them, refer to my article, "A Build-It-Yourself Modem for Under \$50," in the August 1980 BYTE, page 22. . . . Steve

High-speed Printers

Dear Steve,

I would like to build a 16-bit microcomputer system to drive a 600-line-per-minute printer. Printers like that are advertised in BYTE, but I have my doubts that anything can actually print at that speed. What do you think?

Colin Morris
New York, NY

Six-hundred-line-per-minute printers do indeed exist. Your doubts as to anything printing that fast are natural, especially if you are used to seeing a dot-matrix or daisy-wheel printer printing one character at a time. The higher-speed printers print a whole line at a time (like the old mechanical adding machines) and can be driven much faster.

I think the ultimate in printers is the IBM laser printer. It is capable of 1800 lines per minute. It works by having the laser, acting like the electron beam of a TV screen, scan a metal plate. The plate becomes charged, and the image is transferred to paper much like a xerographic copier. The problem with this type of printer is the manpower necessary to load and unload the boxes of paper that are used. . . . Steve

Level I Tape Format

Dear Steve,

I wrote a program that brought data from the tape and stored them in memory of my TRS-80 Model I so that I could examine them. But the data format did not match any listed in my refer-

ences. Part of the problem was that I was using a Level I BASIC machine and reading programs like Eliza, Micro-movie, and Pyramid 2000.

So I modified my program to read Level II tapes and sure enough, the formats were correct. Can you tell me where to find the format for Level I tapes?

Bob Fabiano
El Cajon, CA

Radio Shack has machine-language programs for converting your Level I BASIC programs and data files into the Level II format. They are called CONV and DCONV, respectively, and are furnished free of charge when a Level I machine is upgraded to Level II. See your local Radio Shack dealer.

The Level I cassette-tape format can be found in The Custom TRS-80 and Other Mysteries by Dennis Kitz.

... Steve

Computer Lab Essentials

Dear Steve,

I am a sometime practitioner of simple chip and micro-processor designs. I am approaching retirement in a few years and I'd like to build more ambitious projects. To do that I'd like to set up a lab of sorts. Accordingly, I would value your recommendations about the kinds of test instruments I should be thinking about getting. I should tell you also that I have a 35-year-old degree in electrical engineering and, in the mid-fifties, I worked in hardware. The point being I'm not worried about my ability to use dual-trace scopes, voltmeters, and the like.

I'll probably try to build a computer from scratch. I was particularly intrigued by your article, "Build a Computer-Controlled Tank," in the February 1981 BYTE, page 44. Maybe I'll try to tie a specially built computer to a complex model railroad layout. I tell you this to give you an idea of what I think I'd like to do. I'm not especially worried about the price of the test instruments, but naturally I'd like to avoid buying the fanciest Tektronix scope. I'm an experienced kit builder, so if you think a particular Heath scope is a good value and desirable, that might be best.

B. H. Kramer
St. Louis, MO

The two instruments that are absolute musts for a computer lab are an oscilloscope and a DVM (digital voltmeter). The scope should have a 15 to 25 MHz bandwidth with dual trace and a time-base range between 200 nanoseconds and 0.5 seconds (without having to use the time-base magnifier). Vertical sensitivity should be at least 10 millivolts per division. Delayed sweep and trigger view are not necessary. I just purchased a Tektronix 2215 (\$1400), and it is very good for the money. As for the DVM, any 3½ digit model should suffice.

Other useful equipment would be a function generator and variable-voltage power supply with short-circuit and overload protection.

The above recommendations should suffice for the application that you describe. In any event, this represents the foundation of a good lab system and will require only a modest investment. Enjoy your retirement. ... Steve

XENIX™-BASED WORK STATION

Here is the complete, no-compromise UNIX™-based package that gives you full UNIX power at truly minimal cost. Your investment is protected against obsolescence because we use industry standard components. Unlike other UNIX or "UNIX-act-alike" systems, this is a true, complete UNIX Version 7 running on a PDP-11. This is exactly as it was meant to be in the original design and conforms to Bell Laboratories UNIX Version 7 documentation.

MSD Corporation is making a special offer on our XENIX-based 23/256 Work Station:

- LSI-11/23 based processor with floating point, 256Kb random access memory, 4 port serial interface, 5 quad slots for expansion.
- Dual floppy subsystem, single sided (double sided may be specified at additional cost), bootstrap loader, formatting and diagnostic software.
- 20.8 Mb Winchester disk with integrated cartridge tape backup.
- One (1) VT-100 terminal with advanced video option.
- One (1) LA38-HA tractor feed printer with keyboard, numeric keypad and stand.
- One (1) Auto-Answer, Auto-Dial 300 Baud Modem.
- Cables for the above.
- XENIX Operating System, a true UNIX Version 7, configured for 4 users.
- Complete manual set and 1 year telephone support.

This system is expandable up to 8 users and 83.2 Mb of disk storage. Multiple work stations, terminals, other UNIX systems, or non-UNIX systems can be networked together with no additional software.

Price: \$23,256. Terms: 25% Down with purchase order, balance 75% upon delivery.

MSD

MSD Corporation
2449 Camelot Court, SE
Grand Rapids, MI 49506
(616) 942-5060

MANAGEMENT SYSTEMS DEVELOPMENT

UNIX and XENIX are trademarks of Bell Laboratories and Microsoft respectively.

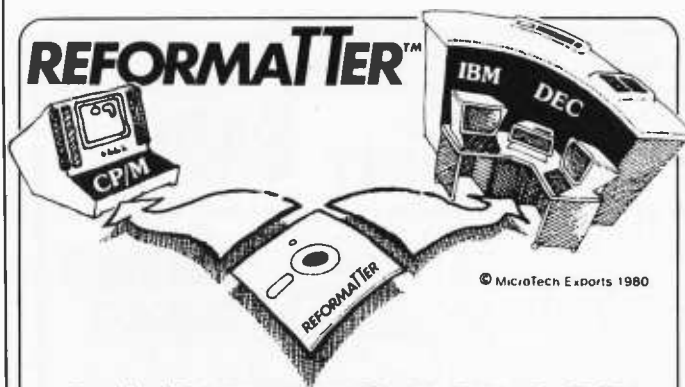

GETS FILES ACROSS!

With **REFORMATTER** disk utilities you can read and write IBM 3740 and DEC RT-11 single density formatted diskettes on your CP/M® system.

REFORMATTER enables you to access large system databases, improve data exchange with other organizations, increase program development capabilities, and use your micro in distributed processing.

REFORMATTER programs feature bi-directional data transfer and full directory manipulation. ASCII/EBCDIC conversion provided with CP/M ↔ IBM. *MPIM is now fully supported.*

Program Data Sheets, Application Guides, and Machine Compatibility Guides available.

Each program \$195.00 from stock. Specify CP/M ↔ IBM or CP/M ↔ DEC. Order from MicroTech Exports, Inc., 467 Hamilton Ave., Suite 2, Palo Alto, CA 94301 ☐ Tel: 415/324-9114 ☐ TWX: 910-370-7457 MUH-ALTOS ☐ Dealer and OEM discounts available.

CP/M® is a registered trademark of Digital Research.

SOFTWARE FOR MANUFACTURERS

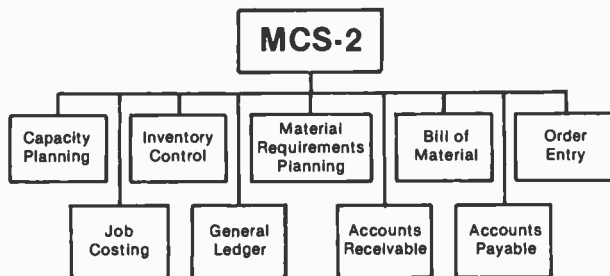

Micro Manufacturing Systems has been developing and supplying manufacturing software directly to manufacturers for several years and is now offering its MCS-2 system to dealers and OEM's.

MCS-2 is the most comprehensive manufacturing control system designed for the CPM based micro computer. MCS-2 consists of nine separate modules which can be purchased as a complete system or individually as required.

For more information contact:

MM MICRO MANUFACTURING SYSTEMS

1670 Norma Rd. • Columbus, Ohio 43229
Phone: (614) 885-0738

Ask BYTE

Programming the RS-232C Serial Port

Dear Steve,

I have been unable to find any information on programming the RS-232C serial port on the Radio Shack Color Computer. A call to the "hot line" indicated that Radio Shack consultants were somewhat in the dark, although they tried to be helpful. Can you shed any light on this topic?

Martin F. Rooney
Troy, NY

The RS-232C serial port on Radio Shack's Color Computer consists of 3 bits of 3 addresses of a Motorola MC6821 Peripheral Interface Adapter (PIA). At address hexadecimal FF20, bit 1 represents the RS-232C Data Output and is brought out to pin 4 of connector P2. Address hexadecimal FF21, bit 1, is the Status Input line, connected to pin 1 of P2. Address hexadecimal FF22, bit 0, is the RS-232C Data Input and is connected to pin 2 of P2; pin 3 of P2 is ground.

In software, the only RS-232C device supported by the 8K-byte BASIC is a serial printer, so pin 1 of P2 is not used. Pin 2 is intended to be connected to the printer status or busy line, and pin 4 is the output to the printer. To program the MC6821, a rather elaborate discussion must ensue. An article from EDN magazine, September 20, 1980, "Understanding PIA Operations Increases Your Design Options" by Randy Hutcheson, explains this rather well.

The TRS-80 Color Computer Technical Reference Manual (Cat. No. 26-3193) explains all the input/output memory map. It is available through any Radio Shack store. . . . Steve

Build Your Own

Dear Steve,

I have read some of your articles and especially liked "Build the Disk-80" (see the March 1981 BYTE, page 36), but I was sorry that it was not designed to work with 8-inch disk drives. I would like to build a computer, perhaps based on Zilog's Z80, with provisions for four 8-inch disk drives and with the ability to directly address 128K bytes of nonvolatile memory. Do you have any suggestions?

W. Edward Kelsey
New London, NH

I'm glad to see that there are still some people who enjoy building computers rather than buying them. Your idea of a Z80-based system sounds fine, but I don't plan anything like it in the near future. Below are a few suggestions that may help.

You don't say what your experience level is, but at the risk of sounding like a commercial I would recommend my book, Build Your Own Z80 Computer (a McGraw-Hill publication available from BYTE Books, Peterborough, NH 03458). It contains the necessary information to build a complete computer and configure it any way that you wish.

As for the disk controller and memory, I would suggest that you buy them either as bare boards or assembled and tested. Configure your Z80 to an S-100 bus and save yourself a lot of grief. You will have your fun building the Z80 and you will save a lot of headaches by using prewired boards for the rest of the system.

You then can use bank-selectable memory boards and can easily have your 128K bytes of memory. . . . Steve

STOCK ORDERS SHIPPED IN **24 HOURS**

ADDS VIEWPOINT \$499* QTY. 1

TERMINAL

The Best Equipped Printer for the Money!
MODEL 889
BAG FEATURES

Graphical
Friction Feed
Adjustable Tractor Feed
Parallel Interface
Serial Interface
Data Buffer
Compatibility Font 11 x 7
Print Speed
Number of Columns
Variable Form Length

Standard
Standard
Standard
Standard
Standard
Standard
Standard
Standard



mp

\$649* QTY. 1

Interface cables for TRS-80, II, III, Apple
Centronics Atari and P11

DISC DRIVES

QUME: DT-8...\$525.00* QTY. 1 8 DSDD 2H 1P	DT-5...\$310.00* QTY. 1 5 1/4" 1SDO 4H 1P
TANDON: TM-100-2...\$335.00* QTY. 1 5 1/4" DSDD 4H 1P	TM-100-4...\$425.00* QTY. 1 5 1/4" 1SDO 4H 1P
TM-848-1...\$475.00* QTY. 1 8 DSDD 1H 4H 1E	TM-848-2...\$550.00* QTY. 1 8 DSDD 1H 4H 1E
TM-602...\$995.00* QTY. 1 5 1/4" 1MBYTE WINCHESTER	TM-603...\$1175.00* QTY. 1 5 1/4" 1MBYTE WINCHESTER

QUME LETTER QUALITY PRINTERS
SPRINT 9/45 \$2245* QTY. 1

OTHER MODEL AND CONFIGURATIONS AVAILABLE



(408) 438-5454

4444 SCOTTS VALLEY DR., SCOTTS VALLEY, CA 95066

TERMS: Cashiers Check, VISA, M/C, COD

Shipping charges added to all orders

* Quantity Discounts Available

MEDIA DISTRIBUTING

Radio Frequency Interference

Dear Steve,

I have been reading your column in BYTE since I first picked up an issue about four months ago. I am writing this on my newly acquired Vector Graphic System B and would deeply appreciate a reply to a nagging question.

The Vector System B installed for word processing in my home is about 15 feet from our TV antenna (located on rafters in the garage—our elevation precludes an external antenna). The system kills channel 2 and distorts 5 and 7. The dealer suggested a Radio Shack filter, which did nothing. I learned from another dealer that the System B uses a crystal oscillator with a frequency near television channel 2.

Please suggest what course of action I should take or what remedies I might initiate myself, such as a radio-frequency filter a novice could install in or around the computer case.

Jacob D. Pottgen
New Lenox, IL

I'm glad to hear that you've been reading my column for the past four months. Had you read the January 1981 BYTE on page 48, you would have seen my article on "Electromagnetic Interference." After reading it, you should have enough information to solve your radio-frequency interference problems.

It is important to understand what causes the problem and to recognize that it is difficult to determine what may be radiating the interfering signal. . . . Steve

Plotting with the TRS-80

Dear Steve,

I would like to find a program that will allow me to make x-y plots of graphs of linear and logarithmic equations and data points. I have a TRS-80 Model III and an IDS-560 printer with graphics capability. I don't need to see the plots on the screen; I only need to be able to print them out on the IDS-560.

Any help you could give me would be most appreciated. Thanks a lot.

Donald M. Lammers
Wexford, PA

Programs for x-y plotting are available at your local Radio Shack store. The following two books are quite thorough in the explanation of equations and data points and are directed, naturally, toward Radio Shack BASIC: TRS-80 Programs, Cat. No. 62-2064, and TRS-80 Graphics, Cat. No. 62-2063. . . . Steve

A Matter of Environment

Dear Steve,

I've taken instructions from a page from your recent book, *Build Your Own Z80 Computer*, and modified them to "Build Your Own Z8000," which is the source of my problem. The S-100 system I'm designing uses a Zilog Z8001 segmented microprocessor with a 4 MHz 9511 arithmetic processor. Hardware design is a snap so far. (I plan to purchase the Disk-1 floppy-disk controller from Godbout and build all other boards that I need.) The problem will be software; specifically, I need an operating system such as Unix or Unix-compatible Coherent. But Coherent is written in unsegmented code.

SUPERBRAIN™ 5 MB Plus (K System Five)

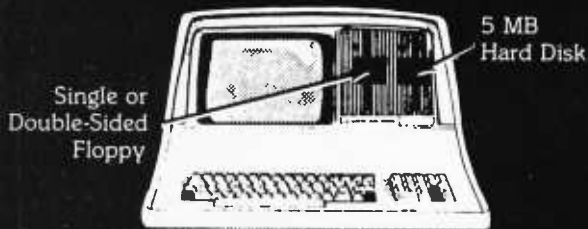

Now available INTERTEC'S amazing SUPERBRAIN with a built-in 5MB Hard Disk Storage. The K SYSTEM FIVE looks and operates like a normal SUPERBRAIN but with the advantage of 5 MB of hard disk storage and hard disk speed that are immediately available to the operator.

Kramer Systems International, Inc. has successfully installed COMPUSTAR™ and SUPERBRAIN™ Systems worldwide.

Dealer and International inquiries invited.
Available on the GSA schedule.



Kramer Systems International, Inc.
8403 Dixon Avenue
Silver Spring, Maryland 20910
(301) 585-7480

Call today for additional information

AT LAST AN AFFORDABLE HARD DISK SYSTEM DESIGNED EXCLUSIVELY FOR THE APPLE II®

HDS-520 HARD DISK SYSTEM

HDS-520 FEATURES:

- 5 Megabytes of formatted storage
 - Self-contained (with controller and power supply)
 - Uses one computer board slot (number 1 thru 7)
 - Compatible with Apple® DOS 3.3 and other Apple® software
 - Manufactured by the same company that designed and manufactures the Winchester Production Test System currently used by Seagate Technology and their major OEM's
- * Registered Trademark

5 MEGABYTE VERSION - \$2,795.00

Discount Available
for Quantity Orders

DEALER INQUIRIES INVITED



IR Industrial Resources

2701 SATURN STREET • BREA, CALIFORNIA 92621

Complete AIM 65 Expansion

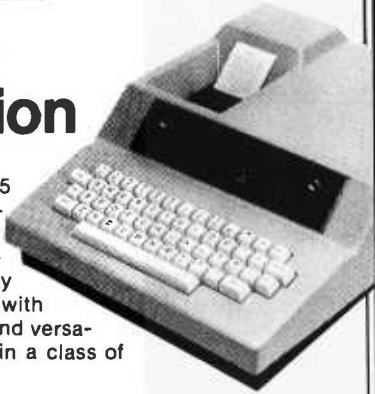

For complete AIM 65 expansion, Forethought Products brings you the AIM-Mate Series, quality expansion products with price, performance and versatility that puts them in a class of their own.

AIM-Mate Series expansion, including RAM (to 48K), PROM, I/O, video and floppy disk interface, STD BUS interface, parity protection and more, lets you configure the kind of system you need.

The compact AIM-Mate case puts it all together in a sturdy, portable, desk top unit.

Write today for complete details on the AIM-Mate System- AIM 65 expansion products for the professional.



87070 Dukhobar Road, Eugene, Oregon 97402 (503) 485-8575

WARNING!

Electric Power Pollution.
Spikes & Lightning
HAZARDOUS to
MICROCOMPUTERS!!

Patented ISOLATORS provide protection from . . .

- Computer errors caused by power line interference
- Computer errors due to system equipment interaction
- Spike damage caused by copier/elevator/air conditioners
- Lightning caused damage

**** FULLY GUARANTEED****

- ISOLATOR (ISO-1) 3 isolated 3-prong sockets; Spike Suppression; useful for small offices, laboratories, classrooms. \$69.95
- ISOLATOR (ISO-2) 2 isolated 3-prong socket banks; (6 sockets total); Spike Suppression; useful for multiple equipment installations. \$69.95
- SUPER ISOLATOR (ISO-3) similar to ISO-1 except double isolation & oversize Spike Suppression; widely used for severe electrical noise situations such as factories or large offices. \$104.95
- SUPER ISOLATOR (ISO-11) similar to ISO-2 except double isolated socket banks & Oversize Spike Suppression; for the larger system in severe situations. \$104.95
- MAGNUM ISOLATOR (ISO-17) 4 Quad Isolated Sockets; Multiple Spike Suppressors; For ULTRA-SENSITIVE Systems in extremely Harsh environments. \$181.95
- CIRCUIT BREAKER, any model (Add-CB) Add \$9.00
- CKT BRKR/SWITCH/PILOT (-CBS) Add \$17.00

AT YOUR DEALERS MasterCard, Visa, American Express
ORDER TOLL FREE 1-800-225-4876 (except AK, HI, PR & Canada)



Pat. #4,259,705

Electronic Specialists, Inc.

171 South Main Street, Natick, Mass. 01760

Technical & Non-800: 1-617-655-1532

Ask BYTE

Where can I get an operating system?

This sort of operating system is not the type usually advertised in BYTE; and you know how much good my beautiful hardware is going to be without it. (I'd prefer Unix if available.) The computer is intended as a multi-user, multitasking system, preferably with a FORTRAN compiler, as well as an assembler/editor/debugger.

Frank Barresi
Woodhaven, NY

Your problem is somewhat sticky. The problem is not altogether in the operating system. Unix, like CP/M, does not contain the primitives (software subroutines) for any I/O (input/output). Like CP/M's BIOS (basic input/output subsystem), these are totally hardware dependent.

In other words, you might be able to use Unix if you can write the subroutines for the I/O primitives. Be wary, however; Unix may use some strange hardware-dependent software, but I'm not an expert on Unix and can't be sure of this.

Two good sources of information about Unix are: The July-August 1978 issue of the Bell System Technical Journal, devoted to Unix, available for \$2.98 from Bell Laboratories Circulation Group, Whippany Road, Whippany, NJ 07981; and Using the Unix System by Richard Gauthier, Reston Publishing Co., Reston, VA. 1981.

Get as much information on Unix as you can and study the various implementations of Unix. Pay special attention to system environmental requirements and I/O requirements.

What it all boils down to is this: if you can make your hardware as much like the proper environment for Unix as possible, it should work. (By the way, I'll let you know when I do anything with the

Z8000. Remember what happened to Colossus in the sequel?) Good luck in any event. . . . Steve

Feasibility Study

Dear Steve,

I am presently studying electronics at a technical school. I have a technical writing course in which we are assigned to do some sort of feasibility study. I have chosen to do mine on the feasibility of purchasing a microcomputer for home use.

I am hoping that you could give me some references and, if possible, pass along some information which would help me in my study. This would be most appreciated.

Douglas E. Sprague
Hancock, ME

There is a wealth of information available on purchasing a computer for home use. The field of home computing is rapidly expanding and makes an excellent choice for a feasibility study.

The following are some references that should be quite helpful: Popular Computing, November 1981; Personal Computing—Home Professional and Small Business Applications by Daniel R. McGlynn, John Wiley and Sons, 1979; and Your Own Computer by Mitchell Waite and Michael Pardee, Howard W. Sams & Co. . . . Steve

VIP Expansion

Dear Steve,

I have an RCA COSMAC VIP with the 20K-byte memory upgrade so that I can use the VIP Floating Point (VIP 711). What I would like is to add a printer. Is it possible to do this with the VIP 711? I

know very little about the 1802 microprocessor.

I also have a TRS-80 with 48K bytes of memory, one disk drive, and a printer, and I have a Quick Printer 2. I would like to hook up the Quick Printer 2 to the VIP, but I don't even know how to start. I have no knowledge of electronics at all. Is this project possible? If so, where would I get the driver for the printer? (I have looked for 1802-based software to drive a printer, but so far, no soap.) Can you help me?
Nicholas Mulchin
Meadville, PA

The RCA COSMAC VIP is a powerful single-board computer. Unfortunately, there is little support for it in the computer magazines. It does, however, have expansion capability in the form of a 44-line I/O (input/output) interface that will allow almost anything to be added, including up to 32K bytes of programmable memory. It requires a fair amount of technical skill to accomplish the interface.

I doubt if there exists a printer interface such as you are looking for that would simply "plug in" to your VIP. The two manufacturers listed below make interface boards for the 1802 processor, and they may have the necessary information to connect with the VIP: Netronics Research & Development, Ltd., 333 Litchfield Road, New Milford, CT 06776, (203) 354-9375; and RCA Solid State, Box 3200, Somerville, NJ 08876.

Any software must first test the "printer busy" signal. If it is active, the computer must not send data to the printer, or it will not be seen. When the busy signal is low, the 8-bit data character may be sent from the output port

which will cause the printer to print it. When the next character is ready, the process must begin again. . . . Steve

TTL Data Books

Dear Steve,

I am looking for a TTL (transistor-transistor logic) data book that has descriptions and pinouts for the majority of the manufactured ICs (including the special and less frequently used ICs). Your suggestions are appreciated.

Paul Russo
Naples, FL

Every manufacturer of integrated circuits publishes a data book for its product line. One of the most readily available data books is published by National Semiconductor and is available at your local Radio Shack store or through Jameco Electronics, 1355 Shoreway Rd., Belmont, CA 94002, (415) 592-8097. Price lists for various data books can also be obtained by writing directly to the manufacturers.

. . . Steve ■

In "Ask BYTE," Steve Garcia answers questions on any area of microcomputing. The most representative questions received each month will be answered and published. Do you have a nagging problem? Send your inquiry to:

Ask BYTE
c/o Steve Garcia
POB 582
Glastonbury CT 06033

If you are a subscriber to The Source, send your questions by electronic mail or chat with Steve (TCE317) directly. Due to the high volume of inquiries, personal replies cannot be given. Be sure to include "Ask BYTE" in the address.

Circle 145 on inquiry card.

New, Unique Products Alternate Energy, Telescopes, Optics, Weather, Magnets, Microscopes & More!

In One Giant FREE Catalog



Biggest Catalog! Finest Quality!

Since 1941, thousands of engineers, craftsmen & hobbyists nationwide have been coming directly to the Edmund Scientific Catalog for quality products. . . fully guaranteed!

FREE! Simply fill in below, mail today, and your Edmund Scientific Catalog will be on its way to you.

Send FREE Catalog

Name _____

Address _____

City _____ State _____ Zip _____



Edmund Scientific

Dept. 8211 KH06 Edscorp Bldg.
Barrington, N.J. 08007

No. 3484 *1982 Edmund Scientific Co.

Some T.L.C.



It may be the best reason to switch to Opus.

We know how important personal service is. As well as attention to detail

and guaranteed quality and performance. Plus 48-hour delivery turn-around. We're just the right size for you. Large enough to fill your every need: Small enough so you never get lost in the shuffle. So dial 800/321-9330.

Or write to Computer Resources, Inc., 4650 West 160th Street, Cleveland, OH 44135. And begin to enjoy T.L.C.

OPUS®

Quality Flexible Diskettes, Single-Disk Cartridges, Multi-Level Disk Packs, and Magnetic Tape.



Circle 96 on inquiry card.

March 1982 © BYTE Publications Inc 447

Event Queue

March 1982

March

Courses and Seminars from George Washington University, Amsterdam, Netherlands; London, England; Long Island, NY; San Diego, CA; and Washington, DC. Among the courses and seminars to be presented are "Microcomputers in Control Systems," "Comparative Database Management Systems," and "Structured Programming and Software Engineering." For further information, contact The Director, Continuing Engineering Education, George Washington University, Washington, DC 20052, (800) 424-9773; in Washington, DC, (202) 676-6106.

March

Courses in Structured Systems, various sites throughout the U.S. Courses in "Structured Systems Design" and "Structured Requirements Definition" are being offered by Ken Orr and Associates. For information on meeting times, places, and fees, contact Ken Orr and Associates Inc., 715 East 8th, Topeka, KS 66607, (800) 255-2459; in Kansas (913) 233-2349.

March-April

Computer Network Design and Protocols, various sites throughout the U.S. Participants in this workshop will learn to determine network-system requirements and to perform design trade-offs, implement network-communication and control protocols, use packet- and message-switching techniques, evaluate network hardware and software components, interface local systems to networks, and design and build private networks. The course fee is

\$845. Contact Ruth Dordick, c/o Integrated Computer Systems, 3304 Pico Blvd., POB 5339, Santa Monica, CA 90405, (800) 421-8166; in California, (800) 352-8251.

March-April

Fundamentals of Data Processing for Administrative Assistants and Office Support Staff, various sites throughout the U.S. The American Management Associations (AMA) has designed this three-day course for secretaries, assistants, supervisors, and other personnel desiring to learn the fundamentals of data processing and its use in offices. Computer hardware, software, programming languages, and technology will all be covered. The team fee for AMA members is \$470 per individual and \$550 for nonmembers. Individual fees are \$550 for AMA members and \$630 for nonmembers. For a schedule of dates and locations, contact the AMA, 135 West 50th St., New York, NY 10020, (212) 586-8100. To register by phone, call (212) 246-0800.

March-May

Courses from Boeing Computer Services, various sites throughout the U.S. Boeing Computer Services is offering a wide variety of computer-related courses at its regional service centers. Course topics range from "Introduction to Data Processing" to "Structured Program Development in FORTRAN." For a complete schedule of times, locations, and fees, contact Boeing Computer Services Co., Education and Training Div., POB 24346, Seattle, WA 98124, (206) 575-7700.

March-May

Seminars and Conferences

from Datapro Research, various sites throughout the U.S. Among the topics to be presented are "IBM's Systems Network Architecture," "Data Dictionary/Directory Systems," and "Data Processing: Fundamental Concepts." Enrollment fees are \$640 for Datapro subscribers and \$690 for nonsubscribers. For a complete catalog with descriptions, dates, and locations, contact Datapro Research Corp., 1805 Underwood Blvd., Delran, NJ 08075, (800) 257-9406; in New Jersey, (609) 764-0100.

March-June

Datamation Institute Seminars on Information Management, various sites throughout the U.S. Databases and communications, systems performance, data-processing management, word processing, office automation, computer graphics, and topics of general interest are among the areas to be covered by these two-day seminars. Fees range from \$495 to \$595. For schedules of times and places, contact Karen Smolens, c/o the Center for Management Research, Datamation Institute Seminar Coordination Office, 850 Boylston St., Chestnut Hill, MA 02167, (617) 738-5020.

March-June

National Computer Graphics Association Seminar, various sites throughout the U.S. The National Computer Graphics Association's (NCGA) Winter/Spring 1982 Seminar program covers such topics as "Computer Graphics: Technology and Applications," "Successful Business Graphics," and "Applications of Computer Graphics to Transportation Problems." Seminar fees are \$395 for association

members and \$425 for nonmembers. For complete details, contact Eloise Wenker, NCGA Seminar, 2033 M St. NW, #300, Washington, DC 20036, (202) 466-4102.

March-June

Intensive Two-day Seminars for Professional Development, various sites throughout New England. Among the seminars to be offered by Worcester Polytechnic Institute are "Fundamentals of Data Processing," "Distributed Systems: The Architecture and Utilization of this Revolutionary Technology," and "Microprocessors: Hardware, Software, and Applications." Registration fees range from \$445 for a two-day program to \$990 for a 7-day executive institute. For complete details, contact Ms. Ginny Bazarian, Office of Continuing Education, Worcester Polytechnic Institute, Worcester, MA 01609, (617) 793-5517.

March-June

One- and Two-day Professional Development Seminars, various sites in the greater Boston area. Among the courses being offered by Boston University are "Business Writing for Results," "Improving Customer Service," and "Assertive Management." Registration fees range from \$295 for a one-day program to \$445 for a two-day program. These seminars can be conducted within your company. For details, contact Ms. Joan Merrick, Center for Management Research, 850 Boylston St., Chestnut Hill, MA 02167, (617) 738-5020. For information on the in-company seminars, contact Ms. Elaine Dee at the same address.

March-June

Courses and Seminars from Sira Institute, various sites throughout England. Sira Institute is sponsoring seminars on a wide variety of subjects ranging from microprocessor familiarization to design and development of microprocessor-based equipment. For details, contact Conferences & Courses Unit, Sira Institute Ltd., South Hill, Chislehurst, Kent BR7 5EH, England.

March-July

Technical Classes from Zilog, Campbell, CA. Zilog is offering a series of one- to five-day technical classes at its California-based training facility. Topics range from "Microprocessors: A General Introduction" to "Zeus/System 8000 User." Contact Zilog, Training Dept., 1315 Dell Ave., Campbell, CA 95008, (408) 446-4666.

March 9-11

The 1982 International Zurich Seminar on Digital Communications, Zurich, Switzerland. The theme of this seminar is "Man-Machine Interaction." Its aim is to present recent advances in theory and application of digital-communication systems. Services, facilities, ergonomics, and their impact on peripheral equipment, systems architecture and design, as well as I/O (input/output) concepts and principles will be covered. For details, contact Secretariat '82 IZS, Ms. M. Frey, EAE, Siemens-Albis AG, POB CH-8047, Zurich, Switzerland.

March 9-11

Understanding and Using Computer Graphics, Dallas Hilton Inn, Dallas, TX. This seminar is designed for those needing information about interactive computer graphics, including hardware, software, and applications. Headed by

Carl Machover, the seminar provides a comprehensive overview of the state of the art in graphics systems. For details, contact Bob Sanzo, c/o Frost & Sullivan Inc., 106 Fulton St., New York, NY 10038, (212) 233-1080.

March 9-12

Digital Image Processing and Analysis, San Diego, CA. Integrated Computer Systems' course in digital-image processing is designed for engineers, scientists, technical managers, and other professionals responsible for the specification, design, implementation, or application of digital-image processing systems. Among the topics to be covered are image acquisition, image-processing software and database structures, interactive two- and three-dimensional image processing and display, and real-time arrays. Some of the applications examples to be presented are quality assurance and robot vision. The course fee is \$795; on-site courses can be arranged. Contact Ruth Dordick, c/o Integrated Computer Systems, 3304 Pico Blvd., POB 5339, Santa Monica, CA 90405, (800) 421-8166; in California, (800) 352-8251.

March 9-12

VIO-Voice Input/Output for Computers, Los Angeles, CA. This four-day course is designed for product development and design engineers, systems analysts, programmers, and technical managers involved in the planning, design, and implementation of voice input/output systems. The topics to be covered include voice-processing algorithms and software, evaluating VIO hardware components and systems, utilizing speech-synthesis techniques, and designing voice-recognition techniques. Participants

will have the opportunity to work with devices that permit online generation of computer-voice output, data entry by means of voice input, and voice input for system control. The course fee is \$795; on-site courses can be arranged. For information, contact Ruth Dordick, c/o Integrated Computer Systems, 3304 Pico Blvd., POB 5339, Santa Monica, CA 90405, (800) 421-8166; in California (800) 352-8251.

March 10-12

Cincinnati Business Show, Cincinnati Convention Center, Cincinnati, OH. The Cincinnati Business show features the latest in business technology, office systems, and products. Seminars will also be presented. For information, contact Ray G. Nemo, 5679 Creek Rd., Cincinnati, OH 45242, (513) 531-5959.

March 12-13

The Fifth Annual Computers in Education Conference, Seattle Pacific University, Seattle, WA. Sponsored by Seattle Pacific University and the National Council for Computers in Education, this conference features concurrent talks, workshops, and discussions. Special emphasis will be placed on curricular uses of microcomputers in kindergarten through 12th grade. Contact Tony Jongejan, Everett High School, Everett, WA 98201.

March 12-14

FantasyLair '82, Ponca City, OK. The Northern Oklahoma Dungeoneers will be sponsoring tournaments and games in role-playing, war simulation, and many other card and board games. Admission is \$10 per day. Contact Shelby Cooper, c/o Northern Oklahoma Dungeoneers, POB 241, Ponca City, OK 74602, (405) 762-6077.

March 15-17

Microprocessor Background for Management Personnel, Albuquerque, NM. This course is sponsored by the Electrical and Computer Engineering Department of the University of New Mexico. The course fee is \$375. For details, contact Dr. Martin Bradshaw, Engineering Continuing Education, University of New Mexico, Albuquerque, NM 87131, (505) 277-4354.

March 15-19

Short Course from UCLA, Boelter Hall, University of California-Los Angeles (UCLA), Los Angeles, CA. "Mechanical Reliability, Design by Reliability, Probabilistic Design—The Stress/Strength Interference Approach to Reliability Prediction" is a short course being presented by UCLA. The course fee is \$795, which includes comprehensive course notes. For details, contact Dr. Dimitri Kececioglu, Aerospace and Mechanical Engineering Dept., University of Arizona, Tucson, AZ 85721, (602) 626-2495 or (602) 626-3901. In California, call Robert Rector at UCLA, (213) 825-1295 or (213) 825-3334.

March 16-18

Software/expo-West, Anaheim Convention Center, Anaheim, CA. This conference and show is devoted to packaged software. Exhibitors will display a wide range of software products. For additional information, contact Software/expo-West, Suite 400, 222 West Adams St., Chicago, IL 60606, (312) 263-3131.

March 16-19

Digital Filters and Spectral Analysis, Boston, MA. Integrated Computer Systems (ICS) is presenting this four-day course for project and design engineers, programmers, and technical managers responsible for implementing

PRINTERS

C. ITOH MODEL 8510



PRINT FEATURES

Characters: 8 sizes. 5 different alphabets. upper/lower case descenders.
Print Mode: 9xN. exceptional quality combined with proportional spacing.
Graphics: 144x144 dots/in. and block graphics.
Print Head: 9 pins, heavy duty designed with air-cooled fans.
Number of Columns: 136 max.
Print Speed: 100 CPS.
Print Direction: Bidirectional logic seeking.
Throughput: From 44 to 52 in./min.
Line Spacing: Variable to 1/144 in.
Print Width: 8 in. max.
Form: Folded/Sheet.
Form Feed: Tractor and friction, bidirectional.
Width: 4.5 in. to 10 in.
Number of Copies: Original plus 3.

PRICE

Parallel Interface \$550.00
 RS232-C Interface 650.00
 Apple II Interface 632.00

EPSON

MX-80 \$449.00
 MX-80F/T 550.00
 MX-100 750.00

INTERFACE

Available for 8510/Epson with Apple/Atari/IBM/Osborne/PET/TRS-80.

SOFTWARE MICROPRO

CP/M Version	List Price	Our Price
WordStar	\$495.00	\$297.00
MailMerge	150.00	90.00
SpellStar	250.00	150.00
DataStar	360.00	210.00
SuperSort I	250.00	150.00
SuperSort II	200.00	120.00
WordMaster	150.00	90.00
CalcStar	295.00	177.00
Apple Version	List Price	Our Price
WordStar	\$375.00	\$225.00
MailMerge	125.00	75.00
SpellStar	200.00	120.00
DataStar	295.00	177.00
SuperSort I	200.00	120.00

SYSTEM PLUS

Accounting Plus — CP/M Version.
 Apple Accounting Plus.

MDT MICRO DATA TEK

A Division of Electronic California, Inc.

2630 California Street

Mountain View, CA 94040

(415) 941-7914

TWX 910-373-8500 "INTERAX PTVV"

APPLE™ EXPANSION BOARDS

PROMETHEUS

- **MEM-1:** Memory expansion module with quality 16K RAM. Fully buffered. Compatible with Micro-soft Softcard™ CP/M™ and all Apple software.

List Price Our Price
 \$169.00 \$110.00

- **VERSAcad™:** Serial/Parallel Interfaces. Quartz Clock/Calendar; BSR Control.

List Price Our Price
 \$249.00 \$199.00

ANTEX DATA SYS

- **ADS PRT-1:** Parallel interface card allows you to interface your Apple computer to any printer that has Centronics compatible interface.

List Price Our Price
 \$120.00 \$60.00

ADVANCE LOGIC SYS

- **SMARTERM™:** 80 column card. Expand your Apple to a full 80 columns with the software commands.

Automatic 80 to 40 and 40 to 80 column switching.

Fully compatible with Apple, Pascal and CP/M software.

Lowest power consumption of all presently available 80 column cards on the market.

9 extra characters included that are not provided on the Apple keyboard: Back Slash, Underline, Accent, Left/Right Brace, Logical OR, Tide, Delete, Bracket, Carrot.

List Price Our Price
 \$360.00 \$288.00

- **Z-CARD:** Z-80 CPU with CP/M software.

List Price Our Price
 \$269.00 \$220.00

VIDEX

- **Videoterm:** 80 column display board. Expand your Apple to a full 80 columns with the software commands.

List Price Our Price
 \$345.00 \$270.00

- **Soft Video Switch.**

List Price Our Price
 \$35.00 \$30.00

ORANGE MICRO

- **Grappler**

List Price Our Price
 \$165.00 \$140.00

PLOTTERS

HOUSTON INSTRUMENT HIPL0T™

	List Price	Our Price
DMP-3	\$1085.00	\$ 922.00
DMP-4	1385.00	1177.00
DMP-5	1485.00	1262.00
DMP-7	1985.00	1687.00
DMP-6	1685.00	1432.00
DMP-8	2185.00	1857.00

PEN EXCHANGE KIT

DMP-442	6 PEN	\$356.00
DMP-593	8 PEN	456.00

Phone orders accepted.

Payment:

- Check enclosed Visa
 Master Charge C.O.D.

California residents, please add 6% sales tax. All unit prices are f.o.b. Mountain View, California.

Event Queue

advanced digital signal-processing systems and for others who must understand them and their potential. Fundamentals of digital signal processing, fast Fourier transform (FFT) algorithms, and special- and general-purpose LSI/VLSI (large-scale and very large-scale integration) devices are among the topics to be addressed. The course fee is \$795; on-site courses can be arranged. Contact Ruth Dordick, c/o ICS, 3304 Pico Blvd., POB 5339, Santa Monica, CA 90405, (800) 421-8166; in California, (800) 352-8251.

March 17

Evaluating Decision Support Software: A Managerial Perspective, Suffolk University School of Management, Boston, MA. This conference is sponsored by the local chapters of six management and computer associations. It will examine the managerial issues involved in choosing decision-support software. The focus will be on end-user characterization, problem diagnosis, needs assessment, and the implications of the evaluation and selection process. Industry experts will speak. Contact DSS Conference, 215 First St., Cambridge, MA 02142, (617) 547-5061.

March 19

The Eleventh Annual International Computer Programs Awards Ceremony and Executives' Conference, Savoy Hotel, London, England. The annual International Computer Programs (ICP) awards ceremony honors super software salespeople, advertising agencies, public relations firms, and achievements in the industry. The executive conference is one and a half days of discussion of the major issues and concerns of the industry. The fee for the executive conference is \$250. For information, contact Carol

Stumpf, c/o ICP, 9000 Keystone Crossing, POB 40946, Indianapolis, IN 46240, (800) 428-6179; in Indiana, (317) 844-7461. In England, contact International Computer Programs Inc., 2 Deanery St., Park Lane, London W1Y 5LH, England, Tel: 01 499 6621.

March 19-21

The Seventh West Coast Computer Faire, Civic Auditorium and Brooks Hall, San Francisco, CA. Attendance this year is expected to reach 35,000. More than 300 exhibitors and a wide assortment of seminars make this one of this largest annual computer shows. For more information, contact The Computer Faire, 333 Swett Rd., Woodside, CA 94062, (415) 851-7075.

March 22-23

Oasis Level Two Training Seminars, Phase One Systems, Oakland, CA. Using a step-by-step approach to developing applications software with the multiuser Oasis operating system, this seminar begins with program design and proceeds to a careful study of the Oasis system. Topics to be covered are the Oasis BASIC interpreter and compiler, program segments, file structures and I/O (input/output), matrices and matrix I/O, multiline branching structures, and subroutine and error handling.

The registration fee for this three-day session is \$350. Some background in BASIC programming is recommended. Contact Phase One Systems, Suite 830, 7700 Edgewater Dr., Oakland, CA 94621, (415) 562-8085.

March 22-25

Interface '82 Conference and Expo, Dallas Convention Center, Dallas, TX. Cosponsored by McGraw-Hill's *Business Week* and *Data Communications* magazines, Inter-

face '82 is aimed at users of data-communication equipment, distributed-data processing, and various networks. For details, contact The Interface Group, 160 Speen St., POB 927, Framingham, MA 01701, (800) 225-4620; in Massachusetts, (617) 879-4502.

March 22-26

Computers/Graphics in the Building Process, Washington, DC. This international conference is sponsored by the Advisory Board on the Built Environment (ABBE) of the National Academy of Sciences and by the World Computer Graphics Association (WCGA). The conference features tutorials, technical paper sessions, and exhibits that reflect the state of the art of computers and computer-graphics technology in the building industry. Sessions on case studies, current achievements, and research and development of computer hardware, software, and database programs will be presented. Conference topics include computer aids to management, computer technology, and computer-aided analysis in design development and construction documents. For further details, contact the WCGA, Suite 250, 2033 M St. NW, Washington, DC 20036, (202) 775-9556.

March 22-26

Tutorial Week East '82, Orlando Marriott Inn, Orlando, FL. Tutorial Week East is sponsored by the Institute of Electrical and Electronics Engineers (IEEE) and will consist of 15 tutorials arranged in three tracks: VLSI (very large-scale integration) microprocessor interfacing techniques and graphics; aspects of software design, analysis, and techniques; and data communications, computer networking, and databases. Fees are \$90 per tutorial, \$400 all

week, for IEEE members, and \$110 per tutorial, \$500 all week, for nonmembers. For information, contact Tutorial Week East '82, POB 639, Silver Spring, MD 20901, (301) 589-3386.

March 23-25

Southcon '82, Sheraton Twin Towers Hotel, Orlando Hyatt Hotel, and Holiday Inn International Drive, Orlando, FL. Among the topics to be presented at Southcon '82 will be artificial intelligence and robotics, office automation, computers and microprocessors, and software. For complete details, contact Robert Myers, c/o Electronic Conventions Inc., Suite 410, 999 North Sepulveda Blvd., El Segundo, CA 90245, (213) 772-2965.

March 26-28

The 1982 Computer Showcase Expo, Atlanta, GA. The Computer Showcase is designed for small-business owners, independent professionals, and corporate managers. Admission is \$7.50. For further details, contact The Interface Group, 160 Speen St., POB 927, Framingham, MA 01701, (800) 225-4620; in Massachusetts, (617) 879-4502.

March 27-28

Amateur Radio and Computer Hobbyists (ARCH) Convention, Chase Park-Plaza Hotel, St. Louis, MO. This convention features exhibitions, workshops, forums, and a flea market. For details, contact Gateway Amateur Radio Association, POB 8432, St. Louis, MO 63132, (314) 361-4965.

March 29-30

Information Utilities '82, Rye Town Hilton Hotel and Conference Center, Rye, NY. The Information Utilities conference will focus on videotex, transactional services, elec-

tronic publishing, online database services, cable advertising, and regulations concerning copyright, censorship, and communications. More than 60 speakers are scheduled. For details, contact Online Inc., 11 Tannery Ln., Weston, CT 06883, (203) 227-8466.

March 29-April 1

INFOCOM '82, Las Vegas, NV. INFOCOM '82 is sponsored by the Institute of Electrical and Electronics Engineers (IEEE) Computer and Communications Societies. The conference theme is "Data Processing—Data Communications: The Illusory Boundary." Focusing on the convergence of computer and communication technology, this conference will attempt to bridge the boundary between the two disciplines. Discussions on programming-language and operating system

design, performance evaluation and analysis of computer-communication networks and protocols, standards, and the design of distributed computing and database management systems will be held. Exhibits and tutorials are planned. Write to INFOCOM '82, POB 639, Silver Spring, MD 20901, (301) 589-3386.

March 30-April 2

Digital Image Processing and Analysis, Washington, DC. For details, see March 9-12.

April 1982

April

Courses from George Washington University, Hampton, VA; Salem, NH; Washington, DC; London, England; and Berlin, West Germany.

In Less Than 3 Minutes

Your IBM Model 50, 60, or 75
Electronic Typewriter
can be an RS232C PRINTER or TERMINAL



CALIFORNIA MICRO COMPUTER Models 5060 and 5061 can be installed easily and require NO modifications to the typewriter.

For additional information contact:

CALIFORNIA MICRO COMPUTER
9323 Warbler Ave., Fountain Valley, CA.
92708 (714) 968-0890

Among the courses scheduled are "Voice Input/Output," "Microwave Systems Planning," "Writing Professional and Technical Communications," and "Computer Graphics Systems: Design and Applications." For further information, contact Continuing Engineering Education, School of Engineering and Applied Science, George Washington University, Washington, DC 20052, (800) 424-9773; in the District of Columbia, (202) 676-6106.

April

Courses in Structured Systems, various sites throughout the U.S. "Structured Systems Design," "Structured Requirements Definition," and "Management Overview of Data Structured Systems Development" are being offered by Ken Orr and Associates. For information on meeting times, places, and fees, contact Ken Orr and Associates Inc., 715 East 8th, Topeka, KS 66607, (800) 255-2459; in Kansas, (913) 233-2349.

April

Knowledge Engineering in the 1980s, Boston, MA. Expert Systems are computer programs that reason in tasks that require considerable human expertise, such as locating computer malfunctions, monitoring intensive-care patients, analyzing noisy signal data, and diagnosing medical problems. This one-day executive briefing provides an introduction to the potential benefits and costs of Expert Systems. For further information, contact Dina Barr, c/o Teknowledge, 151 University Ave., Palo Alto, CA 94301, (415) 326-6827.

April 1-2

The Eleventh Annual International Computer Programs Awards Ceremony and Executive Conference, Marriott

Mountain Shadows Resort, Scottsdale, AZ. The annual awards ceremony honors super software salespeople, advertising agencies, public relations firms, and microcomputer software achievements. The executive conference discusses the main issues and concerns of the industry, such as productivity through proper use of people and machines, new software-piracy solutions, and how to get the most out of advertising dollars. The fee for the executive conference is \$250. For detailed information, contact Carol Stumpf, c/o ICP, 9000 Keystone Crossing, POB 40946, Indianapolis, IN 46240, (800) 428-6179; in Indiana, (317) 844-7461.

April 2-3

Educational Computing—The Future Is Now, Anchorage, AK. The Educational Computing Conference is sponsored by the Alaska Association for Computers in Education. Invited speakers, exhibits, and demonstrations of microcomputer products for educational purposes will be featured. Admission to the exhibition area is free of charge. For further details, contact Pat Stowers, '82 Educational Computing, Drawer 129, Healy, AK 99743, (907) 683-2278.

April 2-4

The Second Annual Eighty/Apple Computer Show, New York Statler Hotel, New York, NY. The Eighty/Apple Computer Show features products and services for TRS-80 and Apple computer systems. More than 100 exhibitors of hardware, software, books, magazines, supplies, services, and accessories will attend. For more information, contact Kengore Corp., 3001 Rte. 27, Franklin Park, NJ 08823, (201) 297-2526.

April 4-7

The Seventh Annual Deltak International Training Conference, Access 82, Hyatt Regency, Chicago, IL. More than 1000 training and electronic data-processing professionals are expected to attend 35 workshop sessions. Former president Gerald R. Ford will deliver the keynote address. The registration fee is \$525. Information is available from Gail Bohan, c/o Deltak Inc., 1220 Kensington Rd., Oak Brook, IL 60521, (312) 920-0700.

April 5-7

The Third Annual Office Automation Conference, George R. Moscone Convention Center, San Francisco, CA. This conference is sponsored by AFIPS (American Federation of Information Processing Societies). Exhibits and workshops will be featured. For details, contact Betty Lou Cooke, c/o AFIPS, 1815 North Lynn St., Arlington, VA 22209, (703) 558-3612.

April 6-8

The Sixth Annual Computerized Office Management Expo-Midwest '82, O'Hare Expo Center, Chicago, IL. This conference and exhibition features business-oriented equipment for word and data processing, information management, record storage and retrieval, and micrographics. A three-day high-technology symposium, "Business Automation and Communications" will highlight Midwest '82. For details, contact Cahners Exposition Group, 222 West Adams St., Chicago, IL 60606, (312) 263-4866.

April 13-16

Digital Image Processing and Analysis, Boston, MA. For details, see March 9-12.

April 14-18

Electronic Home Entertainment Show, Arlington Park Race Track Exposition Hall, Arlington Heights, IL. This show will feature audio and video equipment, video games, home computers, and citizen-band radio systems. It will run concurrently with the Fourth Annual Energy & Home Improvement Faire. Contact Expo Management Inc., Suite S2-132 Arcade, The Apparel Center, Chicago, IL 60654, (312) 329-1191.

April 15-17

The 1982 Computer Showcase Expo, St. Louis, MO. For details, see March 26-28.

April 15-18

The Second Southwest Computer Show and Office Equipment Exposition, Market Hall, Dallas Market Center, Dallas, TX. This features mini- and microcomputers for business, education, government, industry, home, and personal use. Data- and word-processing equipment, office machines, computer peripherals, and office supplies will be displayed. General admission is \$5. Contact National Computer Shows, 824 Boylston St., Chestnut Hill, MA 02167, (617) 739-2000.

April 16-17

The Twelfth Annual Virginia Computer Users Conference, Marriott Hotel, Blacksburg, VA. This conference is sponsored in cooperation with the ACM (Association for Computing Machinery). Topics of interest are artificial intelligence, office automation, and database management. Contact Deidre Maskaleris or Wesley Braudaway, 562 McBryde Hall, Virginia Polytechnic Institute & State University, Blacksburg, VA 24061, (703) 961-6931.

April 19-21

Open Systems Interconnec-

tion with X.25 and Other Related Protocols, Denver Marriott Hotel-City Center, Denver, CO. Sponsored by *DataCommunications*, a McGraw-Hill publication, this seminar will present a thorough treatment of the basic OSI (Ohio Scientific) Reference Model, describing the seven-layer structure, service definitions, and emerging protocols. Detailed presentations of the X.25 packet protocol will be included. The seminar fee is \$690. For further details, contact the McGraw-Hill Conference & Exposition Center, Rm. 3677, 1221 Avenue of the Americas, New York, NY 10020, (212) 997-4930.

April 20-22

D-COM, Hynes Auditorium, Boston, MA. D-COM will bring DEC (Digital Equipment

Corporation) vendors together with DEC users. For information, contact Ron Davies, D-COM Inc., 7312 Burdette Court, Bethesda, MD 20817, (301) 469-7650.

April 20-23

VIO—Voice Input/Output for Computers, Boston, MA. For details, see March 9-12.

April 21-28

Hanover Fair '82, Hanover, West Germany. The annual Hanover Fair is one of the world's largest industrial and trade exhibitions. More than 330 American firms are expected to exhibit products, services, and technology at the Fair. Contact M.A. Delia, Hanover Fairs Information Center, POB 338, Whitehouse, NJ 08888, (800)

526-5978; in New Jersey, (201) 534-9044.

April 22

California Computer Show, Hyatt Hotel, Palo Alto, CA. This show is for OEMs (original equipment manufacturers), knowledgeable users, distributors, and dealers. More than 60 computer manufacturers will be exhibiting mainframes, mini- and microcomputers, and peripherals. Contact Carol Reimer, c/o Norm De Nardi Enterprises, 289 South San Antonio Rd. #204, Los Altos, CA 94022, (415) 941-8440.

April 22-25

New York Computer Show and Office Equipment Exposition, Nassau Coliseum, Uniondale, NY. For details, see April 15-18.

April 23-25

The 1982 Computer Showcase Expo, Miami, FL. For details, see March 26-28.

April 24

Computer Swap America, Santa Clara County Fair Grounds, San Jose, CA. This high-technology flea market features everything from home satellite-receiving stations to floppy disks. Admission is \$3. Contact Computer Swap America, POB 52, Palo Alto, CA 94302, (415) 494-6862.

April 27-28

The Eighth Annual National Computer Security and Privacy Symposium: Top Secret '82, Washington, DC. Sponsored by Honeywell, approximately 22 national authorities on computer security and

APPLE AND S-100

PRINTERS — IN STOCK

MX-80	\$ 470.00	MX-80 FT	\$ 590.00
MX-100	750.00	NEC 8023A	595.00

DISK DRIVES — 5 1/4"

Add on for Apple	\$ 370.00
Apple Disk w/ Controller	485.00
MPI-B51 — Sgl/ Dbl	250.00
Tandem — Sgl/ Dbl	230.00
SA400 — Sgl/ Dbl	250.00

DISK DRIVES — 8"

Shugart 801R — Sgl/ Dbl	\$ 390.00
Qume DT-8 — Dbl/ Dbl	500.00

DISK PACKAGES

2-801R Cabinet Power Supply	\$1100.00
2-DT-8 Cabinet Power Supply	1300.00
Cabinet Power Supply	300.00

All Assembled and Tested

TERMINALS

910 Televideo	\$ 599.00	920 Televideo	\$ 740.00
950 Televideo	919.00	Adds Viewpoint	599.00

SINGLE CABINETS

Pwr Sply 8"	\$ 200.00	Pwr Sply 5 1/4"	\$ 90.00
-------------------	-----------	-----------------------	----------

QT SYSTEMS + 8" FLOPPIES

SYS + SS(6)	\$3415	SYS + DS(6)	\$4270
-------------------	--------	-------------------	--------

QT MINI-SYSTEMS — 5 1/4" FLOPPIES

SYS + SS(6)	\$2745	SYS + DS(6)	\$3045
-------------------	--------	-------------------	--------

We carry much, much more, call

Computer
Components
Unlimited

P.O. Box 1936 / Hawthorne, CA 90250

ORDER DESK CALL
(213) 644-3311

Send Mail Order—VISA/ MC,
Check, Wire Transfer

BYTE

Back Issues For Sale

The following issues are available:

\$2.00 ea.	\$2.75 ea.	\$2.75 ea.	\$3.25 ea.
July 76	May 78	Oct. 79	Feb. 81
Apr. 77	June 78	\$3.25 ea.	Mar. 81
May 77	July 78	Nov. 79	Apr. 81
June 77	Aug. 78	Dec. 79	May 81
July 77	Sept. 78	Jan. 80	July 81
Aug. 77	Oct. 78	Mar. 80	Aug. 81
\$2.75 ea.	Dec. 78	Apr. 80	Oct. 81
Sept. 77	Jan. 79	May 80	Nov. 81
Nov. 77	May 79	June 80	Dec. 81
Dec. 77	June 79	July 80	
Feb. 78	July 79	Aug. 80	
Mar. 78	Aug. 79	Oct. 80	
Apr. 78	Sept. 79	Dec. 80	

The above prices include postage in the US. Please add \$.50 per copy for Canada and Mexico; and \$2.00 per copy to foreign countries (surface delivery).

Send requests with payment to:

BYTE Magazine
70 Main St, Peterborough NH 03458
Attn: Back Issues

* Payments from foreign countries must be made in US funds payable at a US bank.
* Please allow 4 weeks for domestic delivery and 8 weeks for foreign delivery.

Event Queue

privacy will speak on a variety of topics. Training workshops in security planning and risk analysis, disaster recovery and contingency planning, and computer fraud investigation will be held. The fee for the symposium is \$525; discounts on multiple registrations are available. Contact the Security Symposium Registrar, Honeywell Inc., M/S T-99-4, POB 6000, Phoenix, AZ 85005; or call Jerome Lobel, (602) 249-5370.

May 1982

May-June

Sensors & Systems '82, various sites throughout the central and western regions of the U.S. This series of three-day conferences will cover all aspects of sensor technology from temperature sensors through to displacement, velocity, acceleration, magnetic field, and moisture. Other topics to be covered include signal conditioning, digital interfaces, and system interfaces. Contact Network Exhibitions, 785 Harriet Ave., Campbell, CA 95008, (408) 370-1661.

May 6-9

The Southern California Computer Show & Office Equipment Exposition, Los Angeles Convention Center, Los Angeles, CA. This show features mini- and microcomputers for business, education, government, industry, home, and personal use. Word- and data-processing equipment, office machines, and computer peripherals will be displayed. Admission is \$5. For details, contact National Computer Shows, 824 Boylston St., Chestnut Hill, MA 02167, (617) 739-2000.

May 7-9

The 1982 Computer Showcase Expo, Anaheim, CA. For details, see March 26-28.

May 10-12

Dexpo 82, Marriott Hotel, Atlanta, GA. This exposition features DEC- (Digital Equipment Corporation) compatible hardware, software, and services. Contact Expoconsul International Inc., 19 Yeger Rd., Cranbury, NJ 08512, (609) 799-1661.

May 10-14

The Twentieth Annual Convention of the Association for Educational Data Systems (AEDS), Sheraton Twin Towers, Orlando, FL. This convention includes presentations on the state of the art in educational computing. Administrative and instructional computing applications will be presented, and new ways of improving educational processes will be explored. Contact Shirley Easterwood, c/o AEDS, 1201 Sixteenth St. NW, Washington, DC 20036.

May 14-15

The Second Annual Southern California Computers-in-Education Conference, University High School, Irvine, CA. This conference covers the application of computers in education from kindergarten through two-year college. All areas of curriculum will be touched upon, including reading, language, mathematics, science, and special education. Hands-on workshops and field trips are planned. Contact Craig Walker, Arrowview Intermediate School, 2299 North G St., San Bernardino, CA 92405, (714) 886-9118.

May 14-16

Applefest/Boston, Hynes Auditorium, Boston, MA. This show will feature more than 200 displays and booths of Apple-compatible products and accessories. Seminars and panel discussions will be held. Ticket prices are \$6 per day or \$15 for a three-day pass. Contact National Computer Shows, 824 Boylston St., Chestnut Hill, MA 02167, (617) 739-2000.

May 15-16

The North American Computer Othello Championship, Learning Resources Center, Andersen Hall, Northwestern University, Evanston, IL. This two-day tournament is sponsored by the United States Othello Association. Champions will be determined in three categories: microcomputer systems (located on site), mainframe systems (telephone hookup), and special-purpose Othello machines. For complete tournament details, write to Professor Peter W. Frey, Dept. of Psychology, Northwestern University, Evanston, IL 60201.

May 18-20

Microcomputers—A New Tool for Foresters, Purdue University, West Lafayette, IN. Sponsored by Purdue University's Department of Forestry and Natural Resources and by the Inventory and Systems Analysis Working Groups of the Society of American Foresters, this conference seeks to advance the professional forester's knowl-

edge of microcomputers and to introduce currently available microcomputer applications in forestry. Session themes include hardware and software considerations as well as information-processing and forest-inventory systems. Contact John W. Moser Jr., Dept. of Forestry and Natural Resources, Purdue University, West Lafayette, IN 47907, (317) 494-3596.

May 19-21

Computer Hong Kong 82, Regent Hotel, Hong Kong. This three-day program, which embraces the Fifth Hong Kong Computer Conference, will focus on the electronic data-processing market. For further details, contact Kallman Associates, 5 Maple Court, Ridgewood, NJ 07450, (201) 652-7070.

May 21-23

The 1982 Computer Showcase Expo, Boston, MA. For details, see March 26-28. ■

BYTE's Bits

Computer Camps

The 1982 National Computer Camp for boys and girls ages 10 to 18 will be held July 11 to August 6 in Simsbury, Connecticut, and Atlanta, Georgia. The kids will learn on mini- and microcomputers in small groups with ample hands-on time. The camp director, Professor Michael Zabinski of Fairfield University, is assisted by elementary and secondary school teachers. For more information, contact Michael Zabinski, POB 624, Orange, CT 06477, (203) 795-3049. ■

In order to gain optimal coverage of your organization's computer conferences, seminars, workshops, courses, etc, notice should reach our office at least four months in advance of the date of the event. Entries should be sent to: Event Queue, BYTE Publications, POB 372, Hancock, NH 03449. Each month we publish the current contents of the queue for the month of the cover date and the two following calendar months. Thus a given event may appear as many as three times in this section if it is sent to us far enough in advance.

The Computer Toolbox

Mark Bernstein
 Department of Chemistry
 Harvard University
 12 Oxford St.
 Cambridge, MA 02138

Scientists everywhere are learning to detest small computers. They hate the things with a special passion reserved for anything that interferes with their research. Although researchers were among the first to embrace the promise of small, inexpensive computers, many now avoid using microcomputers in their labs.

It oughtn't to be so. Scientists *need* computers to monitor, coordinate, and control their experiments. Communicating rapidly and reliably with many different instruments, a computer can read and record data while responding swiftly to any problems that develop. The computer cannot grow bored or tired, nor will it object to uncomfortable or dangerous working conditions.

Above all, experimenters need the flexibility and adaptability that computers promise. Labs are exciting, disorganized, chaotic places. Cables run everywhere to connect instruments piled on tables and stacked on the floor. New equipment and new procedures are commonplace; ideas and plans are in continual flux. Even when everything works perfectly, the results of a few hours' work may call for a complete redesign of the entire experiment.

The modern microcomputer is easy and inexpensive to reprogram, so it *ought* to be a superbly flexible lab assistant. But it is this promise that small computers have betrayed. Microcomputers, expected to help scientists manage the constantly changing laboratory environment, implacably oppose every change and trivial modification.

Each change in the experiment calls for new software. Each new instrument needs new software. Every modification of hardware or tech-

nique demands new software. The computer's constant hunger for new and revised programs may be so daunting that promising experiments aren't even attempted. Laboratory computers have to be intimately involved with many aspects of the experiment, but this intimacy demands that they change and adapt constantly. Unfortunately, common programming techniques often produce programs that are obscure to read and tedious to modify.

The Computer Toolbox

Rather than design an inflexible computer for a specific job, our research group has tried to build a general-purpose laboratory assistant

that can be carried, like a toolbox, from one experiment to another. It is an integrated, consistent package of hardware and software tools for the experimenter, who should be able to patch together a working system in a few days.

Just as a regular toolbox includes many wrenches and screwdrivers of various sizes, the computer toolbox contains many different "inlets" and "outlets" for information and a collection of interfaces of various sorts. Few experiments use every part in the toolbox; we tried to provide enough interfaces of each type for any experiment we expect to do.

The toolbox includes not only many types of interfaces but also

Device Type	Useful For	Relative Cost	Suggested Quantity and Comments
parallel input port	reading digital devices	inexpensive	many
parallel output port	controlling digital devices	inexpensive	many
keyboard	input from people	moderate	1
video display	output to people	expensive	use extra displays for graphics
serial interface	interface printers, computers	moderate	1-5
printer	permanent records	expensive	1
plotter	permanent records	expensive	1
telephone interface	report emergencies	moderate	1 if experiment must run unattended
analog-to-digital converter	analog input	inexpensive	some
digital-to-analog converter	analog output	moderate	some
sound generator	alarms and warnings	inexpensive	many distinct noises can be invaluable if required
digitizing tablet	input from charts and graphs	expensive	
joystick	input from people	inexpensive	sometimes convenient
stepping motor	moving things	inexpensive	very useful
AC controller	power control	moderate	several
arithmetic processor	arithmetic	expensive	for demanding calculations

Table 1: Widely useful equipment for computer toolboxes.

many interfaces of each different type (see table 1). Redundant facilities add little to the cost or complexity of the toolbox and greatly enhance its usefulness. Because several interfaces of each type are available, adding new apparatus to an experiment is easy. Scientists will not be forced to choose between one instrument and another, because they are free to connect lots of instruments at once.

If an interface circuit is accidentally damaged, redundant interfaces allow work to continue. The computer need not be repaired immediately, and the damaged interface can be fixed at the scientist's convenience. Redundancy makes the system robust, despite the hazards of the laboratory environment.

Software Design in the Lab

Most laboratory programs live only a few weeks or months. Indeed, many programs are modified so often that they are really never "finished." To make matters worse, laboratory software is written by scientists, i.e., by ingenious, amateur, and relatively unschooled programmers. The lab computer must emphatically encourage clean, comprehensible, modifiable programming.

Lab programmers face a diverse and confusing array of complicated devices, each posing distinct programming problems. Although the procedures for each instrument may be simple, the entire repertoire of communications methods for a complete experimental setup can easily baffle and dismay the programmer. Programs degenerate to an ill-structured network of procedure calls, timing loops, and code conversions, as a profusion of detail overwhelms the program's overall design.

Debugging these tangled, baroque routines is terribly frustrating. The toolbox restores clarity and explicitness to program structure by treating all devices on an equal footing. Toolbox programs never talk directly with any outside instrument. Instead, they communicate with small programs called *device drivers* that, in turn, communicate with the experiment's instruments and sensors.

Device drivers make programs

STRIKE A PERFECT MATCH...



Wed a Data General Eclipse to the ALPS Word Processing System

Marry ALPS word processing software with Data General terminals for a complete text entry, editing, formatting and text output system.

The wedding costs about \$4,000.

You get all standard word processing features with:

- Fast response.
- "Short Stroke" dictionary facility that provides user defined shorthand and spelling corrections.
- Ease of use for minimal training.
- Search and replace feature yields quick replacement of selected characters or strings.

Plus these options:

- Foreign language capability for rapid translation and word processing in any Romanized alphabet.
- Dictionary look-up of words and phrases to improve translation production.

For complete information on any ALPS system, contact ALPS, 750 North 200 West, Suite 104, Provo, Utah 84601. Telephone 801/375-0090.

alps
AUTOMATED LANGUAGE
PROCESSING SYSTEMS

MULTIPROGRAMMER SYSTEM-10

KITS AVAILABLE

PROGRAMS OVER 100 POPULAR PROMS & EPROMS



Standard Features:

- RS232 Serial Port - Standard Formats
 - 5K Bytes RAM (Expandable)
 - Device Read, Compare & Verify
 - Editing & Special Functions
 - Less Than \$1,000 for Programmer
 - Less Than \$400 for Module and Adapter
 - Attractive OEM Prices
- REP AREAS AVAILABLE

BYTEK

COMPUTER SYSTEMS CORPORATION

100 E. Linton Blvd
Delray Beach, Fla 33444

Phone (305) 272-2051

**Lowest HP prices
anywhere! if not,
WE'LL BEAT 'EM**

**hp HEWLETT
PACKARD**
HP-85...
\$1989



New HP-125 \$2195
CP/M* based... *Limited time only

HP-85 Accessories

- 5 1/4 Dual Master Disk Drive List, \$2500... \$1895
- 8 Dual Master Disk Drive..... \$5459
- WINCHESTER HARD DISKS**
- 5 1/4 WIN. 5mg. Hard Disk List \$4500..... \$3599
- 5 1/4 WIN. w/5 1/4 DSDD floppy. List \$5500. \$4399
- 7225 One Pen Plotter..... \$1979
- 16K Ram Mem. Mod. \$159
- ROM Drawer..... \$35
- HP Standard Applic. Pacs List, \$95..... \$95
- Serial (RS232C) Interface Mod. List, \$395... \$353
- GPIO Interface Module List, \$495..... \$445

**HP-41CV with five times more
memory built in.**

NEW! List \$325 **\$249** HP-41C List \$250 **\$189**

- HP-41CV Printer..... \$289.00
- HP-41CV Quad Mem. \$83.95
- HP-41CV CardReader..... \$167.95
- HP82160A HP-IL Mod. List \$125..... \$99.00
- HP82161A Dig. Cass. Dr. List \$550..... \$449.00
- HP11C List \$135..... \$107.95
- HP12C List \$150..... \$119.95
- HP33C..... \$74.95
- HP34C..... \$117.95

ATARI® 800 \$689
*Limited time only



ATARI

ATARI 400 \$349

- Atari 830 Acoustic Modem..... \$145
- Atari 825 80 Col. Impt. Ptr. \$565
- Atari 16K Ram Mem. Mod. \$69
- Atari 410 Prog. Recorder..... \$69
- Atari 810 Disk Drive..... \$419

**Personal
PC computer
Systems**
P.O. Box 1073
Syracuse, N.Y. 13201

(315) 475-6800

(800) 448-5259 For Placing Orders Only

Prices do not include shipping by UPS. All prices and offers are subject to change without notice

easier to understand and modify. Programmers can concentrate on the experiment without undue distraction from the computer's idiosyncrasies. Device drivers clarify program structure, since irrelevant details need not be represented explicitly. Programs are easier to understand, use, and revise. Documentation is easier to write, and its completeness is less crucial.

Communications between the programmer and the various device drivers are simple and standardized; all device drivers "look" pretty much the same. The device driver, in turn, understands and accommodates the special requirements of each device or instrument. Device drivers shield and protect the toolbox programmer from his confusing and ill-behaved array of instruments (see figures 1 and 2).

For example, different printers may require different character codes, signal levels, and control signals. None-

theless, all printers are logically equivalent—they all accept characters from a computer and print them on paper. A toolbox program that uses a printer need not consider the details of the printer's interface or timing. Whenever a number must be printed, the program invokes the device driver { PRINT! }. If I replace the printer with a different model, I just revise { PRINT! }. All my programs will still work. If, on the other hand, every program communicated directly with the printer, I would have to modify every program. Indeed, I might need to modify every printer command in every program!

Device drivers help adapt the computer to the changing needs of its peripherals. To plot results on a chart recorder instead of printing them, for example, we need to make only slight changes. Chart recorders are logically equivalent to printers; they just accept numbers from the computer and

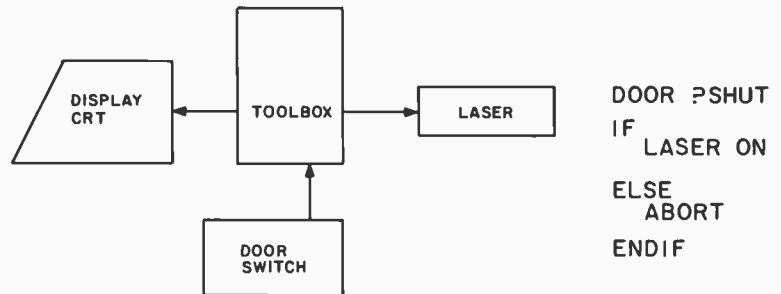

Figure 1: Many scientists defeat the safety interlocks on their equipment because they simply get in the way too often. Simple additions to toolbox programs can help restore protection. Here, a few words prevent the laser from firing if the door is open.

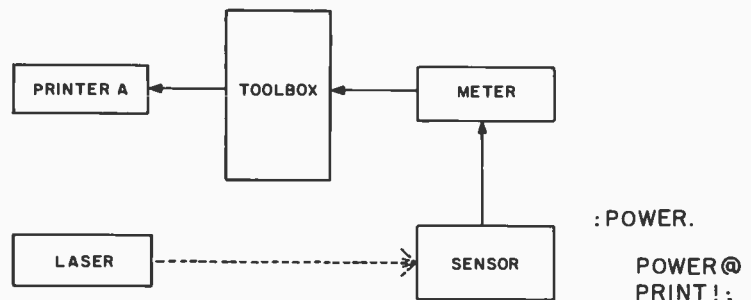

Figure 2: This short program reads the laser's power and prints it. If I buy a new printer, I simply redefine { PRINT! } to work with the new machine. The old program still works with the new printer.

put them onto paper. So, to use the chart recorder we simply replace { PRINT } with { PLOT } and, instead of printing a list of numbers, the computer will draw a graph of the experiment's results.

Device drivers can exchange data with instruments, other toolboxes, even with other computers. In fact, the (still hypothetical) device driver { TELEPHONE! } could connect an experiment to thousands of printers and computers throughout the world.

Programmers don't need to know all the details of every device's design and operation. Of course, the author of the device driver must understand these details, but, since device drivers are all used in pretty much the same way, anyone else can use the device driver.

Tables 2 and 3 describe several device drivers. Drivers that send a single number or character to an instrument have names that end in an exclamation point (!), like { PRINT! }. Drivers that receive a single number or character have names followed by an at sign (@). Device drivers that receive data from an instrument and display it immediately have names ending in a question mark (?), while device drivers that test an instrument's status, and that abort if an error has been detected, have names that begin with a question mark.

In fact, knowing the name of the device driver is often all that a programmer needs to know to use an instrument.

The FORTH Language

Many computer languages might be suitable for use in the toolbox. The language chosen must be implemented efficiently, especially because small computers tend to be slow and their memory space is often restricted. Invocation, the ability to execute a subprogram by naming it, is required for implementing the device drivers. Other features are convenient, but efficiency and invocation are not expendable.

These considerations exclude the two methods most commonly used to program small computers. BASIC does not support invocation, except

ATTENTION GOVERNMENT D P USERS AND PURCHASERS

We represent many fine micro products and manufacturers on the U.S. Government's GSA Schedule, including

**Apple, Cromemco, Micropolis, NorthStar,
Osborne and Seequa Computers**

Purchasing from the Schedule will save you the time consumed by the bid process. Products shipped throughout the United States and world-wide. Visit or write any of our stores for more information or to receive our catalogue of products represented.

**Computers,
Etc.....
the dependable store**

257 West Street, Annapolis, MD 21401 - (301) 268-6505
13A Allegheny Avenue, Towson, MD 21204 - (301) 296-0520
9330 Georgia Avenue, Silver Spring, MD 20910 - (301) 588-3748
6671 Backlick Road, Springfield, VA 22150 - (703) 644-5500
Plaza 38, 2442 Route 38, Cherry Hill, NJ 08002 - (609) 779-0023
Callers outside metropolitan areas served by our stores
Please call (301) 268-5801

*Career Opportunities Available * An Equal Opportunity Employer*

FREE Moore Sample-Pac™ when you request your Moore Computer Supplies Catalog

The Moore Computer Supplies Catalog features a large selection of leading brand name items at low prices, fast delivery from regional warehouses, and the only toll-free technical assistance line in the industry. Plus much, much more.



Just call us toll-free, or mail the coupon below, and we'll send you a FREE copy of our new catalog. And, as an added bonus, we'll send along a complimentary Moore Sample-Pac—filled with samples of some of our most popular products.

For your free Moore Computer Supplies Catalog and free Moore Sample-Pac, call toll free, **800-323-6230*** Ext. 119, or complete and mail the coupon below.

*In Illinois, call 312-459-0210, Ext. 119
In Alaska and Hawaii, 800-323-4185, Ext. 119



Catalog Group
**MOORE
BUSINESS
CENTER**
A Division of Moore Business Forms
Moore Computer Supplies Catalog
Department 119
P.O. Box 20
Wheeling, Illinois 60090

Name _____ Title _____

Company _____

Address _____

City _____ State _____ Zip _____

Mail this coupon today!

1981 MICRO-TAX

Microcomputer Taxsystems, Inc.

**Are you looking for the best
tax package in the USA? Call
MICRO-TAX
For the 1981 Tax System**

INDIVIDUAL PACKAGES

- Level 1:** 23 Schedules and Forms
: Multiple Clients
\$250 : Prints IRS Approved Forms
- Level 2:** 30 Schedules and Forms
: Multiple Clients
: Prints IRS Approved Forms
\$1,000: Prints on IRS Forms or Overlays
: Depreciation System
: State Tax Interface
: Integrated Data Base
: Batch Compute and Print

PARTNERSHIP PACKAGE

- Level 3:** 20 Partnership Schedules and Forms
\$750 : Multiple Clients
: Prints IRS Approved Forms
: Prints on IRS Forms or Overlays
: Depreciation System
: Integrated Data Base
: Batch Compute and Print

Levels 2 and 3 are discounted to a total of \$1,500 if purchased at the same time.

Updates: Annual Updates are available.

Demonstration Package: Demonstration Packages are available for \$50.

State Systems: Information on Individual State Tax Systems is available upon request.

Transparent Overlays: Transparent Overlay sets are available.

All levels operate under most CP/M* formats including Apple*. Compiled Microsoft Basic.

**Consider the advantages this
State-of-the-Art package
can bring you:**

- Complete System
- Versatility
- Complete In-Office Security
- Time Saving
- Pre Year-end Tax Planning

MICRO-TAX

Microcomputer Taxsystems, Inc.

22713 Ventura Blvd., Suite F
Woodland Hills, CA 91364
(213) 704-7800

Available at most
Professional Computer
Retailers



*CP/M is a TM of Digital Research.
*Apple is a TM of Apple Computer, Inc.

in a most primitive and unsatisfactory manner. Common BASIC interpreters, moreover, are too slow for many laboratory situations. Assembly language does not intrinsically support invocation either, although macroassemblers (which support in-

ocation quite satisfactorily) are now available for many machines. Unfortunately, extensive use of macro-instructions only exacerbates the propensity of assembly language to produce very long programs. Few microcomputer assemblers can com-

Device Type	Quantity	Total Channels
parallel port	6	96 data bits 12 control signals
serial port	1	1 (300 bps)
AC power control	4	4 100-W channels
ADC	1	2 bipolar inputs 2 voltage inputs 4 resistor inputs 8 unbuffered inputs
DAC	2	2
IEEE-488 control bus	1	15
sound generator	1	1
graphics display	1	1
scratchpad memory	1	128 bytes
plotter	1	1 (uses DACs)
motor controller	1	1

Table 2: The hardware complement of the author's computer toolbox.

	Driver	Device	Purpose
Data-Transmitting Drivers	!	memory	stores number in specified location in memory
	PRINT!	printer	sends number to printer
	EMIT!	printer	sends character to printer
	DAC!	DAC	sends number to digital-to-analog converter
	VID!	TV camera	sends instruction to camera
	PLOT!	plotter	moves pen to specified coordinate
Data-Receiving Drivers	@	memory	retrieves number from specified location in memory
	THUMB@	thumbwheel	retrieves current thumbwheel setting
	VID@	memory	retrieves current TV camera programming instructions
	ADC@	ADC	requests measurement from analog-to-digital converter
	POINT@	digitizer	requests one coordinate-pair from the digitizer
IEEE-488 Bus Device Drivers	TALK	IEEE bus	transmits "talk" to an instrument
	UNTALK	IEEE bus	transmits "untalk"
	LISTEN	IEEE bus	transmits "listen" to an instrument
	UNLISTEN	IEEE bus	transmits "unlisten"
	IEEE@	IEEE bus	receives data byte from bus
	IEEE!	IEEE bus	transmits data byte over bus
Special Device Drivers	R/W	disk	reads and writes disk files
	CMOVE	memory	moves blocks of data in memory
	EDIT	disk/screen	creates and modifies disk files
	HOME	screen	returns cursor to top of screen
	FORWARD	motor	advances stepping motor
	ON	AC control	supplies power to outlet
	OFF	AC control	disconnects outlet
	TIME!	clock	sets the clock
	TIME@	clock	reads the clock

Table 3: Some typical device drivers, based on the author's system.

fortably develop programs comprising over a thousand instructions, but experiment controllers often exceed this size.

Several higher-level languages are suitable for programming the toolbox. APL's extraordinary facility for array and matrix calculation easily outweighs its handicaps. Pascal, C, or Ada might also be attractive. Even FORTRAN would be adequate, especially since many scientists already know FORTRAN; this consideration also applies to ALGOL-60 and its descendants.

Unfortunately, currently available microcomputers are rather slow, and thus they demand exceptional efficiency from the toolbox language. Compilers and interpreters for common languages do not now produce sufficiently fast programs and cannot be used. This situation will change as the power and speed of microcomputers improve.

We have used the FORTH language in our toolbox, with very satisfactory results. FORTH has been described in several articles in the August 1980 BYTE, in Ronald Loeliger's *Threaded Interpretive Languages* (BYTE Books, 1981), and in FORTH Inc.'s *Using FORTH*. More advanced but invaluable information is available from FIG (the FORTH Interest Group), which publishes assembly-language implementations of FORTH for many common microprocessors.

The FIG implementation of FORTH is extremely efficient in both space and speed. Although some common programming tasks are difficult to express clearly in FORTH, the language adapts unusually well to laboratory programming. In fact, FORTH was originally designed for just this application. FORTH interpreters are uniquely simple to test and to modify. Several writers report successful implementations of significant subsets of FORTH in only a few weeks. While FORTH is now commercially available for many computers, its easy implementation makes it a practical choice even if a commercial version is not available.

FORTH procedures communicate with each other by using a first-in, last-out stack (see figure 4). Toolbox

routines use the *stack* to exchange information. For example, the routine ADC@ measures the input to the analog-to-digital converter, leaving the result on the stack. DAC! sends the number on top of the stack to the digital-to-analog converter, which produces a corresponding voltage.

ADC@ can talk to DAC! by using the stack; the program

```
ADC@ DAC!
```

reads a voltage at the analog input and transmits it to the analog output. Other programs transform data on the stack, accepting information from one routine, transforming it, and leaving the results for another routine. LOG, for instance, takes a number off the stack, calculates its logarithm, and leaves the result on the stack. The sequence

```
ADC@ LOG DAC!
```

sets the output voltage to the logarithm of the input signal.

In FORTH, numbers are simply procedures that put their value onto the stack. "273" is the name of a procedure that leaves the value 273 on top of the stack. FORTH can work in any common base; the procedure HEX instructs FORTH to treat numbers as hexadecimal quantities, DECIMAL tells FORTH to use base ten, and BINARY makes FORTH use base two.

Building Toolbox Commands

A scientist controls an experiment by typing commands into the toolbox. Consider, for example, the simple problem of turning equipment on and off during the course of an experiment.

In Harvard's picosecond laser facility, toolbox hardware includes four 117-V AC outlets controlled by the computer. An experimenter might plug an oscilloscope into socket number 1, a meter into outlet 2, a signal generator into outlet 3, and a laser into outlet 4. At various times during the experiment, the computer must supply and remove power to these devices.

The device drivers for the AC

power controller are named ON and OFF. ON and OFF connect and disconnect power to a specified outlet; the command

```
1 ON
```

supplies power to socket number one.

For flexibility and convenience, we might define a new command called SCOPE:

```
: SCOPE 1 ;
```

Whenever SCOPE is invoked, it leaves the value 1 (the scope's socket number) on the stack, so the command

A Note About FORTH

FORTH uses punctuation in some of its words, which makes representing them in text a difficult problem. For example, one FORTH word is ("), which could be taken to mean one of several character combinations. (For your information, the word has three characters and is made from a left parenthesis followed by a double quote mark and a right parenthesis.)

To decrease the chance of confusion while trying not to clutter text unnecessarily, we have used pairs of braces, { }, to isolate the character string within as a FORTH word or phrase. For example, the above word would be written { (") }. Braces have been used only in the following situations:

- when the material being quoted is a phrase of FORTH words (e.g., { 26 LOAD } or { 35 + })
- with the FORTH words { . } (period), { , } (comma), { : } (colon), { ; } (semicolon), { ? } (question mark), { ! } (exclamation point), { ' } (single quote mark), and { " } (double quote mark)
- with any word using the above punctuation marks (e.g., { \$ } or { . " }).

All other FORTH words are set apart by a space on either side of the word. So, in this article, braces always signal a FORTH word or phrase. The braces are not part of the word or phrase, and FORTH words never use braces within the body of a figure or listing. . . . GW

SCOPE ON

energizes the oscilloscope. If we decide to plug the oscilloscope into some other socket, we simply change the definition of SCOPE. This "informs" all our programs of the change, so we don't have to hunt through every procedure, looking for references to socket number 1.

Commands can be issued singly or in a large burst. Several commands can be put on one line, or a single command can spread over many lines. Extra spaces, carriage returns, and tabs are harmless and make program listings more attractive and easier to follow. Part of an experimental session might read:

```
METER ON   SCOPE ON
           LASER ON
           5 MINUTES
           LASER OFF
```

This set of commands turns on the meter, oscilloscope, and laser, waits for five minutes, and then turns off the laser.

If I need to perform this sequence often, it is simple and convenient to group these commands into a single command:

```
: TEST
  METER ON SCOPE ON
  LASER ON 5 MINUTES
  LASER OFF ;
```

Typing TEST tells the computer to perform the entire sequence. This particular sequence might be used to check whether all the instruments are working, and procedures called ALIGN, COLLECT-DATA, and SHUT-DOWN could be used for other parts of the experiment. In fact, TEST can be included as a part of another procedure.

Toolbox commands are easy to create. New commands cost only a few bytes of memory. Powerful and subtle commands can be built up from simpler ones. The toolbox actually encourages programmers to write convenient and comprehensible programs. Toolbox programs that are easy to write and modify are in-

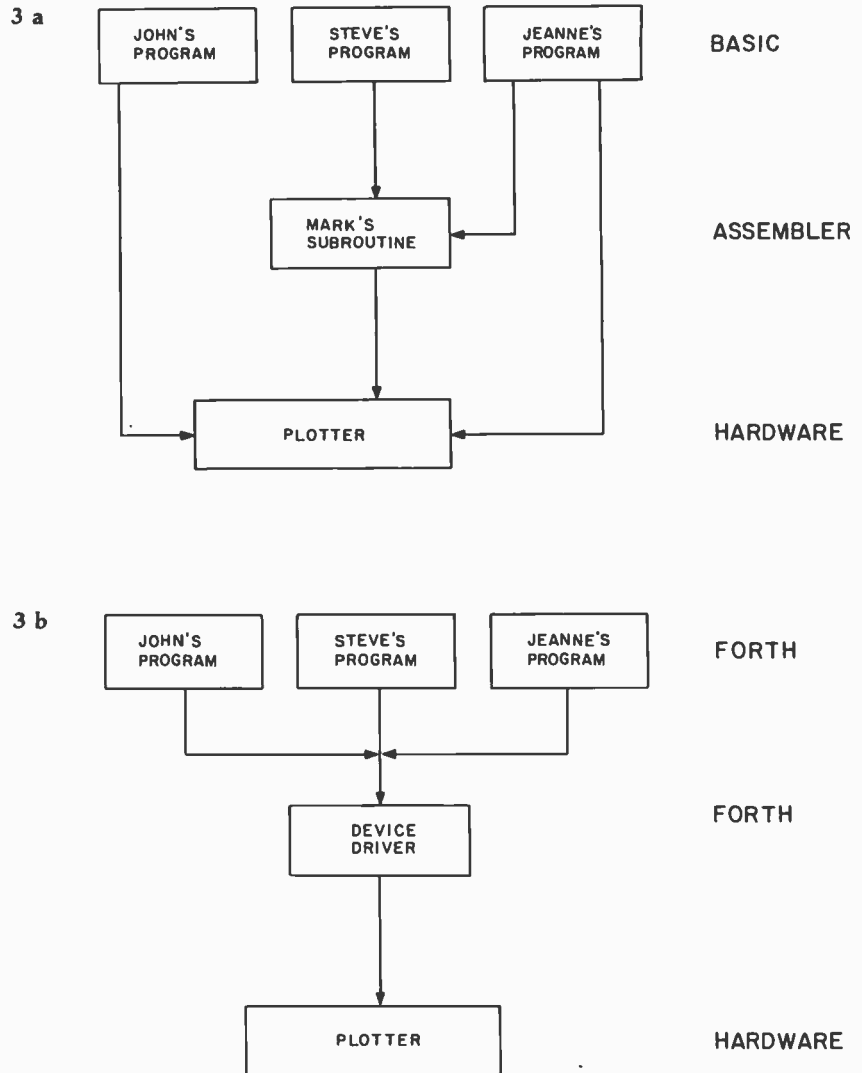

Figure 3: In conventional environments, replacing one hardware device can require many software changes. If the plotter is replaced, many programs must be altered. In figure 3a, John and Jeanne must rewrite parts of their programs, and Mark has to rewrite the assembly-language subroutine Steve and Jeanne both use. If Mark leaves for a new job, Steve and Jeanne may be in serious trouble! As shown in figure 3b, the toolbox insulates users from software changes. If the plotter is replaced, the device driver has to be rewritten, but user programs don't need to be changed.

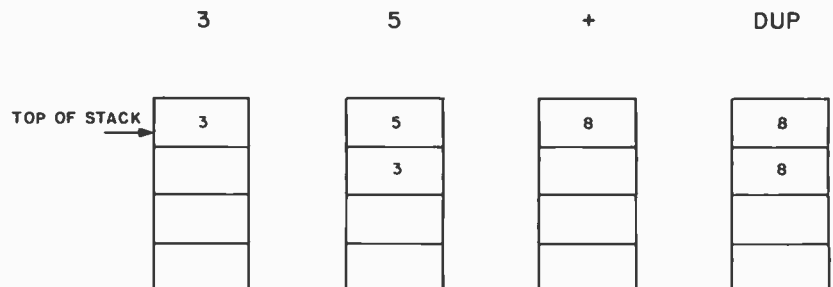

Figure 4: Reverse Polish notation and the computation stack. Reverse Polish makes arithmetic look strange but can be perfectly natural for controlling machines.

herently easy to use; man-machine dialogue is intrinsic in the program's structure, not tacked on as an afterthought.

Amenities

Scientists work in a number-filled world. Contrary to popular myth, though, most scientists have no special facility for arithmetic. In one Cambridge poker game, the regular players include three chemists, a physicist, a stock broker, and a lawyer. To rapidly count and split pots, all defer to the seventh player—an artist.

Since scientists generally can't do arithmetic any better than other people, lab computers should be able to do it for them. When an unexpected question comes up, the lab computer ought to double as a pocket calculator. Our toolbox provides this facility within the FORTH language, because FORTH can do arithmetic very much like any reverse-Polish calculator.

For example, to add 3 to 7 and print the result, we can simply type

3 7 + .

to which FORTH responds

10 OK

{ . } is the FORTH command to display the top value from the stack. FORTH's ability to use any common base is often very useful; to translate, say, hexadecimal 4AF to base ten, we simply type

HEX 4AF DECIMAL .

Clocks and timers are often useful. The command SECONDS instructs the toolbox computer to pause for a specified period. The time-of-day clock may be used (through its device drivers) to ascertain or set the current time. For example,

5 47 TIME!

sets the clock to 5:47. The command TIME@ reads the time, leaving the

According to ARBAGATOR

ARBA Register puts teeth into your inventory control program and takes the bite out of the cost.

ARBA Register: the electronic cash register that interfaces with virtually any computer on the market and doesn't cost more than your system.

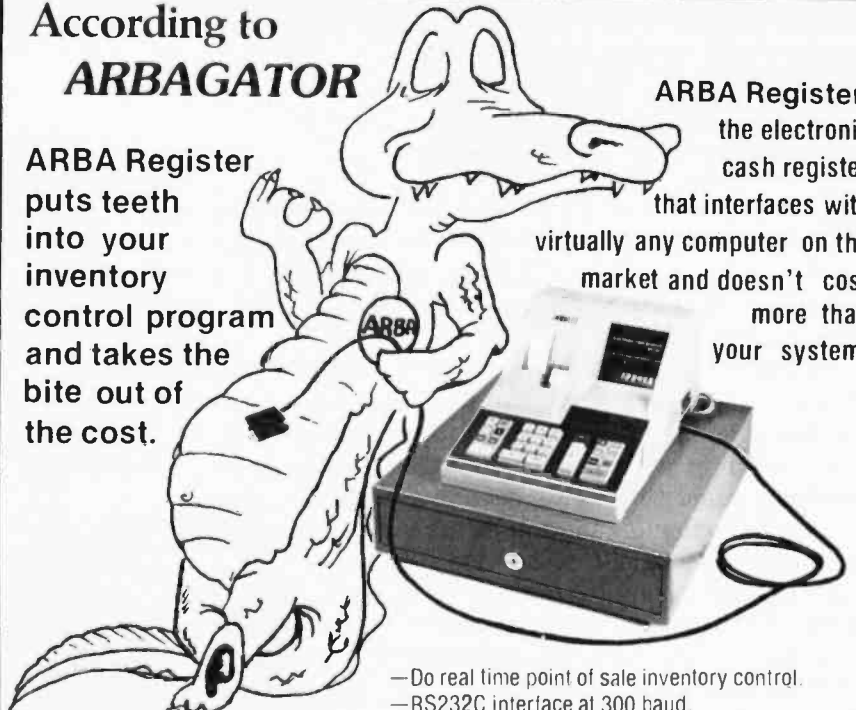

ARBA

FINE BUSINESS COMPUTING
6340 C AMERICANA DRIVE #315C
WILLOWBROOK, IL 60514
312-749-7444

- Do real time point of sale inventory control.
- RS232C interface at 300 baud.
- Standard asynchronous ASCII code.
- Time tested LSI circuitry.
- \$1295 suggested retail—dealer pricing available.

The Birth of UNIX™ for CP/M™!

Brings to CP/M Some of the BEST FEATURES of UNIX!

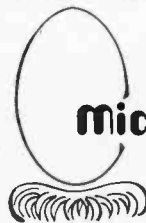

microShell™ The...
•POWER of UNIX
•POPULARITY OF CP/M

Available for adoption by: CP/M SOFTWARE DEVELOPERS
CP/M SOFTWARE USERS

CP/M Compatibility	<ul style="list-style-type: none"> • Loads and Executes as a normal program under CP/M, installing itself under the CP/M operating system • Other CP/M programs - editors/word processors/application programs/compilers/assemblers - may then be run using all MicroShell features • CP/M compatibility is generally not affected by MicroShell's presence • Adds UNIX Power without losing CP/M Compatibility
Console Input/Output Redirection	<ul style="list-style-type: none"> • Send Console Output to a File instead of or in addition to the screen Example: stat * > status - sends "stat" output to file "status" • Take Console Input from a File instead of the Keyboard Example: ed filename < script - takes "ed" commands from the file "script" • Indispensable for: graphic debugging, saving exact Screen Output for documentation, etc.
Automatic Command File Search Path	<ul style="list-style-type: none"> • MicroShell finds your program. User concentrates on the big tasks, MicroShell does the details • Permits development or data files on one drive and all programs on another • User-specified file types for Automatic Search. Example: ".com", ".int", etc. • User-specified Search Path. Example: Current Drive 1st, then Drive A, etc.
Multiple Commands Per Line	<ul style="list-style-type: none"> • User types a logical group of commands to be executed Example: compile file; link file; file • MicroShell executes the commands one at a time
Direct Command File Execution	<ul style="list-style-type: none"> • Files of CP/M or MicroShell commands are executed by MicroShell simply by typing file name • User-specified Command Filetypes. Example: ".sh", ".sub", etc. • Argument substitution (\$1, \$2, etc.) as with CP/M SUBMIT/XSUB
Additional Features	<ul style="list-style-type: none"> • User definable prompt with Disk Drive and/or User Number optional • Install program to customize MicroShell to user's needs & system • Others - ORDER MANUAL FOR FULL DETAILS

CP/M 2.2/32K with 8080/8085/280 CPU Required

★ ADOPTION FEE: \$150.00
Manual Only: \$ 25.00

(VA residents add 4% sales tax)
VISA, MC, Check or Money Order

NEW GENERATION SYSTEMS, inc.

Mail or Phone Adoption Requests to:
2153 Golf Course Drive
Reston, VA 22091
(703) 476-9143

CP/M - TM of Digital Research Corp
UNIX - TM of Bell Telephone Labs

TODAY

TODAY's just another good reason to be a subscriber to the CompuServe Information Service. Because TODAY is a magazine published free-of-charge for our customers and also offered to others interested in the latest developments in the growing videotex industry.

TODAY includes new and current product and service offerings on the System, technological developments at CompuServe and in the industry, customer profiles, features on information providers and announcements of special events. An extensive subject index appears in each issue.

Ask for a demonstration of the CompuServe Information Service at a Radio Shack® Computer Center. Videotex software is available for various brands of personal computers. CompuServe Information Service, 5000 Arlington Centre Blvd., Columbus, Ohio 43220. (614) 457-8650

CompuServe



current time on the stack. CLOCK? prints the time on the TV screen, using an attractive format. Special functions are easy to add; for example, CAL-TIME might print the time in California.

Interestingly enough, our toolbox "clock" is actually a small machine-language program. The device drivers for the clock are "driving" a completely mythical device! In practice, the clock's device drivers manipulate a few bytes of memory in which the clock program leaves the current time, but the user is free to believe that the clock is a hardware device inside the toolbox!

Someday we might just install an integrated circuit to replace the "clock" routine. To do that, we'd simply rewrite the device drivers. If a user did not notice the new integrated circuit inside the computer, he might never know about the new clock circuit.

The Toolbox Development System

The toolbox approach lets scientists apply computers to laboratory problems that tend to resist conventional design and programming methods. Moreover, developments in computer technology will substantially augment the potential of the toolbox in the next few years. Trends in microprocessor architecture favor designs that emphasize the toolbox virtues of modularity and invocation. A microprocessor designed specifically for efficient FORTH implementation, for example, is now under development. The toolbox relies heavily on its abundant input and output devices, and these, too, are subject to constant improvement.

Computer toolboxes are also uniquely suited to incorporate new advances in integrated-circuit technology. New parts can be plugged into the toolbox, often simply by connecting their pins to the appropriate signals on the system bus. New device drivers are easy to write and can use all the existing toolbox facilities.

For example, our toolbox currently includes programs to calculate logarithms. This job could be performed more effectively by an integrated-circuit arithmetic processor. Physically

WICAT system 150

A new standard of excellence and price/performance. Motorola 68000 processor, large memory, hard disk and complete system software included.

Excellent system for business and scientific applications, software development, or personal use.

Full service is available including nationwide on-site maintenance, usually within four hours.

Concurrent Corporation can help you select the proper configuration. To discuss your application, please write or call (513) 281-1270.



\$8500

- Powerful Motorola 68000 processor (32 bit processor with 16-bit data paths)
- 256K bytes of memory with parity checking
- 10 MB 5 1/4" Winchester disk
- 960 KB 5 1/4" floppy disk
- Video terminal
- Two RS232C serial and one 16-bit parallel port
- Operating system, full screen editor, file system with hierarchical directories
- Choice of Pascal, C, FORTRAN, COBOL, BASIC or Assembler
- A wide variety of configurations and options



ConcurrentTM Corporation

1870 Madison Road Cincinnati, Ohio 45206

installing such a device would require only a few additional integrated circuits. To install the processor in the toolbox *software*, we would write device-driver programs to control the math processor's operations. These programs could be written on the toolbox, using the existing toolbox software, and tested by comparing the results of the new and old logarithm routines.

Once a new device has been tested, existing toolbox programs may be modified to take advantage of the toolbox's new capabilities. This unusual flexibility suggests that the toolbox, designed to apply small computers to the scientific laboratory, may be a useful tool for developing computer systems! The toolbox makes no distinction between devices that happen to be inside or outside its box; everything is handled by device drivers. The toolbox, designed specifically to control many external devices, can also configure and control its own internal structure.

The toolbox may, like a snake, shed its skin of peripheral controllers, using them in the end only to create and test a new set of more powerful devices. If a better terminal becomes available, the old terminal can be used to write the new terminal's device drivers. An instrument designed this way could design and test its own successor—in fact, the new model could retain many of the old machine's parts and programs!

The toolbox is easy to customize and simple to modify. It can revise its own language and extend its vocabulary to meet the requirements of its user. It can be connected to many devices and can help test new interfaces and new instruments. In short, the toolbox is a very *personal* computer. ■

Acknowledgments

I'd like to express my gratitude and appreciation to Professor Kevin S. Peters, who patiently supported this work, and to the Merck Corporation for the honor of a Merck Corporation Foundation Fellowship.



68000 MINI-SYSTEMS

IEEE-696 S-100 Compatible

Special Offer

ERG-I \$7995 — CPU, 4 RS232 SERIAL PORTS, 64K STATIC RAM, 10 SLOT BACK PLANE, 2 8" DOUBLE DENSITY, DOUBLE SIDED FLOPPIES OR A 5MB 5¼" WINCHESTER, 68KFORTH¹ SYSTEMS LANGUAGE WITH MACRO ASSEMBLER, ALL INTEGRATED INTO DESK TOP CABINET, BURNED-IN AND TESTED.

ERG-II \$9795 — SAME AS ERG-I EXCEPT FOR MASS STORAGE; ERG-II HAS A 5MB 5¼" WINCHESTER AND ONE 8" DOUBLE DENSITY, DOUBLE SIDED DRIVE.

ERG-III \$12995 — CPU, 4 RS232 SERIAL PORTS, 256K DYNAMIC RAM, 10 SLOT BACK PLANE, 5MB 5¼" WINCHESTER AND ONE 8" DOUBLE DENSITY, DOUBLE SIDED DRIVE, IDRIS² MULTI-USER, MULTI-TASKING OPERATING SYSTEM AND C COMPILER, ALL INTEGRATED INTO DESK TOP CABINET, BURNED-IN AND TESTED.

ERG-IV \$18995 — CPU, 8 RS232 SERIAL PORTS, 512K DYNAMIC RAM, 10 SLOT BACK PLANE, 24MB 8" WINCHESTER AND 20 MB ¼" TAPE CARTRIDGE, IDRIS² MULTI-USER, MULTI-TASKING OPERATING SYSTEM WITH BOTH C AND PASCAL COMPILERS, ALL INTEGRATED INTO DESK TOP CABINET, BURNED-IN AND TESTED.

8MHz CPU Standard, 10MHz Optional; OEM Pricing for CPU, Card Sets and Integrated Systems Available.

Trademark ¹ ERG; ² WHITESMITHS LTD.

30 Day Delivery for Integrated Systems with valid purchase order

United Kingdom
MicroAPL LTD.
London 834-2687

**EMPIRICAL RESEARCH
GROUP, INC.**
POB 1176
MILTON, WA 98354
206-631-4855

Australia/New Zealand
S.I. MicroComputer
Prod. LTD.
Sydney 231-4091

Software Breakthrough!

THE WORD HANDLER

BY SILICON VALLEY

THE ONLY WORD PROCESSOR IN THE WORLD FOR THE APPLE THAT:

- Gives you full line capability on the screen, no boards nec.
- Two character formats to choose from at all times!

RUNS WITHOUT ANY HARDWARE MODIFICATIONS!

HIGH POWER

Simplicity of
Operation!

LARGE SCALE

Direct to disk!

All functions seen on the screen!

- Lower and upper case underlining
- Even and normal justification
- Superscript, bold, and unlimited tabs
- Other functions seen on turnkey systems in the \$13-\$20,000 range
- Proportional spacing

DEALER INQUIRIES INVITED

1625 EL CAMINO REAL, SUITE 4
BELMONT, CA 94002
(415) 593-4344



Skip Sequential: A New File Structure for Microcomputers

Jack Purdum
Ecosoft
POB 68602
Indianapolis, IN 46268

I still remember that fall day almost three years ago at Ecosoft, when we got our first floppy-disk drive up and running. Compared to the cassette system we had been using, it was the greatest thing since fire. It was at that point we began to think that the use of a microcomputer in serious business and research applications was a viable concept. It wasn't much longer before we were sure of it.

Like most disk systems, ours supported both random-access and sequential file structures. Depending upon the intended function, each has certain advantages and disadvantages. Sequential files use disk space very efficiently (an important consideration even with the increased storage capacity of double-density drives), but they are progressively slower on disk accesses as the file size grows. Random-access files are much faster on disk access, regardless of file size, but they require a fixed record length set to the maximum anticipated (i.e., "worst case") size. This often results in a considerable amount of wasted disk space.

The purpose of this article is to discuss a "new" file structure that we developed to help overcome some of the disadvantages associated with random-access and sequential files. The new file structure, which we have named Skip Sequential, is based on such a simple idea that many computerists will wonder why they didn't think of it. It is easy to use, adds little programming overhead, and offers significant advantages over conventional file structures. Although the

text discusses Skip Sequential and its use in terms of North Star BASIC, we have also included listings for Microsoft's BASIC-80. Those familiar with BASIC-80 should have little difficulty implementing Skip Sequential.

Sequential and Random-Access Files

Before discussing Skip Sequential, it's important to understand the differences between random-access and

We needed to overcome some of the disadvantages associated with random-access and sequential files.

sequential files. For purposes of illustration, let's assume that you need a program that will store: (1) the customer's name; (2) the amount paid for an item; (3) the date of the purchase; (4) the invoice number of the sale; and (5) a flag variable to reflect whether or not the invoice has been paid. Let's assume that the variables are:

D = Date Sold
N = Invoice Number
A = Amount of the Sale
N\$ = Customer's Name
F = "Paid" flag
(F=1 is "Not Paid")

This data could be easily stored using

either sequential or random-access files. Let's examine these two possibilities.

An Example Using Sequential Files

The program in listing 1 is an example of storing data with sequential files. It is assumed that the values of the variables were determined elsewhere in the program. (If these were actual subroutines, the END statements would be RETURNS.) Line 230 opens the file to be read, while line 240 looks for an end-of-file mark using the TYP command. In North Star BASIC, a unique type will be associated with the data: if it is a string variable, TYP returns a value of 1; if it is a numeric variable, TYP will equal 2; and, if it is an end-of-file mark, TYP returns with a 0. If line 240 finds that TYP is not equal to 0, it falls through to line 250 and reads the data in the file into a set of dummy variables. (Dummy variables must be used so that we don't destroy the new data that we want to add to the file.) Once the end-of-file is found, the branch in line 240 is executed and we write the new data to the file (line 270).

Note that as new transactions are entered, more and more time is spent in the loop formed by lines 240 through 260 looking for the end-of-file mark. Because sequential files require that the entire data file be read before any new data can be written, the time lost looking for the end-of-file is a major limitation of sequential files. On the other hand, a sequential file is a "dense" file (i.e., there are no

wasted gaps in the file). Each new piece of data is tightly packed against the previous piece of data, so disk space is used very efficiently. However, the programmer must decide between optimal use of disk space or faster operation: a choice that usually dictates use of random-access files.

An Example Using Random-Access Files

Listing 2 presents the same type of program as that shown in listing 1, but using random-access files. A major difference between the two programs is that random-access files must use a fixed record length (i.e., each transaction will use exactly the same number of bytes in all instances). The programmer must decide this length, and in making that determination needs to know the following: how many bytes are required to store a numeric variable; how many bytes should be allocated to store string data (including any "overhead" bytes associated with such string variables); and how many numeric and string variables will be used in each record. In our example, we use four numeric variables (D, N, A, and F) and one string variable (N\$).

The first task is to determine how many bytes are needed for each floating-point number stored in the numeric variables. For North Star BASIC, this can be determined by the following equation:

$$B = (P/2) + 1$$

where:

B = the number of bytes in a floating-point number

P = the precision of the BASIC

For the standard version of North Star BASIC (8-digit precision BASIC), each floating-point number requires 5 bytes.

To determine the requirements for the name field, the programmer must decide on a string length that will be long enough to hold most customer names, but not so long as to waste

Listing 1: This routine, written in North Star BASIC, adds a record to the end of an existing sequential file.

```

100 REM=====
110 REM      This is an example of a sequential file for North Star DOS
120 REM      and Basic
130 REM
140 REM      10-15-80
150 REM      Purdum
160 REM      Ecosoft
170 REM=====
180 REM
190 REM      This program is treated as a subroutine where the values of the
200 REM      variables are determined before entering it.
210 REM
220 REM
230 OPEN #0,"BYTE"\REM      Activate file
240 IF TYP(0)=0 THEN 270
250 READ #0,D1,N1,A1,N1$,F\REM      Read dummies if data present
260 GOTO 240
270 WRITE #0,D,N,A,N$,F\REM      Found E.O.F.,write new values
280 CLOSE #0
290 !"END"\END

```

Listing 2: This routine adds a new record to a random-access file. The number of records in this file is stored at the beginning of the file and updated after each write operation.

```

100 REM=====
110 REM      This is an example of a random access file for North Star
120 REM      DOS and Basic
130 REM
140 REM
150 REM      10-15-80
160 REM      Purdum
170 REM      Ecosoft
180 REM=====
190 REM      This program is also treated as a subroutine where the values
200 REM      of the variables are determined before entering it
210 REM
220 REM
230 OPEN #0,"BYTE"
240 READ #0,R\REM      R contains # of records on disk
250 WRITE #0*(52*R+5),D,N,A,N$,F      Update record count
260 R=R+1\REM
270 WRITE #0%0,R,NOENMARK
280 CLOSE #0
290 END

```

Variable	Type	Bytes	Overhead
D	Numeric	5	-0-
N	Numeric	5	-0-
A	Numeric	5	-0-
N\$	String	30	2
F	Numeric	5	-0-
Totals:		50	2
Record Length:		52	

Table 1: To calculate the fixed record length for a random-access file, simply sum the number of bytes required by each variable (or field) within a record.

unnecessary disk space. In our example, we selected 30 bytes for the name string (N\$). It should be noted that North Star BASIC requires 2 overhead (or housekeeping) bytes for each string that is less than 255 bytes long (3 bytes are required if the string is longer than 255 bytes). We can now determine the fixed record length for the random-access file, as shown in table 1.

Having determined the fixed record length, the programmer can proceed to write the program (see the example shown in listing 2). We have assumed that the programmer has written a 0 (zero) to the file for R (the variable that informs the program of how many previous transactions have been written to the disk). Since R is a floating-point number, the file has 5 bytes in it before it is even used. The

percent sign (%) in line 250 of listing 2 is interpreted to mean "jump the following number of bytes" and write the new record. If this is the first entry, the program will jump over 0×52 bytes, plus 5 more bytes. Since 0×52 is 0, the program jumps over 5 bytes (jumps over the R variable) and writes the new data. Line 260 increments the record count in R and writes the new value of R at the beginning of the file (the %0 says to jump over 0 bytes, hence rewriting R). The NOENDMARK command informs the interpreter not to write an end-of-file mark after updating R. If the end-of-file mark was written after R, the program would think that the file ended after the first 5 bytes.

The advantage of random-access files is that we don't have to read through the entire file to perform a write operation. By simply reading R and jumping the correct number of bytes (lines 240 and 250 in listings 2), we know exactly where the new data should be written. There is a price to pay for the increased speed, however. If a customer's name is "W. Oz", which is only 5 bytes long including the blank, we must still allocate 30 bytes because of the fixed record requirement of random-access files. We have wasted almost 50% of the record space, a circumstance that is of particular importance when working with the smaller capacities of 5-inch floppy disks. Even the end user might get a little cranky if he knew that half of his disk space was going to waste.

Skip Sequential: The Best of Both Worlds

The main advantage of a Skip Sequential file is that it has the same speed as a random-access file, but does *not* require the use of fixed record lengths. This means that it can write data to the disk with the same speed as random access, but does so without wasting disk space. If a customer's name is 5 bytes long, it will use only 5 bytes. We've been using Skip Sequential for almost three years and have virtually eliminated sequential files from our programming choices. In all but the most trivial cases, Skip Sequential beats sequential files, hands down.

Listing 3: *Initializing a Skip Sequential file requires that a single number be written to the file. Since this number will serve as the file byte counter, and is itself 5 bytes long, it is set to 5 on initialization.*

```

100 REM-----
110 REM      Initialization routine for Skip Sequential prior to use
130 REM
140 REM
150 REM                      10-15-80
160 REM                      Purdum
170 REM                      Ecosoft
180 REM-----
190 REM      This program write a single number to a SS data file, the value
200 REM      of which is equal to the number of bytes/floating point number.
210 REM
220 REM
230 OPEN #0,"BYTE"
240 X=5\REM                      We're assuming 8-digit precision
250 WRITE #0,X
260 CLOSE #0
270 END

```

Skip Sequential is easy to use and requires little programming overhead. Essentially, it is a random-access file with a fixed record length of 1 byte: all we have to do is keep track of the number of bytes already written to the file. To this end we must provide a byte counter when the file is initialized (before using Skip Sequential). The program in listing 3 illustrates this process.

When preparing a file for Skip Sequential, you must first write a single number to the file. The value of that number depends upon the number of bytes required for a floating-point number. North Star BASIC, for example, uses 5 bytes for such numbers, so X in line 240 of listing 3 is set to 5. Line 250 writes the number 5 to the file, and the program ends. Why do we have to write this number? Since we must keep track of the number of bytes written to the file, and the counter is a number which is 5 bytes long, 5 bytes are written to the file when we write the byte counter in line 250. The program in listing 3 has done what it's supposed to do: keep track of the number of bytes in the file—exactly 5. Having initialized the byte counter, we are now ready to use the file.

The program in listing 4 can be used to implement the sample program discussed earlier. Line 240 reads the byte counter, while line 260 says to "skip over" B bytes and then write the new data to the disk. The first time through, B will equal 5 bytes, since only the byte counter is in the file. Note that North Star BASIC "skips" with respect to the beginning

of the data file; some operating systems may do this with respect to the disk head after reading B. If this is true, the byte counter must be initialized to 0 in listing 3. Once the skip is performed in line 260, the new data is written to the disk in the conventional manner.

Disk space is saved through line 270, which sets L equal to the length of N\$. Line 280 increases the byte counter to reflect the number of bytes written to the disk. Since there are four numbers of 5 bytes each, this is added to B, plus the length of the string, L, plus the 2 overhead bytes associated with each string. If the name were "W. Oz", L would equal 5, and the total number of additional bytes would be 27. The byte counter would reflect 32, the total number of bytes in the file (27 new bytes plus 5 for the byte counter itself). Line 300 then writes the new value of the byte counter to the beginning of the file.

Note what happens in listing 4 when a second entry is made to the file. Line 240 returns with 32 in B. The program then skips over 32 bytes in line 260 and writes the new transaction in the proper place in the file. The disk-write operation is actually performed faster than the random-access example given earlier, since B does not have to be calculated. Fixed record lengths are not used, so we save the difference between the actual string length and the worst case string length that would have been used with random-access files. As the file grows longer, the savings can be substantial.

It is quite simple to read the file

Listing 4: New records may be added to a Skip Sequential file with this routine. The length of each record varies with the length of N\$, the string variable containing a customer name.

```

100 REM=====
110 REM This is an example of a Skip Sequential file for North Star
120 REM          DOS and Basic
130 REM
140 REM
150 REM          10-15-80
160 REM          Purdum
170 REM          Ecosoft
180 REM=====
190 REM This program is also treated as a subroutine where the values
200 REM          of the variables are determined before entering it
210 REM
220 REM
230 OPEN #0,"BYTE"
240 READ #0,B\REM          B contains # of BYTES written to disk
250 REM
260 WRITE #0%B,D,N,A,N$,F\REM          Skip over the bytes already on disk
270 L=LEN(N$)
280 B=B+(5*4)+L+2\REM          Up B by number of new bytes written
290 REM
300 WRITE #0%0,B,NOENDMARK\REM          Now update byte counter
310 CLOSE #0
320 END
    
```

Listing 5: Each record of a Skip Sequential file is read by calculating the individual record lengths as they are read and adding this value to the current byte count.

```

100 REM=====
110 REM This program reads a Skip Sequential file using North Star DOS
120 REM          and Basic
130 REM
140 REM
150 REM          10-15-80
160 REM          Purdum
170 REM          Ecosoft
180 REM=====
190 REM
200 REM
210 REM
220 DIM N$(30)
230 E=5\REM          Must set a variable, E, equal to the number
240 REM          of bytes per floating point number.
250 OPEN #0,"BYTE"
260 READ #0,B
270 READ #0,D,N,A,N$,F
280 !D,TAB(10),N,TAB(20),A,TAB(30),N$,TAB(65),F
290 L=LEN(N$)
300 E=E+(5*4)+L+2
310 IF E<B THEN 270
320 !!"END OF LISTING"
330 CLOSE #0
340 END
    
```

using sequential techniques. An example is given in listing 5. Note that E is equal to 5 in line 230. By using this variable in the same manner as B in listing 4, a comparison of E and B (as in line 310) is equivalent to testing for an end-of-file mark. Since E is updated in line 300, we know that we have read all of the data in the file when E is equal to B.

The program in listing 5 does point out one potential problem. In those cases where N\$ might be empty, line 270 expects to see an N\$ in the file. The simplest way to avoid a type error on a read operation is to set N\$ equal to one blank before writing it to the disk in listing 4. While this does waste 3 bytes, the loss is trivial compared to the other savings of the Skip Sequential method.

Updating a Skip Sequential File

Another advantage of Skip Sequential over sequential files is that they can be updated almost as easily as random files. Suppose that we want to use the flag variable (F) to reflect whether or not the transaction is paid. Assuming the F equaled 1 when the transaction was originally written, we now want to update it to a paid status. We will further assume that the new value of F will reflect the date it was paid (although it could be a check number or any other numeric data). Listing 6 contains an example of updating a Skip Sequential file.

Line 250 again sets the end-of-file counter, E. Lines 270 through 310 read the data and update E. Line 330 asks if this is the proper invoice number. If it isn't, line 350 is executed: this tests

MAR. SPECIAL SALE ON PREPAID ORDERS

(CHARGE CARDS, C.O.D. OR P.O.'S NOT AVAILABLE)
MIKOS WIRE WRAP PROTOTYPE BOARD, ROOM FOR 5 REGULATORS, GLASS FILLED EPOXY, \$100, OVER 3000 HOLES, PLATED THROUGH HOLE. ALL EDGE CONNECTOR PINS NUMBERED AND LABELED.
 PCBD \$27.95. 5 FOR \$129.95



CALIFORNIA COMPUTER SYSTEMS

\$100

2032 32K STATIC RAM A & T. 200 NSEC	\$629.00
2066 64K DYNAMIC RAM A & T.	\$548.95
2200 S-100 MAIN FRAM A & T.	\$379.95
2422 FLOPPY DISC WITH CP/M 2.2"	\$329.95
2810A Z80 CPU A & T.	\$249.95
2710A 4 SERIAL I/O A & T.	\$291.95
2718A 2 SERIAL, 2 PARALLEL A & T.	\$305.95
2720A 4 PARALLEL A & T.	\$214.95
PROTO BOARDS WW	\$39.95

APPLE PRODUCTS

7114A 12K ROM/PROM	\$68.50
7424A CALENDAR/CLOCK	\$106.95
7440A PROGRAMMABLE TIMER	\$98.50
7470A A TO O CONVERTER	\$105.95
7490A GPIB (IE 488) INTERFACE	\$265.95
7710A ASYNC SERIAL	\$125.95
7712A SYNC SERIAL	\$153.95
7720A PARALLEL STANDARD	\$98.95
7720B PARALLEL CENTRONICS	\$98.95
7811B ARITHMETIC PROCESSOR W/DISC	\$342.95
7811C ARITHMETIC PROCESSOR W/ROM	\$342.95
7500A WW BOARD	\$22.95
7510A SOLDEDTAIL BOARD	\$23.95



SSM MICROCOMPUTER PRODUCTS

\$100 PRODUCTS

CB-2 280 PROCESSOR BOARD	
KIT	\$198.95. A & T \$269.95
VBIC 64 x 16 VIDEO PCBD	\$32.95
KIT	\$153.95. A & T \$199.95
VB3 80 CHARACTER VIDEO 4MHZ	
KIT	\$345.95. A & T \$425.95
IO4 2 PARALLEL 2 SERIAL PCBD	\$32.95
KIT	\$155.95. A & T \$194.95
PB-1 2708, 2716 PROGRAMMER BOARD	
KIT	\$135.95. A & T \$185.95

APPLE PRODUCTS

AIO SERIAL/PARALLEL INTERFACE	
KIT	\$125.95. A & T \$155.95
ASIO SERIAL I/O	
KIT	\$87.95. A & T \$97.95
APIO PARALLEL I/O W/O CABLES	
KIT	\$67.95. A & T \$87.95



WMC inc. WAMECO INC.
BOARDS WITH MIKOS PARTS

MEM-3 32K STATIC RAM, PCBD	\$36.95
KIT LESS RAM	\$95.95. A & T \$135.95
CPU-2 280 PROCESSOR, PCBD	\$32.95
KIT LESS ROM	\$109.95. A & T \$149.95
EPM-2 16K/32K EPROM, PCBD	\$32.95
KIT LESS ROM	\$65.95. A & T \$99.95
FPB-1 FRONT PANEL, PCBD	\$48.50
KIT	\$144.95. A & T \$184.95
QMB-12 13 SLOT MOTHER BOARD, PCBD	\$39.95
KIT	\$95.95. A & T \$135.95



MONDAY-FRIDAY, 8:00 TO 12:00, 1:00 TO 5:30
 THURSDAYS, 8:00 TO 9:00 P.M.

(415) 728-9121

P.O. BOX 955 • EL GRANADA, CA 94018

PLEASE SEND FOR IC, XISTOR AND COMPUTER PARTS LIST
 VISA or MASTERCARD Send account number, interbank number,
 expiration date and sign your order. Approx. postage will be added
 Orders with check or money order will be sent post paid in U.S. If you are
 not a regular customer, please use charge, cashier's check or postal
 money order. Otherwise there will be a two-week delay for checks to
 clear. Calif. residents add 6% tax. Money back 30-day guarantee. We
 cannot accept returned IC's that have been soldered to. Prices subject to
 change without notice. \$20.00 minimum order. \$2.00 service charge on
 orders less than \$20.00.



Oryx software

GUARANTEED LOWEST PRICES!
To celebrate our opening, we are matching any advertised price. Just show us the ad.

**ORDER TOLL FREE - Outside WI
1-800-826-1589**

ACCESSORIES

Apple II Dual Thermometer w/software	260.00
Mountain Expansion Chassis	625.00
CPS Multifunction	199.00
Mountain Music System	395.00
100,000 Day Clock	375.00
Mountain Clock	252.00
Supertalker SD 2000	199.00
A/D + O/A	299.00
CCS 12K RDM/PROM Board	99.00
CCS A/D Converter Board	99.00
CCS Serial Asynch. Board	139.00
CCS Calendar/Clock Board	99.00
VOTRAX Type-n-Talk	375.00
ADALAB Package	495.00
DOS Dater	49.00
ABT Numeric Keypad	125.00
ABT Softkey	150.00
ABT Barwand	195.00
ABT Cash Box	295.00
ABT Pascal Tools I or II	75.00
Scitronic Remote Controller	249.00
Scitronic Energy Watcher 1 Ph.	349.00
Apple Speed Controller	69.00
Applescope (your Apple as an Oscilloscope)	595.00
Scope Driver	49.00
Videx Videoterm	319.00
Videx Enhancer II	149.00
K & D Enhancer	115.00
Videx Character Sets	29.00
Echo Speech Synthesizer	225.00
Upper/Lower Character	39.50
Joysticks 4	59.00
ALS Smarterm	379.00
ALS Z-Card	269.00
S&M A10 s/p interface + cable	195.00
Scott Instrument VET (2)	795.00
ALF Music Card MC1	195.00
ALF Music Card MC15	245.00
ALF Game I/O	16.00
ALF Timing Mode I/O	18.00
ALF Ear Training	49.95
ALF Albums	14.95
Microspeed II	495.00

... AND MANY MORE!

* Programs for Apple, Commodore, TRS and any CP/M computer.

Quoted prices valid for stock on hand and subject to change without prior notice.

Call for price information:

Printers - Epson, Okidata, Microline, NEC, C. ITOH, Qume, Diablo, Anadex, IDS, MPI, Microtek, Printek.

Monitors - Amdek, Sanyo, Hitachi, NEC, Kaga/TSK.

Modems - Novation, Hayes.

Disk Drives - Percom, Corvus, Morrow, CCS, etc.

Plotters - Watanabe.

Ask for our **FREE** catalog.

For Software see our other ad, page 376

Please:

- Wisconsin residents - add 4% sales tax
- Foreign orders - please add 15%
- Add \$2.50 for shipping per software and small item. Call regarding others.

We Welcome:

- Visa, MasterCard - (Add 4%)
- Checks (Allow 1-2 weeks for clearing)
- COD (Add 4%)

TOLL FREE - Outside Wisconsin:

1-800-826-1589

For Technical Info & in Wisconsin:

715-848-2322

Oryx Software

P.O. Box 1981 • Wausau, WI 54401



Listing 6: In order to update a Skip Sequential file, each record must be searched until the proper one is located. A new value of the same length must then be written into that record.

```

100 REM=====
110 REM This program updates a variable in a Skip Sequential files using
120 REM           North Star DOS and Basic
130 REM
140 REM
150 REM           10-15-80
160 REM           Purdum
170 REM           Ecosoft
180 REM=====
190 REM This program assumes we want to set the flag variable, F, to
200 REM equal the current date, which is held in variable Y. The trans-
210 REM action to be updated has an invoice number that must match N1.
220 REM
230 REM
240 DIM N$(30)
250 E=5\REM           Must set a variable, E, equal to the number
260 REM           of bytes per floating point number.
270 OPEN #0,"BYTE"
280 READ #0,B
290 READ #0,D,N,A,N$,F
300 L=LEN(N$)
310 E=E+(5*4)+L+2\REM           Update number of bytes read, variable E
320 REM
330 IF N=N1 THEN 430\REM           Is it the one we're looking for?
340 REM
350 IF E<B THEN 290\REM           Compare to B to see if we've read all bytes
360 !!"CANNOT FIND A MATCH FOR INVOICE NUMBER",N
370 CLOSE #0
380 END
390 REM           ***** Update Flag *****
400 REM           Since F is the last variable read and E con-
410 REM           tains the number of bytes read, back up 5
420 REM           bytes and write the date paid.
430 WRITE #0$(E-5),Y,NOENMARK
440 CLOSE #0
450 !"INVOICE MARKED 'PAID' WITH TODAY'S DATE."!
460 END
    
```

Listing 7: Microsoft BASIC-80 version of the initialization routine for a Skip Sequential file.

```

100 REM=====
110 REM Skip Sequential files for Digital Research's CP/M operating system and
120 REM           Microsoft's Basic-80.
130 REM
140 REM           10-15-80
150 REM           Purdum, ECOSOFT
160 REM=====
170 REM
180 REM The function of this program is to initialize the data file
190 REM called BYTE for use as a Skip Sequential data file. It assumes
200 REM double-precision numbers are used in the data file.
210 REM
220 OPEN "R",#1,"BYTE",8:REM           A random file with a fixed record
230 REM           length of 8 bytes.
240 FIELD #1,8 AS Y$
250 M=1:REM           One record will be in it
260 LSET Y$=MKD$(M)
270 PUT #1,1:CLOSE #1:END
    
```

for an end-of-file condition. If we haven't read all of the data, we go to 290 and read some more. If the proper match is in 330, control is sent to 430 to write today's date (assumed to be in Y) in place of F. Note how this is accomplished. Upon finding a match in 330, E contains the number of bytes read thus far. Since F is a 5-byte number, we need to back up 5 bytes before writing Y in place of F. For this reason, five is subtracted from the variable E in line 430. The rest of the line writes the date, Y, with no end-of-file mark, to the file. We are, of course, assuming that Y is also a number.

Skip Sequential for BASIC-80

We have also included a program similar to the above but modified for Microsoft's BASIC-80. The program listings are similar to the North Star BASIC versions, but the differences between interpreters do require some changes.

One of the major differences between North Star BASIC and BASIC-80 is that BASIC-80 requires that record length be given when the file is opened. Listing 7 shows how a Skip Sequential file is initialized using BASIC-80. Since we use dollar amounts as one of the variables in the data file (i.e., A), the programmer will

Listing 8: BASIC-80 routine to add a record to a Skip Sequential file. Note that this routine uses an 8-byte record length instead of the 1-byte length used in North Star BASIC.

```

100 REM=====
110 REM      Writing data to a Skip Sequential data file
120 REM      CP/M and Basic-80
130 REM
140 REM      Purdum, Ecosoft
150 REM      10-15-80
160 REM=====
170 REM
180 REM      The function of this program is to write the data to the SS file
190 REM      called BYTE. It assumes values are given upon entering the routine.
200 REM
210 REM
220 IF LEN(N$)=0 THEN N$=SPACE$(8):REM      If no name wanted, write 8 blanks
230 REM
240 REM      Begin file write
250 REM
260 OPEN "R",#1,"BYTE",8:FIELD #1,8 AS Y$
270 REM
280 GET #1,1:U=CVD(Y$):U=INT(U):REM      Get # of records already in file in U
290 U=U+1:REM      Up counter
300 REM
310 LSET Y$=MKD$(D):PUT #1,U:REM      Write a new one, D
320 U=U+1
330 LSET Y$=MKD$(N):PUT #1,U:REM      Another one, N
340 U=U+1
350 LSET Y$=MKD$(A):PUT #1,U:REM      Yet another, A
360 U=U+1
370 REM      *** Now find how many records needed for N$ ***
380 REM
390 IF LEN(N$)/8>INT(LEN(N$)/8) THEN X=INT(LEN(N$)/8)+1 ELSE X=INT(LEN(N$)/8)
400 REM
410 LSET Y$=MKD$(X):PUT #1,U:REM      Save number of records, X
420 REM
430 REM      Now write N$ as 8-byte records
440 FOR J=1 TO X
450   LSET Y$=MID$(N$,8*J-7,8)
460   PUT #1,J+U
470 NEXT J
480 REM
490 U=U+X
500 F=1:REM      Add flag variable, F=1=active
510 U=U+1
520 LSET Y$=MKD$(F):PUT #1,U
530 LSET Y$=MKD$(U):PUT #1,1:REM      Update counter for new records added
540 CLOSE #1
550 END
    
```

Listing 9: BASIC-80 program to read data in a Skip Sequential file.

```

100 REM=====
110 REM      This program reads the Skip Sequential file for CP/M and
120 REM      Basic-80
130 REM
140 REM      10-15-80
150 REM      Purdum, ECOSOFT
160 REM=====
170 REM      This is also treated as if it were a subroutine
180 REM
190 OPEN "R",#1,"BYTE",8:FIELD #1,8 AS Y$
200 GET #1,1:U=CVD(Y$):REM      Get record counter in U
210 REM
220 M=2:REM      We want second record
230 GET #1,M:D=CVD(Y$):REM      Get date
240 M=M+1
250 GET #1,M:N=CVD(Y$):REM      Get Invoice number
260 M=M+1
270 GET #1,M:A=CVD(Y$):REM      Get amount
280 M=M+1
290 GET #1,M:X=CVD(Y$):REM      Get byte-length of customer name in
300 REM      terms of 8-byte records into X
310 FOR J=1 TO X
320   GET #1,M+J:N$=N$+Y$:REM      Stuff name in N$
330 NEXT J
340 M=M+X:REM      Bump read counter for N$ length
350 M=M+1
360 GET #1,M:F=CVD(Y$):REM      Get flag and we're done
370 IF M<>U THEN 200
380 CLOSE #1:END
    
```

probably want to use double-precision numbers. In BASIC-80, 8 bytes are required for each numeric variable. Lines 220 and 240 inform the interpreter that we will be using a fixed

record length of 8 bytes instead of the 1-byte record in the North Star BASIC version of Skip Sequential (Microsoft BASIC-80 does not allow a record length of 1). Line 260 con-

MTI stocks 'em all for faster delivery.

Ask about our "QED" discounts. VISA and MasterCard orders accepted.

VIDEO TERMINALS	MTI Price
VT 100 DECscope	\$ 1595
VT 101 DECscope	1215
VT 131 DECscope	1785
VT 132 DECscope	1995
ADM 3A (dumb terminal)	595
ADM 5 (dumb with visual attributes)	645
ADM 31 (two page buffer)	1095
ADM 32 (ergonomic ADM 31)	*
ADM 42 night page buffer avail.	*
TI 940 (two page buffer)	1795
TI "Insight Series 10" personal term.	695
Hazeltine Executive 80 Model 20	1495
Hazeltine Executive 80 Model 30	1715
1410 (Hazeltine dumb terminal)	825
1421 (Consul 580 & ADM 3A comp.)	850
1500 (dumb terminal)	1045
1510 (buffered)	1145
1520 (buffered, printer port)	1395
1552 (VT52 compatible)	1250
Hazeltine Esprit	645
GRAPHICS TERMINALS	
VT 100 with graphics pkg.	3250
VT 125 (DEC graphics)	3100
ADM 3A with graphics pkg.	1795
ADM 5 with graphics pkg.	1845
300 BAUD TELEPRINTERS	
LA 34-DA DECwriter IV	995
LA 34-AA DECwriter IV	1095
LA 36 DECwriter II	1095
Teletype 4310AAG	1045
Teletype 4320AAK	1195
Diablo 630 RO	2295
Diablo 1640 KSR	2775
Diablo 1650 KSR	2835
TI 743 (portable)	1190
TI 745 (port/built-in coupler)	1485
TI 763 (port/bubble memory)	2545
TI 765 (port/bubble/b.i. coupler)	2595
TI "Insight Series 10/11" pers. term.	695
600 BAUD TELEPRINTERS	
Epson MX-80	645
TI 825 KSR impact	1570
TI 825 KSR pkg.	1795
TI 840 RO impact	895
TI 840 KSR impact	1145
TI 840 KSR pkg.	1635
1200 BAUD TELEPRINTERS	
Epson MX-100	995
LA 120 RA (receive only)	2095
LA 120 AA (forms package)	2295
TI 783 (portable)	1645
TI 785 (port/built-in coupler)	2270
TI 787 (port/internal modem)	2595
TI 810 RO impact	1545
TI 810 RO pkg.	1795
TI 820 RO impact	1850
TI 820 RO pkg.	2025
TI 820 KSR impact	2025
TI 820 KSR pkg.	2195
Lear Siegler 310 ballistic	1945
2400 BAUD	
DataProducts M200 (2400 baud)	2910
DATAPRODUCTS LINE PRINTERS	
8300 (300 LPM band)	5260
8600 (600 LPM band)	6776
8900 (900 LPM band)	10220
8P1500 (1500 LPM band)	19700
2230 (300 LPM drum)	8148
2260 (600 LPM drum)	9979
2290 (900 LPM drum)	13098
ACOUSTIC COUPLERS	
A/J A242-A (300 baud orig)	242
A/J 247 (300 baud orig)	315
A/J 1234 (Vadic compatible)	795
Vadic VA 3413 (300/1200 orig)	845
Vadic VA 3434 (1200 baud orig)	845
MODEMS	
GDC 103A3 (300 baud Bell)	395
GDC 2025/T (1200 baud Bell)	565
GDC 212-A (300/1200 baud Bell)	810
A/J 1256 (Vadic compatible)	825
VA 103 (300 baud modem/phone)	235
VA 3451 (orig/lang triple modem)	885
VA 3456 (1200 baud orig/lang)	770
CASSETTE STORAGE SYSTEMS	
Techtran 816 (store/forward)	1050
Techtran 817 (store/for/speed up)	1295
Techtran 818 (editing)	1795
Techtran 822 (dual)	2295
FLOPPY DISK SYSTEMS	
Techtran 950 (store/forward)	1395
Techtran 951 (editing)	1995

*Please call for quote



Distributors, New York, New Jersey and Ohio.

New York: 516/482-3500, 212/895-7177, 518/449-5959
 Outside N.Y.S.: 800/645-8016
 New Jersey: 201/227-5552
 Ohio: 216/464-6688

verts the value of M into a string for writing to the disk. This is essentially identical to the use of random-access files in North Star BASIC to this point.

Listing 8 illustrates how the data is written to the Skip Sequential file. The only unusual part of the program occurs between lines 390 and 480. Line 390 makes the name held in N\$ an even multiple of 8 bytes. The value of X tells us how many multiples there are, and since we need to know this X value later to read N\$, line 410 saves it in the file as part of the transaction. Lines 440 through 480 save N\$ to the disk as 8-byte records. The remainder of the program is the BASIC-80 equivalent of writing the flag variable and the updated record counter.

Listing 9 is the program to read the Skip Sequential file. The only unusual segment is the reconstruction of N\$ in lines 310 through 330. The updating need not be discussed, since it would be identical to updating any other random file in BASIC-80.

Several improvements could be made to the BASIC-80 version. For

example, X could be "packed" with the date, given the double-precision numbers of BASIC-80 and the fact that X will never exceed four in the sample program. We also think that there may be a way to trick the interpreter into accepting a 1-byte record length instead of 8 bytes, but we haven't experimented sufficiently. Still, Skip Sequential can save disk space over conventional random-access files, albeit the savings aren't quite as great.

Concluding Thoughts

Skip Sequential files do offer many advantages to the programmer and, indeed, the end user. In general, Skip Sequential files may be used for the following: in almost any application where ordinary sequential files are appropriate; in any situation where data is archival in nature (e.g., data backups, transactions, or historical entries); and where only limited updating is required (e.g., setting flags). As a general rule, Skip Sequential strings cannot be updated unless the new and old string lengths are the

same. For this reason, data sets that require frequent updating, such as mail or customer lists, are better suited to random-access files.

Finally, Skip Sequential files can be used in a way that simulates ISAM (indexed-sequential access method) files. For example, if a separate file holds the byte-counter values that exist for the first entry of each month, those byte-counter values can be read first and used to jump to the first entry of the month in the Skip Sequential file. This will further enhance the speed of data retrieval.

While the documentation for the Skip Sequential method has been copyrighted, and we have applied for a trademark on the name, I encourage you to make use of the files. If you plan to make commercial use of the Skip Sequential method, I'd appreciate it if you would contact us first. ■

Acknowledgments

I would like to thank my business associate and friend, Dr. J. B. Orris, for his comments on an earlier draft of this article.

FIND OUT WHAT FITS WHAT.



Just our little effort to remove some of the vast confusion from the data processing, word processing and office products world. You can match up hardware model numbers with disc cartridges, disc packs, or diskette model numbers.

Send for our free 145-page guide. One handy book covers entire DP and WP industry usage of magnetic memory media. How can you do without it?

NASHUA

COMPUTER PRODUCTS DIVISION
Nashua Corporation, Dept. A3,
Nashua, NH 03061

We make everything to fit anything



TELEPHONE
New England and New York: (800) 258-1555
East of the Mississippi: (800) 258-1726
West of the Mississippi: (800) 258-1340
TELEX: 943406



A Message to our Subscribers

From time to time we make the BYTE subscriber list available to other companies who wish to send our subscribers promotional material about their products. We take great care to screen these companies, choosing only those who are reputable, and whose products, services, or information we feel would be of interest to you. Direct mail is an efficient medium for presenting the latest personal computer goods and services to our subscribers.

Many BYTE subscribers appreciate this controlled use of our mailing list, and look forward to finding

information of interest to them in the mail. Used are our subscribers' names and addresses only (no other information we may have is ever given).

While we believe the distribution of this information is of benefit to our subscribers, we firmly respect the wishes of any subscriber who does not want to receive such promotional literature. Should you wish to restrict the use of your name, simply send your request to BYTE Publications Inc, Attn: Circulation Department, 70 Main St, Peterborough NH 03458. Thank you.

Finding Words That Sound Alike

The Soundex Algorithm

Jacob R. Jacobs
1903 Fordham Way
Mountain View, CA 94040

The name I am searching for is "Johnson." But is it spelled "Johnson," "Johnsen," "Jonson," "Jonsen," or "Johanson"? The Soundex algorithm can help find words that sound alike by reducing a string to a Soundex code string consisting of a letter and up to three digits.

Alphabetic strings that sound alike generate identical Soundex code strings. The Soundex system is used in the Whatsit data-management system (from Computer Headware, POB 14694, San Francisco, CA 94114) that runs on the Apple, but the program presented here is my own. In the Whatsit program, you can ask, "WHAT SOUNDS (LIKE) JOHNSON?" Whatsit then lists every word it "knows" that sounds like the word "Johnson."

The Soundex algorithm was recently described by P.A.V. Hall and G.R. Dowling ("Approximate String Matching," *ACM Computing Surveys*, 12, 4, December 1980, p. 388), and it works as follows. We will call the entry-name string E\$ and the reduced output code string R\$. The first character of R\$ is merely the first character of E\$. The remaining letters of the E\$ string are replaced by their group code numbers as shown in table 1. Then all zeros are removed, and consecutive occurrences of the same digit are reduced to a single digit. Finally, the code is truncated on the left to leave one letter and up to three digits.

The Soundex program in listing 1 is written in Applesoft BASIC. To simplify conversion to other BASICs, I will give examples of the Applesoft MID\$ and LEFT\$ functions. A\$=MID\$(B\$,6,4) will set the string variable A\$ to a four-character substring of B\$ starting at the sixth character. A\$=LEFT\$(B\$,2) will set A\$ to the first two (i.e., leftmost) characters of B\$.

The Soundex subroutine beginning at line 1000 of listing 1 will accept the input string E\$ and return the reduced-code string R\$, and it will throw away

nonalphabetic characters. Lines 10 through 40 dimension the arrays E\$ and R\$, which are used for demonstration purposes only. The array W(N) is initialized to the group number corresponding to the Nth letter of the alphabet.

Listing 1: Written in Applesoft BASIC, this program accepts a character string E\$ as input, converts it to the Soundex code string R\$, and prints out all words that have the same code string.

```
10 J = 0
20 DIM E$(99),R$(99)
30 DIM W(26)
40 FOR I = 1 TO 26: READ W(I): NEXT
50 PRINT : INPUT "INPUT STRING: ";E$: PRINT
60 GOSUB 1000
70 J = J + 1
80 R$(J) = R$
90 E$(J) = E$
100 FOR M = 1 TO J
110 IF R$(M) = R$ THEN PRINT E$(M)
120 NEXT
130 GOTO 50
1000 REM SOUNDEX SUBROUTINE
1010 L = LEN (E$)
1020 S$ = ""
1030 R$ = LEFT$ (E$,1)
1040 ST = 0
1050 IF L < 2 THEN RETURN
1060 FOR I = 2 TO L
1070 C = ASC ( MID$ (E$,I,1))
1080 IF C < 65 OR C > 90 GOTO 1120
1090 C = C - 64
1100 W = W(C)
1110 IF W < > 0 THEN S$ = S$ + CHR$ (W + 48)
1120 NEXT
1130 L = LEN (S$)
1140 IF L = 0 GOTO 1210
1150 FOR I = 1 TO L
1160 C = ASC ( MID$ (S$,I,1))
1170 IF C < > ST THEN R$ = R$ + MID$ (S$,I,1)
1180 ST = C
1190 NEXT
1200 IF LEN (R$) > 4 THEN R$ = LEFT$ (R$,4)
1210 RETURN
1220 DATA 0,1,2,3,0,1,2,0,0,2,2,4,5,5,0,1,2,6,2,3,0,1,0,2,0,2
]
```

Programming Quickie

For example, `W(3)` contains the number 2 corresponding to the assignment of the letter C (i.e., the third letter of the alphabet) to the group 2. This initialization occurs in line 40, using the data statement in line 1220, and should be done once at the beginning of your main program.

Lines 50 through 130 form a simple demonstration program that stores each word as it is typed in together with its code word. The original word and the code word are stored in arrays `E$()` and `R$()`, respectively. Each time you add a word, the program prints out all words that have the same code word, finding them by doing a linear search through the code words.

The Soundex Subroutine

The Soundex subroutine appears in lines 1000 through 1220. Lines 30 and 40 are also needed to initialize array

Group	Letters
0	A E I O U H W Y
1	B F P V
2	C G J K Q S X Z
3	D T
4	L
5	M N
6	R

Table 1

`W`. The first letter of `E$` is put into `R$`. If the length of `E$` is 0 (null string) or 1, then the subroutine terminates (line 1050). Otherwise each character of `E$`, starting at the second character, is scanned and its group code is put into the intermediate string `S$` unless the character is not a letter or the letter falls in group 0. For example, if we type `SOMMERSET`, when the program gets to line 1130, `S$` will contain `S55623`. Next, consecutive occurrences of the same group number will be reduced to a single occurrence of that number. Thus the `55` in `S55623` will become a single `5`. When the program gets to line 1200, the string `R$` will be `S5623`. Line 1200 truncates the string `R$` to four characters, becoming `S562`, which is the code word for `SOMMERSET`. Let's take another look at the steps, shown *before* the execution of each line:

line	S\$	R\$
1030	null	S
1130	55623	S
1200	55623	S5623
1210	55623	S562

This algorithm has some serious limitations. Although our "Johnson" examples work fine, with the resulting code for the different spellings being `J525`, "phone" and "fone" do not give the same code because they start with different letters; "Rogers" and "Rodgers" do not work because the *d* is not in the same code group as *g*. And words like "tough" and "tuff" do not translate to the same code because *g* and *f* are in different code groups. But the Soundex algorithm works well for most words and proper names.

To try the Soundex algorithm, enter the program in listing 1 and run it. Type in some names. Every time you type a new name, the program will list on the screen all the words entered that have the same Soundex code. If you add the line

```
65 PRINT R$
```

the Soundex code will also be printed.

Applications

The Soundex subroutine has many applications. If you have a card-file program that searches for items by matching a "key" string, rather than returning the message

```
MATCH NOT FOUND
```

or some such, your program could jump into the "Soundex mode," look for matches that sound similar to the key, and then list them. You could then look through the list of near matches to see if the word sought is in the list. This short Soundex subroutine can add a lot of "flash" to what might otherwise be a mundane program. ■

Stocking genuine DEC computer spares

Spare Parts for:
DEC PDP Computer Family
DEC Line Printers
DEC Video Screens
LSI-11
Others

Call Radgo. We handle genuine DEC parts manufactured by DIGITAL EQUIPMENT CORPORATION. We sell at factory prices with FACTORY WARRANTY. Radgo is stocked and staffed to help you with your requirements for most general purpose K & M series and many COMPUTER SPARE MODULES and COMPONENTS. We also stock a large assortment of COMPUTER SUPPLIES.

Radgo Sales Co.

To order or for free catalog call
1-800-543-1986. Ohio customers phone
1-513-752-6880

3988 McMANN RD.. CINCINNATI, OH 45245

What's New?

SYSTEMS



Multifunction Desktop Computers

The AWS family of multifunction work stations offer 0.5 megabyte of storage. These desktop work stations are based on the 16-bit Intel 8088 microprocessor and carry a combination of floppy- and Winchester hard-disk drives in the same enclosure as the processor and the display screen. Each AWS work station supports up to 512K bytes of RAM (random-access memory) based on 64K-byte RAM integrated circuits, an 80-character by 28-line video-display unit, and an optional mass-storage unit. The units can function as stand-alone terminals or as members of a local network by means of a high-speed data link, sharing peripherals and databases.

In single-units, the AWS work station ranges in price from \$3990 to approximately \$11,500, depending on optional equip-

ment. For additional details, contact Pauline Alker, Convergent Technologies, 2500 Augustine Dr., Santa Clara, CA 95051, (800) 538-7560; in California (408) 727-8830. Circle 550 on inquiry card.

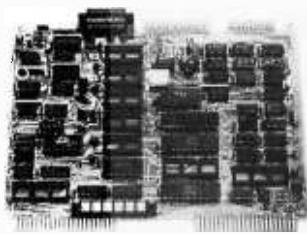

Single-Board Computer Can Support 56K Bytes of Memory

The Flexi Plus is a 6809-based single-board microcomputer that can accommodate up to 56K bytes of on-board RAM (random-access read/write memory), ROM (read-only memory), and EPROM (erasable programmable ROM) in any combination. Flexi Plus features extensive serial and parallel I/O (in-

put/output) capabilities, a 20-milliampere current-loop TTY (teletypewriter) port, and a universal cassette interface. When used without its 6809 option, the Flexi Plus can serve as an expansion board for most 6502-, 6800-, or 6809-based systems.

Optionally, the Flexi Plus can be expanded to include an IBM-format-compatible floppy-disk controller that can support up to four 8-inch drives or three 5¼-inch drives. Additional options include an IEEE-488 bus controller and a fully buffered RS-232C communications port with programmable data formats and transfer rates from 50 to 19,500 bps (bits per second).

The Flexi Plus costs \$320. The 6809 and the RS-232C options are available for \$75 each. Both the floppy-disk and the IEEE-488 bus controllers cost \$125. Literature is available on request. Contact Robert M. Tripp, The Computerist Inc., 34 Chelmsford St., Chelmsford, MA 01824, (617) 256-3649.

Circle 551 on inquiry card.

STD Bus Controller Card

The ZT7805 controller card for the STD bus features an 8085A microprocessor, 1K bytes of programmable memory, up to 8K bytes of ROM (read-only memory), IEEE-488 I/O (input/output) and two serial RS-232C ports, and a control monitor with I/O subroutines. The board

costs \$650. Contact Ziatech Corp., 2410 Broad St., San Luis Obispo, CA 93401, (805) 541-0488. Circle 552 on inquiry card.

Modular Microcomputer

The Sintel-85 is a modular microcomputer training system based on the Intel 8085 microprocessor. It has 2K bytes of ROM (read-only memory) with expandable monitor, 256K bytes of RAM (random-access read/write memory), three programmable I/O (input/output) ports, a 6-digit display with both address and data fields, and a 24-key keyboard with eight command keys and 16 hexadecimal keys.

Sintel-85 can be expanded to include up to 64K bytes of memory and 256 I/O ports. A wide range of expansion and interface boards are available, including A/D (analog-to-digital) and D/A (digital-to-analog) converters, cassette interface, an immediate expansion board, and audio-visual I/O ports interface. The immediate expansion board augments the basic system with additional RAM, 4K bytes of EPROM (erasable programmable ROM), two counter/timers, and 44 programmed I/O lines. It includes two 8156 units, two 2114 static RAMs, and sockets for two 2716 ROMs. Also available is an I/O expansion board that lets you exercise and simulate I/O instructions, external systems operation, and program debugging. An oscillator lets you oper-

What's New?

ate a small speaker. For more details, contact Beth Belkin, Government of Israel Trade Center, 350 Fifth Ave., New York, NY 10118, (212) 560-0661. In

Israel, contact Sintel Systems Ltd., 13 Ovadia St., POB 9209, Haifa, Israel 34564, (04) 334944; Telex: 46400 BXHA IL, ext. 8134. Circle 553 on inquiry card.

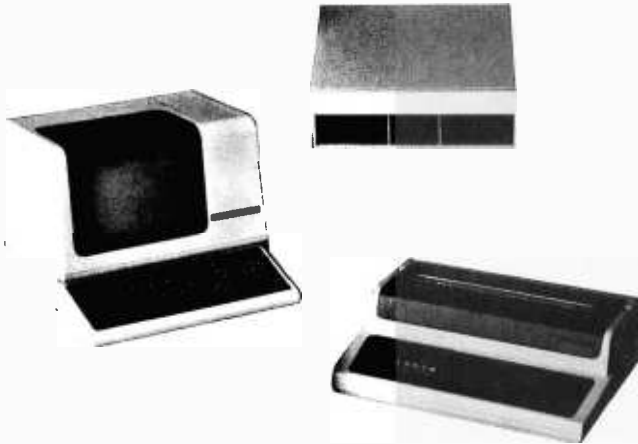

Business System Has Three Z80s

The ARCmicro is a small-business microcomputer system with three separate Z80 microprocessors: the system processor, the disk processor, and the terminal processor. The system supports two 5¼-inch Winchester disks for a total of 20 megabytes of formatted storage and four 5¼-inch double-sided, double-density floppy-disks totaling 3.2 megabytes of storage. System memory is expandable from 64K bytes to 256K bytes. The terminal processor controls all video-display units, printers, and communications links with the system processor, which frees the system processor from interrupts and increases communications throughput.

Other features of the ARCmicro include a shadow ROM (read-only memory) that contains self-

diagnostics and bootstrap programs that execute during system initialization. The self-diagnostic programs perform memory and peripheral device tests to assure integrity each time the system is initialized. The ROM then "disappears" from the address space and is available for use by the program memory.

The ARCmicro is currently available as a complete microcomputer system called the ARCmicro/PAC, which includes a DEC (Digital Equipment Corporation) VT-101 video display, a DEC LA-34 printer, and either the CP/M 2.2 or the MP/M II disk operating system. Contact ARC Automation Group Inc., POB 1009, Bryan, TX 77805, (713) 693-6122.

Circle 554 on inquiry card.

SOFTWARE

Step FORTH to RPL

RPL is a FORTH-like language that runs on PET and CBM (Commodore Business Machines) computers. RPL (Reverse Polish Language) uses the Commodore BASIC screen editor for program entry and editing, but does not inhibit the use of BASIC throughout a software development session. The RPL Compiler and the screen-oriented, object-level Symbolic Debugger reside in the top 8K bytes of memory and can be called directly from BASIC commands. Source code is saved to disk or cassette and is compiled memory-to-memory.

RPL has special keywords and symbols that let you nest multiline IF... THEN...ELSE constructs and FOR...NEXT loops. Other special keywords and symbols offer named subroutines and functions of arbitrary length, 16-bit integer arithmetic and logical manipulations, built-in character-string handling, stack-management directives that include n-index and n-rotate, access to machine language, predefined arrays with numeric and string contents, local and global symbols, and forward and backward symbolic references, including GOTO. Also provided are GET, INPUT, and PRINT operators.

The RPL Compiler, including a 60-page user's manual, is available on disk for \$49.95 or on cassette for \$44.95. The complete

Compiler and Symbolic Debugger costs \$80.91 on disk or \$71.91 on cassette; manuals are available for \$10 and \$4, respectively. For details, contact Samurai Software, POB 2902, Pompano Beach, FL 33062, (800) 327-8965, ext. 2; in Florida (305) 782-9985. Circle 555 on inquiry card.

Take Your Projects to Task

Task is a management tool to help you schedule a project. It combines the procedures of PERT (Performance, Evaluation, and Review Techniques) and the Critical Path Method, which divides a complex project into assignments and determines which are critical to the overall completion of the project. Task determines the scheduled start and completion dates for each assignment in a project, which tasks cannot be delayed if the project is to be completed on time, and the amount of time each noncritical task can be delayed without affecting the completion date of a project. Among the options included with Task are the ability to create a calendar to work with a particular work schedule, an expanded Gantt diagram, and a management report that can detail each task, including its start and finish times.

Task is a compiled program running under CP/M. It costs \$329 and is available from AMSI, Suite 200, 1935 Cliff Valley Way NE, Atlanta, GA 30329, (404) 634-9535.

Circle 556 on inquiry card.

What's New?

Overlay Compiler

An overlay structure is now possible with North Star BASIC under an extension to the Comstar compiler. Overlay structures differ from program chaining in that a root program segment and selected program variables remain intact when a new program segment is introduced. Overlay structures permit large programs to be executed.

The Overlay extension is suitable for menu-driven programs and includes a Comstar-CP/M capability. The Overlay extension is available to registered owners of the Comstar compiler for \$75 from Allen Ashley, 395 Sierra Madre Villa, Pasadena, CA 91107, (213) 793-5748. Circle 557 on inquiry card.

Smartkey for CP/M and Software Applications

The Smartkey is a keyboard utility for the CP/M operating system that solves the problem of incompatibility between the console keyboard hardware and applications software. The program acts as an interface between the keyboard and CP/M by allowing the user to "redefine" the keyboard. Codes generated by individual keys can be changed at will or made to generate a sequence of characters at each keystroke. The keyboard's layout can be improved or customized for particular applications software, and sets of key definitions can be saved to

disk for later use. Definitions can be altered at any time.

Smartkey does not require hardware or software knowledge to install or use. It's available for \$39 from FBN Software, 1111 Sawmill Gulch Rd., Pebble Beach, CA 93953, (408) 373-5303.

Circle 558 on inquiry card.

Mail-List Manager

The One-Disk Mail-List Manager is a mailing-list management and a label-printing utility for Radio Shack's TRS-80 Models I and III. The program disk can hold 430 records that include name, company, address, and zip code. Records can be sorted alphabetically or by zip code using machine language at a speed of 100 records every 3.5 seconds. Entries are made on a first-name-first basis, and multiple entries are handled by single-keystroke repetition of the address. Labels can be printed from sorted or unsorted lists and by any combination of selection fields. Other features include a label-selecting Print Key that can print labels for any geographic area (i.e., city, state, or zip code).

The One-Disk Mail-List Manager requires 32K bytes of memory; conversion to Model III DOS is necessary. It costs \$34.95 and is available from Manhattan Software, POB 1063, Woodland Hills, CA 91365. MasterCard or Visa holders can order by calling (213) 704-8495. Circle 559 on inquiry card.



Continuous Wave Interface for TRS-80

MFJ Enterprises' CW (continuous wave) Transceive Program and Hardware Interface lets you send CW on your keyboard and receive CW on your video-display screen. It features a tri-split screen for received messages, transmit buffer, and programmable message index. Its text buffer can hold 3295 characters when used with a 16K-byte machine, and it can be preloaded while receiving messages. The package has ten 199-character programmable message memories with on-screen message index. Messages can be repeated or combined, and speed is adjustable from 12 to 55 words per minute (wpm). For group-code practice, up to 2200 characters can be stored. The package automatically receives up to 100 wpm and allows you to store up to five screens of received CW. When the transmit buffer is empty, the mode is automatically changed to receive.

MFJ's hardware interface plugs between the transceiver and the computer without modifications. The cassette-based, disk-compatible program and the hardware-interface package run on a 16K-byte

TRS-80 Model I or III. The Transceiver and Hardware Interface costs \$99.95, plus a \$4 shipping charge. Contact MFJ Enterprises Inc., POB 494, Mississippi State, MS 39762, (601) 323-5869. MasterCard or Visa holders can order by calling (800) 647-1800.

Circle 560 on inquiry card.

Let Your Modem Do the Talking

The automated sales force at Telephone Software Connection delivers its products at any time of the day or night over telephone lines. The Connection's Apple-compatible software comes with complete documentation embedded in the programs. The Connection presently offers telecommunications software, games, and educational programs, as well as utilities for the Apple II. Several free programs are offered by means of the telecommunications hook-up.

For more information, contact Telephone Software Connection Inc., POB 6548, Torrance, CA 90504, (213) 516-9430. The telephone number for the modem connection is (213) 516-9432. Payment is by credit card. Circle 561 on inquiry card.

What's New?

Educational Game Show

The Game Show is a multiplayer educational game program featuring animated color graphics. It comes with games in vocabulary, history, algebra, sailing, and computer terms. An authoring system that lets you add your own topics is provided.

The Game Show runs on the Apple computer. It costs \$45, which includes documentation, a one-year warranty, and a backup disk. Available at computer dealers or directly from Computer-Advanced Ideas Inc., Suite 341, 1442A Walnut St., Berkeley, CA 94709, (415) 526-9100. Circle 562 on inquiry card.

Profile III +

The Profile III + is a database management package for Radio Shack's TRS-80 Model III computer. It can communicate with Personal Software's Visicalc financial-modeling program and with Radio Shack's Superscript word-processing program. This combination gives the Model III owner a complete management-information tool.

Profile III + is menu-driven with user options appearing at the bottom of the screen. Customized or special limited menus can be created. The system's screen editor lets database designers visually organize an input screen, and fields and user prompts can be moved by means of function keys. Screens can be password-protected. Up to

99 fields per record can be defined, and as many as 64,000 records are allowed. Maximum record size is 1020 characters. Up to 36 fields can be searched or sorted, and wild cards containing partial-field values are permitted.

Profile III + requires a 48K-byte TRS-80 Model III with a single disk drive. It costs \$300, which includes manufacturer-supplied updates. Contact The Small Computer Company Inc., 40 West Ridgewood Ave., Ridgewood, NJ 07450, (201) 445-5643.

Circle 563 on inquiry card.

Integrate Real-Time Software Tasks

The Multi-Tasking Kernel is a tool for integrating multiple real-time software tasks in 8085-, Z80-, 6502-, 6800-, and 6809-based microcomputer products. The package includes source code for a basic multitasking organization in which tasks self-schedule in a round-robin fashion. The package provides the user with guides through a series of enhancements for carrying out sophisticated, interrupt-initiated, preemptive priority dynamic-task scheduling. Also included are descriptions of dedicated and shared resource scheduling, time-slice scheduling, and intertask communication schemes.

The Multi-Tasking Kernel costs \$195, which includes assembly-language source-code implementations for the 8085, Z80, 6502, 6800, and 6809 micropro-

cessors. Contact US Software, 5470 Northwest Innisbrook Pl., Portland, OR 97229, (503) 645-5043. Circle 564 on inquiry card.

BASIC Editor for TRS-80s

EDIT is a full-screen BASIC editor for Radio Shack's TRS-80 Models I and III. It features a floating-point cursor with automatic repeat functions and a Scipsit-like control structure for easy handling. More than 30 commands permit professional-quality editing of BASIC text at the character, word, line, or block level.

EDIT was developed in England by Southern Software. It costs \$40 and is being distributed in the U.S. by Allen Gelder Software, POB 11721, Main Post Office, San Francisco, CA 94101.

Circle 565 on inquiry card.

Insurance Rating Programs

Orion Business Systems' Orionrater programs could make the insurance agent's rating book a piece of the past. This series of property and casualty rating programs can quickly compare and print out quotes. They are simple to operate and do not require insurance or technical backgrounds. Among the programs available are Auto insurance, Homeowners/Condo Owners and Renters insurance, Commercial Truck insurance, and Commercial Liability insurance.

Most Orionrater programs run on 48K-byte Apple II Plus computers equipped with a disk drive and controller, a monitor, and a printer. Prices range from \$475 to \$750. For complete specifications, contact Orion Business Systems, Suite 102, 11777 Bernardo Plaza Court, San Diego, CA 92128, (714) 485-8580.

Circle 568 on inquiry card.

C/80 Compiler

C/80 is a compiler for the C programming language that provides random-access file I/O (input/output) and Macro-80 compatibility. It generates 8080 assembly-language code for the assembler or for Microsoft's Macro-80 relocatable assembler and linking loader. All C language control statements and arithmetic and logical operators are supported as well as character and 16-bit integer data, pointers, arrays, strings, data initialization, inline assembly language, conditional compilation, and most preprocessor functions. C/80's run-time library provides standard C I/O functions and features dynamic storage allocation, I/O redirection, and a run-time execution-profile facility for easy program optimization.

C/80 lacks structures, pointers to pointers, and long and floating data types. Available on 8-inch CP/M disks and on 5¼-inch Heath/Zenith CP/M or HDOS disks, C/80 costs \$39.95. Contact The Software Toolworks,

What's New?

14478 Giorietta Dr., Sherman Oaks, CA 91423, (213) 986-4885.
Circle 569 on inquiry card.

Atari Graphics Composer

The Graphics Composer is a joystick/paddle graphics software package for Atari 400/800 microcomputers. With it you can draw the outline of a picture in high-resolution screen mode 8 or 7 using a joystick or paddle; then you can use color fill-in, color brushes, and text to complete your graphics scheme. The graphics can then be saved to disk or cassette.

Graphics Composer is supplied with a Geometric Figures program that allows you to define circles, triangles, polygons, parallelograms, and trigonometric curves. Graphics Composer is available in both cassette and disk versions for \$39.95. It requires 32K bytes of programmable memory. Contact Versa Computing Inc., Suite 104, 3541 Old Conejo Rd., Newbury Park, CA 91320, (805) 498-1956.

Circle 570 on inquiry card.

New C Compiler

Phase One Systems has unveiled a C compiler for its Oasis operating system. Oasis C supports most Unix Version Seven C features. It produces Z80 assembler code and is provided with an optimizer that reduces compiled code between 30 and 50%. Among the attributes of Oasis C are

pointers, structures, assignment operators, a full I/O (input/output) library, and compile options. A version of Oasis C for the 16-bit-compatible Oasis-16 will be available.

Oasis C costs \$250. For complete details, contact Phase One Systems Inc., Suite 830, 7700 Edgewater Dr., Oakland, CA 94621, (415) 562-8085.

Circle 571 on inquiry card.

PERIPHERALS

Model III Cash-Register Expansion System

The CR-180 is a cash register/point-of-sale expansion system for the TRS-80 Model III microcomputer. It stores transactions for up to 100 employees, saves eight methods of payments, and provides inventory control and complete reporting. The CR-180 can produce daily sales and cash reports by employee and by type of transaction, inventory usage reports, and gross profit computation. Also, price and shelf labels can be printed.

The CR-180 expansion system is supplied with an electronic cash drawer and a receipt printer which plug directly into the TRS-80 Model III. Audio has been added for keystroke confirmation. Prices range from \$900 to \$1900. Contact Integrated Cash Register/Futuresoft, Southern Region, Suite 203, 2301 Park Ave., POB 1446, Orange Park, FL 32073, (904) 269-1918.

Circle 572 on inquiry card.



Draft- and Letter-Quality Printer

Printer Systems' Model 1800 printer can produce both correspondence- and draft-quality printouts. It is plug-compatible with IBM Series I or System 34/38 computers as well as Univac, Burroughs, Honeywell, DEC (Digital Equipment Corp.), and Data General computers. In the draft mode, the Model 1800 prints at 200 cps (characters per second) with a 7 by 9 dot-matrix format. In the correspondence mode, it prints at 50 cps in a 40 by 18 format. The Model 1800 features a forms-length selector switch and quiet operation.

The Model 1800 printer is available for \$2695 from Printer Systems Corp., Suite 104, 1 West Deer Park Rd., Gaithersburg, MD 20760, (301) 840-1070.

Circle 573 on inquiry card.

I/O Control Card

The G519 I/O card is an interface between the Multibus and Gordos industry-standard PB-16/PB-24 I/O (input/output) module boards. The card

can control up to 72 AC or DC input or output modules in any combination or position on the I/O module board. It can also serve as a general-purpose TTL (transistor-transistor logic) interface card for control of up to 72 bidirectional I/O lines.

Gordos International also has interface cards for the RM-65, the Exorcisor II, and STD bus. The G519 I/O card is priced at \$500. For details, contact Gordos Corp., 250 Glenwood Ave., POB 100, Bloomfield, NJ 07003, (201) 743-6800. Circle 574 on inquiry card.



Analog Peripheral

The Analog Peripheral is a self-contained 8-bit A/D (analog-to-digital) converter that can connect to any computer. It has a switch-selectable RS-232C output line with data transmission rates from 110 to 9600 bps (bits per second). Other features include a 26-pin parallel output, four input channels, conversion speeds of 100 microseconds, power supply, and plug-in sensors for temperature, light and other analog signals. For complete details on the Analog Peripheral, contact Cambridge Development Laboratory, 36 Pleasant St., Watertown, MA 02172, (617) 926-0869.

Circle 575 on inquiry card.

What's New?

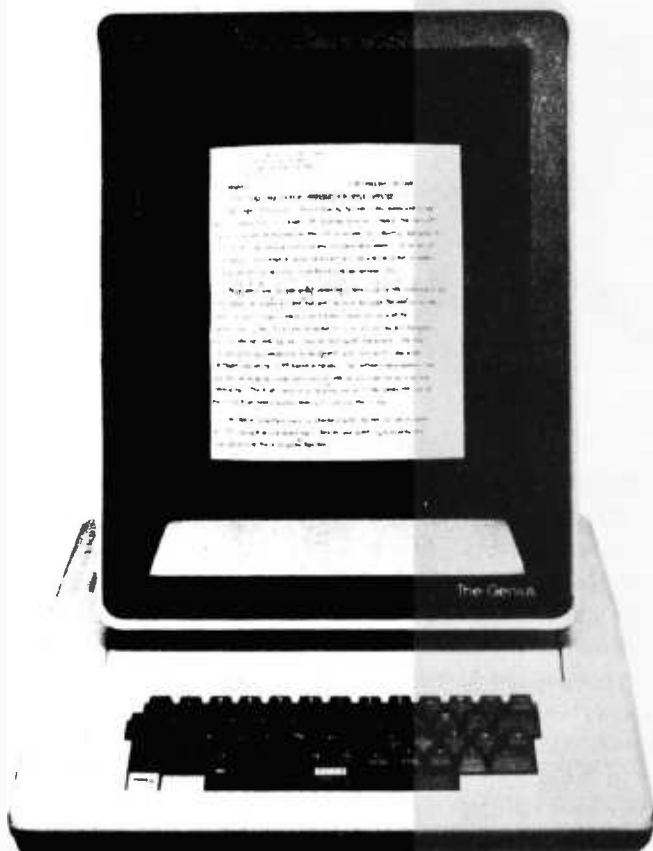

Genius Display System

The Genius is an Apple-compatible, full-page video-display terminal. The 15-inch Genius displays 57 lines of text by 80 characters, or optionally 66 lines by 80 characters. The Genius is compatible with the Wordstar word-processing system and many CP/M-based programs. Large sections of code can be displayed at one time, which is a plus for software

developers, and the high-resolution display has an 87 MHz bandwidth and 6K bytes of high-speed buffer memory.

The Genius is supplied with an Apple interface card. It is available for \$1795 from Micro Display Systems Inc., 514 Vermillion St., Hastings, MN 55033, (612) 437-2233. Circle 576 on inquiry card.

Single-Pen Drum Plotter

The Complot CPS-20 is a single-pen, 11-inch drum plotter that can interface with most computers. The only alteration needed to use the CPS-20 with different computers is the switching of a single interface card. The high-effi-

ciency CPS-20 operates at 3 inches per second at a resolution of 0.005 inch. It costs \$3995. Contact Houston Instrument, One Houston Square, Austin, TX 78753, (512) 837-2820. Circle 577 on inquiry card.

Line Controller Adds Voice Synthesis

The SLC-II is a serial line controller that combines microprocessor intelligence with a versatile voice-synthesis capability. The controller can automatically dial telephone lines and talk by means of its electronically synthesized voice. It can listen and respond to incoming messages that originate at a remote terminal or are generated by a telephone keypad. The SLC-II's vocabulary includes more than 300 words as well as the complete alphabet and numerals, and it will spell any word it cannot say.

The SLC-II provides ASCII input/output, Touch-Tone input, printer output, external amplifier output, and synthesized voice output. A built-in power backup is provided by rechargeable batteries. In addition, the SLC-II features an auto-dial/auto-answer modem; 16K, 32K, or 80K bytes of programmable memory; and automatic time and date entry with day, month, and year. Applications include data collection and transmission, telephone access to large databases, alarm signaling, and security or facility monitoring. Connections to existing computer systems are made by standard RS-232C or 20 mA serial-loop interface.

In single-unit quantity, the SLC-II costs \$1975. Contact Digital Pathways Inc., 1260 L'Avenida, Mountain View, CA 94043, (415) 969-7600. Circle 578 on inquiry card.



Dot-Matrix Printer

NEC Home Electronics' PC-8023A dot-matrix printer can bidirectionally print the upper- and lower-case ASCII (American Standard Code for Information Interchange) character set featured on the PC-8001A microcomputer. In addition, the printer provides many Greek, mathematical, and graphics symbols. The high-speed PC-8023A is equipped with a standard parallel interface and features the ability to print dot-graphics screens on paper. Up to three copies of fanfold, roll, or cut-sheet paper and originals are possible using either pin- or friction-feed delivery. Paper widths range from 11.5 to 25 cm (4½ to 10 inches).

The PC-8023A's matrix options include 7 by 9 English or 8 by 8 graphic and dot graphic, ranging from 40 columns by 4 characters per inch to 136 columns by 17 characters per inch. Print speed is 100 cps (characters per second), and all fonts fea-

What's New?

ture fixed- or proportional-spacing format options at 6 or 8 lines per inch, plus $\frac{1}{144}$ -inch incremental line feed.

The PC-8023A printer costs \$795. Contact NEC Home Electronics USA, Personal Computer Division, 1401 Estes Ave., Elk Grove Village, IL 60007, (312) 228-5900.

Circle 579 on inquiry card.

Apple II ROM Board

The Andromeda ROM (read-only memory) Board lets you plug utility programs into your Apple II and access them without loading from disk. The Board has space for 2K- or 4K-byte PROMs (programmable read-only memories) and it can accommodate 2K-byte programmable memory devices. (This gives you read/write capabilities for developing custom PROM programs.) Two 2732 PROMs allow a total of 8K bytes of memory on the ROM Board.

The ROM Board is supplied with a utility ROM that gives you five options with your Applesoft programs: you can perform automatic line numbering, alphabetize a disk catalog, control a program list with a page mode, restore crashed Applesoft programs in memory, and create a disk without using the disk operating system. The ROM Board with utility ROM costs \$125 and is distributed by Computer Data Services, POB 696, Amherst, NH 03031, (603) 673-7375.

Circle 580 on inquiry card.

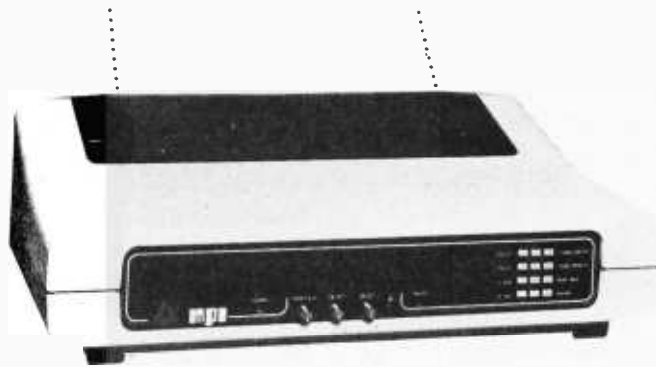

Heavy-Duty Printer

The Model MP150 matrix printer has a heavy-duty print head, rated for continuous duty, with an expected life in excess of 100 million characters. Characters are formed bidirectionally in a logic-seeking mode to optimize system throughput. Nine print wires provide clear characters with true descenders and underscores. The MP150 can print 136 characters per line at 10 characters per inch, or up to 226 columns can be printed by selecting the 12- or 16.7-character-per-inch density. Double-width characters are software-selectable. A 7 by 9 matrix font is used for high-speed data printing and an 11 by 9 serif-style matrix font can be used for high-quality printouts. The MP150 features the standard 96-character ASCII (American Standard Code for Information Interchange) set with four strap-selectable foreign fonts.

The MP150 is capable of high-resolution dot-addressable graphics for plotting, printing of screen graphics, and drawing of illustrations. Forms handling

is carried out by a stepper-motor-drive tractor paper feed that can be adjusted to accept forms from 7.5 to 38 centimeters (3 to 15 inches) in width. Eight user-selectable forms lengths, skip-over-perforation, and six user-selectable character densities are featured.

The MP150's 1K-byte buffer is expandable to 8K bytes, and its Centronics-type interface can accept parallel TTL (transistor-transistor logic) level data at over 1000 characters per second. Optionally, an RS-232C serial interface can be added to the MP150. The RS-232C interface can accept data at any one of seven rates up to 9600 bps (bits per second) and it supports X-ON/X-OFF and ETX/STX protocols. Another option is an IEEE-to-Centronics interface adapter card for connecting devices with an IEEE-488-bus output port.

The Model MP150 printer costs \$1095. Contact MPI, 4426 South Century Dr., Salt Lake City, UT 84107, (801) 263-3081.

Circle 581 on inquiry card.

Universal Systems Interface

The Shugart Associates Systems Interface (SASI) is a universal interface that allows streaming-tape cartridge and floppy- and Winchester-disk drives to use a standard system interface. SASI eliminates having to develop new controllers, host adapters, and software drivers each time a new memory device is integrated into a system. Other SASI operating features include the ability to attach up to eight host processors and controllers per SASI bus, a search capability to assist file-management systems in locating key parameters, multiple command types, and self-arbitration for control of the SASI bus on a memory-device-priority basis.

SASI is already available on Shugart's SA1400 Series of disk-drive controllers.

In OEM (original equipment manufacturer) quantities, the price for Shugart's SA1400 series of disk-drive controllers with an SASI interface begins at \$565. For complete details, contact Shugart Associates, 475 Oakmead Parkway, Sunnyvale, CA 94086, (408) 733-0100.

Circle 582 on inquiry card.

Scorpio Family

The Scorpio family of 8-inch Winchester disk drives from Ampex have an average access time of 30 milliseconds with a data-transfer rate of 1.2 megabytes and an average latency of 8.3 milliseconds. This is achieved by means

What's New?

of a linear voice-coil actuator in a closed-loop servo system. All critical components are enclosed in a sealed module to assure long-term reliability and data integrity. Additional features ensuring data integrity include head-landing zones, module shock mounting, and self-actuating head-carriage and disk-spindle locks. Mean time between failures is 10,000 hours.

The Scorpio family is available in two versions: Model 48 with 49.7 megabytes of storage and the

Model 80 with 82.9 megabytes of unformatted storage capacity and 20,160 bytes per track over 823 cylinders. The Model 80 is interface-compatible and software-transparent to any host system using industry-standard 80-megabyte disk drives, such as the Ampex DM-980.

For further details on the Scorpio family, contact Ampex Corporation, Memory Products Division, 200 North Nash St., El Segundo, CA 90245, (213) 640-0150.

Circle 583 on inquiry card.



Wireless Building Automation

The Telebrain RS-232C is a wireless computer interface that can communicate programmed, automated-switching decisions throughout an entire facility using the existing AC wiring. It can transmit switching decisions emanating from a host computer, per software developed by the facility, to any one of 1600 independent control points, or Teleswitches. The Teleswitch receives and identifies the command and performs the necessary switching.

Telebrain incorporates National Energy's Solution 100 and Solution 1600 programs and the Telegain amplifier. The Solution 100 software includes independent programmable control of up to 83 unique points allowing for 7-day programming, daily start-up, shut-down, and duty cycling. Telebrain can interface with any computer that has an RS-232C serial output port.

Applications include facility management and automation including lighting control, activation of security systems, materials

handling, and energy management encompassing load scheduling, demand limiting, duty cycling, optimum start-up, and so on, based on analog input. For complete details, contact National Energy Corp., 1795 Williston Rd., South Burlington, VT (800) 451-3410; in Vermont (802) 658-6445.

Circle 584 on inquiry card.

Color Word-Processing System

NEC Home Electronics' color word-processing system features a self-teaching program and a 12,000-word dictionary. The system is menu-driven, which reduces the possibility for errors, and features all-green text, instructions in yellow or blue, and violet-highlighted potential deletions. The system provides automatic page numbering, draft printing without leaving the document, stock-paragraph and form-letter appending to any document, automatic disk-overflow routine, user-oriented document name listing, unlimited headers and footers, disk-supply indicator, single-key commands, and block move, copy, delete, write, print, and justification capabilities.

When combined with NEC's PC-8001A micro-computer, color monitor, printer, I/O (input/output) unit, and a disk drive, the color word-processing system adds the final touch to a complete computer system that costs less than

\$6000. Contact NEC Home Electronics USA, Personal Computer Div., 1401 Estes Ave., Elk Grove Village, IL 60007, (312) 228-5900, for complete details.

Circle 585 on inquiry card.

Portable Terminal Has Modem and Printer

Business people will find the Lex-21 portable printing and communications terminal useful in providing access to remote computing services, in field service, for inventory checks, accounting systems, electronic mail, and up-to-the-minute price quotations. Lex-21 features a 59-key ASCII (American Standard Code for Information Interchange) keyboard and a 40-column thermal printer with upper- and lowercase descenders and a 5 by 7 dot-matrix character format. It has a built-in full-duplex 300 bps (bits per second) modem with originate or answer modes, Bell 103A compatibility, and an FCC-approved handset connection. Its industry-compatible asynchronous communications protocol allows transmission at 10 or 30 characters. Its battery-backed memory includes a 1K-byte receive buffer and 2K bytes of compose and edit memory.

The Lex-21 costs \$1195. For details, contact Lexicon Corporation, 1541 Northwest 65th Ave., Fort Lauderdale, FL 33313, (305) 792-4400.

Circle 586 on inquiry card.

What's New?



Video Selector

The Archer Video Selector is a compact, push-button video-switching and control center designed to eliminate the need to repeatedly change cable connections. It simplifies signal routing even for complex home video systems. Two banks of push buttons provide the necessary switching and signal routing between four 75-ohm coaxial inputs and one phono jack to three 75-ohm coaxial outputs. The inputs permit the connection of any combination of five video sources, such as cable television, an

antenna, a videocassette or videodisc player, a camera, and a small computer. The three outputs allow simultaneous viewing and recording of a selected input.

The Archer Video Selector offers a signal-path bandwidth from 50 to 900 MHz. No power is required. The Archer Video Selector costs \$79.95 and is available at Radio Shack stores and participating dealers. Contact Radio Shack, 1800 One Tandy Center, Fort Worth, TX 76102, (817) 390-3300. Circle 587 on inquiry card.

ROM Simulator

Lamar Instruments' ROM (read-only memory) simulator is designed to reside in an Apple II-based development system for use in developing software for another, "target" computer. The device can take the place of a ROM, PROM (programmable ROM), or EPROM (erasable programmable ROM) normally located in the target computer and is useful for developing software eventually destined to be placed in ROM. The ROM simulator connects to the target computer by means of a 24-pin dual-inline package

(DIP) and a ribbon cable.

The double-sided ROM simulator has plated-through holes, silk-screened legends, gold-plated contact fingers, and is solder-masked. It has 2K bytes of high-speed, low-power, CMOS (complementary metal-oxide semiconductor) static programmable memory that resides in hexadecimal C800 to CFFF in the Apple II memory map. It contains the necessary logic to automatically switch control of the address and data bus from the Apple II to Lamar Instruments' Superkim (i.e., target) ROM sockets. The

price is \$295. Contact Lamar Instruments, 2107 Artesia Blvd., Redondo Beach, CA 90278, (213) 374-1673.

Circle 588 on inquiry card.

Options Package for DS180 Printer

Datasouth Computer's special package of options for its DS180 matrix printer includes graphics, compressed print, display mode, an expanded buffer, and a dot-addressable raster-scan feature that lets you print computer-generated charts and graphics. Under program control, six print wires can be addressed to print high-density output at a resolution of 75 by 72 dots per inch.

In the compressed print mode, the package permits manual or program selection of print sizes including 10, 12, and 16.5 characters per inch as well as expanded modes of 5, 6, and 8.25 characters per inch. This permits the DS180 to print from 132 columns on an 8½-inch form to 217 columns on a 14⅞-inch form.

The display mode lets you print out or "display" the nonprinting ASCII (American Standard Code for Information Interchange) control codes.

The package of options costs \$150. The DS180 printer, which operates at 180 characters per second, costs \$595. Contact Datasouth Computer Corp., 4740-A Dwight Evans Rd., Charlotte, NC 28210, (704) 523-8500. Circle 589 on inquiry card.

MISCELLANEOUS



Wire-Wrap Tool

The Model OK-729 pneumatic wire-wrapping tools feature precision steel drive components enclosed in a Lexan-reinforced case. A positive indexing mechanism with adjustable stop location and a 6-foot (2-meter) flexible air hose are provided. The OK-729 is available in two versions: a 5000 RPM (revolutions per minute) version and a model with a higher torque and a speed of 3000 RPMs for cut/strip/wrap applications. Both versions are designed to operate at 80 to 100 pounds per square inch and are fully rated for heavy-duty applications on wire as large as 18 AWG (American Wire Gauge) or for more delicate work on wire as small as 30-32 AWG.

The OK-729 wire-wrap tool is available for \$188.57. Contact OK Machine and Tool Corp., 3455 Conner St., Bronx, NY 10475, (212) 994-6600. Circle 590 on inquiry card.

New EEPROM

The ER5716 EEPROM (electrically erasable programmable read-only memory) is the newest member of General Instrument Microelectronics' line

What's New?

of electrically alterable nonvolatile memories. It's based on N- (negative-) channel silicon-gate MNOS (metal-nitride-oxide semiconductor) technology and is designed for applications that require a large (16K-bit) memory, such as microprocessor program storage, where nonvolatility is essential but occasional data changes must be made. The ER5716 features improved access time and infinite read capabilities. It is bulk-erasable and can be electrically reprogrammed.

The ER5716 EEPROM is available in single units at General Instrument dealers. In OEM (original equipment manufacturer) quantities, it costs \$35.70. Contact General Instrument Corp., Microelectronics Div., 600 West John St., Hicksville, NY 11802, (516) 733-3107, for additional information. Circle 591 on inquiry card.

Cope with Scopes

The XYZs of Using a Scope will not only show you how an oscilloscope works, but how to make one work for you. Divided into two sections, the primer first covers the nuts and bolts and oscilloscope control functions, then expands to demonstrate waveform, waveshapes, and measurement techniques.

The XYZs of Using a Scope is available free from Tektronix Inc., POB 4828, Portland, OR 97208, (800) 547-6711; in Oregon (800) 452-6773. Circle 592 on inquiry card.

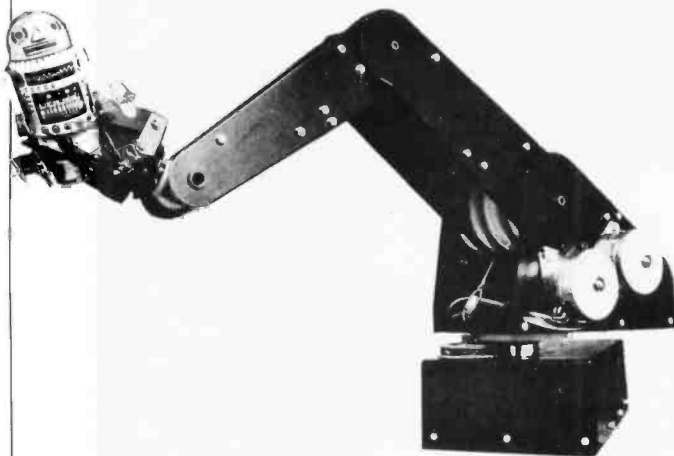

Robotics Arm for Education and Hobby

Colne Robotics of England recently introduced the Armdroid I, an educational and hobbyist manipulating arm. The arm has five axes of rotation (base, shoulder, elbow, wrist up and down, and wrist rotate), a three-finger gripper, and is completely stepper-motor-driven. The Armdroid I will operate with any microcomputer, requiring only a latched 8-bit parallel port to interface. The arm has a 17-inch reach, can lift 10 ounces, has a gripping force of 5 pounds and a resolution of 0.15 inch.

Colne Robotics intends to produce a newsletter for owners of the arm, as well as introduce new products to enhance the arm, such as tactile sensors for closed-loop operations. The Armdroid I can be easily modified to accept experimental devices such as alternate gripper devices, tactile sensors, micro switches, and potentiometers.

The Armdroid I is avail-

able in kit form for \$595 and includes Z80 machine-language driver software for the TRS-80 Model I and the power/interface board kit. An assembled version is also available for \$695. For further information, contact Colne Robotics Inc., 207 Northeast 33rd St., Ft. Lauderdale, FL 33334 or Colne Robotics Co. Ltd., 1 Station Rd., Twickenham, Middlesex TW1 4LL, England, 1-892-7044; Telex: 8814066 GCIC.

Circle 593 on inquiry card.

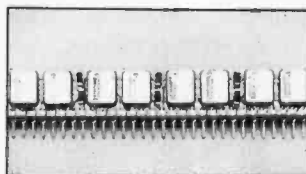

High-Density Memory Requires Less Space

Electronic Designs' EDH-4816 is a 128K-byte high-density memory that requires only one fifth the area of an equivalent DIP (dual inline package). The EDH-4816 consists of eight

industry-standard 16K by 1-bit random-access read/write memories in carriers mounted on a 32-pin SIP (single inline package). The EDH-4816 has all standard operating modes. Access time is 200 ns (nanoseconds); cycle time is 375 ns.

In single-unit quantities, the EDH-4816 costs \$68. In 100-unit quantities, the price is \$59. Contact Electronic Designs Inc., 230 Eliot St., Ashland, MA 01721, (617) 881-5244. Circle 594 on inquiry card.

TRS-80 Network

Radio Shack will use ARCNET to provide a low-cost, high-speed local network for the TRS-80 Model II microcomputer. ARCNET is the local network component of Datapoint's ARC (Attached Resource Computer) system. ARCNET provides an inexpensive, efficient means to link a large number of computers together. Each computer in the ARCNET can access common databases, such as accounting, word-processing information or electronic filing systems, and share peripherals (printers, for example) throughout the network. In addition to Datapoint's new LSI integrated-circuit network interface, Radio Shack will use ARCNET protocols and software for cost-effective, high-speed common-resource networking. The ARCNET will permit as many as 255 Model IIs and their peripherals to be interconnected.

Datapoint processors and peripherals, such as its

Why use their flexible discs:

Athana, BASF, Control Data, Dysan, IBM, Maxell, Nashua, Scotch, Shugart, Syncom, 3M, Verbatim or Wabash

when you could be using

MEMOREX

for as low as \$1.94 each?

Find the flexible disc you're now using on our cross reference list... then write down the equivalent Memorex part number you should be ordering.

Product Family	Product Description	Memorex Part Number (3201-)	CE quant. 100 price per disc (\$)	Athana	BASF	Dysan	IBM	Maxell	Nashua	Scotch 301	Shugart	Syncom	Verbatim	Wabash	Control Data
Flexible Disc 5 1/4 Single Headed Drives Single Density Media	IBM Compatible 128 B/S 26 Sectors	3090	1.99	473071	53478	800546	3005830	FD1-128	FD 1	740 D	S/A-100	15007	FD34-8000	F111111X	421902
	IBM Compatible 128 B/S 26 Sectors w/ Hub Ring	3092	2.04	-	-	-	-	-	-	740 D	-	-	FD34-8000	-	-
	IBM Compatible 128 B/S 26 Sectors w/ Hub Ring	3094	2.39	-	-	-	-	-	-	740 D	-	-	FD34-8000	-	-
	IBM Compatible 128 B/S 26 Sectors HD VERBASF I	1729	3.19	473072	54421	-	-	-	FD 3	740 F 3	-	15150	FD34-8000	F111111X	-
	IBM System 8 Complete	3066	2.04	473077	54561	800628	1669958	-	-	740 D DB8	-	15023	FD60-8000	F118111X	-
	IBM Compatible 128 B/S 26 Sectors	3109	1.99	473073	-	800584	3700845	-	-	740 3800	-	15006	FD36-8000	F112111X	-
	IBM Compatible 1512 B/S 8 Sectors	3110	1.99	473074	-	800584	1669951	-	-	-	-	15004	FD60-8000	F112111X	-
	Shugart Compatible 32 Head Sector w/ Hub Ring	3015	1.99	470801	53807	10171	-	FH1 32	FD 132	740-32	S/A-101	15025	FD37-8000	-	421227
	Wang Compatible 32 Head Sector w/ Hub Ring	3087	2.49	-	54451	-	-	-	-	740 32PH	-	-	-	F37A111X	-
	CFI 8000 Compatible	3045	2.69	-	-	-	-	-	-	-	-	-	15276	-	-
Flexible Disc 5 1/4 Single Headed Drives Double Density Media	IBM Compatible 128 B/S 26 Sectors	3090	2.69	474071	54368	374070	-	FD1 128/427100	FD 1D	741 D	-	-	FD34-8000	F123111X	423002
	Shugart Compatible 32 Head Sector w/ Hub Ring	3091	2.69	470801	54368	10171D	-	FH1 32D	-	741 32	S/A-103	15075	FD37-8000	F38A111X	423222
	Shugart Compatible 32 Head Sector w/ Hub Ring	3086	3.09	-	-	-	-	-	-	-	-	-	-	-	-
	IBM Compatible 128 B/S 26 Sectors	3113	3.09	47417	54726	800815	1788700	-	-	742-0	S/A-180	15183	FD10-4006	F121111X	-
Flexible Disc 5 1/4 Double Density Media	Both Sector IBM/compatible	3102	3.09	473485	-	DV150	-	FD2-150M	FD 2D	743 D	-	15103	DD34-6001	-	425002
	Both Sector 1178 B/S 76 Sectors	3118	3.09	-	-	-	-	-	-	-	S/A-180	-	-	-	-
	Both Sector 1204 B/S 76 Sectors	3103	3.09	473471	54375	800817	1668872	-	-	743-0738	-	15101	DD34-6006	F144111X	426602
	Both Sector 1312 B/S 15 Sectors	3114	3.09	473472	54476	800818	1668044	-	-	743-0172	-	15102	DD34-6015	F145111X	426612
	Both Sector 11024 B/S 8 Sectors	3104	3.09	473473	54465	800818	1668048	-	-	743-0174	-	15102	DD34-6008	F144111X	426522
	37 Head Sector	3105	3.09	470801	-	10172D	-	FH2-32D	-	743 32	S/A-151	15126	DD32-4000	F34A111X	426222
	Burroughs B-80 Compatible 32 Head Sector	3082	3.09	-	-	-	-	-	-	-	-	-	-	F34A611X	-
	Both Sector 11024 B/S 8 Sectors w/ Hub Ring	3116	3.49	-	-	-	-	-	-	-	-	-	-	-	-
	Shugart Compatible 32 Head Sector	3181	3.39	-	-	-	-	-	-	-	-	-	DD32-4000	-	-
	Flexible Disc 5 1/4 Memorex 551 or Equiv Drive Compatible	FD V1 VHS Jaccard	3071003	2.69	470851	-	FDV1	-	-	FD-185	811-0	-	15026	FD65-1000	F81A111X
Mini Flexible Disc 5 1/4 5 - Single Headed Drives Single Density Media	Both Sector IBM/compatible	3401	1.94	475021	54758	10471	-	MD1	MD 1	744-0	S/A-104	15300	MD525-01	M113211X	441002
	10 Head Sector	3403	1.94	475010	54757	10711	-	-	MD 110	744 10	S/A-107	15325	MD525-10	M614211X	441102
	10 Head Sector	3405	1.94	475018	54758	10811	-	MH1	MD 118	744 18	S/A-108	15326	MD525-10	M614211X	441182
	Both Sector IBM/compatible w/Hub Ring	3431	2.14	-	-	-	-	-	-	-	-	-	MD525-01	-	-
	10 Head Sector w/Hub Ring	3433	2.14	-	-	-	-	-	-	-	-	-	MD525-10	-	-
	16 Head Sector w/Hub Ring	3435	2.14	-	-	-	-	-	-	-	-	-	MD525-18	-	-
Mini Flexible Disc 5 1/4 5 - Single Headed Drives Double-Density Media	Both Sector IBM/compatible	3417	2.14	54846	10470	-	-	-	-	-	-	-	MD525-01	-	-
	10 Head Sector	3418	2.14	54849	10770	-	-	-	-	-	-	-	MD525-10	-	-
	16 Head Sector	3419	2.14	54852	10670	-	-	-	-	-	-	-	MD525-18	-	-
	Both Sector IBM/compatible w/Hub Ring	3481	2.34	-	-	-	-	-	-	-	-	-	MD525-01	-	-
	10 Head Sector w/Hub Ring	3483	2.34	-	-	-	-	-	-	-	-	-	MD525-10	-	-
	16 Head Sector w/Hub Ring	3485	2.34	-	-	-	-	-	-	-	-	-	MD525-18	-	-
Mini Flexible Disc 5 1/4 5 - Double Headed Drives Double Density Media	Both Sector IBM/compatible	3421	2.59	54874	10470	-	-	-	-	-	S/A-134	-	MD550-01	-	-
	10 Head Sector	3423	2.59	54827	10770	-	-	-	-	-	S/A-151	-	MD550-10	-	-
	16 Head Sector	3425	2.59	54830	10670	-	-	-	-	-	S/A-135	-	MD550-18	-	-
	Both Sector IBM/compatible w/Hub Ring	3481	2.79	-	-	-	-	-	-	-	-	-	MD550-01	-	-
	10 Head Sector w/Hub Ring	3483	2.79	-	-	-	-	-	-	-	-	-	MD550-10	-	-
	16 Head Sector w/Hub Ring	3485	2.79	-	-	-	-	-	-	-	-	-	MD550-18	-	-

Memorex Flexible Discs...The Ultimate in Memory Excellence

Quality
Memorex means quality products that you can depend on. Quality control at Memorex means starting with the best materials available. Continual surveillance throughout the entire manufacturing process. The benefit of Memorex's years of experience in magnetic media production, resulting, for instance, in proprietary coating formulations. The most sophisticated testing procedures you'll find anywhere in the business.

100 Percent Error Free
Each and every Memorex Flexible Disc is certified to be 100 percent error free. Each track of each flexible disc is tested, individually, to Memorex's stringent standards of excellence. They test signal amplitude, resolution, low-pass modulation, overwrite, missing pulse error and extra pulse error. They are torque-tested, and competitively tested on drives available from almost every major drive manufacturer in the industry including drives that Memorex manufactures. Rigid quality audits are built into every step of the manufacturing process and stringent testing result in a standard of excellence that assures you, our customer, of a quality product designed for increased data reliability and consistent top performance.

Customer-Oriented Packaging
Memorex's commitment to excellence does not stop with a quality product. They are proud of their flexible discs and they package them with pride. Both their packaging and their labeling have been designed with your ease of identification and use in mind. The desk-top box containing ten discs is convenient for filing and storage. Both box labels and jacket labels provide full information on compatibility, density, sectoring, and record length. Envelopes with multi-language care and handling instructions and color-coded removable labels are included. A write-protect feature is available to provide data security.

Full One Year Warranty — Your Assurance of Quality
Memorex Flexible Discs will be replaced by Memorex if they are found to be defective in materials or workmanship within one year of the date of purchase. Other than replacement, Memorex will not be responsible for any damages or losses (including consequential damages) caused by the use of Memorex Flexible Discs.

Quantity Discounts Available
Memorex Flexible Discs are packed 10 discs to a carton and 10 cartons to a case. Please order only in increments of 100 units for quantity 100 pricing. We are also willing to accommodate your smaller orders. Quantities less than 100 units are available in increments of 10 units at a 10% surcharge. Quantity discounts are also available. Order 500 or more discs at the same time and deduct 1%; 1,000 or more saves you 2%; 2,000 or more saves you 3%; 5,000 or more saves you 4%; 10,000 or more saves you 5%; 25,000 or more saves you 6%; 50,000 or more saves you 7% and 100,000 or more discs approved government agencies and most well rated firms at a 10% surcharge for net 10 billing. All sales are subject to availability, acceptance and verification. All sales are final. Prices, terms and specifications are subject to change without notice. Out of stock items will be placed on backorder automatically unless CE is instructed differently. Minimum order \$50.00. International orders are invited with a \$20.00 surcharge for special handling in addition to shipping charges. All shipments are F.O.B. Ann Arbor, Michigan. No COD's please. Non-certified and foreign checks require bank clearance.
Mail orders to: Communications Electronics, Box 1002, Ann Arbor, Michigan 48106 U.S.A. Add \$5.00 per case or partial-case of 100 8-inch discs or \$6.00 per case of 100 5 1/4-inch mini-discs for U.P.S. ground shipping and handling in the continental U.S.A. If you have a Master Card or Visa card, you may call anytime and place a credit card order. Order toll-free in the United States. Call anytime 800-521-4414. If you are outside the U.S. or in Michigan, dial 313-994-4444. Dealer inquiries invited. All order lines at Communications Electronics are staffed 24 hours.
Copyright ©1981 Communications Electronics™



Order Toll-Free!
(800) 521-4414
In Michigan (313) 994-4444

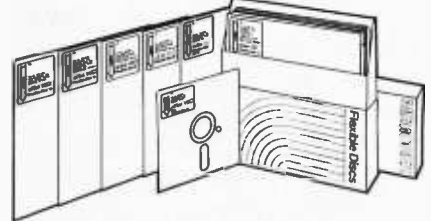

For Data Reliability—Memorex Flexible Discs

COMMUNICATIONS ELECTRONICS™
Computer Products Division

854 Phoenix □ Box 1002 □ Ann Arbor, Michigan 48106 U.S.A.
Call TOLL-FREE (800) 521-4414 or outside U.S.A. (313) 994-4444

What's New?

137-megabyte disk memory and 900-line-per-minute printers, will be compatible with the TRS-80 ARCNET. Also, Radio Shack's bisynchronous communications software packages for the Model II will permit certain IBM and DEC (Digital Equipment Corporation) and other mainframe equipment to link with ARCNET.

Each computer in the TRS-80 ARCNET requires an interface card that installs in an existing card slot on the TRS-80 Model II. The card will be made by Texas Peripherals and will sell for approximately \$400. Other required components are a coaxial cable and a junction box. For further information, contact Tandy Corporation, 1800 One Tandy Center, Fort Worth, TX 76102, (817) 390-3300. Circle 595 on inquiry card.

Formatted Languages for the VT180

Digital Research has made available formatted language packages for DEC's (Digital Equipment Corporation's) CP/M-based VT180 microcomputer. Among the packages being offered are CBASIC, CB80, and PL/I-80. CBASIC is a compiler-interpreter dialect of BASIC. CB80 is a fast-executing compiler version of CBASIC that provides full support for MP/M. PL/I-80 is an implementation of subset G of the PL/I programming language. These products are available at Digital Research dealers or directly from

Digital Research, 130 Central Ave., Pacific Grove, CA 93950, (408) 649-3896. Circle 596 on inquiry card.

PUBLICATIONS

Planning Guide for Educators

A Planning Guide to Successful Computer Instruction is an aid for planning and evaluating the use of computers in the classroom. Written for teachers and administrators, the guide suggests criteria for assessing available computer and microcomputer hardware and software for instructional purposes. Among the topics covered are computer instruction site development and management and sources of hardware and software for education use.

A Planning Guide to Successful Computer Instruction costs \$19.95. Contact Electronic Courseware Systems, POB 2374, Station A, Champaign, IL 61820, (217) 359-7099. Circle 597 on inquiry card.

Educational Software Catalog

Aquarius Publishers is a new company that publishes and distributes educational software oriented toward junior and senior high-school students. Most of the programs run on TRS-80 and Apple II microcomputers. For a free catalog, contact Aquarius Publishers, POB 128, Indian Rocks Beach, FL 33535, (813) 595-7890. Circle 598 on inquiry card.



Compatibility Guide

Nashua Corporation's new pocket-sized Compatibility Guide contains a complete list of all disk drives in use and the Nashua Corporation disk products developed for each. The guide provides a description of the disk pack and cartridge charac-

teristics, a comparison table, and an illustration of a disk layout.

The Compatibility Guide is available from Nashua Corporation, Computer Products Division, 44 Franklin St., Nashua, NH 03061. ■ Circle 600 on inquiry card.

Trade-A-Computer

Trade-A-Computer is a monthly classified magazine dedicated to selling, buying, and trading new and used computer products. Trade-A-Computer has an online data-entry service called Ad-Line, a 300-bit-per-second software system that asks a series of questions concerning your ad, then composes the ad after completing its inquiry. There are no additional charges for this service.

Classified ads cost \$1 per line; display ad rates are available. Ad-Line can be accessed by calling (215) 462-4415. Subscriptions cost \$10 per year. Contact Trade-A-Computer, POB 15842, Philadelphia, PA 19103, (215) 462-4416. Circle 599 on inquiry card.

Where Do New Products Items Come From?

The information printed in the new products pages of BYTE is obtained from "new product" or "press release" copy sent by the promoters of new products. If in our judgment the information might be of interest to the personal computing experimenters and homebrewers who read BYTE, we print it in some form. We openly solicit releases and photos from manufacturers and suppliers to this marketplace. The information is printed more or less as a first-in first-out queue, subject to occasional priority modifications. While we would not knowingly print untrue or inaccurate data, or data from unreliable companies, our capacity to evaluate the products and companies appearing in the "What's New?" feature is necessarily limited. We therefore cannot be responsible for product quality or company performance.

SPECIALS on INTEGRATED CIRCUITS

6502	7.45	10/6.95	50/6.55	100/6.15
6502A/6512A	8.40	10/7.95	50/7.35	100/6.90
6520 PIA	5.15	10/4.90	50/4.45	100/4.15
6522 VIA	6.45	10/6.10	50/5.75	100/5.45
6532	7.90	10/7.40	50/7.00	100/6.60
2114-L200		3.75	25/3.50	100/3.25
2114-L300		3.15	25/2.90	100/2.65
2716 EPROM		7.00	5/6.45	10/5.90
2532 EPROM				14.50
8116 Hitachi 2K x 8 CMOS RAM				14.50
4116				8 for 17
Zero Insertion Force 24 pin Socket				2.00
6550 RAM (PET 8K)				12.70
S-100 Wire Wrap Socket				2.40

A P Products 15% OFF
A P Hobby-Blox 15% OFF

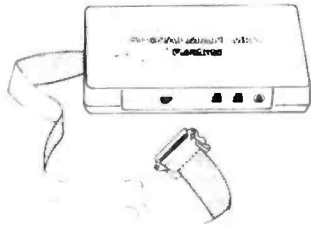

MODEM SPECIAL \$99

SIGNALMAN Mk1 from Anchor Automation
DIRECT CONNECT Modem with RS232 Cable and Connector included. Fully compatible with all Bell 103 modems. 0 to 300 bps. full duplex. frequency shift keyed modulation, automatic ANSW/DRIG selection, direct connect, audible tone carrier detect indicator. self-contained battery powered.

PET/CBM Version (Mk1P) \$169

For Commodore Computers, the Signalman Mk1P includes connector, cable, and machine language software (parallel port)

STAR MODEM

Prentice/Livermore Data Systems	
RS232 MODEM	SALE \$128
IEEE 488 MODEM	SALE \$199
RS232 CCITT	\$170
IEEE 488 CCITT	\$270

We carry Apple II+ from Bell & Howell

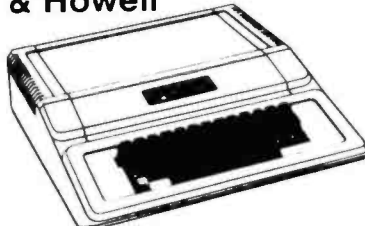

CASH MANAGEMENT SYSTEM \$45

Easy to use. Keeps track of cash disbursements, cash receipts, cash transfers, expenses for up to 50 categories.

FORTH for PET by Cargile/Riley \$50

Full FIG model with all 79 Standard extensions.
Metacompiler for FORTH for independent object code 30

KMMM PASCAL for PET/CBM \$85

Includes translator for true machine language object code.

EARL for PET/CBM 65

Editor, Assembler, Relocator, Linkeditor.

SuperGraphics - BASIC Language Extensions 30

Fast Machine Language Graphics routines for PET/CBM.

SM-KIT - Super PET/CBM ROM based Utilities 40

commodore



CBM-PET SPECIALS

	list	SALE
8023 Printer - 136 col, 150 cps bi-directional	(995)	775
8300 (Diablo 630) Daisy Wheel - 40 cps bi-directional	(2250)	1750
8032 80 x 25 CRT, business keyboard Super Pet	(1495)	1100
8096 Board (extra 64K RAM for 8032)	(1995)	1650
8050 Dual Disk Drive - 1 megabyte	(500)	400
8250 Dual Disk Drive - 2 megabyte	(1795)	1345
CBM IEEE Modem	(2195)	1760
4016 full size graphics keyboard	(395)	199
4032 full size graphics keyboard	(995)	795
4040 Dual Disk Drive - 330,000 bytes	(1295)	999
2031 Single Disk Drive - 165,000 bytes	(1295)	999
4022 Tractor Feed Printer	(695)	550
C2N External Cassette Deck	(795)	630
VIC 20 Color Computer	(75)	65
VIC 1515 Graphic Printer	(299)	259
Used CBM/PET Computers	(395)	335
8024-7 High Speed Printer		CALL
8024-7 High Speed Printer	(1995)	1345

WE WILL MATCH ANY ADVERTISED PRICE

*** EDUCATIONAL DISCOUNTS ***

Buy 2 PET/CBM Computers, receive 1 FREE

WordPro 3 Plus - 32K CBM, disk, printer	215
WordPro 4 Plus - 8032, disk, printer	325
OZZ Data Base System for CBM 8032	335
VISICALC for PET, ATARI, or APPLE	155
SM-KIT - Super PET ROM Utilities	40
Programmers Toolkit - PET ROM Utilities	35
PET Spacemaker II ROM Switch	36
2 Meter PET to IEEE or IEEE to IEEE Cable	40
Dust Cover for PET	7
IEEE-Parallel Printer Interface for PET	110
IEEE-RS232 Printer Interface for PET	120
The PET Revealed	17
Library of PET Subroutines	17

RAM/ROM for PET/CBM

4K or 8K bytes of soft ROM with optional Battery Backup.
 Adds extra RAM which can be write protected like ROM.
 4K Version - \$85 8K Version - \$120 Battery Backup - \$30

EPROM Programmer for CBM/PET 79

Branding Iron with software/hardware for 2716 and 2532.

Watanabe Intelligent Plotter

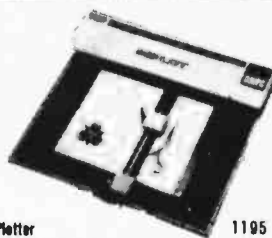

WATANABE WX4671 Plotter	1195
WATANABE WX4675 6-pin Plotter	1445

DISK SPECIALS



SCOTCH (3M) 5"	10/2.75	50/2.65	100/2.60
SCOTCH (3M) 8"	10/2.80	50/2.70	100/2.65
Verbatim 8" Double Dens.	10/3.45	50/3.35	100/3.20
Verbatim 5" Datalife	10/2.45	50/2.40	100/2.35
(add 1.00 for Verbatim 5" plastic storage box)			
BASF 5" soft	10/2.40	20/2.35	100/2.30
Wabash 5" in Plastic Box	10/2.70	50/2.60	100/2.50
Wabash 8" in Plastic Box	10/2.75	50/2.65	100/2.55

WE STOCK MAXELL DISKS

Diskette Storage Pages	10 for 3.95
Disk Library Cases	8" - 2.85 5" - 2.15
Disk Hub Rings	8" - 50 for 7.50 5" - 50 for 6.00

CASSETTES - AGFA PE-611 PREMIUM

High output, low noise, 5 screw housings.			
C-10	10/56	50/50	100/48
C-30	10/73	50/68	100/66

All other lengths available. Write for price list

SPECIALS

EPSON MX-80 Printer	
EPSON MX-80 F/T Printer	
EPSON MX-70 Printer	
EPSON MX-100 Printer	
Centronics 739 Printer with dot graphics	675
STARWRITER Daisy Wheel Printer	1445
Zenith ZVM-121 Green Phosphor Monitor	119
Amdek Color Monitor	355

ALL BOOK and SOFTWARE PRICES DISCOUNTED

OSBORNE/McGraw-Hill, HAYDEN, SYBEX, etc.

Synertek Systems

SYM-1 Microcomputer	SALE 199
SYM BAS-1 BASIC or RAE 1/2 Assembler	85
KTM-2/80 Synertek Video and Keyboard	349
KTM-3/80 Synertek Tubeless Terminal	385

ZENITH data systems

Z90-80 64 K	2170
Z90-82 64K, 1 double dens. drive	2395
Z89-0 48K	1950
Z89-1 48K, 1 drive	2150
Z67 10 Megabyte + Floppy Drive	4495
Z37 1.3 Megabyte Dual Floppy	1495
Z25 High Speed Printer	1195
Z19 Video Terminal (VT-52 compatible)	670
ZVM-121 Green Phosphor Monitor	119

All Zenith Software discounted



ATARI SPECIALS

800 Computer	695	410 Recorder	69
400 - 16K	339	Pilot	68
810 Disk Drive	449	Microsoft BASIC	68
825 Printer	629	Educ. Series	20% off
850 Interface	175	MISSILE COMMAND	32
822 Printer	359	ASTERIODS	32
Paddle Pair	17	STAR RAIDERS	32
Joystick Pair	17	Space Invaders	32
16K RAM	85	Music Composer	45
Assembler/Editor	46	Chess	30
TeleLink	20	Super Breakout	30

Write for prices on other Atari items.

WRITE FOR CATALOG

Add \$1.25 per order for shipping. We pay balance of UPS surface charges on all prepaid orders. Prices listed are on cash discount basis. Regular prices slightly higher. Prices subject to change.

252 Bethlehem Pike
 Colmar, PA 18915

215-822-7727

A B Computers

FLOPPY DISK DRIVES

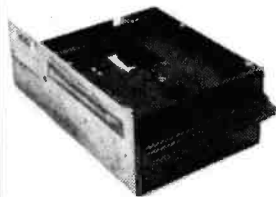

SPECIAL!!!!!!! QUME DATATRAK 8
 Virtually the industry standard. High quality/reliability. Full featured, double sided, double density.

- 1-5 \$499
- 6-9 \$485
- 10 \$475

TANDON DOUBLE SIDED, DOUBLE DENSITY MINIS

TM100-2 48 TPI (500 KBYTES) \$325
 Compatible with Northstar, Cromemco, TRS-80

TM100-4 96 TPI (1000 KBYTES) \$425
 Compatible with Zenith, Heath, etc.

TANDON 5 1/4" HARD DISKS

TM 602 (5MB) \$1195
 TM 603 (10MB) \$1295

CONTROLLERS

- Tarbell single density kit \$195
- Tarbell single density A & T \$310
- Tarbell double density A & T \$425
- CCS 2422 w/CPM 2.2 \$350
- Godbout Disk 1 \$450
- MDA MXV-21 LSI-11 controller (RX-01, RX-02 compatible) \$1050

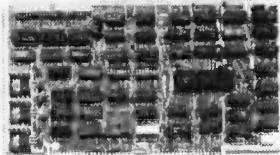

MISCELLANEOUS

- 2 Disk drive enclosure \$ 95
 (fits Siemens, Shugart, Qume)
- CP-206 power supply \$110
 (powers two floppies)

- Cable Kits 2 drives \$ 35
- 3 drives \$ 40
- 4 drives \$ 45
- Diskettes ss \$39/10 - ds \$59/10

- Mini-Enclosure with power supply
- 1 drive \$ 85
- 2 drives \$120

Electrolabs

POB 1608, Palo Alto, CA 94302 (415) 321-5601

CPU

- CCS 2810 \$ 275
- Godbout Z-80A \$ 275
- Godbout 8085A \$ 295

MEMORY

- CCS 2065 64K dynamic \$ 595
- CCS 2116 32K static \$ 625
- Godbout RAM 17 64K \$ 675

I/O

- CCS 2710 4 SIO \$ 325
- Godbout Interfacer 1 \$ 225
- Godbout Interfacer 2 \$ 225

NEW !!!!

Qume Sprint 9

DAISY WHEEL PRINTER . . \$2395

45 CPS, RO. Available in KSR version.

Call for further particulars.

Ribbons: \$125/case

Bidirectional tractor feed \$225

NEW !!!!

ABM 85 Video Terminal . . \$ 895

- Detachable keyboard.
- Televideo 920, ADM 3A compatible
- High resolution green phosphor (23 MHZ)
- Extra multi-bus or S-100 slot for stand-alone capability

Terms of sale: cash or checks, MC/VISA. Min. order \$25. CA residents add 6% tax. Prices subject to change without notice. All goods subject to prior sale.

SUNNY LOW LOW COST POWER SUPPLIES

FOR S-100, FLOPPY DISKS.

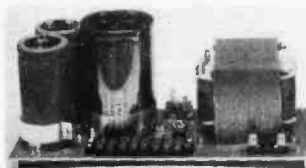

KIT 1, 2 & 3 For S-100

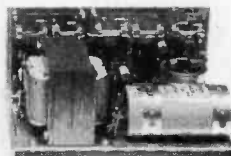

R3 For Three 8" or 5 1/4" Disk Drives

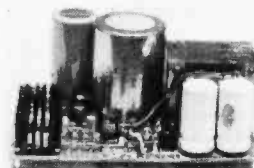

S3 2 in 1 Unit for S-100 and two 8" or 5 1/4" Disk Drives. It fits most Disk System Mainframes.

S-100 POWER SUPPLY KITS (OPEN FRAME WITH BASE PLATE, 3 HRS. ASSY. TIME)

ITEM	USED FOR	@ + 8 Vdc	@ - 9 Vdc	@ + 16 Vdc	@ - 16 Vdc	@ + 28 Vdc	SIZE W x D x H	PRICE
KIT 1	15 CARDS SOURCE	15A		2.5A	2.5A		12" x 5" x 4 7/8"	54.95
KIT 2	SYSTEM SOURCE	25A		3A	3A		12" x 5" x 4 7/8"	61.95
KIT 3	DISK SYSTEM	15A	1A	2A	2A	4A	14" x 6" x 4 7/8"	69.95

DISK DRIVE POWER SUPPLY "R3" REGULATED, OPEN FRAME, ASSY. & TESTED 69.95

SPECS + 5V @ 5A OVP, -5V @ 1A + 24V @ 5A, SHORTS PROTECT 2 SIZES AVAIL. 1.) 9" (W) x 6 1/4" (D) x 4 3/8" (H). 2.) 9" (W) x 4 7/8" (D) x 5 1/4" (H) OPTION 1.) REPLACE + 24V BY + 12V. 2.) FOR SIZE 1 ONLY. ADD + 12V @ 1A. AT AN ADDITIONAL \$12.00.

IDEAL FOR THREE 8" or 5 1/4 FLOPPY DISK DRIVES. SUCH AS SHUGART 801/851. SIEMANS FDD 100-8/200-8 OR 100-5 ETC

DISK SYSTEM PWR SUPPLY "S3" OPEN FRAME, ASSY. & TESTED. COMPACT SIZE: 10" (W) x 6" (D) x 5" (H) 97.95

REGULATED OUTPUTS FOR DISK DRIVES +5V @ 4A, -5V @ 1A, +24V @ 4A (OR + 12V @ 4A) SHORTS PROTECT. UNREGULATED OUTPUTS FOR S-100 +8V @ 14A, + 16V @ 3A (OPTION ADD OVP FOR +5V ADD \$5.00)

A COMPLETE UNIT FOR DISK SYSTEM WITH THE MAINFRAME CONTAINING 12 SLOTS & TWO 8" or 5 1/4" DISK DRIVES.

POWER TRANSFORMERS (WITH MOUNTING BRACKETS)

ITEM	PRIMARY	SECONDARY #1	SECONDARY #2	SECONDARY #3	SIZE W x D x H	PRICE
T1	110/120	2 x 8 Vac, 15A	28 Vac, CT, 2.5A		3 3/4" x 3 5/8" x 3 1/8"	22.95
T2	110/120	2 x 8 Vac, 25A	28 Vac, CT, 3.5A		3 3/4" x 4 3/8" x 3 1/8"	28.95
T3	110/120	2 x 8 Vac, 15A	28 Vac, CT, 2.5A	48 Vac, CT, 2A	3 3/4" x 4 3/8" x 3 1/8"	30.95
T4	110/120	2 x 8 Vac, 6A	28 Vac, CT, 1.5A	48 Vac, CT, 3A	3 3/4" x 3 5/8" x 3 1/8"	23.95
T5	110/120	2 x 8 Vac, 6A	28 Vac, CT, 2A		3" x 3" x 2 1/2"	15.95

SHIPPING For each power supply \$5.50 in Calif., \$8.00 in other states, \$18.00 in Canada. For each Transformer \$5.00 in all States, \$12.00 in Canada. Calif. Residents add 6% Sales Tax.

MAILING ADDRESS:
 P.O. BOX 4296
 TORRANCE, CA 90510
 TELEX: 830-5010
 ANSWER BACK FOR TELEX SUNYCO TRUC

SUNNY INTERNATIONAL
 (TRANSFORMERS MANUFACTURER)
 (213) 328-2425 MON-SAT 9-6

SHIPPING ADDRESS:
 22129 1/2 S. VERMONT AVE
 TORRANCE, CA 90502

CRT CONTROLLER



This intelligent CRT Controller uses an 8085A CPU & an 8275 Integrated CRT Controller. It features:

- 25 lines (80 char./line)
- 5x7 dot matrix
- Upper & lower case
- Two 2716's (controller & char. generator)
- Serial interface RS232 & TTL
- Baud rates of 110, 150, 300, 600, 1200, 2400, 4800 and 9600
- Keyboard scanning system
- Unencoded keyboard required
- Uses +5V & ±12V Power Supplies
- Does not have graphic capabilities.

Documentation includes program listing and composite video circuit.

Bare Board only
(with doc) **\$39.95**
2716 Char. Gen. A7 **\$19.95**
2716 Program A12 **\$19.95**

6522 APPLE II INTERFACE



The JBE 6522 Parallel Interface for the Apple II Computer, plugs directly into any slot 1 through 7 in the Apple. This card has 2 6522 VIA's that provide:

- Four 8 bit bi-directional I/O ports
- Four 16 bit programmable timer/counters
- Serial shift registers
- Handshaking

A 74LS05 is for timing. Four 16 pin sockets provide easy connections to other peripheral devices. (Dip jumpers with ribbon cables are also available from JBE) The 6522 Parallel I/O card interfaces to the JBE EPROM programmer.

Understanding of machine language required to use this board. Inputs and outputs are TTL compatible.

78-295A **\$69.95** Assembled
79-295K **\$59.95** Kit
79-295B **\$19.95** Bareboard

81-260 "SLIM"



Single board large scale Integration Microcomputer. This 4.5 x 6.5 board uses the 6502 Microprocessor, two 6522 VIA's, four 2114 RAM's, 2516, 2716 or 2532 EPROM. The fully buffered 22/44 pin bus is similar to the KIM[®], SYM[®], and AIM[®] expansion connector. The four 8 bit I/O ports connect through 16 pin dip sockets. This board was designed for control and is ideal for Personal and OEM use.

- 6502 MPU
- Two 6522 VIA's
- Four 2114 RAM's (2K bytes)
- One EPROM 2516 or 2532
- Crystal clock 1 Mhz
- Requires 5V 1AMP Power
- 4.5 x 6.5 card
- Power on reset
- Fully buffered-expandable
- Solder mask-both sides

Use your Apple II Computer, JBE 6522 Parallel Interface card and EPROM Programmer as a development system for SLIM.

Prices:
81-260A **\$199.95** Assembled
81-260K **\$149.95** Kit
81-260B **\$ 39.95** Bare Board

JBE I MICROCOMPUTER

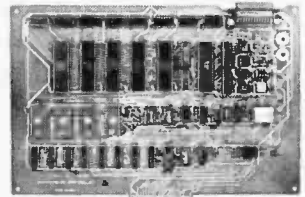

JBE's 7.75 x 11.75 6502 base Microcomputer has the capacity for 16K of EPROM, 4K of RAM, 8 Parallel Ports and 1 Serial Port. Monitor and Tiny Basic are also available. The fully populated version includes:

- 1 6502 CPU
- 4 6522 VIA (8 Parallel I/O Ports)
- 1 AY5-1013 (Serial I/O Ports)
- 8 2114 RAM (4K)
- 2 2716 EPROM (Monitor & Tiny Basic)

The partially populated version includes:

- 1 6502 CPU
- 1 6522 VIA (2 Parallel I/O Ports)
- 1 AY5-1013 (Serial I/O Port)
- 2 2114 RAM (1K)
- 1 2716 EPROM (with Monitor)

Both versions include sockets for 2716s or 2532s, 8 16 pin sockets for I/O interfacing and a DB25 connector for RS232.

All address and data lines are brought off the board to the 50 pin edge connector. (similar to the Apple II bus)

This board also features power on reset and cassette interface.

81-030 C Fully Populated **\$349.95**

81-030M Partially Populated **\$249.95**

81-030B Bare Board **\$ 89.95**
2716 EPROM (with Monitor) **\$ 19.95**

2715 EPROM (with Tiny Basic) **\$ 19.95**

A-D CONVERTER



JBE's 16 channel A-D Converter plugs into your Apple II computer. It uses an ADC0817 which incorporates a 16 channel multiplexer and an 8 bit A-D Converter. The 16 inputs are high impedance and the voltage range is 0 to 5.12 volts. Conversion time is <100µsec. The resolution is 8 bits or 256 steps, linearity is ± 1/2 step. Two 16 pin DIP sockets are used for input, GND & reference voltage connections. There are 3 single bit TTL inputs. Doc/Includes sample program.

81-132A Assm. **\$89.95**
81-132K Kit **\$69.95**
81-132B Bare Board **\$29.95**

SPEECH SYNTHESIZERS



JBE's Speech Synthesizers use the Votrax SC-01 Phoneme Synthesizer chip. The SC-01 phonetically synthesizes continuous speech of unlimited vocabulary. The SC-01 contains 64 different phonemes and 4 levels of inflection accessed by an 8 bit code. It requires 10 Bytes per second for continuous speech. Both boards have an audio amp for direct connection to an 8 ohm speaker.

Documentation includes basic user programs, a phoneme chart and listing of coded words to help you get started. Documentation for the Apple II[®] Speech Synthesizer includes a disk with many user programs.

81-088 Apple II Speech Synthesizer **\$139.95**
81-120 Parallel Input Speech Synthesizer **\$149.95**
Prices include the SC-01 Chip
SC-01 sold separately for **\$ 75.95**

EPROM PROGRAMMER



JBE's EPROM Programmer is designed to program 5V 2516's, 2532's & 2716's. It interfaces to the JBE Parallel I/O card using four ribbon cables. An LED indicates when the EPROM is being programmed. A textool zero insertion force socket is used for the EPROM. Comes with complete documentation for writing and reading EPROM's in the Apple II or Apple II Plus. Cables available separately.

80-244A Assm. **\$49.95**
80-244K Kit **\$39.95**
80-244B Bare Board **\$24.95**

EPROM EXPANSION CARD



JBE EPROM Expander for the Apple II holds six 5V 2716s for a total of 12K bytes of EPROM. This board takes the place of the on board ROM in the Apple. It is software switchable by the same technique used by the Apple II firmware card. Solder jumpers are for reset to the Apple ROM or EPROM Expansion Card. Use JBE EPROM Programmer and Parallel I/O to program your EPROMs. EPROMs sold separately.

81-085A Assm. **\$59.95**
81-085K Kit **\$49.95**
81-085B Bare Board **\$39.95**

6502 MICROCOMPUTER



6502 MPU, 6522 VIA, 2716 EPROM, 2114 RAM single board computer. Single 5 volt power supply at 400 Ma. Two independent 8 bit I/O ports with handshake lines. RC controlled 1 Mhz clock.

Complete documentation. I/O lines use 50 pin edge connector. Data and address lines are not accessible. Mod. for 2532 is included. EPROM is not included. 1K RAM, 2K EPROM, 2 I/O ports.

80-153 Assm. **\$110.95**
80-153 Kit **\$ 89.95**
80-153B Bare Board **\$ 19.95**

Z-80 MICROCOMPUTER

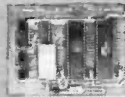

Z-80 MPU, Z-80 PIO, 2716 EPROM, 2114 RAM single board computer. Single 5 volt power supply at 300 Ma. Two independent 8 bit I/O ports with handshake lines. RC controlled 2Mhz clock.

Complete documentation. I/O lines use 50 pin edge connector. Data and address lines are not accessible. Mod. for 2532 is included. EPROM is not included. 1K RAM, 2K EPROM, 2 I/O ports.

80-280 Assm. **\$129.95**
80-280 Kit **\$119.95**
80-280 Bare Board **\$ 19.95**

PARTS

6502 MPU **\$9.95**
6522 VIA **\$9.95**
Z-80 MPU **\$9.95**
Z-80 PIO **\$9.95**
TWO 2114 RAM **\$9.95**
2716 **\$14.95**
50 pin conn. **\$5.95**
Dip Jumper 2ft. **\$4.95**



JOHN BELL ENGINEERING, INC.

ALL PRODUCTS ARE AVAILABLE FROM JOHN BELL ENGINEERING • P.O. BOX 338 • REDWOOD CITY, CA 94064
ADD SALES TAX IN CALIFORNIA • ADD 5% SHIPPING & HANDLING 3% FOR ORDERS OVER \$100

MC

VISA

SEND FOR CATALOG

(415) 367-1137

10% OUTSIDE U.S.A.

\$GOLD DISK\$
CP/M® Compatible
Z-80 Software
Z-80 DISASSEMBLER
 An easy to use program to create source (.ASM) files from executable (.COM) files **\$175** PPD

EZ-TEXT WORDPROCESSOR
 EZ-TEXT will format your text file the way you want it **\$75** PPD

Bower-Stewart & Associates
 POST OFFICE BOX 1389
 HAWTHORNE, CALIFORNIA 90250
213-532-1237 

Trademark Digital Research

Circle 50 on inquiry card.

**You can pay more —
 But you can't get more!**



Model III 16K
\$839



Color Computer 4K
\$310
 w/16K Ext. Basic
\$459

Model III 48K
 2 disc & RS232C
\$2100

BUY DIRECT. These are just a few of our great offers which include Printers, Modems, Computers, Peripherals, Disc Drives, Software and more. call TOLL FREE **1-800-343-8124**

We have the lowest possible fully warranted prices and a full complement of Radio Shack Software.

computer plus
 Write for your free catalog.
 245A Great Road
 Lihon, MA 01460
 617-486-3193

Circle 94 on inquiry card.

PLOTTING SOFTWARE
 Calcomp compatible, for
 EPSON and HIPLLOT with CPM, FORTRAN, and BASIC

PLOTWARE-z 8" ssd 399
 Manuals only 35
 PLOTWARE-z samples 6
 * Refundable on order

E N E R C O M P
 P.O. BOX 28014
 Lakewood, Colo 80228
 303-988-1648

PROG
 PLOTWARE-z
 All The
 Real

VALUE & EASE

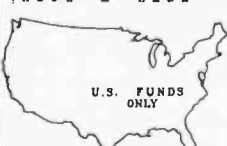

OPTIONAL:
 Maps, Charts,
 Drafting,
 Scientific,
 Characters,
 Terminal
 Emulation

PLOTWARE-z draw this ad

Circle 154 on inquiry card.

HERE IT IS AT LAST!
"SUPERNET"



THIS IS THE MOST UNIQUE S-100 COMPUTER BOARD:
 64K of memory, Z80A CPU, Double Density Floppy Disk Controller, 2 Serial & Parallel I/O, monitor (EPROM) ALL on a single S-100 Computer Board from ADVANCED Micro Digital Corp.

SUPERNET	\$900.
Serial Adapter Cable	\$ 35.
Parallel Adapter Cable	\$ 40.
Shugart SA801R	\$455.
Televideo 912C	\$ 750.
Enclosure with 10 slots, power supply, cut outs for two 8" floppies	\$ 650.
Z-80A CPU	\$5.50
4164 RAM Chips	\$10.00
Z-80A CTC	\$5.50
2716 EPROM	\$5.50

MICRO SPOT ELECTRONICS
 14221 Edwards, Suite 72
 Westminster, CA 92683
 (714) 891-0382

TERMS:
 Pre-Payment or C.O.D. up to \$250. (Cashier's check). Allow one week for checks to clear before shipping. Add \$5 shipping and handling charge to your order. Calif. Residents add 6% sales tax.

Circle 250 on inquiry card.

Verbatim®
Floppy Discs

SAVE 40% Write for our complete list.

5 1/4" Specify soft, 10 or 16 sector	Price/10
MD525 1 side/dbl dens.	\$27.30
MD550 2 sides/dbl dens.	44.20
MD577 1 side/77 track	32.50
MD557 2 sides/77 track	44.20

8" Critically Certified Soft sector

FD34-9000 1 side/sgl dens.	33.80
FD34-8000 1 side/dbl dens.	39.00
FD34-4001 2 side/dbl dens.	46.20

CHECKS - VISA - MC - C.O.D.
 (313) 777-7780 ADD \$2 SHIPPING

LYBEN COMPUTER SYSTEMS
 27204 Harper Ave.
 St. Clair Shores, MI 48081

Circle 220 on inquiry card.

ATARI



400 16K	\$319.00
400 YOURS TO 32K or 48K	CALL
800 16K	649.00
410 RECORDER	89.00
810 DISK DRIVE	445.00
850 INTERFACE	174.00
830 MODEM	139.00
825 PRINTER	575.00
484 COMMUNICATOR	299.00
ITT Cordless phone	199.95
ZEMITH GRN. PHOS. MONITOR	129.00
EPSON PRINTERS	CALL
SOFTWARE	CALL
SHARP CALCULATORS	CALL
SPECIALS:	CALL

Prices subject to change without notice. Shipping extra. No tax out of state. Ca. residents add appropriate taxes.

WE ARE AN AUTHORIZED ATARI SALES AND SERVICE CENTER

COMPUTERTIME, INC.
 PO BOX 216
 KENTFIELD, CA 94914
 CALL TOLL-FREE 800-227-2520
 In California 800-772-4064

Circle 102 on inquiry card.

CHIPS & DALE 

THE INFLATION FIGHTERS!
 — RAM —

4116 250ns 8/\$11.00
4116 200ns 8/\$13.00
4116 150ns 8/\$16.00
2114L 300ns 8/\$16.25
2114L 200ns 8/\$17.00
4164 200ns \$9.00
6116 200ns \$10.00

— EPROM —

2716 (5V)450ns 8/\$3.90 ea. \$4.15 ea.
2732 (5V)450ns 8/\$9.75 ea. \$10.25 ea.
2532 (5V)450ns 8/\$10.50 ea. \$12.00 ea.

Please allow up to 3 wks. for personal checks to clear.
 Add \$2.50 Shipping & Handling
 C.O.D. \$3.00. Wash. residents add 5.4% Sales Tax

CHIPS & DALE
 P.O. Box 31607
 Seattle, Wash. Zip 98103 Master Charge
 1-206-524-9126 VISA accepted.

Circle 74 on inquiry card.

MEMOREX
FLEXIBLE DISCS

WE WILL NOT BE UNDER-SOLD! Call Free (800)235-4137 for prices and information. Dealer inquiries invited and C.O.D.'s accepted.





PACIFIC EXCHANGES
 100 Foothill Blvd
 San Luis Obispo, CA 93401. In Cal call (800)592-5935 or (805)543-1037

Circle 300 on Inquiry card.

NEW 23K PERSONAL COMPUTER

\$239⁰⁰ FACTORY SALE PRICE

You get the NEW APF-IM-1 Full Size Powerful Computer: Includes 14K ROM with Level II BASIC built in, 9K User RAM, Color, Sound, Professional 53 keyboard, Two controllers. Two 10 key numeric pads, High speed cassette, A.C. adapter, RF modulator, T.V. switchbox. Accepts TAPE-DISK-PLUG IN CARTRIDGES. It is PLUG IN EXPANDABLE at low cost. 90 day parts and labor warranty, owners guide, BASIC language manual. All this in a beautiful black and white console case for only \$239⁰⁰.

15 DAY FREE TRIAL Return within 15 days complete and undamaged for refund of purchase price.

PROTECTO ENTERPRIZES
 BOX 550, BARRINGTON, IL 60010
 TO ORDER PHONE 312/382-2192

Circle 322 on inquiry card.

**ORDER
TOLL-FREE**

consumer computers

**Mail Order
DISCOUNTS**

**FREE
SHIPPING***
*on all pre-paid cash orders

**Commodore
VIC-20 \$259**



Personal Computer
Color * Sound * Graphics
Call or write for more info.
Disk drives available soon!

AVAILABLE NOW!

**IBM
ACCESSORIES
BY TECMAR**

256 K Dynamic Ram Card
Hi-Speed Parallel I/O Card
Hi-Speed Serial I/O Card
Real-Time System Clock
Card Expansion Chassis
And Many More Accessories!

CALL FOR BEST PRICES

ATARI



**ATARI 800 16K
CALL FOR BEST PRICE**

Atari 400 w/16K 349
410 Program Recorder 65
810 Disk Drive 449
825 80 col. 7x8 Dot matrix impact printer 699
822 40 col. Quiet Thermal Printer 349
850 Interface Module 159
Atari 16K Ram Module 69
Axlon Ramcram 32K Module 189
Asteroids, Missile Command and Star Raiders 35 ea.

SPECIAL ATARI CATALOG AVAILABLE

Video Monitors

Amdek/Leedex Video 100 12" B&W 129
Amdek/Leedex Video 100G 12" Green Phosphor 149
Amdek (Hitachi) 13" Color w/audio output 389
NEC 12" Green Phosphor Display JB-1201M CALL
NEC 12" Lo-Res Color Display CALL
NEC 12" Hi-Res RGB Color Display CALL
Sanyo 9" B&W Display 185
Sanyo 9" Green Display CALL
Sanyo 12" B&W Display 269
Sanyo 12" Green Phosphor Display 285
Sanyo 13" Color Display 449
Zenith 12" Green Phosphor Display 139

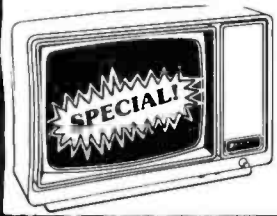

**ZENITH
12"
GREEN
\$139**

S-100

**California Computer
Systems**

Floppy Disk Controller 339
64 K Dynamic Ram Board,
200 ns 469
Z-80 CPU board
w/monitor ROM 269
S-100 12 Slot Mainframe ... 399
2-Port Serial/2-Port
Parallel Interface 249

**16K RAMBOARD by ConComp
for Apple II Computers**

FOR ONLY \$129

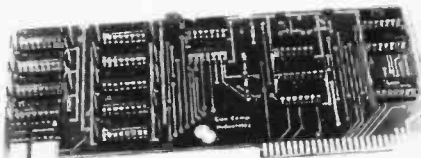

AVAILABLE NOW

Printers

**Epson
MX-80 or
MX-80 FT
CALL**

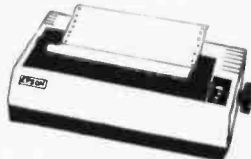

Anadex 9501 w/2K Buffer 1349
C. Itoh Starwriter 25 CPS daisywheel 1449
C. Itoh Starwriter 45 CPS daisywheel 1649
Epson MX-70 CALL
Epson MX-80 & MX-80 FT CALL
Epson MX-100 CALL
NEC 8023 Impact Dot Matrix 629
NEC Spinwriters (Latest models) CALL
Paper Tiger IDS-460G w/graphics 899
Paper Tiger IDS-560G w/graphics 1099
Qume Spring Daisywheels (Latest models) CALL
Dialbe 630 Daisywheel 40 CPS 1795

**ORDER TOLL FREE
800-854-6654
In California and
outside continental U.S.
(714) 698-8088
Telex 695-000 Beta CCMO**

**NEC
Microcomputer**



**CALL FOR
BEST PRICES**

If you're considering a computer, consider this:

4 Mhz Z-80A Operation
80 or 40 column modes STANDARD
Built-in Centronics printer port
Full ASCII keyboard with Shift lock
Real Time Clock STANDARD
RGB Color Output
Mixed text and graphics
Numerica Keyboard STANDARD
CP/M Compatibility
5 programmable Function keys
24K Microsoft NBASIC in ROM with enhanced
color graphic commands

The NEC PC-8001A has all these features and much more. Expandibility you want, expandibility you get. Through the use of the PC-8012A I/O unit, total system RAM can be extended to 160K. The PC-8031 Dual Disk Drive puts 286K of floppy disk storage at your command.

The NEC PC-8001A has so many things that are options on other computers built right in that you may never have to buy another accessory! The quality that the NEC name has come to stand for has been built-in, too.

Compare the competition, and then call Consumer Computers for the NEC PC-8001.

NEC COMPATIBLE SOFTWARE

CP/M Operating system with graphics control ... CALL
SUPERCALC Financial & Scientific Modeling (requires CP/M) CALL
WORDSTAR Word Processing System (requires CP/M) CALL
SYSTEMS PLUS Complete Accounting System (requires CP/M) CALL
MICROSOFT BASIC-80 (requires CP/M) CALL
MICROSOFT FORTRAN-80 (requires CP/M) CALL
MICROSOFT COBOL-80 (requires CP/M) CALL

Ordering information: Phone orders using VISA, MASTERCARD, AMERICAN EXPRESS, DINER'S CLUB, CARTE BLANCHE, bank wire transfer, cashier's or certified check, money order, or personal check (allow ten days to clear). Unless prepaid with cash, please add 5% for shipping, handling and insurance (minimum 5.00). California residents add 6% sales tax. Foreign customers please add 10% for shipping. OEM's, institutions and corporations please send for a written quotation. All equipment is subject to price change and availability without notice. All equipment is new and complete with manufacturer's warranty (usually 90 days). Showroom prices may differ from mail order prices.

**Send Orders To:
consumer
computers Mail Order
8314 Parkway Drive
La Mesa, Calif. 92041**

QUARTZ CRYSTALS

1.000 A	5.195 B	8.140 B	13.000 B	23.854 B	35.368 B	41.937 B
1.8432 A	5.195 B	8.230 B	12.318 B	24.000 B	36.312 B	42.000 B
2.000 A	5.248 B	8.267 B	12.440 B	24.576 B	36.363 B	42.627 B
2.0971 A	5.568 B	8.448 B	12.477 B	25.000 B	36.612 B	42.700 B
2.4578 A	5.568 B	8.499 B	12.538 B	25.000 B	37.062 B	42.752 B
2.5000 A	5.587 B	8.576 B	12.658 B	26.875 B	38.064 B	42.815 B
2.6850 A	5.7143 B	8.605 B	13.1072 B	27.000 B	38.444 B	42.851 B
2.6970 A	5.760 B	8.900 B	13.478 B	28.375 B	38.625 B	42.876 B
3.000 A	5.982 B	9.544 B	13.5168 B	28.400 B	38.676 B	42.926 B
3.0671 A	5.9904 B	9.830 B	14.3182 B	28.627 B	38.925 B	42.963 B
3.2768 A	6.000 B	9.8304 B	14.391 B	29.927 B	38.937 B	43.000 B
3.330 A	6.144 B	9.933 B	15.000 B	30.064 B	39.503 B	43.037 B
3.5780 A	6.236 B	9.950 B	15.180 B	31.437 B	39.886 B	43.074 B
3.800 B	6.250 B	9.958 B	15.638 B	32.000 B	39.753 B	43.111 B
3.8664 B	6.280 B	9.959 B	15.508 B	32.378 B	39.676 B	43.127 B
4.000 B	6.2971 B	10.000 B	16.000 B	32.937 B	39.863 B	43.149 B
4.1634 B	6.308 B	10.240 B	17.274 B	32.200 B	40.375 B	43.185 B
4.323 B	6.400 B	10.498 B	17.508 B	33.875 B	40.444 B	43.259 B
4.434 B	6.5538 B	10.489 B	17.625 B	34.375 B	40.592 B	43.298 B
4.440 B	6.687 B	10.884 B	18.000 B	34.437 B	40.777 B	43.329 B
4.500 B	6.7584 B	10.9250 B	18.1938 B	34.958 B	40.8125 B	43.370 B
4.738 B	6.912 B	10.838 B	18.432 B	34.977 B	40.833 B	43.407 B
4.750 B	7.0918 B	10.850 B	19.750 B	35.784 B	40.875 B	43.444 B
4.8152 B	7.1500 B	11.000 B	20.000 B	35.875 B	40.868 B	43.514 B
4.8582 B	7.183 B	11.138 B	20.480 B	35.875 B	40.926 B	43.550 B
5.000 B	7.935 B	11.218 B	20.890 B	35.975 B	41.000 B	43.592 B
5.0178 B	8.000 B	11.369 B	21.400 B	35.927 B	41.168 B	43.620 B
5.0688 B	8.055 B	11.856 B	22.1184 B	36.000 B	41.377 B	48.000 B
5.1200 B	8.077 B	11.881 B	23.400 B	36.062 B	41.926 B	32.788KHZ A

ALL "A" - 3.49 ALL "B" - 2.49 100M MORE DEDUCT 3%

ADD \$1.00 SHIPPING
CAL. RES. ADD 6% SALES TAX
FREE OSCILLATOR SCHEMATICS
WITH ANY ORDER

QUALITY COMPUTER PARTS
P.O. BOX 743 / CHATSWORTH, CA 91311

Circle 326 on Inquiry card.

EPSON

DOT MATRIX PRINTERS

SUPER DISCOUNTS ON

MX-80F/T	\$699 LOWER!	NOW
MX-80	\$499 LOWER!	IN
MX-100	\$890 LOWER!	STOCK

We also stock direct connect cables for TRS-80, Apple, Atari, Pet or RS 232

CALL TOLL FREE

1-800-344-7493

In CA and for service (209) 667-2888

GRAPHICS ROM'S AVAILABLE

MACROTRONICS, inc.

1125 N. Golden State Blvd
Fountain Valley, California 92708

Circle 224 on inquiry card.

VOLTAGE SURGE & TRANSIENT SUPPRESSOR



Protects Most Electronic Equipment

The SUPPRESSOR electronically removes or reduces sudden voltage changes. It simply plugs into a power receptical on the same circuit as the equipment being protected.

END POWER LINE SPIKES, SURGES, HASH... Only \$29.95 ea. Dealer Inquiries Invited.

CUESTA SYSTEMS, INC.

3440 Roberto Court
San Luis Obispo, California 93401
(805) 541-4160

Circle 115 on inquiry card.

special OF THE MONTH

HP-85's	\$2540.00
HP-83's	\$1450.00
HP-9895 Dual 8" Drives	\$5300.00
HP-8292 Dual 5" Drives	\$1960.00
HP-7225B Plotter	\$1720.00
LOBO Disc Drives	\$ 395.00
IDS 445G Printers	\$ 699.00
NEC Spinwriters	
with Tractors	\$2560.00
IDS 460G Printers	\$1099.00
IDS 560G Printers	\$1330.00
C ITOH Starwriter 25's	\$1300.00
CCS 300 Dual 8" Drive computer with	
64K RAM, OASIS, CP/M 2.4MB Disc	
memory, 2 serial ports, 1 parallel	
port and a Teletype	
9'0 CRT	Call for price
CDC Lark Subsystems	Call for price

Meade's

DATA SYSTEMS

"THE COMPLETE SYSTEMS AND SUPPORT TEAM"

MARKET SQUARE SHOPPING CENTER, RIDGE RD. & CALHOUN AVE., MURKIN, IN 46321

219/836-6350

Circle 231 on inquiry card.

EPROM-32

The only EPROM programmer you need!

- IEEE-696 (S-100) EPROM programmer for single-supply (+5V) EPROMs.
- Programs current 1K through 8K (byte) EPROMs plus future 16K and 32K EPROMs.
- Personality Modules adapt board to different EPROM types:

PM-1 - 2508	2758	PM-4 - 2564	
	2516	2716	PM-5 - 2764
PM-2 - 2532		PM-6 - 68764	
PM-3 - 2732		PM-7 - 2528(TI-16K)	
- Zero-insertion-force socket accommodates both 24-pin and 28-pin EPROM packages.
- DIP switch selection of programming ports and EPROM address for verification and/or use.
- On-board DC-to-DC converter with adjustable regulator for programming voltage.
- Programming voltage switched by software.
- Double-sided PC board with solder masks, silkscreen and gold-plated contact fingers.
- Documentation includes source listing of 8080/280 software for programming and verification.

\$269.95
(assembled & tested)

MicroDynamics Corporation
P.O. Box 17577
Memphis, TN 38117
(901) 755-0619

Price includes EPROM-32, documentation and two personality modules (specify). Additional modules - \$75. Programming/verification software on 8 inch single density CP/M-compatible diskette - \$9.95.

MASTERCARD & VISA - TN residents add 6% sales tax.

Circle 251 on inquiry card.

MEMORY EXPANSION FOR APPLE®

The company that brought you the first 32K RAM board for Apple II® and Apple II+® now offers:

- **128K RAM ALL FOR ONLY \$599**
Includes 1 MOVEDOS (relocates DOS); 5 comprehensive software packages
- **64K RAM \$425**
A medium range memory expansion board which can be upgraded to 128K at a later date. (Upgrade kit sold for \$175) Includes all 5 software packages offered with the 128K board
- **32K RAM STILL ONLY \$239**
The old favorite for Apple users. Includes our first 3 software packages (above) with CP/M® and PASCAL pseudo-disks now offered as options (\$39 each)
- **VC-EXPAND™ MEMORY EXPANSION FOR VisiCalc® ONLY \$100**
Expand memory available to Personal Software's 16 sector VisiCalc®. Add 32K, 64K, or even 128K to your present workspace (even if you already have a 16K card in use!) with this program plus one or more Saturn boards. Simple operation.

© 1982 Apple Computer, Inc. All rights reserved.

Circle 346 on inquiry card.

APPLE EXTENDER CARD

\$29.95

Extends Apple Cards Above Computer for Servicing and Debugging

APPLE EXTENDER CARD	... \$29.95
IBM EXTENDER CARD \$34.95
IBM Prototyping Board \$34.95
RS-232 Board for TRS-80 Model III \$94.95
32K Memory Exp. Board for TRS-80 Color Computer (Adds 16K) \$79.95

(Colo. Residents Add 3% Sales Tax)

DEALER INQUIRIES INVITED

IMAGE TECHNOLOGY, INC.
P.O. BOX 15456
LAKEWOOD, COLORADO 80215

Circle 184 on inquiry card.

SOFTWARE AUTHORS

Cash in on your creative energies, join InfoSoft Computer Systems' SOFTWARE DEVELOPMENT PROGRAM. Get all of your R&D hardware at our distributor cost plus

20% Royalty!

We give you personalized service, offer a non-exclusive marketing agreement, plus other specialized services. We seek: high level language compilers, cross-assemblers, utilities, DMBS, new OS, educ. and business applications, and any other marketable program. We offer full development and documentation. Don't hesitate, contact us immediately.

Michael L. Dean, V.P. R&D
InfoSoft Computer Systems

2699 Clayton Rd.
Concord, CA 94519 (415) 680-0202

Single Source Solution

Circle 188 on inquiry card.

Smartmodem



- Auto-Answer • Auto-Dial • Repeat
- Programmable - Use Any Language
- Touch-Tone and Pulse Dialing
- Audio Monitor - Listen to Connection
- FCC-Approved Direct-Connect
- Full or Half Duplex, 0-300 Baud
- RS-232C Interface • 7 Status LED's
- Two Year Limited Warranty

\$249

Send certified check or money order
Allow two weeks for personal check
Florida residents add 4% sales tax

RCE COMPUTER PRODUCTS
of Florida Inc.
1640 N.W. 3rd STREET
DEERFIELD BEACH, FLA. 33441
VOICE: 305-427-1257/DATA: 305-427-6300

Circle 5 on inquiry card.

WE WILL NOT BE UNDERSOLD

CP/M® Software	Software/Manual only
Computer Pathways	
Pearl (level 1)	\$ 99/\$25
Pearl (level 2)	\$299/\$40
Pearl (level 3)	\$549/\$50
Digital Research	
PL/I-80	\$459/\$35
BT-80	\$179/\$30
Mac	\$ 85/\$15
Sid	\$ 65/\$15
Z-Sid	\$ 90/\$15
Tex	\$ 90/\$15
DeSpool	\$ 50/\$10
Micropro	
WordStar	\$319/\$60
Customization Notes	\$ 89/\$na
Mail-Merge	\$109/\$25
WordStar/Mail-Merge	\$419/\$85
DataStar	\$249/\$60
WordMaster	\$119/\$40
SuperSort I	\$199/\$40
Spell Star	\$175/\$40
Microsoft	
Basic-80	\$289/\$na
Basic Compiler	\$329/\$na
Fortran-80	\$349/\$na
Cobol-80	\$574/\$na
M-Sort	\$124/\$na
Macro-80	\$144/\$na
Edit-80	\$ 84/\$na
MuSimp/MuMath	\$224/\$na
MuLisp-80	\$174/\$na
Organic Software	
Milestone	\$269/\$30
Supersoft	
Diagnostic I	\$ 49/\$20
Diagnostic II	\$ 84/\$20
Disk Doctor	\$ 84/\$20
Forth (8080 or Z80)	\$149/\$30
Fortran	\$219/\$30
Fortran w/Ratfor	\$289/\$35
Other	less 10%
Unicorn	
Mince	\$149/\$25
Scribble	\$149/\$25
Both	\$249/\$50
Data Base	
FMS-80	\$649/\$45
dBASE II	\$595/\$50
Access/80	\$699/\$50
Pascal	
Pascal/MT+	\$429/\$30
Pascal/M	\$189/\$20
Miscellaneous	
SpellGuard	\$299/\$25
The Last One	\$549/\$na
SuperCalc	\$259/\$50
CBASIC-2	\$ 98/\$20
MicroStat	\$224/\$25
StatPak	\$449/\$40
Micro B+	\$229/\$20
Apple Software (Business)	
Micropro	
Wordstar	\$239
MailMerge	\$ 89
Wordstar/MailMerge	\$349
SuperSort I	\$159
Spellstar	\$175
Personal Software	
Visicalc 3.3	\$229
CCA Data Mgr	\$ 99
Desktop/Plan II	\$229
Visitem	\$139
Visidex	\$229
Visiplot	\$185



Personal Software (cont.)	
Visitrend/Visiplot	\$ 275
Zork	\$ 34
Miscellaneous	
Micro Courier	\$ 219
Super-Text II	\$127
ASCII Express	\$ 59
Apple Software (Entertainment)	
Wizard & Princess	\$ 28
Mystery House	\$ 24
Flight Simulator	\$ 29
Raster Blaster	\$ 26
Space Eggs	\$ 18
Sargon II	\$ 29
ABM	\$ 22
Micropainter	\$ 29
Apple Panic	\$ 28
Pool 1.5	\$ 26
Apple Accessories	
Z-80 Softcard	\$ 299
Keyboard Enhancer	\$110
Apple Joystick	\$ 49
Sup-r Mod	\$ 25
CPS Multifunction Card	\$199
Videx Board	\$249
16K Card	\$159
Sup-r Fan	\$ 39
ALF9 Voice Board	\$149
CCS Cards	\$Call
CCS Parallel Model 7720	\$Call
CCS Serial Model 7710D	\$Call
CCS Centronics Model 7728	\$Call
Disk Drives	
For TRS-80® Model 1	
CCI-100 5 1/4", 40 Track	\$ 299
Add-ons for Zenith Z-89	\$ 389
CCI-189 5 1/4", 40 Track	\$995
Z-87 Dual 5 1/4" system	\$Call
Drives for Z-90	\$Call
External card edge and power supply included. 90 day warranty/one year on power supply.	
Corvus 5M	\$ 3089
Corvus 10M	\$ 4489
Corvus 20M	\$ 5429
Corvus Mirror	\$ 699
Shugart 8" 801R Raw Drive	\$ 399
TANDON 5 1/4" Raw Drive	\$ Call
Power Supplies	\$ Call
Diskettes — Box of 10	
Maxell 5 1/4"	\$ 40
Maxell 8"	\$ 45
BASF/Verbatim 5 1/4"	\$26.95
BASF/Verbatim 8"	\$ 36
Plastic File Box—Holds 50 5 1/4" dsks.	\$ 19
Plastic Library Case 5 1/4"	\$ 3
Plastic Library Case 8"	\$ 4
Head Cleaning Diskette	\$ 25
Floppy Saver	\$10.95
Floppy Saver Rings	\$ 6.95
16K RAM Kits	
One Kit	\$13.95
Two Kits	\$25.00
200ns for TRS-80®, Apple II, (specify):	Jumpers \$ 2.50
Computer Systems	
Altos ACS8000 Series	\$ Call
Atari 400	\$ 359
Atari 800	\$ 789
Call for other Atari products	
Zenith Z89, 48K	\$ Call
Zenith Z90, 64K	\$ Call
Call for other Zenith products	



For fast delivery, send certified checks, money orders or call to arrange direct bank wire transfers. Personal or company checks require one to three weeks to clear. All prices are mail order only and are subject to change without notice. Call for shipping charges.

Terminals		
Adds Viewpoint		\$ Call
Zenith Z-19		\$ Call
Televideo 910		\$ 519
Televideo 920C		\$ 729
Televideo 950		\$ 929
S-100 California Computer Systems		
Mainframe		\$ 349
Z80 CPU		\$ 239
64K RAM		\$ 569
Floppy Disc Cntrl		\$ 339
Integrated Sys. w/int. cables, tstd.		\$1975
2P + 2S I/O		\$ 269
4 Port Serial I/O		\$ 249
4 Port Parallel I/O		\$ 179
Casio Calculators		
Pocket Comp.	FX702	\$185.00
Desk Printr/Calc.	FR100	\$ 79.95
Scientific Calc.	FX8100	\$ 49.95
Game Watch	CA90 Plastic	\$ 49.95
Game Watch	CA901 Steel	\$ 69.95
Calendar Watch	AX210	\$ 59.95
Printers	NEC Spinwriter	
	7710 R.O. Ser	\$2395
	7710 Ser w/tr.	\$2595
	7720 KSR w/tr.	\$2795
	7730 R.O. Par	\$2395
	7730 R.O. Par w/tr.	\$2595
	NEW 3500 Series	\$ Call
Epson MX-70		\$ Call
Epson MX-80		\$ Call
Epson MX-80FT		\$ Call
Epson MX-100		\$ Call
PaperTiger 445 Gr. & 2K		\$ Call
PaperTiger 460 Gr. & 2K		\$ Call
PaperTiger 560 Gr.		\$ Call
IDS Prism 80		\$ Call
IDS Prism 132		\$ Call
PaperTiger Access.		\$ Call
Anadex DP-8000		\$ 849
Anadex DP-9500/01		\$1389
Okidata Microline 80 Fric. & pin feed		\$ Call
Okidata Microline 82A Fric. & pin feed		\$ Call
Okidata Microline 83A 120 cps		\$ Call
Okidata 84 200 cps		\$ Call
Centronics 739		\$ 739
C. Itoh Starwriter I 25 cps, par.		\$1525
C. Itoh Starwriter I 25 cps, ser.		\$1620
C. Itoh Starwriter II 45 cps, par.		\$1950
C. Itoh Starwriter II 45 cps, ser.		\$2075
Axiom GP-80M		\$ 319
Data South 180 cps		\$ Call
Olivetti DY 211 Daisy Wheel		\$ Call
Monitors		
Leedex 12" B & W		\$ 129
Leedex 12" Green Screen		\$ 139
Leedex 13" Color		\$ 329
Sanyo 9" B & W		\$ 149
Sanyo 9" Green Screen		\$ 189
Sanyo 12" Green Screen		\$ 249
Sanyo 12" B & W		\$ 239
Sanyo 13" Color		\$ 449
Zenith 13" Color		\$ 349
Zenith 12" Green Screen		\$ 129
Telecommunications		
Prentice Star Modem 1-yr. guar.		\$ 125
Univ. Data System UDS103LP		\$ 135
Univ. Data System UDS103JP		\$ 175
Novation Cat		\$ 139
Novation D-Cat		\$ 149
Novation Auto-Cat		\$ 199
Novation Apple Cat II		\$ 299
D.C. Hayes Smart. Modem		\$ 249
D.C. Hayes Micro-Modem II		\$ 295
CCI Telnet Com. Package		\$ 135



DEALER (NATIONAL/INTERNATIONAL) INQUIRIES INVITED **Send for FREE Catalogue**

The CPU SHOP

TO ORDER CALL TOLL FREE 1-800-343-6522

TWX: 710-348-1796 Massachusetts Residents call 617/242-3361

420-423 Rutherford Ave., Dept. B03M
Charlestown, Massachusetts 02129
Hours 9 AM-8 PM (EST) Mon.-Fri. (Sat. till 5)

Technical Information call 617/242-3361
Massachusetts Residents add 5% Sales Tax
Tandy Corporation Trademark® Digital Research



APPLE, TRS80, TI, IBM, PET...
TRY! OUR \$99 SELECTOR SWITCH
 Available for RS232, IEEE 488, BNC...



Our \$99 - S8AB switch will save you money and aggravation. Share your printer, modem etc. The selection is made by turning the front panel knob. Eliminate the aggravation of connecting and disconnecting cables. Our - S8AB two position unit can connect one printer to two CPU's. It can also be used to connect one CPU to either a printer or a modem. We also have 3, 4, 5, & 6 position units. In fact we have about 30 models to satisfy all the common applications. Our products are the most popular units on the market. We sold over 10,000 units. We offer a 5 YEAR WARRANTY. OUR UNITS HAVE AN EXCLUSIVE MONITORING OPTION. We have distributors and dealers in most cities. If your favorite computer dealer does not carry a Giltronix Switch please have him call us. We offer the greatest discounts as well as evaluation samples. Call us for a FREE colorful catalog.



450 San Antonio Ave., Palo Alto, CA 94306
DEALER INQUIRIES INVITED!
 Call (415) 493-1300

Circle 168 on inquiry card.

Screens in seconds
QUICKSCREEN™

Screen Builder

ABC CORPORATION INVENTORY DISPLAY ITEM ID: 12345	
FINANCIAL	QUANTITIES
PRICE \$8	ON HAND 193
COST \$4	ON ORDER 50
SALES:	ALLOCATED 6
	REORDER 220
MTD \$200	MTD SOLD 25
YTD \$800	YTD SOLD 100

Microsoft BASIC, CBASIC, dBASE II,
 or FMS80 (four separate versions) 56K CP/M

\$149 (user manual: \$20) plus shipping -
 Fox & Geller Associates, Inc. (201)837-0142
 P.O. Box 1053 Credit Cards Accepted
 Teaneck, N.J. 07666

PH80 is a trademark of DJR Associates
 dBASE II is a trademark of Ashton-Tate
 BASIC, CP/M, are trademarks of Digital Research

Circle 162 on inquiry card.



NEW! for
 the '89 from

MAGNOLIA
 MICROSYSTEMS

**DOUBLE DENSITY
 DISK CONTROLLER**

for both 5 1/4" & 8" drives
 only **\$595** complete

including CP/M™ 2.2

MAGNOLIA MICROSYSTEMS, INC.
 2812 Thornndyke W., Seattle 98199
 (206) 285-7266 (800) 426-2841

CP/M is a trademark of Digital Research.

Circle 225 on inquiry card.

TRS 80 USER

GILTRONIX SOLVED YOUR SWITCHING PROBLEM



A. OUR \$189.00 "GTRS-2AB-AP2" SWITCHING UNIT, WILL CONNECT THE OUTPUT OF YOUR TRS 80 TO TWO (2) DEVICES (LINE PRINTERS, DAISY WHEEL PRINTERS ETC). TO SELECT DEVICE 1 OR 2, SIMPLY TURN THE KNOB TO THE DESIRED POSITION. NO MORE MESSING WITH CABLES! EASY TO INSTALL EASY TO OPERATE! 5 YEAR WARRANTY!

B. SAME UNIT FOR THREE (3) DEVICES. REQUEST PART NO. GTRS-2ABC-AP4 (\$199.00).

C. TO SHARE ONE PRINTER BETWEEN TWO (2) TRS 80's, REQUEST PART NO. GTRS-2AB-AP1 (\$199.00).

D. TO SHARE ONE PRINTER BETWEEN THREE (3) TRS 80's, REQUEST PART NO. GTRS-2ABC-AP3 (\$199.00).

ALL FOUR UNITS ARE AVAILABLE FROM STOCK.

OTHER SWITCHING PRODUCTS ARE ALSO AVAILABLE. WE HAVE OVER 30 MODELS OF MANUAL, REMOTE AND AUTOMATIC UNITS. SEE NEXT COLUMN FOR ADDITIONAL INFORMATION.

CONTACT GILTRONIX OR OUR LOCAL DISTRIBUTORS.

DEALER INQUIRIES INVITED!
 Call (415) 493-1300



450 San Antonio Ave., Palo Alto, CA 94306

Circle 169 on inquiry card.



Solve your disc problems. buy 100% surface tested Dysan diskettes. All orders shipped from stock, within 24 hours. Call toll FREE (800) 235-4137 for prices and information. Visa and Master Card accepted.

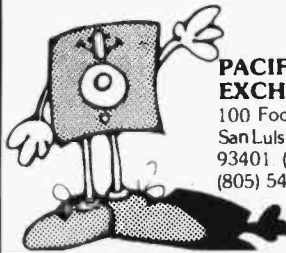

**PACIFIC
 EXCHANGES**

100 Foothill Blvd.
 San Luis Obispo, CA
 93401 (In Cal call
 (805) 543-1037.)

Circle 300 on inquiry card.

**Analog and Power
 Control I/O.....in a
 Single Board Computer**

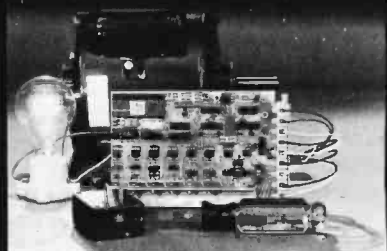

6801 or 68701 MPU with 2K ROM or EROM, 128 RAM, timer. 8 12-bit analog inputs, 8-bit analog output, 8 AC or DC inputs or outputs, serial I/O, digital I/O, watchdog timer, power supply.



Wintek Corp.
 1604 South Street
 Lafayette, IN 47904
 317-742-8428

Circle 417 on inquiry card.

**HOW TO RELOAD
 Multi-Strike Daisy Wheel
 PRINTER RIBBONS**

You can profitably reload

\$96 Richos for \$36

\$90 Diablos for \$24

\$84 Wangs for \$24

\$76 NECs for \$24

\$36 Qumes for \$12

or less

This comprehensive book provides full instructions on how to make as much as \$180 an hour reloading multi-strike ribbons in your home.

Send S.A.S.E. to
WILLIAM WALKER

Box 16-J-B
 164-30 Hillside Ave.
 Jamaica, NY 11432

We sell and reload multi-strike ribbons.
 Prices sent on request.

Circle 405 on inquiry card.

LABELS

299
 perM

15/16" x 3 1/2" white pressure
 1 up - pin feed sensitive

PRICE INCLUDES SHIPPING

Packed 5M per box - Min. order 1 box - \$14.95
 Check with order - Mass Residents add 5% Sales Tax



P.O. Box 103, Randolph, MA 02368
 Telephone: 617-963-7694

Circle 71 on inquiry card.

**ZENITH/Heath
 Users**

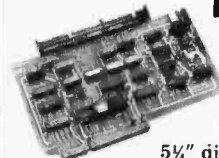

Double Your
 5 1/4" disk storage
 capacity without adding a drive.

Get twice as much from your H88 or H89 microcomputer. Our FDC-880H floppy disk controller, in conjunction with your 5 1/4" drives, for example, expands memory capacity from 256 bytes to 512 bytes per sector.

And it handles single and double-sided, single and double-density, 8" and 5 1/4" drives - simultaneously.

Call 714/275-1272 today
 or write for details.



C.D.R. Systems Inc.

Controlled Data Recording Systems, Inc.
 7667 Vickers St., San Diego, CA 92111

Circle 69 on inquiry card.

HANLEY ENGINEERING CORP.

We Will Beat All Competitor's Prices!!!

Guaranteed to ship within 24 hours on all telephone orders or YOUR ORDER FREE!!

800-426-2668

206-643-0792

**4K STATIC RAM
8/\$20.00**

**16K Memory
8/\$16.00**

74LS00

4000CMOS

74LS00	25	74LS123	30	74LS259	250	4000	35	4040	.95	4501	.50
74LS01	25	74LS124	2.95	74LS260	1.60	4001	35	4041	.95	4502	.95
74LS02	25	74LS125	90	74LS261	2.45	4002	35	4042	.75	4503	.65
74LS03	25	74LS126	80	74LS266	.50	4006	.95	4043	.85	4506	8.95
74LS04	25	74LS132	75	74LS273	1.60	4007	35	4044	.85	4506	1.25
74LS05	25	74LS136	50	74LS275	3.30	4008	.95	4046	.95	4506	1.95
74LS06	30	74LS138	75	74LS279	.50	4009	.45	4047	.95	4508	1.95
74LS09	25	74LS139	75	74LS280	1.95	4010	.45	4048	.75	4510	.95
74LS10	25	74LS145	1.10	74LS283	.95	4011	35	4049	.55	4511	.95
74LS11	30	74LS147	2.25	74LS290	1.20	4012	35	4050	.55	4512	.95
74LS12	30	74LS148	1.25	74LS293	1.80	4013	.45	4051	.95	4514	2.25
74LS13	40	74LS151	1.70	74LS296	1.00	4014	.95	4052	.95	4515	2.20
74LS14	75	74LS153	.75	74LS298	.95	4015	.95	4053	.95	4516	1.50
74LS15	30	74LS155	.90	74LS299	2.50	4016	.45	4055	2.75	4518	1.25
74LS20	25	74LS156	.90	74LS323	3.95	4017	.95	4056	2.75	4519	1.25
74LS21	30	74LS157	.75	74LS324	1.75	4018	.95	4059	9.95	4520	1.25
74LS22	25	74LS158	.75	74LS347	1.95	4019	.45	4063	1.25	4522	1.25
74LS26	30	74LS160	.90	74LS348	1.95	4020	.95	4066	.75	4526	1.25
74LS27	35	74LS161	.90	74LS352	1.50	4021	.95	4068	.40	4527	1.75
74LS28	35	74LS162	.90	74LS353	1.50	4022	.95	4069	.40	4528	1.25
74LS30	25	74LS163	.90	74LS363	1.35	4023	35	4070	.40	4531	.95
74LS32	55	74LS164	.90	74LS366	.90	4024	.75	4071	.30	4532	1.75
74LS35	55	74LS165	.90	74LS366	.90	4025	35	4072	.30	4539	1.75
74LS37	50	74LS166	2.00	74LS367	.65	4026	1.95	4073	.30	4543	1.95
74LS38	35	74LS168	1.70	74LS368	.65	4027	.65	4075	.30	4553	4.95
74LS40	25	74LS169	1.70	74LS373	1.15	4028	.90	4076	.95	4555	.95
74LS42	40	74LS170	1.70	74LS374	1.00	4029	.95	4078	.50	4556	.95
74LS47	75	74LS173	.75	74LS375	.65	4030	.45	4081	.40	4558	2.25
74LS48	75	74LS174	.90	74LS377	1.40	4031	1.50	4082	.40	4568	5.95
74LS49	75	74LS175	.90	74LS385	1.85	4032	2.75	4085	.95	4581	1.95
74LS51	25	74LS181	2.10	74LS386	.60	4033	4.03	4086	.95	4584	1.95
74LS54	35	74LS184	.90	74LS390	1.85	4034	2.75	4083	.95	4584	.95
74LS55	35	74LS190	.95	74LS393	1.85	4035	.85	4094	3.95	4585	.95
74LS63	1.20	74LS191	.95	74LS395	1.60	4037	2.50	4099	1.75	4702	9.95
74LS73	35	74LS192	.80	74LS399	1.55						
74LS74	40	74LS193	.90	74LS424	2.95						
74LS75	50	74LS194	.90	74LS427	.35						
74LS76	40	74LS195	.90	74LS490	1.90						
74LS78	50	74LS196	.80	74LS630	75.00						
74LS83	75	74LS197	.80	74LS640	3.00						
74LS85	1.10	74LS221	1.15	74LS641	3.00						
74LS86	40	74LS240	1.15	74LS642	1.00						
74LS90	60	74LS241	1.15	74LS645	3.00						
74LS91	80	74LS242	1.85	74LS668	1.65						
74LS92	65	74LS243	1.85	74LS669	1.85						
74LS93	60	74LS244	1.00	74LS670	2.15						
74LS95	80	74LS245	1.95	74LS674	1.80						
74LS96	80	74LS247	.75	74LS682	3.15						
74LS107	40	74LS248	1.20	74LS683	2.25						
74LS109	40	74LS249	.95	74LS684	2.35						
74LS112	40	74LS251	1.25	74LS685	2.35						
74LS113	40	74LS253	.80	74LS688	2.35						
74LS114	50	74LS257	.80	74LS689	2.35						
74LS122	45	74LS258	.80	74LS1512	1.25						

74S00

74S00	.40	74S132	1.20	74S201	14.90
74S02	.45	74S133	.95	74S225	8.90
74S03	.45	74S134	.65	74S240	3.95
74S04	.75	74S135	1.45	74S241	3.70
74S05	.75	74S138	1.05	74S251	1.85
74S08	.45	74S139	1.20	74S253	7.40
74S09	.75	74S140	1.40	74S257	1.35
74S10	.65	74S151	1.15	74S258	1.45
74S11	.80	74S153	1.15	74S260	1.80
74S15	.65	74S157	1.15	74S274	19.90
74S20	.65	74S158	1.40	74S275	19.90
74S22	.75	74S161	2.80	74S280	2.85
74S30	.45	74S162	3.70	74S281	1.45
74S32	.95	74S163	3.70	74S288	4.40
74S37	1.85	74S168	4.60	74S289	6.95
74S38	1.65	74S169	5.40	74S301	6.95
74S40	.40	74S174	1.05	74S373	3.40
74S42	.75	74S175	1.05	74S374	3.40
74S44	.75	74S181	4.45	74S381	7.90
74S45	1.20	74S182	2.90	74S387	5.70
74S47	.65	74S188	3.90	74S412	2.95
74S48	2.35	74S189	14.90	74S471	9.90
74S49	1.40	74S194	2.90	74S472	16.80
74S112	1.55	74S196	1.85	74S474	17.80
74S113	1.95	74S196	4.85	74S482	15.50
74S114	1.45	74S197	4.20	74S570	7.75
74S124	2.75			74S572	7.75

74C00 CMOS

74C00	.35	74C161	1.95	74C908	2.00
74C02	.35	74C162	1.95	74C909	2.70
74C04	.35	74C163	1.95	74C910	9.90
74C08	.35	74C164	1.95	74C911	9.90
74C10	.35	74C165	1.95	74C912	9.90
74C14	1.45	74C173	1.95	74C914	1.90
74C20	.35	74C174	2.20	74C915	1.90
74C30	.35	74C175	2.20	74C917	2.70
74C32	.50	74C192	2.20	74C918	1.90
74C42	1.70	74C193	2.20	74C920	16.00
74C48	2.05	80C37	.90	74C922	5.90
74C73	.65	82C19	4.95	74C923	5.90
74C74	.85	74C195	2.20	74C925	6.70
74C76	1.90	74C221	2.20	74C926	7.90
74C83	1.90	74C240	2.20	74C927	7.90
74C86	.90	74C244	2.20	74C928	7.90
74C89	4.50	74C373	2.70	74C929	7.90
74C90	1.70	74C374	2.70	74C930	7.90
74C93	1.70	74C901	.80	74C932	1.95
74C96	1.70	74C902	.80	74C934	1.75
74C107	.95	74C903	.80	74C989	9.90
74C150	5.70	74C904	.80	80C95	.85
74C151	2.20	74C905	10.90	80C96	.90
74C154	3.20	74C906	.90	88C30	3.95
74C157	1.75	74C907	.90	88C29	3.95
74C160	1.95				

LINEAR

7805CT	.85	LM301V	.75	LM567V	1.25
7812CT	.85	LM308V	.75	LM723	.50
7815CT	.95	LM309K	1.50	LM733	.95
		LM311V	.60	LM741V	.30
		LM317T	1.90	LM747	.75
7805KT	1.40	LM317K	3.75	LM749V	.60
7812KT	1.40	LM318N	1.50	LM1414	1.95
7815KT	1.40	LM320	3.75	LM1458V	.65
	.65	LM324N	.60	DS1488N	1.00
78L12	.65	LM337K	3.95	DS1489D	1.00
7905CT	.95	LM339	.75	LM1889	2.45
7912CT	.95	LM377	2.25	LM3300	.60
7915CT	1.15	LM386V	1.25	LM3914	.90
				LM3915	3.75
7905K	1.50	LM555V	.40	LM3916	3.75
7912K	1.50	LM555	.70	DS1545-1	.40
7915K	.75	LM555	.95	DS1545-2	.40
79L12	.75	LM565	.95	DS1545-3	.40
79L15	.75	LM566V	1.50	DS1545-3	.40

HITACHI
2K x 8 CMOS RAM 150NS
Pin Compatible with 2716
HM6116P-3
\$13.00

8200 **8 For \$88.00**

8080A 3.95
8085A 8.95
8085A-2 11.95
8086 99.95
8088 39.95
8155 11.25
8185 29.95
8202 45.00
8205 1.75
8212 1.90
8214 3.85
8216 1.80
8224 2.50
8226 1.80
8228 4.90
8238 4.90
8243 4.50
8251A 5.45
8253 9.80
8254 5.20
8257 - 5 8.95
8259A 6.95
8271 60.00
8272 39.95
8275 29.95
8279 - 5 10.00
8282 6.60
8283 6.60
8284A 5.75
8286 6.60
8287 6.60
8288 25.00
8289 49.95
8755A 45.00
8748 30.00

6800 **8 For \$88.00**

6800A	3.95	6801	3.95
6802	4.90	6803	4.90
6805	11.00	6806	11.00
6809	25.00	6810	3.50
6809B	45.00	6811	3.50
6809C	36.00	6812	3.50
6810	3.50	6813	3.50
6821	3.50	6814	3.50
6840	9.00	6815	3.50
6843	41.00	6816	3.50
6845	22.00	6817	3.50
6847	12.25	6818	3.50
6850	3.50	6819	3.50
6852	3.50	6820	3.50
6875	7.00	6821	3.50
6880	1.80	6822	3.50
6882	4.70	6823	3.50
6885	1.80	6824	3.50
6888	1.80	6825	3.50
6889	1.80	6826	3.50
6848B	12.50	6827	3.50

AUGAT LOW PROFILE SOCKETS

These Are High Reliability Industry Standard Sockets

8PIN	208-AG29D	.10
14PIN	214-AG29D	.16



Scotch® DISKETTES

SAVE 40% Write for our complete list.

5 1/4" Specify soft, 10 or 16 sector	Price/10
#744 1 side/sgl dens.	\$26.70
#744d 1 side/dbl dens.	33.20
#745 2 sides/dbl dens.	40.30
8" Specify soft or 32 sector	
#740 1 side/sgl dens.	27.30
#741 1 side/dbl dens.	35.80
#743 2 sides/dbl dens.	43.60

CHECKS - VISA - MC - C.O.D.
(313) 777-7780 ADD \$2 SHIPPING

LYBEN COMPUTER SYSTEMS
27204 Harper Ave.
St. Clair Shores, MI 48081

Authorized Distributor
Information Processing Products



Circle 221 on inquiry card.

SUPER E-Z80 KIT 64K-Z80A-CP/M™ Compatible Micro-Computer

Features: Z80A CPU-CTC and PIO • 64K Dynamic Ram • 4K Monitor EProm • 54 Key Keyboard (Detachable) • 3 Fully Buffered S-100 Spaces • Integrated Circuit Sockets • RS232-C Asynch. Modem Control (Programmable Baud Rate) • Composite Video • CP/M™ Operating System Compatible • Epson or Centronics Printer Compatible Parallel Port • 8272 Floppy Controller Device • 3740 and 3741 Comp. - 8" & 5 1/4" Drives - up to 4 Drives • Z80 Programming Card • Assembly Instructions • Monitor Listing • Block Diagram.

PRICE: \$1195.00
TERMS: Certified check or money order
(Texas Res. Add Sales Tax)

KIT-80 INC.

18601 LBJ Fwy. • Mesquite, Texas 75150
• 800-527-1593
A Subsidiary of Patrick Computer Systems, Inc.
Manufacturer of the ic436
integrated business computer

™ Trademark of Digital Research

Circle 208 on inquiry card.

STATISTICAL SOFTWARE

ELF - Stepwise regression, factor analysis, correlation coefficients, crosstabs, simple statistics, t-tests, ANOVA, stepwise discriminant analysis, all BASIC transformations and more. \$200.00
TWG/ARIMA - Box-Jenkins for seasonal and non-seasonal models, identification, estimation and forecasting. Price: \$300.00.

Each includes a database manager, numeric software keypad, and is menu-driven. Each requires an Apple II with Applesoft, 48K, and DOS 3.3.

For further information, write

The Winchendon Group
3907 Lakota Road
P.O. Box 10114
Alexandria, VA 22310

* Apple II and Applesoft are trademarks of the Apple Computer Company

Circle 415 on inquiry card.

ELIZA IS HERE!

AT LAST! A FULL IMPLEMENTATION of the original ELIZA program is now available to run on your microcomputer!

Created at MIT in 1966, ELIZA has become the world's most celebrated artificial intelligence demonstration program. ELIZA is a non-directive psychotherapist who analyzes each statement as you type it in and then responds with her own comment or question - and her remarks are often startlingly appropriate!

Designed to run on a large mainframe, ELIZA has hitherto been unavailable to personal computer users except in greatly stripped down versions lacking the sophistication which made the original program so fascinating.

Now, our new microcomputer version possessing the FULL power and range of expression of the original is being offered at the introductory price of only \$25. And if you want to find out how she does it (or teach her to do more) we will include the complete Source Program for only \$20 additional.

Order your copy of ELIZA today and you'll never again wonder how to respond when you hear someone say "Okay, let's see what this computer of yours can actually do!"

ELIZA IS AVAILABLE IN THE FOLLOWING DISK FORMATS:

- Standard 8-inch single density for all CP/M based computers. \$25 for ELIZA COM - add \$20 for Microsoft BASIC-80 Source
- 5 1/4-inch CP/M for Apple II equipped with Z-80 SoftCard. \$25 for ELIZA COM - add \$20 for Microsoft BASIC-80 Source
- 5 1/4-inch for 48K Apple II with Applesoft ROM and DOS 3.3. \$25 for Protected File - add \$20 for Unprotected Source

ARTIFICIAL INTELLIGENCE RESEARCH GROUP

921 NORTH LA JOLLA AVENUE
LOS ANGELES, CALIFORNIA 90046
(213) 656-7368 (213) 654-2214
MC, VISA and CHECKS ACCEPTED



Circle 35 on inquiry card.

WANTED:

APPLE, IBM, TRS-80, CP/M SOFTWARE

Westico is a publisher and distributor of professional software for microcomputers. If you have a new program ready for distribution or want your existing programs to reach a larger market, contact:

Phillip Woelhof, V.P. Mktg.
Westico, Inc.
25 Van Zant Street
Norwalk, CT 06855
(203) 853-6880

To increase your profits, take advantage of Westico's worldwide promotion and distribution.

WESTICO

The Software Express Service

Circle 410 on inquiry card.

ANALOG ↔ DIGITAL DIGITAL ↔ ANALOG

CONVERSION MODULES SOFTWARE GAIN CONTROL

High accuracy - programmable gain instrumentation amplifier - custom board test - \$100 - 9 to 15 kHz conversion time - mixable high and low inputs - gain from 1 to 1024 - 12-bit - sample and hold amplifier
8-channel differential - 16-channel - analog to digital high accuracy - programmable gain instrumentation amplifier - custom board test - \$100 - 2 to 15 kHz conversion time - mixable high and low inputs - gain from 1 to 1024 - 12-bit - sample and hold amplifier
8-channel differential - 16-channel - analog to digital high accuracy - programmable gain instrumentation amplifier - custom board test - \$100 - 9 to 15 kHz

For additional details about the AD-100-4 and other fine California Data Corporation 100% individually tested, high reliability products, circle the reader service card number below or for faster response write or call us.

CALIFORNIA DATA CORPORATION
3475 Old Conejo Road, Suite C-10
Newbury Park, CA 91320
(805) 498-3651

Circle 64 on inquiry card.

RS-232 Got ya down?

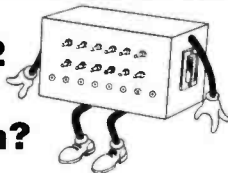

The RS-232 Monitor/Controller will help get ya up again. It simply connects in series with any RS-232 interface and allows you to Monitor and Control The RS232 control and data lines. Operates on 9 volt transistor batteries or without batteries when monitoring. Complete instructions included along with helpful interfacing tips.

Price/Terms \$59.95/money order, check, C.O.D., Master Charge or Visa. Alabama Residents add 6% sales tax, shipping included in price.

KIRBY engineering associates

P.O. Box 509 Pelham, AL 35124
(205) 987-0997

Leaders in computer interfacing

Circle 207 on inquiry card.

PERSONAL COMPUTER SOFTWARE for EXECUTIVES and MANAGERS

- Name/Address/Key Information
- Personal Schedule
- Corporate Schedule
- Document Tracking
- File Indexing Schema
- Tickler File
- Questionnaire Tabulating

Any three for \$150 - All seven for \$250. Functional, well engineered software in the Pascal programming language for Apple II and TRS-80 Model II computers.

SOFTWARE CONSULTING SERVICES
901 Whittier Drive, Allentown, Pa. 18103
(215) 797-9690
ATT. Martha Cichelli

*TM Apple Computer Co. **TM Tandy Corp.

Circle 354 on inquiry card.

"C" COMPILERS FOR MC 6809

- Generates re-entrant/relocatable, efficient, 'rom'able assembly language
- Supports full "C" except: long, floats, doubles, initializers, and bit fields
- Includes object code linker, library manager, and 6809 assembler
- All user program I/O easily configured to target hardware environment
- Available as flex-compatible, resident compiler or CP/M-compatible, cross-compiler

FC 6809 FLEX VERSION \$300.00
CC 6809 CP/M VERSION \$350.00

CP/M - 68XX CROSS-ASSEMBLERS (INCLUDING SOURCE CODE IN "C")

A6800 ... MC 6800, MC 6802, MC 6808 ... \$125.00
A 6801 MC 6801, MC 6803 \$125.00
A 6809 MC 6809 \$125.00

CP/M FORMATS: 8" SOFT SECTORED,
5" NORTHSTAR
FLEX FORMATS: 8" SOFT SECTORED

*Flex Trademark of Technical Systems Consultants, Inc.
*CP/M Trademark of Digital Research

INTROL CORP.

647 W. Virginia St.
Milwaukee, WI. 53204
(414) 276-2937

KIT-80 INC.

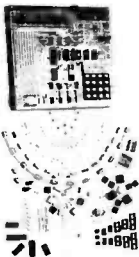

E-Z-80 ENTRY KIT

A Z-80 Micro Computer with CPU: CTC:
PIO: Prom Programmer: Read Outs: Key
Pad: Onboard ROM & RAM: Wire Wrap:
DC Regulator: Manual & Instructions.

Kit Price \$390⁰⁰

18601 LBJ Fwy • Mesquite, Texas 75150 • 800-527-1593
WINNIPEG (204-632-1687) • VANCOUVER (604-224-6620)
CALGARY (403-236-3040) • TORONTO (416-281-3454)
MONTREAL (514-286-4034)

A Subsidiary of Patrick Computer Systems, Inc., man-
ufacturer of the ic436 integrated business computer.

Circle 209 on inquiry card.

FOR YOUR 

HARDWARE AND SOFTWARE

FREE CATALOG
OVER 350 PRODUCTS
SPECIAL OFFER

wabash® DISKETTES

Unique SR-3000 Formulation - 100% Certified
Error Free - Hub Rings Installed on 5 1/4"

5 1/4" SS/SD \$21.95/BX DS/DD \$29.95/BX

8" SS/SD \$23.75/BX DS/DD \$36.75/BX

ONE TIME ONLY - ONE BOX/CUSTOMER

Ask For Our S-100 and Related Products Catalog

2.4MB NEC B" FLOPPY DISKS
SUBSYSTEM \$1675

FETCH COMPUTER PRODUCTS DIVISION OF:
ALMALY TRADING CORPORATION
8135 S.W. 17 STREET, MIAMI, FL 33155
TELEX: 51-9602 "ALMALY MIA"

800-327-2251

Apple is a Registered Trademark of Apple Computers

Circle 12 on Inquiry card.

Verbatim flexible disks

Call Free (800) 235-4137 for
prices and information. Dealer
inquiries invited. C.O.D. and
charge cards accepted.

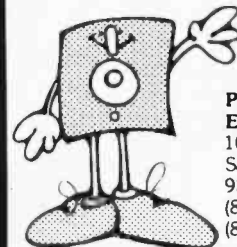



PACIFIC EXCHANGES
100 Foothill Blvd.
San Luis Obispo, CA
93401. In Cal. call
(800) 592-5935 or
(805) 543-1037.

Circle 300 on inquiry card.

CABLES

EIA RS-232-C

- Quality Cables
- Immediate Delivery
- Low Prices

*16-25 conductor (M or F) 15.85 & .50/ft.
13-15 " " 13.90 & .40/ft.
9-12 " " 12.90 & .30/ft.
5-8 " " 12.10 & .25/ft.
1-4 " " 11.30 & .15/ft.

SPECIFY: Male or female connectors
Length of cable
Pins to be connected

*Plus Shipping - All orders pre-paid or C.O.D.

Communication Cable Company (215) 964-9404
319 Louella Ave.
Wayne, PA 19087

Circle 83 on inquiry card.

command your own STARSHIP

with

Fleet Maneuvers

1982's hottest new
play by mail game.

by

FANTASTIC SIMULATIONS

p. o. box 24566
denver colorado 80224

Circle 159 on inquiry card.

Inside the IBM Personal Computer

This collection of useful information
supplements the IBM Manuals to show how to:

- Program the system DMA and Interrupt Controller
- Design expansion slot add-in boards
- Program add-in boards using BASIC, assembler, and DOS
- Use DOS and BIOS functions from user programs

PLUS technical data including:

- System operation and timing diagrams
- Using the extra ROM and co-processor sockets
- Expansion slot signals and timing diagrams

ILLUSTRATED with example schematics
and programs for D/A converters, Parallel
I/O, Clock/Calendar

Send check or money order for \$10.00
(D.C. residents add 6% tax).

TENLEY DESIGN
P.O. Box 39155
Washington, D.C. 20016

Circle 253 on inquiry card.

TYPESETTING from your own COMPUTER

Type your manuscripts, catalogs, or
other text into your word processing com-
puter.

Send it to us on a diskette or via a
modem transmission and we'll send you
camera ready film copy.

Computer typesetting provides high
quality, easy to read copy at a fraction of
the cost of conventional typesetting.

Call or write for instructional brochure
that includes typestyle selections, format-
ting instructions, and examples.

Dream Electronics

131 N.W. 2nd St. 1-503-7524833
Corvallis, Oregon 97330

Circle 136 on Inquiry card.

UCSD p-System™ IV.1

IBM Personal Computer
North Star Horizon
North Star Advantage
ALTOS 8000, 8000-10

Operating System \$300.00
Compiler \$300.00

Extended memory and hard disk
supported. Turnkey prices avail-
able on request.

Dealer Inquiries Welcome



*The Regents of the University of California

Network Consulting Inc.

A106 - 1093 W. Broadway
Vancouver, Canada V6H 1E2
604-738-3500

Circle 279 on inquiry card.

DISKETTES CASSETTES

Error-Free 5 1/4-inch Diskettes (MD-
5) single-sided, soft sector, single or
double density, reinforced hub.

Item	Qty 10	Qty 50
MD-5	\$25.00	\$110.00
C-10	\$ 7.50	\$ 32.50
C-20	9.00	39.00
C-60	11.50	50.00
C-90	15.00	70.00

UPS SHIPPING INCLUDED
in Continental USA
CA Customers add taxes

MICROSETTE

475 Ellis St., Mt. View,
CA 94043 (415) 968-1604

Circle 253 on inquiry card.

We Have It All !..Now at an extra 5% off

AFTER INVENTORY CLEARANCE

\$1,000,000

INVENTORY

***being discounted
an extra 5%.....***

***Included Is Most, But Not All
Products In MiniMicroMart's
Current Inventory. Call Or Send
For Our Special Price List And
Catalog.***

**Special price applies to current inventory, which is subject to prior sale.
Offers on most items will terminate on April 30, 1982**

MiniMicro Mart, Inc.

943 W. Genesee St. P.O. Box 2991 B
Syracuse, N.Y. 13220 315-422-4467

FLOPPY DISKS

NEW Shugart SA400.....\$233.00
 NEW Shugart SA450..... 325.00
 NEW Shugart SAB01R..... 393.00
 NEW Shugart SAB51R..... 520.00
 Dual 8" enclosure, wired, power, rack
 mount slides, remote AC power
 control..... 649.00
 Enclosure, 8" desk top, bare, unwired 75.00
 ENCLOSURE DUAL MINI WITH
 POWER, DESK TOP..... 90.00

DISKETTES

1 year warranty, 10 per plastic library case.
 8" ..single side-single density 28.40
 8" ..single side-double density 39.90
 5 1/4" ..double sided-double density 45.70
 5 1/4" REINFORCED HUB 10/PLASTIC
 LIBRARY CASE SOFT SECTORED,
 10 OR 16 HOLES
 single side-single density 29.70
 single side-double density 36.10
 double sided-double density 43.90

TRACTOR FEED PAPER

9 1/2 x 11 blank, 3700 sheets, perf 27.22
 8 1/2 x 11 blue bar, 3700 sheets 24.72

OTHER TYPES OF MEDIA AVAILABLE...
 CALL FOR PRICE

MI **METAVAN, INC.**
 1805 East Dyer Road, Suite 307
 Santa Ana, CA 92705
 (714) 540-2427

Circle 235 on inquiry card.

PRINTER SOLUTION

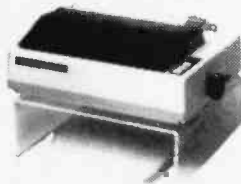

Handsomely crafted of heavy-duty 1/4" Plexiglas.
 Permits easy, convenient storage of paper,
 checks, invoice forms, plus direct feed from shelf
 or surface below. A Programs Unlimited exclusive!
 Regular Size \$29.95
 13" x 15" (Epson MX-80, Okidata u82, u83)
 Large Size \$39.95
 13" x 17" (Epson MX-100, Okidata u84)
 X-Large Size \$59.95
 (Includes Shelf) 13" x 22" (Dataroyal, Paper Tiger)
 Optional Shelf \$14.95



**PROGRAMS
 UNLIMITED**
 COMPUTER CENTERS
 800-645-6038 In NY 516-997-8668

Circle 321 on inquiry card.

68000

MACSBUG & OMNIBYTE
 users

DEBUGGING DISASSEMBLER

Res. in 4 2716's

DISPLAYS:

- ADDRESS
- MNEMONICS
- DATA
- ASCII Equiv.

\$165 (ca. res. add 6.5%)

SYSTEM 300

486 Thompson ave

MT. View Ca. 94042

Circle 369 on inquiry card.

RIBBONS

CARTRIDGE RIBBONS
 FOR COMPUTERS,
 WORD PROCESSORS, etc.

PRICED FROM

175

EACH IN
 LOTS OF 12

PRICES INCLUDE SHIPPING

WRITE FOR PRICE LIST

CHECK-MATE™
 P. O. BOX 103, RANDOLPH, MA 02368
 TELEPHONE: 617-963-7694

Circle 72 on inquiry card.

SILVERA QUALITY

CompuPro™ **GOODCUT**
TECHNOLOGY

CPU Z 6MHz CSC	308	CPU Z A&T	221
CPU 8085/88 CSC	394	CPU 8085/88	319
DISK 1 A&T	371	CPM*2.2	135
INTERFACER 1,11	187	INTERFACER 3	467
RAM 17 64K A&T	597	RAM 16 A&T	671
6MHz CPU Z SYSTEM 64K DUAL 8" DRS	3595		
8MHz CPU 8085/88 SYSTEM 64K (2)8"	3695		

Seattle Computer

SEATTLE SYSTEM 1 64K, SER, PAR	2549
SEATTLE SYSTEM 2 128K SER, PAR	3325
8085 & SUPPORT	596
BASIC 86	235
64K STATIC 8/16	746
BASIC 86 COM	235
PASCAL 86	349
FORTRAN 86	349

MORROW DESIGNS

MORROW DECISION 1	1295	65K STATIC A&T	581
DMA DISK JOCKEY CPM	356	MULTI 1/0	269
SMITCHBOARD 1/0	195	M/OS MULTI-USER	371
BASE 11 & SPELLBINDER TOGETHER (LIST 1195)	749		

CPM is TRADEMARK OF DIGITAL RESEARCH OF CA
 PO 951 WESTMINSTER CA 92583-0951
 714 695-7446

Circle 352 on inquiry card.

NEW! \$795



**Typewriter T35 KSR
 DAISYWHEEL**

- Integral parallel interface KSR version based on the Olivetti PRAXIS Model 35 electronic daisywheel
- 10/12/15 characters per inch spacing
- Now software and manually selectable
- Local and online modes
- Fine line spacing adjustment
- Beautiful case

TRS 80 PRINTER PORT CABLE \$20.00
 TRS 80 KEYBOARD INTERFACE \$49.95
 INTELLIGENT ASCII RS-232 CONTROLLER \$89.00

*T30 from \$649 TRS 80 Apple Software Driver Now Available

See your local dealer or contact

SYSTEMED CORP.
 P.O. BOX 18, MOUNTAIN CITY, TENNESSEE 37683 PHONE (615) 727-6000

Circle 370 on inquiry card.

C compilers and Cross compilers

Available for:

PDP-11	RT-11/RX-11
6809	SDOS/FLEX
8080	CP/M
8085	CP/M
Z80	CP/M
8086	
8088	

OTHERS PENDING

The full C language, as described in
 "The C Programming Language" by
 Kernighan and Ritchie.

UNIX version 7 compatible.

UNIX is a trademark of Bell Labs.
 RT11/RX11 are trademarks of Digital Equipment Corp.
 SDOS is a trademark of Software Dynamics.
 CP/M is a trademark of Digital Research.
 FLEX is a trademark of Technical Systems Consultants.

TELECON SYSTEMS
 90 E. Gish Road, Suite 25
 San Jose, California 95112
 408-275-1659

Circle 379 on inquiry card.

CENTRONICS 739

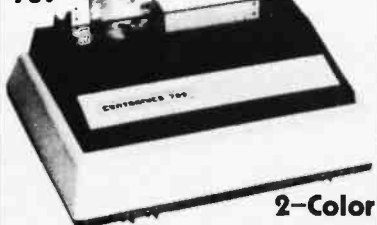

2-Color

- ▶ Printer BLACK and RED
- ▶ Underlining, Subscript & Super Script
- ▶ Proportional Spacing
- ▶ Single Sheet Paper Feed
- ▶ Hi-Resolution Graphics
- ▶ Suitable for Word Processing

#B-P739 (Parallel) \$599.88 Delivered

#B-S739 (RS-232C) \$699.88 Delivered

HIGH TECHNOLOGY AT AFFORDABLE PRICES

**THE
 BOTTOM
 LINE**

12 Johnson Street, Milford NH 03055

TO ORDER
 CALL TOLL FREE
 1-800-228-3900

For Technical Details
 1-603-637-8857

Circle 49 on inquiry card.

Software For IBM

Personal Computer

- General Ledger (48K) \$395
- Accounts Payable (48K) \$395
- Accounts Receivable (48K) 4/1/82
- Payroll (48K) 4/1/82
- Star Trek (32K) \$24.95
- Complete with comprehensive users guide

ZETA Products

Box 147 Georgetown, TX 78626
 (512) 863-3079



Circle 420 on inquiry card.

Printers Plus

...computers, peripherals, accessories and supplies!



APPLE ACCESSORIES

Apple II & 48K	CALL
Disk II w/controller DOS 3.3	CALL
Disk II Add-On	CALL
Microsoft Z80 Softcard	299.
16K Ram Card	159.
CCS Parallel Card	109.
Async Serial Card	139.
Clock/Calendar Card	99.
IEEE Card	239.
A-D Card	99.
Mountain Comp. Romplus	139.
KB Filter ROM	49.
CPS Multifunction Card	199.
Supertalker	259.
Paymar L/C Adapter - New	39.
— Old	49.
M&R Super Mod	25.
Superterm	319.
Videx Video Term	309.

APPLE SOFTWARE

Personal S/W Desktop Plan II	\$ 159.
CCA Data Mgmt	85.
Visicalc	159.
Visiplot	159.
Visitrend/Visiplot	219.
Visidex	169.
Visiterm	129.
Micropro Wordstar	299.
Super-Sort	159.
Mail-Merge	99.
Data Star	239.
Spell Star	199.
Muse Super Text II	129.
Address Book	44.
Form Letter Module	79.
Stoneware-DB Master II	199.
Microcom-MicroCourier	239.
Infotory	199.

RIBBONS

NEC	\$77.00/Doz.
Qume	45.00/Doz.
Diablo	66.00/Doz.
Anadex	135.00/6 ea.
Tritel	95.00/Doz.
TI/DEC/TTY	45.00/Doz.
Epson	13.95/ea.
MPI/Axiom/Base 2	10.00 ea.

MAGNETIC MEDIA

Premium Quality At Bargain Prices
5 1/4" Diskettes, all Formats

100% Certified with hub rings, box of 10

Single sided, single density	26.95
Single sided, double density	29.95
Double side, double density	38.95
8" Diskettes, All Formats, 100% Certified	
Single sided, single density	29.95
SSSD Error Free	32.95
Single sided, double density	39.95
Double sided, double density	49.95

EPSON

Complete Stock of MX-80, MX-80 F/T
MX-100 Printers, Graphics Chip Sets
Cards and Cables

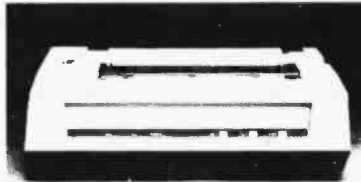

NEC-8023 A, 100 cps Matrix Printer

Hi-Res dot graphics, proportional spacing, correspondent quality printing, bi-directional tractor and friction feed. 80, 132 col. Greek & Math symbols. Everything you need in a small printer.

List \$840 \$599.



MODEMS

UDS 103 LP, direct	\$ 169.
103 JLP Auto Answer	209.
202 LP 1200 BAUD	259.
NOVATION CAT, acoustic	145.
D-CAT, direct	155.
Auto Cat	219.
Apple Cat	339.
HAYES S100 Micromodem	\$349.
Apple Micromodem	299.
Smart Modem	249.

VIDEO MONITORS

Zenith 12" Green	\$ 119.
NEC 12" Green	\$ 185.
Amdex 12" B/W (Leedex)	\$ 139.
Amdex 13" Color Lo-Res	\$439.

VIDEO TERMINALS

Ampex Dialog 80	\$995.
Ampex Dialog 30	795.
Televideo 920C	845.
Televideo 950	995.



NEC
PC-8000 Series
Microcomputer System.

INTRO
PRICING
\$ 1099.00

- Z-80A CPU 4 MHz
- 5 user programmable function keys • 82 Keys with numeric keypad • 160 x 100 resolution • 80 character screen

PC-8001A Microcomputer w/32K RAM	899.
PC-8012A I/O Unit w/32K RAM	
Expansion slots	599.
PC-8031A Dual Mini-Disk Drive Unit	899.
PC-8032A Add-On Dual Mini Disk Drive Unit	799.

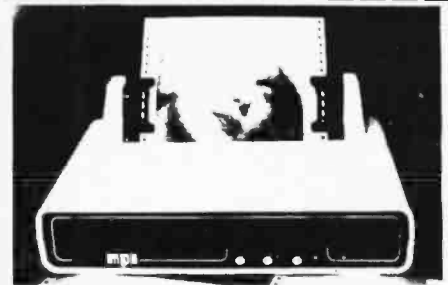

MPI 88G / 99G MATRIX

High resolution dot-addressable graphics for Apple. Enhanced "correspondence quality" printing. Tractor and friction feed. Serial and Parallel Input. 100 cps Bidirectional printing. 80, 96 and 132 column widths!

88 G List	\$749	\$589.
99 G List	\$849	\$660.
Apple Parallel I/O Card/Cable/Disk		\$110.
with Graphics Prom (Ap-Pak)		\$145.
IEEE I/O Card		\$55.
Single Sheet Feeder		\$25.
QT Cover		\$35.

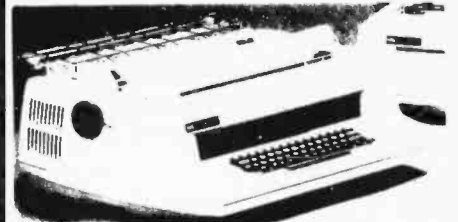

NEC SPINWRITERS

5510/5530 RO w/tractor	\$2,550.
7710/7730 RO w/tractor	\$2,595.
5520 KSR w/tractor	\$2,850.
7720 KSR w/tractor	\$2,895.
3510/3530 RO	\$1,895.
Bi-directional tractor	\$225.
Pusher tractor	\$350.

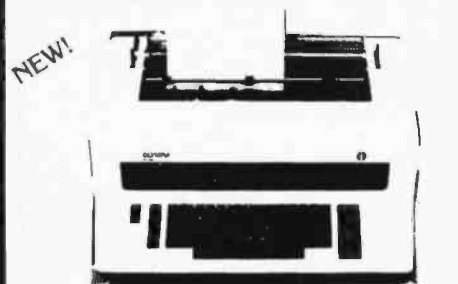

OLYMPIA

Letter quality. Daisy wheel printer/typewriter interfaces to Apple, Atari, NEC, TRS80 and RS232 Serial ports. A truly cost effective letter quality printer that functions as a typewriter.

ES100 RO Computer printer	
List \$1690	CALL
ES100 Typewriter only	CALL
Interface Card Only	CALL
(specify serial or parallel)	
I/O Cable (specify serial or parallel)	CALL
Apple Serial Card	CALL
Print Wheels & Ribbons	CALL

TO PLACE YOUR ORDER CALL:

TELEPHONE (714) 744-7314 TELEX 697120

or write to:

PALOMAR

Computer Products

910-105 W. San Marcos Blvd., San Marcos, CA 92069

TERMS OF SALE: Cash check money order bank wire transfer credit card or purchase orders from qualified firms and institutions. Please include telephone number with order and expiration date on credit card orders. California residents add 6% sales tax. Advertised prices are for prepaid orders. FOB shipping point. Add 3% for shipping in U.S. Pricing and availability subject to change without notice.

YOU CAN SAVE \$\$\$ ON RIBBONS FOR

Anadex DP 9500	\$14.00
Centronics 700 Series Zip Pack (Box of 3)	\$ 8.25
Cartridge	\$ 8.50
D.E.C. LA-34	\$ 6.90
Diablo 630	\$ 6.00
Epson MX 70-80	\$12.95
NEC Spinwriter (Box of 3)	\$14.25
Okidata Microline 80 (Box of 3)	\$ 8.90
Radio Shack LP II - IV	\$ 8.50
Teletype 33 (Box of 3)	\$ 6.00
Teletype 43	\$ 7.50
Ti Silent 700 Thermal Paper (Case)	\$48.00

Plus Many Others - Call for Information on Ribbons, Thermal Paper and Diskettes.

Add \$3.00 for Shipping & Handling
Illinois Res. Add 6% Sales Tax

ILLINOIS COMPUTER PRODUCTS CO.

P.O. Box 112
Mt. Prospect, IL 60056 (312) 228-5590

Circle 183 on inquiry card.

Scotch Diskettes

Rely on Scotch® diskettes to keep your valuable data safe. Dependable Scotch diskettes are tested and guaranteed error-free. The low abrasivity saves your read/write heads. They're compatible with most diskette drives.



(800)235-4137

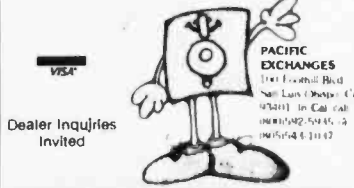

Dealer Inquiries Invited

Circle 300 on Inquiry card.

RS-232 PROBLEMS?

We have a large assortment of problem solvers at **B & B ELECTRONICS**, send for our new Catalog.

RS-232 TESTER. Seven LED'S display the status of RS-232 lines: **\$39.95**

RS-232 DATA TAP. Lets you tap data off a RS-232 line: **\$34.95**

RS-232 NULL MODEM. Replaces a set of modems for testing: **\$19.95**

RS-232 GENDER REVERSERS. Convert a male connector to female or a female to male. Either one: **\$19.95**
Set of both Reversers: **\$34.95**

B & B ELECTRONICS
BOX 475 / MENDOTA, IL 61342
IL Residents add 5% Tax

Circle 43 on Inquiry card.

UV EPROM ERASER



\$49.95

- ERASES ALL UV ERASABLE EPROMS (2708, 2716, 2564, etc.)
- QUICK FIFTEEN MINUTES ERASE TIME
- ERASES OVER FIFTEEN EPROMS AT A TIME
- LAMP LIFE: 7700 HOURS
- INDUSTRIAL MODEL \$68.50
- INDUSTRIAL MODEL WITH TIMER & SAFETY INTERLOCK SWITCH \$97.50 (Rugged steel enclosure with bottom drawer)

THE BEST 6809 SINGLE BOARD COMPUTER AVAILABLE

- Floppy Controller
- Printer Port
- RS-232 Port
- For the 6850 AND 6809 BUS
- ASSEMBLED, TESTED, 24 HOUR BURN-IN, 90 DAY WARRANTY

2114 RAM 300 ns	\$2.95	STRAIGHT FROM THE FACTORY & GUARANTEED
2716 EPROM 550 ns	\$4.50	
EPROM PROGRAMMER for 2716, 2732	\$99.50	
In Circuit Emulator for 68xx, 80xx, 280	\$99.95	

WE ACCEPT VISA, MASTERCARD, C.O.D. CHECKS

PHONE ORDERS (305) 974-0967

LOGICAL DEVICES INC.
791 W. OAKLAND PARK BLVD • FT LAUDERDALE, FLORIDA 33311
ADD \$1.00 SHIPPING, \$2.00 C.O.D. CHARGE

Circle 218 on Inquiry card.

1802 fig-FORTH

high-level compiler language
10-20X faster than BASIC

ELF II / SuperELF / VIP
RCA Microboard

w/editor, strings
macro-assembler
floating-point **\$90**

plus tiny pascal add \$35
on cassette/requires 16k+RAM

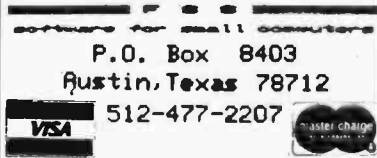

P.O. Box 8403
Austin, Texas 78712

512-477-2207

Circle 164 on Inquiry card.

THE MISSING LINK



\$249*

Adapt IBM ET50, 60, or 75 to Apple II or III with our Missing Link for word processing quality output.

- Does not affect normal typewriter operation
 - Typewriter still qualified for IBM maintenance contract
 - Interface isolates the Apple from the typewriter
- See our full page ad in May 1980 BYTE
Check with your local Apple dealer or to order call: 1-800-845-2712 (In S.C., call 1-800-922-5528)

If you need word processing software, we offer Manuscripter in two versions: Beginner \$95, Advanced \$195

*S.C. residents add 4% sales tax

CompuSystems
2301 DEVINE STREET • P.O. BOX 5144
COLUMBIA, S.C. 29250 • (803) 254-0804

Circle 88 on Inquiry card.

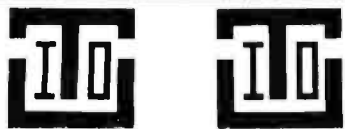

FOR UCSD PASCAL* SYSTEMS

\$650 - PDBASE an Entity Relational Data-base. Complete with English query language, formatted screen, procedure language, data security, multiple users, validity checking and example relations.

\$300 - Program interface for PDBASE

\$ 25 - PDBASE users manual
\$125 - Interactice spelling checker
\$100 - Complete LISP interpreter.

IOTC Inc.

910 Sully/Laramie, WY 82070

*Trademark Regents Univ. of Calif.
(307) 721-5818

Circle 196 on Inquiry card.

YORK 10 BASF-DPS WORLD STANDARD TAPE



DATA TRAC
C-10
C-20

- BLANK COMPUTER CASSETTES
- UNIVERSAL INDUSTRY ACCEPTANCE
- MONEY BACK GUARANTEE

	LENGTH	1 DOZEN	2 DOZEN
	C-10	8.00	14.40
	C-20	10.00	18.00

Shipping: 1 doz \$2 2 doz \$3.50 add'l. doz. \$1.
Calif. residents. add 6% sales tax

For IMMEDIATE SHIPMENT on Credit Card Orders. Call: 213/710-1430

YORK 10 Computerware
24573 Kittridge St. • #B-1, Canoga Park, CA 91307

Circle 431 on Inquiry card.

IEEE-696 S-100 HARDWARE CP/M* SOFTWARE

WORDSTAR for CP/M	\$299
SPELLSTAR (requires WORDSTAR)	\$169
MAILMERGE (requires WORDSTAR)	\$99
dBASE II	\$549

32K STATIC RAM	
IEEE-696 S-100, 8/16 bit data, Extended Addressing 24 bits, Bank Select, 2716 EPROM Mix, Battery backup option	\$379
150 ns CMOS A&T	\$379
NEC 12" green phosphor monitor	\$179
TELEVIDEO 925	\$799
COMPLETE S-100 CP/M MICROCOMPUTER	
280 CPU 4Mhz, 64KRAM, Floppy dbi den controller, 2 parallel, 2 serial interfaces, 28" floppy drives, 1.2 MB storage, CP/M 2.2 and utilities	\$2,899

1 YEAR GUARANTEE on all boards

Outside California CALL TOLL FREE
800-854-6413

In Calif. call 714-497-5777

COTTON ASSOCIATES
1278 Glenneyre, suite 505
Laguna Beach, CA 92651
*CP/M trademark of Digital Research

FULL LINE ALL PARTS & COMPUTER PRODUCTS



P.O. Box 4430X
Santa Clara, CA 95054
Will call: 2322 Walsh Ave.
(408) 988-1640

Same day shipment. First line parts only. Factory tested. Guaranteed money back. Quality IC's and other components at factory prices.

INTEGRATED CIRCUITS

Phone orders only (800) 538-8196

7400TL	1M1307L	1.65	CD4017	1.05	8126	1.69	UART/PRO	1.95	DESSP	1.95	
7402N	1M1307L	3.75	CD4016	95	8128	1.98	AVS-1013	3.95	DA15P	2.10	
7402N	1M1307L	1.49	CD4019	45	8797	99	AVS-1014	6.95	DA15S	3.10	
7404N	22	LM1302N-5	1.35	CD4020	95	8798	99	3341	6.95	Complete Set	9.00
7409N	19	LM3008-12	1.35	CD4021	95					Stapack Kit	28.95
7410N	19	LM3008-15	1.35	CD4022	1.10	2101-1	1.95	PROG	4.50	Auto Check Kit	17.50
7414N	55	LM1301-5	2.85	CD4023	28	2102-1	1.95	1700Z	17.50	Digital Clock Kit	79.95
7420N	19	LM3008-12	1.35	CD4024	75	2102A-1	1.95	2108	2.95		
7430N	19	LM1301-12	85	CD4025	23	2102B-2L	1.65	21101	8.50		
7432N	99	LM3008-12	1.35	CD4026	65	2104A-4	4.95	2716 5 Volt	5.50		
7445N	69	LM1304N-5	4.95	CD4027	65	2107A-1	2.99	2732	16.50		
7447N	69	LM1304N-5	4.95	CD4028	80	2111-1	2.99	2732	16.50		
7448N	69	LM1304N-5	4.95	CD4029	95	2112-1	2.99	2758	7.49		
7474N	69	LM1304N-5	4.95	CD4030	45	2114	2.99	2758	7.49		
7475N	44	LM1304N-5	4.95	CD4031	85	2114L 300ms	2.50	8748	39.95		
7485N	65	LM1304N-5	4.95	CD4032	75	2120A-1	2.37	8748A	34.95		
7489N	1.70	LM1304N-5	4.95	CD4042	75	4116 200ms	2.50	8755A	48.95		
7492N	35	LM1304N-5	4.95	CD4043	85	8-1116 200ms	15.40	N87523	2.95		
7495N	55	LM1304N-5	4.95	CD4044	85	8-1116 200ms	15.40	N87523	2.95		
7495N	55	LM1304N-5	4.95	CD4045	85	8-1116 200ms	15.40	N87523	2.95		
7495N	55	LM1304N-5	4.95	CD4046	95	MM5321	9.95	N85126	5.75		
7495N	55	LM1304N-5	4.95	CD4047	95	MM5321	9.95	N85126	5.75		
7495N	55	LM1304N-5	4.95	CD4048	95	MM5321	9.95	N85126	5.75		
7495N	55	LM1304N-5	4.95	CD4049	95	MM5321	9.95	N85126	5.75		
7495N	55	LM1304N-5	4.95	CD4050	95	MM5321	9.95	N85126	5.75		
7495N	55	LM1304N-5	4.95	CD4051	95	MM5321	9.95	N85126	5.75		
7495N	55	LM1304N-5	4.95	CD4052	95	MM5321	9.95	N85126	5.75		
7495N	55	LM1304N-5	4.95	CD4053	95	MM5321	9.95	N85126	5.75		
7495N	55	LM1304N-5	4.95	CD4054	95	MM5321	9.95	N85126	5.75		
7495N	55	LM1304N-5	4.95	CD4055	95	MM5321	9.95	N85126	5.75		
7495N	55	LM1304N-5	4.95	CD4056	95	MM5321	9.95	N85126	5.75		
7495N	55	LM1304N-5	4.95	CD4057	95	MM5321	9.95	N85126	5.75		
7495N	55	LM1304N-5	4.95	CD4058	95	MM5321	9.95	N85126	5.75		
7495N	55	LM1304N-5	4.95	CD4059	95	MM5321	9.95	N85126	5.75		
7495N	55	LM1304N-5	4.95	CD4060	95	MM5321	9.95	N85126	5.75		
7495N	55	LM1304N-5	4.95	CD4061	95	MM5321	9.95	N85126	5.75		
7495N	55	LM1304N-5	4.95	CD4062	95	MM5321	9.95	N85126	5.75		
7495N	55	LM1304N-5	4.95	CD4063	95	MM5321	9.95	N85126	5.75		
7495N	55	LM1304N-5	4.95	CD4064	95	MM5321	9.95	N85126	5.75		
7495N	55	LM1304N-5	4.95	CD4065	95	MM5321	9.95	N85126	5.75		
7495N	55	LM1304N-5	4.95	CD4066	95	MM5321	9.95	N85126	5.75		
7495N	55	LM1304N-5	4.95	CD4067	95	MM5321	9.95	N85126	5.75		
7495N	55	LM1304N-5	4.95	CD4068	95	MM5321	9.95	N85126	5.75		
7495N	55	LM1304N-5	4.95	CD4069	95	MM5321	9.95	N85126	5.75		
7495N	55	LM1304N-5	4.95	CD4070	95	MM5321	9.95	N85126	5.75		
7495N	55	LM1304N-5	4.95	CD4071	95	MM5321	9.95	N85126	5.75		
7495N	55	LM1304N-5	4.95	CD4072	95	MM5321	9.95	N85126	5.75		
7495N	55	LM1304N-5	4.95	CD4073	95	MM5321	9.95	N85126	5.75		
7495N	55	LM1304N-5	4.95	CD4074	95	MM5321	9.95	N85126	5.75		
7495N	55	LM1304N-5	4.95	CD4075	95	MM5321	9.95	N85126	5.75		
7495N	55	LM1304N-5	4.95	CD4076	95	MM5321	9.95	N85126	5.75		
7495N	55	LM1304N-5	4.95	CD4077	95	MM5321	9.95	N85126	5.75		
7495N	55	LM1304N-5	4.95	CD4078	95	MM5321	9.95	N85126	5.75		
7495N	55	LM1304N-5	4.95	CD4079	95	MM5321	9.95	N85126	5.75		
7495N	55	LM1304N-5	4.95	CD4080	95	MM5321	9.95	N85126	5.75		
7495N	55	LM1304N-5	4.95	CD4081	95	MM5321	9.95	N85126	5.75		
7495N	55	LM1304N-5	4.95	CD4082	95	MM5321	9.95	N85126	5.75		
7495N	55	LM1304N-5	4.95	CD4083	95	MM5321	9.95	N85126	5.75		
7495N	55	LM1304N-5	4.95	CD4084	95	MM5321	9.95	N85126	5.75		
7495N	55	LM1304N-5	4.95	CD4085	95	MM5321	9.95	N85126	5.75		
7495N	55	LM1304N-5	4.95	CD4086	95	MM5321	9.95	N85126	5.75		
7495N	55	LM1304N-5	4.95	CD4087	95	MM5321	9.95	N85126	5.75		
7495N	55	LM1304N-5	4.95	CD4088	95	MM5321	9.95	N85126	5.75		
7495N	55	LM1304N-5	4.95	CD4089	95	MM5321	9.95	N85126	5.75		
7495N	55	LM1304N-5	4.95	CD4090	95	MM5321	9.95	N85126	5.75		
7495N	55	LM1304N-5	4.95	CD4091	95	MM5321	9.95	N85126	5.75		
7495N	55	LM1304N-5	4.95	CD4092	95	MM5321	9.95	N85126	5.75		
7495N	55	LM1304N-5	4.95	CD4093	95	MM5321	9.95	N85126	5.75		
7495N	55	LM1304N-5	4.95	CD4094	95	MM5321	9.95	N85126	5.75		
7495N	55	LM1304N-5	4.95	CD4095	95	MM5321	9.95	N85126	5.75		
7495N	55	LM1304N-5	4.95	CD4096	95	MM5321	9.95	N85126	5.75		
7495N	55	LM1304N-5	4.95	CD4097	95	MM5321	9.95	N85126	5.75		
7495N	55	LM1304N-5	4.95	CD4098	95	MM5321	9.95	N85126	5.75		
7495N	55	LM1304N-5	4.95	CD4099	95	MM5321	9.95	N85126	5.75		
7495N	55	LM1304N-5	4.95	CD4100	95	MM5321	9.95	N85126	5.75		
7495N	55	LM1304N-5	4.95	CD4101	95	MM5321	9.95	N85126	5.75		
7495N	55	LM1304N-5	4.95	CD4102	95	MM5321	9.95	N85126	5.75		
7495N	55	LM1304N-5	4.95	CD4103	95	MM5321	9.95	N85126	5.75		
7495N	55	LM1304N-5	4.95	CD4104	95	MM5321	9.95	N85126	5.75		
7495N	55	LM1304N-5	4.95	CD4105	95	MM5321	9.95	N85126	5.75		
7495N	55	LM1304N-5	4.95	CD4106	95	MM5321	9.95	N85126	5.75		
7495N	55	LM1304N-5	4.95	CD4107	95	MM5321	9.95	N85126	5.75		
7495N	55	LM1304N-5	4.95	CD4108	95	MM5321	9.95	N85126	5.75		
7495N	55	LM1304N-5	4.95	CD4109	95	MM5321	9.95	N85126	5.75		
7495N	55	LM1304N-5	4.95	CD4110	95	MM5321	9.95	N85126	5.75		
7495N	55	LM1304N-5	4.95	CD4111	95	MM5321	9.95	N85126	5.75		
7495N	55	LM1304N-5	4.95	CD4112	95	MM5321	9.95	N85126	5.75		
7495N	55	LM1304N-5	4.95	CD4113	95	MM5321	9.95	N85126	5.75		
7495N	55	LM1304N-5	4.95	CD4114	95	MM5321	9.95	N85126	5.75		
7495N	55	LM1304N-5	4.95	CD4115	95	MM5321	9.95	N85126	5.75		
7495N	55	LM1304N-5	4.95	CD4116	95	MM5321	9.95	N85126	5.75		
7495N	55	LM1304N-5	4.95	CD4117	95	MM5321	9.95	N85126	5.75		
7495N	55	LM1304N-5	4.95	CD4118	95	MM5321	9.95	N85126	5.75		
7495N	55	LM1304N-5	4.95	CD4119	95	MM5321	9.95	N85126	5.75		
7495N	55	LM1304N-5	4.95	CD4120	95	MM5321	9.95	N85126	5.75		
7495N	55	LM1304N-5	4.95	CD4121	95	MM5321	9.95	N85126	5.75		
7495N	55	LM1304N-5	4.95	CD4122	95	MM5321	9.95	N85126	5.75		
7495N	55	LM1304N-5	4.95	CD4123	95	MM5321	9.95	N85126	5.75		
7495N	55	LM1304N-5	4.95	CD4124	95	MM5321	9.95	N85126	5.75		
7495N	55	LM1304N-5	4.95	CD4125	95	MM5321	9.95	N85126	5.75		
7495N	55	LM1304N-5	4.95	CD4126	95	MM5321	9.95	N85126	5.75		
7495N	55	LM1304N-5	4.95	CD4127	95	MM5321	9.95	N85126	5.75		
7495N	55	LM1304N-5	4.95	CD4128	95	MM5321	9.95	N85126	5.75		
7495N	55	LM1304N-5	4.95	CD4129	95	MM5321	9.95	N85126	5.75		
7495N	55	LM1304N-5	4.95	CD4130	95	MM5321	9.95	N85126	5.75		
7495N	55	LM1304N-5	4.95	CD4131	95	MM5321	9.95	N85126	5.75		
7495N	55	LM1304N-5	4.95	CD4132	95	MM5321	9.95	N85126	5.75		
7495N	55	LM1304N-5	4.95	CD4133	95	MM5321	9.95	N85126	5.75		
7495N	55	LM1304N-5	4.95	CD4134	95	MM5321	9.95	N85126	5.75		
7495N	55	LM1304N-5	4.95	CD4135	95	MM5321	9.95	N85126	5.75		
7495N	55	LM1304N-5	4.95	CD4136	95	MM5321	9.				

BASF DISKETTES

BASF Diskettes at competitive price. Call TOLL FREE (800) 235-4137 for prices and information. Visa and Master Card accepted.

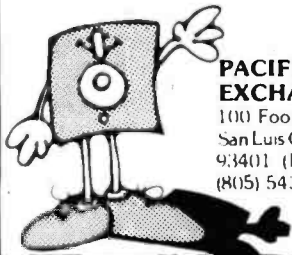

PACIFIC EXCHANGES
100 Foothill Blvd
San Luis Obispo, CA
93401 (In Cal call
(805) 543-1037)

Circle 300 on inquiry card.

Z-80 and 8086 FORTH

Z-80[®] FORTH—a complete program development system. Uses standard CP/M[®] compatible random access disk files for screen storage. Package includes: Interpreter/compiler with virtual memory management, line editor, screen editor, Z-80 Assembler, decompiler, utilities, demonstration programs, and 80 page user manual. System requirements: Z-80 microcomputer, 48 kbytes RAM, CP/M 2.2 or MP/M[®] 1.1. \$50.00

Z-80 FORTH WITH NAUTILUS SYSTEMS CROSS-COMPILER. Extend/modify the FORTH runtime system, recompile on a host computer for a different target computer, generate headerless code, generate ROMable code with initialized variables. Supports forward referencing to any word or label. Produces load map and list of unresolved symbols. 107 page manual. System requirements as for Z-80 FORTH above. \$200.00

8086 FORTH with line editor, screen editor, assembler, and utilities. Uses standard CP/M compatible random access files for screen storage. Requires 8086, or 8088 microcomputer, 64 kbytes RAM, and CP/M 86 operating system. \$100.00

MACHINE TEST PROGRAM PACKAGE for Z-80 systems. Includes memory, floppy disk, printer, and terminal tests with all source code. Requires CP/M 2.2. \$50.00

All software distributed on eight-inch soft sectorized single density diskettes. Prices include shipping by first class or UPS within USA or Canada. COD charges extra. Purchase orders accepted at our discretion. (CP/M and MP/M are registered trademarks of Digital Research, Inc. Z-80 is a registered trademark of Zilog, Inc.)

Laboratory Microsystems
4147 Beethoven Street
Los Angeles, CA 90066
(213) 390-9292

Circle 211 on inquiry card.

QUICK CUBE

TRS-80[®]
Model
I/III

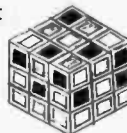

Level II
16 K

Guaranteed to solve any Rubik's Cube (TM) or triple your money back. Enter 54 color faces of cube or let program set up random pattern to be solved. Program run can be interrupted to allow user to enter his/her own moves. Interesting program. Send \$19.95 plus \$1.50 postage & handling to:

**Alpha Queue Systems
Dept. B**

**P. O. Box 20885
Dallas, TX 75220**

Texas residents add 5% (\$1.00) sales tax. Checks only please.

™ Trademark of Tandy Corp.
TM Trademark of Ideal Toy Corp.

JRAM

New 512K RAM card for the IBM Personal Computer. Parity and paging hardware. Up to one and a half megabytes per system using 3 JRAM's. Included is floppy with software to allow any portion of memory to be used as simulated floppy drive. All RAM locations are socketed and partially stuffed cards are available on special request.

\$1500

Tall Tree Systems

1036 Los Altos Avenue
Los Altos, CA 94022
(415) 941-8748

Circle 375 on inquiry card.

Wear it!

We're it for your hardware and software needs.

**MARCH
SPECIAL
SuperCalc™**

\$236

THE APPLICATIONS GROUP



(214) 749-5513

PO Box 992 Carrollton TX 75006

Circle 30 on inquiry card.

ATLANTIC CABINET
P.O. Box 100,
Williamsport,
Maryland 21795

Design Line Micro Work Stations



- A range of work stations designed specifically to house all micro-computers.
- Delivered heavily packed, in self-assembly form needing only a Phillips screwdriver and a few minutes of your time to assemble.
- Manufactured from 1" all wood particleboard surfaced with hard-wearing melamine veneer, in either Oak or Walnut.

DEALER AND DISTRIBUTOR PRICES ON REQUEST
FOR MORE INFORMATION WRITE OR CALL 301-223-8900

Circle 391 on inquiry card.

RAM: 64K-200ns (128 refresh) — 8/\$79

Color R.F. Modulator Kit: — \$13.79

14A S-100 Power Supply Kit—\$29.95

(for line cord and circuit breaker, add \$8.95)
47.63 Hz, 95-250 VAC with RFI filter included.

Disk Power Kit—24V/5A — \$19.95

New! RGB Color Displays

- 320 x 525 lines
- 15.7 KHz
- Black Stripe Tube
- 90 Day Warranty
- Perfect for:
IBM
CAT-100
Microangelo



13" - \$329.00
19" - \$369.00

Add shipping and insurance. We are philosophically against VISA & M.C. (for 5% who wouldn't be!)

Dealin' Electronics

735 Loma Verde, Palo Alto, CA 94303 • 415-493-5930
Please send 40 ct. SASE for our flyer.

Circle 124 on inquiry card.

SCR SUPER-BUYS

\$10.00 MIN. ORDER HANDLING/SHIPPING... \$5.00
UPS ANYWHERE IN CONTINENTAL U.S.

① FREE DECODER PLANS plus a brochure describing our new UHF-VHF Conversion Kit are yours just by sending us your name, address and a 20¢ stamp.

② UHF-VHF CONVERSION KIT. Complete with PC board; all required components; jumper wire; cabinet with speaker; and comprehensive brochure incl. schematic, board layout, mounting and hook-up diagrams, parts list, and assembly and set-up instructions. All parts are industrial prime quality.

③ 9-INCH BLACK AND WHITE CRT MONITOR. Ideal for microcomputer or security use. 22 transistors. Designed for excellent resolution. Frequency response — 12 MHz. Continuous DC restoration for superior contrast.

List Price \$225.00 each.

SCR ELECTRONICS INC.
9533 Valley View Street, Cypress, CA 90630

Pay by CHECK, M.O., VISA, M/C, C.O.D.
For Free Buyers Guide Circle Number Shown Below

FREE

Our Own Famous Kit

\$119.95

Our Factory Direct Price

\$165.00

Circle 349 on inquiry card.

NEW! S-100 BUS COMPATIBLE

SINGLE BOARD COMPUTER WITH VIDEO OUTPUT

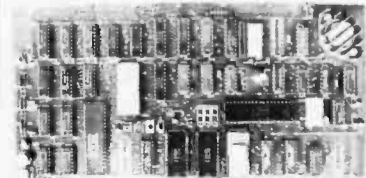

USES:
This card can function as a stand alone single board computer or a S-100 intelligent video interface card.

FEATURES:
2 8088 Z8000A, up to 8K of EPROM, up to 2K Static RAM, two 8 BIT input ports, two 8 BIT output ports, one 8 BIT sense input port with interrupt, composite video output (RGB/24), video attributes (contrast, underline, blanking), graphics capabilities.

PRICE:
Base board with documentation \$29.95
Monitor and video terminal software (in EPROM) \$49.00
Source listings (with Monitor purchased) \$15.00
Hard to find Parts Kit (crystal and fuse link PROM) \$15.00
CALIFORNIA RESIDENTS ADD 4.75% REGISTRATION FEE

EMS Educational Microcomputer Systems
P.O. BOX 14115 IRVINE, CA 92714-1115

Circle 146 on inquiry card.

INCREDIBLE? BELIEVE IT!

Washington Computer Services

an affiliate of **WASHINGTON ELECTRIC COMPANY** est. 1912

CUSTOM COMPUTER ROOM WIRING SINCE 1960

97 Spring Street, New York, New York 10012 TELEX #12-5606

TO ORDER: CALL OUR TOLL-FREE NUMBER: (800) 221-5416 In N.Y. State and for technical information: (212) 226-2121

HOURS: 9 AM-5:30 PM (EST) Monday-Friday

PRINTERS



150 cps bidirectional - 9x9 dot matrix, quietized case, 136 col, vertical form control and many other functions

\$1195

We feel this printer offers the best price/performance ratio available. RS-232 serial to 19.200 baud x-on, x-off add \$40

NOVELL 800



Teletype 40, 300 LPM-typewriter quality, RS-232 interface. This quality printer is available in many configurations including forms access, quietized case, etc.

SCALL

from Only

\$2928

Teletype 43

Teletype AP-200, 340 cps dot matrix (similar to Data Prod. M-200)

from \$995

\$2799

NEC Spinwriter-55 cps, bidirectional, letter quality

R.O. 7710

\$2560

KSR 7720

\$2799

DIABLO 630-40 cps, bidirectional, daisy wheel, plot/graph

\$2349

QUME Sprint 9/45 cps, daisy wheel

\$2228

C. ITOH Starwriter, 25 cps, daisy wheel

\$1575

C. ITOH Starwriter, 45 cps, daisy wheel

\$1725

EPSON MX-80, 100, 80 cps, 9x9 dot matrix

SCALL

ANADIX 9500/9501, up to 200 cps, high resolution dot

\$1325

OKIDATA Microline 80, 80 cps, 9x7 dot matrix

\$399

Microline 82A, bidirectional, friction/pin feed

\$525

Microline 83A, bidirectional, 120 cps, uses 15" paper

\$799

TI-810, 150 cps, Basic

\$1449

Package-Compressed print, vertical form control

MANNESMANN MT 1705 200 cps, 7x9, 132 col

\$1630

TALLY MT 1805 200 cps, 7x9 + NLQ 40x18 matrix

SCALL

CENTRONICS 704-9, 180 cps, 9x9 dot matrix, 132 col

SCALL

739 100 cps, nx9 dot matrix, Full Graphics

\$700

DEC LA-34

\$1085

IDS 460G

\$892

S-100 SPECIALTIES



68000 16 bit multi-user UNIX V.7

SCALL



8086 16 bit, 128K RAM, Syst. #2

\$3499

Systems Group

Call us for best prices on these high quality 2nd generation boards and systems.



These high quality, reliable products have made CCS defacto industry standard for S-100 products

Assembled and tested:

2200 H.D. Mainframe, 20a. P.S., 12 slot MB

\$434 \$359

2065C 64K dynamic RAM/Bank Select

\$720 \$580

2810A Z-80 CPU, serial port, ROM monitor

\$310 \$259

2422A Floppy Cont, CP/M 2.2 ROM monitor

\$425 \$345

IMS 8000 SX, multi-user, multi-processor, turbo DOS

SCALL

INTERNATIONAL CPM 2.2. FULL 2 YEAR WARRANTY!



We offer generous discounts on the Compupro line of fast, quality 8 and 16 bit boards



ADVANTAGE & HORIZON

SCALL

Similar savings on the full lines of CCS, SSM, NNC, MORROW, DELTA, NORTHSTAR, ITHACA INTERSYSTEMS, GODBOUT, NEC, TELEVIDEO, IMS ZENITH, ADDS, DEC, DATA GEN., ATARI, DYNABYTE, TECMAR, DUAL

8" DISK DRIVE SALE

8" SHUGART SA801R \$450 8" SHUGART SA 851R \$669 2 for \$1289

QUME DATATRACK 8 \$589 2 for \$1110

VISTA Industrial grade enclosure for 2 drives with P.S. \$420

MORROW Discus 2D + CP/M MICROSOFT BASIC, CONT. \$950

Discus 2 + 2 + CP/M MICROSOFT BASIC, CONT. \$1195

Enclosure, power supply for 2 8" drives A & T \$350

HARD DISK SPECIALS

CORVUS 10MB and controller List only \$5358 SCALL

20MB and controller \$6450 SCALL

Constellation Network Multiplexer and Mirror-Video Tape Disk Backup

MORROW 26MB + controller + CP/M 2.2, M basic \$4495 \$3821

controler, CDC Hawk Drive (5 fix, 5 rem) \$7995 \$6795

controler, Western Dynex (5 fix, 5 rem) \$5995 \$5099

Winchester 5 1/4 drives complete with case, cable, software, S-100 controller. Adapter avail. for use with any Z-80 system. Cartridge drive controllers avail.

List \$2898

OEM discounts available! R.S. MOD. II \$3398

S-100



PRIAM 8" and 14" Winchester/tape subsystems avail.

WORDSTAR \$300 DBASE II \$525

MBASIC 80 \$235 SUPERCALC \$221

FULLY CONFIGURED BUSINESS SYSTEMS

The following are some examples of the fully assembled and tested business and scientific computer systems which we offer. All include 64K bytes RAM, Z-80A, 4mh CPU. We offer a full line of quality, tested software.

Delta Systems fine computers \$CALL

Delta S-4500 10 User, Multi-Processor, 40 MB hard 17 MB tape \$CALL

CC 2210A w/floppy controller, 1 serial port \$1849

CCS 300-1A w/1.2 MB floppy drives, 2 serial, 2 parallel ports \$4849

CCS 400-1A w/10 MB hard disc, 2 serial, 2 parallel ports \$6999

NNC 80W w/5MB floppy, 8.4 MB hard disc, (OASIS optional) \$6693

ALTOS single and multi-user systems \$CALL

MORROW Decision 1, CP/M Microsoft Basic, UNIX \$CALL

XEROX 820 Desktop computer-64K, 2 floppys. (CP/M avail.)

List \$2995 \$CALL

We offer multi-user networks by DELTA PRODUCTS, DISCOVERY, TELEVIDEO, MUSYS, IMS, DIGITAL MICROSYSTEMS

TERMINALS PMMI MODEM \$359

AMPEX DIALOGUE 30, 80 \$CALL

TELEVIDEO 910 C (multi-terminal) \$610

925C \$795

950C \$950

SOROC IQ 120 \$729

HAZELTINE ESPRIT \$669

DEC VT-100 \$1575

Similar savings for our HAZELTINE and LEAR SIEGLER lines

LOOK HERE!

Call us for ALL your software needs Dialogue 80" Systems Houses, Educational Institutions, & Government Agencies Given Special Consideration

AMPEX



ALL OF OUR PERIPHERALS CAN BE CONFIGURED FOR RADIO SHACK® MODEL II

DEALER and INTERNATIONAL INQUIRIES WELCOME

For fast delivery, send certified check, money order or call to arrange direct bank wire transfer. Personal or company checks require two to three weeks to clear. All prices are mail order only. Prices subject to change without notice; call for latest prices. Prices include 3% cash discount. N.Y. residents add sales tax. Qantex is a trademark of North Atlantic Industries, Inc. Radio Shack® is a trademark of the Tandy Corp. CP/M® is a trademark of Digital Research. All sales subject to our standard sale conditions (available on request).

PRIORITY ONE ELECTRONICS

S-100 CPU

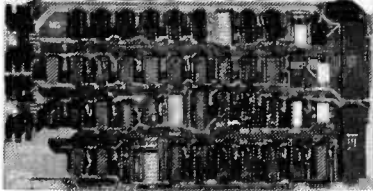

CPU-Z - GODBOUT

2/4 MHZ Z80 CPU 24 Bit Addressing

PART NO.	DESCRIPTION	LIST PRICE	OUR PRICE
BCGBT160A	A & T	\$295.00	\$189.00
BCGBT160C	CSC 3-6 MHZ	\$395.00	\$375.00

DUAL PROCESSOR 8085-8088 - GODBOUT

6 or 8 MZ Provides true 16 Bit Power with a standard 8 bit S-100 bus.

BCGBT1612A	A & T 6 MHZ	\$425.00	\$399.00
BCGBT1612C	CSC 6/8 MHZ	\$525.00	\$498.00

SOLID STATE DISK DRIVE, 3500% FASTER!

Not Really, But the Next Best Thing For Godbout 8085/88 Users. Call for Details on M-Drive. See Page 340 of November BYTE

BCGBT M0 128K		\$1,550.00	
BCGBT M0 256K		\$3,000.00	

2810 Z80 CPU-CA. COMP. SYST.

2/4 MHZ Z80A CPU with RS232C Serial I/O Port complete with Monitor PROM for 2422 Disk Controller

BCCCS 2810A	A & T	\$350.00	\$260.00
-------------	-------	----------	----------

CB2 Z80 CPU - S.S.M.

2/4 MHZ will accept 2716, or 2732, or RAM

RUN/STOP and single step switches

BCSSMCB2K	Kit	\$260.00	
BCSSMCB2A	A & T	\$344.00	\$310.00
BCSSM280M	SSM280 Monitor	\$69.00	

CB1A 8080 CPU - S.S.M.

8080 CPU, 1K RAM, Holds 1 2708,

1 Bit parallel input port.

BCSSMCB1K	Kit	\$183.00	
BCSSMCB1A	A & T	\$252.00	\$225.00
BCSSM8080M	SM 8080 Monitor	\$59.00	

S-100 I/O BOARDS

SYSTEM SUPPORT 1 - GODBOUT

Serial port (software prog baud), 4K EPROM OR RAM provision, 15 levels of interrupt, real time clock, optional math processor

PART NO.	DESCRIPTION	LIST PRICE	OUR PRICE
BCGBT162A	Assembled & Tested	\$399.00	\$380.00
BCGBT162C	CSC	\$495.00	\$460.00
BCGBT16231	Math Chip	\$195.00	\$195.00
BCGBT16232	Math Chip	\$195.00	\$195.00
BCGBT162AM1	A&T with 8231 Math Chip	\$555.00	\$555.00
BCGBT162CM1	CSC with 8231 Math Chip	\$655.00	\$655.00
BCGBT162AM2	A&T with 8232 Math Chip	\$555.00	\$555.00
BCGBT162CM2	CSC with 8232 Math Chip	\$655.00	\$655.00

MPX CHANNEL BOARD - GODBOUT

I/O Multiplexer, using 8085A-2 CPU on board

BCGBT166A	A & T	\$495.00	\$450.00
BCGBT166C	CSC	\$595.00	\$550.00

INTERFACER I - GODBOUT

Two Serial I/O

BCGBT133A	A & T	\$249.00	\$219.00
BCGBT133C	CSC	\$324.00	\$298.00

INTERFACER II - GODBOUT

Three parallel, one serial I/O board

BCGBT150A	A & T	\$249.00	\$219.00
BCGBT150C	CSC	\$324.00	\$298.00

INTERFACER III - GODBOUT

Eight channel multi-use serial I/O board

BCGBT148A	A & T	\$699.00	\$629.00
BCGBT148C	CSC 200 hr. Burn In	\$849.00	\$750.00

INTERFACER 3 WITH 5 SERIAL PORTS

BCGBT1745A	A & T	\$599.00	\$559.00
BCGBT1745C	CSC 200 hr. Burn In	\$699.00	\$629.00

MULTI I/O - MORROW DESIGNS

Three Serial, Two parallel

BCMOSM83200	A & T	\$359.00	\$329.00
-------------	-------	----------	----------

SWITCHBOARD - MORROW DESIGNS

Two serial I/O, four parallel I/O, one status port, one strobe port

BCMOS82411		\$299.00	\$269.00
------------	--	----------	----------

I/O4 - SSM

Two serial I/O, two parallel I/O

BCSSM104K	Kit	\$210.00	\$210.00
BCSSM104A	A & T	\$290.00	\$260.00

I/O 5 - SSM

2 Serial, 3 Parallel including 1 Centronics

BCSSM1051	A & T	\$329.00	\$309.00
-----------	-------	----------	----------

I/O 8 - SSM

8 Port Serial I/O with Timer

BCSSM108A	A & T	\$550.00	\$495.00
-----------	-------	----------	----------

2710 4 PORT SERIAL - CCS

4 Full handshaking RS232 ports and optional 2K ROM

BCCCS271001	A & T	\$360.00	\$310.00
-------------	-------	----------	----------

2718 2 SERIAL & 2 PARALLEL - CCS

2 RS232 C ports, 2 8 bit parallel ports, 8 optional 2K ROM

BCCCS271801	A & T	\$360.00	\$325.00
-------------	-------	----------	----------

2720 4 PORT PARALLEL - CCS

4 8 bit parallel ports and optional 2K ROM

BCCCS272001	A & T	\$250.00	\$225.00
-------------	-------	----------	----------

S-100 10 MHZ STATIC RAM

NEW LOW PRICES!

RAM 20 - 32K

SALE \$299.00

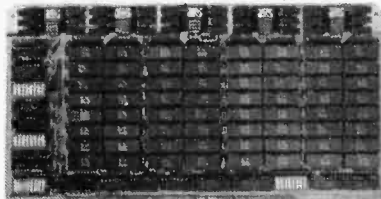

32K STATIC RAM - GODBOUT

RAM 20 10 MHZ, 4K byte block disable, bank select or 24 bit addressing available 8, 16, 24 or 32K

PART NO.	DESCRIPTION	LIST PRICE	OUR PRICE
BCGBT164A48	8K A&T	\$270.00	\$190.00
BCGBT164A48C	8K CSC	\$280.00	\$260.00
BCGBT164A16	16K A&T	\$285.00	\$260.00
BCGBT164A16C	16K CSC	\$355.00	\$325.00
BCGBT164A24	24K A&T	\$355.00	\$325.00
BCGBT164A24C	24K CSC	\$425.00	\$385.00
BCGBT164A32	32K A&T	\$425.00	\$299.00
BCGBT164A32C	32K CSC	\$495.00	\$450.00

CMOS STATIC RAM

For a complete analysis of the advantages of CMOS memory, see the "Product Description" on page 416 of the January Issue of BYTE.

64K CMOS STATIC RAM - GODBOUT

RAM 17, 10 MHZ, 2 Watt, DMA Compatible 24 Bit Addressing

BCGBT175A48	48K A&T	\$650.00	\$619.00
BCGBT175C48	48K CSC 200hr.	\$750.00	\$710.00
BCGBT175A64	64K A&T	\$795.00	\$755.00
BCGBT175C64	64K CSC 200hr.	\$895.00	\$850.00

NEW! 32K x 16 BIT CMOS STATIC RAM - GODBOUT

RAM 16 10 MHZ, 32K x 16 or 64K x 8 IEEE/696 16 BIT 2 Watt, 24 Bit Addressing

NEW! 128K NMOS STATIC RAM - GODBOUT

RAM 21 10MHZ 128K X 8 OR 64K X 16 IEEE/696 8 or 16 Bit 1.2 Amps 24 Bit Addressing

BCGBT167A	128K A&T	\$1695.00	\$1810.00
BCGBT167C	128K CSC	\$1895.00	\$1795.00

S-100 PROM

FBI PROM PROGRAMMER - SSM

Programs 2708 or 2716's, operates as a 4K/8K EPROM BOARD AS WELL.

BCSSMPB1K	Kit	\$179.00	
BCSSMPB1A	A & T	\$265.00	\$220.00

ECONOROM 2708 - GODBOUT

16K x 8 EPROM Board using 2708, Power on jump to any 256 byte

BCGBT125A	A & T	\$135.00	\$120.00
BCGBT125C	CSC	\$195.00	\$175.00

MB8A - SSM

1K/16K 2708 EPROM board, disable in 1K increments

BCSSM8BAK	Kit	\$114.00	
BCSSM8BA	A & T	\$179.00	\$159.00

S-100 VIDEO BOARDS

SPECTRUM - GODBOUT

Color Graphics board with Parallel I/O

BCGBT144A	A & T	\$399.00	\$349.00
BCGBT144C	CSC	\$449.00	\$399.00
BCGBT20	Sublogic Universal Graphics Interpreter Software		\$35.00

VB - 3 S.S.M.

80 x 25 or 50 character video display Memory Mapped, Parallel Keyboard port

BCSSMVB3K24	80 x 24 Kit	\$425.00	
BCSSMVB3A24	80 x 24 A&T	\$499.00	\$440.00
BCSSMVB3UP	80 x 50 Line Upgrade	\$39.00	

VB2-S.S.M.

I/O Mapped Video Board, with Parallel Keyboard port

BCSSMVB2K	Kit	\$199.00	
BCSSMVB2A	A & T	\$269.00	\$229.00

VBBB - S.S.M.

Memory Mapped Video Board 64 x 16 character display or 64 x 16 graphics display

BCSSMVB1K	Kit	\$179.00	
BCSSMVB1A	A & T	\$242.00	\$220.00

S-100 MOTHERBOARDS - GODBOUT

Active termination, 6-12-20 slot

BCGBT153A	A&T 6 slot, 2 lbs	\$140.00	\$126.00
BCGBT153C	CSC 6 slot, 2 lbs.	\$190.00	\$175.00
BCGBT154A	A&T 12 slot, 3 lbs.	\$175.00	\$155.00
BCGBT154C	CSC 12 slot, 3 lbs.	\$240.00	\$220.00
BCGBT155A	A&T 20 slot, 4 lbs.	\$265.00	\$235.00
BCGBT155C	CSC 20 slot, 4 lbs.	\$340.00	\$310.00

S-100 DYNAMIC RAM

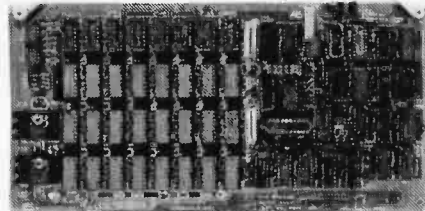

THE EXPANDABLE 1

PRIORITY 1 ELECTRONICS

THE EXPANDABLE 1™ 64K Dynamic Ram board provides your S-100 system with 64K of reliable, high-speed dynamic RAM. Compatible with most of the major S-100 systems on the market, including those with front panels, it supports DMA operations and requires no Wait states with current microprocessors.

- User expandable from 16 to 64K
- Supports DMA
- Designed to IEEE proposed S-100 bus standards • 2 or 4 MHz operation
- Operates with either an 8080 or Z-80 based S-100 system, providing processor-transparent refreshes with both
- Supports IMSAI-type front panels
- Jumper-selectable Phantom input
- Uses Popular 4116 RAMS
- All ICs in sockets
- Any 16K block can be made bank-independent
- Fully buffered address and data lines
- Fail-safe refresh circuitry for extended Wait states
- Board configuration with reliable, easy-to-configure Berg jumpers

BCPRIEXP116	16K Assembled & Tested	\$299.00
BCPRIEXP132	32K Assembled & Tested	\$339.00
BCPRIEXP148	48K Assembled & Tested	\$378.00
BCPRIEXP164	64K Assembled & Tested	\$409.00

S-100 DISK CONTROLLERS

2422A - CA. COMP. SYST.

I/O Mapped, controls 8"; single or double density A&T with CPM 2.2 8" S.D.

PART NO.	LIST PRICE	OUR PRICE
BCCCS2422A	\$475.00	\$375.00

DISK JOCKEY 2D - MORROW

Memory Mapped, controls 8"; single or double density, serial I/O

BCMDI0J2208	A&T with CPM 2.2	\$399.00	\$375.00
-------------	------------------	----------	----------

S-100 DISK SUBSYSTEMS

DJ2B DISC SINGLE SIDED MORROW

8" DBL Density drives with cabinet, power supply controller, with CPM/2.2 and Microsoft Basic

BCMDSF1218	Single Drive System	\$1095.00	\$950.00
BCMDSF1228	Dual Drive System	\$1875.00	\$1598.00

DJ2B DISC DOUBLE SIDED - MORROW

8" DBL Density/sided drives with cabinet Power supply controller, with CPM/2.2 and Microsoft Basic

BCMDSF2218	Single Drive System	\$1395.00	\$1250.00
BCMDSF2228	Dual Drive System	\$2495.00	\$2050.00

S-100 HARD DISK - MORROW

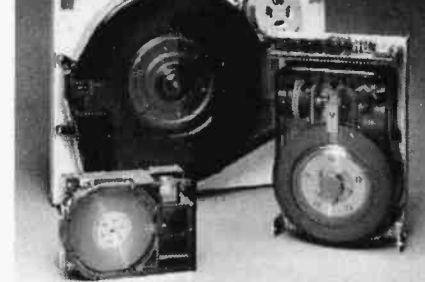

5.25" 5MB, 8" 10 & 20MB, 14" 26MB formatted hard disk complete with cabinet, P.S., Controller, CPM/2.2 and Microsoft MBASIC 80

PART NO.	LIST PRICE	SALE PRICE
BCMOCMAMS	5 MB	\$2495.00
BCMOSM10S	10 MB	\$3695.00
BCMOSM20S	20 MB	\$4795.00
BCMOSM26S	26 MB	\$4495.00

VIDEO MONITORS

VM121 - ZENITH

15 MHz 12" P31 Green phosphor 40 or 80 characters per line

BCZVM121	20 lbs.	\$159.00	\$139.00
----------	---------	----------	----------

PRIORITY ONE ELECTRONICS

GODBOUT DMA DISK 1 WITH FREE CP/M 2.2 SALE \$450.00

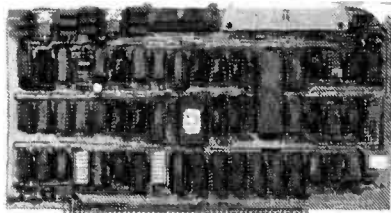

SAVE \$220.00

Priority 1 Electronics is pleased to offer the **GODBOUT DISK 1 High Performance Disk Controller** at our regular low price with CP/M 2.2 and BIOS at no additional cost. That's a savings of \$220.00 of the manufacturer's list price.

- Third generation INTEL 8272/NEC 765A LSI floppy disk controller.
- High speed cycle stealing DMA interface for processor independent data transfer between system memory and flexible disk.
- Handles up to four 8 or 5.25 inch floppy disk drives
- Single or double density/single or double sided capability.
- Supports IBM 3740 soft sectored formats.
- 24 bit DMA addressing with data transfer across 64K boundaries for data transfer throughout the 1Mbyte memory map.

PART NO.	DESCRIPTION	LIST PRICE	OUR PRICE
BCPDB171ACPM	A&T w/CP/M 2.2 & BIOS	\$670.00	\$450.00
BCGB171C	CSC	\$595.00	\$555.00
BCGBTCPMB0*	CP/M 2.2 for Z80/8085 with manuals & BIOS 8" S/D disk	\$175.00	\$175.00
BCGBTOAS8S	Oasis 8 bit single user 8" S/D disk	\$500.00	\$500.00
BCGBTOAS8M	Oasis 8 bit multiuser 8" S/D disk	\$850.00	\$850.00

S-100 SYSTEMS

SUPERSIXTEEN — GODBOUT

HERE IS WHAT EACH PACKAGE INCLUDES:

- BCGB1812A 6 MHz 8085/8088 Dual Processor Board
 - BCGB171A High Speed DMA Disk Controller
 - BCGB162A System Support 1 Multi-Function Board
 - BCGB133A Interfacer 1 Dual Serial I/O
 - BC128K 10MHz Low Power Static Ram
 - BCGBTCP/M 86 16 Bit Operating System Ready to Load & Go
- Cables and Documentation Three interlacer cables one disk I/O cable, complete documentation for all hardware, and manuals for both CP/M operating systems.

Compu Pro's famous 1 Year limited warranty.

Now to the best part of all. If purchased separately, these quality components would list for \$4,344.00. BUT SuperSixteen's low package price is an amazing \$3,485.00. You save \$849.00! For boards qualified under the Certified System Component high-reliability program - with extended 2 year warranty, 200 hour burn-in and 8 MHz processors - add \$600.00 to the package price.

BCPDB87SJ	SuperSixteen A&T	\$3495.00
BCPDB87SK	SuperSixteen CSC	\$4095.00

PRINTERS

BEST PRICE!



MICROLINE — OKIDATA

WITH FRICTION AND TRACTOR FEED

- Bi-DIRECTIONAL - 120 CPS
- 9x9 Matrix (Alphanumeric)
- 6x9 or 12 Matrix for Graphics
- 5.8, 3, 10, 16 Characters/Inch
- 6 or 8 Lines per Inch
- 80 CPL @ 10 CPI for 82A
- 132 CPL @ 10 CPI for 83A
- Parallel and Serial I/O
- 100 Thru 1200 Baud
- Self Test
- Out of Paper Switch
- Friction or Tractor Feed
- 3" to 14" Top of Form (Switch Selectable)
- 10 Different Character Sets

PART NO.	DESCRIPTION	LIST PRICE	SALE PRICE
BCOKIAT82AT(26 lbs)	80 CPL @ 10 CPI	\$799.00	\$539.00
BCOKIAT83AT (37 lbs)	132 CPL @ 10 CPI	\$1195.00	\$750.00
BCOKISER2KBF	9600 baud with 2K Serial	\$159.00	\$159.00
BCOKIGRAPH	Butler upgrade with X-on Y-off High Resolution Graphics Prom	\$99.00	\$99.00

CALL FOR THE NEW MICROLINE 84

MX80 — EPSON

NEED WE SAY MORE?

BCPEMX80	Tractor Feed 17 lbs	\$645.00	\$450.00
BCMBSSE1	Printer Interfaces - MICROBYTE RS232 Serial Conversion for MX80 A & T	\$55.00	\$55.00
BCMBSAE11	Apple Contronics 8 bit parallel interlacer for Contronics, Epson & OKIDATA printers	\$55.00	\$55.00
BCMBSAE1C	Cable for above	\$14.95	\$14.95

Printer interfaces & cables sold only with printer purchase

S-100 MAINFRAMES



S-100 MICROFRAME - TEI

110V 60HZ CVT Mainframes, the best money can buy!
12 Slot $\pm 8V$ 17A $\pm 16V$ @ 2A
22 Slot $\pm 8V$ @ 30A $\pm 16V$ @ 4A

PART NO.	DESCRIPTION	LIST PRICE	1-9	10-24
BCTEIMCS 112	12 Slot Desk	\$685.00	\$615.00	\$570.00
BCTEIMCS 122	22 Slot Desk	\$825.00	\$760.00	\$705.00
BCTEIRM 12	12 Slot Rackmount	\$725.00	\$720.00	\$619.00
BCTEIRM 22	22 Slot Rackmount	\$875.00	\$850.00	\$750.00

Shipping Weight: On 12 Slot Mainframe 45 lbs.
On 22 Slot Mainframes 55 lbs.

TEI S-100 FRAMES

3 - 5" DISK CUTOUTS

$\pm 8V$ @ 17 $\pm 16V$ @ 1.2A. Internal Cables

PART NO.	DESCRIPTION	LIST PRICE	1-9	10-24
BCTEITF12	12 Slot desk	\$675.00	\$625.00	\$580.00
BCTEIRF12	12 Slot Rackmount	\$795.00	\$715.00	\$685.00

Shipping Weight: On 12 Slot Desk 40 lbs.
On 12 Slot Rackmount 45 lbs.

DUAL 8" DISK DRIVE CHASSIS - TEI

For Shugart 800/801R or 850/851R with internal power cables provided
+24V @ 1.5A +5V @ 1.0A -5V @ .25A

PART NO.	DESCRIPTION	LIST PRICE	1-9	10-24
BCTEBCFDO	Desk Top	\$535.00	\$485.00	\$455.00
BCTEIRFDO	Rack Mount	\$720.00	\$670.00	\$630.00
BCPDBFDO01	DFDO with 1 Shugart 801R	\$590.00		
BCPDBFDO02	DFDO with 2 Shugart 801Rs	\$1375.00		
BCPDBRFDO01	RFDO with 1 Shugart 801R	\$1095.00		
BCPDBRFDO02	RFDO with 2 Shugart 801Rs	\$1495.00		
BCPMS06CEZ	Internal Data Cable .50 pin plug connector to 2 Card Edge	\$34.95		

Due to UPS shipping regulations, disk drives will be shipped separately from the cabinet. Don't forget to include shipping for each drive. (Shipping Weight, 16 lbs each.)

CALL FOR NEW TEI PRICES MARCH 1st

S-100 MAINFRAME - GODBOUT

110V 60HZ CVT Mainframe uses famous 20 slot GODBOUT Motherboard. 55 lbs.

BCGBTEMC20RM	20 Slot Rack Mount	\$895.00	\$825.00
BCGBTEMC20DK	20 Slot Desk Top	\$825.00	\$760.00

S-100 MAINFRAME - CCS

12-slot motherboard with removable termination card

BCCCS220001	Office Cream	35 lbs	\$575.00	\$535.00
BCCCS220002	Blue	35 lbs	\$575.00	\$535.00

SOFTWARE - MICROPRO

All software is supplied on 8" Single Density IBM 3740 CP/M Compatible Diskettes

WORDSTAR

Screen-Oriented, integrated word processing system specifically designed for non-technical personnel

BCMPRWSTAI		\$495.00	\$300.00
------------	--	----------	----------

MAIL MERGE WORD STAR OPTION

Powerful file merging tool (Requires Word Star 2.1 or later) \$250.00 \$100.00

BCMPRLMR6AI		\$250.00	\$100.00
-------------	--	----------	----------

SPELLSTAR WORD STAR OPTION

One Step "Proofreader" with compressed 20,000 word dictionary and user-created supplemental dictionaries (Requires Word Star 3.0 or later) \$250.00 \$150.00

BCMPSPPLSTAI		\$250.00	\$150.00
--------------	--	----------	----------

SUPERSORT

Sophisticated program that will select and re-arrange variable length information from data files

BCMPSPRSRAI		\$250.00	\$150.00
-------------	--	----------	----------

CALC STAR

Sophisticated, easy-to-use, electronic spreadsheet and financial planner

BCMPRCLGCSAI		\$295.00	\$200.00
--------------	--	----------	----------

DATA STAR

Office-Oriented Data Entry, retrieval, and updating system

BCMPDATSTAI		\$350.00	\$200.00
-------------	--	----------	----------

FLOPPY DISC DRIVES

Tandon TM-800 Thinline is exactly half the size of conventional 8" floppy disk drives.

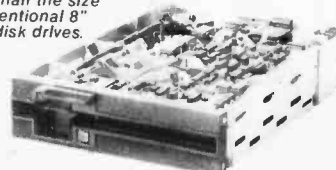

1 ONE

Exactly one-half the height of any other model. Proprietary, high-resolution, read-write heads patented by Tandon D.C. only operation - no A.C. required Industry standard interface.

Three millisecond track-to-track access time
BCTNDTM8481 Single Sided \$495.00 2 or more \$470.00
BCTNDTM8482 Double Sided \$625.00 2 or more \$600.00
BCTNDTM88M Manual - not included with drive \$ 16.00

801R - SHUGART

Single sided double density most popular 8" drive
BCSHU801R \$425.00 ea or 2 or more (16 lbs) for \$395.00 ea.
BCSHUS801RM Manual for 801R drives \$ 16.00

DT-8 - QUME

2 OR MORE \$499.00

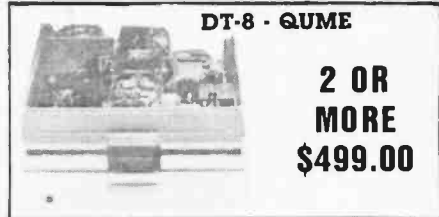

Data track 8 double sided, double density 8" Sh. Wt. 16 lbs \$225.00 ea.

2 or more \$499.00 each

BCQME0T8M	Manual for DT-8	\$ 10.00
-----------	-----------------	----------

5 1/4" DRIVES - TANDON

BCTNDTM1001	Single Sided, 250KB (5 lbs)	\$310.00
BCTNDTM1002	Double Sided, 500KB	\$370.00
BCTNDTM1003	Single Sided, 500KB	\$370.00
BCTNDTM1004	Double Sided, 1000KB	\$495.00

Manual, not included with drive \$ 10.00

DISK CABINETS

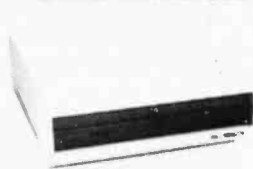

V-100 - VISTA

• Desk or rack mountable • Internal power and data cables • Drives pull out for easy service and maintenance

BCVISV100 Disk Drive Cabinet (43 lbs) \$495.00 \$449.00

SINGLE 8" - Q.T.

Single 8" cabinet with power supply (22 lbs) \$249.00 \$225.00

DUAL 8" - Q.T.

Dual 8" cabinet with power supply (24) \$395.00 \$349.00

5" CABINETS - VISTA

BCVIS 9801 Single 5" with P.S. \$75.00
BCVIS 9802 Dual 5" with P.S. \$95.00

TERMINALS



VT200 — VISUAL TECHNOLOGY

THE MOST RELIABLE TERMINAL WE'VE EVER USED!

Detachable keyboard, RS232C or 20MA interface, 110 to 19200 baud, 12" non glare 80 x 24 display, RS232 Aux. port and composite video out.

BCVSL200 Shipping Weight 55 lbs. \$995.00

VIEWPOINT — ADDS

Detachable keyboard, RS232 interface and auxiliary port. 80 x 24 display, tilt/able screen

BCADDVWPR Shipping Weight 40 lbs. SALE \$599.00



PRIORITY ONE ELECTRONICS

9161-B DEERING AVE • CHATSWORTH, CA 91311

ORDER TOLL FREE (800) 423-5922 CA, AK, HI CALL (213) 709-5464

Terms U.S. VISA, MC, BAC, Check, Money Order, U.S. Funds Only. CA residents add 6% Sales Tax. MINIMUM PREPAID ORDER \$15.00. Include MINIMUM SHIPPING & HANDLING of \$2.00 for the first 3 lbs. plus .25¢ for each additional pound. Orders over 50 lbs. sent freight collect. Just in case, please include your phone no. Prices subject to change without notice. We will do our best to maintain prices through March, 1982. Credit Card orders will be charged for appropriate freight. See November BYTE for 60 page Catalog or send \$1.00 for your copy today. Sale prices are for prepaid orders only.



1
ONE

SAVE \$1,000.00 ON 2.4 MEGA-BYTE S-100 DUAL 8" DISK COMPUTER SYSTEM



California Computer Systems

HERE'S WHAT YOU GET: 2210 MICROCOMPUTER SYSTEM

- 2 or 4 MHZ operation
- Z-80 CPU
- 65,536 bytes of dynamic RAM
- RS-232-C serial port
- Accepts 8" and 5 1/4" floppy disk drives
- 12-slot, cream colored mainframe
- Internal cabling installed
- CP/M 2.2 (on diskette) Operating System

The Model 2210 Computer System is a Z-80 based system containing 65,536 bytes of dynamic RAM memory and floppy disk controller mounted in a 12 slot mainframe. The system is ideally suited for applications where user defined peripheral devices are to be used and a high degree of system flexibility and expandability is desirable.

The system components are the Models 2810 CPU, 2065 64K Byte Memory Module, 2422 Floppy Disk Controller and 2200 Mainframe. Also included in the system are internal cables interconnecting the DPU serial channel, disk controller 8" disk channel and disk controller 5 1/4" disk channel to the mainframe back panel. This permits connecting user peripherals directly to the system without the need of opening the mainframe.

Of the 12 slots available in the mainframe, only three are used for the basic system components. 9 slots are available for user options or other CCS products such as memory (expandable up to 512K bytes (serial and parallel I/O boards).

System software is provided using the CCS version of the CP/M Operating System, Version 2.2. The system is totally linked to permit auto-boot start-up with the CP/M on diskette.

The system is completely integrated and tested prior to shipment from CCS to assure proper configuration and system integrity.

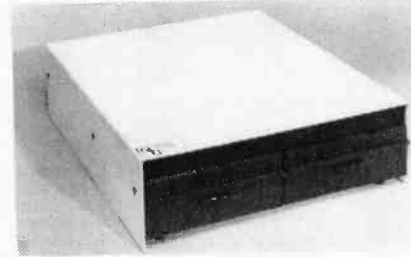
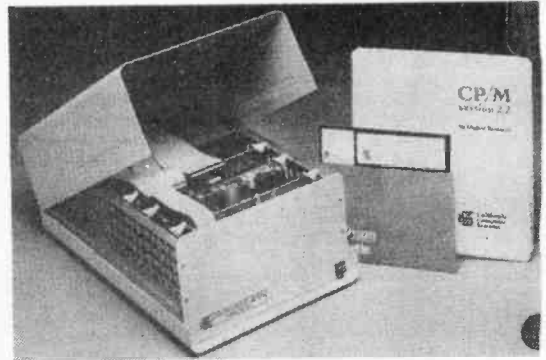

BCCCS221001

\$2350.00

We add two REMEX 4000 Double Density, Double Sided 3ms 8" drives and a QTCDDC88 Dual 8" disk enclosure with power supply data cable and documentation

SALE PRICE

\$2930.00

This is a complete system, just add a terminal

ORDER PART NO BCPDBCCSSA INCLUDE \$30.00 FOR SHIPPING

IF THAT'S NOT A GOOD ENOUGH DEAL FOR YOU, WE WILL SELL YOU THE BCOKIDAT82AT FOR \$475.00 OR THE BCOKIDAT83AT FOR \$700.00 WHEN YOU BUY THIS SYSTEM AT THE SAME TIME!

DIRECT CONNECT MODEM PRICE BREAKTHROUGH!

THE SIGNALMAN MK 1

Meet the direct-connect SIGNALMAN MK 1... the smallest, lightest, most compact modem available today. Its long life 9 volt self-contained battery and exclusive audible Carrier Detect Signal allows you to install the SIGNALMAN anywhere... out of the way, and out of sight. Now, there is no need for messy cables, and no need to look at an LED to verify carrier.

Anchor's SIGNALMAN has been designed for transmitting both voice and data signals over all common telephone lines. And when you're in the data position, your SIGNALMAN automatically changes from ORIGINATE to ANSWER and back again as the need arises — ending all that confusion.

Your SIGNALMAN is fully compatible with all BELL 103 modems — putting your computer in instant communications with thousands of other computers.

Anchor Automation has taken the FUSS out of communications. For business or fun, SIGNALMAN is the ideal modem.

PRODUCT FEATURES

- Direct Connect Modem
- Built-in RS232C Cable and Connector
- Self-contained 9V Battery — Wall plug transformer available.
- Audible carrier detect signal
- Automatic mode selection
- Talk/Data switch
- CONNECTS IN SERIES WITH MULTIPLE HANDSET JACK ON TELEPHONE
- Complete with RS232C and Modular Handset Cables, eliminates need to buy cables — save \$20.00-\$30.00, assures correct fit!

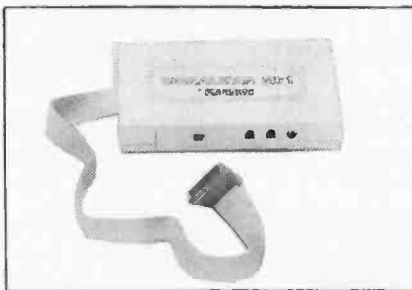

- Uses low cost 9V battery. Eliminates unsightly cords and need for "another"
- AC outlet. Optional plug-in transformer available.
- Audio Transducer eliminates need to view LED to confirm connection — can be placed anywhere (velcro tape provided).
- Advanced IC Circuitry eliminates confusion of who is originator — ends need to manually switch from Originate to Answer and Vice Versa.
- Permits you to listen/talk on phone or switch to data communications mode.
- Permits you to communicate with most other computer networks
- Small size, light weight permits you to install the SIGNALMAN anywhere.
- Lowest priced modem available.

ANCHOR AUTOMATION \$129.00

Circle 318 on Inquiry card.

RS232C SPECIFICATIONS

Data Format: Serial, binary, asynchronous. Operate Mode: Manual dial, Automatic ANSW/ ORIG selection. Data Rate: 0 to 300 bps, full duplex. Modulation: Frequency shift keyed (FSK)

Line Interface: Direct Connect. Data Interface: RS232C. Cable to Computer Built-In.

Transmit Frequency: MARK 1270 Hz, SPACE 1070 Hz

Transmit Frequency Accuracy: 0.1%. Transmit Level: -12dbm. Receive Frequency: MARK 2225 Hz, SPACE 2025 Hz

Carrier Detect Threshold: -44 dbm, plus or minus 2 dbm (ORIG), / -46 dbm, plus or minus 2 dbm (ANSW). Carrier Detect Indicator: Audible Tone. Power Requirement: Self-Contained — 9V Transistor Battery / 110 VAC Through Adapter. Mechanical: 8" x 4" x 1"

BCANCMK1 \$129.00

ORDERING INFORMATION

HARD DISK FOR LESS THAN FLOPPIES

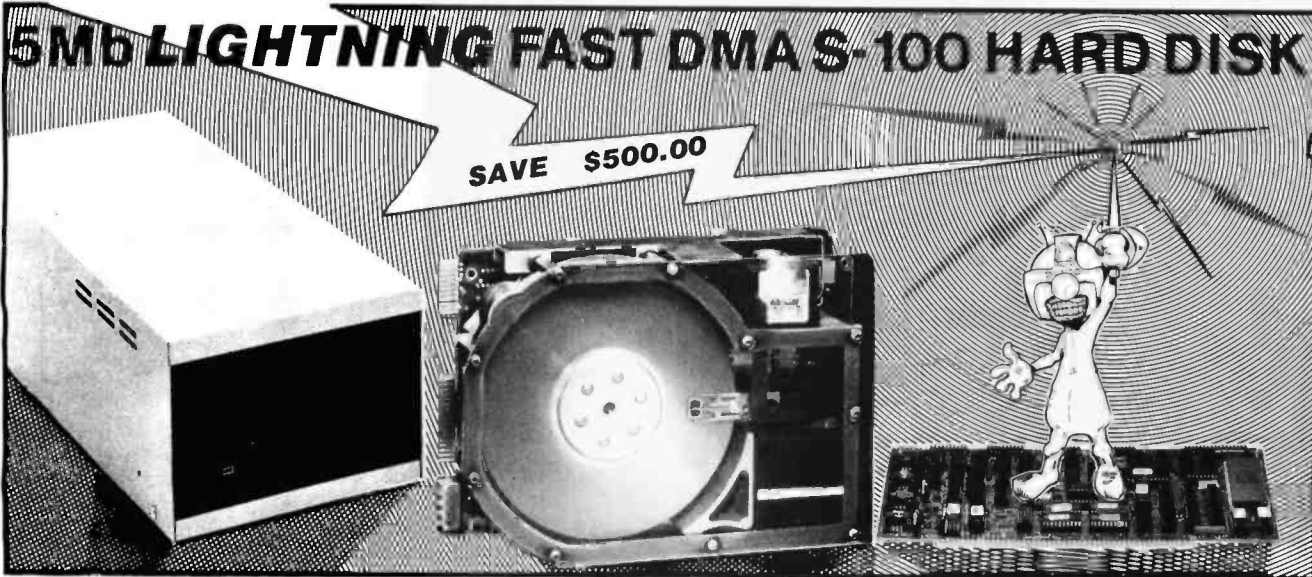

DISCUS M5 by MORROW DESIGNS

PRIORITY **1** ELECTRONICS

INTRODUCTORY PRICE:

\$1 995.00
LIST PRICE: \$2495.00

PRIORITY 1 ELECTRONICS is pleased to announce Morrow Designs' DISCUS M5, the lowest cost 5 megabyte Winchester sub-system and the fastest. Now you can afford a hard disk for the price of floppies. Morrow Designs is the largest supplier of hard disk sub-systems to the S-100 market. With the new DMA Hard Disk Controller and the ST506 mini-Winchester drive, Morrow has attained speeds over 600,000 bytes per second.

As with all Morrow Designs' systems, Morrow delivers it complete. Drive, controller, cabinet, power supply, fan, transformer, cables, CP/M 2.2* operating system, Microsoft™ Basic 80 and a ninety day warranty.

The DISCUS M5 regularly sells for \$2495.00. Priority 1 Electronics is proud to offer the DISCUS M5 for a limited time at only \$1995.00. Winchester speed, 5Mb capacity and reliability for only \$1995.00. Three additional drives may be daisy-chained to the controller for future expansion. Perfect to back up each other at the end of each day. Takes seconds, is more reliable than tape and with the outside lock can be unplugged and removed (after the locking screw has been put in place.)

A few facts about the ST506 drive which is being used in the Discus M5:

Key Features

- Storage Capacity of 6.38 megabytes unformatted. 5.0 megabytes formatted as shipped
- Winchester design reliability, 9.5 gram head load force, 19 micro-inch flying height
- Same physical size and mounting as the mini-floppy
- Same DC voltages as the minifloppy
- Band actuator and stepper motor head positioning
- 5.0 megabit/second transfer rate
- Same track capacity as a double density 8 inch floppy
- 170 millisecond random average access time, reducible to 95 ms via a simple software algorithm

This is the hard disk controller that the S-100 bus has been waiting for. Please allow us to introduce you!

A few interesting facts

- The only single S-100 DMA Hard disk controller board on the market today

CPM is a registered Trademark of Digital Research.

- Fully compatible with high speed 6MHz and 8 MHz CPUs of today and tomorrow
- DMA bus arbitration as outlined by the IEEE 696 standard
- Controls 1 to 4 soft sectored Winchester drives
- Supports both 5¼" and 8" drives
- ST506 or SA 1000 Interface compatible
- Variable sector length (256, 512, 1024, or 2048 byte sectors)
- Automatic CRC generation and checking
- Addresses 1 to 16 heads
- Addresses an infinite number of tracks
- Contains its own on-board microprocessor
- 24-bit address burst DMA transfers
- Channel driven
- All disk driver routines resident on the controller
- Variable format
- No buffering required
- Maximum transfer rate 5,000,000 bits per second

Pure Speed

The speed of this Winchester controller is enhanced by Morrow's channel driven concept. This DMA hard disk controller (DMAHDC) picks up its commands from the host processor via memory on the system bus. The host processor writes commands into memory and then picks them up during DMA cycles from this memory. The channel, commands and transfers may be located anywhere in the 24-bit address range. At the completion of the command, the controller returns appropriate status and can generate an interrupt. Commands may be chained together by the CPU to allow the controller to execute many commands in succession, generating an interrupt at the end of each command and/or at the end of the completed command chain.

Communications

An imbedded microprocessor enables the user to easily communicate with this intelligent device. All low level disk drive routines are resident on the controller itself.

These include:

- format
- seek
- read a header
- read a sector
- write a sector
- return status
- set DMA address
- set channel address

Circle 318 on Inquiry card.

Variable sector lengths are available. On Morrow Designs system products 512 byte sector lengths are standard. This is being done to maximize the capacities available on current drive units but may be varied by independent system integrators when desired.

The DMAHDC has been designed for expansion. One to four drives can be attached directly and controlled. One to sixteen drive heads may be addressed. Any number of tracks may be specified during the seek routine by specifying one to two hundred and fifty-six tracks one or more times. Each of the expansion abilities prepare the user to upgrade his system as technology advances to additional platters and tracks.

The controller has no peer today in the S-100 bus market.

Systems interfaced:

- | | |
|--------------------|------------------------|
| 1. North Star | 6. Exidy |
| 2. Cromemco | 7. Imsai |
| 3. Vector Graphics | 8. Sol |
| 4. Dynabyte | 9. California Computer |
| 5. Micromation | 10. Godbout |
| | 11. Ithaca Intersystem |

Look to Morrow for answers!

Look to PRIORITY 1 for the best price!

Priority 1 Electronics, as the world's largest stocking distributor of Morrow Designs' products committed to buy an entire production run of DISCUS M5 sub-systems so we can offer them at a special introductory low price. The DISCUS M5 is a good buy at the list price of \$2495.00. The DISCUS M5 is an excellent value at our introductory low price of:

\$1 995.00

ORDER PART NO. BCMDSMAM5

1
PRIORITY **ONE** ELECTRONICS
ORDER TOLL FREE (800) 423-5922



Include \$10.00 for UPS Ground Shipping

Sale prices are for prepaid orders only. Orders on open account will be accepted at \$2250.00 each.

ORDERING INFORMATION

www.priority1electronics.com

COMPARE HITACHI SCOPES TO ANY OTHER

**1
ONE**

100 MHz Scope \$1595.00
50 MHz Scope \$1250.00

... and we're not joking!



**No one can match the features or performance at our
MARKET-SHATTERING PRICES!**

Buy with confidence from the nation's largest Hitachi distributor.

BCHITV1050 100 MHz, List \$2375.00

Sale \$1595.00

BCHITV550B 50 MHz, List \$1745.00

Sale \$1250.00

BCHITV352 35 MHz, List \$1150.00

Sale \$795.00

BCHITV202 20 MHz, List \$850.00

Sale \$595.00

- 6" square CRT with internal graticule (illuminated scale)
- High sensitivity; 1mV/div. (10 MHz) V550B
- High sensitivity; .5mV/div. (10 MHz) V1050
- Automatic focus eliminates lag
- Trace rotation for easily adjusting brightline inclination caused by terrestrial magnetism
- Third Channel Display (Trigger View) V550B
- Fourth Channel Display (Trigger View) V1050
- X-Y Operation Convenient for observation of two types of waves
- Delayed sweep permits 1,000 x magnification
- Variable Hold-off circuitry facilitates pulse measurement
- Single Sweep capability
- 10 x sweep magnification facilitates precision measurement
- Delayed sweep jitter held below 1/20,000
- 2 probes and cover included
- 2 year warranty

- 6" Square CRT with internal graticule (illuminated scale)
- High-accuracy voltage axis and time axis set at $\pm 3\%$ (certified at 10° to 34° C)
- High-sensitivity 1mV/div.
- Low drift
- 2 Year Warranty
- Dynamic range 8 div.
- TV sync-separator circuit
- Built-in signal delay line (V-352)
- X-Y operation
- Sweep-time magnifier (10 times)
- Trace rotation system
- Fine-adjusting, click-positioning function
- 2 probes included

Until now, if you wanted a 50MHz or 100MHz dual trace oscilloscope of uncompromising quality, there was only one choice. Now there is a second... outstanding new delay sweep with an established name — the Hitachi V550B and the V1050.

The HITACHI V550B (50MHz) and V1050 (100MHz) offer all the capabilities you might demand from a lab grade oscilloscope. Capabilities such as a max. sweep rate of 2ns/div (V1050) 5ns/div (V550B). Also features you may not expect, like sensitivity of 1 mV/div (V550B) .5mV/div (V1050) @ 10MHz, automatic focus correction, and a built-in TV sync separator circuit.

The cost? Remarkably reasonable, especially when you compare it to the other leading 50MHz or 100MHz Dual trace oscilloscopes. It's a price breakthrough made possible by using up-to-date production techniques and a design backed up by over 20 years of oscilloscope experience.

HITACHI Oscilloscopes are innovative oscilloscopes designed and manufactured by Hitachi Denshi Ltd. The wide experience gained by HITACHI electronic specialists in producing oscilloscopes has resulted in this line of modern oscilloscopes featuring wider band width, more compact design and light weight. Through adopting circuitry with linear IC's and logic IC's plus modern manufacturing techniques, including automatic component-insertion machines. These oscilloscopes offer increased stability, improved reliability, excellent performance and enhanced operating ease.

The panel layout is designed to create maximum operating ease by considering measuring processes and operation frequency. The layout is divided into three blocks according to respective functions identified by different colors. This convenience-oriented design for users improves daily controllability and drastically reduces operating errors.

**1
ONE**

PRIORITY ONE ELECTRONICS
9161 Deering Ave., Chatsworth, CA 91311

ORDER TOLL FREE (800) 423-5922
CA, AK, HI CALL (213) 709-5464



TERMS U.S. VISA, MC, BAC, Check, Money Order, U.S. Funds Only. CA residents add 6% Sales Tax. INCLUDE \$15.00 FOR EACH OSCILLOSCOPE for UPS Surface Shipping and Handling. Just in case, include your phone number. Prices subject to change without notice. We will do our best to maintain these prices through March, 1982. For complete specifications, see our 60 page catalog in the November issue of BYTE or send \$1.00 for your copy today. Sale Prices are for prepaid orders only.

HITACHI — THE MEASURE OF QUALITY

Circle 319 on Inquiry

www.americanradiohistory.com



PROTECT YOUR INVESTMENT

PROTECT YOUR DATA WITH



With Built-In Noise Filters and Surge Suppressors



ISOLATES SENSITIVE AND VALUABLE EQUIPMENT FROM: Equipment interaction - Damaging High Voltage Spikes - AC line noise and hash.

PROTECTS AGAINST: Voltage transients caused by lightning, contact switching, turn-off of inductive components, noise due to electromagnetic coupling.

USE THE GSC ISOBAR TO ISOLATE: Microprocessor from peripherals - Lab instruments from noisy equipment - Sensitive pre-amp or tape deck from power amplifier.

THE GSC ISOBAR ELIMINATES: Equipment interaction - Equipment damage from power line spikes and surges - Errors - False printouts - Disk Skips - Audio or video hash.

FEATURES: Inactive isolated ground - Sockets individually filter isolated - Circuit breaker protected at 15A

VOLTAGE TRANSIENT SPIKE PROTECTION: 2000 A peak for up to 6 Sec duration spikes 1000A, 8/20 Sec protection from repeated spikes.

LOAD HANDLING: 1875 W max. total load; 15A per socket. **INPUT:** 125 VAC, 15 amps; standard 3-prong plug.

Three common outlets built-in circuit breaker, pilot light, hang-up bracket and a 6 foot cord.

BCGOFIBAR3	SH. WT. 3 lbs.	LIST PRICE \$59.95	OUR PRICE \$39.95
------------	----------------	--------------------	-------------------

IBAR 46 - Four independently isolated outlets. Built-in 15A circuit breaker, pilot light, switch, and 6 foot cord.

BCGOFIBAR46	SH. WT. 4 lbs.	\$79.95	\$49.95
-------------	----------------	---------	---------

IBAR 86 - 8 outlets, grouped to form 4 independently isolated sets of two. Built-in 15A circuit breaker, on/off switch, pilot light.

BCGOFIBAR86	SH. WT. 5 lbs.	\$84.95	\$54.95
-------------	----------------	---------	---------

IBAR 9RM - Eight rear-mounted outlets grouped to form four independently isolated sets of two, plus one non-isolated convenience outlet on front face. 19" rack mount cabinet. Built-in 15A circuit breaker, pilot light, on/off switch, and 6 foot cord.

BCGOFIBAR9RM	SH. WT. 6 lbs.	\$99.95	\$74.95
--------------	----------------	---------	---------

RS232 Breakout Box

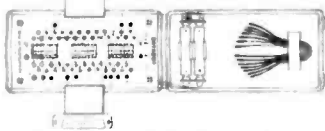

A must for every technician, repair man or systems integrator

The Breakout Box contains 24 Dual-In-Line Switches which allow any of the interface signals (except Pin 1, which is not used) to be interrupted. The switches are located in the center of the main control panel. A 25 way female connector for connecting the box to the DTE is fitted to the left hand side via a ribbon cable and a 25 way male connector for connection to the DCE is similarly connected to the right hand side.

DTE and DCE interface connection pins are located on both sides of the Dual-In-Line switches. Using the jumpers supplied, these pins permit monitoring of any of the interface lines with either or both the positive and negative test indicators on the front panel. These pins also permit cross-patching or the connection of an external test meter or oscilloscope.

The Breakout Box contains indicators which monitor the following signals:

Pin	Function
2	Transmitted Data
3	Received Data
4	Request to Send
5	Ready for Sending (clear to send)
6	Data Set Ready
8	Data Channel Received Line Signal Detector
15	Transmitter Signal Element Timing
17	Receiver Signal Element Timing
20	Connect Data Set to Line/Data Terminal Ready
21	Signal Quality
22	Ring Indicator
25	Busy

Database is contained in a tough plastic case and is powered by two 1.5 volt penlight batteries. No power is consumed by the tester when not in use. Dimensions: 2.9" x 5.55" x 1.45". Weight: 10 ounces, with batteries.

BCDNW232BOX	\$199.00	\$159.00
-------------	----------	----------

GLOBAL SPECIALTIES LOGIC PROBES

SPECIFICATIONS Shipping Wt. 2 lbs

MODEL	LP1	LP2	LP3
Response	50 ns, 80 ns single shot event, 10MHz pulse train	300 ns, 1.5MHz pulse train	6 ns typical, tested at 10 ns 70MHz pulse train
Pulse Mode	High Speed Train or Single Event		

Part No.	Description	List Price	Our Price
BC0558CLP1	3-wire 10MHz w/Memory	\$50.00	\$45.00
BC0558CLP2	1-wire 1.5MHz	\$32.00	\$30.00
BC0558CLP3	High speed 10MHz w/Memory	\$77.00	\$69.00
BC05CDPI	High speed 1-wire digital pulsar	\$83.00	\$76.00
BC05CLT1	1-P1 and 1-M1 in molded case	\$240.00	\$220.00
BC05CLT2	1-P3, 1-P1 and 1-M1 in molded case	\$270.00	\$245.00

MICROCOMPUTER PRODUCTS MEMORY 8080 SERIES

PART NO.	PRICE	PART NO.	PRICE
BC4116AC20	8/\$20.00	BCINS 8080A	\$5.50
BC2016P3	8/\$72.00	BCINS 8085A	\$19.95
BC2114N3L	8/\$28.00	BCDP8212N	\$2.95
BC5257N3L	8/\$50.00	BCDP8214N	\$5.25
BC2732	8/\$120.00	BCDP8216N	\$2.95
BC2716	8/\$50.00	BCDP8224N	\$3.25
BC2708	8/\$20.00	BCDP8224-4N	\$9.95
		BCDP8226N	\$3.50
		BCDP8228N	\$5.55
		BCDP8238N	\$5.55

Z80 SERIES			
BCZ80A	\$14.95	BCINS8250N	\$15.00
BCZ80AP10	\$14.95	BCINS8251N	\$7.50
BCZ80ACTC	\$13.95	BCINS8253N	\$17.95
BCZ80ADMA	\$45.00	BCINS8255N	\$6.80
BCZ80AS100	\$59.95	BCINS8257N	\$16.45
BCZ80AS101	\$59.95	BCINS8259N	\$18.00
BCZ80AS102	\$59.95	BCINS8275N	\$59.95
		BCINS8279N	\$49.95

UARTS			
BCAY51013A	\$5.95	FLOPPY DISC CONTROLLER	
BCTR1602B	\$5.95		
BCTR1863	\$6.95		
BCIM6402	\$7.95		
		BCFD1771B-01	\$24.95
		BCFD1791B-01	\$44.95

KEITHLEY

Handheld DMMs For Every Application and Budget

- Easy-to-use Rotary Switches
Large 0.6" LCD displays
dc Voltage
ac Voltage
dc Current
ac Current
Resistance
Diode Test
3 1/2 or 4 1/2 Digit Accuracy
Overload Protection
Externally Accessible Battery & Fuse
Rugged 0.1" ABS Plastic Case
Shock-Mounted PC Board
- BCKTH130** ±0.5% DCV accuracy, 10M Ω input impedance, auto polarity and current measurement through 10A **\$124.00**
 - BCKTH131** Same as BCKTH130 except 0.25% accuracy and enhanced band with on top ACV ranges **\$139.00**
 - BCKTH128** See/hear display includes both over/under threshold indicator arrows, audible tone that operates on all ranges & functions, and adjustable threshold **\$139.00**
 - BCKTH135** 4 1/2 digit, 0.05% accuracy **\$235.00**
 - BCKTH870** Thermocouple (TC) based thermometer **\$199.00**
 - BCKTH1304** Soft Carrying Case & Stand (handhelds) **\$ 10.00**
 - BCKTH1306** Deluxe Carrying Case (handhelds) **\$ 25.00**

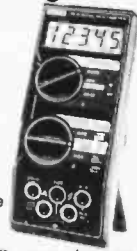

- #### LCD & LED Bench DMMs
- BCKTH169** 3 1/2 Digit, LCD Display **\$189.00**
 - BCKTH176** 4 1/2 Digit, LCD Display **\$269.00**
 - BCKTH179A** 4 1/2 Digit, LED Display, TRMS **\$359.00**
 - BCKTH1793** IEEE-488 Interface (Model 179-20A) **\$325.00**
- See pp. 42-43 of our Engineering Selection Guide in the November **BYTE** for a complete list of specifications and accessories.

- #### SPECIAL PURCHASE GOLD 16 PIN LOW PROFILE IC. C95 SOCKETS
- BCTIG16LP** pkg of 100 **\$16.00**
 - BCTIG16LP** pkg of 1000... **\$120.00**
- EMS Stock up at this LOW PRICE!

- #### ZERO INSERTION FORCE TEST SOCKETS
- | | 1-9 | 10-24 |
|-------------|---------|--------|
| BCZIP16 DIP | \$ 5.50 | \$5.35 |
| BCZIP24 DIP | \$ 7.50 | \$7.25 |
| BCZIP40 DIP | \$10.25 | \$9.85 |

D-SUBMINIATURE CONNECTORS

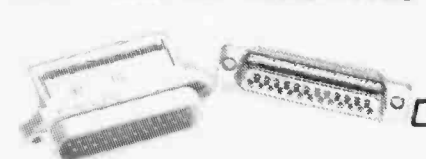

INSULATION DISPLACEMENT TYPE

P = Plug, Male Type - S = Socket, Female Type - C = Cover Hood

PART NO.	NO. OF PINS	NO. OF			
		1-9	10-24	25-99	100-249
BCIC00EP	9	4.20	4.00	3.60	3.20
BCIC00ES	9	4.50	4.20	3.80	3.40
BCIC00EC	9	1.25	1.10	1.00	.95
BCIC00A15P	15	4.35	4.20	3.75	3.40
BCIC00A15S	15	5.00	4.85	4.35	3.90
BCIC00A15C	15	1.40	1.25	1.10	.95
BCIC00B25P	25	6.25	6.00	5.20	4.70
BCIC00B25S	25	6.80	6.35	5.60	5.00
BCIC00B25C	25	1.80	1.50	1.35	1.20
BCIC00C37P	37	8.80	8.00	7.20	6.40
BCIC00C37S	37	11.00	10.25	9.20	8.20
BCIC00C37C	37	2.25	2.20	1.80	1.60

SOLDER TYPE

PART NO.	DESCRIPTION	PRICE		
		1-9	10-24	25-99
BCCND0EP	9 Pin Male	\$2.10	\$1.90	\$1.70
BCCND0ES	9 Pin Female	\$2.70	\$2.40	\$2.10
BCCND0EC	9 Pin Cover	\$1.50	\$1.25	\$1.10
BCCND0A15P	15 Pin Male	\$2.75	\$2.45	\$2.15
BCCND0A15S	15 Pin Female	\$3.95	\$3.60	\$3.20
BCCND0A15C	15 Pin Cover	\$1.50	\$1.30	\$1.10
BCCND0B25P	25 Pin Male	\$3.00	\$2.75	\$2.25

★ **BCCNDDB25P** 100 pcs at **\$1.95 ea** ★

BCCND0B25S 25 Pin Female \$4.00 \$3.75 \$3.00

★ **BCCNDDB25S** 100 pcs at **\$2.95 ea** ★

- BCCND0B5122B 2 Pc. Black Hood \$1.90 \$1.65 \$1.45
- BCCND0B51212 1 Pc. Grey Hood \$1.80 \$1.45 \$1.30
- BCCNDP25H 2 Pc. Grey Hood \$1.50 \$1.25 \$1.10
- BCCND0C37P 37 Pin Male \$5.80 \$5.10 \$4.45
- BCCND0C37S 37 Pin Female \$8.70 \$7.70 \$6.70
- BCCND0C37C 37 Pin Cover \$1.80 \$1.55 \$1.30
- BCCND0D50P 50 Pin Male \$8.75 \$7.75 \$6.70
- BCCND0D50S 50 Pin Female \$11.65 \$10.25 \$8.90
- BCCND0D50C 50 Pin Cover \$2.00 \$1.80 \$1.60
- BCCND020418 Hardware Set 2 Pr. \$1.00 \$.80 \$.70
- RS232, DB25P, EIA Class 1 Cable 8 Con. 8 Ft \$19.95 \$17.95 \$15.95
- BCCND0530360 Cent. 700 Series/Epson \$9.00 \$7.50 \$6.00
- Printer Conn.
- BCIC05730360 IDC Version of Above \$9.95 \$9.00 \$6.00

THE STAR MODEM

from PRENTICE FEATURE

FITS GTE HANDSETS!

1 YEAR WARRANTY

EXCLUSIVE ACOUSTIC CHAMBERS:

The exclusive triple seal of Prentice's new flat mounted cups locks the handset into the acoustic chamber yielding superior acoustic isolation and mechanical cushioning. Designed to adapt to most common handsets used throughout the world.

SELF TEST:

The self test feature on the STAR allows the user to verify total operation of the acoustic modem by using the terminal in the full duplex mode. No need for remote assistance in diagnosing terminal or modem problems.

SPECIFICATIONS:

- Data Rate: 0 to 30 baud
- Compatibility: Bell 103 and 113; CCITT
- Frequency Stability: ±0.3 percent; Crystal controlled
- Receiver Sensitivity: -50 dBm ON, -53 dBm OFF
- Modulation: Frequency shift keyed (FSK)
- Carrier Detect Delay: 1.2 seconds ON, 120 sec OFF
- EIA Terminal Interface: Compatible with RS232 specs
- Teletype Interface: 20 milliampere current loop
- International (CCITT) frequencies available.
- Switches: Originate/Off/Answer/Full duplex/Test/Halt Duplex
- Indicators: Transmit Data, Receive Data, Carrier Ready, Test.

PART NO.	DESCRIPTION	LIST PRICE	SALE PRICE
BCPRNSTAR	RS232, TTL 200 Ma Current Loop	\$199.00	\$129.00

PRIORITY ONE ELECTRONICS

9161-B DEERING AVE • CHATSWORTH, CA 91311

ORDER TOLL FREE (800) 423-5922 CA, AK, HI CALL (213) 709-5464

Terms US VISA, MC, BAC. Check Money Order, US Funds Only. CA residents add 6% Sales Tax. MINIMUM PREPAID ORDER \$15.00. Include MINIMUM SHIPPING & HANDLING of \$2.50 for the first 3 lbs plus 25¢ for each additional pound. Orders over 50 lbs. sent freight collect. Just in case, please include your phone no. Prices subject to change without notice. We will do our best to maintain prices through March, 1982. Credit Card orders will be charged appropriate freight. See November **BYTE** for 60 page Catalog or send \$1.00 for your copy today. Sale prices are for prepaid orders only.

JADIE Computer Products

Sunnyvale • Woodland Hills • Hawthorne • San Diego

Printers

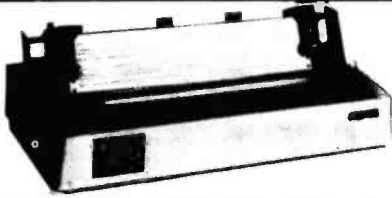

BETTER THAN EPSON! - Okidata

Microline 82A 80/132 column, 120 CPS, 9 x 9 dot matrix, friction feed, pin feed, adjustable tractor feed (removable), handles 4 part forms up to 9.5" wide, rear & bottom feed, paper tear bar, 100% duty cycle/200,000,000 character print head, bi-directional/logic seeking, both serial & parallel interfaces included, front panel switch & program control of 10 different form lengths, uses inexpensive spool type ribbons, double width & condensed characters, true lower case descenders & graphics
PRM-43082 with FREE tractor \$544.95

Microline 83A 132/232 column, 120 CPS, handles forms up to 15" wide, plus all the features of the 82A.
PRM-43083 with FREE tractor \$774.95

Microline 84 132/232 column, 200 CPS, full dot graphics built in, handles forms up to 15" wide, plus all the features of the 83A.
PRM-43083 with FREE tractor ... \$1249.95

PRA-27081 Apple card \$39.95
PRA-27082 Apple cable \$19.95
PRA-27087 TRS-80 cable \$24.95
PRA-43081 Hi speed 2K serial board \$169.95
PRA-43080 Extra ribbons pkg. of 2 ... \$9.95

INEXPENSIVE PRINTERS - Epson

MX-70 80 column, 80 CPS, 5 x 7 dot matrix, adjustable tractor feed, & graphics
PRM-27070 List \$459 \$399.95

MX-80 80 column, 80 CPS, bi-directional/logic seeking printing, 9 x 9 dot matrix, adjustable tractor feed, & 64 graphics characters
PRM-27080 List \$645 \$469.95

MX-80FT same as MX-80 with friction feed added.
PRM-27082 List \$745 \$559.95

MX-100 132 column, correspondence quality, graphics, up to 15" paper, friction feed & adjustable tractor feed, 9 x 9 dot matrix, 80 CPS.
PRM-27100 List \$945 \$759.95

PRA-27084 Serial interface \$69.95
PRA-27088 Serial intf & 2K buffer .. \$144.95
PRA-27081 Apple card \$74.95
PRA-27082 Apple cable \$22.95
PRA-27086 IECE 488 card \$52.95
PRA-27087 TRS-80 cable \$32.95
PRA-27085 Graftrax II \$95.00
PRA-27083 Extra ribbon \$14.95

Modems

SMARTMODEM - Hayes

Sophisticated direct-connect auto-answer/auto-dial modem, touch-tone or pulse dialing, RS-232C interface, programmable
IOM-5400A Smartmodem \$249.95
IOK-1500A Hayes Chronograph ... \$199.95

CAT MODEMS - Novation

CAT 300 baud, acoustic, answer/originate
IOM-5200A List \$189.95 \$149.95

D-CAT 300 baud direct connect, answer/originate
IOM-5201A List \$199.95 \$169.95

AUTO-CAT Auto answer/originate, direct connect
IOM-5230A List \$299.95 \$239.95

Apple-CAT - Novation

Software selectable 1200 or 300 baud, direct connect, auto-answer auto-dial, auxiliary 3-wire RS232C serial port for printer.
IOM-5232A Save \$50.00!!! \$325.00

Accessories for Apple

16K MEMORY UPGRADE

Add 16K of RAM to your TRS-80, Apple, or Exidy in just minutes. We've sold thousands of these 16K RAM upgrades which include the appropriate memory chips (as specified by the manufacturer), all necessary jumper blocks, fool-proof instructions, and our 1 year guarantee.

MEX-16100K TRS-80 kit \$25.00
MEX-16101K Apple kit \$25.00
MEX-16102K Exidy kit \$25.00

16K RAM CARD - for Apple II

Expand your Apple to 64K, 1 year warranty
MEX-16500A Save \$70.00 !!! \$129.95

Z-80* CARD for APPLE

Two computers in one. Z-80 & 6502, more than doubles the power & potential of your Apple, includes Z-80* CPU card, CP/M 2.2, & BASIC-80
CPX-30800A A & T \$299.95

8" DISK CONTROLLER

New from Vista Computer, single or double sided, single or double density, compatible with DOS 3.2/3.3, Pascal, & CPM 2.2, Shugart & Qume compatible
IOD-2700A A & T \$499.95

2 MEGABYTES for Apple II

Complete package includes: Two 8" double-density disk drives, Vista double-density 8" disk controller, cabinet, power supply, & cables. DOS 3.2/3.3, CP/M 2.2, & Pascal compatible.

1 MegaByte Package (Kit) \$1495.00
1 MegaByte Package (A & T) \$1695.00
2 MegaByte Package (Kit) \$1795.00
2 MegaByte Package (A & T) \$1995.00

DISK DRIVES - Micro Sci

Inexpensive disk drives for your Apple
A2 Direct replacement for Apple Disk II, works with Apple II controller as first or second drive.
MSM-123101 Micro Sci A2 \$429.95

A40 40 track drive for Apple II. Improved storage capacity and speed over Apple Brand drives - requires Micro Sci controller.
IOD-2340A Micro Sci A40 \$399.95

A70 70 track drive for Apple II. Twice the storage capacity and three times faster than Apple Brand drives - requires Micro Sci controller
IOD-2370A Micro Sci A70 \$499.95

Micro Sci Controller Disk controller for up to two Micro Sci A40 or A70 disk drives. DOS 3.2, 3.3, Pascal, and Z-80 SoftCard compatible. includes utility disk and 40/70 track patch.
IOD-2300A Micro Sci controller \$95.00

VISION 80 - Vista Computer

80 column x 24 line video card for Apple II, 128 ASCII characters, upper and lower case, 9 x 10 dot matrix with 3 dot descenders, standard data media terminal control codes, CP/M Pascal & Fortran compatible, 50/60 Hz
IOV-2400A Vista Vision 80 \$375.00

AIO, ASIO, APIO - S.S.M.

Parallel & serial interface for your Apple (see Byte pg 11)
IOI-2050K Par & Ser kit \$139.95
IOI-2050A Par & Ser A & T \$169.95
IOI-2052K Serial kit \$89.95
IOI-2052A Serial A & T \$99.95
IOI-2054K Parallel kit \$69.95
IOI-2054A Parallel A & T \$89.95

CPS MULTICARD - Mtn. Computer

Three cards in one! Real time clock, calendar, serial interface, & parallel interface - all on one card.
IOX-2300A A & T \$199.95

Single Board Computer

Z-80 STARTER KIT - SD Systems

Complete Z-80 microcomputer with RAM, ROM, I/O, keyboard, display, kludge area, manual, & workbook
CPS-30100K KIT \$299.95
CPS-30100A A & T \$469.95

SYM-1 - Synertek Systems

Single board computer with 1K of RAM, 4K of ROM, key-pad, LED display, 20ma & cassette interface on board.
CPK-50020A A & T \$249.95

VIC 20 - Commodore

Complete personal computer with 5K RAM, full color, 61 key keyboard, 4 dual special-function keys, serial ports, cassette port, composite video output (connects to standard color TV set), BASIC language, & expansion port.
COM-VIC20 VIC-20 Under \$300.00

PERSONAL COMPUTERS

Also available from Jade - Call for Price and Info
AIM-65, Altos, Apple II, Atari, Commodore, California Computer Sys, Hewlett-Packard, Intersystems, Jade, NEC, Novell, SD Systems, SYM-1, Xerox, and more...

Video Monitors

HI-RES 12" GREEN - Zenith

15 MHz bandwidth, 700 lines/inch, P31 green phosphor, switchable 40 or 80 columns, small, light-weight & portable.
VDM-201201 List price \$150.00 \$118.95

12" GREEN SCREEN - NEC

20 MHz, P31 phosphor video monitor with audio, exceptionally high resolution - A fantastic monitor at a very reasonable price
VDM-651200 Special Sale Price \$199.95

12" COLOR MONITOR - NEC

Hi-res monitor with audio & sculptured case
VDC-651212 Color Monitor \$479.95
NEC-1202D RGB color monitor ... \$1045.00

Leedex / Amdek

Reasonably priced video monitors
VDM-801210 Video 100 12" B&W .. \$139.95
VDM-801230 Video 100-80 12" B&W \$179.95
VDM-801250 12" Green Phosphor \$169.95
VDC-801310 13" Color I \$379.95
VDC-801320 Color II \$895.00
IOV-2300A DVM board for Apple .. \$199.95

Video Terminals

TELEVIDEO 910

Full featured - inexpensive terminal
VDT-901210 List 795.00 \$695.00

TELEVIDEO 950

VDT-901250 List \$1195.00 \$995.00

AMBER SCREEN - Volker Craig

Detachable keyboard, amber on black display, 7 x 9 dot matrix, 10 program function keys, 14 key numeric pad, 12" non-glare screen, 50 to 19,200 baud, direct cursor control, auxiliary bi-directional serial port
VDT-351200 List \$795.00 \$645.00

VIEWPOINT - ADDS

Detachable keyboard, serial RS232C interface, baud rates from 110 to 19,200, auxiliary serial output port, 24 x 80 display.
VDT-501210 Sale Priced \$639.95

DIALOGUE 80 - Ampex

VDT-230080 List \$1195.00 \$895.00

JADE

Computer Products

FREE 1982 CATALOG

Just circle our reader service number on the information request card located near the index.

S-100 CPU Boards

THE BIG Z* - Jade

2 or 4 MHz switchable Z80* CPU with serial I/O, accommodates 2708, 2716, or 2732 EPROM, baud rates from 75 to 9600

CPU-30201K Kit	\$139.95
CPU-30201A A & T	\$189.95
CPU-30200B Bare board	\$35.00

2810 Z-80* CPU - Cal Comp Sys

2.4 MHz Z80* CPU with RS-232C serial I/O port and on board MOSS 2.2 monitor PROM, front panel compatible

CPU-30400A A & T	\$269.95
------------------------	----------

CB-2 Z-80 CPU - S.S.M.

2 or 4 MHz Z80 CPU board with provision for up to 8K of ROM or 4K of RAM on board, extended addressing, IEEE S-100, front panel compatible.

CPU-30300K Kit	\$239.95
CPU-30300A A & T	\$299.95

S-100 PROM Boards

PROM-100 - SD Systems

2708, 2716, 2732 EPROM programmer w/software

MEM-99520K Kit	\$189.95
MEM-99520A A & T	\$249.95

PB-1 - S.S.M.

2708, 2716 EPROM board with built-in programmer

MEM-99510K Kit	\$154.95
MEM-99510A A & T	\$219.95

EPROM BOARD - Jade

16K or 32K uses 2708's or 2716's, 1K boundary

MEM-16230K Kit	\$79.95
MEM-16230A A & T	\$119.95

S-100 Video Boards

VB-3 - S.S.M.

80 characters x 24 lines expandable to 80 x 48 for a full page of text, upper & lower case, 256 user defined symbols, 160 x 192 graphics matrix, memory mapped, has key board input.

IOV-1095K 4 MHz kit	\$349.95
IOV-1095A 4 MHz A & T	\$439.95
IOV-1096K 80 x 48 upgrade	\$39.95

VDB-8024 - SD Systems

80 x 24 I/O mapped video board with keyboard I/O, and on-board Z-80A*.

IOV-1020A A & T	\$459.95
-----------------------	----------

VIDEO BOARD - S.S.M.

64 characters x 16 lines, 128 x 48 matrix for graphics, full upper lower case ASCII character set, numbers, symbols, and greek letters, normal/reverse/blinking video, S-100.

IOV-1051K Kit	\$149.95
IOV-1051A A & T	\$219.95
IOV-1051B Bare board	\$34.95

S-100 Motherboards

ISO-BUS - Jade

Silent, simple, and on sale - a better motherboard
6 Slot (5 1/4" x 8 3/4")

MBS-061B Bare board	\$19.95
MBS-061K Kit	\$39.95
MBS-061A A & T	\$49.95

12 Slot (9 3/4" x 8 3/4")

MBS-121B Bare board	\$29.95
MBS-121K Kit	\$69.95
MBS-121A A & T	\$89.95

18 Slot (14 1/2" x 8 3/4")

MBS-181B Bare board	\$49.95
MBS-181K Kit	\$99.95
MBS-181A A & T	\$139.95

S-100 RAM Boards

MEMORY BANK - Jade

4 MHz, S-100, bank selectable, expandable from 16K to 64K

MEM-99730B Bare Board	\$49.95
MEM-99730K Kit no RAM	\$199.95
MEM-32731K 32K Kit	\$239.95
MEM-64733K 64K Kit	\$279.95
Assembled & Tested	add \$50.00

64K RAM - Calif Computer Sys

4 MHz bank port / bank byte selectable, extended addressing, 16K bank selectable, PHANTOM line allows memory overlay, 8080 / Z80 / front panel compatible.

MEM-64565A A & T	\$575.00
------------------------	----------

64K STATIC RAM - Mem Merchant

64K static S-100 RAM card, 4-16K banks, up to 8MHz

MEM-64400A A & T	\$789.95
------------------------	----------

32K STATIC RAM - Jade

2 or 4 MHz expandable static RAM board uses 2114L's

MEM-16151K 16K 4 MHz kit	\$169.95
MEM-32151K 32K 4 MHz kit	\$299.95
Assembled & tested	add \$50.00

16K STATIC RAM - Mem Merchant

4 MHz 16K static RAM board, IEEE S-100, bank selectable, Phantom capability, addressable in 4K blocks, "disableable" in 1K segments, extended addressing, low power

MEM-16171A A & T	\$164.95
------------------------	----------

S-100 Disk Controllers

DOUBLE-D - Jade

Double density controller with the inside track, on-board Z-80A*, printer port, IEEE S-100, can function on an interrupt driven bus

IOD-1200K Kit	\$299.95
IOD-1200A A & T	\$375.00
IOD-1200B Bare board	\$59.95

DOUBLE DENSITY - Cal Comp Sys

5 1/4" and 8" disk controller, single or double density, with on-board boot loader ROM, and free CP/M 2.2* and manual set.

IOD-1300A A & T	\$374.95
-----------------------	----------

S-100 I/O Boards

S.P.I.C. - Jade

Our new I/O card with 2 SIO's, 4 CTC's, and 1 PIO

IOI-1045K 2 CTC's, 1 SIO, 1 PIO ..	\$179.95
IOI-1045A A & T	\$239.95
IOI-1046K 4 CTC's, 2 SIO's, 1 PIO ..	\$219.95
IOI-1046A A & T	\$299.95
IOI-1045B Bare board w/ manual ..	\$49.95

I/O-4 - S.S.M.

2 serial I/O ports plus 2 parallel I/O ports

IOI-1010K Kit	\$179.95
IOI-1010A A & T	\$249.95
IOI-1010B Bare board	\$35.00

S-100 Mainframes

MAINFRAME - Cal Comp Sys

12 slot S-100 mainframe with 20 amp power supply

ENC-112105 Kit	\$329.95
ENC-112106 A & T	\$399.95

EPROM ERASER - Spectronics

Ultra-violet EPROM erasers

XME-3100A With out timer	\$69.50
XME-3101 With timer	\$94.50
XME-3200 Economy Model	\$39.95

Disk Drives



Handsome metal cabinet with proportionally balanced air flow system • Rugged dual drive power supply • Power cable kit • Power switch, line cord, fuse holder, cooling fan • Never-Mar rubber feet • All necessary hardware to mount 2-8" disk drives, power supply, and fan • Does not include signal cable

Dual 8" Subassembly Cabinet

END-000420 Bare cabinet	\$59.95
END-000421 Cabinet kit	\$225.00
END-000431 A & T	\$359.95

8" Disk Drive Subsystems

Single Sided, Double Density

END-000423 Kit w/2 FD100-8Ds ..	\$924.95
END-000424 A & T w/2 FD100-8Ds ..	\$1124.95
END-000433 Kit w/2 SA-801Rs ..	\$999.95
END-000434 A & T w/2 SA-801Rs ..	\$1195.00

8" Disk Drive Subsystems

Double Sided, Double Density

END-000426 Kit w/2 DT-8s	\$1224.95
END-000427 A & T w/2 DT-8s	\$1424.95
END-000436 Kit w/2 SA-851Rs ..	\$1295.00
END-000437 A & T w/2 SA-851Rs ..	\$1495.00

5 1/4" Disk Drives

Shugart SA400L snlgl-sided dbl-density 40 track
MSM-104000 .. \$234.95 ea 2 for \$224.95 ea

Shugart SA450 dbl-sided dbl-density 70 track
MSM-104500 .. \$349.95 ea 2 for \$329.95 ea

Qume DT-5 dbl-sided dbl-density 80 track
MSM-750050 .. \$359.95 ea 2 for \$349.95 ea

MPI B-51 snlgl-sided dbl-density 40 track
MSM-155100 .. \$234.95 ea 2 for \$224.95 ea

MPI B-52 dbl-sided dbl-density 40 track
MSM-155200 .. \$344.95 ea 2 for \$334.95 ea

MPI B-91 snlgl-sided dbl-density 77 track
MSM-155300 .. \$369.95 ea 2 for \$359.95 ea

MPI B-92 dbl-sided dbl-density 77 track
MSM-155400 .. \$469.95 ea 2 for \$459.95 ea

8" Disk Drives

Shugart SA801R single-sided double-density
MSF-10801R .. \$394.95 ea 2 for \$389.95 ea

Shugart SA851R double-sided double-density
MSF-10851R .. \$554.95 ea 2 for \$529.95 ea

Qume DT-8 double-sided double-density
MSF-750080 .. \$524.95 ea 2 for \$499.95 ea

Siemens FDD 100-8 snlgl-sided dbl-density
MSF-201120 .. \$384.95 ea 2 for \$349.95 ea

BUS PROBE - Jade

S-100 diagnostic analyzer board, dynamic visual display of all 96 IEEE S-100 signals, aids in real time analysis of faulty hardware and software

TSX-200B Bare Board	\$59.95
TSX-200K Kit	\$119.95
TSX-200A A & T	\$149.95

SD Systems ExpandoRAM III

256K RAM \$879.95

Single User System

SBC-200, 64K ExpandoRAM II, Versafloppy II, CP/M 2.2

\$1095.00

4 MHz Z-80A CPU, 64K RAM, serial I/O port, parallel I/O port, double-density disk controller, CP/M 2.2 disk and manuals, system monitor, control and diagnostic software.

Add \$100.00 for upgrade to ExpandoRAM III 64K (expandable to 256K)

-All boards are assembled and tested-

SBC-200

2 or 4 MHz single board computer

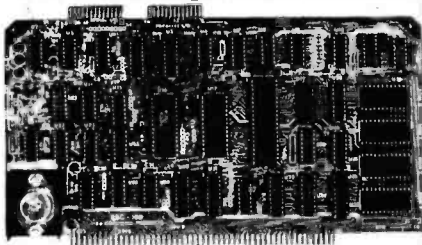

- S-100 bus compatible • Powerful 4MHz Z-80A CPU • Synchronous/asynchronous serial I/O port with RS-232 interface and software programmable baud rates up to 9600 baud • Parallel input and parallel output port • Four channel counter/timer • Four maskable, vectored interrupt inputs and a non-maskable interrupt • 1K of on-board RAM • Up to 32K of on-board ROM • System monitor PROM included

The SBC-200 is an excellent CPU board to base a microcomputer system around. With on-board RAM, ROM, and I/O, the SBC-200 allows you to build a powerful three-board system that has the same features found in most five-board microcomputers. The SBC-200 is compatible with both single-user and multi-user systems.

CPU-30200A A & T with monitor \$299.95

Versafloppy II

5 1/4" & 8" double density controller

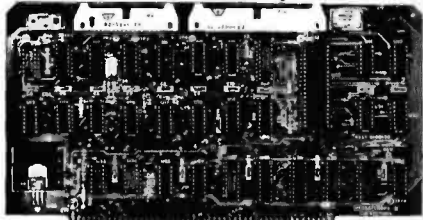

- S-100 bus compatible • IBM 3740 compatible soft sectored format • Controls single and double-sided drives, single or double density, 5 1/4" and 8" drives in any combination of four simultaneously • Drive select and side select circuitry • Analog phase-locked loop data separator • Vectored interrupt operation optional • Standard CP/M 2.2 disk operating • Control/diagnostic software PROM included

The Versafloppy II is faster, more stable and more tolerant of hit shift and "jitter" than most controllers. All control and diagnostic software included.

IOD-1160A A & T \$359.95

For CP/M 2.2 and manual set add \$99.95

ExpandoRAM III

64K to 256K expandable RAM board

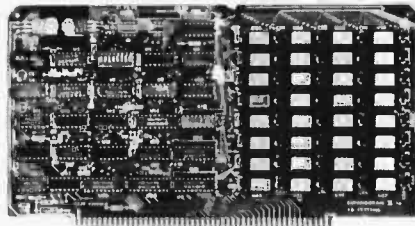

SD Systems has duplicated the famous reliability of their ExpandoRAM I and II boards in the new ExpandoRAM III, a board capable of containing 256K of high speed RAM. Utilizing the new 64K x 1 dynamic RAM chips, you can configure a memory of 64K, 128K, 192K, or 256K, all on one S-100 board. Memory address decoding is done by a programmed bipolar ROM so that the memory map may be dip-switch configured to work with either COSMOS/MPM-type systems or with OASIS-type systems.

Extensive application notes concerning how to operate the ExpandoRAM III with Cromemco, Intersystems, and other popular 4 MHz Z-80 systems are contained in the manual.

MEM-65064A	64K A & T	\$495.00
MEM-65128A	128K A & T	\$639.95
MEM-65192A	192K A & T	\$769.95
MEM-65256A	256K A & T	\$879.95

ExpandoRAM II

16K to 64K expandable RAM board

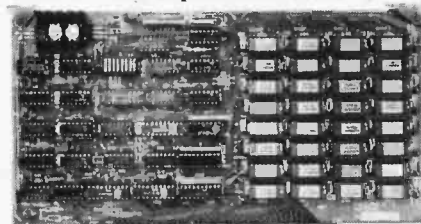

- S-100 bus compatible • Up to 4MHz operation • Expandable from 16K to 64K • Uses 16 x 1 4116 memory chips • Page mode operation allows up to 8 memory boards on the bus • Phantom output disable • Invisible on-board refresh

The ExpandoRAM II is compatible with most S-100 CPUs. When other SD System' series II boards are combined with the ExpandoRAM II, they create a microcomputer system with exceptional capabilities and features.

MEM-16630A	16K A & T	\$345.00
MEM-32631A	32K A & T	\$365.00
MEM-48632A	48K A & T	\$385.00
MEM-64633A	64K A & T	\$399.95

PROM-100

Versatile EPROM Programmer

- S-100 bus compatible • Programs 2708, 2758, 2716, 2732, 2516 EPROMs • DIP switch selection of EPROM type • 25 VDC programming pulse generated on-board • Very fast programming and verification • Zero insertion force socket • Programming software included on 8" diskette

MEM-99520K Kit w/ software \$189.95

MEM-99520A, A & T w/ software \$249.95

www.americanradiohistory.com

Multi-User System

SBC-200, 256K ExpandoRAM III, Versafloppy II, MPC-4 COSMOS Multi-User Operating System, C BASIC II

\$1995.00

Two Z-80A CPUs (4 MHz), 256K RAM, 5 serial I/O ports with independently programmable baud rates and vectored interrupts, parallel input port, parallel output port, 8 counter/timer channels, real time clock, single and double sided/single or double density disk controller for 5 1/4" and 8" drives, up to 36K of on-board ROM, CP/M 2.2 compatible COSMOS interrupt driven multi-user disk operating system, allows up to 8 users to run independent jobs concurrently, C BASIC II, control and diagnostic software in PROM included.

-All boards are assembled and tested-

MPC-4

Intelligent communications interface

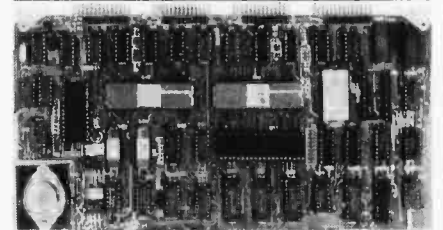

- Four buffered serial I/O ports • On-board Z-80A processor • Four CTC channels • Independently programmable baud rates • Vectored interrupt capability • Up to 4K of on-board PROM • Up to 2K of on-board RAM • On-board firmware

This is not just another four-port serial I/O board! The on-board processor and firmware provide sufficient intelligence to allow the MPC-4 to handle time consuming I/O tasks, rather than loading down your CPU. To increase overall efficiency, each serial channel has an 80 character input buffer and a 128 character output buffer. The on-board firmware can be modified to make the board SDLC or BISYNC compatible. In combination with SD's COSMOS operating system (which is included with the MPC-4), this board makes a perfect building block for a multi-user system.

101-1504A A & T with COSMOS \$495.00

Place Orders Toll Free

Continental U.S. Inside California
800-421-5500 800-262-1710

For Technical Inquiries or Customer Service call:
213-973-7707

JADE

Computer Products

4901 W. Rosecrans, Hawthorne, Ca 90250

TERMS OF SALE: Cash, checks, credit cards, or Purchase Orders from qualified firms and institutions. Minimum Order \$15.00. California residents add 6% tax. Minimum shipping & handling charge \$3.00. Pricing & availability subject to change

Circle 201 on Inquiry card.

THE WAVE MATE "BULLET" - (SBC) is the STATE-OF-THE-ART Single Board Computer.

Never before has there been so much technology contained on ONLY ONE Single Board Computer.

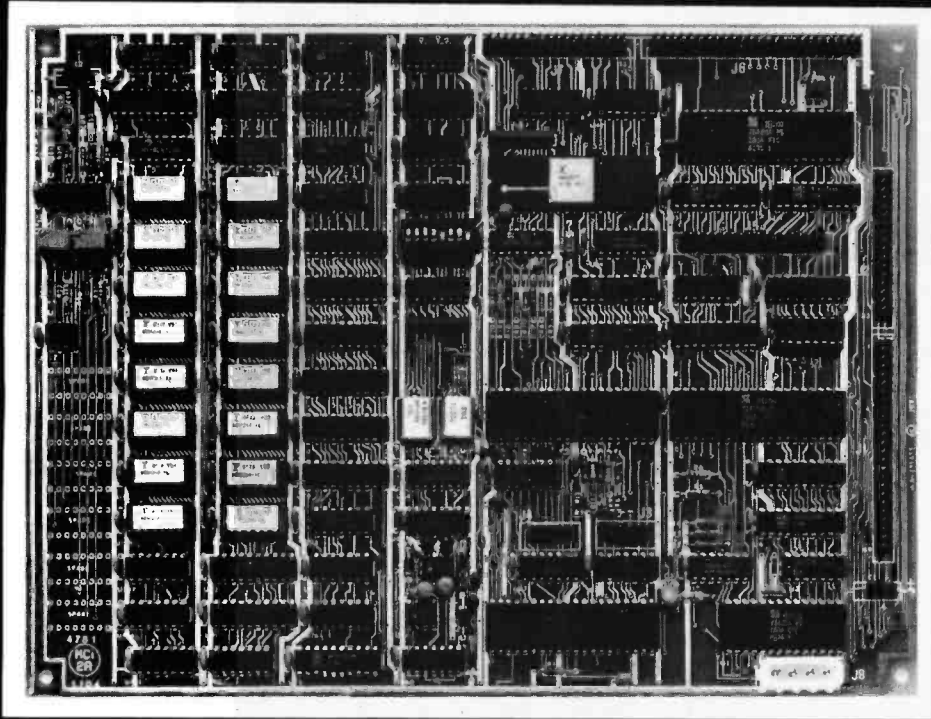

Standard size 8 x 10.7 inches

COMPARE THESE FEATURES:

- 4 MHz Z-80A CPU
- 128 K byte RAM with bank select
- Single/Double density floppy disk controller for both 5 1/4 inch and 8 inch drives
- DMA floppy disk operation with optional high speed RAM track buffer
- General purpose external DMA I/O
- 2 serial ports with transmission rates to 38.4 K baud with optional DMA operation
- Centronics printer port with optional DMA operation
- Hard disk interface with optional DMA operation
- Vectored interrupts
- Real time clock
- 5 volts only

THE WAVE MATE ENHANCED C-BIOS PROVIDES SEVERAL POWERFUL ADDITIONS TO THE INDUSTRY STANDARD OPERATING SYSTEM. THESE ARE AS FOLLOWS:

- Optimized disk track interlacing
- Full disk track buffering
- Keyboard type-ahead
- Optional multi-user operation
- Disk write verification
- Real time clock
- Various soft sectored mini floppy diskette formats

ONLY \$995.00

single quantity
price includes
WAVE MATE'S
enhanced C-BIOS.

The Wave Mate "BULLET," fast, compact and powerful, is a completely integrated Z-80A, CP/M based microcomputer system packed in an attractive dual mini floppy drive enclosure. Connect any serial terminal and Centronics compatible printer and you are in business with an unbeatable PRICE/PERFORMANCE ratio.

XXX

WAVE MATE INC.

Circle 65 on inquiry card.

DISTRIBUTED

BY:

California Digital
4738 156th Street
Lawndale, Calif. 90260
(213) 679-9001

WAVE MATE INTERNATIONAL
159, chée de Vleurgat
1050 Brussels, Belgium
Tel.: (02) 649 10 70 Telex: 24050

DEALER, OEM & INTERNATIONAL INQUIRIES WELCOME

www.americanradiohistory.com

California Digital

Post Office Box 3097 B • Torrance, California 90503

California Digital STATIC • 64

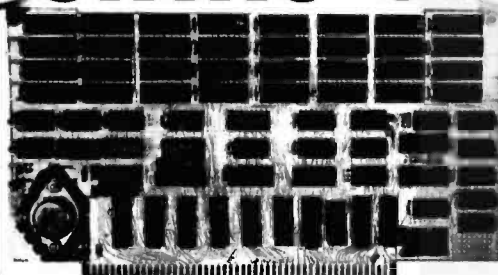

RELIABILITY OF STATIC ... PRICE OF DYNAMIC

Sixteen Bit Memory

\$595

February Price '850

30% Price Reduction

Utilizing the new Hitachi 5167/2167 ram chip, the Static 64 is the most current technology available in S-100 memory products. 24 bit extended addressing, 8 or 16 bit data paths along with 16 bit request and acknowledge make this unique board completely compatible with the IEEE 896 S-100 buss standard.

The Static 64 has been engineered to allow each 16K segment of memory to be bank selectable supporting multiter systems. Other selectable features allow the board to fully integrate with all current bank selecting schemes including Cromex and Alpha-Micro. Operates with all 16 bit computers including Seattle Computers, Tecmar and Lomas. Designed for DMA operations at clock frequencies in excess of 10 MHz. Standby power consumption less than one Amp.

To add to the total integrity of the product, each board is subjected to extensive high temperature burn-in and test procedures. CAL-6400



ZENITH \$119

GREEN PHOSPHOR MONITOR

The new Zenith ZVM-121 monitor features a P-31 green phosphor tube along with 15 MHz bandwidth.

Switch selectable for 40 and 80 character per line screen formats.

Accepts composite video and is fully compatible with 80 column Apple cards. VDM-121 20 lbs.



EPSON MX80

\$450

Epson MX80/T friction/fr \$595.00
Epson MX100 132 column
Graphix II option 70.00
Apple I/O & cable (8131) 129.00
Serial interface (8131) 79.00
Serial inter., 2k buf. (8151) 145.00
Cable for I/O-80 35.00
IEEE 488 interface (8161) 65.00
Replacement head 45.00
Replacement Ribbon 14.00
Paper 3500 sheets 9 1/2" 35.00



NEC PC-8023A

\$535

Dot-matrix, bi-directional, logic-seeking, friction or tractor feed, impact printer. Complete graphics, upper and lower case ASCII, Greek, mathematics along with the ability to print dot graphic screen images directly onto paper.
Proportional spacing and 132 column compressed print make this low cost machine the best value in today's printer market.



IBM Direct Price \$1395

California Digital

discount \$ 1295

price



AMPEX
DIALOGUE 80
REDUCED PRICE

\$795

New from the AmpeX Corporation. The Dialogue 80 features removable keyboard, displayable two pages (four optional) dual program keys, half intensity protected fields and status line. Transmits data either block, line or character mode. Excellent value. VDT-D80 shipping 47 lbs.

ACCESSORIES FOR THE APPLE COMPUTER

CALIFORNIA COMPUTER SYSTEMS	MOUNTAIN COMPUTER PRODUCTS
Arithmetic Processor 7811 B/C 3319	Intro X-10 system for ISR 239
Asynchronous serial interface 7710 1129	16 channel AD/DA 8 bit 185
Centronics interface card 7728 95	Apple Clock battery back-up 228
12K PROM module 7114 89	Superaker S2700 245
Calendar/Clock, Bat. back-up 7424 99	ROM Plus with filter 165
Parallel interface 7720A 99	ROM Writer/Programmer 119
Programmable Timer 7740A 99	APPLE BRAND PRODUCTS
And/or Digital converter 7470A 99	Apple Language card 450
MICROSOFT PRODUCTS	Floppy disk with controller 360
Apple to Z-80 CPU card 378	Floppy disk without controller 495
D. C. HAYES PRODUCTS	Apple parallel interface 175
Micromodem for Apple 319	SSM MICROCOMPUTER
COMPUTER STOP PRODUCTS	Dual serial parallel interface AIO
Double Vision / 80 Column Video 250	SOBRETO VALLEY ASSOCIATES
INTERACTIVE STRUCTURES	8" Floppy controller (P-ascal) 360
16 Channel A/D card AIO/2 275	



PRINTRONIX
P-300 \$4500

P-600 \$6150

PRINTERS

Epson MX80	PREMX80	\$475	NEC/Seilmu 1	PRN5510ps	2695
Epson MX80/T	PREMX80F	595	NEC/Sm 16K	PRN5515ps	2795
Epson MX100	PREMX100		TEC/Starwit	PRV300	1395
Anadex 9500	PR9500	1295	Okidata 80	PRC80	419
Anadex 9501	PR9501	1295	Okidata 82	PRC82	619
Anadex 150	PR150	1075	Okidata 83	PRC83	895
IBM Paper Top	PRG480G	1095	Teletype 13K	PTT1320K	1095
IBM Tiger 560	PRG560G	1350	Texas Ins. 810	PR7810H	1450
Udaho 620	PR620	2150	Tex. Ins 810C	PR7810C	1795
Udaho 1650	PRD1650	2850	Centronics 730	PRC730P	529
Udaho 1640	PRD1640	2495	Centronics 737	PRC737P	695
Datasouth 180	PRD180	1350	Centronics 739	PRC739P	795
Printworks 300	PRP300	4500	Centrx 704-9	PRC704-9	
Printronic 600	PRP600	6150	Centrx 704-11	PRC704-11	

SYSTEMS



HEWLETT
PACKARD
HP 85 COMPUTER
BELOW OUR COST
\$2295

Apple
48K Memory
\$1150

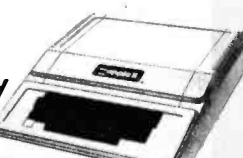

VIDEO TERMINALS

ADDS Viewpoint	VDT-RVP	595
ADDS Regent 25 numeric cluster	VDT-R25	850
ADDS Regent 30 25th status line	VDT-R30	850
ADDS Regent 40 limited graphics	VDT-R40	1195
ADDS Regent 60 Block mode	VDT-R60	1495
AmpeX Dialogue 80 two page, detach	VDT-D80	
Digital Equipment VT-100	VDT-V100	1595
Digital Equipment VT-132	VDT-V132	1895
IBM 3101-10 character mode green	VDT-3101	1195
IBM 3101-20 block mode	VDT-31012	1395
Visual 200	VDT-V200	995
Televideo 910C (new)	VDT-T910	595
Televideo 912C	VDT-T912	665
Televideo 920C	VDT-T920	745
Televideo 950C detachable keybd.	VDT-T950	985
Zenith Z-19	VDT-Z-19	

VIDEO MONITORS

BMC KG-12C 20 MHz	
P31 green phosphor	\$169
NEC gm. 1201	189
Zenith gm ZVM121	119
BMC color composit	339
Zenith color 13"	395
NEC RGB 1202DH	895

EPROM ERASER
Ultra Violet Products

\$65
UVP-11E



Rotron Muffin Fan

\$14.77 \$12.00 @ 100
10.50 @ 1000
115 VAC. 7 Watts WR2A1
Factory fresh Muffin fans
NOT pull-outs. EMF-4M



TOLL FREE ORDER LINE
(800) 421-5041
TECHNICAL & CALIFORNIA
(213) 679-9001

All merchandise sold by California Digital is premium grade. Shipping: First five pounds \$2.00; each additional add \$.40 Foreign orders 10% shipping. Excess will be refunded. California residents add 6% sales tax. COD's discouraged. Open accounts extended to state supported educational institutions and companies with a "Strong Dun & Bradstreet." Warehouse: 15608 Inglewood Blvd. Visitors by appointment.

Circle 66 on Inquiry card.
www.americanradiohistory.com

TWX 910 325-6212



CALIFORNIA DIGITAL

Post Office Box 3097 B • Torrance, California 90503

DISKETTES

FREE PLASTIC LIBRARY CASE INCLUDED WITH THE PURCHASE OF EVERY BOX OF DISKETTES

\$24.95



Private Labeled for California Digital by one of the most respected producers of magnetic media. Each diskette is certified double density at 40 tracks. To insure extended media life each diskette is manufactured with a reinforced hub-hole. And of course, a plastic library case is included with every box of diskettes. 3M10-2150(10) Please specify computer or required sectors. Ten boxes \$22.75 One hundred boxes \$21.50

5 1/4" DISKETTES WITH LIBRARY CASE \$26.50



	Soft Sector	10 Sector	16 Sector	
SCOTCH	744-0	744-10	744-16	\$26.50
MEMOREX	3401	3403	3405	26.50
VERBATIM	525-01	525-10	NA	26.50
DYSAN	104/1	107/1	NA	39.50

Single Side Double Density

DYSAN	104/1D	107/1D	NA	45.00
-------	--------	--------	----	-------

Double Side Double Density

SCOTCH	745-0	745-10	745-16	42.50
DYSAN	104/2D	107/2D	NA	49.50
DYSAN 96	204/2D	NA	NA	59.50

EIGHT INCH DISKETTES

Single Side Single Density			Single Side Double Density		
SCOTCH	740-0	29.50	SCOTCH	741-0	39.00
MEMOREX	3060	29.50	MEMOREX	3090	35.00
DYSAN	3740/1	39.50	DYSAN	3740/D	57.50
Thirty Two Sector			Double side Double Density		
SCOTCH	740-32	29.50	SCOTCH	743-0	47.50
<small>Scotch Head Cleaning Kit 5 1/4" & 8" \$24.95 Plastic Library Cases 5 1/4" & 8" 2.95 Dynamic Flip Tools 5 1/4" diskettes 5 1/4" 24.95 Dynamic Flip Tools 8" diskettes 8" 28.95</small>			MEMOREX	3114	39.50
			DYSAN	3740/2D	65.00

PLEASE PHONE FOR VOLUME PRICING.



BSR SYSTEM X-10

The new BSR timer runs your home just like clockwork. Turns on lamps and appliances while you're away from home. Completely compatible with your existing System X-10 devices.
 BSR Timer eight channel \$65.00 Appliance Module 500 W. \$13.95
 Master control console 34.95 Lamp Module 300 Watts 13.95
 Ultrasonic Controller 19.95 NEW full control wall switch 14.50

WINCHESTER SUBSYSTEM

\$1250

Includes seven megabyte Winchester hard disk, dual enclosure and power supply. Floppy backup drive \$199.00 additional.

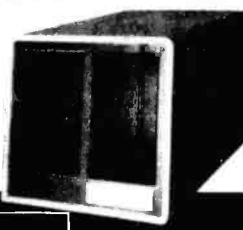

MEMORY

64K DYNAMIC \$9.95	16K STATIC \$13.95
4164 100-	2167 70ns.
16K DYNAMIC \$2.10	2716 EPROM \$4.95
4116 100-1.85	100-14.50 1K-14.00



2732 EPROM SALE \$7.95

STATIC

	ea.	32+	100+	1K+
21L02 1K	1.19	1.09	1.05	.99
2114 300ns.	2.95	2.75	2.50	1.99
4044-4 450ns.	4.50	4.19	4.00	3.75
4044-2 250ns.	4.95	4.65	4.50	4.25
6116 16k 24 pin	7.95	7.50	6.75	5.43
2167/6167 20 pin	11.95	10.75	9.65	9.25

EPROM

2708 450ns.	3.95	3.50	3.25	3.00
2716 5V.	4.95	4.00	3.75	3.50
2716 tri-volt	8.50	7.95	7.65	7.25
2732 Intel/Pitac.	7.95	7.50	7.00	6.65
2532 Texas Inst	12.95	11.50	10.00	9.50
2764 64K Eprom	29.95	27.00	25.00	23.50



direct connect MODEM Your Choice \$169

Direct connect modems eliminate loss of information due to the carbon compression associated with acoustic modems. Choose either of these two great units.

The Universal Data Systems 103LP is switch selectable between answer and originate modes. Fully Bell 103 compatible. Directly connects to the new modular telephone jack. 100% powered from the telephone line. No need to locate modem in proximity to A.C. power receptacle. MIO-D-103LP 2 ports.

Novation 'D' CAT connects to most of the new 'Bell' modular handsets. Ideal for multiple line office telephones. Requires external A.C. power. MOD-DCAT 2 Lb.

SWITCHES

DIP SWITCHES				TUMBLE			
pos.	ea.	100+	1K+		ea.	100+	
4	.88	.75	.60	7101 on/off	1.19	.98	
7	.99	.83	.70	7103 on/off	1.39	1.19	
8	1.95	.91	.87	7107 on/off	1.39	1.19	
12	1.19	.90	.91	7105 on/off	1.39	1.19	
				7205 slip mount	1.85	1.65	

CONNECTORS

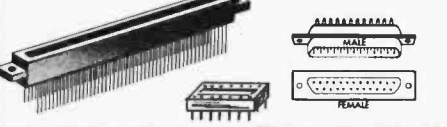

GOLD EDGE CONNECTORS				
S-100 125' centers	each	10*		
Imzal solder .230" row	\$2.95	\$2.50		
Imzal wire wrap (TJ)	3.95	3.50		
Sullins Hi-Rel. .250"	4.50	4.00		
Sullins Hi-Rel. W/W	5.35	4.90		
Sullins/Airair. .140"	1.95	4.50		
.156" Centers (standard)				
2744 Kin. Ejector	2.50	2.15		
3672 Digital Group S/T	5.95	5.50		
3672 Digital Group W/W	6.60	6.15		
43765 Monorail 6500 S/T	5.60	6.15		
43765 Mon. 6500 W/W	5.00	6.85		
INTEGRATED CIRCUIT SOCKETS				
Low Profile Wire Wrap	each	100*	each 100*	
8 pin	\$3.0	\$2.99	\$4.6	\$4.1
14 pin	10.09	.97	11.41	
16 pin	12.11	.90	13.45	
18 pin	13.13	.89	15.41	
24 pin	26.24	.94	28.87	
40 pin	42.40	1.60	47.47	
CENTRONICS				
57-30360	7.95	6.75	5.75	
HIBERN CABLE CONNECTORS				
17734 5" disk	4.85	4.15	3.95	
20/40 TRS-80	5.65	5.05	4.70	
25/90 8" disk	5.90	5.15	4.00	



NEW OLIVETTI 801 \$295
Eight Inch Disk Drive

		ONE	TWO	TEN
★ OLIVETTI 801	single	\$319	309	295
★ OLIVETTI 802/851	double	425	419	410
SHUGART 801/R	single	395	385	375
SHUGART 851/R	double	525	495	475
QUME DATA TRACK 8	double	525	495	475

* The 8" Olivetti drives are approx. 1/2" wider than the Shugarts.

Five Inch Disk Drives

OLIVETTI 501/400	single	199	185	175
OLIVETTI 502/451	double	235	225	215

Upon request, all drives are supplied with power connectors and one manual per order.

230 volt 50Hz. 8" add \$50.00 per drive.



\$995 Eight Inch Subsystem

Two Olivetti 801 disk drives with power supply, 4" exhaust fan, complete in dual enclosure with all necessary power cables. Documentation included. 50 Lbs. CAL-2801

Signal cable add \$35.00 WCA-6500

Same as above but with:

Shugart 801R MSD2801	\$1195.	Divetti 802 CAL2802	\$1250
Shugart 851R MSD2851	1450	Qume DTR MSD80T	1450

SPECIAL \$895

Volume Pricing Upon Request

Seagate Compatible 7.5 MEGABYTE Winchester Hard Disk Drive

We have priced this so low that the manufacturer has asked not to use their brand name in our advertising. Industry standard Seagate plug compatible. Drive fits into the same space as a 5 1/4" floppy disk drive. CAL-561/2

S-100 MOTHER BOARD

\$35

MSAI 18 Slot CAL-M18

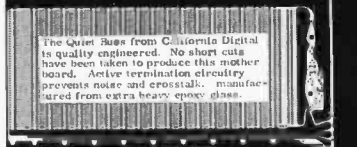

The Great Stuff from California Digital is quality engineered. No short cuts have been taken to produce this mother board. Active termination circuitry prevents noise and crosstalk. Manufactured from extra heavy epoxy glass.

TOLL FREE ORDER LINE (800) 421-5041
TECHNICAL & CALIFORNIA
(213) 679-9001

TWX 910 325-6212

All merchandise sold by California Digital is premium grade. Shipping: First five pounds \$2.00; each additional add \$4. Foreign orders 10% shipping. Excess will be refunded. California residents add 6% sales tax. COD's discouraged. Open accounts extended to state supported educational institutions and companies with a "Strong Dun & Bradstreet." Warehouse: 15608 Inglewood Blvd. Visitors by appointment.

www.americanradiohistory.com

Circle 66 on Inquiry card.

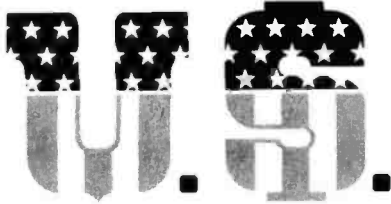

**MICRO
SALES
WEST**

15381 CHEMICAL LANE ★ HUNTINGTON BEACH, CA 92649

★ (714) 891-2677 ★

TERMS: Prepayment – C.O.D. up to \$100.00 – M/C Visa
\$5.00 Processing and Handling added to each order PLUS
Shipping Charges – 15% Restocking Fee
Please allow personal check to clear before shipment

OPEN FRAME POWER SUPPLIES

DISK POWER SUPPLIES				
PRIAM – SHUGART – CENTURY – MICROPOLIS				
+5V @ 9A	-5V @ .8A	+24V @ 7A	US-384	89.00
SHUGART – SIEMANS – MPI 5 1/2"				
+5V @ .5A	+12V @ .9A		US-340	33.50
+5V @ 2A	+12V @ 4A		US-323	56.25
SHUGART – SIEMANS – CDC 8"				
+5V @ 1A	-5V @ .5A	+24V @ 1.5A	US-205	52.50
+5V @ 2A	-5V @ .5A	+24V @ 3A	US-206	69.00
+5V @ 3A	-5V @ .6A	+24V @ 5A	US-162	89.00
+5V @ 1.7A	-5V @ 1.5A	+24V @ 2A	US-272	69.00
+5V @ 2A	+12V @ .4A	-12V @ .4A	US-HTAA	37.50



If you can beat these prices we will be truly amazed. OEM's at 500 lot pay more than this. Call or write for full spec. sheets.

BREAK THE COST BARRIER!

*NO ONE ANYWHERE CAN TOUCH
THIS GRAND OPENING SPECIAL!!*

*YOU CAN BUY A COMPLETE
**S-100 12 SLOT
COMPUTER SYSTEM***

(less drives and terminal) FOR ONLY

\$975.00

Assembled and Tested!

HERE'S WHAT YOU GET!!

- 4MHZ CPU with 2 Programmable Serial Ports and 3 8 Bit Parallel Ports
- 64K Dynamic Ram Card with 8 Extended Address Lines and I.O. Port 40 Bank Select
- 8" and 5" Double Density Double Sided Disk Controller
- S1-MOD 30 Amp Integrated Power Supply with Regulated Power for Four 8" or 5" Floppy Drives
- Attractive Metal Cabinet Similar to CCS Unit Shown at Right

FEATURES!

TERMINAL

- Feather Touch Capacitance Keyboard
- 60 Key Standard ASCII PLUS + Hex Keypad PLUS + 8 Special Function Keys PLUS + 20 Screen Editing Keys
- SOROC Type Screen Attribute Set
- Half Intensity

COMPUTER

- 8 Slot S-100
- 64K Dynamic Ram
- 4MHZ Z-80
- Double Density Disk Controller
- Programmable Baud Rate
- Programmable Keyboard Set
- Serial Printer Port (150-19.2K)

S-100-8

**INCLUDING CP/M 2.2®
AND WORDSTAR®**

**WITH: 8" SS/DD Drives Only \$2850.00
5 1/4" SS/DD Drives Only \$2700.00**

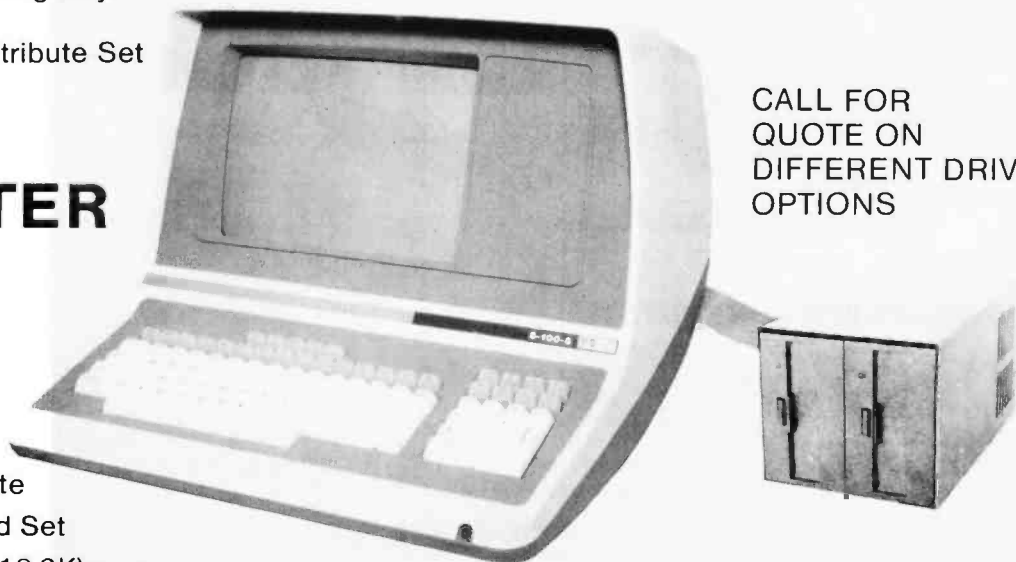

**CALL FOR
QUOTE ON
DIFFERENT DRIVE
OPTIONS**

WORDSTAR is a TM of Micropro Inc. - CP/M 2.2 is a TM of Digital Research Inc.

16K Memory

4116-200ns **8/15.95**

ALL MERCHANDISE 100% GUARANTEED!

CALL US FOR VOLUME QUOTES

EPROMS

	Each	8 pcs
1702	256 x 8 (1ns)	4.95 4.50
2708	1024 x 8 (450ns)	2.99 2.75
2758	1024 x 8 (5V) (450ns)	9.95 8.95
TMS2516	2048 x 8 (5V) (450ns)	6.95 5.95
2716	2048 x 8 (5V) (450ns)	5.50 4.95
2716-1	2048 x 8 (5V) (350ns)	9.00 8.50
TMS2716	2048 x 8 (450ns)	9.95 8.95
TMS2532	4096 x 8 (5V) (450ns)	12.95 11.95
2732	4096 x 8 (5V) (450ns) (200ns)	CALL
2764	8192 x 8 (5V) (450ns)	CALL

DYNAMIC RAMS

	100 pcs
4027	4096 x 1 (250ns) 2.50 2.00
4116-120	16,384 x 1 (120ns) 8/29.95 CALL
4116-150	16,384 x 1 (150ns) 8/18.95 1.95
4116-200	16,384 x 1 (200ns) 8/15.95 1.80
4116-300	16,384 x 1 (300ns) 8/14.95 1.75
4164	64,536 x 1 (200ns) CALL

STATIC RAMS

	100 pcs
2101	256 x 4 (450ns) 1.95 1.85
2102-1	1024 x 1 (450ns) .89 .85
2102-4	1024 x 1 (LP) (450ns) 1.29 1.15
21L02-2	1024 x 1 (LP) (250ns) 1.69 1.55
2111	256 x 4 (450ns) 2.99 2.49
2112	256 x 4 (450ns) 2.99 2.79
2114	1024 x 4 (450ns) 8/16.95 1.95
2114L-2	1024 x 4 (LP) (200ns) 8/19.95 2.35
2114L-3	1024 x 4 (LP) (300ns) 8/18.95 2.25
2114L-4	1024 x 4 (LP) (450ns) 8/17.95 2.10
2147	4096 x 1 (55ns) 9.95 CALL
TMS4044-4	4096 x 1 (450ns) 3.49 3.25
TMS4044-3	4096 x 1 (300ns) 3.99 3.75
TMS40L44-2	4096 x 1 (LP) (200ns) 4.49 4.25
TMM2016	2048 x 8 (200ns) (150ns) CALL
HM6116	2048 x 8 (200ns) (150ns) (120ns) CALL

LP = LOW POWER

CRYSTALS

32.768 KHZ	3.95
1.0 MHZ	4.95
1.8432	4.95
2.0	3.95
2.097152	3.95
2.4576	3.95
3.2768	3.95
3.579545	3.95
4.0	3.95
5.0	3.95
5.0688	3.95
5.185	3.95
5.7143	3.95
6.5536	3.95
8.0	3.95
10.0	3.95
14.31818	3.95
18.0	3.95
18.432	3.95
20.0	3.95
22.1184	3.95
32.0	3.95

MISC.

AY5-2376	12.50
11C90	13.95
XR2206	4.95
3242	7.95
3480	9.00
MC4024	3.95
MC4044	4.50
7103	9.50
7106	9.95
7107	12.95
76477	3.95
8038	3.95
95H90	7.99
9602	1.50

DISC CONTROLLERS

1771	24.95
1791	36.95
1793	44.95
1797	54.95
UPD765	39.95

UARTS

AY3-1014	6.95
AY5-1013	3.95
TR1602	4.95
IM6402	7.95

INTERFACE

8T26	1.69
8T28	2.49
8T95	.99
8T96	.99
8T97	.99
8T98	.99
DM8131	2.95
DS8836	1.29

CLOCK CIRCUITS

MM5369	3.95
MM5375	3.95
MSM5832	7.45
7207	7.50
7208	15.95

CONVERTERS

MC1408 L8	4.95
ADC-0800	4.95
ADC-0804	4.95

April Specials

Z80B	CPU 6MHZ	17.95
Z80A	CPU 4MHZ	6.00
Z80A	PIO 4MHZ	6.00
68000	CPU 4-10MHZ	call
6802	MPU, CLK, RAM	9.95
6845	CRT CONTROLLER	15.95
6502A	CPU 2MHZ	8.95
6502B	CPU 3MHZ	15.95
8086	16 BIT CPU	59.95
8088	8 BIT CPU	34.95
8089	8/16 BIT PROC	89.95
14 Pin Gold Wirewrap Sockets		.49ea
16 Pin Gold Wirewrap Sockets		.59ea

SUPER SPECIAL

Hitachi HM6116LP 2048 x 8 CMOS Static Ram pin compatible with the 2716 EPROM. Super low power data retention characteristics: 2.0 volts at only 50ua yes 50 microamps.

	1-31 pcs.	32 pcs.
HM6116LP-2	120ns 19.95ea	18.95ea
HM6116LP-3	150ns 16.95ea	15.95ea
HM6116LP-4	200ns 15.95ea	14.95ea

STANDARD POWER RAMS

HM6116P-2	120ns 18.95ea	17.95ea
HM6116P-3	150ns 11.95ea	10.95ea
HM6116P-4	200ns 10.95ea	9.95ea

Specials end April 30, 1982. Please state "April Specials" when ordering.

6502

6502	6.95
6502-A	12.95
6504	6.95
6505	8.95
6507	9.95
6520	4.35
6522	9.95
6532	14.95
6551	11.85

Z80

Z80-CPU	8.95
Z80A-CPU	6.00
Z80-P10	6.50
Z80A-P10	6.00
Z80-CTC	5.95
Z80A-CTC	8.65
Z80-DART	15.25
Z80A-DART	18.75
Z80-DMA	17.50
Z80A-DMA	27.50
Z80-S10/0	23.95
Z80A-S10/0	28.95
Z80-S10/1	23.95
Z80A-S10/1	28.95
Z80-S10/2	23.95
Z80A-S10/2	28.95
Z80-S10/09	17.95
Z80A-S10/9	22.95

Z80B-CPU	18.95
Z80B-CTC	17.95
Z80B-P10	17.95

Z8671	39.95
Z6132	34.95

74LS00 SERIES

74LS00	.25	74LS85	1.15	74LS166	2.40	74LS293	1.85
74LS01	.25	74LS86	.40	74LS168	1.75	74LS295	1.05
74LS02	.25	74LS90	.65	74LS170	1.75	74LS298	1.20
74LS03	.25	74LS91	.89	74LS173	.80	74LS324	1.75
74LS04	.25	74LS92	.70	74LS174	.95	74LS352	1.55
74LS05	.25	74LS93	.65	74LS175	.95	74LS353	1.55
74LS08	.35	74LS95	.85	74LS181	2.15	74LS363	1.35
74LS10	.25	74LS96	.95	74LS189	9.95	74LS364	1.95
74LS11	.35	74LS107	.40	74LS190	1.00	74LS365	.95
74LS12	.35	74LS109	.40	74LS191	1.00	74LS366	.95
74LS13	.45	74LS112	.45	74LS192	.85	74LS367	.70
74LS14	1.00	74LS113	.45	74LS193	.95	74LS368	.70
74LS15	.35	74LS114	.50	74LS194	1.00	74LS373	.99
74LS20	.25	74LS122	.45	74LS195	.95	74LS374	1.75
74LS21	.35	74LS123	.95	74LS196	85	74LS377	1.45
74LS22	.25	74LS124	2.99	74LS197	85	74LS378	1.18
74LS26	.35	74LS125	.95	74LS221	1.20	74LS379	1.35
74LS27	.35	74LS126	.85	74LS240	.99	74LS385	1.90
74LS28	.35	74LS132	.75	74LS241	.99	74LS386	.65
74LS30	.25	74LS136	.55	74LS242	1.85	74LS390	1.90
74LS32	.35	74LS137	.99	74LS243	1.85	74LS393	1.90
74LS33	.55	74LS138	.75	74LS244	.99	74LS395	1.65
74LS37	.55	74LS139	.75	74LS245	1.90	74LS399	1.70
74LS38	.35	74LS145	1.20	74LS247	.76	74LS424	.95
74LS40	.35	74LS147	2.49	74LS248	1.25	74LS447	.37
74LS42	.55	74LS148	1.35	74LS249	.99	74LS490	1.95
74LS47	.75	74LS151	.75	74LS251	1.30	74LS668	1.69
74LS48	.75	74LS153	.75	74LS253	.85	74LS669	1.89
74LS49	.75	74LS154	2.35	74LS257	.85	74LS670	2.20
74LS51	.25	74LS155	1.15	74LS258	.85	74LS674	9.65
74LS54	.35	74LS156	.95	74LS259	2.85	74LS682	3.20
74LS55	.35	74LS157	.75	74LS260	.65	74LS683	2.30
74LS63	1.25	74LS158	.75	74LS265	.55	74LS684	2.40
74LS73	.40	74LS160	.90	74LS273	1.65	74LS685	2.40
74LS74	.45	74LS161	.95	74LS275	3.35	74LS688	2.40
74LS75	.50	74LS162	.95	74LS279	.55	74LS689	2.40
74LS76	.40	74LS163	.95	74LS280	1.98	81LS95	1.69
74LS78	.50	74LS164	.95	74LS283	1.00	81LS96	1.69
74LS83	.75	74LS165	.95	74LS290	1.25	81LS97	1.69
						81LS98	1.69

HOURS: Mon. - Fri., 9 to 5; Sat., 11 to 3



JDR MICRODEVICES, INC.

1224 So. Bascom Ave.

San Jose, CA 95128

800-538-5000 • 800-662-6279 (CA)

(408) 995-5430 • Telex 171-110

VISIT OUR RETAIL STORE!

TERMS: For shipping include \$2.00 for UPS ground, \$3.00 for UPS Blue Label air. \$10.00 minimum order. Bay Area residents add 6 1/2% sales tax. California residents add 6% sales tax. We reserve the right to limit quantities and substitute manufacturer. Prices subject to change without notice. Send SASE for complete list.

2716 EPROMS 450NS (5V)

8/4.95 ea.

ALL MERCHANDISE 100% GUARANTEED!

CALL US FOR VOLUME QUOTES

8000

8035	16.95
8039	19.95
8080A	3.95
8085	12.95
8085A-2	16.95
8086	99.95
8088	39.95
8155	11.95
8156	11.95
8185	29.95
8185-2	39.95
8741	39.95
8748	29.95
8755	44.95

8200

8202	45.00
8205	3.50
8212	1.85
8214	3.85
8216	1.80
8224	2.50
8226	1.80
8228	4.90
8237	19.95
8238	4.95
8239	4.85
8243	4.45
8250	14.95
8251	4.75
8253	9.25
8253-5	9.85
8255	4.75
8255-5	5.25
8257	8.75
8259	6.90
8272	39.95
8275	29.95
8279	9.50
8279-5	10.50
8282	6.65
8283	6.65
8284	5.70
8286	6.65
8287	6.50
8288	25.00
8289	49.95

TV CIRCUITS

MC1330	1.89
MC1350	1.29
MC1358	1.79
LM380	1.29
LM386	1.50
LM565	.99
LM741	.29
LM1310	2.90
LM1800	2.99
LM1889	2.49



APPLE FAN \$69.00

- EXTRA PLUG-IN CARDS CAN CAUSE YOUR APPLE TO OVERHEAT
- ULTRA-QUIET APPLE FAN DRAWS COOL AIR THROUGH YOUR COMPUTER
- ELIMINATES DOWN TIME
- SAVES REPAIR CHARGES
- INCREASES RELIABILITY
- CLIPS ON — NO HOLES OR SCREWS
- COLOR MATCHES APPLE
- LONG LIFE, LOW NOISE MOTOR



* APPLE IS A TRADEMARK OF APPLE COMPUTER INC.

EPROM ERASERS

PE-14	78.50
PE-14T (with timer)	108.50
PE-24T (with timer)	154.50

ALL ARE HIGH QUALITY UNITS ENCLOSED IN A BLACK ANODIZED ALUMINUM ENCLOSURE.

800-538-5000

800-662-6279

(CALIFORNIA RESIDENTS)

CALL JDR BEFORE YOU BUY!
WE WILL BEAT ANY COMPETITORS' PRICES

6800

6800	5.70
6802	10.95
6808	9.95
6809	24.95
6809E	29.95
6810	4.60
6820	4.95
6821	4.95
6828	14.95
6834	16.95
6840	14.95
6843	42.95
6844	44.95
6845	16.95
6847	15.95
6850	4.75
6852	5.75
6860	10.95
6862	11.95
6875	6.95
6880	2.95
68800	10.95
68821	12.95
68850	12.95

LEDS

Jumbo Red	10/1.00
Jumbo Green	6/1.00
Jumbo Yellow	6/1.00
5082-7760 43°CC	.79
MAN74 3°CC	.99
MAN72 3°CA	.99

VOLTAGE REG's

7805T	.79	7905T	.89
7808T	.99	7912T	.89
7812T	.79	7915T	1.19
7815T	.99	7924T	1.19
7824T	.99		

7805K	1.39	7905K	1.49
7812K	1.39	7912K	1.49
7815K	1.39	7915K	.79
78L05	.69	79L12	.79
78L12	.69	79L15	.79
78L15	.69		
LM309K	1.49	LM317K	3.95
LM317T	1.95	LM323K	4.95
		LM337K	3.95

T = TO-220 K = TO-3 L = TO-92

LINEAR

LM301V	.34
LM308V	.98
LM309K	1.49
LM311	.64
LM317T	1.95
LM317K	3.95
LM318	1.49
LM323K	4.95
LM324	.59
LM337K	3.95
LM339	2.99
LM377	2.99
LM380	1.29
LM386V	1.50
LM555V	.39
LM556	.69
LM565	.99
LM566V	1.49
LM567V	1.29
LM723	.49
LM733	.98
LM741V	.29
LM747	.79
LM748V	.59
LM1310	2.90
MC1330V	1.89
MC1350V	1.29
MC1358	1.79
LM1414	1.59
LM1458V	.69
LM1488	.99
LM1489	.99
LM1800	2.99
LM1889	2.49
LM3900	.59
LM3909V	.98
LM3914	3.95
LM3915	3.95
LM3916	3.95
75451V	.39
75452V	.39
75453V	.39

74S00 SERIES

74S00	.44	74S74	.69	74S163	3.75	74S257	1.39
74S02	.48	74S85	2.39	74S168	4.65	74S258	1.49
74S03	.48	74S86	1.44	74S169	5.44	74S260	1.83
74S04	.79	74S112	1.59	74S174	1.09	74S274	19.95
74S05	.79	74S113	1.98	74S175	1.09	74S275	19.95
74S08	.48	74S114	1.50	74S181	4.47	74S280	2.90
74S09	.98	74S124	2.77	74S182	2.95	74S287	4.75
74S10	.69	74S132	1.24	74S188	3.95	74S288	4.45
74S11	.88	74S133	.98	74S189	14.95	74S289	6.98
74S15	.70	74S134	.69	74S194	2.95	74S301	6.95
74S20	.68	74S135	1.48	74S195	1.89	74S373	3.45
74S22	.98	74S138	1.08	74S196	4.90	74S374	3.45
74S30	.48	74S139	1.25	74S197	4.25	74S381	7.95
74S32	.98	74S140	1.45	74S201	14.95	74S387	5.75
74S37	1.87	74S151	1.19	74S225	8.95	74S412	2.98
74S38	1.68	74S153	1.19	74S240	3.98	74S471	9.95
74S40	.44	74S157	1.19	74S241	3.75	74S472	16.85
74S51	.78	74S158	1.45	74S244	3.98	74S474	17.85
74S64	.79	74S161	2.85	74S251	1.90	74S482	15.60
74S65	1.25	74S162	3.70	74S253	7.45	74S570	7.80
						74S571	7.80

TRANSISTORS

PN2222	10/1.00	100/	8.99
2N2222	.25	50/10.99	
2N2907	.25	50/10.99	
2N3055	.79	10/	6.99
2N3904	10/1.00	100/	8.99
2N3906	10/1.00	100/	8.99
1N4148 (1N914)		25/	1.00
1N4004		10/	1.00

IC SOCKETS

	1-99	100
8 pin ST	.13	.11
14 pin ST	.15	.12
16 pin ST	.17	.13
18 pin ST	.20	.18
20 pin ST	.29	.27
22 pin ST	.30	.27
24 pin ST	.30	.27
28 pin ST	.40	.32
40 pin ST	.49	.39
ST = SOLDDERTAIL		
8 pin WW	.59	.49
14 pin WW	.69	.52
16 pin WW	.69	.58
18 pin WW	.99	.90
20 pin WW	1.09	.98
22 pin WW	1.39	1.28
24 pin WW	1.49	1.35
28 pin WW	1.69	1.49
40 pin WW	1.99	1.80
WW = WIREWRAP		

CONNECTORS

RS232 MALE	3.25
RS232 FEMALE	3.75
RS232 HOOD	1.25
S-100 ST	3.95
S-100 WW	4.95

DIP SWITCHES

4 POSITION	.85
5 POSITION	.90
6 POSITION	.90
7 POSITION	.95
8 POSITION	.95

7400 SERIES

7400	.19	7451	.23	74136	.50	74186	18.50
7401	.19	7453	.23	74141	.65	74190	1.15
7402	.19	7454	.23	74142	2.95	74191	1.15
7403	.19	7460	.23	74143	2.95	74192	.79
7404	.19	7470	.35	74144	2.95	74193	.79
7405	.22	7472	.29	74145	.60	74194	.85
7406	.22	7473	.34	74147	1.75	74195	.85
7407	.22	7474	.35	74148	1.20	74196	.79
7408	.24	7475	.49	74150	1.35	74197	.75
7409	.19	7476	.35	74151	.65	74198	1.35
7410	.19	7480	.59	74152	.65	74199	1.35
7411	.25	7481	1.10	74153	.55	74221	1.35
7412	.30	7482	.95	74154	1.40	74246	1.35
7413	.35	7483	.50	74155	.75	74247	1.25
7414	.55	7485	.65	74156	.65	74248	1.85
7416	.25	7486	.35	74157	.55	74249	1.95
7417	.25	7489	4.95	74159	1.65	74251	.75
7420	.19	7490	.35	74160	.85	74259	2.25
7421	.35	7491	.40	74161	.70	74265	1.35
7422	.29	7492	.50	74162	.85	74273	1.95
7423	.29	7493	.49	74163	.85	74276	1.25
7425	.29	7494	.65	74164	.85	74279	.75
7426	.29	7495	.55	74165	.85	74283	2.00
7427	.29	7496	.70	74166	1.00	74284	3.75
7428	.45	7497	2.75	74167	2.95	74285	3.75
7430	.19	74100	1.00	74170	1.65	74290	.95
7432	.29	74107	.30	74172	5.95	74293	.75
7433	.45	74109	.45	74173	.75	74298	.85
7437	.29	74110	.45	74174	.89	74351	2.25
7438	.29	74111	.55	74175	.89	74365	.65
7440	.19	74116	1.55	74176	.89	74366	.65
7442	.49	74120	1.20	74177	.75	74367	.65
7443	.65	74121	.29	74178	1.15	74368	.65
7444	.69	74122	.45	74179	1.75	74376	2.20
7445	.69	74123	.55	74180	.75	74390	1.75
7446	.59	74125	.45	74181	2.25	74393	1.35
7447	.69	74126	.45	74182	.75	74425	3.15
7448	.69	74128	.55	74184	2.00	74426	.85
7450	.19	74132	.45	74185	2.00	74490	2.55

HOURS: Mon. - Fri., 9 to 5; Sat. 11 to 3



JDR MICRODEVICES, INC.

1224 S. Bascom Ave.
San Jose, CA 95128

800-538-5000 • 800-662-6279 (CA)
(408) 995-5430 • Telex 171-110

VISIT OUR RETAIL STORE!

TERMS: For shipping include \$2.00 for UPS Ground, \$3.00 for UPS Blue Label Air. \$10.00 minimum order. Bay Area residents add 6 1/2% sales tax. California residents add 6% sales tax. We reserve the right to limit quantities and substitute manufacturer. Prices subject to change without notice. Send SASE for complete list.

7400

SN7400N	.20	SN7472N	.29	SN74156N	.79
SN7401N	.20	SN7473N	.35	SN74157N	.69
SN7402N	.25	SN7474N	.35	SN74160N	.89
SN7403N	.25	SN7475N	.49	SN74161N	.89
SN7404N	.25	SN7476N	.35	SN74162N	.89
SN7405N	.29	SN7477N	5.00	SN74163N	.89
SN7406N	.35	SN7480N	5.00	SN74164N	.89
SN7407N	.35	SN7482N	.99	SN74165N	.89
SN7408N	.29	SN7483N	.69	SN74166N	1.25
SN7409N	.29	SN7485N	.89	SN74167N	2.79
SN7410N	.25	SN7486N	.35	SN74170N	4.95
SN7411N	.29	SN7489N	1.75	SN74172N	1.95
SN7412N	.25	SN7490N	.89	SN74182N	1.35
SN7413N	.49	SN7491N	.59	SN74183N	.99
SN7414N	.69	SN7492N	.45	SN74175N	.99
SN7416N	.29	SN7493N	.45	SN74176N	.79
SN7417N	.29	SN7494N	.69	SN74177N	.79
SN7420N	.25	SN7495N	.59	SN74178N	1.69
SN7421N	.29	SN7496N	.69	SN74180N	.99
SN7422N	.45	SN7497N	3.00	SN74181N	2.25
SN7423N	.29	SN74100N	.49	SN74182N	.79
SN7425N	.29	SN74101N	.89	SN74183N	2.49
SN7426N	.29	SN74102N	.89	SN74185N	2.49
SN7427N	.25	SN74103N	.35	SN74190N	1.25
SN7428N	.49	SN74109N	.39	SN74191N	1.25
SN7430N	.25	SN74116N	1.95	SN74192N	.89
SN7432N	.25	SN74121N	.39	SN74193N	.89
SN7433N	.25	SN74122N	.55	SN74194N	.89
SN7438N	.40	SN74123N	.59	SN74195N	.89
SN7439N	.25	SN74125N	.49	SN74196N	.89
SN7440N	.25	SN74126N	.49	SN74197N	.89
SN7441N	.49	SN74127N	.75	SN74198N	.49
SN7442N	.59	SN74128N	.75	SN74199N	1.49
SN7443N	1.10	SN74141N	.99	SN74201N	1.25
SN7444N	1.10	SN74142N	3.25	SN74201N	.99
SN7445N	.89	SN74143N	3.49	SN74205N	.99
SN7446N	.89	SN74144N	3.49	SN74206N	.99
SN7447N	.69	SN74145N	.79	SN74207N	1.49
SN7448N	.79	SN74147N	1.95	SN74208N	3.95
SN7450N	.20	SN74148N	1.25	SN74209N	3.95
SN7451N	.20	SN74150N	1.25	SN74210N	.69
SN7453N	.20	SN74151N	.69	SN74211N	.69
SN7454N	.20	SN74152N	.69	SN74212N	.69
SN7459A	.20	SN74153N	.69	SN74213N	.69
SN7460A	.20	SN74154N	1.25	SN74214N	1.49
SN7470N	.29	SN74155N	.79	SN74215N	.69

74LS

74LS00	.29	74LS192	1.45
74LS01	.29	74LS193	1.15
74LS02	.29	74LS194	1.15
74LS03	.29	74LS195	1.15
74LS04	.29	74LS196	1.15
74LS05	.29	74LS221	1.19
74LS06	.29	74LS240	1.49
74LS07	.29	74LS241	1.49
74LS08	.29	74LS242	1.49
74LS09	.29	74LS243	1.49
74LS10	.29	74LS244	1.49
74LS11	.29	74LS245	2.95
74LS12	.29	74LS246	1.19
74LS13	.29	74LS247	1.19
74LS14	.29	74LS248	1.19
74LS15	.29	74LS249	1.19
74LS16	.29	74LS250	1.19
74LS17	.29	74LS251	1.19
74LS18	.29	74LS252	1.19
74LS19	.29	74LS253	1.19
74LS20	.29	74LS254	1.19
74LS21	.29	74LS255	1.19
74LS22	.29	74LS256	1.19
74LS23	.29	74LS257	1.19
74LS24	.29	74LS258	1.19
74LS25	.29	74LS259	1.19
74LS26	.29	74LS260	1.19
74LS27	.29	74LS261	1.19
74LS28	.29	74LS262	1.19
74LS29	.29	74LS263	1.19
74LS30	.29	74LS264	1.19
74LS31	.29	74LS265	1.19
74LS32	.29	74LS266	1.19
74LS33	.29	74LS267	1.19
74LS34	.29	74LS268	1.19
74LS35	.29	74LS269	1.19
74LS36	.29	74LS270	1.19
74LS37	.29	74LS271	1.19
74LS38	.29	74LS272	1.19
74LS39	.29	74LS273	1.19
74LS40	.29	74LS274	1.19
74LS41	.29	74LS275	1.19
74LS42	.29	74LS276	1.19
74LS43	.29	74LS277	1.19
74LS44	.29	74LS278	1.19
74LS45	.29	74LS279	1.19
74LS46	.29	74LS280	1.19
74LS47	.29	74LS281	1.19
74LS48	.29	74LS282	1.19
74LS49	.29	74LS283	1.19
74LS50	.29	74LS284	1.19
74LS51	.29	74LS285	1.19
74LS52	.29	74LS286	1.19
74LS53	.29	74LS287	1.19
74LS54	.29	74LS288	1.19
74LS55	.29	74LS289	1.19
74LS56	.29	74LS290	1.19
74LS57	.29	74LS291	1.19
74LS58	.29	74LS292	1.19
74LS59	.29	74LS293	1.19
74LS60	.29	74LS294	1.19
74LS61	.29	74LS295	1.19
74LS62	.29	74LS296	1.19
74LS63	.29	74LS297	1.19
74LS64	.29	74LS298	1.19
74LS65	.29	74LS299	1.19
74LS66	.29	74LS300	1.19
74LS67	.29	74LS301	1.19
74LS68	.29	74LS302	1.19
74LS69	.29	74LS303	1.19

74S

74S00	.45	74S243	3.25
74S01	.45	74S244	3.25
74S02	.45	74S245	3.25
74S03	.45	74S246	3.25
74S04	.45	74S247	3.25
74S05	.45	74S248	3.25
74S06	.45	74S249	3.25
74S07	.45	74S250	3.25
74S08	.45	74S251	3.25
74S09	.45	74S252	3.25
74S10	.45	74S253	3.25
74S11	.45	74S254	3.25
74S12	.45	74S255	3.25
74S13	.45	74S256	3.25
74S14	.45	74S257	3.25
74S15	.45	74S258	3.25
74S16	.45	74S259	3.25
74S17	.45	74S260	3.25
74S18	.45	74S261	3.25
74S19	.45	74S262	3.25
74S20	.45	74S263	3.25
74S21	.45	74S264	3.25
74S22	.45	74S265	3.25
74S23	.45	74S266	3.25
74S24	.45	74S267	3.25
74S25	.45	74S268	3.25
74S26	.45	74S269	3.25
74S27	.45	74S270	3.25
74S28	.45	74S271	3.25
74S29	.45	74S272	3.25
74S30	.45	74S273	3.25
74S31	.45	74S274	3.25
74S32	.45	74S275	3.25
74S33	.45	74S276	3.25
74S34	.45	74S277	3.25
74S35	.45	74S278	3.25
74S36	.45	74S279	3.25
74S37	.45	74S280	3.25
74S38	.45	74S281	3.25
74S39	.45	74S282	3.25
74S40	.45	74S283	3.25
74S41	.45	74S284	3.25
74S42	.45	74S285	3.25
74S43	.45	74S286	3.25
74S44	.45	74S287	3.25
74S45	.45	74S288	3.25
74S46	.45	74S289	3.25
74S47	.45	74S290	3.25
74S48	.45	74S291	3.25
74S49	.45	74S292	3.25
74S50	.45	74S293	3.25
74S51	.45	74S294	3.25
74S52	.45	74S295	3.25
74S53	.45	74S296	3.25
74S54	.45	74S297	3.25
74S55	.45	74S298	3.25
74S56	.45	74S299	3.25
74S57	.45	74S300	3.25
74S58	.45	74S301	3.25
74S59	.45	74S302	3.25
74S60	.45	74S303	3.25

CA-LINEAR

CA3010H	.99	CA3089N	3.75
CA3013H	2.15	CA3096N	3.95
CA3023H	3.25	CA3130H	3.95
CA3035H	2.49	CA3140H	1.20
CA3039H	1.35	CA3160H	1.20
CA3046H	1.30	CA3401N	.59
CA3059H	3.25	CA3600N	3.50

CD-CMOS

CD4001	.39	CD4056	2.49
CD4002	.39	CD4057	.99
CD4003	1.19	CD4058	3.95
CD4009	.49	CD4059	3.95
CD4010	.49	CD4060	1.95
CD4011	.49	CD4061	1.95
CD4012	.49	CD4062	1.95
CD4013	.49	CD4063	1.95
CD4014	1.39	CD4064	1.95
CD4015	1.19	CD4065	1.95
CD4016	1.19	CD4066	1.95
CD4017	1.19	CD4067	1.95
CD4018	.99	CD4068	1.95
CD4019	.99	CD4069	1.95
CD4020	1.19	CD4070	1.95
CD4021	1.39	CD4071	1.95
CD4022	1.19	CD4072	1.95
CD4023	.79	CD4073	1.95
CD4024	.79	CD4074	1.95
CD4025	.79	CD4075	1.95
CD4026	2.95	CD4076	1.95
CD4027	.69	CD4077	1.95
CD4028	.69	CD4078	1.95
CD4029	1.49	CD4079	1.95
CD4030	1.49	CD4080	1.95
CD4031	1.49	CD4081	1.95
CD4032	1.49	CD4082	1.95
CD4033	3.49	CD4083	1.95
CD4034	3.49	CD4084	1.95
CD4035	3.49	CD4085	1.95
CD4036	3.49	CD4086	1.95
CD4037	3.49	CD4087	1.95
CD4038	3.49	CD4088	1.95
CD4039	3.49	CD4089	1.95
CD4040	3.49	CD4090	1.95

Bulova Quartz Ladies Watches

ONE YEAR FACTORY WARRANTY

Looker LCD (Monochrome) Driver Quartz
Looker LCD (Monochrome) Driver Quartz
Looker LCD (Monochrome) Driver Quartz
Looker LCD (Monochrome) Driver Quartz

82395-5Y SUGG. RETAIL \$140.00
82396-5Y SUGG. RETAIL \$140.00
82397-5Y SUGG. RETAIL \$140.00
82398-5Y SUGG. RETAIL \$140.00

YOUR CHOICE — 50%-OFF SUGG. RETAIL PRICE

CALL OR SEND ORDER — REFERENCING TO THIS AD FOR SPECIAL PRICE
Because of Limited Supply, please provide a second and third choice
EXAMPLE: 82395-5Y, SUGG. RETAIL \$140.00, 50% OFF — YOUR COST \$70.00

LITRONIX Stick Display Sale

MULTI-DIGIT REFLECTOR ARRAYS FOR CLOCKS

Part No.	Description	Price
74121	1-Digit Reflector Array	1.95
74122	2-Digit Reflector Array	2.95
74123	3-Digit Reflector Array	3.95
74124	4-Digit Reflector Array	4.95
74125	5-Digit Reflector Array	5.95
74126	6-Digit Reflector Array	6.95
74127	7-Digit Reflector Array	7.95
74128	8-Digit Reflector Array	8.95
74129	9-Digit Reflector Array	9.95
74130	10-Digit Reflector Array	10.95

2 FOR SALE

NATIONAL Stick Display Sale

LED NUMERIC ARRAYS

Part No.	Description	Price
74131	1-Digit LED Numeric Array	1.95
74132	2-Digit LED Numeric Array	2.95
74133	3-Digit LED Numeric Array	3.95
74134	4-Digit LED Numeric Array	4.95
74135	5-Digit LED Numeric Array	5.95
74136	6-Digit LED Numeric Array	6.95
74137	7-Digit LED Numeric Array	7.95
74138	8-Digit LED Numeric Array	8.95
74139	9-Digit LED Numeric Array	9.95
74140	10-Digit LED Numeric Array	10.95

2 FOR SALE

COMPUTER GRADE CAPACITORS

MFD	WVDC	PRICE	MFD	WVDC	PRICE	MFD	WVDC	PRICE
100	50	1.95	1000	50	1.95	10000	50	1.95
1000	50	1.95	10000	50	1.95	100000	50	1.95
10000	50	1.95	100000	50	1.95	1000000	50	1.95

LOW PROFILE (TIN) SOCKETS

Pin Count	Price	Pin Count	Price
8 pin LP	.17	14 pin ST	.27
16 pin LP	.22	28 pin ST	.35
18 pin LP	.25	36 pin ST	.42
20 pin LP	.33	40 pin ST	.50
22 pin LP	.37	48 pin ST	.59
24 pin LP	.43	56 pin ST	.67
28 pin LP	.45	64 pin ST	.75
36 pin LP	.63	72 pin ST	.83
40 pin LP	.65	80 pin ST	.91

ADVANCED COMPUTER PRODUCTS

TOLL FREE ORDER LINE
800-854-8230



Apple Computer Sales and Service

COMPUTERS	LIST	ACP
Apple II 16K	\$1330.00	\$1029.00
Apple II 48K	1530.00	1099.00
Apple II 64K	1729.00	1225.00
Apple II 64K w/ 280 SoftCard & Vision 80	2519.00	1775.00
Apple III 128K	3495.00	2895.00

APPLE HARDWARE	LIST	ACP
Apple Disk II w/ interface	\$ 645.00	\$ 529.00
Apple Disk II w/ io	525.00	449.00
Silentype Printer	395.00	355.00
Prototype Card	24.00	21.95
IEEE-488 interface	450.00	375.00
1 year ext. warranty	225.00	175.00
Parallel Printer Interface	180.00	159.95
Communications Card	225.00	189.00
Pascal Language System	495.00	425.85
High Speed Serial Interface	195.00	174.95
Applesoft II ROM Card	200.00	159.95
Applesoft II ROM Card Language Card	195.00	174.95
12" Graph. Monitor III	320.00	275.00
Pratice Hard Disk Subsystem	3495.00	2995.00
Graphics Tablet	795.00	695.00

APPLE COMPATIBLE HARDWARE	LIST	ACP
Microsoft Z80 SoftCard	\$299.00	
Microsoft 16K RAMCard	159.00	
SSM AIO Serial/Parallel	165.00	
The Keyboard Company Joystick	45.00	
Numeric Pad	119.00	
Mountain Computer ROMPlus	159.00	
RAMPlus	call	
CPS Multifunction Expansion Chassis	229.00	
Thunderclock X-10 option	69.00	
PatSci option	29.00	
CCS Serial AIO Parallel I/O	139.00	
M & R Enterprises Apple Fan	45.00	
Sup R Mod	29.95	
Aux Switcher Supply	199.00	
Sup R Term	299.00	
ALS Smarterm 5MB Hard Disk	2995.00	
Corvus 10Mb	4325.00	
20Mb	5240.00	
Apple 16K Upgrade Kit	15.95	
Votrax Voice Box	call	
Scott Voice Recognition	849.00	

APPLE SOFTWARE	LIST	ACP
VisiCalc	\$ 169.00	
SuperCalc	199.00	
Visi-Trend/VisiPlot	239.00	
VisiDoc	169.00	
VisiText	129.00	
BPI General Ledger	329.00	
Accounts Receivable	329.00	
Inventory	329.00	
MicroCrewer	229.00	
Micro Telegraph	229.00	
Accounting Plus	1195.00	
DB Master	179.00	
Wordstar	259.00	
Super Sort	149.00	
Mail Merger	89.00	
Data Star	199.00	
Spell Star	169.00	
VTS 80 CP/M	219.00	
Fortran 80	699.00	
PF5 Filing System	75.00	
PF5 Reporter	75.00	

FLOPPY DISK DRIVES QUME DT/8 D/D/D/S	LIST	ACP
QUME DT/8 D/D/D/S	\$ 569.95	
Random FM100 1 1/4" Disk Drive	279.00	
MPI B5-16 1 1/4" 40 tracks	279.00	
Shugart SA400 5 1/4" 35 tracks	295.00	
Shugart 800/801R 8"	449.00	
Siemens Shugart Compatible Model FDD-100 80	429.00	
PERSC Model 277 Dual	1195.00	
MPI B2 5 1/4" Dual	249.00	
WANG/SIEMENS 2 MPI 91 Double Track Density Single Side 80 Tracks	290.00	
MPI 92 Double Track Density Double Side 160 Track	375.00	
	475.00	



Vista

VISTA COMPUTER

	LIST	ACP
Vision 80 8024 display card	\$395.00	\$299.00
Vision 40 40 col. enhancement	199.00	149.00
Vision 20 lower case ROM	29.95	25.00
A800 8" D/D FDC	595.00	499.00
A800 9 voice music	195.00	99.00
GB/5 IBM Regen/AApple I/O	195.00	169.00
I/O'S PROM development	595.00	399.00
TYPE AHEAD BUFFER	49.95	35.00



VISTA V-DRIVE

VISTA V-DRIVE	LIST	ACP
Model V-1000 8" floppy disk enclosures with Qume Datalink 8		
CABINET	\$ 459.95	
w/ 2 single-sided drives, ps&c	\$1495.00	
w/ 2 double-sided drives, ps&c	\$1995.00	
A800 Double density controller (for Apple computers)	\$ 499.00	

VISTA V 80

MINI DISK DRIVE	LIST	ACP
V 80 Single drive case ps	\$299.00	
V 80 Dual drive case ps	\$589.00	
D 5 D/D also available		

APPLE COMPATIBLE DRIVES (MicroSci)

	LIST	ACP
A2 Series is plug-compatible		
Save \$300 on dual drive system		
DD5 software not included		
A2 5 1/4" 143K Drive	\$479.00	\$389.00
A2C controller	100.00	89.00
A405 1/4" 160K Drive	449.00	365.00
A70 5 1/4" 286K Drive	599.00	480.00
A40C controller for A40-A70	100.00	79.00

DISKETTES

Verbatim SSSD 5 1/4"	per box	\$ 24.95
Maxell SSSD 5 1/4"	per box	29.95
Top Quality Private Label SSSD 5 1/4"	per box	19.95
	per 100	149.00
	per box	29.95



ROBOTIC ARM

MicroBot Minimover-5		
Completely Assembled w/ Applications Manual	\$1695.00	
ARMBASIC Software For IRS-80	39.95	
Application/Reference Manual	16.95	



HEWLETT PACKARD CALCULATORS

HP-11CV w/2.2K memory	NEW	375.00	256.00
HP-41C Calculator		290.00	169.95
Memory Module for 41C			26.00
Quad RAM		95.00	81.95
Card Reader for 41C, CV		215.00	169.95
Printer for 41C, CV		365.00	291.95
Optical Wand for 41C, CV		125.00	99.95
HP-11C Advanced Scientific	★ NEW	135.00	149.95
HP-12C Financial		150.00	129.95
HP-34C Prog. Scientific		150.00	119.00
HP-38C Prog. Business		150.00	119.00
HP-97 Programmable Printer		750.00	595.00



PRINTERS EPSON/VISTA

	LIST	ACP
MX-80 Dot Matrix	\$645.00	\$429.00
MX-80 FT	745.00	529.00
MX-100	995.00	725.00
Apple I/O & cable	110.00	89.00
GaltraX option	95.00	89.00
IEEE I/O & cable	130.00	95.00
Serial I/O & cable	130.00	95.00
Serial w/ P & cable	175.00	149.00
Universal Graphics Utility	39.95	35.95

NEC

8023 Dot Matrix	795.00	649.00
-----------------	--------	--------

DIABLO

630 Daisywheel Tractor	2965.00	2295.00
	249.00	169.95

C. ITOH/VISTA

Starwriter V300	25 cps	1895.00	1485.00
	45 cps	2195.00	1735.00
	100 cps	749.00	675.00

ANADIX

9500/9501	1650.00	1350.00
-----------	---------	---------

QUME

9/45	3295.00	2995.00
------	---------	---------

ID5

460G w/Graphics	1385.00	899.00
560G 14 75" Carriage	1695.00	1199.00



TERMINALS

	LIST	ACP
TELEVIDEO		
910	\$ 699.00	\$ 599.00
912C	950.00	699.00
920C	950.00	799.00
950C	1195.00	999.00

SORDC

IQ120		699.00
IQ135		899.00
IQ140		1149.00



MONITORS SANYO

	LIST	ACP
SANYO		
9" B&W	\$225.00	\$169.95
9" Green	219.00	199.95
12" B&W	340.00	249.00
12" Green	360.00	279.00
13" Color	550.00	429.00
13" RGB	1195.00	995.00



NOVATION MODEMS

	LIST	ACP
Novation		
Cat	\$199.95	\$149.00
D-Cat	199.95	169.00
Apple-Cat	349.95	309.00
Auto-Cat	299.95	239.95

HAYES

Macromodem	1379.00	1299.00
Smartmodem	279.00	249.00



ROTRON MUFFIN FAN

115 VAC 7 watts WR2A1	\$19.95
-----------------------	---------



IBM COMPATIBLE BOARDS

Top Quality 1 year warranty		
256K Add-on memory	\$1145.00	\$899.00
PC Communications	295.00	269.00
Graphics		call
Wire Wrap kit w/extension	95.00	89.00



ATARI

ATARI COMPUTER

	LIST	ACP
400 w/16K RAM	\$399.00	\$339.95
400 Basic Language Module	49.00	47.00
800 w/16K RAM	899.00	699.00
410 Prog. Recorder	90.00	60.00
825 Printer	799.95	699.00
830 Acoustic Modem	199.95	159.00
850 Interface Module	219.95	189.95
MTK 16K RAM	99.50	84.00
MTK 32K RAM	199.50	139.00
ATARI VisiCalc	200.00	160.00
ATARI Pac-Man	44.95	36.95

ATARI "THE COMMUNICATOR" KIT

850 I/O	Package Deal	
830 Modem	Source Pkg	
Tetrah 1	Down Jones Pkg	
Total Value \$444.85	Compuserve Pkg	ACP \$379.95

XEROX 820

"The Personal Computer"

FREE TCS BUSINESS SOFTWARE w/purchase All G.L.P. Payroll Inventory \$1100.00 VALUE 8" only

	LIST	ACP	
820-1	5 1/4" system	\$2995.00	\$2490.00
820-2	8" system	3795.00	3195.00
CP/M		200.00	169.95
SuperCalc		295.00	239.95
Word Processing		500.00	429.95

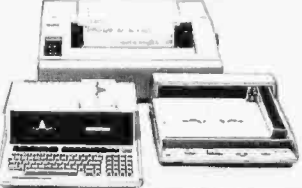

HEWLETT PACKARD

HEWLETT-PACKARD COMPUTERS

	LIST	ACP
HP-125 CPM Microcomputer	\$3750.00	\$3000.00
HP-85 Microcomputer	2750.00	2375.00
HP-83 Microcomputer	2250.00	1899.00
82903A 16K Memory Module	195.00	174.95
7225 Graphics Plotter	2490.00	2125.00
7225 Personality Module	750.00	675.00
HP-125080 B" Disk	1210.00	1085.00
HP-9895A B" Drive	6850.00	5750.00
HP-9111A Graphics Tablet	2050.00	1790.00

SINGLEBOARD COMPUTERS

	LIST	ACP
ROCKWELL		
AIM 55 w/1K		\$435.00
AIM 60 w/4K		475.00
8K BASIC ROM		99.00
1K Assembly RDM		84.00
Power Supply		64.95
Enclosure		49.95
Total system w/1K		669.00</

BECKMAN DIGITAL MULTIMETERS

TECH 300 Digital Multimeter	\$ 110.00
TECH 310 Digital Multimeter	140.00
TECH 330 Digital Multimeter	189.00
VC-201 Vinyl Carrying Case	10.00
DC-202 Deluxe Carrying Case	24.00
HV-211 High Voltage Probe	35.00
RP-221 RP Probe	35.00
CT-231 AC Current Clamp	42.00
DL-242 Deluxe Test Lead Kit	10.00
TL-242 Square Test Leads	6.00

NLS TOUCH TEST 20

Digital Multimeter \$349.95

S100 32K STATIC RAM BOARD



2 or 4 MHz Expandable uses 21414's

16K x 4MHz Kit	\$159.95
16K x 4MHz A&T	217.95
32K x 4MHz Kit	299.95
32K x 4MHz A&T	339.00
Bare Board	39.95
Bare Board w/all parts	99.95
ess. mem.	

8080/8085 SUPPORT

8155 8156 I/O	\$ 11.95
8755 I/O w/ EPROM	44.95
8202 Dyn. RAM Cont.	34.95
8205 74S 138 Decoder	3.95
8712 8 bit I/O	2.75
8214 Priority Int.	2.75
8216 Bus Driver	2.95
8224 Clock Gen.	2.95
8224 4 MHz	9.75
8226 Bus Driver	2.95
8226 Bus Driver	4.95
8228 Sys. Con.	2.95
8238 Sys. Con.	5.50
8243 I/O Exp.	9.50
8250 Async. Con.	15.95
8251 Prog. I/O	6.95
8253 Int. Timer	12.95
8255 Prog. I/O	4.50
8257 Prog. DMA	9.95
8259 Prog. Int.	9.95
8275 CRT Contr.	29.95
8279 Prog. Keyboard	9.95

Z80 SUPPORT

Z80 PIO	2.5 MHz	\$ 6.75
Z80 PIO	4.0 MHz	9.95
Z80 CTC	2.5 MHz	6.75
Z80A CTC	4.0 MHz	3.95
Z80 DMA	2.5 MHz	19.95
Z80 DMA	4.0 MHz	23.95
Z80 SID 0	2.5 MHz	24.95
Z80A SID 0	4.0 MHz	29.95
Z80 SID 1	2.5 MHz	21.95
Z80A SID 1	4.0 MHz	29.95
Z80 SID 2	2.5 MHz	24.95
Z80A SID 2	4.0 MHz	29.95

4K STATIC RAM SELL-OFF

For Z80 based systems

★ 2400 6101-4 4Kx1-450ms ★ \$14.99

PROTO BOARDS

PB-6	\$ 15.95
PB-100	21.00
PB-101	28.00
PB-102	34.00
PB-103	37.00
PB-104	47.00
PB-202	130.00
PB-203A	170.00
PB-203A Kit	140.00

PROTO CLIPS

PC-14	14 Pin	\$ 3.25
PC-16	16 Pin	3.50
PC-24	24 Pin	8.50
PC-40	40 Pin	13.95

6800 SUPPORT

6810 128x8 RAM	\$ 4.75
6820	6.50
6821	6.50
6828 Priority Int.	10.75
6831-1 512x8 Eprom	16.95
6845 HD-64000 CRT Cont.	29.95
6847 Color CRT	29.95
6850 ASCIA	5.95
6852 Serial Adapter	2.95
6853 Modem	10.95
6854 Modulator	23.95
6871A 1 GMHz OSC	2.19
6880 Bus Driver	16.95
MC66488	24.95
68047	

6502 SUPPORT

6520 PIA	\$ 7.50
6522 MUX	11.95
6530-002 003 004 005	21.95
6532	19.95
6551	19.95

BIPOLAR PROMS

87523 6330 5600 74S188	\$ 4.95
87515 1512x16	12.95
875123 5610 74S288 (32x8) TS	4.25
875126 5603 74S288 (256x4) OC	4.75
875129 5620 74S287 (256x4) TS	4.75
875130 5604 74S270 (512x4) OC	6.50
875131 74S571 (512x4) TS	6.95
875137 74S573 (512x4) TS	12.95
875141 74S472 (512x4) TS	12.95
875142 74S472 (512x4) TS	12.95
74S471 6309 (256x8) TS	7.95

MOS PROMS

2764 (8Kx8) TS	\$89.95
2732 (4Kx8) TS	16.95
2716 2516 5V (2Kx4) TS	8.95
1462716 5V 12V	17.95
2716 5V (450ms)	7.50
2708 (450ms)	5.75
2708 (850ms)	5.25
1702A	5.75
MMS2034Q	14.50
MMS204Q	9.95

TOLL FREE ORDER LINE

800-854-8230
TWX: 910-595-1565

IC SPECIAL PURCHASE

87509 6419 RAM	\$ 8.95
DP8304 Octal Driver	2.95
DC8264 DAC Conv.	6.95
MC16550 H. Speed A/D	10.00
MS1536	46
MC10210	89
LM339	79
LM710CN	29
LM711CN	29
78M06	49
79M06	49
74157	49
74161	49
74C74	49
MC14333P 3.5 Digit A/D	13.95
ICL8211 Volt. Ref.	1.95
LM1550N Gr. Fault	3.10
LM2900N Quad Amp	2.10
LM2917N Freq. to Volt. Conv.	2.10
MEM4863 Mosfet Smoke Detector	7.95
27508 32x8 PROM (1M5600)	2.95
LM2023A Tern. St.	4.50
MCM14505 64 bit S1 RAM	6.95
MCM1003 Optio Cap (4N28)	3.10
SP433 Optio Coupl.	3.10
HM545403 Sys. DPST	1.25
UA3045 Trans. Array	1.95
TR1402A UART	1.95
MMK1000 Dyn Mem. Shift Reg.	3.85
3318 1V Ch. Disp. Circuit	4.50
8700 C.I. 8 bit A/D	9.95
7520/25	50
148E1489	2.10
MC1322	8.95
MT45298A/B	2.95
LM377	1.25
LM380	1.25
LM388T	1.25
LM74558	3.10
RC4136	2.10
RC4131	2.10
COM1507	39.95
COM5037	49.95
TMS4060 4K RAM (22 Pin)	1.95
TMS4048 4K RAM (18 Pin)	1.49
MCM6504 4K RAM (16 Pin)	1.49

DYNAMIC RAM

416 4116 16K (16 Pin)	\$ 2.49
416 200 mV. Sel. of 8	15.95
4115 8K (16 Pin)	2.49
4050 4Kx1 (16 Pin)	4.95
4096 4Kx1 (22 Pin)	4.95
4096 4Kx1 (16 Pin)	3.95
2114 4Kx1 (16 Pin)	4.75
4027 4Kx1 (16 Pin) UPD 414	4.95
5261	1.95
5262	1.95
5270	4.95
5280	4.95
4008L	4.95
6605	7.95
6604	4.95
6602	1.50
64K RAM	9.95

MICROPROCESSORS

Z8001 16 bit to 8Kbit	\$ 110.00
Z8002 16 bit to 64K	75.00
Z8003	9.95
Z8004	11.95
F8 (38550)	16.95
2650	16.95
CD1807	9.75
8080A	4.75
8080A-4MHz	19.95
8085	14.95
8088-1	14.95
2901	14.95
2901A	9.95
1415 9500L	49.95
6502	9.95
6502A	16.95
IM5100	29.95
6800	11.75
68000 2.0 Mhz	11.95
6802P	14.95
6803	14.95
68039	12.95
INS 8073N	34.95
8755	49.95
8748	49.95
6809	30.00
8086	49.95
68800	129.95

CHARACTER GEN.

2513-001 (5V) Upper	\$ 9.50
2513-005 (5V) Lower	10.95
2513-ADM3 (5V) Lower	14.95
MCM66710 Asc. Shifted	12.95
MCM66740 Main Symbol	13.95
MCM66750 Alpha Control	13.45

CONNECTORS (GOLD)

DB25P (RS232)	\$ 3.25
DB25S Female	3.75
Head	1.25
Int. w/ Hood. Sale	11.50
22x44 W/W S.T. KIM	2.95
4386 W/W S.T. KIM	6.50
50-100 S-100 Connector w/w	4.95
50-100 S-100 Connector s/w	3.95

BARE PC BOARDS

S-100 Sound Board	\$ 34.95
8080A CPU	34.95
32K Static RAM (2114)	34.95
8K Eprom (2708)	24.95
2708 2716 Eprom	34.95
ACP-Proto. Bd	22.95
Vector 8500 Proto	22.20
Vector 8503 11 bit Mb	29.95
ACP Extender w. Conn.	18.95
13 Slot Mother Board (IMC)	32.95
9 Slot Mother Board (WMC)	29.95
5 Slot Mother (E expandable)	34.95
Fluopy PCB 18 (SHUGART)	39.95
C132 (A95-89 80) Sound Bd	34.95
Apple Sound Bd	24.95

UV "EPROM" ERASER



Model UVs-11E \$79.95
Model 5-SZT ★ \$325.00

16K MEMORY EXTENSION KITS

for Apple/TRS-80
8 Pcs 4116 16K 200-250ms
Specify computer
CALL FOR VOLUME PRICING
\$ 15.95

KEYBOARD ENCODERS

A95-2376	\$13.75
A95-3600	13.75

MOSTEK

4K Dynamic RAM (16 Pin)
MK 4015 20 pcs @ 1.99
(Pkg. Equiv. MR 4027 w/ 1 mV. ret. volt.)
16K RAM SALE (4161) 100 pcs @ \$1.15 ea
64K RAM SALE (4164) 10 pcs @ 9.95 ea
16K STATIC RAM (1MM 2016) 8 Pcs @ 9.95 ea

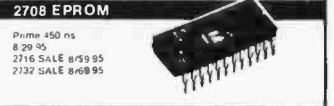

2708 EPROM

Prime 450 ns
8 29 95
2716 SALE @9.95
2732 SALE @6.95

NEW! from Zilog

★ Z-8 CPU w/ Tiny Basic & debug program \$69.95 w/dator
Plus 6132 companion quasi-static RAM \$34.95 ea

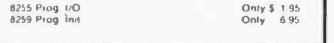

STATIC RAMS

LM74558	1-24	25-99	100
21102 450ms	\$ 1.30	\$ 1.25	\$.99
21102 250ms	1.59	1.55	1.19
COM1507	21.11	3.75	3.65
2112-1	2.95	2.85	2.65
2101-1	2.90	2.70	2.55
2114N (450ms)	3.75	3.50	3.25
2114L-250ms (4045)	6.50	5.95	5.50
2114L-450ms (4045)	4.75	4.25	3.95
4044 250ms	8.95	7.50	6.90
4044 450ms	5.95	5.95	4.75
EM484200A	9.75	8.75	7.95
EM4400	7.95	7.25	6.25
AMD9140/41	10.95	10.25	9.25
AMD9130/31	12.95	11.95	10.25
110 15	1.95	1.75	1.25
P2125-9425 (45ns)	9.95	8.35	8.25
6518 1Kx1 CMOS	7.95	7.95	7.25
2717 Low Power 4 K. Static	9.95	8.95	6.95
8345	3.95	3.95	6.50

SOCKETS

Wire Wrap 3 Level			
* Pins	Lo-Pro Solderless	Tin	Gold
15	15	36	45
19	19	36	45
18	20	38	62
18	24	59	84
20	20	39	99
22	24	79	110
24	38	85	120
26	43	110	149
36	58	125	159
40	60	140	189

FLOPPY DISK I/O

1771-01 8 & M multiplop	\$ 24.95
1781 Dual Floppy	26.95
1791-01 Dual Floppy	36.95
1791-02 Dual Floppy	44.95
1793 DD DS Floppy	44.95
1797 DD DS Floppy	44.95
1691 Data Separator	18.95
2143 Clock Gen	18.95

A/D CONVERTERS

8700 8 bit Binary	\$ 13.50
8701 10 bit Binary	22.00
8703 8 bit TS	13.50
8410 Volt to Freq Conv	7.25
8750 3 1/2 Digit BCD	13.95
1406L 6 bit	2.95
1406L 8 bit A	5.95
DAC01 D to A	1.25
DAC08	9.95
DAC 100	9.95

WAVEFORM GEN.

8038 Function Gen	\$ 4.50
MC4024VCO	2.95
XR2206 Function Generator	1.95
	5.25

SHIFT REGISTERS

2504V	\$ 1.49	MM500H	\$.50
2507V	1.49	MM5060N	2.95
2517V	1.49	MM5060N	2.95
2524V	1.49	2510A	1.95
2525	1.49	2847	4.95
2527	1.49	3347	4.95
2528	1.49	3351	17.95
2529	1.49	3351	6.95
2533	1.49	9403	24.95
3347	5.95	9408	9.95

CTS DIPSWITCHES

C15206-2	\$ 1.75	C15206-7	\$ 1.75
C15206-4	1.75	C15206-8	1.95
C15206-5	1.75	C15206-9	1.95
C15206-6	1.75	C15206-10	1.9

Unclassified Ads

FOR SALE: BYTE, May 1978 through May 1981 (37 issues), *Kilobaud Microcomputer* #11 through #29 and #37 through #54 (37 issues), *Creative Computing*, January 1978 through July 1981 (34 issues), *unComputing*, Summer 1979 through Spring 1981 (8 issues). Each issue for \$1.75 or all of them for \$150. I will pay postage. Joe, 3503 Berkeley Pl. NE, Albuquerque, NM 87106. (505) 266-2344.

FOR SALE: 16-column calculator printer. Works, but little documentation. \$25 plus shipping (5 pounds). Hex keypad and display, obviously homemade. \$20. Fifty Tri-state bipolar ROMs that decode and drive eight S-100 signals directly from Z80. No external buffering necessary. Derives sMEMR, MWRT, sINP, sOUT, pSYNC, INTA, sWO, and pWR. \$6 each. Mark Dertchick, 7 Fraternity Row, St. Louis, MO 63130. (314) 721-9093.

FOR SALE: Heath H-89 all-in-one microcomputer. Built in July 1981. Floppy-disk drive, 48 K programmable memory, cassette interface, HDOS 2.0 DOS, Microsoft and BH BASIC, 15 disks of club programs, and all documentation. \$3000 value for \$1700. Also have Heath ET-3400 trainer, EE-3401 microprocessor self-instruction course, and final exam: \$195. Will pay shipping in U.S. Gary Bagby, 2520 Chids Rd., Omaha, NE 68147. (402) 731-1871.

FOR SALE: Ohio Scientific Challenger III (Model C3-S1) with three processors (6502A, 68B00, Z80A) and 56 K memory. Double-sided 8-inch floppies for 1.2 megabytes storage. CP/M operating system with FORTRAN and COBOL compilers. Manuals and documentation included. \$4800. Ron Hopson, POB 7929 (N173), Philadelphia, PA 19101.

FOR SALE: Interac computer—not used, still in the package. With 16 K RAM, 2 K ROM, cassette, 1500 bps, eight colors, and sound: \$284. Write for more details. Steve Buhk, 109 East Kentucky Ave., Deland, FL 32720.

FOR SALE: Centronics 730 printer, same as Radio Shack Lineprinter II. New, only tested. Full documentation. Extra ribbons. \$600 UPS COD. D. Dingley, 417 Liberty St., Painesville, OH 44077. (216) 354-5759.

FOR SALE: SSM CB1A 8080 S-100 processor board with 1 K RAM, 2 K video monitor in ROM, and parallel I/O port. Assembled and tested. Virtually unused. \$125. Craig Cline, 40 Creighton St., Cambridge, MA 02140. (617) 661-3966.

FOR SALE: Linear programming package for Hewlett-Packard 9825 computer. Complete package consisting of manual and three cartridges in binder. Originally cost \$450 and used only a couple of times. Will sell for \$125 or exchange for HP-85 software Pacs I don't have. Will also consider HP-85 ROMs. C.J. Kanak, POB 28206, Tempe, AZ 85282. (602) 968-6542.

FOR SALE: Apple II with 64 K Pascal language system, two disk drives, software, and other accessories: \$2000. Zenith Z19 terminal: \$600. Heath H-14 printer, assembled: \$500. All items in good working order. Thomas McDonnell, 1738 Orchard Dr., Canton, MI 48188. (313) 326-3047 weekends or after 6 p.m. weekdays.

FOR SALE: Texas Instruments TI-745. Like new. Under constant maintenance by TI. Must sell. Asking \$1000 or best offer. D.P. Apt. 25102 Friar Lane, Southfield, MI 48034.

FOR SALE: TEC V-300 daisy-wheel printer. Brand new. Bidirectional printing at 25 cps/136 print positions wide. Proportional spacing: 1/20-inch horizontal and 1/48-inch vertical. Centronics parallel interface. Listed at \$1595; will sell for \$1000 FOB. R.G. Lathrop, 810 Rush Court, Chico, CA 95926. (916) 343-7098.

FOR SALE OR SWAP: TRS-80 4 K Color Computer, pair of joysticks, and three cartridges of games. Will send in original carton via U.P.S. \$325 or will swap for a Model I mini-disk drive. Jack Liskey, 360 Mae Rd., Glen Burnie, MD 21061.

Ciarcia Wins BOMB by Remote Control

Steve Ciarcia's project on using your computer for remote control earned him first place in the December BOMB contest. Now if we could only send him the \$100 cash prize by remote control. Senior editor Gregg Williams took second place with his photo essay, "The Coinless Arcade." Though Gregg is a gamesman, he's not a gambler and when playing video games he can't afford to lose because as a staff member he is ineligible for the second-place \$50 prize. Third place went to William Barden Jr.'s "Color Computer from A to D, Make Your Color Computer 'See' and 'Feel' Better," the first installment in a series devoted to Radio Shack's TRS-80 Model I, Model III, and Color Computer.

UNCLASSIFIED POLICY: Readers who are soliciting or giving advice, or who have equipment to buy, sell or swap should send in a clearly typed notice to that effect. To be considered for publication, an advertisement must be clearly noncommercial, typed double spaced on plain white paper, contain 75 words or less, and include complete name and address information.

These notices are free of charge and will be printed one time only on a space available basis. Notices can be accepted from individuals or bona fide computer users clubs only. We can engage in no correspondence on these and your confirmation of placement is appearance in an issue of BYTE.

Please note that it may take three or four months for an ad to appear in the magazine.

BOMB BYTE's Ongoing Monitor Box

Article #	Page	Article	Author(s)
1	26	Commodore 4022 Printer	Holmes
2	44	Integral Data Systems' Prism Printer	Umlor
3	50	Use Voiceprints to Analyze Speech	Ciarcia
4	68	Apple Panic	Williams
5	70	Missile Command	Wszola
6	74	Dino Wars	Stewart
7	80	The Atari Tutorial, Part 7: Sound	Fraser
8	100	Build a Half-year Clock for the Color Computer	Barden
9	126	The Input/Output Primer, Part 2: Interrupts and Direct Memory Access	Leibson
10	142	A BASIC Plotting Subroutine, Sophisticated Plotting with Your MX-80	Bregoli
11	158	Modify Your Paper Tiger for Different Paper Thicknesses	Sarna
12	172	Graphics II by Selanar, High-Resolution Hard Copy from a DECwriter	Macero, Holmes, Banks, Burgess
13	198	Custom and Standardized Forms for the Microcomputer User	Lemmons
14	218	The Fill Forms System, CP/M Programs to Cut Down on Paperwork	Roch
15	206	Base 2 Printer	Jeffries
16	248	Lowercase Descenders for the Epson MX-70	Piggott
17	262	Text Editing with Compuview's VEDIT	Thompson
18	278	BYTE Printer Directory	Feigel
19	316	Four Implementations of Pascal	Woteki, Sand, Kelly
20	358	Microsoft's BASIC Compiler for the TRS-80	Daneliuk
21	372	LDOS—Disk Operating System for the TRS-80	Archer
22	384	COBOL for the TRS-80 Models I/III	Rhodes
23	414	John Bell Engineering's Apple II Parallel Interface Board	Bernstein
24	456	The Computer Toolbox	Purdum
25	466	Skip Sequential: A New File Structure for Microcomputers	

Reader Service

Inquiry No.	Page No.	Inquiry No.	Page No.	Inquiry No.	Page No.	Inquiry No.	Page No.
1	47th STREET PHOTO 351	86	COMPULINK CORP. 35	166	GENERAL ELECTRIC CO. 111	249	MICRO WORKS, THE 425
2	A.S.T. RESEARCH 176	*	COMPUMART 120, 121	167	GENSTAR RENTAL ELECTR 128	250	MICRO-SPOT ELECTR. 490
3	AB COMPUTERS 487	*	COMPUPRO/GODBOU 78, 79	168	GILTRONIX, INC. 494	251	MICRODYNAMICS 492
4	ABM PRODUCTS 386	87	COMPUSERVE 464	169	GILTRONIX, INC. 494	*	MICROHOUSE 159
5	ACE COMP. PROD. 492	88	COMPUSYSTEMS 502	170	GNOSIS 328	252	MICROMAIL 396
6	ACKERMAN DIGITAL SYS. 235	443	COMPUTER COMPONENTS 453	171	GNT AUTOMATIC INC 412	253	MICROSETTE INC. 498
7	ACTION COMPUTER 73	90	COMPUTER DISC.OF AM. 424	172	H&E COMPUTRONICS 315	254	MICROSOFT (CPD) 323
8	ADV.COMP.PROD. 524, 525	91	COMPUTER EXCHANGE 297	173	H&E COMPUTRONICS 317	255	MICROTAX 460
9	ADV.MICRO DIGITAL CORP. 193	92	COMPUTER FURN.& ACCSS. 426	174	HANLEY ENGNRING 495	256	MICROTECH EXPORTS 443
10	ADVENT PRODUCTS 132	93	COMPUTER MAIL ORDER 212, 213	175	HAYDEN BOOK CO INC 393	257	MICROTEK INC. 363
*	ALF PRODUCTS, INC. 412	94	COMPUTER PLUS 490	176	HAYES MICROCOMP.PROD. 127	259	MIKOS 469
11	ALL ELECTRONICS CORP 415	*	COMPUTER PROFESSIONAL 288, 289	177	HAZELTINE CORP 163	260	MILLER MICROCOMP.SERV. 228
12	ALMALY TRADING CORP. 498	96	COMPUTER RESOURCES 447	32	HEATH COMPANY 247	313	MILWAUKEE COMP.INC 329
13	ALPHA BYTE COMP.PROD. 38, 39	284	COMP SHOPPING CNTR 298, 299	97	HEWLETT-PACKARD 57	261	MIN MICROCOMP SFTW 362
14	ALPHA BYTE COMP.PROD. 179	97	COMPUTER SPCLTIES. 273	178	HEWLETT-PACKARD 207	262	MINI COMP.SUPPLIERS 110
*	ALPHA QUEUE SYS 504	438	COMPUTER TOOLBOX 405	179	HOUSTON INSTRUMENTS 59	263	MINI MICRO MART 184, 499
16	ALPS 457	*	COMPUTER WRHSE. 131	180	HOUSTON INSTRUMENTS 59	264	MOORE BUSN. FORMS 459
17	ALSPA COMP.SYS. 217	98	COMPUTERS ETC. 94	181	HUNTINGTON COMPUTING 341	265	MORGAN PRODUCTS 427
18	ALTOS COMP.SYS. 136, 137	99	COMPUTERS ETC. 282	53	HYPERTEK, INC 72	266	MORROW DESIGNS 143
19	AMDEK CORP. 81	425	COMPUTERS ETC. 459	182	IBM 103	267	MOUNTAIN COMPUTER 19
20	AMER.SQUARE COMP. 124, 125	101	COMPUTERS WHOLESALE 149	183	ILLINOIS COMP.PROD. 502	268	MOUNTAIN VIEW PRESS 303
21	ANADIX 190	102	COMPUTERTIME INC. 490	184	IMAGE TECH. INC 492	269	MSD 443
22	ANADIX 191	79	COMPUTERWARE 417	185	IMPRINT SOFTWARE 388	270	MTI, INC. 471
23	ANCRONA 311	103	COMPUTERWORLD INT'L. 431	186	IMS INTERNATIONAL 241	271	MULTI BUSN.COMP.INC. 174
24	ANDERSON JACOBSON 322	104	COMPUTEX CORP 86	187	INDUSTRIAL RESOURCES 445	433	NASHUA CORP 472
25	ANDERSON JACOBSON 419	105	COMPUIVIEW PROD.INC. 66	188	INFOSOFT COMP.SYS. 492	*	NCCIAFIPS 397
26	ANN ARBOR TERMINALS 181	*	COMPUIVIEW PROD.INC. 67	189	INT'L.MICRO SYS. 211	272	NCL DATA INC. 421
27	ANSWER CORP. 96	106	CONCORD COMP.PROD. 421	190	INTEGRAL DATA SYS. 104, 105	273	NEBS 318
28	APPARAT INC 233	107	CONCURRENT CORP. 464	191	INTEGRAND 428	274	NEC HOME ELECTR.USA 135
29	APPLE COMPUTER INC 84, 85	108	CONSUMER COMP. 387	192	INTEL CORP 184, 185	275	NEEO 305
30	APPLICATIONS GROUP,THE 504	109	CONSUMER COMP. 491	193	INTERACTIVE MICROWRE. 429	277	NET PROFIT COMP. 182
31	APPLIED ANALYTICS 420	110	CONTEXT MANGMNT.SYS. 23	194	INTERMEDIA SYSTEMS 76	278	NETRONICS 252, 253
33	ARBA 463	*	COTTON ASSOC. 502	195	INTERTEC DATA SYS. 119	279	NETWORK CONSULTING CORP 498
35	ARTIFICIAL INT'L. RESRCH 496	112	CPU SHOP, THE 493	195	INTROL CORP 496	280	NEW GENERATION SYS. 463
36	ASAP COMP.PROD.INC 276, 277	*	CROMEMCO CV II	196	IOTC 502	281	NORTH STAR COMP. 244, 245
37	ASAP COMP.PROD.INC. 353	113	CROMEMCO 1	197	IPEX INT'L. 352	282	NORTHPROP 295
38	ASHTON-TATE 301	114	CROMEMCO 2	198	ITHACA INTERSYSTEMS 8	*	ORIS SCHOOLS ELECTR.DIV. 433
*	ASPEN SFTW.CO. 60	115	CUESTA SYSTEMS 492	199	ITHACA INTERSYSTEMS 9	*	OASIS SYSTEMS 22
39	ATARI 201	116	D & W DIGITAL 170	200	JADE COMP.PROD. 512, 513	283	OLYMPIC SALES 417
39.1	ATLANTIC CABINET CORP 504	117	DATA ROYAL INC. 197	201	JADE COMP.PROD. 514	285	OMIKRON 321
40	AUTOCONTROL INC 180	118	DATA-ED 18	202	JAMECO ELECTR. 522, 523	286	OMNI RESOURCES 383
41	AUTOMATED EQUIPMNT. 189	119	DATA-RX INC. 366	203	JDR MICRODEVICES 520, 521	288	ORANGE MICRO 220, 221
*	AVOCET 422	120	DATA-TYPE INC. 37	204	JIM-PAK 497	289	ORANGE MICRO 227
42	AXIOM CORP 313	121	DATAFACE 98	205	KADAK PRODUCTS 339	290	ORYX SOFTWARE 376
43	B&B ELECTR. 502	122	DATASOUTH COMP.CORP. 77	206	KENGORE CORP. 430	291	ORYX SOFTWARE 470
43.5	BBI MAIL ORDER 405	123	DATASOUTH COMP.CORP. 418	207	KERN PUBLISHING 222	292	OSBORNE COMPUTERS 31
44	BASF SYSTEMS 355	124	DEALIN' ELECTR. 504	208	KIRBY ENG. ASSOC. 496	293	OSBORNE/MCGRAW-HILL 116
45	BAY TECHNICAL ASSOC. 415	125	DELMART-DELUX CHK.PRNTRS. 138	209	KIT-80 INC. 496	294	OSBORNE/MCGRAW-HILL 117
*	BELL,JOHN ENGR. 489	126	DELPHIC SYSTEMS 234	210	KIT-80 INC. 498	295	OSBORNE/MCGRAW-HILL 118
*	BETA COMP.DEVICES 107	128	DELTA PRODUCTS 250, 251	209	KRAMER SYS INT'L. 445	296	OSBORNE/MCGRAW-HILL 208
46	BISON PRODUCTS 432	129	DIABLO SYS INC 343	211	LABORATORY MICROSYS. 504	297	OSM COMPUTER 161
47	BLAT RESRCH & DEVELP 432	*	DIGITAL EQUIPMNT.CORP. 307	212	LEADING EDGE PROD CIII	*	OWENS ASSOC. 268, 269
48	BMC INTERNATIONAL 75	130	DIGITAL GRAPHIC SYS 150	214	LEXICON CORP. 90	418	PACE 434
49	BOTTOM LINE,THE 500	131	DIGITAL MARKETING 6	215	LIFEBOAT ASSOC. 359	298	PACIFIC COMP BRK. 216
50	BOWER-STEWART 490	132	DIGITAL RESEARCH 24, 25	216	LJK ENTERPRISES INC. 331	299	PACIFIC EXCHANGES 440
51	BRIDGE COMPUTER 246	276	DIGITAL RESEARCH 280, 281	217	LNW RESEARCH 231	300	PACIFIC EXCHANGES 490
52	BUCKEY STAMPING CO. 429	134	DISCOUNT SOFTWARE 398	218	LOGICAL DEVICES 502	300	PACIFIC EXCHANGES 494
54	BUSINESS OPERATING SYS 239	135	DMA 333	219	LOMAS DATA PRODUCTS 361	300	PACIFIC EXCHANGES 498
55	BWJ TECHNOLOGY INC. 32	136	DREAM ELECTRONICS 498	220	LYBEN COMP.SYS. 490	300	PACIFIC EXCHANGES 502
56	BYTE BOOKS 91	137	DUAL SYS.CONTROL CORP. 32	221	LYBEN COMP.SYS. 496	300	PACIFIC EXCHANGES 504
57	BYTE BOOKS 279	444	DUAL SYS.CONTROL CORP. 34	223	MACROTECH INT'L. 223	305	PALOMAR COMP.EQUIP. 501
58	BYTE BOOKS 287	445	DUAL SYS.CONTROL CORP. 36	224	MACROTRONICS 492	306	PAN AMERICAN ELEC INC. 326
59	BYTE BOOKS 411	138	DUPRE ENTERPR. 417	225	MAGNOLIA MICROSYS. 494	307	PCD SYSTEMS INC. 243
60	BYTE BOOKS 413	139	DYMARC IND. 435	226	MARK OF THE UNICORN 237	*	PERCOM DATA 7
*	BYTE BACK ISSUE 453	140	DYNABYTE BUSN.COMP. 70	227	MARYMAC INDUSTRIES 261	308	PERCOM DATA 167
*	BYTE SUBSCRIBER 472	141	DYNACOMP 308, 309	228	MAXELL DATA PRODUCTS 183	309	PERCOM DATA 167
*	BYTE WATS 66, 423	142	DYSAN CORP. 264, 265	229	MAXTEK 431	310	PERCOM DATA 167
61	BYTEK COMP. SYS. 457	143	ECLECTIC SYSTEMS 324	111	MCGRRAW-HILL BOOKSTORE 210	311	PERISOFIT INC. 368
62	C. ITOH ELECTR.INC. 349	144	EGOSOFT 427	230	MCGRRAW-HILL MAG. 123	*	PERSONAL COMP.OWNERS 430
63	CALICO SYSTEMS 310	145	EDMUND SCIENTIFIC CO 447	230	MCGRRAW-HILL RESEARCH 409	312	PERSONAL COMP.SYS. 458
43.6	CALDISK 405	146	EDUCATIONAL MICROCOMP. 504	231	MCMILLAN BOOK CLUBS 337	*	PERSONAL S/W--VISICORP 89
64	CALIF DATA CORP 496	147	ELECTROLABS 488	231	MEADLE'S DATA SYS. 492	427	PHASE ONE SYS.INC. 367
65	CALIF. DIGITAL 515	148	ELECTRONIC CONTROL 423	232	MEDIA DISTRIBUTING 444	314	PICKLES & TROUT 421
66	CALIF. DIGITAL 516, 517	149	ELECTRONIC SPCLISTS 446	232	MEDIAMIX 192	315	P.M.K. ASSOCIATES 87
68	CALIF.MICRO COMP. 451	150	ELECTRONIC SYS.FURN 242	233	MEMORY MERCHANT 225	316	POPULAR COMPUTING 257
68	CAMBRIDGE DEVEL LABS 435	151	ELLIS COMPUTING 10	234	META COMPANIES,THE 27	*	POTOMAC MICRO-MAGIC 431
69	CAWTHON SCIENTF.GRP. 178	152	EMPIRICAL RESRCH GRP. 465	235	METAVAN INC. 500	317	PRACTICAL PERIPH. 15
70	CDR SYSTEMS 494	153	EMULOG 209	236	MFJ ENTERPRISES INC 148	317	PRIORITY ONE 506, 507
71	CENTRONICS 199	154	ENERCOMP 490	237	MICRO AGE COMP.STORE 113	318	PRIORITY ONE 508, 509
72	CHECK-MATE 494	155	EPIC COMPUTER CORP. 139	334	MICRO BUSINESS WORLD 147	319	PRIORITY ONE 510, 511
73	CHECK-MATE 500	156	EPIC COMPUTER CORP. 427	238	MICRO BUSN.ASSOC 352	321	PROGRAMS UNLTD. 500
74	CHECKS-TO-GO 200	*	EPSON AMERICA 194, 195	239	MICRO DATA BASE SYS 325	322	PROCTO ENTERPR. 490
75	CHIPS & DALE 490	157	ESSEX PUBLISHING 435	240	MICRO DATA-TEK 450	323	PURCHASING AGENT,THE 270
75	CHRISLIN INDUSTRIES 327	158	EXPOTEK 64	241	MICRO EXCHANGE,THE 338	324	PURCHASING AGENT,THE 423
76	CMC,INT'L. 115	159	FANTASTIC SIMULATIONS 498	242	MICRO FOCUS 133	325	QUADRAM CORP. 267
77	CMC,INT'L. 171	160	FORD MOTOR CO. 389	243	MICRO MAGAZINE 395	326	QUALITY COMP.PARTS 492
78	CMC,INT'L. 381	161	FORETHOUGHT PRODUCTS 446	244	MICRO MANAGEMENT SYS. 429	327	QUALITY COMPUTER 399
80	COLUMBIA DATA PROD. 357	162	FOX & GELLER ASSOC 494	245	MICRO MFG SYS. 444	328	QUALITY SOFTWARE 173
43.7	COLUMBIA MICRO SYS. 405	163	FSS 419	246	MICRO MINT 407	329	QUASAR DATA PROD.INC. 369
81	COMMODORE BUSN.MACH. 97	164	FSS 502	247	MICRO PRINTER MRKTG 101	330	QUEST ELECTR. 503
83	COMMUNICATION CABLE 498	165	FUTRA CO. 20	248	MICRO PRO INT'L. 285	331	QUEST ELECTR. 503
84	COMMUNICATIONS ELECTR. 485			247	MICRO SCI 61	332	QUEST ELECTR. 503
85	COMP TRANSCEIVER 378			248	MICRO TERM 157	333	QUEST ELECTR. 503

To get further information on the products advertising in BYTE, fill out the reader service card with your name and address. Then circle the appropriate numbers for the advertisers you select from the list. Add an 18-cent stamp to the card, then drop it in the mail. Not only do you gain information, but our advertisers are encouraged to use the marketplace provided by BYTE. This helps us bring you a bigger BYTE. The index is provided as an additional service by the publisher, who assumes no liability for errors or omissions. *Correspond directly with company.

Reader Service

Inquiry No.	Page No.	Inquiry No.	Page No.	Inquiry No.	Page No.	Inquiry No.	Page No.
344	SANTA CRUZ SFTW.SERV. 236	426	STATIC MEMORY 379	*	TENLEY DESIGN 498	*	VOTRAX 330
345	SANYO COMMUNICATIONS 95	361	STRAWBERRY TREE COMP. 110	383	TERRAPIN INC. 283	*	VR DATA 345
346	SATURN SYSTEMS INC. 492	362	STREET ELECTR CORP 373	384	TEXAS COMP.SYS. 293	440	VYNET CORP. 405
347	SCION CORP 5	*	SUBARU OF AMERICA 291	*	TINNEY,RBT.GRAPHICS 455	405	WALKER, WILLIAM 494
348	SCITRONICS 332	363	SUBLOGIC 306	385	TNW CORP. 425	406	WARN ELECTRONICS 352
*	SCOTTSDALE SYSTEMS 202	364	SUNNY INT'L. 488	386	TRANSNET CORP. 434	407	WASHINGTON COMP.SERV. 505
349	SCR ELECTR. 504	365	SUPERSOFT 99	387	TRAXX COMP.CORP. 215	408	WESPER MICRO SYSTEMS 168
350	SEATTLE COMP PRODS 155	366	SUPERSOFT 203	*	TRISTAR DATA SYS. 122	409	WESPER MICRO SYSTEMS 169
430	SIERRA DATA SCIENCES 335	367	SUPERSOFT 314	389	U.S. MICRO SALES 518, 519	*	WESTICO INC. 165
351	SILICON VALLEY SYS.INC. 465	368	SYBEX 263	390	U.S. ROBOTICS 360	410	WESTICO INC. 496
*	SINCLAIR 92, 93	369	SYSTEM 300 500	392	UNISOURCE ELECTR.INC 274	411	WESTWARE 145
352	SLUDER 500	370	SYSTEMED 500	439	UNITED CONTROLS 405	*	WHITESMITHS LTD 141
353	SOFTTECH MICROSYS 401	371	SYSTEMS GROUP, THE 29	*	UNITED SFTW.OF AMER. 109	*	WICAT SYSTEMS 71
354	SOFTWARE CONSLTG.SERV. 496	372	SYSTEMS GROUP, THE 29	393	VECTOR ELECTR. 410	412	WIGGLESWORTH,C.J. 408
355	SOFTWARE DISTR. 371	373	SYSTEMS PLUS INC. 403	394	VECTOR ELECTR. 410	413	WILD FIRE PUBLISHING 260
34	SOFTWARE HOWS 271	374	TAB BOOKS 385	395	VECTOR ELECTR. 410	414	WILD HARE COMP.SYS. 219
*	SOLID STATE SALES 439	375	TALL TREE SYSTEMS 504	396	VECTOR ELECTR. 410	415	WINCHENDON GRP.THE 496
356	SORRENTO VALLEY ASSOC 439	376	TARBELL ELECTR. 377	397	VECTOR ELECTR. 410	417	WINTEK CORP. 494
*	SOURCE EDP 346	*	TECHNICAL SYS CONS 129	398	VECTOR ELECTR. 410	340	WINTERHALTER & ASSOC. 160
*	SOURCE EDP 347	377	TECMAR INC 83	399	VECTOR ELECTR. 410	419	XAVAX CORP. 196
*	SOURCE TELECOMM.CORP. 375	378	TECMAR INC 275	400	VECTOR GRAPHICS 175	431	YORK-10 502
441	SOUTHERN COMP.SYS 405	*	TEKTRONIC 364	401	VERBATIM CORP 255	420	ZETA PRODUCTS 500
357	SSM MICRO COMP PROD 11	379	TELECON SYSTEMS 500	432	VICTOR DATA PROD. 365	421	ZILOG COMP.SYS. 402
358	STANDARD MICROSYS.INC. 390	380	TELEVIDEO INC 65	402	VIDEX 21	422	ZOBEX 151
359	STANDARD SFTW.CORP. 394	381	TELEVIDEO INC 152, 153	403	VISIBLE COMP.SUPPLY 354		
360	STATCOM CORP. 33	382	TERMINALS TERRIFIC 164	404	VISTA COMPUTER CO 177		

*Correspond directly with company.

National Advertising Sales Representatives:

Northeast (617) 444-3946
ME, NH, VT, MA, CT, RI, DE, MD,
VA, WV, OK, TX, Upstate NY,
Eastern Canada

Hajar Associates
280 Hillside Ave.
Needham Heights, MA 02194

Mid Atlantic (201) 741-7744
NY, NYC, NJ, PA

Hajar Associates
321 Broad St.
Red Bank, NJ 07701

Southeast (305) 628-3525
NC, SC, GA, FL, AL, MS, TN, KY

Hajar Associates
Diplomate Bldg.
5400 Diplomate Circle
Suite 272
Orlando, FL 32810

Midwest (312) 966-0160
MN, WI, MI, IA, IL, IN, OH,
MO, NE, KS, ND, SD, AR

Hajar Associates
5225 Old Orchard Rd.
Suite 50
Skokie, IL 60076

Northwest (415) 964-0706
AK, HI, WA, OR, ID, MT, WY,
Northern California, Nevada Except
Las Vegas, Western Canada

Hajar Associates
1000 Elwell Ct.
Suite 124
Palo Alto, CA 94303

Southwest (714) 540-3554
UT, CO, AZ, NM, Las Vegas,
Southern California

Hajar Associates
3303 Harbor Blvd.
Suite H-4A
Costa Mesa, CA 92626

European Advertising Sales Representatives:

Simon Smith
34 Dover St.
London W1X 3RA
England

Andrew Karnig
Andrew Karnig & Associates
Kungsholmsgatan 10
112 27 Stockholm, Sweden

Hans Csokor
Publimedia
Velthgasse 6/3
A-1037 Vienna, Austria

Fritz Krusebecker
Liebigstrasse 27c
D-6000 Frankfurt/Main 1
West Germany

Michael Sales
17 rue Georges Bizet
F 75116 Paris, France

A. Fabio Guarnieri
Via Bracchini 1
20123 Milan, Italy

Mrs. Gurli Gepner
115 Yosephthal St.
Bat Yam, Israel

REMEMBER.

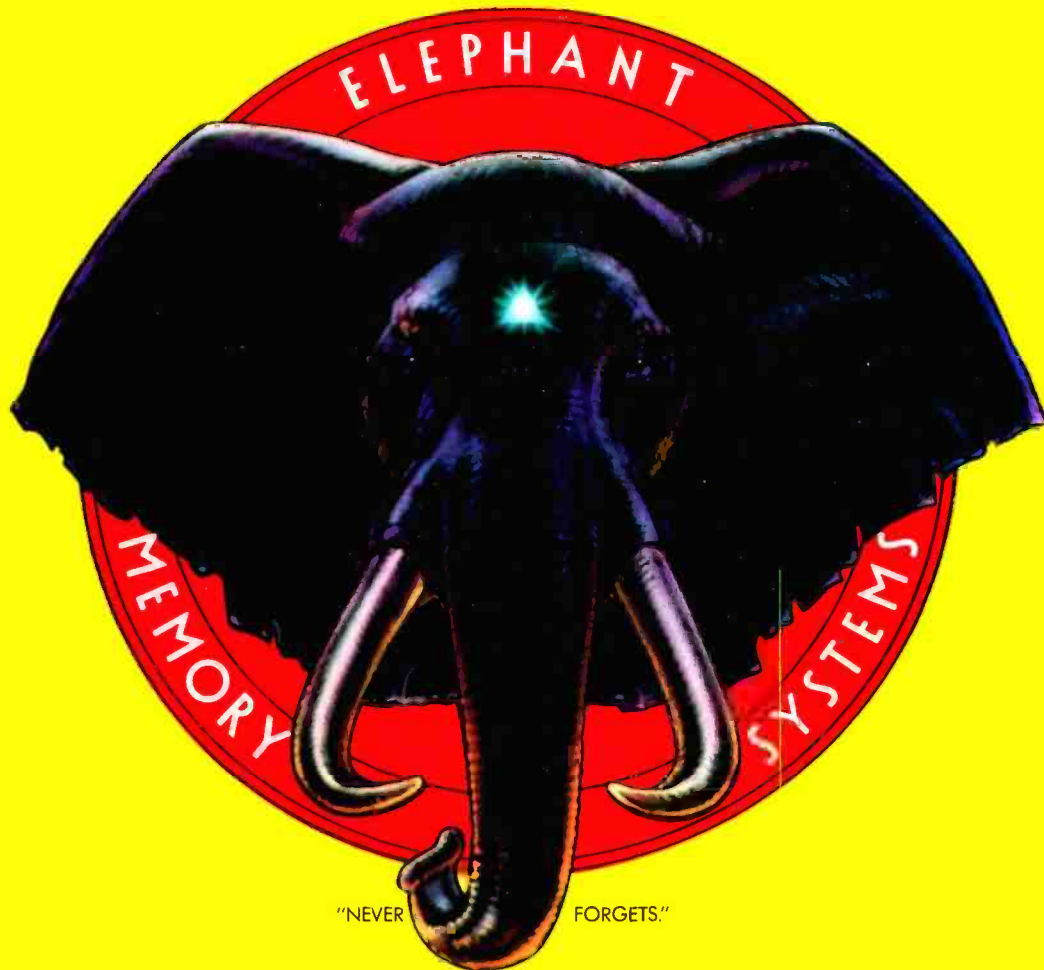

Elephant™ floppies. They're guaranteed to meet or beat every industry standard for quality. They come standard with reinforced hub rings at no extra cost. They come in every popular 5¼" model, in both hard and

soft sector. And they sell at some of the lowest prices in the business. Elephant Flexible Disks. They're heavy duty. They work for peanuts. They never forget. Get yourself a trunkful.

HEAVY DUTY DISKS.

Distributed Exclusively by Leading Edge Products, Inc., 225 Turnpike Street, Canton, Massachusetts 02021
Call: toll-free 1-800-343-6833; or in Massachusetts call collect (617) 828-8150. Telex 951-624.

Circle 212 on Inquiry card.



Get More Than Just a Computer!

Get Radio Shack's TRS-80 Model II Multi-Purpose Workstation.

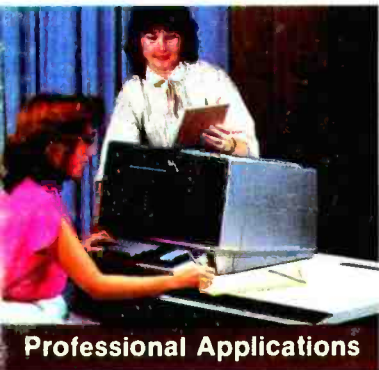

Professional Applications



Management Assistant

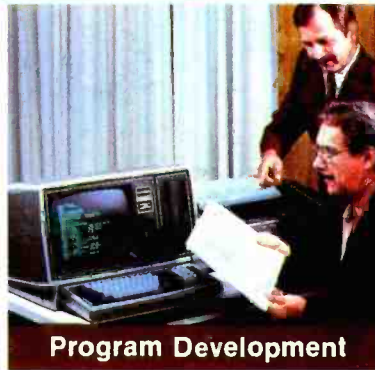

Program Development



Bi-Sync Communications

Radio Shack's top-of-the-line TRS-80® Model II is more than a computer. It's a versatile, stand-alone system that's the heart of a multi-purpose workstation. You can use the Model II by itself, or with a printer and other peripherals to accomplish a wide variety of tasks.

Professional Business Applications. A complete Model II business system has the storage capacity and expandability to streamline your accounting, inventory control, order entry, and many other tasks. We also have ready-to-run software for legal, medical, and other specialized applications. Best of all, every Radio Shack software program can be put to work without formal operator training, thanks to our easy-to-understand documentation.

Management Assistant. The TRS-80 Model II is also for managers. It can help with planning and modeling, word processing, electronic filing, statistical analysis, and much more. You can do jobs that are too "hot" to wait for shared computer time or too small for cost-effective handling by your company's mainframe. Putting a Model II by your desk is one of the easiest ways to boost your personal productivity.

Program Development. To meet your specific requirements, Radio Shack offers you a choice of Model II programming languages. We have BASIC interpreter and compiler, COBOL, FORTRAN and ASSEMBLER. In addition, Model II's sophisticated Disk Operating System has many powerful features, yet it's easy to use. It gives you a full set of library commands, utility programs and useful system routines that can be called directly by user programs.

Bi-Sync Communications. The TRS-80 Model II is ideal for use in existing data processing operations because it offers the versatility that a mere terminal lacks. With our bi-sync communications packages, Model II provides low-cost access to large mainframe computers. With our exclusive TRS-80 VIDEO-TEX software, you can also access data base networks and information services.

It's Affordable. Model II systems start as low as \$3899. Let us show you what the TRS-80 Model II can do for you! Drop by a Radio Shack Computer Center or the expanded computer department of selected Radio Shack stores and dealers nationwide for a personal demonstration.

Radio Shack®

The biggest name in little computers™

A DIVISION OF TANDY CORPORATION
Retail prices may vary at individual stores and dealers.
Optional-extra equipment required for some applications.

Tell me more! Send me a free TRS-80 Computer Catalog.
Radio Shack, Dept. 82-A-128
1300 One Tandy Center, Fort Worth, Texas 76102

NAME _____
COMPANY _____
ADDRESS _____
CITY _____ STATE _____ ZIP _____